

BYTE

THE SMALL SYSTEMS JOURNAL®

Also in this issue:
Compaq 386
Soviet Micros
Lotus Manuscript

THEME:
Knowledge
Representation

Ciarcia's
Super
Graphics
Board

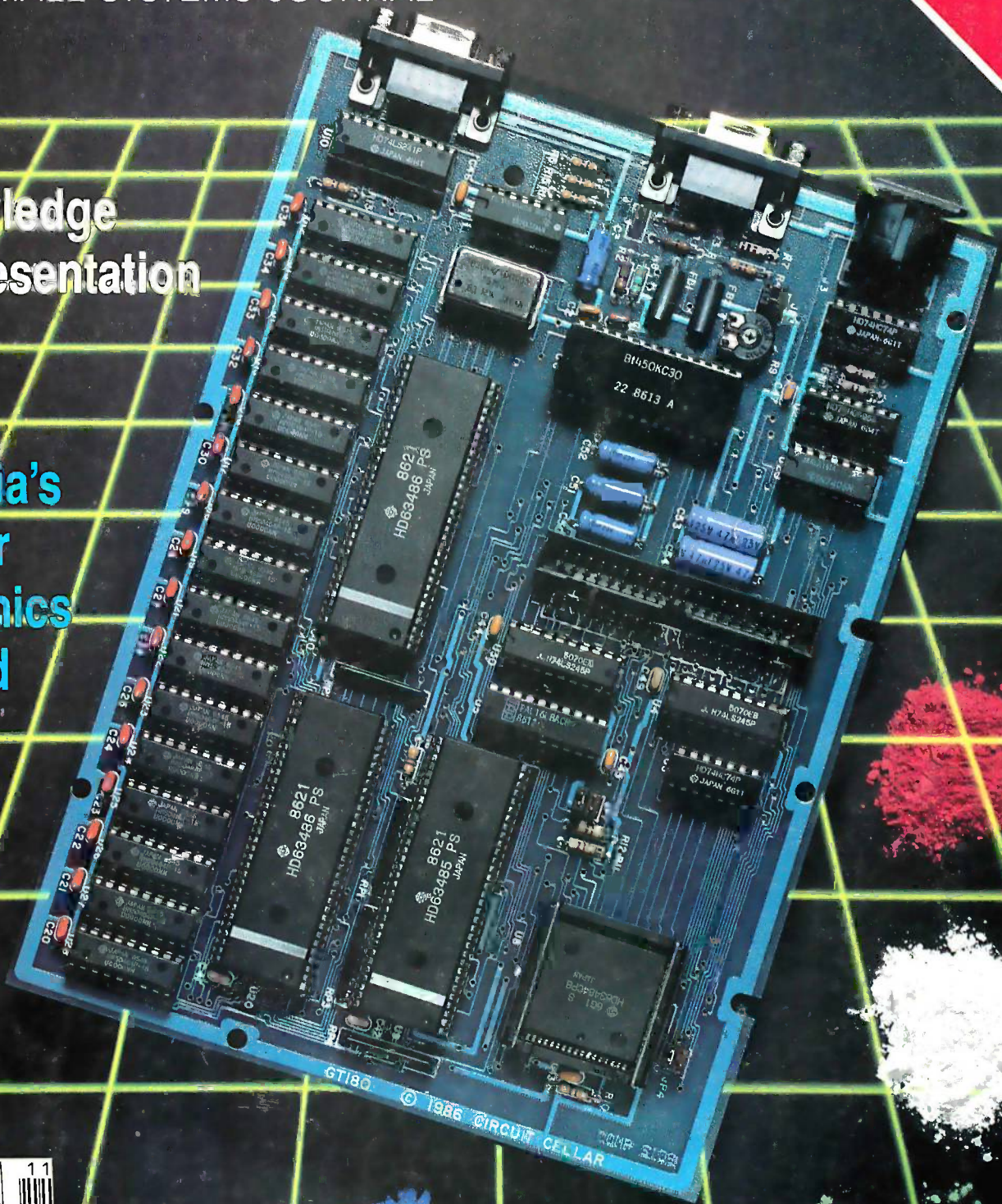

11
24 409
COMPUTER NOOK
106 \$3.50

Turbo Pascal Programming

Learn Secrets, Strategies,
Game Theory!

\$10.00 Scratch 'n Win Rebate!

Turbo GameWorks®

Also recently released, Turbo GameWorks is what you think it is: "Games" and "Works." Games you can play right away (like Chess, Bridge and Go-Moku), plus the Works—which is how computer games work. All the secrets and strategies of game theory are there for you to learn. You can play the games "as is" or modify

them any which way you want. Source code is included to let you do that, and whether you want to write your own games or simply play the off-the-shelf games, Turbo GameWorks will give hours of diversion, education, and intrigue. George Koltanowski, Dean of American Chess, and former President, United States Chess Federation, reacted to Turbo GameWorks like this: "With Turbo GameWorks, you're on your way to becoming a master chess player." And Kit Woolsey, writer, author, and twice Champion of the Blue Ribbon Pairs, wrote, "Now play the world's most popular card game—Bridge... even program your own bidding and scoring conventions." Suggested retail: \$69.95. Use a \$10.00 Scratch 'n Win Rebate and you're talking an incredible \$59.95! Minimum memory: 192K.

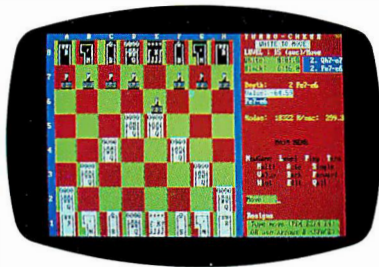

Turbo GameWorks' Chessboard

Create Your Own
High-Res Graphics!

\$10.00 Scratch 'n Win Rebate!

Turbo Graphix Toolbox®

It includes a library of graphics routines for Turbo Pascal programs. Lets even beginning programmers create high-resolution graphics with an IBM, Hercules,™ or compatible graphics adapter. Our Turbo Graphix Toolbox includes all the tools you'll ever need for complex business graphics, easy windowing, and storing screen images to memory. It comes complete with source code, ready to compile. Suggested retail: \$69.95, but with a \$10.00 Scratch 'n Win Rebate, only \$59.95! Minimum memory: 192K.



The Ultimate
Learning Experience!

\$10.00 Scratch 'n Win Rebate!

Turbo Tutor® 2.0

COMPLETELY
NEW VERSION!

The new Turbo Tutor can take you from "What's a computer?" through complex data structures, assembly languages, trees, tips on writing long programs in Turbo Pascal, and a high level of expertise. Source code for everything is included. New split screens allow you to put source text in the bottom half

of the screen and run the examples in the top half. There are quizzes that ask you, show you, tell you, teach you. You get a 400-page manual—which is not as daunting as it sounds, because unlike many software manuals, it was not written by orangutans. Suggested retail: \$39.95. Use a \$10.00 Scratch 'n Win Rebate and you're down to an unheard of \$29.95! Minimum memory: 192K.



How to use Scratch 'n Win Rebates

It's really simple. You purchase the product between 9/5/86 and 3/31/87, and return the license agreement along with dated proof of purchase and your rebate card. We'll mail you a check for \$10.00 on single product purchases or a check for \$15.00 when you buy an advertised "bundle"—which means our Turbo Pascal Jumbo Pack, or Turbo Lightning and Lightning Word Wizard, or Reflex: The Analyst and Reflex Workshop, or SideKick and Traveling SideKick. (Restrictions do apply. See Official Rules on back of Instant Winner card).



Recognition for Borland International has come from business, trade, and media, and includes both product awards and awards for technical excellence and marketing.

America's Cup. Coming Soon!

Send a buck to the boat!

If you'd like to help America's effort to recapture the America's Cup from Australia, you can make a tax-deductible donation to "Heart of America" Challenge, 11 South LaSalle St., Suite 1670, Chicago, Illinois 60603

Sail designs generated
from Shore Sails' Turbo
Pascal programs.

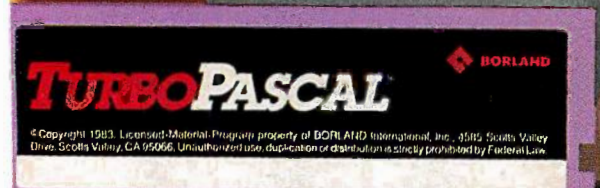
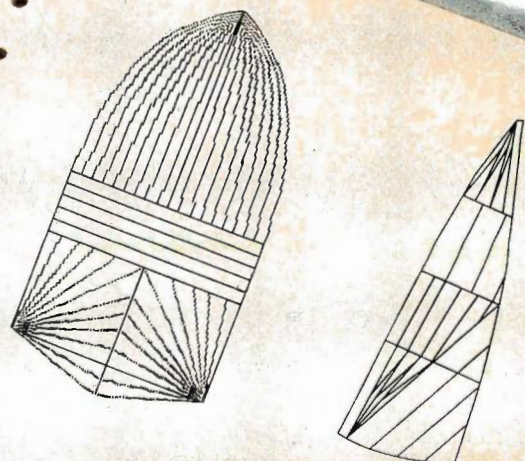

© Copyright 1983. Licensed Material. Program property of BORLAND International, Inc., 4515 Scotts Valley Drive, Scotts Valley, CA 95066. Unauthorized use, duplication or distribution is strictly prohibited by Federal Law.

Turbo Pascal Programming

Build Your Own Word Processor!

\$10.00 Scratch 'n Win Rebate!

Turbo Editor Toolbox™

Recently released, we called our new Turbo Editor Toolbox a "construction set to write your own word processor." Peter Feldmann of *PC Magazine* covered it pretty well with, "A 'write your own word processor' program for intermediate level programmers, with lots of help in the form of prewritten

procedures covering everything from word wrap to pull-down windows." Source code is included, and we also include MicroStar, a full-blown text editor with pull-down menus and windowing. It interfaces directly with Turbo Lightning to let you spell-check your MicroStar files. Jerry Pournelle of *BYTE* magazine said, "The new Turbo Editor Toolbox is the Turbo Pascal source code to just about anything you ever wanted a PC-compatible text editor to do." Suggested retail: \$69.95. Use a \$10.00 Scratch 'n Win Rebate and you'll get all this for only \$59.95! Minimum memory: 192K.

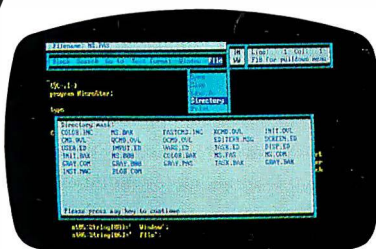

MicroStar file directory accessed by pull-down menu

New! Artificial Intelligence!

5th-Generation Language!

\$10.00 Scratch 'n Win Rebate!

Turbo Prolog™

"Borland International, Inc. is gunning onto the fast track in the artificial intelligence and engineering-language-software race, riding aboard a new \$99 Turbo Prolog," says Tom Schwartz in *Electronic Engineering Times*.

And so we are. Our new Turbo Prolog has drawn rave reviews—which we think are

well deserved—because Turbo Prolog brings 5th-generation language and supercomputer power to your IBM PC and compatibles. Turbo Prolog is a high-speed compiler for the artificial intelligence language, Prolog, which is probably one of the most powerful programming languages ever conceived. We made a worldwide impact with Turbo Pascal and you can expect the same results and revolution from Turbo Prolog, the natural language of artificial intelligence. Darryl Rubin, writing in *AI Expert* said, "Turbo Prolog offers generally the fastest and most approachable implementation of Prolog." Suggested retail, \$99.95. Use a \$10.00 Scratch 'n Win Rebate and that goes down to only \$89.95! Minimum memory: 384K.

"If you're at all interested in artificial intelligence, databases, expert systems, or new ways of thinking about programming, by all means plunk down your \$100 and buy a copy of Turbo Prolog."
Bruce Webster, *BYTE*

Technical Specifications:

TURBO PASCAL 3.0 Minimum memory: 128K; includes 8087 and BCD features for 16-bit MS-DOS and CP/M-86 systems. CP/M-80 version minimum memory: 48K; 8087 and BCD features not available. **TURBO DATABASE TOOLBOX** Minimum memory: 128K. CP/M-80 minimum memory: 48K. Requires Turbo Pascal 2.0 or later. **TURBO GRAPHIX TOOLBOX** Minimum memory: 192K. Requires PC/MS-DOS 2.0 or later. Turbo Pascal 3.0, and IBM CGA, Hercules Monochrome Card or equivalent. **TURBO TUTOR 2.0** Minimum memory: 192K. CP/M-80 version minimum memory: 48K. Requires PC/MS-DOS 2.0 or later and Turbo Pascal 3.0. **TURBO EDITOR TOOLBOX** Minimum memory: 192K. Requires PC/MS-DOS 2.0 or later and Turbo Pascal 3.0. **TURBO GAMEWORKS** Minimum memory: 192K. Requires PC/MS-DOS 2.0 or later and Turbo Pascal 3.0. **TURBO PROLOG** Minimum memory: 384K. **REFLEX: THE ANALYST** Minimum memory: 384K. Requires IBM CGA, Hercules Monochrome Card or equivalent. Works with Intel's AboveBoard-PC and -AT, AST's RAMpage! and RAMpage! AT, Quadram's Liberty-PC and -AT, Tecmar's 640 Plus, IBM's EGA and 3270/PC, AT&T's 6300 and many others. **REFLEX WORKSHOP** Minimum memory: 384K. Requires Reflex: The Analyst. **TURBO LIGHTNING** Minimum memory: 256K. Two disk drives required. Hard disk recommended. **LIGHTNING WORD WIZARD** Minimum memory: 256K. Requires Turbo Lightning Turbo Pascal 3.0 required to edit source code. **SIDICK** Minimum memory: 128K. **TRAVELING SIDICK** Minimum memory: 256K. **SUPERKEY** Minimum memory: 128K. *For IBM PC, AT, XT, PCjr and true compatibles only, running PC/MS-DOS 2.0 or later.

Borland's Business Productivity Programs:

- Reflex: The Analyst** Analytical database manager. Provides complete, new look at data normally hidden by programs like 1-2-3* and dBASE.* Best report generator for, and complement to, 1-2-3.
- Reflex Workshop** Important new addition to Reflex: The Analyst. Gives you 22 different templates to run your business right.
- SideKick** Complete RAM-resident desktop management includes notepad, dialer, calculator and more.
- Traveling SideKick** Electronic version of business/personal diaries, daytime organizers; works with your SideKick files; important professional tool.
- SuperKey** Keyboard enhancer. Simple macros turn 1000 keystrokes into 1. Also encrypts your files to keep confidential files confidential.

Borland's Electronic Reference Programs:

- Turbo Lightning** Works with all your programs and checks your spelling while you type! Includes 80,000-word Random House® Concise Word List and 50,000-word Random House Thesaurus. Forerunner of Turbo Lightning Library.™
- Lightning Word Wizard** Includes ingenious crossword solver and six other word challenges. If you're into programming, Lightning Word Wizard is also a development toolbox and the technical reference manual for Turbo Lightning.

All Borland products are registered trademarks or trademarks of Borland International, Inc. or Borland Analytica, Inc. Turbo Lightning Library is a trademark of Borland International, Inc. AST TurboLaser, RAMpage! AT, AdvantagePremium, SixPakPremium, 3G Pak and RAMpage! are trademarks of AST Research, Inc. Lotus 1-2-3 is a registered trademark of Lotus Development Corp. dBASE is a registered trademark of Ashton-Tate. IBM is a registered trademark of International Business Machines Corp. Random House is a registered trademark of Random House, Inc. Hercules is a trademark of Hercules Computer Technology. CP/M is a registered trademark of Digital Research, Inc. Traveling SideKick is not in any way associated with Traveling Software, Inc. of Seattle, Washington. Copyright 1986 Borland International. BI-1075A

TURBO PASCAL
EDITOR TOOLBOX™

TURBO
PROLOG™

TURBO PASCAL
GRAPHIX TOOLBOX™

How Borland is helping bring the America's Cup back to America!

"I think those who grasp the technology will prevail"

Bill Shore, President, Shore Sails Co., Newport, RI



HEART OF AMERICA

Borland's Philippe Kahn at the helm of America's Cup challenger "Heart of America," with Shore Sails' President Bill Shore

"Sail-making is traditional—a craft—but I think we're huge steps ahead of the competition when we get involved with higher technology," says Shore.

He and Shore Sails' 17 different franchised sail lofts in the U.S. are in what Shore describes as a "highly competitive business, whether it's America's Cup racing or any race." And he adds, "You guys (Borland) do good stuff that's affordable, which is one of the reasons why we wrote all our sail design programs in Turbo Pascal."

"These days," he says, "there are many parts to a sail, and Turbo Pascal lets us arrange all the parts properly. We design what the garment industry calls a 'marker'—and rely on Turbo Pascal to do critical things like getting thread lines in the same direction as load lines."

We take the diskette to our new \$250,000 laser cutter, which follows the Pascal program precisely, draws out the sail and cuts out the sail. We glue and sew and you've got the best there is."

"Heart of America" sporting its new Borland spinnaker, surging downwind, Santa Cruz, California



"The wrong sails will sink your chances—if not your boat—so we wrote Turbo Pascal programs"

Win Fowler, Shore Sails Co., Portland, Maine

The right sail design, at the right price, right now, has to happen in 17 different Shore Sails Lofts across America.

It had to happen with America's Cup challenger *Heart of America* which carries Shore sails—and it has to happen with the (currently) 700 different boats that Shore Sails has in their Turbo Database Toolbox."

Sail design, sail pricing and "beating the handicapper" are all done at Shore Sails with Turbo Pascal.

In case you don't know the sharp end from the blunt end of a boat, the right sail design for any boat is more than design and price. It's tactical advantage. Designing sails that take the greatest advantage of the boat's basic design and rigging without getting stuck with a heavier-than-desirable Official Handicap. (Handicaps can eat your chances faster than a Great White.)

The "right sail" design bends but doesn't break the

racing rules written by, amongst others, MORC (Midget Offshore Racing Club) or IOR (International Offshore Rules). Turbo Pascal spills out "right sail" designs for Shore Sails so their customers tend to "handicap" the Rules Committee instead of the other way around.

Shore Sails' connection with Borland doesn't end with Turbo Pascal and our Database Toolbox.

Shore's Fowler has also written SuperKey® macros for "every file we have" and says, "We'd be lost without them."

He uses SideKick® to dial every phone call and SideKick's Notepad to communicate between all the Lofts, saying, "That way we don't need a word processor." Shore Sails also uses Turbo Lightning® and Reflex: The Analyst.®

So why so many Borland products in one company?

Win Fowler says, "We'd be sunk without them!"

"There is no second prize" Omar Bradley

Sail designs generated from Shore Sails' Turbo Pascal programs.

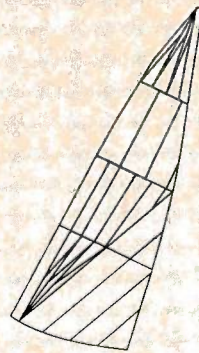
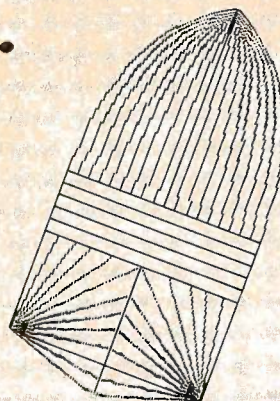

Borland's Instant Winner Game

Scratch this card now and you could *instantly win* 2 free round-trip airline tickets to Australia for the America's Cup Race!



\$10,000

First Prize (\$10,000 value!) includes accommodations for two in Perth, Australia

during the final America's Cup races, which start January 31, 1987. See America win it back after our *only* loss in 134 years! There's more than one *instant winner* in Borland's



\$6,895

Instant Winner Game, because you could win one of two new \$6,895 4-WD Suzuki Samurai convertibles,

printer, or a \$4,499



or a \$4,995 AST TurboLaser™

\$2,399 Toshiba T1100™

Toshiba T3100,™ or a

AST SixPakPremium™, or a \$69.95 Traveling SideKick,® or

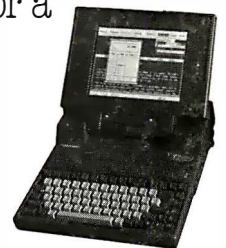

\$4,499

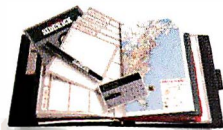

\$69.95

any one of hundreds of other Borland products—and at the very least a Borland Rebate Coupon, good for \$10 off any single product or \$15 off any bundled product offer!

See Official Rules on the back of this card for details.

Don't delay! There will be a second-chance drawing for the trip if not claimed by 12/30/86. There's also a second-chance drawing for the two Suzukis if not claimed by 2/28/87. All rebate coupons are good for products purchased 9/5/86-3/31/87. Product prices above are suggested list prices.

Rub the silver box to reveal whether you win a prize or get a rebate coupon. Then fill in the second-chance entry blank to the right.

SCRATCH 'N WIN!

Second-Chance Sweepstakes Entry!

We're running two Second-Chance Sweepstakes drawings to award the trip and cars. They *will be won* by someone—it *could be you!* Fill in the entry coupon and mail it now. Winners will be notified immediately, because the final America's Cup races start in Australia on January 31, 1987, and you'll have to pack in a hurry.

(You will need a valid passport and the ability to comprehend Australian versions of the English language.)

Name _____
 Address _____
 City _____
 State _____ Zip _____



OFFICIAL RULES - BORLAND INSTANT WINNER GAME

1. NO PURCHASE NECESSARY: To participate, you may obtain a game card inserted into the October, November, December, or January issue of the following magazines: PC World; Byte; PC Tech Journal; PC Magazine. You may also obtain a game card by mailing a self-addressed, stamped envelope to: Borland International Game Card, P.O. Box 870, Wilton, CT 06897. (Washington State residents send self-addressed envelope.) Limit one game card per stamped request. All requests must be received by January 15, 1987.

2. TO PLAY: Remove the rub-off area on the game card to reveal what prize or rebate offer you have obtained.

3. PRIZES/REBATES: Beneath the rub-off area one of the following prizes may be revealed: Trip for Two to America's Cup Races or \$10,000; 1986 Suzuki 4W Samurai Convertible or \$6,895; AST Turbo Laser; Toshiba 1100 Portable Computer; Toshiba 3100 Portable Computer; AST Sixpak premium; AST Advantage premium; AST 3GPak; AST Rampage; AST Rampage AT; Free Borland Product, or you may obtain the following rebate offer: \$10 rebate offer on any individual product or \$15 rebate offer on any single advertised Borland bundle (See rule #11 for prize details).

4. PRIZE CLAIMS: If you obtain one of the prizes stated in Rule #3, sign your full legal signature on the game card and send via certified mail (copy should be made for your records) along with your name and address to: Borland International Prize Claim, 196 Danbury Road, Wilton, CT 06897. All prize claims must be received or postmarked by February 15, 1987. (See Rule #12 for Trip for Two to America's Cup exception.)

5. REBATE CLAIMS: Rebates are good for products purchased from September 5, 1986 through March 31, 1987. The \$10 rebate is good for any individual Borland product and the \$15 rebate is good for any advertised Borland software bundle. To receive your rebate you must return your completed license agreement from the manual, this game card and dated proof of purchase to: Borland International Game Card Rebate, 4585 Scotts Valley Drive, Scotts Valley, CA 95066. Upon receipt of the license agreement, game card and proof of purchase, Borland will send your check. Rebate is not valid with any other rebate or promotion offered directly from Borland.

6. VERIFICATION: All game materials are subject to verification. Game materials are void and will be rejected if not obtained through authorized, legitimate channels, and may be rejected if any part is reproduced, counterfeited, torn or altered in any way, or if materials contain printing, typographical, or mechanical errors. Decisions of the Redemption Center are final. Game pieces from any game other than the Borland Instant Winner Game may not be used in this game.

7. CONDITIONS OF PARTICIPATION: Material submitted becomes the property of Borland International. The submission of game pieces is the sole responsibility of the individual seeking verification, who is solely responsible for lost, late, or misdirected mail. All taxes, registration and inspection fees are the sole responsibility of the verified winner. Winners may be required to execute an affidavit of eligibility and name and likeness public release. By participating in the game you accept and agree to be bound by these rules and the decision of the Official Redemption Center which will be final.

8. ELIGIBILITY: Participation is open solely to residents of the United States 18 years of age and over, except employees and agents of Borland International, service agencies, and individuals engaged in the development, production, or distribution of game materials. The Merritt Group, Inc. and their immediate family or members of their households. Void in Vermont and where prohibited by law.

9. GAME SCHEDULE AND AWARD OF PRIZES: The Borland Instant Winner Game will commence on or about September 5, 1986 and end on January 30, 1987. It will officially end, however, when all game pieces are distributed. Verified game prizes will be awarded within thirty (30) days from the date of their receipt for verification at the Official Redemption Center. A major prize winners' list can be obtained by sending a stamped, self-addressed envelope to: Borland Instant Winner Game Winners' List, P.O. Box 7089, Wilton, CT 06897.

10. ODDS CHART: The odds of winning prizes are based upon obtaining the one rare game piece among the applicable number of game pieces.

PRIZE	Qty.	Total Value	Odds of Winning
Trip for Two to America's Cup or \$10,000	1	\$ 10,000.00	1 in 6,458,000
Suzuki 4W Samurai Convertible JA or \$6,895	2	\$ 13,790.00	1 in 3,229,000
AST Turbo Laser	1	\$ 4,995.00	1 in 6,458,000
Toshiba Portable Computer	2	\$ 6,898.00	1 in 3,229,000
AST Memory Boards	25	\$ 15,025.00	1 in 258,320
Borland Products	1,000	\$149,000.00	1 in 6,458
OVERALL TOTAL	1,031	\$199,708.00	1 in 6,264

All remaining game cards will contain a \$10 rebate good on any individual Borland product or a \$15 rebate good toward any advertised Borland software bundle.

11. PRIZE DETAILS: Trip for two to America's Cup Races (or \$10,000) will include coach seating round trip airfare on regularly scheduled commercial airline from San Francisco, California to Perth, Australia and up to two weeks hotel accommodations in Perth, Australia plus \$4,500 spending cash. Winners will be responsible for obtaining visa, passport, and all other travel documents. Trip does not include meals, taxes, excess baggage charges and other hotel charges. Minor must be accompanied by parent or legal guardian.

Suzuki 4W Samurai Convertible JA Standard Equipment Package (or \$6,895), verified winner will be responsible for all registration, insurance, and licensing fees. AST Turbo Laser; Toshiba Portable Computer Model # T1100; Toshiba Portable Computer Model # T3100; AST Memory Boards and Free Borland Products are non-substitutional except by sponsor due to product availability and all warranties and guarantees are subject to manufacturers terms. All prizes are non-transferable. Winning consumer is responsible for all local, state and federal taxes.

12. SECOND CHANCE SWEEPSTAKES: There are two Second Chance Sweepstakes drawings scheduled to be conducted on December 31, 1986 and February 28, 1987. Random drawing from all entries received by December 30, 1986 will award trip for two to America's Cup Races (or \$10,000). Random drawing from all entries received by February 26, 1987 will award two (2) Suzuki 4W Samurai (or \$6,895). All remaining prizes that are unclaimed after February 15, 1987 will remain unclaimed. Send entry to: Second Chance Entry P.O. Box 870 Wilton, CT 06897.

If you have any questions concerning the Borland Instant Winner Game, call 1-800-451-4471.

The Worldwide
Programming
Standard

Turbo Pascal Programming!



New Mac Version
available!

\$10.00 Scratch 'n Win Rebate!

Turbo Pascal® 3.0

"For the IBM® PC, the benchmark Pascal compiler is undoubtedly Borland International's Turbo Pascal," says Gary Ray of PC Week. We and

more than 500,000 other people around the world think Mr. Ray got that right. Since launch, Turbo Pascal has become the *de facto* worldwide standard in high-speed Pascal compilers. Described by Jeff Duntemann of PC Magazine as the "Language deal of the century," Turbo Pascal is now an even better deal than that—because we've included the most popular options (BCD reals and 8087 support). What used

Turbo Pascal now includes
free 8087 support and BCD!

to cost \$124.95 is now only \$99.95! You now get a lot more for a lot less: the compiler, a completely integrated programming environment, and BCD reals and 8087 support—all for a suggested retail of only \$99.95. And with a Scratch 'n Win \$10.00 Rebate, you pay only \$89.95—which really is the "language deal of the century"! Minimum memory: 128K.

\$10.00 Scratch 'n Win Rebate!

Turbo Database Toolbox™

A perfect complement to Turbo Pascal, because it contains a complete library of Pascal procedures that allows you to

search and sort data and build powerful database applications. Having Turbo Database Toolbox means you don't have to re-invent the wheel each time you write a Turbo Pascal program. It comes with source code for a free sample database—right on disk. The database can be searched by key words or numbers. Update, add, or delete records as needed. Just compile it and it's ready to go to work for you. (Shore Sails has



Build Your
Own Database
Applications!

more than 700 boat designs and rigs in their Database Toolbox. See front page story.) Suggested retail: \$69.95. With a \$10.00 Scratch 'n Win Rebate check back from us, only \$59.95! Minimum memory: 128K.

SPECIAL PRICES! AMAZING VALUE! ACT NOW!

It's the Works! Everything! The whole electronic enchilada! It's the Jumbo Pack... Turbo Pascal 3.0, Turbo Tutor 2.0, Turbo Editor, Turbo GameWorks, Turbo Graphix and Turbo Database. All 6 Turbo Pascal programs for only \$299.95—or only \$284.95 with a \$15.00 Scratch 'n Win Rebate! That's about \$47.00 each and that's a deal!

Save a bundle
on our bundles!

SideKick and Traveling SideKick for only \$125.00 but only \$110.00 after a \$15.00 Scratch 'n Win Rebate!

Reflex: The Analyst and the new Reflex Workshop for only \$199.95! And a \$15.00 Scratch 'n Win Rebate cuts that down to only \$184.95!

\$15.00 Scratch 'n Win
Rebate on all Xmas packs!



Vive la différence

Inquiry 50 for End-Users.
Inquiry 51 for DEALERS ONLY.

YES!

I want
the best!

For credit card orders
or the dealer nearest you
call (800) 255-8008
in CA call (800) 742-1133

Copies	Product	Price	Totals
—	Turbo Pascal 3.0 w/8087 & BCD	\$99.95	\$ _____
—	Reflex: The Analyst	149.95*	\$ _____
—	Reflex Workshop	69.95*	\$ _____
—	Reflex, Reflex Workshop	199.95*	\$ _____
—	Turbo Prolog	99.95	\$ _____
—	Turbo Pascal/CPIM-80	69.95	\$ _____
—	Turbo Database Toolbox	69.95	\$ _____
—	Turbo Graphix Toolbox	69.95	\$ _____
—	Turbo Tutor 2.0	39.95	\$ _____
—	Turbo Editor Toolbox	69.95	\$ _____
—	Turbo GameWorks	69.95	\$ _____
—	Turbo Lightning	99.95	\$ _____
—	Lightning Word Wizard	69.95	\$ _____
—	Turbo Lightning, Lightning Word Wizard	149.95	\$ _____
—	SideKick	84.95	\$ _____
—	Traveling SideKick	69.95*	\$ _____
—	SideKick, Traveling SideKick	125.00*	\$ _____
—	SuperKey	69.95	\$ _____
—	Turbo Jumbo Pack	299.95	\$ _____

Outside USA add \$10 per copy

CA and MA res. add sales tax \$ _____

Amount enclosed \$ _____

Prices include shipping to all US cities.

Carefully describe your computer system:

Mine is: 8-bit 16-bit

I use: PC-DOS CPIM-80

MS-DOS CPIM-86

My computer's name and model is: _____

The disk size I use is: 3 1/2" 5 1/4" 8"

Payment: VISA MC Money order Check

Credit card expiration date: ____/____/____

Card # _____

Name: _____

Shipping Address: _____

City: _____

State: _____ Zip: _____

Telephone: _____

CCDs and purchase orders WILL NOT be accepted by Borland.

Outside USA make payment by bank draft, payable in US

dollars drawn on a US bank.

*Limited Time Offer

GF15

NOT COPY PROTECTED

60-DAY MONEY-BACK GUARANTEE

If within 60 days of purchase you find that this product does

not perform in accordance with our claims, call our customer

service department and we will gladly arrange

a refund.

All prices are suggested list prices and are subject to change

without notice.



Pictured on the cover is the GT180 color graphics display board from Ciarcia's Circuit Cellar. The printed circuit board was made by drawing a schematic and producing a net list using SCHEMA and then using a Calay auto-routing CAD system at Custom Photo and Design (Wallingford, CT). The finished films were given to Tech Circuits (Wallingford, CT) for production of the PCB. The entire schematic-to-board process took 24 hours. Steve Ciarcia would like to extend special thanks to Greg Peterson, Phil Walton, Ray Long, and Jim McGrath for their fast turnaround on this project.



82



146

C·O·N·T·E·N·T·S

FEATURES

INTRODUCTION	82
PRODUCT PREVIEW: THE COMPAQ DESKPRO 386 <i>by Tom Thompson and Dennis Allen</i>	84
A high-performance PC AT-compatible system based on Intel's 80386.	
PRODUCT PREVIEW: LOTUS MANUSCRIPT <i>by George A. Stewart</i>	91
Designed for scientists and engineers, this technical word processor is worth looking into.	
CIARCIA'S CIRCUIT CELLAR: BUILD THE GT180 COLOR GRAPHICS BOARD, PART I: BASIC TECHNOLOGY <i>by Steve Ciarcia</i>	105
To achieve inexpensive PGA resolution on the SB180, Steve designed the GT180 project using Hitachi's advanced CRT controller and Borland's Graphix 'toolbox.	
PROGRAMMING INSIGHT: EXTRACTING THE <i>n</i>th ROOT FROM A BINARY NUMBER <i>by Lau Siu Wo</i>	115
A general algorithm developed for extracting any real root from a binary number.	
PROGRAMMING INSIGHT: PASSING FILENAMES TO COMPILED BASIC <i>by Bruce Hubanks</i> ..	119
An assembly language subroutine retrieves the command-line text for a compiled BASIC program.	
MEMORY MANAGEMENT UNITS FOR 68000 ARCHITECTURES <i>by Gregg Zehr</i>	127
A look at currently available MMUs and design options that speed up memory management.	
THE STATE OF SOVIET MICROELECTRONICS <i>by Paul Walton</i>	137
To say the least, the Soviet computer culture is weak.	

THEME: REPRESENTING KNOWLEDGE

INTRODUCTION	146
FINDING RULES IN DATA <i>by Beverly Thompson and William Thompson</i>	149
The ID3 algorithm lets you obtain knowledge directly from a set of data.	
A BIT-MAPPED CLASSIFIER <i>by Peter W. Frey</i>	161
This unconventional expert system is based on pattern recognition.	
PREDICTING INTERNATIONAL EVENTS <i>by Philip A. Schrod</i>	177
Modeling political knowledge and making short-term forecasts with a Holland classifier.	
HANDLING CONFLICTS IN DATA <i>by Clara Y. Cuadrado and John L. Cuadrado</i>	193
A decision support system in Prolog helps managers make the right choice.	
THE ART OF DEDUCTION <i>by J.-C. Emond and A. Paulissen</i>	207
Watson, an AI program in Prolog, plays the mystery game CLWEDO.	
RULE-BASED PROGRAMMING <i>by Leonard Moskowitz</i>	217
A look at OPS5, the production-system language popular with AI researchers.	
MACHINE LEARNING <i>by Angelos T. Kolokouris</i>	225
Teaching computers to learn with a language that grows.	

REVIEWS

INTRODUCTION	234
REVIEWER'S NOTEBOOK <i>by Jon Edwards</i>	237
THREE IBM CLONES <i>by John D. Unger</i>	239
Offerings from Kaypro, Epson, and Multitech.	
THE MACINTOSH PLUS <i>by Chris Crawford</i>	247
The first major redesign of the Macintosh.	

BYTE (ISSN 0360-5280) is published monthly with one extra issue per year by McGraw-Hill Inc. Founder: James H. McGraw (1860-1948). Executive editorial, circulation, and advertising offices: One Phoenix Mill Lane, Peterborough, NH 03458, phone (603) 924-9281. Office hours: Monday through Thursday 8:30 AM - 4:30 PM, Friday 8:30 AM - 1:00 PM, Eastern Time. Address subscriptions to BYTE Subscriptions, P.O. Box 590, Martinsville, NJ 08836. Postmaster: send address changes, USPS Form 3579, undeliverable copies, and fulfillment questions to BYTE Subscriptions, P.O. Box 596, Martinsville, NJ 08836. Second-class postage paid at Peterborough, NH 03458 and additional mailing offices. Postage paid at Winnipeg, Manitoba. Registration number 9321. Subscriptions are \$21 for one year, \$38 for two years, and \$55 for three years in the U.S. and its possessions. In Canada and Mexico, \$23 for one year, \$42 for two years, \$61 for three years. \$69 for one year air delivery to Europe, 31,000 yen for one year air delivery to Japan, 15,600 yen for one year surface delivery to Japan, \$37 surface delivery elsewhere. Air delivery to selected areas at additional rates upon request. Single copy price is \$3.50 in the U.S. and its possessions, \$4.25 in Canada and Mexico, \$4.50 in Europe, and \$5 elsewhere. Foreign subscriptions and sales should be remitted in U.S. funds drawn on a U.S. bank. Please allow six to eight weeks for delivery of first issue. Printed in the United States of America.

BYTE November

VOLUME 11, NUMBER 12, 1986

THREE 24-PIN DOT-MATRIX PRINTERS by Robert D. Swearingin	255
A trio of models with reasonable speed, quality, and flexibility.	
DIGITIZERS FOR DATA ENTRY by Eldon D. Hearn	261
Eight devices for transferring coordinate data to personal computers.	
TWO C COMPILERS FOR THE AMIGA by Charlie Heath	271
Lattice C versus Manx Aztec C68K	
SPSS/PC+ by Jeffrey M. Jacques	279
An analytical production tool with three modules.	
AEGIS ANIMATOR AND AEGIS IMAGES by Warren Block	285
Software for creating video sequences on the Amiga.	
TURBO LIGHTNING AND STRIKE by Ross Ramsey	289
Two RAM-resident spelling checkers.	
FILEPRO 16 AND FILEPRO 16 PLUS by Richard Harkness	297
Database management software for a variety of systems.	
REVIEW FEEDBACK	301

KERNEL

INTRODUCTION	304
COMPUTING AT CHAOS MANOR: A GRAPHIC DISPLAY by Jerry Pournelle	307
Jerry signs up Big Kat for the EGA tour.	
ACCORDING TO WEBSTER: 68000 WARS: ROUND 3 by Bruce Webster	323
Bruce compares various flavors of the Macintosh.	
BYTE JAPAN: TECHNICAL CURIOSITIES by William M. Raïke	347
On-line info from vending machines, an NEC export machine, and a Japanese-language BBS.	
BYTE U.K.: INTEGRATION ON A NEW SCALE by Dick Pountain	351
Water-scale integration is starting to yield its first products.	
APPLICATIONS ONLY: RESIDENT HEADACHES by Ezra Shapiro	361
More memory-resident programs and Works for the Macintosh.	
MATHEMATICAL RECREATIONS: PARADOXES OF PROBABILITY by Robert T. Kurosaka	373
Some classic sucker bets and how they work.	

BEST OF BIX

AMIGA	385	MACINTOSH/APPLE II	394
ATARI ST	386	ADA	405
IBM PC AND COMPATIBLES	390		

DEPARTMENTS

EDITORIAL: BYTE AND THE 80386	6	CHAOS MANOR MAIL	381
MICROBYTES	9	BOMB RESULTS	453
LETTERS	16	READER SERVICE	455
WHAT'S NEW	29	LISTINGS	
EVENTS AND CLUBS	50	FROM BIX	372
ASK BYTE	52	FROM BYTENET	(617) 861-9764
CIRCUIT CELLAR FEEDBACK	58	ON DISK	see card after page 352
BOOK REVIEWS	65	IN PRINT	see card after page 352

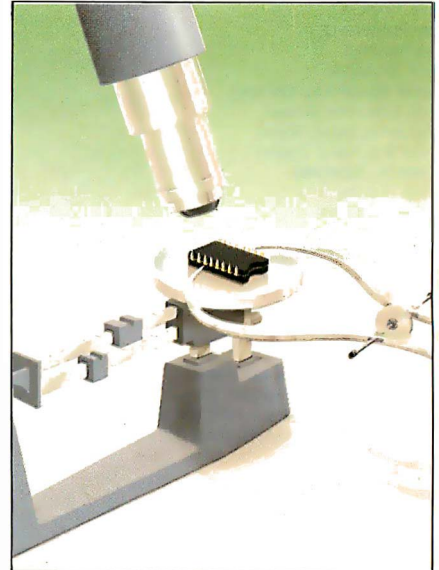

234

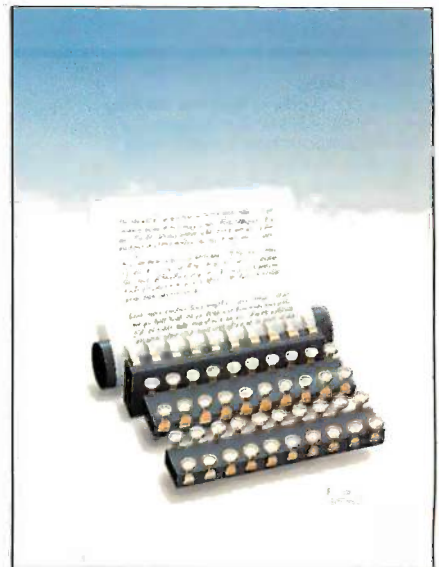

304

Address editorial correspondence to: Editor, BYTE, One Phoenix Mill Lane, Peterborough, NH 03458. Unacceptable manuscripts will be returned if accompanied by sufficient postage. Not responsible for lost manuscripts or photos. Opinions expressed by the authors are not necessarily those of BYTE.

Copyright © 1986 by McGraw-Hill Inc. All rights reserved. Trademark registered in the United States Patent and Trademark Office. Where necessary, permission is granted by the copyright owner for libraries and others registered with the Copyright Clearance Center (CCC) to photocopy any article herein for the flat fee of \$1.50 per copy of the article or any part thereof. Correspondence and payment should be sent directly to the CCC, 29 Congress St., Salem, MA 01970. Specify ISSN 0360-5280/86 \$1.50. Copying done for other than personal or internal reference use without the permission of McGraw-Hill Inc. is prohibited. Requests for special permission or bulk orders should be addressed to the publisher. BYTE is available in microform from University Microfilms International, 300 North Zeeb Rd., Dept. PR, Ann Arbor, MI 48106 or 18 Bedford Row, Dept. PR, London WC1R 4EJ, England.

Subscription questions or problems should be addressed to: BYTE Subscriber Service, P.O. Box 328, Hancock, NH 03449



MANAGING EDITOR, BYTE
FREDERIC S. LANGA**ASSISTANT MANAGING EDITOR**

GLENN HARTWIG

CONSULTING EDITORSSTEVE CIARCIA
JERRY POURNELLE
EZRA SHAPIRO
BRUCE WEBSTER**SENIOR TECHNICAL EDITORS**JON R. EDWARDS, *Reviews*
G. MICHAEL VOSE, *Themes*
GREGG WILLIAMS, *Features***TECHNICAL EDITORS**DENNIS ALLEN
RICHARD GREHAN
KEN SHELDON
GEORGE A. STEWART
JANE MORRILL TAZELAAR
TOM THOMPSON
CHARLES D. WESTON
EVA WHITE
STANLEY WZOLA**ASSOCIATE TECHNICAL EDITORS**CURTIS FRANKLIN, JR., *Best of BIX*
MARGARET COOK GURNEY, *Book Reviews*
BRENDA McLAUGHLIN, *Applications Software Reviews*,
San Francisco**COPY EDITORS**BUD SADLER, *Chief*
JEFF EDMONDS
FAITH HANSON
NANCY HAYES
CATHY KINGERY
PAULA NOONAN
WARREN WILLIAMSON
JUDY WINKLER**ASSISTANTS**PEGGY DUNHAM, *Office Manager*
MARTHA HICKS
L. RYAN McCOMBS
JUNE N. SHELDON**NEWS AND TECHNOLOGY**GENE SMARTE, *Bureau Chief, Costa Mesa*
JONATHAN ERICKSON, *Senior Technical Editor, San Francisco*
RICH MALLOY, *Senior Technical Editor, New York*
CINDY KIDDOO, *Editorial Assistant, San Francisco***ASSOCIATE NEWS EDITORS**DENNIS BARKER, *Microbytes*
CATHRYN BASKIN, *What's New*
ANNE FISCHER LENT, *What's New***CONTRIBUTING EDITORS**JONATHAN AMSTERDAM, *programming projects*
MARK DAHMEKE, *video, operating systems*
MARK HAAS, *at large*
RIK JADRNICKEK, *CAD, graphics, spreadsheets*
ROBERT T. KUROSAKA, *mathematical recreations*
PHIL LOPICCOLO, *computers in medicine*
ALASTAIR J. W. MAYER, *software*
ALAN R. MILLER, *languages and engineering*
DICK POUNTAIN, *U.K.*
ROGER POWELL, *computers and music*
WILLIAM M. RAIKE, *Japan*
PHILLIP ROBINSON, *semiconductors***ART**NANCY RICE, *Art Director*
JOSEPH A. GALLAGHER, *Associate Art Director*
JAN MULLER, *Art Assistant*
ALAN EASTON, *Drafting***PRODUCTION**DAVID R. ANDERSON, *Production Director*
DENISE CHARTRAND
MICHAEL J. LONSKY
VIRGINIA REARDON**TYPOGRAPHY**SHERRY MCCARTHY, *Chief Typographer*
LEN LORETTE
DONNA SWEENEY**EXECUTIVE EDITOR, BIX**
GEORGE BOND**SENIOR EDITOR**DAVID BETZ
ASSOCIATE EDITORS
TONY LOCKWOOD
DONNA OSGOOD, *San Francisco***MICROBYTES DAILY**DENNIS BARKER, *Coordinator, Peterborough*
GENE SMARTE, *Bureau Chief, Costa Mesa*
CATHRYN BASKIN, *Peterborough*
JON ERICKSON, *San Francisco*
MARTHA HICKS, *Peterborough*
CINDY KIDDOO, *San Francisco*
ANNE FISCHER LENT, *Peterborough*
RICH MALLOY, *New York*
LYNNE NADEAU, *Peterborough*
DAVID NEEDLE, *San Francisco*
WAYNE RASH, *Washington, DC***GROUP MODERATORS**DAVID ALLEN, *Applications*
FRANK BOOSMAN, *Artificial Intelligence*
LEROY CASTERLINE, *Other*
MARC GREENFIELD, *Programming Languages*
JIM HOWARD, *Graphics*
GARY KENDALL, *Operating Systems*
STEVE KRENEK, *Computers*
BROCK MEEKS, *Telecommunications*
BARRY NANCE, *New Technology*
DONALD OSGOOD, *Computers*
SUE ROSENBERG, *Other*
JON SWANSON, *Chips***BUSINESS AND MARKETING**DOUG WEBSTER, *Director, (603) 924-9027*
PATRICIA BAUSUM, *Secretary*
DENISE A. GREENE, *Customer Service*
BRIAN WARNOCK, *Customer Service*
TAMMY BURGESS, *Customer Credit and Billing***TECHNOLOGY**CLAYTON LISLE, *Director, Business Systems Technology, MHS*
BILL GARRISON, *Business Systems Analyst*
JACK REILLY, *Business Systems Analyst*
LINDA WOLFF, *Senior Business Systems Analyst***ADVERTISING SALES**DENNIS J. RILEY, *Director of Sales and Marketing*
SANDRA FOSTER, *Administrative Assistant***ADVERTISING/PRODUCTION (603-924-6448)**LISA WOZMAK, *Supervisor*
LYDA CLARK, *Senior Account Coordinator*
MARION CARLSON
KAREN CILLEY
WAI CHIU LI, *Quality Control Manager*
JULIE MURPHREE, *Advertising/Production Coordinator***MARKETING COMMUNICATIONS**HORACE T. HOWLAND, *Director (603-924-3424)*
VICKI REYNOLDS, *Promotion Manager*
LISA JO STEINER, *Marketing Assistant*
STEPHANIE WARNESKY, *Marketing Art Director*
SHARON PRICE, *Associate Art Director*
WILBUR S. WATSON, *Operations Manager, Exhibits***RESEARCH**JULIE PERRON, *Market Research Analyst*
CYNTHIA DAMATO SANDS, *Reader Service Coordinator***PLANNING AND DEVELOPMENT/PUBLIC RELATIONS**(603-924-7255)
MICHELE P. VERVILLE, *Director*
FAITH KLUNTZ, *Copyrights Coordinator***FINANCIAL SERVICES**PHILIP L. PENNY, *Director of Finance and Services*
KENNETH A. KING, *Business Director*
CHRISTINE LEE, *Assistant*
VICKI WESTON, *Accounting Manager*
LINDA SHORT, *D/P Manager*
MARILYN HAIGH
DIANE HENRY
VERN ROCKWELL
LISA TEATES
JOANN WALTER**PUBLISHER'S ASSISTANT**

BEVERLY JACKSON

CIRCULATION (800-258-5485)LAURIE SEAMANS, *Assistant Manager*
SUSAN BOYD
LOUISE MENEGUS
AGNES E. PERRY
JENNIFER PRICE
JAMES BINGHAM, *Single-Copy Sales Manager*
CATHY A. RUTHERFORD, *Assistant Manager*
CLAUDETTE CARSWELL
KAREN DESROCHES**PERSONNEL**CHERYL HURD, *Office Manager*
PATRICIA BURKE, *Personnel Coordinator***BUILDING SERVICES/TRAFFIC**ANTHONY BENNETT, *Building Services Manager*
BRIAN HIGGINS
MARK MONKTON**RECEPTIONIST**

DONNA HEALY

Officers of McGraw-Hill Information Systems Company: President: Richard B. Miller. Executive Vice Presidents: Frederick P. Jannott. Construction Information Group: Russell C. White. Computers and Communications Information Group: J. Thomas Ryan. Marketing and International. Senior Vice Presidents: Francis A. Shinal, Controller; Robert C. Violette. Manufacturing and technology. Senior Vice Presidents and Publishers. Laurence Altman, Electronics Week; Harry L. Brown, BYTE; David J. McGrath, Construction Publications. Group Vice President: Peter B. McCuen. Communications Information. Vice President: Fred O. Jensen. Planning and Development.

Officers of McGraw-Hill, Inc.: Harold W. McGraw, Jr., Chairman; Joseph L. Dionne, President and Chief Executive Officer; Robert N. Landes, Executive Vice President and Secretary; Walter D. Serwatka, Executive Vice President and Chief Financial Officer; Shel F. Asen, Senior Vice President, Manufacturing; Robert J. Bahash, Senior Vice President, Finance and Manufacturing; Ralph R. Schulz, Senior Vice President, Editorial; George R. Elsing, Vice President, Circulation; Ralph J. Webb, Vice President and Treasurer.

BYTE, BIX, and The Small Systems Journal are registered trademarks of McGraw-Hill Inc.

EDITORIAL AND BUSINESS OFFICE: One Phoenix Mill Lane, Peterborough, New Hampshire 03458, (603) 924-9281.

West Coast Offices: 425 Battery St., San Francisco, CA 94111, (415) 954-9718; 3001 Red Hill Ave., Building #1, Suite 222, Costa Mesa, CA 92626, (714) 557-6292. **New York Editorial Office:** 1221 Avenue of the Americas, New York, NY 10020, (212) 512-2000.

BYTEnet: (617) 861-9764 (set modem at 8-1-N or 7-1-E: 300 or 1200 baud).

Circuit-Board-Artwork Software: \$895. And guaranteed.

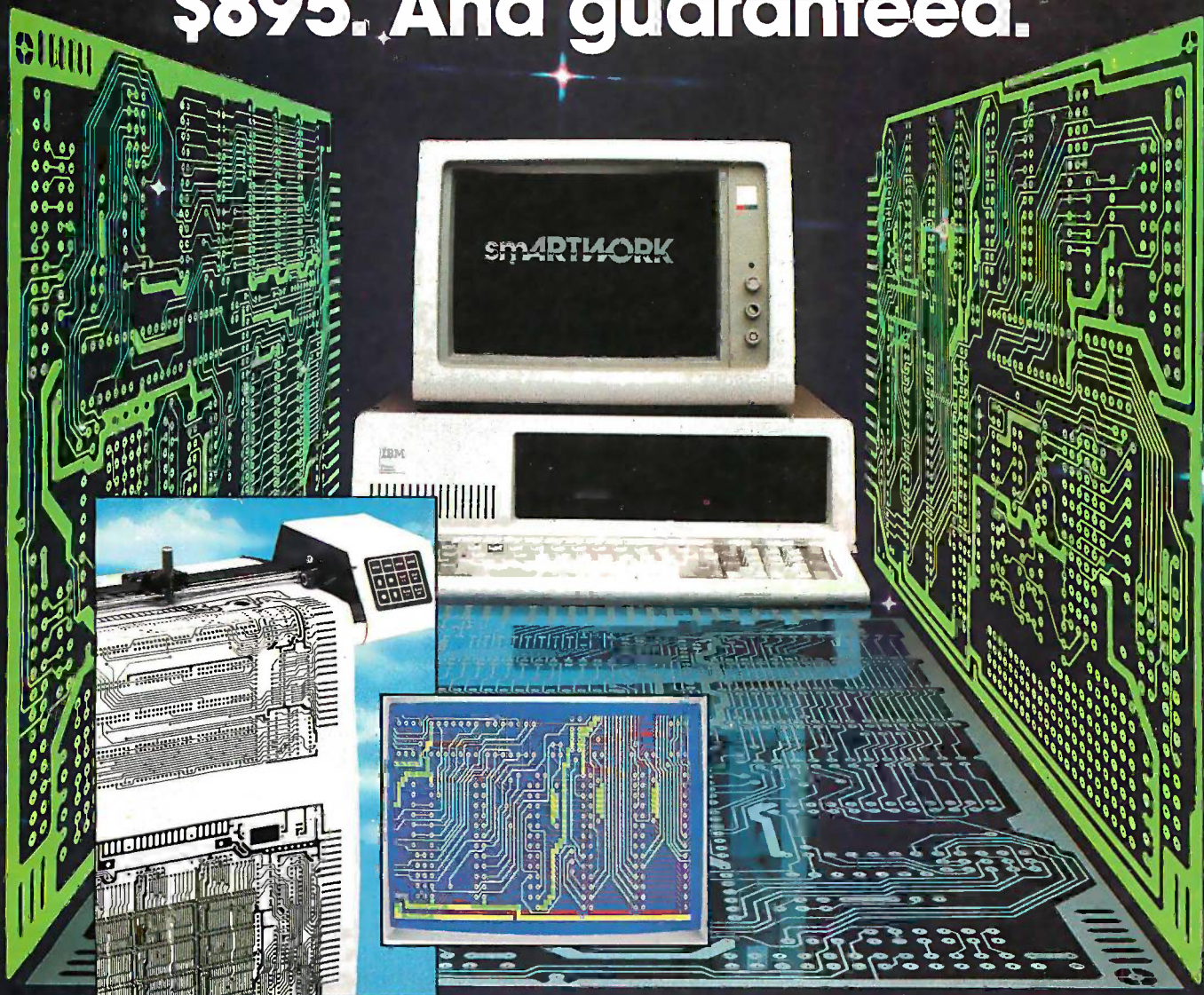

smARTWORK® lets the design engineer create and revise printed-circuit-board artwork on the IBM Personal Computer. You keep complete control over your circuit-board artwork — from start to finish.

And smARTWORK® is reliable. When we couldn't find a package that was convenient, fast, and affordable, we created smARTWORK® to help design our own microcomputer hardware. We've used it for over two years, so we know it does the job.

That's why we offer every design engineer a *thirty-day money-back no-nonsense guarantee*.

smARTWORK® advantages:

- Complete interactive control over placement and routing
- Quick correction and revision
- Production-quality 2X artwork from a pen-and-ink plotter

- Prototype-quality 2X artwork from a dot-matrix printer
- Easy to learn and operate, yet capable of sophisticated layouts
- Single-sided and double-sided printed circuit boards up to 10 x 16 inches
- Multicolor or black-and-white display

System Requirements:

- IBM Personal Computer, XT, or AT with 320K RAM, 2 disk drives, and DOS Version 2.0 or later
- IBM Color/Graphics Adapter with RGB color or black-and-white monitor
- IBM Graphics Printer or Epson FX/MX/RX series dot-matrix printer
- Houston Instrument DMP-41 pen-and-ink plotter
- Microsoft Mouse (optional)

The Smart Buy

At \$895, smARTWORK® is proven, convenient, fast — *and guaranteed*. Call us today. And put smARTWORK® to work for yourself next week. Try it for 30 days at absolutely no risk. That's smart work.

Wintek Corporation Inquiry 375
1801 South Street
Lafayette, IN 47904-2993
Telephone: (317) 742-8428
Telex: 70-9079 WINTEK CORP UD



In Europe contact: RIVA Terminals Limited,
Woking, Surrey GU21 5JY ENGLAND,
Telephone: 04862-71001, Telex: 859502

smARTWORK®, "Wintek" and the Wintek logo are registered trademarks of Wintek Corporation.

BYTE AND THE 80386

During the next several months, BYTE will cover Intel's 32-bit microprocessor, the 80386, in unprecedented breadth and depth. We will offer articles in print in BYTE and interactive on-line events on BIX. The combination of in-depth articles with open on-line discussions promises to give BYTE's readers a head start into an exciting new world.

BYTE has already covered the 80386 extensively. In our special issue, *Inside the IBM PCs* (which is still available on newsstands), we provide Paul Wells's introductory article "Intel's 80386 Architecture," Bill Nicholls's lucid sidebar "Systems Implications of the Intel 80386," and Jon Shiell's insightful "Virtual Memory, Virtual Machines."

This issue of BYTE contains a preview of Compaq's impressive Deskpro 386 by Tom Thompson and Dennis Allen on page 84. We posted the same article on BIX on September 9, the date of the Compaq announcement. As is the case with other 80386 systems that have so far appeared, the Deskpro 386 is much more powerful than an 80286-based system despite the lack of systems software to tap the new chip's full power. To the user, the Deskpro 386 seems to be a blazingly fast IBM PC AT, the culmination of the IBM PC-compatible movement rather than the first brave inhabitant of a new world.

Only new systems software can give the Deskpro 386 and other 80386-based systems the full benefit of their magnificent new microprocessor. Two BIX events related to the 80386 are now under way. One of these concerns 80386 systems software; the other event provides a forum for users of the early 80386-based machines.

The systems software picture on the 80386 is fascinating and complex. Users have a choice of DOS under UNIX, from either Phoenix Software or Interactive Systems; DOS merged with UNIX, from either Locus or Microport; Softguard's VM-like VM/386, which also has a DOS emulator; XENIX from Microsoft; or the forthcoming and as yet unnamed Microsoft operating system that succeeds MS-DOS. In order to choose among these, computer users need to ask themselves

what, if anything, VM, the mainframe operating system, and UNIX, the popular minicomputer and supermicrocomputer operating system, can provide users of small computers who have done nicely with operating systems like MS-DOS and CP/M.

Clearly, access to large memory is a must—but what else? Operating systems designed to divide the resources of one big machine among several users may or may not have special advantages for the user with an individual dedicated machine—in short, a personal computer. Peter Calingaert's *Operating System Elements: A User Perspective* (Prentice-Hall, 1982) points out that the provision of a virtual machine "costs both storage and speed of execution." In a personal computer, is the virtual machine worth the price? The BIX conference on 80386 systems software is an ideal place to seek the answer. You can take part in this conference by logging on to BIX and typing "join OS386."

The BIX conference on early user experience with 80386 machines will let us all explore these new machines even if we don't yet have access to one. We are offering free BIX connect time for the first 10 users who will share their experiences with 80386-based machines like Compaq's Deskpro 386. (See the accompanying text box for more details.) Other users are welcome to participate as well. To join this conference, log on to BIX and type "join users386."

Highlights of the 80386 conferences will appear in print in BYTE. We will also offer several more 80386 articles in the next few months. Jon Shiell is preparing three more articles—one on what is involved in a VM operating system on the 80386; a second on VM and what it has to offer; and a third on the Cheetah CPU/386, a kit for upgrading an IBM-compatible 80286-based system to use an 80386. The kit and support from Cheetah will be available to BYTE readers who want to explore the 80386 now but aren't yet ready to take the plunge and buy an 80386-based system. BIX will be the setting for a users group for the Cheetah CPU/386.

We also will offer a multipart introduction to Microsoft's new operating system,

which is sure to be an important one for the 80386. In fact, it may prove to be as dominant in the single-user environment as MS-DOS has been on the 8088/86 and 80286. Gordon Letwin, a BYTE author from way back (October 1978, to be exact), heads up the Microsoft project to develop this new operating system. Microsoft has released no information about it yet, but industry sources have provided us with some of the system's important generalities.

First, although this new software borrows some features from UNIX, it is intended as an ideal environment for individual users of personal computers in networks. The original design goals of UNIX were quite different. The new Microsoft operating system is based on algorithms that optimize response time for the user, rather than throughput for the system as a whole. Second, the operating system is not a mere extension of MS-DOS. It is a truly new system that has backward compatibility as one of its features. To appreciate and exploit the new powers of this operating system, users will need to learn its ins and outs. Gordon Letwin's introductory article will give the structure of the new operating system and explain how programmers can use it to their advantage.

We will provide discussions of the new Microsoft operating system on BIX when information becomes available from Microsoft and early users of the new software. See you there.

—Phil Lemmons
Editor in Chief

Free BIX Hours to Discuss 80386 Machines

The first 10 owners of 80386-based machines who contact us will receive 10 free connect hours for the subsequent month if they agree to share their experiences with the machines with other BIX users. To pursue this, 80386-system owners should contact BYTE Associate Technical Editor Curt Franklin at (603) 924-9281. All BIX users are welcome to participate in the BIX conference "users386" at regular BIX connect-time charges.



When computers get down to business, they move up to Maxell.

Maxell is ready when you are with the newest technology in magnetic media. A perfect example is this double-sided 3½" microdisk.



maxell
THE GOLD STANDARD

smarterm[®]

The Communications Software That Knows You Can't Ignore Evolution

The world of computing has much in common with nature: Those who adapt to their environment flourish. Those who can't—go the way of the dinosaur.

If your computing environment includes mini computers, you can access them using standard terminals. But the smarter alternative is an IBM* compatible PC* and SmarTerm terminal emulation software—an advanced species of communications software.

Persoft began where most terminal emulation software companies strive to end—with exact, feature-for-feature emulation. Then Persoft took SmarTerm software to the next stage of evolution: superiority.

SmarTerm 240, the latest in the SmarTerm series, not only provides the ReGIS* and Tektronix* graphics capabilities of a DEC* VT240* terminal, but adds capabilities that are only possible through the power of a PC.

Features like error-free data transfer (using Kermit or XMODEM protocols), on-line help screens, remappable keyboard layouts, and programmable softkeys.

SmarTerm 240 is just one example of the most advanced line-up of DEC, Data General and Tektronix terminal emulation software in the industry.

Make the "natural selection." Ask your local dealer about SmarTerm terminal emulation software. Or contact:

Persoft, Inc.
465 Science Drive
Madison, WI U.S.A. 53711
(608) 273-6000
Telex 759491



persoft

Inquiry 257

Visit Booth #8624
Hilton Pavillion West
COMDEX/Las Vegas

**SmarTerm Terminal Emulation Software
... The Natural Selection**

"Neuron" Chips Emulate Brain Cells, Hold Promise of Much Faster Processors

Perhaps the most complex data communications system of all is the neural network found in even the simplest of animals. These extremely complex interconnecting structures allow most animals to perform pattern-recognition tasks that even today can be approximated only by the largest supercomputer.

One division of AT&T's Bell Laboratories (Holmdel, NJ) is trying to develop better pattern-recognition capabilities by emulating very simple neural networks on integrated circuit chips. Some of this work has evolved from studies at another division of Bell Labs concentrating on the neural networks of slugs.

So far, the researchers have designed three electronic neural network (ENN) chips. The first, with 22 neurons and 22 input channels, was successfully tested last March. A second chip, with 54 neurons and input channels, was successfully tested in September. This chip contains almost 3000 synapses, connecting each input with each electronic neuron. Each synapse is a programmable resistor, which can be adjusted during the ENN's learning period.

Design work has just been completed on a 256-neuron chip, which will be built using a combination of standard CMOS and electron beam lithography. A fourth chip, with 512 neurons, is in the design stages.

The 54-neuron chip has been tested using simple search tasks. The chip was first "taught" a list of names. It was then shown a new name and asked which name on the list was most like it.

Because of the inherently parallel structure of the network, it can perform such tasks much faster than a conventional processor. According to Larry Jackel, head of Bell Labs' Device Structure Research Department, ENN chips can perform these tasks 100 to 1000 times faster than a conventional computer, and perhaps 10 to 30 times faster than special-purpose hardware. The response time of each electronic neuron is only 400 nanoseconds, much faster than a biological neuron.

The relatively small size of the resistors used on these chips makes possible a very high chip density, higher than that associated with conventional transistor-based circuits. Complexity of future chips may be somewhat limited, however, by the number of input connectors that can be added. Multiplexing the connectors may ease this problem but then might cause its own bottleneck. Jackel says his group is also working on combining the ENNs in hierarchically structured gangs.

IBM to Drop CGA; EGA Next on Chopping Block

IBM has moved to drop the Color Graphics Adapter from its line of available video cards. The company will also drop its CGA monitors, which have been the mainstay of color video for IBM since the introduction of its PC five years ago. According to a highly placed industry marketing executive, IBM's Enhanced Graphics Adapter and monitor are next on the chopping block.

"IBM will move to a system called the EGA Plus," the executive told Microbytes Daily. "Video is the only area where IBM can make big improvements quickly, and this is what you'll see," he said. He added that the EGA Plus will have higher resolution than the current EGA card but will not achieve the sought-after goal of 1024 by 1024 pixels. "That simply requires too much video memory to fit into their cost structure," the executive said.

The source declined to say when Big Blue would make the changes, but he did say it would be "within 12 months." He added, however, that other companies are on the trail of the EGA Plus. "Keep your eye on Paradise [Systems]," he said. "That's the same system that IBM will be using, but Paradise will release it first."

(continued)

Math Model Lets Engineers Simulate Earthquakes

Engineers at EPI-Center (Palo Alto, CA), an environmental engineering firm, and the Stanford University Earthquake Engineering Center have developed an earthquake analysis program. Called the Seismic Survival Indicator (SSI), the program is a mathematical model that's used with Lotus 1-2-3. SSI, which runs on an HP-110 portable computer for on-site analysis, provides structural analysis of a building's resistance to earthquakes.

Once the engineer enters data, including information about horizontal and vertical symmetry of the building, weight of the roof, amount of glass, and type of building material, an earthquake is mathematically simulated; the program returns the amount of structural damage as a percentage between 0 and 100 (0 indicating no potential damage, 100 meaning total collapse). When the data is used in conjunction with a review of building plans and local geography, recommendations regarding building design and insurance requirements can be made.

Beta tests on the program were run in the Coalinga and Morgan Hill districts of California, areas that have received heavy earthquake damage within the last three years. Engineers compared program results with real results and found that virtually all simulated results were within 1 or 2 percentage points of actual damages.

SSI is limited to single-site analysis and structures less than three floors in height.

Macintosh Helps Shape New Techniques in Metalwork

Mark Stanitz, an assistant professor in the School for American Craftsmen at Rochester Institute of Technology (Rochester, NY), is using an Apple Macintosh and Imagewriter for goldsmithing and other metalwork. He does design work on the Macintosh, removes the Imagewriter's ribbon, and then runs pure 24K gold or silver foil 3/1000 inch thick through the printer. The Imagewriter's printhead replaces the hammer and tool traditionally used to shape and decorate metal; it creates a shallow bas-relief of 15/1000 inch, similar to the impression on a quarter.

Stanitz coats the back of the foil with an epoxy resin, which fills the negative areas and hardens. He can then cold-set his creation with prongs or bezels into a superstructure (a piece of jewelry, for example). Other applications include copper wall murals created with MacDraw and hollowware fashioned by molding the foil and electroplating the back of it.

Advantages to Stanitz's method include faster and more exact geometric design and more efficient production work. Also, a goldsmith can incorporate pure materials, such as 24K gold, into jewelry at a small price. And perhaps most important, artists can spend 90 to 95 percent of their time on creative design and only 5 to 10 percent on mechanical processes.

Talking Tablet Speaks in Different Voices

Personal Data Systems (Campbell, CA), an electronics design firm specializing in computer aids for the visually handicapped, is working on an 8086-based briefcase-size computer called the Talking Tablet. The computer, designed and built by Noel Runyon, a blind electronics engineer and computer scientist who is president of the company, consists of a CPU and a detachable IBM-like keyboard. The CPU includes an 80-column by 25-line touch tablet that "displays" data that normally appears on a CRT. As you pass your fingers across the tablet, a built-in speaker "voices" the information that "appears on" the tablet. The speaker also repeats whatever you type in character, word, or line format.

The Talking Tablet is intelligent in the sense that it recognizes emphasis and format. Words that appear on a CRT in boldface or reverse video are spoken in a different voice pitch. Date, time, dollar, address, abbreviations, and other formats also are understood. For example, if you enter "1986," the Tablet returns it as "one-thousand nine-hundred eighty-six"; if you enter the address "St. John St.," it is returned as "Saint John Street." The speech circuitry is proprietary but uses a commercially available speech-synthesis chip.

The Talking Tablet's internal data storage is 756K bytes with a nonvolatile RAM disk; there's battery backup for static RAM. The built-in word processor can read MS-DOS text files as long as special graphics characters aren't present. Delivery dates and prices were unavailable at press time.

Zenith Chief Forecasts Multimegabyte Floppies, 386-based Machine

Multimegabyte floppy disks and a Zenith 80386-based machine will soon be with us, according to Robert Dilworth, president of Zenith Data Systems (Glenview, IL). Speaking at the

(continued)

We invented the modem that makes fewer demands on your PC.

The Ven-Tel Half Card™ modem. All the power and speed of our regular modems, but with some major advantages for people who demand versatility from their PC.

Regular modems plug into one of your computer's full-size slots. Just like expansion boards—color boards, graphics cards and memory expanders.

The Ven-Tel Half Card modem is different. It plugs into a short slot, freeing up a long slot so your PC can handle an additional function. And while other modems have about 300 components, ours has 70. So it not only demands less space from your computer—it also demands less power and generates less heat. Your PC stays cool and stress-free.

Competitively priced, the Half Card modem is available in both 1200 baud and 2400 baud speeds. And it's backed by Ven-Tel's free *five-year* warranty. No other major manufacturer even comes close.

If you make a lot of demands on your PC... demand the less-demanding modem: The Ven-Tel PC Modem Half Card.



Ven-Tel
Modems

Our free 24-page booklet, "How To Select The Correct Modem," contains specific information about our full line of modems. To request your copy, call 800-538-5121. In California, call 408-727-5721.

Inquiry 362

Air Force Small Computer Conference, Dilworth also indicated that a read/write optical disk may already be in final development.

Dilworth told Microbytes Daily that he expects big changes in mass storage. His forecast includes 20-megabyte floppy disks, hard disks that are so rugged they can be dropped on the floor without damage, and optical disks with full read/write capability. He said that all these products are under development and should be available soon. He also announced that Zenith would begin designing products that use 1-megabit RAM chips.

Dilworth said ZDS would introduce a computer based on the Intel 80386 "earlier than any other major company." (Compaq Computer Corp. of Houston, certainly a major company, rolled out the Deskpro 386 in early September, less than a month after Dilworth's claim.) Zenith has already introduced a 32-bit bus for its 240 line of IBM PC AT clones. Dilworth said most manufacturers will introduce 80386 machines that are simply faster versions of 80286 machines.

French Firm's System Allows Handwritten Input

Anatex has developed a combination software/hardware package that lets users input handwritten notes into a Macintosh. The system, called Personal Writer, uses special software with a Summagraphics graphics tablet. The software lets the user emulate both the keyboard and the mouse merely by moving the stylus of the graphics tablet in a certain way. Since handwriting varies dramatically from person to person, the user can teach the system to recognize his or her own style. According to Xavier Maury, general manager of the company, the system can be taught to recognize the handwriting of almost every possible user, except those with bizarre penmanship.

Personal Writer will be available initially for the Mac in the first quarter of next year. An IBM PC version will reportedly be available in the second quarter.

Anatex is located at 18 Rue Troyon, F-75017, Paris, France; the telephone number is (1) 47 66 02 60.

NANOBYTES

Xerox Palo Alto Research Center and **Xerox Artificial Intelligence Systems** (Palo Alto, CA) have jointly designed the Xerox VLSI Common LISP Processor. The microprocessor, which has a reduced LISP instruction set hard-coded on the chip (hence its nickname "LISP-on-a-chip"), supports both Common LISP ("CommonLoops") and the Xerox Artificial Intelligence Environment. The 40-bit device is the first object-oriented-program chip of its kind. . . . At the Seybold Desktop Publishing Conference, Microsoft's **Bill Gates** said that at least 10 firms would introduce plug-in full-page displays with graphics coprocessors for IBM PC compatibles at COMDEX this month. . . . **Fairchild Semiconductor** (Cupertino, CA) will begin shipping early in 1987 a 40-MHz version of its CMOS 32-bit Clipper microprocessor. The new chip set will execute as many as 6.5 million instructions per second, Fairchild says. The current Clipper—actually a CPU chip and two cache/memory-management chips mounted on a 3- by 4½-inch printed circuit board—executes 5 MIPS at 33 MHz and supports floating-point arithmetic. . . . **Locus Computing** (Santa Monica, CA) has licensed its PC-Interface software to Motorola Computer Systems. The software will be ported to the UNIX-based System 6300, 6350, 6400, and the 68020, as well as the VME-based 8000, for use as an MS-DOS file server. A Locus spokesperson said this will give users of IBM PCs and compatibles access to Motorola systems running UNIX System V. . . . **Atari Corp. Ltd.** (Berkshire, UK) unwrapped two new models of its ST, as well as a blitter chip that speeds graphics performance, at the Personal Computer World Show in London. The new 2080STF and 4160STF have memory capacities of 2 and 4 megabytes, respectively. The blit chip increases the speed of graphics applications by at least five times, the company claims. . . . Talking about microcomputers, **Richard Carver**, assistant secretary of the Air Force, said, "We can't go to war without these computers." Opening the Air Force Small Computer Conference, Carver said microcomputers "should be viewed as another weapon system."

TECHNOLOGY NEWS WANTED. *The news staff at BYTE is always interested in hearing about new technological and scientific developments that might have an impact on microcomputers and the people who use them. We also want to keep track of innovative uses of that technology. If you know of advances or projects that involve research relevant to microcomputing and want to share that information, please contact us. Phone the Microbytes staff at (603) 924-9281, send mail on BIX to Microbytes, or write to us at One Phoenix Mill Lane, Peterborough, NH 03458.*



INTRODUCING THE A★STAR II™

We're having a party! It's a going away party. And, it's for IBM. But, shhhh! Don't tell them. We want it to be a surprise!

Why a party? Well, it's because we've been told that more than a few of IBM's customers have been "going away" ever since we introduced our A★Star™ PC/AT compatible micro-computer. Now that we've announced our new A★Star II, we figure a lot *more* of their customers will be going away. That's because the A★Star II is the *only* "network ready" PC/AT compatible that can operate at 6, 8, 10 and 12 MHz. And because it's available in a super selection of models starting at only \$995!

The A★Star II is not just another clone, it's better...*much* better! Not only is it faster and more powerful

than IBM's model, it's also incredibly less expensive. Better yet, the A★Star II is built and backed by Wells American - a company that's been making micro-computers *longer* than IBM. (We bet that surprises even you!) Plus, the A★Star II is serviced nationwide by RCA Corporation - one of the world's largest and most respected consumer electronics firms. And if that's not enough, every unit includes free schematics and a money back guarantee!

If you'd like to be a part of our IBM going away party, clip and return the coupon or call us at the number below. But don't tell IBM! If they find out how many of their customers are going away, they might just go away themselves! Of course, that would be okay with us. We never *really* invited them anyway!

A PC/AT FOR ONLY \$995? WHAT A REASON TO CELEBRATE!

Special Introductory Offer: Order now and receive a \$395 option - absolutely FREE! Limit one per customer. Hurry! This offer and quantities are limited.

Name: _____

Company: _____

Phone: _____

Address: _____

City: _____

State: _____ Zip: _____



Wells American

803/796-7800 • TWX 510-601-2645
Sunset Boulevard • West Columbia, SC 29169

Corporate Headquarters: 3243 Sunset Boulevard • West Columbia, South Carolina 29169 • 803/796-7800 • TWX 510-601-2645

IBM, Personal Computer AT and AT are trademarks of International Business Machines.

CONSTANT
COMMITMENT

Complete
Management
Tool

There are enough copies of Symphony® software in use today to make Symphony, by itself, the fourth largest independent microcomputer software company in the world. Now let's discuss why.

It's a truly complete workstation for the modern manager... incorporating 1-2-3's® powerful spreadsheet capability with Symphony's own word processing, graphics, database and communications. All of them working together, all in one program.

As your computer knowledge grows, so Symphony grows. The more you use Symphony, the more you find you can do with it. And with a growing line of Symphony add-in products from Lotus® (Text Outliner, Spelling Checker, Symphony Link™ etc.), Symphony offers steady and seemingly endless potential for expansion.

A workstation. Thoroughly integrated. Geared for growth.

That's why Symphony is one of the world's most successful business software programs for IBM® personal computers and compatible products.

And that's why you ought to get a complete demonstration.

Lotus Symphony

A complete general-purpose software tool built around the world's leading spreadsheet technology.

© 1986 Lotus Development Corporation. Lotus, 1-2-3 and Symphony are registered trademarks of Lotus Development Corporation. Symphony Link is a trademark of Lotus Development Corporation. IBM is a registered trademark of International Business Machines Corporation.

You can't
outgrow it



CONTINUOUS
INNOVATION

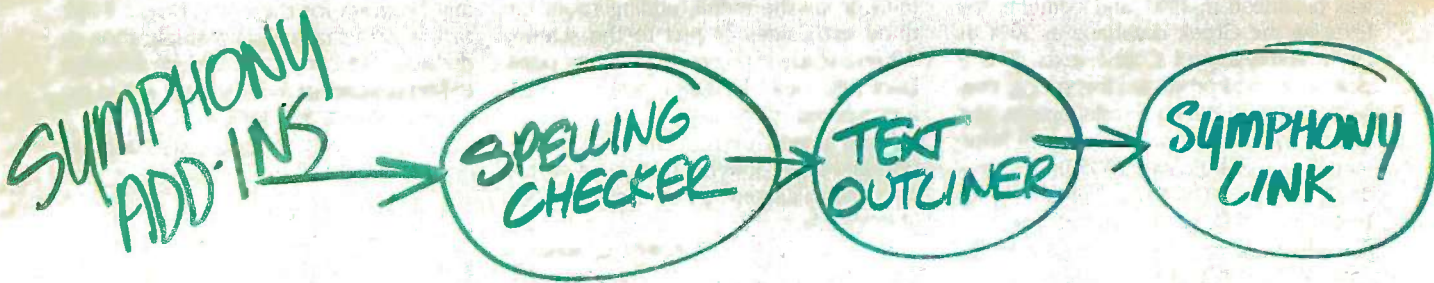
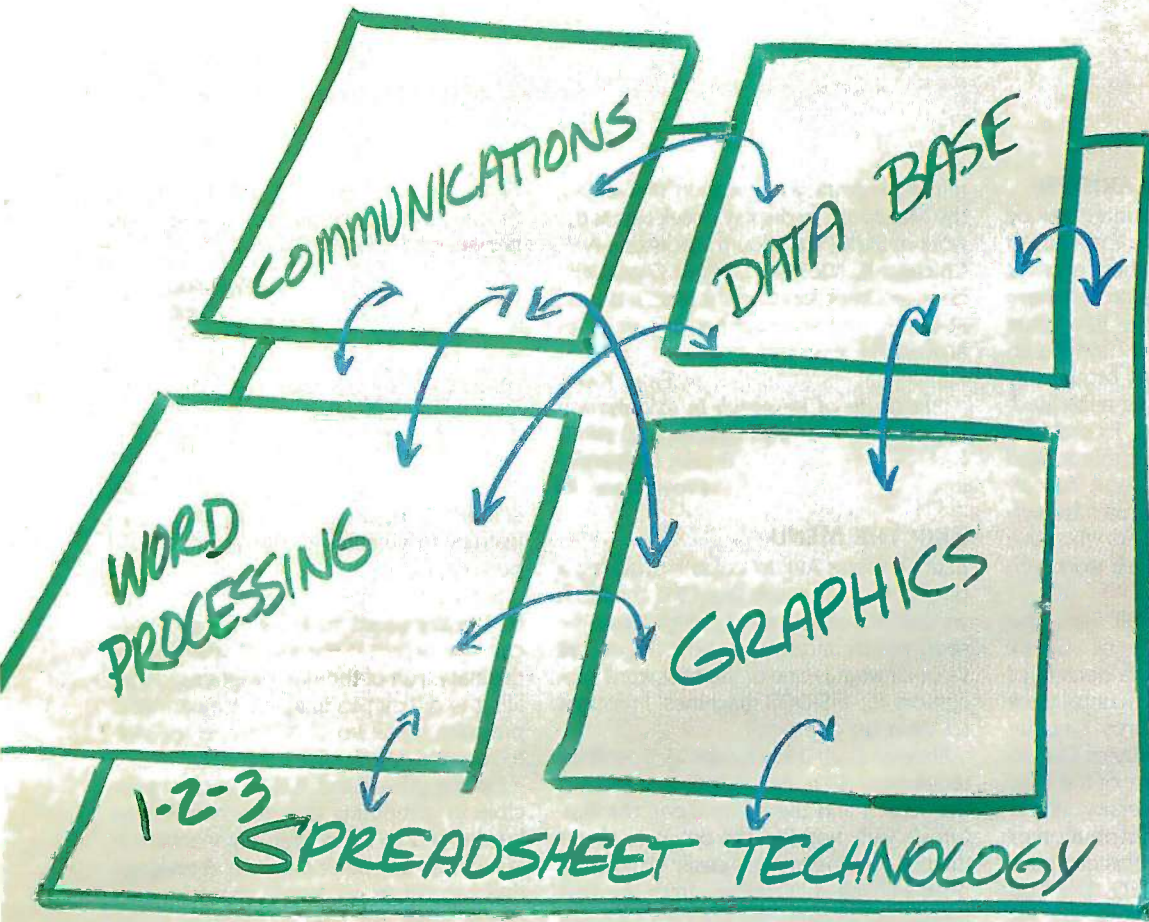

ISOCRATES PROJECT CLARIFIED

As the result of a telephone interview by a member of your New York-based editorial staff, BYTE published a small description of the Isocrates project here at Brown University in your July issue (Microbytes). While we appreciate the attention your publication has brought to our work, the description, as published, misstated what we are doing. Isocrates is very much a collaborative project, and much of what your description has attributed to "researchers at Brown University" is in fact the work of others who have been kind enough to share their work with us.

The Greek database itself (i.e., the machine-readable version of Greek authors) is the result of over a decade of data entry, verification, and maintenance by the staff of the Thesaurus Linguae Graecae (TLG) at the University of California, Irvine, and is the property of the TLG. It is used by Brown University under license from the TLG. Any distribution or use of a CD-ROM containing this database is at the discretion of the TLG. The TLG has in fact produced two CD-ROMs, referred to as the A and B disks. The A disk was produced in 1985 and contains the texts of the Greek database as well as Latin, Hebrew, and Coptic texts. The B disk, which was produced this spring, contains the Greek database plus indices. The role of the Institute of Research in Information and Scholarship (IRIS) in the production of the "TLG Pilot CD-ROM #B for Experimental Purposes" (the B disk) was limited to the creation of the index files and the formatting of the data for pressing. The production of the CD-ROM is the work of the TLG under the direction of Theodore Brunner and was supported by a grant from the David and Lucille Packard Foundation.

The ability of "Greek scholars... to find... every occurrence of a particular word in the work of an ancient author" has existed for some time now and is not the result of work done at Brown University. Our part has been in porting programs that do this to the IBM RT PC and integrating them with one of the TLG's CD-ROMs.

The modification of the Macintosh ter-

minimal program you mention that allows the Macintosh to display Greek text is the work of SMK (5760 South Blackstone Ave., Chicago, IL 60637), maker of GreekKeys, classical Greek fonts for the Mac. It is used at Brown and at a number of campuses around the country.

PAUL KAHN
*Institute of Research in Information
 and Scholarship (IRIS)
 Brown University
 Providence, RI*

SKIP THE MENU

Ezra Shapiro's August column provided a brief look at Microsoft Word 3.0, the latest version of that valuable program. Since he seems to be undecided about the overall value of what is one of the best word processors for MS-DOS machines, I thought I'd clear up one point.

Shapiro says, "I loathe the Microsoft interface (. . . with the useless box around the screen and the menu along the bottom)." Well, nothing can be done about the box, but the menu is easily eliminated. If he will select "Options" from the first menu, he can eliminate the menu display by selecting the "Menu: no" option. Word then drops the menu, adding room for three extra lines of text to the screen. When Escape is pressed, the menu pops back into view, disappearing again after a command is chosen.

Given Word's outstanding printer support and other powerful features, it seems a shame to judge it on an easily correctable interface.

GEORGE CAMPBELL
Los Osos, CA

COMPARING CLOCK RATES

When I upgraded myself from my 1977 Apple to a new Leading Edge, one of the reasons for the change was the attractive clock rate of the 8088 processor, which is 4.66 times faster than the old 6502. Thus, my programs should run faster, which is nice.

Indeed, modest research into the execution times of various 8088 commands indicated that increased speed could be expected. Using the timing technique I've outlined elsewhere (*Computing with the Apple*, Reston, 1984), I obtained the following

figures for some 8088 operations, expressed in terms of number of executions per second:

NOP	1,300,000
MOV BX,CD	350,000
MOV BX, AX	990,100
INC BX	1,080,000
ADD BX,CD	350,000
ADD BX,[1001]	165,000
MOV BX, [1001]	235,000

Corresponding times for the 6502 are simpler: Except for NOP and BRK, every instruction executes at the rate of 262,000 per second.

But such comparisons don't show what one really wants to know, namely, what can one expect in the way of speedup for ordinary, run-of-the-mill programs? After all, it is difficult to imagine a meaningful program made up of NOPs and register-to-register operations.

On the other hand, it is an ancient principle in computing that benchmarks can be devised to show that any machine is faster than any other machine. A program that capitalizes on certain characteristics of the 8088 (e.g., the inclusion of multiply and divide commands) should beat any program for the 6502 (or the 8080, or the Z80) that needs multiplication or division. Similarly, it should be possible to find features of the 6502 that would run circles around the 8088.

So, to satisfy my own curiosity, I decided on this program:

1. Generate ten random bytes.
2. Bubble-sort them.
3. Repeat 2000 times.

The ingenious random-number genera-
 (continued)

LETTERS POLICY: To be considered for publication, a letter must be typed double-spaced on one side of the paper and must include your name and address. Comments and ideas should be expressed as clearly and concisely as possible. Listings and tables may be printed along with a letter if they are short and legible.

Because BYTE receives hundreds of letters each month, not all of them can be published. Letters will not be returned to authors. Generally, it takes four months from the time BYTE receives a letter until it is published.

AST Sets The Multifunction Standard.

Again.



MULTIFUNCTION PRODUCTS

SIXPAK PREMIUM

AST RESEARCH INC.

Enhanced EMS Multifunction Board for the IBM PC, PC-XT and Compatibles

Offering Up To 2 Megabytes of Expanded Memory, Two Serial Ports, Parallel Port, Battery-Backed Clock/Calendar, Game Port, SuperPak™ Utility Software.

MULTIFUNCTION PRODUCTS

SIXPAK PLUS

AST RESEARCH INC.

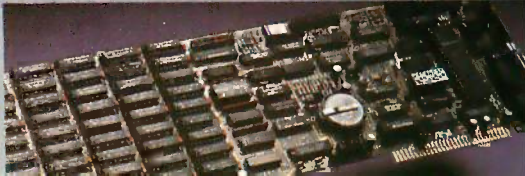

MULTIFUNCTION PRODUCTS

SIXPAK PLUS

AST RESEARCH INC.

Single-Slot Multifunction Enhancement Product for the IBM PC, XT and IBM PC-Compatibles

Offering up to 384Kb of Memory with a Serial Port, a Parallel Port, Clock/Calendar, and an Optional Game Port

First there was SixPakPlus®...the single most popular PC enhancement product in history.

Now AST has made the best even better. And SixPakPremium™ sets the new standard for multifunction boards

More Memory, More I/O And More Capability. We boosted SixPak memory with our Enhanced Expanded Memory Specifications (EEMS). SixPakPremium now gives you up to 2 megabytes of memory. Plus there's up to 2 serial ports, a parallel port, optional game port, clock/calendar and SuperPak™ utilities.

And to take full advantage of your expanded memory, we've included a powerful operating environment software package. It allows you to load all the applications you use during the day into SixPakPremium's memory once in the morning.

Now you can FastTask™, that's what we call the ability to move instantly between applications. FastTasking saves time because there's no fussing with diskettes or closing down one application to open another.

Certified By Lotus.® SixPakPremium is fully compatible with all the new, expanded-memory (EMS) versions of your favorite software packages. It's even certified by the Lotus Development Corporation to be compatible with its EMS versions of 1-2-3® and Symphony®.



Give us the test. Buy SixPakPremium. If



within 90 days you find an EMS application incompatible, we'll either establish compatibility or buy you a comparable EMS board of your choice*

You know us. You know SixPakPlus. Now get to know SixPakPremium—the new standard in PC functionality. **Now Call (714) 863-1480 For More Information.** Or send the attached coupon to AST Research, Inc, 2121 Alton Ave., Irvine, CA 92714-4992, Attn. M.C.

AST
RESEARCH INC.

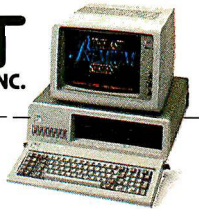

Yes! Tell Me More About SixPakPremium.

Name _____

Title _____

Company _____

Address _____

City _____ State _____ Zip _____

Phone (_____) _____

Send to: AST Research, Inc., 2121 Alton Ave.
Irvine, CA 92714-4992, Attn. M.C. OIBRO59A02SS 11-86

*Applies to boards purchased after 9/1/86. Valid only in U.S.A. Some additional restrictions apply. For complete details write to AST Research, Attn. M.C.G.

The AST SixPakPremium expanded memory multifunction board has successfully passed compatibility testing with Symphony Release 1.1, and 1-2-3 Release 2 and Release 2.01 on an IBM Personal Computer using PC DOS 3.1. Two megabytes of expanded memory were installed.

SixPakPlus registered and SixPakPremium, SuperPak, Premium Guarantee, Premium Series, and FastTask trademarks AST Research, Inc. Lotus, 1-2-3 and Symphony registered trademarks Lotus Development Corp. Copyright © 1986, AST Research, Inc. All rights reserved.



Super Power Compatibility

The POWER SYSTEM™ from PECAN has set a new standard for comprehensiveness in program development environments that you won't find anywhere else:

PORTABILITY: Whether you're an ardent beginner or a seasoned pro, THE POWER SYSTEM lets you design software that can run on virtually any mini or micro without having to rewrite the program. The program you write on one computer will operate on another — even if the two hardware systems are incompatible. Your software never becomes obsolete — even if your hardware does.

INTEGRABILITY: The versatility and flexibility of THE POWER SYSTEM enables different users to exchange program modules freely with one another, even though the modules may be written in different programming languages.

LANGUAGE INTERCHANGEABILITY: THE POWER SYSTEM lets you customize the modules of your application in the most appropriate of Pecan's powerful languages including UCSD PASCAL, BASIC, FORTRAN-77, ASSEMBLER, or MODULA-2. Once you've created your multi-language program, the modules are linked automatically. The application then runs as if you'd written it all in one language.

THE POWER SYSTEM FEATURES:

- NATIVE CODE • SEPARATE COMPILATION OF UNITS • EXTENDED PRECISION ARITHMETIC
- DYNAMIC MEMORY MANAGEMENT • EVENT-DRIVEN MULTI-TASKING • CONFORMANT ARRAYS
- PROCEDURAL PARAMETERS • 8087 AND BCD SUPPORT (PC'S AND COMPATIBLES) • LARGE FILE EDITOR
- LIBRARY UTILITY • ON-LINE HELP SYSTEM • FILE MANAGER

THE POWER SYSTEM Only \$99.95

For PC-DOS, MS-DOS, AMIGA, ATARI ST, MACINTOSH, RAINBOW, TANDY, STRIDE, as well as most popular 8/16/32 bit systems. Also available in VAX, UNIX, PDP-11 OS's & others.

THE POWER SYSTEM includes the language of your choice: UCSD PASCAL, MODULA-2, BASIC, ASSEMBLER and FORTRAN-77. Choose an additional language for only \$79.95. Buy three and we will send you a fourth one **FREE!**

To custom-tailor software, PECAN offers such programming tools as:

CROSS-ASSEMBLER/NGC PACKAGE.....	\$79.95	SOFTTEACH TUTORIAL.....	\$49.95
KEYED SEQUENTIAL ACCESS METHOD....	\$59.95	MENUMAKER.....	\$49.95
CODE OPTIMIZER.....	\$59.95	PROGRAM ANALYSIS TOOLKIT.....	\$59.95
SYMBOLIC DEBUGGER.....	\$59.95	SORT UTILITY.....	\$59.95

Write for complete list of development aids.

ATTENTION CORPORATIONS: Call and ask about our training seminars.
SCHOOLS: Special Educational Discounts

NOT COPY PROTECTED

Mail Your Check Or Money Order To:
Pecan Software Systems, Inc.
1410 - 39th Street
Brooklyn, New York 11218
(718) 851-3100
ITT TELEX NUMBER: 494 8910
COMPU SERVE CODE: 76703,520

PECAN™
The UCSD Pascal Company

Credit Card Orders
Call Toll Free **1-800-63-PECAN**
(NYS) 1-800-45-PECAN

Please add \$2.50 for shipping within the US. Foreign orders add \$10.00 and make payment by bank draft payable in US dollars on US bank. New York State residents add appropriate sales tax.

UCSD Pascal is a trademark of The Regents of University of California.

Inquiry 255

tor of Art Matheny (*Micro*, August 1982) is short and simple, passes every test except the correlation test, and uses only simple addition. It can be coded identically on the 6502 and the 8088.

After many trials, to cancel out any extremes caused by randomness, the time for the runs of 2000 was 6.38 seconds for the 6502 and 6.90 for the 8088.

This will lead to lots of wailing on the part of 8088 devotees. I would suggest that you take some program that you devise and make your own comparison.

My point is this: The widely acclaimed clock speed of the 8088 is almost meaningless, since the number of bytes per instruction can range from one to six. What counts is the mix of commands that *your* work requires.

I was astonished, however, to discover that, for the first program I could think of for a test, the 6502 turned out to be nearly 8 percent *faster* than the 8088.

FRED GRUENBERGER
Northridge, CA

IN SEARCH OF CHEAPER TRANSMISSION

More people are spending a lot of time communicating via modem these days. One major hassle with Buzby (British Telecom) and Ma Bell is uploading and downloading large amounts of text. Even at 1200 baud (not too common in Britain yet), it seems to take several eternities for even a short piece of text to wend its electronic way. Higher baud rates tend to require special (expensive) leased lines and require the user at the other end to have similar (expensive) equipment.

When dealing with text, the same characters often keep appearing in the same order: In this letter, the word "the" appears 24 times; including the terminating space, this requires 32 bits each time you want to send the same word. Given the move to 16-bit machines, perhaps it is time for an extended ASCII set to be introduced for datacomm transmission of text. I envision it as something like this:

The basic ASCII code would be a subset of this new code. With bit 7 = 0, the byte would be treated as a single standard ASCII code. If, however, bit 7 = 1, the lower 7 bits of this byte and the 8 of the following byte would be treated as a single 15-bit entity, giving 32,768 separate meanings.

This could be an index to a standard predisseminated dictionary of common words and regularly occurring letter groups (the latter technical terms). Each language could have its own dictionary; by selecting the same code for the word

(continued)

Inquiry 309 for End-Users.

Inquiry 310 for DEALERS ONLY. →

To Over 30,000 Installations, MultiLink® MEANS Multi-User.

At over 30,000 sites, as many as one-quarter of a million users tap into the power of MultiLink® Advanced everyday.

Since 1983, they've come to rely on our multi-tasking, multi-user system for compatibility with their favorite software, and the ability to share disks, files, printers, and programs in a *true* PC-DOS environment.

From the largest of the Fortune 500 to the smallest in small business, MultiLink® has provided a cost-effective multi-user solution that's available from no one else.

MultiLink® Means Cost-Effective Timesharing on a PC. MultiLink® Advanced utilizes the principle of timesharing by sharing a central PC's peripherals, files, and processor time among nine users. Up to eight inexpensive terminals can be connected to a single non-dedicated IBM PC, XT, AT or 100% compatible using standard RS-232 ports. Each terminal effectively emulates a PC having up to 512K RAM.

PC-Shadow™ Workstations, shown below, even have an AT look-alike, as well as work-alike, keyboard, display, and serial port. In addition, password-protected remote access via modem can be made with either dumb terminals or PCs running our terminal emulation software.

MultiLink® Means PC-DOS Compatibility with a Software-Driven System. Lotus 1-2-3, Symphony, WordStar, dBASE III, & Multimate are just a sampling of the wide variety of PC-DOS software that's fully compatible.

Our software-driven system is also IBM NETBIOS compatible, so programs that are written for IBM's Token Ring will run on our multi-user system, as well.

MultiLink® Means Multi-User to Leading Computer Publications. Whether you read *PC Magazine*, "MultiLink® Advanced delivers on...convenience, speed, and flexibility;" or *InfoWorld*, "If you want a low-cost multiuser system with up to eight terminals, MultiLink® Advanced is worth a serious look;" it becomes clear that MultiLink® Advanced is a formidable contender in the multi-user marketplace.

See What MultiLink® Can Mean to You. Learn, firsthand, how our multi-user system can benefit your company. Call The Software Link TODAY for complete information and the authorized dealer nearest you. MultiLink® Advanced is \$595 and comes with a money-back guarantee.

MultiLink® is a registered trademark of The Software Link, Inc. MultiLink® Advanced & PC-Shadow™ are trademarks of The Software Link, Inc. IBM PC, XT, AT, PC-DOS, Token Ring, & NETBIOS are trademarks of IBM Corp. WordStar, dBASE III, Multimate, Lotus 1-2-3 & Symphony are trademarks of MicroPro, Ashton-Tate, Multimate International, & Lotus Development Corp., respectively.

MultiLink® ADVANCED



THE SOFTWARE LINK, INC.

8601 Dunwoody Place, Suite 632, Atlanta, GA 30338 Telex 4996147 SWLINK

CALL: 404/998-0700

Dealer Inquiries Invited

THE SOFTWARE LINK, INC./CANADA
250 Cochrane Drive, Suite 12 Markham, Ontario L3R 6B7
CALL: 416/477-5480

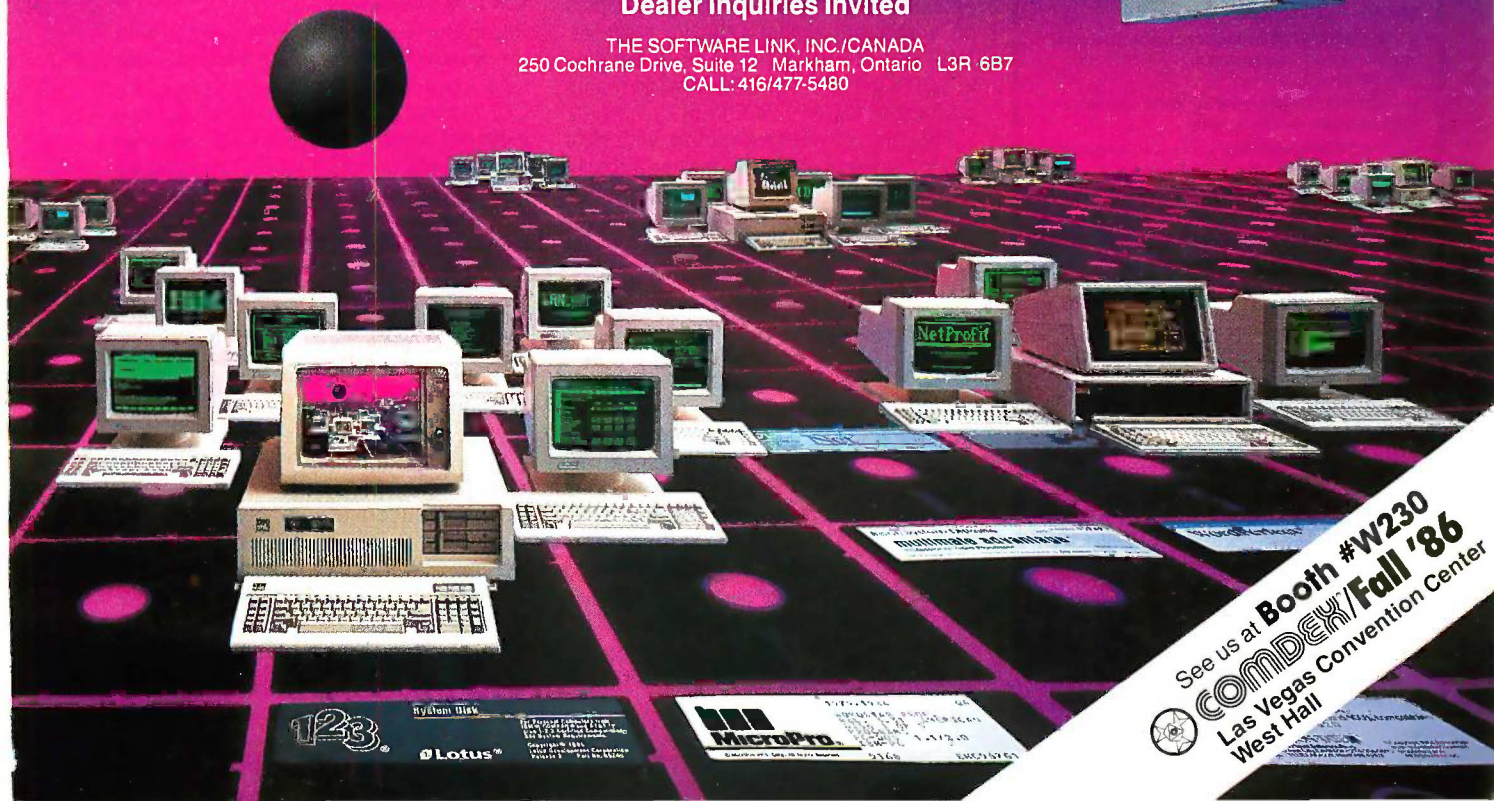

See us at Booth #W230
COMDEX/Fall '86
Las Vegas Convention Center
West Hall

Finally, software you don't have to be rich to own.

We're PC-SIG. The world's largest library of user-supported programs where authors ask that you send a donation—and free public domain programs. For only \$6, you buy software that's been selected from leading authors, thoroughly analyzed, and technically supported. Perhaps that's why we've been referred to as the Robin Hood of software publishers.

- #499 **PROCOMM** Professional communications program written in compiled MicroSoft C and assembly code.
- #523 **SIDE WRITER** Perfect for spreadsheets, this application prints text files sideways.
- #528, 529 **NEW YORK WORD** Powerful word processing with split-screen editing, mail merge, auto hyphen, and more.
- #574 **FREECALC** Word processing and spreadsheet application for forecasting and budgeting.
- #78 **PCWRITE** Our most popular word processor. "I'm more at ease with PCWRITE than WordStar."
- #521 **FREE FILE** Easy-to-use and learn relational data base manager.
- #522 **INSTANTRECALL** Memory-resident program for storing and retrieving a wealth of information.
- #405 **DESKMATE** Desk organizational tool with phone dialer, notepad, calendar, and calculator.
- #478 **HARD DISK UTILITIES** The best and most useful utilities for the hard disk user.
- #133 **ULTRA UTILITIES** A must for every PC owner. For recovering lost or accidentally erased files.
- #558 **PC-PROMPTA** memory-resident help utility that provides formatting for DOS commands online.
- #429 **ELEMENTARY C** Application for learning C language.
- #424 **PASCAL COMPILER** Popular compiler written in Turbo Pascal.
- #423 **PROJECT MANAGEMENT** PC management system capable of handling 1000 tasks.
- #237 **PC-GENERALLEDGER** For the serious bookkeeper. All the controls needed for balancing the books. Plus an audit trail.
- #404 **EZ-FORMS** Program for generating tailor-made forms. "Compared to \$80 packages, this is super."
- #518 **EXPERT SYSTEM** Now your computer can act as if it were actually thinking. For diagnosing situations and formulating solutions.
- #480 **PC OUTLINE** Like Thinktank, this is a great way to organize, outline, and classify ideas.
- #515, 516 **THE DRAFTSMAN** Create data graphs or slide shows from Lotus 1-2-3, Symphony, or Visicalc.
- The PC-SIG introductory special: any 5 diskettes plus 1-year membership...\$39.
- 1 year PC-SIG Membership (\$35 foreign). Includes printed directory, supplement, quarterly magazine....\$20.

Total Enclosed \$_____ by Check VISA MC Card No. _____

Signature _____
 Exp. date _____ Phone # _____
 Name _____
 Address _____
 City _____
 State _____ Zip _____

To order, call: 800-245-6717
 In CA: 800-222-2996
 For technical questions or local orders: (408) 730-9291
 1030-D East Duane Avenue,
 Sunnyvale, CA 94086
 Dealer inquiries invited.



Software in the public interest.
 Add \$4 postage and handling (\$10 foreign)—CA residents add state sales tax.

with the same meaning in different languages, it would even provide the basis for a crude language translator.

There are other refinements, such as using bits to switch "Trailing space" or "Leading character capitalized" on and off for individual codes, but the fine details would be better left to a standards committee to nail down and enforce. It is worth noting that this will also allow large text databases (such as the text of a megablocking novel) to be compressed to perhaps 25 percent of their original storage space. My own personal dream is to have the complete runs of Astounding/Analog, Fantasy and Science Fiction, Galaxy, and all the other SF magazines on one CD-ROM in machine-readable and machine-searchable form; duplication cost: about ten bucks. The transcription and royalty costs are another problem, but we have the technology.

ROBERT SNEDDON
Glasgow, Scotland

NOT YOUR BASIC BASIC

ZBasic is fast and is the only interpil that creates .COM files in CP/M (and so it has no BASIC competitors) but I had hoped for more when I bought it. In fact, I had hoped for what the ZBasic ad promises: "It retains the old commands you already know." Well, some, but not all. Its differences require hours to convert MBASIC-80 programs to ZBasic. For example, SORT works fine in MBASIC-80 but not in ZBasic, because SORT contains OR, a reserved word, within it. (Microsoft solved the embedded-words problem five years ago!) SORT is only one of many examples of translations that ZBasic requires. MBASIC allows periods in variables (SORT.SCORES), but ZBasic allows only underlines (SORT__SCORES).

ZBasic is a hacker's paradise, with data types carried to absurdity, making it totally wrong for education. For example, for PRINT 1/3, ZBasic gives the false answer of zero! To get a correct answer, ZBasic needs one of these: 1./3, or 1!/3, or 1#1/3. And as if four compulsory data types were not enough, ZBasic also provides 2 to 54 digits of precision, which programmers may use to produce data files with enough variations in numbers to confound and confuse not only others, but even the unwary programmer himself when he attempts to use such data files later without knowing the exact digits of precision in the data file. Applesoft, North Star BASIC, and Turbo Pascal opted to keep data simple—much to the convenience of the users—and ZBasic could have provided a default of one precision (maybe 11 digits, like Turbo Pascal) and allowed other options

for the hackers.

In many ways ZBasic is a modern, powerful, fast, ingenious implementation of BASIC, but in other ways it is five years out of date.

EDWARD L. TOTTLE
Baltimore, MD

COMPUTERS IN MUSIC

I think BYTE is missing an opportunity. I expect that there is a large portion of your readership that would be interested in a regular column that examines the MIDI interface and MIDI devices.

Computers and music seem to go together, especially in this digital age, and many programmers are also interested in music. After having my interest piqued by your June (Computers and Music) issue, I started to look through music stores and picked up a copy of *Keyboard* magazine. Although I've been a loyal BYTE reader since 1978 and have read several other personal computer magazines as well, I was caught completely by surprise by the capabilities of even inexpensive MIDI synthesizers and the scope and state of the art of MIDI software.

Your June issue presented an excellent overview of the hardware and software that's now literally taking over the music world, but an issue every year or so that deals with music can at best hit only the very high spots. *Keyboard* has a regular column on programming. Perhaps BYTE should have a regular column on music.

BEN BARLOW
Rochester, NY

CRT RADIATION

Regarding the letter by Forrest Mims III in the August BYTE (page 20) where he corrects a previous author's comments about CRT radiation levels: Mr. Mims's work is itself not without fault. I am familiar with some of his previous work and have no quarrel with his hardware expertise; I am sure that he has built a very sensitive radiation detector. However, there is a problem involved in the nature of the measurements he is making.

Measurement of ionizing radiation is a textbook example of a random process. In this case, the random factor is the time between events; thus, in a given time period the number of events (counts of the Geiger counter) is also random. The mathematical properties of phenomena that have random components have been studied for a long time, and in modern times we have a fairly good understanding of them. The twin sciences of probability theory and statistics allow certain types of predictions to be made concern-

(continued)

THE NO FRILLS PLOTTER

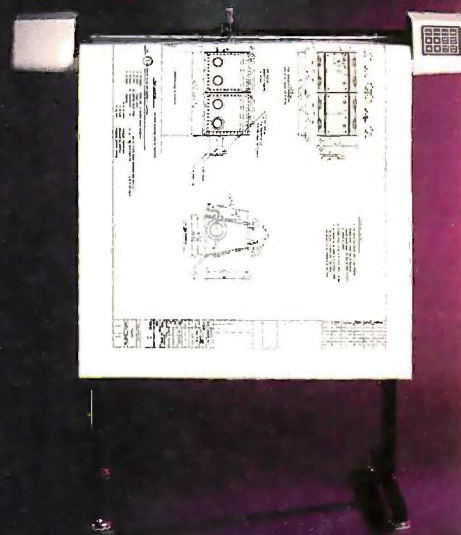

Enter the world of professional CAD applications with Houston Instrument's low cost DMP-41/42 series plotters. These single-pen plotters give you the features you need—C and D size plots, extensive software compatibility, and proven reliability—for a very affordable no frills price of \$3295.*

The DMP-41/42 series' large C and D size formats are ideal for a wide range of CAD applications, from architectural elevations to assembly drawings. And a .005 inch resolution ensures crisp drawings on a variety of media—paper, matte film, or vellum.

With the DMP-41/42 series, you can choose from an impressive selection of off-the-shelf graphics software packages such as VersaCAD, AutoCAD, and CADKEY. Or, by using Houston Instrument's popular DM/PL™ language, you can create your own custom software and be assured of upward compatibility with Houston Instrument's entire line of plotters.

The DMP-41/42 series. The plotters that offer superb reliability, comprehensive graphics capabilities, and a no frills price. The proven performers for low-cost CAD.

For more information, call

1-800-531-5205 (512-835-0900 if in Texas), or write Houston Instrument, 8500 Cameron Road, Austin, Texas 78753. In Europe, contact Houston Instrument, Belgium NV., Rochesterlaan 6, 8240 Gistel, Belgium. Tel.: 32-(0)59-277445. Tlx.: 846-81399.

*U.S. suggested retail price. Pricing subject to change.
DM/PL is a trademark of Houston Instrument.

houston instrument

A Division of **AMETEK**

Inquiry 152

ing the behavior of such phenomena.

In the case at hand, I'm sure Mr. Mims has noticed that, when repeating either of his measurements (background or CRT), the value obtained was not exactly the same each time. This difference is a fundamental property of the nature of the random process being studied. In the case of ionizing radiation measurements, the amount of variation to be expected is a well-known quantity and is described by a mathematical construct called the

Poisson distribution.

One of the properties of the Poisson distribution is that the amount of variation you might expect to encounter depends upon the number of events involved. This translates, in the particular case we are discussing, into the fact that the variation in the number of counts per minute decreases as the total measurement time gets longer. Mr. Mims gives no details as to how he made his measurements; therefore, my best guess is that he counted for

1-minute intervals and reported the number of counts measured in that time period. If, in one case, you have measured 17 counts (as Mr. Mims did for the background), then the properties of the Poisson distribution tell us that in other measurements of the same quantity you will get a variation that has an upper limit of just about 35, the count found for the CRT. In other words, Mr. Mims's measurement of 35 counts does not prove that the CRT has higher radiation levels, because he could have gotten the same measurement from a repeat reading of the background! For this reason I find his measurements less than convincing. A much stronger case could be made simply by counting for intervals of several minutes in both cases and calculating the average counts per minute from that data.

HOWARD MARK
New York, NY

Mr. Mark incorrectly assumes that my conclusion that some CRTs can emit ionizing radiation was based on a single 1-minute measurement of two CRTs. In fact, I made several such measurements and reported a representative set of results in my letter.

For the purpose of this reply I placed a commercial radiation counter adjacent to the screen of a color television set and made a series of six 5-minute measurements. Between some of these measurements I monitored the background count for 5 minutes at a point 1 meter from the TV set. The results (counts per 5 minutes) were:

TV On	TV Off	Background
119	111	72
122	108	67
110	87	58

The averages of these data are 23.4 counts per minute when the TV was on and 20.4 when the TV was off. The background count averaged 13.1 events per minute.

The most interesting aspect of these results is the high count when the TV set is off. Apparently, the CRT or other components of the set are slightly radioactive. My guess is that the phosphor coating behind the faceplate of the CRT is the source. In any event, the conclusion of my original letter that CRTs can emit low but measurable levels of ionizing radiation remains valid.

Readers of BYTE with access to a radiation meter may wish to automate CRT radiation-level measurements. I have described a simple optocoupler interface for a radiation meter and a computer in

(continued)

FoxBASE wins the dBASE race! 6.43 times faster than dBASE III PLUS

New FoxBASE+ sweeps the field: runs 2.26 times faster than Clipper, 6.69 times faster than dBCOMPILER, and 10.86 times faster than dMAN! And FoxBASE compiles programs up to 60 times faster than other compilers.

The others aren't even close!

New FoxBASE+ is totally compatible with dBASE III PLUS as is original FoxBASE with dBASE II. No changes in your present programs, databases, screens, or reports!

Though FoxBASE is a super-fast compiler, it offers the familiar, user-friendly interactive features of dBASE and the full power of "dot prompt" mode plus many significant enhancements.

FoxBASE is available in single and multi-user versions for MS-DOS, XENIX, UNIX, many networks, and other environments.

Best of all, FoxBASE is economical. Single-user FoxBASE costs just \$395, multi-user FoxBASE \$995*—no matter how many workstations you have.

So call (419) 874-0162 now, and ask for a copy of our detailed benchmarks. After all . . .

Nothing Runs Like a Fox.

FOXBASE 

Fox Software
27475 Holiday Lane, Perrysburg, OH 43051
(419) 874-0162 Telex: 6503040827

*Computed as reported in Computer World, 10/11/87, p. 10. For benchmark programs: "for MS-DOS, Multi-user XENIX version available at \$795. FoxBASE and FoxBASE+ are trademarks of Fox Software. dBASE II and dBASE III PLUS are trademarks of Ashton-Tate. Clipper is a trademark of HanUckel. dBCOMPILER is a trademark of Worldtech Systems Inc. dMAN is a trademark of VersaSoft Corporation. UNIX is a trademark of AT&T Bell Laboratories. XENIX and MS are registered trademarks of Microsoft Corporation.

You can buy the Leading Edge® Model “L” Series™ 2400B Modem with communication software for less than what you'd pay for a Hayes® 1200B Modem.

And the Leading Edge Model “L” Series 2400B is fully Hayes and IBM®-compatible, has auto-answer and auto-dial features, fits in a half-size expansion slot and operates at 300, 1200 and 2400 bps as well. It's priced at only **\$289⁰⁰**

Also available, the Leading Edge® Model “L” Series™ 1200B Modem priced at **\$149.95**

Call 1-800-USA-LEAD for more information or a dealer near you. In MA call (617) 828-8150.

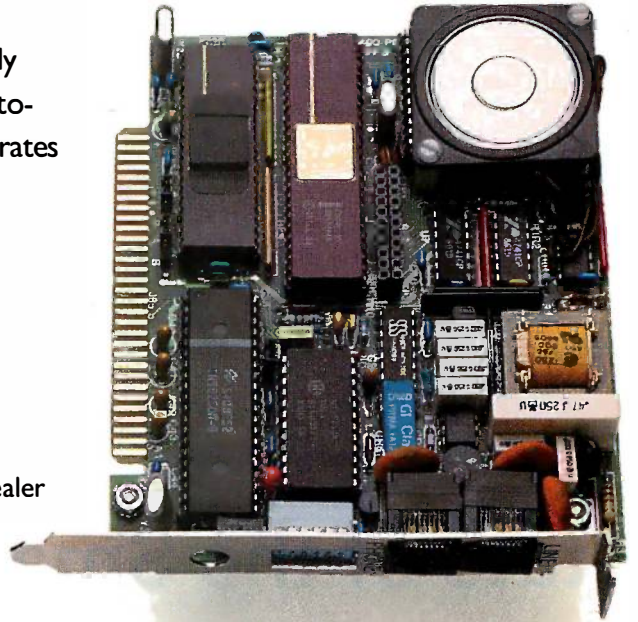

LEADING EDGE

Leading Edge Hardware Products, Inc.

225 Turnpike Street, Canton, MA 02021

1-800-USA-LEAD or (617) 828-8150 in MA

Forrest Mims's Computer Projects (*Osborne/McGraw-Hill, 1985, pages 55-60*). I plan to describe a similar technique for long-term radiation measurements in my column in *Modern Electronics*.

FORREST M. MIMS III
Seguin, TX

MATHEMATICS OF PROGRAMMING

While Prof. Hoare's objective of applying mathematics of programming (August) is laudable, he starts off on the wrong foot. Many mathematical laws do not apply to truncated or rounded numbers of fixed word length. Consider, for example, the following instance of the associative law (his figure 1), in which the numbers are rounded to two significant figures after multiplication:

$$(.12 \times .95) \times .67 = (.11) \times .67 = .074(1)$$

$$(.12 \times (.95 \times .67)) = .12 \times (.64) = .077(2)$$

In programming many numerical tasks (for example, finding all of the roots of a polynomial), coping with finite-digit arithmetic is the only nontrivial part of the job.

PHILIP R. GEFPE
Salisbury, MD

COMPATIBILITY— A ONE-WAY STREET

There is one aspect of computer compatibility that appears to have been largely overlooked: the reverse compatibility of the IBM microcomputers with their various compatibles as well as the compatibility of the compatibles with each other. Here is how I came face to face with this problem.

I have recently compiled a GW-BASIC program on a Zenith Z-158 computer using the Microsoft BASIC compiler version 3.02. The compiler created an .EXE file that worked beautifully on the Zenith. However, to my great surprise, when I tried the disk with my .EXE file on IBM, Tandy, NCR, Leading Edge, and Epson computers, the program would not work. In each case the computer returned the message "Cannot execute a child of BASIC." As far as I could ascertain, the only computer other than the Zenith Z-158 on which the program did work was a Hewlett-Packard.

I then compiled the same BASIC program on the Zenith by using the Microsoft QuickBASIC compiler version 2.0. As before, the compiled program worked

beautifully on the Zenith and also on the IBM PC. But the IBM PC XT and Epson Equity I would not even read my .EXE file, returning the message "Not ready error reading drive A," although both computers properly showed the disk directory in response to the DIR command (I did not try this compiled program on the other computers).

I then compiled the same BASIC program on the IBM PC XT by using the same Microsoft QuickBASIC compiler. Now the program ran perfectly on the IBM and on all other computers.

Thus, computer compatibility is mostly a one-way affair. The "compatibles" are designed to execute machine-language programs created for the IBMs on the IBMs. But, in general, neither the IBMs nor the compatibles can execute, or even read, machine language programs created on a different machine.

Let this be a warning to those who intend to create IBM software by using a compatible computer. Better make sure beforehand that your intended compatibility is two-way compatible.

OLEG D. JEFIMENKO
Morgantown, WV ■

State of the Smart.

* FCC APPROVED

SmarTEAM 2400B

- Internal slot modem for IBM PC, XT, AT and compatible computers
- 7.5 inches length with the same great features of SmarTEAM 2400
- MITE+ software optional

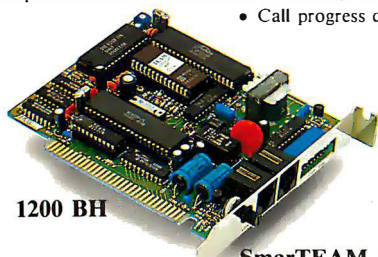

1200 BH



SmarTEAM 1200 AT

- Bell 103, 212A standard
- Fully Hayes compatible.
- Auto dial (pulse or tone), auto answer
- 2 self test modes (analog loop back and remote digital loop back test)
- Call progress detection (dial tone, busy)

SmarTEAM 1200 BH

- 5 1/4' length with the same great features of SmarTEAM 1200 AT
- Internal slot modem for IBM PC, XT, AT and compatible



SmarTEAM 2400

- 0-300, 1200, 2400 bps. Bell 103, 212A. CCITT V22, V22 bis. Full duplex
- Auto dial (pulse or tone), auto answer automatically switches between tone and pulse
- Hayes 2400 commands compatible
- 6 self test modes
- Call progress detection (ringing, dial tone, busy)

SmarTEAM 1200 CT

- Compatible with CCITT V.21 and V.22 Alternate B 1200bps asynchronous
- 0-300, 1200 bps full duplex
- Compatible with Hayes commands
- Auto dial (pulse or tone), auto answer

* OEM WELCOMES

HEAD OFFICE:

TEAM TECHNOLOGY INC.

2F, No. 2, Alley 2, Szu Wei Land
Chung Cheng Rd., Hsin-Tien City
Taipei, Taiwan, R.O.C.
TLX: 19725 PETRCHEN
FAX: (02)7251830
TEL: (02)918-9249 • 7252836 (Sales Dept)

U.S. Sales And Service

SmarTEAM INC.

19205 PARTHENIA St. Ste. J
Northridge, CA 91324
TEL: (818)886-9726
Service No.:
(818)8869729
FAX: (818)886-6731

CANADA

BUDGETRON INC.

TEL: (416)673-7800

SINGAPORE:

PET Computers

TEL: 5331313

SPAIN

ARCE IBERICA. S.A

TEL: (414)440462

HONG KONG

QUANTUM DATA SYSTEMS LTD.

TEL: 3-897278

- ★ Hayes is a registered trademark of Hayes Microcomputer Products, Inc.
- ★ IBM PC, XT, AT are registered trademarks of International Business Machines Corp.
- ★ MITE is a registered trademark of MYCROFT LABS INC.

LANGUAGES THAT ARE CAUSING THE BIGGEST PROGRAMMING BACKLOG IN HISTORY ARE ALSO EATING NICE BIG HOLES IN OUR POCKETS.

Whether it's BASIC, COBOL, Pascal, "C", or a data base manager, you're being held back.

Held back because the language has frustrating limitations, and the programming environment isn't intuitive enough to keep track of what you're working on.

In the real world, there's pressure to do more impressive work, in less time, and for more clients.

We've been given some incredibly powerful hardware in recent times, but the languages aren't a whole lot better than they were 20 years ago.

So, whatever language you have chosen, by now you feel it's out to get you — because it is.

Sure, no language is perfect, but you have to wonder, "Am I getting all I deserve?"

And, like money, you'll never have enough.

Pretty dismal, huh?

We thought so, too.

So we did something about it.

We call it CLARION™.

You'll call it "incredible."

Distributed on 7 diskettes, CLARION consists of over 200,000 lines of code, taking 3+ years to hone to "world-class" performance.

With CLARION you can write, compile, run and debug complex applications in a New York afternoon.

Even if you're in Savannah.

It gives you the power and speed to create screens, windows and reports of such richness and clarity you would never attempt them with any other language.

Because *you* would have to write the code.

With CLARION you simply design the screens using our SCREENER utility and then CLARION writes the source code AND compiles it for you in seconds.

Likewise, you can use REPORTER to create reports.

Remember, only CLARION can recompile and display a screen or report layout for modification.

And with no time wasted.

All the power and facilities you need to write great programs, faster than you ever dreamed of.

Programs that are easy to use. Programs that are a pleasure to write.

And to you that means true satisfaction.

You've coveted those nifty pop-up help windows some major applications feature. But you can't afford the time and energy it takes to write them into your programs.

That's the way it used to be.

So we fixed that, too.

CLARION's HELPER is an interactive utility that let's you design the most effective pop-up help screens that you can imagine. And they're "context sensitive," meaning you can have help for every field in your application.

Unlike the other micro languages, CLARION provides declarations, procedures, and functions to process dates, strings, screens, reports, indexed files, DOS files and memory tables.

Imagine making source program changes with the CLARION EDITOR. A single keystroke terminates the EDITOR, loads the COMPILER, compiles the program, loads the PROCESSOR and executes the program. It's that easy!

Our data management capabilities are phenomenal. CLARION files permit any number of composite keys which are updated dynamically.

A file may have as many keys as it needs. Each key may be composed of any fields in any order. And key files are updated whenever the value of the key changes.

Like SCREENER and REPORTER, CLARION's FILER utility also has a piece of the CLARION COMPILER. To create a new file, you name the Source Module. Then you name the Statement Label of a file structure within it.

FILER will also automatically rebuild existing files to match a changed file structure. It creates a new record for every existing record, copying the existing fields and initializing new ones.

Sounds pretty complicated, huh?

Not with CLARION's documentation and on-line help screens. If you are currently competent in BASIC, Pascal or "C" you can be writing CLARION applications in a day. In two days you won't believe the eloquence of your CLARION programs.

Okay, now for the best part of all. You can say it in CLARION for \$295.00—plus shipping and handling. All you need is an IBM® PC, XT, AT or true compatible, with 320 KB of memory, a hard disk drive, and a parallel port.

And we'll allow a full 30 day evaluation period. If you're not satisfied with CLARION, simply return it in its original condition for a full refund.

If you're not quite ready to take advantage of this no-risk opportunity, ask for our detailed 16 page color brochure. It vividly illustrates the elegance of CLARION. Consider it a preview of programming in the fast lane.

Either way, the 800 call's a freebie.



SAY IT IN

CLARION™

DEPT. A4BY/7

1-800-354-5444



BARRINGTON SYSTEMS, INC. 150 EAST SAMPLE ROAD POMPANO BEACH, FLORIDA 33064 305/785-4555

IBM is a registered trademark of International Business Machines Corporation. CLARION™ is a trademark of Barrington Systems, Inc. ©1986 Barrington Systems

STATE OF THE

Tech PC Desktop Computers are designed for survival. The XT's leave your desktop looking comfortably empty with their slim non-obtrusive profile; The AT's give you a powerful presence with a clean lined sturdy chassis. Combined with a 14 inch, 800 by 400 line amber monochrome monitor or a 14 inch, 1280 by 800 black and white monochrome monitor you've got **State**

of the Art staring straight back at you. If 8 MHz 80286 power isn't fast enough for you . . . try the Tech Turbo PC/AT with its 10MHz 80286 and 10 MHz 80287 math co-processor socket. The Tech Turbo PC/AT gives you the **strongest, most powerful** 80286 performance available from anyone, anywhere . . . available with up to 16 megabytes of memory and hard disks up

TECH PC DESKTOP COMPUTERS are available now in 4 different base models:

TECH PC/XT DESKTOP \$ 529

Options:

Tech PC/XT with 20MB Hard Disk \$979

Tech PC/XT with 20MB Hard Disk, Monochrome Monitor, Hercules® Compatible Mono/Graphics Card \$1179

TECH TURBO PC/XT DESKTOP \$629

Options:

Tech Turbo PC/XT Desktop with 20MB Hard Disk . . \$1079

Tech Turbo PC/XT 20MB Hard Disk, Monochrome Monitor, Hercules® Compatible Mono/Graphics Card \$1279



ART DESKTOPS

to 1 gigabyte with our new optical storage disk, the Tech Personal Computer Desktops represent the cutting edge of desktop microcomputer technology.

Tech Personal Computers, Inc. is a full service manufacturer of Micro Computer Products and offers a complete line of Desktop, Portables and Multi-User Computer Systems as well as an accessory line of over one hundred

enhancement products. **Tech Personal Computers, Inc.** are all backed by a full one year warranty with additional maintenance coverage and extended maintenance contracts available through Momentum Service Corp. For more information concerning hundreds of Service Centers throughout the United States, contact **Tech Personal Computers, Inc.** at (714) 754-1170.

TECH PC/AT DESKTOP\$1399

Options:

Tech PC/AT with 20MB Hard Disk\$1799
 Tech PC/AT with 20MB Hard Disk, Monochrome Monitor, Hercules® Compatible Mono/Graphics Card\$1999

TECH TURBO PC/AT DESKTOP\$1599

Options:

Tech Turbo PC/AT Desktop with 20MB Hard Disk . . . \$1999
 Tech Turbo PC/AT with 20MB Hard Disk, Monochrome Monitor, Hercules® Compatible Mono/Graphics Card . . . \$2199

All **TECH PC DESKTOPS** available with tape backups, hard disks up to 1 gigabyte, networking systems, and hundreds of other hardware and software accessories.

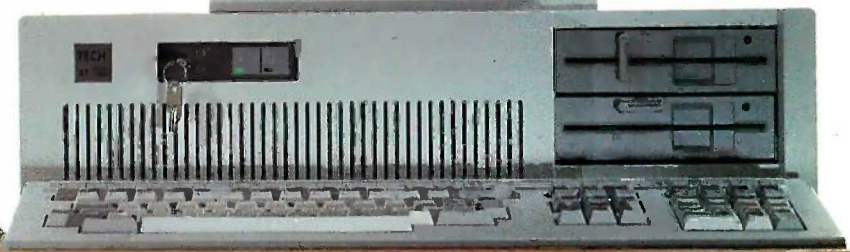

TECH PC (714) 385-1711

1911 Betmor Lane, Anaheim, California 92805
 Telex 272006 Answer Back - TECH FAX: 7143851523

EXPAND YOUR PC TO NEW HORIZONS

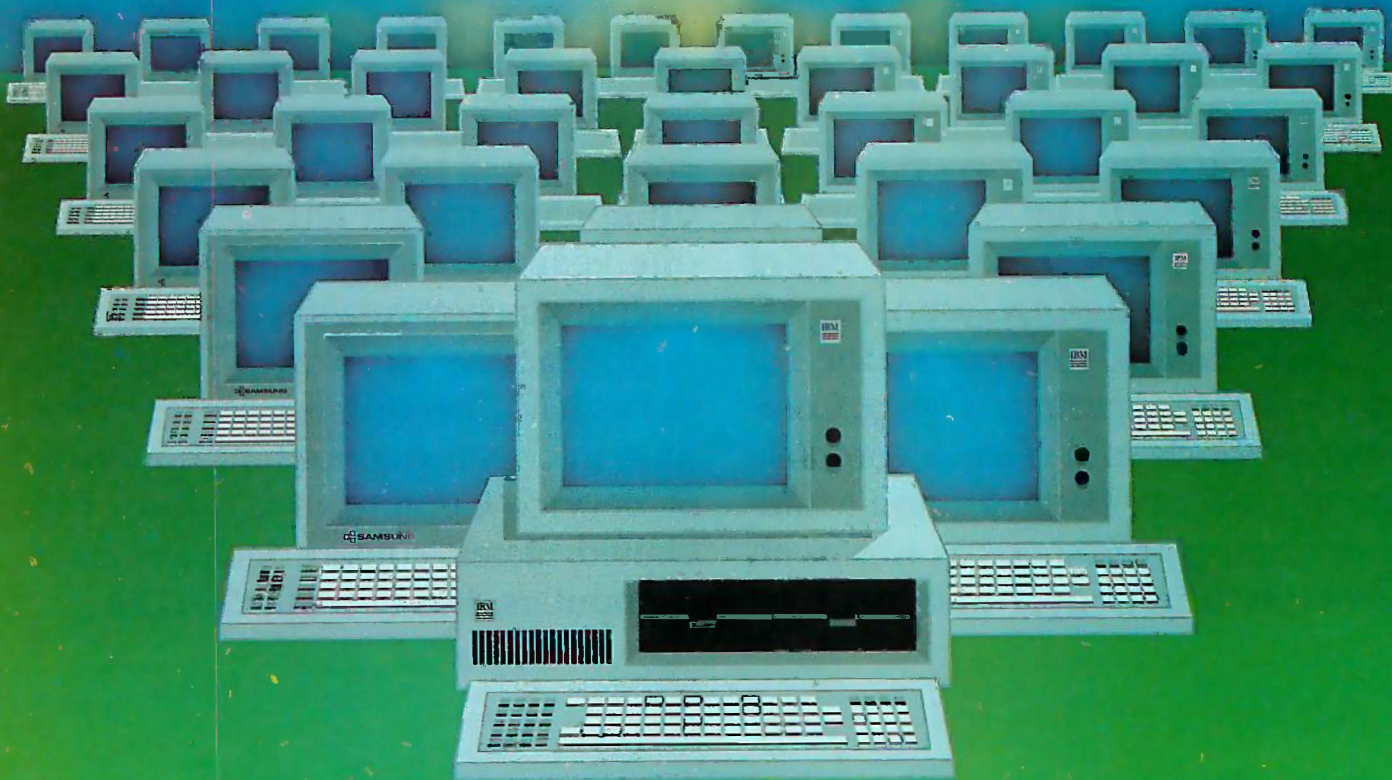

PC-Slave II The Ultimate Two-User Card

Advanced Digital now offers you two additional users for the price of one!

With our PC-Slave II, you can quickly turn your personal computer into a host computer for a complete 3-user system. The PC-Slave II lets two additional users share one PC and all the expensive hardware and peripherals that you've already paid for. Plus you share access and communication between users and PC's.

Each slave has two CPU's, two 512K bytes of memory, keyboard and monitor interface, making it possible for each user to work on the same program or two entirely different programs...as if they were two independent PC's.

PC users often ask us how to network their many PC's. The solutions are many but expensive and slow. Advanced Digital's answer — the PC-Slave II — allows you to add additional workstations at a more reasonable cost...and with much faster performance than any local area network or software package.

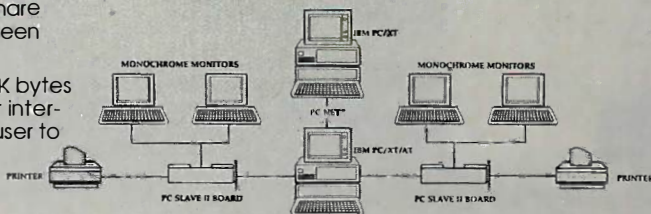
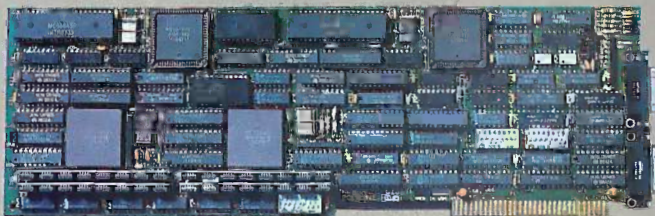

All you need to complete your 3-user system is the PC-Slave II, IBM's PC-NET software, and two low-cost monochrome monitors and keyboards. No new operating system, no new commands and no complications of a LAN.

Each PC-Slave II gives your PC the full capabilities of two PC's and can support DOS 3.1 providing each user 100%

compatibility with PC programs.

Advanced Digital offers many other PC products including the ADC-TAPE60, PC-EXBUS, PC-Slave, and more!

For more information, call 1-800-251-1801 (outside California).

Advanced Digital Corporation
5432 Production Drive
Huntington Beach, CA 92649
(714) 891-4004; (800) 251-1801
Telex 183210 ADVANCED HTBH

Advanced Digital U.K. Ltd.
27 Princes Street
Hanover Square
London W1R8NQ—
United Kingdom
(01) 409-0077
Telex 265840 FINEST

ADC
ADVANCED DIGITAL CORPORATION
Inquiry 402 for End-Users.

DEC Introduces VAXmate PC

Digital Equipment Corp. announced the VAXmate computer, an IBM PC AT compatible capable of networking with VAX and MicroVAX computers. At the same time, the company introduced PC All-in-1, a MicroVAX II-based system that can connect up to 30 computers including VAXmates, and VAX/VMS Services for MS-DOS, software that links the VMS and MS-DOS operating systems.

The VAXmate, which runs on an 8-MHz 80286 microprocessor, consists of a system unit with a built-in monitor and 5¼-inch floppy disk drive. The \$4045 computer comes with a mouse and a keyboard that supports both DEC and IBM key functions. In addition to MS-DOS 3.1, the system's software includes Microsoft Windows, Microsoft's Networks software, and VT220 and VT240 terminal emulators; the software license costs \$250. The networking software and Windows run in the upper 360K of the computer's 1 megabyte of RAM.

The VAXmate is also equipped with an Ethernet transceiver that supports the company's DECnet and Thin-Wire Ethernet local area network, which transmits information at 10 megabits per second. Via a server, the VAXmate can store and access files on VAX and MicroVAX systems. Besides VAX-based computers, the network can connect DEC Rainbows and IBM PC XT's and AT's running Digital's



DEC's VAXmate, a networking AT compatible.

DECnet software, as well as IBM mainframe systems linked to the network through DECnet/SNA Gateway software. Network integration kits for IBM PCs and Rainbows will be available in 1987, the company says.

Additional features of the VAXmate include serial and parallel ports and a video controller that supports DEC and IBM graphics modes, including CGA, EGA, and PGA standards. The VAXmate can hold an optional 2-megabyte memory-expansion board (\$1600), an internal Hayes-compatible 2400-bps modem (\$995), and a math coprocessor (\$500). Other options can be added with an expansion box (\$1945) that has a 20-megabyte hard disk and two AT-compatible expansion slots.

With PC All-in-1, the VAXmate can access services of DEC's All-in-1 integrated office system, such as document processing and electronic mail. Priced at \$81,160, PC All-in-1 contains all the MicroVAX II hardware, software, and services for linking up to 30 computers: several PC All-in-1

systems can also be connected.

Using Microsoft Windows as an interface, VAX/VMS Services for MS-DOS enables PC-compatible computers to store and access information on VAX, MicroVAX, and VAXmate computers acting as servers. With the software, computers can access MS-DOS applications software and files, share laser printers and other peripherals, and access VMS-based files from remote systems on the network. The software ranges in price from \$650 to \$19,500, depending on configuration; the company plans to offer versions for Rainbows and IBM PC XT's and AT's in 1987.

Digital will also sell server-based licenses for Microsoft's Multiplan, Project, and Chart and Access Technology's 20/20 spreadsheet package. According to DEC, third-party software companies will offer versions of their software for use on the servers.

For more information, contact Digital Equipment Corp., Maynard, MA 01754-2571, (800) 344-4825.

Inquiry 550.

Ashton-Tate Brings dBASE to the Mac

Ashton-Tate introduced dBASE Mac, designed with pop-up menus and dialog boxes to enable you to create and modify the program's data files. A feature called Quick Create provides you with a template for data entry screens and reports, or you can customize the templates with dBASE Mac's graphic layout capabilities.

Using the mouse, you can combine up to 36 data files through common fields. To create custom reports, you can select type styles and sizes, design and draw on the screen, and store and incorporate graphic images.

Software developers can create turnkey applications, including customized alerts and pull-down and pop-up menus. A procedural language includes pre- and postprocessing, add, delete, and write records procedures, if-then statements, and mathematical calculations. A Protect mode prevents you from altering applications.

A 512K Macintosh or a Macintosh Plus, with at least one 800K floppy disk drive, is required. The program costs \$495. For more information, contact Ashton-Tate, 20101 Hamilton Ave., Torrance, CA 90502-1319, (213) 329-8000.

Inquiry 551.

(continued)

Works for the Mac

Microsoft Works contains a word processor, database, spreadsheet with graphics, and a communications module. You have the ability to work with up to ten files at once, and Microsoft reports that you can combine information from one module into another with a click of the mouse button.

The word processor has a drawing facility that lets you draw lines, boxes, and circles around or on top of your text. It also has automatic background pagination, a copy format option to copy paragraph formatting from one paragraph to another, and an option for printing mailing labels in custom sizes. With the word-processing module, you also have the ability to create form letters, and text and graphics can be mixed on screen.

With the database, you can add, delete, or rename fields, and you can store data in up to 60 fields per form.

The spreadsheet has 256 columns and 9999 rows with 54 built-in functions that enable you to perform financial, scientific, or logical calculations. You can also create pie, bar, line, or combination charts for display with data.

The communications module enables you to transmit all spreadsheet, database, and word-processor files without conversion. It also allows you to store up to eight telephone numbers for each document. XMODEM and MacBinary file transfer protocols are supported.

Microsoft Works sells for \$295 and runs on a 512K Macintosh or a Macintosh Plus.

For more information, contact Microsoft Corp., P.O.

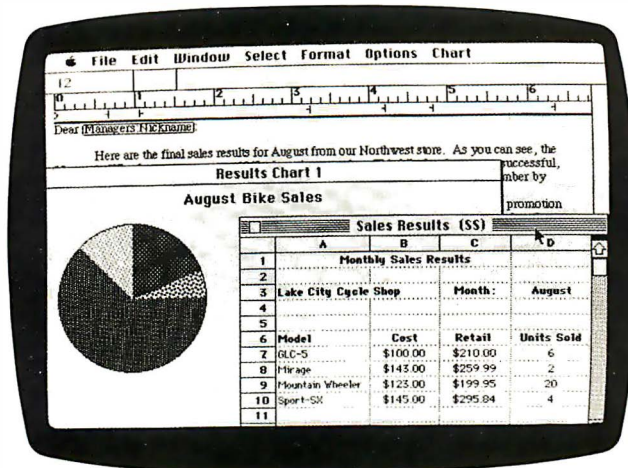

Microsoft Works' word-processing module mixes text and graphics on-screen.

Box 97017, Redmond, WA 98073-9717, (206) 882-8080. Inquiry 552.

Corvus Announces 80386-based Series

Corvus Systems introduced the Series 386 workstation and 70- and 126-megabyte file servers, all based on Intel's 80386 microprocessor. The machines' 80386 operates at 16 MHz and provides 32-bit memory, two 32-bit expansion bus interfaces for RAM expansion, and enhanced BIOS functions.

The workstation, which is compatible with the IBM PC AT, and file servers come with 512K bytes of RAM on the motherboard and a 16-bit, 2-megabyte RAM expansion board. Each unit can hold six half-height storage devices. Standard features include an AT-compatible keyboard, a 1.2-megabyte floppy disk drive, and a 200-watt power supply. The workstation and lower-capacity file server are equipped with a 70-megabyte hard disk drive with an average access time of 40 ms; the higher-capacity file server uses a 126-megabyte hard disk with an access time of 30 ms. The file servers also incorporate a

60-megabyte streaming tape drive and come with Novell 2.0a software, available in 8086 or 80286 protected-mode versions.

The workstation sells for \$12,795; the 70- and 126-megabyte file servers cost \$16,595 and \$19,795, respectively. The company says that it is working with Award Software of Los Gatos, California, to develop an extended AT-compatible ROM BIOS for use on the Series 386. According to the company, the extended BIOS will take advantage of the 80386's advanced capabilities and maintain compatibility with the 80286 BIOS used in the IBM PC AT. For more information, contact Corvus Systems Inc., 2100 Corvus Dr., San Jose, CA 95124, (408) 559-7000. Inquiry 553.

SCSI-based Hard Disks for the Mac Plus

General Computer announced an external 20-megabyte hard disk drive, the HyperDrive FX/20, for the Macintosh. The drive uses the SCSI port that's standard with the Macintosh Plus and with upgraded versions of 512K Macs. The drive's data transfer rate

ranges from 510K bytes per second to 1.25 megabytes per second (peak). Priced at \$1199, the drive includes a print spooling utility that enables you to queue several documents for printing on a LaserWriter while the computer performs other tasks. Also bundled with the drive are a backup utility and a security program that encrypts data in a file and destroys all traces of the original. For more information, contact General Computer Corp., 215 First St., Cambridge, MA 02142, (617) 492-5500. Inquiry 554.

Supra Corp., manufacturer of the SupraDrive hard disks for the Atari ST computer, also introduced a 20-megabyte external hard disk drive for the Macintosh Plus. The 3½-inch drive connects to the Mac's SCSI port and sells for \$799. The drive comes formatted and boots without the use of a floppy disk. The drive's software uses Apple's Hierarchical File System and, the company says, is compatible with all Macintosh applications. For more information, contact Supra Corp., 1133 Commercial Way, Albany, OR 97321, (503) 967-9075. Inquiry 555.

ProAPP introduced the ProAPP 40S, an external 40-megabyte hard disk drive that connects to the SCSI port on the Macintosh Plus. The drive operates with an average access time of less than 30 ms and is compatible with the original version of the Finder as well as with Apple's Hierarchical File System. Priced at \$1995, the drive comes preformatted and with menu-driven installation software. Contact ProAPP Inc., 10005 Muirlands, Suite O, Irvine, CA 92718, (714) 855-9088. Inquiry 556.

(continued)

RAM-Resident Program Users...

IT'S EASY TO WIN WHEN YOU BUY THE REFEREE™

**With Referee,
you make
the rules.**

If you use desktop organizers, spell checkers, keyboard enhancers or other RAM-resident programs, you may have already discovered the horror of "RAM Cram."

RAM Cram occurs when memory-resident programs compete with each other (and with applications programs) for control of your keyboard or other computer resources. It's a fierce competition that can cause your computer to lock up completely. Then you pay the penalty—in lost time and lost data.

Referee, by Persoft, is a new type of software that puts you in total control of your RAM-resident programs.

And that puts Referee in a league all its own. You can create your own RAM Teams™ for specific applications programs. Team Superkey™ and Sidekick™ with Lotus 1-2-3™. Or call in Prokey™ and bench the others when you switch to dBASE III™.

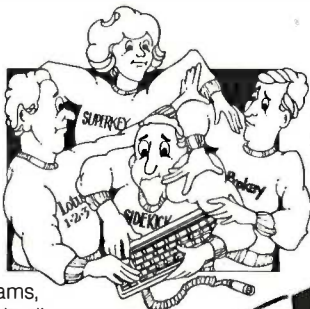

Load all the programs you need at the beginning of your workday. Referee automatically activates and deactivates the ones you need according to *your* set of rules. Instantly. Invisibly. You can also use Referee to unload programs from memory—even those with no unload option of their own.

Referee's Sideline™ menu enables you to control RAM-resident programs from within an applications program!

It's ideal for integrated packages like Symphony™. You can use a keyboard enhancer with the spreadsheet module. Or deactivate it, enter the word processing module and activate your favorite spell checker. It's easy. And you never have to back all the way out of the program!

Referee puts an end to RAM-resident program conflicts. At \$69.95, it solves a very big problem for a very small price.

It's easier to win with the Referee on your side. For more information, and for the dealer nearest you, contact: Persoft, Inc., 465 Science Drive, Madison, WI 53711, (608) 273-6000—Telex 759491.

Referee™

persoft

© Copyright 1986 Persoft, Inc. All rights reserved.
Referee, Sideline, and RAM Teams are trademarks of Persoft, Inc.
Sidekick and Superkey are registered trademarks of Borland International, Inc.
Lotus 1-2-3 and Symphony are registered trademarks of Lotus Development Corp.
Prokey is a trademark of RoseSoft, Inc.
dBASE III is a registered trademark of Ashton-Tate.

**Visit Booth #8624
Hilton Pavillion West
COMDEX/Las Vegas**

Sperry Introduces Fast AT Clone

Sperry introduced the PC/microIT, a smaller, lower-cost, speeded-up version of the firm's PC/IT. The new machine features a 15-inch-square footprint and five expansion slots, arranged horizontally. Like the older PC/IT, the new computer is manufactured by Mitsubishi but features a slightly faster processor. The PC/microIT's processor runs at a top speed of 8 MHz with no wait states, whereas the older processor has a top speed of 7.16 MHz with no wait states. A standard feature of the computer is support of synchronous communications as well as the more common asynchronous communications. According to Sperry, all one has to do is attach a modem and the appropriate terminal emulation software in order to communicate with various mainframe computers. The system can also be configured to support five users under XENIX System V.

A diskless version of the PC/microIT with 512K bytes of memory and a Key Tronic-type keyboard costs \$2345. A version that includes a 20-megabyte hard disk drive, but no floppy drive, costs \$3590. A 20-megabyte hard disk card is available for \$995, and a 1.2-megabyte floppy drive costs \$275. Monitors are additional. For more information, contact Sperry Corp., World Headquarters, Blue Bell, PA 19424-0031, (215) 542-4213 or 542-4217. Inquiry 557.

Modular Business Software

Open Access II is a six-function modular business system. The modules include a database with a



Sperry's PC/microIT runs at a top speed of 8 MHz

programming language, spreadsheet, graphics, word processor, communications, and utilities.

The programming language within the database module controls window generation and other screen functions. It uses a free-text format that eliminates line numbers and column restrictions. The database also features global update functions and a status window that shows calculation results as you add, change, or delete records.

With the spreadsheet, a goal-seeking function enables you to define up to five target values, then work backward to perform "what if" calculations automatically. The spreadsheet also features three-dimensional, high-resolution graphics. And you can use the cross-table analyzer to summarize data and incorporate it into specific tables. The spreadsheet also features a text

editor, mail-merge and calc-merge capabilities, and the ability to display up to four spreadsheets on-screen simultaneously.

According to the manufacturer, you can use the desktop utilities no matter where you are in the Open Access II system. Utilities include appointment scheduling, a business-card file with auto-dial, a calculator, alarm, three-time-zone clock, and a calendar.

Open Access II runs on IBM PCs, XTs, ATs, and compatibles with at least 256K bytes of RAM. The program costs \$595, and a network version is available for \$995. For more information, contact Software Products International, 10240 Sorrento Valley Rd., San Diego, CA 92121, (619) 450-1526. Inquiry 558.

External RAM Storage for IBM PCs

Santa Clara Systems announced a nonvolatile RAM-based external storage system called BATRAM

(short for "battery RAM") for use with the IBM PC and compatible computers. The unit is functionally the same as a hard disk drive although it has no internal moving or mechanical parts. According to the company, the device can transfer data at rates as high as 4 megabytes per second, up to 700 percent faster than hard disk drives. The BATRAM's rechargeable electrolyte gel batteries provide up to two weeks of uninterrupted power so that no data is lost when the system is turned off or power is interrupted. The unit can also be treated as extended memory.

The basic model comes with a 4-megabyte memory board and has four slots available for memory upgrades. The system can be expanded with 4- or 16-megabyte memory cards, to a maximum of 80 megabytes. The unit's interface card plugs into a short slot and supports 8-bit and 16-bit architectures; interrupts and DMA channels are not used. Other features include full error detection and correction capabilities and support for Novell NetWare utilities. The unit also supports all DOS utilities and lets you create and use multiple DOS partitions. The BATRAM's base price is \$1895 for a 4-megabyte system; additional 4-megabyte cards cost \$1295 each. Memory cards with 16 megabytes of RAM will not be available until next year.

The company also plans to introduce next year optional software that automatically backs up data onto a hard disk connected to the unit. For more information, contact Santa Clara Systems Inc., 1610 Berryessa Rd., San Jose, CA 95133, (408) 729-6700. Inquiry 559.

(continued)



Perfect Balance

Now the scales are in your favor. Dac-Easy Accounting gives you the best price plus tremendous performance. That means value, and the experts agree. Dac-Easy Accounting was recognized by *InfoWorld* as 1985's overall "BEST SOFTWARE VALUE."

No other accounting package can match the explosive user base or the unanimous acclaim from industry experts. Dac is the perfect choice for your first accounting system or for upgrading from a single module system. Either way compare, and you will join over 150,000 people who have computerized with Dac-Easy.

PERFORMANCE

Accurate information when you need it is what performance is all about. Fast, flexible reports give you what you need to know to manage cash-flow, turn inventory and increase profits... Listen to the skeptics-turned-believers.

"Dac-Easy Accounting is so inexpensive... we were skeptical... We expected to find a program that couldn't compete on a feature-by-feature basis... We were wrong."
InfoWorld, 1985

EXPANDABILITY

You never have to worry about outgrowing the Dac-Easy Series, which offers seven software products, support, and ten different business forms. All of our products are top performers offered at amazing prices.

Dac-Easy Payroll is the best full featured payroll system on the market.

Dac-Easy Tutors are disk-based tutorials available for Accounting and Payroll.

Dac-Easy Port sends accounting and payroll files to your favorite spreadsheet.

Dac-Easy Mate is the perfect companion to Accounting and Payroll offering file look-up, macros, calculator, color, and much more.

Dac-Easy Word is our easy to use word processor that is packed with powerful features. Dac-Easy Forms and Fast Forms offer the best in continuous, multi-part forms, and checks.

INTEGRATION

Dac-Easy's seven modules work together perfectly. Enter data once and it's posted to the other modules automatically. Also, most modules can be used stand-alone.

FEATURES

General Ledger

- Unlimited multi-level accounts with screen inquiry for three years
- Pencil and pen correction option
- Automatic budgeting by department
- Unlimited journals and departments
- Excellent audit trail and flexible financial statements

Accounts Receivable

- Open invoice or balance forward per customer for unlimited number of customers
- Multi-sorted mailing labels
- Statements and invoices support automatic finance charges and special comments
- Detailed history for three years for number of invoices, sales, cost, and profits
- Customized aging report
- Automatic sales forecasting

Accounts Payable

- Checks handle multiple invoices, unlimited allocations and cash available protection
- Multi-sorted vendor labels and directories
- Customized aging report
- Automatic forecasting of purchases

Inventory

- Average, last purchase, and standard costing
- Physical inventory with perpetual comparisons
- Accepts fractional measure such as dozens
- Automatic forecasting of product needs
- Automatic forecast of product sales
- Detailed three-year history for every product
- Automatic pricing, alert and activity reports
- Screen inquiry for on-hand/ on-order/sales/cost/profit/turns/GROI/etc.

Purchase Order

- Inventory and non-inventory items
- Allows up to 99 lines
- Per line discount in %
- Accepts generic deductions
- Accepts back orders and returns
- Purchase journal

Billing

- Service or Inventory invoicing on plain or pre-printed forms with remarks
- Prints sales journal
- Allows return credit memo

Forecasting

- Uniquely program that automatically forecasts using your three-year history:
- Revenue and expense accounts
- Vendor purchases
- Customer sales, cost and profit
- Inventory item usage
- Four different forecasting methods

OVER 80 ROUTINES AND 300 REPORTS

FLEXIBILITY

Dac offers the rare ability to handle either service or product-oriented companies without sacrificing features.

"Dac-Easy Accounting is everything its designers say it is... It is also flexible enough to fulfill the accounting needs of almost any type of business."

Journal of Financial Computing, 1985

NOW FOR ATARI & APPLE

Dac-Easy Accounting and Payroll are now available for the Atari 520 & 1040 ST.

Dac-Easy Accounting is also available for the Apple II+, IIe & IIc.

SUPPORT

Subscribe to our toll free support agreement and join the best support program in the industry. Our friendly 12 person support staff are trained to answer your accounting and technical questions. No excuses, and no delays.

Find out for yourself why Dac-Easy is the fastest selling accounting package in history. Call us today!

1986 PC WORLD World Class Winner

TO ORDER
CALL TOLL FREE
1-800-992-7779

Ask for Operator #829

IN TEXAS CALL

1-214-458-0038

or mail the
order form below.

Mail to:

dac software, inc.

4801 Spring Valley Rd
Bldg. 110-B
Dallas, TX 75244

**Yes, please rush me
the following Dac
products:**

Product	Qty.	Price	Total
Dac-Easy Accounting	—	69.95	—
Dac-Easy Payroll	—	49.95	—
Dac-Easy Word	—	49.95	—
Dac-Easy Mate	—	39.95	—
Dac-Easy Port	—	29.95	—
Dac Accounting Tutor	—	19.95	—
Dac Payroll Tutor	—	19.95	—

Add Shipping Charge 7.50

Texas Residents
Add Sales Tax (6½%)

TOTAL

Check Money Order

AMEX VISA MASTERCARD

Account # _____

Expires _____

Signature _____

Name _____

Company _____

Address _____

City _____

St. _____

Zip _____

Phone _____

Computer Brand _____

Type of Business _____

No. of Employees _____

30 Day Money-Back Guarantee

Dac Software offers an unconditional guarantee on all Dac-Easy products (less shipping charges). There is a \$10 restocking fee if the disk seal is broken. This guarantee is available on all products bought directly from Dac Software.

MS-DOS is a trademark of MicroSoft Corp. IBM and PC-DOS 2.0 are registered trademarks of International Business Machines Corp.

#829

Minimum hardware requirements

All Dac-Easy products run on IBM or other compatibles. 256K memory, two disk drives, MS-DOS, PC-DOS 2.0 or later, 132 column printer in compressed mode, color or monochrome monitor. Selected products available on the Atari ST and Apple II series.

Dac Easy Accounting™

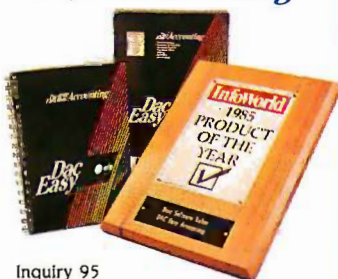

Inquiry 95

Compaq Adds Hard Disk, RAM to Deskpro 286

Compaq Computer Corp. announced a new version of the Deskpro 286 that features a 20-megabyte hard disk, 640K bytes of RAM, and a 1.2-megabyte floppy disk drive. The new machine, the Model 20, carries a suggested retail price of \$3999. The Model 20 incorporates an 8-MHz 80286 processor and can hold four storage devices. At the same time, the company reduced the price of the Model 1, the earlier version of the Deskpro 286, from \$3999 to \$2999; the Model 1 has 256K bytes of RAM and a 1.2-megabyte floppy disk drive. For more information, contact Compaq Computer Corp., 20555 FM 149, Houston, TX 77070, (713) 370-0670. **Inquiry 560.**

Bubble-Memory Card for IBM PCs

Intel introduced a memory-expansion board for IBM PCs and compatibles that provides up to 1 megabyte of nonvolatile storage. The PC-Bubble Card fits into an expansion slot and emulates the functions of a hard disk drive. According to the company, the card's bubble memory enables it to withstand harsher environmental conditions than traditional hard disk drives.

The card comes with 512K bytes (\$895) or 1 megabyte of bubble memory (\$1545). It's equipped with a controller, a PC bus interface, PC I/O channel interface logic, and an EPROM-based I/O driver that makes the unit compatible with all versions of MS-DOS and PC-DOS.

An evaluation version of the card is also available

and includes software that enables designers to program a bubble-memory controller and build prototype bubble-based systems. A half-megabyte evaluation board costs \$495; a 1-megabyte board costs \$945. For more information, contact Intel Corp., 3065 Bowers Ave., P.O. Box 85065, Santa Clara, CA 95052-8065, (916) 351-2746.

Inquiry 561.

C++ Translator for the IBM PC

Guidelines Software has released a low-cost C++ translator for the IBM PC family of computers. Developed by Bjarne Stroustrup of Bell Labs, the translator allows you to add features such as object-oriented programming, constructors and destructors, and data abstraction to C programs. The package requires a 640K-byte IBM PC and currently works only with Microsoft's C compiler version 3.0. According to Nathaniel Stitt, a cofounder of the company, Guidelines is currently working on versions for the Lattice and Computer Innovations compilers. The C++ translator sells for \$195.

Contact Guidelines Software, P.O. Box 749, Orinda, CA 94563, (415) 254-9393. **Inquiry 562.**

Turbo Pascal for the Macintosh

Borland announced that Turbo Pascal for the Macintosh features pull-down menus and dialog boxes. The program makes use of the Macintosh point-and-click interface and the Hierarchical File System.

The company reports

compilation speeds of over 12,000 lines per minute. You can create large programs with the feature called Unit Structure, which allows you to link separate units to form one Turbo Pascal program.

Multiple editing windows enable you to edit, compile, and execute each window individually. You can switch from one window to another with several windows open at the same time.

You also have a choice of how to compile programs, and you can define default volume and folder names for filenames used in compiler directives.

Turbo Pascal for the Mac is not copy-protected. It sells for \$99.95 and runs on a Macintosh with at least 256K bytes of RAM and a 400K disk drive.

For more information, contact Borland International, 4585 Scotts Valley Dr., Scotts Valley, CA 95066, (408) 438-8400.

Inquiry 563.

IBM PC Compatibility for the DEC Rainbow 100

Code Blue is a conversion program that transforms the DEC Rainbow 100's operating system into IBM's PC-DOS. Intersecting Concepts, the manufacturer, reports that you do not need to add to or modify the Rainbow's hardware to use Code Blue.

A DEC Rainbow 100 running MS-DOS 2.05 or higher with a minimum of 256K bytes of RAM is required. The company suggests 768K bytes or more for best results.

Code Blue costs \$99.95 and is not copy-protected. For more information, contact Intersecting Concepts, 4573 Heatherglan Court, Moorpark, CA 93021, (805) 529-5073.

Inquiry 564.

Develop 68000 Software on IBM PCs

Language Resources has introduced a hardware/software system that enables users of the IBM PC, XT, AT, and compatibles to develop software for the Motorola 68000 processor. The system, called the 68000 SDS, includes a 68000 plug-in board, an in-circuit emulator, and development software. Programs developed on the system can run in any 68000 operating environment, the company claims.

The plug-in board has an 8-MHz 68000 and 512K bytes of zero-wait-state, dual-ported RAM. The board can run user-developed programs in real time or under the control of the symbolic debugger, which provides load, execution, breakpoint, and single-step functions. The debugger also has commands to address, display, and modify memory and registers. The system's in-circuit emulator provides real-time emulation of the 68000 in the target hardware.

The MASM-68 assembler that comes with the system is a Motorola-compatible assembler incorporating advanced features such as string macros, conditional assembly, structured control, and INCLUDE statements. The system comes with either a C or Pascal compiler, both of which have a run-time interface and floating-point libraries, as well as a linker/locator.

The system sells for \$4700. Additional utilities and upgrade options are available. For more information, contact Language Resources Inc., 4885 Riverbend Rd., Boulder, CO 80301, (303) 449-6809. **Inquiry 565.**

(continued)

YOU ARE ABOUT TO BE SEDUCED BY POWER AND MONEY.

Admit it. You're intrigued with the idea of C programming. You may be working in BASIC, Pascal or Assembler now. But you're drawn to the power, portability and flexibility of C. And if money is what motivates you, imagine having it all for just \$75 with Mark Williams Let's C.®

EVERYTHING YOU COULD ASK FOR IN A C COMPILER.

Let's C is no mere training tool. It's a complete, high quality C compiler. With the speed and code density to run your programs fast and lean. It won't get you sidetracked on some quirky aberration of C; Let's C supports the complete Kernighan & Ritchie C language—to the letter. And it comes from the family of Mark Williams C compilers, the name chosen by DEC, Intel, Wang and thousands of professional programmers.

POWERFUL UTILITIES ARE A REAL BONUS

Let's C doesn't stop with being a high performance C compiler. It includes utilities you'd expect to pay extra for—like a linker and assembler plus the MicroEMACS full screen editor with source code included. Having the source code not only allows you to customize the editor, it offers a close up, fully commented view of C programming at its best.

REVIEWERS ARE SOLD ON LET'S C, TOO.

"Let's C is an inexpensive, high-quality programming package...with all the tools you will need to

Features

- For the IBM-PC and Compatibles
- Fast compact code plus register variables
- Full Kernighan & Ritchie C and extensions
- Full UNIX compatibility and complete libraries
- Small memory model
- Many powerful utilities including linker, assembler, archiver, cc one-step compiling, egrep, pr, tail, wc
- MicroEMACS full screen editor with source
- Supported by dozens of third party libraries
- Upgradeable to C Programming System for large scale applications development
- Not copy protected

Let's C Benchmark Done on an IBM-PC/XT, no 8087.
Program: Floating Point
from BYTE, August, 1983.

Exec Time in Seconds	
Let's C	134
MS 4.0	147

MARK WILLIAMS LET'S C
\$75
60 DAY MONEY BACK GUARANTEE

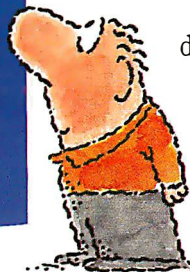
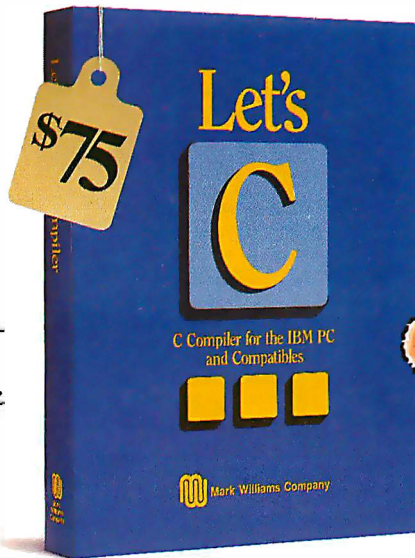

create applications."

—William G. Wong, *BYTE*, August 1986.

"Let's C is a thoroughly professional C environment loaded with tools and programming utilities...another fine Mark Williams product."

—Christopher Skelly, *COMPUTER LANGUAGE*, February 1986

"The performance and documentation of the \$75 Let's C compiler rival those of C compilers for the PC currently being sold for \$500... highly recommended..."

—Marty Franz, *PC TECH JOURNAL*, August 1986

ADD THE *csd* DEBUGGER AND CUT DEVELOPMENT TIME IN HALF.

Invest another \$75 and you've got Mark Williams revolutionary source level debugger. *csd* lets you bypass clunky assembler and actually debug in C. That's a big help when you're learning C and indispensable when you're programming. *csd* combines the interactive advantages of an interpreter with the speed of a compiler, slicing development time in half. This is how Byte Magazine summed it up: "*csd* is close to the ideal debugging environment." William G. Wong, *BYTE*, August 1986

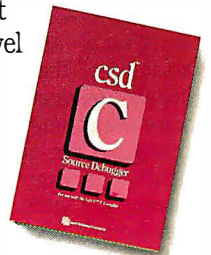

ARE YOU STILL RESISTING?

If there's any doubt that now's the time to get your hands on the power of C, consider Mark Williams 60-day money back guarantee. You can't lose. But with Let's C and *csd*, imagine what you could gain.

Ask for Let's C and *csd* at your software dealer's, in the software department of your favorite bookstore, through the Express Program at over 5500 Tandy stores or order now by calling 1-800-MWC-1700.*

*In Illinois call 312-472-6659



1430 West Wrightwood, Chicago, Illinois 60614

Inquiry 198

© 1986, Mark Williams Company
Let's C is a registered trademark of the Mark Williams Company
UNIX is a trademark of Bell Labs.

MARK WILLIAMS LET'S C. ONLY \$75.

SYSTEMS

MC-32 Personal Supermini

Mighty Computers Co. has introduced its MC-32 Personal Supermini, an IBM PC-compatible computer equipped with a 32-bit coprocessor. The coprocessor board features a 10-MHz 32032 processor with 32-bit data paths and addressing, a 32081 floating-point coprocessor, and 1.5 megabytes of RAM that can be expanded to 8 megabytes. The machine's main processor is an 8088 running at 4.77 MHz.

Under the MS-DOS operating system, the MC-32 runs standard PC-compatible programs. Software development for the 32032 is handled through the host computer. Three high-level languages—C, FORTRAN, and Pascal—are available, in addition to the assembler/linker/debugger/loader software that comes with the computer. An optional virtual I/O package lets developers write code that can occupy up to 15.5 megabytes.

The MC-32 can also run UNIX System V version 5.2. With 1.5 megabytes of RAM and a 20-megabyte hard disk, the system sells for \$3500. For more information, contact Mighty Computers Co., 4529 Angeles Crest Highway, Suite 207, La Canada Flintridge, CA 91011, (818) 952-8832. **Inquiry 566.**

Low-Cost AT Clones

HiTech International is offering the SAM 3001, an IBM PC AT compatible, for \$995. The computer, manufactured by Samsung, is based on an 80286 running at 6 or 8 MHz and includes 640K bytes of on-

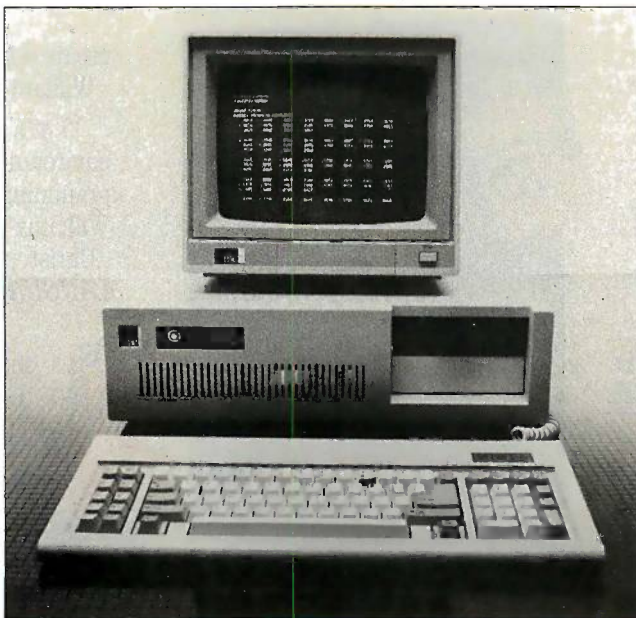

The dual-processor MC-32 Personal Supermini.

board RAM, a 1.2-megabyte floppy disk drive, two serial ports, one parallel port, eight expansion slots, and a color graphics board. An enhanced version, which sells for \$1595, is also available. For more information, contact HiTech International Inc., 1180-M Miraloma Way, Sunnyvale, CA 94086, (408) 738-0601.

Inquiry 567.

Computer Direct's CD/286 computer runs on a 10-MHz 80286 processor and offers compatibility with the IBM PC AT. Priced at \$1295, the system is equipped with a 1.2-megabyte floppy disk drive, 512K bytes of memory on the motherboard, an AT-style keyboard, and a 192-watt power supply. Various peripherals and add-ins, including monitors, hard disks, and tape backup units, are available as options.

The company's \$1795 system includes a Hercules-compatible monochrome graphics card, a monochrome monitor, and a 20-megabyte hard disk. A \$2295 system comes with an EGA-compatible monitor and EGA-compatible graphics card with 256K bytes of video RAM. Contact Computer Direct, 7801 North Lamar, Suite E-216, Austin, TX 78752, (512) 459-4199 or 459-4190. **Inquiry 568.**

ACP International is selling the Advanced 286, an IBM PC AT-compatible computer that's based on a 6- or 8-MHz 80286 microprocessor. With a price of \$1495, the basic system (Model I) comes with 640K bytes of memory on the motherboard, a 1.2-megabyte floppy disk drive, a keyboard, eight expansion slots, a 200-watt power supply, a clock with battery backup, and Phoenix ROM

BIOS. The Model II adds a 30-megabyte hard disk drive. Either system can hold three half-height storage devices and use 3½- or 5¼-inch floppy disk drives.

Upgrades and options for the systems are available. Contact ACP International Inc., 1310 East Edinger, Suite C, Santa Ana, CA 92705, (714) 558-8822. **Inquiry 569.**

32-bit VME Computer Runs at 25 MHz

Heurikon's HK68/V2F is a 68020-based VME single-board computer designed for real-time applications, including robotics and high-speed communications control. The board features a 68020 processor operating at speeds of up to 25 MHz, up to 4 megabytes of dual-ported RAM, up to 128K EPROM, 128 bytes of non-volatile static RAM, and an RS-232C serial port; an RS-422 port is an option.

Among the other features of the board are four 8-bit counter timers, mailbox interrupt support, and a master/slave interface to a VMEbus with 32-bit data paths, 32-bit addressing, and single-level arbitration. A 68881 floating-point coprocessor and clock with battery backup are available as options.

The board sells for \$1695. It supports Hunter and Ready's VRTX and Micro-ware's OS-9 operating systems. Contact Heurikon Corp., 3201 Latham Dr., Madison, WI 53713, (800) 356-9602; in Wisconsin, (608) 271-8700. **Inquiry 570.**

(continued)

MARK WILLIAMS C. AN ENLIGHTENING DEVELOPMENT FOR ATARI ST USERS.

If you've tried your hand at developing applications on the Atari ST, you know the problem. Programming tools aren't only hard to come by, they're hard to use. One might even say primitive. But now for some enlightening news: you can have all the power, portability and versatility of the C language from a leader in professional C programming tools, Mark Williams.

BRING YOUR PROGRAMMING UP TO SPEED.

The Mark Williams C compiler produces fast, dense code and supports the complete Kernighan & Ritchie industry standard C. You'll have access to GEM's AES and VDI libraries for programs using graphics, icons and the Atari mouse. And Mark Williams C lets you take advantage of the full 16 megabytes in Atari's 68000 microprocessor.

STREAMLINE DEVELOPMENT WITH POWER UTILITIES.

Mark Williams C is loaded with everything you'll need for professional development. Bring the power of the UNIX environment to your Atari ST with our

Features

C compiler

- Complete Kernighan & Ritchie C plus extensions
- Up to eight register variables
- Full access to AES and VDI libraries for programs using graphics, icons and mouse
- Complete UNIX-compatible libraries allow easy portability to and from UNIX development environment.
- Over 300 Atari-specific routines
- One-step compiling, linking with cc command
- English error messages
- Lint-like error checking

Microshell Command Processor, powerful UNIX style shell includes I/O redirection, pipes, command substitutions

MicroEMACS Full Screen Editor with commented source code included

Make Program Building Discipline Complete symbolic debugger with single-step, breakpoints and stack traceback

Assembler, linker and archiver Powerful Utilities Package: egrep, sort, diff, cmp, pr, tail, uniq, wc and more

Over 600 pages of documentation including 120 sample C programs Not copy protected

MARK WILLIAMS C FOR THE ATARI ST
\$179.95
60 DAY MONEY BACK GUARANTEE



Microshell Command Processor including pipes, I/O redirection and more. Edit your program with the highly acclaimed MicroEMACS full screen editor. Accelerate and simplify compiling with *make* which finds and recompiles only those modules affected by your changes. Then, when you're ready for debugging, call on our db Symbolic Debugger with single step, breakpoint and stack traceback functions. Over 40 commands, including a linker and assembler, provide a total development package for your Atari ST.

DEPEND ON A NAME WITH A HISTORY OF PERFORMANCE.

Mark Williams C for the Atari ST is part of our growing line of C compilers. A line that includes the C compiler chosen by DEC, Intel, Wang and thousands of professional programmers. Now our Atari C compiler is earning its own reputation:

"Finally a great C compiler that exploits the power of the ST"—Sigmund Hartmann, President, Atari Software Group

"The all-around best choice for serious software development on the ST."—Douglas Weir of *ANALOG COMPUTING*

GET WHAT YOUR ATARI ST HAS BEEN WAITING FOR.

Mark Williams C is just what your Atari ST was made for: powerful, professional programming. So now that you can have Mark Williams C for just \$179.95, what are you waiting for?

Ask your Atari dealer about Mark Williams C or order today by calling **1-800-MWC-1700.***

*In Illinois call: 312-472-6659

 **Mark
Williams
Company**

1430 West Wrightwood, Chicago, Illinois 60614

© 1986, Mark Williams Company
UNIX is a trademark of Bell Labs.

Inquiry 199

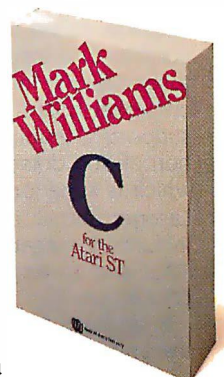

PERIPHERALS

Book-size Tape Backup for IBM PCs

Irwin Magnetics introduced its 400 Series Backup tape subsystems for the IBM PC XT, AT, and compatibles. The units come with 10, 20, or 40 megabytes of storage capacity and measure about 2 inches by 7 inches. The 10- and 20-megabyte models for the IBM PC XT and compatibles transfer data at a rate of 250,000 bits per second. The 20- and 40-megabyte models for the PC AT and compatibles feature a data transfer rate of 500,000 bps.

The units have the ability to read tapes created on lower-capacity drives. All models come with a tape cartridge and software; options include an external power supply and cables. Retail prices are \$799 for the 10-megabyte model; \$950 for the 20-megabyte models; and \$1095 for the 40-megabyte model. For more information, contact Irwin Magnetics, 2311 Green Rd., Ann Arbor, MI 48105, (313) 996-3300. Inquiry 571.

Add PostScript to LaserJet Printers

The Laser Connection, an affiliate of laser-printer maker QMS, unveiled an add-on for the Hewlett-Packard LaserJet that gives PostScript compatibility to the printer. The \$2995 upgrade, called the PS Jet, consists of a top-cover assembly that includes a controller board. The PS Jet supports a graphics resolution of 300 dots per inch, which is superior to normal LaserJet output, and it includes 2 megabytes of RAM and an AppleTalk connection.

In addition to the LaserJet, the unit works with other

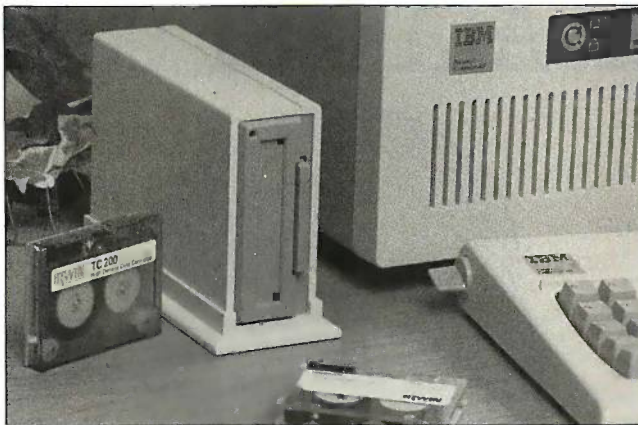

Irwin Magnetics' 400 Series tape backup system.

laser printers based on the Canon print engine. The one-piece unit, the company says, can be installed in a printer in 15 minutes with a screwdriver. Contact The Laser Connection Inc., 7852 Schillinger Park West, Mobile, AL 36608, (205) 633-7223. Inquiry 572.

AST's TurboScan Digitizes Text, Art

The TurboScan page scanner from AST Research converts color or black-and-white text, art, and photographs into binary code for further processing with a Macintosh or IBM PC and compatible computers. The scanner digitizes images with a resolution of up to 300 dots per inch and uses data compression and DMA transfer to scan an 8½- by 11-inch document in less than 10 seconds, the company says.

The scanner's line-art mode converts images, including those with shades of gray, into black and white. Its halftone mode, which provides 12 screening options, simulates the shades of the original document.

You can also mix the two modes when scanning a single image.

The TurboScan, which costs \$2395, is equipped with a parallel and a serial port and bundled with software that lets you incorporate scanned images into WordStar documents. Contact AST Research Inc., 2121 Alton Ave., Irvine, CA 92714, (714) 863-1333. Inquiry 573.

Okidata's Highest-Speed Printer

The Microline 294 dot-matrix printer from Okidata prints at a rate of 400 characters per second in draft mode and at 100 cps in near-letter-quality mode. The printer can also output bit-mapped graphics at a resolution of up to 288 dots per inch.

The 294 comes with one of six plug-in modules that emulate an IBM Graphics Printer or other Microline printers and provide a parallel, RS-232C, or RS-422 interface. Software for type font selection and color printing is bundled with the IBM-compatible module.

The printer can handle continuous forms or cut sheets up to 16 inches wide. An 8K buffer is standard; a 32K buffer is optional. Sug-

gested retail price for the 294 is \$1499, which includes one plug-in module; additional modules cost \$125 each. Contact Okidata, 532 Fellowship Rd., Mt. Laurel, NJ 08054, (609) 235-2600. Inquiry 574.

SCSI Tape Backup for Mac Plus

The TDBK-20+, a tape backup unit from MDIdeas for the Macintosh Plus, can back up 22 megabytes of data on each tape cartridge. The unit connects to the computer's SCSI port and works with MDIdeas' HD-20 and HD-30, Apple's Hard Disk 20, and most other hard disks for the Macintosh.

The unit is compatible with Apple's HFS and the original version of the Finder. Suggested retail price is \$1095, which includes a 110/220-volt power supply. Contact MDIdeas Inc., 1111 Triton Dr., Suite 205, Foster City, CA 94404, (415) 573-0580. Inquiry 575.

Test 3½-inch Disk Drives

Proto PC has introduced a 3½-inch adapter kit for its EX2000 Disk Drive Exerciser. When purchased as an option for current models of the EX2000, the adapter kit costs \$29 and comes with cables for the connectors on 3½-inch drives. The upgrade kit, sold to owners of older models of the EX2000, costs \$49 and includes a ROM upgrade with 3½-inch drive tables in addition to cables. Contact Proto PC Inc., 2424 Territorial Rd., St. Paul, MN 55114, (612) 644-4660. Inquiry 576.

(continued)

Clipper is the fastest dBase III and dBase III Plus™ compiler available. Nothing else comes close. When performance counts, experts rely on Clipper for more speed, more power, and more creative freedom. You can, too. Call for details.

- Clipper compiled programs run 2 to 20 times faster.
- No royalties...no runtime fees.
- Source code security.
- User defined functions.
- Arrays.
- Simple menu commands.
- Context sensitive help can be included with programs.
- More fields; more memory variables.
- Call C and Assembly programs.
- Complete debugging facilities.
- Multiple file relationships.
- IBM PC, XT, AT, 3270 compatible™.
- Multi-user capability.

Clipper™

CLIPPER. THE dBASE COMPILER.
A WINNING PERFORMANCE EVERY TIME.



Nantucket™

Nantucket Corporation
5995 South Sepulveda Boulevard
Culver City, California 90230
(213) 390-7923
Outside California call toll-free:
1-800-251-8438

dBase, dBase III, and dBase III Plus are trademarks of Ashton-Tate, Inc.
IBM PC, XT, AT, and 3270 are trademarks of International Business Machines Corporation.
Clipper and Nantucket are trademarks of Nantucket Corporation.



“Xerox Desktop Publishing makes every document look like the work of a genius.” —Leonardo da Vinci

A lot of the success you have in selling your ideas depends upon the success you have in putting those ideas on paper.

That's why we invented the Xerox Documenter desktop publishing system. A system that encourages you to express your original ideas quickly, more easily, and with better results.

Our Documenter desktop publisher is built around the Xerox Workstation. It makes it easy to lay down your text in any format you choose.

In an amazing array of typefaces and in 30 languages. Convert data to charts. Create your own graphics. Enlarge or reduce any element. Then combine them, easily revising the page until it's just the way you want it.



When you're satisfied (what you see on the Workstation screen is what you get on paper), you send it to the other half of our desktop publisher—the Xerox Laser Printer. With a mere button-push, you get finished originals that come out laser-perfect.

The Documenter desktop publisher is another Xerox innovation designed to help you put your ideas on paper.

For more information, call your local Team Xerox sales office or: 1-800-TEAM-XRX, extension 291A.

Xerox brings out the genius in you.

Xerox Corporation, P.O. Box 24, Rochester, NY 14692.
 Show me how to make my documents look like the work of a genius.
 Please have a sales representative contact me.
 Please send me more information.

NAME _____
 COMPANY _____ TITLE _____
 ADDRESS _____ CITY _____
 STATE _____ ZIP _____ PHONE _____

Or, if you can't wait, call
1-800-TEAM-XRX, ext. 291A

291A (1-800-832-6979, ext. 291A)

XEROX® is a trademark of XEROX CORPORATION.

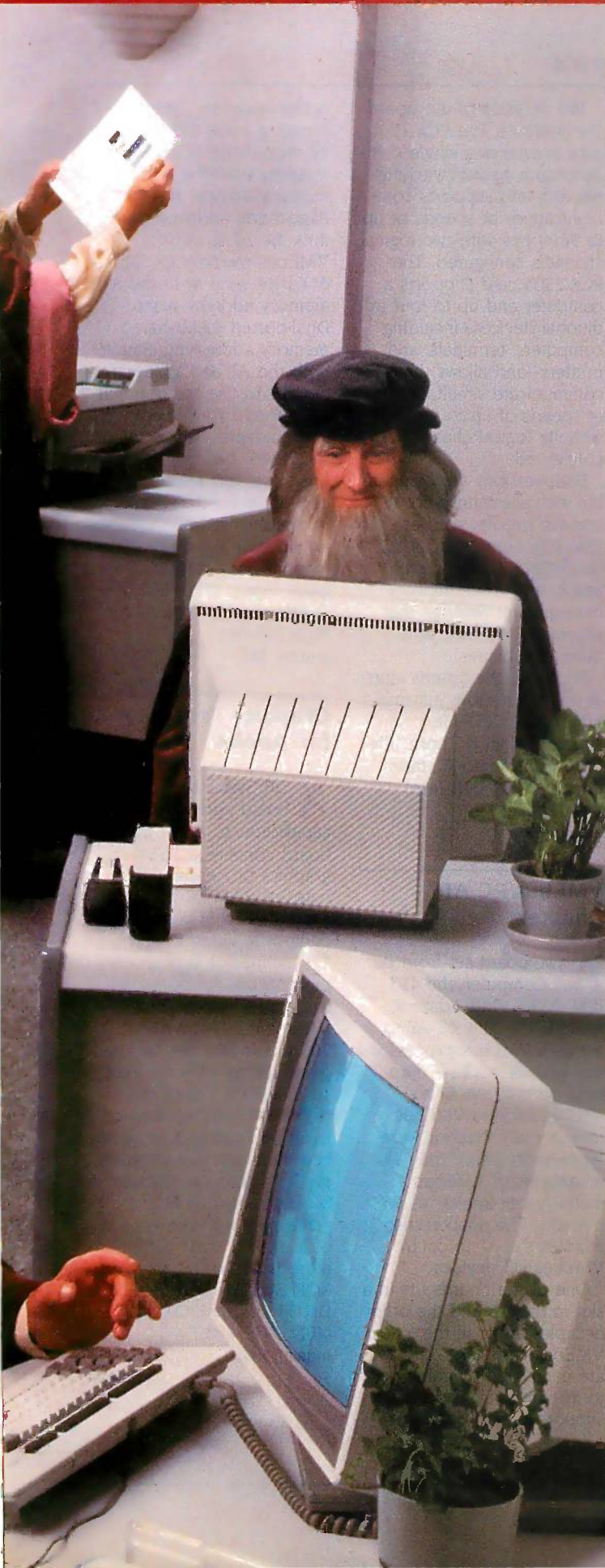

A D D - I N S

**Drive Uses
Bubble Memory**

The BDH-1 Bubbl-Dek, a solid-state replacement for floppy disk drives, is the same size as a standard full-height 5¼-inch drive and fits in the same mounting holes in an IBM PC or compatible computer. The system provides an average access time of less than 14 ms, the company says, and offers data storage at temperatures ranging from -40° to +80° C.

The unit is available with one or two front-panel slots for plug-in Bubbl-Pac cartridges. A one-slot model costs \$1199; a two-slot model, \$1689. Each cartridge (\$175) provides 128K bytes of nonvolatile storage and measures less than 3 square inches. The cartridges can be write-protected or write-enabled at any time. The drive's data transfer rate is 90,000 bps when used with an external controller and 30,000 bps when used with the optional internal controller.

The unit has five internal slots, three of which can be used for add-on boards, including the optional controller, processors, memory, I/O, and others. For more information, contact Bubbl-Tec, 6805 Sierra Court, Dublin, CA 94568, (415) 829-8700. Inquiry 577.

Mac Video Adapter

The DVA Composite Video Adapter lets you connect a Macintosh or Macintosh Plus to high-resolution monitors and projectors. The board attaches to the power supply connector inside the Mac and comes with a cable that connects to monitors and projectors.

Packaged with tools and instructions for installation, the board costs \$99.95. Also available for use with the adapter is slide show and presentation software that's capable of producing special effects such as block fade. For more information, contact Julian Systems Inc., 4345 Fairwood Dr., Concord, CA 94521, (415) 686-4400. Inquiry 578.

**MIDI Interface
for Amigas**

The Bright-1 MIDI interface connects MIDI instruments to the Commodore Amiga and works with music software such as Activision's Music Studio.

The \$39.95 device attaches via cable to the computer's serial port and provides 5-pin connectors for MIDI-In and MIDI-Out. Its two bicolor LEDs verify proper connection and monitor activity on the interface. Contact Micro Engineering of Northern Virginia, P.O. Box 11780, Alexandria, VA 22312, (703) 750-7860. Inquiry 579.

**Boards Support
X.25 Standard**

The PCX.2500 series of plug-in boards from EDA Instruments gives users of IBM PCs and compatibles access to digital communications facilities on packet-switching networks, such as Telenet and Tymnet, that use the X.25 protocol. According to the company, benefits of the boards include increased speed, error checking, more reliable communications, and cost savings in some instances.

Two versions of the board are available. The PCX.2501 card interfaces a single computer to a packet-switching network and supports communications at speeds of up to 9600 bps with two logical channels configured. The PCX.2505 card supports a computer and up to four additional devices—including computers, terminals, and printers—and allows them to communicate simultaneously at speeds of up to 9600 bps with six logical channels configured.

Both versions are compatible with communications and file transfer software for IBM PCs, support XON/XOFF or ENQ/ACK flow control, and come with a network management package that provides diagnostic and other capabilities.

Prices for the boards start at \$675. For more information, contact EDA Instruments Inc., 4 Thorncliffe Park Dr., Toronto, Ontario, Canada M4H 1H1, (416) 425-7800. Inquiry 580.

**VMEbus/PC AT
Adapter**

A two-board set from Bit 3 Computer, the 403 IBM PC/AT VME Adaptor, enables the IBM PC AT to act as a VMEbus processor. The boards' address mapping permits the AT to directly address VMEbus memory as though it were AT memory. More than 14 megabytes of VMEbus memory can appear as AT memory. The adapter also enables the AT to control VMEbus I/O devices.

One of the boards fits in a slot in the AT, and the other occupies a slot in the VMEbus card cage. The two are connected by cable up to 50 feet long. The boards support three modes of

communication. Direct addressing maps 65K bytes to 14 megabytes of VMEbus memory onto the AT's memory address space. Page-mode addressing permits the AT to control VMEbus memory through a 65K-byte window in the AT's memory address space. Dual-ported RAM-shared memory addressing enables both the AT and VMEbus devices to use the optional dual-ported RAM memory.

The adapter, which sells for \$1280, can function as a bus slave, bus master, or one of several bus masters in a multiprocessor VMEbus application. For more information, contact Bit 3 Computer Corp., 8120 Penn Ave. S, Minneapolis, MN 55431, (612) 881-6955. Inquiry 581.

**Graphics Processor
for Apples**

XOR Systems' Mega-Pix board adds graphics capabilities to Apple IIs. The board contains a 16-bit graphics processor, 128K bytes of RAM that can be expanded to 512K bytes, composite video circuitry, a TTL connector, and an expansion bus for upgrading to color, when available.

Resolution starts at 640 by 200 pixels and can be programmed to 1024 by 1024. To provide a variety of resolutions and configurations, you can add up to six boards to one computer. A graphics software package is bundled with the board.

The monochrome version of Mega-Pix costs \$299. For more information, contact XOR Systems, 986 Live Oak Dr., Santa Clara, CA 95051, (408) 249-5388. Inquiry 582.

(continued)

CRITIC'S CHOICE AWARD
 ★★★★★ — Family Computing, 1986

HERE ARE THE ADDITIONAL FONTS YOU ORDERED FOR USE WITH

FANTASY

Thank you for ordering from

OVERHEAD FOILS

- Quick and easy to prepare
- Centering, tabbing, indenting
- Large variety of typefaces
- Great for report covers, too

PROSOFT's Fantasy **NEWSLETTERS** on the IBM PC

Personal Publishing

Highlights

- Christmas fonts & drawings
- Multi-column templates
- Read text from disk and print
- Holiday
- Sales and position clip art

\$69.95

Request the
 Your Company
 at the Wedding of
 their daughter

We build good ships here.
 At a profit, if we can.
 At a loss, if we must.
 Always, good ships.

NEW **FANTASY ART FOLDERS™**

Each folder contains about 100 professionally drawn pictures, converted by camera to computer images and ready for use with FANTASY VERSION 2. Now available in six popular categories: Holiday; Sports-Recreation-Music; Attention-Getters; Food; Animals-and-Plants; Home-and-Office. \$29.95 per disk.

Fantasy printed all of these.

See What You Can Do With

Presentations! Newsletters! Flyers! Signs! Overhead foils! Invitations! Menus! Logos! Announcements! Banners! Layouts! When you need a good-looking visual quickly, you need FANTASY — superb typefaces, drawing, and pictures in one easy-to-use package.

FANTASY gives you a "what-you-see-is-what-you-get" picture, as you type and draw on the graphics screen of your IBM-PC. You can create a page at a time, see a mini-picture of it, print it, and save it on disk. Page size is limited only by memory, not by screen size.

Highlights

Proportional space, justify, kern, boldface, re-position, magnify and shrink, black/white reversal, rotate, mirror image, lines, rectangles, ovals, draw, fill-in, undo (and un-undo), on-line help, 200-page book, and easy control from keyboard or mouse.

Fonts, fonts, and more fonts! We have over 275 Add-On typefaces in our growing library. Each disk of about 10 fonts costs \$24.95 and we will be happy to send you free print samples on request.

Picture Library! Each of the six FANTASY ART FOLDERS™ contains about 100 large (full-screen), high-quality add-on pictures and costs \$29.95 per disk. Please see back issues of this magazine for examples, or ask us for free print samples. Inquiry 267



\$69⁹⁵

Includes 28 Fonts & 60 small pictures

Equipment Needed

IBM-PC, XT, AT, or true compatible (Compaq, etc.) with IBM or Hercules graphics adapter and graphics monitor. 256K memory needed for partial pages, 448-640K recommended for full pages on most printers. Mouse optional. MS-DOS 2.10 or above. FANTASY supports: IBM Graphics Printer, Proprietary; Epson FX, JX, LX, MX, RX, and LQ; C. Itoh 8510, 1550, 1570, Prowriter-Jr; H-P LaserJet, LaserJet-Plus, ThinkJet; Microliner 92-293 (native or IBM-compatible); Gemini 10X, 15X; Radio Shack DMP 105-430, 2100; Toshiba 351, 1340-1351; Star; and most IBM / Epson-compatible printers.

Money-Back Guarantee

FANTASY is not copy-protected and has a 30-day money-back guarantee. If you order now, we will include 28 fonts (a \$50 value) at no extra charge. So, call today, TOLL-FREE:

1-800-824-7888, operator 669 (ORDERS ONLY)

For further information and same day shipping, call: (818) 765-4444

PROSOFT®
 7248 Bellaire Ave., Box 560
 No. Hollywood, CA 91603-0560

FANTASY \$69.95

Tax _____
 Shipping _____
 Total _____

Name _____ Company _____
 Address _____ Telephone _____
 City, State, ZIP _____
 Visa/MC _____ Exp. Date _____
 Computer _____ Memory _____ Printer _____

Terms: M/C, Visa, checks. Please add \$3.00 shipping and handling in U.S. or Canada, \$15.00 overseas, \$2.00 for C.O.D., and sales tax in Calif.

SOFTWARE • PROGRAMMING LANGUAGES AND AIDS

FORTH Compiler for the Atari ST

Palo Alto Shipping announced the Mach 2/ST FORTH-83 multitasking development system for GEM and non-GEM applications. The system has a text editor, Motorola assembler, symbolic debugger, and floating-point math capability.

The \$59.95 Mach 2/ST runs on the Atari 520ST and 1040ST with either a monochrome or color monitor. Other Mach 2 systems are available for the Macintosh and the Amiga. For more information, contact Palo Alto Shipping, P.O. Box 7430, Menlo Park, CA 94026, (415) 854-7994. Inquiry **583**.

C Database Management System Toolkit

Jaybe Software has released Cdb, a C database management system toolkit for UNIX systems. The toolkit comes with 25 programs that you can use alone or with other UNIX tools for developing UNIX applications. Cdb is driven by a dictionary that you set up with descriptions of databases, indexes, and reports. You can then edit

and scan the databases, which are made up of variable-length records and allow unlimited fields per record, unlimited records per file, formula fields, and unlimited key fields, according to Jaybe. You can also split or connect databases, or you can run them through filters to create new databases. Cdb supports fixed or floating-point decimal, dollar amount, date, and alphanumeric field types. You can reorganize and restructure records with the index generator and maintain multiple indexes at once.

For security in a multiuser environment, Cdb also features record locking, password protection, and read-only restriction. The toolkit is priced at \$495. For more information, contact Jaybe Software, 2509 North Campbell, Suite 259, Tucson, AZ 85719, (602) 327-2299. Inquiry **584**.

LISP Library and C Programming Environment

Clisp is a LISP library and a programming environment for C that runs on IBM PCs, XT's, and AT's. The program contains over 100 functions, including LISP

primitives, predicates, and conditionals, a context-sensitive database and stack, and an interpreter to which you can add your own functions. The price of \$189 includes source code. Contact Frederick J. Drasch Computer Software, RFD 1, Box 202, Ashford, CT 06278, (203) 429-3817. Inquiry **585**.

dBASE III Plus Compiler

WordTech Systems announced Quicksilver, a dBASE III Plus compiler that features assembly code output, networking, and windowing. You can define your own functions, and you have the ability to link compiled C routines into dBASE applications. The company reports that you also have access to dBASE Tools for C and up to 4000 memory variables.

A set of dBASE-like windowing commands, dB FRAME, is incorporated in Quicksilver. The commands enable you to use source code instructions to create up to 99 active on-screen windows. Quicksilver runs on IBM PCs, AT's, XT's, and compatibles with 256K bytes of RAM and MS-DOS or PC-DOS 2.1 or higher.

The basic Quicksilver package costs \$599 and includes the compiler, linker, PC-DOS libraries, debugger, and assembly code translator. MS-DOS libraries are available for \$79.

For more information, contact WordTech Systems, P.O. Box 1747, Orinda, CA 94563, (415) 254-0900. Inquiry **587**.

Generate Screens in Any Language

Softway, publisher of the screen generator High Screen, reports that you can design screens in almost any language. When designing with High Screen, you can open windows, display and manage pull-down menus, and manage an on-line help facility. Cursor positioning and management, as well as tests and message displays, are performed by the resident module.

High Screen sells for \$199 and runs on IBM PCs, XT's, AT's, and compatibles with PC-DOS or MS-DOS 2.0 or higher. A minimum of 256K bytes of RAM is required. Contact Softway Inc., 500 Sutter St., Suite 222, San Francisco, CA 94102, (415) 397-4666. Inquiry **586**.

SOFTWARE • SCIENTIFIC AND ENGINEERING

Scientific Word Processing

ChiWriter, a scientific word processor from Horstmann Software Design, runs on IBM PCs and compatibles with a minimum of 256K bytes of RAM and a Color Graphics Adapter. The word processor features cut-and-paste, search-and-replace, margin justification, and pagination. The company reports that it can han-

dle up to 20 fonts, which you switch by pressing function keys, and you can use an unlimited number of superscripts and subscripts.

The program is not copy-protected and costs \$79.95. For more information, contact Horstmann Software Design, P.O. Box 4544, Ann Arbor, MI 48106, (313) 663-4049. Inquiry **588**.

Schematic Drawings Output to Plotter or Dot-Matrix Printer

HiWIRE is a menu-driven schematic design package that has a library of over 700 common components. Using a mouse, you choose the components, and they are then connected with wires and buses. You can modify the symbols and also create new ones with labels, lines, and arcs. You can output hard-copy sche-

matics to either a plotter or a dot-matrix printer.

To use HiWIRE, you need an IBM PC or compatible with at least 320K bytes of RAM and a Color Graphics Adapter or Enhanced Graphics Adapter. The program sells for \$895. For more information, contact Wintek Corp., 1801 South St., Lafayette, IN 47904-2993, (317) 742-8428. Inquiry **589**.

(continued)

COMPUTER INNOVATIONS

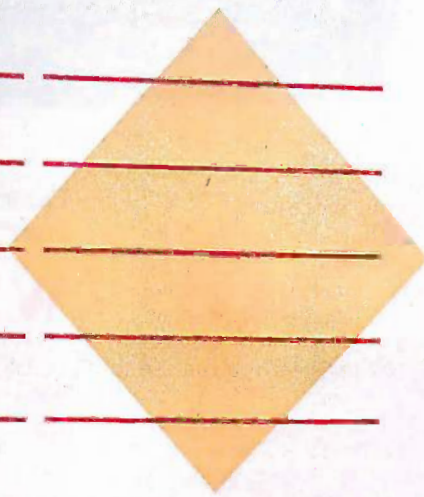

C86 **PLUS**
C COMPILER

86 PLUS
REFERENCE MANUAL

SUPREMACY.

С КОМПИЛЕР
C86 **PLUS**

Monitor the Wind and Seismic Activity

Lbs Engineering announced Lbs-Wind, a wind and seismic analysis program. The program uses wind and seismic building-code data to calculate forces and moments at which they occur. The user can change the data once it is entered into the data file.

Lbs-Wind sells for \$19.95 and runs on an IBM PC with at least 96K bytes of RAM and PC-DOS 2.0 or later. For more information, contact Lbs Engineering Inc., 1320 Lincoln St., Hollywood, FL 33019, (305) 920-1584. Inquiry 590.

ELI-41 Emulates the Hewlett-Packard 41 Calculator

Eclipse Logic has released the ELI-41 pop-up program that emulates an HP-41. The screen displays the calculator's keypad layout, and all the calculator's functions are included in the program, along with a view of the stack, flags, and registers.

You can program ELI-41 using nested subroutines and an unlimited number of program statements, according to Eclipse. You can also develop conversion tables with standard text editors or



ELI-41 emulates the HP-41, with the calculator's keypad on-screen.

word processors.

The calculator functions with 15-digit precision and has binary, octal, decimal, and hexadecimal display and input. There are also 500 registers you can use to store data.

The program is not copy-protected and sells for \$74.95. It runs on an IBM PC, XT, AT, or compatible with at least 192K bytes of RAM. A monochrome or color monitor and card are necessary, and you must have MS-DOS or PC-DOS 2.0 or higher.

For more information, contact Eclipse Logic Inc., P.O. Box 2003, Huntington Park, CA 90255-1303, (213) 569-6020. Inquiry 591.

Exploring the Fourth Dimension

With 4D Graphics Laboratory, you can rotate and view four-dimensional objects in each of six reference planes—in one frame at a time or all six at once. You can create your own four-dimensional shapes or modify the supplied shapes by controlling the color and position of each line.

The program is written in 8086 assembler and runs on an IBM PC, XT, AT, or compatible with MS-DOS or PC-DOS 2.0 or higher and a Color Graphics Adapter. It costs \$44.44. For more information, contact 4D Graphics Lab, 12021 Wilshire

Blvd., Suite 537, Los Angeles, CA 90025, (213) 479-4792.

Inquiry 592.

Perform Statistical Analysis on the Macintosh

Data Desk enables you to interpret statistical relationships by displaying variables as icons. Rotating plots are displayed so you can see the structure of the data, and you can reshape the display to view alternate scalings. It is also possible to compute and display the calculations performed. The program records the date and time that you created or modified a variable, and you can store background information on any variable.

Editing and data entry are performed as word-processing tasks and include searching and replacing. You also have the ability to move data to other Macintosh programs for spreadsheet analysis, word processing, graphical data analysis, and presentation graphics.

Data Desk runs on a 512K Macintosh and sells for \$175. A student version is also available. For more information, contact Data Description Inc., P.O. Box 4555, Ithaca, NY 14852, (607) 257-1000. Inquiry 593.

Two Desktop Publishers

FTL systems announced MacT_EX, a \$750 desktop typesetting program that offers hyphenation and justification, kerning, ligatures, automatic pagination, headers, footnotes, and automatic generation of indexes, tables of contents, and bibliographies. There are

over 1100 commands and macros, as well as a multi-window text editor.

MacT_EX automatically adjusts the space between words, lines, and paragraphs, so the document fits the page layout. Standard templates for letters, reports, articles, and other types of documents are included, and a single command

changes the style of the document. You can create your own macros and libraries of customized page or document styles, and mathematical symbols are available for typesetting.

For more information, contact FTL systems Inc., 234 Eglinton Ave. E., Suite 205, Toronto, Ontario, Canada M4P 1K5, (416) 487-2142. Inquiry 594.

You can use memory-resident LaserWare with any application program to produce laser-quality output, according to SWFTE International. LaserWare works with the Hewlett-Packard LaserJet and an IBM PC or compatible. The program's com-

(continued)

SUBSTANTIATED.

SUPREMACY

It's a bold claim. A claim we're prepared to stake our reputation on. And at Computer Innovations, we've always taken our reputation very seriously.

It's no industry secret that the competitive C Compilers are at the end of their optimization cycle — they're just about as good as they are going to get. C86PLUS begins where everybody else has left off. It's an entirely new technology based on artificial intelligence and advanced compiler design techniques. Designed with the serious programmer in mind, C86PLUS provides the ultimate development environment, matching unparalleled execution speed with a host of productivity features.

FAST EXECUTION

- 20% faster than Microsoft C, version 4.0
- 70% faster than existing C86, version 2.3 (timings based on the classic sieve benchmark)

ANSI C COMPILER FEATURES

- Register variables
- Structure assignment
- Function prototypes
- New type modifiers
 - near
 - far
 - signed
 - const
 - volatile
- Long double 80 bit floating-point
- Enumerator data types (enums)
- Extended preprocessor capabilities

FULL CONTROL OVER COMPILATION ENVIRONMENT

- Small, Medium, and Large memory models
- 8086/80186 and 80286 code generation options
- In-line 8087/80287 floating point
- 8087/80287 auto detect emulator
- Source level debugger support
- Wild-card compilation
- Make utility
- ROMable code
- Linkable with macro assembler output
- Intel-standard OMF object files
- Optional assembly language output
- Warning level control

EXTENSIVE FUNCTION LIBRARIES FOR INCREASED PRODUCTIVITY

- Over 250 library functions
- Full ANSI C library
- Functional equivalents to most UNIX System V libraries
- Shared file and network support
- Low-level machine access functions
- IBM ROM BIOS support routines
- Fully compiled small, medium and large model libraries
- C library source code
- Run-time start-up source code
- Source code librarian
- Object code librarian

MICROSOFT COMPATIBILITY

If you're a current Microsoft user, we invite you to consider this simple point. C86PLUS will recompile most applications developed using MS-C without changes to your source code. You'll find that your application runs much faster.

PROVEN EXPERIENCE

In 1981, Computer Innovations and its founder, George Eberhardt, revolutionized the DOS programming world with the introduction of the first C Compiler for the PC called C86. Today, C86 boasts a satisfied and loyal user base of over 20,000 programmers worldwide. C86PLUS represents an extension of this expertise and reputation. It's backed with more than a decade of intensive research and development.

PROVEN SUPPORT

Making the claim that C86PLUS is supreme is one thing, standing behind it is another. Computer Innovations has always offered timely and intelligent technical support, and this is an important customer service which we do not intend to change.

CALL TO ORDER

The call is on us. For more information or to order call:
800-922-0169
or **201-542-5920** (in NJ)

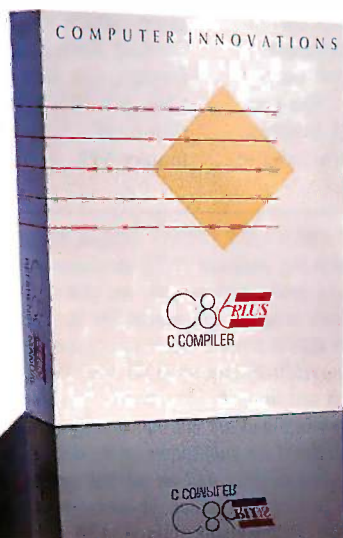

C86PLUS™
COMPUTER
INNOVATIONS

980 Shrewsbury Ave.
Tinton Falls, NJ 07724, USA
Telex: 705127 COMP INNOV UD

C86 PLUS is a trademark of Computer Innovations, Inc.
Microsoft is a registered trademark of Microsoft Corporation
UNIX is a registered trademark of AT&T Bell Laboratories IBM
is a registered trademark of International Business Machines Corporation

©1986 Computer Innovations, Inc.

See us at
COMDEX Fall '86
Las Vegas Convention Center
Booth 454

mands operate with all the LaserJet cartridge-based fonts, and you also have the ability to make font changes, center, justify, indent, and set decimal tabs.

Graphics capabilities include capturing graphic plots as they are printed, saving the images to screen, merging graphics directly into text, and printing in variable resolutions.

Forms management features include line and box drawing, shading, and data integration. LaserWare's typesetting capabilities enable you to produce custom forms.

LaserWare sells for \$99.95. Contact SWFTE International, P.O. Box 219, Rockland, DE 19732, (302) 658-1123.
Inquiry 595.

Sales Repeater

Salespeople can keep track of their current customers' buying habits, patterns, and preferences with Sales Repeater's customer database, which stores addresses, phone numbers, and purchase history. Sales Repeater also has a tickler and a business-card file. A search-and-call feature enables you to sort customer files by specific category and create a list of customers who might respond.

The program comes with seven modules directed toward specific industries, and if your industry is not covered, you can use the general module that is available. The utility Call Log Reports produces reports on sales calls. Another utility, Print Menu, produces mailing labels or prints on envelopes.

With Sales Repeater, you can store 300 customer and prospect names per floppy disk and 10,000 on a 10-megabyte hard disk. The

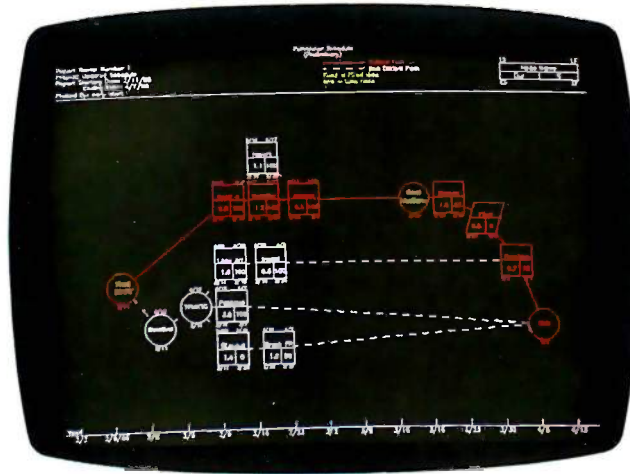

Timepiece, a project management program for the IBM PC.

program requires an IBM PC or compatible with 128K bytes. The list price is \$249. Contact Streamline Software Systems, 14 Perimeter Center E, Suite 1406, Atlanta, GA 30346, (800) 624-5886; in Georgia, (404) 392-9500.
Inquiry 596.

Amiga Telecommunications

Kent Engineering & Design introduced MacroModem, a telecommunications program for the Amiga. With MacroModem you can create sets of macros and companion help screens. One macro can include up to 35 keystrokes and can load a new set of macros from disk. You can also create files of macros and edit them while on-line.

MacroModem supports the Amiga's windowing environment, enabling you to display your current capture file, read forward or backward, and run the capture file as an independent task in its own window. You can also prepare up to 10 lines of an electronic message in the compose window while the terminal window continues displaying the conference.

You can store up to 36 phone numbers in MacroModem's phone directory, and the program also features auto-dial capability.

An Amiga with 256K bytes of RAM and one disk drive is required to run the program, which sells for \$69.95. Contact Kent Engineering & Design, P.O. Box 178, Mottville, NY 13119-0178, (315) 685-8237.
Inquiry 597.

WHERE DO NEW PRODUCT ITEMS COME FROM?

The new products listed in this section of BYTE are chosen from the thousands of press releases, letters, and telephone calls we receive each month from manufacturers, distributors, designers, and readers. The basic criteria for selection for publication are: (a) does a product match our readers' interests? and (b) is it new or is it simply a reintroduction of an old item? Because of the volume of submissions we must sort through every month, the items we publish are based on vendors' statements and are not individually verified. If you want your product to be considered for publication (at no charge), send full information about it, including its price and an address and telephone number where a reader can get further information, to New Products Editor, BYTE, One Phoenix Mill Lane, Peterborough, NH 03458.

Manage Multiple Projects

Timepiece, project management software for the IBM PC family, lets you manage projects, perform "what if" scenarios, create custom calendars for each project, and produce reports in 19 formats. You can also add graphics and sound to reports and output them to printers, plotters, film recorders, and slide-making devices, according to Communication Dynamics.

Timepiece runs on an IBM PC, XT, AT, or compatible with a minimum of 512K bytes of RAM and MS-DOS or PC-DOS 2.0 or higher. The company recommends a hard disk, and to produce reports with graphics, you need a graphics display device. The program sells for \$695. Contact Communication Dynamics Inc., 7300 Southwest Hunziker, Suite 200, Tigard, OR 97223, (503) 684-5151.
Inquiry 598.

WriteNow

The Macintosh word-processing program WriteNow enables you to do WYSIWYG (what you see is what you get) editing in up to four columns on-screen. You can also insert graphic images in a line of text.

Written in assembly language, WriteNow saves, scrolls, finds, replaces, prints, reformats, and repaginates. There is a 50,000-word spelling checker, and the program handles unlimited headers, footers, and auto-numbering of footnotes, according to T/Maker. WriteNow is priced at \$175. Contact T/Maker Co., 1973 Landings Dr., Mountain View, CA 94043, (415) 962-0195.
Inquiry 590.

**Upgrade
Your Lotus 1-2-3,
Framework, Symphony,
Enable Or Smart Software
For Only \$155! Call For Details.
Act Now! Offer Expires Nov. 30, 1986.**

Available in English Language Version Only

INTRODUCING OPEN ACCESS® II™

THE FULLY INTEGRATED BUSINESS SYSTEM
WITH THE WORLD AT YOUR FINGERTIPS

Come see us at Fall Comdex,
West Hall Booth #W948.

Open Access II Comparison Chart

	Database	Form Query	Report Generator	Query Processor	Relational Database	Graphics	3-D Graphics	Spreadsheet	Goal Seeking	Word Processor	Communications	Time Management	Price
Open Access II	✓	✓	✓	✓	✓	✓	✓	✓	✓	✓	✓	✓	595⁰⁰
Lotus 1-2-3	✓					✓		✓					495 ⁰⁰
Symphony	✓	✓	✓			✓		✓		✓	✓		695 ⁰⁰
Framework	✓		✓	✓		✓		✓		✓	✓		695 ⁰⁰
Enable	✓		✓			✓	✓	✓		✓	✓		695 ⁰⁰
Smart	✓		✓			✓	✓	✓		✓	✓	✓	895 ⁰⁰

**NETWORK VERSION
AVAILABLE**



Open Access II is a new, super-program which can perform virtually every managerial and business task you'll ever need with performance and ease-of-use unheard of in the industry.

Open Access II combines an extremely powerful relational database and superior spreadsheet with data communications, word processing, 3-dimensional graphics, and time management. Information is conveniently changed from module to module.

Open Access II's Database features an effective and flexible report generator and user definable screens. "Programmer," our new Database language, features simple interacting English-like commands to produce your customized applications.

Open Access II's Spreadsheet offers a unique combination of business problem solving capabilities; including goal-seeking, and an advanced table look-up command. Professional business presentations are easily produced by the enhanced graphic capabilities.

Open Access II's improved Word Processor can merge data from Spreadsheet or Database easily to produce reports, mail merge and graphic presentations.

Inquiry 311 for End-Users.
Inquiry 312 for DEALERS ONLY.

Open Access II's data communications provides you with the capabilities to handle any of your micro computer communications needs. All of Open Access II's modules work together and data is easily communicated to the rest of the world.

**BEST OF ALL,
THE PRICE**

\$595. U.S. Version Only

Open Access II's super program is also available in the network version. Ask for details. Call (619) 450-1526 in California, or (800) 521-3511 if outside California for your nearest authorized dealer or distributor and expand your business base with Open Access II, the fully integrated business system.

SPI

SOFTWARE PRODUCTS INTERNATIONAL

10240 Sorrento Valley Road
San Diego, California 92121
(619) 450-1526
For Your Authorized Dealer
In California

(800) 621-7490

Outside California
(800) 521-3511

© 1986 Software Products International, Inc. All rights reserved.
Open Access is a registered trademark of Software Products International, Inc.
Open Access II is a trademark of Software Products International, Inc.
Lotus 1-2-3 and Symphony are registered trademarks of Lotus Development Corp.
Framework is a registered trademark of Ashton-Tate.
Enable is a trademark of The Software Group.
Smart is a trademark of Innovative Software, Inc.

*Price: U.S. Version Only

E·V·E·N·T·S A·N·D C·L·U·B·S

November 1986

EVENTS

EXPLORING THE KNOWLEDGE-BASED SOCIETY: ASSOCIATION FOR COMPUTING MACHINERY—IEEE COMPUTER SOCIETY 1986 FALL JOINT COMPUTER CONFERENCE (FJCC '86), Dallas, TX. Dr. Stanley Winkler, FJCC '86, 1730 Massachusetts Ave., Washington, DC 20036-1903, (202) 371-0101.

November 2-6

THE COMMUNICATIONS CONNECTION, Portland, OR. Terrie Walker, Telecommunications Association, Portland Community College, 12000 Southwest 49th Ave., Portland, OR 97219.

November 3-5

ELECTRONIC IMAGING '86, Boston, MA. Electronic Imaging '86, Institute for Graphic Communication Inc., 375 Commonwealth Ave., Boston, MA 02115, (617) 267-9425. November 3-6

IMPLEMENTING CLINICAL COMPUTER SYSTEMS, Phoenix, AZ. American Society for Testing and Materials, 1916 Race St., Philadelphia, PA 19103, (215) 299-5526. November 5-6

COMPUTER SECURITY AND ACCESS CONTROL, Milwaukee, WI. Peter L. Tocups, Center for Continuing Engineering Education, University of Wisconsin-Milwaukee, 929 North Sixth St., Milwaukee, WI 53203, (414) 224-3952. November 5-6

SCIENTIFIC COMPUTING & AUTOMATION CONFERENCE AND EXPOSITION, Atlantic City, NJ. Expocon Management Associates Inc., 3695 Post Rd., Southport, CT 06490, (203) 259-5734. November 5-7

NORTH AMERICAN TELECOMMUNICATIONS ASSOCIATION CONVENTION & EXHIBITION SHOWCASE (NATA 86), St. Louis, MO. North American Telecommunications Association, 2000 M St. NW, Suite 550, Washington, DC 20036. November 5-7

ASSOCIATION FOR THE DEVELOPMENT OF COMPUTER-BASED INSTRUCTIONAL SYSTEMS 28TH INTERNATIONAL CONFERENCE, Washington, DC. Gordon Hayes, ADCIS, Miller Hall Room 409, Western Washington University, Bellingham, WA 98225, (206) 676-2860. November 10-13

COMDEX/FALL '86, Las Vegas, NV. The Interface Group, 300 First Ave., Needham, MA 02194, (617) 449-6600. November 10-14

PC FAB EXPO '86, Long Beach, CA. PMS Industries, 1790 Hembree Rd., Alpharetta, GA 30201, (404) 475-1818.

November 11-12

WINTER NATIONAL DESIGN ENGINEERING SHOW, San Francisco, CA. Winter National Design Engineering Show, 999 Summer St., Stamford, CT 06905, (203) 964-0000.

November 11-13

EDUCOM '86, Pittsburgh, PA. EDUCOM, P.O. Box 364, Princeton, NJ 08540, (609) 734-1888. November 11-14

SIXTEENTH ANNUAL MEETING OF THE SOCIETY FOR COMPUTERS IN PSYCHOLOGY, New Orleans, LA. Cyndi McDaniel, Psychology Department, Northern Kentucky University, Highland Heights, KY, 41076, (606) 572-5310. November 12

TOOLS FOR RENDERING 3-D IMAGES, RECURSION IN COMPUTER GRAPHICS, AND COMPUTER GRAPHICS IN THE CLASSROOM, New York University, New York, NY. Gideon Nettle, 80-40 Lefferts Blvd., Kew Gardens, NY 11415, (718) 849-6313. November 17

WESCON/86, Anaheim, CA. Electronic Conventions Management, 8110 Airport Blvd., Los Angeles, CA 90045, (800) 421-6816; in California, (800) 262-4208 or (213) 772-2965. November 18-21

TENTH ANNUAL WESTERN EDUCATIONAL COMPUTING CONFERENCE, Irvine, CA. Alexia Devlin, California Educational Computing Consortium, San Francisco State University, Accounting Data, NADM-358, 1600 Holloway Ave., San Francisco, CA 94132. November 20-21

EIGHTH ANNUAL FORTH CONVENTION & BANQUET, Santa Clara, CA. FORTH Interest Group, P.O. Box 8231, San Jose, CA 95155, (408) 277-0668. November 21-22

FORTH MODIFICATION LABORATORY (FORML), Pacific Grove, CA. FORTH Interest Group, P.O. Box 8231, San Jose, CA 95155, (408) 277-0668. November 28-30

If you send notice of your organization's public activities at least four months in advance, we will publish them as space permits. Please send them to BYTE (Events and Clubs), One Phoenix Mill Lane, Peterborough, NH 03458.

CLUBS

INTELLOG ASSOCIATION FOR THE APPLICATION OF ARTIFICIAL INTELLIGENCE, 85 rue du Fbg. St. Denis, 75010 Paris, France.

STM USERS GROUP (Not affiliated with STM Corp.), 3778 Hitching Post Road, Jackson, MI 49201, (517) 782-2297.

ZSIG (Z-SYSTEM SPECIAL INTEREST GROUP), Michael Broschat, 2610 East Aloha, Seattle, WA 98112, (206) 328-0561.

MESA (MACINTOSH ENTHUSIASTS OF SAN ANTONIO), J. Eddie Field, Rt. 4, Box 2151, Lakehills, TX 78063, (512) 751-2947. (They are also seeking exchanges with other Mac users groups.)

PC WORD PROCESSING NEWSLETTER, Leo Dmitri, 60 West 10th St., New York, NY 10011.

NEW HAVEN ST's, Robert Fischer, 80 Killdeer Rd., Hamden, CT 06517, (203) 288-9599. (Atari ST users group.)

NORTH AMERICAN AMSTRAD USER SUPPORT GROUP (NAAUSG), Sage Enterprises, Rt. 2, Box 211, Russellville, MO 65074.

AMIGA USERS GROUP/HUDSON VALLEY (AMICUS/H.V.), Ralph Blanchette, Box 327 Willowbrook Rd., Clinton Corners, NY 12514, (914) 266-5606.

H/P DESKTOP USERS GROUP, METRO AREA, Bruce E. Baxter, IRS D:R:R:M, 1111 Constitution Ave. NW, Washington, DC 20224, (202) 566-6759.

GSBUG (GREATER SOUTH BAY PC USER GROUP), P.O. Box 1937, Redondo Beach, CA 90278.

AMIGA GURU, CA-AUG, 3715 Townley Rd., Shaker Heights, OH 44122.

A.L.I.E.N. (ATARI LOVERS OF ILLIANA EQUAL TO NONE), Richard Thompson, 7609 Jarnecke Ave., Hammond, IN 46324 (219) 932-2866.

DENVER AREA TRS-80 ASSOCIATION (D.A.T.A.), Frank Berndt, 1799-D South Lee St., Lakewood, CO 80226, (303) 989-6068.

CoCo CARTEL, A COLOR COMPUTER USERS GROUP, Dennis Weldy, 4059 Acacia Dr., Columbus, GA 31904. ■

MINUTE MAN^{T.M.}

UNINTERRUPTIBLE POWER SUPPLIES



PROTECTION FROM:

- ★ BLACKOUTS
- ★ BROWNOUTS
- ★ INTERRUPTIONS
- ★ SPIKES
- ★ SURGES
- ★ EMI/RFI

See Us At: Comdex-Las Vegas
Nov. 10-14, 1986

EVALUATION PROGRAM

(30-DAY MONEY BACK GUARANTEE)

- Completely automatic operation
- From 1 msec to 4 msec switching time
- Audible and visual status indicators
- Order - ship same day
- Toll Free ordering
- Full one year warranty

MINUTE MAN 250	MINUTE MAN 300	MINUTE MAN 500	MINUTE MAN 1000
250 WATT (120V) STEPPED SQUAREWAVE	300 WATT (120V) SYNCHRONIZED SINEWAVE	500 WATT (120V) SYNC. STEPPED SQUAREWAVE	1000 WATT (120V) SYNCHRONIZED SINEWAVE
\$359⁰⁰	\$549⁰⁰	\$699⁰⁰	\$1399⁰⁰
Suggested Retail U.L. and C.S.A. Approved	Suggested Retail	Suggested Retail U.L. and C.S.A. Approved	Suggested Retail

230 V Units Also Available

11425 Mathis St.
Suite 404
Dallas, Texas 75234



Telephone:
(214) 869-1688

1-800-238-7272

Conducted by Steve Ciarcia

ENCODING A KEYBOARD

Dear Steve,

Can you tell me how to encode an unencoded keyboard? I have a surplus keyboard from a Coleco Adam that I would like to use in building the Term-Mite smart terminal (January and February 1984 BYTE). I need to know how to produce the parallel data needed by the Term-Mite board from the keyboard matrix. I have the pin-out diagram that shows which intersection corresponds to which key. Is there a chip that performs the encoding automatically, or do I have to work out my own logic?

MARK T. JOHNS
Naperville, IL

There are a number of ways to encode an unencoded keyboard. All of the methods generally rely on a scanning technique so that when a keypress is generated, the circuitry senses this and reports the address of the key. Usually, debouncing of the switches is done to improve the reliability of the encoding.

A chip that is readily available and "does it all" is the KR-3600-Std (also an AY5-3600) and is intended for a 90-key keyboard, something like the keyboard you mentioned. You can buy one of these from

Jameco Electronics
1355 Shoreway Rd.
Belmont, CA 94002
(415) 592-8097

You can also purchase a data sheet from them for this chip for 50 cents, which I highly recommend.—Steve

ONE THING AT A TIME

Dear Steve,

Here's a software problem that gets down to hardware constraints: Can an IBM PC's (or PC XT compatible's) disk drives be used in I/O interrupt mode? I have often wished that I could run programs concurrently with I/O processing. Although MS-DOS does not support multitasking, the PC's hardware does provide interrupt capability and has DMA (direct memory access) circuitry.

A simple algorithm featuring "double-buffered" I/O would allow a program to

use one buffer while the disk driver software is filling or emptying the other. The completion of the two processes could be synchronized and the role of the two buffers could be switched so that I/O would take place continuously. Are there any disk drivers available for the PC that start an I/O operation, return control to the calling program immediately, and then signal completion at a later time?

GREG DENTON
San Jose, CA

It is possible for you to run the disk drives using DMA and interrupts, but you'll gain no practical advantage. The reason, as you have already stated, is that DOS does not support multitasking. The implications of this are more restrictive than you imagine. Let's suppose you add overlapped I/O without changing anything else.

Consider what happens if a program writes two buffers of data to disk. It issues a write request for the first buffer, DOS starts the I/O operation, and control returns to the program while the data is being transferred. The program issues the second write request, DOS puts the new request into a queue because the first one isn't done yet, and control returns to the program again.

Now, if a glitch occurs, the data in the first transfer is corrupted. DOS knows that there has been an error, but how does it signal the program that all is not well? The two write requests were issued in the past, and the program is off and running something else.

Of course, if you write the program and the disk driver together you could make it work the way you want, but then your system isn't MS-DOS-compatible. The Fastback hard disk backup program works this way. Its authors wrote a special device driver for the floppy drive that bypasses DOS and uses DMA data transfers with interrupts to stream data onto the floppy. The resulting disks can't be read by DOS, but the program is the fastest disk backup utility around.

Oddly enough, the device driver program format used by PC-DOS and MS-DOS has two entry points called STRATEGY and INTERRUPT, which are

obviously designed for use in a multitasking interrupt-driven system similar to the one we'd both like to have. The current versions of DOS fake a device interrupt and enforce the single-threaded method of handling devices, but at least there's hope.—Steve

DISABLING AUTO-REPEAT

Dear Steve,

I want to disable the automatic-repeat feature of the keyboard on an Apple IIe. My objective is to make the machine easier to use for people with poor manual dexterity (cerebral palsy). The IIe was recommended because of its expansion slots that allow for special peripherals.

I asked a local Apple repair department how to disable the auto-repeat feature, and the responses I got included "It can't be done" and "It can only be done by changing a ROM, but we don't know how you could get the right ROM."

I looked at the Sams Computerfacts schematics and troubleshooting information for the IIe and it appears that capacitor C70 and resistor R32 are involved in the auto-repeat function. It looks like C70 charges or discharges through R32 and thus generates a time delay that is used by the decoder chip E14. I don't have enough information to know exactly what to do; a technician at an Apple dealer suggested removing C70, but my theory is that putting a resistor in parallel with C70 would be better.

(continued)

IN ASK BYTE, Steve Ciarcia answers questions on any area of microcomputing. The most representative questions received each month will be answered and published. Do you have a nagging problem? Send your inquiry to

Ask BYTE
c/o Steve Ciarcia
P.O. Box 582
Glastonbury, CT 06033

Due to the high volume of inquiries, personal replies cannot be given. All letters and photographs become the property of Steve Ciarcia and cannot be returned. Be sure to include "Ask BYTE" in the address.

The Ask BYTE staff includes manager Harv Weiner and researchers Eric Albert, Bill Curlew, Ken Davidson, Jeannette Dojan, Jon Elson, Roger James, Frank Kuechmann, Dave Lundberg, Edward Nisley, Dick Sawyer, Andy Siska, and Robert Stek.

News about the Microsoft Language Family

Compiling Efficiently with Microsoft® QuickBASIC

Microsoft QuickBASIC Version 2.0 offers you a wide range of choices when you compile. You can compile programs directly into memory, or create executable programs on disk depending on your needs. To get the most out of the compiler, you should know the various size/speed tradeoffs associated with each compile option.

In-memory compilation places an executable file directly into memory from the Microsoft QuickBASIC programming environment. This is the easiest way to compile and run Microsoft QuickBASIC programs during program development. The advantage of this method is that it allows you to compile and run without leaving Microsoft QuickBASIC. However, the program can only be executed from inside the Microsoft QuickBASIC programming environment.

You can also use Microsoft QuickBASIC to create an executable file on disk that can be run without entering the programming environment. There are two different kinds of stand-alone executables: programs that include the run-time environment in the .EXE file and programs that require the presence of the run-time module BRUN20.EXE when run.

The .OBJ(BCOM.LIB) or /o option creates an object file that when linked to the BCOM20.LIB library becomes a program that runs without the presence of the run-time module BRUN20.EXE. Programs linked with the BCOM20.LIB are larger, but execute much faster than programs that require the run-time module. Besides execution speed, the advantages of this method are that the program does not require an additional file to run and the program can be conveniently copied to other disks.

The .OBJ(BRUN.LIB) option creates an object file that when linked to the BRUN20.LIB library requires the presence of the run-time module BRUN20.EXE to execute. Programs linked with BRUN20.LIB are smaller, but run slower than programs linked with BCOM20.LIB. The speed degradation results from the fact that BRUN20.LIB uses software interrupts to call the run-time routines, whereas BCOM20.LIB uses direct calls. The Speed or /q option explained below can minimize this difference. Depending on your size and speed requirements, you should probably link with BCOM20.LIB if you are distributing only one program, or if the user might copy the program to another disk without also copying the run-time module. If your application chains programs, or your distribution will include several programs, you should link with BRUN20.LIB and distribute BRUN20.EXE with your programs. There are no licensing requirements and no fee for distributing the BRUN20.EXE run-time module.

The .EXE option creates an executable program on the disk. This program requires the presence of BRUN20.EXE to execute.

The Debug or /d option should be used in debugging your program during development. It generates larger and slower code by including debugging and error handling code in the executable program that checks for arithmetic overflow/underflow, array bounds and the existence of GOSUBs with each RETURN statement. When the program is completely debugged and ready for distribution, you will want to compile the program without this option to maximize speed and minimize size.

You must use the On Error or /e option in programs that contain ON ERROR GOTO and RESUME *linenumber* statements. This option creates a larger program (by building a table of entries for each line number). Use the Resume Next or /x option in programs that contain RESUME, RESUME NEXT, and RESUME 0 statements. Compilation takes longer and results in larger object files than the On Error or /e option because it increases the table of line number entries.

The Checking Between Statements (/v) and Event Trapping (/w) options enable event trapping for communications, lightpen, joystick, timer and function keys. Both of these options increase code size and slow execution. The Event Trapping (/w) option checks between lines for the occurrence of an event and takes less space and execution time than /v.

The Speed or /q option optimizes the programs compiled using BRUN20.LIB to be nearly as fast as programs compiled using BCOM20.LIB, but results in a larger executable because every call has two bytes more overhead. If you do not specify this option, the program will be as small as possible but the execution speed is slower than if you specified /q. The size and speed effects of this option depend on the number of repeated statements in loops you use in your program.

If you are compiling in memory and you are getting "Out of Memory" errors, you may want to use the Minimize String Data or /s option. This option writes quoted strings to the .OBJ file instead of the symbol table. This allows you to compile a large, string-intensive program without getting "Out of Memory" errors when compiling in memory, but it increases the size of the .OBJ file. De-selecting the Debug option may also solve out of memory problems in large programs.

For more information on the products and features discussed in the Newsletter,
write to: Microsoft Languages Newsletter
16011 NE 36th Way, Box 97017, Redmond, WA 98073-9717

Or phone:
(800) 426-9400. In Washington State and Alaska,
call (206) 882-8088. In Canada, call (416) 673-7638.

Microsoft is a registered trademark of Microsoft Corporation.

Latest DOS Versions:

Microsoft C Compiler	4.00
Microsoft COBOL	2.10
Microsoft FORTRAN	3.31
Microsoft Macro Assembler	4.00
Microsoft Pascal	3.31
Microsoft QuickBASIC	2.00

Look for the Microsoft Languages Newsletter every month in this publication.

I would greatly appreciate any assistance you could give us in solving this problem; I'm sure that many handicapped users of the IIe would be interested in a solution to "unwanted auto-repeat."

THOMAS K. JOHNSON
Crystal Lake, IL

Capacitor C70 and resistor R32 in the Apple IIe keyboard circuit are part of the oscillator that causes the decoder IC to scan the keyboard. They have nothing to do with the keyboard auto-repeat function. Altering the values of either will do nothing but damage, and if you remove either, the keyboard encoder will cease functioning.

The auto-repeat feature of the Apple IIe is located in a custom IC called the "IOU" chip on the motherboard. You would have to replace this chip in order to disable the function, but there is nothing available to replace it with. Consequently, there is no reasonable way to disable this feature.—Steve

COMPAQ RESET SWITCH

Dear Steve,

I am interested in adding a reset switch

to my Compaq Portable. I would appreciate it if you could show me a schematic of such a circuit. Such a switch would prove invaluable, especially when debugging assembly language programs that invariably freeze up the computer. I understand that grounding the microprocessor's RESET pin does not result in a complete reset.

RICK RETTER
Danbury, CT

There is more to resetting a computer than grounding the RESET pin on the CPU chip. If you want to find out where your code is hanging, you need to do something more sophisticated.

Grounding the RESET pin on the CPU will initiate the memory test routine—thus erasing the code you are trying to debug—and then go about the process of restarting DOS. This will probably get the computer back up and running, since most of the resetting of the hardware is done by ROM code. It would be nicer if you could get into a debugger program while the system is hung.

Unfortunately, the 8088 does not have many features to protect the monitor,

debugging facilities, and interrupt vectors from damage done by a runaway program. So, if these areas are damaged, a reset through a software vector to a debugger would be useless anyway. There are several reset cards on the market, but I cannot say with confidence that any particular one will work on the Compaq (although they all should). Still, the problem of code damage may make these cards less than perfect.

To reset the CPU, you need to follow the signal back from the CPU RESET pin (pin 21) to the device that drives it. It will have an RC timing circuit attached that applies a proper RESET signal level for a time after the power comes on. Grounding this circuit with a push-button switch will reset the processor; but, as I have said, you will lose all history of what went wrong.—Steve

READING CATALOG INTO ARRAY

Dear Steve,

I would like to be able to read the contents of a DOS 3.3 disk catalog into an array, so that the name of every text file (file type "T") on the disk is loaded into its own

(continued)

Now works with DOS 3 DEBUG! **X-VIEW 86™**

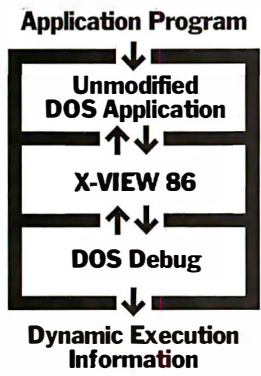

X-VIEW 86 profiles the execution of DOS software, and displays information needed to improve program performance, identify compatibility issues, and pinpoint conversion problems.

Profiles DOS application software and solves problems Debug can't touch.

X-VIEW 86 is a DOS software X-ray machine. X-VIEW 86 monitors internal software operations during execution to help you debug, test, port, or convert programs. X-VIEW 86 adds new features to Debug to profile either your own applications software or top-sellers like 1-2-3.® You get fast, reliable results.

- Real solutions to technical challenges.** Save hours of time-consuming, tedious work using data from X-VIEW 86's built-in reports that identify:
- Execution hotspots
 - Segment usage
 - Memory map references
 - I/O port references
 - Interrupt calls
 - Instruction set usage
- Report information is displayed on screen. And new breakpoint commands added to Debug stop a program on:
- I/O port references
 - Interrupt calls
 - Memory data references

Hardware and software requirements. X-VIEW 86 runs on the IBM PC and compatibles with DOS Debug 2.x or 3.x. Even if you use a different debugger, X-VIEW 86 turns Debug into your program profiler. And it's not copy protected.

Priced at an affordable \$59.95. Get a whole new outlook on your work with X-VIEW 86. We've made it easy: Order today by calling 1-800-227-0900; in California, 800-772-2531; or outside the U.S., call 415-549-6625. We accept Visa, MC, and AmEx cards. Or order by writing to: Osborne/McGraw-Hill, Software Dept., 2600 Tenth St., Berkeley, CA 94710. X-VIEW 86 is just \$59.95 plus sales tax and \$3.00 shipping (\$9.00 outside the U.S.). Be sure to include credit card number and expiration date with mail orders. Orders paid by check are subject to delay.



OsborneMcGraw-Hill
2600 Tenth Street, Berkeley, California 94710

X-VIEW 86 is a trademark of McGraw-Hill, Inc.; IBM is a registered trademark of International Business Machines; 1-2-3 is a registered trademark of Lotus Development Corporation.

SOLUTIONS!

POWER

The Power to Run Z-80 software on a PC!

Never before has it been easier, or more affordable to add the power of Z-80 compatibility. Plug this half size card in your PC, XT, AT or compatible and within minutes you will be running the most powerful CP/M software available including the most popular assemblers, compilers, word processors, spreadsheets, etc. Included with each Z-80 card is our incredible RUN/CPM™ emulation software which will allow your PC to emulate 100's of popular CP/M computers, such as "Kaypro," "Osborne," "Morrow," etc. Your CP/M programs will run up to 300% faster, with full color, and you can run them from your PC's hard disk or "RAM" disk, and run MS-DOS background programs such as Borland's "Sidekick" on top of your CP/M programs. RUN/CPM™'s amazing disk emulation feature will actually allow your PC's floppy drives to Directly READ, WRITE and FORMAT over 165 different CP/M disks, offering you the utmost in data disk compatibility. The RUN/CPM software and Z-80 Co-processor are the perfect solution to bringing the power of the Z-80 to the PC. Call today and order the most affordable Z-80 Co-Processor ever!

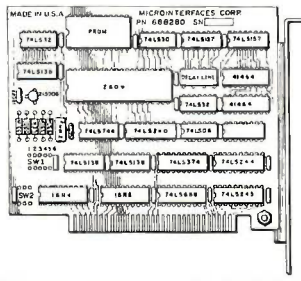

Z-80 Co-processor \$199.95

RUN/CPM™ V20/30 Emulator

RUN/CPM™ is also available for the popular N.E.C. V-20 micro-processor chip. This version supports the 8080 instruction set and runs on PC's and XT's. Order now at only \$99.95 software only, or \$124.95 including an 8 mhz V-20.

COMPATABILITY

Run INTEL® on a PC



Transform an IBM PC, XT, AT, or compatible into an "Intel" Micro Development System, capable of running 8 bit ISIS-II, and 16 bit ISIS-III (UDI) software while remaining 100% MS-DOS compatible. MICRUN 80, our 8 bit ISIS-II Interface is priced at \$495 and includes the above pictured Z-80 card plus all necessary software for running 8 bit Intel software on PC's and AT's. MICRUN 86, our 16 bit Interface is \$450 and does not require hardware. MICRUN 80 and MICRUN 86 are the solutions to Intel compatibility on a PC.

**Fast!
Hard
Disk
Back
Up.**

Quiksave™ is the solution to all of your hard disk back up needs. Quiksave's incredible speed will allow you to back up 10 megabytes of data in only 10 minutes! Because Quiksave backs up data on to standard floppy diskettes, there is no need for an expensive tape drive system. Best of all, Quiksave comes with 20 "Free" pre-formatted floppy disks,* so you can start backing up your valuable hard disk data immediately. Don't risk costly data loss, order Quiksave™ today and rest assured.

*Enough disks to backup 10 Megabytes of data on most systems.



QUIKSAVE
ONLY \$99.95

SPEED Backup 10 Megabytes in 10 Minutes

Call to Order, or for more information.
All products come with a 30 Day Money Back Guarantee.

1-800-637-7226



MICRO INTERFACES

6824 N.W. 169th Street
Miami, Florida 33015
(305) 823-8088
Telex 5106004680 MICRO INTER CO.

Inquiry 210 for INTEL on PCs. Inquiry 211 for RUN/CPM.

RUN/CPM is a registered trademark of Micro Interfaces Corporation; Sidekick is a registered trademark of Borland International; Kaypro is a registered trademark of the Kaypro Corporation. Intel is a registered trademark of the Intel Corporation; CP/M is a registered trademark of Digital Research; z-80 is a registered trademark of Zilog Corp.; Quiksave is a registered trademark of Micro Interface Corp.

NOW. POWERFUL WITHOUT POWER

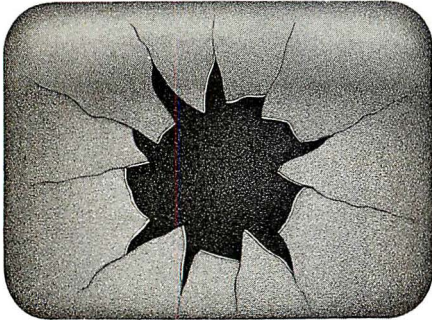

A typical DBMS user's screen, after the 497th line of code.

With most database management software for the IBM PC family and compatibles, you're quickly confronted with a painful reality: the only way to make your package live up to its promise is to learn its programming language. Which can take months. Then you have to write the code, line after frustrating line.

But now, there's R:BASE™ System V. And for the first time, you can quickly create programs that automate your most important data management tasks. Without programming.

Of course, with R:BASE System V, you can enter, query, and report on data in a non-automated, ad hoc fashion. Without programming. And there's a high-level procedural language for programmers. But that's just the beginning.

R:BASE SYSTEM V. IT GIVES NON-PROGRAMMERS POWERFUL PROGRAMS.

With the EXPRESS System in R:BASE System V, you can access powerful features, without programming, that other data management software can't touch.

With Definition EXPRESS,

SELECT ALL FROM calrpt SORTED BY caldate WHERE...

—Choose an operator to combine conditions—Choose (Done) when done—
AND OR AND NOT OR NOT (Done)

	Column	Operator	Value
OR	district	EQ	Boston
AND	district	EQ	New York
AND	caldate	GT	March 12, 1985
	comment	CONTAINS	American Baking Company

An R:BASE System V Prompt-By-Example (PBE) screen. With PBE's query capabilities, you can retrieve just the information you need. Without programming.

you can build a database structure with advanced features like computed columns, and *searchable* note fields. VIEWS that combine up to five tables in a single, powerful table. Data validation rules that check incoming data for errors. All without programming.

Then you can use Forms EXPRESS to create customized data entry forms. The forms you create can load data into five different tables, linked in One-To-Many relationships. You can also include scrolling regions, custom borders, and custom colors, all without programming.

And with Reports EXPRESS, you can design reports exactly the way you want. And see what they'll look like, right on the screen. To see how complex your reports can be, take a close look at the example at the end of this page.

Finally, you can tie it all together with Application EXPRESS. First, you design your own multi-level system of menus. Your first menu level might look like this:

Aunt Betty's Sales Reporting System

- (1) Enter Sales Data
- (2) Edit Sales Data
- (3) Print Daily Sales Report
- (4) File Processing
- (5) Exit

For each menu choice, you assign an action. For example, to define

Aunt Betty's Baked Goods

Transaction date: 6/25/86 Date: 6/25/86

Transaction number: 4609

Customer number: 666

Name: Speedy Shopper, Inc.
Address: 4092 Industrial Way
City, State, Zip: Dryden, New York 15055
Phone: 800-555-0661

Stock #	Brand	Qty	Price	Extended Price
207	Bake-A-Batch Cookies	95	2.00	186.00
508	Peanut Butter Crunch	100	2.50	250.00
619	Double Rich Brownies	150	4.95	742.50

A data entry screen designed without programming, using Forms EXPRESS.

menu choice #3, choose the action "PRINT," select the report you just created in Reports EXPRESS, and specify the appropriate data sorting and selection criteria. Then Application EXPRESS automatically writes the program code.

Which means you've just created a very sophisticated program to deliver the full power of your DBMS. And you've done it all without learning how to program. From this point on, every time you want to run a report, all you do is choose item #3. With one simple keystroke, you've got it.

R:BASE SYSTEM V. IT GIVES PROGRAMMERS A POWERFUL ENVIRONMENT.

If you're an experienced programmer, you can use R:BASE System V to tackle the most demanding applications. You can use Application EXPRESS to create prototypes faster than with any other microcomputer-based DBMS.

There's a high-level procedural language, and a full set of relational operators that can leverage up to 80 tables, all of which can be open at once. While you're racing along, a data dictionary

DBMS PROGRAMS REFUL DBMS PAIN.

keeps track of the action.
Automatically.

For demanding analyses, there's a set of 70 math, statistical, financial, scientific, and string manipulation functions. You also get more capacity for your data. Comprehensive menu-driven import/export capabilities. Superior relational power. And much, much more.

THE MOST POWERFUL DBMS FOR ONE USER OR A WHOLE NETWORK— ALL IN ONE PACKAGE.

In addition to its standalone personal computing power, R:BASE System V has all the features you need to share data on a local area network (LAN) built right in. When you're ready to network—now or later—this is the only DBMS package you'll ever need. And no matter how many users you add, you'll never have any growing pains. Because an unlimited number of users, attached to a LAN, can access R:BASE System V.

SEE FOR YOURSELF:
\$15.95.

We're confident you'll find R:BASE System V the shortest distance to your data management solution. Visit your computer dealer for a trial run. Or, if you prefer, we'll send you a Trial Pack

for only \$15.95, plus shipping. It's a fully functional, row-limited version of R:BASE System V. Just call 1-800-547-4000, Dept. 980. In Oregon or outside the U.S., call 1-503-684-3000, Dept. 980.

What if you already own R:BASE 5000? If you bought your copy before June 30, 1986, you can trade it for the full power of R:BASE System V. For only \$99. (Offer expires January 31, 1987.) Just give us a call at 1-800-248-2001. Outside the U.S., call 1-206-885-2000.

15 line header (up to 65 lines possible)

Four levels of grouping... (up to 10 levels possible)

Time and date stamping

Supports italic and other special printer commands

Prints summary line for grouping

Draws boxes anywhere in report

Aunt Betty's Baked Goods, Incorporated California Division Daily Sales Report For June 23, 1986 Confidential Information		TOTAL SALES
1 01-1986		
2 Southern California		
3 Cracker Products		
4 Wheat Crisps		
4 Rye Crackers		
Total Cracker Product Sales		97,536.22
Sweet Goods Products		235,223.11
Bake-A-Batch Cookies		332,759.33
Peanut Butter Crunch		
Coconut Macaroons		25,006.23
Double Rich Brownies		8,623.30
Total Sweet Goods Product Sales		19,446.90
Total Sales, Southern California		113,636.01
Northern California		166,712.44
Cracker Products		
Wheat Crisps		
Rye Crackers		
Total Cracker Product Sales		57,406.25
Sweet Goods Products		175,223.56
Bake-A-Batch Cookies		232,629.81
Peanut Butter Crunch		
Coconut Macaroons		45,146.55
Double Rich Brownies		47,123.80
Total Sweet Goods Product Sales		9,390.99
Total Sales, Northern California		517,446.25
Total Sales		619,107.59
Total Sales		851,737.40
Total Sales		1,351,209.17

A program to print this report daily, with a one keystroke menu pick, was developed without programming using R:BASE System V's EXPRESS Technology. Whether you know how to program or not, R:BASE System V is the shortest distance to your data management solution.

NEW R:BASE SYSTEM V FROM MICRORIM

Trademarks/Owners: Microrim,
R:BASE/Microrim, Inc.; IBM/International
Business Machines, Inc. ©1986 Microrim, Inc.

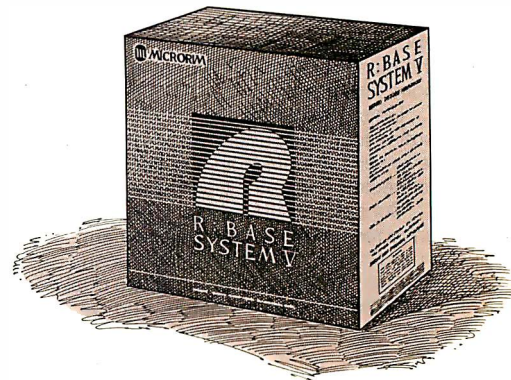

array entry. I have tried a number of ways to do this, but to no avail.

DAVID FREIBRUN
Los Angeles, CA

Call—A.P.P.L.E. in Depth, Number Three: All About DOS (A.P.P.L.E. Co-op, 290 SW 43rd St., Renton, WA 98055) contains a program that will read a disk catalog into an Applesoft array. Using it as a starting point, you should be able to create the program you want.—Steve

CIRCUIT CELLAR FEEDBACK

VOICE RECOGNITION TECHNOLOGY IN DENTAL RESEARCH

Dear Steve,

I am the director of a clinical research group in Boston. Our work includes the testing of diagnostic methods for early signs of periodontal (gum) disease. Al-

though several methods being tested can be interfaced to a computer (e.g., temperature, tooth mobility, and periodontal pocket depth), inevitably we are faced with the need to compare results with older, subjective rating schemes. Thus, voice recognition becomes a technology worth considering.

My principal concern is the expected error rate of this methodology. Although the vocabulary requirements are small, our current methods achieve error rates on the order of 1 in 1000 or better and we would not consider 1 in 100 acceptable. I don't know the expected error rate of current voice recognition technology.

The problem I am describing is general for clinical research. Classically, a second individual is employed to write verbal information (usually numbers) on a piece of paper, so the design of a total computer interface environment creates the potential for single-clinician diagnosis, thereby multiplying productivity.

I would appreciate your thoughts on the practicality of conducting clinical experiments using voice recognition and if you think it practical, could you recommend specific hardware and software to accomplish this task.

J. MAX GOODSON, D.D.S., PH.D.
Department of Pharmacology
Forsyth Dental Center
Boston, MA

While voice recognition is indeed a viable method of accomplishing your needs for data collection, the level of accuracy you're looking for is dependent on a number of factors both inside and outside the system you choose to do the recognition.

Hobby-style boards typically achieve successful recognition rates in the 95 to 99 percent range at best with vocabularies of 30 to 60 words. Room noise is a factor, as are variations in voice. Usually, a system is "trained" to recognize a specific individual, so that every time a new researcher uses it, retraining is required for full recognition.

To achieve the error rates you indicate, even with the low vocabulary, would require a relatively expensive system. On the other hand, I can think of other ways to accomplish the same thing with no errors associated with the data collection process and no writing involved.

The suggestion I have is to use a simple, reduced keyboard that has one key for each of the possible responses. Prompting could easily be done using voice synthesis with the clinician indicating his or her answer by pushing the

(continued)



USRobotics' COURIER 2400™
...The most dependable
at 2400- or 1200-bps

You get 2400/1200/300-bps data communications and every first-class feature you'd expect in an auto-dial, auto-answer modem... at a surprisingly affordable price.

But a modem at any price is only as good as its performance... And that's where Courier 2400 really shines. Don't take our word for it. Ask any of the nearly 2,000 electronic bulletin board system operators who have chosen the Courier 2400 for one of the most demanding modem applications imaginable.

Listen to the unanimous chorus of praise for the Courier 2400 from tough reviewers at more than a dozen highly respected computer magazines.

Consider Courier 2400's performance record—less than one percent of all Courier 2400s sold have been returned for service, a record we challenge the industry to match. And we back up our confidence in Courier 2400

with a full two-year parts and service warranty.

Quality, performance, value—your modem should be this good. It is, if it's the **Courier 2400** from USRobotics.

USRobotics

The Intelligent Choice in Data Communications

8100 McCormick Blvd., Skokie, Illinois 60076
Phone toll free 1 (800) DIAL USR
In Illinois (312) 982-5001

To learn more, send for our
FREE booklet: "24 Questions
and Answers on 2400-BPS
Modems."

NAME _____

ADDRESS _____

CITY _____

STATE _____ ZIP _____

COMPANY _____

TITLE _____

PHONE () _____

PERSONAL USE BUSINESS USE

Inquiry 356 for End-Users.
Inquiry 357 for DEALERS ONLY.

IBM AT Compatible Features:

- 512K RAM expands to 1MB
- 33% faster than IBM AT
- 1.2MB floppy drive
- 8/6 MHZ CPU 80286-8
- USA BIOS fully compatible
- Clock/calendar w/battery
- Hard disk/floppy controller
- AT style Keyboard
- 195 watt power supply
- 48 hour burn in
- Full documentation
- Includes setup software
- One year limited warranty

\$1125*

MADE IN U.S.A.



* Monitor not included

Hard Disks

Let PC INNOVATIONS provide, install, and test the proper Hard Drive for your AT

(drive only)	
SEAGATE 225 65MS	\$310
SEAGATE 4026 39MS	\$549
SEAGATE 4038 39MS	\$595
SEAGATE 4051 39MS	\$699
TOSHIBA 70MB 23MS	\$1395

10MHz Zero Wait State SI Rating 11.7 \$1495

EVEREX EGA GRAPHIC CARD

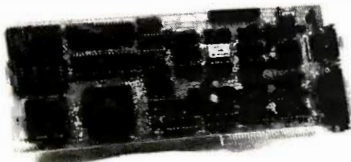

- 16 colors 640 x 350 res.
- 256K video memory
- Parallel port

\$249

NEC MULTISYNC



- EGA, PGA, CGA monitor
- 800 x 560

\$569

EVEREX TAPE BACKUP SYSTEMS

The best tape backup money can buy

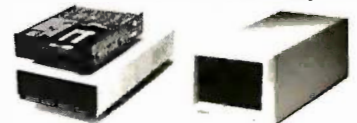

	INTERNAL	EXTERNAL
20MB	\$589	\$639
60MB	\$759	\$829
100MB	—	\$929
Complete subsystem w/software		

TRY PC INNOVATIONS PERIPHERAL CARDS FCC CLASS 'B' APPROVED

I/O for AT



\$75

* XT Version available

- Half slot
- Parallel port
- Serial port
- Optional 2nd serial

THE EDGE



\$215

- Color display
- Hercules mono
- 132 column
- Printer port
- Software
- Lotus 123 graphics

HERCULES COMPATIBLE



\$99

- Monochrome graphics
- Requires no software
- Printer port
- Optional serial port
- Runs Lotus 123 graphics

AT MEMORY CARD



\$165

- Up to 3MB
- No piggy back
- Split memory
- Uses 64K or 256K chips
- Software

MULTIFUNCTION CARD FOR AT



\$175

- Up to 3MB
- Serial port
- Optional 2nd serial port
- Parallel port
- Game adaptor
- Software

HAYES 1200B MODEM



With SmartCom II

\$349

2400 BAUD
EVERCOM 1200 BAUD
U.S. Robotics:
2400 Internal **\$389**
2400 External **\$389**

CALL **\$128**
CALL **\$389**
CALL **\$389**

PC INNOVATIONS SPECIAL OFFERS

TEAC floppy disk 360K	\$89	1.2MB	\$119
Toshiba floppy disk 360K	\$95	1.2MB	\$125
Floppy disk controller			\$40
Multifunction floppy disk controller			\$95
XT 150 watt power supply			\$75
AT 192 watt power supply			\$109
Memory chips, Eproms, 8087, 80287			CALL

EPSON FX 286	\$539
EPSON FX 85	\$379
EPSON LQ 800	\$379
EPSON LQ 1000	\$739
Toshiba P321 printer	\$525
Toshiba P341 printer	\$757
Leading Mfg. 13" RGB display	\$259
MS400 AT 4 port serial card	\$115
MS400 XT 4 port serial card	\$110

VOLUME DISCOUNTS AVAILABLE

PC INNOVATIONS

UNIVERSITY AND CORPORATE BUYERS WELCOME

ESTABLISHED SINCE 1980

10 Hughes Street, Suite A-200 • Irvine, CA 92718
631 S. Main Street • Plymouth, MI 48170

IBM, IBM AT, Hayes, Hercules are trademarks of their respective companies.

(714) 768-8130
(313) 451-0664

VISA & MasterCard Welcome
Prices subject to change

Our trained sales and technical staff is ready to serve you.

NOW, REAL CADD FOR ATARI ST JUST \$49.95

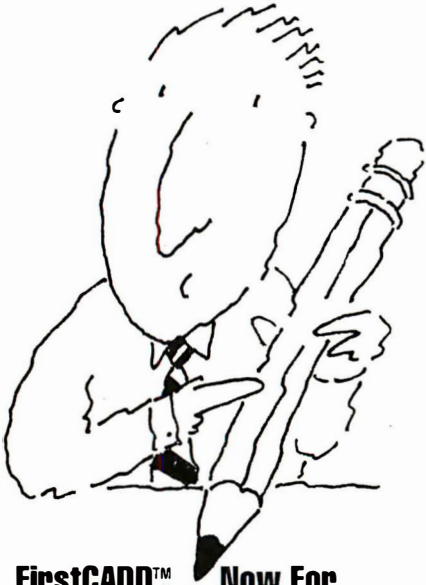

FirstCADD™, Now For Atari 520ST & 1040ST, and IBM PC & Compatibles

If you draw, design, draft or doodle use FirstCADD™ to do it faster and do it better.

FirstCADD™ can change the way you do business! If any part of your business calls for putting pencil to paper, then FirstCADD™ is for you. For anyone who uses a pencil ... for anything!

If you're an executive, use FirstCADD™ to do flow charts, graphs, presentations. **We make it a snap to combine words with pictures.**

If you're a contractor, plumber, electrician or building manager, use FirstCADD™ to do floor plans, elevations and alterations. With FirstCADD™ you can change your mind without having to start a whole new drawing—from scratch.

FirstCADD™ is ideal for the architect or interior designer, store owner, developer, graphic designer, engineer, draftsman.

Anytime you have to draw with precision. Any time you have to combine drawing with words, FirstCADD™ can help you do it quicker, cleaner and a lot easier.

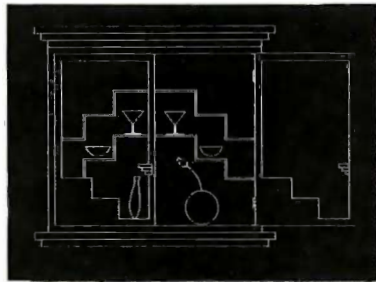

FirstCADD™ is so easy to use that all you do is pop in the diskette and you'll be on your way! In minutes you'll be drawing lines, circles, arcs with ease. Plot your work on virtually any popular dot matrix printer.

Don't go another day without FirstCADD™. Call our toll free hot-line today. We'll give you the name of your nearest dealer or have FirstCADD™ in your hands in just a couple of days.

Not copy protected.

System Requirements:
Atari 520ST or Atari 1040 ST
PC or compatible with 256K RAM min., graphics card and two disk drives.
IBM is a registered trademark of International Business Machines Corp.
Atari ST and 1040 ST is a trademark of Atari Corp.
FirstCADD and Generic CADD 2.0 are registered trademarks of Generic Software, Inc., 8763 148th N.E. Building C, Redmond, WA 98052

Inquiry 134 for End-Users.
Inquiry 135 for DEALERS ONLY.

A full featured, 2-dimensional drafting and design package.

- Automatic line drawing
- Draw points, lines, arc, circles, ellipses, rectangles, polygons, Curves
- Snap-to and "rubber banding"
- Two-key commands
- On-screen menus
- User defined menus
- Create your own fonts
- Create libraries of frequently used components
- Zoom
- Edit
- Measure lines, angles, areas
- Drawing size limited only by memory

From the makers of Generic CADD 2.0™ (just \$99.95) the industry's first completely modular, expandable CADD package.

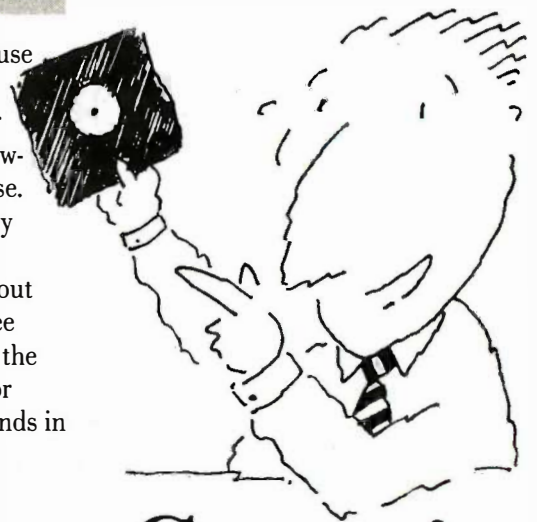

Generic
S O F T W A R E

**TOLL FREE
ORDER HOTLINE:
1-800-228-3601**
Dealer inquiries
encouraged

ASK BYTE

proper key on either a wired or wireless keyboard. I demonstrated a wireless keyboard project in the July 1980 issue of BYTE.—Steve

AUDIO-AND-VIDEO MULTIPLEXER

Dear Steve,

I have attempted to build a simpler version of the system you described in your February Circuit Cellar ("Build an Audio-and-Video Multiplexer"). I wanted to use my Atari's 5-volt DC discrete-output joystick port to control the CD4066. I tried to make a simplified circuit that would allow my computer to select whether I was allowing my VCR output or the computer video output to be displayed on the TV set.

I'm not sure why I had problems, but the pictures were too snowy to use and the VCR signal would completely block out the computer video when the VCR was connected as an input. I tried to provide noise protection by using in-line capacitors grounded to the metal box for the two 5-volt control lines, the 5-volt supply line, and the ground line. I used your low-pass filter on the chip input and a matching load for the untransmitted signal to no avail. Can you help?

HARRY MALTBY
Cypress, CA

From your description, I fear that you have misunderstood what I tried to accomplish with the audio-video multiplexer.

The display you describe and the associated problems indicate that you were probably trying to use the RF channel outputs of both your computer and VCR to feed your TV set, using the CD4066 as a switch. First, the CD4066 does not have the bandwidth capabilities to pass a video or audio signal without distortion of the signal. Second, neither the CD4066 nor the multiplexer system could sufficiently isolate or switch RF without severe crosstalk and signal degradation.

Unfortunately, in this instance, the easiest solution is still the "A-B switch." You might consider controlling a coaxial relay with your computer. However, the crosstalk problem could still exist, since your TV input stage is very sensitive, and the RF feeding from your two sources is much stronger than a normal antenna signal.—Steve

SB180

Dear Steve,

I read with great interest your SB180 article (September and October 1985). It

(continued)

HARMONY COMPUTERS

2357 CONEY ISLAND AVE. (Bet. Aves. T & U) BKLYN. NY 11223
800-VIDE084 or 800-441-1144 or 718-627-1000



Commodore 128
\$259.95
STAR NX-10
\$219.00

PANASONIC 1091
\$206.95
IBM (268)
\$1399.00

"PRINTER SPECIALS"

Brother HR 15XL 289
Brother 1509 359
Brother HR 35 (Comrex CA) 419
Citizen 120D 169
Citizen MSP 10 269
Citizen MSP 15 369
Citizen MSP 20 319
Citizen Premier 35 398
Epson LX80 (Homewriter 10) 169
Epson LQ800 489
Epson LQ 1000 699
Epson FX 85 339

Epson 286 459
IBM Proprinter 359
IBM Proprinter XL 519
Juki 6100 409
NEC 3550 719
NEC 8850 1039
NEC P6 449
NEC P7 619
Okidata 182 209
Okidata 93 289
Okidata 192 284
Okidata 193 Plus 494

Okidata 292 w/INTFC 468
Okidata 293 w/INTFC 599
Panasonic KXP 1091 207
Panasonic KXP 1092 285
Panasonic KXP 3131 234
Panasonic KXP 3151 369
Panasonic KXP 1592 529
Panasonic KXP 1595 219
Star NX-10 189
Star SG-10C 219
Star LV 120 169
Star SG 15 331

Star SD 10 289
Star SD 15 386
Star SR 10 419
Star SR 15 539
SR 10, SR 15 Sheetfeed 49
Star SB 10 389
Star NB 15 998
Silver Reed Exp 550 279
Silver Reed Exp 800 619
Toshiba 341 634
Toshiba 351 949
Toshiba 321 429

IBM
AT Unenhanced 2495
AT Enhanced IBM 2 Meg 3499
AT Enhanced IBM 3 Meg 3999
IBM Monitor 219
IBM PC 799
PC XT 268 1999
PC XT Clone 359
AST Six Pack 384K 189
AST Advantage 128K 329
Hercules Color Card 139
Hercules Monochrome Card 179
Quad EGA+ 319
Video 7 EGA+ 289
STB EGA+ 259
Multifunction Card 109
IBM Disk Drive 104
80287 Chip 112
80287 Chip 174
Everex EGA+ 229
Everex Graphics Edge 214
Everex Edge 219
Everex Graphics Pacer 189
Joystick for IBM 29

Leading Edge Model D 256K
2 Dr. Monitor **\$1199**

SEAGATE
Hard Drives
20 Meg. No Controller 329
10 Meg. w/controller 369
20 Meg. w/controller 419
30 Meg. w/controller 479
30 Meg. AT 639
40 Meg. AT 760
Random 20 Meg. Hard Card 459
COMPAQ
Compaq Drives
Portable 256K 2-360K 1499
Portable 256K 1-360K 1899
Deskpro 640K 1-360K 1999
1-20MB Hard
APPLE
2E Enhanced w/128K & Apple Drive 929
Drive 159
Apple Drive 229
AT&T
256K 2-360K 1499
640K 1-360K 1-20MB 1899

MODEMS
Hayes 1200 349
Hayes 1200B w/Smartcom 323
Hayes 300 124
Hayes 2400 559
Hayes 2400B w/Smartcom 499
Hayes 2400C No Smartcom 459
Micromodem 2E 125
Promethias 1200 249
Promethias 1220B 149
ATARI
130 XE 119
65 XE 89
Atari 801 Printer 145
1050 Drive 116
Atari Writer+ 37
Atari Modem 301 99
Comrex Printer 759
520 ST Color System 559
520 ST B & W System 629

Leading Edge Model D 30MB
w.monitor **\$1595**

MONITORS
Amdek 300 Green 113
Amdek 300 Amber 119
310 Amber 139
Color 600 374
Color 722 454
Princeton HX12 394
Princeton HX12E 479
Princeton Max 12E 148
SR12 529
Scan Doubler 159
NEC Multisync 529
COMMODORE
Commodore 128 258
1571 Drive 229
1670 Modem 159
Commodore 64 149
1541 Disk Drive 172
1802 Monitor 174
1902A Monitor 274
MSP 1000 Printer 228
Comrex Printer 189
Star SG10C 109

Commodore Amiga 256K, DOS
Mouse, Amiga color monitor
\$1049

800-441-1144

Items reflect 4% cash or check discount. For your protection we check for stolen credit cards m.c. visa welcome. Personal checks cause 4 week delay. Shipping & Handling charge extra. All Sales Final - Price and availability subject to change without notice.

A CROSTALK[®] XVI SuperKlone[™]



FEATURING
Foreground/Background Communications



The Age of KloneWare Has Arrived

1210 E. Park Ave. • Tallahassee, FL 32301
For information call 1-904-878-8564
TX: 6714280 KLON

MIRROR[™] provides:

- Crosstalk XVI compatibility
 - Background communications
 - Built-in text editor
 - Learn-mode for automatic script file generation
 - Transaction log
- AND MUCH MORE[™]

MIRROR[™]
\$69.95

Site Licensing Available
60-Day Money-back Guarantee
Not Copy Protected



To Order Call (904) 878-8564

Distributed in Canada by
Saratoga Software Distributors
Telephone: (416) 923-1500

Distributed in Scandinavia by
UNC, (Norway)
Telephone: 02 38 39 10

Distributed in the UK by
Management Data Processing, Ltd.
Telephone: (0224) 60491
Trisoft Ltd. Telephone: (0629) 3021

Distributed in Australia by
Delta Computer Systems Pty. Ltd.
Telephone: (02) 633-4055
P.C. Extras Pty. Ltd.
Telephone: (02) 319-2155

MIRROR is available for the IBM PC/XT/AT and compatibles running MS-DOS 2.0 or higher. MIRROR[™], SuperKlone, KloneWare and SoftKlone are trademarks of SoftKlone Distributing Corporation. Crosstalk XVI and Microsoft are registered trademarks of Microsoft, Inc.

UNLOCK™ Removes Copy Protection

Produces Unprotected Backup Copies

RUNS YOUR SOFTWARE ON ANY HARD DISK

UNlock "copying" disk allows you to make "unprotected" DOS copies of popular original program disks. Unprotected backup copies perform perfectly, as do copies of these copies. UNlock copies run on any hard disk, including Bernoulli Boxes. No original

required in drive "A." Run on a RAM disk simply and conveniently. Also, copy DOS 5¼" programs to 3½" diskettes. For IBM® PC, XT, AT, compatibles, 256K or more, DOS 2.1 or higher. Choice of the critics!

Guaranteed to work only with programs below:

UNLOCK™ ALBUM "A" PLUS **\$69.95**
(Plus \$4 ship/handling. Foreign orders \$10)

- dBASE III & dBASE III PLUS™
- FRAMEWORK I & II™
- CHARTMASTER™ (6.1)
- SIGNMASTER™ (5.1)
- FASTBACK™ (5.3)
- HARVARD TOTAL PROJECT MGR.™ (1.10)
- THINKTANK™ (2.0, 2.1)
- LOTUS 1-2-3™ (1.A-2.0)
- IBM WRITING ASSISTANT™ (1.01)
- IBM FILING ASSISTANT™ (1.0)
- IBM REPORTING ASSISTANT™ (1.0)
- GRAPHWRITER™ (4.3, 4.31)
- REALIA COBOL™ (1.2, 2.0)
- MULTILINK ADVANCED™ (3.02, 3.03)
- DOLLARS & SENSE™ (2.0)

UNLOCK™ ALBUM "B" PLUS **\$69.95**
(Plus \$4 ship/handling. Foreign orders \$10)

- SYMPHONY™ (1.1)
- CLIPPER™
- LOTUS 1-2-3 REPORT WRITER™ (1.0)
- DOUBLEDOS™
- smARTWORK™ (1.0 Rev. 8 thru 10 & 1.1)
- DISK OPTIMIZER™
- MANAGING YOUR MONEY™ (1.5, 1.51, 2.0)
- MICROSOFT WORD™ (1.15, 2.0, 2.01)
- PFS: ACCESS™ (1984 Ed.)
- PFS: PLANT™ (B)
- PFS: GRAPH™ (B)
- PFS: WRITE™ (1.01, C)
- PFS: REPORT™ (B, C)
- PFS: FILE™ (B, C)
- DATABASE MANAGER II—THE INTEGRATOR™ (2.0, 2.02)

SPECIAL OFFER "Best of UNLOCK" **\$74.95**
ALBUM "D" PLUS (Plus \$4 ship/handling. Foreign orders \$10)

- dBASE III & dBASE III PLUS™
- FRAMEWORK I & II™
- CLIPPER™
- FASTBACK™ (5.3)
- CHARTMASTER™ (6.1)
- SIGNMASTER™ (5.1)
- DOLLARS & SENSE™ (2.0)
- LOTUS 1-2-3™ (1.A-2.0)
- SYMPHONY™ (1.1)
- LOTUS 1-2-3 REPORT WRITER™ (1.0)
- DOUBLEDOS™
- HARVARD TOTAL PROJECT MGR.™ (1.10)
- MANAGING YOUR MONEY™ (1.5, 1.51, 2.0)
- THINKTANK™ (2.0, 2.1)
- MICROSOFT WORD™ (1.15, 2.0, 2.01)

UNLOCK™ FLIGHT/JET #202 **\$29.95**
 • FLIGHT SIMULATOR™ • JET™ • SCENERY DISKS (Plus \$4 ship/handling. Foreign orders \$10)

CHOICE OF THE CRITICS!

PERSONAL COMPUTING "UNlock has two particularly endearing characteristics: it works, and works simply. I was able to quickly produce unprotected copies of Lotus 1-2-3 release 2, Symphony 1.1, Microsoft Word 2.0, dBase III 1.1, and Framework II. These copies performed flawlessly, as did copies of these copies." Christopher O'Malley, PERSONAL COMPUTING, April '86

PC MAGAZINE "Because copy protection can interfere with the ability to back up a hard disk, business-oriented users may prefer programs like TranSec's UNlock series." Winn L. Rosch, PC MAGAZINE, May 27, 1986

BYTE "UNlock 4.7 defeats the latest Prolok and SuperLock type of copy protection scheme. It's menu-driven and works fine on the programs it's supposed to work on: Lotus 1-2-3, dBase III, Framework, Symphony, Paradox, and several others." Jerry Pournelle, BYTE, Feb. '86



ORDER TODAY TOLL FREE:
1-800-423-0772
 IN FLORIDA: 1-305-474-7548



TranSec Systems, Inc., 220 Congress Park Drive, Delray Beach, FL 33445
Trademarks are the sole property of their respective owners. UNlock is for use only to improve the useability of legally acquired and operated software.

seems that such a unit would be ideal for my application. But before I commit to this product, it would be helpful if you could answer the following questions:

What ZCPR3 utilities and documentation are included as part of the \$499 price?

What disk format does it use for the 3½-inch, 5¼-inch, and 8-inch drives? My application depends heavily on the use of all three disk sizes.

You mention optional disk format conversion programs. I am interested in the following formats:

- CP/M 8-inch IBM standard
- CP/M 8-inch Heath/Magnolia
- MS-DOS 5¼-inch IBM PC
- MS-DOS 3½-inch DG/One

Will the SBI80 work with any 3½-inch drives, or do you have recommendations as to drive manufacturer or model?

Does the unit include documentation of the HD64180 chip?

Will a Z80 CP/M program run "as is" under ZCPR3 without modification?

Thanks for your help.

ALLYN ROTHMAN
 Syosset, NY

I will answer your questions in the order you pose them. First, the SBI80-1-20 includes the full set of ZCPR3 utilities (far too numerous to list here) plus an assembler, linker, debugger, and source for the monitor ROM, the BIOS, ZCPR3, and SBI80-specific utilities. The documentation includes the book ZCPR3: The Manual, descriptions of the utilities not covered in the book, a technical manual for the SBI80 that has full setup details and schematics, and finally the HD64180 data book.

The SBI80 BIOS supports six 5¼-inch disk formats and three 8-inch formats. (The SBI80 doesn't know the difference between a 3½-inch drive and a 5¼-inch drive, so the formats are the same for both sizes.) The software comes on double-sided, double-density, 40-track, "native" format disks. Other formats supported include the Kaypro 2, Osborne I, Hitachi QC-10, Ampro SS, and the standard IBM 8-inch format.

In order to use the other formats you mention, you need a utility called Uni-Form. It supports over two hundred 3½-inch, 5¼-inch, and 8-inch formats and is available from us or its authors at Micro Solutions for \$69.95.

It's impossible to say that the SBI80 will work with any 3½-inch drive. I have used Teac 35F drives successfully. Owners of the SBI80 have reported success with other drives, but since I have only

(continued)

Convert any dBASE III® Program to dBASE III Plus®...



...automatically, with true record and file locking for multiuser operation

- dANALYST features syntax/blocking analysis, tabbed file output, variable cross reference
- dANALYST gives the programmer a graphic picture of a program structure
- dANALYST saves programmer's time and helps to analyze common programming errors
- dANALYST supports many multiuser networks

TranSec dANALYST™ automatically converts any dBASE III program to dBASE III PLUS with true record and file locking for multiuser operation. Features include syntax/blocking analysis, tabbed file output, variable cross reference lists. Now, program with the speed, simplicity and convenience of Framework-type interface command windows, pop-up menus, and graphic analysis REPORTS menus.

Graphic Command Structures

The graphic display of nested command structures helps in forming

good structured programming techniques. The separation of complex instructions, through proper tabbing by dANALYST, provides clarification of today's sophisticated dBASE applications. Using dANALYST you will be able to quickly check and make sure that the programs you are writing will not malfunction due to simple program errors.

Save Debugging Time

Graphic reports are prepared, along with "variable status tables" that track all of the variables in a

program. These reports can reduce hours of tedious debugging in extensive, sophisticated applications.

Wide Multiuser Support

Full support is provided for multiuser Clipper™ and the network version of the WordTech™ compiler for true record and file locking. TranSec dANALYST will support multiuser operation on the following networks when used with Clipper and the Communications Horizons™ multiuser library: Novell Netware™ 4.61 or Advanced, IBM® PC Network

(DOS 3.1) NetBIOS™ Multi-Link™ Orchid Technology™ Alloy™ AST™ 3Com Ethernet™

dANALYST also supports and can create CLP files for Clipper, LNK files for PLINK86™ Tree Files, RSP files for dBASE runtime support, and variable tabbing.

Automatic Documentation

Automatic Programmer documentation also can be added to files, along with an efficient Search Program to allow users to search for any text string occurrence in the file.

The Productivity Utility!

dANALYST is an efficient time-saver for the IBM® PC, XT, AT and compatibles, whether programming in dBASE II, dBASE III, dBASE III PLUS or other supported multiuser or network programs.

NOT COPY PROTECTED

\$74.95
plus \$5 s/h



ORDER TODAY TOLL FREE:

1-800-423-0772

IN FLORIDA: 1-305-474-7548

dANALYST Makes dBASE Easier to Program, Reduces Logic Errors, Bugs

```

0 *****
0 * FILE NAME: SAMPLE1
0 * BY:
0 * DATE: 9/1/86
0 * DESC:
0 * CALLED BY:
0 * DATA FILES:
0 *****
0 SET EXCLUSIVE OFF
1 use cost index cost
2 CLEAR
3 STORE J. TO TEST
4 --DO CASE
5   -CASE Costing = '1'
6     YN = 'N'
7     IF (.NOT. FLOCK())
8       DO FILELOCK WITH YN
9     ENDFIF
10    IF FLOCK() .AND. UPPER(YN) = 'Y'
11      DELETE ALL
12    ENDFIF
13  UNLOCK
14  RELEASE YN
15  -CASE Costing = '2'
16    CLEAR
17  -DO WHILE TEST
18    IF TEST
19      DO CHKTEST
20      ACCEPT TO MVAR1
21      MVAR1 = VAL(MVAR1)
22      IF MVAR1 <= 0 .OR. MVAR1 > RECNO()
23        ?
24        Out of range: do you want to continue (Y or N)?
25      WAIT TO CHANGING
26    ELSE
27      STORE F. TO TEST
28      EDIT MVAR1
29      ON = 'N'
30      IF (.NOT. FLOCK())
31        DO RELOCK WITH YN
32      ENDFIF
33      IF FLOCK() .AND. UPPER(YN) = 'Y'
34        RECALL WITH MVAR1
35      ENDFIF
36    ENDIF
37  ENDDO
38 *****
  
```

Multiuser example of record and file locking as formatted by dANALYST

```

0 *****
0 * FILE NAME: TEST.PRG
0 * BY:
0 * DATE: 9/1/86
0 * DESC:
0 * CALLED BY:
0 * DATA FILES:
0 *****
1 use cost index cost
2 CLEAR
3 STORE J. TO TEST
*** Error: LOOP statement not within DO WHILE ... ENDDO block.
4 --DO CASE
5   -CASE Costing = '1'
6     DELETE ALL
7     -DO WHILE TEST
8       CLEAR
9       IF TEST
10        DO CHKTEST
11        ACCEPT TO MVAR1
12        MVAR1 = VAL(MVAR1)
13        IF MVAR1 <= 0 .OR. MVAR1 > RECNO()
14          ?
15          Out of range: do you want to continue (Y or N)?
16        WAIT TO CHANGING
17      ELSE
18        STORE F. TO TEST
19        EDIT MVAR1
20        REPLACE Name WITH UPPER(Name);
21        Client WITH UPPER(Client)
22      ENDFIF
23    ENDDO
24  -DO WHILE TEST
25    IF TEST
26      DO CHKTEST
27      ACCEPT TO MVAR1
28      MVAR1 = VAL(MVAR1)
29      IF MVAR1 <= 0 .OR. MVAR1 > RECNO()
30        ?
31        Out of range: do you want to continue (Y or N)?
32      WAIT TO CHANGING
33    ELSE
34      STORE F. TO TEST
35      EDIT MVAR1
36      REPLACE Name WITH UPPER(Name);
37      Client WITH UPPER(Client)
38    ENDFIF
39  ENDDO
40 *****
  
```

Debugging for the programmer is simple, fast with errors clearly visible

TRANSEC
dANALYST™ THE dBASE PRODUCTIVITY UTILITY
TranSec Systems, Inc., 220 Congress Park Drive, Delray Beach, FL 33445

dBASE, dBASE II and dBASE III are registered trademarks of Ashton-Tate

THE ATARI
TEN COMMANDMENTS

#1

"We shall create a computer that will be a landmark in the history of computers." Jack Tramiel
ATARI CORP.

Recently, a writer compared the revolutionary 1040ST™ to Henry Ford's Model T.™

You may be surprised to learn that we were very complimented.

The truth is that both the ST™ and the Model T were designed to be machines of great power and usefulness at a price that was affordable to everybody.

The only difference is that the 16-bit 1040ST uses the most advanced technology in the world. And the result is a computer that has 1024 Kbytes of memory for the amazingly affordable price

of \$999. That's actually less than \$1 per Kilobyte.

We think Henry Ford would be very proud.

The ATARI 1040ST is at your computer retailer now.

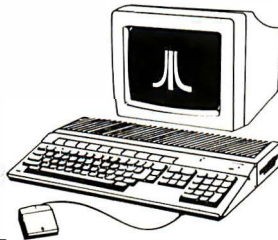

© 1986, Atari Corp.
ATARI, 1040ST, and ST are TM's or reg. TM's of Atari Corp.
Model T is a TM of Ford Motor Company

What is a Best Western?



The right place at the right price.

Make reservations at any Best Western, see your travel agent, or call toll-free

1-800-528-1234



"World's largest chain of independently owned and operated hotels, motor inns and resorts"

tried the Teacs. I can't make any specific recommendations.

Any CP/M 2.2 program that makes standard CP/M calls will work unmodified on the SB180.—Steve

BUILD YOUR OWN EXPANSION CHASSIS

Dear Steve,

In light of the number of relatively inexpensive IBM-compatible motherboards, power supplies, and computer cases currently available, is there a way to use them to construct an expansion chassis for the IBM PC?

R. L. CLINE, JR.
Littleton, CO

The motherboards that you see advertised in a number of computer publications are just that—motherboards. A motherboard contains all the circuit traces and pads required for a working PC when populated with the proper integrated circuits. Using a motherboard is an expensive way to go when all you require are expanded control, data, and address buses.

A few years ago, when expanded function boards were not as integrated as today, expansion slots were quickly filled. In order to expand the system, you could purchase an additional box (with or without a power supply) that provided additional card slots. You would connect the expansion box to the motherboard of the host PC via cable that plugged into one of the host's card slots. With today's integration of electronics, expansion chassis are not as common as they used to be.

You can build one using an enclosure, power supply, etc., that you have seen advertised. If you use a motherboard, you will have to ensure that all components are removed, since all electrical signals will be generated by the host PC. Then it's a simple matter of connecting one of the expansion card connectors in the host PC to one in the expansion chassis on a pin-for-pin basis.—Steve ■

Over the years I have presented many different projects in BYTE. I know many of you have built them and are making use of them in many ways.

I am interested in hearing from any of you telling me what you've done with these projects or how you may have been influenced by the basic ideas. Write me at Circuit Cellar Feedback, P.O. Box 582, Glastonbury, CT 06033, and fill me in on your applications. All letters and photographs become the property of Steve Ciarcia and cannot be returned.

COMPAQ[®],
the company that
first improved
the personal
computer standard,
does it again...



COMPAQ advances personal



COMPAQ announces a major improvement to the industry standard, one that carries you far beyond the limits of today's "advanced technology" personal computers. It's the new COMPAQ DESKPRO 386™ and it reaches far higher levels of speed, compatibility, performance, and expandability than have ever been attainable in personal computers. Dozens of separate

Introducing the new COMPAQ DESKPRO



enhancements have been combined in one desktop computer to make the COMPAQ DESKPRO 386 the most advanced personal computer in the world. There's no personal computer more ideal for power users, networking, and connecting to a mainframe.

The most advanced personal

advanced-technology computers

The new high-speed, 32-bit, 16-MHz Intel® 80386 microprocessor forms the heart of this breakthrough. It's the latest from Intel's popular family of microprocessors that now power well over nine million industry-standard PC's. As such, it runs all the popular personal productivity software you already own two to three times faster than ever *and* now lets you do things never before possible on personal computers. But the chip is only the beginning of this story.

The Intel 80386 microprocessor is faster and much more powerful than any of its predecessors.

Each component the very best

Performance enhancements go far beyond the microprocessor, however. Every component has been optimized to take advantage of the increased speed and power of the 80386.

We offer, for instance, far greater memory than other advanced-technology personal computers. Plus more storage with

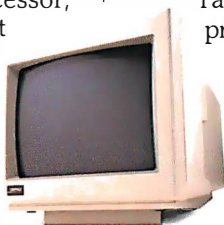

The COMPAQ Color Monitor works with software designed for a wide variety of display standards: EGA, CGA and monochrome.

faster access. Enhanced color graphics. A built-in interface for your lightpen. And even a built-in expanded memory manager that breaks the "640K barrier" of current operating systems.

We made improvements to the keyboard and the internal fixed disk drive backup, and added a host of other features, which taken together, make this the most advanced personal computer available, and the very first to offer a true minicomputer level of performance in an industry-standard desktop computer.

The winning numbers

The new COMPAQ DESKPRO 386 features advanced 32-bit architecture that processes twice as much information as 16-bit computers in the same amount of time. Coupled with a much faster 16-MHz processing speed, it radically

improves the responsiveness of spreadsheets, databases, and networks; the ease of multi-tasking; and the power of engineering software. Because the 80386 is compatible with today's soft-

ware, it is setting a clear direction for the future. It preserves your investment in software and training while allowing the development of powerful business programs, far more advanced engineering software and artificial intelligence applications.

No compromises

From the integrity of its components, to its unquestionable compatibility and connectability, to its numerous enhancements, the COMPAQ DESKPRO 386 pushes all of the limits of



Run industry-standard software 2-3 times faster than ever.

advanced technology—with no compromises. It's clearly the computer of choice for today's *and* tomorrow's most demanding users. From the company that has the highest user satisfaction ratings in the industry.

It simply works better.

computer in the world

COMPAQ
DESKPRO 386™

Why the COMPAQ continue to be the world's most long after others

The 80386 microprocessor is just one of the many ways COMPAQ increased system performance.

For that reason, other 80386-based personal computers will be measured by how well, or how poorly, they stack up to the COMPAQ DESKPRO 386.

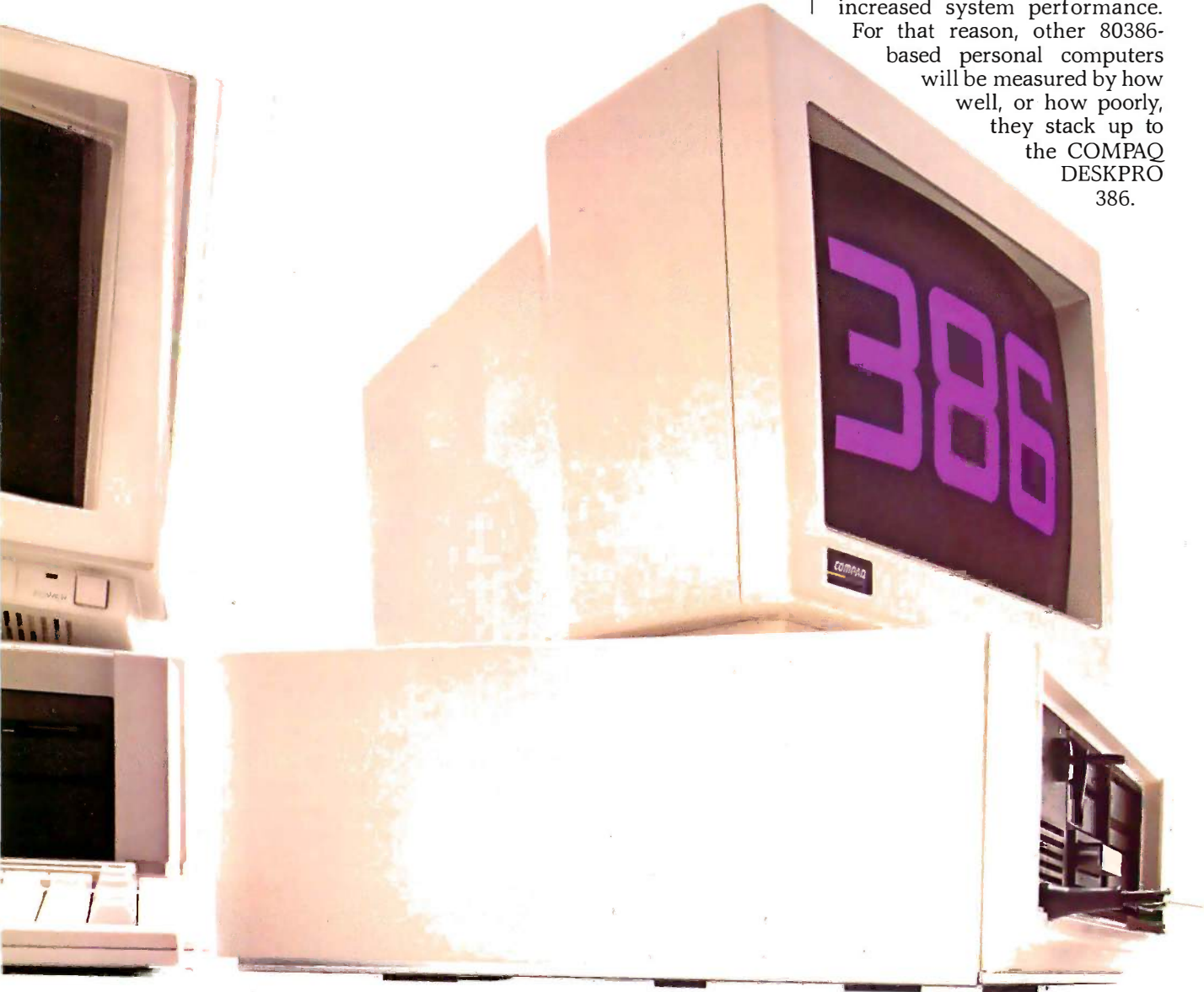

The most advanced personal

DESKPRO 386 will advanced personal computer copy its engine

Greater stores of knowledge

The COMPAQ DESKPRO 386 provides the most storage capacity and performance available in any personal computer. High-performance 40- and 130-Megabyte fixed disk drives are 50 to 150 percent faster than those used in other PC's. And they store a total of 5,000 to 50,000 more pages of data.

We also developed a fast, economical way to protect all that data. You can back up and verify 40 Megabytes of data on a single formatted cartridge at the timesaving rate of one Megabyte per minute.

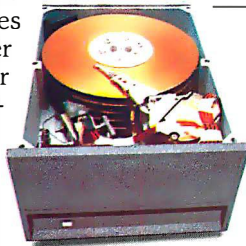

*Storage drives
access data faster,
enhancing performance.*

The most memorable personal computer

Break the 640-Kbyte memory barrier and use up to 8 Megabytes of high-speed 32-bit RAM with the COMPAQ Expanded Memory Manager. This software comes standard and works with programs that follow the Lotus®/Intel®/Microsoft® (LIM) Expanded Memory Specification, allowing you to build bigger

spreadsheets, sort larger databases and run more programs. And unlike other personal computers, this feature requires no additional software, and the high-speed RAM uses no expansion slots, leaving more for you.

Lead a much more colorful life

When combined with the COMPAQ Enhanced Color Graphics Board, the new COMPAQ Color Monitor can display 16 colors at once from a 64-color palette. And this same board provides the

high-resolution graphics—640 × 350—that many users require.

Expanding horizons

Exceptional expandability lets you add as many as four internal storage devices. You can add more RAM, too. Up to 10 Megabytes of RAM can be placed on the system board without using an expansion slot; 14 Megabytes using only two. You can also add our Enhanced Color Graphics Board that has a lightpen interface built in. This leaves four expansion slots compatible with industry-standard

expansion boards. So you can communicate with mainframes, in a network, or in a multi-user environment.

Built to higher standards, with "more" standards

We build more into the COMPAQ DESKPRO 386, with more care. We have included interfaces for printers and modems. We protected storage devices with shock isolation systems. We improved the keyboard to help touch typists avoid mistakes and simplify common chores. And we offer a full one-year warranty.

Some companies may copy one or two features of our latest computer. But it will be years before they copy them all. That's just one more reason why COMPAQ Computers are recognized as best in their classes by industry experts and users alike.



*Use a mouse
with an expansion
board. Or a lightpen with
a built-in interface on the
COMPAQ Enhanced Color Graphics Board.*

*The most advanced personal computer
because it incorporates the most advances.*

It simply works better.

computer in the world

COMPAQ
DESKPRO 386™

COMPAQ creates computer that

The COMPAQ DESKPRO 386 is so advanced it will replace many larger, more expensive computers. Engineers and other power users will now be doing many things on personal computers once thought impossible or impractical. The new COMPAQ DESKPRO 386 breaks all the barriers of personal computing.

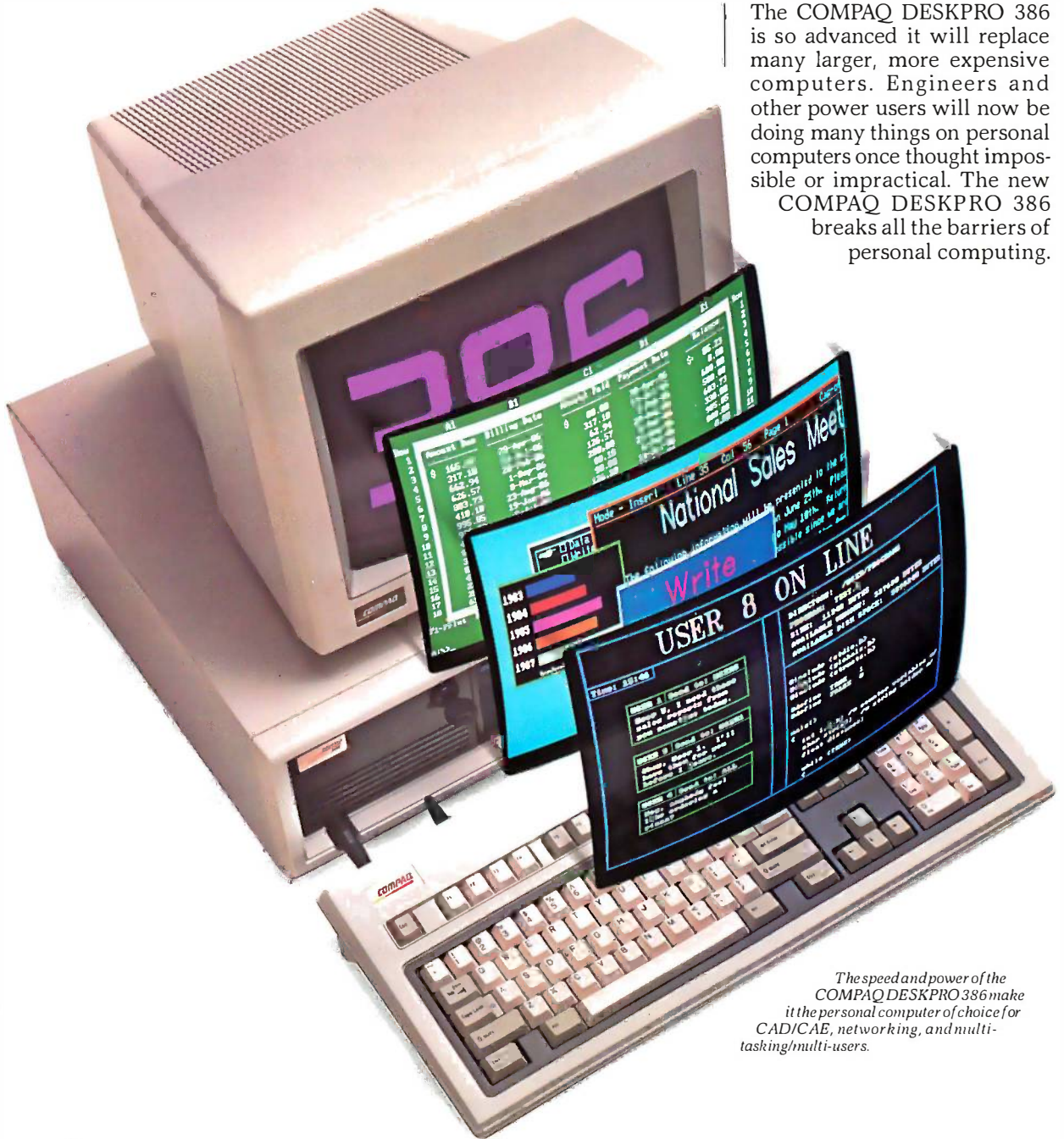

*The speed and power of the
COMPAQ DESKPRO 386 make
it the personal computer of choice for
CAD/CAE, networking, and multi-
tasking/multi-users.*

The most advanced personal

the first personal thinks it isn't

The better alternative to the dedicated workstation

The COMPAQ DESKPRO 386 is a powerful alternative to dedicated systems that do one thing, like computer-aided design, extremely well. Now, you can match their performance, and still run hundreds of industry-standard programs as well, with a system costing thousands of dollars less.

A desktop minicomputer?

Faster disk drives, 32-bit architecture and a large linear address space allow software developers to easily modify minicomputer programs for use on the COMPAQ DESKPRO 386. Plus, you get minicomputer-level performance with your current personal productivity software.

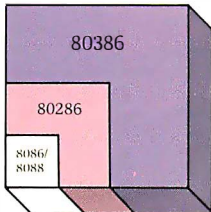

The 80386 runs software written for earlier chips and adds more power.

Net gain

With the COMPAQ DESKPRO 386 as your network file server or multi-user host computer comes greater productivity. Your system will run faster than ever. And you

CAD/CAE programs like AutoCAD™ enable you to do detailed electronic modeling, and the speed of the 80287 coprocessor provides real-time response.

can handle additional users with no loss of performance.

Multi-task master

Running several programs simultaneously, and switching between them, has never been better. Its speed and vast memory capacity make the COMPAQ DESKPRO 386 ideal, especially when running software under XENIX. System V/286 by COMPAQ.

Exceptional speed and memory make the COMPAQ DESKPRO 386 ideal for multi-tasking. You can run several programs at the same time and switch between them.

Building bridges to engineers

Engineers can now turn to the COMPAQ DESKPRO 386 instead of costly minicomputers or mainframes. Used with the 80287 coprocessor option, it gives you the speed you need. In addition, the new COMPAQ Color Monitor and Enhanced Color Graphics Board offer resolution required for most graphics applications with a built-in interface for those who use a lightpen.

Artificial intelligence

The speed, memory and storage of the COMPAQ DESKPRO 386 now make artificial intelligence in personal computers a real possibility. Soon available, these new AI programs promise to make personal computing even easier than it is now. The COMPAQ DESKPRO 386 is an investment in the future that pays handsome dividends today.

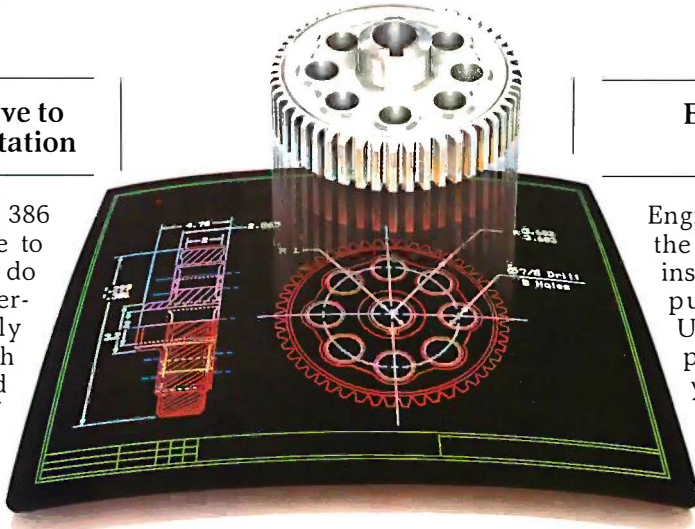

It simply works better.

computer in the world

COMPAQ
DESKPRO 386™

History in the making from a company that knows how

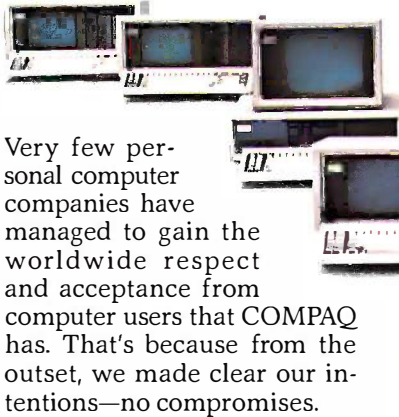

Very few personal computer companies have managed to gain the worldwide respect and acceptance from computer users that COMPAQ has. That's because from the outset, we made clear our intentions—no compromises.

First and best

The COMPAQ DESKPRO 386 is the first PC from a major manufacturer based on the new 80386 microprocessor. Its power, speed, performance, and built-in features exceed every other personal computer you can buy. Not surprising from a company with a history of being first with the best.

A long line of firsts

COMPAQ was the first to introduce a full-function portable computer that could do more than most desktops.

We were the first to offer desktops that were faster and more expandable than the IBM®-PC.

The first to offer an internal fixed disk drive backup system.

The first to introduce a desktop more powerful than the IBM PC-AT®. And the first to offer an equally powerful, yet *portable* 80286-based personal computer.

COMPAQ makes the widest line of desktop and portable business personal computers, each tops in its class, giving COMPAQ the highest user satisfaction ratings in the industry.

One good thing leads to another

The COMPAQ Portable led the company to the most successful first year in American business history. Each successive product led COMPAQ to the Fortune 500 faster than any other company in history. By refusing to compromise, we'll keep making history.



Available only at
Authorized COMPAQ
Computer Dealers.
Over 3000 worldwide
offer outstanding
service and support.

For the Authorized Dealer
nearest you, call 1-800-231-0900 and
ask for Operator 23. In Canada, call 416-449-8741, Operator 23.

COMPAQ®

It simply works better.

B·O·O·K R·E·V·I·E·W·S

EXPERT SYSTEMS 85:
PROCEEDINGS
OF THE FIFTH
TECHNICAL
CONFERENCE
OF THE BRITISH
COMPUTER SOCIETY
SPECIALIST GROUP
ON EXPERT SYSTEMS
Martin Merry, ed.
Cambridge University Press
New York: 1986
334 pages, \$39.50

STRUCTURE AND
INTERPRETATION OF
COMPUTER PROGRAMS
Harold Abelson
and Gerald Jay Sussman
with Julie Sussman
MIT Press
Cambridge, MA: 1985
542 pages, \$34.95

SOFTWARE VALIDATION,
VERIFICATION, TESTING
AND DOCUMENTATION
(A SOURCE BOOK)
Stephen J. Andriole, ed.
Petrocelli Books
Princeton, NJ: 1986
300 pages, \$49.50

EXPERT SYSTEMS 85:
PROCEEDINGS OF THE FIFTH TECHNICAL
CONFERENCE OF THE BRITISH COMPUTER
SOCIETY SPECIALIST GROUP ON EXPERT SYSTEMS
Reviewed by Paul E. Hoffman

Dozens of expert system products are available for microcomputers, but the concepts and the technology they represent are not the most advanced available. The articles in *Expert Systems 85* indicate that the current generation of expert system shells is only a first step in the evolution of expert systems. Apparently, current research is rapidly advancing the usefulness of expert systems.

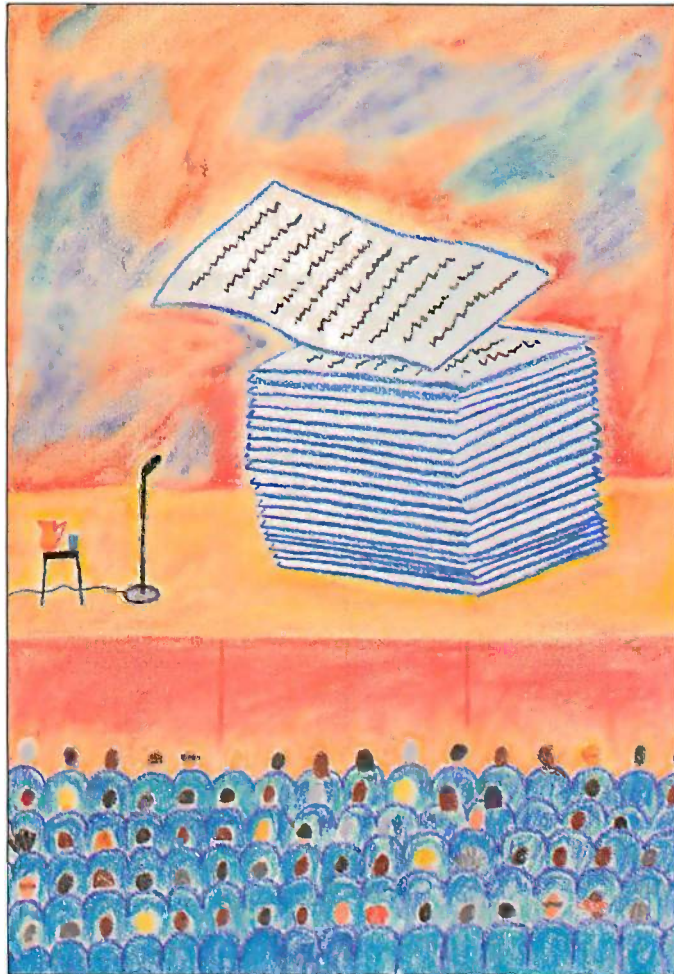

Expert Systems 85 is a collection of 24 papers presented at the British Computer Society's expert system conclave held in December 1985 at the University of Warwick in England. The papers are strictly academic and do not propose to be related to the current family of microcomputer expert system packages. Judging from the range of these papers, it is evident that the increasing power of expert systems will continue to diversify.

OVERVIEW

The papers in *Expert Systems 85* cover many of the major topics in expert system research: the user interface, planning systems, uncertainty, and the definition of knowledge. While some focus on very small areas, others deal with large issues that also relate to areas of computer science well outside of expert systems.

The first paper is by Martin Merry, both the program committee chairman and editor of this collection of proceedings. While he theorizes on the potential of expert system research, he regards the current state of expert systems skeptically: "The well-known early expert systems, DENDRAL and MYCIN, date from the late 60s and early 70s. . . . Most current applications work involves very few substantive new ideas over these early systems."

Merry goes on to describe three topics of expert systems research: knowledge-based planning, new architectures for expert systems, and qualitative reasoning. He assesses these fields realistically, pointing out that although a great deal of theory has been described, very little of it has been

(continued)

ARTEK™ ADA®

TAKE THE NEXT STEP FOR ONLY \$495!

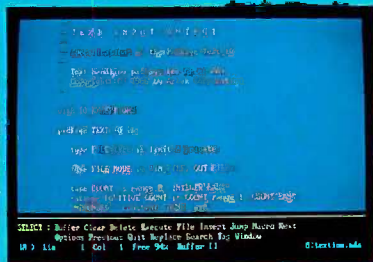

Ada's powerful features make it the programming language of choice for today's complex software. Artek Ada is the most advanced Ada compiler for PCs.

Artek Ada is a new approach to personal computing. Our fast and efficient Ada compiler runs on a vanilla PC, XT or AT with 384 Kb RAM, giving you unprecedented power and ease of use. But don't take our words for it. Take Artek Ada out for a test drive yourself. Order a Demo diskette today!

Artek Ada is an extensive, totally upwards-compatible implementation of the 1983 ANSI Ada military standard. It compiles amazingly fast and includes an Ada Programming Support Environment to greatly enhance productivity. In the APSE we have integrated the compiler with a powerful editor and a high-level debugger.

True to Artek's PC heritage the compiler is not copy-protected, and the complete source code for the Ada library is included free of charge.

We are now working on a new, validated version of Artek Ada, expected to be available in the first half of 1987. You will be able to trade in your compiler at full price, if you decide to upgrade.

Artek Ada is ideally suited for universities and in-house training. Our new, low price and aggressive educational and volume discounts won't stretch your budget.

For orders or information call toll-free **1-800-PC-ARTEK**, in New Jersey or outside the continental U.S.A. call **201-867-2900**, or write to our address.

A free brochure is available on request. Our Demo kit, including the real compiler with a 40-line maximum program length costs \$ 29.95, including p&p anywhere in the world. The compiler costs \$ 495.00. VISA, MC and AMEX accepted. In New Jersey add 6% sales tax. Outside the U.S.A. add \$20.00. Please pay with credit card or a bank draft, payable in U.S. Dollars, drawn on a U.S. bank.

Dealer and distributor inquiries welcome.

CALL: 1-800-PC-ARTEK

Artek Corporation, 100 Seaview Drive, Secaucus, NJ 07094

A r t e k

Artek is a trademark of Artek Corporation. Ada is a registered trademark of the U.S. Government, AJPO.

Inquiry 32

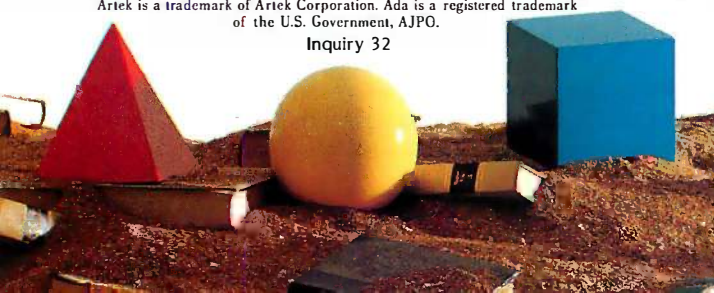

BOOK REVIEWS

applied to working systems. Merry is optimistic about the future of academic expert systems research and feels that the current attention will help advance the field.

INTERNATIONAL RESEARCH

The remaining 23 papers deal with much more specific issues and are often based on the applied research projects of the authors. Some are implementation discussions of specific systems, such as a browser for a knowledge base of ecological facts, which I'll go into shortly. Others are attempts to define some of the key terms in knowledge engineering, such as those found in the paper titled "Deep Knowledge Representation Techniques."

Expert Systems 85 is interesting in that none of the papers are from Americans. In the U.S., we are accustomed to reading mostly American research papers. Many of the researchers published in *Expert Systems 85* work in the U.K., although researchers from France, Italy, Bulgaria, and Holland also have papers in this collection.

USER INTERFACE

One of the many problems that expert system designers face is taking in and displaying knowledge. For input, these problems include validation that user input can be considered factual—that an input is not a conclusion based on other facts and rules that should be used instead. To add further complications, there are many levels of knowledge. For output, an expert system must decide what the user really wants to find out and how to convert the information in the knowledge base into a form that is best suited to the user.

For example, "The ECO Browser," prepared by a group of people at the University of Edinburgh, describes the design considerations for a system that lets users browse through a knowledge base of ecological information. The program has to cope with a loosely structured knowledge base, inexperienced users, and users who don't know what they want to get out of the system when they start using it. The paper describes how the browser program achieves these goals.

"What Do Users Ask?—Some Thoughts on Diagnostic Advice" explores one of the major acknowledged weaknesses of current expert systems, namely the mismatch between the user's needs and the system's abilities. The author, who works for British Telecom, defines the methods that human experts use to suggest remedies for any kind of problem: negotiated remedies, evaluation of a proposed remedy, and explanation of existing remedies. He goes on to describe how these different methods of arriving at a goal will affect how users interact with computer experts.

UNCERTAINTY

Many computer users marvel at the fact that knowledge bases can deal with uncertain information. MYCIN can use rules that include a relative amount of uncertainty and come up with a result that includes the degree of confidence it has in that result. However, simple values of

(continued)

Softline

PRICE BUSTERS



Lotus 1-2-3 \$319	Paradox \$469	dBase III Plus \$389	FrameWork II \$389	Multimate Advantage \$279	Word Perfect 4.1 \$209
--------------------------------	-------------------------	-----------------------------------	---------------------------------	--	-------------------------------------

Software

Word Processing

FANCY FONT	\$139
FINAL WORD II	\$219
MICROSOFT WORD 3.0	\$279
MULTIMATE	\$249
MULTIMATE ADVANTAGE	\$279
OFFICE WRITER/ SPELLER	\$239
PFS: WRITE	\$ 89
SAMNA WORD III	\$279
THINK TANK	\$109
TURBO LIGHTNING	\$ 65
VOLKSWRITER 3	\$159
VOLKSWRITER SCIENTIFIC	\$259
WORD PERFECT 4.1	\$209
WORDSTAR 2000	\$249
WORDSTAR 2000 +	\$289
WORDSTAR PRO	\$259
XYWRITE III	\$199

Database Systems

CLIPPER	\$359
CONDOR III	\$339
DBASE III PLUS	\$389
KMAN 2	\$339
PARADOX	\$469
PFS: FILE/ REPORT Q&A	\$169
QUICK CODE III	\$249
QUICKREPORT	\$159
R BASE SYSTEM V	\$359
REFLEX	\$ 89
REVELATION	\$499

Spreadsheets/ Integrated Packages

ENABLE	\$349
FRAMEWORK II	\$389
JAVELIN	\$419
LOTUS 1-2-3	\$319
MULTIPLAN	\$135
OPEN ACCESS II	\$299
SMART SYSTEM	\$439
SPREADSHEET AUDITOR	\$ 99
SUPERCALC 4	\$289
SYMPHONY	\$449
TWIN	\$ 79

Graphics

CHARTMASTER	\$219
DIAGRAPH	\$309
DIAGRAM MASTER	\$199
ENERGRAPHICS 2.0	\$299
FREELANCE	\$209
GEM DRAW	\$149
GRAPHWRITER COMBO	\$309
IN-A-VISION	\$259
MAPMASTER	\$239
MS CHART	\$189
PC DRAW	\$209
PC PAINTBRUSH	\$ 99
PFS: GRAPH	\$ 89
PICTURE PERFECT	\$245
SIGNMASTER	\$149
WINDOWS/DRAW	\$119

Project Management

HARVARD TOTAL	
PROJECT MANAGER	\$279
MICROSOFT PROJECT	\$249
PROJECT SCHEDULER NETWORK	\$339
SUPERPROJECT +	\$269
TIMELINE 2.0	\$239

Communications/ Productivity Tools

CARBON COPY	\$ 129
CROSSTALK	\$ 99
PROKEY	\$ 85
RELAY GOLD	\$149
REMOTE	\$109
SMARTERM	\$Call
SMARTCOM II	\$ 99
SUPERKEY	\$ 55

Statistics

SPSS/PC +	\$699
STATGRAPHICS	\$449
STATPAC GOLD-WALONICK	\$399
SYSTAT—NEW	\$499

Accounting

BPI	\$309
GREAT PLAINS	\$479
IUS EASYBUSINESS	\$309
ONE WRITE PLUS	\$159
OPEN SYSTEMS	\$409
REAL WORLD	\$399
STAR ACCOUNTING PARTNER II	\$529

Network Applications

DBASE III LAN PAK	\$599
KMAN 2	\$899
MULTIMATE	\$639
MULTIMATE ADVANTAGE	\$749
OPEN SYSTEMS	\$459
RBASE 5000	\$799
REVELATION	\$999
SAMNA WORD III	\$799
WORD PERFECT SERVER STATION	\$309
WORD PERFECT STATION	\$ 75

Languages/Utilities

C86 C COMPILER	\$ 319
COPYWRITE	\$ 45
FASTBACK	\$ 89
LATTICE C	\$259
MICROSOFT C COMPILER	\$289
MS BASIC COMPILER	\$249
MS FORTRAN	\$229
NORTON UTILITIES	\$ 59
QUICK BASIC	\$ 69
TURBO PASCAL	\$ 69
TURBO PROLOG	\$ 69
XENIX	\$Call
ZERO DISK	\$ 70

Desktop Environments

DESQVIEW	\$69
GEM DESKTOP	\$39
MS WINDOWS	\$69
SIDEKICK	\$49

Hardware *

Multifunction Boards

AST ADVANTAGE (128K)	\$349
AST 6 PAK PLUS (64K)	\$169
AST I/O MINI	\$139
AST MP MINI	\$199
AST PREMIUM PAK (512K)	\$359
AST RAMPAGE PC	\$249
AST RAMPAGE AT	\$459
AST SHORTRAM (0K)	\$159
INTEL ABOVEBOARD PS AT	\$399
JRAM AT-3 (0K)	\$239
JRAM 3 (0K)	\$179
ORCHID CONQUEST (0K)	\$279
ORCHID ECCEL (0K)	\$399
PC TURBO 286 (1MB)	\$799
PC TINY TURBO 286	\$459
QUADBOARD (64K)	\$139

Display Boards

HERCULES GRAPHICS CARD	\$199
HERCULES COLOR CARD	\$159
PARADISE MODULAR GRAPHICS	\$259
QUADRAM EGA +	\$369
SIGMA COLOR 400	\$449
STB EGA PLUS	\$299
TECMAR EGA MASTER	\$299
TSENG ULTRA PAK	\$429
TSENG EVA-CM II	\$379
TSENG EVA 480	\$Call

Emulation Boards

AST 5211-11 +	\$649
AST 5251-12	\$499
AST BSC	\$489
AST SNA	\$599
IRMA	\$725
SMART ALEC 5251	\$699

Modems

AST REACH 1200	\$359
HAYES 1200	\$389
HAYES 1200B	\$349
HAYES 2400	\$579
HAYES 2400B	\$549
TRANSNET 1000	\$279
VENTEL 1200 HALF CARD	\$369
VENTEL 1200 PLUS WATSON	\$299
	\$339

Mass Storage/Backup

IOMEGA 10 + 10 W/INTFC	\$1999
IOMEGA 20 + 20 W/INTFC	\$2599
IRWIN 120D 20MB TBU	\$ 599
IRWIN 145AT 40MB TBU	\$ 699
MOUNTAIN DRIVECARD 20MB	\$ 719
PLUS HARDCARD 10MB	\$ 569
PLUS HARDCARD 20MB	\$ 719
PRIAM 42MB AT	\$949
SYSGEN SMART IMAGE 20MB (INT)	\$ 625
TALLGRASS	\$ Call
TECMAR QIC-60AT TBU (INT)	\$1199

Monitors

AMDEK 310A	\$159
AMDEK 600/722	\$429/539
NEC MULTISYNC	\$619
PRINCETON HX-12	\$449
PRINCETON MAX-12E	\$179
PRINCETON SR-12	\$499
PRINCETON HX-12E	\$539
PRINCETON HX-9	\$529
TAXAN 122 AMBER	\$159
TAXAN 630/640	\$469/539

Networks

AST PC NET	\$Call
NOVELL	\$Call
ORCHID PC NET	\$Call

Printers/Plotters

BROTHER TWINWRITER	\$ 939
DATA PRODUCTS DATA PRODUCTS	\$Call
DIABLO 635	\$1149
EPSON FX-85	\$ 399
EPSON FX-286	\$ 579
EPSON LQ-800	\$ 589
EPSON LQ-1000	\$ 769
HP 7475A	\$ Call
NEC 3550	\$ 799
OKIDATA 192	\$ 379
OKIDATA 193	\$ 519
OKIDATA 292	\$ 539
OKIDATA 293	\$ 689
TOSHIBA P321	\$ 499
TOSHIBA P341	\$ 829
TOSHIBA P351	\$1069

Input Devices

KEYTRONICS 5151	\$169
KEYTRONICS 5153	\$299
MICROSOFT MOUSE	\$129
PC MOUSE W PAINT +	\$139

Accessories

CURTIS SURGE PROTECTORS	\$Call
DATASHIELD BACKUP POWER	\$Call
DATASHIELD SURGE PROTECTORS	\$Call
GILTRONIX SWITCHES	\$Call
MASTERPIECE PLUS	\$ 135
MICROFAZER INLINE BUFFERS	\$Call
256K RAM SET	\$ 39
8087 MATH CHIP	\$ 119
80287 MATH CHIP	\$ 189

*CALL FOR SHIPPING COSTS

NEC Multisync \$619	Mountain Drivecard 20 \$719	Quadram EGA+ \$369	Hayes 1200B Halfcard \$349	JRAM AT-3 \$239	IRMA Board \$725
-------------------------------	---------------------------------------	------------------------------	--------------------------------------	---------------------------	----------------------------

FREE SHIPPING

on all orders over \$1000.00, credit card orders and prepaid orders.

Our Policy:
* Visa or MasterCard — add 3% — * G.C. Cash M.G. for bank check only — add \$5.00 per order — * Prepaid personal or company check — allow two weeks to clear — * No sales tax on orders shipped out of NY State — * Shipping via UPS surface — add \$3.00 per item — UPS Blue — add \$8.00 per item — All returns require prior authorization — Prices subject to change, call for latest prices



1-800

221-1260

In New York State call (718) 438-6057

Softline

P.O. Box 729, Brooklyn, NY 11230
TELEX: 421047 ATLN UI
FAX: 718-972-8346

Chalcedony PROLOG

Not Copy
Protected

A REAL **\$99.95**

Clocks in & Mellish Prolog for BOTH major microcomputing operating systems — with full cross-compatibility.

Complete with the predicates necessary for POWER AI programming:
op () name () functor () clause () =.. ("Univ")
...And no constraining data typing.

- Floating point
- Step-by-step tutorial
- Math functions
- Integrated editor

PROLOG*i*

Extensible overlay library, 8087 support, large memory model (up to 640K)

PROLOG*m*

Complete Macintosh environment with extensive pull-down menus and dialogue boxes.

No Risk Offer: Examine the PROLOG/i or PROLOG/m documentation at our risk for 30 days. If not completely satisfied, return with disk still sealed for refund.

APPLICATIONS — Complete with SOURCE CODE

NFL X-pert **\$49.95**

A true interactive expert system written by a professional knowledge engineer. A valuable learning tool for any Prolog programmer interested in using Prolog to develop expert systems.

TOOLBOX **\$29.95**

More than 50 subroutines that speed and compress list handling, searches, sorts, and reversal algorithms. An inside look at the tricks of the professional Prolog programmer.

TOYBOX **\$29.95**

Written by an academician to help his students understand Prolog, this collection of puzzles and mind-teasers will illustrate how the Prolog programmer creates programs that find the best solution to the problem. Turn your computer into a super reasoning machine!

System Requirements:
Minimum 256K RAM
(320K recommended)
PC-DOS/MS-DOS
ANSI Standard Support

Minimum 512K
Macintosh
Macintosh-plus and
HFS Compatible

SAVE 10% when you buy either PROLOG/i or PROLOG/m and all 3 applications.

CHALCEDONY SOFTWARE, INC.

5580 LA JOLLA BLVD.
SUITE 126 B
LA JOLLA, CA
92037
(619) 483-8513

PHONE ORDERS: 1-800-621-0852 EXT 468

<input type="checkbox"/> PAYMENT ENCLOSED \$ _____	PROLOG/i \$99.95
CA residents add 6% sales tax	PROLOG/m 99.95
<input type="checkbox"/> CHARGE MY: <input type="checkbox"/> MasterCard <input type="checkbox"/> Visa	Check: _____
Card No. _____ Exp. Date _____	MS-DOS <input type="checkbox"/> Mac <input type="checkbox"/>
Signature _____	NFL X-pert 49.95
Mr./Mrs./Ms. _____	TOOLBOX 29.95
(please print full name)	TOYBOX 29.95
Address _____	Complete Pack 188.82
City/State/Zip _____	SHIPPING:
	\$ 5.00 U.S.
	7.50 Canada
	10.00 Caribbean,
	Hawaii Air
	20.00 Overseas Air

BOOK REVIEWS

uncertainty, such as "if A and B are true, then C is 90 percent certain to be true," are inadequate at describing the way that most humans confront probabilistic choices.

In "Inference Under Uncertainty," the authors explain some of the many problems faced by expert systems when they have to confront uncertain data. The authors point out significant areas where human experts perform significantly better than their computer counterparts. For example, most experts must cope with cases where there is inconsistent information. Human experts can take this into account on a case-by-case basis much more easily than expert systems are able to.

To overcome some of these problems, the authors of "Symbolic Uncertain Inference: A Study of Possible Modalities" formulate a mathematical notation for uncertainty in expert systems. They show that there are many types of uncertainty (such as imprecision, guesses, etc.) and that expert systems must be very careful in their handling of uncertainty. They conclude that, "Using classical expert systems techniques and logic, we hope both to have a better intelligence of inexact reasoning and to build efficient mechanisms."

APPLICATIONS

Many of the articles in *Expert Systems 85* also cover future applications of expert systems. In "An Application of Knowledge Based Techniques to VLSI Design," the authors show how expert systems can be embedded in CAD software to help designers connect parts of a VLSI chip. The decisions that go into device interconnection are based on a very large set of rules. Instead of forcing the person designing part of the VLSI to test the interconnections, an expert system can suggest connection strategies.

Other articles in this collection cover the application of expert systems to real-time process control, hardware troubleshooting, and office management. Some of the more theoretical articles point out the massive difficulties involved in implementing applied expert systems. For instance, "ESCORT: The Application of Causal Knowledge to Real-time Process Control" discusses an expert system that can control part of a chemical separation process on North Sea oil platforms. However, "Real Time Multiple-motive Expert Systems" cites many examples of conflicts that real-time expert systems will encounter when they are forced to simultaneously evaluate sensor data, formulate plans of action, and act on those plans. The paper concludes that current expert systems are not nearly flexible enough to mimic human experts.

FORECAST

Expert Systems 85 provides a very broad view of the academic research being done on expert systems. It is clear from the book that the systems in use today will be vastly improved as more effort goes into solving some of the thorny problems relating to knowledge and representation. Merry sums up the near future by saying, "We must be careful not to assume that mere publicity is sufficient to solve these problems; mounting large scale projects

(continued)

MAGITRONIC

CHASSIS

- C-600 A AT Jr. Case\$39
XT Size, AT Style, Open Top
- C-600 XT Case\$29
For IBM XT Boards & 5-1/4" Disk Drives, Open Top/Slide Off
- C-700 AT Case\$99
For IBM AT Boards, With Lock Key For Extra Security

POWER SUPPLY

- P-150 Switching Power Supply\$65
150 Watt Output
- P-200 Switching Power Supply for IBM PC/AT\$115
Max. 200 Watt Output
- Power Center\$40
100% Burn-In Test, Short Circuit Protection, Meets UL/CSA/VDE standards

DRIVES

- Fujitsu 360K Drive\$85
- Teac 360K Drive\$90
- Teac 1.2MB Drive\$135
- Mitsubishi 1.2 MB Drive\$125
- 20 Meg Hard-drive Seagate w/ Controller\$399
- 30 Meg Hard-drive SeagateCall
- 40 Meg Hard-drive SeagateCall

KEYBOARDS

- K-139 AT/XT Keyboard\$75
Large Return Key, 12 Function Key, Enhanced Keyboard
- K-136 AT/XT Keyboard\$65
Software Switchable, Large Return Key
- K-135 XT Keyboard\$70
Features Separate Num. & Cursor Pads/LED Cap Lock & Num. Lock w/Large Return

SAMSUNG MONITORS

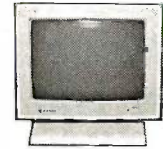

- MD-1252G Amber or Green\$79
12" Monochrome Monitor TTL, Swivel Base, 720 x 350 Dot Resolution, 80 character x 25 Rows
- CD-1464W RGB\$269
16 color, 640 x 200 Dot Resolution, 80 Character x 25 Rows
- CD-1452M EGA—Hi Resolution RGBCALL
640 x 350 Dot Resolution

AT SYSTEM

PC/AT SYSTEM 1000

Mono \$1549.00
Color \$1739.00



- 200W Power Supply/Case
- K-136 AT/XT Keyboard
- 1024K Memory On 80286 Mother Board
- 1.2M High Capacity Floppy Drive
- AT HDC/FDC Controller
- Mono or Color Graphic Adapter
- Monitor
- Assembled and Fully Tested

PC/AT ADD ON BOARDS

- MGB-201 AT Mother Board Bios\$575
- MGB-202 AT 3M Multi Card\$179
- MGB-205 AT 1:2M Floppy Disk Card\$82
- MGB-205-1 AT 1:2M 360K Controller\$119
- MGB-208 AT 2.5M RAM Card\$109
- MGB-210 AT HDC/FDC Controller w Cable\$225
- MGB-231 AT I/O Card\$80
- MGB-109-1 AT/XT Parallel/Serial\$55
- MGB-135 EGA Card\$285

CABLES

- 8510 Computer To Printer
- 6 ft\$7 10 ft\$7.50
- 15 ft\$8
- 8511 RS 232 Serial Cable
- DB 25
- 6 ft\$7
- 8512 Computer To Printer Centronic
- 36 pin c/c
- 6 ft\$8.50 10 ft\$9.50
- 25 pin c/c
- 6 ft\$7.50 10 ft\$8.50
- 8513 RS 232 Serial
- DB 25
- 6 ft\$7 10 ft\$8
- 8514 RS232 Serial
- DB 25 m/m
- 6 ft\$7
- 8515 Computer To Modem
- 6 ft\$4.50 10 ft\$5.50
- 8519 Computer To Modem
- DB 25 M/DB 9F
- 6 ft\$7
- 8524 Gender Changer
- DB25 m/m\$4
- 8525 Gender Changer
- DB825 I/O\$4
- 4 Ways Switch Box-Serial\$35
- 4 Ways Switch Box-Parallel\$37
- A/B Switch-Serial\$25
- A/B Switch-Parallel\$25
- Power Outlet Strip UL\$9.99
- Monitor Cable\$750

XT SYSTEM

- Slide Off case
- Power Supply
- 640K Expandable Mother Board
- 256K Installed
- K-136 AT/XT Keyboard
- Floppy Control Card
- 360K Drive
- Mono or Color Graphic Adapter
- Monitor
- Assembled and Fully Tested



Runs all major software

PC/XT SYSTEM 800

Mono \$569.00
Color \$759.00

XT TURBO SYSTEM 900

Mono \$599.00
Color \$789.00

PC/XT ADD ON BOARDS

- MGB-101 XT Mother Board\$105
- MGB-102 Multifunction Card\$78
- MGB-103 Monochrome Graphic\$65
- MGB-103-1 Monographic Printer\$75
- MGB-104 Color Graphic\$55
- MGB-105 Floppy Disk Card 1 port\$29
- MGB-105-1 Floppy Disk Card 2 port\$38
- MGB-106 RS 232 Card 1 port\$25
- MGB-106-1 RS232 Card 2 port\$30
- MGB-107 Game I/O Card\$20
- MGB-108 XT512K RAM Card\$44
- MGB-109 XT Parallel Printer Card\$21
- MGB-110 6220 XT HD & FD Controller\$125
- MGB-111 XT Color Graphic Printer Card\$66
- MGB-112 Monochrome Card\$50
- MGB-113 XT 640K RAM Card\$46
- MGB-128 XT 640K Turbo Board\$130
- MGB-129 Clock Card\$29
- MGB-131 XT I/O Plus Card\$49
- MGB-132 XT Multi I/O Card\$79
- MGB-133 6210 XT HOC\$105

MAGITRONIC TECHNOLOGY INC.

9-02 43 Road, Long Island City, NY 11101

ORDERS ONLY: 1-800-227-5454 PLEASE CALL FOR QUANTITY PRICES

NY & West Coast Information: 718-706-7670 West Coast Shipping Available

All Orders are Shipped UPS COD Cash, Certified Check or Money Order Within 24 Hours.

IBM® PC/XT and Hayes are registered trademarks of their respective companies.

✓ COMPATIBILITY ✓ AFFORDABILITY

✓ RELIABILITY ✓ EXPANDABILITY

IBM XT/AT COMPATIBLE COMPUTERS BY

✓ **AFTON COMPUTER INC.**

QUANTUM 286 TURBO

**Made
In The
USA**

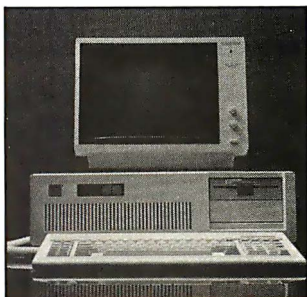

- IBM AT COMPATIBLE
- PHOENIX BIOS
- 8-10 MHZ SWITCHABLE CLOCK SPEED
- 512K UP TO 1 MB RAM ON BOARD
- 2 SERIAL PORTS 1 PARALLEL PORT ON BOARD
- 20 MB HARD DISK
- 1.2 MB FLOPPY
- 8 EXPANSION SLOTS
- AT KEYBOARD
- 200 WATT POWER SUPPLY
- ONE YEAR WARRANTY

All For Only \$1995⁰⁰

QUANTUM XT TURBO (Made in the USA)

- PHOENIX BIOS
- 4.77-8MHZ SWITCHABLE CLOCK SPEED
- 640K ON BOARD
- SERIAL, PARALLEL AND CLOCK
- AT STYLE KEYBOARD
- 360K FLOPPY
- 135 WATT POWER SUPPLY
- ONE YEAR WARRANTY

All For Only \$745⁰⁰

Quantum XT 4.77 MHz... Call For Pricing

AFTON COMPUTER INC.
(714) 863-6951

**24825 Calle El Toro Grande
El Toro, California 92630**

**Customer Service (714) 553-1701
Telex 756731**

Prices and Configurations Subject To Change.

which require unsolved research questions to be answered before they can be completed is rather unwise."

Paul E. Hoffman (2000 Center St., Suite 1024, Berkeley, CA 94704) consults on artificial intelligence and edits Text in Computers, a new scholarly journal.

STRUCTURE AND INTERPRETATION OF COMPUTER PROGRAMS

Reviewed by Haim Kilov

Though *Structure and Interpretation of Computer Programs* by Harold Abelson and Gerald Jay Sussman with Julie Sussman is intended as a textbook for entry-level computer science at Massachusetts Institute of Technology in Cambridge, Massachusetts, it is also recommended for professional programmers who are really interested in their profession.

The book is based on the idea of abstraction, successfully used throughout to "increase the conceptual clarity." Indeed, the titles of three of the five chapters use the term "abstraction." The language used is Scheme, a modern dialect of LISP with lexical scoping. The authors show quite a lot of programming paradigms that are language-invariant. One can wholeheartedly agree with the choice of paradigms, which are not just proclaimed but actually used repeatedly. However, the authors simultaneously ignore both the use of the same paradigms in traditional imperative language programming and, more strikingly, in program correctness and related methodology issues as stated by Dijkstra, Hoare, Wirth, Gries, and others. In some cases, the authors succeed in not using the classical terminology when they present well-established paradigms. No reference is made to program correctness or to contributions in programming methodology by the authors mentioned, despite a lengthy reference list. (Note, however, that these authors also do not usually refer to the subculture presented in the book.)

Experienced programmers as well as readers with some maturity will find the presentation interesting, useful, and instructive. Although the main underlying topic of the book—the use of abstraction in controlling complexity—is convincingly shown throughout, the intended audience (entry-level students) will need to have a gifted instructor to keep pace with the chapters presented here. Most readers could benefit from rereading some parts of the book.

The authors use a case study approach, and the reader is encouraged to actually use the computer with the Scheme interpreter. Nevertheless, it is possible, though more difficult, to follow the book without access to such an interpreter. The authors show only a part of the story—the means to trace a particular execution: to test a program, to simulate its execution, or to use the interpreter in order to convince the reader of something. This is not enough because, remembering Dijkstra's remark, testing can show the presence of errors, but not their absence.

(continued)

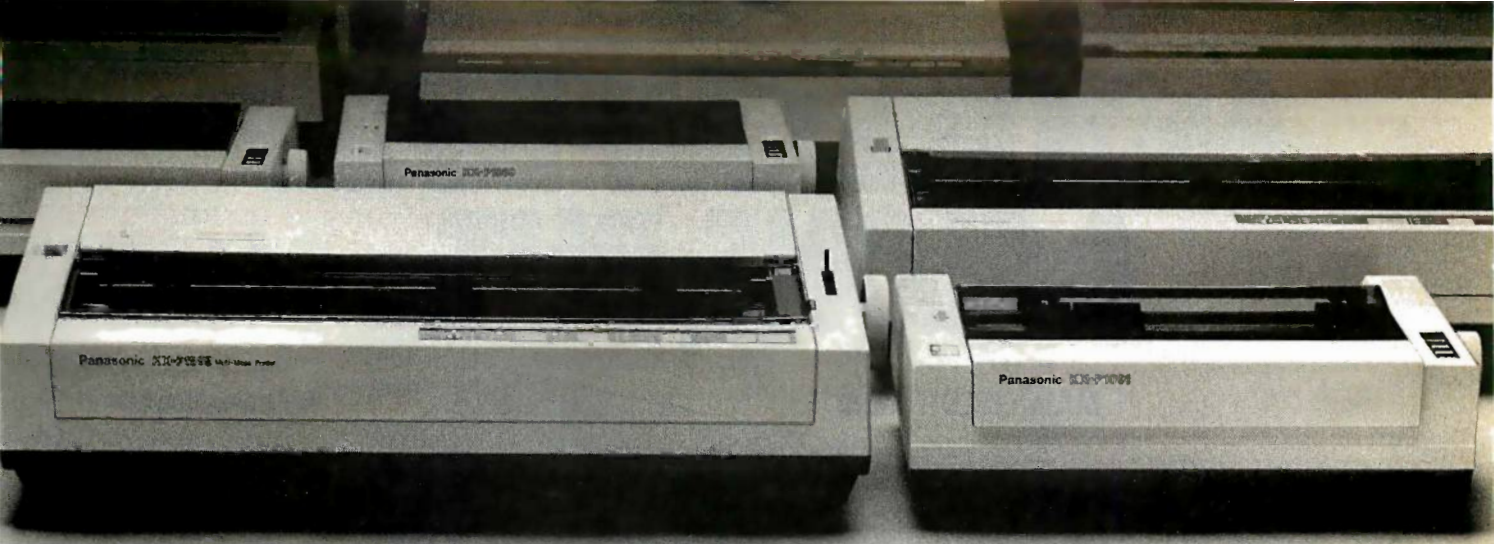

PANASONIC® PRINTERS. THEY'RE GENERATING A LOT OF GOOD PRINT.

The good reviews keep rolling in. And, as you can see, the critics agree: Panasonic printers are real winners!

But that shouldn't come as too big of a surprise. After all, Panasonic printers offer the advanced features and ease-of-use you've come to expect from Panasonic.

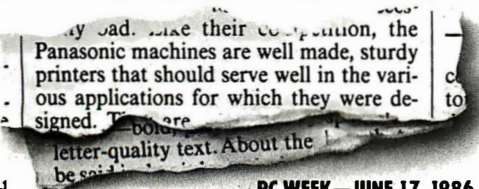

PC WEEK—JUNE 17, 1986

So, whether your business is big, small or in-between, you'll find a printer with features to love every bit as much as the critics. Like—as one

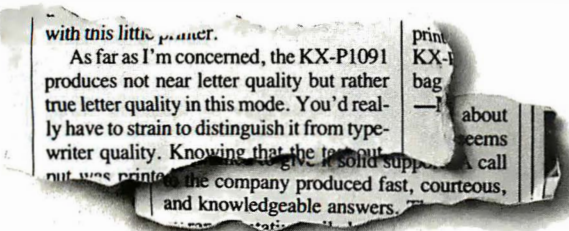

PC—SEPT. 17, 1985

reviewer observed—extraordinary near-letter-quality on our dot matrix models. They also come standard with impressive high-resolution graphics capability. So you can add graphs, charts, illustrations—even your company's logo.

Not to be outdone, all our daisy wheel printers give you sophisticated advances like boldface, shadow and underline.

Of course, we've put just as much care into the human side of our printers, too. You'll find

switches and buttons that let you change print sizes and styles right on the printer rather than through the computer. And, with our continuous, self-re-inking ribbons, you'll find yourself changing ribbons less often. When you do, our snap-in cartridge makes it a snap.

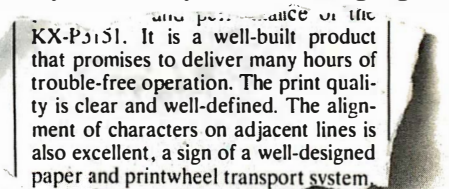

PC PRODUCTS—APRIL, 1985

Finally, just when you thought all this would be hard to top, there's more: all our printers are backed with an unprecedented two-year limited warranty.

Now that you've reviewed all of this for yourself, call toll-free 1 (800) PIC-8086 for the name



PRINTERS BUYERS GUIDE & HANDBOOK #3

of the dealer nearest you. Or you can write to: Panasonic Industrial Company, Computer Products Division, Two Panasonic Way, Secaucus, NJ 07094. You'll see how easily Panasonic printers generate good print for you.

And you'll agree: **THE EASIER, THE BETTER.**

Panasonic
Office Automation 
Inquiry 245

ANYONE CAN BUILD A CLONE, BUT...

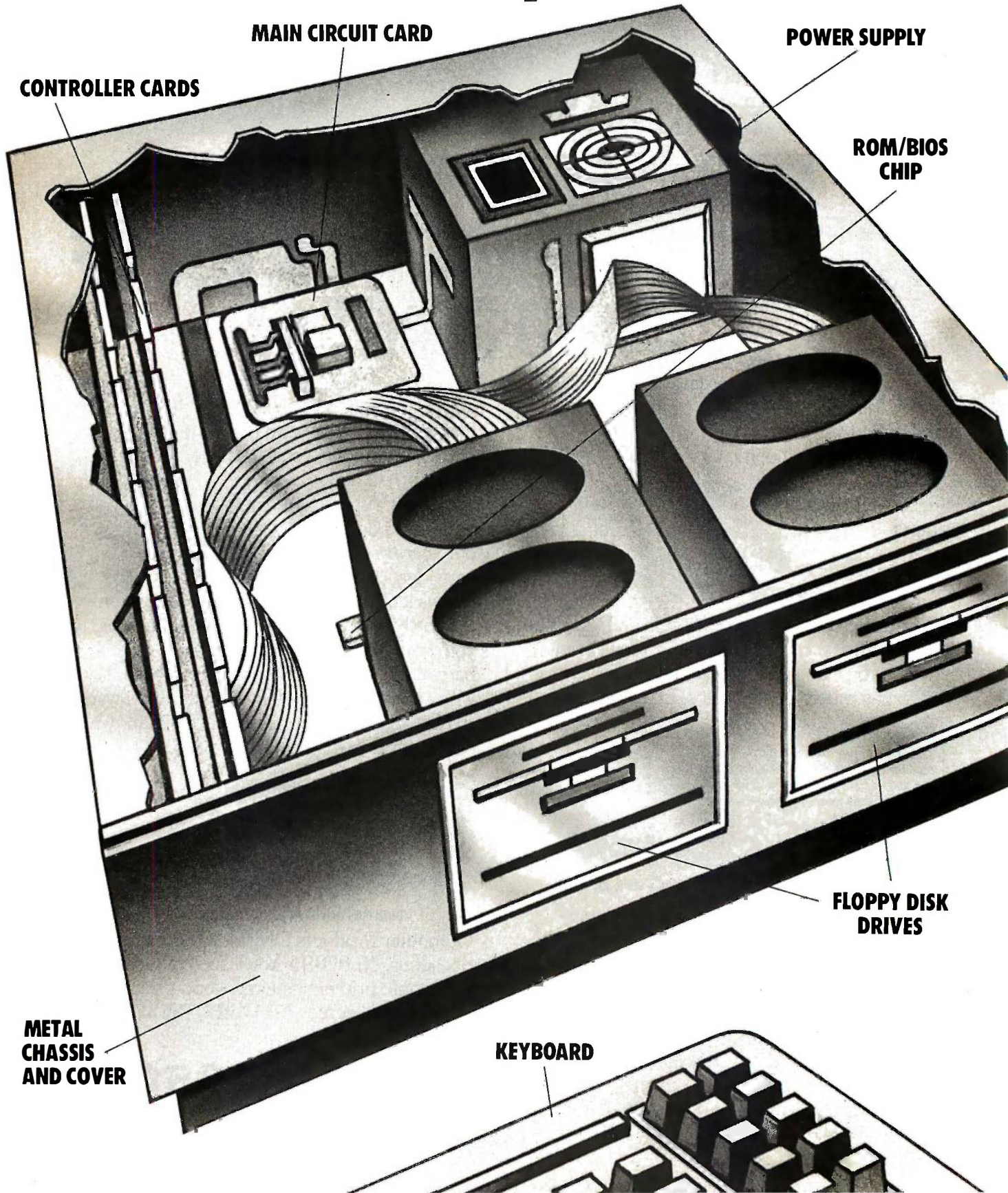

MAIN CIRCUIT CARD

POWER SUPPLY

CONTROLLER CARDS

ROM/BIOS
CHIP

METAL
CHASSIS
AND COVER

KEYBOARD

FLOPPY DISK
DRIVES

ONLY PANASONIC® GIVES YOU A BUSINESS PARTNER.™

Everyone seems to be jumping on the bandwagon. Today, companies that weren't there yesterday, and may not be there tomorrow, are building computers from easily assembled components.

The result is a sea of computer clones with little to distinguish one from another.

THE PANASONIC DIFFERENCE—A POWERFUL BUSINESS ALLY. Our approach to offering you a computer was entirely different. We looked at what would work best for you and your business.

The result is the Panasonic Business Partner and Panasonic Business Partner 286. Two powerful business allies, designed to answer your most demanding computer requirements.

YOU CAN SEE THE DIFFERENCE PANASONIC MAKES. With our long, unparalleled heritage in video technology, you get high-quality, high resolution monitors. An optional Panasonic CGA PLUS board is switchable to let you use a color or monochrome display for both graphics and text.

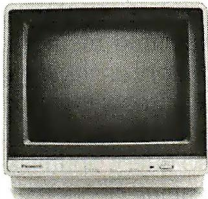

BUILT-IN FLEXIBILITY. No two businesses run exactly the same way. So you can configure the Business Partners to your own individual needs. In addition to their built-in floppy disk drives, you can add a hard disk drive, additional half-height drives—even a magnetic tape drive.



SPEED AND PERFORMANCE. The Business Partner 286 is built with maximum power and speed. Its 80286 processor runs at 6 MHz or 8 MHz, with the ability of addressing up to 15Mb RAM.

The Business Partner, with its 8086-2 processor, runs at 4.77 MHz, and for projects that need added acceleration, it will run up to 7.16 MHz.

FUTURE GROWTH. Both Business Partners have been designed to grow as your business grows. Extra slots are built in to offer you the flexibility—now and in the future—to add on cards for high resolution graphics, communications accessories and other peripherals.

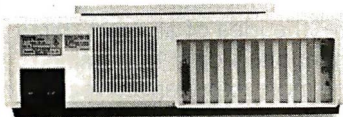

POWER TO SPARE. As your business grows, you'll put greater demands on your Business Partner. Don't worry, it can handle it. With 130 watts on the Business Partner and 220 watts on the Business Partner 286, you'll be able to drive additional peripherals and expansion boards.

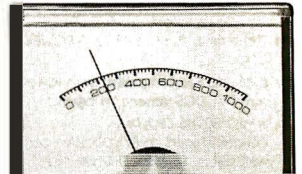

IMPORTANT DESIGN CONSIDERATIONS. The deluxe, detachable keyboards on both models have been designed for comfort and ease of use. We've separated the cursor keys and numeric keys for quick, convenient access. Swivel monitors adjust for each operator. On the Business Partner 286, you can lock the cabinet with a key to help prevent tampering and prying.

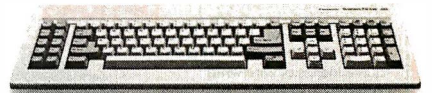

SOME REASSURING LAST WORDS. You'll find the Business Partner compatible with the IBM* PC/XT. And the Business Partner 286, with the PC/AT. So you'll be able to run the most popular software. You'll also get compatibility with Panasonic's wide range of quality peripherals, for the complete Panasonic office.

And more importantly, both Business Partners are from Panasonic, the company firmly committed to building a high-quality and dependable reputation in computer products. So both are backed with a full-year limited warranty.

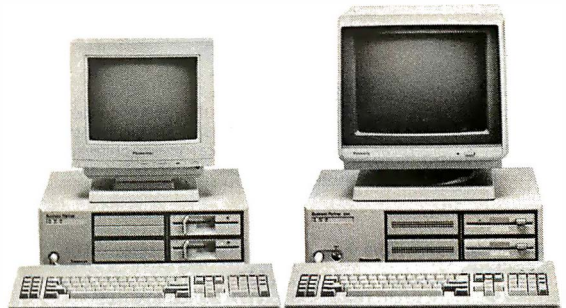

For more information, and the location of the dealer nearest you, call **1-800-PIC-8086**. Or write: Panasonic Industrial Company, Computer Products Division, Two Panasonic Way, Secaucus, NJ 07094. And discover how the right Business Partner can make running your business easier. You'll see: **THE EASIER, THE BETTER.**

*IBM is a registered trademark of the International Business Machines Corp.

Panasonic
Office Automation 
Inquiry 246

SCSI ENGINES

Little Board/186™ \$495

High Performance, Low Cost PC-DOS Engine

**Boots IBM PC-DOS
(not included)**

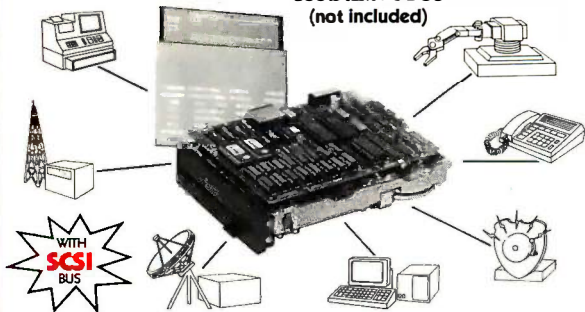

- Three times the COMPUTING POWER of a PC
- Data and File Compatible with IBM PC, runs "MS-DOS generic" programs
- 8 MHz 80186 CPU, DMA, Counter/Timers, 128/512K RAM zero wait states, 16-128K EPROM
- Mini/Micro Floppy Controller (1-4 Drives, Single/Double Density, 1-2 sided, 40/80 track)
- 2 RS232C Serial Ports (50 -38,400 baud), 1 Centronics Printer Port
- Only 5.75 x 7.75 Inches, mounts directly to a 5-1/4" disk drive
- Power Requirement: +5VDC at 1.25A; +12VDC at .05A; On board -12V converter
- SCSI/PLUS™ multi-master I/O expansion bus
- Software Included:
 - PC-DOS compatible ROM-BIOS boots DOS 2.x and 3.x
 - Hard Disk support

OPTIONS

PROJECT BOARD/186™ - adds 25 square inches of wire wrap prototype area with buffered and pre-decoded 80186 bus interface for Little Board/186



EXPANSION/186™ - adds five key options to Little Board/186

- 512K RAM
- 8087 co-processor
- Battery-backed Real Time Clock
- 2 RS232/422 sync/async serial ports
- I/O expansion bus

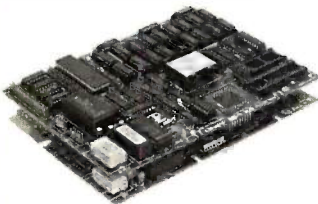

VIDEO RAM EMULATOR™ - allows use of software that writes to display controller "VIDEO RAM"

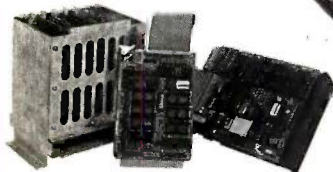
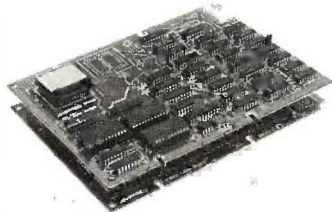

SCSI/IOP™ - permits connection of off-the-shelf STD bus industrial I/O interfaces (analog, digital, serial, display, power control, etc.)

DISTRIBUTORS

ARGENTINA: FACTORIAL, S.A., 41-0018
 TLX 22408 **AUSTRALIA:** ASP
 MICROCOMPUTERS, (613) 500-0628,
 TLX 36587 **BELGIUM:** CENTRE ELECTRONIQUE
 LEMPEREUR, (041) 23-45-41, TLX 42621
BRAZIL: COMPULEADER COMPUTADORES
 LTDA., (41) 262-1939, TLX 416132 **CANADA:**
 TR-M, (604) 438-9012 **DENMARK:** DANBIT,

(03) 66 20 20, TLX 43558 **UK:** AMBAR
 SYSTEMS LTD., 0296 35511, TLX 837427
FINLAND: SYMMETRIC OY, 358-0-585-392,
 TLX 121394 **FRANCE:** EGAL PLUS,
 (1) 4502-1800, TLX 620893 **ISRAEL:** ALPHA
 TERMINALS, LTD., (03) 49-16-95, TLX 341667
SWEDEN: ABAKTA, (08) 54-20-20, TLX 13702
USA: CONTACT AMPRO COMPUTERS INC.,

IBM®, IBM Corp.; 80186®, Intel, Corp.,

AMPRO

COMPUTERS, INCORPORATED

67 East Evelyn Ave., Mountain View, CA 94041 • (415) 962-0230
 TELEX 4940302 • FAX (415) 962-1042

BOOK REVIEWS

Correctness arguments are needed but are not mentioned anywhere in the text. (See "Program Transformation" by John Darlington, August 1985 BYTE.)

The range of topics covered is very wide. The book begins with "Building Abstractions with Procedures," which instills the idea of procedures as black box abstractions, and goes through "Building Abstractions with Data," which includes information hiding, data structures, and data representation—right up to top-down design of sizable programs using data-directed programming and generic operators. Then assignment is introduced, and problems dealing with local state are considered, giving rise to the notion of mutable objects. Streams and lazy evaluation are next, and the authors discuss the merits and shortcomings of functional programming.

"Metalinguistic abstraction" is covered in a chapter that establishes (and interprets) new descriptive languages developing the ideas set forth earlier. A LISP dialect evaluator is shown as well as a logic-programming-based query language and its evaluator. In the last chapter, a more traditional register machine is designed to execute the LISP evaluator (to do this a language is developed!). As an alternative, a LISP compiler is designed next for this machine. The last section shows the implementation of list-structured memory on top of "conventional" computer memory (including garbage collection). In such a manner, the authors mention diverse and important programming concepts, including not only a lot of textbook ones, but also query optimization in DBMSs, infinite loops and the meaning of "not" in logic programming, various primality tests, functional programming problems with bypassing assignment using streams, possible inadequacy of pure syntactic reasoning, and so on. Many of these are topics of active current research, and references are made to results published in the 1980s.

This enthusiastically written book is not easy reading, but neither is programming. When the authors develop solutions for nontrivial problems, they convincingly show the only right way of doing this—erecting abstraction barriers. First, abstract operations are presented without regard to implementation details, and only then is their implementation given; moreover, at times a hierarchy of such abstraction layers is used. This main idea is used time and again, and the authors' justifications of the decisions made in building abstractions are excellent, irrespective of the technical means used, which become more involved from chapter to chapter. Such presentations include elegant top-down developments of systems for symbolic differentiation, database query management, and compilation for a register machine. (Again, the use of this same principle in such imperative languages as Modula-2 or Ada is not even mentioned, as if these ideas were nonexistent there; the idea of abstract data types and encapsulation is mentioned only in passing.)

The more experienced reader will find the book instructive because of its new look at familiar concepts as well as for its many novel and interesting ones.

The authors include a lot of suitably annotated programs

(continued)

\$2000? That's Too Darned High!

Why should a CAD package cost more than a Word Processor? It shouldn't! Lots of people ask how we can offer a CAD system as good as ProDesign II at a price as low as \$299. It's easy. A PC Software Package does not cost \$2000 to manufacture. It doesn't even cost \$200. It makes us ask the questions "Why do comparable CAD packages cost \$2000 and more? What makes a CAD package cost more than a Word Processor?"

ProDesign II doesn't. ProDesign II is the complete CAD package you get for \$299. With ProDesign II, you get such advanced features as Auto Dimensioning, Area Fill (Hatching), Fillets, Mirroring, Isometrics, Curve Fitting, Object Snap, Attributes, Drawing Merge, Area Calculation, Parallel Lines, Parallel Curves, Tangents, Perpendiculars, and many many more. Features once available only for \$2000 or more. Features you get at no extra charge with ProDesign II.

But there is another, very important reason you should get ProDesign II. ProDesign II is very unique among CAD packages. It is easy to learn and use. When we call ProDesign II "The Easy to Use CAD System", we're not joking. You will be productive with ProDesign II in an hour or two instead of a week or two. In fact, we are confident that ProDesign II is without a doubt the easiest CAD system in the world to learn and use!

What else does ProDesign II offer? Compatibility. Com-

patibility with over 150 printers. Compatibility with over 80 plotters. Compatibility with most graphics adapters, digitizing tablets, and mice. Compatibility with most display adapters. Compatibility with any software that can produce HP plotter commands. Compatibility with mainframe CAD systems (IGES). All at no extra charge! (You can also get an AutoCAD Interchange Utility for \$99 that converts drawings to or from the AutoCAD format.)

What additional hardware do you need? None! An IBM PC compatible and 512K RAM is all you need. ProDesign II produces high resolution drawings on your dot matrix printer - better than .005" resolution on a IBM/Epson compatible printer. And you don't have to get a mouse or digitizing tablet. ProDesign II is designed for easy and efficient keyboard use. You won't even need a math coprocessor, although it is supported. From a small drawing on a dot matrix printer to an E-Size drawing on a large platter, ProDesign II is the one to use!

ProDesign.II — Affordable, Compatible, and Usable!

Where do you get it? See your local dealer or contact:

American Small Business Computers

118 South Mill Street

Pryor, OK 74361

Inquiry 28

918/825-4844

TELEX 9102400302

PRODESIGN II — ONLY \$299!

F-18 HORNET DRAWN USING PRODESIGN II

1. RADOME
2. RADAR ROTARY CARTRIDGE
3. AMMUNITION MAGAZINE
4. WINDSCREEN
5. INSTRUMENT PANEL
6. HEAD-UP DISPLAY
7. CANOPY
8. EJECTION SEAT
9. AVIONICS EQUIPMENT
10. SECOND SEAT SPACE
11. LEADING EDGE ROOT EXTENSION
12. FUSELAGE TANKS
13. LEADING EDGE FLAP
14. WING TANK
15. SIDEWINDER AIR-AIR MISSILE
16. MISSILE LAUNCH RAIL
17. NAVIGATION LIGHT
18. WING FOLD HINGE JOINT
19. ALLESON
20. FLAP VANE
21. FLAP
22. HYDRAULIC RESERVOIRS
23. STROBE LIGHT
24. RUDDER HYDRAULIC ACTUATOR
25. NAVIGATION LIGHT
26. RADAR WARNING ANTENNA
27. FUEL JETTISON
28. MOVING TAILPLANE
29. ECM ANTENNA
30. RADAR WARNING ANTENNA
31. FORWARD LIGHTING STRIP
32. AFTERBURNER NOZZLE
33. AFTERBURNER NOZZLE ACTUATORS
34. MOVING TAILPLANE
35. TAILPLANE PIVOT MOUNTING
36. TAILPLANE HYDRAULIC ACTUATOR
37. TURBOFAN ENGINE
38. ALLESON HYDRAULIC ACTUATOR
39. WING FOLD ACTUATOR
40. SIDEWINDER AIR-AIR MISSILE
41. LEADING FLAP ACTUATOR
42. WING TANK
43. LEADING FLAP DRIVE SHAFT
44. EQUIPMENT CARRIER
45. AUXILIARY POWER TURBINE
46. REAR LANDING GEAR
47. SPARROW AIR-AIR MISSILE
48. LEADING FLAP DRIVE MOTOR
49. MAIN RETRACT ACTUATOR
50. FORWARD RETRACT ACTUATOR
51. LIQUID OIL/ICE CONVERTER
52. BOARDING LADDER
53. FORWARD LANDING GEAR
54. CATAPULT LAUNCH STRAP
55. CONTROL COLUMN
56. RUDDER PEDALS
57. AMMUNITION FEED CHUTE
58. ANGLE OF ATTACK SENSOR
59. PILOT HEAD
60. FORWARD LIGHTING STRIP
61. RADAR EQUIPMENT BAY
62. FORWARD ECM ANTENNA
63. RADAR PIVOT MECHANISM
64. RADAR SCANNER

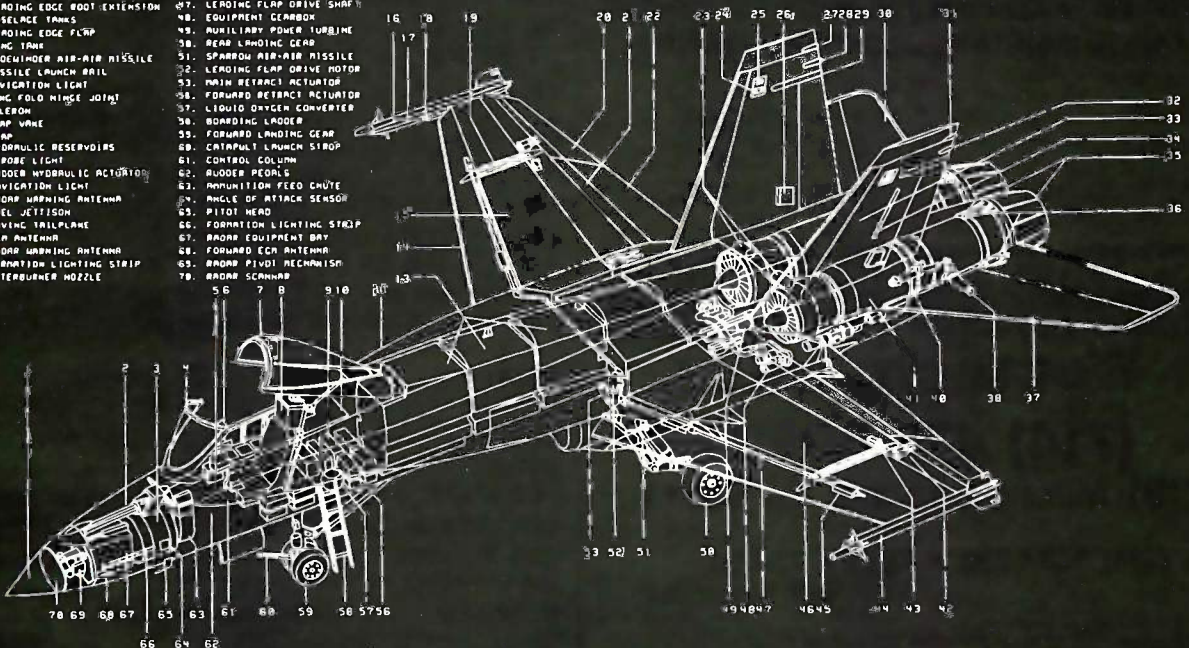

NEW 10 MHz

TIME IS MONEY... 10 MHz IS FAST!!!

FULL IBM PC-AT* COMPATIBILITY

IF YOU ARE TIRED OF WAITING FOR A 'SOMEDAY' PRODUCT
OR YOU DON'T WANT TO BUY YESTERDAY'S TECHNOLOGY,
THEN TREAT YOURSELF TO THE PERFORMANCE & FEATURES
OF THE "WESTECH 286 TURBO™" 10 MHz

PHOENIX BIOS - THE MISSING LINK IN
SOFTWARE COMPATIBILITY - ON BOARD

LOWEST COST 10 MHz AVAILABLE

COMPLETELY DESIGNED, MANUFACTURED, ASSEMBLED
AND TESTED IN U.S.A.

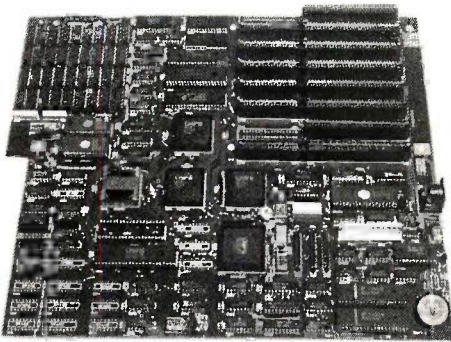

- 8 I/O Slots
- Parallel Port
- Up to 2 RS-232 Ports
- 1 RS-232 Included
- Phoenix BIOS
- Up to 1 MB Onboard
- 512K Included 120ns
- 4 Layer Mother Board
- Onboard Battery
- CMOS Clock Calendar
- Standard Power Connector
- Low Power Circuitry
- 10 MHz 80286
- Socket for 80287
- One-Year Warranty

HIGH SPEED INDUSTRIAL GRADE COMPUTER FOR:

- Industrial
- Medical
- Scientific
- Engineering
- University/Education
- Artificial Intelligence

QUANTITY DISCOUNTS AVAILABLE FOR QUALIFIED DEALER,
OEM, UNIVERSITY AND CORPORATE ACCOUNTS.

\$599.00 OEM Quantity Price

Call for other pricing

Westech, Inc.

(714) 474-6022

17781 Mitchell, Irvine, CA 92714

FAX (714) 553-0236 • TELEX 756731

Answer Back: Western Comp

Prices and availability subject to change.

* IBM AT is a trademark of International Business Machines Corporation.
Westech 286 Turbo is a trademark of Westech, Inc.

Inquiry 369 for End-Users.

Inquiry 370 for DEALERS ONLY.

BOOK REVIEWS

and program fragments. Some of them are simple, others more complex. The development of the latter is shown usually in a mixture of top-down and bottom-up ("tools to construct a language of") approaches, with more emphasis on top-down, and the reader can, with some effort, understand these programs. The amount of interesting examples presented by Abelson and the Sussmans make reading and studying their book fun. All the procedures are included in a thorough index. The typographic quality of the text is unusually high; I did not notice any misprints. Ample stimulating exercises (without solutions) are an integral part of the text. The choice of the particular abstract operations and the choice of particular representation is often elegant, but how and why it was made remains at times a secret of the authors.

Despite its shortcomings, this experiment in creating an unusual, modern, and demanding first computer science text is successful.

Haim Kilov (Karl Marx St. 75-13, Riga 11, U.S.S.R.) is involved in both the design and implementation of relational database management systems and computer science education. His papers and reviews have been published in the U.S.S.R. and the U.S.

SOFTWARE VALIDATION, VERIFICATION, TESTING AND DOCUMENTATION (A SOURCE BOOK)

Reviewed by John McCormick

Software Validation, Verification, Testing and Documentation is a collection of government publications whose aim is to develop software that is easy to use and maintain. The techniques and methods described by the collection's various authors are not language- or operating-system-specific; they are well-organized general procedures that can be applied to almost any software production problem. Each report also contains its own glossary and bibliography.

"Planning for Software Validation, Verification and Testing" is edited by Patricia B. Powell of the National Bureau of Standards. An overview of the software development process and management, it contains some software maintenance considerations. Detailed examples, among them code excerpts, are included to clarify points developed in the text. This report's primary goal is to ensure not only that the finished software works but that the development team and its management can have a high level of confidence in its quality and reliability.

TESTING

Book Two, entitled "Validation, Verification and Testing of Computer Software," covers validating software at the application level. Reliability and testability are the bywords of this book, with an emphasis on the importance of test data and especially test results. Statistical analysis of test data to determine its appropriateness is stressed, as is the technique of inserting errors statistically similar to those anticipated in the actual application. Twenty-one

(continued)

Explore AI on your PC

Smalltalk/V transforms your PC into a versatile AI workstation

Only Smalltalk/V lets you experience the thrill of a responsive AI workstation while learning artificial intelligence techniques and using them to create practical applications.

"Smalltalk/V gives me the feel of an AI workstation on my PC."

—Darryl Rubin,
Technical Editor,
AI Expert
Magazine

Watching someone use an AI workstation is a vision of what the computer was meant to be. Fingers dance across the keys as windows dilate, shift, overlap, and disappear on the bit-mapped display. Ideas spring to life as program fragments execute, are modified, expanded, combined and tried again in a creative arabesque of text and graphics. The interface vanishes, man and machine are one. Smalltalk/V brings that experience to your IBM-PC.

"We use Smalltalk as our primary language for teaching artificial intelligence."

—Dr. John Pugh
Director, School of Computer Science
Carleton University

Of the three main AI languages, Smalltalk, LISP, and Prolog, only Smalltalk was intended for individual use on a personal computer. Only Smalltalk was designed to provide a match between human and computer models of reality. Only Smalltalk is easy to learn, easy to read, and easy to use.



"Smalltalk/V is the highest performance object-oriented programming system available for PCs."

—Dr. Piero Scaruffi
Chief Scientist
Olivetti Artificial Intelligence Center

\$99.00

Smalltalk/V Features

- High-performance object-oriented programming
- Integrates object-based and rule-based programming with object-oriented Prolog
- A user-extensible, open-ended environment
- A responsive graphical user interface
- Supports exploratory programming and prototyping
- Class hierarchy with inheritance creates highly re-useable code
- Smalltalk source code included, with browser windows for easy access and modification
- A huge toolkit of classes and objects for building a variety of applications
- Object-swapping creates virtual memory on hard or RAM disk
- Bit-mapped graphics with bit and form editors
- A sophisticated source-level debugger
- Automatic change log for easy recovery from errors
- Powerful directory/file browser system for organizing DOS files
- Optional communications interface to Unix™ and other systems
- Access to other languages and DOS functions
- DOS command shell
- Detailed owner's manual designed for both beginners and advanced programmers

"We found Smalltalk/V excellent for developing advanced decision-support tools based on decision analysis and AI techniques."

—Dr. Samuel Holtzman,
Professor, Stanford University

Smalltalk/V is pure object-oriented programming — a powerful tool for designing frame/script-based knowledge representations, inference engines, expert systems, simulation environments, intelligent interfaces, network control software, communications interfaces, and much more.

Methods, our character-based Smalltalk, is now available for \$79. It has all of the features of Smalltalk/V except graphics, rules, source-level debugger, and object-swapping. However, it supports color, includes the communication package, and does not require a mouse.

BYTE and BIX are trademarks of McGraw-Hill, Inc. IBM, IBM-PC, and IBM PC-AT are trademarks of International Business Machines Corporation. Unix is a trademark of Bell Laboratories.

Inquiry 107

YES! I want to turn my PC into an AI workstation. Send me . . .

Smalltalk/V \$99

Communications for Smalltalk/V . . . \$49

Methods (including
Communications) \$79

Shipping and Handling \$

CA residents add applicable
sales tax \$

TOTAL \$

Shipping and Handling
U.S., Canada, and Mexico \$ 5.00
Elsewhere \$15.00

I enclose Check Money Order

Credit card information MC VISA

Number: _____ Expiration: _____

Signature _____

Name: _____

Street Address: _____

City/State/Zip: _____

Phone: _____

NOT COPY PROTECTED, 60-DAY MONEY-BACK GUARANTEE
ON-LINE USER-SUPPORT CONFERENCE ON BYTE'S BIX™

Smalltalk/V requires DOS and 512K RAM on IBM PCs (including AT) or "compatibles," a Microsoft or compatible mouse, and a CGA, EGA, Hercules, or AT&T Hi-Res graphic controller.



5200 West Century Boulevard
Los Angeles, CA 90045 (213) 645-1082

New Quark®/PC Single Board Computer



Base model 5.75" x 8"
Only \$ **495.**
Quantity discounts available

- IBM PC® compatible single board computer mounts to 5 1/4" drive
- Includes Floppy Disk & Color Graphics CRT Controllers plus more

Also includes: Legal BIOS • Boots PC DOS® 2.1 • Printer Port • 2 Serial Ports • 256K RAM • Clock Speed at 4.77 MHz • Alphameric and Graphics Modes for Color Video Controller • Standard IBM® Keyboard Port.

Options include: 512K RAM • Piggyback I/O channel OEM Expansion Board • XT - Compatible Hard Disk SCSI Interface • Real Time Clock with battery-back-up • Clock speed of 9.5 MHz (Twice as fast as a PC)

The Megatel Quark/PC is for OEM and end user applications that require PC compatibility in a compact single board computer. The Quark/PC BIOS will run most IBM PC® software including Flight Simulator and Lotus®. To meet your specifications a set of options let you add memory, speed and an XT-compatible hard disk interface. Not only does it quickly mount to a 5 1/4" drive, it also comes with floppy disk and CRT color graphics controllers — all for just \$495.

To order or enquire call us today. Dealer enquiries welcome. Megatel Computer Technologies (416) 745-7214 150 Turbine Drive Weston, Ontario M9L 2S2
Telex: 065-27453 U.S. Address: 1051 Clinton St., Buffalo, NY, 14206 Distributors: NCS Electronics Varese, Italy • SES Electronics Nordlingen, Germany • Perdix Microtronics Biggin Hill, UK • Microcomputing Ghent, Belgium • Asp Microcomputers Melbourne, Australia.

Quark is a registered trademark of F. and K. MFG. CO. LTD. IBM, IBMPC and PC DOS are registered trademarks of International Business Machines Corp. Lotus is a registered trademark of Lotus Development Corp. MSDOS is a registered trademark of Microsoft Corp.

megatel

Visit us at Comdex Booth #H7642

BOOK REVIEWS

automatic and manual testing and verification techniques, including peer review and simulation, are described.

APPROACH

The highly structured approach to software testing is discussed in "Structured Testing: A Software Testing Methodology Using the Cyclomatic Complexity Metric" by Thomas J. McCabe. This piece uses graph theory to develop a complexity measure that is used in determining whether particular software is inherently untestable due to its complexity.

Testability is a measure of whether the software is so complex that the task of testing it becomes unreasonably expensive or time-consuming. This section is devoted to determining the complexity and testability of particular software and ultimately determining whether the complexity must be reduced or the testing technique improved.

30 TOOLS

From algorithm analysis and analytic modeling of systems designs to test support facilities and walk-throughs, Book Four, entitled "Software Validation, Verification, and Testing Technique and Tool Reference Guide," describes 30 verification, validation, and testing tools.

This section on practical applied testing contains a wealth of information for someone actively seeking a tool for a specific testing purpose. This book includes specific references for each of the 30 tools.

The discussion of each tool includes a description of its basic features, the input and output information, an example, the difficulty in learning the technique, costs, and effectiveness. This information will help you quickly narrow down the search for the appropriate tool.

MANAGEMENT LEVEL

"Management Guide to Software Documentation" by Albrecht J. Neumann explores the management aspects of documentation production and includes a number of checklists intended to guide managers in the production of software documentation.

Each book in this volume begins with a short abstract and list of the section's keywords. This entire work is distilled from reports published by the U.S. Department of Commerce's National Bureau of Standards. The text is liberally sprinkled with charts, tables, graphs, and examples. Some sections deal with general managerial considerations, and others deal with specific programming applications, providing useful information for a variety of software development specialists.

This publication is for the serious professional who deals with software at the production level and not for the software user. While the book does not deal specifically with software maintenance and operation, these topics are certainly made easier with well-verified, -tested, and -documented software.

John McCormick (Box 99, RD#1, Mahaffey, PA 15757) is a freelance writer specializing in personal computers. Formerly with Wang Labs, he has also worked with IBM mainframes. ■

Computerfone™

Interactive Voice Response System



TouchTone In/Voice In/Text In
Voice Out
Excellence
in-Voice Quality

- Text-to-Speech
- Digitized Speech
- Synthesized Speech
- Auto Answer/Auto Dial
- Host Independent

Call to hear our demo:
1-800-843-9363
In Florida call 904-478-6477
1986 Suncoast Systems, Inc. 24 Hrs./7 Days/Wk.

Attention Microsoft Word Users

Stunning Microsoft Word Processing *Fancy*WORD™

If you are a Microsoft Word user, using a dot matrix or laser printer, you now can print your letters, reports and presentation materials in **near typeset quality** with FancyWord.

You simply use Microsoft Word like you always have, including the paragraph and character format commands. The difference is **superior quality and font variety!** In fact, the copy and sample page in this ad were printed on an Epson FX80 printer using FancyWord.

Standard FancyWord font styles include Roman, Sans Serif, **Bold**, *Italic*, *Script*, **Old English** and many more in 10 to 24 point sizes. SoftCraft offers hundreds of optional fonts in sizes from 6 to 72 points. There is also an option that enables you to create your own **special characters and logos**.

Impact Your Laser

Combine the high quality of the HP LaserJet printer with the font styles and sizes of FancyWord for the ultimate in visual impact.

Cost Effective

FancyWord is available from your local dealer or direct from SoftCraft for only \$140.

You get near typeset quality at a small fraction of the time and cost of using art or typesetting services.

FancyWord runs on PCDOS and MSDOS systems with Epson, Toshiba, LaserJet and compatible printers.

Call **TOLL FREE** today to order FancyWord. We'll also be happy to answer any questions or send you additional information including actual samples and independent reviews.

CALL TODAY 1-800-351-0500

MasterCharge and Visa accepted

SoftCraft, Inc. Inquiry 303

222 State Street, Madison, WI 53703 (608) 257-3300

For Fancy letters, take our "WORD" for it.

SoftCraft, Inc.  8

Fancy WORD, from the developers of the highly-acclaimed *FancyFont* personal typesetting system, brings Microsoft Word users the amazing print quality and variety of *FancyFont* and the ease-of-use of Word. Use the Word "Format Character" command to select **bold** or *italic* for emphasis, **Old English** for formality, a clean Sans Serif font or *script* for a *handwritten look*. Print with *superscript*, *subscript* or fine print or use a large, bold font to produce headlines with impact, such as:

Printed on an Epson Printer

All of Word's powerful formatting and on-screen editing features can be used with *Fancy* WORD, including justification, multiple columns and footnotes. This entire page was prepared with Word and printed with *Fancy* WORD.

In addition to the fonts that come with *Fancy* WORD hundreds of fonts in sizes from 6 points to 72 points are available, at a nominal charge, from SoftCraft's font library. You can also purchase the *FancyFont* font editing utilities to create your own characters or logos, up to 1 inch by 1 inch in size.

The special math and symbol fonts available from the font library can be used in many special applications, such as printing equations:

$$\pi(n) = \sum_{k=2}^n \left[\frac{\phi(k)}{k-1} \right]$$

Now compatible with
Microsoft Word
Versions 2 and 3.

Quality

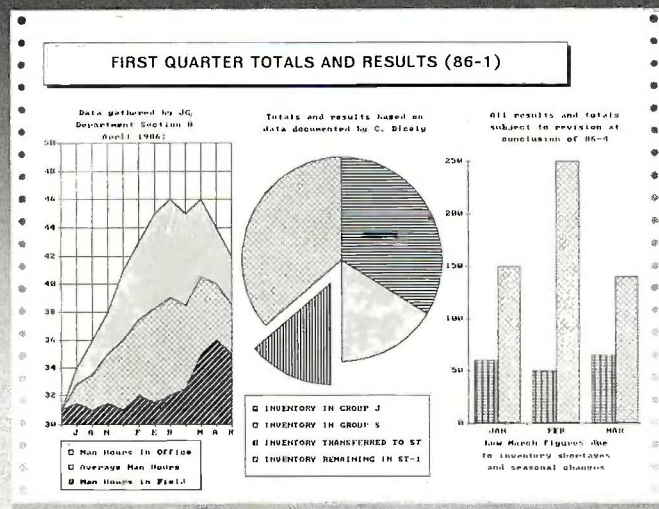

Quality in Star's line of advanced printers begins with the exceptional appearance of their letter quality printouts. They're crisp. Professional. The images sharp. And true letter quality is fast and quiet. But whether it's a spreadsheet, graphics, or a letter, all our printers give you Star quality output, because of Star's quality input.

We design our printers. We make our own precision parts. In fact, we even make the machines that make the parts. But what good is quality without control?

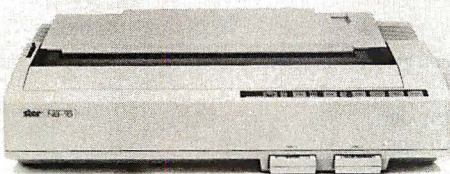

NB-15 The top of the line 24-wire business printer. 300 cps draft 100 cps true letter quality.

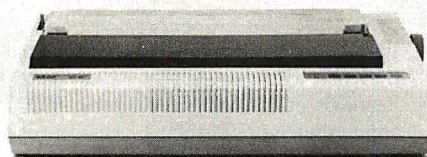

SR-10/SR-15 The high speed printers for home or office. 200 cps draft 50 cps near letter quality.



SD-10/SD-15 The no-nonsense printers that are flexible and affordable. 160 cps draft 40 cps near letter quality.

Control

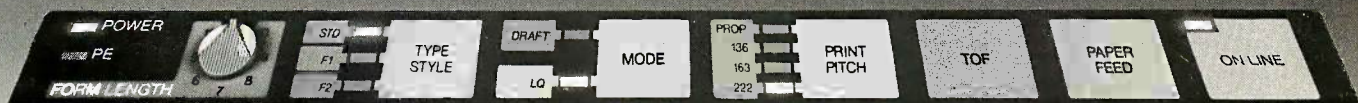

Control begins with the convenient front panel. With advanced features at your fingertips you'll find touch control throughout the entire line of Star printers.

Our premiere printer, the 24-wire NB-15™, lets you select draft or letter quality at a touch. Choose type style—either standard, or any two of five optional fonts. Print pitch—pica, elite, standard or proportional. And you can also feed in single sheets of paper automatically.

Star's line of printers also has standard memories ranging up to a 16K buffer that can expand to 32K. Draft speeds as fast as 300 characters per second (cps). True letter quality as fast as 100 cps. And of course, there's compatibility with all major personal and business computers.

Discover the quality and control of Star's entire printer line at participating ComputerLand and other computer products retailers.



NX-10/NX-15 The economical printers that combine speed and convenience. 120 cps draft 30 cps near letter quality.



NL-10 The versatile printer with interchangeable interface cartridges. 120 cps draft 30 cps near letter quality.

star
MICRONICS

200 Park Avenue
New York, NY 10166 Inquiry 323

Regional Offices:

Atlanta, GA (404) 441-3126
Chicago, IL (312) 773-3717
Irvine, CA (714) 768-7203

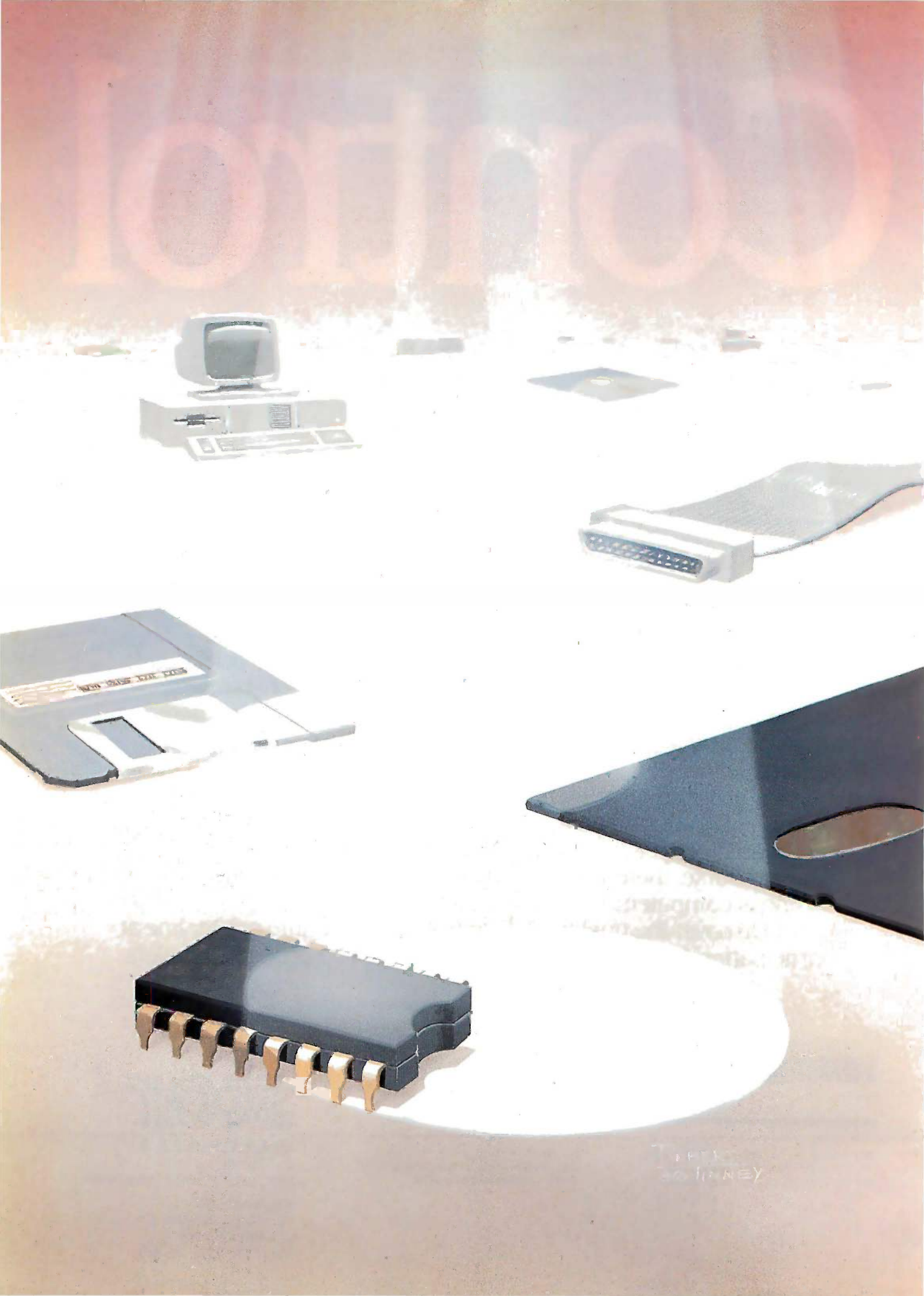

TERRY
LINNEY

Features

PRODUCT PREVIEW: THE COMPAQ DESKPRO 386 <i>by Tom Thompson and Dennis Allen</i>	84
PRODUCT PREVIEW: LOTUS MANUSCRIPT <i>by George A. Stewart</i>	91
CIARCIA'S CIRCUIT CELLAR: BUILD THE GT180 COLOR GRAPHICS BOARD, PART I: BASIC TECHNOLOGY <i>by Steve Ciarcia</i>	105
PROGRAMMING INSIGHT: EXTRACTING THE <i>n</i>th ROOT FROM A BINARY NUMBER <i>by Lau Siu Wo</i>	115
PROGRAMMING INSIGHT: PASSING FILENAME TO COMPILED BASIC <i>by Bruce Hubanks</i>	119
MEMORY MANAGEMENT UNITS FOR 68000 ARCHITECTURES <i>by Gregg Zehr</i>	127
THE STATE OF SOVIET MICROELECTRONICS <i>by Paul Walton</i>	137

THIS MONTH'S FEATURES include two Product Previews. The first, "The Compaq Deskpro 386" by Tom Thompson and Dennis Allen, offers an advance look at Compaq's new high-performance IBM PC AT-compatible system based on Intel's 80386 microprocessor. The second, "Lotus Manuscript" by George A. Stewart, previews Lotus Development Corporation's technical word processor. Watch for complete reviews of both products in the near future.

Steve Ciarcia begins the Circuit Cellar by saying, "Graphics has more of a direct influence on user satisfaction than any other aspect of a computer." Up until now, his SBI80 computer has had graphics capabilities that paled in comparison to the graphics on other popular computers. This is no longer the case. In the first part of a three-part series, Steve describes the GT180, which is both an expansion board and an intelligent graphics system. The GT180 will combine with the SBI80 to provide high-quality graphics at a low cost.

We also have two Programming Insights on the agenda this month. In "Extracting the *n*th Root from a Binary Number," Lau Siu Wo explains the general algorithm he developed for extracting any real root from a binary number. In "Passing Filenames to Compiled BASIC," Bruce Hubanks walks us through an assembly language subroutine he created to retrieve the command-line text for a compiled BASIC program.

Gregg Zehr's "Memory Management Units for 68000 Architectures," this month's 68000 feature, looks at the design options that speed up memory management.

Finally, Paul Walton takes us into the Soviet Union for an inside look at the state of microelectronics. Is Russia's computer culture anywhere near as advanced as ours? The answer is a resounding "Nyet."

THE COMPAQ DESKPRO 386

*A high-performance
PC AT-compatible
system based on
Intel's 80386*

Editor's note: The following is a BYTE product preview. It is not a review. We provide an advance look at this product because we feel that it is significant. A complete review will follow in a subsequent issue.

About a year ago, Intel began selling samples of its latest-generation microprocessor, the 80386 (see *Microbytes*, November 1985 *BYTE*). After much anticipation this processor has finally made its way into the design of several new microcomputer systems. Compaq, the Houston-based manufacturer widely known for its IBM-compatible computers, introduced one of the first such systems, the Compaq Deskpro 386. The new Compaq machine was designed to be compatible with 80286-based systems, such as the IBM PC AT, yet take advantage of the 80386's processing power for better performance. Like the PC AT, the Deskpro 386 was also designed to run much of the existing software written for the older 8086/8088 Intel microprocessors.

SYSTEM DESCRIPTION

From the outside, the Deskpro 386 is Spartan in design (see photo 1). The system is housed in an IBM PC AT-style box with indicator lights, a security key, and space for up to four

half-height disk drives or other storage devices. The back panel of the system unit has a 9-pin serial port and a 25-pin parallel printer port. The system comes with your choice of a standard 84-key PC keyboard or the Compaq Enhanced Keyboard, an IBM RT PC-style 101-key keyboard.

The standard configuration, called the Model 40, sells for \$6499 and includes 1 megabyte of RAM, a 1.2-megabyte floppy disk drive, and a 40-megabyte hard disk. Compaq also offers a system configured with a 130-megabyte hard disk (instead of the 40-megabyte hard disk) called the Model 130, which sells for \$8799.

Because no production machines were available at press time, we examined a preproduction Model 40 system with an additional megabyte of RAM (2 megabytes total), a numeric coprocessor, a 360K-byte floppy disk drive, a 40-megabyte tape cartridge unit, and a color graphics adapter. The system runs MS-DOS 3.1.

Inside the machine is a 192-watt power supply, a fan, and a single motherboard (see photo 2). The motherboard contains a real-time clock with battery backup, seven expansion slots, the CPU, and a 32-bit slot occupied by the System Memory Board. Four of the expansion slots are full-size 8-/16-bit slots and three are 8-bit slots, of which two are full size and one is half size. Compaq's multi-purpose disk controller, which is included with the base system, occupies one of the full-size 8-/16-bit expansion slots. The disk controller supports two 1.2-megabyte floppy disk drives, a 40-megabyte hard disk, and either a second 40-megabyte hard disk or a 40-megabyte tape backup unit. The

Model 130 requires an additional drive controller in one of the full-size 8-/16-bit expansion slots for the 130-megabyte hard disk.

UNLEASHING THE 80386

The CPU is a version B1 80386 microprocessor running at 16 MHz. The 80386 has built-in memory management and supports a numeric coprocessor, but the motherboard has a socket for only a 4- or 8-MHz 80287—not an 80387. The 80386 uses two separate 32-bit buses for addressing and data. The processor can dynamically size its data bus to handle 32-bit or 16-bit data bus operations. Also, the address bus can be pipelined; the processor can perform address decoding for the next bus operation during the previous bus cycle, allowing for overlap of bus activity.

To tap the performance potential of the 80386, Compaq designed a high-bandwidth CPU bus and memory bus. The CPU bus is a 32-bit nonmultiplexed address and data bus that provides signals for interfacing to both the 32-bit memory bus and the 8-/16-bit expansion bus. In the event of bus contention between the memory bus and the expansion bus, the memory bus has priority. The expansion bus is electrically compatible with existing plug-in cards for the PC AT. However, we did not test any plug-in cards in the system.

The memory bus provides the bandwidth necessary to take advantage of the 80386's speed and bus pipelining. It uses a paged memory architecture to improve access times. The memory bus does not include I/O status or control signals, and it is not intended to be used as a general-purpose bus.



Photo 1: The Compaq Deskpro 386 with optional color monitor, 40-megabyte backup unit, and extra 1.2-megabyte floppy disk drive.

The maximum physical memory this bus can address is 16 megabytes. However, using Compaq options you can expand the system only to 10 megabytes of RAM on the 32-bit bus.

FASTER MEMORY

Naturally, a faster memory bus requires faster memory. The System Memory Board is equipped with thirty-six 256K-bit static-column RAM chips soldered directly to the board for a total of 1 megabyte of memory

with 4 bits for parity. Using this arrangement with 100-nanosecond RAM reduces the number of wait states required for memory access in the paged mode to nearly 0. Memory cells within the same physical page can be accessed rapidly by keeping the row address of the RAM constant while modifying the column address. For such consecutive memory fetches within a page, access times can be as low as 50 ns. During nonpaged operations, access times are about 100 ns.

A PC AT, on the other hand, is equipped with 150-ns RAM.

The System Memory Board has sockets for another megabyte of RAM chips, which costs \$549. Additional memory must be added in 1-megabyte increments. When upgrading memory, you must change a set of

(continued)

Tom Thompson and Dennis Allen are BYTE technical editors. They can be reached at BYTE, One Phoenix Mill Lane, Peterborough, NH 03458.

IN BRIEF

Compaq Deskpro 386

Company

Compaq Computer Corporation
20555 FM 149
Houston, TX 77070
(713) 370-0670

Price

Model 40: \$6499
Model 130: \$8799

Microprocessor

Intel 80386 16-MHz, 32-bit microprocessor

Main Memory

1 megabyte of 100-ns RAM, expandable to 14 megabytes
128K ROM containing system code

Disk Memory

1.2-megabyte 5¼-inch double-sided floppy disk drive
40-megabyte hard disk with 30-ms access time (Model 40)
130-megabyte hard disk with 25-ms access time (Model 130)

Keyboards

Detachable 84-key IBM PC keyboard plus numeric keypad and 10 function keys;
Detachable 101-key IBM RT enhanced keyboard with numeric keypad, cursor keys, and 12 function keys

Ports

9-pin serial port
25-pin parallel port

Optional Peripherals

- Compaq color monitor (EGA compatible) \$799
- Color adapter card \$599
- Monochrome monitor (amber or green) \$255
- Video display controller board \$199
- 40-megabyte tape backup unit \$799
- 8-MHz 80287 math coprocessor \$349
- Deskpro 386 Technical Reference Guide* \$149
- Additional 1 megabyte of RAM for System Memory Board \$549
- 2-megabyte piggyback board with 1 megabyte of RAM \$849
- 2-megabyte piggyback board with 2 megabytes of RAM \$1398
- 8-megabyte piggyback board with 4 megabytes of RAM \$2999
- Additional 4 megabytes of RAM for piggyback board \$2699

9-pin jumpers on the memory board. You can also set the jumpers to reduce the 640K-byte base memory of the system to 512K or 256K.

A special expansion board can be piggybacked on the System Memory Board to bring the total memory to 4 megabytes using 256K-bit chips. Compaq also offers a piggyback board with 4 megabytes of RAM using 1-megabit chips for \$2999. This board has sockets for another 4 megabytes of RAM (\$2699), again using the 1-megabit chips. Together, a fully populated System Memory Board (2 megabytes) and expansion board using 1-megabit chips (8 megabytes) give you a total of 10 megabytes of 32-bit high-speed memory. You could also use two 16-bit boards configured with 2 megabytes each to bring the Deskpro 386 to a maximum of 14 megabytes using Compaq options. In doing so, however, you would lose the speed advantage of the 32-bit memory bus.

THE VIRTUAL MACHINE

An important feature of the 80386 CPU is its virtual mode. Combined with memory paging, this mode allows a real mode environment (64K-byte segments, 1 megabyte of physical address space, no memory protection) to be emulated anywhere within the 80386's physical address space of 4 gigabytes. The virtual mode also features I/O protection so that the host operating system can imitate various I/O ports. Compaq claims to have successfully "virtualized" an

8086 machine in the Deskpro 386. In other words, MS-DOS programs should run on the Deskpro 386 with little or no modification. More important, ill-behaved programs—programs that read or write directly to hardware I/O ports rather than using DOS functions—should operate properly.

To access memory beyond the 640K bytes of base memory under MS-DOS control, the Deskpro 386 uses a proprietary software driver called the Compaq Extended Memory Manager (CEMM). The CEMM takes advantage of the 80386's memory paging features to emulate the Lotus/Intel/Microsoft (LIM) expanded memory specifications in the Deskpro 386's 32-bit memory system. In effect, it virtualizes an Intel AboveBoard. You can install the CEMM and define the memory size (up to the 8-megabyte LIM limit) using the MS-DOS configuration file, CONFIG.SYS. Using the CEMM with the Deskpro 386's 32-bit memory should result in favorable speeds compared to using the LIM specifications with a 16-bit memory board.

This virtual machine arrangement promises to resolve possible software compatibility problems with existing 8086/8088 and 80286 real mode programs, at least in the single-user mode. In fact, the 80386's virtual mode will allow copies of different operating systems to execute real mode applications concurrently with memory protection and privilege control. But for now at least, Compaq

(continued)

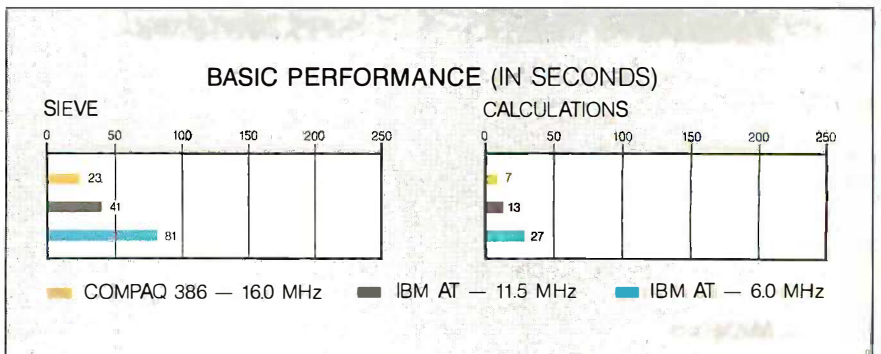

Figure 1: The results of two BYTE BASIC benchmarks, Calculations and Sieve, run on the Compaq Deskpro 386. These times are compared with the same benchmarks run on a 6-MHz IBM PC AT and a PC AT specially equipped with 100-ns memory running at 11.5 MHz.

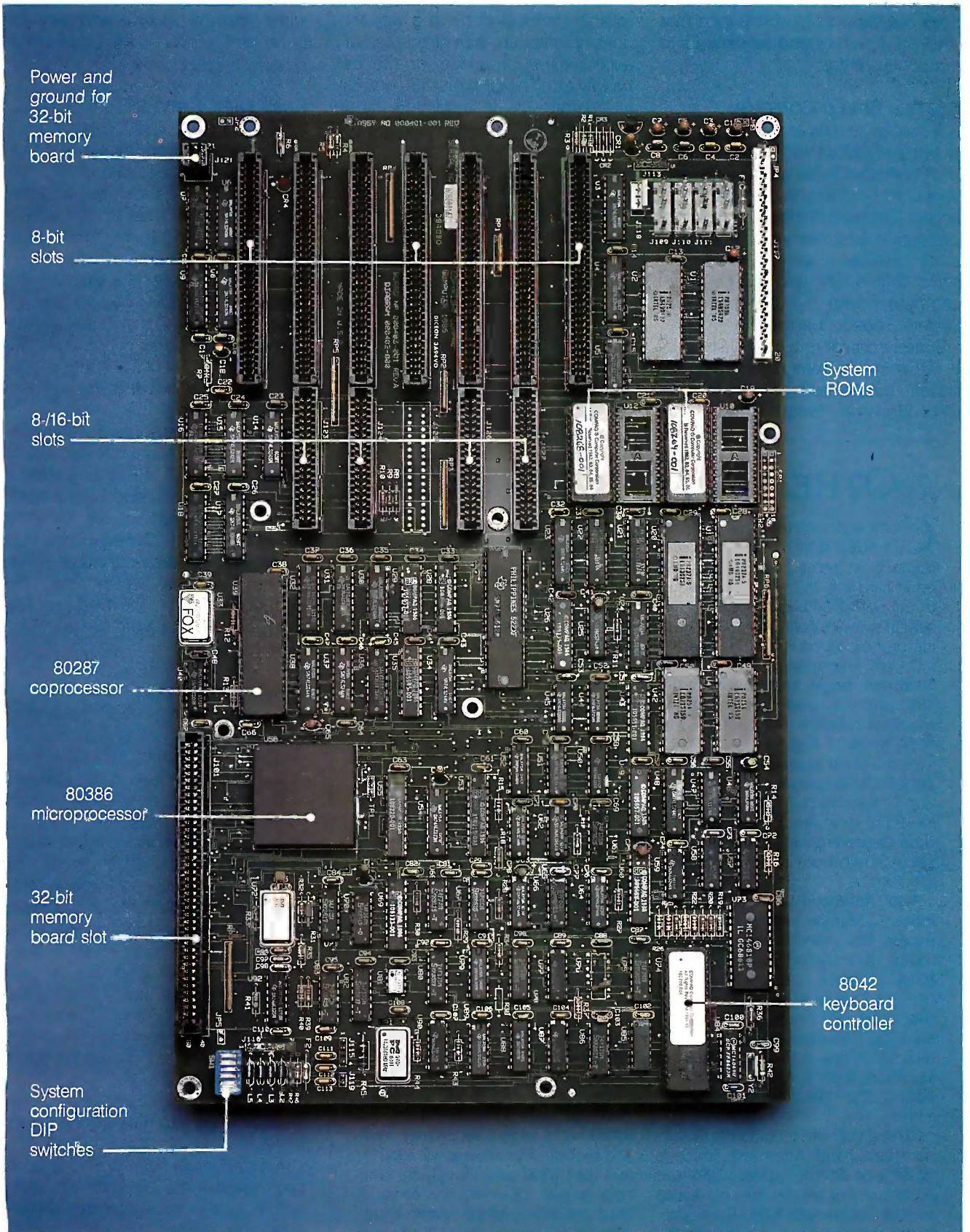

Photo 2: The Compaq Deskpro 386 motherboard.

does not support host software that allows different operating systems to run concurrently.

SYSTEM SPEED CONTROL

Another feature promises compatibility with programs that use time-dependent code that relies on the computer system to be operating at a particular speed. Compaq hopes to trick copy-protection schemes and certain program displays (typically games) by simulating 8088- and 80286-based computers with the Deskpro 386's System Speed Control.

Speed control is accomplished by lengthening the refresh cycles on the system bus, effectively slowing the CPU. However, lengthening of the

refresh cycles is done in a way that does not interfere with direct memory access (DMA) transfers or the bus bandwidth. The Deskpro 386 normally operates in an automatic mode where the CPU speed is reduced to 8 MHz—essentially mimicking a PC AT—each time a program accesses a floppy disk drive. The system resumes its high-speed operation as soon as the disk I/O is finished. Performance is not degraded since the system must wait on the slower disk drive.

An MS-DOS command, MODE, allows you to select a system speed manually. You can select a 4-MHz 8088, a 6- or 8-MHz 80286, or a 16-MHz 80386 system speed using this command. The speed remains the

same (even through a keyboard reboot) until you alter the setting or a power-on reset occurs.

FAST DISK DRIVES

To complement the Deskpro 386's data processing performance, Compaq used high-speed disk drives. The 40-megabyte hard disk has an average access time of under 30 milliseconds, and the 130-megabyte hard disk's average access time is under 25 ms. In contrast, the PC AT's 20-megabyte hard disk has an average access time of 40 ms. Data transfer rates are 5 megabits per second (the same as the PC AT's 20-megabyte hard disk) and 10 megabits per second, respectively.

For hard disk backups, the 40-megabyte tape drive has a transfer rate of 500 kilobits per second, which is about twice the speed of the drive previously offered for the Deskpro line of computers. The tape drive uses a new DC2000 tape cartridge, unlike its predecessors, which used the DC1000. However, the Deskpro 386 can read—but not write to—the older tape cartridges.

DISPLAY ADAPTERS

The system we examined was equipped with Compaq's new Enhanced Color Graphics Board (\$599), which also made use of the system's virtual mode. The graphics board provides 640- by 350-pixel resolution with 16 simultaneous colors, and it is compatible with IBM's Enhanced Graphics Adapter. Although the graphics board has only an 8-bit data path, the system cleverly relocates the board's ROM to the 32-bit RAM area. As a result, Compaq claims that graphics execution speed is increased by approximately four times. (The system also relocates the contents of its 16-bit ROMs to the 32-bit RAM area for speed improvement.) Compaq offers a 13-inch RGB color monitor to go with the color board for \$799.

In a departure from previous Compaq systems, the Deskpro 386 does not include a monochrome display controller. Instead, the company sells its Video Display Controller Board separately for \$199. It provides the

OTHER 80386 OFFERINGS

Compaq is not the only company involved in 80386 systems development. At press time, at least two other hardware manufacturers had introduced 80386-based systems, and several software companies were working on new 32-bit system software.

Corvus Systems of Santa Clara, California, began shipping its Series 386 systems in September. The Corvus machines include a 16-MHz 80386 with 512K bytes of RAM and two 32-bit memory expansion slots, and either a 70- or 126-megabyte hard disk. The Corvus systems use a PC AT-compatible BIOS developed by Award Software. Depending on the configuration, prices range from about \$13,000 to \$16,500.

Also, Advanced Logic Research of Irvine, California, had announced its Access 386, which uses a 16-MHz 80386. It includes a socket for an 80387 numeric coprocessor, 512K bytes of 32-bit RAM, and a 1.2-megabyte floppy disk drive. A 30-megabyte hard disk is available as an option. Access 386 is one of the first systems to use Phoenix BIOS; many more are expected. The basic system sells for \$3999.

Getting into the 80386 system software battle with Microsoft, which is working on XENIX System V/386 (see accompanying article), are companies such as Softguard of Santa Clara, California. Softguard says it is developing host software, called VM/386, that will

allow you to run several virtual 8086 machines simultaneously on an 80386-based system.

According to Softguard, each virtual machine could be running a different operating system. For example, you could run Lotus 1-2-3 under MS-DOS 2.1, dBASE III under DOS 3.1, UNIX, and perhaps a proprietary operating system such as Convergent Technologies' CTOS, all at the same time. Better still, the company claims that because its software will also create virtual I/O devices, such as displays, even ill-behaved programs that bypass DOS can run in the VM/386 environment. The company also claims its software will support popular user interfaces such as Microsoft Windows and IBM's TopView (VM/386 does not add a new user interface).

If successful, VM/386 certainly represents a major innovation for personal computers, but neither the concept nor the technology to implement the system is new. The VM/386 software stems from the mainframe world and 15-year-old technology. In fact, it is modeled after IBM's VM/370 operating system. Softguard says VM/386 will incorporate many of VM/370's commands and functions to let you set priority levels and so forth. The package will retail for less than \$300, and though the company would not reveal the name, at least one 80386-based system manufacturer will bundle the software with its computer.

COMPAQ DESKPRO 386

same video control as that found in other Compaq systems and is compatible with IBM's Color Graphics Adapter. The controller board can be used with either an RGB monitor (such as Compaq's), a composite color monitor, or Compaq's Dual-Mode Monitor, a monochrome monitor that sells for \$255.

COMPATIBILITY AND PERFORMANCE

The 80386 CPU is object-compatible with 8086/8088 and 80286 code. To examine how well Compaq implemented this capability, we first ran several programs that we considered thorough in their use of memory and I/O operations. The BASICA present on the machine accepted and ran the IBM PC tokenized versions of two BYTE benchmark programs (the Sieve and Calculations benchmarks) without problems. The programs conveniently provided us with a performance estimate.

The results of these preliminary benchmarks are impressive when compared to a 6-MHz PC AT (see figure 1). Generally, the Deskpro 386 ran about three to four times faster. We also compared the Deskpro 386's times to those of a PC AT specially equipped with 100-ns memory running at 11.5 MHz, and the Deskpro 386 was about twice as fast.

Next, we compiled several small C programs with Manx's Aztec C, version 3.20C, using the small memory model. We used the two floppy disk drives to compile and link the programs without any problems. Not only did these programs run flawlessly, but they also ran faster than we had ever seen before.

Then we ran two programs that are considered ill-behaved in their use of DOS, the XyWrite editor, version 3.05, with SideKick version 1.52A resident. The XyWrite editor responded correctly to the cursor and function keys, and SideKick responded properly when invoked.

Admittedly, these tests are less than comprehensive. But they do indicate a high level of software compatibility.

Unfortunately, the only operating system offered for the Deskpro 386 at press time was MS-DOS. Only a

true 32-bit operating system could push the system to its limits. Compaq did say that it would offer Microsoft's XENIX System V/386 during the first half of 1987 (a developer's toolkit is available now). According to Compaq, the new XENIX will be demand-paged and allow multitasking operations. We did not, however, see even a preliminary version of the package.

FOR A SELECT FEW

There are a number of folks who might benefit from using the Deskpro 386. First, there are those who need the raw processing power to run very large spreadsheets or simulations. The linear address space provided by the 80386 combined with the Deskpro 386's processing speeds not only makes such work possible but also makes it bearable. And large, complicated programs, such as expert systems, should run with respectable performance on this machine. There are also software developers who need a high-performance machine to shorten their software development cycle. Here, fast storage devices are particularly helpful. Moreover, the system's 80386 CPU allows developers to begin writing the next generation of software. For others, the large storage capacity of the Model 130 and its claimed compatibility with networking software should make it a high-powered file server.

But like any new system, the Deskpro 386 is not without its disappointments. Although CAD and desktop publishing are likely candidates for development on the machine, with no I/O signals on the memory bus and the CPU's 32-bit bandwidth to peripherals effectively halved by the expansion bus, we don't see the Deskpro 386 as a serious threat in the high-speed graphics workstation arena. Also, the Deskpro 386 seems like overkill in the single-user mode. Certainly a multitasking 32-bit operating system would put the system to fuller use.

More powerful 32-bit peripherals and operating systems are coming for the 80386-based systems. For now, the Deskpro 386 appears to be a well-engineered bridge to a new generation of those machines. ■

SAFE BACKUP POWER



No Computer Should be Without It!

No matter how you stack it up, SAFE has it all with the most complete line of power protection products in the industry. Why settle for less?

Get the Facts — Free!
Send for our "Inside Story" booklet. It's packed with the information you need to know about power protection.



SAFE

SAFE POWER SYSTEMS, INC.

BOOTH 184
COMDEX
Fall '86
November 10-14, 1986
Las Vegas, Nevada

1-800-325-5848

HERE'S THE DEAL:



\$895

VISO

PORTABLE/DESKTOP COMPUTER SERIES MPC-160V

- * FULLY IBM-PC COMPATIBLE
 - * MS-DOS 3.1
 - * TWO SERIAL AND ONE PARALLEL I/O PORT
 - * RGB AND COMPOSITE MONOCHROME OUTPUTS
 - * 512K RAM, RTC ON BOARD
 - * WEIGHS 11 POUNDS
 - * ONE 5 1/4" FLOPPY DISK DRIVE
- OPTIONS:
- * SECOND FLOPPY DRIVE
 - * 3-SLOT EXPANSION BOX
 - * MONOCHROME OR RGB MONITORS
 - * 640K RAM
 - * HANDSOME CARRYING BAG



\$1695

COMPUTITAN

SERIES MPC-2100

- * IBM PC/AT COMPATIBLE
- * 80286 CPU, SOCKET FOR 80287-8
- * SOFTWARE-SELECTABLE 8- OR 6-MHz CPU SPEEDS
- * MS-DOS 3.2 AND GW BASIC
- * 640K RAM ON BOARD, EXPANDABLE TO 1MB
- * ONE 1.2 MB FLOPPY DRIVE
- * SIX AT SLOTS AND TWO XT SLOTS
- * 84-KEY AT-STYLE KEYBOARD
- * 192-WATT POWER SUPPLY
- * REAL-TIME CLOCK

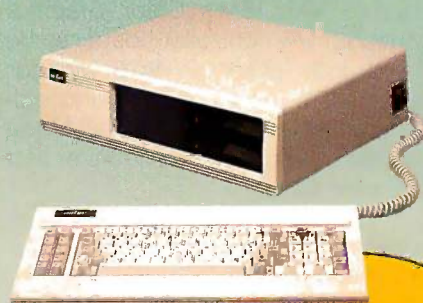

160T

"TURBO"

\$599

SERIES MPC-160T

- * IBM PC/XT COMPATIBLE
- * SOFTWARE SELECTABLE 8/4.77 MHz CPU
- * MS-DOS 3.2
- * 640K RAM
- * ON-BOARD FLOPPY DISK CONTROLLER
- * ONE 5 1/4" FLOPPY
- * 84-KEY AT-STYLE KEYBOARD
- * 135 WATT POWER SUPPLY
- * REAL-TIME CLOCK

FAMOUS-NAME QUALITY, A GREAT PRICE, AND NATIONWIDE SERVICE. THAT'S THE DEAL.

THERE ARE CHEAPER COMPUTERS THAN MITAC, BUT THEN...

...we don't make cheap computers. Mitac takes pride in maintaining some of the highest quality control and quality assurance standards in the industry.*

THERE ARE MORE FAMOUS COMPUTERS THAN MITAC, BUT THEN...

...if you buy a famous name, there's a good chance you're buying Mitac anyway. Mitac has been supplying major computer and telecommunications manufacturers with high-quality equipment since 1974, producing over forty thousand systems annually.

LOOK AROUND. YOU WON'T FIND A FINER COMPUTER AT A FAIRER PRICE THAN MITAC.

What Mitac is offering is this: Major brand quality, a fair price, plus the support of Mitac's nationwide service network—we stand behind everything we make. That's the deal. If this makes good sense to you, do the sensible thing and call the toll-free number below for the name of the Mitac dealer in your area.

* Each Mitac computer undergoes a total of seventy-two hours' burn-in and forty-eight quality auditing processes before release.

mitac

When reliability is a decisive factor

DEALER INQUIRIES WELCOME

NATIONWIDE SERVICE!

American Mitac Corp. 3385 Viso Ct., Santa Clara, CA. 95054. TEL: (408) 988-0258, 988-7508; TOLL FREE: 1-(800) 321-8344; TLX: 910-338-2201; MECTEL: FAX: 408-980-9742.
Mitac Inc. No. 585 Ming Sheng E. Rd., Taipei, Taiwan, ROC. TEL: (02) 501-8231; TLX: 20261 MECTAC, 11942 TAIAUTO; FAX: 886-2-501-4265.

IBM, PC, PC/XT, AND PC/AT are registered trademarks of International Business Machines, Inc.
MS-DOS and GW BASIC are registered trademarks of Microsoft Corp.

BY GEORGE A. STEWART

LOTUS MANUSCRIPT

An innovative word processor for technical writing

Editor's note: The following is a BYTE product preview. It is not a review. We provide an advance look at this product because we feel that it is significant. A complete review will follow in a subsequent issue.

Lotus Development Corporation's newest product is Manuscript, a word processor designed for scientists, engineers, and others who work with technical documents. Manuscript, which runs on IBM PCs and compatibles, combines the features of an outline processor, a word processor, and a sophisticated print formatter. With the program, a writer can incorporate text, formulas, graphics, and tables into a single document that can be printed in presentation quality on a laser printer or in draft quality on a dot-matrix printer.

Lotus plans to sell its word processor for \$495 and expects to begin shipping in November.

This early look at Manuscript is based on interviews with Lotus programmers and managers, preliminary documentation and specifications, and use of a preliminary version.

PRODUCT PHILOSOPHY

The basic assumption of Manuscript's designers was that existing, "stan-

dard" word-processing programs for personal computers are not well suited to writing and editing technical documents. Manuscript is designed to handle the specific demands of technical word processing. Let's take a look at these requirements individually.

Document length. Many word processors require that long documents (over 100 pages) be broken up into smaller files. Other programs will accept very large files, but moving from chapter to chapter or from beginning to end can be slow and awkward. Manuscript handles documents up to 800 pages long, and moving from beginning to end takes very little time, regardless of document size.

Structure. With a standard word processor, you can type in a manuscript in outline form, but the word-processing software is oblivious to the structure. Thus, adding a section in the middle of a document means that you must renumber manually all following sections on the same logical level. Manuscript renumbers sections automatically.

Format. Setting the format of a long technical document can be tedious and inefficient with a standard word processor. Suppose you want to start

a new right-hand page at the beginning of every level-2 subheading, or you want to set every level-2 subheading in 14-point bold italic type. Standard word processors have no way of referring to structural entities within the document; instead, you must locate the specific level-2 subheadings and insert the necessary formatting codes. Manuscript lets you define format templates that individually govern the first five structural levels within a document.

Graphic images and tables. Standard word processors have limited facilities (or none at all) for including this type of data in a document. Usually you have to paste in the graphic or table after the document is printed. Manuscript lets you incorporate graphic images into the document at print time (graphics are not shown on the screen during editing).

Tables. Typing in tables is especially tedious with standard word processors. Revising them is even more so. Manuscript has a table editor that vastly simplifies the process.

Mathematical formulas. Producing

(continued)

George A. Stewart is a BYTE technical editor. He can be reached at BYTE, One Phoenix Mill Lane, Peterborough, NH 03458.

formulas and equations with most word processors is a matter of compromise and approximation. A better alternative is to have them typeset, but this is expensive. Manuscript includes a command language for specifying equations precisely and uniformly. The results obtained on a laser printer are quite acceptable for mass printing quality in many applications.

Print quality. The advent of laser printers has made it feasible to produce documentation in-house without typesetting, but not many word processors are able to take full advantage of laser printer technologies. Manuscript's print formatter comes with

drivers for the Apple LaserWriter and other laser printers and PostScript devices, so you can take full advantage of the various typefaces and styles available on a given printer.

STRUCTURED DOCUMENT FEATURES

Manuscript works on two kinds of documents: structured and unstructured. The latter is simply a sequential file of text—a standard word-processing document. In contrast, structured documents are made up of several entities: text, columns, blocks, and sections. Figure 1 shows the elements of a structured document.

Document structure enables you to

manipulate text in new ways. You can, for instance, contract or expand the text to any level of detail, automatically number the sections, sort all the sections within a "parent" section, and insert a section and have all "sibling" sections renumbered automatically.

Text is the lowest-level entity in Manuscript. Each character of text can have its own attributes (normal, italic, bold, underlined, subscript, superscript, strike-through, and "printer-dependent"). The next higher level is the *column*, which refers to parallel sets of text that are at the same level in the outline. A *block* con-

(continued)

3 Community Issues

3.1 Neighborhood Support

The development of the park must be responsive to the needs of the neighbors as well as the city at large. Meetings will be held to ascertain the feelings of the community and to respond to these needs. Safety and security on the site as well as traffic, noise, lighting, and visual impact will all need to be addressed in public meetings.

3.2 Park Security

Police and fire department access to the site, fencing, and area lighting all will be investigated in the promotion of park security. Both the city and the neighbors will have input on this important topic so that all parties feel their concerns have been considered. Any pathways will accommodate police and maintenance vehicles. Special fencing to protect private property may be required in places.

3.3 Parking and Traffic

Parking requirements will depend on the access routes, park user type, and the method of transportation that park users choose. A thorough study involving communication with city and neighborhood groups will be completed before determination of the amount of parking. The Preliminary Traffic Survey results appear in the graph. These findings will be reviewed following the established community guidelines prior to final determination.

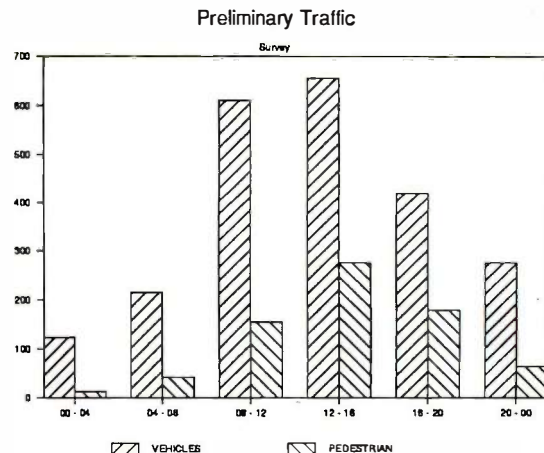

Figure 1: Elements of a structured document: numbered section headings, text blocks, columns, and a graphic image.

Princeton Graphic Systems wins World Class competition three years running.

Sharp resolution, full compatibility, and rugged reliability. That's what you get in every Princeton Graphic Systems monitor. That's why Princeton Graphic Systems is number one in the minds of more and more personal computer owners every year.

Only Princeton Graphic Systems offers a complete family of quality personal computer

displays. Our color and monochrome monitors outperform the competition every time. That's why, for the third year in a row, our HX-12 high resolution color monitor has been voted best in the world.*

So for the very best in personal computer monitors, pick the company that's number one. Princeton Graphic Systems.

*PC WORLD Magazine's 1986 World Class Survey.

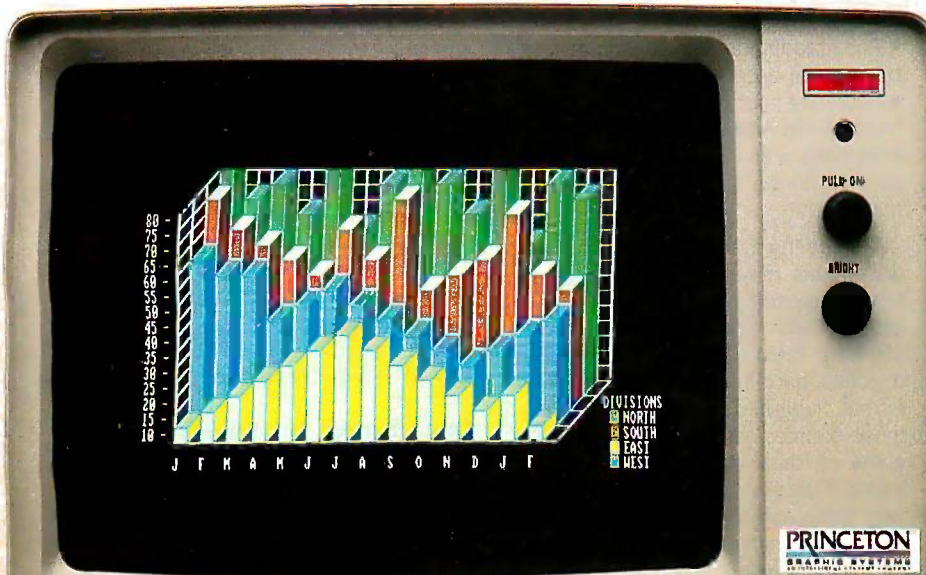

PRINCETON®

GRAPHIC SYSTEMS
 AN INTELLIGENT SYSTEMS COMPANY

601 Ewing Street, Bldg. A, Princeton, NJ 08540, (609) 683-1660, Telex: 821402 PGSPRIN, (800)221-1490, ext. 1704

sists of one or more columns of text at the same logical level. The next level up is the section. *Sections* correspond to the document's outline in that each section has a number that describes its hierarchical position within the document.

Manuscript assigns arabic decimal numbering to keep track of document structure. However, you can specify a variety of other numbering systems to use when the document is displayed

or printed: uppercase and lowercase roman numerals and letters can all be specified in any combination to apply to the successive section levels within a document. User-definable tags are also available for the first five levels. For instance, the same section could be headed by any of the following:

Section 1.2.1
Part I, Subpart 2, Paragraph a
Chapter I, Verse ii, Line 1

You can also choose to omit section numbering entirely from a document when it is printed or displayed.

Structured documents are much easier to peruse than unstructured ones. If the section headings are carefully chosen, a document becomes self-indexing. With a single keystroke combination (Alt plus a number), you can set the level of detail shown on the screen, enabling you to locate a particular section quickly, regardless

A DAY IN THE LIFE OF A TECHNICAL WRITER

BY CHARLES WESTON

Once upon a time (and not too long ago), technical writers wrote manuscripts in longhand with a pencil. They edited by striking a line through unwanted text and writing changes in the margins. The first draft of a document was often typeset directly from this handwritten manuscript.

The typesetter then presented the writer with a collection of unformatted galleys to correct (again, with his or her pencil). Figures were sketched on notepads and given to an artist to be drawn. After the galleys and figures were corrected and the second draft was output by the typesetter, the pasteup cycles began. This process continued until the product was finally complete.

In one manufacturing organization back in these dark ages, an enterprising young technical writer decided to change the old tried-and-true process by typing his manuscripts into a computer and printing out a preliminary copy of his document before it went to be typeset. When his manager discovered what he was doing, he ordered the writer to "Stop this foolishness. After all, we are *writers*, not *clerks*." The young writer and his manager soon parted company.

The young writer of the story is me.

TOWARD THE FUTURE

Let's look at the technical writer of today and see how a technical word processor can improve on the old method.

The writer's schedule for a typical day might include the following:

- Meeting with project engineers to discuss the format of the manual for

an upcoming project. Taking notes for the theory-of-operation section.

- Incorporating these notes with notes taken last month.
- Generating a plan for adding new changes to the previous edition of the technical manual for product X and revising tables and figures to include new information.
- Proofreading and correcting galleys of the proposed manual.
- Gathering information collected from various departments (Field Service, Marketing, Sales, Quality Control, etc.) to incorporate in the new technical manual.

Assembling these notes and parts of documents may take six months or more, depending on the scope of the project. Each type of communication will have been written by various individuals, each in a particular style and format. Published documentation from these sources will be in formats germane to their departments. For instance, Field Service material would be very terse and in the technical style, possibly in military document structure. Marketing documentation would be more loosely structured, possibly in chapter and paragraph format, and so on.

ORGANIZING THE DATA

The technical writer must attempt to organize this collection of information into some kind of structured outline. He or she will then use the outline to generate chapter headings and subtopics for the proposed technical manual. Later, these subtopics will be fleshed out to become the final manual.

Some of this information will be edited to produce different documents, such as a user's guide, a sales brochure, or possibly a product data sheet. The style and format of all these documents will be very different, so the writer must generate unique outlines for each of them.

With a technical document processor the writer can compile these pieces of information randomly in a single file, in distinct, individual levels. The writer can then rearrange these levels to produce a structured outline of headings and subheadings. The writer can reorganize the information repeatedly without adding or deleting anything. Figures and tables are defined at this stage of the organizing process. Before word processing, this first step in the creation process sometimes required half of a project's allotted time.

DETERMINING THE FORMAT

In the process of combining fragmented pieces of documentation, a lot of time is spent reformatting to achieve some kind of consistency in the proposed document. Chapters need to be renumbered. What was a subhead in one piece of documentation might become a chapter title in the final document. A great deal of the technical writer's time is taken up by these mundane tasks.

A technical document processor can reformat these pieces of documentation on the fly as they are incorporated into the overall framework. A document processor with this capability makes the job of restructuring a document much easier. By using a filter, or "template," that changes the format of

of the size of the document. After moving the cursor to the section heading, you can expand the document again.

You can move sections, blocks, or columns almost instantaneously with Manuscript—regardless of the amount of text being moved. Manuscript's programmers say this is because the document isn't kept sequentially in memory. Instead, the blocks are scattered around and connected by

pointers in linked lists. Moving a structural entity simply requires adjusting pointers in memory, rather than copying the actual text to a new area and deleting the original.

Manuscript provides a number of simple tools for working on the document's structure. Splitting and appending sections, subsections, blocks, and columns are all one- or two-step operations. Columns can be moved around within a block, blocks can be

moved around within a section, and sections can be moved throughout a document.

Other types of text-move operations, such as moving a block, column, or table to another section, require a cut-and-paste procedure.

TABLES

Manuscript includes a table editor that vastly simplifies the task of entering, revising, and formatting tables. And since columns are one of the structural elements of the system, they can be manipulated in a variety of ways. They can be moved around; for instance, the second and third column of a table can be interchanged. Their widths can be changed, and the attributes of text (bold, italic, etc.) within a column can be changed. A particularly nice feature of tables is the variable-width column, which always expands to the right or left margin; this makes documents look neater when they are printed but doesn't require that you know what the margins will be when you construct the table.

The table editor also lets you specify the borders to be used (single or double lines) and allows individual control of the line type for interior and exterior column borders.

Once a table is set up, entering data into it is very easy. You can enter all of the information that belongs in a given cell (row-column intersection) and then move to another cell in the same row or column and continue entering the text. Manuscript adjusts all the table rows and borders to accommodate cells of different sizes.

MATHEMATICAL EQUATIONS

Manuscript has a command language for specifying mathematical formulas and equations. When output to a printer, the equations appear in proper form. For instance, the command

```
\ equation "x=[-b+-root[b super 2-4ac]]over[2a]" \
```

produces the quadratic formula

$$x = \frac{-b \pm \sqrt{b^2 - 4ac}}{2a}$$

(See figure 2 for other examples.)

(continued)

documents as they arrive at your word processor, all you have to do to produce the final document is locate these component parts in their respective places.

MERGING TEXT AND GRAPHICS

The technical writer must integrate tables and figures into the new document in a cohesive fashion. Often, figures and tables have to be resized a number of times until the intended page layout is satisfactory. Just about the time that a figure or table is sized to the intended page and finalized, someone will add another column or another entry that requires yet another resizing.

This doesn't sound like a monumental problem until you realize that the whole document must be reformatted to accommodate the change of space required for the revised table. Tables must be laid out separately and then pasted into the final layout. This iterative process represents most of the production time used in a documentation project.

A technical document processor enables the writer to create, size, and edit tables easily, eliminating tedious, repetitious manual labor.

HANDLING REVISIONS

Finally the document is ready in preliminary form and is sent to the various contributors for approval. It is subsequently returned with a number of changes, some of which are substantive. (Due to a design change in the product, for example, an entire new section might be required in one chapter.)

Under the old system, these revisions would have taken a great deal of time because they necessitated reformatting the entire document. The technical writer had to insert the required changes in the original manuscript and make copies for the next review cycle. He or she would have had to include a copy of the original manuscript so that reviewers could compare the revised manuscript, paragraph by paragraph, with the original manuscript.

The technical document processor combines both the new and the old manuscripts in such a way as to indicate only those words and sentences that differ between the two documents. The recently added text is underlined, and text that has been deleted is indicated by a line struck through it. As a result the reviewer has only a single revised document to read, and all the changes are immediately obvious.

The final task of the technical writer is to produce a table of contents, a list of tables and figures, and an index. The technical document processor produces these items automatically and updates them as changes continue throughout the writing process. The last step is to select fonts and type sizes for the final output of the document. When this step is complete, the technical document processor outputs the document, complete with tables, figures, and graphics, in camera-ready form.

Charles Weston is a BYTE technical editor and former technical writer. He can be reached at BYTE, One Phoenix Mill Lane, Peterborough, NH 03458.

The formula specification language allows you to use uppercase and lowercase Greek letters and a comprehensive set of mathematical symbols. Eight distinct bracket types are available; they are automatically sized to fit the expressions they enclose. Manuscript automatically puts variable names (Greek or alphabetic) in italic type, leaving other formula text in roman, or standard, type. The sub-language includes a method for specifying matrix layouts and for stacking equations.

FOOTNOTES, INDEX, AND TABLE OF CONTENTS

Manuscript can generate an index, table of contents, table of figures, table of tables, and footnotes without your having to keep track of section and page numbers manually or having to number footnotes manually.

Footnotes and cross-references are indicated on the display by a special marker character. A keystroke expands the marker to let you see and edit the footnote or reference.

WORD-PROCESSING FEATURES

Manuscript offers an ample selection of word-processing tools. Single- and double-keystroke commands control cursor movement by character, word, line, and screen, as well as by the structural elements of columns, sections, and the beginning and ending of the document. Single-keystroke commands are also available for deleting the individual structural elements of a document. Deleting or copying sentences or arbitrary sequences of text requires that you select the delete or copy function, highlight the text, and press Return. The editor offers both insert and

overstrike mode for entering text. Global search and replace operations offer a few extra features, such as the ability to search for a phrase with a certain attribute. For instance, you can search for all instances of Note: when the word is set for boldface and change them to *Notice*: in italic. It is not possible, however, to search for all words that are in boldface; you must specify a character string in addition to any attribute. Wild-card searches are not available in Manuscript.

Manuscript does not allow control characters to exist in documents, with the exception of carriage returns and tabs. You *can* search for these two control characters.

USER INTERFACE

Manuscript's user interface presents a good compromise between the (continued)

Step Two, Curve Fitting

Curve-fitting templates are available for 1-2-3, but below a procedure for a second order least squares regression is given.

Second Order Curve Fitting

In a second order estimate the data is fitted to an equation of the form $Y^*(X) = AX^2 + BX + C$. In this case if we let X_i be each data sample and Y_i be the actual temperature for that sample, the best fit will be obtained when:

$$\sum(Y_i - Y^*(X_i))^2$$

is minimized. To solve for A, B, and C requires a knowledge of differential calculus. The results are:

$$Y^*(X_i) = AX_i^2 + BX_i + C$$

where: A = 0.00528 B = -1.05 C = 164.7

Partial Sample Data Table and Regression Values

Data	Actual	Data	Actual	Data	Actual
18	179	26	147	34	132
20	163	28	142	36	129
22	157	30	138	38	126
24	152	32	135	40	123

Figure 2: Equations and tables in Manuscript.

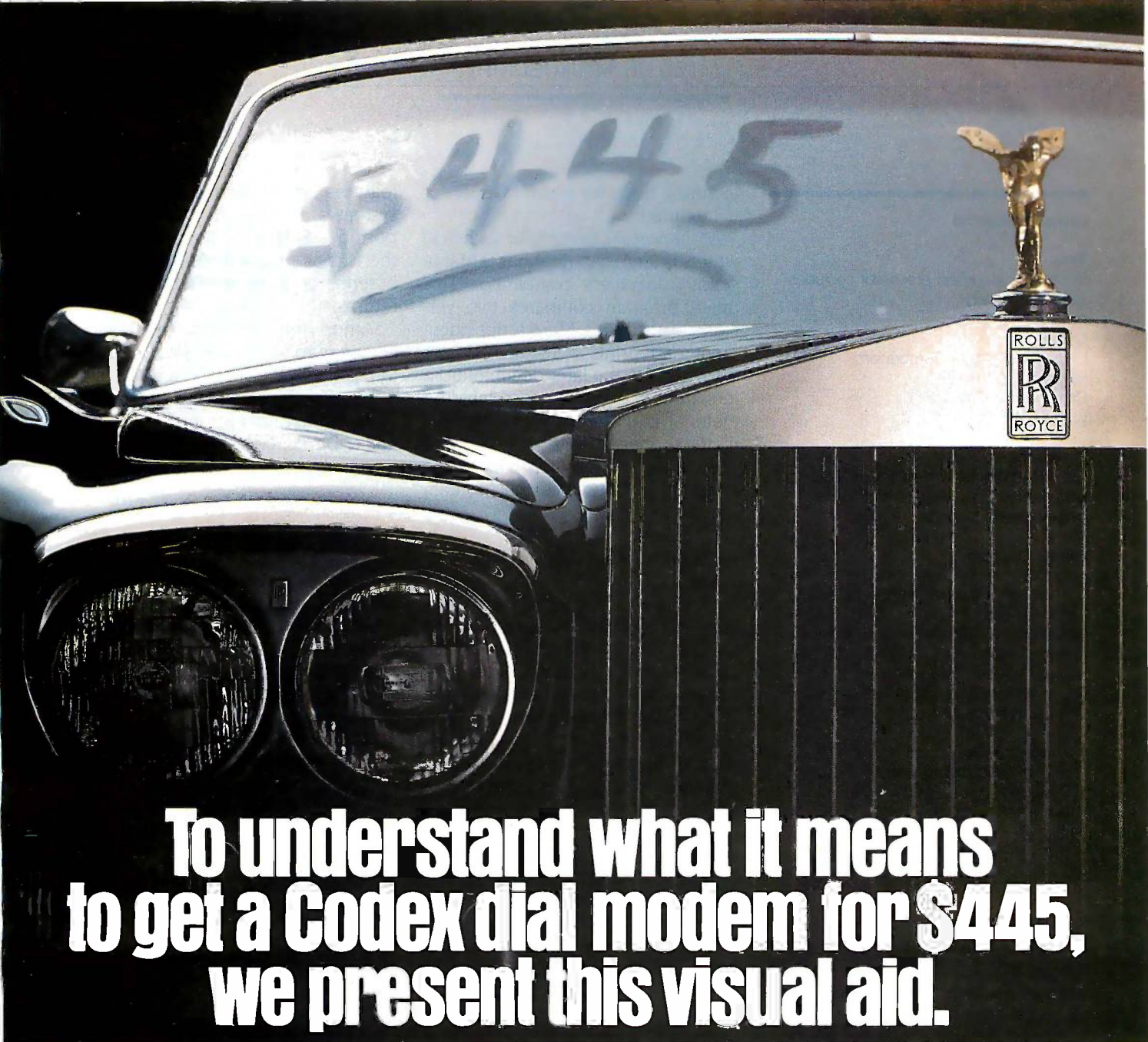

To understand what it means to get a Codex dial modem for \$445, we present this visual aid.

All too often something with an incredibly high reputation for quality also comes with an incredibly high price tag. And that's what makes the price of a Codex 2400 bps dial modem hard to believe.

Because our 2230 Series of 2400 bps modems is made to the same exacting standards as other Codex modems. Modems that have earned such a reputation for quality, they are preferred by more experienced data communications managers than any other brand.

Yet the prices of the 2230 Series start at just \$445.

The 2230 Series provides outstanding performance, reliability, and flexibility. They are all full duplex 2400 bps modems that operate synchro-

nously or asynchronously with a unique auto dial feature that supports virtually any computer. Plus they're Hayes compatible and are available as standalone units or as dual modem cards that pack two modems on a single card for maximum space savings.

Obviously, if you want to get a Rolls Royce for \$445 you'll have to use your imagination. But to get a Codex dial modem for \$445, all you have to use is your telephone. For more information call us at 1-800-426-1212 Ext.

234. Or write Codex Corporation, Department 707-34, 20 Cabot

Boulevard,
Mansfield,
Massachusetts
02048.



codex



Lotus Manuscript

Type

Structured document processor (includes spelling checker)

Company

Lotus Development Corporation
55 Cambridge Parkway
Cambridge, MA 02142
(617) 577-8500

Computer

IBM PC and compatibles; requires MS-DOS version 2.0 or higher and 512K bytes of RAM; hard disk required

Printer Support

Apple LaserWriter; Hewlett-Packard ThinkJet and LaserJet (all font cartridges); Epson LQ-1500, FX-80/100, FX-85, FX-286; IBM Proprinter, Quietwriter, and Graphics Printer; Okidata ML92, ML93, ML193, and ML293; Toshiba 1300 series and P351; Diablo 630; NEC 3550; other PostScript printers; other printers to be announced

Documentation

Reference manual and tutorial

Price

\$495

needs of expert users and the needs of novices. You can specify most operations by moving the cursor through a series of menus or by one or more keystrokes. When you have to input a variable parameter, the program offers a pop-up data-entry menu showing the various options available for that field. An experienced user can simply type in the needed parameter without stopping to look at the options.

A context-sensitive help facility makes it possible to use Manuscript without relying on printed reference materials. Pressing the F1 key calls up a help screen appropriate to the current operation.

UTILITIES

Manuscript includes an 80,000-word spelling checker from Proximity Software. The same package is integrated into Lotus Symphony. The spelling checker lets you create and maintain your own auxiliary dictionary, which would be essential in many of the

technical fields for which Manuscript is intended.

An important feature for technical writers in large organizations is Manuscript's document comparator. This utility program compares two versions of the same Manuscript document and prints a reconciled text showing how the later document differs from the earlier one. Inserted material is underlined, and deleted material appears with a "strike out" line through it. Revision bars in the margin highlight lines that contain changes.

IMPORTING AND EXPORTING DATA

Switching to a new word-processing program might be impractical if none of your existing text files could be ported over to the new system.

Manuscript can read any ASCII-encoded text file; however, control characters other than tabs, carriage returns, and linefeeds may cause problems and should probably be removed before the file is imported. For instance, printer control codes should not be included in a text file to be imported by Manuscript. Extended ASCII characters (codes greater than 127) should also be removed.

Initially, Manuscript puts the imported ASCII text into a structured or unstructured document (your choice). In the former case paragraphs become separate blocks. In the latter case, you must break up the blocks manually. In both cases, you must define your own section boundaries between the blocks.

Manuscript can import two other forms of text files: DCA and ThinkTank. DCA (document content architecture) is an IBM structured-document standard used in a number of systems; these documents retain their structure and can be revised when imported into Manuscript. ThinkTank is a popular outliner and was one of the early models for Manuscript. (The product's code name was SOL, an apparent acronym for scientific outliner.)

Manuscript also lets you export documents in ASCII and DCA formats. Exported DCA documents retain their structure when read in by DCA-conforming programs, but Manuscript

features not supported by the DCA system are lost in the process. Exported ASCII documents resemble the text as it appears on the screen in terms of indentation and carriage returns.

Manuscript can incorporate a variety of graphic images into a document: Lotus PIC, PostScript (for output to PostScript devices only), and bit-map files. For example, a pie chart could be included in a Manuscript document with the command

```
\ picture piechart.pic width=rm \
```

The width=rm parameter forces the graphic to be scaled so that it extends out to the right margin. Other scaling and sizing tools are available.

The files must contain the proper header information, so not every graphic file is automatically loadable. Some processing or conversion might be necessary.

Lastly, Manuscript can accept spreadsheet data in the Lotus 1-2-3 or Symphony format. Such data can be converted into a true Manuscript table structure or input as a simpler table in which tab characters separate the columns.

OUTPUT QUALITY

Manuscript outputs at highest quality and performance to devices equipped with a PostScript interpreter, such as Apple's LaserWriter. Based on the formatting specified in a document, Manuscript prepares the necessary PostScript commands for generating both text and graphics.

Outputting to non-PostScript devices is done through a set of custom drivers, one for each device. For text output, the drivers operate the printers in text mode, that is, using the printers' built-in character sets. Graphics mode is used only to generate special characters in formulas and for graphic images and table borders.

The advantage of this system is speed and quality of output; printing in text mode is much faster than printing in graphics (bit-image) mode. A printer's built-in character set is typically better designed than a bit-image character set can afford to be

(continued)



The C for Microcomputers

PC-DOS, MS-DOS, CP/M-86, Macintosh, Amiga, Apple II, CP/M-80, Radio Shack, Commodore, XENIX, ROM, and Cross Development systems

MS-DOS, PC-DOS, CP/M-86, XENIX, 8086/80x86 ROM

Manx Aztec C86

"A compiler that has many strengths... quite valuable for serious work"

Computer Language review, February 1985

Great Code: Manx Aztec C86 generates fast executing compact code. The benchmark results below are from a study conducted by Manx. The Dhrystone benchmark (CACM 10/84 27:10 p1018) measures performance for a systems software instruction mix. The results are without register variables. With register variables, Manx, Microsoft, and Mark Williams run proportionately faster, Lattice and Computer Innovations show no improvement.

	Execution Time	Code Size	Compile/Link Time
Dhrystone Benchmark			
Manx Aztec C86 3.3	34 secs	5,760	93 secs
Microsoft C 3.0	34 secs	7,146	119 secs
Optimized C86 2.20J	53 secs	11,009	172 secs
Mark Williams 2.0	56 secs	12,980	113 secs
Lattice 2.14	89 secs	20,404	117 secs

Great Features: Manx Aztec C86 is bundled with a powerful array of well documented productivity tools, library routines and features.

Optimized C compiler	Symbolic Debugger
AS86 Macro Assembler	LN86 Overlay Linker
80186/80286 Support	Librarian
8087/80287 Sensing Lib	Profiler
Extensive UNIX Library	DOS, Screen, & Graphics Lib
Large Memory Model	Intel Object Option
Z (vi) Source Editor -c	CP/M-86 Library -c
ROM Support Package -c	INTEL HEX Utility -c
Library Source Code -c	Mixed memory models -c
MAKE, DIFF, and GREP -c	Source Debugger -c
One year of updates -c	CP/M-86 Library -c

Manx offers two commercial development systems, Aztec C86-c and Aztec C86-d. Items marked -c are special features of the Aztec C86-c system.

Aztec C86-c Commercial System	\$499
Aztec C86-d Developer's System	\$299
Aztec C86-p Personal System	\$199
Aztec C86-a Apprentice System	\$49

All systems are upgradable by paying the difference in price plus \$10.

Third Party Software: There are a number of high quality support packages for Manx Aztec C86 for screen management, graphics, database management, and software development.

C-tree \$395	Greenleaf \$185
PHACT \$250	PC-lint \$98
HALO \$250	Amber Windows \$59
PRE-C \$395	Windows for C \$195
WindScreen \$149	FirsTime \$295
SunScreen \$99	C Util Lib \$185
PANEL \$295	Plink-86 \$395

MACINTOSH, AMIGA, XENIX, CP/M-68k, 68k ROM

Manx Aztec C68k

"Library handling is very flexible... documentation is excellent... the shell a pleasure to work in... blows away the competition for pure compile speed... an excellent effort."

Computer Language review, April 1985

Aztec C68k is the most widely used commercial C compiler for the Macintosh. Its quality, performance, and completeness place Manx Aztec C68k in a position beyond comparison. It is available in several upgradable versions.

Optimized C Macro Assembler	Creates Clickable Applications
Overlay Linker	Mouse Enhanced SHELL
Resource Compiler	Easy Access to Mac Toolbox
Debuggers	UNIX Library Functions
Librarian	Terminal Emulator (Source)
Source Editor	Clear Detailed Documentation
MacRam Disk -c	C-Stuff Library
Library Source -c	UniTools (vi,make,diff,grep) -c
	One Year of Updates -c

Items marked -c are available only in the Manx Aztec C86-c system. Other features are in both the Aztec C86-d and Aztec C86-c systems.

Aztec C68k-c Commercial System	\$499
Aztec C68d-d Developer's System	\$299
Aztec C68k-p Personal System	\$199
C-tree database (source)	\$399

AMIGA, CP/M-68k, 68k UNIX call

Apple II, Commodore, 65xx, 65C02 ROM

Manx Aztec C65

"The AZTEC C system is one of the finest software packages I have seen"

NIBBLE review, July 1984

A vast amount of business, consumer, and educational software is implemented in Manx Aztec C65. The quality and comprehensiveness of this system is competitive with 16 bit C systems. The system includes a full optimized C compiler, 6502 assembler, linkage editor, UNIX library, screen and graphics libraries, shell, and much more. The Apple II version runs under DOS 3.3, and ProDOS, Cross versions are available.

The Aztec C65-c/128 Commodore system runs under the C128 CP/M environment and generates programs for the C64, C128, and CP/M environments. Call for prices and availability of Apprentice, Personal and Developer versions for the Commodore 64 and 128 machines.

Aztec C65-c ProDOS & DOS 3.3	\$399
Aztec C65-d Apple DOS 3.3	\$199
Aztec C65-p Apple Personal system	\$99
Aztec C65-a for learning C	\$49
Aztec C65-c/128 C64, C128, CP/M	\$399

Distribution of Manx Aztec C

In the USA, Manx Software Systems is the sole and exclusive distributor of Aztec C. Any telephone or mail order sales other than through Manx are unauthorized.

Manx Cross Development Systems

Cross developed programs are edited, compiled, assembled, and linked on one machine (the HOST) and transferred to another machine (the TARGET) for execution. This method is useful where the target machine is slower or more limited than the HOST, Manx cross compilers are used heavily to develop software for business, consumer, scientific, industrial, research, and educational applications.

HOSTS: VAX UNIX (\$3000), PDP-11 UNIX (\$2000), MS-DOS (\$750), CP/M (\$750), MACINTOSH (\$750), CP/M-68k (\$750), XENIX (\$750).

TARGETS: MS-DOS, CP/M-86, Macintosh, CP/M-68k, CP/M-80, TRS-80 3 & 4, Apple II, Commodore C64, 8086/80x86 ROM, 68xxx ROM, 8080/8085/Z80 ROM, 65xx ROM.

The first TARGET is included in the price of the HOST system. Additional TARGETS are \$300 to \$500 (non VAX) or \$1000 (VAX).

Call Manx for information on cross development to the 68000, 65816, Amiga, C128, CP/M-68k, VRTX, and others.

CP/M, Radio Shack, 8080/8085/Z80 ROM

Manx Aztec CII

"I've had a lot of experience with different C compilers, but the Aztec C80 Compiler and Professional Development System is the best I've seen."

80-Micro, December, 1984, John B. Harrell III

Aztec C II-c (CP/M & ROM)	\$349
Aztec C II-d (CP/M)	\$199
C-tree database (source)	\$399
Aztec C80-c (TRS-80 3 & 4)	\$299
Aztec C80-d (TRS-80 3 & 4)	\$199

How To Become an Aztec C User

To become an Aztec C user call 1-800-221-0440 or call 1-800-832-9273 (800-TEC WARE). In NJ or outside the USA call 201-530-7997. Orders can also be telexed to 4995812.

Payment can be by check, COD, American Express, VISA, Master Card, or Net 30 to qualified customers.

Orders can also be mailed to Manx Software Systems, Box 55, Shrewsbury, NJ 07701.

How To Get More Information

To get more information on Manx Aztec C and related products, call 1-800-221-0440, or 201-530-7997, or write to Manx Software Systems.

30 Day Guarantee

Any Manx Aztec C development system can be returned within 30 days for a refund if it fails to meet your needs. The only restrictions are that the original purchase must be directly from Manx, shipped within the USA, and the package must be in resalable condition. Returned items must be received by Manx within 30 days. A small restocking fee may be required.

Discounts

There are special discounts available to professors, students, and consultants. A discount is also available on a "trade in" basis for users of competing systems. Call for information.

Inquiry 196

MANX

To order or for information call:

800-221-0440

without using up a great deal of memory.

The disadvantage of this system is that documents can't be printed out in the same manner on all devices. For instance, a document being prepared for a PostScript device may have specifications for large headings in four different typefaces (Times Roman, Courier, Helvetica, and Symbol). Before that document is printed on an Epson FX-80, the specifications must be changed to accommodate the limited type sizes and faces available with that printer.

When you start Manuscript, a setup menu lets you specify the printer you will use. The choice you make determines what typefaces Manuscript will offer you. Manuscript allows up to 10 different faces, though few printers will actually make that many available.

To print a document using a device other than the one originally specified, you simply change the typeface map using a global typography menu or let Manuscript make the conversion.

REQUIREMENTS

Manuscript runs on MS-DOS versions 2.0 and higher. It requires at least 512K bytes of RAM and a hard disk. (If you have very large documents,

you probably need a hard disk anyway just for document storage.)

The program uses standard BIOS functions for keyboard input, and thus Lotus programmers say it should be compatible with memory-resident programs like SideKick and Spotlight (a product Lotus acquired when the company purchased Software Arts).

Manuscript supports the use of an extended memory board, enabling you to use memory in excess of 640K bytes. A document spooling scheme allows extended memory, RAM disk, hard disk storage, and even floppy disk storage to be treated as RAM for handling very large files.

The system provides specific support for various display cards, including IBM's monochrome, color graphics, and enhanced color graphics boards and the Hercules Graphics Card and the new Hercules Graphics Card Plus. The latter card makes it possible to display the following text attributes on the screen: normal, bold, underlined, italic, superscript, subscript, and strike-through. If the system you are using can't display all these attributes, a field on the display's status bar shows the attributes of the text at the current cursor location.

Manuscript will support use of a wide variety of popular laser, ink jet, and dot-matrix printers (see the At a Glance box on page 98).

MANUSCRIPT OUTPUT VS. TYPESETTING

A Manuscript document printed on a LaserWriter cannot literally duplicate the quality of a typesetter. For one thing, the 300-dot-per-inch resolution of laser printers does not match the quality obtained when using a 1200-dot-per-inch typesetter.

It's true that Manuscript could be used to drive a PostScript-equipped typesetting machine, but the end result would still not duplicate what you would expect from a professional typesetter. Manuscript is unable to provide all the typesetting subtleties like kerning and loose and tight lines. When Manuscript underlines a word, the underline goes right through any descenders that appear on the line, contrary to typographic aesthetics.

These kinds of problems can be worked out through PostScript commands; unfortunately, Manuscript doesn't let the user enter PostScript commands directly. On the positive side, Manuscript does give you access to all of a printer's characters, some of them through the use of special backslash sequences. In this manner, one can obtain em dashes, en dashes, minus signs, opening and closing quotes, and ligatures (combined letters such as fl, ff, and fi).

PARTIAL WYSIWYG

Manuscript is not a true "what you see is what you get" editor. Because it supports varying point sizes and typefaces dependent on your printer and because it allows you to incorporate graphics into documents, providing a WYSIWYG system would entail operating the screen in graphics mode. Lotus designers chose to restrict the editor to the text mode (no graphics) during editing for one simple reason: speed. Tasks like scrolling and redrawing take far longer in graphics mode than in text mode.

The editor does let you see some of the attributes of the finished product: indentation, the appearance of columns and tables, and the presence

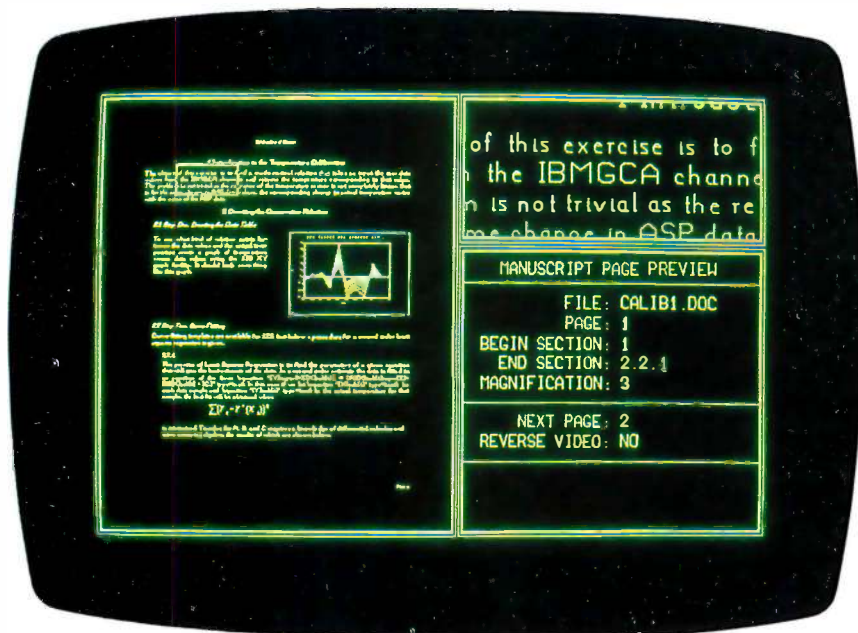

Figure 3: Manuscript's preview option displays text and graphics as they will appear on the page, at various levels of magnification (graphics card required).

of section tags and numbers, for example. The attributes and elements you do not see on-screen are natural page and line breaks, graphics, font sizes, line spacing, and formulas.

Manuscript includes a page preview utility that lets you see the document on-screen in graphics mode before it is printed. The utility scales the output so that one page fits on the screen. A magnification window gives you a close-up of any part of the page. Text, graphics, tables, and formulas appear in these page previews. This function is available only on systems with a graphics card (see figure 3).

In the area of word processing, there's room for improvement. The pop-up windows often block the portion of the text you are working on, making it difficult to complete the dialogue required by the pop-up menu. For instance, when you want to make a global replacement, you might need to glance back at the text to see how a word is spelled or what its attributes are. You can't see the word because the menu is covering it up.

The word-processing interface is not consistent throughout Manuscript. For instance, when you're editing a document, Control-arrow advances to the next word. But when you're entering text to a menu field, Control-arrow has no effect.

I wish Manuscript had more flexibility in the area of global searches. For example, it would be handy if you could search for all carriage returns and insert a block or section divider wherever one was found. This would simplify the process of converting an unstructured document to a structured one (the automatic conversion of paragraphs to blocks during file importation is a step in the right direction).

Keyboard macros would also be a nice feature, although Lotus says you can use keyboard enhancer programs with Manuscript if your system has sufficient memory.

SUGGESTIONS FOR TESTING MANUSCRIPT

I tested a preliminary form of Manuscript. Thus it is not fair or meaningful to record any benchmark results here. However, by the time you read this,

TECHNICAL WORD PROCESSOR CHECKLIST

- Does the system let you integrate text and graphics into the hard copy?
- Does it offer a way to specify mathematical and scientific formulas?
- What is the limit on document size?
- Does the product let you use extended memory?
- Does it recognize hierarchical document structure? How many levels?
- Does it let you see an on-screen facsimile of the document, or does it have a preview facility?
- What types of files can it import and export?
- Does it allow you to sort sections based on their headings?
- How fast does the word processor print a document? Try a document that includes a graphic image, all table, and mathematical formula. Compare the speed on a laser printer and a dot-matrix printer.
- How fast does it load and convert an ASCII text file?
- How fast can you go from the beginning to the end of a very large document (several hundred pages)?
- Does the system allow you to set up templates defining the formats for the various structural levels within a document?

the first release of the product should be out.

Lotus believes it is creating a new product niche with Manuscript: PC-level technical/professional word processing. No doubt other companies will follow with new products for this field (or new features for old products). The text box on this page gives a checklist to help you evaluate word processors.

PERSONAL REACTIONS

After a week's experience using a preliminary version of Manuscript, I am enthusiastic about its potential for writers. It encourages a rapid, free-flowing style of writing and lets you put down your thoughts as they occur to you, without worrying whether the sequence is ideal from an organizational standpoint. Later, you can move the ideas around to fill an outline.

Manuscript is also a good tool for people with writer's block, because it encourages you to start writing, if only by producing a rough outline of what you intend to write. By successively refining the outline, you may discover that what seemed to be a formidable

task has been transformed into a series of manageable short topics.

The product's strongest points are its structure cognizance, its ability to integrate text and graphics in a printed document, its support for PostScript devices, and its convenient user interface. On the basis of standard word-processing features, it is acceptable but not revolutionary. Presumably, Manuscript will be used by people who work with computers a lot—at least for word processing. These kinds of users tend not to mind a little product complexity if it gives them more control and convenience.

Many people will probably consider it a fault that Manuscript does not provide a "what you see is what you get" interface. And for shorter documents where speed of access is not so important, a WYSIWYG system might indeed be preferable. But for writers who must assemble large volumes of information from various sources and fit it all together into an organized whole, the decision to favor speed of operation over on-screen graphics will almost certainly be welcome. ■

Quite incredible.

The IBM Proprinter XL. Under \$800.



For under \$800, the Proprinter XL packs an incredible number of features into a single machine.

It's the wide carriage model of the Proprinter and it attaches to most personal computers.

The Proprinter XL lets you print spreadsheets (see below) on paper up to 16½ inches wide. It lets you print on standard computer paper, too. And, without removing the computer paper, you can easily feed envelopes or single sheets through a separate slot in the front. You can also switch between fast-draft and near-letter-quality

print modes with the touch of a button (what you're reading now was printed on a Proprinter XL). You can even do graphics. But the best thing is, you can do all this--and more--for less than \$800.

J.V. ALLEN & SON, INC. YEARLY SALES (THOUSANDS)

	JAN	FEB	MAR	APR	MAY	JUN	JUL	AUG	SEP	OCT	NOV
Region 1	243.33	253.21	255.45	261.34	273.22	280.12	282.34	284.98	291.43	293.55	299.43
Region 2	132.34	135.34	137.45	140.43	141.67	146.78	142.34	146.33	149.02	151.43	164.34
Region 3	223.32	234.56	254.12	255.11	267.23	270.23	274.32	276.75	279.65	282.12	284.43
Region 4	12.34	21.43	23.45	24.98	25.32	30.98	145.98	156.90	178.89	210.21	213.78
Region 5	332.12	343.56	345.76	347.87	349.65	354.33	355.23	357.89	361.12	332.12	311.21
Region 6	89.34	91.23	93.46	94.56	95.45	96.67	97.59	98.31	99.89	101.45	101.95
Region 7	99.36	100.54	101.45	101.90	102.23	102.09	102.89	103.23	104.21	104.33	104.95
Region 8	65.34	66.37	66.98	67.12	67.36	68.23	69.41	70.12	70.78	72.65	73.95
Region 9	13.43	15.36	14.98	16.11	16.78	17.32	18.32	18.54	18.99	19.45	20.34
Region 10	96.45	97.32	98.49	99.31	100.11	101.23	101.98	102.32	102.87	103.21	104.41
Region 11	143.67	144.32	146.47	148.73	149.34	151.23	152.53	153.22	155.78	159.65	162.53
Region 12	325.43	326.46	326.98	354.32	312.29	315.46	320.21	332.87	332.91	335.12	334.91
Region 13	243.78	245.11	211.36	201.98	213.48	224.31	223.47	229.31	231.35	239.43	241.02
Region 14	540.11	540.78	541.43	543.95	544.21	544.99	545.37	543.79	548.73	549.39	550.41
Region 15	436.49	433.82	435.99	448.93	451.78	452.23	453.78	455.39	456.31	462.45	463.11
Region 16	357.36	352.57	353.11	353.98	354.32	355.52	356.26	357.41	358.32	359.29	362.43
Region 17	392.43	393.41	311.84	316.93	325.38	332.34	334.29	335.28	335.99	338.72	342.64
Region 18	431.21	433.93	434.25	435.26	435.87	436.31	436.25	437.42	437.97	438.32	439.53
Region 19	35.86	35.21	35.98	36.31	36.11	36.84	35.98	36.73	36.82	36.89	37.21
Region 20	146.73	146.99	147.36	147.93	148.91	149.32	152.52	153.19	154.21	154.79	154.91
TOTAL	6358.19	4411.52	4336.36	4397.05	4261.80	4467.34	4448.54	4496.79	4551.03	4589.78	4612.83

Incredibly quiet

The IBM Quietwriter® Printer Model 2.

The "Quietwriter" Printer Model 2 prints as crisply as a top-of-the-line IBM typewriter (what you're reading now was done by a Model 2).

Even so, it prints so quietly you may have to remind yourself it's on.

The Model 2, which attaches to most personal computers, is terrific for creating first-rate presentations and reports.

With the right software, it lets you merge text and graphics. It lets you print on single sheets, company letterhead, or even on transparencies to use on overhead projectors. And there's an optional paper feeder to help you print multi-page reports with ease.

But the best thing is, you can do all this--and more--at just above a whisper.

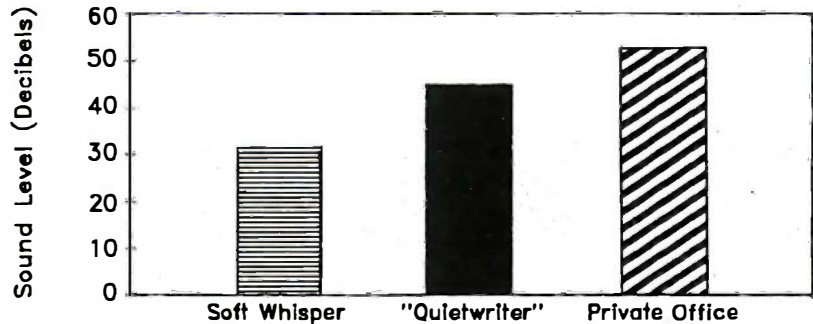

For free literature on our growing family of remarkable personal printers --or for the authorized IBM dealer nearest you-- call 1 800 IBM-2468, Ext. CP/104. Or contact your IBM marketing representative.

DEC	TOTAL
243.09	3261.51
112.98	1700.45
292.12	3193.98
230.12	1274.36
310.43	4101.29
103.12	1163.06
74.23	832.57
15.49	146.20
104.55	1212.25
164.37	1831.90
336.31	3953.34
240.99	2745.59
542.48	6535.65
464.39	5414.70
363.97	4284.56
344.28	4103.53
441.01	5237.32
37.88	437.82
155.35	1812.29
82.88	941.69
4577.16	55508.45



Personal Printers.
The Finishing Touch.

Softstrip[®]
COMPUTER READABLE PRINT

The
PC
USER'S
EDGE

NOW! TRANSFER DATA – PROGRAM TO PROGRAM WITH SOFTSTRIP[®].

Now you can move data between programs quickly and easily using SOFTSTRIP data strips.

Using the Softstrip System, you can move data between computers and such programs as WordStar and MacWrite, dBASE and AppleWorks, Lotus 1-2-3 and Excel and ReadySetGo and many others.

We've created a series of several dozen Application Notes on Softstrip data strips. These lead you through simple steps to make the file transfer as easy as possible, adding even more versatility to your personal computer when you purchase the SOFTSTRIP SYSTEM. The advanced system you've been hearing so much about.

All you need to move data between programs is STRIPPER[™] software at \$19.95 and the Softstrip System Reader at \$199.95.

For a complete list of Application Notes, contact your dealer or call Cauzin.

NOVEMBER CASE HISTORY

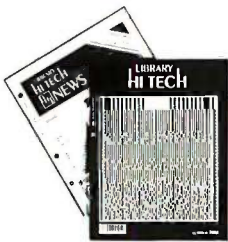

LIBRARY HI TECH JOURNAL and LIBRARY HI TECH NEWS, the world's leading source of information on library automation and information technology, are printing Softstrip data strips to make it easier for their readers to stay abreast of the vast amount of material published monthly.

According to C. Edward Wall, Editor and Publisher, LIBRARY HI TECH NEWS monitors more than 200 publications dealing with information with application to library operations. The newsletter includes bibliographies of books, conference reports and articles published in hundreds of other periodicals.

The newsletter prints bibliographies in Softstrip data strip form. As Mr. Wall notes, this permits any library or information center to build a valuable on-line data base of useful information.

The data strips are ASCII based, and will operate with most of the information retrieval software developed for micro computers.

*LIBRARY HI TECH JOURNAL and LIBRARY HI TECH NEWS are published by Pierian Press,
Box 1808, Ann Arbor, MI 48106 (313) 434-5530*

Users' Groups: Call for Special User Group Discounts.

**ACT NOW! Don't delay. See your local Softstrip dealer or call us at
1-800-533-7323. In Connecticut: 203-573-0150.**

CAUZIN

835 South Main Street
Waterbury, CT 06706
(203) 573-0150

For Europe and Asia Contact:
Softstrip International, Ltd.
53 Bedford Square
London, WC1 B3DP England
01-631-3775 Telex: 263874SOFTST G

Inquiry 61



Softstrip
COMPUTER READABLE PRINT

This data strip contains IBM2MAC, a utility that runs on the IBM and converts an IBM file to Macintosh format.

BUILD THE GT180 COLOR GRAPHICS BOARD

PART 1: BASIC TECHNOLOGY

BY STEVE CIARCIA

*Achieve PGA resolution on the SB180
at a fraction of the cost*



Graphics has more of a direct influence on user satisfaction than any other aspect of a computer. For the most part, CP/M and ZCPR3 users have been excluded from a club whose ranks are swelled by owners of IBM PCs, Ataris, and Apples. With the GT180, I will endeavor to rectify this inequity and present a high-performance graphics subsystem for the SB180 that surpasses the graphics capabilities of most presently available computers at significantly less cost. Borland International has helped supply utilities that provide the basis for advanced graphics software development.

The GT180 (graphics technology for the SB180) is both an expansion board and an intelligent graphics system. As a plug-in peripheral to the SB180 XBUS, it adds Professional Graphics Adapter (PGA)-type 640-by-480-pixel color graphics capability to the SB180. When mated with the SB180, the two-board set defines a low-cost SCSI/RS-232C ported graphics terminal for any computer system (see photo 1).

Those who use the GT180 as a general-purpose workstation have the ability to add modern graphics while retaining compatibility with existing Z-System and CP/M application software. The GT180 can also serve as an embedded graphics engine for stand-

alone applications like a graphics/videotext terminal, a presentation graphics system, or image processing. Finally, the graphics subsystem design core can easily be ported for application in non-SB180 systems like IBM PC, VME, Multibus, and S-100. In this case, the GT180 serves as a low-cost development tool for prototyping and bootstrapping the ported design.

GT180 OVERVIEW

The GT180 graphics specifications are compared to those of the IBM PGA and Enhanced Graphics Adapter (EGA), the Macintosh, Commodore's Amiga, and the Atari 520ST in table 1.

The key to the design is a recently announced CMOS VLSI graphics processor, the Hitachi HD63484 ACRTC (advanced CRT controller), and two companion chips: GMIC (graphic memory interface controller) and GVAC (graphic video attributes controller). These are supplemented by a highly integrated CMOS Brooktree BT450 palette D/A converter; a 512K-byte frame buffer that can hold three screens of data as well

(continued)

Steve Ciarcia (pronounced "see-ARE-see-ah") is an electronics engineer and computer consultant with experience in process control, digital design, nuclear instrumentation, and product development. The author of several books on electronics, he can be reached at P.O. Box 582, Glastonbury, CT 06033.

Table 1: The GT180's graphics specifications are compared with those of other popular microcomputers.

	GT180 (TTL)	GT180 (Analog)	Apple Macintosh	Atari 520ST	Commodore Amiga	IBM CGA	IBM EGA	IBM PGA
Resolution	640x400	640x480	512x350	640x200*	640x400	640x200†	640x350	640x480
Colors	16	16/4096	1	16/64	16/4096	2	16/64	256/4096
Digital/Analog	digital	analog	digital	digital	analog	digital	digital	analog
Scan Mode	noninterlaced	noninterlaced	noninterlaced	noninterlaced	interlaced	noninterlaced	noninterlaced	noninterlaced
Graphics Coprocessor	yes	yes	no	no	yes	no	no	yes

*Atari 520ST is 320x200 with 16 colors or 640x200 with 4 colors or 640x400 monochrome.

†IBM CGA is 640x200 with 2 colors or 320x200 with 4 colors or 160x100 with 16 colors.

as a library of graphics objects like windows, fonts, or icons; and an IBM PC-compatible keyboard connector (see figure 1).

The GT180 display resolution is 640 by 480 pixels with 16 of 4096 colors. It can also be set to 640 by 400, 640 by 350, 640 by 200, 320 by 200, and other resolutions by changing the initialization parameters (the lower resolutions also require changing the crystal frequency). The GT180 has both TTL RGBI (red-green-blue-intensity) and analog RGB outputs

and can directly connect to a number of standard CRT monitors, for example, the Princeton Graphics SR-12 and SR-12P (see photo 2).

The GT180 is a big project that can't be easily explained in a few pages. As with any sophisticated computer peripheral these days, the end product is a combination of hardware and software. So that you can recognize the dividing line between these two camps and understand why I have built the GT180 as I have, I will begin with a description of basic graphics

technology. This will also help those who may need a refresher course.

The GT180 project is spread over three months. Part 1 is devoted to the basic technology and understanding the hardware/software dividing line of a graphics peripheral. Part 2 presents the hardware and details the individual VLSI components. Part 3 gives an explanation of the GT180 Graphix Toolbox written by Borland International and also demonstrates its application using Borland's CP/M-compatible Modula-2.

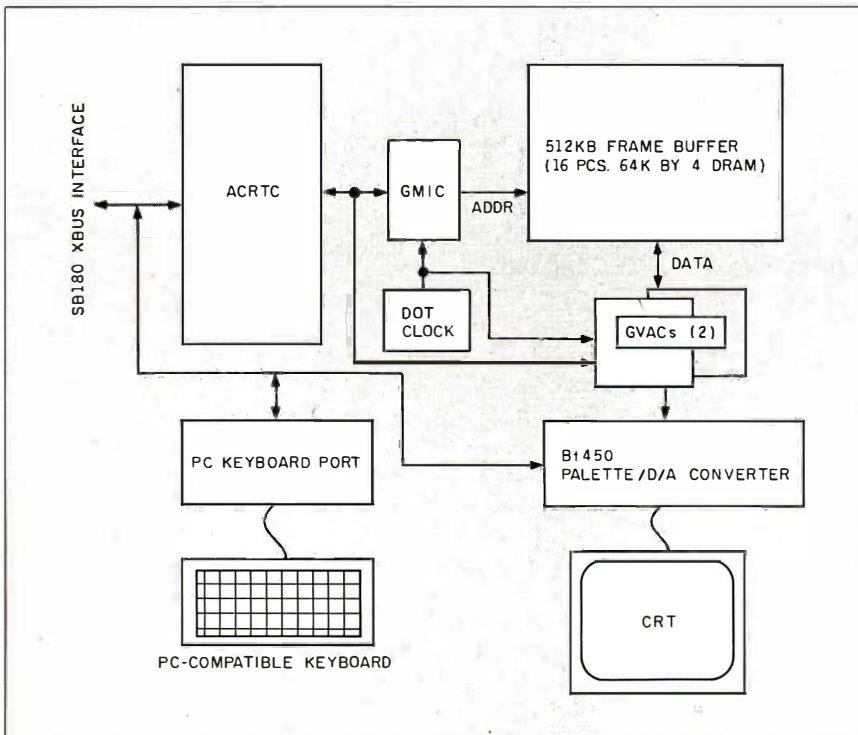

Figure 1: A block diagram of the GT180.

CRT BASICS

While other display technology comes and goes, the dominant device remains the standard CRT. The underlying technology has been driven by one of the most popular products of all time: the TV set. Many have predicted the end of this glass dinosaur at the hands of other technologies (LCD, plasma, electroluminescence, etc.), but reports of the CRT's demise may be exaggerated. (I tend to use CRT to describe both the glass display tube and the entire terminal display unit with driver electronics.)

The basic principle of CRT operation is simple: An electron beam scans the CRT screen, which is coated with a phosphor. Where the beam hits the phosphor, light is generated. By varying the intensity of the beam, the amount of light generated changes accordingly. In the simplest case (monochrome), the beam is either on or off—each point on the screen is either illuminated or not.

The scanning pattern of the beam

is similar to the way you write with a pencil on a piece of paper. Starting at the top left corner, the beam scans to the right edge of the screen at which point the beam is brought back to the left edge of the screen, one line down from the top. This left-to-right scanning proceeds down the screen until the beam reaches the bottom right corner, then the beam is repositioned at the top left corner and the whole process repeats.

The process of repositioning the beam is called *retrace*. Repositioning from the right edge of the screen to the left edge on the next line down is called horizontal retrace. Repositioning from the bottom right corner to the top left corner is called vertical retrace. The beam is *blanked* (turned off) during retrace, just as your hand is raised off the paper when you reposition the pencil.

As you might guess, the signal that causes the CRT monitor to perform a horizontal retrace is called horizontal sync (HSYNC), and the signal that causes the CRT monitor to perform a vertical retrace is called vertical sync (VSYNC). An important point to realize is that the times at which horizontal and vertical retrace occur are the responsibility of the video-signal generator and not the CRT screen or monitor electronics (see figure 2).

It is important that the controller provide HSYNC and VSYNC timing within the limits specified by the CRT. Some CRTs will self-destruct if sync timing is incorrect! In the case of a computer, the video controller sync timing is generally software-programmable to allow for compatibility with different CRTs. This means the CRT has the distinction of being one of the few pieces of computer hardware that might be physically destroyed by software bugs. Read and heed!

CRT TIMING

Scan timing involves a number of constraints. First, the CRT phosphor, like a dynamic RAM, needs to be refreshed. As soon as the beam passes a point on the screen, the image at that point will begin to fade. If the refresh period (time between consecutive beam passes) is too slow, the

(continued)

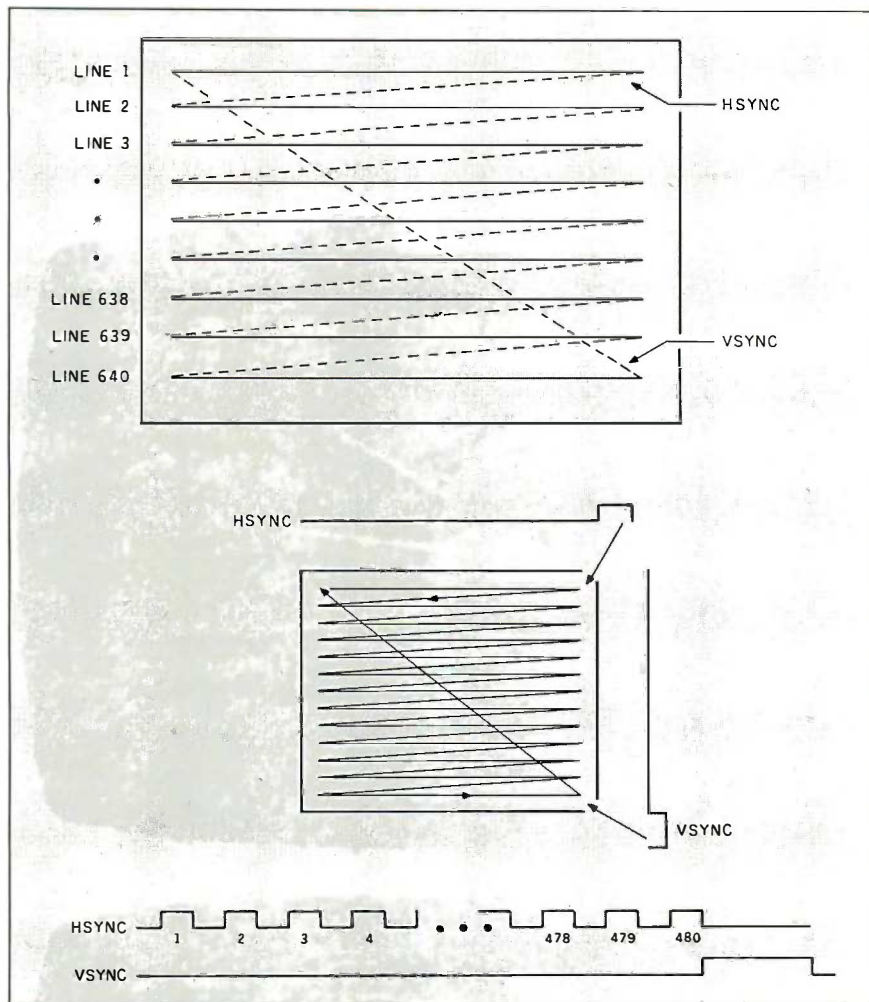

Figure 2: The electron beam scans the CRT much as you would write on a piece of paper. HSYNC causes the beam to perform a horizontal retrace; VSYNC causes it to perform a vertical retrace.

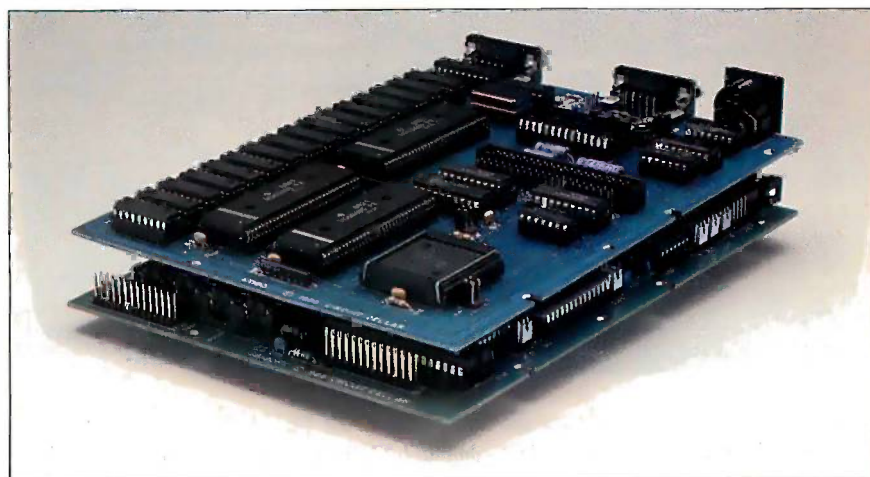

Photo 1: The GT180 board attached atop the new SB180FX single-board microcomputer. (The SB180FX is an enhanced version of the SB180. See the September 1985 Circuit Cellar for a description of the SB180.)

result will be an annoying flicker as each point cycles through the refresh-fade sequence.

One solution is to use a special CRT phosphor characterized as *long persistence*—this means the phosphor

fades more slowly, allowing longer times between refresh before flicker becomes noticeable. Unfortunately, a phosphor with a persistence that is too long produces an effect that is just as annoying as flicker: smear. When

the picture on the CRT changes, a ghost of the previous image persists. If the CRT is updated quickly, detail is lost as each new image is superimposed on the vestiges of the past images.

Therefore, the first major constraint can be characterized as the number of times the beam sweeps the entire screen per second (i.e., the number of VSYNCS per second). It's clear that faster is better, since a short-persistence phosphor (fast updating with no smear) can be used while avoiding the threshold of perceivable flicker. Most commonly, designers choose 60 hertz (60 VSYNCS per second) because this provides a good performance, matches standard phosphor characteristics, and is easily derived from the 60-Hz component of the AC power line (within the U.S.). High-performance (and high-price) systems may offer faster vertical scan rates (i.e., 65–80 Hz).

Since we want to sweep the entire screen, line by line, 60 times each second, a rough calculation shows that very high speed is required. After all, an enhanced screen (640 by 400) contains 256,000 dots. If we insist that the dots be refreshed 60 times a second, that means the video controller must transmit more than 15 million dots per second!

The scanning technique discussed so far, in which each line on the screen is scanned sequentially, is called noninterlaced. To ease the high-speed timing constraints, some systems often use another scanning approach: interlaced. In this scheme, the beam still scans the entire screen at 60 Hz. However, instead of scanning every line during a sweep of the screen, half the lines are scanned, reducing the amount of information that must be transmitted. In fact, conventional TVs use interlaced scanning; although the picture contains 525 lines, only half of them are refreshed each 1/60 of a second. (Note: Actually, not all lines are displayed on the TV screen; some contain supplementary information like closed captions for the hearing impaired and stereo audio.)

If you've followed the previous discussion, you may have deduced that

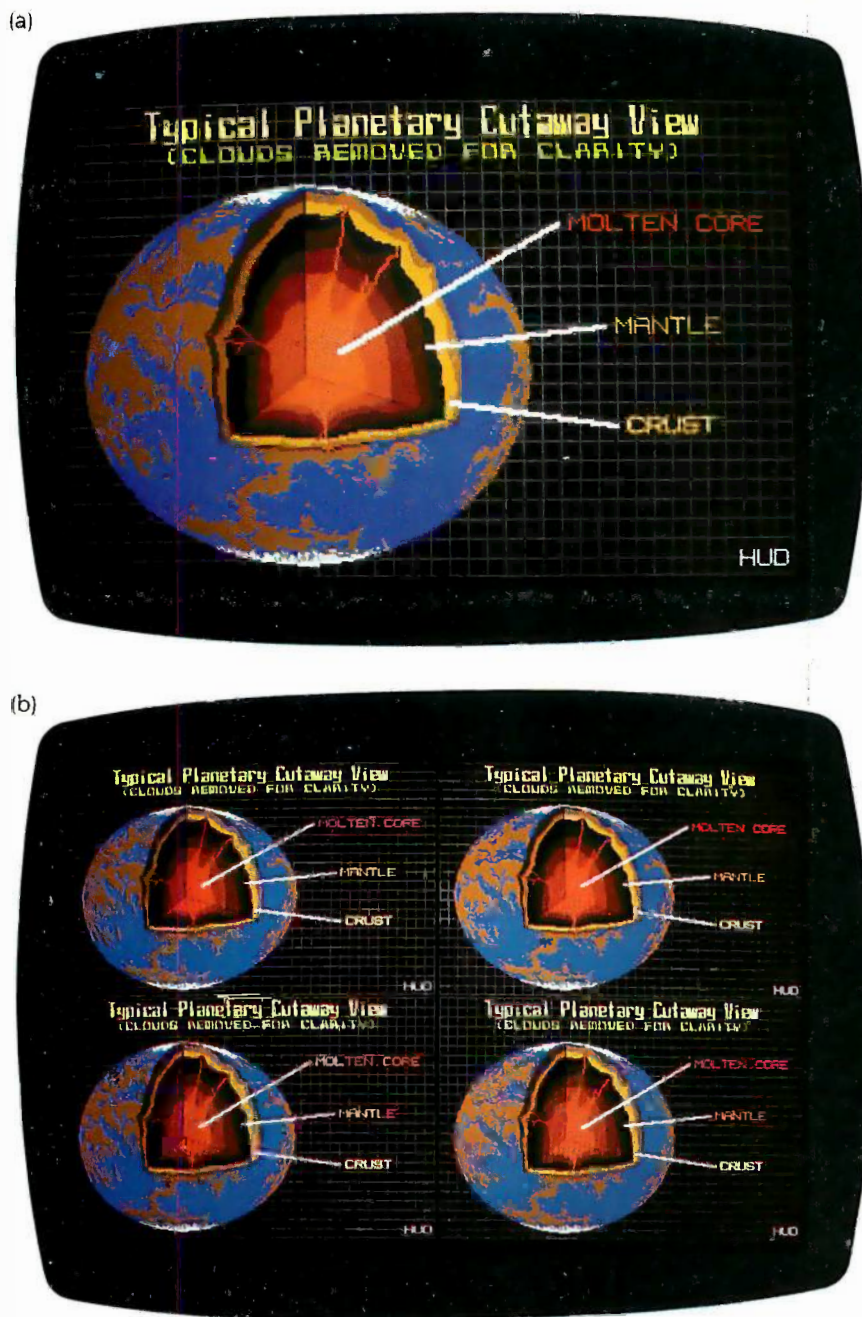

Photo 2: The resolution and graphics capabilities of the SB180 are best illustrated by borrowing a few bit maps from another computer. (a) A standard 16-color Atari 520ST bit-mapped picture with 320-by 200-pixel resolution. By setting the GT180 to a resolution of 640 by 400, four Atari pictures can be put on a single screen. The result is shown in (b). The GT180 can be set to a display resolution as high as 720 by 500.

TV sets must use a long-persistence phosphor to ensure that flicker doesn't occur. The price you pay for the long-persistence phosphor is some smear, but objects on TV are moving slowly enough so that the effect is unnoticeable. Unfortunately, the same cannot be said for computer images, in which operations like scrolling quickly highlight the smear effect. Generally speaking, high-performance computer displays use only noninterlaced scanning.

Accepting the 60-Hz noninterlaced vertical scan, the other important CRT timing considerations include the horizontal scan rate and video bandwidth. Together, these three parameters dictate the actual resolution (i.e., the number of dots that can be displayed on the screen).

As the vertical scan rate (60 Hz) corresponds to the rate of VSYNC, the horizontal scan rate corresponds to the rate of HSYNC. Given the constraint of scanning all the lines of a screen in 1/60 of a second, you can see that for a given line width, the number of lines that can be displayed on the screen is directly related to the speed with which each line is horizontally scanned. For example, older displays like the IBM CGA, which have a resolution of 640 by 200, use a horizontal scan rate of 15.75 kilohertz. Similarly, displays with a resolution of 640 by 400 have a horizontal scan rate of 31.5 kHz.

The final CRT timing parameter is known as bandwidth or dot rate. This refers to the timing of the actual video signal that modulates the electron beam in the CRT. This is influenced by a number of factors, including the CRT video-signal input circuits and the response time and accuracy of the electron gun. The higher the required resolution, the higher the bandwidth needed. A 640 by 200 noninterlaced 60-Hz CRT typically requires a bandwidth of about 15 megahertz, while a similar 640 by 400 CRT needs 30-MHz bandwidth.

Although CRTs have a number of other timing parameters (like sync pulse widths), the three primary parameters—vertical scan rate, horizontal scan rate, and bandwidth—along with scan mode (interlaced or nonin-

terlaced) define the overall performance envelope.

MONOCHROME VS. COLOR

Previously, we assumed that a single scanning electron beam could take only two states: on or off. In fact, this is the case for a monochrome display like the Macintosh. Achieving a color display is an elaboration of the same basic scheme. Two changes must be made: The CRT must be able to display multiple colors, and the video controller must provide color information for each dot.

The most prevalent technique for making color CRTs (and color TVs) is to replace the single electron beam with three beams and to coat the CRT face with three phosphors. Each beam/phosphor is responsible for generating a different color: red, green, and blue. You can generate eight different colors by combining red, green, and blue. For instance, you produce a white dot by turning the red, green, and blue beams on simultaneously.

The video controller must also provide three signals, instead of the single signal required for monochrome. In fact, a fourth signal, intensity, is often provided, giving the effect of 16 possible colors instead of 8. For example, white is red+green+blue with intensity on; gray is red+green+blue with intensity off. This type of CRT is referred to as an RGBI monitor.

DIGITAL VS. ANALOG

In the previous discussion, for both monochrome and color, the video signal (one signal for monochrome, four signals for RGBI) was assumed to take one of two states: on or off. This is called a digital TTL monitor.

An analog monitor adds the capability to modulate the electron beam(s) to intermediate levels between on and off. For a monochrome monitor (one video-input signal), this allows various shades of gray. For a color monitor (three video-input signals: R, G, and B), it allows various tints and hues. The visual results are much more pleasing than those of digital monitors. TV sets use this approach. Moving upscale from mono-

The vertical scan rate, the horizontal scan rate, and the video bandwidth dictate the actual resolution.

chrome to either digital color or analog color is just a matter of more memory and more speed—no problem in this era of VLSI.

THE FRAME BUFFER

I have explained how a CRT turns video signals into pictures on the screen. Where does the video signal come from?

In the case of a conventional TV receiver, the video signal comes from a station transmitter and is captured by the receiver in the TV for display. The TV station transmits a continuous stream of display frames, eliminating any requirement for video-frame retention or buffering in the TV receiver.

The computer holds a digital representation of the screen in a special memory called the frame buffer. Display circuits in the computer extract and condition this video information to generate the video signal(s) required to recreate the image on the CRT screen. A key part of this function is parallel-to-serial conversion. The display controller pulls a number of bits (8, 16, 32, or more) from the frame buffer at once and shifts them out as a serial video signal. The shift clock is also known as the dot clock and corresponds directly to the CRT bandwidth discussed earlier. To change the image on the CRT—a process known as drawing—the drawing processor need only change the contents of the frame-buffer memory (see figure 3).

BIT MAPPING

The simplest frame-buffer organization is called bit mapping. In this organization, a bit (monochrome) or bits (color) in the frame buffer are pro-

(continued)

vided for each dot on the CRT screen. The bits in the frame buffer map directly to points on the CRT screen. The minimum amount of frame-buffer memory required is equivalent to the number of dots on the screen times the number of bits required to specify the color information for each dot.

For a monochrome bit map, only 1 bit is required for each dot on the screen. Thus, a 640 by 400 monochrome display requires about 32K bytes. For a 16-color RGBI display, where each dot requires 4 bits of information (R, G, B, and I), a 640 by 400 image requires about 128K bytes.

PALETTE D/A CONVERTER

For a TTL RGBI color monitor, it is easy to see that 4 bits (R, G, B, and I) are required for each dot on the display. Furthermore, the system is totally digital. The frame buffer contains 1s and 0s, and the CRT itself accepts 1s and 0s (i.e., the CRT R, G, B, and I inputs are either on or off). What is the difference between it and an analog RGB display?

First, there is a difference in the CRT

monitors themselves. In a TTL RGBI monitor, the three beams are either at a low or high intensity as defined by the state of the intensity signal. To achieve a greater variety of colors, the intensity of each beam is varied. Instead of on/off TTL levels that would be applied to a TTL RGBI monitor, an analog RGB monitor is sent an analog voltage for each beam.

Within the frame buffer, the color information is still stored digitally, but each dot must now include the intensity settings for each beam as a 6-bit (64 colors), 9-bit (512 colors), or 12-bit (4096 colors) data word. This digital information is converted to analog video-signal levels through a D/A converter.

Since each of the three CRT guns (R, G, B) must be driven independently, we need three D/A converters. Unlike the industrial-control-oriented D/A converters discussed in previous articles, these "video D/A converters" need to be very fast. Bandwidth (the speed with which the D/A converter converts the digital frame-buffer information to an analog video signal)

must match that of the CRT. Furthermore, other D/A converter performance characteristics are also strict in order to produce a glitch-free display.

As in the case of the digital monitor, the number of colors that can be displayed is a function of the number of bits in the frame buffer for each dot. Thus, 4 bits/dot means each dot can take one of 16 colors, 8 bits/dot=256 colors, 12 bits/dot=4096 colors, etc. Since the system drives three guns (R, G, B), we normally select a number of bits per dot that is evenly divisible by 3. A typical application might have 12 bits per dot, using three 4-bit D/A converters. Thus, each signal (R, G, and B) can take on 16 levels. The total number of combinations yields 4096 colors.

With that in mind, it would appear that to move up from a 16-color display to a 4096-color display simply requires tripling the frame-buffer size, since each dot now requires 12 bits. While the increased memory is supportable (384K bytes for a 640 by 400 display), unfortunately a substantially higher bandwidth is also required. To

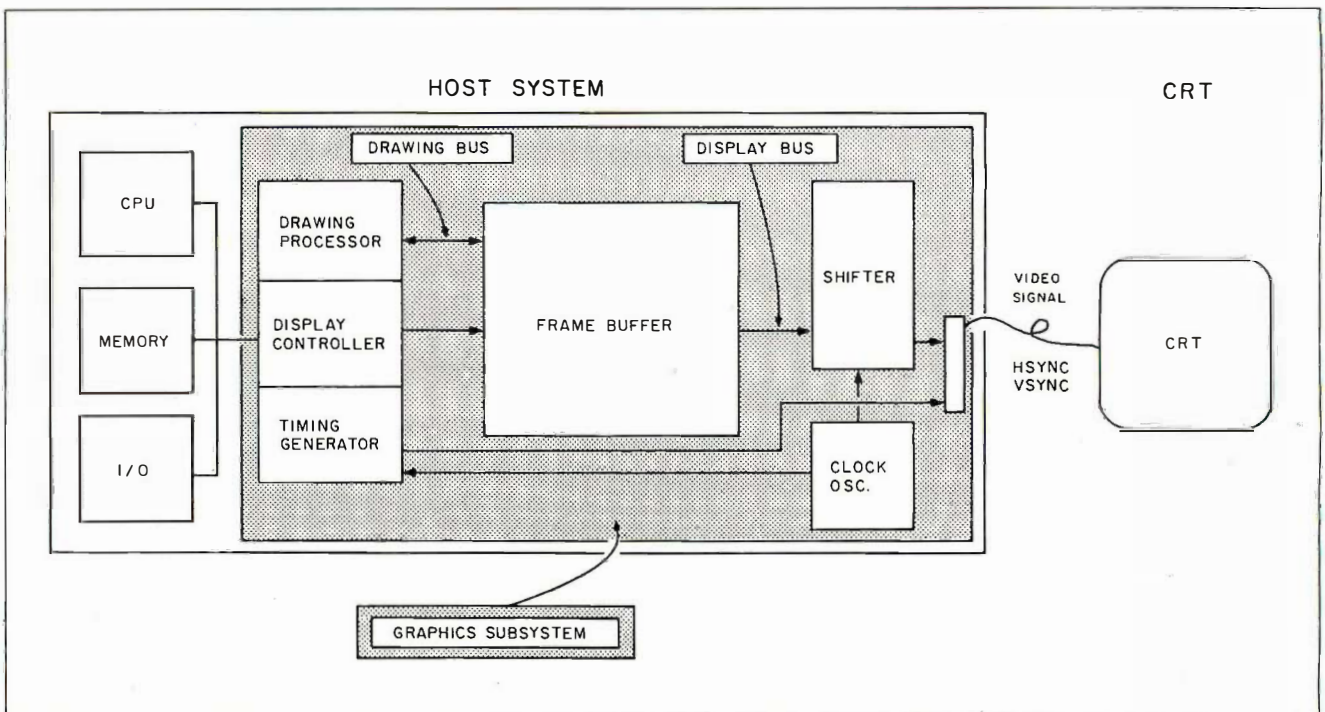

Figure 3: A diagram of a typical graphics system, including host computer, graphics subsystem, and CRT. Key components of the subsystem are the frame buffer, drawing processor, display controller, timing generator, and shifter. Data is read in parallel fashion from the frame buffer by the display controller, which passes it to the shifter to be serialized into the video signal. The timing generator controls basic system timing and generates the HSYNC and VSYNC control signals.

display a dot on the screen, 12 bits (4096 colors), instead of 4 bits (16 colors) or 1 bit (monochrome), must be pulled from the frame buffer to refresh each dot on the screen 60 times a second.

As we calculated earlier, for a 640 by 400 monochrome display with 60-Hz vertical scan, we need to extract 15,360,000 bits from the frame buffer each second. While this is fast, most memory ICs and display controllers can handle the required transfer rate of 2 megabytes per second. With 12 bits instead of 1 bit per dot, however, the speed requirement increases twelvefold! Instead of 15.36 megabits per second, the system must extract 184 megabits per second (23 megabytes per second)! This is too fast for most microcomputers.

The solution is to use a device called a palette D/A converter. Like an artist's palette, this device provides the total range of color possibilities, even if we can use only a few of them at one time. The technique is straightforward: The typical palette RAM, like the Brooktree BT450, is organized as 16 cells, each containing 12 bits of data. Within the 16 cells are stored 12-bit values representing 16 of the 4096 possible colors (these 16 cells are loaded by the CPU prior to a video scan). Each dot on the display is defined by a 4-bit value in the frame buffer. These 4 bits serve as an address selecting one of the 16 palette entries. The 12 bits stored in the selected cell are in turn presented to three 4-bit D/A converters connected to the RGB lines (see figure 4).

While the 16 colors available through a palette D/A converter may seem to offer no improvements beyond a 16-color RGBI system, remember that we can choose 16 of 4096 colors. It is possible for the CPU to change the contents of the palette D/A converter at the end of each horizontal scan line. Rather than showing only 16 colors then, an entire screen can display all 4096 colors. Reloading the palette can create some interesting effects. For example, the color of a certain area on the screen can be changed by simply changing the corresponding palette entry—this is considerably faster than actually chang-

ing the color of each dot in the frame buffer.

SPLIT SCREENS AND WINDOWS

A powerful visual interface like the Macintosh depends on graphics techniques like split screens and windows to implement popular features like pull-down menus, dialog boxes, and application windows. In a simple bit-mapped system, the display controller cycles sequentially through the frame buffer from beginning to end and back to the beginning. In other words, the relative position of an image on the screen corresponds exactly to its relative position in the frame buffer. To move a window on the screen requires physically moving the associated image in the frame buffer. If you shrink or move a window on the display, you must also restore the newly uncovered background.

Having the host CPU responsible for all this is possible, but problems emerge as the amount of information to be moved increases. The screen response for tasks like dragging a window can become annoyingly sluggish. In any case, CPU cycles devoted to screen housekeeping can be used for more useful work.

Adding intelligence to the display controller provides hardware split screens and windows. This feature requires that the display controller, in-

Moving a screen image becomes as simple as programming a new start address instead of actually moving each dot.

stead of scanning in a fixed sequential order, be able to scan different areas of the frame buffer at will. The programmer defines the physical position on the screen of a split or window. Then the display controller monitors the physical location being displayed and accesses the appropriate location in the frame buffer. This allows the various pieces of the screen image (menus, dialog boxes, windows, etc.) to be stored in separate areas of the frame buffer—the hardware will automatically put each piece in the right place on the screen (see figure 5). Moving a screen image becomes as simple as programming a new start address instead of actually moving each dot. (Note that I am implying that the frame buffer may be

(continued)

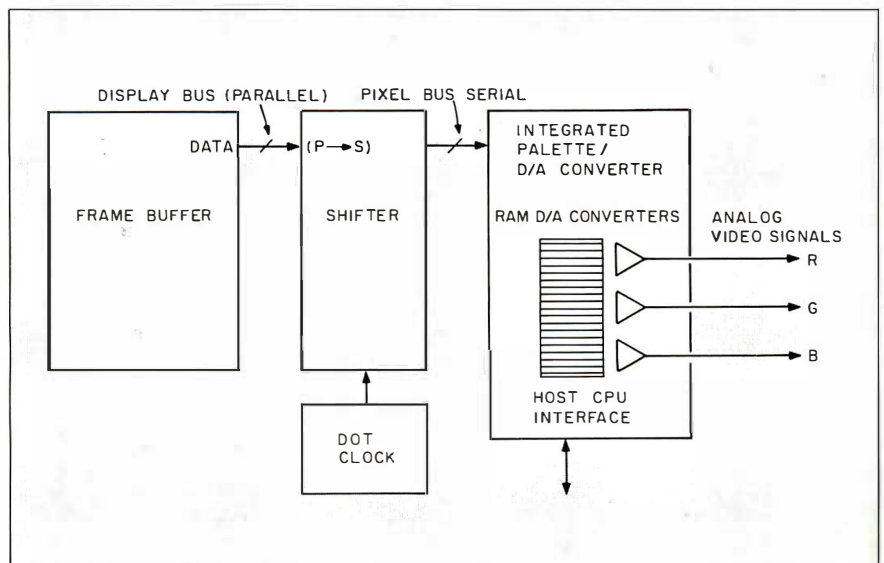

Figure 4: New integrated palette D/A converters, like the Brooktree BT450 used on the GT180, combine a number of functions formerly requiring separate chips.

larger than can fit on the screen at one time.)

DRAWING

The process of writing into the frame buffer is called drawing, while the process of reading from the buffer to the CRT is called display. The drawing and display processes contend for access to the frame buffer. One way to resolve such contention is to use dual-port RAMs for the frame buffer. Another approach is timeshared access to a single-ported frame buffer.

In any case, the application programmer needs to be able to move pictures in and out of the frame buffer and issue commands like LINE, CIRCLE, PAINT, WINDOW, and ZOOM. Ideally, the programmer can use logical x,y coordinate addressing, rather than being burdened with computing a frame-buffer physical address (e.g., "move the pointer to screen x,y position (100,200)" instead of "move the pointer to the dot in the high-order 4 bits of address 1234 hexadecimal"). A myriad of other graphics commands can be imagined for use in a variety of applications.

Opinion has been divided as to whether the host CPU should perform these drawing algorithms, or whether

a separate drawing processor should be used. My opinion has always been to do it in hardware, and I think the trend to higher resolution, more colors, and faster response will ultimately lead others to conclude that an intelligent graphics coprocessor is the only way to go.

TRANSPORTABLE GRAPHICS

Any graphics system has several distinct command levels. At the lowest level is the hardware: the registers associated with the graphics-display chips used on the display board. At the next level is usually a group of drawing primitives: point plotting and line drawing. Next, a graphics environment like that found in GEM and Microsoft Windows may be defined that provides standard function calls like "draw a box containing this text" or "open this window." At the highest level is the application program that provides the user with commands necessary to complete the task the program was designed to perform.

An ongoing debate is occurring over which of the above levels should be performed by hardware and which should be performed by software. (Most of the systems in use today perform the higher two levels in software

on the host system.) Further, there must be, at some level, a standard interface between the host processor and the graphics device. For example, on IBM's CGA card, the hardware level consists of the 6845 registers (the 6845 is the PC's graphics-controller chip). At the primitive level, the BIOS provides simple character output. To remain compatible with the various graphics boards and clones on the market, programs should make calls to the BIOS for character display. Programs that access the 6845 directly may run into problems.

The Hitachi HD63484 ACRTC takes control of graphics operations one level higher than most graphics boards do. Most graphics boards provide the host processor with a set of registers and perhaps a simple set of drawing primitives in EPROM. The host processor is still responsible for all drawing overhead, including translation of x,y coordinates to absolute memory addresses, setting of color information, and calculating each dot for a given line or arc. Consequently, the graphics device/host processor interface takes place at the lowest level: the hardware level.

The ACRTC, however, performs many primitive functions right on the chip. For example, it translates x,y coordinates into absolute addresses; draws lines, given the endpoints, boxes, arcs, and ellipses; and performs screen clears and area fills using an optional pattern. All these functions are performed in hardware. Using this as the graphics controller, the graphics device/host processor interface shifts up a notch to the primitive level. The host processor does all its communications with the graphics device via calls to primitives rather than register accesses.

Another issue related to the graphics board/host processor interface is that of how to maintain compatibility when using a program with different kinds of hardware. There are any number of ways to build a graphics controller in hardware that provides a given resolution and number of colors. Each design is bound to use a different graphics-controller chip and, as a result, a different method of communicating with the host processor

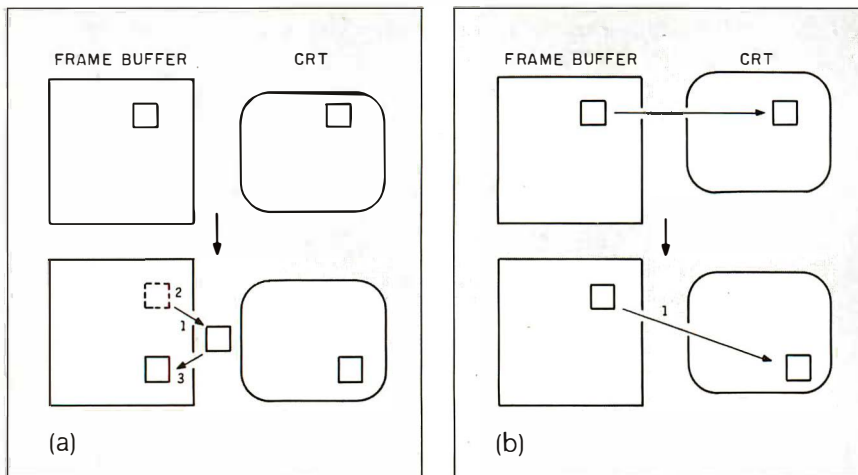

Figure 5: (a) If the display controller isn't "smart," moving a window requires actually moving the data. The algorithm might require a three-step process: Copy the window contents to a temporary buffer; erase the old window, restoring what was underneath; and copy the window contents to the new location. (b) In a smart display controller, changing a window position is as simple as reprogramming a few display-controller address registers. This method is fast, and the time required to move the window is independent of window size. Also, the hardware window has priority, so what was underneath the moved window reappears.

(the registers will probably be different between boards).

The primitive level is usually used as a buffer between a higher-level program that uses a standard set of function calls and the hardware that is different between various boards. If the higher-level program stays on its side of the fence and doesn't cross over into the hardware level, it will function properly with every graphics board, regardless of hardware configuration. When the program does start accessing hardware registers specific to a particular graphics board, it will likely have trouble when used with a different board.

The implementation modules for the set of tools used with the GT180 were written with the HD63484 in mind. However, as long as the target graphics board can display the same resolution and number of colors as the GT180, a program written using Borland's Graphix Toolbox (designed to interface via Borland's Modula-2) can be ported with little effort to the new graphics board. The definition modules of all the tools will stay the same, regardless of what machine it is running on. The implementation modules contain all the machine-specific code.

There still hasn't been a graphics standard defined that is widely used in industry. The problem is exacerbated by a graphics technology that grows in leaps and bounds, often opening new frontiers not considered in older standards proposals. The issue of where to place the graphics board/host processor boundary is a constant issue. For example, all the IBM graphics adapter cards require hardware-level programming (even though there are BIOS calls, the processor still must do all the work). With the SBI80/GT180, the ACRTC does most of the low-level primitives.

The physical interface between devices must also be considered. Most display adapters plug directly into the backplane, allowing the processor direct access to all hardware registers. The GT180 also plugs directly into the SBI80's XBUS, but the processor must talk to the ACRTC through a pair of I/O ports, even though the ACRTC does have internal registers. The host

processor doesn't need to access the hardware registers often (if at all). Since this graphics device/host boundary is at a higher level requiring less information exchange, it is easier to merely send the ACRTC a stream of drawing commands.

The real problem of defining a graphics standard comes down to defining a set of commands that is rigid enough to allow simple program transportation and that takes hardware differences into account while allowing the programmer to take advantage of any special features of the graphics processor. There is no easy solution, as evidenced by the lack of a widely accepted graphics standard. I hope that the SBI80/GT180 with Modula-2 and Graphix Toolbox will make the waiting more constructive.

CIRCUIT CELLAR FEEDBACK

This month's feedback begins on page 58.

NEXT MONTH

Part 2 looks at the GT180 hardware. ■

Special thanks to Tom Cantrell, Ken Davidson, and Mike Weisert for their contributions to this project.

All screen pictures presented in this article were produced using the GT180 with a Princeton SR-12P monitor. The bit-mapped pictures were originally composed on an Atari 520ST using DEGAS by Tom Hudson. They are reproduced and used here by permission.

The following items are available from

The Micromint Inc.
25 Terrace Dr.
Vernon, CT 06066
(800) 635-3355
(203) 871-6170
Telex: 643331

1. GT180 graphics board: RGBI version less palette D/A converter. Comes with demo disk and user's manual.
board alone.....\$395
board with Modula-2 and GT180
Graphix Toolbox.....\$449
2. GT180 graphics board: RGBI and analog version with palette D/A converter. Comes with demo disk and user's manual.
board alone.....\$449
board with Modula-2 and GT180
Graphix Toolbox.....\$499
3. Borland International Turbo Modula-2 and GT180 Graphix Toolbox software for the

SBI80 and SBI80FX computers, optimized for the 64180 processor. Supplied on 5¼-inch DS/DD SBI80 format disks with 300-page manual.

SBI80 Modula-2 alone.....\$69
SBI80 Modula-2 with Graphix

Toolbox alone.....\$89

4. SBI80FX 5.75-by-8-inch single-board computer, accommodates 512K bytes of memory, two serial ports, three parallel ports, parallel printer port, floppy disk controller, SCSI controller, ROM monitor, 6-MHz 64180. Comes with ZRDOS, ZCPR3, hard disk BIOS, and user's manuals. Populated with 256K-byte memory, less 53C80 SCSI controller chip.

SBI80FX board alone.....\$409

SBI80FX board with software.....\$499

9.288-MHz 64180 processor upgrade

(SBI80FX only).....\$50

GMIC, GVAC, ACRTC, and palette D/A converter chip sets are available for experimenters who wish to hand-assemble the GT180. Call for price and availability information. Borland Turbo Modula-2 is also available for most CP/M Z80 machines. Consult regular CP/M and 8-bit software distributors for various disk formats and prices. The SBI80FX is hardware- and software-compatible with the SBI80.

Surface delivery (U.S. and Canada only): add \$5 for U.S., \$10 for Canada. For delivery to Europe via U.S. airmail, add \$20. Three-day air freight delivery: add \$8 for U.S. (UPS Blue), \$25 for Canada (Purolator overnight), \$45 for Europe (Federal Express), or \$60 (Federal Express) for Asia and elsewhere in the world. Connecticut residents please add 7.5 percent sales tax.

There is an on-line Circuit Cellar bulletin board system that supports past and present projects. You are invited to call and exchange ideas and comments with other Circuit Cellar supporters. The 300/1200/2400-bps BBS is on-line 24 hours a day at (203) 871-1988.

Editor's Note: Steve often refers to previous Circuit Cellar articles. Most of these past articles are available in book form from BYTE Books, McGraw-Hill Book Company, P.O. Box 400, Hightstown, NJ 08250.

Ciarcia's Circuit Cellar. Volume I covers articles in BYTE from September 1977 through November 1978. *Volume II* covers December 1978 through June 1980. *Volume III* covers July 1980 through December 1981. *Volume IV* covers January 1982 through June 1983. *Volume V* covers July 1983 through December 1984.

To be included on the Circuit Cellar mailing list and receive periodic project updates and support materials, please circle 100 on the Reader Service inquiry card at the back of the magazine.

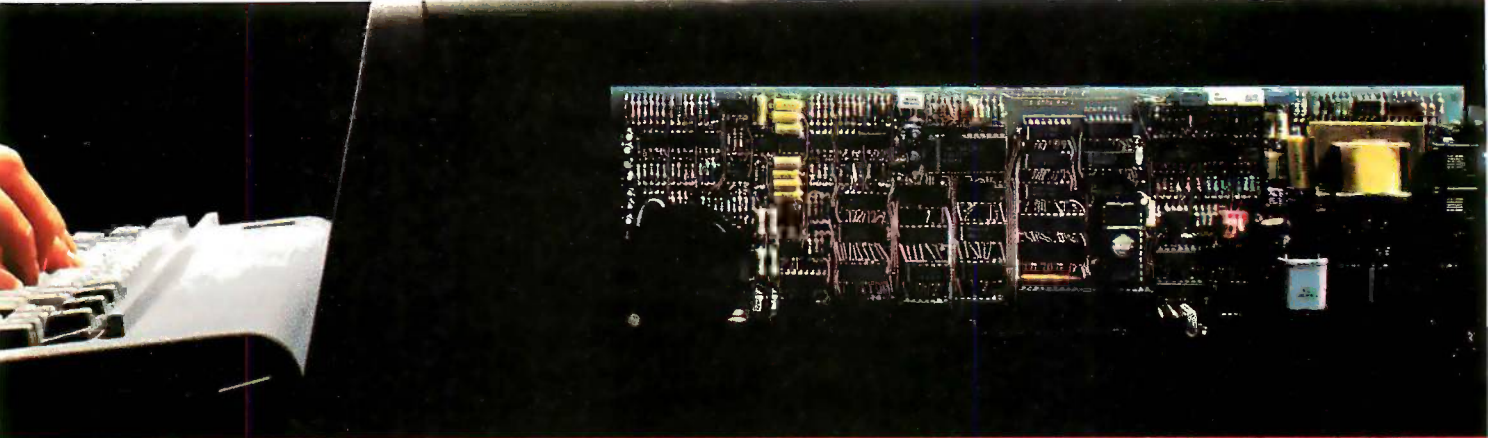

Error-Correcting 2400 bps Modems from Multi-Tech Systems:

When it has to be as good as it is fast

- Dial-up 2400 bps modems have arrived. More datacomm users are upgrading from 1200 to 2400 than ever before. But there can be a flip side to increased speed: More transmission errors.
- That's why our MultiModem224E™ offers MNP™ error correction. Available in our 2400 bps desktop, internal and rack-mounted modems, MNP gives you 100% error-free transmissions. No matter how bad the phone line. And MNP does it without the speed degradation of the less efficient, software-based protocols.
- Another important point: MNP Class 3 has emerged as an industry standard. It's now in the public domain, and has been implemented in virtually all 2400 bps modems that offer error-correction.

● So, why buy error-correcting modems from Multi-Tech? There are lots of good reasons, including:

1. Multi-Tech modems are 100% Hayes-compatible (more so than Hayes' own 2400 bps modems*). And our MultiModem224E with error-correction costs less than a Hayes Smartmodem 2400™ without error-correction.
2. Bonus features, like speed conversion. Both synch and asynch operation. And battery-backed option settings and phone number memory.
3. Versatility. The auto-dial/auto-answer Multi-Modem224E modems run at 2400, 1200 or 300 bps, with or without error-correction, and do so automatically.
4. A two year warranty that means something. Since Multi-Tech modems are designed and manufactured at our Minnesota headquarters (as they have been for the last sixteen years), you know we'll be here when you need us.

● Please call us toll-free, at **1-800-328-9717**, to get the rest of the reasons. And get a modem that's as good as it is fast.

**InfoWorld-8/5/85-reprints available*

See Us at Comdex/Fall '86.

Trademarks: MultiModem and the Multi-Tech Systems logo:
Multi-Tech Systems Inc. • MNP: Microcom Inc.
Smartmodem: Hayes Microcomputer Products, Inc.

MultiTech 
Systems

Inquiry 222 for End-Users.
Inquiry 223 for DEALERS ONLY.

The right answer every time.

Multi-Tech Systems, Inc. • 82 Second Avenue S.E. • New Brighton, Minnesota 55112 U.S.A.
1-800-328-9717 • 1-612-631-3550 • TWX 910-563-3610 (Domestic) • Telex 4998372 MLTTC (International)

MultiTech 
Systems

MultiModem 224E
2400/1200/300 BPS Error Correcting Modem



EXTRACTING THE *n*th ROOT FROM A BINARY NUMBER

BY LAU SIU WO

A general algorithm for extracting real roots

I HAVE DEVELOPED a general algorithm for extracting any real root from a binary number. Figure 1 shows the mathematical justification for the procedure.

To begin, the binary number whose *n*th root you want to take should be divided into groups of *n* bits from the least significant bit out. Thus, if *n* does not evenly divide the number of bits, the most significant bits group will contain fewer than *n* bits.

First, you save 1 as the most significant bit of the root and subtract 1 from the most significant group of bits. Append the next *n*-bit group to the remainder to make a new

number, *REM*, and calculate the comparator *CMPR* $[(2R+1)^n - (2R)^n]$, as explained in figure 1. If $REM \geq CMPR$, then the next bit of the root is 1 and the new remainder is $CMPR - REM$. If $REM < CMPR$, the next bit of the root is 0 and the remainder is left untouched. To obtain the succeeding remainders, shift the previous remainder *n* bits

(continued)

Lau Siu Wo is a lecturer on computer-aided engineering in the integrated circuit design department of the French-Singapore Institute. He can be reached at 12 Science Centre Road, Jurong, Singapore 2260, Republic of Singapore.

Let $X_n, X_{n-1}, X_{n-2}, \dots$ and R_1, R_0 be the binary digits of two numbers such that

$$X = 2^n X_n + 2^{n-1} X_{n-1} + \dots + 2X_1 + X_0,$$

and $R = 2R_1 + R_0$,

where for all natural numbers of *i*, R_i , and X_i ,

$$1 \geq X \geq 0 \text{ and } 1 \geq R \geq 0$$

and *R* is the closest *n*th root of *X*.

Therefore, $X \geq R^n$,

$$\rightarrow 2^n X_n + 2^{n-1} X_{n-1} + \dots + 2X_1 + X_0 \geq (2R_1 + R_0)^n$$

From this we derive the recursive inequality,

$$\rightarrow 2^n (X_n - R_1^n) + 2^{n-1} X_{n-1} + \dots + 2X_1 + X_0 - ((2R_1 + R_0)^n - (2R_1)^n) \geq 0$$

This inequality suggests that if R_1 is the closest *n*th root of X_n , then the next digit R_0 can be found by making the comparator $(2R_1 + R_0)^n - (2R_1)^n$ closest to the remainder

$$2^n (X_n - R_1^n) + 2^{n-1} X_{n-1} + \dots + 2X_1 + X_0.$$

Since X_n is chosen to be nonzero, $R_1^n = 1$, and R_0 can be only 0 or 1. For programming convenience, we can always force $R_0 = 1$ and evaluate whether $(2R_1 + 1)^n - (2R_1)^n$, the comparator *CMPR*, is smaller than $2^n (X_n - R_1^n) + 2^{n-1} X_{n-1} + \dots + 2X_1 + X_0$, the remainder *REM*. The recursive property of the previous inequality can be easily shown:

$$\text{if } R = 2^n R_n + 2^{n-1} R_{n-1} + \dots + 2R_1 + R_0,$$

$$X = 2^n X_n + 2^{n-1} X_{n-1} + \dots + 2X_1 + X_0,$$

equating $X \geq R^n$, then the second and succeeding comparator is always

$$(2R+1)^n - (2R)^n,$$

where *R* is the value of the previous result.

Figure 1: Derivation of the comparator formula.

Z Best Sellers

Z-COM (7 disks) \$119.00
 Easy auto-installation complete Z-System for virtually any Z80 computer presently running CP/M 2.2. In minutes you can be running ZCPR3 and ZRDOS on your machine, enjoying the vast benefits. Includes 70+ utility programs and **ZCPR3: The Manual**.

Z-Tools (4 disks) \$150.00
 A bundle of software tools individually priced at \$260 total. Includes the ZAS Macro Assembler, ZDM debuggers, REVAS4 disassembler, and ITOZ/ZTOI source code converters. HD64180 support.

PUBLIC ZRDOS (1 disk) \$59.50*
 If you have acquired ZCPR3 for your Z80-compatible system and want to upgrade to full Z-System, all you need is ZRDOS. ZRDOS features elimination of control-C after disk change, public directories, faster execution than CP/M, archive status for easy backup, and more!

TERM III (6 disks) \$99.00*
 TERM III has been called "a cosmos". Why? Because it's 29 programs, featuring T3MASTER and T3SERVER, are galactic in scope. KERMIT, XMODEM, 1k XMODEM, and batch YMODEM protocols supported.

DSD (1 disk) \$129.95
 The premier debugger for your 8080, Z 80, or HD64180 systems. Full screen, with windows for RAM, code listing, registers, and stack. We feature ZCPR3 versions of this professional debugger.

Quick Task (3 disks) \$249.00
 Z80/HD64180 multitasking realtime executive for embedded computer applications. Full source code, no run time fees, site license for development. Comparable to systems from \$2000 to \$40,000! Request our free Q-T Demonstration Program.

*ZCPR3 required.

Z-System OEM inquiries invited.
 Visa/Mastercard accepted.
 Add \$4.00 shipping/handling in North America, \$18.00 elsewhere. Specify disk format.



Echelon, Inc.

885 N. San Antonio Road • Los Altos, CA 94022
 415/948-3820 (Order line and tech support)

EXTRACTING NTH ROOTS

$$R = \frac{1}{\begin{array}{r|l} 100 & 1100010 \\ \hline 1 & 0101101 \end{array}} = 78125_{10}$$

$$\frac{1}{11 \ 1100010} = REM$$

$$CMPR = 3^7 - 2^7 = 2059_{10} = 100000001011_2$$

$$CMPR > REM, \text{ so } \boxed{?} = 0$$

$$R = \frac{1 \quad 0}{\begin{array}{r|l} 100 & 1100010 \\ \hline 11 & 1100010 \end{array}} = 78125_{10}$$

$$11 \ 1100010 \ 0101101 = REM$$

$$CMPR = 5^7 - 4^7 = 61741_{10} = 1111000100101101_2$$

$$CMPR = REM, \text{ so } \boxed{?} = 1$$

$$R = \frac{1 \quad 0 \quad 1}{\begin{array}{r|l} 100 & 1100010 \\ \hline 11 & 1100010 \\ 11 & 1100010 \end{array}} = 78125_{10}$$

$$0 = REM$$

REM = 0, so 101_2 is a perfect 7th root.

Figure 2: Demonstration of the algorithm to take the 7th root of 78125_{10} , 10011000100101101_2 .

to the left and the *n*-bit vacancy with the succeeding group of the number. The calculation loops until the end of the significant bit count is encountered.

To illustrate the procedure, let's take the 7th root of 78125. First, we represent 78125 in binary (10011000100101101) and divide the bits into groups of seven, as shown in figure 2. Next, we subtract 1 from the most significant bit group, leaving 11_2 . We calculate the comparator by substituting $R=1$ into the formula and obtain 100000001011 , which is larger than the remainder, 111100010 . Thus, we enter 0 as the second bit of the root. The next comparator is formed by substituting $R=10_2$ into the formula, which is 1111000100101101 . Since the next remainder is the same as the comparator, the last bit of the root is 1. Thus, $R=101_2$, or 5_{10} , and is a perfect 7th root of 78125_{10} . ■

MOVE UP TO LIGHTSPEED AND CATCH THE WORLD



\$399

UNIVERSAL MODEM

LIGHTSPEED 2400 LIGHTSPEED 1200

300/1200/2400 bps 0-300/600/1200

Bell 103, 212A & CCITT Bell 103, 212A & CCITT

V.21, V.22, V.22 bis CCITT V.21, V.22 \$199

See us at **COMDEX/Fall**

booth No. M443 November 10-14 Las Vegas.

*Dealer and distributor wanted!

LIGHTSPEED TECHNOLOGY INC.

8F-10, NO. 746 MIN SHEN EAST ROAD

TAIPEI TAIWAN R.O.C.

TELEX: 14217 LIGHTSPO

FAX: (02)7161024

TELEPHONE: (02)7134585

TANDY®... Better Again™

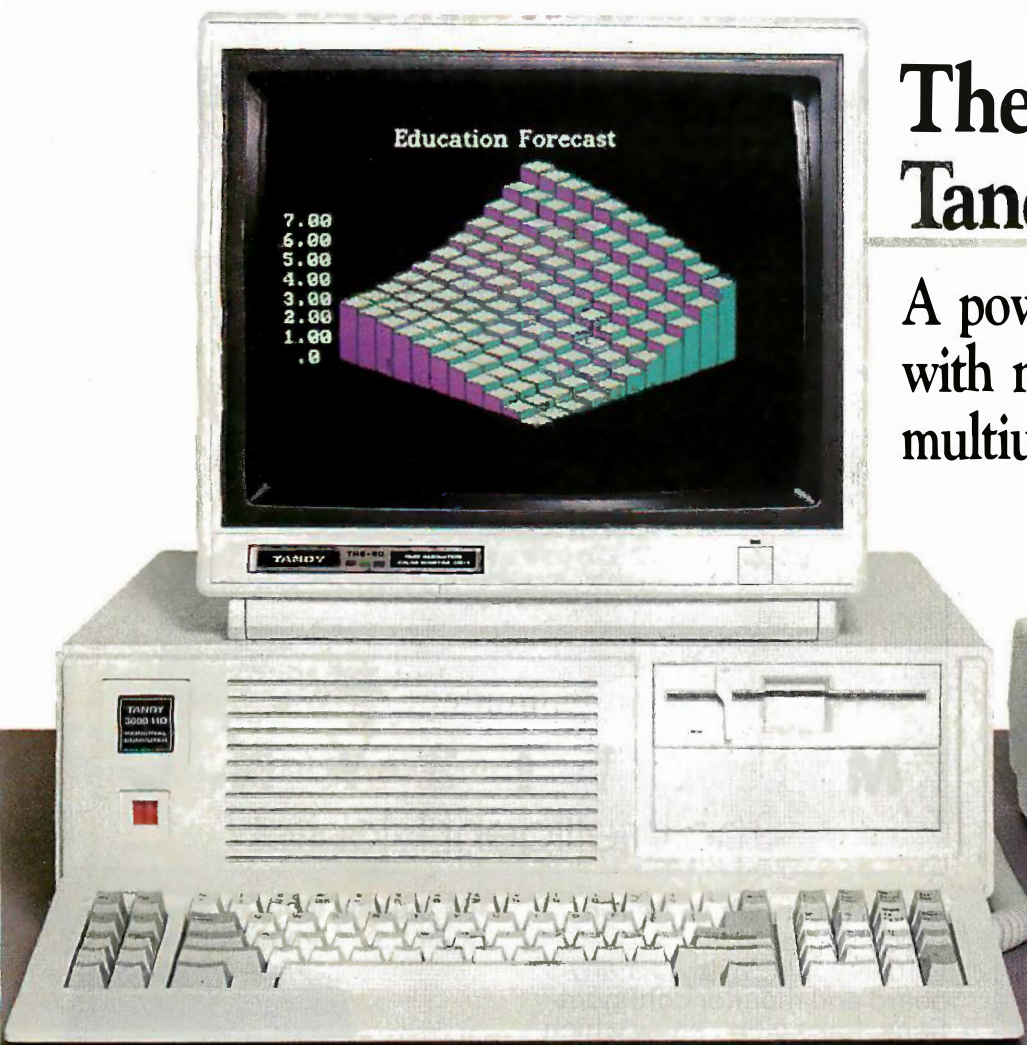

The New Tandy 3000 HD

A powerful workstation
with networking and
multiuser capacities.

The 3000 HD is compatible with the IBM PC/AT®, offers greater hard disk storage (40 megabytes vs. the PC/AT's 30), yet is priced at only \$4299 (vs. \$5295 for the PC/AT).

Based on the 16-bit Intel 80286 microprocessor, the Tandy 3000 HD (25-4001) operates at 8 megahertz—33% greater than the industry standard. The Tandy 3000 HD features 640K main memory and a high-capacity 5¹/₄" slim-line floppy disk drive which has been designed to read both 1.2-megabyte and 360K formats, allowing it to run either IBM PC/AT or IBM® PC software.

The high-performance design of the 3000 HD makes it a natural for use in a local area network such as ViaNet®. ViaNet can link together

multiple MS-DOS® computers into a powerful office automation system.

The Tandy 3000 HD also uses the forthcoming XENIX® System V multiuser operating system. Up to five users with low-cost display terminals are capable of tapping the power of the Tandy 3000—permitting each to work independently on such projects as accounting, word processing and electronic filing. Each remote user has all the power of a fully configured computer system . . . for the price of a terminal.

The Tandy 3000 HD is quality-designed and built by Tandy in the U.S.A. We back the 3000 HD with full support, nationwide service, commercial leasing and professional training. Come see it today!

Available at over 1200
Radio Shack Computer Centers and at
participating Radio Shack stores and dealers.

Radio Shack®
COMPUTER CENTERS

A DIVISION OF TANDY CORPORATION

Inquiry 282

Send me a Tandy 3000 brochure.

Radio Shack, Dept. 87-A-358
300 Tandy Center, Fort Worth, Texas, 76102.

Name _____

Company _____

Address _____

City _____

State _____ ZIP _____

Phone _____

Your first color monitor should be good enough to be your last.

NEC introduces the only color monitor you need. Superb resolution plus MultiSync for across-the-board compatibility with all three PC graphics boards made by IBM[®], for business graphics, CAD/CAM, computer art, and text.



Now there's one high resolution color monitor that does things your way. The MultiSync™ monitor from NEC. It gives you the best color resolution available at the price.

- Compatibility with the IBM Professional Graphics Adapter, the IBM Enhanced Graphics Adapter, and the IBM Color Graphics Adapter.

Compatibility with the IBM[®] Enhanced Graphics Adapter Board

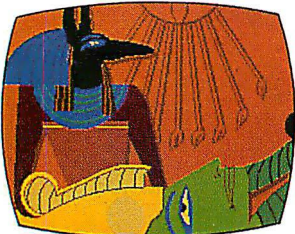

- MultiSync, the NEC feature that automatically adjusts to color adapter board scanning frequencies from 15.75 KHz to 35 KHz—suggesting the possibility that the MultiSync monitor might be compatible with *all* color graphics boards that are fully compatible with the IBM PC, PC/XT, and PC/AT, now and in the future.

- Full implementation of high resolution graphics software for business and other applications, now and in the future.

- And color capability limited only by the board being used.

See Things Our Way

Until now, you had to choose different color monitors for

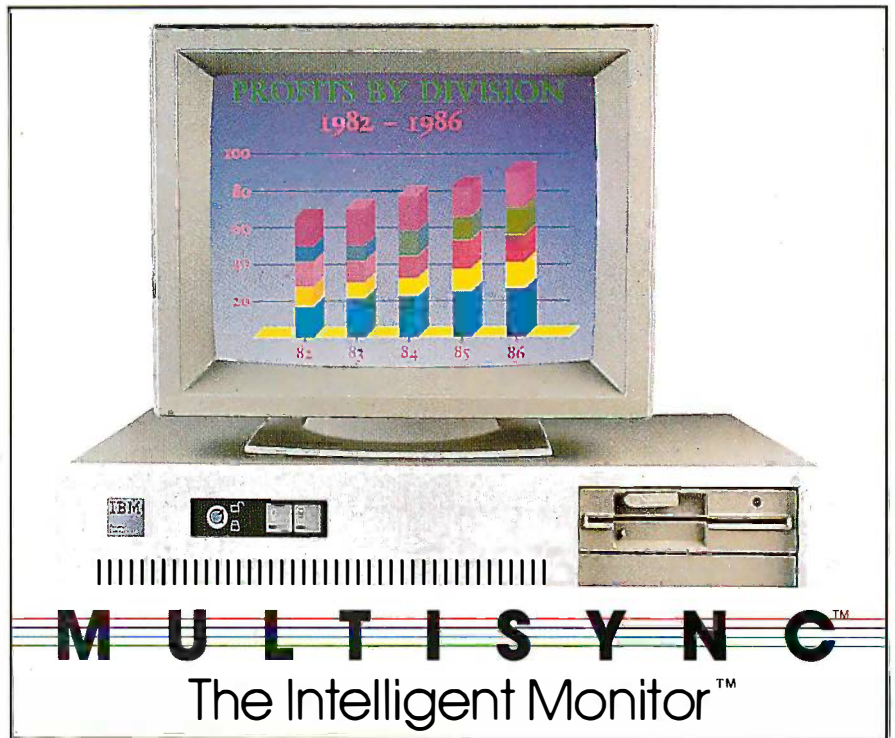

compatibility with all three PC color graphics boards made by IBM. With so many board and monitor configurations, folks didn't know which way to look.

The new MultiSync color monitor gives you unique compatibility. As well as TTL and analog color. With 7 switchable text colors. And resolution up to maximum 800 horizontal dots and maximum 560 vertical lines, on a large, 13" diagonal viewing area.



All from NEC, a name respected around the world for advanced, reliable products backed by nationwide service.

Compatibility with the IBM[®] Professional Graphics Adapter Board

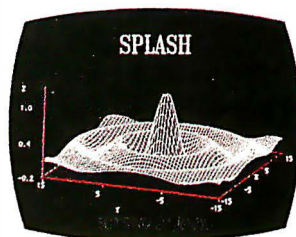

It's the one color monitor that does everything your way.

Compatibility with the IBM[®] Color Graphics Adapter Board

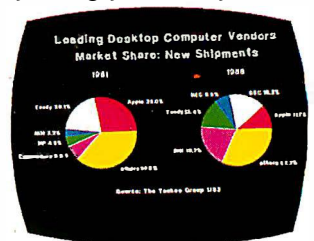

But why talk more about it? Visit your nearest dealer and see a graphic demonstration of the new NEC MultiSync monitor's capabilities. Then draw your own conclusions.

For information dial
I-800-447-4700

NEC HOME ELECTRONICS (U.S.A.) Inc.
Computer Products Division
1255 Michael Drive
Wood Dale, IL 60191-1094



PASSING FILENAMES TO COMPILED BASIC

BY BRUCE HUBANKS

This assembly language subroutine retrieves the command-line text for a compiled BASIC program

WHEN YOU START an application program, it is often desirable to be able to specify a filename on the MS-DOS command line. For instance, given a hypothetical data encryption program named Encode, you might like to be able to process a data file named Filex by typing

ENCODE FILEX

Many language compilers provide a library function to retrieve secondary filenames and parameters from the command line. Unfortunately, Microsoft's BASIC Compiler does not.

I have written an assembly language subroutine called Getspec to remedy this deficiency. To make use of the routine from a BASIC application program, you simply include a couple of lines at the beginning of your program, as shown in listing 1. Then compile the program and link it to Getspec. The result will be an executable application. (If you use BASCOM's IO option, you won't even need BASRUN to run the program.)

Because Getspec obeys the Microsoft conventions for parameter passing, it could also be used to retrieve filenames for other language compilers that obey these conventions.

(Getspec cannot be used with Microsoft's BASIC Interpreter.)

MS-DOS PROGRAM AND DATA CONVENTIONS

A brief explanation of how MS-DOS handles command-line information will help you understand the program in listing 2.

When a program is invoked from the MS-DOS command line, MS-DOS creates a bookkeeping area called the program segment prefix (PSP) at the lowest available memory location. Within this area, the data transfer area (DTA) contains all the characters typed after the program name.

On entry to the program, the stack pointer (SP) gives the code offset address of the calling program. This address enables the subroutine to retrieve parameters from the calling program and pass values back to it.

Refer to listing 2 as you read the following commentary.

Getspec starts by copying the all-important SP value into BP. [BP]+4 gives the code segment address. The starting address of the PSP can be derived from this code segment address by subtracting 16. Adding 128 gives the start of the DTA, which contains a length byte followed by the specified number of bytes that were typed before the end of the line.

The Getspec subroutine uses the stack information to locate the command-string text in the DTA. The program searches for the first nonblank character and then reads the text up

(continued)

Bruce Hubanks (2701-C West 15th St., Suite 228, Plano, TX 75075) has eight years' experience in computer systems design and is currently designing an artificial intelligence application for military aircraft.

Listing 1: A BASIC program demonstrating the use of the Getspec subroutine.

```
10 REM "FILENAME.EXT"
20 F$ = " "
30 CALL GETSPEC(F$)
40 PRINT "Text remaining on command string is: ";F$
50 END
```

**ORDER TOLL FREE
24 HOURS EVERY DAY
800-662-2686**

**HARDWARE
COMPUTERS**

IBM COMPATIBLES 256K Ram, Keyboard, 1 yr. war.
w/1 Floppy... 459 Plus 20MB Hard Disk... 869

PANASONIC Business & Executive Partners... CALL

ATARI ST COMPUTERS... CALL

MODEMS, BOARDS, DRIVES

Anchor Lighting 2400... 329	Flashpak Turbo Board... 319
Evercam 1200 Internal... 129	SixPakPlus384K... 209
Hayes Modems... CALL	SixPak Premium 512K... 359
Practical Modem 1200... 135	Intel Above Board PC... 225
Genoa Spectra... 319	Above Board PS... 289
Genoa Spectrum... 199	Above Board AT... 355
Hercules Graphics +... 189	Tallire J-Ram 2... 145
Mono Graphics Card... 89	J-Ram3/3AT... 189/249
Sigma Turbo EGA... 589	Practical 1200 Multiboard... 269
STB EGA Plus... 289	20MB Hard Disk Kit... 399
Taxon 560 EGA... 375	30MB Hard Disk Kit... 469
Tecmar EGA Master... 285	Seagate ST4026... 499
Video 7 Vega... 369	Filecard 20MB... 609
384K RAM Card... 99	Hardcard 20MB... 679
AST Advantage... 339	Drivecard 30MB... 839
AST Rampage... 239	Imega 210H... 1899
AST Rampage AT... 439	Sigma Fast Track 20... 749

PRINTERS, PLOTTERS & MONITORS

EPSON-AII Models... BEST	NEC 1280 TTL Mono... 129
LX/FX/EX/LQ... PRICES	NEC 1401 Multi-Sync... 649
Citizen 120D... 195	Samsung TTL... 89
Citizen Premiere 35... 499	Sony KV1311 RGB/TV... 429
Panasonic 1092... 315	SonyCPD 1302 Multi-Sync... 629
Panasonic P3131... 265	Taxon 630/640... 449/519
Roland DXY-800 Plotter... 409	Taxon 760 EGA... 539
Houston Inst DMP-29... 1799	Thompson 36432 RGB... 309

SOFTWARE

ACCOUNTING		WORD PROCESSING	
BPI Accting/Mod... from 309	Volkswriter 3... 149	BPI Enterprise/Mod... 409	Microsoft Word3... 249
Pacsoft/Module... 259	Word Perfect 4.1... 209	Complete Bus. Actng... 159	PFS: First Choice... 89
DAC EZ Accounting... 42	PFS: Pro Write... 115	Open Systems V3/Mod... 429	Multimate Advantage... 309
Paragon... 569	Turbo Lightning... 59		

DATABASE

SPREADSHEETS

dBase III Plus... 409	Lotus/Symphony... CALL
Clipper... 359	Framework II... 419
Javelin... 459	Supercalc 4... 269
Paradox... 449	Open Access II... 289
R Base System V... 359	Ability... 61
Reflex... 83	Smart SW System... 449
Revelation... 529	Mosaic Twin... 57
PFS: Pro File... 145	
Q & A... 239	

UTILITIES

Alice Pascal... 59	
Microsoft C... 269	
Charlmaster... 215	Macro Assembler... 90
Click Art Pers. Pub... 109	Quick Basic... 60
Energraphics 2.0... 299	Turbo Pascal Ver 3... 59
Fantasy... 43	Turbo Pralog... 59
Freelance... 205	Desqview... 59
Graphwriter Combo... 309	Windows... 60
Harvard Pres. Graphics... 229	Carbon Copy... 117
Generic Cad... 69	Fastback... 97
In*A*Vision... 255	Inset... 87
Microsoft Chart 2... 179	Norton Commander... 44
ProDesign II... 169	Pop-Up Deskset... 43
Dr. Halo II w/Mouse... 109	SQZ... 56
Fontrix... 89	Xtree... 31
Summosketch... 379	Statgraphics... 449

800-662-2686 orders only

for Ca. Orders, Tech Support, Price Quotes, info

415-668-9350 9-5 pacific time, m-f

Call or Write for Free Catalog

PAYMENT: (No Fee For Credit Cards) Visa, MasterCard, Cashier's Checks, Personal Checks with 2 week hold, Qualified P.O.'s. California residents add sales tax.

SHIPPING: UPS ground-2% per order, \$5 min. FREE for SW orders over \$1000. UPS Blue-3% per order, \$7 min. FREE for SW orders over \$1500. Printers, Monitors, Disk Drives, Computers - Call for charges.

All Products New with full warranties. Price & availability subject to change without notice.

THE BAY

THE
BEST
PRICES

THE
BEST
SERVICE

COMPANY

PASSING FILENAMES

Listing 2: Assembly language code for the Getspec program.

```

; Routine to get a filename from the MS-DOS command line
; using a call from a compiled BASIC program
;
const segment word public 'const'
const ends
;
data segment word public 'data'
data ends
;
dgroup          group    data,const
;
code segment byte public 'code'
public getspec
assume cs:code,ds:dgroup
;
getspec         proc     far
;
push           bp           ; save registers
mov            bp,sp
push          ax
push          si
push          di
push          dx
push          cx
push          bx
push          es
push          ds
;
mov            dx,[bp]+4   ; Get code segment address.
sub            dx,10h     ; Adjust to PSP address
mov            ds,dx      ; Move PSP to ds.
;
; Set up pointer to dta to get parameters.
mov            si,0080h   ; Point to string length and
mov            ci,[si]    ; check that many bytes.
mov            ch,0       ; Make cx 16-bit.
inc            si         ; Skip over length byte.
;
; Scan past the spaces.
mov            al,' '     ; Skip spaces.
getspec1:
cmp            [si],al    ; Check for spaces.
jne            getspec2  ; Exit loop if not a space.
inc            si         ; Otherwise point to next.
loop          getspec1   ; Loop back for next byte
jmp            getspec3  ; unless max is exceeded.
;
; move the rest into place
getspec2:
mov            bx,[bp]+6   ; Get address BASIC string.
pop            ds         ; Get original ds value.
mov            di,[bx]+2  ; Point to start of string
push          ds         ; Put ds back to PSP segment
mov            ds,dx     ; address.
cld                    ; Forward direction.
rep            movsb     ; Make the transfer.
clc                    ; No error, so clear carry
jmp            getspecxit ; and return.
;
getspec3:
mov            ax,20      ; No file was specified.
stc                    ; Error, so set flag.
;
getspecexit:
pop            ds
pop            es
    
```

(continued)

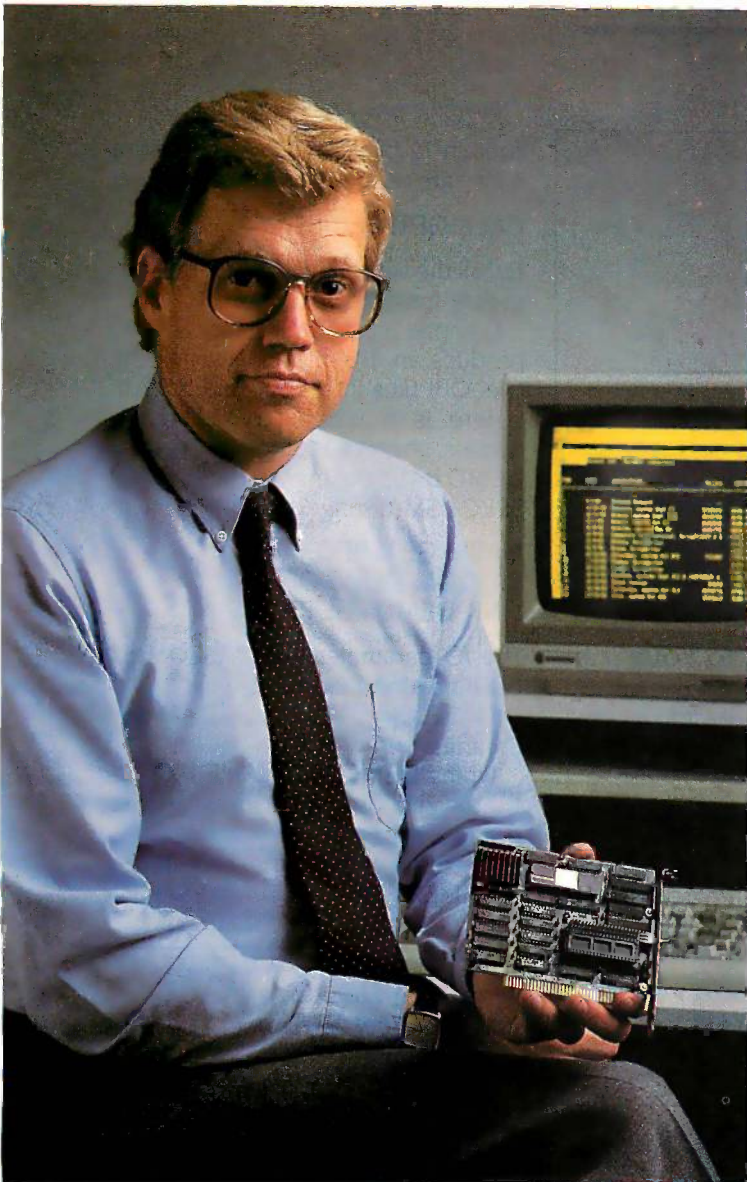

How I work three times faster without raising a sweat.

accounting, finance, and other business professionals. And the only company offering a full line of turbos. They've even got a super high-performance Pcturbo 286e with *five* times the speed of the PC. Nice to know, in case the work really piles up.

**ORDER YOUR TINYTURBO TODAY.
IT WILL PAY
FOR ITSELF IN FOUR WEEKS.**

I always considered myself a 'power' PC user. But waiting for the system to load and recalculate spreadsheets, post accounts, and sort databases, was holding me back.

Then I installed Orchid's TinyTurbo 286 high-performance accelerator. It's tiny in size: just a half slot card. And tiny in price. But there's nothing tiny about the performance: now my programs run three to four times faster than before. So I get AT performance without the AT price. And without the downtime of transferring my files to a new system.

I count on my PC every day. So I was glad to learn that TinyTurbo 286 is made by Orchid—the leading manufacturer of turbo products for

	IBM XT	WITH TINYTURBO
Post 700 accounts	12 sec/acct (2.3 hours)	3.5 sec/acct (0.7 hours)
Sort 10,000 records	25.4 minutes	14.9 minutes
Spreadsheet recal.	44 seconds	14 seconds
Integer calculation	10 minutes	3 minutes

I used to panic when my boss asked me to work up some additional reports an hour before a big meeting. Now I just smile and say, "no sweat."



**WHEN YOU SAY TURBO,
YOU MEAN ORCHID.**

TinyTurbo 286™

TinyTurbo 286 and Pcturbo 286e are trademarks of Orchid Technology.
IBM is a registered trademark of International Business Machines Corp.

47790 Westinghouse Drive, Fremont, CA 94536
(415) 490-8586 TELEX 709289

Inquiry 237 for End-Users. Inquiry 238 for DEALERS ONLY.

```

pop     bx
pop     cx
pop     dx
pop     di
pop     si
pop     ax
pop     bp
ret     1*2

getspec     endp
code ends
end
    
```

to the first blank or the end of text, whichever comes first. The nonblank characters are copied into a string that was defined in the main BASIC program. The string storage location is at the address given by [BP]+6.

In the demonstration program of listing 1, F\$ receives the filename from the subroutine. The demonstration program allocates 12 bytes to F\$—enough to contain a filename—but you can allocate up to 255 bytes to F\$ if your application program

needs to retrieve additional parameters from the MS-DOS command line.

LINKING GETSPEC TO YOUR PROGRAM

To incorporate Getspec into an existing program, create a source file that matches the one shown in listing 2. Use an assembler to generate an .OBJ file.

At the beginning of your application program, define a string constant to

contain 12 blanks (you can use more if they are needed). Use the statement CALL GETSPEC(F\$)

to call the subroutine and get the necessary text into F\$.

Compile your BASIC program to produce an .OBJ file. Finally, link the two .OBJ files into a single .EXE file.

Here is a typical command sequence, given two source files named DEMO.BAS (listing 1) and GETSPEC.ASM (listing 2):

```

MASM GETSPEC
BASCOM DEMO/O
LINK DEMO+GETSPEC
    
```

The /O parameter tells BASCOM to create a single executable file called DEMO.EXE that contains all needed libraries.

Typing DEMO FILENAME.EXT activates the program, which should produce the message "Text remaining on command string is: FILENAME.EXT." ■

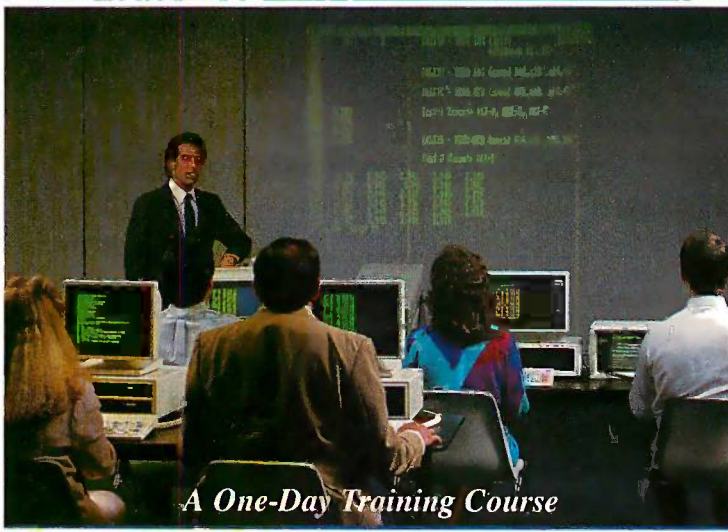

A One-Day Training Course

LOCATIONS:

- Atlanta, Georgia — January 5, 1987
- Boston, Massachusetts — November 24, 1986
- Chicago, Illinois — January 16, 1987
- Cleveland, Ohio — January 12, 1987
- Dallas, Texas — January 29, 1987
- Denver, Colorado — January 23, 1987
- Edison, New Jersey — November 17, 1986
- Los Angeles, California — December 10, 1986
- Jessup, Maryland — November 21, 1986
- Mountain View, California — December 8, 1986
- New York, New York — November 19, 1986
- Philadelphia, Pennsylvania — January 7, 1987
- Portland, Oregon — January 21, 1987
- San Diego, California — December 12, 1986
- St. Louis, Missouri — January 19, 1987
- Toronto, Canada — January 9, 1987
- Troy, Michigan — January 14, 1987

Call: National Instruments
 (512) 250-9119
 (800) 531-4742 in U.S.
 (800) IEEE-488 in Texas
 Cost is \$95 per registrant

Measuring Device to PC Spreadsheet Software

Learn to use a new Lotus 1-2-3 add-in module. This module acquires and stores data directly into Lotus 1-2-3 spreadsheets using standard 1-2-3 menus and new advanced macro commands. The data is immediately available for analysis and graphic display.

I/O support allows control of GPIB devices, RS-232C instruments, A/D and D/A plug-in boards.

The course includes a Hands-on laboratory with several PC types, assorted software analysis packages and numerous instruments.

National Instruments has experience supporting more than 40 thousand GPIB users on the PC. Lotus has experience supporting more than 2 million 1-2-3 users.

NATIONAL INSTRUMENTS
 12109 Technology Blvd.
 Austin, Texas 78727-6204

Lotus.
 55 Cambridge Parkway
 Cambridge, MA 02142

Canon presents your personal print shop.

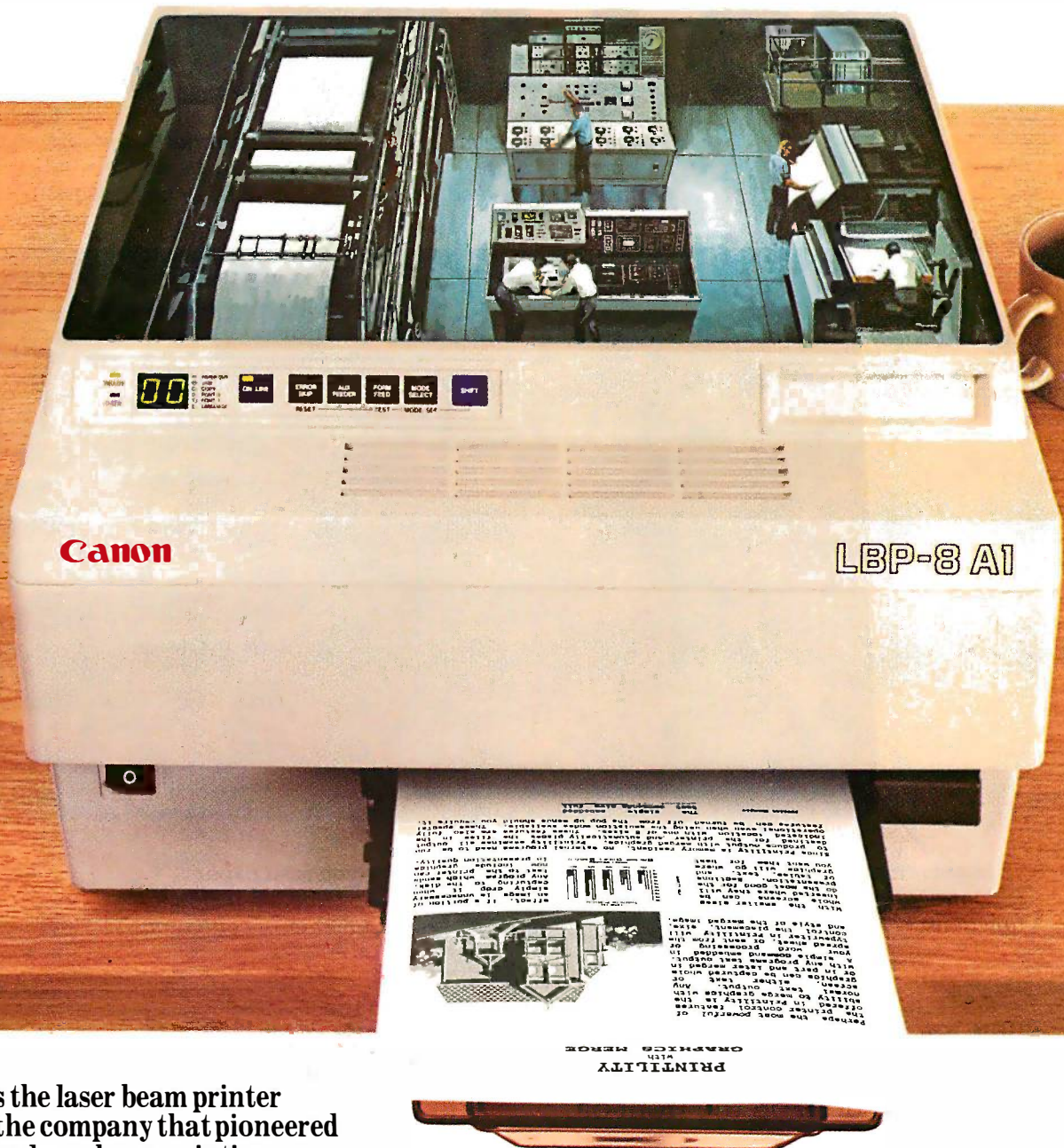

Here's the laser beam printer from the company that pioneered desktop laser beam printing.

From the shortest memo to the longest report, the Canon LBP-8 A1 makes everything you print look hot off the presses. Your output will look so professional you'll think it came from a print shop.

The LBP-8 A1 is incredibly fast, producing copy at a rate of 8 pages per minute, and because it's non-impact, it prints so quietly that you'll hardly know it's working.

This versatile printer lets you use a wide range of plug-in fonts. And Canon's replaceable cartridge

system makes it virtually maintenance-free.

To set up your own personal print shop, get the Canon LBP-8 A1, or the LBP-8 A2 with full graphics capability. You're sure to make a favorable impression with everything you print. To learn more about Canon's advanced laser beam printers as well as the complete line of wire dot matrix and bubble-jet printers, call 1-800-453-3307. (In Utah, 1-800-662-2500.)

Canon
PRINTERS
Printouts that stand out.

MEET DISTINGUIS

3 paper feeding controls,
plus paper-saving
push/pull tractor feed.

Diagnostic self-test
signals errors with
flashes and beeps.

Go off-line to change
type styles and modes
without lengthy
software commands.

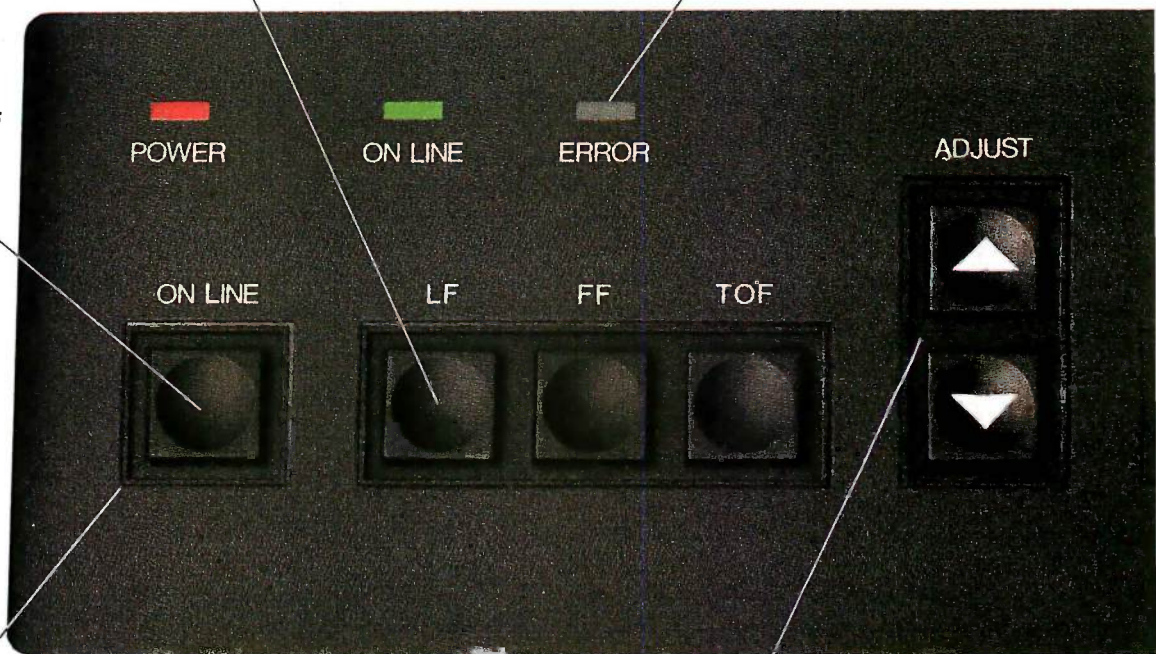

12 pushbuttons
to control printing
functions.

Lets you feed paper
line-by-line, by 1/216-inch
increments, or continuously.

This could be the most intelligent
group of buttons ever assembled.

You'll find them on the front of
every Alps Dot Matrix
Printer. And you'll
use them to do
something most
printers can't.

Everything.

Just push a
button on our front panel. You can
change type styles and print modes,

load paper automatically, reprint data
stored in the print buffer, even over-
ride your software to do things it can't.

All while using your
PC for other work
at hand.

But of course,
Alps printers are
more than a bunch
of buttons.

They're fast. The new P2100™ prints
drafts at an amazing 400 cps, the

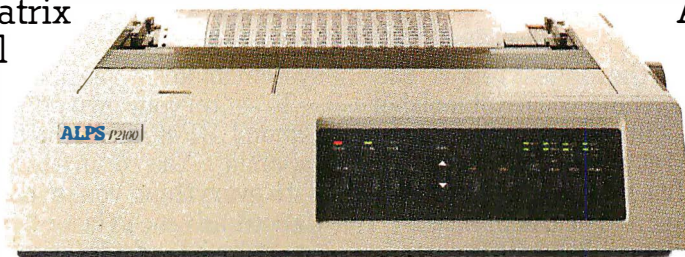

OUR HIED PANEL.

SEE US
AT COMDEX
BOOTH 7452, HILTON

*Clears print buffer
of data without
printing it.*

*17 LEDs indicate
functions in operation.*

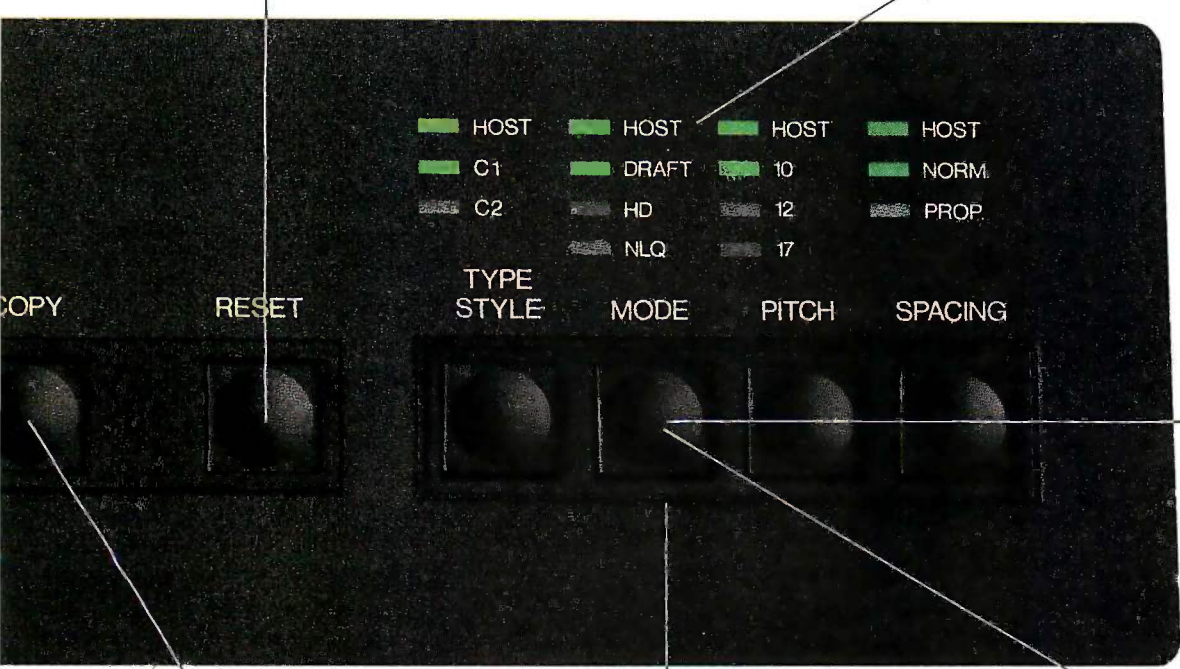

*Choose three
almost amazing
P2000 speeds:
250 cps draft,
125 cps memo,
or 50 cps letter
quality. Price: \$995.*

*Automatically reprints data
stored in print buffer
(4K expandable to 256K).*

*Select font cartridges,
printing modes, print
pitches and spacing
quickly and easily.*

*Choose three amazing
P2100 speeds: 400 cps
draft, 200 cps memo,
or 80 cps letter quality.
Price: \$1595.*

P2000™ at an almost amazing 250 cps. They're versatile. They print everything from letters and graphs to six-part forms and 16-inch-wide spreadsheets. And they run with all the most popular PCs and software. Best of all, they're reliable. Because Alps printers are among the most solidly built at any price. In fact, with normal care, they'll run five years or more without a breakdown. And their precision-engineered print-

head will deliver over 200 million characters of superb output. So don't just get a printer that does a lot of work. Get one that doesn't interfere with yours. An Alps. For our brochure and name of our nearest dealer, call (800) 828-ALPS. In CA, (800) 257-7872. We'll show you how to push all the right buttons.

ALPS
AMERICA

Inquiry 13 for End-Users. Inquiry 14 for DEALERS ONLY.

P2000 and P2100 are trademarks of Alps Electric Co., Ltd. ©1986 Alps America.

10 MHz 286 TURBO™



The Code of the West

The Good

Western 286 Turbo™

Western Computer Corp. has built a strong reputation in the Micro-computer Industry by sticking to a few basic principles. We call it the "Code of the West" and it goes something like this:

MAKE IT BETTER.

with added features like 8-10 MHz switchable, 512K of RAM expandable to 1MB, Standard RS-232, Parallel Ports and 1 year Warranty on parts and labor.

MAKE IT NOW.

it doesn't matter how good a deal you make if you have to wait forever to get it!

MAKE IT CHEAPER.

and pass the savings on to the Buyer.

MAKE IT COMPATIBLE.

we can't think of anything worse than getting a good deal on a new system, but not being able to run your favorite Software! By the way, we use Phoenix Bios for total compatibility.

MAKE IT IN AMERICA.

Please!

The Bad

\$5295.00

What could a Personal Computer with fewer standard features, actually do for you that would compel you to part with an additional \$3,300.00. Will it pick-up the kids from school, wash the car or walk the dog? Think about it!

& The Ugly

Regardless of what you pay for it, a Foreign Import can be one big gamble, with no guarantees of compatibility, service, or support.

Western Computer Corp. has a full line of personal computers and peripherals designed around your needs and your budget including: **WESTERN COMPUTER XT TURBO™**, **WESTERN CARRY-ON™** and...

...Coming soon—**WESTERN 80386™**

Call one of our salespersons at (714) 553-1611 to find out how to hang-on to more of your money!

Western Computer

17781 Mitchell St., Irvine, CA 92714 USA
Phone (714) 553-1611

Customer Service Only (714) 533-1705
Telex: 7566731

Answer Back WESTERN COMP
FAX (714) 553-0236

Western Computer Australasia Limited

4-82 Abbot Street, Ascot Brisba
Queensland, Australia 4007

#(07) 268-6589 - Telex: AA144746
FAX: *(07) 2685256 - Answer Back MCGUIR

Western Computer Spain

Diputacion, 238-6° Despacho 8
08007 Barcelona, Spain
Tele: 317 7128

Western Computer Greece - Busisoft Ltd.

102 Syngrou Ave., Athens 11741. Greece
Tele: 902 4248 - TLX: 210364

MEMORY MANAGEMENT UNITS FOR 68000 ARCHITECTURES

Design options that speed up memory management

The Motorola 68000 family of microprocessors has spawned a whole new group of computer systems. The original 68000, with its large, linear addressing range, makes it a natural for single-user, personal graphics workstations such as the Macintosh. And multiuser systems based on the 68020 can offer computing power and speed that rival many minicomputers—often at a fraction of the cost. Not surprisingly, many of the design features for these larger systems have evolved from well-established minicomputer architectures. Memory management units, or MMUs, are one example. The MMU function came about as minicomputer designers began to include special hardware to expand the amount of addressable memory. MMUs have now become a key feature in modern computer architectures. In fact, several MMUs designed specifically for the 68000-family architecture are available (see table 1).

THEORY OF OPERATION

The MMU functions at a very low level in the computer system. Unlike a UART or other peripheral chip that at-

taches to the system bus and is idle most of the time, the MMU attaches directly to the CPU address bus and intercepts each CPU read or write cycle. The CPU and MMU combine to form a new functional unit. Several manufacturers have even moved the MMU onto the same silicon as the CPU, in effect declaring that you can't have one without the other.

The most important function provided by all MMU designs is the ability to relocate a program to another part of memory according to a set of pre-assigned translation rules. This relocation is done in hardware, without requiring any modification to the application software.

Before a system with an MMU runs a program, the operating system configures the MMU so that the program can be moved to and run in an available section of memory. The program then begins execution, unaware of the MMU's actions. For example, if a program has been compiled and linked with a starting location of 400 but that location is being used for some other purpose, the operating system configures the MMU hardware to convert all the program's memory references

to an unused section of memory. Although the MMU is obviously useful in a system that has multiple users running separate programs, it is just as useful in a multitasking single-user system.

In a simple 68000 system that does not have an MMU (figure 1), a typical memory read cycle begins when the CPU asserts an address and address strobe (AS), and the cycle ends when the memory places data on the data bus and activates the data transfer acknowledge (DTACK) line. Assuming that the memory is very fast, the cycle can be completed in eight transitions of the clock, or 500 nanoseconds for an 8-MHz CPU.

In a 68000 system that has an MMU in series with the CPU's address bus (figure 2), for each read cycle the CPU asserts a logical address and logical address strobe (LAS). (The address and address strobe lines are now

(continued)

Gregg Zehr is a senior design engineer at Altos Computer Systems (2641 Orchard Parkway, San Jose, CA 95121). He received his M.S.E.E. from the University of Illinois and is interested in advanced computer architectures.

prefaced with the term *logical* since they are the absolute addresses from the CPU's point of view.) The MMU accepts the address and logical address strobe and then translates the logical address according to a set of translation rules into a physical address. It then asserts a physical address and a physical address strobe (PAS). (The term *physical* is used to indicate that

these addresses are physically attached to the memory.) The memory again responds by putting data on the data bus and asserting DTACK.

But, as the saying goes, nothing is free. There are two penalties for attaching the MMU in series with a bus—speed and pin count. First, each memory cycle must now be slowed down while the MMU performs the

translation. Second, the MMU must monitor a wide input bus and drive a wide output bus. Expect a single-chip MMU for a 68000/68010-based system to have at least 64 pins and an MMU for the 68020 to have over 120 pins. Although the cost of a device is directly proportional to the number of pins on the package, in most systems, fortunately, the cost of adding MMU hardware is less than developing a layer of software to perform similar functions.

Since the MMU operates on each memory access, it is the perfect place to add special hardware support for certain operating system functions that are not strictly related to address translation. The most important extras are memory protection, cache, and virtual memory support hooks. For example, by monitoring the three function code bits from the 68000, the MMU can divide the CPU's address space into user- and supervisor-level instruction and data areas. Thus, while you debug a program, the MMU can trap unauthorized (usually unintentional) attempts to access reserved system functions such as memory-mapped I/O or interrupt vectors. In this case, the MMU hardware ensures that a bug in a program does not hang the system.

Table 1: A summary of memory management units.

Device	Manufacturer	Translation	CPU Supported
68451	Motorola	Segmented	68008/00/10
68905	Signetics	Segmented/Paged	68000/10
68070	Signetics/Philips	Segmented/Paged	Integrated 68000
68910	Signetics	Demand paged	68010
68920	Signetics	Demand paged	68020
68461	Motorola	Demand paged	68010/20
68851/MMB	Motorola	Demand paged	68010/20
68851	Motorola	Demand paged	68010/20

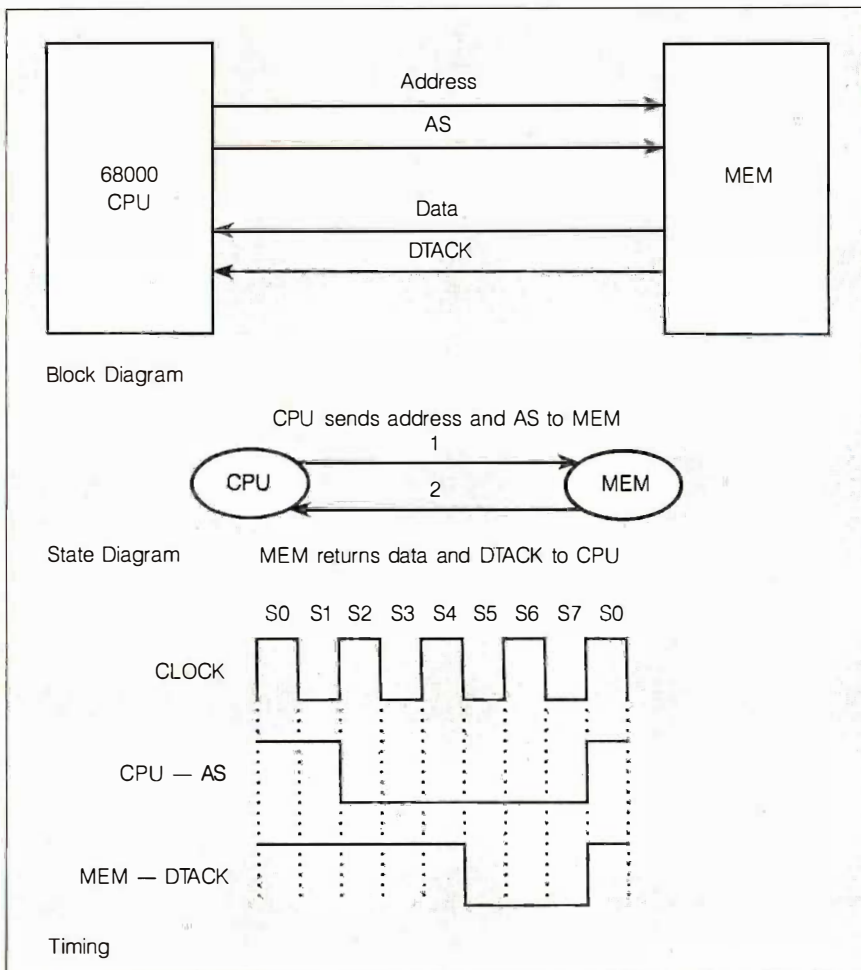

Figure 1: A 68000-based system without an MMU.

13-bit offset into one of 2048 pages. Physically, memory is divided into 2K pages with a fixed size of 8K bytes.

Although several popular 68000/68010 systems have been built by simply implementing the segment table with high-speed static RAM, such an approach does not fit into 32-bit 68020 designs very well. If the lowest 12 lines are used for the page index, there are 20 lines left. This implies that the segment table RAM must hold 1 megabyte of page numbers.

Since pages have a fixed size, this type of translation is susceptible to internal memory fragmentation. This means that some segments will likely include memory that is unused. For example, suppose that a program needs 1K byte of storage for its data. When run, the system assigns the program one 4K-byte segment. The other 3K bytes become a memory fragment that cannot be used by any other program. Most paged systems include at least two levels of translation and a smaller page size that reduces such internal fragmentation.

A simple trick, however, can increase the capabilities of this approach. The segment table RAM can be wider than the segment number to provide additional control bits, and from the physical address bus, these control bits cannot be distinguished from normal 68000 control lines. So these extra bits can be used as address lines, and in fact this technique has worked to extend the addressing capability of CPUs ranging from the 6502 to the PDP-11. Other uses for these bits include memory protection attributes, virtual memory paging indicators, and cache inhibit mark bits.

SEGMENTED TRANSLATION

In theory, segmented translation should be more efficient since most memory requests are not integer multiples of some fixed-size page. The upper bits of the address are called the segment number and the lower bits are called the segment displacement or offset (figure 4). The segment number is used to address a table of descriptors. The descriptor includes a base address, which is the starting address of the segment in physical mem-

ory. The descriptor also includes the length of the segment. The segment offset should be smaller than the length; if it is not, the memory cycle is aborted and an error is indicated. Assuming there is no error, the translation is completed by arithmetically adding the segment offset to the base address. Physical memory can now be divided into 256 variable-size segments. Each segment can be from 1 to 64K bytes long.

Although variable segment size allows memory allocation to fit memory requests better, it leads to another problem called external fragmentation. This problem, which is unique to

segmented MMUs, occurs when variable-size segments leave holes in physical memory that are too small for practical use. Several algorithms have been developed to simplify allocation in segmented systems and are described by Baer and Knowlton (see the Bibliography).

DEMAND-PAGED TRANSLATION

As CPU buses become wider, the amount of memory required to store page tables or segment descriptors becomes larger. This in turn increases the cost of the MMU and the overhead associated with task switching.

(continued)

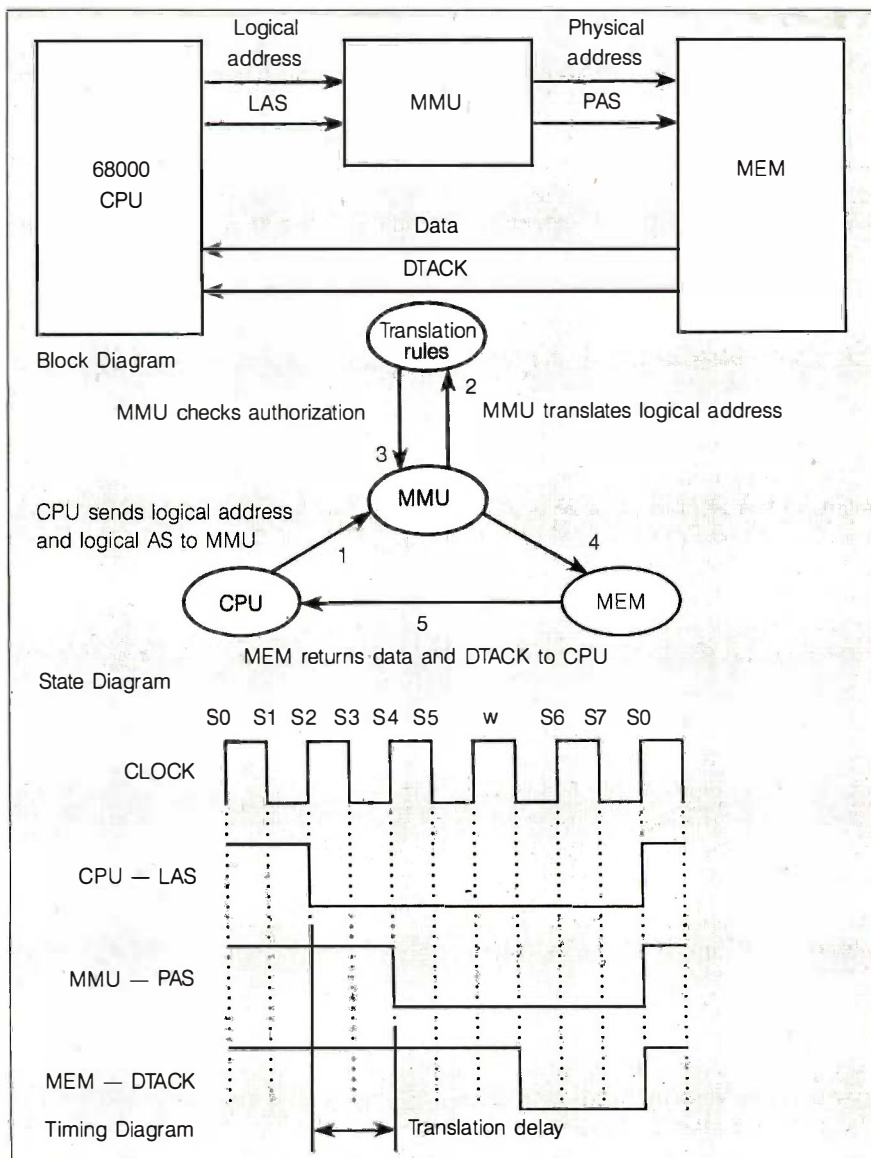

Figure 2: A 68000-based system with an MMU.

14 Intensive On-Line Users At Same Time?

Accessing a Common Data Base?
No Waiting At The Terminal?
No Performance Degradation?

YOU BET!

With CompuPro's Multi-Processor
MP14™

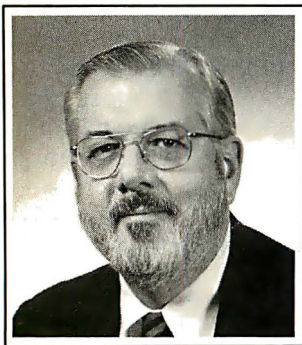

Bill Godbout, architect of the CompuPro MP14, says,

"The only way to get this kind of performance is to build it in, chip by chip. That's what we've done. The MP14 contains 8 separate 10 MHz Intel 286 and 186 CPUs, all processing at the same time. It has 6.5 megabytes of high-speed no-wait-state RAM. And it has 80 megabytes of buffered high-speed hard disk storage."

Here's the best part: With the same operating system, the same application software, you can start with the \$5,995 CompuPro 10 Plus™ (4 intensive users at the same time), move up to the \$18,995 CompuPro MP14, and go way beyond that to the CompuPro MP42™ (42 intensive users on-line at the same time, 24 separate 286 and 186 CPUs, 19.5 megabytes of RAM, no waiting, no performance degradation, \$49,995!).

These superb multi-processor systems are completely tested, are operating today at customer sites, and will be shipped 23 days after receipt of order. The MP14 is available through CompuPro's 127 dealers. Third party maintenance is available through Sperry Corp.

The MP14 could be the answer to your hardware problems. Call today, (415) 786-0909, for the complete story of this remarkable multi-processor system, and the telephone number of your nearest CompuPro dealer. OEMs and VARs who wish to port their applications to the MP14, please contact Bill Godbout.



Trademarks: MP14, MP42, 10 Plus, CompuPro: Viasyn Corporation.

MEMORY MANAGEMENT UNITS

The demand-paged MMU provides support for 32-bit microprocessors by allowing translation tables to be stored in main memory (figure 5). When the system initializes, the CPU writes the translation tables into main memory and then tells the MMU where they are by writing a pointer into a control register. The MMU includes bus control logic that allows it to search the tables and find the correct translation information. To avoid searching the tables for each translation, the MMU maintains a buffer of recently used translation information in a small cache memory called a translation lookaside buffer (TLB). Thus, once the tables are established, the MMU can translate any logical address without advance warning from the CPU (translation on demand). This arrangement also means that the MMU will only take time to fetch those descriptors that are actually used by a program; in a timeshared, multiuser system this method is usual-

ly more efficient than loading all the descriptors each time the program runs.

When a demand-paged MMU finds the translation information in its TLB, it translates the logical address into a physical address. If the translation information is not in the TLB, the MMU must back the CPU off the bus while it searches the translation tables in the main memory. This search process is referred to as a table walk. At the end of its table walk, the MMU writes the new descriptor into its TLB and tells the CPU to retry the access.

Although the demand-paged MMU provides an elegant solution to a difficult problem, the table walk process is slow. A typical table walk will cost the CPU 20 or more wait states. This means that the performance of the MMU is governed by the percentage of times that it finds the needed information in the TLB—the TLB hit rate. If the CPU includes an efficient cache memory, the TLB hit rate may vary

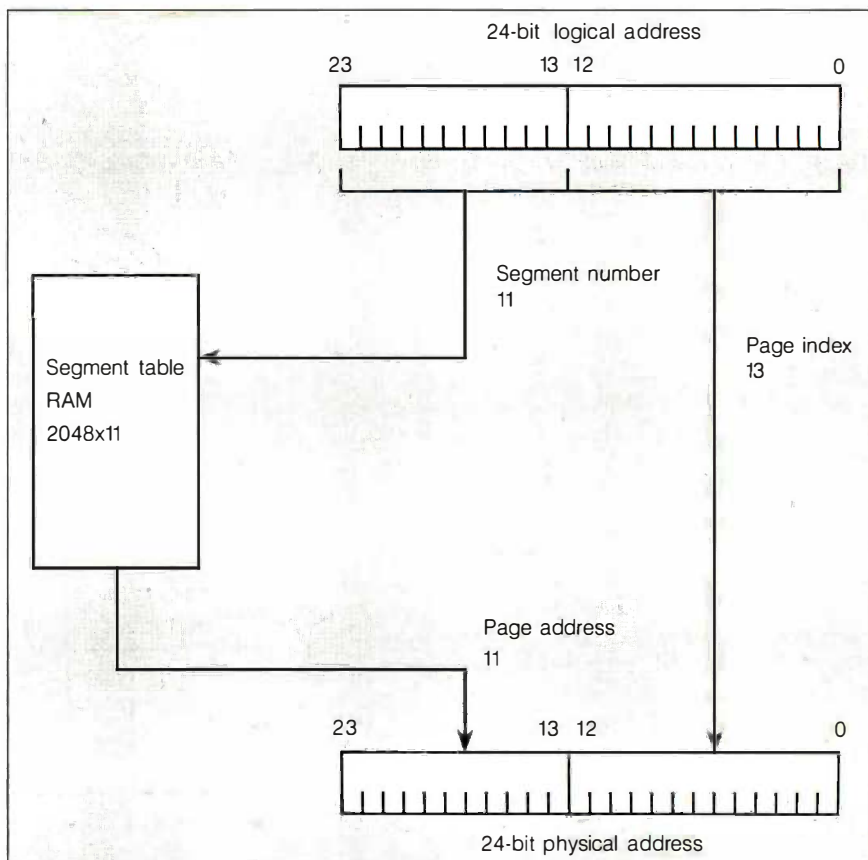

Figure 3: In a paged translation the upper bits are called the segment number and the lower bits are called the page index.

MEMORY MANAGEMENT UNITS

well become the factor that limits system performance.

If you plan to include an MMU in your next design, you must match the CPU and MMU combination with the overall system architecture and cost. For each possible MMU design alternative you must consider hardware and software issues. The most important hardware issues include how to minimize translation delay, how the MMU should signal error conditions to the CPU, and how to reduce hardware overhead related to a software task. Of course, the nature of these issues depend on whether you are using a 68000, 68010, or 68020.

In typical systems, a discrete paged MMU will support a simple operating system or real-time executive in a small single-user or embedded control system. Segmented systems have been used in large computers for many years, but the advantages are probably not worth the additional complexity in a small system. The

demand-paged memory system provides the best features of both paged and segmented systems and has become the standard for multiuser UNIX machines.

MMU DESIGN OPTIONS

Given an understanding of the MMU's theory of operation and the system design considerations, there remain the actual design implementation options. The first and most obvious option is to not use an MMU at all. That's exactly the design decision made for the Apple Macintosh, the Commodore Amiga, and the Atari 520ST. Although the graphics interface used by these machines, which includes multiple windows and desk accessories, may give the impression the systems perform multitasking quite naturally, none of these systems includes any MMU hardware. Instead, they place the burden of memory management on application software. In each case

(continued)

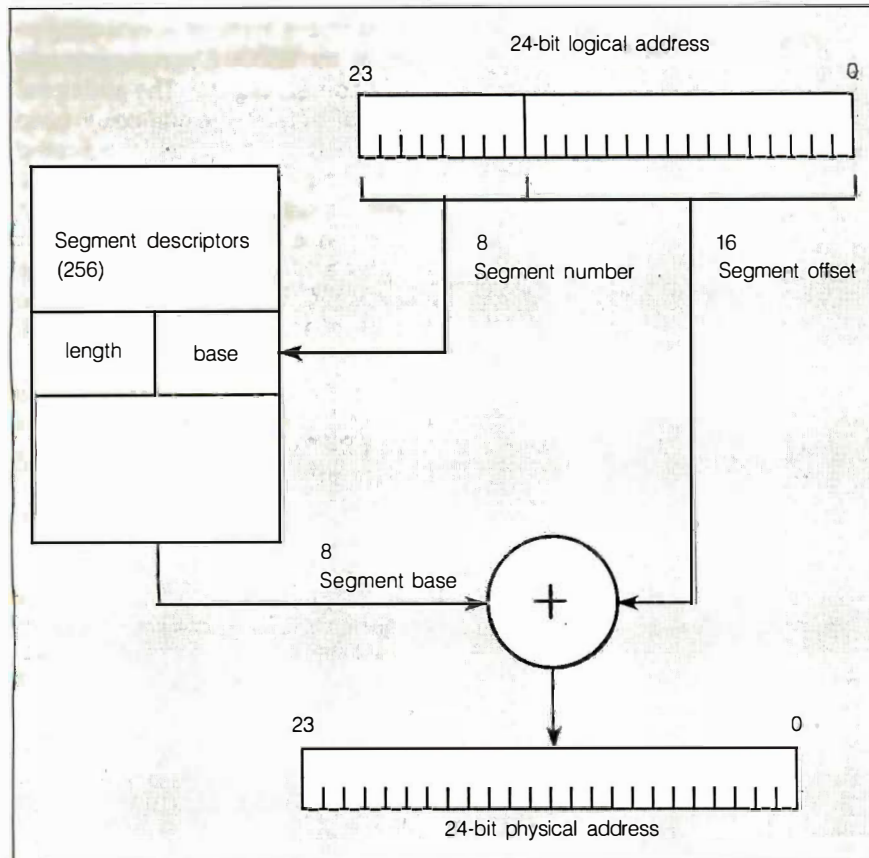

Figure 4: In a segmented translation the upper bits are called the segment number and the lower bits are called the segment displacement or offset.

Boost cursor speed. Stop cursor run-on.

With all the recent hoopla over performance, it's ironic that two of the PC's ergonomic deficiencies have been overlooked — its slow cursor, and the tendency of the cursor to remain in motion (run-on) after a cursor key has been released. Finally, the solution — Cruise Control™ from Revolution Software.

Cruise Control is a new productivity tool for serious PC users. It boosts cursor speed, typically by 3-5 X. It eliminates annoying cursor run-on. And it adds hands-free cursor navigation to any application.

If you use 1-2-3, Symphony, dBASE, Reflex, or Paradox, you need Cruise Control's Anti-Skid Braking. Here's what the leader of one Lotus users group said about Cruise Control:

"Once I used it, I wanted it! Excellent idea. Very practical. One of the best programs ever sent to us for review!"

If you use Word Perfect, MS-Word, Q&A, DisplayWrite, MultiMate, WordStar 2000, Framework, PC-Write, or SideKick, you need Cruise Control's Screen Runner, the high-performance, adjustable-speed cursor.

Cruise Control's namesake feature takes the drudgery out of paging through data base records, long documents, and large spreadsheets. It lets you repeat any key, hands-free — at the speed of your choice.

And there's more. A Chronometer "types" the time or date into your application at the current cursor position. The keyboard-controlled Screen Dimmer protects your privacy. The programmable Auto-Dimmer extends the life of your display screen.

Compatible with thousands of today's popular programs, including Lightning, SuperKey, and Ready!. Uses only 3K RAM. For DOS 2.0 or later. Not copy-protected. No risk, 60-day money-back guarantee.

Cruise Control™

From now until 12/31/86:

Only \$29.95.

Call now to order by credit card (VISA/MC/AX):

201-366-4445

Or, mail \$29.95 plus \$3.50 shipping and handling to:

Revolution Software, Inc.

715 Route 10 East • Randolph, NJ 07869

MEMORY MANAGEMENT UNITS

the designers have provided a real-time executive with a set of low-level interface routines and a complex set of so-called gentlemen's agreements to provide multitasking. For example,

an application running on one of these machines must understand when and how to call low-level routines for tasks such as memory allocation. It is also up to the application

to decide what to do if those routines cannot allocate the requested memory.

Also, when a program runs on one of these machines, it has access to all system resources, and a programming error can easily write over any of the other programs in memory including the operating system. This is usually a fatal situation to the system, requiring a power reset. Even a modest amount of MMU hardware could improve the performance and reliability of these machines by reducing the amount of memory management the operating system has to perform and by providing memory protection in hardware.

A paged MMU can also be built using discrete logic and high-speed static RAM to hold the segment table. This approach was very common in early 68000-based multiuser systems. The basic paged-translation concept is usually extended to two levels (figure 6). In this approach, the logical address is divided into three fields. The segment number is extended to include the 68000 function code bits and a context register. The additional field, called the page number, is used to address the page table indicated by the segment table output. Most operating systems set up the segment tables once, then use the context register and page tables to allocate memory for each task. The page tables are small enough that they can be paged to main memory when a task switch occurs.

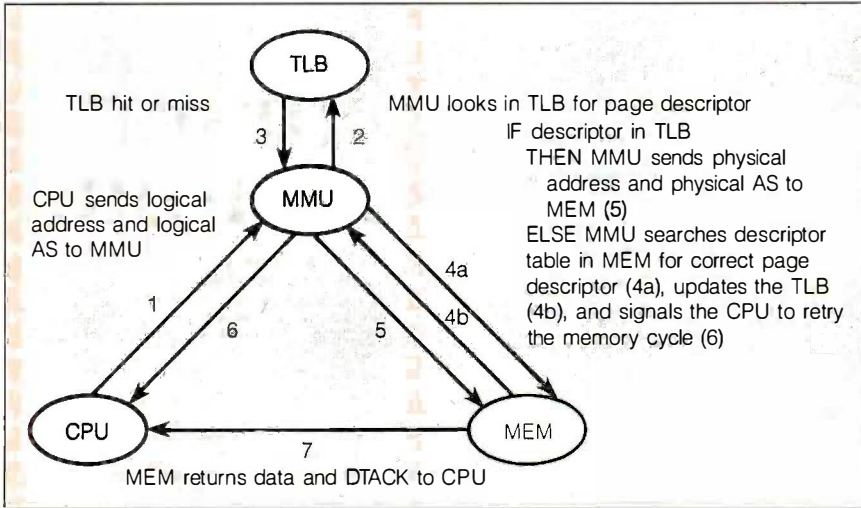

Figure 5: Demand-paged translation state diagram.

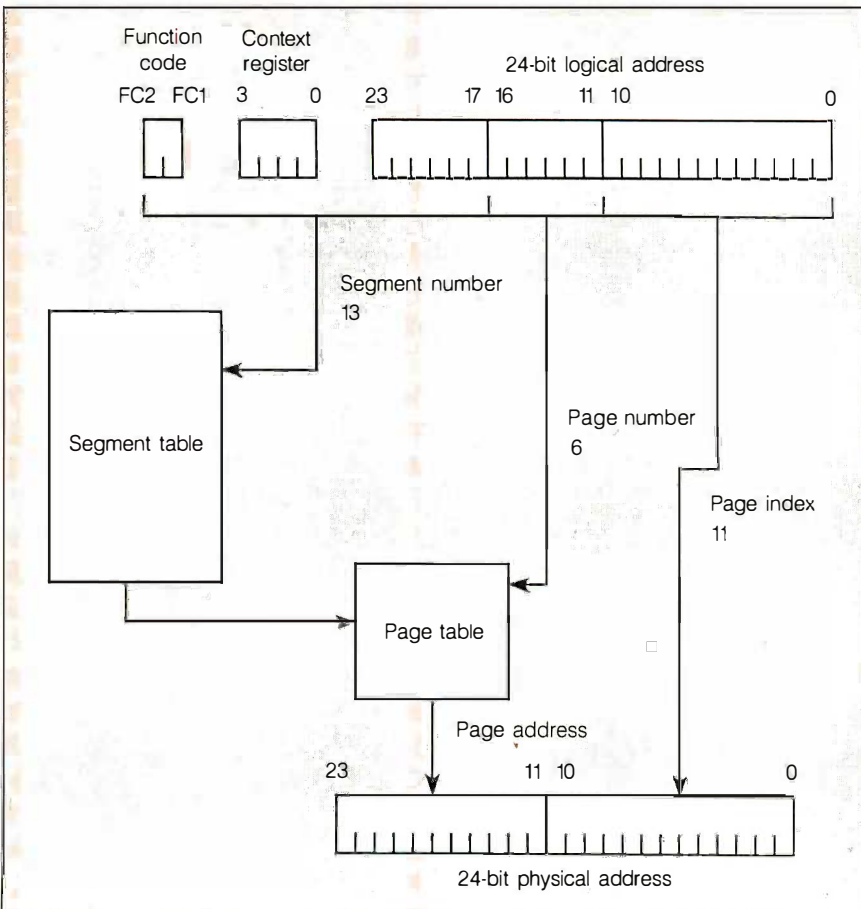

Figure 6: Two-level paged translation.

THE 68451 MMU

Shortly after the first 68000 CPU chip made its debut, the Motorola 68451 appeared. It was, in fact, one of the first monolithic MMUs available to system designers. The 68451 is a segmented MMU that comes packaged as a 64-pin DIP (figure 7). It includes 32 segment descriptors that partition memory into variable-size segments. Each of these descriptors also includes an 8-bit status register that provides support for a virtual memory architecture.

There are several serious limitations with this device, however. The biggest problem is that 32 descriptors are not enough. The 68451 includes special

MEMORY MANAGEMENT UNITS

lines that allow several chips to be chained together to expand the number of descriptors, but since the MMU still costs almost twice as much as the CPU, this is an expensive option. The 68451 is also relatively slow. Typically, translation requires more than one wait state (especially in a multi-MMU system), and if a task switch requires CPU intervention (and most do), the overhead is greater than that of a simple paged system. The 68451 also lacks support for CPU cache memory or the 32-bit 68020. Since all of these problems have been resolved with a new Motorola MMU chip, the 68851, the 68451 will probably not be used in many new designs.

If you are porting an operating system to a machine that does use this device, you should consider using the binary buddy memory allocation algorithm as described by Knowlton. This algorithm should allow you to take advantage of the variable segment size while reducing fragmentation and operating system memory allocation overhead.

THE 68905 BMAC

The 68905 basic memory access controller (BMAC) is the first in a series of ambitious announcements by Signetics and its parent company, Philips. The BMAC integrates MMU and cache control functions for

(continued)

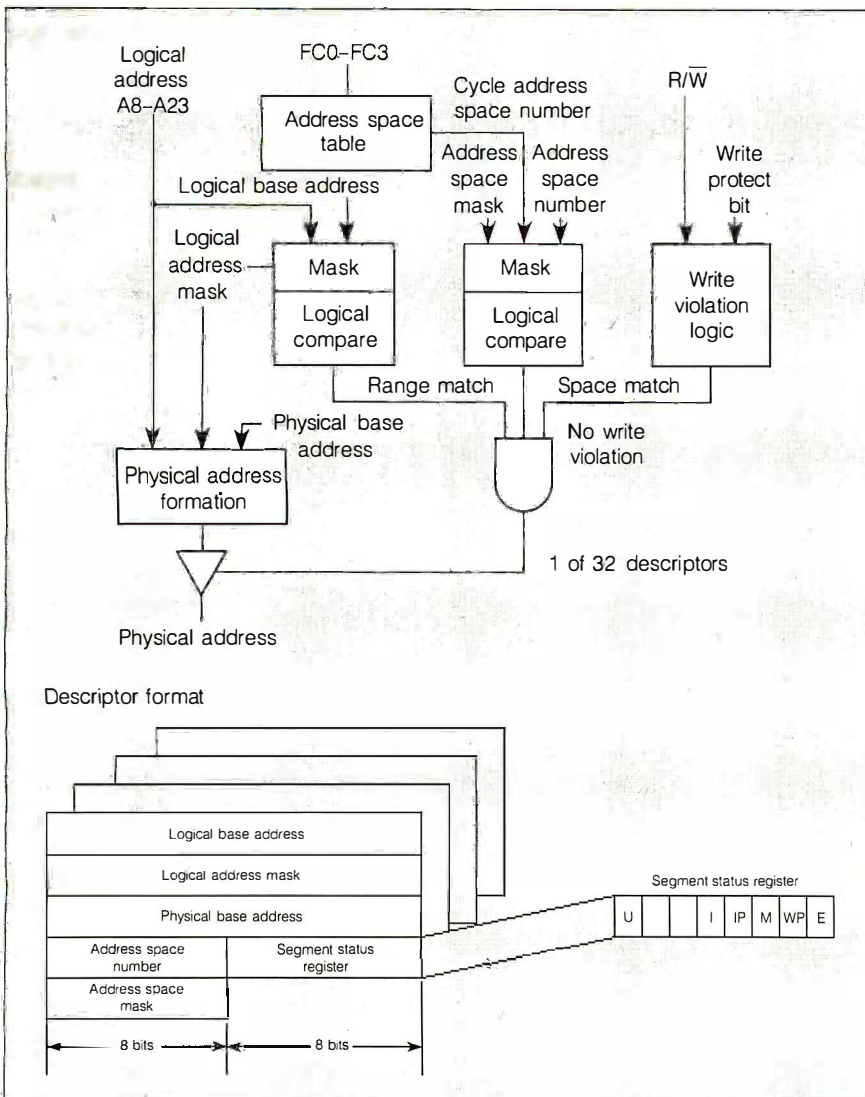

Figure 7: 68451 MMU.

MicroCom Systems OUTSTANDING SOFTWARE

For IBM PC's and Compatibles

\$350 PER DISK

SMALL QUANTITIES

\$300 PER DISK

FOR TEN OR MORE

\$1 OFF 5 DISKS OR MORE WITH THIS COUPON

- CAD 1** — Altamira, an object oriented CAD program, and Supergraph 3 Color gr. req'd.
- COMM 1** — The ever popular QMODEM 2.0E modem communications program.
- COMM 2** — PROCOMM 2.3, an excellent modem program with terminal emulation.
- COMM 3** — Communications utilities to be used with QMODEM or PROCOMM.
- DATABASE 3** — The Phbase relational database manager with query language.
- FINANCE 1,2** — (2 disks) PC-Accountant and a personal finance manager.
- GAMES 1** — Chess, 3-D Packman, Kong, Spacewar, Janitjoe, and more. Color gr. req'd.
- GAMES 2** — Qubert, Pango, Centipede, Monopoly, Zoarre, and more. Color gr. req'd.
- GAMES 3** — Blackjack (you set rules), Arm Chair QB, and Empire (war game).
- GAMES 4** — Star Trek, the original Colossal Caves ADVENTURE, and Castle.
- GAMES 5** — The HACK adventure game from the universities. Like Rogue.
- GAMES 6** — Pinball, Othello, Dragons, Sopwith (fly one), and more. Color gr. req'd.
- GAMES 7** — Round42 (16 color graphics), Backgammon, Risk, and more. Color gr. req'd.
- LANGUAGE 2** — The renowned SMALL-C compiler and a C interpreter!
- LANGUAGE 3** — 8086/8088 assembler, disassembler, and tutorials.
- LANGUAGE 4** — 370 assembler language on the PC. A must for IBM 370 users.
- LANGUAGE 5** — Turbo Pascal interactive debug, pop-up help, formatters, etc.
- MUSIC 1** — Many clever tunes, and an excellent color graphics music editor.
- ORGANIZER 1** — DESKMATE, a sidekick clone, and the JUDY calendar program.
- ORGANIZER 2** — Menu driven project management using critical path scheduling.
- ORGANIZER 3** — The PC-OUTLINE windowing outline editor/thought organizer.
- PICTURES 2** — High res digitized graphics pictures. Color graphics required.
- PINUP 2** — Provocative high res digitized graphics pinups. Color graphics required.
- PRINTER 1** — Font and sideways utilities, spoolers, banner makers, and more.
- SPREAD 1** — The PC-CALC spreadsheet program.
- UNIX 1** — A Unix command shell and various Unix commands for DOS. Emacs, etc.
- UTILITIES 1** — A collection of invaluable general purpose DOS utilities. A must.
- UTILITIES 2** — More invaluable general purpose utilities including NEWKEY.
- UTILITIES 3** — A comprehensive set of debugging and diagnostic utilities.
- UTILITIES 4** — The Ultra File Utilities; Norton-like utilities for diskettes.
- WORD 2** — Waterloo Script (like IBM's SCRIPT) text formatter for the PC.

— NEW (LATEST) RELEASES —

- COMM 4,5,6,7** — (4 disks) Latest RBBS Bulletin Board System 14.1A.
- DATABASE 1,2** — (2 disks) File Express 3.7, menu driven database manager.
- EDUCATION 1** — Interactive DOS tutorial for new PC users. Makes learning DOS painless.
- LANGUAGE 1** — The artificial intelligence languages LISP (XLISP 1.6) and PROLOG.
- LANGUAGE 7** — Pascal interpreter/compiler. Great for learning/debugging Pascal.
- PRINTER 2** — Letter quality print for your Epson compatible printer.
- WORD 1** — PC-WRITE 2.6, a powerful and complete word processing system.
- WORD 3** — The PC STYLE writing style analysis program.

Cost of Disks _____
CA Res 7% Tax _____
Ship/Handling _____
Total Enclosed _____

\$1.00

MicroCom Systems
P.O. Box 51657, Palo Alto, CA 94303

68000/68010-based systems into a single 84-pin grid array package (figure 8). You can program the BMAC to perform segmented or paged translation.

Most MMUs that support paging data between hierarchies of memory allow two levels that are usually dedicated to primary memory (RAM) and secondary memory (disk). The BMAC also supports a third level, local memory (RAM). Although most operating systems do not currently support this third level, local memory could be used to provide improved performance in a multiprocessor system. Using this local memory would

provide fast access to private data structures.

The BMAC also provides support for a logical bus cache memory. Placing the cache on the logical bus allows translation and cache searches to occur in parallel, but in order to avoid cache coherency problems, care should always be taken to flush the cache at each task switch. Although a logical cache is fast, it may not, however, be transparent to the operating system.

Signetics has also announced the 68910 and 68920 memory access controllers, or MACs, that extend the BMAC design by including a micro-

controller that effectively provides demand-paging capability for 68010 and 68020 systems.

THE 68461 MMC

Shortly after introducing the 32-bit 68020 CPU chip, Motorola announced its plans to develop a demand-paged virtual MMU, which would support multitasking, multiuser environments such as UNIX. Unfortunately, the new MMU chip was not ready in time to be shipped with the first CPUs. Recognizing the need for MMU support, Motorola made the 68461 memory management controller (MMC) available as an interim solution—until the single-chip 68851 paged MMU is available.

The 68461 is fast; it's built with Motorola's 2800-series bipolar gate array, and it can translate a 16-MHz 68020 access in one wait state. The MMC is housed in a 147-pin grid array package, which requires a heat sink. The MMC does not include everything required to implement a demand-paged MMU. To use this device, you must use external logic to implement the TLB function. A single-set-associative TLB can be built with 15 or 16 external chips (figure 9). Even this simple TLB architecture, however, offers a hit rate in the UNIX environment of better than 90 percent, which is high enough to provide good system throughput.

An MMU incorporating the MMC can provide demand-paged memory support for either the 68010 or the 68020. It includes the extra control bits that are required for memory protection, virtual memory, and CPU cache memory functions. It maintains its translation descriptors in a tree structure in main memory. The translation process divides the logical address into three fields, which are used to search three levels of descriptors (figure 10). Limit fields at each level of the table reduces the total amount of RAM needed to hold the descriptors. Yet a typical system requires about 128K bytes for the MMU. Protection bits at each level of the table can provide read and write access protection based on the function codes. For example, you can configure a page to allow supervisor read

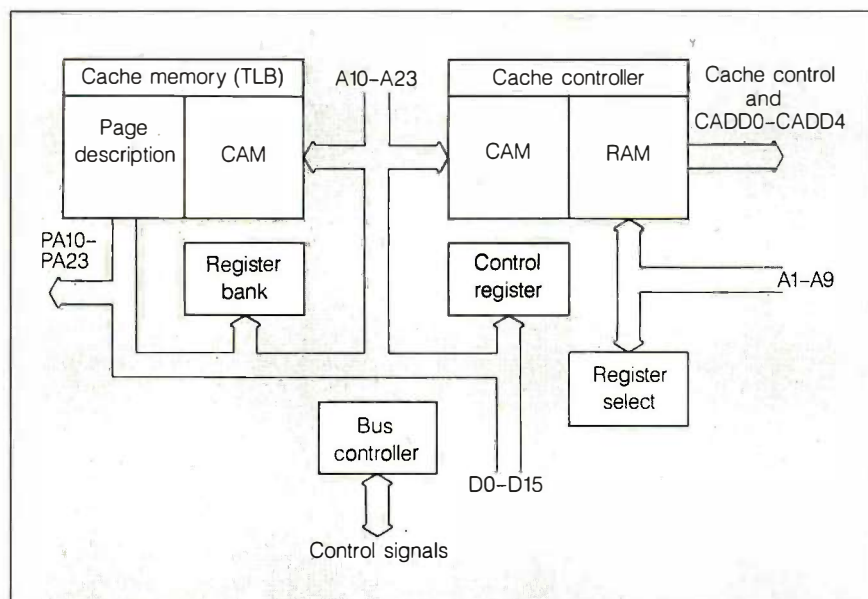

Figure 8: 68905 block diagram.

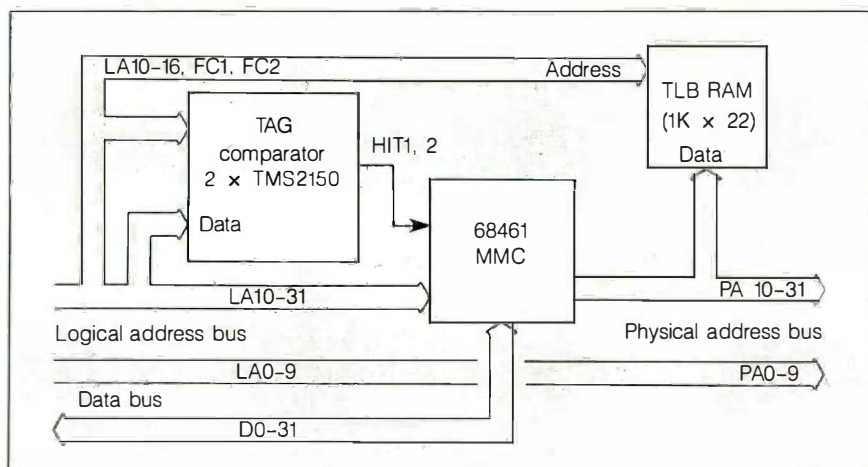

Figure 9: Block diagram of MMU using 68461.

and write access while a user mode write will generate an error.

THE 68851 PMMU

The Motorola 68851 paged MMU, or PMMU, provides complete demand-paged MMU support in a single chip. This advanced design includes a 64-entry fully associative TLB that is more efficient than the single-set design of the 68461 MMC. Since the PMMU attaches to the 68020's coprocessor interface, its registers are extensions to the existing programmer's model of the CPU. The CPU/PMMU combination adds new MMU instructions to the existing 68020 instruction set. While all the other devices discussed here decode the MMU's control registers as memory-mapped I/O, this coprocessor approach integrates the PMMU into the programming environment. For example, a single instruction allows a conditional branch based on the condition of the PMMU status register.

The PMMU's translation mechanism is similar to the MMC, but the PMMU offers more flexibility. The PMMU page sizes can range from 256 to 32K bytes, and page tables are not fixed at three levels. The PMMU can partition the logical address into one to four fields, each of which serves as an index to the table at that level.

PMMU hardware includes arbitration logic for both the logical and the physical bus. A separate pointer register is provided for an alternate logical bus master, such as a DMA controller. In a multiprocessor environment, PMMU's can share descriptor tables in main memory, reducing storage requirements. The PMMU offers full support for system functions such as virtual memory, cache memory, and a floating-point coprocessor.

Besides using the CPU function code bits for memory protection, the PMMU adds up to eight levels of access authorization. This concept is also extended into the 68020 call module (CALLM) and return from module (RTM) instructions so that authorization can be verified at the subroutine level.

For the faint of heart, Motorola also offers the 68461 and discrete TLB

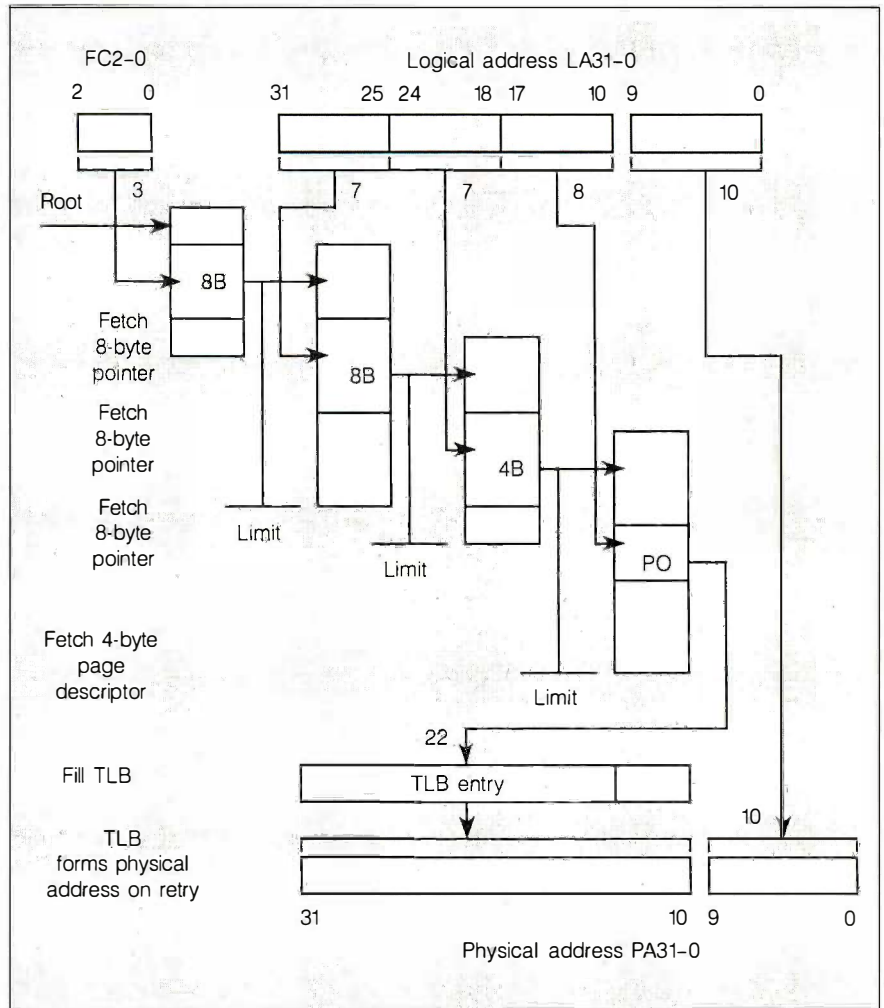

Figure 10: Demand-paged translation.

already assembled on a printed circuit board, which is pin-for-pin compatible with the 68851. You can plug this board-level product, the 68KVMMB851, into your next 68020 design to provide MMU support until the 68851 is available in production quantities.

FUTURE TRENDS

It's difficult to determine which has advanced more rapidly, the microprocessor or the MMU. Certainly the supermicrocomputers available today depend on the MMU just as much as the microprocessor to provide high performance for a lower-than-ever cost per user. If history is any indication, IC manufacturers will continue to integrate more and more system functions onto silicon.

Integrated units that combine the

68000 CPU and a simplified 68920 MMU in a single device, such as the recently announced Signetics/Philips 68070, are sure to abound in the future. The advantages of putting the CPU and MMU on the same silicon include faster translation, lower pin count (and therefore cost), and improved software portability. Moreover, by offering silicon that can simplify the layer of software required for multitasking, this device is sure to find its way into the next generation of mouse-and-windows machines. ■

BIBLIOGRAPHY

- Baer, Jean-Loup. *Computer Systems Architecture*. Rockville, MD: Computer Science Press, 1980.
- Knowlton, Kenneth C. "A Fast Storage Allocator." *Communications of the ACM*, vol. 8 (October 1965), pages 623-625.

“I ♥ American”

COMPU-BRUSH™ EGA/CGA GRAPHICS CONTEST

American MOUSE



TWO CHANCES TO WIN
A GRAND PRIZE OF
\$2,000 + American 286-A
PERFECT SYSTEM WITH MONITOR

FREE SOFTWARE!

Introducing Compu-Brush—an electronic paintbrush program which allows you to capture any graphic screen of another program to enhance its presentation with a variety of colors, text styles and fonts. Create your own library of frequently used graphics and save it with the SMALL command using 50% to 90% less disk storage space. Additionally, you may develop a computerized “slide presentation” for a professional and effective demonstration.

Compu-Brush will be included in every American computer system or other American hardware products, including the American Mouse—FREE!

\$35,000 IN CASH AND PRIZES! Create a design using the “I ♥ American” slogan with your Compu-Brush software and you could win a grand prize of \$2,000 and an American 286-A (AT compatible) Perfect System with a color monitor. Other prizes include American (IBM AT/XT® compatible) systems with color monitors.

DOUBLE YOUR CHANCES! Phase One of the “I ♥ American” graphics contest concludes at Comdex/Spring '87 in April. Keep the creative flow going and enter Phase Two of the “I ♥ American” contest to conclude at Comdex/Fall '87 in November.

Look for specially marked packages of American systems and American hardware products and create winning graphics with your FREE Compu-Brush!

FREE
90 day
On-site
Service*

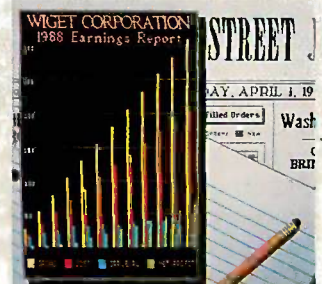

CRT (EGA) DISPLAY USING COMPU-BRUSH

American
COMPUTER & PERIPHERAL, INC.

Corporate Office: 2720 Croddy Way, Santa Ana, CA 92704 USA
Tel: (714) 545-2004 • Fax: (714) 545-2146 • TELEX: 3710523 AMERICAN
Northeastern Office: 830 Busch Court, Columbus, OH 43229 USA
Tel: (614) 846-5433 • Fax: (614) 846-7656

Contest rules and entry forms may be obtained from AC&P.
Deadlines for receipt of entries are April 1, 1987 for Phase One and November 1, 1987 for Phase Two.
Void where prohibited, licensed or taxed by law.
IBM AT and XT are registered trademarks of International Business Machines Corporation.
*On all American 88 and 286. Effective October 1, 1986. Subject to Intellogic Trace geographic restrictions and regulations.

Inquiry 21 for End-Users. Inquiry 22 for DEALERS ONLY.



THE STATE OF SOVIET MICROELECTRONICS

*Is the Soviet
Union doomed to lag
behind the West?*

When microelectronic technology and personal computers first appeared in the West 15 years ago, the Soviet Union was building the versions of third-generation IBM mainframe computers on

which it still relies. While the East Bloc covertly acquired minicomputers for reverse engineering, IBM overtook Apple in the personal computer market, and the first 32-bit microprocessors put the power of a minicomputer on a single chip. But only now are microcomputers becoming available to the children of those party members allowed to buy them.

To say the least, the Soviet computer culture is weak. Original and copied IBM PCs and Apple IIs are reserved for the state, military, and party elite. Packaged software is scarce, printers are poor, disk drives are rare, modems are virtually unobtainable, and there is no public digital data communication network.

Enthusiasm for personal computers is muted because East European copies of Western computers are unpredictable, inefficient, and garish in design, with their heavy gray or black metal cases, bright emerald-green phosphor screens, and sticky, unresponsive keyboards. The few office systems in the U.S.S.R. are based on CP/M and MS-DOS operating systems. Popular applications packages from the West such as WordStar and VisiCalc are available, but not with Cyrillic scripts.

In fact, the Soviet Union seriously lags behind and greatly relies on the West, according to Professor Seymour E. Goodman at the University of Arizona's Department of Management Information Systems (see refer-

(continued)

Paul Walton, a freelance journalist with an electronics background, is interested in the social, economic, and political influence of high technology. He can be contacted at 175 Swaton Rd., London E3 4EP, U.K.

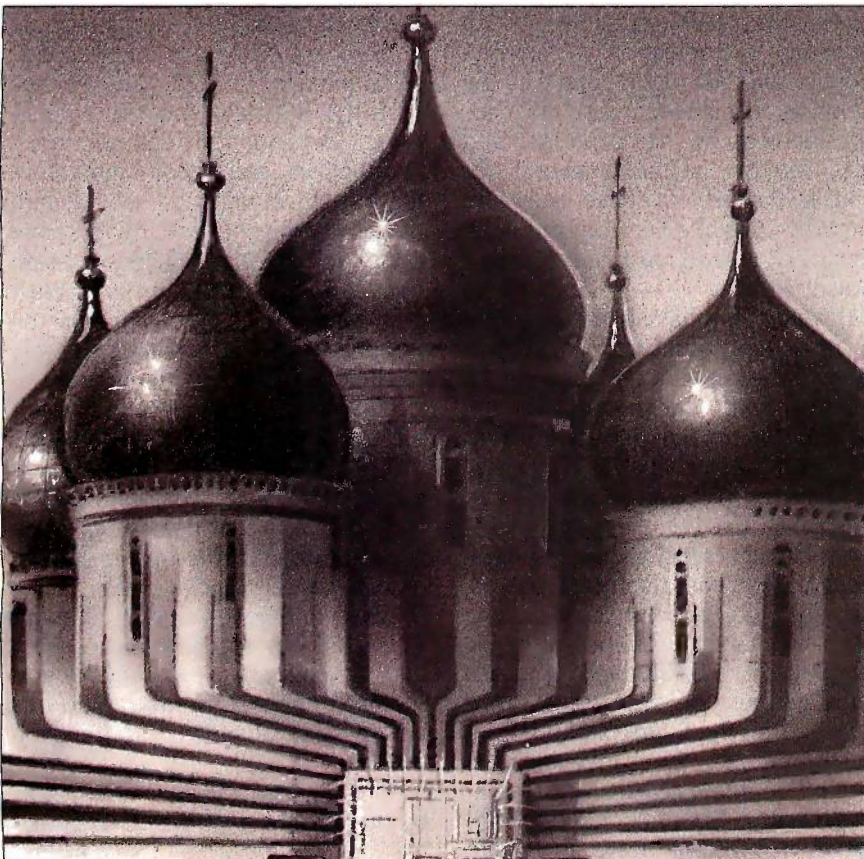

*The Soviets recognize
the need for small
systems, but so far
have failed to match
Western technology.*

ence 1). In effect, he argues, the Soviets go about things in entirely the wrong way. They decided to follow the West, ditching almost all indigenous developments in favor of copying—to the extent that they are sentenced to lag several years behind.

Goodman is roundly skeptical of the East Bloc's capabilities, yet other observers are more optimistic. A British study of Soviet microelectronics to 1982 states that the West has underestimated or even ignored Soviet accomplishments (see reference 2). Paul Snell from Birmingham University's Centre for Russian and East European Studies says that copying can bring rewards. Pentagon research on covert Soviet acquisition supports Snell's arguments. According to one study, the Soviets saved billions of dollars on military development costs by obtaining thousands of items for subsequent copying. As a result, their microelectronics industry made significant advances, which "reduced the overall Western lead... from 10 to 12 years in the mid-1970s to 4 to 6 years today" (see reference 3).

DEVELOPING A NEW INDUSTRY

The Soviet electronics and computer industry is highly diffuse, controlled by the defense-oriented Military-Industrial Commission (VPK) and spread across several ministries. The State Committee for Science and Technology acts as the domestic policy-making body for a large domestic manufacturer and a few smaller subsidiaries, while the Council for Mutual Economic Assistance (CMEA), a body designed to ensure the socialist division of labor, coordinates Warsaw Pact activities on

research, standards, and production levels.

In practice each CMEA member country is charged with producing a different component part or microcomputer peripheral, and in each country a separate organization or factory might further subdivide production. Managing this system without access to computers is a nightmare. Parts are often mismatched, testing is poor, and software and systems are often left to the unfortunate end user to sort out.

This organization coped well enough with the supply of mainframe and minicomputers, copying IBM and DEC hardware and software, with satellite states manufacturing peripherals such as disk drives, printers, and terminals. But it failed to track innovations in microcomputers until the late 1970s. The Soviets then recognized the need for small systems, but so far have failed to match Western technology.

There has been no competitive customer demand, entrepreneurial spirit, or free exchange of ideas to match Silicon Valley. For instance, the output of the main VPK-run factory, which produces microelectronics, minicomputers, and microcomputers in the Zelenograd high-tech park 30 miles outside Moscow, has been reserved first for the military, second for GRU/KGB state security services, and third by special edict from the Politburo. Zelenograd has been closed to Soviet citizens.

Development has also been stifled by technological shortcomings. Small systems began as a development of minicomputer technology in the U.S.S.R., aping the development of PDP systems and later LSI board-level systems. Bit-sliced processor design was taken up, but the gains of LSI microcircuits could not then be realized. Sophisticated software was assiduously copied. But basic innovations such as simplified programming languages like BASIC were ignored.

Indigenous developments were quashed by the Soviet computer industry, despite the capabilities exhibited. (Centers of excellence exist: The Central Scientific Research Institute in Moscow designed 8- and

16-bit mini- and microcomputers, and the National Cybernetic Institute in the Ukraine developed a microcomputer DOS, which was dropped in favor of CP/M.) Copying was preferable because it was thought to be more reliable. It was perhaps essential when the Soviet authorities dictated that space and nuclear weapons programs must keep up with Western technology, which was growing many times faster. The bureaucratic party attitude became "West is best; East is least."

The party even declared a second space race, this time in computers. President of the Moscow Academy of Sciences and chief Soviet scientist Alexi Alexandrov said that despite the technology gap, and in the face of a technology embargo, the U.S.S.R. would go all out to catch up: "Have [the Americans] forgotten that problems of no less complexity, such as the creation of the atomic bomb or space rocket technology... [we] were able to solve ourselves without any help from abroad, and in a short time" (see reference 4). Brave words, but the reality is a little different.

According to Snell, an air of confidence returned to the Soviet computer industry in 1979. He even suggests that the industry could now progress independently. Microelectronics production has been mastered, thanks to an infusion of Western manufacturing equipment prior to the tough embargo introduced by President Ronald Reagan. In fact, direct copies now make up only part of the Soviet microelectronics inventory, and Snell adds that there are signs of ingenuity in the designs of the microelectronic devices he has studied.

The East Bloc is not standing still; the Soviet Union has established a commission to consider ways in which it can overstep the present technology gap and move directly from third- to fifth-generation technology. And CMEA is organizing a research and development program for the socialist member countries, and it is improving the standard of production facilities.

Hungary has unveiled its own ambitious project to develop VLSI cir-

(continued)

MICRO CAP and MICRO LOGIC put your engineers on line... not in line.

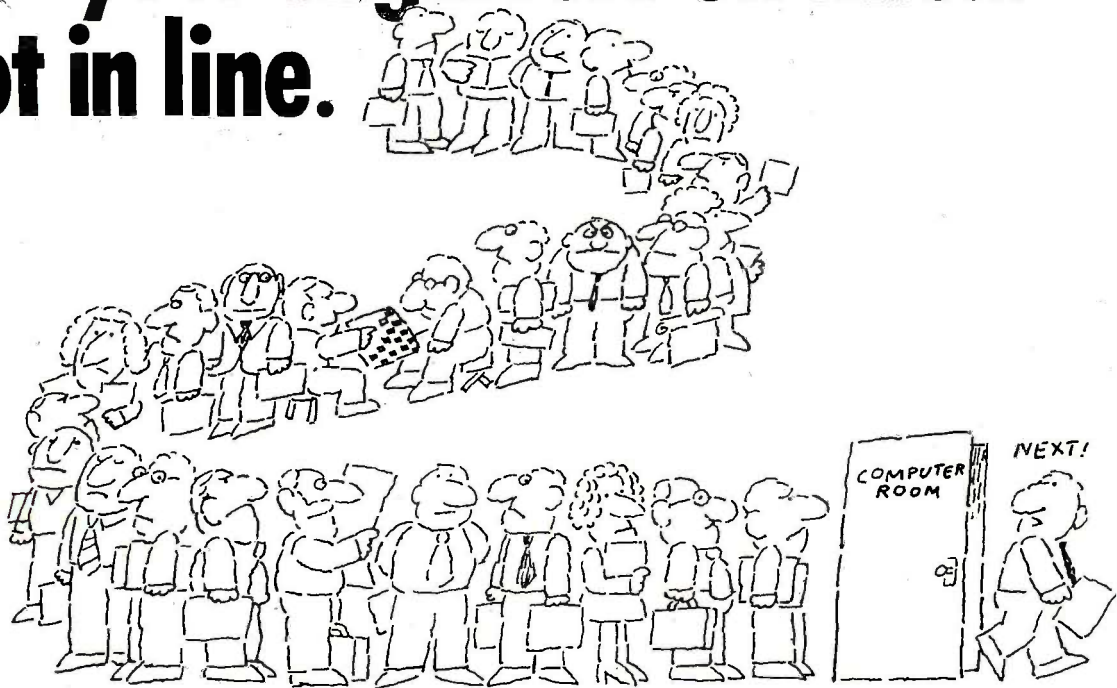

MY OWN WORKSTATION



How many long unproductive hours have you spent "in line" for your simulation? Well, no more. MICROCAP and MICROLOGIC can put you on line by turning your PC into a productive and cost-effective engineering workstation.

Both of these sophisticated engineering tools provide you with quick and efficient solutions to your simulation problems. And here's how.

MICROCAP: Your Analog Solution

MICROCAP is an interactive analog circuit drawing and simulation system. It allows you to sketch a circuit diagram right on the CRT screen, then run an AC, DC, or Transient analysis. While providing you with libraries for defined models of bipolar and MOS devices, Opamps, transformers, diodes, and much more, MICROCAP also includes features not even found in SPICE.

MICROCAP II lets you be even more productive. As an advanced version, it employs sparse matrix techniques for faster simulation speed and larger net-

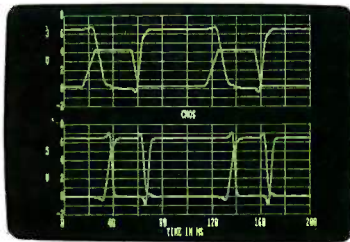

"Typical MICROCAP Transient Analysis"

works. In addition, you get even more advanced device models, worst case capabilities, temperature stepping, Fourier analysis, and macro capability.

MICROLOGIC: Your Digital Solution

MICROLOGIC provides you with a similar interactive drawing and analysis environment for digital work. Using standard PC hardware, you can create logic diagrams of up to 9 pages with each containing up to 200 gates. The system automatically creates the netlist required for a timing simulation and will handle networks of up to 1800 gates. It provides you with libraries for 36 user-defined basic gate types, 36 data channels of 256 bits each, 10 user-defined clock waveforms, and up to 50 macros in each network. MICROLOGIC produces high-resolution timing diagrams showing selected waveforms and associated delays, glitches, and spikes—just like the real thing.

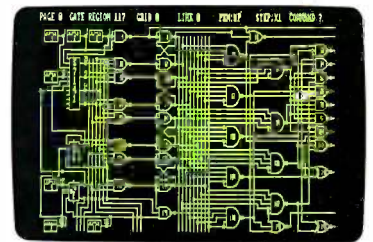

"Typical MICROLOGIC Diagram"

Reviewers Love These Solutions

Regarding MICROCAP... "A highly recommended analog design program" (PC Tech Journal 3/84). "A valuable tool for circuit designers" (Personal Software Magazine 11/83).

Regarding MICROLOGIC... "An efficient design system that does what it is supposed to do at a reasonable price" (Byte 4/84).

MICROCAP and MICROLOGIC are available for the Apple II (64k), IBM PC (128k), and HP-150 computers and priced at \$475 and \$450 respectively. Demo versions are available for \$75.

MICROCAP II is available for the Macintosh, IBM PC (256k), and HP-150 systems and is priced at \$895. Demo versions are available for \$100.

Demo prices are credited to the purchase price of the actual system.

Now, to get on line, call or write today!

Spectrum Software

1021 S. Wolfe Road, Dept. B
Sunnyvale, CA 94087
(408) 738-4387

Inquiry 322

DISCOVER LISP MACHINE PERFORMANCE WITH YOUR PC/AT AND GOLD HILL.

It's hard to believe that you can do serious AI development on a PC. But one look at the Gabriel Benchmarks (see chart) will convince you.

You'll see that Gold Hill's compiled GCLISP 286 Developer runs *faster* than the Xerox 1108, and approaches the speed of the VAX 750.

Put that performance together with the power of 3 5-Mbyte (that's

right, 15 MB!) AT-Optimizer memory boards and you turn your PC/AT into a *very* serious LISP development and delivery environment indeed.

This powerful programming environment includes:

- enhanced EMACS editor with over 150 commands including keyboard macros, LISP and text mode, and the ability to compile from the edit buffer
- debugging tools including step, trace, backtrace, pprint, break, and complete on-line help
- interface to C and Assembly language
- lexical scoping.

In addition, GCLISP 286 Developer supports Ethernet (GCL NET), graphics (Halo Graphics), and run-time delivery (GCL RUN).

If you want to get serious about AI development on *your* PC/AT, talk to Gold Hill today. We're the expert in AI on PCs.

For details about Gold Hill's GCLISP 286 Developer and a special offer, call toll-free:

1-800-242-LISP

In Mass.: (617) 492-2071

Gold Hill Computers, Inc.

163 Harvard Street

Cambridge, MA 02139

Inquiry 139

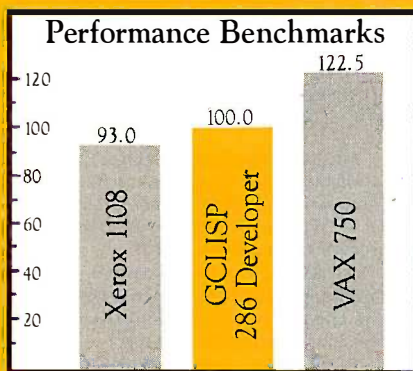

Gold Hill. The expert in AI on PCs.

*The results are found by taking the mean of the benchmark results from the performance and evaluation of LISP Systems by Richard P. Gabriel, normalized by the times of the GCLISP 286 Developer running on a COMPAQ Portable 286.

© 1986 Gold Hill Computers, Inc. GCLISP 286 Developer and GCLRUN are registered trademarks of Gold Hill Computers, Inc. PC AT is a trademark of International Business Machines Corp. Xerox is a registered trademark of Xerox Corporation. VAX is a trademark of Digital Equipment Corporation. Microsoft is a trademark of Microsoft Corporation. COMPAQ Portable 286 is a trademark of Compaq Computer Corporation. AT-Optimizer is a trademark of MA Systems.

cuits. It has developed a local micro-computer industry around the state-owned manufacturer Videoton and small software houses. And Hungary now has the capability to produce artificial intelligence systems using the Prolog language.

Poland was similar to Hungary before the present civil and economic clampdown. Small-scale enterprises were developing software and micro-computer-based systems for sale in and out of the East Bloc. Advanced fourth-generation software, especially in the field of database management, is a notable Polish achievement.

East Germany's state-owned Robotron is producing an office system and general computer line that matches Western suppliers like Wang or IBM, and the country has turned the precision camera-maker Zeiss to making display units and optical drives. East Germany is the largest East Bloc supplier.

Czechoslovakia, like East Germany, has the task of mass-producing a full range of microelectronic devices. That country's automated factories and skilled workforce tend to produce more reliable products than the U.S.S.R. Together, Czechoslovakia and East Germany are expected to produce 2 million ICs annually.

Bulgaria produces traditional magnetic storage media, including tape and disk drives, at the Beroe plant on the Black Sea. This plant also refined basic microelectronic production techniques to produce RAM chips.

Yugoslavia has historically had a strong telephone industry, and the semiprivate Iskra Associated Enterprise (IAE) has the job of producing advanced telecommunications products—digital switching, modems and multiplexers, and laser and satellite links. IAE also trades with the West, exporting \$106 million in 1984.

MANUFACTURING LIMITATIONS

Manufacturing is generally the big headache for all these countries—Soviet production techniques are way behind those in the West. (Czechoslovakia is more advanced in the production of some microprocessors, East Germany in making memory devices.) Manufacturing problems are

exacerbated by the logistics of reverse engineering, or the process by which copies are made of basic components. Goodman says, for example, that miniaturization of microelectronic circuits has made it more difficult to interpret the original design of microprocessors that cannot be bought directly by the U.S.S.R.

To make matters worse, Soviet scientists do not have the benefit of CAD/CAM. They cannot define a circuit by minimizing the distance between internal connections, so Soviet chips tend to locate similar functions together, regardless of the resultant inefficiency. Together with the aggravation in covertly obtaining all the component parts or information, even for a single device, the overwhelming efforts involved in reverse engineering do not yield comparable rewards.

The Soviets have generally shied away from the highest technologies such as LSI and VLSI, and sophisticated fabrication techniques such as that for CMOS (with the exception of a military-led initiative to develop GaAs production in space). A few VLSI devices, such as the KI801VEI 16-bit single-chip microprocessor, do exist, but they are the exception.

Instead the Soviets have concentrated on traditional design, fabrication, and packaging of traditional devices, such as bit-sliced microprocessors. This has meant that small systems are limited to the speed, capacity, and functionality of the very first microcomputers. (The Apple II-compatible Agatha, named after a favorite niece of Brezhnev, is perhaps an apt example of leading-edge Soviet products.)

Paradoxically, Soviet-designed 8-/16-bit, 16-bit, and 32-bit microprocessors exist. But these are short-run devices intended primarily for the military, for nuclear or space research, and for use in prestige factory automation and robotics projects. Mass-market microcomputers take a back seat.

The staple diet of homemade devices is supplemented with other copied devices including the Zilog Z80, Intel 8080, 8086, and 8088, and Motorola's 64K-byte static and dynamic RAM—all known to be in

The staple diet of homemade devices is supplemented with other copied devices.

large-scale (several thousands) production in at least three Warsaw Pact countries.

TECHNOLOGY EMBARGO

The Pentagon has successfully lobbied for tight export controls to restrict the trade in basic manufacturing capability. The argument is that U.S. products and know-how go into Soviet weapons systems, giving them an edge and saving R&D expenditure. One section of a report (reference 3) on the covert acquisition of computers and microelectronics fabrication equipment suggests that "nearly half" of the covert trade diversions fall into this category.

A catalogue of equipment obtained in one year during the early 1970s includes 30 sophisticated crystal pullers, 99 diffusion furnaces, 3 integrated circuit testers, and 10 mask aligners. The list for the following year includes 24 crystal pullers, 64 diffusion furnaces, 3 photorepeaters, 3 pattern generators, 3 epitaxial reactors, and an IC tester. Raw materials, too, are required by the U.S.S.R. By 1980—before export controls—the Soviets had purchased hundreds of tons of electronics-grade silicon.

The report alleges that integrated circuits are also obtained in great quantity—as many as 100 million circuits a year. Suppliers face stiff penalties under the U.S. Export Administration Act, but the trade still continues.

Export law (defined under the CoCom rulings and translated into law by each of the Western allies and Japan) allows certain small systems to be exported but denies others that are more powerful. It is illegal to export the IBM PC, for instance, but not the Commodore 64. A simple, single-user accounting package can be sold across the Iron Curtain, but not the

(continued)

multiuser version. And while a monochrome monitor is okay, a high-resolution color monitor is not.

Ambiguity in these laws, their complexity, and the lure of greater profits have conspired to produce "gray" exports to the Warsaw Pact. BK Dynamics estimates the value of hardware alone to be in the billions of dollars. In Europe and Japan many traders simply ignore export laws.

The trade in other component parts—drives or expansion boards, complete small systems, systems software and applications—is probably impossible to quantify given the ease with which products can be obtained. One U.S. export official in London says that this illegal trade is "a mist floating Eastwards: How can we grab mist?"

Another by-product of the embargo

has been increased Soviet efforts to coordinate computer research and development, improve manufacturing, and rely less on imports. Snell points out that *Pravda* (July 10, 1984) even says the Soviet Union benefited from the trade sanctions.

SOVIET OUTLOOK

To date, the Soviet Union has developed 15 distinct microprocessor

Table 1: *The Soviet microcomputers.*

Model	Processor	Bits	DOS and Programs	Major Uses
Elektronika-60	K581/K536	16	BASIC FORTRAN Assembler	Word processing, data storage, and accounting (a wide range of peripherals such as printers and extra terminals is available)
Elektronika-S5	K536	16	Assumed to have ported MS-DOS (2.0 or higher), MBASIC, etc., on to later machines such as S5-21	Multiboard and single-board microcontrollers, and single-chip, 16-bit microprocessors
Elektronika-NT	K587 or K1801VE1	16	MS-DOS 2.0 or higher Now porting CP/M-86	Largest selling micro for business use in USSR; designed at the Central Scientific Research Institute (TsNII)
Kristall-60	K80IK80	8	Intel 8080A look-alike chip running CP/M	Large seller, educational version available to schools
Agatha (or Agat)	K587	8	Supposedly running Apple ProDOS under a copy of the 6502 instruction set	Apple II copy, packaged in a single unit; small production run only; difficult to obtain Apple peripherals, software, add-ons, etc; popular with scientists and programmers.
Iskra	580 series chips	16	Direct copy of IBM PC; runs English PC-DOS, GW-BASIC, MicroCOBOL, and POP software packages (Cyrillic DOS being developed)	Very few Russian PCs have been made; copies are significantly slower, have poor (mono only) display, and consist of 5 system components (rather than 3); hard disk to 5 megabytes only; few peripherals and little or no add-ons

SOVIET MICROELECTRONICS

devices, including direct copies like the K580 (Intel 8080A), K589 (Intel 3000), and K1804 (Advanced Micro Devices 2900). The KR580IK80A microprocessor is a modified version of the Intel 8080A that even bears the U.S. part number (note the "8080A" in KR580IK80A). But the Pentagon report confirms that copying is getting more difficult, and so reverse engineering is expected to be less frequent in the future.

From the basic Soviet components, at least four major small system computers have been produced (table 1). These small systems are based on implementations of either CP/M or MS-DOS. These small systems conform to Western operation but are lacking in functionality and speed.¹ Although most are obtained only through work organizations, party members and local officials can buy home computers priced from around 300 rubles (about \$225), but that price might represent three months' pay. Western machines are not available—even in the elite Moscow party shops such as GUM.

The Kristall-60 (presumed to be the biggest seller) and other 8-bit micros with ancient versions of CP/M are just now reaching the mass market. Some Moscow schools are even getting educational versions of the Kristall. The Agatha is particularly popular with programmers and scientists, but it is in short supply.

True 16-bit micros are rare in the Soviet Union. The IBM PC-compatible Iskra is reserved for the important state bodies, local party dignitaries, and the GRU/KGB. But the Elektronika NT line of MS-DOS 2.0-based computers has been taken into mass production. In fact, one model has sold several tens of thousands.

But the lack of good software has created a major problem. The Soviets do not tend to produce Cyrillic-based operating systems, compilers, and programming languages. A drive to collect indigenous programs, to commission basic packages, and to convert more Western software is now being promoted by the old Algorithm Committee at the Moscow Academy of Sciences. (Many Western firms report that customer support and ser-

vice notes and inquiries about software often find their way from the Soviet Union, even though no record of a sale can be found.)

The solution to this software problem involves the mass availability of systems and a higher level of computer literacy than currently exists. Although numerous training schemes have been considered, little has been done to provide more machines. A microcomputer education course by mail, for example, instructs students in DOS and BASIC commands—but without the luxury of a computer. And the story in schools and colleges is the same.

Peripheral devices such as second floppy disk drives, hard disks, daisy-wheel printers, and graphics output devices are even more difficult to obtain. Expansion boards are rare. Magnetic media are expensive. And to be caught with a modem or acoustic coupler would be viewed as a reprehensible civil offense by the KGB. The State is paranoid about the free flow of information.

In the end, a combination of Soviet technical inability, strict administration, and the lack of a computer culture will inhibit the growth of this industry. And because of this, the efficiency of Soviet administration and economy and the freedom of its people will suffer. On technology alone, the Soviets may appear doomed to lag behind the West. But that view of the Soviet microelectronics and small-system industry may soon change. Soviet premier Mikhail Gorbachev has addressed every major political meeting and organization to the problem of technological rebirth. ■

REFERENCES

1. Goodman, S. E. *Technology Transfer and the Development of the Soviet Computer Industry*. University of Arizona: March, 1984. (Research sponsored by The Center for Strategic and International Studies, Georgetown University, Washington, D.C.)
2. Snell, P. *Soviet Electronics: The Case of Microprocessors*. Centre for Russian and East European Studies, University of Birmingham, England, 1985.
3. *Soviet Acquisition of Militarily Significant Technology: An Update*. September 1985. (BK Dynamics for the Pentagon.)
4. Alexendrov, A. *Izvestiya*. January 19, 1984.

DRIVE INN

Enclosures
& power
supplies for
**FLOPPY,
WINCHESTER,
TAPE DRIVES,
SINGLE
BOARD
COMPUTERS
&
S-100
SYSTEMS.**

8 inch
5 inch
3 inch

**CUSTOMIZING
AVAILABLE**

Call or write
for free
catalogs
and
application
assistance.

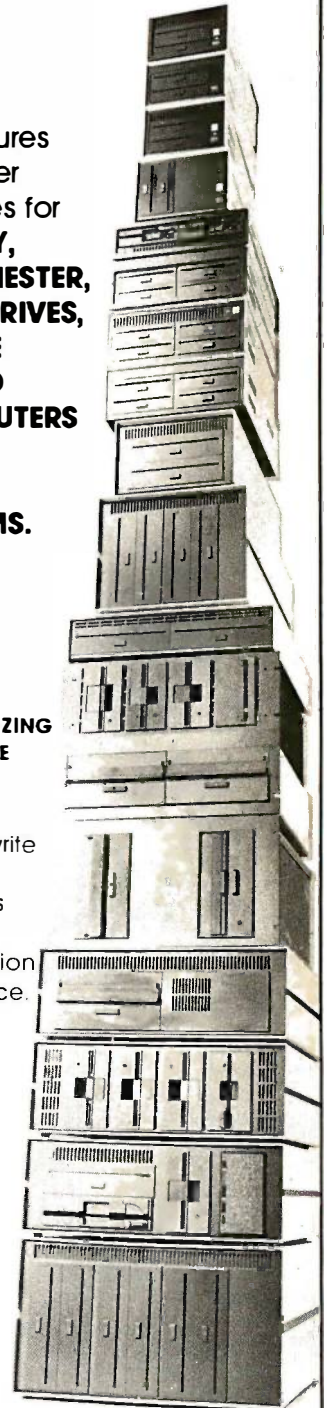

INTEGRAND

RESEARCH CORPORATION
8620 Roosevelt Ave. • Visalia, CA 93291
209/651-1203

TELEX 5106012830 (INTEGRAND UD)
EZLINK 62926572

We accept BankAmericard/VISA
and MasterCard

Smart.
"Undoubtedly
the most
powerful,"
Software
Digest.

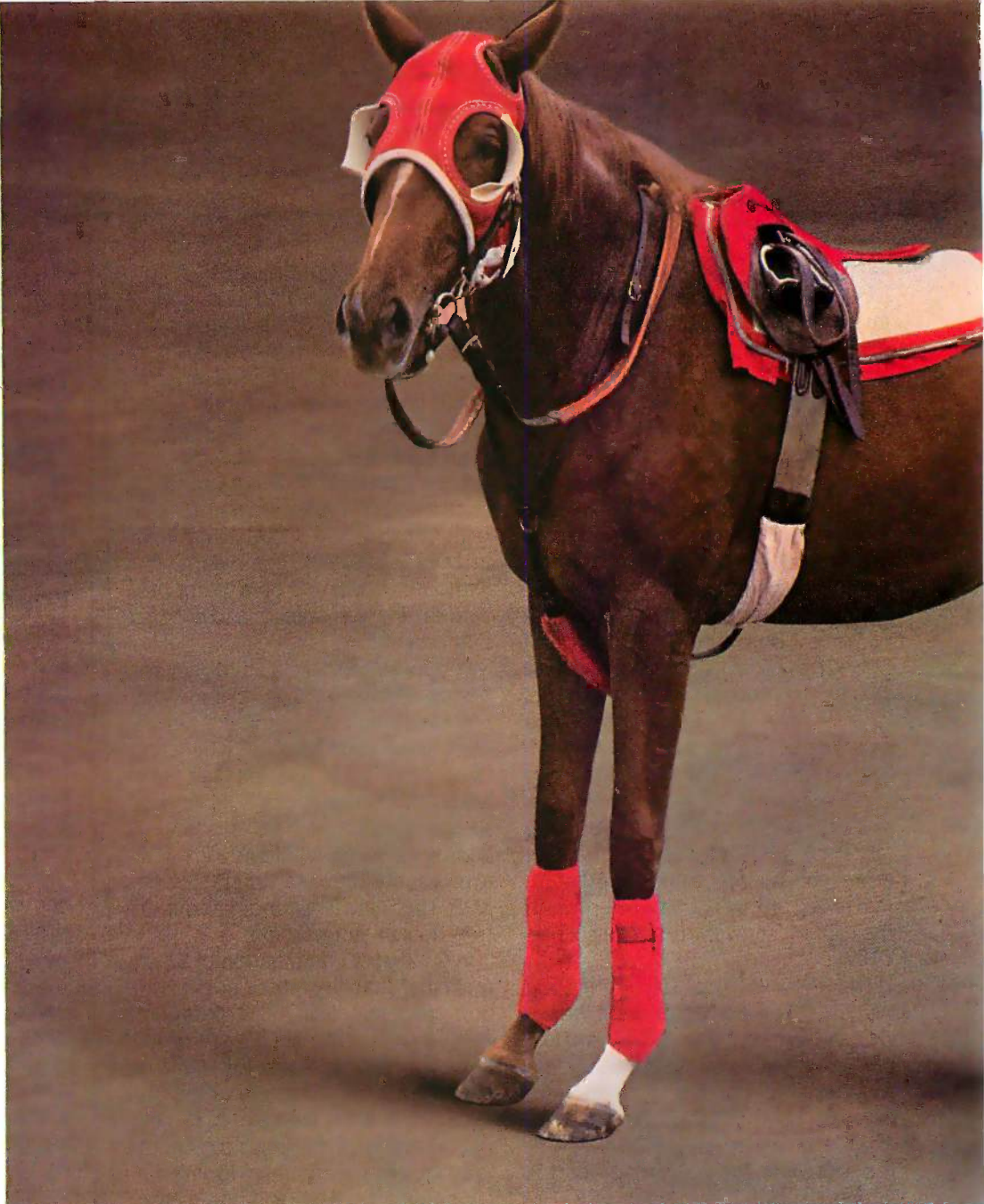

The difference is speed.

The Smart Spreadsheet is the fastest, most powerful mathematical modeling software you can buy.

That's not just our opinion; in recent tests by the independent National Software Testing Labora-

tories Smart outperformed Lotus 1-2-3 in 39 separate tests of speed and capacity.

But if speed alone doesn't impress you, these facts will:

Smart's "virtual memory" lets you

build models nearly ten times larger than you could with 1-2-3. Smart's windows let you reference up to 50 worksheets at once (that's 49 more than Lotus).

Then there's the built-in *Business*



The difference is more than speed.

	Smart	1-2-3
• Virtual Memory	Yes	No
• View Multiple Spreadsheets Simultaneously	Yes	No
• Full-Screen Formula Editing	Yes	No
• Link Spreadsheets	Yes	No
• Records English Commands	Yes	No
• Designed For Multiuser LAN (file locking)	Yes	No
• Programming Language	Yes	No
• Built-In Communications	Yes	No
• Not Copy Protected	Yes	No
List Prices:		
single-user	\$495	\$ 495
3-user LAN	\$995	\$1485

Ask for a Smart Demo-Pack.

Now for just \$24.95, you can experience the complete Smart System on your single-user PC or LAN workstations.

The Demo-Pack includes all of Smart's powerful features, along with a complete set of disk tutorials. To order, just call toll-free 800-438-7627 (in Kansas, Alaska or Canada call 913-492-3800, ext. 3800).

Once you see the difference, you'll get Smart.

Graphics package: 78 colorful ways to display your data. Pies, bars, scatters, stacks, 3-D, exploded, you name it.

Application Programming couldn't be easier. Smart records English commands instead of key-strokes, so editing is quick and simple. A set of advanced

statistical functions (regression, N-solve, etc.) are included.

Best of all, Smart integrates with a whole family of powerful applications. You can pull sales figures from *The Smart Data Base Manager*, then send graphs and charts to a report in *The Smart Word Processor*.

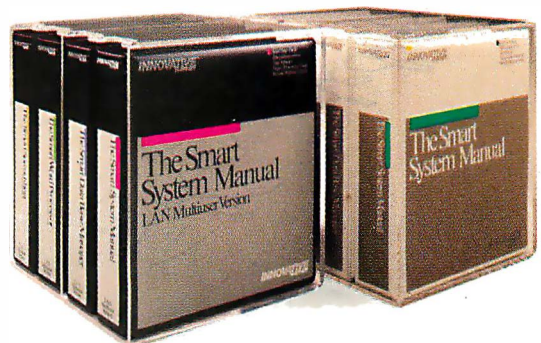

The Smart Spreadsheet

© 1986 Innovative Software, Inc.
Inquiry 159

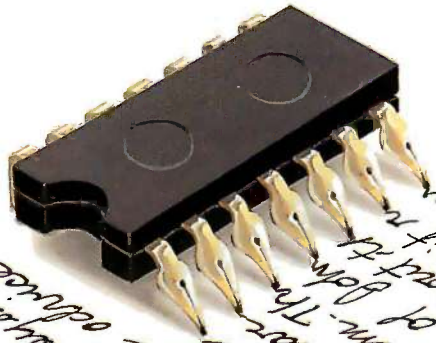

In what follows, I describe an unconventional approach to the problem of providing advice or conclusions based on the results of a program. The approach can be applied to a wide range of situations, and is particularly useful in the area of program testing. The approach is based on the idea of providing advice or conclusions based on the results of a program. The approach is based on the idea of providing advice or conclusions based on the results of a program. The approach is based on the idea of providing advice or conclusions based on the results of a program.

Frederick
 Speer

ROBERT
 B. TINNEY

Representing Knowledge

FINDING RULES IN DATA <i>by Beverly Thompson and William Thompson</i>	149
A BIT-MAPPED CLASSIFIER <i>by Peter W. Frey</i>	161
PREDICTING INTERNATIONAL EVENTS <i>by Philip A. Schrod</i>	177
HANDLING CONFLICTS IN DATA <i>by Clara Y. Cuadrado and John L. Cuadrado</i>	193
THE ART OF DEDUCTION <i>by J.-C. Emond and A. Paulissen</i>	207
RULE-BASED PROGRAMMING <i>by Leonard Moskowitz</i>	217
MACHINE LEARNING <i>by Angelos T. Kolokouris</i>	225

REPRESENTING KNOWLEDGE, some researchers say, is the key issue right now in the development of artificial intelligence. There's no doubt that progress in recent years has been impressive, especially in commercial knowledge-based or expert systems. But AI researchers still struggle with the problems of encoding massive amounts of information and formal reasoning procedures as data structures that computers can manipulate with ease.

This month's theme presents new approaches to the problems of representing knowledge. In the articles that follow, the programming techniques vary. Most rely on general-purpose programming languages like Pascal and BASIC, a couple make use of Prolog, and one is based on a specialized AI language. The types of knowledge-based systems vary as well, reflecting the thought that the merits of a particular scheme depend on the eventual use of the knowledge.

Leading off, Beverly and William Thompson examine a technique based on the ID3 algorithm, an induction method often used for building commercial expert systems. Implemented here in Pascal, the algorithm reduces redundancy in the knowledge base, organizes the data to recognize patterns, and produces a set of rules that can then be manipulated by an expert system shell.

In a more unconventional approach, Peter Frey presents a BASIC program that forgoes symbolic reasoning and uses bit mapping as the basis for a pattern-matching scheme. Based on John Holland's work on classifying information, Frey's simple expert system can be implemented in almost any standard high-level language. Also using Holland's classifier, Philip Schrod presents a political expert system in Pascal designed to make short-term forecasts. Schrod's system relies on an elaborate bit-mapping scheme that matches patterns in a detailed database of past political behavior.

One of the problems encountered in any approach to representing knowledge is that of maintaining consistency and minimizing conflicts in a changing knowledge base. John and Clara Cuadrado tackle this problem with a Prolog frame-based technique. Their decision-support system adjusts its deductions when information is added or deleted and provides "what if" capabilities as well. In a lighter vein, J.-C. Emond and A. Paulissen deal with the problem of incomplete knowledge with their Prolog program, Watson, which simulates the reasoning of a player in a game called CLUEDO.

Many well-known expert systems have been built not with general-purpose programming languages but with specialized rule-based or production systems. Len Moskowitz explains the workings of one such system, OPS5. Although developed and used for years on mainframes, OPS5 is now available in versions for a variety of microcomputers.

For a glimpse at where knowledge representation can lead, our final article in this month's theme examines machine learning, an area still in its infancy. As Angelos Kolokouris explains it, machine learning involves teaching a computer to form concepts. What this requires is a language that can grow as its knowledge increases, which is exactly what Marvin, a Prolog program, does.

—Cathryn Baskin, Associate Editor

We have 100's of Software and hardware items in stock. Shipments on almost all items within 24 hours!



SPECIAL
WORD PERFECT
\$195

Call for programs not listed

Technical & Other Info. (602) 246-2222

TOLL-FREE ORDER LINE 1-800-421-3135

FREE! UP TO \$100 SOFTWARE FREE!

With every purchase over \$100.00 you can select one of the following MS/DOS diskettes at no charge. Please indicate choice(s). 1. Blueberry I - 54 basic utility programs includes printer select, graphic generation, etc. **Retail value \$10.** 2. Blueberry II - includes a banner generator, a label maker and a checker game (requires graphics card). **Retail value \$10.** 3. Print Select program - Assembly language program to select different type fonts, etc., or make your printer function as a correctable typewriter - perfect for envelopes, notes, etc. Adaptation modules for popular printers included and capability to adapt to any printer. **Retail value \$40.** 4. Deposit Program Compiled DBase to list and total cash, check, bank card for bank deposit and keeps history - Developed for our corporate use - Super Program! (source code available). **Retail value \$40.** Select an additional diskette for every additional purchase of \$150 or purchase over \$500 and receive all four at no charge.

DATA BASE MANAGERS

Clipper	\$329
Clout 2	117
Condor III	310
Knowledgeman II	290
Powerbase 2.2	212
PFS: File	76
Q&A	Call
Quickcode	138
Quickreport	138
Revelation	445
R: Base System V	332

WORD-PROCESSING

Easy	88
Leading Edge w/Merge/Spell	75
Microsoft Word	252
Multimate Advantage	Call
Peachtext 5000	145
PFS: Write	76
Volkswriter 3	139
Webster Spellcheck	37
Wordstar	162
Wordstar Propac	233
Wordstar 2000	233
Wordstar 2000+	278

SPREADSHEET

Microsoft Multiplan	108
PFS: Plan	76
Spreadsheet Auditor 3.0	82
Supercalc 4	Call
VP Planner	49

ACCOUNTING

BPI AP, AR, PR, GA	299 ea.
Cyma	Call
Dac Easy Accounting	39
Dollars & Sense	94
Managing Your Money	94

INTEGRATIVE

Ability	59
Enable	312
Smart Software	Call

COMMUNICATION PROGRAMS

Crosstalk	89
Remote	89
Smartcom II	83

GRAPHICS

Chartmaster	199
Energraphics 2.0	269
In-A-Vision	249
Microsoft Bus Mouse	106
Microsoft Chart	164
Microsoft Serial Mouse	119
Newsroom	31
PC Mouse W/DR Halo II	106
Printshop	33
Signmaster	132

PROJECT MANAGER

Harvard Total Project	262
Microsoft Project	219
Super Project Plus	239
Timeline 2.0	209

EDUCATIONAL

Flight Simulator	\$28
Turbo Tutor II	25
Typing Tutor III	Call

LANGUAGES

Lattice C Compiler	242
Microsoft C Compiler	249
Microsoft Fortran	195
Microsoft Macro Assembler	84
Microsoft Pascal Compiler	166
Microsoft Quick Basic	55
Ryan McFarlan Fortran	305
Ryan McFarlan Cobol	479
Turbo Pascal w/8087 + BCD	55

UTILITIES

Carbon Copy	115
Copy II PC	19
Copywrite	39
Desqview	55
Double Dos	27
Fastback	85
Microsoft Windows	55
Norton Commander	37
Norton Utilities 3.1	49
PC Tools	19
Prokey 4.0	70
Sidekick	31
Sidekick (unprotected)	47
Sideway 3.1	36
Superkey	39
Traveling Sidekick	39
XTree	27

ACCESSORIES

Copy II PC Board	75
IBM 135 watt power supply	59
Mini Micro Parallel Print Buffer	69
Masterpiece	88
Masterpiece Plus	113

INCREDIBLE VALUE

Nationally advertised boards for IBM PC and most compatibles at give away prices.	
Keyboards (similar to 5151)	\$79
Monochrome Board w/printer port (similar to Hercules Graphics)	\$79
Expansion Board 0 to 576K	\$42
Multifunction Board w/game port (similar to AST six pack)	\$79
Four Drive Floppy Controller	\$39
Color Card w/o printer port	\$69
Color card w/printer port	\$79

HARD DRIVES

Bernoulli 20 MB w/cont.	2077
Filecard 20 MB	555

Maynard 20 MB Hard Card ...	Call
Seagate 20 MB Int. w/cont. ...	\$385
Seagate 30 MB Int. w/cont. ...	479
Seagate 30 AT Int.	Call

PRINTERS

CANON LASER	1939
CITIZEN	
MSP-10	285
MSP-15	385
MSP-20	325
Premiere 35 Daisywheel	469

EPSON SPECTACULAR

Hurry — Call us now for special low, low pricing on the following Epson printers:

FX86	FX286
LQ800	LQ1000
EX800	EX1000
LX86	LQ2500

Pricing good through December 31, 1986.

NEC	
NEC P5XLP	1126
NEC P7 Parallel	635
NEC 8850	1098
NEC P6 Parallel	455
OKIDATA - Call on all models	
PANASONIC	
1091	235
1092	299
1592	425
KXP3151	399

STAR MICRONICS	
LV1210	179
NB15	975
NX10	232
SG15	365
SR15	585
TOSHIBA	
P351	969
P341	768
P321	Call

MONITORS

AMDEK 310A	142
AMDEK 600	395
Magnovox Color RGB	Call
Multitech Color RGB	259
Princeton Max 12	159
Samsung TTL Amber	72
Samsung TTL Green	70

EGA MONITORS

AMDEK 722	505
NEC Multisync	Call

EGA BOARDS

Everex Enhancer EGA	235
Paradise Auto Switch EGA Card	359
Quad EGA Plus	349
STB EGA Plus	Call
Vega Video	Call

RAM

64K 150NS (set of 9)	\$11.50
256K 150NS (set of 9)	30
256K 200NS (set of 9)	39

MODEMS

Everex 300/1200	120
Hayes 1200	Call
Hayes 1200B	Call
U.S. Robotics Courier 2400	359
U.S. Robotics Passwd. 1200	180

BOARDS

AST Advantage	329
AST Premium	359
AST Sixpac (384K)	Call
Hercules Color Card	145
Hercules Graphics +	182
Intel Above Boards	Call
J Lazer (Tall Tree)	Call
J Ram III (Tall Tree)	179
J Ram III AT (Tall Tree)	Call
STB Chauffeur	185
STB Mono	155

COMPUTERS

ABBOTT TURBO PC

IBM Compatible Computer, 4.77 or 7.47 key selectable, AT style keyboard, 640K, dual drive, 135 watt power supply, or with 20 MB Seagate Harddrive. \$599 \$970
6 month limited warranty

Corona PC

Multitech 900 Accel

IBM AT Compatible, 512K, expandable to 1 MB on the mother board, one 1.2 MB drive, 195 watt power supply, MS/DOS 3.1, clock, 6 or 10 MHz key selectable, soft white monitor, AT style keyboard, 1 year TRW warranty. Call

Multitech Turbo

IBM Compatible Computer, 256K, dual drives, 8 MHz, ports-parallel-serial-clock, 5151 type keyboard, graphics board (similar to Hercules), mono monitor DOS 3.1, 6 month national warranty. Call

Sharp Portable

TERMS: Add 3% for C.O.D. orders. Shipping on most software is \$5.00. AZ orders +6.7% sales tax. Personal check - allow fourteen (14) days to clear. We accept purchase orders from authorized institutions for 1.5%. All returns are subject to our approval. There will be a 20% restock fee. Minimum phone order \$50.

No Charge for Master Card or Visa



TOLL-FREE ORDER LINE 1-800-421-3135

WAREHOUSE DATA PRODUCTS

2701 West Glendale Ave. • Phoenix, AZ 85051

Hours 7 A.M. to 5:30 P.M. M.S.T. - Mon. thru Fri.
Saturday 10:00 A.M. to 3:00 P.M.

FINDING RULES IN DATA

BY BEVERLY THOMPSON AND WILLIAM THOMPSON

An algorithm for extracting knowledge from data

MUCH OF THE FOCUS of computing in the past has been on collecting, manipulating, and disseminating data. Many people are now saying that the primary focus of computing in the future will be on the collection, manipulation, and dissemination of knowledge and that our view of it will be profoundly changed in the process. Much artificial intelligence research to date has been concerned with representing knowledge in a way that can be efficiently collected, stored, and utilized by a computer.

In this article we describe one method of obtaining knowledge directly from a set of data. This knowledge will be represented in a series of if-then statements called rules. The method used, the ID3 algorithm, was developed by J. Ross Quinlan (reference 1) and is the method most commonly used in the commercial expert systems that employ induction methods to generate rules.

CLASSIFICATION TREES

One structure that has been extensively used to represent knowledge is the classification tree (also called the "decision tree"). A simple example is the best way to show how a classifica-

tion tree works. Suppose that you want to invest money in a company in the computer industry and are seeking advice from a friend who is a financial expert in that industry. When you call him on the phone, something like the following conversation may take place:

Expert: Is the company a hardware or software company?

You: Software.

Expert: Would you say that the company's main product is new, in midlife, or old technology?

You: Midlife.

Expert: Does this product have any significant new competition?

You: No.

Expert: From what you've told me, it seems that the company's profits should continue to go up.

Figure 1 shows how this same exchange could be represented as a classification tree. This partial tree completes only the branch of the tree that represents the answers you supplied during your conversation. A complete tree would fill in all of the questions and answers that could possibly take place during a consultation session.

Although trees show the relationships that exist among the various components, they can be very difficult to manipulate. One structure that can represent similar information but is easier to use is called a rule. The rule that can be made from the tree in figure 1 is this:

If type is software
and age is midlife
and competition is no
then profit is up.

One rule is made to represent each completed branch of the tree, with the subject of each question being represented by a keyword called an attribute. The question associated with the attribute can be stored along with the rule in the form of a prompt. An example of a prompt would be

prompt type

Is the company a hardware or software company?

The entire collection of rules and

(continued)

Beverly and William Thompson are consultants specializing in the design of knowledge-based systems for microcomputers. They can be contacted at MicroExpert Systems, R.D. 2, Box 430, Nassau, NY 12123.

prompts is called a knowledge base.

Each rule is a single fact that can be easily verified or modified. In addition, work done on expert system shells provides us with many excellent methods for using a set of rules to conduct a consultation. For a detailed description of one of these methods (called a backward-chaining inference engine), see our article "Inside an Expert System" in the April 1985 BYTE.

THE KNOWLEDGE ACQUISITION BOTTLENECK

If the problem of selecting a winning company were as easy as our example makes it appear, there would be no problem stating all of the knowledge about the subject in a simple set of rules and we could make a fortune in the stock market. Unfortunately, the complexity of real-world problems often makes it difficult to design a detailed set of rules. In some problem areas the amount of information needed for a solution is prohibitively large. In others, the knowledge is not well enough defined to put into rules. Even in cases where the problem is manageable, the number of experts with the inclination and the time to work on these systems is small. This situation is often referred to as the knowledge acquisition bottleneck.

In order to solve the problem of acquiring expertise, we should ask ourselves how the experts became experts in the first place. Why, for example, did our financial analyst ask those specific questions? People learn through their experiences. The financial analyst, for instance, constantly absorbs data about different companies, their products, and their financial situations. His mind has the ability to observe patterns in data and

organize it. This process allows a person to extract meaning and thus knowledge from data. As we said, the computer has revolutionized the collection and storage of data, but have we really been able to make the most use of that data? Shouldn't it be possible to find some way to organize data to recognize patterns and extract knowledge directly from it? The ID3 algorithm attempts to do just that. No one claims that it works in any way like our own brains, but it does provide a way to produce a classification tree directly from a set of examples within a problem area. Once we can make a classification tree, it is a direct step to rules that can be manipulated by an expert system shell.

To illustrate how the algorithm works, let's return to the problem of predicting whether a given company's profits will increase or decrease. This time, let's suppose that when you ask your friend for advice he tells you that he makes it a policy not to give financial advice to friends. Instead, he suggests some magazines that you could read to familiarize yourself with the ups and downs of the industry. You take his advice but find it's very difficult to make use of all the reading material. So you make a table that lists some of the companies, some facts about them, and whether their profits have increased or decreased in the last quarter. A sample of this table is shown in table 1. The labels on the columns "profit," "age," "competition," and "type" are the attributes for which the values are stored in the table. Each row in the data table is called an example. The first attribute, "profit," is called the class attribute. Your goal is to determine a relationship between the class attribute and the values of the other attributes. The

first example says that "profits were down in a company whose product was old, had no significant competition, and which produces software." You can see that the table alone does not give you much insight into predicting when a company's profits are likely to increase. What is needed is a way to use the examples in the table to produce a classification tree.

BUILDING THE CLASSIFICATION TREE

To build a classification tree, you select one of the attributes to be the starting point or root node of the tree. Once you select this attribute, you split up (partition) the example set into a number of smaller tables, each containing examples with the same value of the selected attribute. If you select "age" as the root of the tree, the table will be split into the sets shown in figure 2. You can see in figure 2 that when "age" has the value "old," the value of the class, "profit," is always "down." When the value of "age" is "new," the class value is always "up." In these two new example sets, no further classification is necessary. However, in the example containing "age = midlife," you must select a new attribute and split the set again. Figure 3 shows the results of a split on the attribute "competition." Since each partition now contains only a single value for the class attribute, the tree-building process is complete.

You can produce a set of if-then rules from this tree by following each branch from the root to a terminal node. Each rule is a series of conditions consisting of attribute and value pairs, followed by a single conclusion that contains the class and the corresponding class value. The inter-

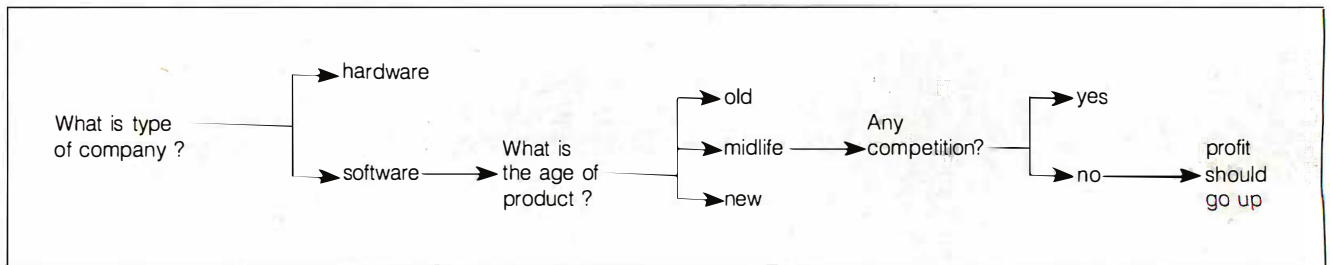

Figure 1: Classification tree showing the results of one consultation session.

mediate nodes and their branches form the conditions of the rules; the terminal nodes form the rules' conclusions. For example, following the first branch on the right results in the rule

If age is old
then profit is down.

One rule is produced for each terminal node of the tree. The rules that can be formed from this tree are shown in figure 4.

Figure 3 illustrates an interesting side effect of the tree-building process. Even though the original example set contained three attributes, you did not need the attribute "type" to classify the examples in the set. This is a valuable result because it can reduce the amount of data that needs to be collected. Brieman et al. (reference 2) used a classification-tree-building technique called CART to classify the mortality risk of heart attack victims. This process allowed them to reduce the number of attributes in the data set from 19 to 3.

WHY THIS TREE?

The tree in figure 3 is certainly not the only possible tree that could have been generated from this set of examples. Rather than selecting "age" as the first attribute on which to split the example set, you could have selected

(continued)

Table 1: Table of example set.

Profit	Age	Competition	Type
Down	Old	No	Software
Down	Midlife	Yes	Software
Up	Midlife	No	Hardware
Down	Old	No	Hardware
Up	New	No	Hardware
Up	New	No	Software
Up	Midlife	No	Software
Up	New	Yes	Software
Down	Midlife	Yes	Hardware
Down	Old	Yes	Software

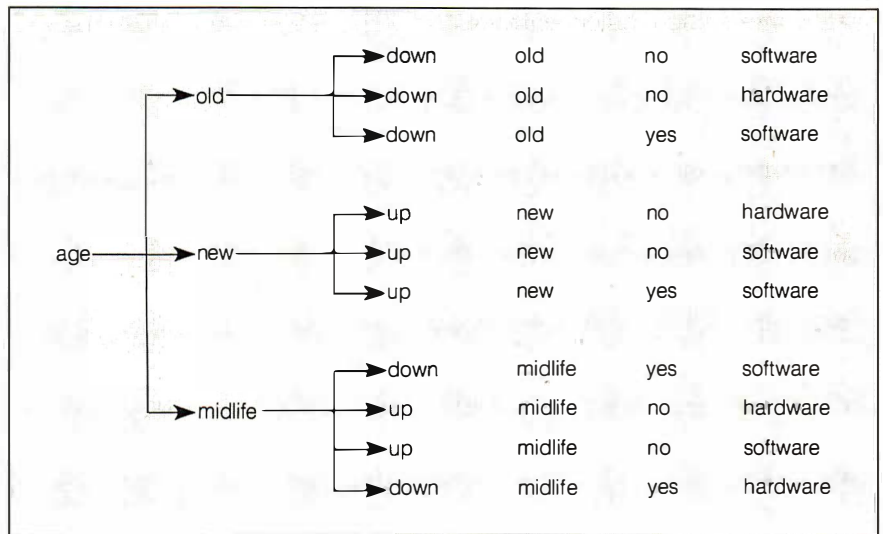

Figure 2: Example set from table 1 split on attribute "age."

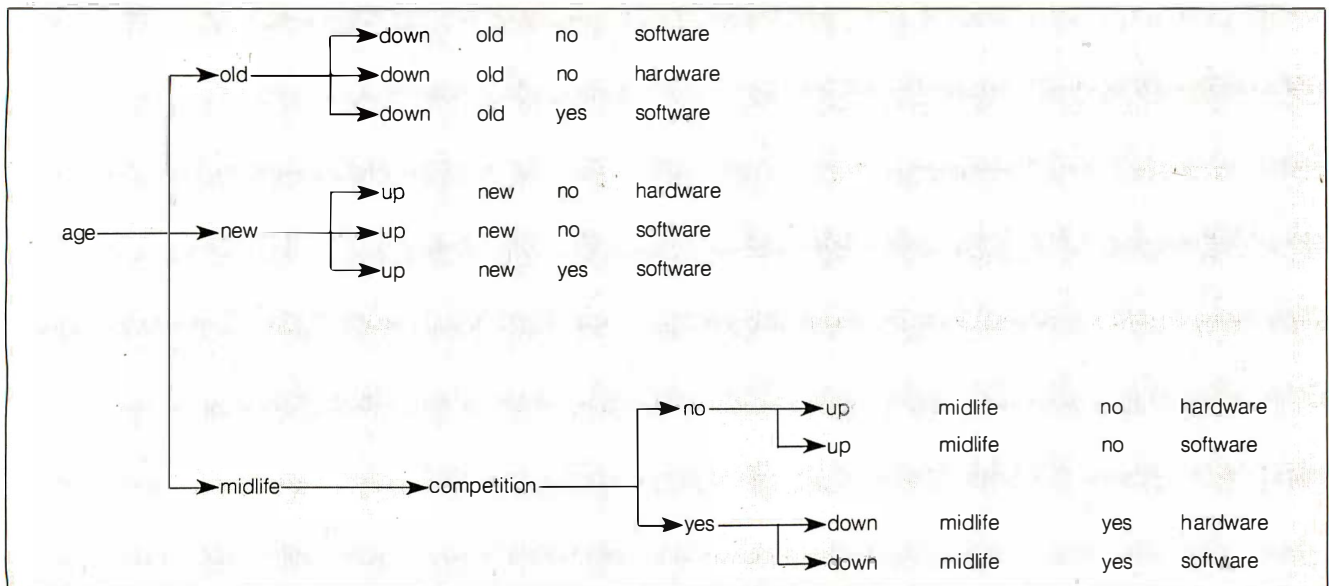

Figure 3: Example set of figure 2 after second split—this time on "competition."

one of the other attributes. This would have resulted in a different tree and a different set of rules. Since some attributes tell us more about how to classify an object than others (in our example, "type" was not even needed), it is important to split the example set using attributes that lead to efficient classification trees. Put another way, how do you measure the amount of information about classification contained in a single attribute?

ENTROPY

If we turn to communication theory, we find that there is a precise measure of information called entropy. Applying this concept to the classification problem, we find that if an object can be classified into one of several different groups, the entropy is a measure of the uncertainty of the classification of that object. As the entropy increases, the amount of information that we gain by knowledge of the final classification increases. Mathematically, if an object can be classified into N different classes, c_1, \dots, c_N , and the probability of an object being in class i is $p(c_i)$, then the entropy of classification, $H(C)$, is

$$H(C) = -\sum_{i=1}^N p(c_i) \log_2 p(c_i)$$

If you are a bit rusty on logarithms, recall that $\log_2(x) = y$ means the same as $2^y = x$ or, more plainly, the log to the base 2 of any number is the number of bits that it would take to represent that many different objects. Consequently, $\log_2(16) = 4$ tells you that it takes 4 bits to uniquely represent 16 different objects. (All logarithms mentioned in this article are assumed to be taken to base 2.)

Let's apply the entropy formula to the example set in table 2. In this set there are two possible values for the class attributes, "up" and "down." The probability (actually the frequency of occurrence) of the class having the value of "up" is 5 out of a total sample set of 10, or 5/10. The probability of "down" is also 5/10. The entropy of classification for the total set is

$$\begin{aligned} H(C) &= -p(\text{up}) \log p(\text{up}) - \\ &\quad p(\text{down}) \log p(\text{down}) \\ &= -5/10 \log (5/10) - \end{aligned}$$

If age is old then profit is down.
If age is new then profit is up.
If age is midlife and competition is no then profit is up.
If age is midlife and competition is yes then profit is down.

Figure 4: Rules produced from the classification tree of figure 3.

Table 2: Part of the example set split on "competition."

Competition	Profit
No	Down
No	Up
No	Down
No	Up
No	Up
No	Up
Yes	Down
Yes	Up
Yes	Down
yes	Down

$$\begin{aligned} &5/10 \log (5/10) \\ &= 1.00 \end{aligned}$$

Although this number represents the uncertainty about profits going up or down based on the data in table 1, it does not tell us anything about the amount of information contained in the individual attributes.

CALCULATING THE ENTROPY OF CLASSIFICATION OF AN ATTRIBUTE

What we really want to know to help us decide the attribute on which to split is the entropy of classification after deciding on a particular attribute. This entropy represents the amount of uncertainty about a particular outcome, so we'll want to split on the attribute that results in the smallest entropy of classification.

The first step in calculating the entropy of classification after deciding on a partitioning attribute, symbolized by $H(C|A)$, is to split the table into subtables where each example has

the same value of the partitioning attribute. Table 2 shows a partition of the example set after splitting on the attribute "competition." The entropy of each subtable, $H(C|a_j)$, is calculated for each value of the attribute, a_j . $H(C|a_j)$ is given by the expression

$$H(C|a_j) = -\sum_{i=1}^N p(c_i|a_j) \log p(c_i|a_j)$$

The function $p(c_i|a_j)$ is the probability that the class value is c_i when the attribute has its j th value.

We can now calculate the entropy of each subtable:

$$\begin{aligned} H(C|\text{competition=no}) &= -p(\text{up}|\text{competition=no}) \\ &\quad \times \log p(\text{up}|\text{competition=no}) \\ &\quad - p(\text{down}|\text{competition=no}) \\ &\quad \times \log p(\text{down}|\text{competition=no}) \\ &= -4/6 \log (4/6) - 2/6 \log (2/6) \\ &= 0.918 \end{aligned}$$

$$\begin{aligned} H(C|\text{competition=yes}) &= -p(\text{up}|\text{competition=yes}) \\ &\quad \times \log p(\text{up}|\text{competition=yes}) \\ &\quad - p(\text{down}|\text{competition=yes}) \\ &\quad \times \log p(\text{down}|\text{competition=yes}) \\ &= -1/4 \log (1/4) - 3/4 \log (3/4) \\ &= 0.811 \end{aligned}$$

The expression $p(\text{up}|\text{competition=no})$ is the probability that the class value is "up" when the value of the attribute "competition" is "no." It is just the number of times class "up" appears in a row with "competition" equals "no" divided by the total number of cases in which "competition" equals "no."

In order to find the entropy of the entire table after the split, $H(C|\text{competition})$, we must take the sum of the entropy of each of the values of the attribute multiplied by the probability that the value will appear in the table. Stating all of this concisely, the entropy of classification after choosing a particular attribute, $H(C|A)$, is the weighted average of the entropy for each value a_j of the attribute.

Mathematically this is expressed as

$$H(C|A) = \sum_{j=1}^M p(a_j) H(A|a_j)$$

M is the total number of values for the attribute A .

In this example this gives

(continued)

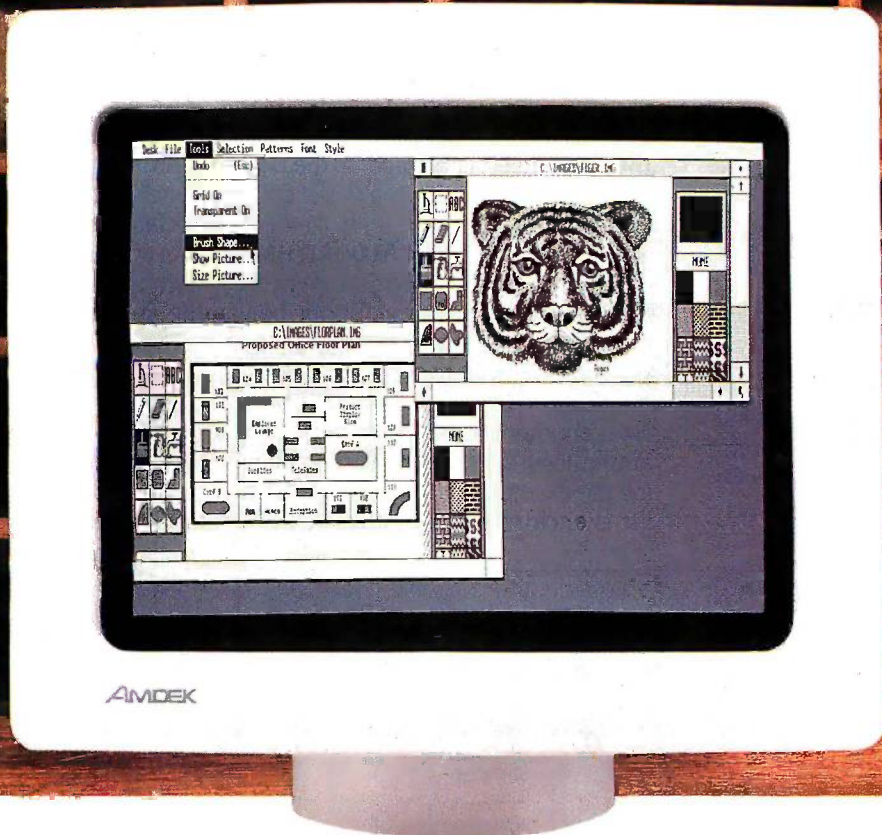

Is this the best monitor for desktop publishing?

You can make book on it.

Sometimes, you can't tell a book by its cover. And that's particularly true of the new 1280 graphics subsystem by Amdek. It's designed specifically for the high resolution demands of desktop publishing and CAD applications. But it's still completely compatible with all standard IBM PC software.

Amdek's 1280 consists of a high-contrast, non-glare 15" white phosphor monitor and a bit-mapped graphics board. The extra-large CRT can display up to 160 characters per line by 50 lines of text (vs. 80 x 25 for IBM).

Incredibly high resolution, 1280(H) x 800(V), plus the use of a 16 x 32 dot character (vs. 8 x 8 IBM standard), result in text and graphics that are remarkably sharp and

easy to read. So, creating high quality flyers, reports, newsletters, bulletins or whatever else you want to "publish" at your desk is as simple as ABC.

The Amdek 1280 is also supported by one of the most popular IBM PC desktop publishing software packages, Clickart by T/Maker. Compatibility with AutoCAD and CADvance gives you full CAD potential. Convenience features include front-mounted operator controls for power, brightness and contrast; and a tilt-swivel base which allows you to select the most comfortable viewing angle.

So, stop the presses—Amdek has done it again! Because everything that's fit to print looks better on an Amdek 1280.

AMDEK

Clearly the finest in monitors.

```
( ( down old no software )
  ( down midlife yes software )
  ( up midlife no hardware )
  ( down old no hardware )
  ( up new no hardware )
  ( up new no software )
  ( up midlife no software )
  ( up new yes software )
  ( down midlife yes hardware )
  ( down old yes software ) )
```

Figure 5: Lists used to represent the example set.

```
( ( profit down up )
  ( age old midlife new )
  ( competition no yes )
  ( type software hardware ) )
```

Figure 6: List used to store attributes and their values.

```
( age ( old classify ( ( ( down old no software )
                        ( down old no hardware )
                        ( down old yes software ) ) ) )
      ( new classify ( ( ( up new no hardware )
                        ( up new no software )
                        ( up new yes software ) ) ) )
      ( midlife classify ( ( ( down midlife yes software )
                           ( up midlife no hardware )
                           ( up midlife no software )
                           ( down midlife yes hardware ) ) ) ) )
```

Figure 7: The list equivalent to the tree in figure 2. This list is returned after the first call to the classify routine.

```
( age ( old ( profit ( down ) ) )
      ( new ( profit ( up ) ) )
      ( midlife ( competition ( no classify ( ( ( up midlife no hardware )
                                                ( up midlife no software )
                                                ( yes classify ( ( ( down midlife yes software )
                                                                ( down midlife yes hardware ) ) ) ) ) ) ) ) )
```

Figure 8: The list equivalent to the tree in figure 3.

```
( age ( old ( profit ( down ) ) )
      ( new ( profit ( up ) ) )
      ( midlife ( competition ( no ( profit ( up ) ) )
                             ( yes ( profit ( down ) ) ) ) ) )
```

Figure 9: The final list returned by the classify routine.

$$H(C|competition) = 6/10 \times 0.918 + 4/10 \times 0.811 = 0.8752$$

If we perform these same calculations for the other attributes in our example, we find that $H(C|age) = 0.4$ and $H(C|type) = 1.0$. Since $H(C|age)$ gives us the smallest entropy and thus the least uncertainty, "age" is the best attribute to select for the initial split.

IMPLEMENTING THE ALGORITHM

To implement this algorithm we need to make some decisions about how to represent the example tables in the program. We will store the table of examples as a list. Each element of the list is another list that contains one example. Figure 5 shows the list containing the example set from table 1. Each list is enclosed in parentheses. Even

though considerable overhead is associated with the use of list structures in a program, lists provide a great deal of flexibility and allow us to use a single representation for both the examples and the final classification tree.

We will also use a list to keep track of the attributes and their values. This is another list of lists. The first sublist consists of the class name and associated class values. The other sublists contain the attribute names and each attribute's values. Figure 6 shows the attribute list for the example set.

The actual tree-building procedure is performed by a function called classify. If you pass an example list to this function, it returns the classification tree for that example set. This tree is also represented by a list. The first element in the list is an attribute or class name, and it is followed by a series of lists. Each list contains a class value if the first item was the class name; otherwise, each list contains a value for the attribute followed by the tree produced by classifying the partition of the example set that has that value. In other words, classify is a recursive procedure that either returns the class name and the class value of the example set or calls itself to classify the new partitioned example set. The clearest way to explain classify is to demonstrate how it would process our example set.

Figure 7 shows a list that is equivalent to the tree returned by classify. By calculating $H(C|A)$ for each attribute, classify has chosen "age" as the attribute on which to split. It returns the attribute name followed by three lists. Each list contains a value of the attribute followed by the classification of the appropriate subset of examples. The calls to classify in the first two lists (the values "old" and "new") will result in no further recursion because each of the lists contains only a single class. In both cases, classify will return the class name, "profit," and the appropriate class value. The third list requires a new partitioning of the example set. Figure 8 shows the results when classify splits the new example set on "competition." The final tree returned

(continued)

OUR PLUG-IN CARD GIVES YOU PLUG-IN CONTROL.

PC \square 488 allows your IBM PC/XT/AT or compatible to control IEEE-488 instruments.

WHAT ADDITIONAL SOFTWARE DO I HAVE TO BUY?

None. **PC \square 488** supports all popular programming languages including interpreted and compiled BASIC, TBASIC™, Microsoft® Pascal, Turbo™ Pascal, C, and FORTRAN.

You can use Tektronix® Standard Codes and Formats and emulate HP controller statements.

PC \square 488 also runs IBM's IEEE-488 software as well as application programs.

IS IT DIFFICULT TO USE?

You just plug it in. **PC \square 488** is totally self-contained with all software packaged in read only memory. Documentation includes a complete tutorial and programming reference, plus more than thirty application programs.

WILL IT WORK WITH ALL MY INSTRUMENTS?

You bet! More than 500 companies, including every major instrument manufacturer in the U.S. and Europe, are currently using **PC \square 488**.

WHAT'S THE BOTTOM LINE?

That's the best part. **PC \square 488** costs just \$395 including software support for all popular programming languages, extensive applications library, and the programming and reference manual. Order today by calling (617) 273-1818 or Telex 247316.



cec

Capital Equipment Corporation
10 Evergreen Ave., Burlington, MA 01803.
(617) 273-1818, Telex 247316.

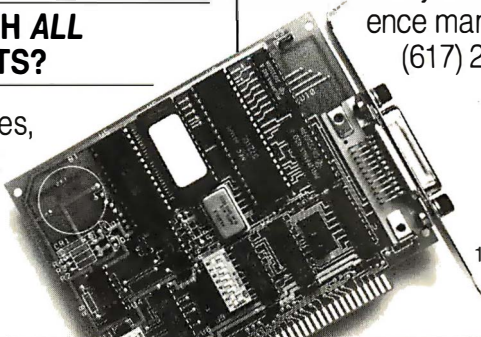

by classify is shown in figure 9. If you examine the "list of lists" in figure 8, you can see that its structure is similar to the classification tree shown in figure 3.

The classify function produces the tree in a depth-first manner. In our example that means classify would continue to the end of the branch for "age" is "old" before looking at the other values for "age."

HANDLING CONFLICTS IN THE DATA

Conflicts among the examples can lead to the generation of erroneous rules. A conflict occurs when two examples contain identical values for all attributes but have different class values. A conflict usually signifies that the attributes chosen are inadequate for the classification task. You can remove this problem by introducing additional attributes. Deciding which new attributes to include is a task for an expert in the problem domain

being considered, but identifying conflicts is relatively easy. Since each example is stored as a list, you can recognize a conflict by comparing the list representing an example against each of the other lists. A conflict occurs when the tails (the entire list except for the first item) of two lists match, but the first items on the list are different.

"DON'T CARE" VALUES

When creating examples, we find it useful to specify that a particular attribute does not play a role in the classification. We use a special symbol, called a "don't care" value, to indicate this fact. For instance, (down old no *) indicates that if the value of the attributes "age" and "competition" are "old" and "no," respectively, the class value is "down" no matter what the value of "type." An asterisk represents a "don't care" value. Examples containing "don't care" values are expanded into a new set of examples,

each containing one of the possible values for the "don't care" attribute. The example above would be expanded to (down old no hardware) and (down old no software).

ATTRIBUTES WITH NUMERIC VALUES

All of the attributes in the example set had values chosen from a limited group of possibilities. Suppose that instead of assigning the values "old," "new," and "midlife" to the attribute "age," you wanted to assign numeric values. In this case, you would use the numeric values of "age" to create a set of new attributes that contain the ranges of possible values. For example, assume that you have four companies with products aging 6, 10, 16, and 36 months. You would make three new attributes, each representing the range formed by splitting the consecutive values at their midpoints. The new attributes would be "age < 8,"

(continued)



INT'L, INC.

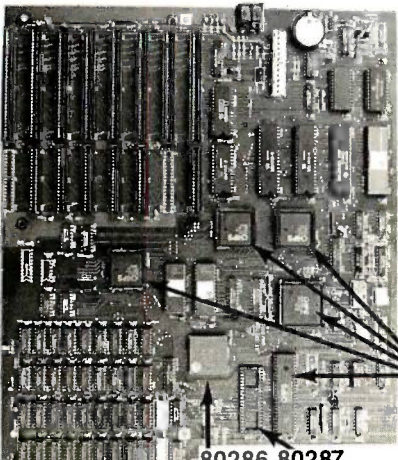

80286 80287

← TURBO AT

- 80286 IBM Compatible
- 6 MHz, 8 MHz, or 10 MHz Keyboard Switch
- 5 CHIPS SET—(Lower Heat. Higher Quality)
- 0 or 1 Wait State
- 1 MB Memory
- On Board Battery
- 80287 Socket Ready
- 3MB with serial/parallel port on board
- XT size AT JR motherboard available

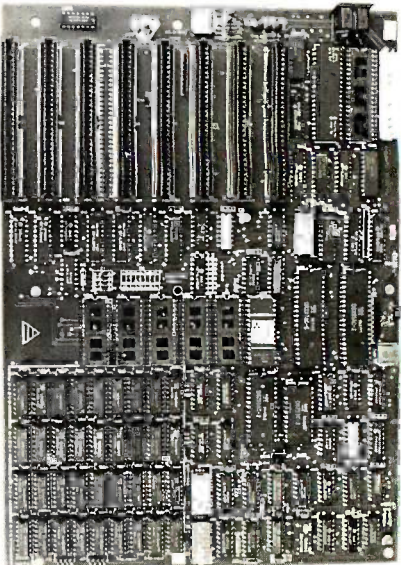

5VLS1

TURBO XT →

- 8088-2 IBM-XT Compatible
- 4.77 MHz or 8 MHz Keyboard Switch
- 4 Layer PC Board
- 640K Memory
- 8087 Socket Ready

WiseTEK International, Inc.
513 Valley Way
Milpitas, CA 95035

Micronic
108 East 16th Street
New York, NY 10003

See us at
COMDEX/Fall '86
November 10-14, 1986
Riviera Hotel
Las Vegas, Nevada
Booth #8421

**Distributors, Dealers,
OEM Welcome**

TEL: (408) 263-1237
(212) 529-4699
FAX: (408) 263-1870

Your free ticket to The Source.

Save \$49.95! Join The Source Information Network before November 30th!

Send the coupon below or call The Source right now. And we'll waive our standard \$49.95 registration fee.

And once you're online, you'll have all the time in the world to learn the ins and outs of The Source since our step-by-step tutorial doesn't cost you a penny in online charges.

Soon you'll be zipping through a whole new world of online data base attractions like an Investor Services package with automated portfolio management.

Grolier's full-text, online encyclopedia. Stimulating Special Interest Groups, where you can download free software. Plus, electronic mail, comprehensive news, travel services and much more. All at very competitive online charges.*

But you have to act now. To take advantage of our free membership offer, call 1-800-336-3366** and give our representative this claim number, 78AC329. Or mail the coupon below. And do it before November 30th!

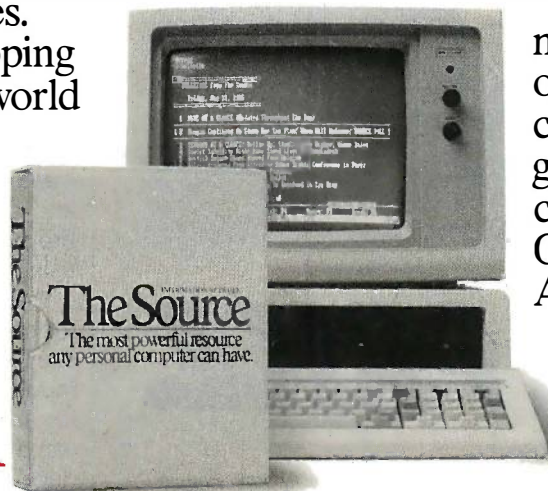

*Online rates as low as 10¢/minute. \$10 monthly minimum applies.

**In Virginia, call 703-821-6666.

Send no money. To sign up, just mail this coupon. Or call The Source toll-free at **1-800-336-3366** and give our representative this claim number, **78AC329**.

INFORMATION NETWORK
The Source
The most powerful resource any personal computer can have.

Bill my SourcePak Manual (if ordered) and all charges on my account (including monthly minimums) to:

Visa MasterCard
 American Express

Yes, I want to join The Source and take advantage of your free membership offer.

Also send me the SourcePak Manual (shown) at a special reduced rate of \$9.95 (plus \$3.00 postage and handling+.) Regularly \$19.95—Save 50%!

MAIL TO: The Source, PO Box 1305,
McLean, VA 22102

Offer expires November 30th, 1986

+International customers add \$15.00 postage and handling.

Credit card # _____
(must be provided)

Expiration date _____

Name _____

Address _____

City _____ State _____ Zip _____

Signature _____

Mother's maiden name _____
(for online password verification)

PC type _____

Phone (day) _____ (evening) _____

ACTUAL SIZE.



ACTUAL PRICE.

Introducing The Turner Hall™ Card. The lowest priced complete 256K memory expansion board you can buy.

We made it so inexpensive by using the very latest 256K RAM chips instead of four times as many 64K chips.

That same technology makes the Card fit in a half-length PC/XT™ slot. And the reduced chip count increases reliability, so we can offer a 30-day money-back guarantee and 1-year warranty.

The Card comes with a clock/calendar with replaceable battery backup, illustrated Owner's Manual, and software including clock, print spooler, and disk emulator.

That's everything the most popular

multifunction boards have. Except a couple of extra ports and a lot of extra cost.

IBM® or Compaq® owners will find the Card remarkably easy to install. And if you have any questions after you buy, call our Help Hotline.

The Turner Hall Card is just \$99.95,* plus \$2.00 shipping (\$12.00 outside of U.S.A.).

Order by phone. We accept MasterCard or Visa. Or send us a check or money order with your business card attached.

 **Turner Hall Publishing**
10201 Torre Ave., Cupertino, CA 95014

1-800-556-1234 x526. (In CA 800-441-2345 x526).

*CA residents add 7% sales tax (\$7.00). Requires IBM PC, PC/XT, Portable PC, or Compaq with at least 256K of memory. Turner Hall is a trademark of Turner Hall Publishing. IBM is a registered trademark, and PC/XT is a trademark of International Business Machines Corp. Compaq is a registered trademark of Compaq Computer Corp.

FINDING RULES

"age < 13," and "age < 26." The values in the original table under "age" are used to determine if the value of the new attributes is "yes" or "no." The entropy of classification after splitting is calculated for each new attribute along with the other attributes to determine the best attribute to use to partition the data set.

THE COMPLETED PROGRAM

A Turbo Pascal program called INDUCE for the IBM PC and compatibles implements the techniques described above. [Editor's note: INDUCE is available on disk, in print, and on BIX; see the insert card following page 352 for details. It is also available on BYTenet; see page 4.] The program contains a collection of low-level routines for the manipulation of the list structures described in this article. Since Turbo Pascal is not optimized for list processing, the program is slow compared to some of the commercial implementations of the ID3 algorithm, but we hope that by examining the commented source code, programmers can gain some insight not only into the ID3 algorithm but also into the power of symbolic computation using list-like structures.

The program produces rules in the format accepted by the expert system shell MicroExpert, but you can easily modify the program to produce rules for another expert system shell. You can also modify the program to produce Prolog sentences.

Also available is Crossref, a parser that reads and parses rules that use the same rule syntax as the one we have described. A description of this program and how to write an inference engine that uses the rules can be found in our April 1985 article. [Editor's note: Crossref is available on BIX and BYTenet.] ■

REFERENCES

1. Quinlan, J. Ross. "Learning Efficient Classification Procedures and Their Application to Chess End Games." In *Machine Learning: An Artificial Intelligence Approach*, R. S. Michalski et al., eds. Palo Alto, CA: Tioga Publishing Co., 1983.
2. Brieman, Leo, et al. *Classification and Regression Trees*. Belmont, CA: Wadsworth International Group, 1984.

JOB INVOICE

SOLD TO: MANHATTAN EXPORTS
 ATTENTION: [redacted]
 YOUR P HONORABLE

DATE: 04/15/86
 INVOICE NO.: 8210
 SHIPMENT NO.: 2198
 CODE: AMOUNT:
 \$10,287.50

TH SEAS SHIPPING COMPANY
 THLY SALES TRAFFIC AGENTS
 BY CUSTOMER

Ext. Price
 7,000.00
 3,750.00
 1,000.00
 00.00

Representative No: 54
 Cost
 \$1,530.00



South Seas Shipping Company

November 20, 1986

Ms. Cathy Lyons
 Import Officer
 Botanical Research Ltd.
 55 Wawak Road
 Moresby, Papua, New Guinea

Re: Palm Fruit Research

Dear Ms. Lyons:

This letter confirms the agreement we reached at our meeting last week in San Francisco. Botanical Research, Ltd. will recommend the optimal conditions for shipping palm fruit and palm oil. Most important issues for consideration are: temperature during shipping and length of time between [redacted] and shipping.

South Seas Shipping Company
 Corporate Organizational Chart

PRESIDENT
 Trevor Cardinal

INVESTOR'S UPDATE

SHIPPING GOES WILD IN THE SOUTH PACIFIC

South Seas is crushing the shipping world. In fact, every other shipping company, South Seas has managed to maintain its growth despite the strong dollar and lower-than-ever freight rates. For the first quarter ending in March 31, South Seas turned in a record \$20 million profit on sales of \$117.1 million. President Trevor Cardinal cited several reasons for this record-breaking quarter. First of all, by expanding operations into special-ized, price insensitive commodities like palm oil and rum, South Seas has been relatively unaffected by the strong dollar and unfavorable exchange rates.

Second, South Seas is now reaping the benefits of long-term relationships it has developed with port authorities throughout the South Pacific. These relationships have let South Seas keep its rates competitive, yet profitable, during recent freight rate wars.

Finally, Mr. Cardinal said South Seas had money left over for costs funds it set aside last year for launching of new container ships.

Outlook for Sales

Spectacular sales for the first quarter will set the pace for what industry analysts expect will be a record year for South Seas. "South Seas will be the industry leader by 1990," says Michael Wong, a vice-president at Donovan, Krull & Co. "Their growth strategy is sound and their balance sheet continues to be the financial muscle to continue to grow even during the current slump in the shipping industry."

Competitive Factors

One of the primary factors in South Seas success has been the company's ability to identify new market opportunities and then to establish the dominant position in that market. The palm oil trade is a prime example of this successful strategy. Since entering the market in 1977, South Seas has become the key player in the specialty shipping market.

However, LBC Ltd. is expected to become a more aggressive player. The Singapore concern had concentrated its efforts on short-haul container freight in the Indian Ocean. Last year, LBC purchased the ailing Barton Lines. This move more than doubled LBC's tanker capacity. Several of these mid-sized tankers have been refitted for the palm oil trade and are expected to enter service by mid-1986. So far, the LBC has been unsuccessful in winning any of South Seas customers. In the future, increased competition can be expected to depress both prices and margins, but for the short-term, South Seas contracts with most of the palm oil industries largest producers should insulate it.

Joint Ventures Considered

Another growth strategy South Seas is exploring is to establish joint ventures with several of the producers of these commodity. These ventures would be similar to the TransPac/South Seas tea cooperative, in that South Seas v offer its shipping capabilities as a share of the venture. At this time, the company is holding preliminary talks with many agri-culture firms. Another pc export firm. Another pc would be to join with a turning concern. One company expect interested in a joint venture is Mountain View has seen Mountain View has seen for its products grow in the Japanese market. T this demand, Mountain begin to strengthen.

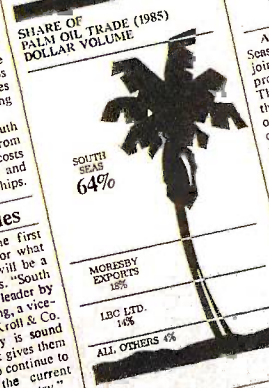

What if...

YOU COULD PRINT EVERYTHING ON THIS DESK FROM A BUSINESS PC?

The world's best-selling desktop laser printer has something in store for just about every business that's ever dealt with the printed word.

Because the Hewlett-Packard LaserJet Printer is the only printer of its kind specifically designed to work with over 300 software programs. And since it hooks up to almost any business PC, it's right for all kinds of users—not just the art department. So you can print everything on this desk—from simple memos to your life's memoirs. And get high-quality, professional-looking output.

Combined with our very fast, very versatile HP Vectra PC (it's IBM PC/AT compatible) and the software of your choice, the HP LaserJet is the cornerstone for a complete desktop publishing solution. One your whole company can easily use.

Of course, the HP LaserJet also works with IBM PC's and compatibles. As well as software like Lotus 1-2-3, WordStar and d:BASE II. And, for around \$3,000, it's the laser printer you can afford.



We can't print all the reasons our HP LaserJet is the printer of choice. But if you stop by an authorized HP dealer or call us at 1 800 367-4772, Dept. 276E for the one nearest you, we'll show you why HP quality printing makes very good business sense indeed.

Print samples produced on a LaserJet Plus with the following software packages: Studio Software, Spellbinder Desktop Publisher, MicroPro WordStar 2000, Lotus 1-2-3, and FormMaker II. HP Vectra PC is a trademark of Hewlett-Packard. IBM PC is a registered trademark of International Business Machines Corp. Lotus 1-2-3 is a registered trademark of Lotus Development Corp. WordStar is a registered trademark of MicroPro International. d:BASE II is a registered trademark of Ashton-Tate. © 1986 Hewlett-Packard Co.



hp HEWLETT PACKARD
 Business Computing Systems
 Inquiry 149 PG601BTX

Announcing BYTE's New Subscriber Benefits Program

Your BYTE subscription brings you a complete diet of the latest in microcomputer technology every 30 days. The kind of broad-based objective coverage you've read in this issue. *In addition*, your subscription carries a wealth of other benefits. Check the check list:

DISCOUNTS

- 13 issues instead of 12 if you send payment with subscription order.
- One-year subscription at \$21 (50% off cover price).
- Two-year subscription at \$38.
- Three-year subscription at \$55.
- One-year GROUP subscription for ten or more at \$17.50 each. (Call or write for details.)

SERVICES

- BIX:** BYTE's Information Exchange puts you on-line 24 hours a day with your peers via computer conferencing and electronic mail. All you need to sign up is a microcomputer, a modem and telecomm software.
- Reader Service:** For information on products advertised in BYTE, circle the numbers on the Reader Service Card enclosed in each issue that correspond to the numbers for the advertisers you select. Drop it in the mail and we'll get your inquiries to the advertisers.
- TIPS:** BYTE's Telephone Inquiry System is available to subscribers who need *fast response*. After obtaining your



Subscriber I.D. Card (see TIPS information adjacent to Reader Service cards), dial TIPS and enter your inquiries. You'll save as much as ten days over the response to Reader Service Cards.

- Disks and Downloads:** Listings of programs that accompany BYTE articles are now available free on the BYTEnet bulletin board; and on disk or in quarterly printed supplements (see reply cards in this issue).
- Microform:** BYTE is available in microform from University Microfilm International in the U.S. and Europe.
- BYTE's BOMB:** BYTE's Ongoing Monitor Box is your direct line to the editor's desk. Each month, you can rate the articles via the Reader Service

Card. Your feedback helps us keep up to date on your information needs.

- Customer Service:** If you have a problem with, or a question about, your subscription, you may phone us during regular business hours (Eastern time) at our toll-free number: 800-258-5485. You can also use Customer Service to obtain back issues and editorial indices.

BONUSES

- Annual Separate Issues:** In addition to BYTE's 12 monthly issues, subscribers also receive our annual IBM PC issue free of charge, as well as any other annual issues BYTE may produce.
- BYTE Deck:** Subscribers receive five BYTE postcard deck mailings each year—a direct response system for you to obtain information on advertised products through return mail.

To be on the leading edge of microcomputer technology *and* receive all the aforementioned benefits, make a career decision today—complete and mail in a subscription card or, call toll-free weekdays, 8:30am to 4:30pm E.S.T.: 800-258-5485.

*And... welcome to
BYTE country!*

BYTE
THE SMALL SYSTEMS JOURNAL



Make a
career move
today. . .
Subscribe to
BYTE and
stay on the
leading edge
of micro-
computing
technology.



For direct ordering
call toll free weekdays
8:30am-4:30pm
E.S.T. :

800-258-5485

(603-924-9281 for
New Hampshire
residents)

OR

Complete adjacent
postcard and mail.

Note our special offer:
*Send cash with your order
and receive 13 issues at
the price of 12 for each
year you subscribe (North
America only).*



YES! I want to subscribe to **BYTE
and save 50% off* the cover price.**

U.S. \$21.00 (1 yr.) *Basic subscription rate \$38.00 (2 yrs.) \$55.00 (3 yrs.)
 Canada/Mexico Europe-Air Delivery Worldwide-Surface Delivery
 \$23.00 U.S. (1 yr.) \$69.00 U.S. (1 yr.) \$37.00 U.S. (1 yr.)

Enclose payment (check or credit card information) and get one extra issue for each year you subscribe (North America only).

- Bill me (North America only)
 Payment enclosed (U.S. funds drawn on a U.S. bank only)
 Charge to my VISA MasterCard



46BTNX

Card # _____ Expires _____ Signature _____

Name _____

Address _____

City/State _____ Country _____ Code _____

Please allow 6-8 weeks for processing your subscription



YES! I want to subscribe to **BYTE
and save 50% off* the cover price.**

U.S. \$21.00 (1 yr.) *Basic subscription rate \$38.00 (2 yrs.) \$55.00 (3 yrs.)
 Canada/Mexico Europe-Air Delivery Worldwide-Surface Delivery
 \$23.00 U.S. (1 yr.) \$69.00 U.S. (1 yr.) \$37.00 U.S. (1 yr.)

Enclose payment (check or credit card information) and get one extra issue for each year you subscribe (North America only).

- Bill me (North America only)
 Payment enclosed (U.S. funds drawn on a U.S. bank only)
 Charge to my VISA MasterCard



46BTNX

Card # _____ Expires _____ Signature _____

Name _____

Address _____

City/State _____ Country _____ Code _____

Please allow 6-8 weeks for processing your subscription



YES! I want to subscribe to **BYTE
and save 50% off* the cover price.**

U.S. \$21.00 (1 yr.) *Basic subscription rate \$38.00 (2 yrs.) \$55.00 (3 yrs.)
 Canada/Mexico Europe-Air Delivery Worldwide-Surface Delivery
 \$23.00 U.S. (1 yr.) \$69.00 U.S. (1 yr.) \$37.00 U.S. (1 yr.)

Enclose payment (check or credit card information) and get one extra issue for each year you subscribe (North America only).

- Bill me (North America only)
 Payment enclosed (U.S. funds drawn on a U.S. bank only)
 Charge to my VISA MasterCard



46BTNX

Card # _____ Expires _____ Signature _____

Name _____

Address _____

City/State _____ Country _____ Code _____

Please allow 6-8 weeks for processing your subscription

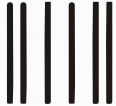

NO POSTAGE
NECESSARY
IF MAILED
IN THE
UNITED STATES

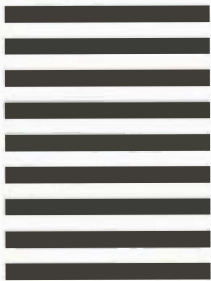

BUSINESS REPLY MAIL

FIRST CLASS MAIL PERMIT NO. 39 MARTINSVILLE, NJ

POSTAGE WILL BE PAID BY ADDRESSEE

BYTE Subscriptions

PO Box 597
Martinsville, NJ 08836-9956



NO POSTAGE
NECESSARY
IF MAILED
IN THE
UNITED STATES

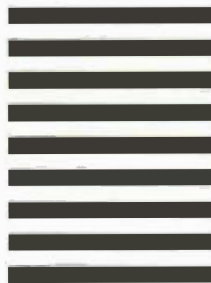

BUSINESS REPLY MAIL

FIRST CLASS MAIL PERMIT NO. 39 MARTINSVILLE, NJ

POSTAGE WILL BE PAID BY ADDRESSEE

BYTE Subscriptions

PO Box 597
Martinsville, NJ 08836-9956



NO POSTAGE
NECESSARY
IF MAILED
IN THE
UNITED STATES



BUSINESS REPLY MAIL

FIRST CLASS MAIL PERMIT NO. 39 MARTINSVILLE, NJ

POSTAGE WILL BE PAID BY ADDRESSEE

BYTE Subscriptions

PO Box 597
Martinsville, NJ 08836-9956



Make a
career move
today...
Subscribe to
BYTE and
stay on the
leading edge
of micro-
computing
technology.



For direct ordering
call toll free weekdays
8:30am-4:30pm
E.S.T. :

800-258-5485

(603-924-9281 for
New Hampshire
residents)

OR

Complete adjacent
postcard and mail.

Note our special offer:
*Send cash with your order
and receive 13 issues at
the price of 12 for each
year you subscribe (North
America only).*

A BIT-MAPPED CLASSIFIER

BY PETER W. FREY

This unconventional approach yields a small, fast, pattern-oriented expert system

IN THE PAST DECADE, expert systems have matured from laboratory curiosities to useful commercial products. They are an evolutionary outgrowth of early work in artificial intelligence on search-based problem solving and theorem proving. In their most common form, these systems use simple IF . . . THEN productions to represent a wide range of ideas, concepts, and actions in a uniform data structure. Conclusions are drawn and advice is given by reasoning in a sequential manner. Sometimes the expert system uses forward chaining by starting with initial observations and working through the list of productions until it can derive an appropriate conclusion. In other instances, the inference engine works by backward chaining. In this case, the system starts with the desired conclusion and attempts to work through the production list to find a link to the conditions of the specified problem.

CLASSIFIER SYSTEMS

In what follows, I describe an unconventional expert system that is based on pattern recognition rather than on reasoning. This approach can be implemented in conventional pro-

gramming languages on an inexpensive desktop system. The architecture is surprisingly simple, and the program can be modified or extended easily. When implemented cleverly, expert systems based on this approach can provide advice or conclusions rapidly even when the knowledge base is extensive. I hope to show that a simple method can sometimes be a good one.

The literature on expert systems shows that most existing programs function as categorizers. A set of environmental stimuli (features or symptoms) is classified into one of many possible categories. For example, medical diagnosis is performed by assigning each set of symptoms to a specific illness category. Other diagnostic programs work in a similar manner to deal with mechanical malfunctions in automobiles, airplanes, or air-conditioning systems. Systems for speech recognition or visual object identification can also be treated as classification systems. Expert systems that provide travel recommendations or suggest where to drill for oil can also be placed in this same category.

The pattern-recognition program described in this article is based on

a familiar concept that is commonly known as a classifier system. The terminology I use is based on the recent work of John Holland (see reference 1) at the University of Michigan. Information about the set of conditions is encoded as a string of bits where each bit represents a specific feature that is typically binary in nature (present or absent). This bit string, which can be 10 or 12 bits for simple problems or several hundred bits for complex problems, is usually referred to as a *message*. For example, a system for recognizing a particular person at a sports event might have specific bits representing such features as blue eyes, black hair, 6 feet tall, 190 pounds, blue jacket, brown pants, gray sideburns, shoulder-length hair, wire-rim glasses, etc. The set of features can be broad enough to uniquely categorize thousands of different individuals. The message for any given person would have a 1 in locations representing specific attributes that

(continued)

Peter W. Frey (Northwestern University, 2021 Sheridan Rd., Evanston, IL 60201) is a professor at the Cresap Neuroscience Laboratory. He has interests in decision processes, expert systems, and machine learning.

are present and a 0 in locations for features that are not present. This bit-map approach is very general and yet is extremely simple to implement.

A particular pattern of features, such as those associated with a target person, is denoted by a bit-string pattern called a *classifier*. Classifiers are more complicated than messages because they are based on a multi-letter alphabet rather than a two-letter alphabet. One way to represent a classifier in a binary system is to use one bit string to denote present or absent and other bit strings to represent the relative importance of different bits. I will refer to the first string as the classifier and the others as *classifier masks*. Eleanor Rosch (see reference 2) has argued persuasively that natural categories do not have fixed boundaries. Instead, members of a category vary in their characteristics depending on how many of their attributes are central or peripheral to the category. To represent this aspect of categoriz-

ing people, objects, or events, we employ three classifier masks specifying which attributes are absolutely essential to the category (type A), which ones are usually present (type B), and which ones are sometimes present (type C). This strategy permits flexibility in defining category prototypes (the classifiers) that seem necessary for real-world applications.

To perform a task such as finding a specific person at a sports event, you would create a classifier that specifies which attributes among those possible are possessed by the target individual. A message would then be created for each individual at the sports event by specifying the attributes that each possessed. The classifier would then be compared to each message, and the message that was most similar would be identified as the target individual. This strategy is conceptually simple. Note, however, that several very important matters need to be considered. In particular,

you must specify the global set of attributes. The effectiveness of the process depends critically on a judicious choice of attributes. The process can discriminate among similar individuals only if the bit map includes the right features. Knowing in advance what these features should be usually requires an expert's knowledge.

The second major problem of the description given above is the phrase "most similar." There are many ways to measure similarity. With simple bit maps, the most obvious measure of similarity between a message and a classifier is the number of relevant bits in common. A relevant bit is one indicated by the classifier mask as being important. By comparing each of the three classifier masks with the message, you can determine if all the essential bits (type A) in the classifier are matched exactly, how many of the type B bits are set properly, and whether any of the type C bits match.

In most cases, you need to empha-

6.0 Now Released!
• Larger Variables
• Added Features

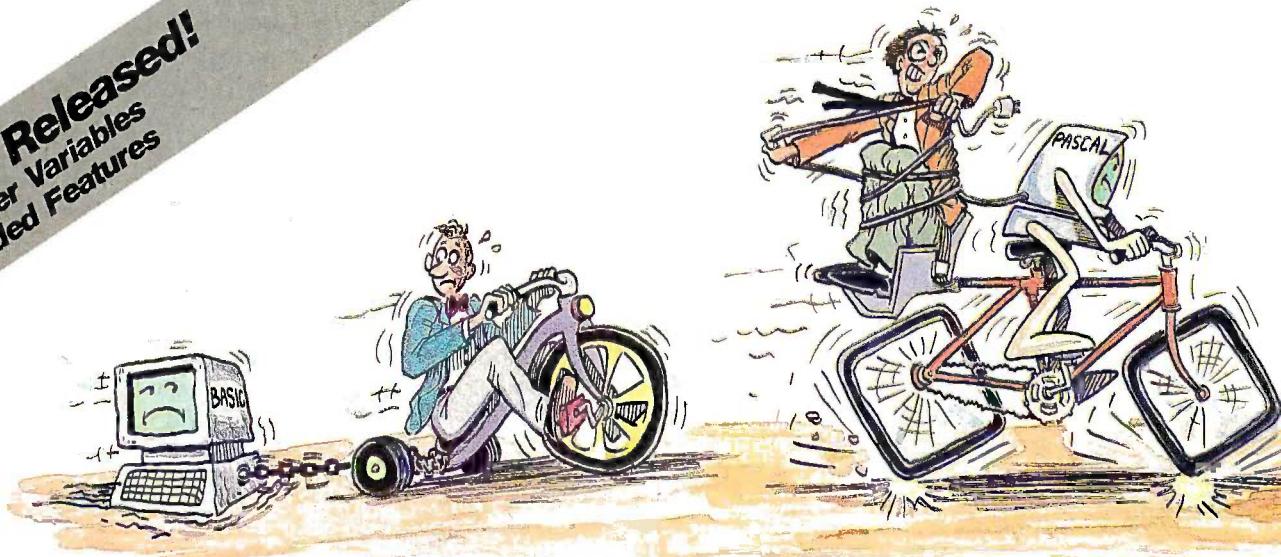

A Personal Language

When it comes to problem solving, the APL*PLUS System is the undisputed leader.

That's because the APL*PLUS System works with you. It goes far beyond what application software like Lotus® or dBASE® could possibly ever offer. And, it won't tie you down with the details of standard programming languages.

The APL*PLUS System is a personal language, with productivity features that help you concentrate on getting answers,

rather than struggle with intricate calculations and modeling.

With it you can manipulate tables of numbers as easily as single numbers and get quick results from your computer using short, simple statements.

When you've reached the limits of other packages, move up to the APL*PLUS System. It's a powerful and flexible tool that grows with you as your needs become more sophisticated. With over 200 built-in

applications—like graphics, report formatting and communications—you have all the tools at your fingertips to quickly and easily solve those seemingly impossible problems.

Best of all, the APL*PLUS System interfaces well with software packages you're already using—like databases, spreadsheets, and graphics packages. The APL*PLUS System also makes it easy to link those packages that aren't

size some bits more than others. Some attributes are absolutely critical (type A). If one or more of these are absent, the message is not compatible with the classifier. In a sense, each of these crucial attributes is given an absolute veto in the matching process. Type B and type C attributes influence the judgment of similarity but in a less central way. The proportion of type B matches is important because bits that do not match are negative evidence. Type C attributes are diagnostic when present but not damaging when absent. To be most similar to a classifier, a message must match all the critical features exactly and match more type B and type C features than any other message that meets the type A conditions. This implementation of the similarity idea provides a very powerful method for approximate pattern matching.

Another device that increases the generality of this procedure is to represent higher-level concepts with

more than one classifier pattern. For example, you might wish to identify a specific person at a sporting event and not know what clothing the person was wearing. But you might know that the person was likely to be wearing one of three favorite outfits. An easy way to deal with this ambiguity is to define three separate classifiers for the target person, one for each outfit. These three classifiers would be identical except for the bits representing clothing. This capability of defining more than one classifier for a given category is a powerful way to deal with concepts that are not precisely defined. In medical diagnosis, there are illnesses in which the pattern of symptoms is quite different for men and women or different for children and adults. These complexities are easy to deal with when separate classifiers can be defined for each special case.

When classifiers differ in the number of relevant features, the yard-

stick for measuring similarity needs to be modified to take into account the specificity of the classifier (see reference 1). One classifier is said to be more specific than another when it has more bits that are designated as relevant. Similarity is then defined as a joint function of the proportion of relevant bits that match and the total number of relevant bits.

An additional complication in many expert systems is that all aspects of the problem are not known in advance. For example, in medical diagnosis, it is usually necessary to ask the patient a series of specific questions or to administer specific medical tests in order to uncover the relevant information. This process of sequential information acquisition complicates the procedure since the computer system must decide in what order to administer the questions and/or tests. In medicine as well as in other applications, there is a financial cost

(continued)

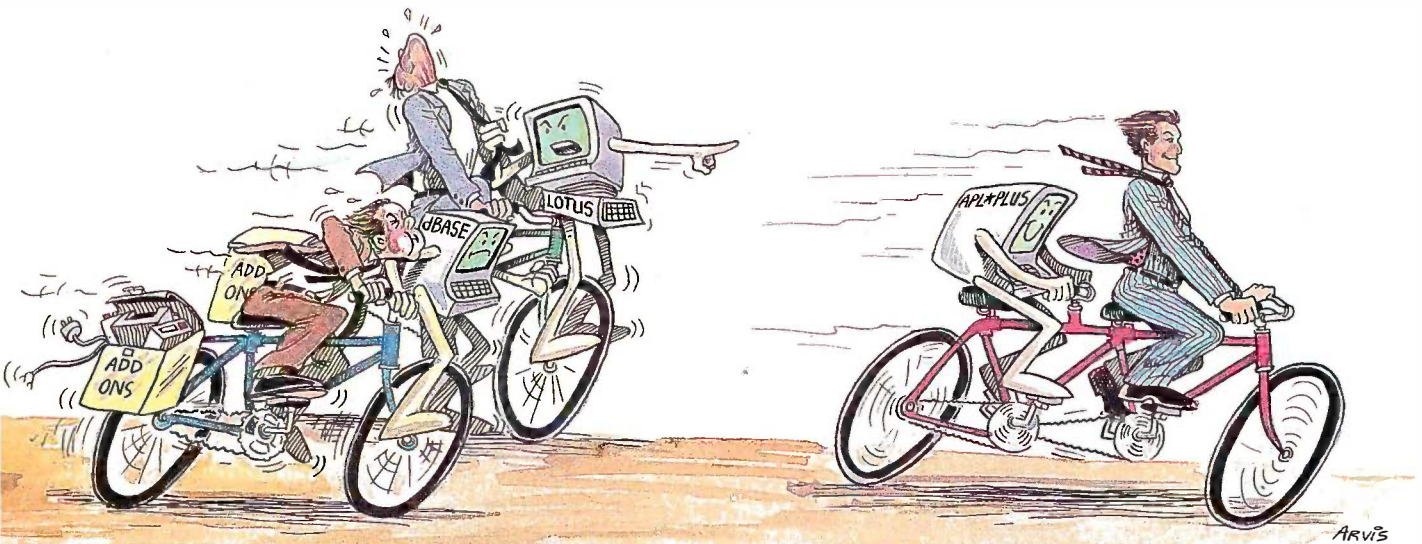

The APL★PLUS® System and You.

currently talking with each other.

With all this problem-solving power, it's no wonder STSC's APL★PLUS System is the personal choice of so many business professionals—financial planners, business analysts, actuaries, scientists, mathematicians, engineers, statisticians, and consultants. Especially since the APL★PLUS System is available on a full range of computers from desktops to mainframes.

Put the power, speed, and flexibility of the APL★PLUS System to work for you. See your local dealer today to get your APL★PLUS System. If they don't have it, refer them to STSC or call STSC toll-free, **(800) 592-0050**. In Maryland or Canada, **(301) 984-5123**.

SEE US AT COMDEX.

Available nationally through Softsel, Micro Central, and distributors worldwide. Dealer inquiries welcome.

Problem-Solving at the Speed of Thought

STSC STSC, Inc.
2115 East Jefferson St.
Rockville, MD 20852

APL★PLUS is a service mark and trademark of STSC, Inc. PLUS★WARE is a trademark of STSC, Inc. Lotus and dBASE are registered trademarks of Lotus Development Corporation and Ashton-Tate, respectively.

A PLUS★WARE™ PRODUCT

Inquiry 326

©1986 STSC, Inc.

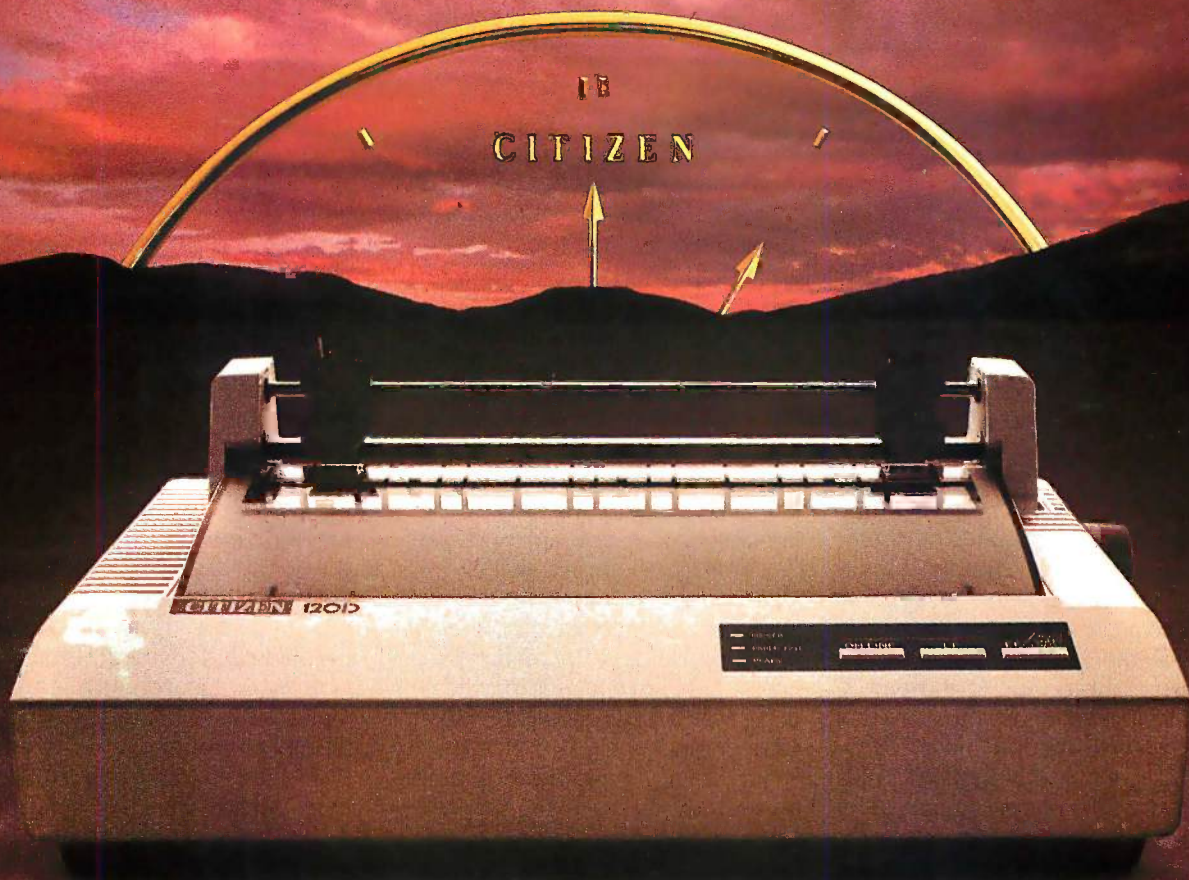

FOR PEOPLE WHO WANT MORE, BUT AREN'T WILLING TO PAY THE PRICE.

Citizen™ just took all the features of a high-end printer and made a small change.

We put them into a low-end printer. The Citizen 120D.

We created a dot matrix printer with more features and a lower price than any other printer in its class. One that produces clean, precise letters at a draft speed of 120 cps, with superior correspondence quality at 25 cps.

We added little extras, like a 4K-byte buffer, proportionally spaced printing, full graphics capabilities, and a unique paper loading system that's a small wonder. And we gave it the ability to survive the long run with most leading computer systems.

Because after 50 years of placing a world of precision on your wrist, we've come to realize something. Good things do come in small packages.

For more information, call 1-800-556-1234 Ext. 34. Or in California, call 1-800-441-2345 Ext. 34.

The Citizen 120D. Never has so much been offered to so many for so little.

 **CITIZEN™**

Printers that run like clockwork.

© 1986 Citizen America Corporation. Citizen and the Citizen logo are trademarks of Citizen Watch Company Ltd.

A BIT-MAPPED CLASSIFIER

associated with information gathering, and experts should be skilled at making the proper diagnosis at a minimal cost. This complication can be addressed within the message-classifier system by defining a message mask that indicates which attributes are known at any given time. Similarity between a message and a classifier is then measured by excluding features for which no information is available as well as excluding features that are not marked by the classifier mask.

You can develop many strategies for determining what feature to ask about next. A simple strategy is to identify the classifier that currently has the greatest similarity to the message and ask about its unknown features. If the answer to the question increases the degree of similarity, continue to seek information relevant to this classifier. If the answer decreases the similarity, check to see if another classifier is now more similar. If so, switch the line of questioning to features that are relevant to the second classifier. This strategy approximates the hypothesis-testing approach that is commonly observed in humans. Doctors try to gather information that will confirm or disprove the most likely diagnosis. Criminal investigators also usually concentrate their information-gathering efforts on their prime suspect.

IMPLEMENTING A BIT-MAPPED CLASSIFIER SYSTEM

The pattern-recognition system described above is well suited to the architecture and instruction set of a modern microprocessor. In particular, registers and memory locations are physical representations of a bit map. There are instructions such as EQUAL, NOT-EQUAL, AND, OR, and XOR that are designed to compare and manipulate whole strings of bits as a single operation. The bottleneck that determines execution speed is the time required to match classifiers with messages. In some applications there are many messages and a few classifiers. In others, there is only one or a few messages and many classifiers. For medical diagnosis, you might

(continued)

Peace On Earth.



One minute it's hot war. With tantrums and back talk. The next minute it's cold war. With pouts and pained sulks. It's life with anyone 5 to 18 years old. Get Mind Over Minors.™ And get some peace of mind. Within minutes, you'll learn ways to manage and motivate your young person based on your personality and theirs.

Mind Over Minors. It's a peace program for healthier, happier relationships. Call 1-800-624-5227 (In California, 1-800-824-7325). Separate editions for parents and teachers. IBM/Apple/Macintosh/Commodore.

Mind Over Minors™
From The Makers Of Mind Prober™

THE ATARI TEN COMMANDMENTS

II

"We shall create a computer that is as smart as the people who buy it." Jack Trammell
ATARI CORP.

The real genius of the ATARI 1040ST™ is that the level of performance you want is already built in.

Our competitors, however, think they can sell you a computer with a puny memory, and then charge you a small fortune to expand it.

We don't think that makes much sense.

That's why the 1040ST offers you 1024 Kbytes of memory built in for the incredibly low price of just \$999. That's less than \$1 per Kilobyte.

About the only thing the competition offers is the

chance to spend big bucks to upgrade their systems to where the ST™ started in the first place.

We're pretty sure which computer smart shoppers will buy.

The ATARI 1040ST is at your computer retailer now.

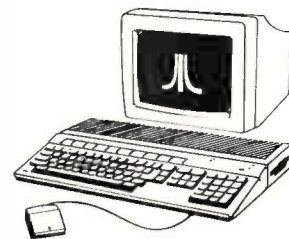

ATARI®

© 1986, Atari Corp.
ATARI, 1040ST, and ST are TM's or reg. TM's of Atari Corp.

Knowing which attributes to include separates an expert from a novice.

have a single message with 500 or 600 features (all of the symptoms the patient might have) and 300 or 400 classifiers (symptom patterns that fit particular illness definitions). To match this long message against each long classifier, you want to compare bit patterns at a very high rate.

To implement this process, the computer starts by performing an XOR operation between the message and the classifier. The resulting string is negated (NOT), reversing all 0s and 1s. Next, an AND operation is performed between the string representing the message mask and the string representing one of the classifier masks, setting the bits in those locations

where the feature is relevant and is currently known. This hybrid mask is then ANDed with the result of the first two operations. The number of bits set in this last string provides a count of the relevant matching bits between the classifier and the message. This process requires two ANDs, one XOR, and one NOT to produce the two relevant strings. Some mainframes have machine-level instructions that count the number of bits that are set in a word. Microprocessors do not have this instruction, so the only way to do a speedy bit count is to examine the word in 8-bit sections and use a table with 256 entries to look up the proper bit counts. This is not very elegant, but it is reasonably fast. For messages that are longer than the word size of the machine (usually 16 or 32 bits), the matching process must be repeated in 16- or 32-bit segments until the entire message has been examined. For most applications, the matching algorithm described above

executes rapidly. For the program described below, you get responses in about 2 to 3 seconds, using a BASIC interpreter.

AN EXAMPLE BASED ON HOUSE ARCHITECTURE

The advantages of this bit-mapped approach can be demonstrated by applying the method to a realistic example. I have chosen house architecture because the ideas and terminology are familiar to a general audience. Because I am not an expert on this topic, the program's knowledge is derived almost entirely from a recent book (see reference 3). Unlike many examples that are based on "toy" problems, house architecture provides a level of complexity and conceptual richness that is equivalent to applications addressed by serious commercial expert systems. The implementation I describe covers over 58 distinct house styles and involves over 160 descriptive attributes. It can be extended without any major changes to encompass an even broader range of architectural themes and subtypes.

The first step in developing a knowledge base is to specify the attribute classes that define group membership. To identify the architectural style of a house, you focus on specific features, including date of construction, roof shape, roof pitch, nature of the junction between the roof and the exterior wall, material composing the exterior wall, type of windows, shape and decorations of the front door, ornamental details, and a multitude of other possible features.

A partial list of relevant attributes is presented in table I. The list is organized by general categories starting with date of construction. Any given house is designated by creating a bit map (a message) that has a 1 set in the bit position for each attribute that is present and a 0 set in the bit position for each attribute that is not. The number associated with each attribute represents the location of this attribute in the bit map. In the beginning, the proper identity of these bits is unknown. Appropriate values are assigned in a sequential fashion on

(continued)

Table I: A partial list of architectural attributes.

Date of Construction

1. before 1820
2. between 1820 and 1880
3. between 1880 and 1940
4. after 1940

Roof Pitch

5. flat
6. low slope (less than 30 degrees)
7. moderate slope (30 to 45 degrees)
8. steep slope (more than 45 degrees)
9. combination of the above

Exterior Walls

10. wood
11. stone
12. brick
13. stucco or adobe
14. combination of the above
15. other

Junction Between Roof and Exterior Wall

16. absence of eaves (little or no overhang)
17. parapet (exterior wall extends above edge of roof)
18. slight overhang with exposed rafters
19. slight overhang with boxed rafters
20. wide overhang with exposed rafters
21. wide overhang with boxed rafters
22. other

A MEGABYTE FOR DOS!

MicroWay is the world's leading retailer of 8087s and high performance PC upgrades. We stock a complete selection of 8087s that run from 5 to 12 MHz. All of our coprocessors are shipped with a diagnostic disk and the best warranty in the business - one year! We also offer daughterboards for socketless computers (NEC PC) and 287Turbo which increases the clock speed of the 80287 from 4 to 10 MHz. Our NUMBER SMASHER/ECM™ runs at 12 MHz with a megabyte of RAM and achieves a throughput of .1 megaflops with 87BASIC/INLINE, Intel For-

tran, or Microsoft Fortran. Software reviewers consistently cite MicroWay software and 8087 expertise as the best in the industry! Our customers frequently write to thank us for recommending the correct software and hardware to meet their specific needs. They also thank us for our same-day shipping! In addition to our own products which support the 8087 and 80287, we stock the largest supply of specialized software available. For more information call us at

617-746-7341

NUMBER SMASHER/ECM™ THE FASTEST ACCELERATOR CARD AVAILABLE

gives you 12 MHz speed in two modes: 704K or one megabyte of "Extended Conventional Memory." MEGASWITCH MMU and MegaDOS software make it possible to run DOS applications with up to 1015K using PC compilers, AutoCAD and Lotus 1-2-3. Does not require EMS software. Totally compatible... from \$599 for 512K and 9.54 MHz to \$1199 with one megabyte and 8087-12.
Cooling Fan (for 12 MHz)..... \$80

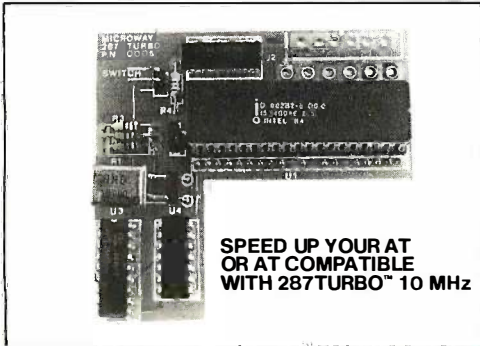

MicroWay® 8087 Support

For the IBM PC, PC XT, PC AT and Compatibles.

A2D-160™ MicroWay's Data Acquisition Board performs 160,000 12 bit Analog to Digital conversions per second! Includes software drivers. The fastest 12 bit A to D board available. For the IBM PC XT and compatibles..... **\$1295**

87SFL™ Accurate and fast Scientific Subroutine Packages. More than 145 functions: 34 Elementary Fcns, 18 Probability and Statistical Fcns, 15 Random Number Generators, $Ei(x)$, $E_1(x)$, $li(x)$, $Si(x)$, $ci(x)$, $\Gamma(x)$, $\psi(x)$, $B(x,\omega)$, $I_0(a,b)$, $erf x$, $S(x)$, $C(x)$, $J_0(z)$, $Y_0(z)$, $I_0(z)$, $K_0(z)$, $Ai(x)$, $Bi(x)$, $Ai'(x)$, $Bi'(x)$, $ber x$, $bei x$, $ker x$, $kei x$, $K(x)$, $E(x)$, $F(\rho|a)$, $E(\rho|a)$, $\Pi(\rho|a,b)$, $\Lambda(a,b,\rho)$, $\mathcal{P}(z)$, $\mathcal{D}(z)$, $P_n(x)$, $H_n(x)$, $L_n^{(\alpha)}(x)$, $J_n^{(\alpha,\beta)}(x)$, $G_n(p,q,x)$, $C_n^{(\alpha)}(x)$ and many more. Callable from FORTRAN, Pascal, BASIC and C. 1st module \$250, 2nd on \$100.

MATRIXPAK™ manages a MEGABYTE! Written in assembly language, our runtime package accurately manipulates large matrices at very fast speeds. Includes matrix inversion and the solution of simultaneous linear equations. Callable from RM or MS Fortran, MS Assembler, or 87BASIC/INLINE..... each **\$99**

87FFT™ Written in assembly language, performs Forward and Inverse FFTs on real and complex arrays which occupy up to 512 Kbytes of RAM. Also does convolutions, auto correlations, hamming, complex vector multiplication, and complex to radial conversions. Callable from most 8087 compatible compilers..... **\$200**

87FFT-2™ performs two-dimensional FFTs. Ideal for image processing. Requires 87FFT **\$100**

FASTBREAK™ 8087 support for Lotus 1-2-3™ Version 1A or 1A*..... **\$79**
Microsoft Fortran V.3.31..... **\$209**
IBM Professional Fortran..... **\$565**
Ryan-McFarland Fortran V.2.0..... **\$399**
LAHEY Fortran F77L..... **\$477**
Grafmatic for Fortran or Pascal..... **\$125**
MultiHalo Graphics (1 language)..... **\$189**
Microsoft C V.4.0..... **\$299**
STSC APL*PLUS/PC..... **\$450**
INTEL, JRAM, AST, MAYNARD..... **CALL**

MegaPage™ The only Intel-Lotus EMS board which comes with two megabytes of cool-running, low power drain CMOS RAM installed. Includes RAM disk print spooler, disk cache, and EMS drivers. For the IBM PC, XT & compatibles.... **\$549**

DFixer™ Our disk utility which thoroughly checks PC or AT hard disks for bad sectors and updates the MS DOS file allocation table accordingly. Solves the AT hard disk problem! ... **\$149**

Optimizer™ Optimizes the way your hard disk or floppy stores its files. Speeds up accesses by recombining fragmented files..... **\$49**

DCache™ Our disk caching software speeds up your I/O by storing repetitively used tracks in memory. The amount of memory used can be selected in 64 Kbyte banks..... **\$49**

87MACRO/DEBUG™ Contains all the pieces needed for writing 8087/80287 assembly code & MicroWay's 87DEBUG debugger. **\$199**

OBJ→ASM™ A multipass object module translator and disassembler. Produces assembly language listings which include public symbols, external symbols and labels commented with cross references. Ideal for patching object modules for which source is not available..... **\$200**

87BASIC™ includes patches to the IBM BASIC or MS Quick BASIC Compiler for USER TRANS-PARENT 8087 support. Provides super fast performance for all numeric operations including trigonometrics, transcendental, addition, subtraction, multiplication, and division..... each **\$150**

87BASIC/INLINE™ converts the output of the IBM BASIC Compiler into optimized 8087 inline code which executes up to seven times faster than 87BASIC. Supports separately compiled inline subroutines. Requires the IBM BASIC Compiler Version 1 and a Macro Assembler. Includes 87BASIC..... **\$200**

RTOS - REAL TIME OPERATING SYSTEM RTOS is a multi-user, multi-tasking real time operating system. It includes a configured version of Intel's iRMX-86, LINK-86, LOC-86, LIB-86, OH-86, and MicroWay's 87DEBUG. Runs on the IBM-PC, XT, PC-AT and COMPAQ..... **\$600**

INTEL COMPILERS™
FORTRAN-86..... **\$750**
PASCAL-86..... **\$750**
PL/M-86..... **\$500**
ASM-86..... **\$200**

*Requires RTOS or iRMX-86. All Intel compiler names and iRMX-86 TM Intel Corp

8087 UPGRADES

All MicroWay 8087s include a one year warranty, complete MicroWay Test Program and accurate installation instructions.

8087 5 MHz..... \$114
For the IBM PC, XT and compatibles.

8087-2 8 MHz..... \$149
For Wang, AT&T, DeskPro, NEC, Leading Edge.

80287-3 5 MHz..... \$179
For the IBM PC AT and 286 compatibles.

80287-6 6 MHz..... \$229
For 8 MHz AT compatibles.

80287-8 8 MHz..... \$295
For the 8 MHz 80286 accelerator cards.

NEC V20, V30..... \$16, \$30

64K RAM Set 150ns..... \$10

256K RAM Set 150ns..... \$29

256K RAM Set 120ns..... \$39

128K RAM Set PC AT..... \$49

287Turbo™ 10 MHz If you own an AT, Deskpro 286 or AT compatible, this is the card you need to get reasonable numeric performance. It plugs into your 80287 socket and includes a specially driven 10 MHz 80287. The card comes in three configurations. The IBMAT version includes a hardware RESET button..... **\$450**

287Turbo 8 MHz..... \$369

87/88Turbo™ is a stubby card which includes a clock calendar and a speed controller which changes the speed of your motherboard from 4.77 to 7.4 MHz. Its use requires your PC to have a socketed 8284. Typical speed increase is 1.6 to 2.0. The card overcomes slow hardware by slowing up only when such devices are accessed and running at full speed otherwise..... **\$149**
Optional 8087-2..... **\$149**

286TurboCache™ This accelerator for the PC or XT uses 8K of cache memory and 80286/80287 processors to provide an average speed increase of 3:1 for most programs. Call for specifications and benchmarks..... **\$469**

Call for our complete catalog of software which supports the 8087.

In London, please phone 223-7662

MicroWay
P.O. Box 79
Kingston, Mass.
02364 USA
(617) 746-7341

The ultimate time saving input device for IBM PC!

KEYPORT 60

60 Programmable Function Keys!

Polytel's programmable multifunction keypad, the KEYPORT 60, is your key to one-finger pushbutton software.



The KEYPORT 60 by Polytel is your Productivity Booster—one keystroke instead of many!

- ★ Every key fully programmable
- ★ Label the keys so you never forget which key does what
- ★ Ideal for entering repetitive commands with a single touch.
- ★ No need to memorize hard-to-remember command sequences
- ★ Includes ready-to-go templates for DOS, WordStar, Lotus 1-2-3, and BASIC.
- ★ Runs on IBM PC, XT, AT, and compatibles
- ★ Connects to game port—leaves your other ports free
- ★ Does not interfere with normal operation of regular keyboard.
- ★ 60-day money back guarantee—no risk to you.

★ ★ ★ Price—\$139 ★ ★ ★
(add \$6 shipping for each Keypoint)

— SPECIAL OFFER —
Game port included!
A \$45 value!

To order, call Polytel at

1-800-245-6655

In California, call 1-408-730-1347

Or send \$145 check or money order to:

Polytel Computer Products Corp.
1250 Oakmead Parkway, Suite 310
Sunnyvale, California 94086

In the UK and Scandinavia, contact

Electrone Ltd.
Haywood House, High Street
Pinner, Middlesex HA5 5QA
Tel: 01-429-2435



VISA, MasterCard & American Express cheerfully accepted!

A BIT-MAPPED CLASSIFIER

the basis of information provided by the human user during a question-and-answer session. Attributes are selected to capture the distinctive features of each house style and to discriminate among types that may have many similarities. Knowing which attributes to include on the list is one of the things that separates an expert from a novice.

When a conventional rule-based expert system has difficulty making a proper categorization, the knowledge engineer typically modifies one or more existing rules or devises additional rules. The system I describe adjusts for weak performance in a similar manner by modifying or adding to the attribute list. Almost any two styles can be distinguished by identifying critical differences and adding features that are sensitive to these differences. A powerful technique in this regard is to note which attributes never appear and include their negations as part of the classifier.

Sample classifiers are presented in table 2. Each architectural style is defined in terms of features from the

attribute list that are assigned a type A (must be present), type B (usually present), or type C (sometimes present) role. Each number corresponds to a bit in a descriptive string. An attribute in the table that is underlined is one that should not be present (negation). Note that the Italian Renaissance style is defined with two classifiers because there are two distinct variations on the theme. These examples give the flavor of this flexible way to represent knowledge. By using messages and classifiers in combination with a carefully developed attribute list, the method can easily deal with a broad range of objects and concepts.

The program HOUSE.BAS was written in Microsoft BASIC version 2.0 to implement this system on the Macintosh. Double-clicking on the file loads MS-BASIC, which then executes the program. [Editor's note: HOUSE.BAS is available on disk, in print, and on BIX; see the insert card following page 352. It is also available on BYTEnet; see page 4.] You will see a banner announcing HOUSE.BAS's purpose and will have to wait several

(continued)

Table 2: Sample classifier definitions. The number indicates the bit position in the classifier string; an underlined value indicates negation.

Queen Anne Victorian

- A. 3, 8, 80, 83
- B. 41, 131
- C. 14, 42, 43, 45, 48, 49, 55, 57, 60, 69, 82, 84, 105, 116, 117, 118, 120, 121, 122, 132, 133, 134, 153

Colonial Revival

- A. 3, 60
- B. 7, 19, 26, 61, 83
- C. 24, 25, 30, 31, 32, 55, 70, 81, 87, 89, 91, 96, 116, 135, 136, 137, 138

Tudor

- A. 3, 8, 41
- B. 90, 105
- C. 12, 23, 33, 63, 64, 98, 126, 130, 156

Italian Renaissance I

- A. 3, 6, 21, 93
- B. 10, 115
- C. 25, 26, 65, 71, 76, 109, 110, 136, 137

Italian Renaissance II

- A. 3, 5, 11
- B. 83, 116, 123
- C. 25, 26, 43, 44, 65, 71, 76, 136, 137

Get a new handle on your business with SBT.

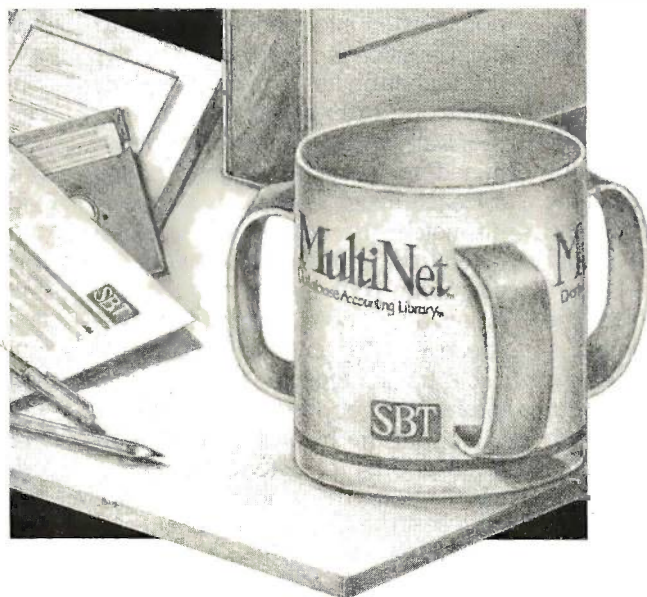

Now you can handle up to 254 users, all working in the same data files, with the SBT MultiNet Database Accounting Library. The accounting software written in dBASE III PLUS.

So whether your business is large or small, you can grow to the limits of the most advanced PC networks available.

When you want that special report, or your business needs something we didn't think of, you can quickly and easily modify our programs to meet your needs exactly (because our dBASE source code is included).

And if you don't have time to make the changes yourself, there's a nearby consultant who can make them for you.

So if your company has two users or two hundred and fifty, you can add customers, update records, and have as many people enter orders as it takes to keep your business growing.

Isn't it nice to know there's software you can't outgrow? The SBT MultiNet Database Accounting Library.

Now you can get a new handle on your business.

Three Harbor Drive Sausalito, CA 94965
(415) 331-9900

Call today for our demo disk and brochure.
(415) 331-9900.

THE SBT DATABASE ACCOUNTING LIBRARY.

dProfessional	Time & Billing	\$395
dOrder	Sales Order processing	\$195
dInvoice	Billing/Inventory Control	\$195
dStatement	Accounts Receivable	\$ 95
dPurchase	Purchase Order	\$195
dPayable	Accounts Payable	\$295
dPayroll	Payroll/Labor	\$395
dLedger	General Ledger/Finance	\$395
dAssets	Asset/Depreciation	\$295
dProject	Project/Job Accounting	\$395
dProperty	Tenant/Unit Management	\$395
dBackup	Menu/Backup	\$ 65

MultiNet versions \$200 additional per module

Call today for the name of the SBT consultant
in your area.

* Compiled versions also available. dBASE III and dBASE II are registered trademarks of Ashton-Tate, Inc. Copyright 1986, SBT Corporation.

The bit-mapped classifier approach is a model of organizational simplicity.

seconds while lists and masks are loaded. Click inside the banner window when the program is ready. Initially, you are asked to indicate the date of construction by pointing and clicking the mouse on one of four choices. A similar procedure is used to determine the roof slope, the material composing the exterior walls, and the type of junction between the roof and exterior wall. After these four attributes have been determined, the program continues by asking about one feature at a time. I have also added graphic examples of three features, namely, a board-and-batten door, a front door with recessed panels, and pilasters alongside the front door (see figure 1). These are included to demonstrate how an expert system can define unknown technical terms. Unfortunately, I don't have the time to develop a graphic depiction of the other 157 features. Questions then follow in a variable sequence un-

til the program determines that it has only one candidate that is consistent with the information.

The reasoning process that is used by this program is remarkably simple. A goodness-of-fit value is computed for each classifier by accumulating points when information relevant to the classifier is obtained. After the first four attributes (construction date, roof slope, exterior wall material, and roof-wall junction) have been determined, the program assigns 5 points for each match. If there is a type A mismatch, the house type is eliminated from further consideration. For each type B or type C mismatch, 5 points and 1 point are deducted, respectively. The cumulative total for each house type is treated as a measure of goodness of fit. The classifier with the highest score is then given priority for determining which information to seek next. If there are type A attributes that are unknown, a question about one of these is asked next. If all of the type A attributes are known, type B questions and then type C questions are posed to the user. If the score of the leading candidate drops below that of a rival, the questioning process immediately switches to the rival to determine attribute selection.

There are two termination condi-

tions. If one classifier accumulates a score that exceeds a predetermined threshold, this house type is declared the winner and no further information is needed. The notion is that the weight of evidence for this hypothesis is so strong that the decision is obvious. In this case, there is no need to waste your time with further questioning. On occasions when none of the classifiers has an overwhelming amount of support, the termination condition is much more conservative. Evidence is collected until the program can determine that the leading candidate has more support than any of its competitors could have. This is determined by noting which questions have not yet been asked and then doing a hypothetical calculation assuming negative outcomes for the leading candidate and positive outcomes for all the rivals. If the leader's projected score still exceeds those of its rivals, there is no need to seek further information. In this eventuality, the winner is announced and the process is stopped. For HOUSE.BAS, the program will identify the house type (if possible) and then loop indefinitely at this display until you halt it by typing the sequence command-period.

There are alternative reasoning strategies that are much more sophisticated than the one described above. You could assign subjective probabilities to each piece of evidence in a categorical fashion (e.g., 0.98 to type A items, 0.8 to type B items, and 0.3 to type C items) and then employ Bayesian or Dempster-Shafer reasoning to reach a decision. I am not eager to add these complexities until my simplified approach shows serious deficiencies. Because people apparently solve these problems without resorting to complex calculations, it seems reasonable to start with a machine model that avoids heavy number crunching.

EVALUATION AND EXTENSIONS

The bit-mapped classifier approach described above is a model of organizational simplicity. The knowledge base and reasoning mechanism are separate entities. Each can be modi-

(continued)

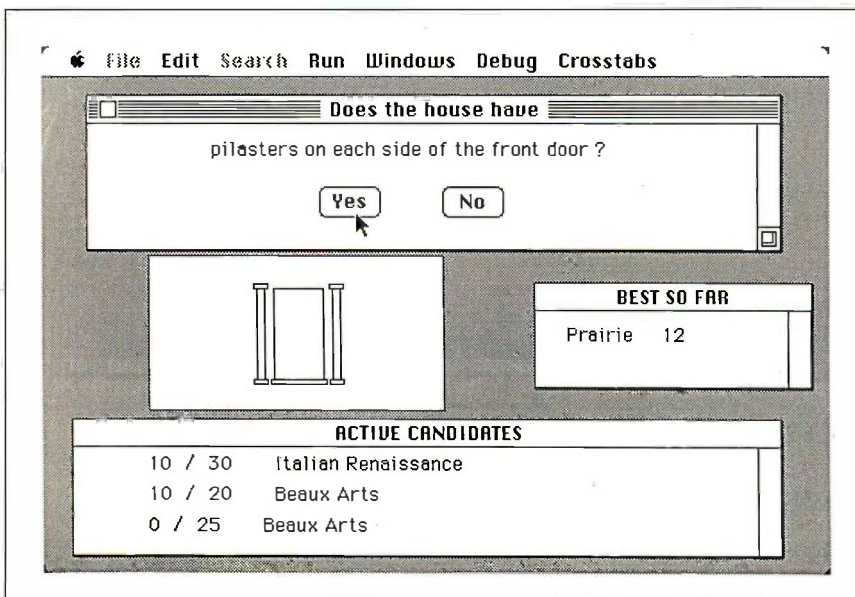
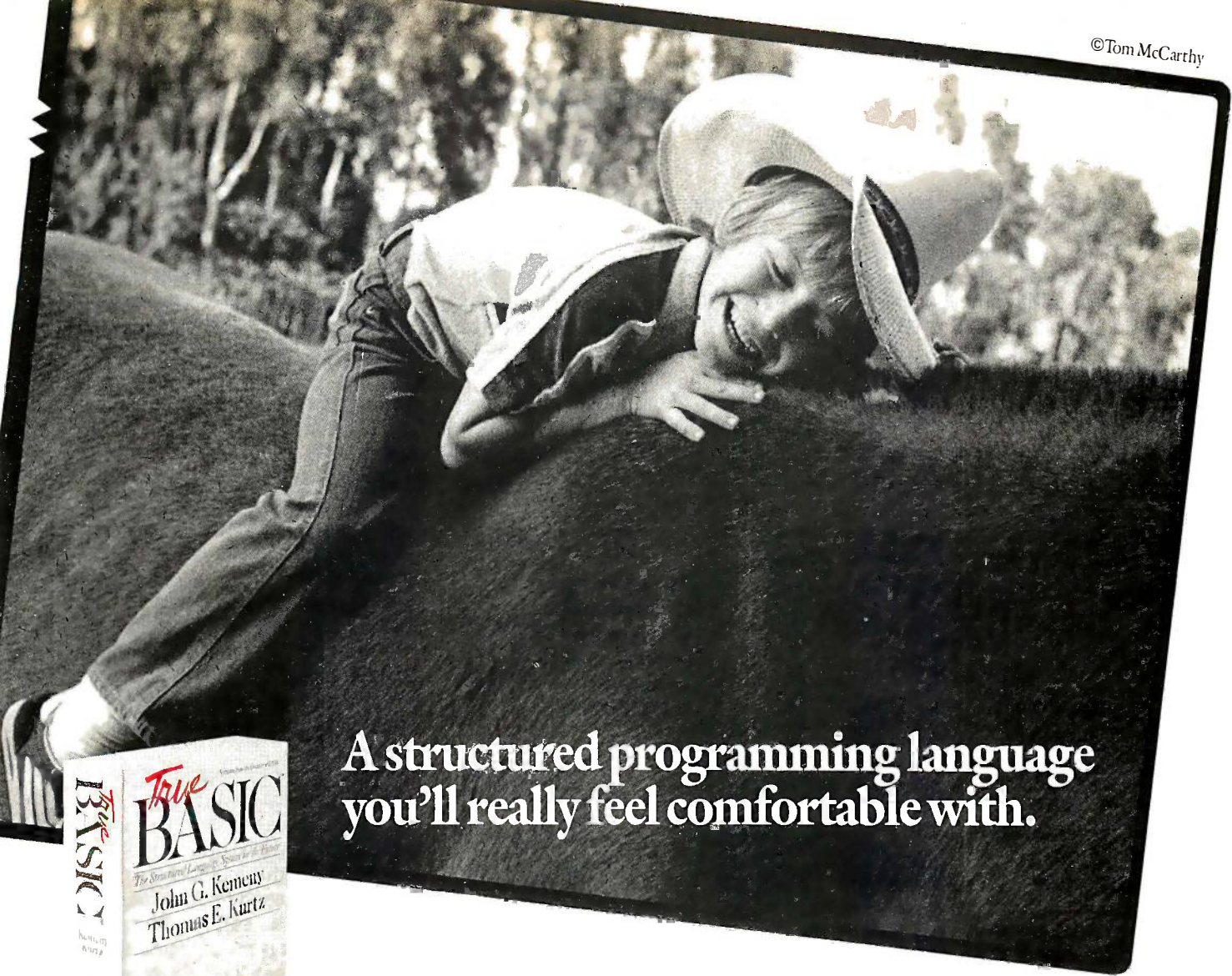
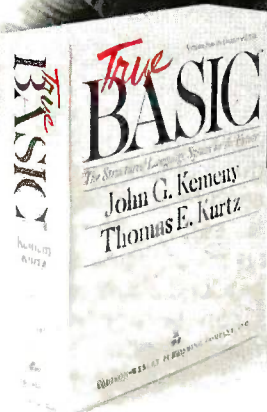

Figure 1: The HOUSE.BAS program in operation.



A structured programming language you'll really feel comfortable with.



You know John Kemeny and Tom Kurtz. They developed the original BASIC. Now they're back with an even better version: a flexible, easy-to-use structured programming language they call True BASIC.™

True BASIC offers a full selection of control structures. External procedures can be compiled into libraries, making True BASIC faster and more powerful than any other programming language.

True BASIC has a complete matrix algebra package and the best graphics ever in a higher level language. And there are optional libraries for things like sorting and searching and 3-D graphics.

True BASIC programs run on any computer which runs True BASIC, good news for users with more than one kind of PC.

You'll love True BASIC. Whether you're programming for your own applications, teaching others, or developing products to go to market, send in the coupon below to receive a free demo disk.

Available for the IBM-PC™ and compatibles, Apple Macintosh,™ and Commodore Amiga.™ To order, talk to your local dealer or call (603) 643-3882 TODAY!



True BASIC™ inc.

39 South Main Street,
Hanover, NH 03755 (603) 643-3882

My computer is: IBM-PC/compatible
 Apple Macintosh
 Commodore Amiga

- I'D LIKE TO GET MY FREE DEMO DISK.
- I'd like more information on the True BASIC language products.
- I'm ready to buy. Call me and tell me how.
- I'd like information on True BASIC Mathematics Series and other products.

Name _____
 Title _____
 Company/University _____
 Address _____
 City, State, ZIP _____
 Telephone _____

BY11

Suggested retail price \$149.90
Educational site licenses available from
Addison-Wesley Publishing.

True BASIC Language System is a trademark of True Basic, Inc.
Macintosh is a trademark of Apple Computer Corp.
Amiga is a trademark of Commodore Business Machines.
IBM is a trademark of International Business Machines Corp.

fied or extended without affecting the other. Because of this structure, you can diagnose performance problems quickly and easily. The transparency of the process greatly simplifies the knowledge engineer's task. When the program has difficulty categorizing a particular house or when a misclassification occurs, you can usually determine why the problem occurred and what needs to be done to correct it.

The development process can be aided by building tools that provide the knowledge engineer with rapid access to information that is frequently needed. To aid you in modifying this program, I have included two special menus, Debug and Crosstabs. The Debug menu provides a bit-map representation of the current message or its most likely classifier and its masks. Crosstabs allows you to select a house

type and see a list of all features that are relevant, or select a feature and see a list of relevant houses.

Another characteristic of these bit-mapped classifier systems is that they can be implemented in almost any standard high-level programming language. You can use Pascal, C, FORTRAN, BASIC, and many others. No special hardware is required, and the memory and computational demands are such that even an inexpensive microcomputer system is a feasible host. The ultimate yardstick, however, will be the functional utility of the approach. In the next few years, my students and I and perhaps others will examine various applications for this type of expert system. We will have confidence in the ultimate success of the approach only after we have field results that are consistent with a positive evaluation.

John Holland has worked with classifier systems for several years in a more complicated context. His objective has been to develop a conceptual basis for using this method of knowledge representation to do sequential reasoning and self-modification (learning). What is encouraging about the approach described above is that Holland's ideas can be applied to achieve much more powerful results than simple classification. If my bit-mapped classifier approach proves to work effectively on categorization problems, I will be very interested in exploring extensions of this approach that use Holland's bucket brigade and genetic algorithm. Since no special hardware or software is required, I am hoping that many of BYTE's readers will join the expedition. ■

REFERENCES

- Holland, J. "Escaping Brittleness: The Possibilities of General Purpose Learning Algorithms Applied to Parallel Rule-based Systems." In R. S. Michalski, J. G. Carbonell, and T. M. Mitchell, eds. *Machine Learning II*. Los Altos, CA: Morgan Kaufmann Publishers, 1986.
- Rosch, E. "Human Categorization." In N. Warren, ed., *Advances in Cross Cultural Psychology*, vol. 1. London: Academic, Press, 1977.
- McAlester, V., and L. McAlester. *A Field Guide to American Houses*. New York: Alfred A. Knopf, 1985.

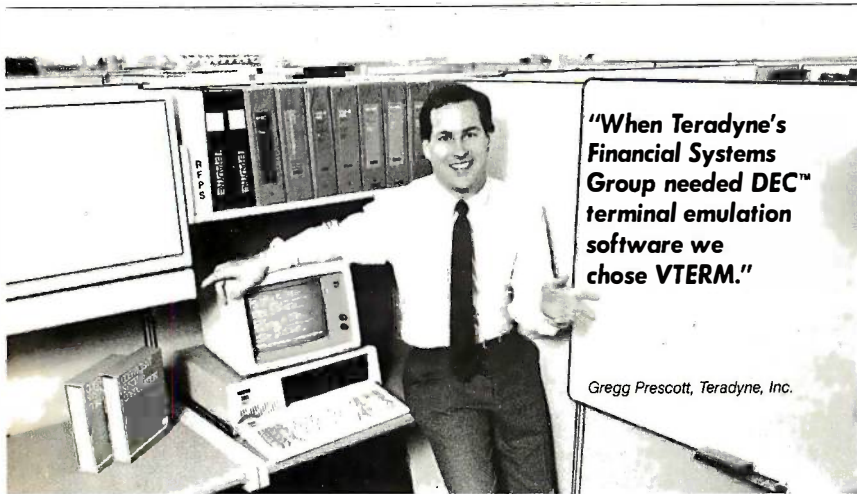

VTERM/220 Quality makes all other DEC terminal emulators obsolete

Over 35,000 demanding professionals, like Teradyne's Gregg Prescott, have recognized VTERM's superior quality.

Now this same VTERM quality is available in Coefficient's powerful new emulator, VTERM/220.

Features include:

- Plug compatible VT220 emulation with 132-column support and optional Tektronix™ 4010/4014 graphics.
- Extensive file transfer system offering KERMIT, XMODEM and our VTRANS protocol with VMS™, RSX 11 M/M+,™ RSTS/E™ and UNIX™ software.
- Host data capture on PC with conversion to Lotus® 1-2-3®, Symphony® and dBase®.
- "Hot Key" toggle between host session and PC DOS.

Call us today at 212-777-6707 ext. 402.



Coefficient

The Leader in DEC Emulation Software

Coefficient Systems Corporation
611 Broadway, New York, N.Y. 10012

Trademarks: DEC, VMS, RSTS/E, RSX 11 M/M+, Digital Equipment Corp.; Tektronix, Tektronix, Inc.; Lotus, 1-2-3, Symphony, Lotus Development Corp.; dBase, Ashton-Tate, UNIX, AT&T, Bell Laboratories



TGA mode (640 x 400)

Buy one. Get two free.



EGA mode (640 x 350)

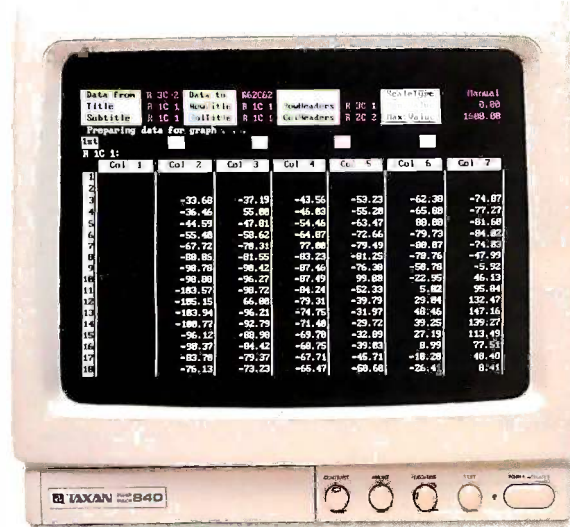

Improved CGA text mode

Inquiry 334 for End-Users. Inquiry 335 for DEALERS ONLY.

Sometimes life gives you less than you bargained for. Taxan would like to even that out a bit by giving you more than you'd expect—our Multi-Resolution System.™

Our display products not only give you EGA software compatibility, but also switch modes to CGA or TGA (640x400). This eliminates the hassles of swapping adapter cards or resetting internal switches. And, at the same time, it gives you three modes for the price of one.

Because of its ability to automatically switch modes, the Taxan Gold Card™ graphics adapter allows you to add new programs, with different display standards, to your software library without the worry of compatibility.

The Taxan Gold Card is also equipped with a built-in serial port. Making it easier to use mouse-driven software, like Windows, without buying a separate board or giving up valuable expansion slots in your PC.

Best of all, the Taxan Gold Card is designed to complement our high performance RGB monitors. Like the new large-screen model 840 or the improved models 635 and 650. The higher-than-industry standard horizontal scan rate of 25 KHz, and a doubled line count of 640x400 combine to give you sharp, clean text. Bright, clear colors. And crisp chart titles. All without annoying flicker.

Taxan's Multi-Resolution System is fully compatible with popular IBM and IBM-compatible PCs, including the AT&T 6300 and 6300 Plus.

Give us a call at your regional Taxan office for performance data on the Multi-Resolution product family. And remember that the best things in life are free.

Graphics Mode	
TGA	Ultra-high resolution (640x400)
EGA	IBM standard (640x350)
CGA	Double-scanned, high-quality image

RGB Monitor Applications	
Model 840	16-inch, large-screen CAD/CAM graphics. 0.39mm dot pitch
Model 635	Superior text display and business graphics
Model 650	Personal CAD/CAM graphics. 0.28mm dot pitch

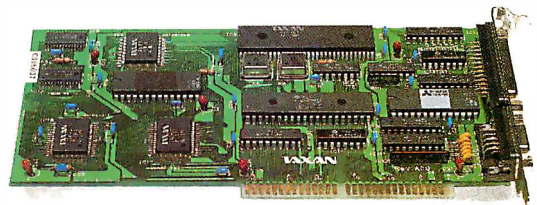

TAXAN

18005 Cortney Court, City of Industry, CA 91748
 Taxan East (201) 769-6500. Taxan Central (214) 550-1244.
 Taxan Midwest (312) 299-1060. Taxan West (818) 810-1291.

Multi-Resolution System and Taxan Gold Card are trademarks of Taxan USA Corporation.

“If you can

If you can find a company with better tape achievements, buy from them:



EVEREX Streaming Tape Family

- Over 30,000 streaming tape sub-systems, ½ height, 5¼” form factor industry standard QIC 24 recording format, QIC-36 hardware interface and largest installed customer base worldwide.
- Over 100,000 industry standard streaming tape controllers in the field.
- The first company to release QIC-02 IBM-compatible software drivers to the OEM community.
- The first company to release an internal 5¼” half-height IBM compatible tape subsystem.
- The first company to release file-by-file retrieval from a mirror-image backup.

If you can find better streaming tape software, buy it:

User Interface

- Menu driven.
- Multiple windows (nestable and movable).
- Context sensitive on-line help.
- File selection from directory listing or command line.
- Constant tape status display.
- Menu driven hardware configuration guide.

Tape Functions

- Multiple tapes allowing unlimited backup capacity.
- Multiple datasets for multiple backups on the same tape.
- Tape sequence management recorded on the tape.
- Programmable messages.
- File-by-file and image backup on the same tape.
- Installation program.

Functionality

- Physical image backup/restore of local disks.
- Logical image backup/restore of local or remote disks.
- File backup from any local or remote disk of any file size.
- File restore from image backup or file backup.
- Allows wildcards for selection of files.
- Automatic scheduler for unattended backups.
- Backup across networks (using logical image or file-by-file).
- Real time clock display.
- Backup any disk whether formatted for DOS or not
- Escape to DOS while in backup/restore operation.



Automatic Scheduler

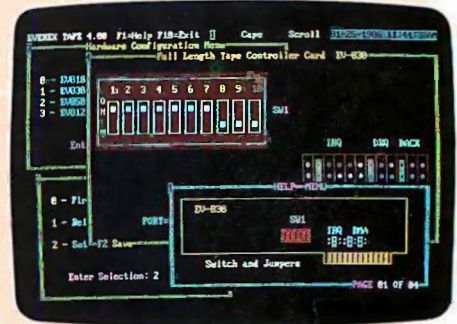

Nestable, Movable Windows

find...

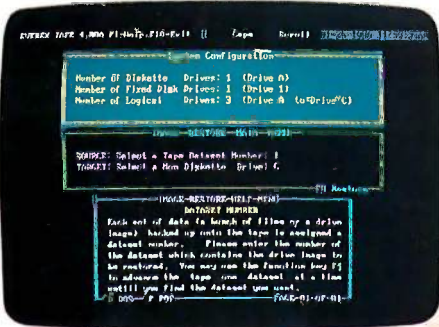

Backup with Multiple Datasets



Multiple Tape Restores

If you can find a streaming tape with better performance and system characteristics, buy it:

Performance

- File-by-file operations near streaming speed.
- Dynamic adjustment to disk and system speeds.

System Characteristics

- Hardware identification provides software integrity.
- External systems can be shared with many users.
- Same software for all types of tape drive, controller, and computer system configurations
- External systems uses a shielded round cable with a D-connector for tangle-free, easy connect and disconnect.
- Hardware read-after-write data verification.
- Track 0 seek to insure tape interchangeability.
- Original controller manufacturer.
- Industry standard QIC-24 tape format.
- Industry standard QIC-36 interface.
- Industry standard QIC-02 commands.
- Tape does not require pre-formatting.
- Available in 20MB, 60MB, and 100MB drive capacities.

...buy it!"

EVEREX Excel Streaming Tape.

For the name of your nearest EVEREX dealer or more information, call us. Remember... We are EVER for EXcellence.

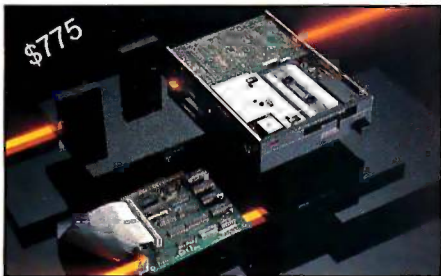

Excel Stream 20 Internal

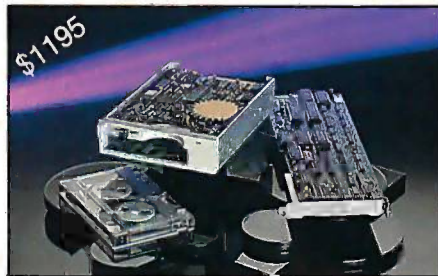

Excel Stream 60 Internal



Excel Stream 60 External 1/2 Height



Excel Stream 20 External



Excel Stream 60 External



Excel Stream 60-8 External



1-800-821-0806 1-800-821-0807 (in CA)

48431 Millmont Dr., Fremont, CA 94538

Inquiry 120 for End-Users. Inquiry 121 for DEALERS ONLY.

CAD and Mouse...

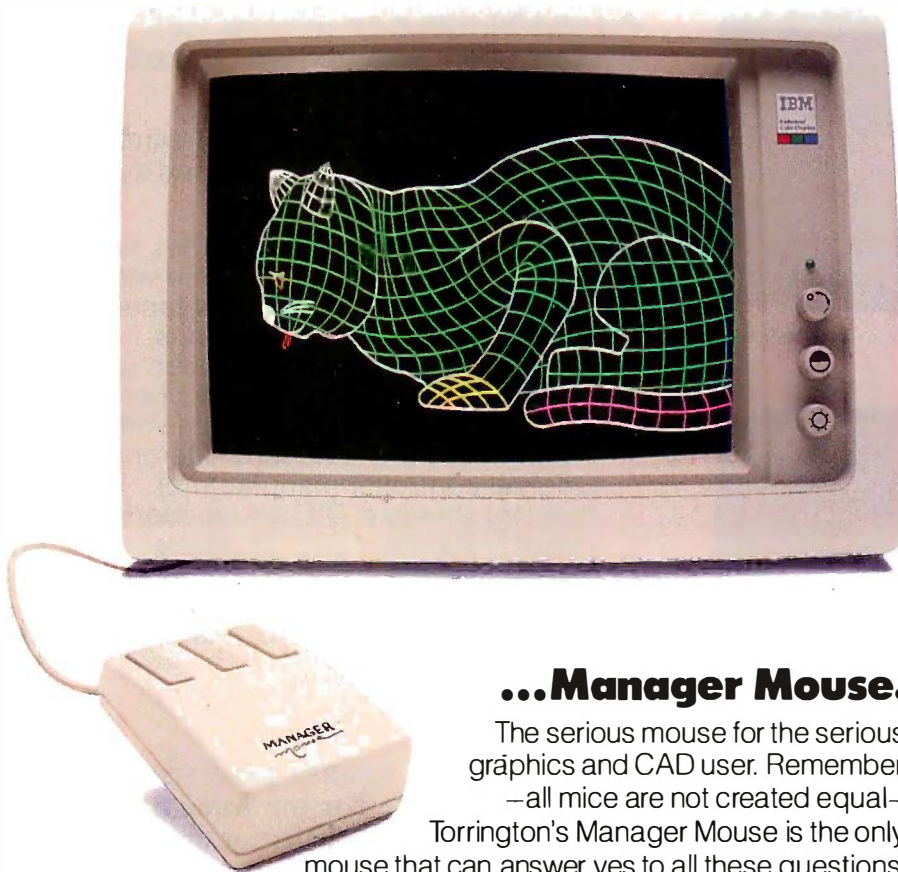

...Manager Mouse.™

The serious mouse for the serious graphics and CAD user. Remember –all mice are not created equal–

Torrington's Manager Mouse is the only mouse that can answer yes to all these questions:

- Can it sustain extended use without maintenance?
- Can it operate on a variety of desktop surfaces at any angle?
- Is it conveniently portable with no external power supply, no special pads?
- Does it have a unique, patented independent suspension system for trouble-free performance?
- Can it be used with Lotus 1-2-3™?*

A mouse by any other name?
You can't be serious.

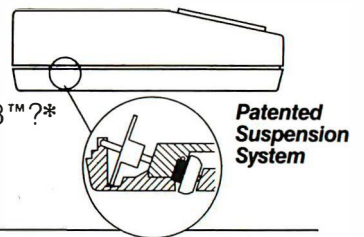

Manager Mouse can be used with these CAD programs:

AutoCAD™	CADVANCE™	EasyCAD™	Generic CADD™	ProDesign II™	smARTWORK™
CADKEY™	drafix 1™	EE Designer™	Procad™	RoboCAD-PC™	VERSACAD™

And these popular graphics programs:

Freelance™	EnerGraphics™	Harvard Presentation Graphics™*	Front Page™	EGA PAINT™
Telepaint™	Dr. HALO™	ClickArt Personal Publisher™	IPRINT™	

Call 1-800-654-5449 (Ct. 1-800-225-7219) or your nearest Manager Mouse dealer.

*Specify Manager Mouse with KeyFree.

Manager Mouse is a registered trademark of The Torrington Company; AutoCAD of Autodesk, Inc.; CADKEY of Micro Control Systems Inc.; CADVANCE of Calcomp; ClickArt Personal Publisher of T/Maker company; Front Page of Studio Software Corp.; Dr. HALO of Media Cybernetics, Inc.; drafix 1 of Foresight Resources Corp.; EasyCAD of Evolution Computing, Inc.; EE Designer of Visionics Corp.; EGA PAINT of RIX SoftWorks, Inc.; EnerGraphics of Enertronics Research, Inc.; Freelance of Graphic Communications Inc.; IPRINT of Indigo Software Ltd.; Lotus 1-2-3 of Lotus Development Corp.; Generic CADD of Generic Software, Inc.; Harvard Presentation Graphics of Software Publishing Corp.; Procad of Procad Systems, Inc.; ProDesign II of American Small Business Computers; RoboCAD-PC of Robo Systems Corporation; smARTWORK of Wintek Corporation; TelePaint of LCS Telegraphics; VERSACAD of T + W Systems, Inc.

TORRINGTON

Part of worldwide Ingersoll-Rand

PREDICTING INTERNATIONAL EVENTS

BY PHILIP A. SCHRODT

*Using a Holland classifier to model political knowledge
and make short-term forecasts*

WHILE POLITICAL events occasionally appear random and capricious, to an expert politics is, for the most part, regular and predictable. Even though a single event may be devoid of practical consequences, foreign policy experts are able to see meaning in ordinary political behavior and accurately forecast its effects on international behavior. The existence of regularities in international behavior makes politics possible; it also makes feasible at least some formal modeling of political behavior.

REPRESENTING POLITICAL KNOWLEDGE

With the development of improved communications and computers in the 1950s, the prospect of systematically studying politics attracted a number of political scientists. Armed with statistical techniques borrowed from the life sciences and emboldened with the new computing technology that reduced months of manual statistical computations to hours, these researchers led the statistically oriented behavioral revolution and changed the face of political science.

The most conspicuous success of

the behavioralist effort has been in the field of voting behavior, where advanced statistical and measurement techniques enable the prediction of elections. By questioning only a couple of thousand properly selected potential voters, we can predict the outcome of tens of millions of votes. Nowadays a politician would no sooner consider running a national campaign without survey research than he or she would consider using a Conestoga wagon as a primary means of transportation.

Some political behavior that can be described numerically—such as bureaucratic budgeting and international arms races (see Schrodt, 1982)—has been modeled with difference equations. And researchers have progressed in theoretical understanding of some political processes using models similar to those used in economics. Luterbacher and Ward (1985) provide a survey of the contemporary formal modeling effort in the international relations field.

Surveys, difference equations, and economics-based preference orderings are, in fact, forms of knowledge representation of political behavior. If you can predict an election using

results of a 2000-person survey or predict an arms race by plugging a few numbers into the appropriate equations, you can represent political behavior in a compact form. With few exceptions, these representations are numerical and usually involve classical statistics and mathematics.

Political behavior, however, is often not easily understood through numerically oriented techniques. Here, political science differs substantially from economics, where almost all of the interesting variables are numerical. In retrospect, political science lacked a systematic means of dealing with rules: the specific conditional (if-then) statements about nonnumerical factors that appear to be regularly used in political decision making. Although behavioralists hoped to reduce this conditional information to a small number of numerical indicators—in the same manner that economic indicators such as unemployment rate, inflation rate, and GNP

(continued)

Philip A. Schrodt teaches mathematical modeling and international relations at Northwestern University. He can be contacted at the Department of Political Science, Northwestern University, Evanston, IL 60201.

characterize the overall state of an economy—or reduce political knowledge to a small number of categorical indicators, neither approach was universally successful.

AI APPROACHES

Around the beginning of the 1980s political scientists began to experiment with alternative models based on concurrent developments in arti-

ficial intelligence and expert systems. Spearheaded by work at MIT, Ohio State, and Syracuse, this effort has focused on two problems that had, for the most part, remained intractable to existing statistical techniques: the prediction of individual votes by a member of Congress and the short-term prediction of international events. By embodying political knowledge in a conditional rule base rather

than in statistical distributions, algebraic equations, or preference orderings, a means of systematically studying political behavior gradually developed.

Aside from their intrinsic importance, these two problems have a couple of advantages. They are easily testable: congressional votes are known, and testimony relating to these votes is readily available; and accounts of day-to-day international events are available through historical and journalistic sources. More important, human experts can readily forecast these political behaviors. Lobbyists and congressional aides constantly calculate voting probabilities; international relations experts can usually make fairly precise short-term predictions. Since political predictions are indeed possible, surely we can at least approximate those and similar predictions using AI techniques.

The dominant cognitive mode of traditional international analysis involves a combination of analogy or pattern matching based on historical precedent and some general rules. The incidence of analogy as justification for policy actions is very high. For example, the analogical terms "Munich," "Vietnam," and "Pearl Harbor" are some of the most powerful constructs in the foreign policy lexicon of the United States. These analogies use a very large database of past events, and the acquisition of that database is a major part of the training of an expert. In hindsight, the use of these analogies may sometimes seem inappropriate or inconsistent, yet they are accurate with sufficient frequency to be effective in policy formulation.

Precedent is probably used in lieu of statistical knowledge because the international system is a variable-rich but sample-poor environment. The international system changes very slowly and hence provides little new information at any given time. The number of potential variables that are important is very large, and repeated experimentation is virtually impossible. Therefore, the number of occasions on which variables co-occur under a roughly similar set of conditions is

(continued)

CONSIDER THIS JUST A BRIEF AUDITION.

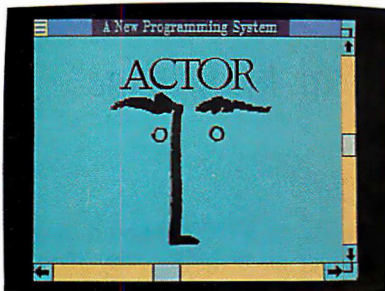

ACTOR™ is a new, interactive programming system, the first with Microsoft® Windows. You have Windows when you write a program, and users have Windows when they run it.

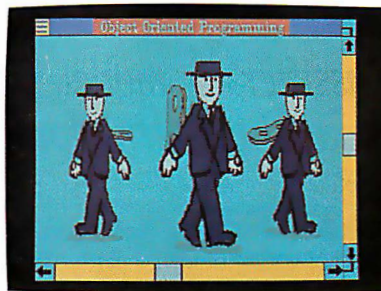

Moreover, ACTOR is a new, object-oriented programming language. Winding objects up and turning them loose is a lot easier, more productive, and more fun than old fashioned programming.

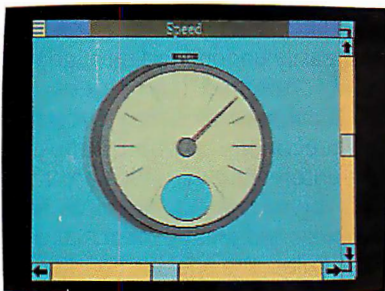

Thanks to a new method of "incremental garbage collection," ACTOR never has to slow down to clean up memory like other advanced languages. You can even use it for real-time control. It's that fast.

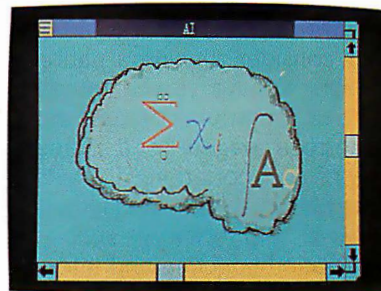

ACTOR offers all the features of an ideal artificial intelligence language, but in a familiar, Pascal-style syntax. Which makes artificial intelligence programming easier. And what could be smarter than that?

From a brief audition like this, you really can't see how much better it is programming with ACTOR. ACTOR is more than just a research tool. It's an effective language for developing real applications. For more information, write us at the address below or call **312-491-2370**. It'll help you appreciate the performance.

The Whitewater Group®
Technology Innovation Center
906 University Place, Evanston, IL 60201



YOUR #1 CHOICE Technoland™

5830 E. Washington Blvd.
City of Commerce, CA 90040

We used to be PC 1,
We're still your #1 Choice!

**Order Toll Free :
(800) 222-3978**

In California : (213) 724-2781
Technical Support : (213) 724-1684
Customer Service : (213) 724-1685

Basic System

- 8088-2 CPU — Runs at 4.77 or 7.4 MHz
- 640K RAM
- 360K Half-Height Floppy Drive w/Controller
- Runs All Major PC-DOS Software
- AT™ Style Keyboard
- 135 Watt Power Supply
- System Manual
- MS-DOS 3.10
- Full 18 Month Warranty



\$659

AT™ System

- 80286 Processor (Switchable 6/8 Mhz)
- 512K RAM (1.024K Optional)
- 1.2 MB Half-Height Floppy Disk Drive
- Floppy/Hard Disk Controller Card
- Clock/Calendar w/Battery Backup
- Runs All Major PC-DOS Software
 - 200 Watt Power Supply
 - AT™ Style Keyboard
 - System Manual
 - MS-DOS 3.10
- Full 18 Month Warranty

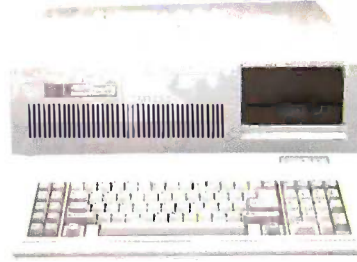

\$1259

Monochrome System

- Basic System Plus...
- Monochrome Graphics Adapter
- 12" TTL Monochrome Monitor

XT **\$859**
AT **\$1459**

Color System

- Basic System Plus...
- Color Graphics Adapter
- 13" RGB Color Monitor (640 x 200)

XT **\$1059**
AT **\$1659**

EGA System

- Basic System Plus...
- Enhanced Graphics Adapter
- 13" High-Res RGB Color Monitor (640 x 350)

XT **\$1339**
AT **\$1939**

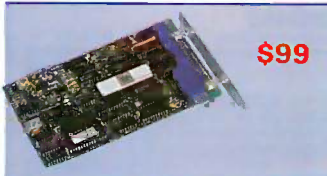

\$99

Turbo Speed Hard Disk Controller

- 1:1 Interleave Lets Hard Drive Run at Full Speed
- Up To 6 times Faster Than Standard Controller
- No Hardware Setup Required

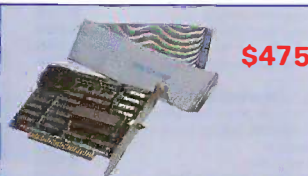

\$475

Tiny Turbo Card

- High-Speed Accelerator for PC and PC/XT
- Replaces 8088 with 80286
- Socket for 80287 on Board
- Short Card



\$148

Hayes Compatible Modem

- 300 & 1200 BPS
- Short Card
- Fully Hayes Compatible



\$79

Enhanced Keyboard

- Separate Cursor & Numeric Pads
- Keys in Standard Locations
- LED Status Indicators
- Keytronic 51 51 Compatible

Citizen High Speed Dot Matrix Printer

MSP-20 (80 Column) **\$329**
MSP-25 (136 Column) **\$489**

- 200 CPS Draft / 50 CPS NLO
- IBM, Epson Compatible
- Centronics Parallel Interface



\$169

AT Multifunction Card

- Expandable to 3 MB — 1.5 MB on Board, 1.5 MB on Piggyback Board (OK Installed)
- Supports 64K & 256K RAM Chips
- Parallel, Serial and Game Ports

AT Mini I/O Card

- Parallel, Serial and Game Ports **\$89**

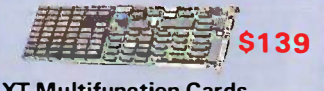

\$139

XT Multifunction Cards

- 384K RAM
- Optional FDC
- Parallel, Serial and Game Ports
- RAM Disk & Printer Spooler Software

XT Mini I/O Card

- Parallel, Serial and Game Ports **\$89**



\$90

135 Watt Power Supply

- XT Compatible
- UL Recognized (UR)
- Extra Power for Hard Drives

Hard Disk Kit

- 20 MB - **\$399**
- Boots from Hard Disk
- Instruction Manual
- Cables & Mounting Hardware
- Hard Disk Controller



Hard Disk Card

20 MB — **\$408**

- 3 1/2" Hard Card
- Easy Installation
- Formatted and Tested
- Boots From Hard Disk
- IBM XT Compatible

Expansion Box

\$150

- Room for 3 Half-Height Drives
- 120 Watt Power Supply
- 5 Slot Bus

Host Bus Interface Cards w/Cable

\$119

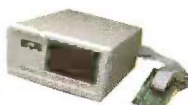

AT Type Hard Disk Drives

- 20 MB - **\$549**
- 30 MB - **\$629**
- 40 MB - **\$759**
- Boot from Hard Disk
- Instruction Manual
- Cables & Mounting Rails
- Works w/AT Hard Disk Controller

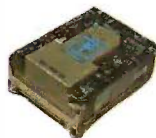

Floppy Disk Drive

- Half-Height
- DS/DD — 360K
- Name Brands — TEAC, Panasonic, Mitsubishi, Sanyo, Etc.



\$90

Fast Tape Backup

20 MB — **\$449**
60 MB — **\$725**

- Easy Loading Tape Reels
- Responds to Standard DOS File Handling Commands
- Cables, Mounting Hardware and Tape Cartridge Included
- Software Included

"IBM's Brother" Monochrome Monitor

- IBM Lookalike **\$119**
- 12" Screen
- Amber or Green



Mono-Graphics Adapter

- Hercules™ Compatible
- Parallel Port

\$99

High Resolution RGB Color Monitor

- 13" Screen **\$339**
- 640 x 200 Resolution
- RGB — 16 Colors



Color Graphics Adapter

- 80 x 25 Character Text Mode
- 640 x 200 Dot Graphics Mode
- Fully IBM Compatible

\$89

EGA Compatible Color Monitor

- 31" mm Dot Pitch
- 13" Screen **\$449**
- 640 x 350 Resolution
- RGB — 16 Colors



EGA Card

- EGA, CGA, MDA & Hercules™ Compatible
- Flicker-Free Display
- Short Card - Add \$10

\$249

Technoland's Policy:

We accept Master Card and VISA (no surcharge), money order, cashier's check, personal check (please allow 10 days to clear), company / institutional PO's and wire transfers. We pay shipping (UPS ground — faster shipping available at additional charge) in continental US. We pay applicable sales tax.

Any item bought from Technoland (including software if unopened) may be returned for a full refund within 30 days of the date it was shipped if for any reason you are not 100% satisfied. All Technoland products carry Technoland's one year limited warranty; some products also carry manufacturer's warranty. Selected Technoland products may carry additional warranties. Warranty policy requires that you submit proof of purchase and obtain an RMA number from us by telephone.

IBM, Hercules, Compaq, ATT, Panasonic, TEAC, Mitsubishi, ARC, Sanyo, Western Digital and Seagate are trademarks of their respective companies. MS-DOS is a trademark of Microsoft Corporation. IBM PC, IBM XT and IBM AT are trademarks of IBM Corporation.

Quantity Discount Available!

Ask Us About Our "Order It Today, Use It Tomorrow" Special

30 Day Money-Back Satisfaction Guarantee

California Residents — We'll Pay Your Sales Tax!

COMPUTER WAREHOUSE

CALL TOLL FREE **1-800-528-1054**

FREE FEDERAL EXPRESS
Air Express Shipping
See Details Below

NOW No Charge for Bank Cards

HARDWARE

PRINTERS

Brother All Models	Call
Citizen MSP-10	\$260
MSP-15	\$379
MSP-20	\$319
MSP-25	\$475
Premier35	\$475
Diablo D-25	\$509
635	\$1019

EPSON

All Printer Models	Call
IBM Proprinter	\$399
Juki	
6100	\$369
6300	\$769
NEC	
3510, 3550	\$729
8810, 8850	\$1039
P5	\$969
P6	\$439
P7	\$619

OKIDATA

All Printer Models	Call
Panasonic 1080	\$195
1091	\$239
1092	\$305
1592	\$425
KXP3151	\$389

STAR MICRONICS

All Printer Models	Call
Toshiba 321 Parallel & Serial	\$455
341 Parallel	\$575
P351 Parallel & Serial	\$929
Laser Printer	Call

KEYBOARDS

Keytronics 5151	\$159
-----------------	-------

PLOTTERS Epson Hi-80

DISKETTES

Maxell MD-2 (Qty 100)	\$100
Sony MD/2 (Qty 100)	\$119

MONITORS

Amdex All Monitors	Call
NEC All Monitors	Call
Princeton Graphics	Call
Zenith All Models	Call

VIDEO TERMINALS

Qume QVT Green 101	\$299
QVT Amber 101	\$314
Wyse30	\$299
50	\$419
75	\$559
Wyse 85	\$439
Wyse350	\$859
Zenith Z-22	\$455
Z-29A	\$559
Z-49	Call

MODEMS

Anchor Automation	
Signalman Express	\$235
Practical Peripherals	
Practical 1200 Baud	\$124

HAYES

All Modems	Call
Prometheus All Models	Call
US Robotics Courier 2400	\$349
Password 1200	\$180
Microlink 2400	\$369

DISK DRIVES

Omega Bernoulli 10 meg	\$1195
Bernoulli 20 meg	\$1595
Bernoulli 40 meg	\$2325

SEAGATE

20 meg w/Western I/O	\$385
----------------------	-------

BOARDS

AST Advantage	\$329
Rampage AT	\$445
Rampage PC	\$239
Six Pack Plus	\$159
Hercules Color Card	\$149
Graphic Card	\$179
Intel Above Board PC (1110)	\$239
Above Board AT (2010)	\$329
Above Board PS/AT (2110)	\$369
Paradise Modular Graphic06-1	\$239
Five Pak	\$115
Plus Development	
Plus Hard Card 20 Megabyte	\$669
Quadram Gold & Silver Boards	Call
Quadlink	\$329
Quad EGA+	\$359
Tec Mar Graphics Master	\$445
Captain No Memory	\$169

COMPUTERS

PC 1 Drive 256K	\$1199
XT 1 Drive 256K	\$1729
XT 1 Drive 20 Meg 640K	\$2169
AT/68	\$2849
AT/339	\$4449
COMPAQ	
Portable II-2 Drive	\$1649

PANASONIC

Business Partner Dual Drive	\$1008
Sr. Partner Dual Drive	\$1204
Exec. Partner Dual Drive	\$1750
Other Models	Call

TOSHIBA

T-1100	\$1299
T-1100 Plus	Call
T-3100	Call

Zenith Computer Products

SAVE Up to 50%	
All Models	Call

COPIERS

Canon
«PC»

Canon PC-20	\$719
Canon PC-25	\$939

SOFTWARE

TRAINING

Flight Simulator	\$28
PC Logo	\$75
Typing Instructor	\$28
Typing Tutor III	\$28

LANGUAGES

C Compiler (Microsoft)	\$249
Fortran Compiler (Microsoft)	\$195
Lattice C Compiler	\$242
Macro Assembler (Microsoft)	\$84
Pascal Compiler (Microsoft)	\$166
Quick Basic 2	\$55
Run C Interpreter	\$65
Turbo Pascal w/8087 & BCD	\$59
Turbo Database Tool Box	\$38

PROJECT MANAGEMENT

Harvard Total Project Manager	\$262
Microsoft Project	\$219
Super Project Plus	\$239
Timeline 2.0	\$209

COMMUNICATIONS

CompuServe Starter Kit	Best Price
Crosstalk XVI	\$92
MS Access 1.01	\$139
PFS Access	\$76
Remote	\$92
Smartcom II	\$83

IBM PC and

100% Compatibles

INTEGRATIVE SOFTWARE

Enable 1.1	\$319
Framework II	Call
Smart Software System	\$389
Symphony	Call

GRAPHICS

Chartmaster	\$199
Diagram Master	\$185
Energraphics 2.0	\$269
In-A-Vision	\$249

Microsoft Buss Mouse

w/PC Paintbrush 3.0	\$106
Microsoft Chart	\$164
Microsoft Serial Mouse	\$119
Newsroom	\$31
PC Buss Plus Mouse	
w/Print Plus	\$115
PC Draw	\$199
Click A rt Personal Publisher	\$99
PC Mouse w/Dr. Halo II	\$99
PC Paint w/Mouse	\$115
PFS Graph	\$76
Printmaster	\$29
Signmaster	\$132
Turbo Graphix Tool Box	Call

WORD PROCESSORS

Leading Edge Word Processor	On Special
Leading Edge W/P w/Spell & Mail	On Special
Lightening	\$55
Microsoft Word 3.0	\$249
Multimate Advantage	\$275
PFS: Write w/Tutor	\$76
Wordstar w/Tutor	\$162
Wordstar Pro Pack	\$233

Word Perfect (Ver.4.1) \$199
Wordstar 2000 + 2.0 \$278

UTILITIES

Copy II PC	\$19
1 DIR	\$46
Fastback	\$86
Norton Utilities 3.1	\$48
Printworks	\$36
Sidekick	\$30
Sidekick (Unprotected)	\$47
Sidekick-Superkey (Bundle)	\$85
Travelling Sidekick	\$39
Turbo Prolog	\$54
Sideways 3.1	\$34
Superkey	\$39

SPREADSHEETS

Lotus 1-2-3	Call
Multiplan	\$108
Spreadsheet Auditor 3.0	\$82
VP Planner	\$48
Supercalc 4	\$259

MONEY MANAGEMENT

Dollars & Sense w/Forecast	\$94
Tobias Managing Your Money	Call

DATA BASE MANAGEMENT

Clipper	\$329
Cornerstone	\$56
dBase II	Call
dBase III Plus	Call
Extended Report Writer	Call
KnowledgeMan II	\$249
Nutshell II.0	Call
PFS: File	\$76
PFS: Report	\$67
Quickcode	\$138
QuickReport	\$138
Reflex	\$82
Think Tank	\$91

R:Base 5000 System V Call

Many other titles available.

Inquiry 85 for MS-DOS Products. Inquiry 86 for all others.

COMPUTER WAREHOUSE

Order Line: 1-800-528-1054
Order Processing: 602-224-9345
2222 E. Indian School Rd.
Phoenix, Arizona 85016
602-954-6109

Store Hours: Mon-Fri 10-5:30
Saturday 9-1
Order Line Hours: Mon-Fri 7-5:30
Saturday 9-1
Order Processing Hours: Mon-Fri 10-3

Product shipped in factory cartons with manufacturer's warranty. Please add \$6.00 per order for UPS ground shipping on orders up to 10 lbs. Orders 10 lbs. and under you pay for ground service, receive air service at no extra charge. Available on orders 11-30 lbs. \$17 for air service. Prices & availability subject to change without notice. Send cashier's check or money order...all other checks will delay shipping two weeks.

We do not guarantee computer compatibility.

limited. This complex, uncontrollable, unrepeatable nature of international events means that statistical methods requiring large sample sizes, controlled conditions, or random sampling techniques cannot be used in this task. Analogy and pattern matching seem to fill the gap.

In addition to analogy, other considerations are important. These include, for example, various common-sense rules of inference, knowledge of how the resources available to a nation constrain its scope of action, and knowledge of the existing policies of a state. In many cases, repeated patterns of behavior imply certain knowledge. For example, while large states sometimes invade small states, small states almost never invade large states. Thus, in attempting to duplicate political expertise, a plausible starting point is to look for historically based rules and pattern matching.

HOLLAND CLASSIFIERS

Over the past year I've used a learning system called the Holland classifier to model a simple but real problem of short-term international behavior prediction. Simply put, a Holland classifier solves classification problems; that is, it takes a set of attributes about a situation and classifies that situation into one of a number of discrete categories. If used in a medical expert system, for example, a Holland classifier would accept a large number of characteristics about a patient (including symptoms, results of medical tests, reactions to medications, and so forth) and on the basis of this information classify the patient into a disease and treatment category.

In the general scheme I'm using, the Holland classifier has three components: messages, a "bulletin board," and a rule base. Messages posted on the bulletin board describe the situation. The rules then scan the bulletin board for messages that match the classifier of the rule. If there are matches, the rule "bids" for the right to replace that message with the rule's result. Bids are based on the strength of the rule and the specificity of the match. The highest-bidding

(continued)

UNIX is a trademark of AT & T Bell Laboratories.



M680UX Series

A HARD ACT TO FOLLOW

SORD's M680UX Series sets a new standard in performance.

- * Operable with UNIX™
- * Astonishing speed: use of 32-bit Motorola 68020 CPU
- * Easy expansion: VME bus architecture.

Also available on OEM basis.

SORD®

SORD COMPUTER CORPORATION
 Kyobashi K-1 Bldg., 2-7-12 Yaesu, Chuo-ku, Tokyo 104 Japan
 (03) 281-8130 New York: (212) 759-0140
 London: (01) 631-0787 W. Germany: (02161) 66-3077

TEACHING LEARNING LOGIC





PROLOG

ARTIFICIAL INTELLIGENCE

EXPERT SYSTEMS TOOLS

LPA micro PROLOG and LPA mac PROLOG now being used by major corporations, universities and middle schools as a teaching and learning tool and for building intelligent Expert Systems. PROLOG was chosen by the Japanese as the core language for their Fifth Generation Project for building "thinking machines".

NEW LOW PRICES



	COMPILER FOR THE MACINTOSH	\$295 REDUCED
	FOR MICRO COMPUTERS MS DOS AND OTHERS	\$99 & up
	FOR BUILDING INTELLIGENT EXPERT SYSTEMS	\$149 & up
	PROFESSIONAL FULL MEMORY MS DOS	\$395

LPA PROLOG RUNS ON THE APPLE II, COMMODORE 64, IBM PC AND COMPATIBLES, AND UNDER THE UNIX & VMS SYSTEMS.

Call or write for our complete catalog of Artificial Intelligence products.

NORTH AMERICA
 Programming Logic Systems Inc.
 31 Crescent Drive
 Millford, CT 06460, U.S.A.
 Tel: (203) 877-7988

ELSEWHERE
 Logic Programming Associates, Ltd., Dept. BY/3
 Studio 4, The Royal Victoria Patriotic Building
 Trinity Road, London SW18 3SX, England
 Tel: 01-874-0350

Inquire about Expertech Xi plus™ "The Expert System"

C Programmers!

First high-speed DBMS written exclusively for C applications is also transportable

High-Speed data retrieval and access are the result of db_VISTA's unique database model. db_VISTA is designed exclusively for C application programmers and developers so that their applications will retain key benefits of C such as speed, transportability and efficiency.

**Says, Dave Schmitt,
President of Lattice, Inc.**

"If you are looking for a sophisticated C programmers database, db_VISTA is it. In either a single or multi-user environment, db_VISTA lets you easily build complex databases with many interconnected record types. The multi-user implementation handles data efficiently with a LAN and Raima's customer support and documentation is excellent. Source code availability and a royalty-free runtime is a big plus."

- ♦ **Written in C for C Programmers**
- ♦ **Royalty-Free, You only pay once**
- ♦ **Source Code Available**
- ♦ **Multi-user and LAN capability**
- ♦ **Fast B-tree indexing method**
- ♦ **Transaction processing**
- ♦ **Faster without Data Redundancy**
- ♦ **Complete Documentation Included**

Operating system support for MS-DOS, PC-DOS, Unix, Xenix or Macintosh, **C compiler support** for Lattice, Microsoft, DeSmet, Aztec, Computer Innovations, Xenix and Unix.

Ask db_QUERY™

With royalty-free db_QUERY you can ask more of your database, db_QUERY is a linkable, SQL-based ad hoc query and report writing facility.

30-day Money-Back Guarantee

Try db_VISTA for 30 days and if not fully satisfied, return it for a full refund.

Royalty Free Price Schedule

	db_VISTA	db_QUERY
Single-user	\$195	\$195
Single-user with Source	\$495	\$495
Multi-user	\$495	\$495
Multi-user with Source	\$990	\$990

FREE 60 days application development support
Not copy protected

Call Toll Free Today!

1-800-327-2462



RAIMA™
CORPORATION

High-speed programming tools
transportable by design

3055-112 N.E.
Bellevue, WA 98004 USA
(206) 828-4636 Telex: 9103330300

PREDICTING EVENTS

A Holland classifier is totally self-organizing and extremely flexible.

rule gets to replace the message. It then pays the bid to the rule that posted the message it responded to.

This process (summarized in listing 1) continues until a terminal message is posted, which becomes the classification. The system rewards the rule posting the terminal message with a payoff. This payoff is positive if the terminal message is the correct classification (based on some evaluation function); it is negative if the classification is incorrect.

Rules in the Holland system consist, then, of three parts: classifier, result, and strength. Like messages, the classifier and the result are simple strings of characters; the strength is represented by a number. Rules are, in effect, IF. . . THEN statements similar to

those used in expert systems: The classifier is the antecedent, and the result is the consequent.

In Holland's scheme, the characters that represent the classifier and the result come from an alphabet that has only three values:

0 Feature is absent.

* Pass-through: Feature may be present or absent.

1 Feature is present.

When a pass-through value occurs in a result, the value encountered in the message that was matched is substituted for the pass-through character. Thus, messages contain only {0,1} characters.

The process of competitive bidding and payoffs for posting terminal messages ensures that the rules that have been most successful in posting useful messages in the past are most likely to be successful in the future. Rules that post meaningless or incorrect messages diminish in strength so that they are less likely to succeed in

(continued)

Listing 1: The Holland classifier main evaluation loop. The loop is continued until one of the following three conditions has been met: (1) There are no messages left on the board; (2) All bids for rules are below a set threshold (none of the rules match the messages particularly well); (3) The loop has been repeated more than a set number of times. This rule prevents infinite looping due to recursive parasitic rules whose classifiers match their own output messages.

Loop

With each message do

With each rule do

1. Compute Match(Rule, Message)

2. Compute

Bid=Match*Strength*Bid_Weight

3. If Bid>Highest Bid for Message

Then Replace Bid_Winner with Rule

End_With {rule}

With Bid_Winner do

1. Subtract Bid from Strength

2. Add Bid to Strength of Rule which posted Message

3. If Bid_Winner's Result is a Prediction

Then

1. Compute Payoff by comparing prediction to actual events.

2. Add Payoff to Strength

3. Remove Message from Board

Else

1. Replace Message with Result on Board

End_With { Bid_Winner }

End_With {message}

End_Loop

SAVE ON THESE PRINTERS

STAR MICRONICS

LV 12-10 (New)	CALL
NL-10	CALL
NX-10	CALL
NB-15	CALL
SB-15	CALL
SG-15	367
SD-10	319
SD-15	438
SR-10	469
SR-15	578
SB-10	589

OKIDATA

Okimate	199
292	499
293	599
120 NLO	205
182	214
192	348
93	CALL

PANASONIC

1080	195
1091	225
3131	249
1092	309
1592	419
1595	595

CITIZEN

120-D	179
MSP-10	265
MSP-15	385
MSP-20	325
MSP-25	485
Premier 35	469

SEIKOSHA

SP-1000 VC (C-64)	165
SP-1000.A Centronics	185
SP-1000 IBM	185
SP-1000 As Rs-232	185
SP-1000 AP, APlic	185
BP-1300	469
BP-5200	649
BP-5420	999
Color Kit	119
BP-5420 ribbon	12.50
SP-1000 ribbon	8.50

EPSON

LX80	CALL
FX85	CALL
DX10	CALL
DX20	CALL
DX35	CALL
H180	CALL
HS80	CALL
FX286	CALL
LQ800	CALL
LQ1000	CALL

JUKI

Juki 6100	CALL
RS-232 Serial board	55
6100 tractor	119
6100 sheet feeder	209
5510 Juki	CALL
Juki 6300	CALL

LEGEND

808	148
1080	199
1380	229
1385	289

C. ITOH

1550 SP+	CALL
D 1040	CALL
Prowriter Jr	CALL
Prowriter 8510 SP+	CALL

BROTHER

HR-15XL-P	359
1509	409

SILVER REED

EXP 420P	209
EXP 600P	489
EXP 800P	649
EXP 770	740



DIABLO

D25	549
P-32 CO1	699
635	1029
P-38	1749
D-80 1F	2395

TOSHIBA

321 P/S	495
351 sheet feeder	529
P 341P	969
P 341S	999
P 351+	1149

COLOR RIBBONS AVAILABLE!

COLOR RIBBONS AVAILABLE!

MONITORS

PANASONIC

TR-122 MYP 12" Amber TTL	139
TR-122 M9P 12" Green TTL	139
TX-12H3P 12" RGB	369
DT-H103 10" RGB	349

ZENITH

ZVM 1220	89
ZVM 1230	89
ZVM 1240	149

HITACHI

MM-1218 12" Green	99
MM-1220 12" TTL Amber	129
CM-1406C 13" color w/ cable	179
CM-1409 13" RGB	305
CM-1216D 12" RGB	385
CM-1455S 13" 720x350	525
CM-1457A 13" RGB 720x460	679

TEKNIKA

MJ-10	149
MJ-22	249
MS-305 RGB	309

PRINCETON GRAPHICS

MAX-12 Amber	175
HX-12 RGB	458
SR-12 RGB	575

THOMPSON

365 12 RGB	CALL
------------	------

COMMODORE

1902 Color	CALL
1802	CALL

MODEMS

ZOOM

PC 1200 ST	189
PC 1200 XL	259
PC 1200 XL/PFS	279

ANCHOR

Volksmodem 12	179
---------------	-----

US ROBOTICS

Password 1200	189
Courier 2400	395

MISCELLANEOUS

DUST COVERS

PC-AT 2 pc	10.99
PC-XT 2 pc	10.99

LEADING EDGE

Nutshell	69.95
Nutshell Filer	149.00

STB

EGA Plus	329
----------	-----

JOYSTICK

Tac 10 (Ap/Pc)	22.95
----------------	-------

AST

Six Pack Plus	209
---------------	-----

DISKETTES

5 1/4" DISKETTES MAXELL

SSDD	9.99
DSDD	12.99

BONUS

SSDD	6.99
DSDD	7.50

SKC

SSDD	8.50
DSDD	9.50
DSHD 96 TPI	19.50

BRODERBUND (IBM)

Bank st. writer	48.95
Print shop	34.95
Graphics Lib 1	22.95
Graphics Lib 2	22.95
Ancient Art of War	22.95
Karateka	22.95
Toyshop	39.95
Print shop paper	12.95

SUBLOGIC (IBM)

Jet Simulator	34.95
Scenery disks EA	14.95
Set 1-6	69.95
S.D. Japan	14.95
S.D. San Fran	14.95
S.D. Wash, D.C.	14.95
S.D. New York City	14.95

SSI (IBM)

Battle for Normandy	24.95
Knights of Desert	24.95
Tigers in Snow	24.95
Computer Baseball	24.95
Cartels & Cutthroats	24.95

QUADRAM

Gold Quadboard	399
Silver Quadboard	229
Quadboard	199

HI TECH (IBM)

Cardware	8.95
Partyware	8.95
Heartware	8.95
War With All	12.95
Holiday Paper	8.95

ACTIVISION (IBM)

Borrowed Time	24.75
Tass Times	24.75
Shanghai	24.75
Mindshadows	24.75
Music studio	29.95
Alter Ego	29.95
Alter Ego M	29.55
Pebble Beach golf	29.95

TOLL FREE 1-800-233-8760

IN PA 717-494-1030
CUSTOMER SERVICE 717-494-1670
or send to

LycO Computer
P.O. Box 5088
Jersey Shore, PA
17740

Inquiry 192



Risk Free Policy

In-stock items shipped within 24 hrs of order. No deposit on C.O.D. orders. Free shipping on prepaid cash orders within the continental U.S. Volume discounts available. PA residents add sales tax. APO, FPO and international orders add \$5.00 plus 3% for priority mail. Advertised prices show 4% discount for cash, add 4% for MasterCard and VISA. Personal checks require 4 weeks clearance before shipping. We cannot guarantee compatibility. We only ship factory fresh merchandise. Ask about UPS Blue and red label shipping. All merchandise carried under manufacturer's warranty. Return restriction applicable. Return authorization required. All items subject to change without notice.

LYCO COMPUTER MARKETING & CONSULTANTS

LYCO COMPUTER MARKETING & CONSULTANTS

If You Need Data Communication Software Try BitCom™ 3.0

Before you invest in costly and hard to use communication software, look into BitCom 3.0. More than 100,000 users told us they prefer BitCom over other communications software. Here are just some of the reasons:

Simple User Interface

While other programs force you to type commands after commands, BitCom just gives you a form to fill out. To help you select the correct answer, there are even multiple choices for you to pick. Once you set up the parameters for communication, you can start up BitCom without even touching a key.

Flexible File Transfer

Now, BitCom 3.0 supports the most popular public domain file transfer protocols including XMODEM CRC, YMODEM and batch file transfer. You can send and receive multiple files as easy as typing "*.*". With CRC error checking, you can be sure data are sent and received without error.

Make Your Own Communication Procedures.

There are over 70 powerful script file functions to turn BitCom 3.0 into a flexible tool. For example, you can set up a script file to dial into Western Union's Easylink™, check your mail box, read your messages, print them and save them to a disk file.

Other features are:

- Supports speed up to 9600 baud.
- Uses XON/XOFF flow control for talking to systems with different speeds.
- Can be set up to work on COM1 to COM4
- Can re-assign or re-define any function keys.
- Phone directory stores up to 32,767 names and descriptions.
- Sorts phone directory by name, ID or phone number.
- Terminal emulation includes IBM 3101, VT100, VT52.
- Set your own screen color during communications.
- 132 column support with graphics card.

Only **\$6900**

Not Copy Protected.

Order Today.

Call **(408) 262-1054**



Bit Software, Inc.
P.O. Box 360619
Milpitas, CA 95035

BitCom is a trademark of Bit Software, Inc.
Easylink is a trademark of Western Union.

PREDICTING EVENTS

the future. This modification of strength allows the system to learn.

Although a Holland classifier usually requires a large number of trials to attain efficient performance, it has the advantage of being totally self-organizing and extremely flexible. Like natural problem-solving systems—the brain and DNA—a Holland classifier is very robust. Because the "knowledge" in the system is spread over a number of rules, the failure of one or two rules due to a change in the system is unlikely to have much effect on the overall behavior. Another advantage of the system is that while parts of it are intrinsically parallel (in principle, at least, all rules could scan the message board simultaneously), it is sufficiently simple that it can be implemented efficiently on a serial system—even on a microcomputer.

PREDICTING WITH A HOLLAND CLASSIFIER

The work I have done uses international relations "events data" to approximate international behavior. In its most basic form, events data summarizes the daily interactions between nations. The summaries use four variables: date, actor nation, event, and target nation.

For example, to summarize that on May 28, 1986, the United States (actor) protested (event) the Soviet Union's (target) behavior during the Chernobyl nuclear accident, you would code:

860528 002 09 365

In this example, 002 and 365 are standard codes for the United States and the Soviet Union, respectively; 860528 is the date, and 09 is an event code indicating a protest. (For more information on events data, see the *International Studies Quarterly* issue cited in the Bibliography.)

While a single event carries very little information about the relations between two nations, using events gathered over a long period of time, you can ascertain distinctive patterns of interactions. The use of events data sacrifices short-term detail to facilitate coding and statistical analysis and then reestablishes detail by looking at thousands of events.

In my experiments, I have used the Conflict and Peace Data Bank (COPDAB) events data set collected by Edward Azar and Thomas Sloan and provided through the Inter-University Consortium for Political and Social Research at the University of Michigan. The COPDAB set uses only 15 codes, ranging from 01 for international unification to 15 for violent conflict such as war. To get the highest density (events per day) of data, I focused on events between the United States and three European nations: the United Kingdom, France, and West Germany. COPDAB covers the period 1948–1978. I analyzed events nondirectionally; for example, the U.S./U.K. data set includes events in which the U.S. was actor and the U.K. was target as well as events in which the U.K. was actor and the U.S. was target. I coded data only for occurrence, not frequency, so that each of five instances of an event code 07 appeared the same as one instance. You could, however, expand the system to use frequencies.

I used the COPDAB data to generate a large number of event "archives." An archive is the set of events that occurred in a time period. In the experiments, each prediction problem is created by choosing a random date T and then coding the following archives:

Input messages: [T-1 to T-10]
 [T-11 to T-20]
 [T-21 to T-30]
 [T-31 to T-40]

Output occurrence: [T to T+20]

The specific coding I used allocated 16 bits to the events and 4 bits for the lag. For example, if only interactions of types 07 and 08 occurred during the period 11 and 20 days prior to the date, that archive would be coded 00000011000000000010.

This gives a surplus of at least 2 bits (and actually more, as event types 1, 14, and 15 aren't found in this data), which the system could use to identify intermediate rules. While these archives consist primarily of cooperative events, they show quite a bit of variety and there are no obvious ways

(continued)

Breaking the 640K DOS Barrier:

New version of Alsys PC AT Ada* compiler improves speed, adds application developer's guide, brings seven 80286 machines to latest validation status.



Alsys' landmark Ada compiler for the PC AT, the first to bring Ada to popular-priced microcomputers, has been upgraded to Version 1.2 with significant improvements.

The new version compiles faster than its predecessor, is validated for a full range of popular compatibles using the latest AJPO test suite 1.7, and includes a Developer's Guide in the documentation set. The price remains at \$2,995 for single units, including a 4 megabyte RAM board.

Both the original and the newly upgraded versions utilize the inherent capabilities of the 80286 chip and "virtual mode" to eliminate the 640K limitations of DOS. These techniques permit addressing up to 16 MB of memory, under the control of DOS, without changes to DOS in any way!

80286 machines validated in the new release include HP's Vectra, Compaq's Deskpro 286, Sperry's PC/IT, Zenith's 200 series (including the Z-248), Tandy's 3000 HD, the Goupil/40, and the IBM PC AT. The compiler supports DOS 3.0 or higher. Ada programs compiled on the AT will also run on PCs and XTs supporting DOS 2.1 or higher.

ALSYS, INC.,
1432 Main Street, Waltham, MA 02154
BY1186

ADA NOW. Tell me more about the PC AT Ada compiler.

Name _____

Title _____

Company _____

Address _____

City _____

State/Zip _____

Phone/Ext _____

In the US: Alsys Inc., 1432 Main St., Waltham, MA 02154 Tel: (617) 890-0030

In the UK: Alsys Ltd., Partridge House, Newtown Rd., Henley-on-Thames, Oxon RG9 1EN
Tel: 44 (491) 579090

In the rest of the world: Alsys SA, 29, Avenue de Versailles, 78170 La Celle St. Cloud, France
Tel: 33 (1) 3918.12.44

* Ada is a registered trademark of the U.S. Government (AJPO). Alsys is the trademark of Alsys, Inc. References to other computer systems use trademarks owned by the respective manufacturers.

Inquiry 17

Ada now

to produce accurate predictions.

The initial rules in the system were generated by reading a random set of data records, randomly choosing one of the input archives as the classifier and the output archive as the message. Both parts of the rule were then randomly mutated with a fixed probability, called `Mutation_Probability`, by changing some of the feature-absent and feature-present characters

to the pass-through character. This captures, in a very primitive fashion, the process of precedent-based prediction: The initial rules are based directly on earlier observed events with some random modification. Actual human learning is, of course, far more systematic and involves teaching carefully chosen examples of characteristic behavior rather than random examples, but this approxima-

tion allows my system to be totally self-organizing. The input archives, with information identifying their time lag (0, 10, 20, or 30 days), are posted on the bulletin board of the classifier, and the payoff is computed based on a measure of difference between the prediction produced by the classifier and the actual outcome occurrence.

Rules match posted messages using a simple comparison of the features of the classifier and the message. I defined a match simply as

$$\text{Match} = 40 - \sum_i |\text{Classifier}_i - \text{Message}_i|$$

with the summation over the event types, and the characters having the numerical values of 0 = 0, * = 1, and I = 2.

Consequently, a perfect match would have a value of 40; a perfect mismatch would have a value of 0, and a match against a classifier consisting solely of pass-through characters would have a value of 20. A rule may bid for a message provided the degree of match exceeds a level called `Match_Minimum`; this is a minor modification of Holland's scheme, which required perfect matches but didn't penalize pass-through codes. This is only a first approximation to a matching criterion and one chosen largely for computational efficiency; an obvious alternative measure would be a more complex pattern-match measure such as a Levenshtein metric.

A prediction—which is the terminal message in this system—is identified by coding 1111 as the final 4 bits of the message. The payoff function compares the output predicted in the message to the observed outcome. This function is similar to the match function except that it can take negative values:

$$\text{Payoff} = 20 - \sum_i |\text{Outcome}_i - \text{Message}_i|$$

The use of negative values means that if the prediction is particularly inaccurate, the payoff will be negative and decrease the strength of the rule that posted it.

Finally, to allow the system to recognize that it has not seen a situation before and respond by not making a prediction, the `Match_Minimum` is

(continued)

Do You Ever Get the Feeling That No One Speaks Your Language?

Arity/Prolog. The Language That Spans the Generation Gap.



Arity listens to what you ask for. You want a serious, versatile language that will go the distance for you. There are two very good reasons for you to use Prolog—to do your work smarter and faster. That's exactly what the Arity/Prolog development environment will help you do. Our powerful tools, based on the general purpose programming language Prolog, will significantly reduce your development time and allow you to solve a wide range of application problems.

No translation required. Our development environment for the IBM PC family and all MS-DOS compatibles includes the Arity/Prolog Compiler and Interpreter, the Arity/Expert System, and Arity/SQL. And you can tie them all together. You can interface with several other programming languages and build extensions to your existing applications. You'll be truly multilingual—what better way to span the generation gap?

It can take you to new places. You'll discover amazing speed, power, and flexibility using the Arity/Prolog programming environment, with its one gigabyte of virtual memory and fast, compact compiled code, for conventional applications. And if you're working in new territories, like expert systems or sophisticated database management systems, you'll be speaking the native tongue.

Speak it freely. Our products are not copy protected and we charge no royalties, so you can use them in as many end-user applications as you'd like. Why keep the language of solutions all to yourself?

Join the thousands of assembly and C programmers who already use Arity/Prolog—the language of solutions.

Call 1-800-PC-ARITY Today.

Massachusetts residents call 617-371-1243.

Software that roars.

ARITY CORPORATION

30 Domino Drive, Concord, MA 01742 U.S.A.

1-800-722-7489 or in Massachusetts call 617-371-1243

What's New at AMERICAN DESIGN COMPONENTS?

"The Source" of the
electro-mechanical components
for the hobbyist.

We warehouse 60,000 items at American Design Components — expensive, often hard-to-find components for sale at a fraction of their original cost!

You'll find every part you need — either brand new, or removed from equipment (RFE) in excellent condition. But quantities are limited. Order from this ad, or visit our retail showroom and find exactly what you need from the thousands of items on display.

Open Mon. — Sat., 9-5

THERE'S NO RISK.

With our full 90-day warranty, any purchase can be returned for any reason for full credit or refund.

ADAM COMPUTER KIT! (Less printer & w/o cabinet)



Build it yourself from subassemblies. No wiring necessary (just plugs together). Hook-up diagram included. Includes: Keyboard, 1 cassette digital data drive, 2 game controllers, power supply, all memory boards, and one cassette. Is capable of running CP/M, has built-in word processor. Item #7410 \$99.00 (complete)

1/2 HT., 3 1/2", 10MB HARD DISK DRIVE

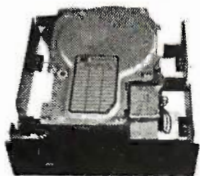

ST225 Compatible. Fits standard 5 1/4" spacing. Shock mounted. High speed, low power. Mfr — MMI #MM212
Item #9217 \$179.00 New

250 CFM SPACE SAVER FAN



115VAC/60Hz., 24W. For high volume in limited space (depth). Cooling in electronic equipment, computer chassis, etc. 7-die cast alum. blades, alum. housing. Sealed bearings, thermally protected. Dim.: 6 1/4" W x 5 7/8" H x 1 1/2" deep Mfr — EBM #W2E142
Item #8201 \$22.50 New

5 1/4" DISK DRIVE 96 TPI, DS/QUAD DENSITY FULL HEIGHT



Mfr — CDC #9409T
Item #1893 \$99.00

12/24 VDC 1" THIN MUFFIN- TYPE FAN



55/100 CFM, 8W. Can be mounted for blowing or exhaust. 5 plastic blades with feathered edges, aluminum housing. Brushless, ball-bearing type. Dimen.: 4 1/8" sq. x 1" deep Mfr — Centaur CUDDC24K4-601
Item #8541 \$19.95

DUAL 3 1/4" DISK DRIVE EXPANSION MODULE IBM PC/XT



Stacked mounting, replaces old-fashioned 5 1/4" disk drives. Contains: 2 Tabor TC-500 3 1/4" disk drives. Ttl. cap. 500K bytes unformatted. Plugs right into your controller. Item #8827 \$169.00
*Ttl. capac. IBM unformatted w/ special software. Each unit supplied with two 3 1/4" flexible diskettes.

IBM FORMAT COMPATIBLE 3 1/4" DISK DRIVE



Tabor TC-500 drive. Single-sided, quad density. Capacity:
Unformatted—250/500K bytes*
Formatted—164K bytes.
80 track/140 TPI, based on 16 sectors. Will work with any 5 1/4" disk controller. Item #8824 \$79.95
*Total cap. 500K bytes with special software.

12 VDC SPRINT® FAN



27 CFM, 12 VDC, 1.4 Watts. Polarity protected. Can be mounted for cooling or exhaust. Dim.: 3 1/2" sq. x 1 1/4" deep Mfr — Rotron — DAYNA
Item #9218 \$12.95 New

INTEGRATED CIRCUITS

Programmable Logic
PAL12L6 \$3.35
PAL14H4 3.50
PAL16R4 4.25

Static Rams
2147H-1 4096x1 35NS \$6.30
2167-55 16384x1 55NS 8.00
2114-45 1024x4 450NS .99

Dynamic Rams
M116-2 16384x1 200 N.S. \$.75
4517P12 16384x1 120 N.S. .85

Microprocessors & Interface
MC6871A Clock, 2-phase \$35.00
75452 Dual periph. NAND dvr. .35
8085 8-bit microproc. 2.25

Microcomputers
68701 8-bit with eeprom \$15.00
87P50D-11 8-bit w/piggy-back eeprom 35.00

CRYSTALS
3.579545 Mhz. \$.99
4 .99
6 .99
7.3728 .99
8 .99
12 .99
48 .99

STEPPING MOTORS FOR ROBOTICS

Precision steppers with increments from 1 to 7.5 degrees. Speeds up to 5,000 steps.

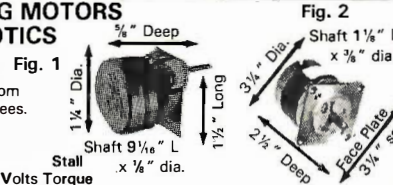

Item No.	Step Angle	Volts DC	Torque oz/in	Type	Mfr. & Part No.	Fig.	Price
5431	1	5	17	PM N.A.	Phillips A82310-M2	1	\$9.95 ea. 2/ \$14.95
5271	1.8	1.8	150	PM Superior Electric	4.0 M091-FD-6009	2/	\$34.50 ea. 2/ \$59.50
5275	1.8	1.8	72	PM Superior Electric	2.0 M061-FF-6201B	2/	\$19.95 ea. 2/ \$37.50

DIGITAL VOLTMETER



3 1/2 digits, .3" high. Bipolar. Movable decimal point. Accuracy: .05%. Nominal range 2 VDC. Case size: 2 1/2" W x 7/8" H x 3 3/4" L Mfr — Non-Linear Systems #PM349
Item #9219 \$19.95 New

ADAM PRINTER



Complete, less top cover plate. Friction feed. Takes standard paper 8 1/2" x 11". (Customer returns; tested — operational.)
Item #8839 \$69.50

ADAM ACCESSORIES

Data Drive	#6641	\$9.95
D.D. Power Supply	#6642	\$14.95
ASCII Keyboard	#6643	\$19.95
Asst. Cassettes	#7786	\$19.95

PUMPS — COMPRESSORS — BLOWERS — MOTORS — POTENTIOMETERS — COUNTERS TIMERS — RELAYS — VOLTAGE REGULATORS — POWER SUPPLIES

48-KEY KEYBOARD



Replace the membrane keyboard on your Timex/Sinclair Z-81/1000 with this brand new "big computer" keyboard from Texas Instruments. Simple to install — complete instructions and schematic included.
Item #6712 \$5.95 New

MULTI OUTPUT COMPUTER SUPPLY



5 VDC @ 10 A. regulated
-12 VDC @ 2 A.
+12 VDC @ 1/2 A.
30 VDC @ 1/2 A.
-250 VDC @ 1/2 A.
Display driver. Trans regulated. Input: 115/230V, 50/60 Hz. Mfr — Burroughs #14337190
Item #61 \$29.95 New

SWITCHING POWER SUPPLY



115 & 230V. 47-440 Hz. Input: 90-135V/180-270V Output: 5VDC @ 5.5A +12VDC @ .4A -12VDC @ .3A
Perforated metal case enclosure. Dim.: 9 1/2" L x 3 3/4" W x 2" H. Mfr — General Instrument
Item #7983 \$14.95 New

Rechargeable NICAD BATTERY BACKUPS

12V @ 450 ma Contains 10 AA cells. Recharge rate: 45 ma. 16-18 hours. Case with tab output connections. Dim.: 2 1/8" H x 1 1/4" W x 2 1/8" L Mfr — GE 123233 or equiv.
Item #5443 \$5.95 New
13.2V @ 1.65 AH Contains 11 C cells. For model boats, toys, etc. Mfr — GE #41B035BB00101
Item #5444 \$15.95 New

500 VA MICRO-COMPUTER REGULATOR (Protect Your Equipment)



Output: 120V/60Hz. Input range: 95-130V ± 3% Sinusoidal wave output contains less than 3% harmonic distortion. Maintains output additionally +5% -10% down to 78V input. 6 ft. line cord. Input with dual 3-conductor "U" ground output. Dim.: 16 1/4" L x 8 3/4" W x 7 1/2" H. Mfr. — Sola #63-13-150.
Item #8007 \$199.00 New

FREE CATALOG of
electro-mechanical
devices sent with
every order.

AMERICAN DESIGN COMPONENTS, 62 JOSEPH STREET, MOONACHIE, N.J. 07074
YES! Please send me the following items:

Item No.	How Many?	Description	Price	Total

Shipping & handling, we ship UPS unless otherwise specified. Add \$3 plus 10% total. Canadian: \$3 plus P.O. cost. Charge only. Sales Tax (N.J. residents only, please add 6% of total)
ORDER TOTAL

My check or money order is enclosed.
 Charge my credit card.
 Visa Master Card Amex

Card No. _____
 Exp. Date _____
 Signature _____
 Telephone: Area Code _____ Number _____
 Name _____
 Address _____
 City _____
 State _____ Zip _____

All inquiries and free catalog requests call 201-939-2710.
For all phone orders, call TOLL-FREE 800-524-0809. In New Jersey, 201-939-2710.

also used as a threshold for acceptable bids. If no rule can make a bid above the threshold, the system creates a new rule by randomly choosing one of the messages on the board (one of the actual antecedent archives), mutating it to include a few pass-through characters, then taking the actual outcome as a result. This new rule replaces the weakest existing rule in the set. This process guarantees that if the system encounters behavior it has not seen before, it will incorporate that new behavior into its rule base.

RESULTS

I implemented the Holland classifier in UCSD Pascal on an Apple II. The program involves about 1000 lines of code, around half of which deal with output and statistical monitoring routines. To limit the amount of run time to something reasonable, I used a set of only 32 rules; in almost all my experiments, strength concentrated in about eight or fewer rules. [Editor's note: HCLASS, a Turbo Pascal translation of the program, is available on disk, on paper, and on BIX; see the insert card following page 352. Listings are also available on BYTEnet; see page 4.]

Keep in mind that this classifier is

a stochastic process and its performance must be measured statistically. Random behavior enters in because of random selection of the initial rule set, random sampling of the database, random mutations of the rules, and some randomness in the ordering of rules (if two rules make identical bids, the first bidder will win). Usually, the random variation of the performance of the classifier is tightly bound, but unusually high and low values occur occasionally.

To measure the prediction success, I computed a statistic (unoriginally called S) for the classifier and a variety of alternative estimators. S is equal to

$$\frac{\text{correct predictions} - \text{incorrect predictions}}{\text{total predictions}}$$

Here, S takes on values between -1.0 (all predictions incorrect) and 1.0 (all correct).

To ascertain whether the Holland classifier was doing anything other than simply making random predictions, I made comparisons with three other predictors: a random predictor based on the observed event frequency alone, a prediction that simply repeated the previous observed archive, and a statistically optimized

predictor I labeled "Best." I computed the average value of S for 100 trials of the predictors, then for a summary statistic used the ratio of S for the classifier with S for the Best predictor:

$$R_{100} = (\text{average } S_{\text{Holland}}) / (\text{average } S_{\text{Best}})$$

If R_{100} is greater than 1.0, the classifier is doing better than the statistically optimal predictor; if R_{100} is less than 1.0, it is doing worse. The overall performance of the classifier is summarized in figure 1, which shows the distribution of the value of R_{100} over about 200 runs of the classifier (involving about 500 hours of computation) with various parameter values. This distribution is more or less normal with a mean around 0.94. Similar ratios for the random and previous predictors to the Best predictor are about 0.88 and 0.85, respectively, so the Holland classifier is usually doing considerably better than these, particularly since figure 1 includes a number of experimental runs with parameters that produced low success.

The classifier has several free parameters, such as the amount of reward given, the probability of a 1 or 0 mutating to a pass-through character, and the minimum acceptable

(continued)

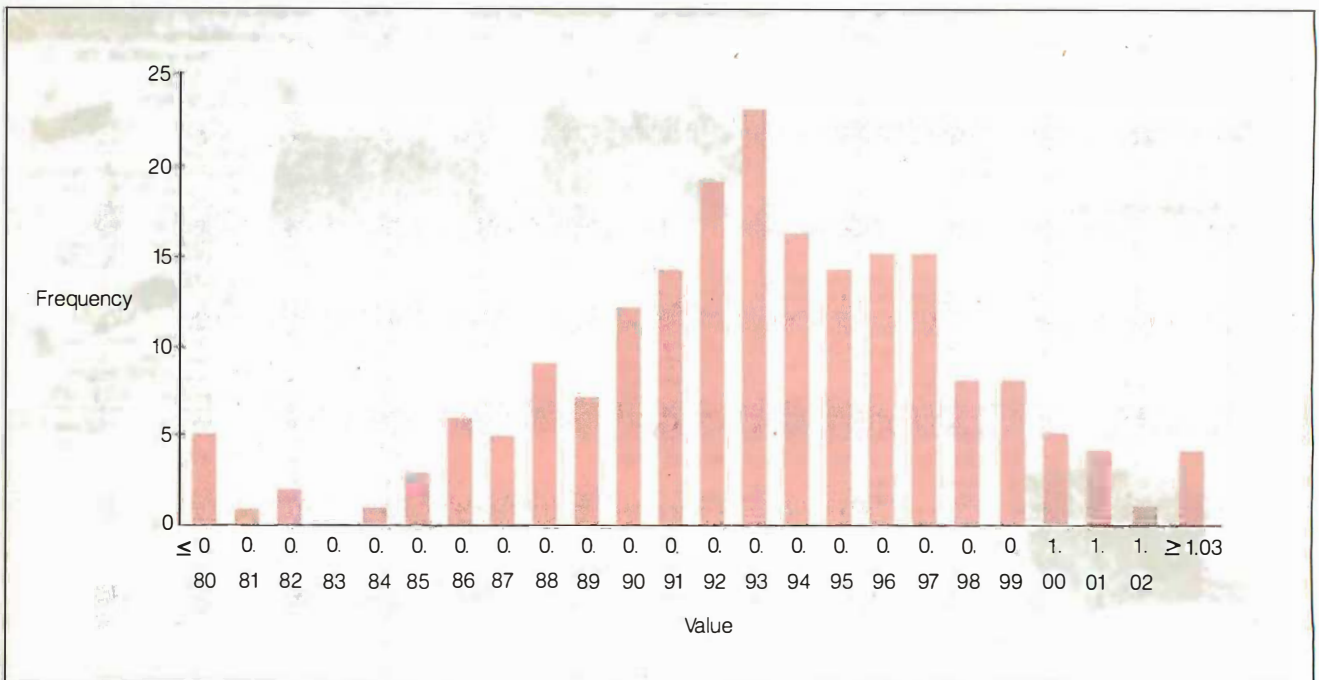

Figure 1: The distribution of R_{100} over about 200 runs of the Holland classifier using various parameter values.

AT jr. NOW \$599.



FREE! A \$185.00 VALUE.

With any order of \$1,000 or more, AMT will send you, absolutely FREE, a *Micro* brand dress wristwatch. Finest precision Japanese quartz movement. Specify male or female size.

LAUGH, CLONE, LAUGH! Who would guess that our AT jr. has more on the ball than his big brother?

AT jr. not only delivers fantastic features at fabulous prices, but gives you top quality in design, components, materials, and construction!

And for reliability, every AT jr. is burned-in at the factory prior to shipment.

No IBM® compatible system gives you more capability and value for your dollar than our incredible AT jr.

AT jr. \$599. This feature-packed model is based on an Intel 8088-2 (or NEC V20-8) CPU, running at 4.77 MHz or 8 MHz, selectable; handles PC DOS®, MS DOS®, XENIX®, and other operating systems, plus a full range of IBM-compatible software.

The standard system has a "0" wait state on memory, and operates many times faster than the IBM PC/XT®. Offers 640 KB of RAM on

the motherboard; 360 KB floppy disk drive; eight expansion slots; LED indicator for the turbo mode; AT-style keyboard; 135-watt integral power supply; and security key lock. Optional features include a 40 MB hard disk (38 ms), EGA, and an 8087-2 math co-processor.

LAP TOP. \$1699. AMT's compact Lap Top system gives you full IBM compatibility in less than 12.2 pounds of high-powered computer.

Features an 80C86 microprocessor, giving you twice the speed of IBM's lap top; 640 KB of memory; two 720 KB, 3.5-inch disk drives; an 80-by-25 LCD display with 640 x 200 resolution; RGB and printer ports; and a 1200 baud internal modem, optional.

AMT-286. \$1199. AMT's top-of-the-line AT system outperforms the IBM PC AT® at a fraction of the

price. Tagged "Best Priced" by PC Week, March 1986 issue.

Our phenomenal AT has a 16-bit Intel 80286 CPU running at 8 MHz (10 MHz or 12 MHz optional); 640 KB of RAM, expandable to 1 MB; 1.2 MB floppy disk drive; accommodations for 20, 30, or 40 MB hard disk drive; a socket for an Intel 80287 math co-processor; and a "0" wait state on memory, optional.

DON'T WAIT—CALL NOW

Pick up your phone now and get full details or place your order:



AMERICAN MICRO TECHNOLOGY

14751-B Franklin Avenue
Tustin, California 92680
Phones: (714) 731-6800;

in LA call (213) 477-6320;
in Bay area call (415) 490-7967
TWX 5106003265 AMT USA

*Prices and availability subject to change without notice. Dealer inquiries accepted.

®Registered Trademarks—IBM, IBM PC, IBM PC/XT, IBM PC AT, PC DOS: International Business Machines Corporation; MS DOS, XENIX: Microsoft.

match. I experimented with a variety of values for these, but only the Mutation_Probability seems to have a consistent impact. With that parameter, higher mutation probabilities (30 to 40 percent) seem to produce better predictors than low mutation probabilities. Some fine-tuning in Match_Minimum is also needed. When a strict matching criterion (40 or 38) is used, rule replacement occurs with very high frequency: Few rules get an opportunity to build up any strength, and all rules are vulnerable to being wiped out in a replace operation when matches fail. Conversely, loosening the match criterion to 34 seems to allow too much flexibility and encourages random bidding. While I have not done sufficient experimenting to draw a firm conclusion on this issue, slight looseness on matching (one or two mismatches) seems best.

A key characteristic of most self-organizing systems based on John

Holland's work is the use of "evolution" involving genetic-like mutation and recombination of rules. I have done some experimental work with the full Holland evolutionary system, but due to the length of time required for the programs to run, only a few sequences are available. Most of these exhibit a weak upward trend, though even this is very uneven and in some cases the performance of the classifier will rapidly deteriorate. It appears that you gain some predictive value from the evolutionary scheme but not a great deal and without a lot of consistency.

The weakness in the evolutionary system for this problem seems to lie in the lack of new input. Once a few strong rules are established, replacement of rules by outside data rarely occurs, and hence the only source of "innovation" is recombination and mutation. This means that the Holland predictions after, say, 1000 trials are still based on the original 32 samples

while after about 200 samples the Best estimator has attained its asymptotic value and fluctuates only moderately around it. This genetic "aging" (or genetic drift, to use the more appropriate biological term) of some of the rule sets may account for the tendency to see long downward trends in some sequences. The obvious cure for this would be to allow the system to recognize when new rules should be brought in from the data to provide variability. The poor evolutionary performance may also be due to the original rule set being precedent-based and allowing for some rule replacement, so it is difficult to improve upon.

OPTIMISTIC FUTURE

That the Holland classifier managed only a mean success of 94 percent of the statistically Best estimator was somewhat disappointing—I had hoped to do better. However, the

(continued)

**For serious hackers...
and serious
professionals.**

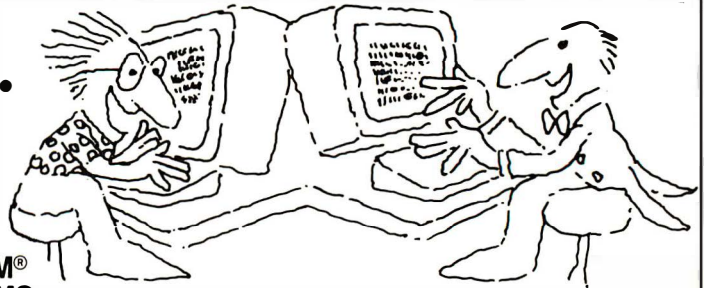

**AN INTRODUCTION TO
ASSEMBLY LANGUAGE
PROGRAMMING FOR THE
8086 FAMILY**

Thomas P. Skinner

Covering fundamental data types, segmentation, assembler operation and modular programming, this book lets you apply assembly language shortcuts to all machines incorporating the 8086, 8088, 80186, and 80286 microprocessors. \$17.95

**C WIZARD'S
PROGRAMMING
REFERENCE**

W. David Schwaderer

A reference guide packed with techniques to solve the many glitches that arise with C, this book also clarifies the areas of C that are often misunderstood. \$19.95

**JCL FOR IBM®
VSE SYSTEMS
A Self-Teaching Guide**

Ruth Ashley and Judi N. Fernandez

Using the proven STG format of reviews, self-tests, objectives, and exercises, this guide to the operating system that controls IBM's new 4300 series will enable application programmers to handle virtually any communication and control requirement encountered on the job. \$12.95

**PC DOS
Using the IBM PC
Operating System
2nd Edition**

Ruth Ashley and Judi N. Fernandez

This new edition provides clear, step-by-step guidance to the IBM PC's current disk operating systems, including DOS 2.1, 3.0, and 3.1. Explains all functions, commands, and utilities. \$16.95

THE 80286 ARCHITECTURE

Stephen P. Morse

Douglas J. Albert

An in-depth guide to Intel's new 80286 and 80287 microprocessors, the chips used in IBM's PC/AT and many compatibles. Shows how to program the chips to perform a wide range of business, scientific, and microcomputer applications. \$24.95

Wiley Press guides have taught more than three million people to program, use, and enjoy microcomputers. Look for them at your favorite bookshop or computer store! For a complete list of Wiley's computer titles, write to Gwenyth Jones, Dept. 6-0912.

JOHN WILEY & SONS, INC.
Business/Law/General Books Division
605 Third Avenue, New York, N.Y. 10158.

Prices subject to change and higher in Canada.

**WILEY PRESS
COMPUTER BOOKS**

AMT-286: MORE THAN AN IBM® LOOK ALIKE.



AMT-286.
\$1199.

The IBM PC AT® laid the foundation. AMT accepted the challenge, and put its AMT-286 into orbit. Now you can get the best of both worlds at a fraction of IBM's price!

Speed. The AMT-286 cruises at 8MHz, with optional clock rates of 10MHz and 12MHz. That's 30% to 40% faster than the IBM PC AT.

Main Memory. User-friendly programming takes lots of RAM. The AMT-286 comes with 640K, but can be expanded to an incredible 6 MB. IBM can't say that.

Mass Storage. Up to 60,000 pages of words and numbers—a full 120 MB of storage—can be crammed into the AMT-286 hard disks. That's twice what the IBM PC AT can handle.

Other Goodies. Intel's fabulous 80286 16-bit microprocessor chip on an American-made motherboard. 1.2 MB floppy disk; and accommodations for an 80287 math co-processor. The system runs all software and accepts all hardware designed for the IBM PC AT.

For \$1199, how can you lose?

AT jr.
\$599.

This feature-packed model has an Intel 8088-2 running at 4.77MHz or 8MHz, selectable—many times faster than the IBM PC/XT®. Also has a "O" wait state on memory, and provides 640 KB of RAM on the motherboard. Offers eight expansion slots, an LED indicator for the turbo mode, and a security key lock. Optional features include a hard disk, up to 40 MB (38 ms), EGA, and an 8087-2 math co-processor.



Case style may vary from photograph.

With any order of \$1,000 or more, AMT will send you, absolutely FREE, a Micro brand dress wristwatch. Finest precision Japanese quartz movement. Specify male or female size. Only one watch per customer.

REACH FOR YOUR PHONE.

An AMT-286 or AT jr. is yours by dialing one of our convenient numbers. All orders filled immediately, following complete systems checkout and 72-hour factory burn-in.



AMERICAN MICRO TECHNOLOGY

14751-B Franklin Avenue
Tustin, California 92680

Phones: In Orange County call (714) 731-6800
In LA call (213) 477-6320
In Bay area call (415) 490-7967
TWX 5106003265 AMT USA

*Dealer inquiries accepted

*Prices and availability subject to change without notice

*Registered trademarks IBM, IBM PC/XT, IBM PC AT: International Business Machines Corporation

*I had to use calculus
to figure out Best,
but the Holland system
did well on its own.*

result is more impressive when you consider the following factors. First, the Holland success is far better than what would be produced by chance, almost never dropping to the level of the random and previous estimators, so the system is indeed learning. Second, the Holland estimator comes close to the Best estimator despite the fact that it has absolutely no information about what this optimal predictor is. In other words, I had to use calculus to figure out Best, but the Holland system was able to do almost as well (and, about 7 percent of the time, better) on its own.

Another problem with the test is that there was not a great deal of variability in the data, and hence a statistic predicting modal behavior (which Best did) was difficult to beat. However, during the process of debugging I discovered some circumstances where the Holland system would be better suited. Having cleverly turned off array bounds checking to save 10 percent on run times and then forgotten to initialize an index, I did about two days' worth of runs where the system roamed for hours through RAM reading data until it evoked some fatality in the operating

system. Here, interestingly, the Holland estimator did considerably better than the Best estimator because, with rule replacement, it adapted fairly quickly to the changing data while Best was slower to respond. In these experiments, R_{100} values of 2.0 and greater were not uncommon. In a denser, more varied event data set, the Holland system would probably be far superior to the statistical techniques.

The system discussed here is only a first, highly simplified approximation to the knowledge base and learning techniques of a political expert. The system is not a Metternich nor anywhere close. But similar techniques used with a vastly larger and more detailed database of past political behavior and probably with some systematic training by human experts (as is now done with some advanced chess-playing programs) could well be capable of predicting many political situations at least as accurately as a human expert.

A computer-based knowledge system would be useful in at least two ways. First, a machine can process large amounts of new information more rapidly than a human can, so that it could presumably master, for example, the complex internal politics of a new governing political party based on historical data more quickly than a human analyst could. Second, the machine is insensitive to the tendency of human decision makers to ignore precedents that point to undesired outcomes and would at least call these to the attention of the ex-

perts. Moreover, AI-based techniques such as the Holland classifier and rule-based systems are expanding the ways we have available of representing political knowledge and may, in the long run, lead to techniques as profound in their impact on the practice of politics as survey research. ■

ACKNOWLEDGMENT

Partial support for this research was provided by the Gordon Scott Fulcher Chair of Northwestern University.

BIBLIOGRAPHY

- Cimbala, Stephen, ed. *Artificial Intelligence and National Security*. Lexington, MA: Lexington Books, 1986.
- Holland, John H. *Adaptation in Natural and Artificial Systems*. Ann Arbor, MI: University of Michigan Press, 1975.
- _____. "Escaping Brittleness: The Possibilities of General Purpose Algorithms Applied to Parallel Rule-Based Systems," in R. S. Michalski, J. G. Carbonell, and T. M. Mitchell, eds., *Machine Learning 2*. Los Altos, CA: Morgan Kaufman, 1986, Chapter 20.
- Luterbacher, Urs, and Michael Don Ward, eds. *Dynamic Models of International Conflict*. Boulder, CO: Lynn Reinner Publishing, 1985.
- Schrodt, Philip A., "Microcomputers in the Study of Politics: Predicting Wars with the Richardson Arms-Race Model," *BYTE*, July 1982.
- _____. "Set Prediction of International Behavior Using a Holland Classifier." Paper presented at the International Studies Association, Anaheim, CA, March 1986.
- "Symposium: Events Data Collections." *International Studies Quarterly*, vol. 27, no. 2, 1983.



**PC/AT/XT, TURBO, ADD ON CARDS.
.....IS YOUR RIGHT CHOICE**

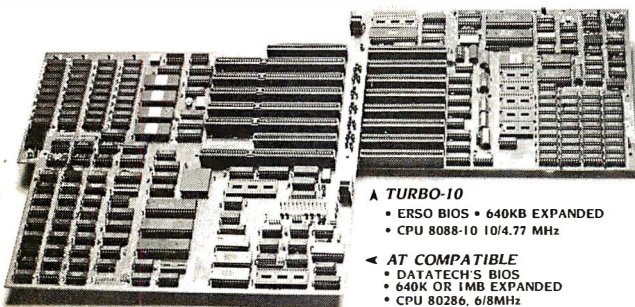

- A TURBO-10**
 - ERSO BIOS • 640KB EXPANDED
 - CPU 8088-10 10/4.77 MHz
- ◀ AT COMPATIBLE**
 - DATATECH'S BIOS
 - 640K OR 1MB EXPANDED
 - CPU 80286, 6/8MHz

TURBO-640

- ERSO BIOS • 640KB EXPANDED • CPU 8088-2, 8/4.77 MHz
- OPTIONAL 70108-8 CPU, 3 TIMES FASTER

PC/XT COMPATIBLE

- EROS BIOS • CPU 8088 • OPTIONAL CPU 70108-5, 1.7 TIMES FASTER

ADD-ON CARD

FOR AT:

- DISK DRIVE CONTROLLER. SUPPORTS 2x1.2 MEGA FLOPPY DISK DRIVE.
- I/O CARD • 2 MEGA M/F CARD. • 3 MEGA RAM CARD.
- SERIAL + PARALLEL PRINTER CARD AND MORE....

FOR PC/XT AND COMPATIBLE:

- ENHANCE COLOR CARD • MULTI I/O CARD.
- MONOCHROME GRAPHICS PRINTER CARD.
- COLOR GRAPHICS PRINTER CARD AND MORE...

****ALL PRODUCTS HAVE FCC APPROVAL****



DATATECH ENTERPRISES CO., LTD.
3RD FL. NO. 68 PA TE RD., SEC. 4, TAIPEI, TAIWAN, R.O.C.

TELEX: 12086 DATATECH
TEL: (02)7672553 (4 LINES)

P.O. BOX: 96-361 TAIPEI, TAIWAN
FAX: (02)7610681 DATATECH TPE

DOING IT RIGHT!

A SIMPLE FORMULA FOR SUCCESS FROM THE IBM OF THE MAIL ORDER BUSINESS

When we founded PC Network, our goal was to create the IBM of our Industry.

In three short years, we have grown to an annual sales volume of over \$75,000,000 employing over 200 people! We have served over 200,000 members. We ship over 7,000 orders per week.

We have become the world's largest PC Mail Order Firm.

We are often asked how we did it by the Editors of Computer and Business Magazines, Newspapers, Computer Manufacturers and Fledgling Entrepreneurs.

Our answer is our philosophy.

Price computer products at what they're worth, not the most you can get. For us that became our wholesale + 8% pricing applied to over 30,000 products, not just the "Grabbers".

The customer is the most important person in the universe!! Treat him or her well and your business will grow and prosper.

10 Day hardware returns, software rentals, a 24 hour bulletin board with over 20,000 FREE software programs yours for the picking, and numerous other benefits are only the tip of the iceberg in translating this philosophy into practice.

These commitments all cost money. A lot of money. But we firmly believe that for every dollar we spend on YOU our customer, we will receive many in return.

We are told we should be proud of our accomplishments, and we are. But we realize that they all come from working for you, giving you exceptional value and good service.

That means at PC Network, the Customer will always come first!

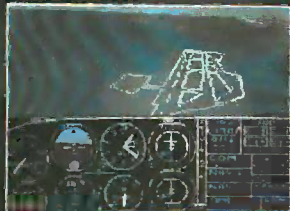

FLIGHT
SIMULATOR
\$27.00*

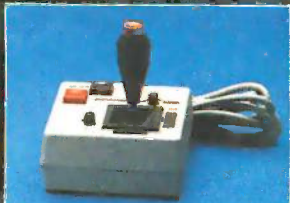

HAYES MACH III
JOYSTICK
\$30.25*



EPSON
FX-85
\$355.00*



MICROSOFT
MOUSE
\$107.00*



ANY TITLE
ABOVE
\$20.00*



William R. Stankiewicz
Warehouse Manager

Richard A. Koril
Vice President

Stephen A. Dikker
President

PC Network
(800) 621-SAVE

Simply put: **THE™** highest quality and best value in computer products anywhere.

THE™ commitment to our customers is compatibility, quality, value, service and support

THE™ backs every product with a **45 DAY MONEY BACK GUARANTEE**

and a **FULL 1 YEAR PARTS AND LABOR WARRANTY**

THE™ MULTI 384

This multi-function card features 0-384K memory, a parallel printer port, a serial port for communications, a clock/calendar with battery backup, and a software bonus that includes RAMdisk and other utilities. Retail \$90.00

\$67.00*
Special Wholesale Price



BEST BUY
Functional Clone of AST SixPackPlus

THE™ H720 MONO

This monochrome graphics card with printer port features 100% IBM™ and Hercules™ compatibility, at a fraction of their prices. Retail Price \$91.25

\$69.00*
Special Wholesale Price



BEST BUY
Functional Clone of Hercules Graphics Card

THE™ MODEMS

100% Hayes compatible

THE™ 1200 COM EXTERNAL

This self-testing 1200 BPS modem comes with auto answer, auto dial, auto redial and a built-in speaker. Retail Price \$161.25*

Special Wholesale Price **\$119.00***



THE™ 1200 COM INTERNAL

Features auto answer, dial and redial, with a built-in speaker, RS 232-C serial port and PC Talk III. Retail Price \$148.75

Special Wholesale Price **\$109.00***

THE™ 2400 COM EXTERNAL

Eight times the speed of a 300 BPS unit makes this 2400 Baud modem truly affordable, and we've made it truly compatible. With auto answer, auto dial, auto redial, and a built-in speaker with volume control. Retail Price \$346.25

Special Wholesale Price **\$259.00***

THE™ 2400 COM INTERNAL

Features auto answer, auto dial, auto re-dial a built-in speaker and Free PC Talk III. Retail Prices \$332.00

\$197.00*

THE™ COLOR CARD

100% compatible with the IBM™ color card with display modes of 320x200 graphic and 80x25 alphanumeric, w/printer port. Retail Price \$75.00

\$60.00*

THE™ 2MB EMS RAM

Intel™/Lotus/Microsoft specs. Features up to 2MB of RAM Retail Price \$172

\$99.00*

A \$120.00 VALUE!

ADAM OSBORN'S PAPERBACK SOFTWARE

- Paperback Writer
 - Paperback Speller
 - Numberworks Spreadsheet
- All three for only...

PC + STARTER KIT

\$32.00*

With the purchase of a PC +

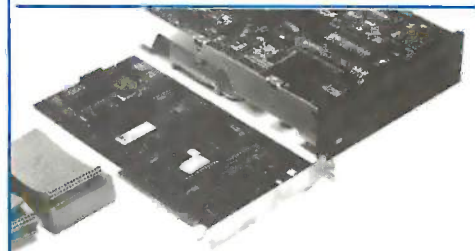

THE™ 20MB HARD DISK KIT

Featuring a half-height IBM™ PC compatible internal 20MB disk drive, controller card, connecting cables and installation manual. Retail \$458.75

Special Wholesale Price **\$357.00***

THE™ MULTI I/O

Feature for feature, **THE™** matches the **AST™ I/O +** and comes up a winner, with serial/parallel and game ports standard, (a second serial port optional), a clock/calendar, RAMdisk and print spooler. Retail Price \$75.00

\$60.00*

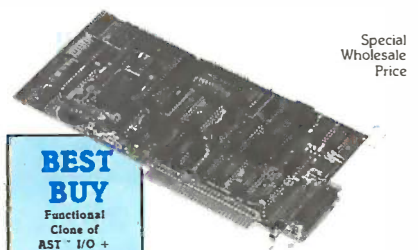

Special Wholesale Price

BEST BUY
Functional Clone of AST™ I/O +

THE™ EGA PLUS

With 256K standard this 100% IBM™ EGA and Hercules Graphics compatible card is ideal for high resolution graphics display of Microsoft™ Windows, Lotus™ and AutoCAD™ w/printer port. Retail Price \$300.67

Retail Price \$300.67

Special Wholesale Price

\$220.00*

Thompson, Harriman and Edwards Computer

THE™

Thompson, Harriman and Edwards
Computer Products Company Ltd.

THE™ PC + COMPUTER

THE™ PC + is compatible with all business, professional and personal software written for the IBM™ PC. It will also enhance your productivity with its ability to switch to an 8 megahertz clock rate, enabling you to run your software twice as fast as the IBM™ PC. THE™ PC + also comes standard with an "AT" style keyboard, correcting the inefficiencies found by IBM™ on their regular PC keyboard. 256K standard (640K optional) on the mother board will allow you to run memory intensive programs such as Lotus 1-2-3, dBase III and Framework without adding extra memory cards. Plenty of power, with a 135 Watt source and lots of room for expansion with 8 card slots is also standard. Base unit includes: 256K RAM, Computer with One 360K 5¼" Floppy Drive, Dual Turbo Clock Speed, 8 Expansion Slots, 135 Watt Power Supply, "AT" Style Keyboard, Full 1 Year Warranty and 45 Day Money Back Guarantee!

Retail Price \$586.25*

Special Wholesale Price
\$444.00*
(Monitor Not Included)

All THE products in this special sale are offered thru

PC Network
*All prices in this ad are wholesale — PC Network Members pay wholesale + 8% and shipping.
CALL TOLL FREE B3NZ
(800) 621-SAVE
In Illinois (312) 280-0002

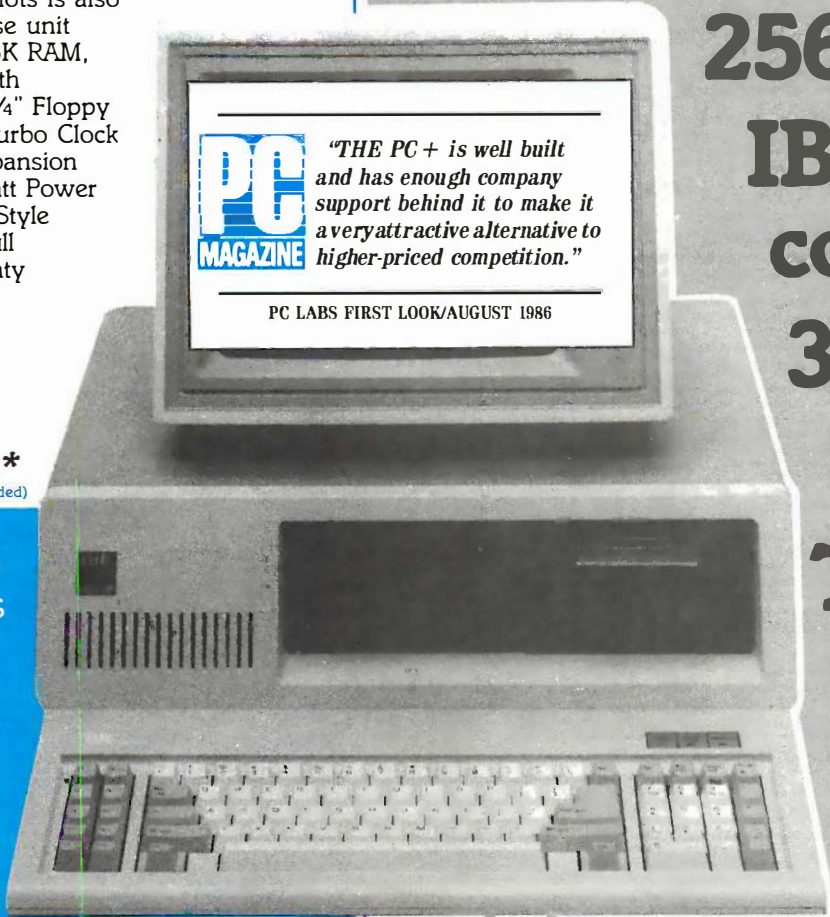

PC MAGAZINE
"THE PC + is well built and has enough company support behind it to make it a very attractive alternative to higher-priced competition."
PC LABS FIRST LOOK/AUGUST 1986

THE MOST INCREDIBLE
LIMITED TIME OFFER IN
COMPUTER HISTORY, FROM
THE™ and PC NETWORK...

THE™ PC➔

256K RAM,
IBM™ PC
compatible,
360K 5.25"
Disk Drive,
Turbo Speed,
"AT" Style
Keyboard

Special Wholesale Price

\$444.00*

\$469.00* for 640K System

Products Company Ltd.

Dealer Inquiries Call THE™ at (312) 642-9626
319 West Ontario Street, Chicago, Illinois 60610

COMPLETE SYSTEMS

(Optional local warranty service available in most major metro areas)

IBM PC BASE SYSTEM

IBM PC w/256K
Floppy Drive Controller
2 Double Sided Double
Density Disk Drives
Mix and Match with
your Favorite Monitor
and Printer!

\$1,025.00*

CUSTOM
CONFIGURATIONS
WELCOME



IBM PC HARD DISK SYSTEM

IBM PC w/256K
Floppy Drive Controller
1 Double Sided Double
Density Disk Drive
Half Height Hard Disk

\$1,337.00*

CALL FOR
LATEST IBM
ANNOUNCEMENTS

PORTABLE HARD DISK SYSTEM

256K/1 Floppy/20MB Hard Disk

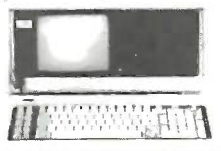

\$1,800.00*

DESKPRO SYSTEM

256K CPU/1 Floppy/Hard Disk



\$1,999.00* w/30MB
\$1,775.00* w/20MB

COMPAQ™

MACINTOSH
512K
ENHANCED
AND
1.2MB SYSTEMS
CALL

PRICES TOO
LOW TO PRINT



LASER 128

128K RAM, 1 Internal Drive
Apple IIe/IIc Compatible
1 Parallel & 2 Serial Ports Included

\$355.00*

64K IBM PC MEMORY EXPANSION KITS

Quantity Discounts Available.
Guaranteed for Life!

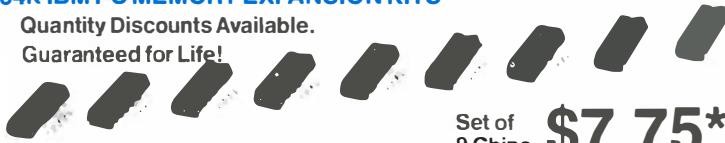

Set of
9 Chips **\$7.75***

1/2 HEIGHT DS/DD DISK DRIVES

The Network buys direct
and makes fantastic deals
with manufacturers like MPI/
Tandon/CDC/Shugart/Dume/
TEAC and others to bring you
fantastic prices on Name
Brand drives for your PC/AT/
XT/jr/for Compatible.

\$75.00*

Quantity Discounts Available

INTERNAL PC HARD DISK

Low Power/Automatic Boot. Works on standard PC's
and Compatibles. Includes drive/controller/cables/
mounting hardware and instructions

Full one year warranty!



10MB **\$299.00***
20MB **\$357.00***

Quantity Discount Available

Lotus™
\$285.00*

WordPerfect
\$185.00* ea.

*Members pay 8% above this wholesale price plus shipping.

CALL TOLL FREE 1-800-621-S-A-V-E (orders and memberships)

In Illinois call (312) 280-0002 Validation code: B326
Customer Service and Order Status (312) 280-1567

™ & R - Registered trademarks of IBM/COMPAQ/APPLE/AST Research/LOTUS/Multimate Int./IOMEGA.

SEE WHY OVER 200,000 HAVE JOINED MAKING US THE NATION'S #1 SOURCE FOR EVERYTHING IN COMPUTING

- **Our 600 Page Wholesale Catalog**
Over 30,000 products priced at Wholesale + 8%. Anything you will ever need at a Consistent low price...
- **Periodic Catalog Updates**
Your Catalog is never obsolete! Keep on top of the newest products and latest price changes.
- **The Printout**
Our newsletter gives you fantastic specials with unbiased analysis of new products and industry trends.
- **10 Day Returns on any Hardware!**
If you don't like any hardware product—for any reason—return it for a refund.
- **1000 + Title Rental Library**
14 to 30 day rentals on over 1000 different titles. Try before you buy!!
- **Size, Strength and Stability**
The Network has over 200 employees, 55,000 square feet of office and warehouse space, inventory valued in excess of \$25,000,000 and is ranked the largest computer product supplier in the nation! Our commitment is to serve our customers and our 90% repeat business rate is proof!!
- **OnLine™ Bulletin Board**
Download "Freeware" from the nation's largest single concentration of Public Domain software available! Get tied into the nation's largest technical information network! Place orders, get tech support or contact customer service from the Network's OnLine, "not just a bulletin board but a complete customer information network."

Starting
Nov. 1
Mon.-Fri.
7 am-9 pm
CST

**CALL TOLL FREE
1-800-621-S-A-V-E**

(Orders Membership and Advice!!)

In Illinois (312) 280-0002

Your Membership Validation Number is **B326**

You can validate your membership number and, if you wish, place your first money saving order over the phone by using your VISA, MASTERCARD or AMERICAN EXPRESS card. Our knowledgeable sales consultants are on duty Monday - Friday 8:00AM to 7:00PM, Saturday 9:00AM to 5:00PM CST.



PC Network, Incorporated
320 West Ohio Street
Chicago, Illinois 60610

Call now... Join the PC Network and start saving today!
For Customer Service and Order Status call (312) 280-1567
Monday - Friday 8:30AM and 4:30PM CST



EPSON FX-286 PRINTER



132CPS/200CPS Letter Quality **\$440.00***

Epson FX-85 160CPS 10" Par	\$355.00*
Epson FX-286 200CPS/40CPS NLQ	440.00*
Epson LQ-800 180COL/46CPS Par	519.00*
Epson LQ-1000 180CPS/60CPS NLQ	699.00*
Epson LQ-2500 180CPS/132COL Par/Ser	995.00*
Epson EX-800 NEW! 80COL/Par/Matrix	445.00*
Epson EX-1000 132COL/Par/Matrix	629.00*

MAGNAVOX 12" RGB MONITOR

\$250.00*



Amdek Video 310 Amber TTL	\$130.00*
Amdek Color 722 NEW! Enhanced	424.00*
Magnavox Amber IBM Type TTL	79.00*
Nec JC-1401 Multisync RGB Color	530.00*
Princeton HX-12 RGB	369.00*
Princeton Max-12E Mono or RGB	138.00*
Taxan 630 High Res RGB	383.00*
Taxan 640 Highest Res (720x400)	439.00*

FULL HOUSE

BUY THE WORLD'S #1 PRINTER FROM THE WORLD'S #1 SOURCE

It's an unbeatable combination. We're the nation's largest mail order source for everything in computing. Epsos are the nation's best-selling family of printers...and for good reason. Epsos are unmatched in speed, versatility, choice of fonts, letter and correspondence quality, and are backed by the strongest local service network in the nation. So we stock them in tremendous volume, ready for immediate shipment...at the kind of prices that helped make us #1. Epson printers, as well as 30,000 other products are priced at Wholesale + 8%. Also, when you join the Network you get our catalog, our own periodical newsletter, a vast software rental library, free phone consultation, our 10 day money-back guarantee and more! Watch your benefits stack up.



EX-1000

Introducing the EX-800 and EX-1000, for highspeed throughput, at 300 COL draft mode, 60 CPS Near Letter Quality mode.

THOUSANDS IN STOCK READY FOR
IMMEDIATE SHIPMENT



EPSON®

PC NETWORK
(800) 621-SAVE

In Illinois Call (312) 280-0002

HANDLING CONFLICTS IN DATA

BY CLARA Y. CUADRADO AND JOHN L. CUADRADO

A decision support system in Prolog

ONE OF THE major research areas of artificial intelligence concerns the representation and maintenance of knowledge. A problem of first-generation expert systems is that they cannot handle perturbation of their knowledge bases. Since in reality it is virtually impossible for us to provide exactly the right amount of knowledge and information to achieve our goals, we must be able to reason with incomplete and inconsistent knowledge and handle the removal or change of portions of the knowledge base. In drawing inferences from incomplete or inconsistent data, AI systems must be able to make choices among plausible alternatives and, if necessary, retract the inferences, undo the effects, and make new choices based on revised beliefs or new evidence. A related problem is carrying out deductions based on different beliefs and multiple sets of criteria.

Thus, an important component of state-of-the-art inference systems is a belief/evidence/truth maintenance subsystem. The responsibilities of such a subsystem include the accumulation of supporting evidence for each

major deduction that the system carries out and the provision of mechanisms for the propagation of automatic maintenance of such sets of supporting evidence. Today there are many competing approaches to achieving these goals. (See references 1, 2, 3, and 4.)

In this article we will illustrate the knowledge representation and belief maintenance functions via a simple decision support system that has two major capabilities. First, based on incomplete or inconsistent data, the system may reach certain conclusions. When information is added or deleted, the deductions are adjusted or retracted, which entails forward and backward evidence propagation. Second, the system provides for "what if" analysis capabilities. We can make certain assumptions, let the system make deductions based on them, then withdraw a set of the assumptions and bring the system back to a consistent state. The system presented is implemented in Prolog. For a short introduction to how Prolog works, see reference 5.

To facilitate understanding, we have

chosen an area of application that is both relevant and self-explanatory. Our example is based on a fictitious situation where personnel selection is supported by different individuals' beliefs about such "hard" evidence as technical competence relative to a specific project and such "soft" factors as interpersonal relationships. As it is, this simple decision support model can be used in any level of the control hierarchy of a corporation. It can also be expanded to help develop management strategies or to aid crisis management. The ideas illustrated here, however, are generic and can be used in any domain.

A DECISION SUPPORT EXAMPLE

One of the most frustrating duties of corporate managers is dealing with in-

(continued)

Clara Y. Cuadrado and John L. Cuadrado (Octy Inc., 10920 Oxford Court, Fairfax Station, VA 22039) both earned Ph.Ds from the University of Illinois at Urbana-Champaign. They taught at the University of Maryland and Dartmouth College, respectively, and now run their own company developing AI systems.

Long distance or local, Pacific Telesis gets great reception with the MasterCard BusinessCard.

Pacific Telesis chose the new MasterCard BusinessCard™ because it is consistent with the company's philosophy... progress, intelligently planned. It's a philosophy Pacific Telesis is bringing to life in many ways—from providing quality phone service in California to operating a paging company in Thailand. And, it's a philosophy that warrants the best corporate card program possible.

Whether it's a technician in California or an executive in New York, the BusinessCard makes every employee's work easier. It's welcome in four times more places than any other corporate card and offers cash access at 110,000 locations.

The BusinessCard program enables Pacific Telesis to control business expenses with virtually no administrative effort. It offers individual credit limits and monitoring for each of the 12,000 cardholding employees at Pacific Telesis.

Finally, the BusinessCard offers unparalleled flexibility. The program was tailored for Pacific Telesis by its bank so the company chose services that were right for its business. In addition, each card carries the Pacific Telesis logo.

The distinctive silver BusinessCard is an investment in progress for Pacific Telesis. The program is helping the company live up to its corporate philosophy by keeping it in touch with all the possibilities.

For more information call 1-800-821-7700. Ext. 706

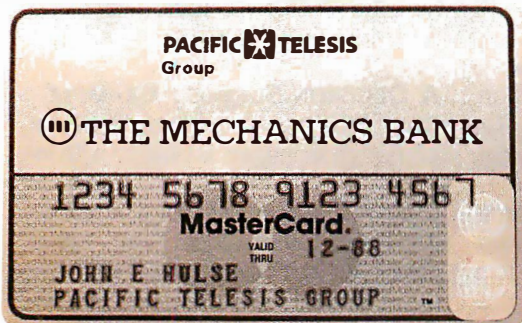

Master
The Business Possibilities™

PACIFIC TELESIS Group



terpersonal conflicts in their organization. While most experienced managers will tell you that interpersonal relationships greatly impact the structure and the efficiency of an organization, somehow the illusive quality of these relationships prevents them from becoming an acknowledged factor in a formal decision-making process. This is not difficult to understand: interpersonal relationships are complex, tenuous, and unstable. They are often difficult to detect and even more difficult to describe. Rumors and whispers in the office, "gut feelings," and "vibes" are not the kind of stuff our traditional corporate decision-making process is made of.

We will demonstrate our system with a fictitious case. Let's say that a middle-level manager, Mike, has a project that requires two engineers to work closely to develop a new design. He has four possible candidates: Alan, Bob, Charlie, and Dan. Assuming for now that all other qualifications of these candidates are irrelevant (we will introduce an important qualification later), we want to help Mike make his choice of a team based solely on one criterion: that the two individuals be able to work well together.

We know a few things about this selection process: First, Mike decides that he wants to be open-minded about the selection and therefore asks each of the four candidates to state his belief as to whether they can work with each other. Mike will try to base his decision on the mutual evaluation of his subordinates. For simplicity and clarity, in our example we allow the candidates to say only "yes," "no," or "don't know" to straightforward questions such as "Do you think you can work well with Dan?" "Do you believe Dan will be able to work well with Charlie?" We do not ask them to supply weights to their beliefs, nor do we consider the reasons for their answers.

In a more complex decision support system, naturally, all these weights to answers would be included. The individuals' justifications would consist of hard facts as well as less tangible evidence. The point is, the evidential hierarchy can be made arbitrarily

deep and complex, but then at some point computational requirements for the system become an important consideration, a consideration beyond the scope of this article.

Next, Mike gives us a ranking of his opinion of the judgment of the four subordinates. He also supplies us with weights and justifications for his belief in the judgment of his subordinates, which we summarize in table 1. As we

can see, Mike values Bob's opinion a great deal, not only because Bob is a good judge of character and always tells the truth but also because Bob knows the other three better than Mike himself. For this reason, Mike has assigned a "3" for his own judgment on the compatibility issue.

After Mike makes his choice of the engineering team based on compati-

(continued)



SYMMETRIC
ΣΑΜΜΕΤΡΙΚ
COMPUTER SYSTEMS

THE 375 - A SOFTWARE DEVELOPER'S DREAM

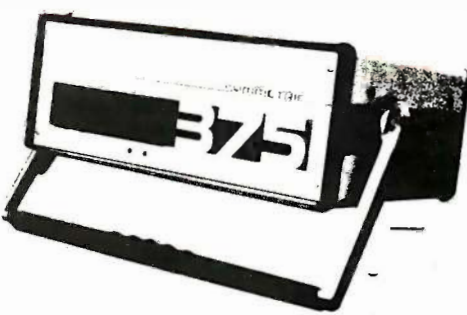

THE BEAUTY AND THE BSD

\$4,995*

OVER 1,000 PROGRAMS, 3,000 FILES !

<p>Full 4.2BSD UNIX™ Each 375 comes standard with a complete configurable 4.2BSD UNIX system. We don't skimp on software. And we can even give you EMACS, INGRES, TEX and SPICE for those special applications.</p>	<p>Loaded With Languages Turn on your 375 and start developing your own applications. It's that easy. C, FORTRAN, PASCAL, BASIC, APL, Assembler, LISP and PROLOG: they all come standard on every 375.</p>
<p>Loaded With Standard Features</p>	
<ul style="list-style-type: none"> ★ 50MB Winchester Disc Drive ★ 1MB 5¼" Floppy ★ 2MB RAM (8MB optional) ★ Integral SCSI & ST506 interfaces 	<ul style="list-style-type: none"> ★ 4 RS232 Ports (up to 36 optional!!) ★ Parallel Printer Port ★ External Winchester and Floppy Ports ★ Series 32000, 10MHz, VM, FPU

Also Available: 10 Mb ETHERNET, up to 280MB disk memory, streaming tape, and more !

A Portable Computer for the Serious User

At last, a powerful, portable (22lbs) scientific computer for all your serious work. The 375 combines the advantages of a VAX™ with the size, versatility, and price of a micro. All the software tools are there. It's even small enough to leave on your desktop or take wherever you need it. **And it's available direct to you right now !**

CALL US TODAY (408) 279-0700

SYMMETRIC COMPUTER SYSTEMS - 1620 Oakland Rd. Suite D200 - San Jose, CA 95131

* Prepaid. Sales tax and Shipping Costs not included.
UNIX is a registered trademark of AT&T Bell Labs.
VAX is a trademark of Digital Equipment Series 32000 is a trademark of National Semiconductor Corp.

MAC INKER™

Re-ink Any Fabric Ribbon
Automatically for less
than 5 cents.

Dedicated Units Start at **\$54.95**

Universal Cartridge
MAC INKER **\$68.50**

Universal Spool
MAC INKER **\$66.95**

shipping \$3.00



Lubricated, Dot Matrix Ink \$3.00,
bottle available in black/brown/
red/green/yellow/purple/
orange/gold and silver.

Over 50,000 MAC INKER(s) in the field.

Over 7500 printers supported.

MERCURY MODEM

Really 100% Hayes* Compatible.

- 300/1200 baud.
- audio monitor/front panel lights.
- 18 months warranty.

Shipping \$4.00



\$205.00

*Hayes is a trademark of Hayes Microproducts.

DATA SWITCHES

All types, all lines switched, all metal,
heavy duty switch, elegant design, best
value for money.



2 Ports Parallel or Serial **\$ 7500**

4 Ports Parallel or Serial **\$15000**

2 Computers/2 Printers
Parallel or Serial **\$15000**

We have cables too. Please inquire or
specify at time of order.

Order Toll Free.

Call or write for free brochure.

1-800-547-3303

In Oregon 503-297-2321 (24 hours line)

Computer Friends®

6415 SW Canyon Ct., #10, Portland, OR 97221.
telex 4949559

Dealer inquiries welcome.

A selection can be made by combining the compatibility and competence analyses.

bility, he will present his decision to his boss, Penelope. Penelope has the final say on the selection of the team, and she wants to be able to play "what if" games to see what the results will be when changes are made in the assumptions. For example, because Dan is a new employee, the others have little to go on in judging whether he can work well with a particular colleague. Penelope may test out several assumptions. In one scenario she may make Dan a Mr. Congeniality, and in another she may make him Enemy-of-the-People. In this way, she can get a feel of the impact Dan's personality may have on Mike's group.

Penelope also has considerations other than personal compatibility in mind. She calls in Jack, the chief scientist of her division, and asks him to rate the four candidates on the basis of their respective technical competence. The list Jack gives her is summarized in table 2.

Penelope wants to combine Mike's compatibility analysis and Jack's technical competence analysis to arrive at a reasonable selection of the team. She first obtains a list of qualified teams that have a compatibility rating of, say, 3 or above. Then she ranks these eligible teams according to their technical competence (based on Jack's beliefs) and picks the team with the highest technical rating. Here, for illustrative purposes, we chose to use a naive rule of combination. A more sophisticated approach such as the Dempster-Shafer mathematical evidential theory (see reference 6) should be incorporated in an industrial-strength system.

In this manner, Penelope knows she *(continued)*

Table 1: Mike's ranking of the judgment of the four subordinates.

Name of Employee	Weights (5: most credible, 0: least credible)	Justification
Bob	4	Good judgment, intuition; always says what he means.
Charlie	3	Observant, reliable.
Dan	2	New employee, can't quite judge others' relations yet; seems smart and trustworthy.
Alan	1	Tends to be opinionated, emotional; distorts facts occasionally.
Mike	3	Manager; does not know the others very well on a personal level.

Table 2: Jack's ranking of the technical competence of the four subordinates.

Name of Employee	Weights (5: best, 0: worst)	Justification
Dan	5	Recent Ph.D.; has excellent new ideas.
Bob	3	Good command of general knowledge.
Alan	4	Veteran engineer; very experienced.
Charlie	2	Skills somewhat outdated.

HANDLING CONFLICTS

Listing 1: *The Decision Support System program illustrates the flexibility of a simple knowledge representation and belief maintenance system. In walking through the Prolog code, the comments are enclosed in /* */ pairs (for general comments) or preceded by a % (for clarifying specific functions of the code).*

% The various possible teams are:

```
teams([team(charlie,bob),team(charlie,alan),
      team(charlie,dan),team(bob,alan),
      team(bob,dan),team(alan,dan)]).
```

% Mike's opinions are:

```
mike(credibility(assumption,3),[opinion],[ ]).
mike(credibility(bob,4),[opinion],[ ]).
mike(credibility(charlie,3),[opinion],[ ]).
mike(credibility(dan,2),[opinion],[ ]).
mike(credibility(alan,1),[opinion],[ ]).
```

% Jack's opinions are:

```
jack(technical_competence(assumption,3),[opinion],[ ]).
jack(technical_competence(dan,5),[opinion],[ ]).
jack(technical_competence(alan,4),[opinion],[ ]).
jack(technical_competence(bob,3),[opinion],[ ]).
jack(technical_competence(charlie,2),[opinion],[ ]).
```

% Bob's opinions are:

```
bob(can_work_with(no,bob,alan),[opinion],[ ]).
bob(can_work_with(yes,bob,charlie),[opinion],[ ]).
bob(can_work_with(yes,bob,dan),[opinion],[ ]).
bob(can_work_with(no,alan,charlie),[opinion],[ ]).
bob(can_work_with(yes,charlie,dan),[opinion],[ ]).
```

% Alan's opinions are:

```
alan(can_work_with(yes,alan,bob),[opinion],[ ]).
alan(can_work_with(yes,alan,charlie),[opinion],[ ]).
alan(can_work_with(yes,bob,charlie),[opinion],[ ]).
```

% Charlie's opinions are:

```
charlie(can_work_with(yes,charlie,alan),[opinion],[ ]).
charlie(can_work_with(yes,alan,charlie),[opinion],[ ]).
charlie(can_work_with(yes,charlie,bob),[opinion],[ ]).
charlie(can_work_with(yes,bob,charlie),[opinion],[ ]).
```

% Dan's opinions are:

```
dan(can_work_with(yes,dan,alan),[opinion],[ ]).
dan(can_work_with(yes,dan,bob),[opinion],[ ]).
dan(can_work_with(yes,dan,charlie),[opinion],[ ]).
dan(can_work_with(yes,alan,charlie),[opinion],[ ]).
dan(can_work_with(no,alan,bob),[opinion],[ ]).
```

```
/* The main predicate of the system is "decide."
This is what a top-level manager, like Penelope in
our story, would use to produce rankings for each
of the possible teams for a given project.
*/
```

```
decide :-
    evaluate(mike,[bob,charlie,alan,dan]),
    % generate Mike's view
    rank_teams(Rankings),
    eligible(Rankings,Eligible),
    % determine eligible teams
    sortem(Eligible,Sorted),
    cls,
    report_ranks(Sorted),
    nl.
```

```
% The "eligible" predicate is a filter that applies a
% threshold criterion to each of the possible teams.
```

(continued)

**MAKE YOUR PC
SEEM LIKE AN AT!**

**MAKE YOUR AT
SEEM LIKE A
DREAM MACHINE!**

**FANSI-
CONSOLE™**

The Integrated Console Utility™
**FAST, POWERFUL
ANSI.SYS REPLACEMENT**

For the IBM-PC, AT, and clones

New Version 2.00 is MUCH FASTER!
Now blink free scrolling on CGA!

GET A BOX FULL OF UTILITIES!
MAKE LIFE EASIER FOR ONLY \$75!

- Speed up your screenwriting 2-6x
- Extend your ANSI.SYS to full VT100
- Add many more escape sequences
- Scroll lines back onto screen
- Save scrolled lines into a file
- Add zip to your cursor keys
- Free your eyes from scroll blinking
- Easy installation
- Get a 43 line screen w/EGA
- Get a 50 line screen w/CGA
- No more annoying typehead beep
- Prevent screen phosphor burnin
- Control many programs' use of color
- Generate breakpts from keyboard
- Shorten that annoying bell
- Over 40 other useful options

*"The psychological difference is
astonishing"*
—Lotus June 85 pg 8.

*"So many handy functions rolled into
one unobtrusive package"*
—PC-World Feb 86 pg 282.

*"The support provided by the
publishers is extraordinary"*
—Capital PC Monitor May 86 pg 25.

*"... the best choice for improving your
console..."*
—Capital PC Monitor June 86 pg 282.

400p Manual (w/slip case) & disks \$75.

**Satisfaction Guaranteed!
Order Yours Today!**

HERSEY MICRO CONSULTING
Box 8276, Ann Arbor, MI 48107
(313) 994-3259 VISA/MC/Amex



ENCLOSURE PRODUCTS



- Tape and Hard Disk Drives Enclosures for all Major Micros.
- Single Board Computer Packages
- Custom Design Available
- Class 'B' Certification Support Can Be Provided
- Call For Pricing and Catalog

Microware Inc.

41711 Joy Road • Canton, MI 48187
(313) 459-3557

Inquiry 218

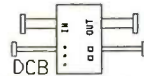

! not only a printer buffer!

THIS IS THE MOST SOPHISTICATED
PRINTER BUFFER - MULTIPLEXOR - SWITCH

WITH TWO SEPARATE INPUTS (SERIAL AND PARALLEL) AND TWO SEPARATE OUTPUTS (SERIAL AND PARALLEL) CAN BE USED LIKE STANDARD BUFFER. WITH ANY INPUT TO ANY OUTPUT - BUT ALSO YOU CAN CONNECT 2 COMPUTERS TO 1 PRINTER, OR 1 COMPUTER TO 2 PRINTERS, OR 2 COMPUTERS AND 2 PRINTERS - AND MORE - 1 COMPUTER TO 3 PRINTERS OR 3 COMPUTERS TO 1 PRINTER
HIGH CAPACITY - 64 KB TO 256 KB AND - 256 KB TO 1 MB (MODELS A AND B) PAUSE, COPY AND RESET FUNCTIONS SERIAL PORTS WITH 7 OR 8 BITS WORD LENGTH, 1 OR 2 STOP BIT, PARITY, XON/XOFF, DTR, RTS

DCB-A-64K \$ 195 DCB-B-256K \$ 255 (*)

(*) Power supply and parallel cables are included

ALSO, WE HAVE THE MOST COMPLETE DATA CONVERTER UNIT CONVERTS RS232 SERIAL TO CENTRONICS PARALLEL OR VICE VERSA, JUST BY MOVING JUMPERS BAUD RATE AND PROTOCOL FULLY PROGRAMABLE FROM 150 TO 19200 BAUDS INCLUDES DTR, RTS, XON/XOFF, PARITY, etc

DCU \$ 80 (**)

(**) Power supply and cables NOT included



serial \leftrightarrow parallel
bi-directional converter



INECTRA Inc. - Dept. 232

2629 TERMINAL BLVD
MOUNTAIN VIEW CA 94043

(415) 967-8818 TX 345545

HACKERS BEWARE!

PC Security and Management

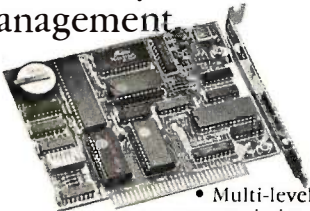

- Multi-level access restriction
- File Protection
- File Encryption
- Complete Usage Reports
- Physical Locking

only \$495 ea.

ELECTRONICS, INC.

2137 Flintstone Dr. • Tucker, GA 30084
404-491-8044

Inquiry 401

HANDLING CONFLICTS

```
% It discards those teams whose compatibility is below
% the given threshold (specified as 3 in this case).
eligible([],[]).
eligible([team(P1,P2,R1,R2)|Teams],[team(P1,P2,R1,R2)|Es]):-
    R1 >= 3,
    % teams with Compatibility 3 or higher are OK
    eligible(Teams,Es).
eligible([_|Teams],Es):-
% teams with low Compatibility we discard
eligible(Teams,Es).
```

```
% the "rank_teams" predicate produces rankings for each
% of the teams based on both compatibility (according
% to Mike) and competence (according to Jack).
rank_teams(Rankings):-
    clis, write('Please wait while')
        write('eligible teams are ranked.'),
        teams(Teams),
% fetch the possible teams from the database
rankem(Teams,Rankings).
```

```
rankem([],[]).
rankem([team(P1,P2)|Teams],[team(P1,P2,R1,R2)|Rankings]):-
    assess_compatibility(mike,P1,P2,R1),
    assess_competence(jack,P1,P2,R2),
    rankem(Teams,Rankings).
```

```
report_ranks([]).
report_ranks([team(P1,P2,R1,R2)|Teams]):-
    report_ranking(P1,P2,R1,R2),
    report_ranks(Teams).
```

```
report_ranking(P1,P2,R1,R2):-
    nl,write('for the team of '),write(P1),
    write(' and '),write(P2),nl,
    write('compatibility (according to '),
    write('Mike) --> '),write(R1),
    write(' competence (according to '),
    write('Jack) --> '),write(R2),nl.
```

```
assess_competence(View,P1,P2,R):-
    V1 =.. [jack,technical_competence(P1,R1),_,_],
    V1,
    V2 =.. [jack,technical_competence(P2,R2),_,_],
    V2,
    R is R1 + R2.
```

```
% We do not assume that the compatibility relation
% "can_work_with" is symmetric. That is, it may be
% possible to have "can_work_with(yes,bob,charlie)"
% and yet also have "can_work_with(no,charlie,bob)"
% Therefore, in assessing compatibility we look at
% the relation going both ways and then take an average.
```

```
assess_compatibility(View,P1,P2,R):-
    assessment(View,P1,P2,R12),
    assessment(View,P2,P1,R21),
    R is (R12+R21)//2.
```

```
assessment(View,P1,P2,Result):-
    rank(View,can_work_with(yes,P1,P2),Yes),
    rank(View,can_work_with(no,P1,P2),No),
    Result is Yes - No.
```

```
rank(View,Predicate,Rank):-
    V =.. [View,Predicate,Sby,_],
    V,
    analyze(View,Sby,Rank).
rank(_,_,0).
```

(continued)

TAPE BACKUP



- 60MB Tape Backup **\$879** External **\$794** Internal
- 20MB Cassette **\$699** **\$599**
- Tape backup
- Backup 20MB in less than 5 minutes
- Image/file-by-file backup and restore
- Menu driven software
- Interchangeable DMA, port address and interrupt

MODEM

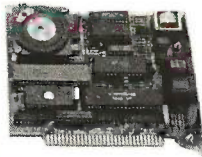

\$128
EVEREX
EVERCOM

- Comes with Bit-Com Software
 - 1/2 size 300/1200 Baud Modem
 - Fully Hayes, Bell 103 & 212 compatible
 - Supports Coin 1, 2,3,& 4
- External 300, 1200 Baud **\$189**
1200/2400 Baud internal **\$289**
1/2 size modem **\$289**
Modem, multifunction card

HARD DISK



20 MB Seagate 1/2Ht. hard disk (with controller)
C.O.D., VISA, MC only **\$379**

Company Terms **\$429**

- 30MB seagate 1/2Ht. hard disk (65 Ms) **\$499** with controller
- 20MB Seagate full Ht. hard disk (40 Ms) **\$528**
- 30MB Seagate full Ht. hard disk (40 Ms) **\$628**
- 40MB Seagate full Ht. hard disk (40 Ms) **\$759**

TURBO XT

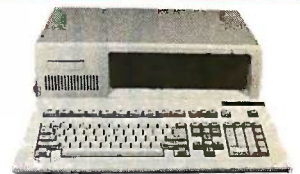

- 8088 CPU (4.77 and 8 MHz keyboard switchable) **\$659**
- 8 Expansion slots
- 640K Memory on Motherboard
- 360K Drive with controller **FCC Class B**
- 150 W power supply
- Keytronic 5151-compatible keyboard
- Socket for 8087 Math Co-processor

ACCELERATOR 80286 TURBO BOARD



- Runs with IBM PC, XT and compatibles **FCC Class B** Made in USA
 - With the Turbo card, your PC will run 7 times faster than IBM, PC, XT or 33% faster than 6 MHz IBM AT
 - 16 bit 80286 design
 - Accepts optional 80287 Math Co-processor
- \$399**

EXPANSION CHASSIS



- FCC Class B** Made in USA **\$429**
- Compatible with AT, XT and PC
 - 0 wait state, work with any video display card and multifunction card
- 3 sizes Power supply
- Full size, 8 slots 130W
 - 1/2 size, 4 slots 75W
 - slimline, 3 long and 1 short slots 70W

AT MULTIFUNCTION



- QIC multifunction AT (OK) **\$179**
- Hold up to 2 MB (64K or 256K) Made in USA
- 1 parallel, 2 serial and 1 game port
- Come with chip tester, RAM disk and spooler program **FCC Class B**

PC/XT MULTIFUNCTION



- \$95**
- Serial port
 - Software
 - Game port
 - Expandable to 384k
 - Clock/Calendar
 - Parallel port

QIC RESEARCH INCORPORATED

QIC-286-QT

INCREDIBLE MACHINE

INCREDIBLE PRICE

Thousands of systems installed proven reliable

Made in the U.S.A.
\$1125

Quality is what we stand for.
Special dealer and corporate discount.

- Fully IBM AT compatible, runs all major software
- 80286 CPU, 6/8 MHz clock/calendar
- 512K RAM on mother board, expandable to 1024K
- 1.2MB or 360K floppy disk drive
- Combined floppy/hard disk drive
- AT style keyboard
- 192W power supply
- 8 Expansion slots
- Clock/calendar with battery backup
- Documentation and setup program
- FCC Class B approved**

QIC MONOGRAPHIC



- 720 x 348 Resolution
 - Hercules compatible
 - Runs Lotus 123 Graphics
 - Printer Port
- \$95**

QIC COLOR CARD



- IBM Color Card compatible
 - 16 colors, 640 x 200 resolution
 - RGB and composite output
 - Parallel Printer Port
- \$95**

HD/FLOPPY CONTROLLER



- FCC Class B** Made in USA
- AT Version (16 bit) **\$169**
 - XT size format XT Version (8 bit) **\$149**
 - Western Digital Chipset
 - Control 2 hard disks and 2 floppy drives

FLOPPY DRIVE



- Teac/Fujitsu/Toshiba
- 1/2 Ht. size 1.2 MB **\$135**
- High Reliability 360K **\$95**
- Low Power Consumption

CHIPS



- 256K RAM (150 ns) **\$27**
- 64K RAM (150 ns) **\$9**

KEYBOARD



- Keytronic 5151 style keyboard
 - IBM PC/XT, AT compatible
 - 95 keys keyboard • LED lights
- \$88**

QIC EGA



- IBMEGA compatible
 - 640 x 350, 16 colors
 - 720 x 348 mono
 - 640 x 200 color
- \$249**

EMS BOARD



- Expandable up 2MB
 - Compatible with IBM, PC/XT
 - Fully socketed with parity check
 - Lotus/Intel/Microsoft compatible
- \$139**

MONO & I/O CARD



- Hercules compatible graphics
 - Monochrome high resolution 720 x 348
 - Parallel printer port • Game port
 - Serial communication port
- \$139**

POWER SUPPLY



- PC, XT compatible 135W **\$79**
- Power leads for drives 150W **\$89**
- Reliable



QIC RESEARCH INCORPORATED
489 Valley Way
Milpitas CA 95035

800-843-0806 (Sales)
(408) 942-8086 (CA)
Tech support (408) 942-0856
Dealer and Quantity discount are available

QIC Research of Chicago
1926 Waukegan Rd., Suite 3A
Glenview IL 60025
(312) 998-8903

Seagate, Tandon, Hercules, Hayes, Bell, IBM are trademarks of their respective companies

Policy:
Returned items must be as-new, not modified or damaged, with all warranty cards, manuals and packaging intact. Returned items must be shipped prepaid and insured, and must bear a QIC Return Authorization (RA) on the shipping label. Call QIC Customer Support Department for RA. No credit issued after 30 days from date of shipment

STOP SOFTWARE PIRACY

With our Copy Protection Products. They really work and do not burden the honest user. . .

For Hard Disk Protection
 • HDCOPY

For Disk Security
 High Level Security
 • PADLOCK II DISK
 • SAFEGUARD DISKS
 • COUPON DISKS

Low Level Security
User Installable Protection
 • PC-PADLOCK

The market is filled with copy protection products which burden the user or simply don't work. We have over 1500 satisfied software firms utilizing our systems. The high-level fingerprint has not required an update in over 2 years.

Why should your valuable data or useful software program become available in the Public Domain?

Call or write for more information.



GLENCO ENGINEERING INC.
 SERVING THE SOFTWARE INDUSTRY

3920 Ridge, Arlington Hts., IL 60004
 (312) 392-2492 Telex 493-7109

```
analyze(.,[],0).
analyze(View,[Sby|Sbys],I) :-
    V =.. [View,credibility(Sby,W),_,_],
    V,
    analyze(View,Sbys,I1),
    I is I1 + W.
```

```
/* Typical output for the "decide" predicate,
when run with the database of workers' opinions
about their mutual compatibility and their managers'
evaluations, is as follows:
for the team of bob and dan
compatibility (according to Mike) --> 3
competence (according to Jack) --> 8
```

```
for the team of charlie and dan
compatibility (according to Mike) --> 3
competence (according to Jack) --> 7
```

```
for the team of charlie and bob
compatibility (according to Mike) --> 5
competence (according to Jack) --> 5
```

```
*/
/* Predicates to propagate "new" information
*/
% The "evaluate" predicate cycles through a list
% of Persons and ascertains their opinion on the
% compatibility of the various workers. It installs
% these views in the View frame.
evaluate(View,Persons) :-cis, write('Please wait for
propagation of information. '), inv(View,Persons,Persons).
```

```
inv(.,[],_).
inv(V,[P|Ps],Persons) :-
    inv1(V,P,Persons),
    inv(V,Ps,Persons).
```

```
inv1(V,.,[]).
inv1(V,P,[P|Ps]) :-
    inv1(V,P,Ps).
inv1(V,P,[PP|Ps]) :-
    explore(V,P,PP,[bob,charlie,alan,dan]),
    inv1(V,P,Ps).
```

```
% The "explore" predicate determines who can work
% with whom and propagates this information both
% forward and backward. That is, for a given pair
% of individuals it determines whether they can
% work together according to the various Views and
% for each of these views it manages both the
% Supported_by and the Supports slots for the
% "can_work_with" relation.
explore(View,P1,P2,Views) :-
    gather_evidence(View,can_work_with(yes,P1,P2),Views),
    gather_evidence(View,can_work_with(no,P1,P2),Views),
    assessment(View,P1,P2,Result).
```

```
gather_evidence(Checker,Predicate,Views) :-
    checkem(Checker,Predicate,Views).
```

```
checkem(.,.,[]).
checkem(Checker,Predicate,[V|Vs]) :-
    check(Checker,V,Predicate),
    checkem(Checker,Predicate,Vs).
```

```
check(Checker,View,Pred) :-
    V =.. [View,Pred,Sby,S],
    retract(V),
    update_view(View,Pred,Sby,Checker,S),
    % adjust what View supports
```

```

    update_checker(Checker,View,Pred).
    % adjust what Checker is supported_by
check(.,.,.).
% this View does not support this Pred, no harm done.

% Update the Support set for this Pred in this View
update_view(View,Pred,Sby,Checker,S) :-
    member(Checker,S),
    % if already in Support set don't add it again
    V =.. [View,Pred,Sby,S],
    assert(V).
update_view(View,Pred,Sby,Checker,S) :-
    V =.. [View,Pred,Sby,[Checker|S]],
    assert(V).

% Update the Supported_by set for this Pred in this View
update_checker(Checker,View,Pred) :-
    C =.. [Checker,Pred,Sby,S],
    retract(C),
    % is Pred already supported_by other views?
    (member(View,Sby),
    % is this View already recorded?
    assert(C)
    % yes, don't include again
    ;
    New_C =.. [Checker,Pred,[View|Sby],S],
    assert(New_C)
    ).
update_checker(Checker,View,Pred) :-
% Pred not supported by any
    C =.. [Checker,Pred,[View],[ ]],
    % other views so far
    assert(C).

% The "assume" predicate is used in "what if"
% processing. That is, the user can add
% assumptions at any level and they will be
% propagated through the system. For example,
% Mike might find there is no information on
% the compatibility of Alan and Dan. He can
% then assume that is true:
% assume(mike,can_work_with(yes,alan,dan))
% and run the system to see what impact this
% has on the team rankings.
assume(View,Pred) :-
    update_checker(View,assumption,Pred).

/* Predicates to withdraw information
*/
% The "remove" predicate retracts Pred from the
% given View. It also adjusts the Supported_by
% set and the Supports set. It is used primarily
% in "what if" processing. For example, Mike might
% decide to discard Charlie's opinion on the
% compatibility of Bob and Dan. He can do this
% by issuing the command:
% remove(charlie,can_work_with(yes,bob,dan))
% and then run the system to see the impact on the
% team rankings.
remove(View,Pred) :-
    V =.. [View,Pred,Sby,S],
    retract(V),
    adjust_Sby(View,Pred,Sby),
    adjust_S(View,Pred,S).

adjust_Sby(.,.,[ ]).
adjust_Sby(View,Pred,[assumption|Sbys]) :-
% if it was an assumption
    adjust_Sby(View,Pred,Sbys).
% there nothing to go back to
adjust_Sby(View,Pred,[Sby|Sbys]) :-

```

(continued)

*The system lets you
adjust to changing
situations should
new information
become available.*

can make a reasonably good choice because all her subordinates have had some appropriate input in the selection process and she has taken into consideration both the compatibility and competence criteria. What is more, she knows that she can adjust to changing situations quickly and logically should new information become available. For instance, if at a certain point of the project previous experience becomes significantly more important than innovation, she can raise Alan's competence weight over Dan's and run the systems through to see if the team will do better with Alan. Again, Alan's compatibility rating will be considered along with his competence rating.

THE IMPLEMENTED SYSTEM

The Decision Support System program in listing 1 implements the simple belief maintenance system discussed above. [Editor's note: The Prolog source code for the Decision Support System is available on disk, in print, and on BIX; see the insert card following page 352 for details. It is also available on BYTEnet; see page 4. The source code, in Arity Prolog, is compatible with any Prolog that supports Clocksin and Mellish's full standard (reference 7).] The system illustrates the representation of inconsistent and incomplete knowledge as well as the propagation of beliefs through the various levels of the system.

The first part of the program consists of the database as described in the body of this article, which can be changed and experimented with easily. Next come the main driver of the program and the predicates used to propagate the addition and removal of information up and down the

(continued)

```

V =.. [Sby,Pred,SSby,S],
retract(V),
efface(View,S,New_S),
VV =.. [Sby,Pred,SSby,New_S],
assert(VV),
adjust_Sby(View,Pred,Sbys).

adjust_S(.,.,[]).
adjust_S(View,Pred,[S|Ss]) :-
    V =.. [S,Pred,Sby,SS],
    retract(V),
    efface(View,Sby,New_Sby),
    check_empty_Sby(S,Pred,New_Sby,SS),
    adjust_S(View,Pred,Ss).

% If Pred no longer has any Support under this
% view then we had better adjust all other things
% that depend on it
check_empty_Sby(View,Pred,[],S) :-
    adjust_S(View,Pred,S).
check_empty_Sby(View,Pred,Sby,S) :-
% we still have a non-empty Sby
    V =.. [View,Pred,Sby,S],
    % so no problem upstream
    assert(V).

/* Utilities
*/
% pretty print a Predicate according to a certain View
ppr(View,Predicate/Arity) :-
    functor(F,Predicate,Arity),
    V =.. [View,F,Sby,S],
    V,
    nl, write(F),
    nl, tab(5), write('Supported_by: '), write(Sby),
    nl, tab(5), write('Supports: '), write(S), nl,
    fail.
ppr(.,.).

% remove the first occurrence of an element from a list
efface(A,[A],[]) :- !.
efface(A,[A|L],L) :- !.
efface(A,[B|L],[B|M]) :- efface(A,L,M).
member(X,[X|_]) :- !.
member(X,[_|Y]) :- member(X,Y).

% do quicksort
sortem(List,Result) :- qsort(List,Result,[]).

qsort([H|T],S,X) :-
    split(H,T,A,B),
    qsort(A,S,[H|Y]),
    qsort(B,Y,X).
qsort([],X,X).

split(H,[A|X],[A|Y],Z) :-
    order(A,H),
    split(H,X,Y,Z).
split(H,[A|X],Y,[A|Z]) :-
    split(H,X,Y,Z).
split(.,.,[],[]).

order(team(.,.,.,A),team(.,.,.,B)) :-
    A > B.

/* End of program. */

```

hierarchy. Utility predicates are also included.

In the database the general scheme for storing predicates under a given view is as follows:

```

<view> (<predicate> (...
    <arg-list> ...).
<supported_by>, <supports<

```

where "supported_by" and "supports" are lists that refer to other views which support this predicate and which this predicate supports, respectively.

Note that we include the credibility and technical competence factors under Mike's and Jack's views, rather than making them stand-alone facts. In this way it is possible to use the "what if" mechanism (provided by the "assume" and "remove" predicates) to try various scenarios in which the factors can be changed and their effects on the team rankings determined.

SUMMARY

As we progress deeper into the information age, it becomes increasingly obvious that, in any decision-making process, what we need is not just more information but more intelligent techniques to obtain better, more pertinent, and accurate information. With artificial intelligence techniques, information processing can be augmented with capabilities to deal with incompleteness, inconsistency, uncertainty, different beliefs, views, and attitudes. ■

REFERENCES

1. Doyle, J., "A Truth Maintenance System," *Artificial Intelligence*, no. 12 (1979), pages 231-272.
2. McCarthy, J., "Circumscription—A Form of Non-monotonic Reasoning," *Artificial Intelligence*, no. 13 (1980), pages 27-39.
3. Reiter, R., "A Logic for Default Reasoning," *Artificial Intelligence*, no. 13 (1980), pages 81-132.
4. de Kleer, J., "An Assumption-based TMS," *Artificial Intelligence*, no. 28 (1986), pages 127-162.
5. Cuadrado, C., and J. Cuadrado, "Prolog Goes to Work," *BYTE*, August 1985, pages 151-158.
6. Shafer, G., *A Mathematical Theory of Evidence*. Princeton University Press, 1976.
7. Clocksin, W. F., and C. S. Mellish, *Programming in Prolog*. New York: Springer-Verlag, 1981.

Powerful MS-DOSTM Software.

For the IBM[®]-PC, XT, AT & others with generic MS-DOS/PC-DOS 2.0 or higher.

Not copy
protected!

Only **\$39.95** Each!

UTAH COBOLTM

Whether student, teacher or professional programmer, this is the one you've heard so much about.

- It's easy to use. Compiles 5000 statements on a 128K machine.
- 170 clear error messages, i.e. DATA-NAME IS MISSING OR MISSPELLED.
- Distribute your object code programs royalty free.
- Small object code programs conserve disk space.
- Fast compile times to increase programmer productivity. Over 25 times faster than one compiler costing \$995!
- You get a diskette and 213-page manual with lots of examples and 16 complete COBOL source code programs. **\$39.95.**

Also available: COBOL Application Packages, Book 1 **\$9.95.**

UTAH PASCALTM

- 14-digit precision, BCD math, no round-off errors with decimal arithmetic for business and floating point +63 -64 for scientific.
- A very nice TRACE style debugging.
- Arrays up to 8 dimensions and 64K strings.
- External procedures and functions with dynamic auto-loading.
- One-step compile, no assembly or link required.
- You get a 132-page manual and diskette. **\$39.95**

UTAH PILOTTM

- Perfect for industrial training, office training, drill and testing, virtually all programmed instruction, word puzzle games, and data entry facilitated by prompts.
- John Starkweather, Ph.D., the inventor of the PILOT language, has added a built-in full-screen text editor, and much more.
- Meets all PILOT-73 standards for full compatibility with older versions.
- You get a diskette, 125-page manual and ten useful sample programs. **\$39.95.**

Also still available for 8-bit machines with CP/M[®] is our world famous Nevada Software Series used by 50,000 customers in 40 countries. These include Nevada COBOL, Nevada FORTRAN, Nevada PASCAL, Nevada PILOT, Nevada BASIC and Nevada EDIT. **\$39.95** each.

Satisfaction guaranteed. If for any reason you're not completely satisfied, just return the package within 15 days in good condition, and we'll refund your money.

IBM is a registered trademark of International Business Machines Corp. CP/M is a registered trademark of Digital Research. MS is a trademark of Microsoft Corp. © 1985 Ellis Computing, Inc.

UTAH FORTRANTM

- FORTRAN IV based upon ANSI-66 standards.
- Very fast compile times and easy to use.
- IF . . THEN . . ELSE constructs.
- Chaining with blank and named common.
- Copy statement.
- ENCODE and DECODE.
- Free-format input and output.
- A very nice TRACE style debugging.
- 150 English language error messages.
- You get a diskette, and 223-page manual. **\$39.95**

UTAH EDITTM

- A character-oriented full-screen video display text editor designed specifically to create COBOL, FORTRAN and PASCAL programs.
- Only requires 15K disk space so it can fit on the same disk as your compilers.
- Completely customizable tab stops, default file type, keyboard control key layout and CRT by menu selection.
- Diskette comes with easy to read 58-page manual. **\$39.95.**

UTAH BASICTM

- This interpreter has a built-in full-screen editor.
- Single- and Multi-line user definable functions.
- BCD Math- no round-off errors.
- Full Matrix operations.
- You get 220-page manual and diskette. **\$39.95.**

Handling/Shipping: No shipping charge within US. Overseas add \$10 for first package, \$5 each additional. Checks must be in US Dollars, drawn on a US bank.

Utah Software requires 128K RAM and PC-DOS or MS-DOS 2.0 or higher.

HOW TO ORDER. Send check or money order to Ellis Computing, Inc. with VISA or MASTERCARD order by phone. Sorry no COD's.



Ellis Computing, Inc.
5655 Riggins Court, Suite 10
Reno, Nevada 89502
Phone (702) 827-3030

SINCE 1977



ELLIS COMPUTINGTM

Miss OSGOOD, I have some
Splendid News: The Company has decided
to install **AT&T's** Extraordinary
"NEW" **SYSTEM 25** a Digital
PBX that will give Us "BIG BUSINESS"
Features - AND Cost Us Less than the System
we're Using Now..... Somehow Miss OSGOOD
I'd thought You'd be More Excited.....
Miss OSGOOD, Can You Hear Me
in There.....?



Introducing AT&T's System 25, a state-of-the-art small PBX that can help the state of your business.

Not to mention the state of Miss Osgood. System 25—from AT&T's Small Business Connection—is an instant solution to outmoded, over-the-hill equipment. It can give any company with 20-150 telephones the kind of special features once found only on "big business" systems.



For instance, callers can reach everyone in your business without going through the receptionist. Its unique Personal Dial Code allows your calls to follow you around from office to office. And you can activate the code from any location on your route.

System 25's digital technology lets voice and data travel the same telephone lines. So you can add computers or other data equipment now or whenever the need arises.

What's more, it doesn't require special telephones. You can probably use the traditional telephones you have now. That makes System 25 perhaps the most cost-effective way to upgrade your phone system.

And it's cost-effective *after* you upgrade. For instance, System 25 sends all long-distance calls over the least expensive route. And keeps detailed records of those long-distance calls so you can charge clients or track expenses. But most important, you know your telephone investment is protected, because System 25 is from AT&T.

Plus, with System 25, Miss Osgood will have less work on her hands and a permanent smile on her face.

For more information about System 25, call 1 800 247-7000.

AT&T's Small Business Connection / 1 800 247-7000

This toll-free number connects you to the office in your area. In Hawaii call 1 808-946-2509.



AT&T

The right choice.

ECOSOFT HOLIDAY SPECIALS



EVERYTHING FOR THE C PROGRAMMER

If you know someone (perhaps yourself!) that wants to learn the C programming language, have we got a deal for you. For a limited time, you get:

Eco-C88 C compiler	\$59.95
CED Program editor	29.95
Developer's Library Source Code	25.00
ISAM File Handler	15.00
Flexi-Graph Graphics Package	39.95
Eco-Lib MSDOS Compatible Librarian	29.95
Ecosoft Windowing Library	29.95
C Programming Guide book (Que Corp)	20.00
C Self Study Guide book (Que Corp)	17.00
C Programmer's Library book (Que Corp)	22.00

Total: \$288.75

Holiday Special: \$175.00

Save Over: \$110.00!!!

The Holiday Special has everything you need for your C programming needs. Eco-C88 is a full K&R C compiler (less bit fields), with over 200 library functions, source code to our cc and mini-make utilities, and generates code rivaling compilers costing 10 times as much. You also get the source code to our library, an MSDOS-obj compatible librarian, one of the neatest graphics packages around, an easy-to-use windowing package plus a library of books to teach you the C language. An unbelievable package at an unbeatable price of only \$175.00.

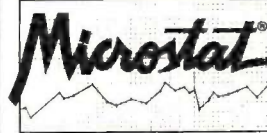

Microstat Statistics Package

Since 1977, Microstat has been one of the most popular statistics packages available for microcomputers. Just some of its features include:

Data Management Subsystem	Multiple Regression (with Stepwise)
Data transformations	Correlation Analysis
Convert External data (e.g. Lotus, Dbase 11. etc.)	Time Series Analysis
Descriptive Statistics	Nonparametrics
Hypothesis Testing	Probability Distributions
Crosstabs and Chi-Square	Scatterplots
ANOVA	Factorials, Permutations

Holiday Special: \$250.00

plus many other unique and easy-to-use features. Microstat is available for all MSDOS machines or any CP/M80 system using a Z80 CPU.

The regular price is a bargain at \$375.00. At the Holiday Special price of \$250.00, it's a steal!

To take advantage of these special prices, we must have your order in our offices by Jan. 15, 1987.

To order, call or write:

1-800-952-0472 (for orders)
or
1-317-255-6476 (tech. info.)



Ecosoft Inc.
6413 N. College Ave.
Indianapolis, IN 46220



Trademarks: Ecosoft; Microstat; Eco-C88; Microsoft; MSDOS; New Orleans General Data Services; Flexi-Graph

THE ART OF DEDUCTION

BY J.-C. EMOND AND A. PAULISSEN

A simple program that demonstrates the deductive power of Prolog

ARTIFICIAL INTELLIGENCE is a growing science, and the present literature refers more frequently to real-world problems and less to the domain of games. However, many logic puzzles or games can still be used for illustrative purposes. In this article, we present Watson, a Prolog program for an n-person, zero-sum game with imperfect information, based on the game CLUEDO. [Editor's note: CLUEDO is a registered trademark of J. Waddington.]

CLUEDO uses an unusual set of playing cards that evokes the context of a detective investigating a crime. The game has three kinds of cards: suspects (potential murderers), locations (places where a murder might have been committed), and weapons (murder weapons).

When preparing to play the game, a referee draws, in a random fashion, one card of each type from the complete deck. During the game these three cards, which define the murderer, the location, and the weapon used, are kept in a box controlled by the referee. The remaining cards are divided at random among the competitors. Players then take turns, and each player has two options: question the next player or formulate an accusation.

A question has a fixed structure and is composed of the names of one suspect, one location, and one weapon. If the player addressed has some of the named cards, that player must show one of these to the questioner (and only the questioner). If the player addressed has none of the named cards, the questioner will address the next player, and so on, until one card has been shown to the original questioner or until all of the players have been addressed.

At this point, the active player may also formulate an accusation by naming a suspect, a location, and a weapon card. The referee checks the accusation against the cards hidden in the box. If the accusation proves to be completely correct, the player has won the game. If the accusation contains a fault, the player is eliminated; however, the player will continue to answer the questions of the other players.

PROBLEM CHARACTERISTICS

In a game like CLUEDO, players have to cope with three very distinct problems. The first is keeping track of the partial knowledge that emerges during the game. Each player has to remember this information in a suitable

form for future use. The second problem is deciding which questions should be asked to solve the crime as soon as possible. The third problem is exploiting the information available, to decide whether an accusation can be safely formulated.

Generally, players deal with problems two and three by building hypotheses, checking them against facts to validate or invalidate them, and building new hypotheses. Programming such a strategy with a procedural programming language would require significant effort to administer the tree of hypotheses and their validation status. In Prolog, however, the hypotheses are handled automatically by the backtracking mechanism. The program has only to manage the monotonically increasing knowledge of proven facts.

The Prolog program Watson simulates the reasoning of a CLUEDO player and could be used for giving advice to one of the players. The pro-

(continued)

J.-C. Emond (Brugmann Ave. 488, 1180 Brussels, Belgium) is a project manager for Philips.

A. Paulissen, D.R.S. (I.H.B.O., AFD, HTS-I, Eindhoven, Holland), is a professor of computer science.

gram not only has to answer questions by combining known facts, but it also has to generate the best questions for the player to ask to improve his or her position.

Similar situations exist in many expert systems that interact with humans, such as diagnostic systems. To have an efficient dialog the expert system must select the next question carefully in order to converge most

rapidly upon the solution.

A possible extension to Watson would be to create various versions that compete with each other, possibly with one human player.

Our primary purpose here is to demonstrate the use of Prolog for such a project. In doing so, we'll use the Prolog syntax of W. F. Clocksin and C. S. Mellish from their book, *Programming in Prolog* (Springer-Verlag,

1981), to develop a simple program. Interested readers can add embellishments to the user interface, change the number of players, introduce more elaborate strategies, or create versions for different implementations of Prolog. For those interested in a complete program with user interface, we have developed a version of Watson in micro-PROLOG 1.21.

THE KNOWLEDGE BASE

The knowledge base for our program has to hold game-independent and game-dependent knowledge. Game-independent knowledge includes definitions of the elements of the game, their constraints, and the strategic rules that must be applied to win. Game-dependent knowledge includes the facts that emerge during the current game.

To begin with, the knowledge base holds facts about the names of the players. For now, we simply call them p1, p2, and p3. By convention, p1 is the program itself or the person using the program.

Similarly, we will represent the suspect cards by s1 through s6, the location cards by l1 through l9 (i.e., a lowercase L, followed by a number from 1 to 9), and the weapon cards by w1 through w6.

To express that a player may be p1, p2, or p3 we can write in Prolog `player(P) :- (P=p1); (P=p2); (P=p3).`

An alternative and terser expression, using the list features of Prolog, may be

`player(P) :- member(P,[p1,p2,p3]).`

provided that you include the classical membership function

`member(X,[X|_]).`
`member(X,[_|Y]) :- member(X,Y).`

That is, X is a member of the indicated set if X equals the first element or if X is a member of the rest of the set.

Using the same mechanism, we will express that C is a card if C is of type suspect or of type location or of type weapon by writing

`card(C) :- type(C,suspect).`

and C is of type suspect if C is a

(continued)



Announcing 2 New BYTE Collector Prints by Robert Tinney.

Limited Edition Classics

We are proud to announce the annual release of two new 16" x 20" BYTE Magazine Cover Art reproductions by renowned BYTE artist Robert Tinney. Only 1,000 of these flawless Collector Edition Classics will be produced, on acid-free 100% cotton fiber stock to ensure that they will keep their brilliance and quality over the years without cracking or yellowing. The color separations for these sumptuous prints are made *directly from the original paintings*, guaranteeing absolutely faithful reproduction of every subtle nuance present in the originals. Each is individually inspected, signed and numbered by the artist, and accompanied by a handsome Certificate of Authenticity (also signed and numbered). The plates are then destroyed, and no future editions of any size or number will ever be published.

The price of these magnificent limited editions is just \$55, or \$45 each if you order two or more. Your prints will be shipped flat by UPS Blue Label (2-day delivery) and carry an unconditional 30-day guarantee. Order today!

Order Form

Please send me the following Limited Edition BYTE Collector Prints at \$55 (\$45 each for 2 or more):

Qty.	Title	Amount
_____	_____	\$ _____
_____	_____	\$ _____
\$4 Postage & handling (\$15 overseas)		\$ _____
TOTAL:		\$ _____

I enclose my check money order payable to Robert Tinney Graphics; or, bill:

MasterCard VISA American Express card
 # _____ Expires: _____

NAME _____
 ADDRESS _____
 CITY _____ STATE _____ ZIP _____

Please send me your FREE color catalog.
 VISA, MasterCard or American Express orders, call 1-504-272-7266

ROBERT TINNEY GRAPHICS
 1864 N. Pamela Drive Baton Rouge, Louisiana 70815



member of the set [s1, s2, s3, s4, s5, s6], as expressed by

```
type(C,suspect):-
  member(C,[s1,s2,s3,s4,s5,s6]).
```

These rules for suspect cards and similar ones for location and weapon cards are given at the beginning of listing 1.

Two rules of the game constrain the card partition: the number of cards received by each player and the number of cards hidden in the box. In our simple system with three players and 21 cards, each player receives six cards, and the solution box contains only one card of each type.

GAME-DEPENDENT KNOWLEDGE

We must represent the information that emerges during the game. This includes, to start with, the cards that p1 (the person using the system) has received (such as s3, w2, w5, and so on). This knowledge is maintained by the system as the facts

```
has(p1,s3).
has(p1,w2).
has(p1,w5).
```

and so on. Note that Watson does not know, at first, what cards are held by players p2 and p3. During the game, however, new facts about these players owning a specific card (or not owning a specific card) may emerge and be inserted into the knowledge base.

First, we will get new facts when, following a question, a player (pi) shows a card (cj) to the player using the system, who will add the fact

```
has(pi,cj).
```

to the Watson knowledge base. If a player cannot show any of the three cards requested by the program, player p1 must insert three facts of the type

```
has__not(pi,cj).
```

into the knowledge base.

When a player shows a card upon the request of a player other than p1, we know that this player must have at least one of the three requested cards. Therefore, p1 will insert into the knowledge base a fact of the type

```
has__at__least__one__of__three
(pi,cj,ck,cl).
```

Finally, when a player requests three cards, we can normally assume that the player does not have any of the requested cards. Otherwise, the request would not provide any new information. This assumption has its drawbacks: If a player requests, accidentally or by guile, to see three cards he or she holds, the program will fail to produce the solution! Nevertheless, in general we will have

p1 add to the knowledge base a fact of the type

```
has__not__all__three(pi,cj,ck,cl).
```

STRATEGY

As we have pointed out, the knowledge base will also contain the rules. The rules represent the strategic knowledge that the program needs to make inferences as an expert player would. Strategies are in general hard to come by, but in this case, we think

(continued)

Listing 1: The source code for the simple version of Watson developed in this article.

```
player(P):- member(P, [p1,p2,p3]).

type(C,suspect):- member(C, [s1,s2,s3,s4,s5,s6]).
type(C,location):- member(C, [l1,l2,l3,l4,l5,l6,l7,l8,l9]).
type(C,weapon):- member(C, [w1,w2,w3,w4,w5,w6]).
card(C):- type(C,suspect).
card(C):- type(C,location).
card(C):- type(C,weapon).

may_be_in_the_box(C):- card(C),
                        not (owns(p1,C)),
                        not (owns(p2,C)),
                        not (owns(p3,C)),
                        not (( type(C,T),
                              type(C1,T),
                              not (C=C1),
                              is_in_the_box(C1))).

is_in_the_box(C):- owns_not(p1,C),
                  owns_not(p2,C),
                  owns_not(p3,C).

owns_not(P,C):- has_not(P,C).
owns_not(p1,C):- not (has(p1,C)).
owns_not(P,C):- (has_not_both(P,C,C1);
                has_not_both(P,C1,C) ),
                has(P,C1),
                asserta( has_not(P,C) ).

owns(P,C):- has(P,C).
owns(P,C):- (has_at_least_one(P,C,C1);
            has_at_least_one(P,C1,C) ),
            has_not(P,C1),
            asserta( has(P,C) ).

has_at_least_one(P,C1,C2):-
  (has_at_least_one_of_three(P,C,C1,C2);
   has_at_least_one_of_three(P,C1,C,C2);
   has_at_least_one_of_three(P,C1,C2,C)),
  has_not(P,C).

ask(C):- may_be_in_the_box(C), !.

request(C1,C2,C3):- type(C1,suspect), ask(C1),
                   type(C2,location), ask(C2),
                   type(C3,weapon), ask(C3).

member(X, [X|_]).
member(X, [_|_Y]):- member(X,Y).
```

The order of the rules in a Prolog program is vital to its semantics.

that a few strategies are sufficient to beat most human players. However, we don't claim completeness and realize that you could elaborate and implement other strategic tricks.

Player p1 is confronted with two questions. The first is, "Do I have enough information to formulate an accusation?" In other words, "Can I deduce, using the current facts, which three cards are hidden in the box? If the answer to this question is no, which request will bring me information to formulate an accusation before the other players?" These two questions are related to the following basic ones:

1. When is it proved that a specific card is in the box?
2. When is it proved that a player does not own a specific card?
3. When is it proved that a player does not own two specific cards?
4. When is it proved that a player owns a specific card?
5. When is it proved that a player owns at least one of two specific cards?
6. Finally, which cards should the program tell player I to ask for?

We will present the rules designed to answer these questions, first in plain English and then in Prolog.

"When is it proved that a specific card C is in the box?" The answer is very straightforward: If it can be shown that none of the players owns this card, the card must be in the box. That is, if it can be shown that p1 does not own card C, p2 does not own card C, and p3 does not own card C, then C must be in the box.

In Prolog, we say

```
is_in_the_box(C) :- owns_not(p1,C),
                   owns_not(p2,C),
                   owns_not(p3,C).
```

Here we have introduced the

predicate `owns_not`, which brings us to the second question: "When is it proved that a player does not own a specific card?" If the fact `has_not(pi,cj)` is already present in the knowledge base, the proof is trivial:

```
owns_not(PC) :- has_not(PC).
```

We introduced the predicate `owns_not` (which looks so similar to `has_not`) instead of just using `has_not` in the rule `is_in_the_box` to prevent Prolog from entering endless looping in the following clauses. Then `owns` and `has` have the same meaning, but we always prove "ownership" by using "having" arguments and never the other way round.

Regarding player p1, Watson can easily prove that he or she does not own a specific card by looking at the cards p1 *does* hold. If there is no `has(p1,cj)` fact in the knowledge base, it is proved that p1 does not own cj. In Prolog, this would be

```
owns_not(p1C) :- not(has(p1,C)).
```

Let's remember here the difference between

```
has_not(pi,cj).
```

which means that it is proved, as a fact or by deduction from facts, that player pi does not have the card cj, and

```
not(has(pi,cj)).
```

which means that Prolog cannot *prove*, using current facts, that player pi has the card cj. When all cards of a player pi are known (and only then), we have

```
owns_not(pi,C) :- not(has(pi,C)).
```

as we did for p1 above. The condition "all cards of pi are known" could become true for any player during the game, but for the sake of simplicity we introduce the rule only for p1, because for this player the condition is true from the beginning of the play.

How can we answer the second question, "When is it proved that a player does not own a specific card?" for the players other than p1 and using the facts emerging during the game? If we have shown that a player does not own both of two specific

cards and we have shown that he or she does own one of them, we have proved that the player cannot own the other one. In Prolog, this would be

```
owns_not(PC) :-
    (has_not_both(PC,C1) ;
     has_not_both(PC1,C) ),
    has(PC1).
```

Note the similarity between the fact `has_not_both(PC,C1)` and the fact `has_not_both(PC1,C)` in the sub-goal of this rule. Here we are merely telling Prolog that the given facts are equivalent.

We have now introduced three rules containing `owns_not`. How does Prolog know that it must not use the second rule, `owns_not(p1,C) :- not(has(p1,C))`, for players p2 and p3? This is accomplished by the unification mechanism of Prolog: `owns_not(p2,C)`, for example, just doesn't match the rule for `owns_not(p1,C)`, so Prolog will not try it.

On the other hand, how does Prolog know that it should use the first `owns_not` rule first, and only when this rule fails should it go on to the second and third `owns_not` rules? Here we see that the order of the rules in a Prolog program is vital to its semantics. In the logical formulation of a given problem the order of the clauses doesn't matter; in a Prolog program it most certainly does! Prolog always starts from the top trying to satisfy goals and continues downward as they fail.

In the third `owns_not` rule we introduced the `has_not_both` predicate. This predicate relates to the third question, "When is it proved that a player does not own two specific cards?" The answer: When a player does not own all of three specific cards and it is known that he or she does own one of them, the player cannot hold both of the other two. Thus, in Prolog we can say

```
has_not_both(PC1,C2) :-
    (has_not_all_three(PC,C1,C2);
     has_not_all_three(PC1,C,C2);
     has_not_all_three(PC1,C2,C) ),
    has(PC).
```

We will not introduce a rule for `has_not_all_three` only because

(continued)

**It used to take up to \$15,000
and a video technician to
project real-time PC images.
Now anybody can do it
in five minutes for \$1270.***

1.
Plug the unit into your PC.
2.
Place it on your overhead projector.
3.
Begin your real-time presentation.

New KODAK DATASHOW System

Just think of all the applications.

Call for details:

1 800 44KODAK, Ext 865

(1 800 445-6325, Ext 865)

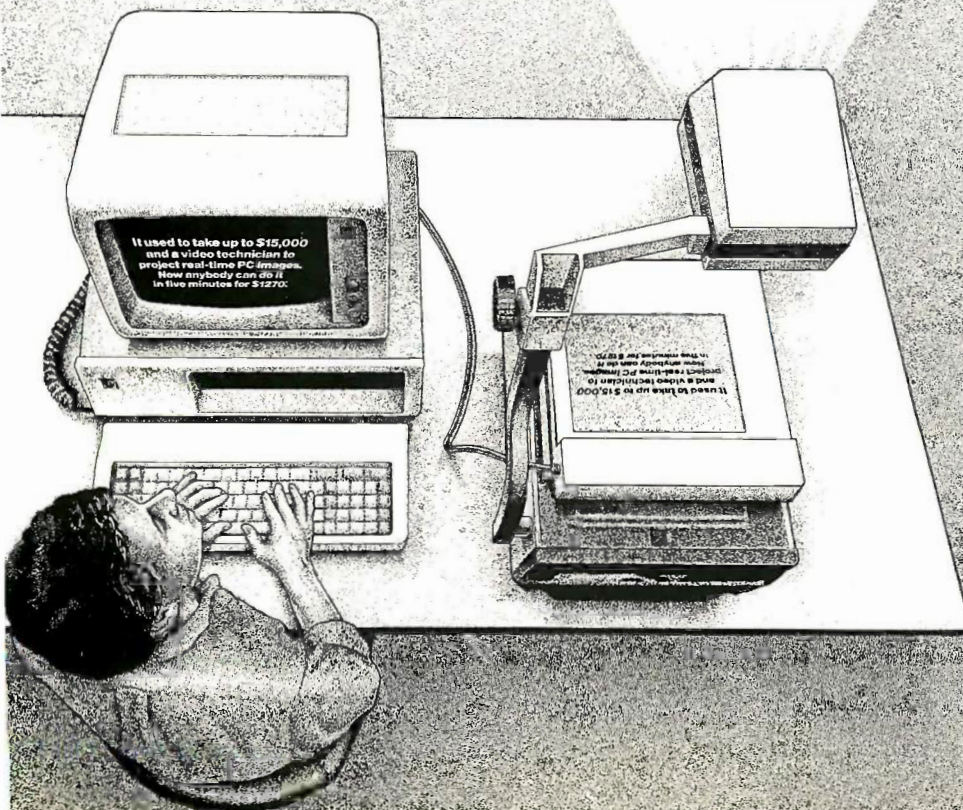

The DATASHOW System is used with an IBM PC or 100% compatible computer.

*Price shown is Kodak's suggested price only. Actual selling price is determined by dealer.



Eastman Kodak Company
Motion Picture and
Audiovisual Products Division
Inquiry 396

*Clearly, the program
should have player 1
request cards that
it believes, given its
current knowledge,
may be in the box.*

`has_not_all_three(PC,C1,C2)` is a fact that is inserted into the knowledge base during the game, as we have pointed out before, when a player shows no cards in response to a question.

This brings us to the fourth question, "When is it proved that a player owns a specific card?" When the card has been shown or when we know that a player owns at least one of two specific cards and we know also that he or she does not own one of them, then clearly the player must hold the other one. In Prolog we can say

```
owns(PC) :- has(PC).
owns(PC) :-
    (has_at_least_one(PC,C1);
     has_at_least_one(PC1,C)),
    has_not(PC1).
```

Now we will define a rule for the predicate `has_at_least_one`, introduced above. We must answer the fifth question, "When is it proved that a player owns at least one of two specific cards?" If we can show that a player has at least one of three specific cards and at the same time that he or she cannot own one of them specifically, then he or she must own at least one of the two other cards. In Prolog, that would be

```
has_at_least_one(PC1,C2) :-
    (has_at_least_one_of_three
     (PC,C1,C2);
     has_at_least_one_of_three
     (PC1,C,C2);
     has_at_least_one_of_three
     (PC1,C2,C) ),
    has_not(PC).
```

Again, we will not define a rule for `has_at_least_one_of_three` because that is a fact, inserted into the

knowledge base during the game.

We will now focus on the actions of the system as it advises player p1 during his or her turn. Clearly, the program should have p1 request cards that it believes, given its current knowledge, may be in the box. A card may be in the box when the program hasn't enough information to tie it to one of the players and when the program knows of no other card of the same type that is in the box. In Prolog, we can express that as

```
may_be_in_the_box(C) :-
    card(C),
    not (owns(p1,C)),
    not (owns(p2,C)),
    not (owns(p3,C)),
    not (( type(C,T),
           type(C1,T),
           not (C=C1),
           is_in_the_box(C1))).
```

Note that Prolog unifies the type T in `type(C,T),type(C1,T)`.

Now we can answer the final question, "Which card should the program tell player p1 to ask for?" He or she should ask for a card that may be in the box, as shown in the code by

```
ask(C) :- may_be_in_the_box(C).
```

Here, it might be best to use the fact that the program probably has the most information about player p2 (the next player in the rotation of the game), but we have not added this, for the sake of simplicity.

The program must request to see three cards, each of a different type. So we have, in Prolog

```
request(C1,C2,C3) :-
    type(C1,suspect), ask(C1),
    type(C2,location),ask(C2),
    type(C3,weapon), ask(C3).
```

PROLOG RULES

We have mentioned before that the order of the rules in a Prolog program matters. This means that you must consider how Prolog solves a problem. A more serious difficulty arises when the program is running too slowly, as in many cases it will do when using a Prolog interpreter. Then you are faced with the purely technical although important problem of speeding things up. One way is to commit Prolog to its previous conclusions. We will give two examples in

the program we have written up to now.

In the `owns` rule, we establish the fact that a player owns a certain card. Once Prolog has done this, it should never have to bother to establish this fact again. To accomplish this we extend the `owns` rule by the predicate `asserta(has(PC))`,

which will effectively add the fact `has(PC)` to the knowledge base. Having ordered the `owns` rule the right way, Prolog will always first determine whether it has an appropriate previously asserted fact in its knowledge base before trying the other rule. The same remarks apply to the `owns_not` rule, which will be extended with

```
asserta( has_not(PC) ).
```

Therefore we present new versions for these rules:

```
owns(PC) :-
    (has_at_least_one(PC,C1);
     has_at_least_one(PC1,C),
     has_not(PC1),
     asserta( has(PC) ).
```

```
owns_not(PC) :-
    (has_not_both(PC,C1) ;
     has_not_both(PC1,C) ),
    has(PC1),
    asserta( has_not(PC) ).
```

To commit Prolog to choices it has made within a rule we must use Prolog's cut mechanism, implemented via a trailing exclamation point. We have an example in the request rule. Once Prolog has found a suitable card to ask of the suspect type, it should never go back on this choice when it is trying to find suitable cards to ask of the location and weapon types. This means that we must force Prolog to skip the `ask(C)` goal when backtracking. So we have as a new version of the `ask` rule:

```
ask(C) :- may_be_in_the_box(C), !.
```

USING THE SYSTEM

Before using the simple version of Watson described here (and shown in listing 1), you must invoke the Prolog interpreter and then load the program. After this, you have two possible actions: adding facts to the knowledge base and getting advice from the system.

(continued)

Business Tools Introduces Reality Pricing.®

- ✓ Relational Database
- ✓ 4th Generation Language
- ✓ Screen Painter
- ✓ Program Generator
- ✓ Report Writer
- ✓ Source Code Editor
- ✓ Runtime Compiler

**Reality Pricing means
real features +
real savings.**

TAS-Plus just made it faster, easier and cheaper to build database applications. TAS-Plus combines the power of a Relational Database with the ease of a Program Generator. Then TAS-Plus adds a Runtime Compiler to produce lightning-fast finished code. Look at what TAS-Plus gives you.

**Relational Database
4th Generation Language
Screen Painter
Program Generator
Report Writer
Source Code Editor
Runtime Compiler**

TAS-Plus gives you power where it counts. You can store up to 65,000 records, open up to 16 files at a time and enter up to 10,000 characters per record. TAS-Plus even reads your old DBase files.

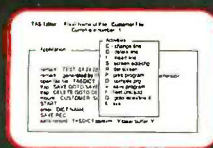

**TAS-Plus
writes the
program
for you**

With TAS-Plus, you can start building professional database applications on day one. Just "paint" the screen the way you want and TAS-Plus writes the program for you. You can even paint

The following are registered trademarks of these companies: TAS-Plus, The Accounting Solution, Business Tools, Inc.; IBM PC/XT/AT, International Business Machines Corp.

Inquiry 56

using different colors or graphic characters. And custom reports are just as easy.

TAS-Plus has over 86 commands and 200 options available in its Source Code Editor, so you won't run out of room to grow.

Easy to use features

Add new databases quickly and easily. Add, change or delete records without any programming at all. Browse through your database and see multiple records on the screen at the same time. Restructure capability allows you to change existing databases without loss of any data.

All this for just \$69

TAS-Plus would be respectable at any price, at \$69 it's awesome.

30 day Money Back Deal

TAS-Plus comes with a 30 day money back guarantee (less \$15 handling fee). TAS-Plus is available for the IBM PC/XT/AT and fully compatible computers. TAS-Plus Accounting applications available.

**Order Today
1-800-648-6258**

Call our Toll-Free Hotline. Use your VISA, MasterCard or American Express to order today. For information or Washington residents call 1-206-644-2015.



TAS+™

NOT COPY-PROTECTED

YES! Rush me the following items.

Qty.	Item	Price	Subtotal
_____	TAS+	\$69	_____
_____	Shipping add \$8 USA, \$25 outside USA	Shipping	_____
_____	WA res add \$5.59 Tax	Tax	_____
_____	Amount Enclosed (US funds only)		_____

Name: _____

Shipping Address: _____

City: _____

State: _____ Zip: _____

Telephone: _____

Payment: VISA MC AMX Check

Credit Card Expiration Date: _____

Card Number: _____

Name on Card: _____

**BUSINESS
TOOLS
INC.**



4038-B 128th Ave. S.E., Suite 266
Bellevue, Washington 98006
(206) 644-2015



© Copyright 1986 Business Tools, Inc.

Two elegant aspects of Prolog are well illustrated by the Watson example, backtracking and the use of variables.

Before starting the game, you must insert facts about your cards (p1's cards) into the knowledge base, using the `asserta` predicate

```
asserta( has(p1,s3) ).
asserta( has(p1,w2) ).
```

and so on. During the game, you may insert new facts into the knowledge base. When a player cannot respond to a given request, you may add three `has_not` facts, as in

```
asserta( has_not(p2,s3) ).
asserta( has_not(p2,l4) ).
asserta( has_not(p2,w1) ).
```

When a player responds to a request from you, you can add one `has` fact, such as

```
asserta( has(p2,s4) ).
```

When a player responds to a request of another player, you may insert a `has_at_least_one_of_three` fact, as in

```
asserta( has_at_least_one_of_three
         (p3,s3,l7,w4) ).
```

When a player (e.g., p2) other than yourself (p1) makes a request, you can add one `has_not_all_three` fact about that player to the knowledge base, as in

```
asserta( has_not_all_three
         (p2,s3,l2,w5) ).
```

To get advice from the system when it is your (p1's) turn, you should enter the goal

```
request(C1,C2,C3).
```

The program will instantiate C1, C2, and C3 to, respectively, a suspect, a location, and a weapon that may be in the box. Early in the game, there

may be many possible combinations of three cards in the box, and Prolog will present you with all of them, if you desire, usually by asking if you want to see more. You present player p2 with one of these requests and, depending on the response from p2 (and possibly p3), you may then enter new `has` or `has_not` facts, as above. Eventually, the program will suggest three cards for you to request, none of which is held by any player, and these are the cards that must be in the box.

Finally, you may ask questions about the state of the game. To see, for instance, what facts the system has derived, you ask Prolog to satisfy the goal

```
listing(has).
```

and the program will present a list of which player is known to have which card.

THE PROS AND CONS OF PROLOG

Two particularly elegant aspects of Prolog are well illustrated by the Watson example, namely, backtracking and the use of variables. The backtracking frees the programmer from coding the search through the tree of hypotheses and from the related administration. The use of variables allows a terse formulation of the program constraints.

Three less attractive aspects of Prolog have also been encountered in the Watson exercise. The first is the danger of loops, which forced us to introduce the unnatural distinction between `has` and `owns`. We quote from the book by Clocksin and Mellish mentioned earlier: "Don't assume that, just because you have provided all the relevant facts and rules, Prolog will always find them. You must bear in mind when you write Prolog programs how Prolog searches through the database and what variables will be instantiated when one of your rules is used."

The second aspect is related to the fact that Prolog only accepts Horn clauses (no disjunctions in the left part). This restriction, which permits the Prolog system to pursue goals efficiently, is sometimes frustrating and

leads to the necessity of describing the problem in a more complex way. For instance, in Watson the clause `has_at_least_one_of_three` is required only because we are not permitted to write it as a fact with disjunctions, as in

```
has(pi,cj); has(pi,cj'); has(pi,cj'').
```

The third less attractive aspect is related to quantitative aspects of the problem. In the approach described in this article, Prolog investigates deeply the known facts and their consequences, avoiding useless questions. It would be more complicated to make Prolog compare various questions, deciding which one is the best, that is, providing a maximum of information to p1 and a minimum of information to the other players. The concept of entropy can be useful in this respect.

The less attractive aspects of using Prolog could be at least partially overcome by incorporating a loop-detecting and escape feature; a preprocessing step, transforming some non-Horn clauses into Prolog clauses; and a tight link to procedural programming languages. By a tight link we mean the ability to call Prolog from the procedural language and vice versa and to have an efficient transfer of data (the current instantiation of the variables) between both program parts. There is a trend to incorporate these functions into Prolog environments. In our opinion this is an important aspect of the usefulness of Prolog.

ACKNOWLEDGMENT

The authors would like to thank D. Connah and A. Weaver for their interesting suggestions and for reviewing this article.

Editor's note: Watson is available on disk, in print, and on BIX for the IBM PC and compatibles using DOS 2.1. See the insert card following page 352 for details. This program is also available on BYTEnet. See page 4. Listing 1 is available as WATSON.PRO, and you will need a Prolog interpreter to use it. A more complete version of Watson, with menu-driven user interface, is also available. You will need micro-PROLOG 1.21 to run this version of Watson, or you can adapt it to work with another Prolog interpreter. ■

Find out how good Business Class can be.

TWA



TWA AND AMERICAN EXPRESS MEAN BUSINESS.

Discover the peace of mind

that comes with TWA's Airport Express® service. TWA recommends you reserve and pay for your tickets ahead of time with the American Express® Card, and get your boarding passes even before you get to the airport.

Plus, Business Class travelers enjoy many other special services like priority luggage drop-off and pick-up.

YOUR COMFORT IS OUR BUSINESS. TWA goes to great lengths and widths to ensure your comfort with extra leg and shoulder room. And on our 747s, Business Class travelers can find themselves sitting in the lap of luxury in our spacious Business LoungerSM—the widest seat in the sky. And all of this special Business Class comfort is available not only across the Atlantic, but also on all TWA widebodies across America.

AMERICAN EXPRESS INTRODUCES GLOBAL ASSIST.SM Wherever business takes you, American Express' new Global Assist service provides worldwide emergency referrals. With one call, toll free, 24 hours a day, American Express will help Cardmembers find a lawyer, doctor, dentist, pharmacist, interpreter—or even suggest which visas or inoculations are needed for specific trips. And American Express has Travel Service Offices worldwide to help you with any changes in your travel plans.



THE BEST TRAVEL AWARDS FOR FREQUENT FLYERS. Only TWA offers frequent flyers the opportunity to earn a free trip for two, First Class, around the world, as well as free travel to a variety of exciting, exotic places. And members of TWA's Frequent Flight Bonus® program who travel Business Class will earn 25% bonus miles on every flight.

THE IDEAL TRAVEL PARTNERS: TWA AND AMERICAN EXPRESS. There's a new spirit and vitality at TWA and we're determined to make sure your Business Class travel goes as smoothly and conveniently as possible. To ensure this ease, TWA gladly accepts the American Express Card with its instant acceptance at TWA counters worldwide. Don't leave home without it.[®]



AMERICAN EXPRESS
Cards

TODAY'S TWA. FIND OUT HOW GOOD WE REALLY ARE.

Microprocessor Development Dreams Come True!

On-Line Help menus,
Command Glossary,
and Word List.

Windows can be used
to view source files,
previous traces,
and more.

Symbol translation
or source code
line display.

Screen displays scroll off
into history buffer –
can be viewed later.

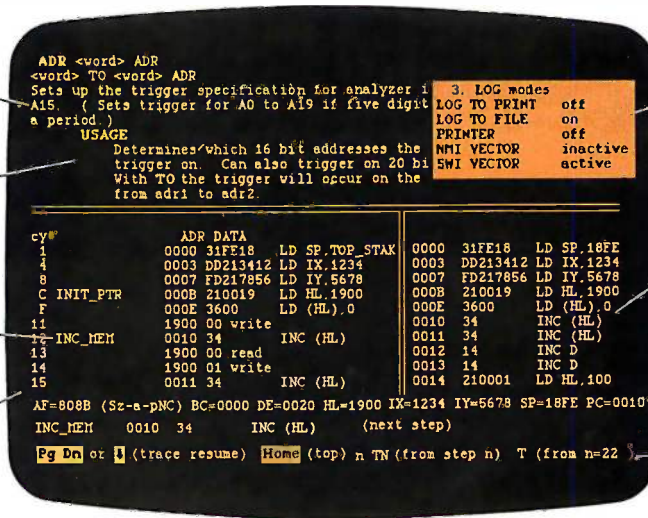

Pop-up Mode
Selection panel
called by soft key.

Disassembly of code
in memory can be
compared with trace in
adjacent window.

Symbolic debug
register display.

Context sensitive
prompt line.

NEW UniLab II™: FOUR INSTRUMENTS IN ONE!

Here are all the development tools you ever dreamed of integrated into one PC-controlled system:

- An Advanced 48-Channel Bus State Analyzer
- An 8/16-Bit Universal Emulator
- A Built-In EPROM Programmer
- An Input Stimulus Generator

The synergy of these instruments that were designed together to work together saves you time and money. All UniLab II commands and menus are seamlessly integrated into a single, super-efficient working environment.

ACTION COUPON

Send me info on UniLab II and your No-Risk 10-Day Evaluation!

Name: _____ Title: _____

Company: _____

Address: _____

City: _____

State/ZIP: _____

Tel.: _____ Ext. _____

UniLab II™

Universal Development Laboratory



Orion Instruments, Inc.

ORION

702 Marshall Street
Redwood City, California 94063

An Integrated Software Environment, too!

Imagine being able to split your screen and look at real-time program traces and the source code that produced them at the same time! Then go to the On-Line Help or pop-up Mode Panels instantly.

If you see something on a trace that doesn't look like last time, you can hold it in one window while you scroll back through your previous displays.

If you set a breakpoint and single-step you can then go back to using the analyzer without missing a beat. You can even execute a DOS batch file from UniLab to edit, assemble, and link, then automatically load the new program and symbol table. UniLab uses the full power of the PC.

Find bugs fast with Hardware-assisted Debugging

The traditional way to look for bugs is to single-step through suspect parts of the code until you catch it in the act. This requires a lot of guessing and wasted time.

With UniLab's built-in analyzer you eliminate the guesswork. Just describe the bug symptom as a trigger, and let the UniLab hardware search

for it as your program runs in real time. UniLab will show you a trace of the program steps leading up to the symptom, almost like magic.

A friendly user interface

UniLab lets you use commands or menus – or a mixture of both. An on-line manual, soft-key help screens, a glossary of commands and their parameters, with full-screen writeups are also at the ready.

Reconfigure for any 8 or 16-bit processor in seconds

Thanks to our unique approach to emulation, changes between processor types require only cable and diskette changes. At last count, we specifically support over 120 microprocessors.

Bonus! The built-in EPROM Programmer and Stimulus Generator are simply icing on the cake.

Affordable capability

How much does all this superior capability cost? A lot less than our less able competitors, and probably a lot less than you expect. Our products are sold with a Money Back Guarantee, and our crack team of Applications Engineers is standing by if you need help. Get the full story on the amazing UniLab II and how it can liberate your development projects, today.

CALL TOLL FREE: 1-800-245-8500

In California (415) 361-8883

RULE-BASED PROGRAMMING

BY LEONARD MOSKOWITZ

*OPS5 lets you add knowledge to a program
without worrying about where to put it*

THE WAY IN WHICH a computer program represents knowledge affects how it can apply and manipulate that knowledge. A good representation makes important features explicit and hides or ignores unimportant ones. Any particular representation may serve well for one task but be less appropriate for another—even closely related—task. For example, Roman numerals are appropriate for representing fixed quantities but not for performing mathematical calculations.

In the field of computer science in general, and artificial intelligence (AI) in particular, the advantages of good knowledge representation are well appreciated. A computer program that displays intelligence must be able to manipulate knowledge in a straightforward manner. The more appropriate the knowledge representation is to the task at hand, the easier the task is to accomplish.

Starting with a collection of basic mathematical theorems, Doug Lenat's discovery program, AM, was able to discover, or rediscover, many mathematical concepts. Its power was traced to its form of knowledge representation. AM used structured LISP

modules that represented knowledge in the Math domain at the proper level of abstraction. Syntactic mutations to these LISP modules resulted in corresponding changes in the Math domain. Since the modules represented knowledge at comparable levels of abstraction, a change to a LISP function had a good chance of causing a reasonable change in the Math domain, too.

While traditional procedural programs embed and intertwine knowledge and program control, expert systems—AM, for example—explicitly separate knowledge and program control. This approach is called knowledge-based programming and may be the key contribution of expert systems to computer science.

Many well-known expert systems are built using production systems. First formulated by Allen Newell and Herbert Simon at Carnegie-Mellon University as a model of human cognitive architecture, production systems represent knowledge as a set of condition-action rules, or productions. Production systems stress the use of independent knowledge modules. Ideally, you should be able to add and delete knowledge (productions) with-

out worrying about how the productions interact.

OPS5 is the production-system language that has found widespread acceptance in the AI research and development communities. The earliest version of OPS (which its authors, with tongue in cheek, say stands for "Official, at least locally, Production System") was written at CMU in the mid 1970s.

PRIMARY CONSTRUCTS

The name production systems (which are also called rule-based systems) comes from the primary programming construct that they use—the production. An OPS5 production, or rule (the terms are interchangeable), has four parts: a title, a left-hand side (LHS), an arrow symbol (\rightarrow), and a right-hand side (RHS). The LHS has a number of patterns called condition

(continued)

Leonard Moskowitz (0-75 Morlot Ave., Fair Lawn, NJ 07410) heads a research and development group that applies artificial intelligence technology to the problems of maintenance and diagnostics at Allied Corporation's Bendix Test Systems Division. He is currently working toward a PH.D. in computer science at Rutgers.

elements. The RHS has a number of actions. If the LHS patterns are matched, or satisfied, the RHS actions are executed. You can think of a production as an IF...THEN rule, with the LHS corresponding to the IF part and the RHS to the THEN part.

Listing 1 contains an example of a simple OPS5 rule that translates into English as follows (note that the attributes are those preceded by the symbol ^):

- This production's title is I'm-cold.
- IF
- working memory has an element that has as its contents the class name temperature and the attribute value that has the value cold (call that element local-temperature), and
- there is another element in working memory that has as its contents the class name window and the attribute state that has the value open (call this

element open-window),
THEN

- modify the element called local-temperature by modifying the value of the attribute value to getting-warmer?, and
- modify the element called open-window by changing the value of its attribute state to closed, and
- tell the world that you were cold and closed the window.

OPS5 keeps information in two places: production memory, which holds all the productions, and working memory, which holds the data against which the LHSs are matched. The elements in working memory are time-tagged: The most recent addition has the highest time tag.

In traditional procedural languages like C, Pascal, or BASIC, program control can be transferred via conditionals, subroutine calls, function calls, and explicit directions. If none of these is present, the program executes sequentially. In OPS5, however, productions can be entered in any sequence. Regardless of where you place a production in the program, it will be executed when the conditions defined in its LHS are satisfied best by the data in working memory.

The control mechanism that determines execution order is called the match-resolve-act cycle. The match part identifies the conflict set, those productions that match the current

state of working memory. Since the conflict set may include more than one production, the conflict resolver selects the one production that is satisfied best and arranges for that production to act, or fire—that is, to execute its RHS.

The ability to add productions to a program without worrying about where to put them is one of the nicest features of OPS5. Production systems try to isolate the knowledge required to do a task from the way that knowledge is applied to teach a program what to know rather than what to do. They don't always succeed in separating the knowledge from the control, but OPS5 does a much better job of it than the traditional procedural languages.

A DEEPER LOOK

LITERALIZATION. In OPS5, the only actual structures are the working memory elements, which typically take the form of a class name followed by the values of the class's various attributes. A literalize statement is used to declare the class. Figure 1a shows a literalization from a hypothetical expert system for real estate agents. It contains a class house with six attributes: address, size-of-property, number-of-rooms, type-of-heating, taxes-per-year, and asking-price. While the production system is executing, working memory may contain many instances of this class that vary only in the values bound to the attributes. Figure 1b shows one instance of this literalization.

OPS5 also requires that you declare references to external functions or subroutines. This declaration uses the name of the function or subroutine as an argument to the keyword external.

THE LEFT-HAND SIDE. The LHS of a production consists of patterns called condition elements, each of which consists of an opening parenthesis, some number of terms, and a closing parenthesis. The terms are typically class names followed by attribute-value pairs (as defined in the literalize statements). An attribute is usually denoted by a preceding ^ symbol. For example, in listing 1, the class name is temperature, the attribute is ^value.

(continued)

```
(literalize house
  address
  size-of-property
  number-of-rooms
  type-of-heating
  taxes-per-year
  asking-price)
```

Figure 1a: A literalization.

```
(house 1402__Main__Street 1/2-acre 7 oil/gas $1500 $120k)
```

Figure 1b: An instance of the literalization.

```
Listing 1: A simple OPS5 production.

(p I'm-cold
  {(temperature ^value cold) <local-temperature>}
  {(window ^state open) <open-window>}}
-->
(modify <local-temperature> ^value getting-warmer?)
(modify <open-window> ^state closed)
(write (crlf)
  |Brrr! I was cold so I closed the window.|))
```

When You're Looking for Answers, Come to the **Library**

**Complete Monographic
10 MHz AT
Compatible System**

Chapter 1
\$1395

- ☑ **Mono monitor**
- ☑ **Display card**
- ☑ 67% Faster than IBM AT
- ☑ 10/6/8 MHz switchable
- ☑ 512KB memory
- ☑ Dual HD/Floppy controller
- ☑ 1.2MB High capacity drive
- ☑ Fully IBM BIOS compatible
- ☑ CMOS clock/calendar
- ☑ 200 watt power supply

- ☑ AT style keyboard
- ☑ One Year Limited warranty
- ☑ FCC class 'B' approved
- ☑ Designed, Manufactured and serviced in U.S.A.

☑ **Free Starter's Kit:**

- ☐ DOS 3.1
- ☐ 3 Diskettes
- ☐ Diskette case



Top Ten Bestsellers

Seagate 20MB Subsystem

- ☑ Controller
- ☑ Cable and hardware
- ☑ Software and Manual

\$365

20MB ST-4026 **\$539**
 30MB ST-4038 **\$639**
 40MB ST-4051 **\$695**
 80MB ST-4096 **CALL**

- ☑ Cable, rails
- ☑ Software and manual

Everex Modem



\$128

- ☑ Half-size
- ☑ 300/1200 BAUD
- ☑ Fully Hayes compatible
- ☑ BITCOM communications software
- ☐ 2400 BAUD **CALL**

EGA Card



\$228

- ☑ Fully IBM EGA compatible
- ☑ Color/Mono display
- ☑ 16 colors from a palette of 64
- ☑ 640 x 350 high res. graphics
- ☑ 256K Display memory

Mini I/O Card



\$59

- ☑ Parallel/Serial
- ☑ Game ports
- ☑ Clock/calendar
- ☑ Half-size card
- ☑ Cables & Software

AT Multifunction



\$175

- ☑ Up to 2MB memory
- ☑ Selectable memory addressing
- ☑ Serial/Parallel/Game ports
- ☑ Software

angtek Tape Backup



\$727
\$827

- ☑ Backup 5 MB in 1 minute
- ☑ Page/file by file
- ☑ Mounting hardware
- ☑ Software and Tape

Hercules Compatible



\$98

- ☑ 720 x 348 pixel graphics
- ☑ 64K display memory
- ☑ Extended 132 x 44 display
- ☑ Parallel printer port

EMS Memory Card



\$139

- ☑ Up to 2MB memory
- ☑ Selectable memory address
- ☑ Lotus/Intel EMS compatible

NEC Multisync



CALL

- ☑ EGA, PGA, CGA display
- ☑ 800 x 560 Resolution
- ☑ Swivel base

Turbo XT \$569



- ☑ Fully IBM compatible
- ☑ 8088-2 CPU
- ☑ 4.77 & 8MHz switchable
- ☑ 360K drive w/controller
- ☑ 640K memory
- ☑ 150 W power supply
- ☑ Keyboard

COMPUTER LIBRARY

Sales (415) 659-8784

Tech Support (415) 659-8849

5349 Randall place
Fremont, CA 94538



Quantity Discounts Available

Inquiry 193

Others:

- ☐ AT 3MB Memory Expansion card **\$150**
- ☐ AT HD/Floppy controller **\$160**
- ☐ PC Multifunction **\$94**
- ☐ Multifunction/mono card **\$139**
- ☐ Expansion chassis **\$428**
- ☐ Floppy controller **\$33**
- ☐ EVEREX Edge **\$229**
- ☐ DOS 3.1 **\$69**
- ☐ 150 W power supply **\$79**
- ☐ Keyboard AT/XT **\$75**
- ☐ Mono monitors **CALL**
- ☐ TEAC 20MB Tape backup **\$580**

and the value of the attribute is cold. Values can be specified as constants—cold is a constant—or by using OPS5's LHS pattern operators, which are listed in table 1.

You can match the contents of working memory in various ways. You can make an exact match by using a constant value or a bound variable (a variable with an assigned value); you can match any value by using an unbound variable (a variable that doesn't yet have an assigned value); and you can place limits on the values you will match by using any of the seven predicates (the logical operators `<`, `<=`, `>=`, `>`, `<>`, `=`, and `<=>`) combined with the disjunction (`<<...>>`) and conjunction (`{...}`) operators. You can also match the absence of an element.

THE RIGHT-HAND SIDE. Once the LHS is satisfied and the production is selected to fire, the production's RHS executes. The RHS consists of a sequence of actions (see table 2). These actions can add, delete, and modify elements in working memory, open and close files, perform input and output, assign values to variables, call user-defined procedures, and halt the program. In some implementations, an action can add productions to the program, thus allowing self-modifying, or learning, programs.

Each action consists of an opening parenthesis, the action's name, its arguments, and a closing parenthesis. The arguments can be element designators that provide a way for an RHS action to refer to the working memory element that a particular LHS condition element matches. (In listing 1, `local-temperature` and `open-window` are element designators.) An action's arguments can also be patterns similar to LHS condition elements. These patterns may contain variables that must be resolved into values and function references that must return a value before the RHS action executes. When these are resolved, the evaluated pattern is called the result element.

Table 3 lists the functions that OPS5 provides. They can extract pieces of a condition element for an RHS action to use, do arithmetic computation, and read input from a variety of

Table 1: *The LHS pattern operators.*

Name	Description
Variable	The first time a variable is used in a production, it is bound to the working memory value it matches. Every subsequent time it is used in the same production, it matches the value previously bound.
Disjunction	Any of the values enclosed in pointed double brackets (<code><<...>></code>) is an acceptable match.
Conjunction	The working memory value must match all the items in the curly brackets (<code>{...}</code>).
=	Matches a value exactly.
<>	The working memory value may be anything but the argument of this operator.
<=>	The working memory value must be the same type—numeric or symbolic—as the argument to this operator.
<, <=, >=, >	The working memory value must be, respectively, less than, less than or equal to, greater than or equal to, or greater than the argument to this operator.
//	The symbol used as an argument will be matched literally and not evaluated.

Table 2: *The RHS actions.*

Name	Description
make	Creates a new working memory element.
remove	Removes an element from working memory.
modify	Changes one or more values in a working memory element.
openfile	Opens a file for either reading or writing and associates a name with it.
closefile	Closes the file associated with the argument.
default	Sets the default file or stream used for input, output, and trace information.
write	Writes output to a designated stream or file.
call	Invokes user-written subroutines.
halt	Stops the interpreter from firing further productions once the current one has completed.
bind	Binds a variable to a value.
cbind	Binds a variable to the last working memory element created by this production.
build	Adds a new production to working memory.

sources. Functions also return their results into the result element.

RESOLVING CONFLICTS

A conflict resolver should be simple, efficient, and straightforward and

should fulfill certain basic needs. First, a particular production/working-memory-elements match, an instantiation, shouldn't fire over and over again. This would be equivalent to getting stuck in a very tight loop. You can

Example	Explanation
<x>	
<< yes no maybe >>	The matched value must be either yes, no, or maybe.
{>10 <20}	The matched value must be greater than 10 and less than 20.
=3	The matched value must be 3. (This is the same as just using 3 without the =.)
<>3	The matched value may be anything but a 3.
<=> 123	The matched value must be a number.
<=> ABC	The matched value must be symbolic.
>= 42	The matched value must be greater than or equal to 42.
<0	The matched value must be a negative number.
// <x>	The matched value must be <x> and not the value bound to the variable <x>.

Example	Explanation
(make house ^price \$120k)	Adds this element to working memory.
(remove 1 <ranch>)	Removes the working memory elements that have been bound to the element designators 1 and <ranch>.
(modify <ranch> ^type modern)	Modifies the type attribute of the working element that is bound to <ranch>.
(openfile testfile test.asm out)	Opens a file named test.asm for writing and assigns the name testfile to it.
(closefile testfile)	Closes the file associated with testfile.
(default nil trace)	Uses the user's terminal to display trace information.
(write testfile (crf) Hil)	Writes a new line with the string Hil to the file associated with testfile.
(call calculate)	Invokes the user-written subroutine entitled calculate.
(halt)	
(bind <x> 3)	Binds the variable <x> to the number 3.
(cbind <last>)	Binds the variable <last> to the last element added to working memory.
(build a-new-one (3) (10) --> (halt))	Builds a new production called a-new-one that matches a 3 and a 10 and halts.

either exclude an instantiation from ever firing more than once—OPS5's method—or ensure that it can't fire twice in a row. Second, execution should stick to one task at a time and not switch tasks needlessly. In effect

there should be an attention mechanism. OPS5 gives preference to those instantiations that include the most recent additions to working memory. In this way, attention stays focused, and simple sequential execution can be

implemented if necessary. Third, the more specific productions should be preferred over the less specific ones, ensuring that the rule that best fits a particular situation will fire. Finally, when none of these strategies applies, you need a rule to fall back on. OPS5 selects a production arbitrarily from the conflict set.

OPS5 has two conflict-resolution strategies that fulfill these needs but differ slightly in detail: LEX and MEA. LEX is simpler than MEA, but MEA provides more explicit execution control than LEX. The choice of which to use depends on the application.

The LEX strategy first discards from the conflict set all instantiations that have previously fired. If none remains, control returns to the top level. If more than one remain, LEX selects the most recent instantiations. If more than one are selected, LEX chooses the most specific. If more than one still remain, it arbitrarily picks one.

The MEA strategy has one more step. It first discards from the conflict set all instantiations that have previously fired. If none remains, control returns to the top level. If more than one remain, MEA compares the *recency* of the working memory elements that satisfy the *first* condition element of the instantiations and selects the most recent instantiations. It then chooses the most recent instantiations considering the entire LHSs (not just the first condition element). If more than one remain, MEA selects the most specific. If more than one still remain, it arbitrarily picks one.

PATTERN MATCHING

The pattern matcher is the heart of OPS5. Estimates of the execution time spent in the match phase are as high as 90 percent of the total, so optimizing the match algorithm pays high dividends. OPS5 uses the Rete match algorithm, written by Charles Forgy, in which each pattern in a production maintains a list of the elements that satisfy it. When you add an element to working memory, you also add it to the lists of all the patterns that match it. When you remove an element from working memory, you remove it from those lists as well. The

(continued)

lists are retained between match-resolve-act cycles. Therefore, you never have to evaluate the entire contents of working memory.

To implement the Rete match algorithm, OPS5 uses a tree-structured sorting network for the productions. This Rete network is compiled for the LHS patterns and acts as a black box with changes to working memory as its input and changes to the conflict set as its output. The Rete network functions as a state memory that changes as you add or remove elements from working memory. This network is the key to OPS5's efficiency.

CONTROL ISSUES

When you first experiment with OPS5, you may tend to write programs with strictly sequential execution that proceed from firing to firing in an explicitly defined order. It takes a while to realize that a large part of OPS5's power is that the language will handle the details of execution if you let it.

Listing 2 contains a sort program that uses only one production to print a sorted list of all the numbers in working memory. The program assumes that working memory holds some numbers, or elements, with the class name number and a value attribute with the value yes or no to indicate whether or not this number has been printed. Initially all the printed-yet? attributes are set to no. The program translates into English as follows:

- The title of this production is sort. IF
- there is a number that has not yet been printed (call the number x and its working memory element smallest), and
- there isn't another unprinted number that is smaller than x, THEN
- write out x on a new line, and
- mark the working element called smallest as printed.

The production fires continuously, printing numbers from the smallest to the largest. When it prints a number, it sets that number's printed-yet? attribute to yes so the production never

Table 3: The RHS functions.

Name	Description
substr	Extracts part of a working memory element and returns it to the result element.
genatom	Creates and returns a new symbolic atom.
compute	Returns the evaluation of an arithmetic expression.
litval	Returns the number assigned by the literalize function.
accept	Returns the value received from the input stream or file.
acceptline	Returns exactly one line of input from the input stream or file.

A SMALL RULE-BASED SYSTEM

AUTO.OPS is a small OPS5 production system that diagnoses some simple electrical problems in automobiles. [Editor's note: AUTO.OPS is available on disk, in print, and on BIX; see the insert card following page 352 for details. It is also available on BYTEnet; see page 4.] It's 36 productions long; knows about the battery, headlights, radio/cassette player, and fusebox; asks you for symptoms of the failure (dead radio, one headlight out, etc.); and tries to gather evidence to make a diagnosis. Listing A shows a sample run.

The program is broken up into four parts. The first is the literalization section, where the working memory elements are described and declared. These are the current phase of the program, the symptoms noted, and the answers to the yes/no questions the program asks. The second is the data-entry section, which has seven productions to print the symptom menu, accept the symptoms, place them in working memory, check for invalid and duplicate ones, and set up the diagnosis phase. The third part does the

diagnosis and has 26 productions. It notes what symptoms you entered, infers certain things (like the battery is not dead because at least one thing is working), and asks you to run tests and report their results until it narrows the problem down. The fourth part, only three productions long, cleans up the working memory and restarts the program.

The only explicit control used in AUTO.OPS is the phase working memory element. It serves to partition the productions into three groups, simplifying conflict resolution and debugging. At first its current-phase attribute is set to data-entry. When you finish entering symptoms, current-phase is set to diagnose. When no more specific rules can fire in the diagnose phase, the production entitled catch-all-production fires, changing current-phase to clean-up.

Typical of expert systems, you can extend this production system incrementally with relative ease. If you wanted to consider symptoms associated with an alternator, you could add productions to accommodate them. If the existing production system is well-structured, few of the preexisting productions should need to be modified. A good learning exercise would be to extend this system. If you do, please let me know how it turns out.

matches it again. Execution halts when no more numbers have their printed-yet? attributes still set to no.

On each cycle OPS5's pattern matcher tries to satisfy the LHS. The order in which the numbers are checked against each other doesn't

really matter, so you needn't write detailed code to control it. In OPS5, the pattern matcher and the conflict resolver handle this chore. Listing 2 remains compact and describes only what a sort is, not exactly how to do it. (For a description of a small but

Example	Explanation
(substr <wme> 3 3)	Extracts and returns the third value from the working memory element associated with <wme>.
(genatom)	Returns a new symbolic atom.
(compute <number> + 2)	Returns the sum of 2 and the value bound to the variable <number>.
(litval price)	Returns the value assigned to price.
(accept input-stream)	Returns the value received from the input stream called input-stream.
(acceptline input-stream)	Returns one line of input from the input stream called input-stream.

Listing A: A sample run of AUTO.OPS (user input shown in uppercase letters).

What's wrong with the old heap now?

```
dead-radio
dead-cassette
no-headlights
one-headlight-out
```

Choose your symptoms from the list and type "end" to finish or "quit" to exit.

```
Symptom: DEAD-RADIO
Symptom: END
```

Is the cassette dead too? (yes/no): YES

Since both the radio and the cassette are dead, check the fuse for the radio.

Is it blown? (yes/no): NO

Hmm. Both the radio and cassette are dead, the radio fuse is ok, and we're still not getting power. Turn on your headlights.

Are they both on? (yes/no): NO

Is one headlight on? (yes/no): YES

Very curious. It appears that the battery is ok, but still no radio. It could be a broken wire somewhere. Get out a voltmeter and a schematic and trace back from the radio. If there's voltage at the radio, then remove the radio for repair. Otherwise, I'm stumped. Sorry!

Replace the dead headlight with one of the same type.

Done. Starting over.

more involved OPS5 system and access to its code, see the text box "A Small Rule-based System.")

THE TOP LEVEL

There are two original versions of OPS5, one written in LISP and one in

BLISS, with only minor variations between them. OPS5 is an interpreted language. As in BASIC, you can enter commands to the interpreter, or the top level. In the LISP version, when you enter OPS5, you are automatically at the top level. In the BLISS ver-

sion, you must compile the productions and link in the OPS5 interpreter. You don't see the top level until you run the program.

The top level is a loop that accepts one command, executes it, and waits for another one. At the top level you can enter productions (either manually or by loading a prewritten file), examine and excise productions, examine and modify working memory, open and close files, invoke user-defined external procedures, step forward (and, in the LISP version, backward) through the execution of a production system, run a production system, select the conflict resolution strategy, select the amount of trace information the production system reports as it executes, show which productions are in the current conflict set, set breakpoints, and exit from OPS5. When a production system finishes executing, control returns to the top level.

INTERFACES

OPS5 is a language for building and applying a knowledge base, but it is not especially efficient for numerical computation, database operations, list processing, or any process that requires lots of file interaction. If you have an application that combines these needs, it would be nice to be able to program each section of it in the language best suited to its function. This would require that all of the languages and their environment or operating system support communications between programs in different languages. OPS5 has a variety of functions that simplify the task of interfacing with or embedding OPS5 programs.

OPS5 supports external user-defined RHS actions and functions. (Actions don't return a value; functions do.) The RHS action call lets you write your own actions. The language provides specific functions to ease the task of interfacing with external procedures by standardizing the transfer of information into and out of OPS5. These functions can pass parameters to an external procedure, allow that procedure to add to working memory, and access objects (e.g., files, streams)

(continued)

that OPS5 has opened for input or output. You can also write your own external functions. You simply declare their invocation names as external and use them as you would use any OPS5 function.

PARALLELISM

OPS5 would seem to lend itself well to an implementation on a parallel computer. Bruce Hillyer and David Shaw modeled OPS5 on a small version of the massively parallel Non-Von machine they are building at Columbia University. By apportioning OPS5's Rete match network among its small processing elements (SPEs), they predict improvements in execution speeds on the order of 100 times the speed of the fastest currently available OPS5 implementation, or roughly 900 production firings per second. The architecture they suggest is a parallel machine with 32 large processing elements (processors with the capability of a Motorola 68020), approximately 16,000 SPEs (8-bit processors with only 64 bytes of RAM each), and a few intelligent disk servers. Such a machine would cost approximately what a VAX-11/780 costs today.

Remember that the OPS5 language was written for sequential machines. You can expect that production systems written expressly for parallel architectures would execute much faster than OPS5.

SHORTCOMINGS

Personally, I think OPS5 is wonderful, but it does have its shortcomings. The price you pay for perspicuity of knowledge representation is speed. The BLISS version runs at between 5 and 12 firings per second on a single-user VAX-11/780. The LISP version runs a bit faster on the specialized LISP workstations. While you could im-

prove speed if you recoded the logic in C or Pascal, you would lose the advantages of a knowledge-based system. You wouldn't be able to add knowledge incrementally, and maintenance would be a nightmare because you would have to contend with a program that mixes knowledge and control.

OPS5's Backus-Naur form (BNF) syntax is simple and easy to learn, taking up less than two pages. (BNF is a formal language used to express context-free grammars.) However, it lacks some important features. You can't do computations in an LHS condition element, so the possible range of a match is restricted. There is no disjunction across condition elements, so you must code X or Y or Z as separate productions. (Forgy suggested that an easy way around this syntactical barrier would be to write a preprocessor that takes a disjunctive form and generates appropriate conjunctive productions.)

OPS5 doesn't provide a means of segmenting independent groups of productions into separate rule bases within a single program. A 3000-production system takes much longer to execute as a whole than three 1000-production systems that maintain independent Rete networks and are activated only when appropriate.

Some programmers call the inability to do traditional procedural programming from within OPS5 a shortcoming. I call it a feature. As long as it provides the "hooks" to interface with other languages, the last thing we need is another procedural language. There is a modular elegance in working in the language best suited to a task. I think we need more special-purpose languages—like Prolog for logic programming, or perhaps a brand-new frame-based language—that integrate with traditional lan-

guages as well as OPS5 does. However, if this concerns you, OPS83, Forgy's latest version of OPS, has a Pascal-like syntax for doing procedural programming.

AVAILABILITY

OPS5 was originally written on a DECsystem-20. It has now been ported over to the Apple Macintosh (Expertelligence), the IBM PC (Dynamic Master Systems), CP/M-80 (Dynamic Master Systems), the LISP machines (Symbolics, LMI, and Xerox, with user-interface enhancements from Verac Inc. and SAIC), the VAX (a BLISS version supported by DEC and a version in Franz LISP), and the Apollo workstations (from Cognitive Systems via Yale's T dialect of LISP and Computer*Thought).

SUMMARY

OPS5 is a powerful language that relies on some very simple ideas. Its strength is in representing knowledge in the surprisingly flexible form of IF...THEN rules. If such a thing as a standard tool for building knowledge-based systems exists, OPS5 is it. Its syntax is simple, and it has a simple interface to other languages. Until recently, it was available only to those with access to large computers. Thanks to the new microcomputer versions, it's now available to all of us. ■

BIBLIOGRAPHY

- Brownston, Lee, Robert Farrell, Elaine Kant, and Nancy Martin, *Programming Expert Systems in OPS5: An Introduction to Rule-Based Programming*. Reading, MA: Addison-Wesley, 1985.
- Forgy, Charles L., *OPS5 User's Manual*. Department of Computer Science, Carnegie-Mellon University, 1981.
- Forgy, Charles L., *Rete: A Fast Algorithm for the Many Pattern/Many Object Pattern Match Problem*. Artificial Intelligence 19, North Holland, 1982.
- Hillyer, B. K., and D. E. Shaw, *Execution of OPS5 Production Systems on a Massively Parallel Machine*. Department of Computer Science, Columbia University, September 1984.
- McDermott, John, and Charles Forgy, "Production System Conflict Resolution Strategies," in D. A. Waterman and F. Hayes-Roth, eds., *Pattern-Directed Inference Systems*. New York: Academic Press, 1978.

Listing 2: A one-production sort program.

```
(p sort
  {(number ^value <x> ^printed-yet? no) <smallest>}
  -(number ^value <x> ^printed-yet? no)
-->
  (write (cr lf) <x>)
  (modify <smallest> ^printed-yet? yes))
```

When Harvard needs Princeton they should call Logicsoft



Whether Harvard University needs Princeton Graphics monitors or any of the over 800 computer products we stock, Logicsoft can get it there quickly, efficiently and at the right price.

Logicsoft is a direct distributor to over 50,000 corporations worldwide including 90% of the Fortune 1000 and most of the nation's leading universities and colleges (including Harvard and Princeton).

Service is the difference between suppliers— that's why we guarantee the lowest price, offer free overnight delivery*, carry products that are fully backed by manufacturers' warranties and offer toll-free customer service and technical support.

And we are the only direct distributor to offer national on-site installation and service on systems through our 96 authorized service centers.

It's easy to do business with Logicsoft. We offer terms to qualified institutions; accept all major cards; and now our newest service...leasing.

Therefore, when Princeton needs Harvard (Total Project Manager) they should call us too!



LOGICSOFT SPECIAL OF THE MONTH
Princeton Graphics HX-12 color monitor. High resolution, 16 superb colors, .31mm dot pitch.
CALL FOR OUR SPECIAL LOW PRICE!



THE NATION'S
LARGEST
DIRECT DISTRIBUTOR
OF COMPUTER
PRODUCTS

LOGICSOFT®

110 Bi-County Blvd., Dept. 543
Farmingdale, NY 11735

CANADA: 800-433-6235
Domestic/Int'l Telex
286905 SoftUR

To order or receive technical assistance, call our National Hotline:

1-800-645-3491

NY STATE: 1-800-235-6442 (516) 249-8440
Customer Service: 1-800-431-9037 NYS: 516-249-8440
FAX #516-249-5289

EUROPE: 020-83 48 64
Telex: 10759 Logic NL

Mail orders to:
LOGICSOFT EUROPE BV
Baarsjesweg 224
Amsterdam, Holland

*FREE OVERNIGHT DELIVERY—available on orders totaling over \$100. Shipped UPS, FREE, if under \$100 (within Cont. U.S.). Due to weight restrictions, printers and monitors & some misc. bulk items are also shipped UPS, FREE. LOWEST PRICE GUARANTEE—If you find a lower price (bonafide advertisement or quote) we'll beat it by \$10. On items under \$100, American Express or terms orders we will meet any lower price. We reserve the right to request a current written price quote.

• No surcharge for MasterCard, VISA, American Express, C.O.D., money order, check or PO's (please call for price verification) • No sales tax on orders shipped outside N.Y. State • Please add 2% for insurance and handling (\$3.00 minimum) (int'l orders add'l) • We do not bill until we ship. All products covered by mfg's warranty. Defective merchandise may be returned for repair or exchange only. We do not guarantee compatibility. Any goods returned for credit are subject to a 15% restocking charge. All prices and policies subject to change without notice.

Free on-site installation



Enhanced Leading Edge Model D

- 512K RAM Memory • 1200B Internal Modem • Two 360K Half/Height Floppy Drives • Four Expansion Slots • Keyboard • Text Display Card • Monochrome Monitor • One Serial and Parallel Port • Software Bundle • Color Monitor Option Available.

• Purchase Price: \$1,375

Lease For **\$59** per month



New IBM XT 286—20 Mb

- 6 MHz • 80286 Based CPU • Zero Wait States • 640K • 1.2 Mb Half/Height Floppy • 20 Mb Half/Height Hard Drive • Serial/Parallel Adapter • Eight Expansion Slots- (5) 16-Bit, (3) 8-Bit • IBM PC Enhanced Keyboard • Free 90-Day, On-Site Contract • Color or Monochrome Monitor Available as Option.

• Purchase Price: \$3,199

Lease For **\$126** per month



New IBM AT-30 Mb

- 8 MHz • 512K • 30 Mb IBM Hard Drive (Full Height, w/controller) • 1.2 Mb Half/Height Floppy • Eight Expansion Slots • IBM Enhanced PC Keyboard • Serial/Parallel Adapter • Free 90-day, On-Site Service Contract • Color or Monochrome Monitor Available as Option.

• Purchase Price: \$4,179

Lease For **\$165** per month



New Compaq Portable II 20 Mb

- 640K RAM Memory • 8 MHz • 80286 Based CPU • One 20Mb Half/Height Hard Drive (w/controller) • One 360K one-third Height Floppy Drive • Two Expansion Slots • Compaq II Keyboard • Text/Graphics Display Card • 9" Text/Graphics Monochrome Monitor • One Serial and Parallel Port • Free 90-Day, On-Site Service Contract.

• Purchase Price: \$3,879

Lease For **\$153** per month

Lease or purchase systems from Logicsoft

A Logiclease of any system entitles you to free installation and 90-day service contract at your place of business! Outstanding flexibility plus possible tax benefits. We'll process your lease application in 24 hours!

A purchase of any system entitles you to installation for only \$99, and free service for 90 days at your place of business.



ON-SITE SERVICE

Trained technicians are ready to respond to your needs within an average of 4 hours from any of our 96 authorized service centers, located in most major metropolitan areas throughout the United States.



Logic AT

FCC Class B Approved.

- 8 MHz • 512K RAM Memory • 80286 Based CPU □ ROM BIOS 32K (Includes auto system test when power is turned on • 1.2 Mb High Density Floppy Drive • Eight Expansion Slots • Enhanced Keyboard • (1) Serial Port & (1) Parallel • Clock/calendar • Graphics Card • Programmable Speaker • Automatic Lock/Unlock Mechanism • Monochrome or Color Monitor Available as Option. Hard Drive Options Available.

• Purchase Price: \$1,485

Lease For **\$58** per month

100% Burn-In and Testing.

All systems undergo a 48-hour configuration, testing and burn-in period. We configure system boards, set DIP switches, format hard drives, perform memory diagnostics and check system with monitor.

ation and service



New Compaq Deskpro 286—30 Mb

- 512K RAM Memory • 80286 Based CPU • One 30 Mb Hard Drive (w/controller) • One 1.2 Mb Half/Height Floppy Drive • Seven Expansion Slots • Compaq Keyboard • Graphics Card • One Parallel Port • Free 90-Day, On-Site Service Contract • Color or Monochrome Available as Option.

• Purchase Price: \$3,859

Lease For **\$152** per month



AT&T 6300

- 640K RAM Memory • One 360K Floppy Drive • Seven Expansion Slots • AT&T Keyboard • High-Resolution Monochrome Graphics Card • High-Resolution Monochrome Graphics Monitor • Serial & Parallel Ports • GW Basic and MS. DOS. Free 90-Day, On-Site Service Contract. Color Monitor Optional.

• Purchase Price: \$1,799

Lease For **\$76** per month



ITT XTRA (Dual Floppy)

- 256K RAM Memory • Two 360K Half/Height Floppy Drives • 4.77 MHz 8088 Based CPU • 5 Expansion Slots • ITT Keyboard • Text Display Card • ITT Monochrome Monitor (Amber or Green.) • One Parallel and Serial Port • Color Option Available.

• Purchase Price: \$1339

Lease For **\$58** per month



ITT XTRA XP W/20 Mb

- IBM XT Compatible with speed of an AT • 512K of RAM Memory (Expandable to 640K on Mother Board) • 80286 Based CPU running at 6 MHz • One 20 MB Hard Drive • One 360K Floppy Drive • 5 Expansion Slots • ITT Keyboard • One Serial Port One Parallel Port • Color or Monochrome Monitor Available as Option.

• Purchase Price: \$2,049

Lease For **\$88** per month



Logic Turbo XT

FCC Class B Approved.

- 8 MHz • 640K RAM Memory • System ROM 8K BIOS • 360K Half/Height Floppy Drive • Eight Expansion Slots • Enhanced Keyboard • (1) Serial & Parallel Port • Clock Calendar • Graphics Card • Monochrome Monitor • Color Option Available • 30-Day Money Back Satisfaction Guarantee • 1 Year Warranty. Hard Drive Options Available.

• Purchase Price: **\$795**



TOSHIBA Lap-Top T-1100 Plus

(DUAL FLOPPY)

- 640K RAM Memory • CMOS 80C86 Running at 7.1 MHz • Two 720K 3.5" Floppy Drives • One Expansion Slot • TOSHIBA Keyboard • LCD Display • Color Graphics/Monochrome Composite Card • One Parallel and Serial Port • Clock Calendar • External Floppy Drives Optional.

• Purchase Price: \$1,799

Lease For **\$76** per month



IBM AT TOTAL BUSINESS SYSTEM

We'll configure a system to your needs, including peripherals and software and make the price affordable through low monthly Logiclease payments. Here's an example of what you can do!

- 512K RAM Memory • 6 MHz • One 30 Mb Hard Drive • One 1.2 Mb High Density Floppy • Eight Expansion Slots • IBM AT Keyboard • Serial/Parallel Port • IBM Color Monitor • Color

- Graphics Card • Toshiba 351 P/S Printer & Cable • Software Bundle (Lotus 1-2-3, dBase III, Wordperfect, IBM DOS 3.2). Free 90-Day On Site Service Contract

• Purchase Price: \$5,499

Lease For **\$208** per month



LOGICSOFT®

110 Bi-County Blvd., Dept. 543
Farmingdale, NY 11735
CANADA: 800-433-6235
Domestic/Int'l Telex
286905 SoftUR

To order or receive technical assistance, call our National Hotline:

1-800-645-3491

NY STATE: 1-800-235-6442 (516) 249-8440
Customer Service: 1-800-431-9037 NYS: 516-249-8440
FAX #516-249-5289

EUROPE: 020-83 48 64
Telex: 10759 Logic NL
Mail orders to
LOGICSOFT EUROPE BV
Baarsjesweg 224 Amsterdam
Holland

Largest selection of peripherals Free overnight delivery!

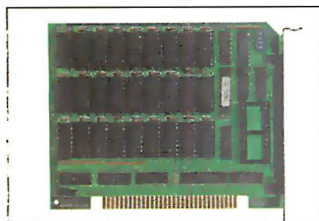

w/0K 59
w/384K 129
w/576K 138

EVEREX

Magic Card II w/384K 199
Logic (AST Comp.) I/O
Mini Half Card 99

TECMAR

Captain (384K) 199

QUADRAM

Quadboard (384K) 199
Silverboard 209
Ems w/256K 349
Liberty(AT)w/128K 315

INTEL

Above Board (PS/AT)
w/128K \$399
Above Board (PC) w/64K ... 275
Above Board (AT) w/128K ... 419
Above Board (PS) 64K 309
Above Board (PS) 256K 389
8087-2 Math Co-Processor . 139
8087-3 Math Co-Processor . 179
80287 Math Co-Processor . 199

GRAPHICS BOARDS

AST

Preview \$239

EVEREX

The Edge 239

Evergraphics ... **Low Price Call!**

HERCULES

Monochrome Graphics
Card 199
Color Card 155
Graphics Card Plus 209

LOGICWARE

Logic (Hercules Comp.)
Color Graphics Board ... 99



Logic (IBM Comp.)
Enhanced Graphics
Adapter (EGA) 239



Logic (Hercules Comp.)
Monographics Board ... 109

PARADISE SYSTEMS

Auto Switch EGA Card 359

Modular Graphics Card 249

Color/Mono 159

QUADRAM

EGA Plus Graphics 369

SIGMA

EGA Board 369

Color 400 (Princeton) 479

STB

Chauffeur 209

EGA Plus 309

TECMAR

Graphics Master 399

COMMUNICATIONS BOARDS

AST

5251-11 Plus \$685

5251-11 629

DCA

IRMA Board 779

MODEMS

AST

Reach 1200 Half Card \$299

EVEREX

Evercom II 149

HAYES

Smartmodem 1200 389

Smartmodem 1200B
w/Smartcom II 359



Smartmodem 2400 599

Smartmodem 2400B
w/Smartcom II 549

LOGICWARE

Logic (Hayes Comp.) 1200
Baud External Modems . 199

Logic (Hayes Comp.) 2400
Baud External Modem . 309

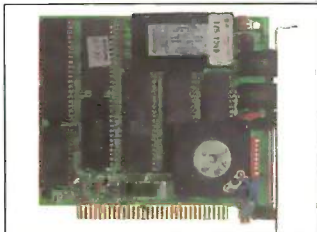

Logic (Hayes Comp.) 1200B
Internal Modem with
Mirror (Crosstalk Clone)
Software 149

Logic 2400B Internal Modem
2400B w/Software 299

PROMETHEUS

Pro-modem 1200 279

Pro-modem 1200B
w/software 239

QUADRAM

Quadmodem Series
..... **Low Price Call!**

VEN-TEL

PC Modem 1200 Half Card . 359

1200 Plus 329

PC Modem 2400 Half Card . 469

MOUSE INPUT DEVICES

MOUSE SYSTEMS

PC Mouse w/DR Halo 2 ... \$129

MICROSOFT

Microsoft Mouse (Serial) . 135

Microsoft Mouse (Buss) ... 125

SURGE PROTECTORS

KENSINGTON MICROWARE



Masterpiece Plus \$119

CURTIS

Diamond 39

Emerald 45

Ruby 59

KEYBOARDS

KEYTRONIC

5151 (Deluxe) \$169

5153 (w/touch Pad) 289

3270 PC 245

5151 (AT&T) 189

Keytronic Jr. 5151 169

MEMORY STORAGE

OMEGA

Bernoulli Box (10 + 10) ... \$1999



Bernoulli Box (20 Mb) 1899

Bernoulli Box (20 + 20) ... 2750

Bernoulli Box Plus 4199

HARD DISK DRIVES

MOUNTAIN COMPUTER

Hard Drive Card (20 Mb) ... \$869

Hard Drive Card (30 Mb) ... 1199

PRIAM CORP

60 Mb Internal Hard Drive
..... 1449

Innerspace ID 40 Mb 1349

PLUS +

Hard Card 10 Mb 629

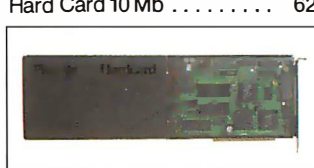

Hard Card 20 Mb 699

SEAGATE

10 Mb 1/2 Ht Int 465

20 Mb 1/2 Ht Int 489

30 Mb 1/2 Ht Int 539

20 Mb Full Ht (AT) 599

30 Mb Full Ht (AT) 749

40 Mb Full Ht (AT) 879

80 Mb Full Ht (AT) 1349

CORE

20 Mb Int (AT) 1299

30 Mb Int (AT) 1399

40 Mb Int (AT) 1495

72 Mb Int (AT) 2749

CARTRIDGE TAPE BACK-UP

EVEREX

Excel Stream 20 Mb Int \$639

Excel Stream 60 Mb Int 799

Excel Stream 60 Mb Ext ... 929

IRWIN

Irwin 11010 Mb Int 499

20 Mb Int 595

20 MB 325 (AT) Ext. D. 779

LOGICWARE



Logic 60 Mb Internal
Cartridge Tape Backup
Kit 725

Logic 20 Mb Internal
Cartridge Tape Backup
Kit 569

SYSGEN

Image Tape Backup

10 Mb Int 789

Image Tape Backup

20 Mb Int 599

Image Tape Backup

20 Mb Ext 649

TECMAR

QIC 60 AT 1239

QIC 60 Ext Tape Backup ... 1579

CORE

60 Mb Ext 1599

FLOPPY DISK DRIVES

Panasonic 360 K 1/2 Ht. \$119

Tandon TM-100 360 K F/Ht. . 125

Tandon TM-100 360 K 1/2 Ht. 105

Toshiba 360 K 1/2 Ht. 115

BACK UP POWER SUPPLIES

DATA SHIELD

200 Wt (PC) \$249

300 Wt (XT) 359



500 Wt (AT) 569

800 Wt (AT) 635

5 YEAR WARRANTY

Look for the items printed in blue to identify our line of LogicWare computer hardware products. They are fully compatible with, but priced well below, the major manufacturers. You save—not by our use of inexpensive labor and parts—but through state-of-the-art technology.

Each product carries our 5 year unconditional replace or repair warranty.

SPECIALS



Canon LBP8A1 Laser Printer

LEASE PRICE **\$85** PER MONTH
Purchase price \$1985

- 8 Pages Per Minute • 128K Built-In Memory • Super Quiet • Has Four Built-In Fonts plus the ability to accept fonts downloaded from a computer and various plug-in font cartridges • As many as 16 different fonts can be mixed on a single page. Great for Word Processing, Spreadsheets & Business Graphics.

CANON LBP8A2 LASER PRINTER

Lease for **\$122** per month
Purchase price \$3089

CANON LBP8A 1/2 TONER CARTRIDGE—\$95

DESKTOP PUBLISHING SOFTWARE

ScLASER plus	\$329
Softype	795
Spellbinder Desktop Publisher	429

PRINTERS*

CANON	
Bubble Jet BJ-80	\$449
EPSON	
LQ 800	569
LQ 1000	749
FX-85	389

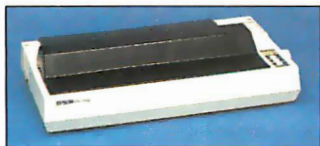

FX-286 579

The Nation's largest and fastest growing

JUKI	
6100	429
6300	699
NEC	
Pinwriter P-5 Series	Low Price Call!
Pinwriter P-6	489
Pinwriter P-7	679
OKIDATA	
182 Plug & Play	223
192 Plus (IBM)	349
193 Plus (IBM)	558
2410 P Plug & Play	1729
PANASONIC	
KX 1091	245
KX 1595	619
TOSHIBA	
P/S 321 (IBM)	489
P 341	799
P/S 351	999
CITIZEN	
MSP 10	299
MSP 15	399
MSP 20	329
MSP 25	499
Premier 35	489

LASER PRINTERS*

CANON	
Laser Printer LBP8A1	\$1985
Laser Printer LBP8A2	3089
HEWLETT PACKARD	
Laser Printer	2489
Laser Printer Plus	3199
LaserJet 500 (+)	4299
OASYS	
Laser Pro Express	1699

PLOTTERS*

CAL COMP	
1043	\$7899
FACIT	
4550 (6 Pen Plotter)	395
HEWLETT PACKARD	
7475A	1629
7550	3349
HOUSTON INSTRUMENTS	
DMP 40	899
DMP 41	2549
DMP 42	2549
DMP 51	3849
DMP 52	3849
DMP 52 MP	4889

PRINTER BUFFERS

QUADRAM	
Microfazer Series	Low Price Call!

MONITORS*

AMDEK	
Color 600	\$ 389
Color 722	499
Color 725	Low Price Call!
12" Amber 310A	149
IBM	
Color Monitor	545
Monochrome Monitor	225
Enhanced Color Display	679

NEC



JC—1401P 3A Multi-sync
color w/swivel base 559

PRINCETON GRAPHICS	
RGB HX-12	419
RGB HX-12E	535
RGB SR-12	559
RGB SR-12P	625
Amber Max 12	159
QUADRAM	
Amberchrome 12"	145
Enhanced Graphics Monitor w/swivel	549
TAXAN	
121/122	145
620	415
640	515

MULTI-FUNCTION BOARDS

AST RESEARCH	
Six Pack Premium	\$379
Six Pack Plus (384K)	229
Rampage w/256K	249
Rampage (AT) w/512K	449
Advantage (128K)	359
I/O Mini Half Card	119
I/O Plus II	125

LOGICWARE

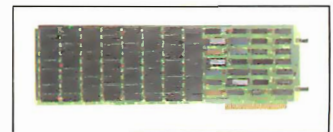

Logic Above Board (Lotus/
Intel/Microsoft Expanded
memory specification) . . . 189



Logic (AST Compatible)
Multifunction Board
w/384K 159

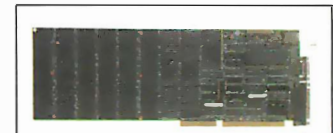

Logic (AST Compatible) AT
Multifunction Board
w/128K (Expandable to
2.0 Mb 219
Logic (AST Compatible)
576K Ram Board 1/2 Card

Free overnight delivery on software for all your IBM PC applications!

30 DAY MONEY BACK GUARANTEE ON LOGICWARE...THE LOGICSOFT LOW COST ALTERNATIVE

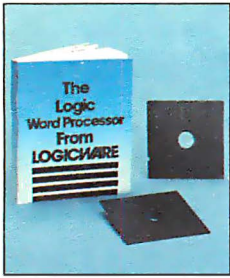

WORDSTAR CLONE
Processing your words now becomes more affordable through this amazing clone!

only **\$79⁹⁵**

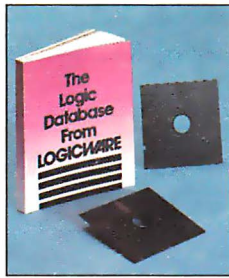

dB III CLONE
A clone that gives you the same capabilities at a very capable cost!

only **\$79⁹⁵**

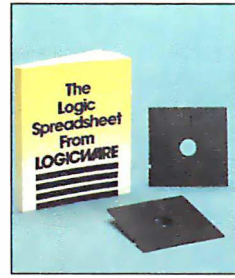

1-2-3 CLONE
Now, a 1-2-3 clone; we've cloned the software, but we didn't clone the price!

only **\$79⁹⁵**

You may return LogicWare software for any reason within 30 days of purchase. Please call for return authorization number.

WORD PROCESSING

Display Write III	\$349
EasyWriter II	195
Microsoft Word 3	269
Multimate	235
Multimate Advantage	277
New Word 3	269
Office Writer	245
Volkswriter 3	147
Word Perfect	219
Wordstar	169
Wordstar Pro Pak	239
Wordstar 2000	245
Wordstar 2000 Plus	295
XY Write III	219

WORD PROCESSING

ADD-ONS

Fancy Font	\$145
Punctuation & Style	75
Reference Set	Low Price Call!
Turbo Lightning	59
Word Finder	55

DATABASE MGMT.

Cornerstone	\$ 75
d Base III Plus	429
d Base III Lan Pak	629
Knowledgeman/2	309
Paradox	495
Powerbase	209
Q & A	249
R: Base 5000	265
R: Base System V	369

Reflex	75
Revelation	519

DATABASE MGMT. ADD-ONS

Clipper	\$349
Clout 2	139
DB III Compiler (Wordtech)	459
dGraph III	149
Ext Report Writer	85
Genifer	289
Quickcode III	145
Quick Report	139

SPREADSHEET/INTEGRATED

Ability	\$ 69
Enable	339

First Choice... Low Price Call!

Framework II	415
Lotus 1-2-3	317
Microsoft Multiplan	119
Smart Integrated	439
Supercalc IV (NEW)	285
Symphony	443

SPREADSHEET ADD-ONS

Cambridge Spreadsheet Analyst	\$ 75
Lotus Report Writer	109
Quickcode for 1-2-3	85
Sideways	45
Smart Notes	Low Price Call!
Spreadsheet Auditor	99
SQZ	65

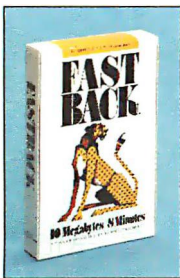

FASTBACK

A low cost alternative to tape backup hardware. Back up 10 Mb in less than 8 minutes using 5 1/4" diskettes.

only **\$93**

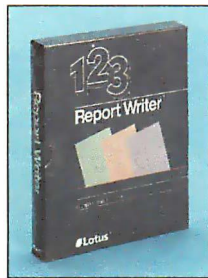

LOTUS REPORT WRITER

The next step for the Power User! Format your own reports, forms and mailings using 1-2-3 files.

only **\$109**

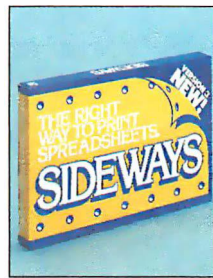

SIDEWAYS

Now you can create extra wide printouts of your spreadsheets without the mess of staples, glue or tape.

only **\$45**

DESKTOP PUBLISHING

Click Art Personal Publisher	\$119
ScLaser Plus	329
Spellbinder Desktop Publisher	429

GRAPHICS

Chartmaster	\$209
Diagram Master	195
Energraphics (New)	289
Freelance	199
Graphwriter	219
Harvard Presentation	289
Map Master	229
Microsoft Chart	179
Sign Master	149

CAD/CAM

Auto CAD 2.5	\$2249
Auto CAD Basic	247
Drafix 1	239
Generic CAD	119
Pro Design II	229

LANGUAGES

BASIC Compiler (MS)	\$245
C Compiler (MS)	265
COBOL Compiler (MS)	425
FORTTRAN Compiler (MS)	217
Lattice C Compiler	259
Macro Assembler (MS)	97
Pascal Compiler (MS)	183
Quick Basic (MS)	67
True Basic	119

Turbo Pascal (plus BCD & 8087)	65
--------------------------------	----

PROJECT MANAGEMENT

Harvard Total	\$285
Microsoft Project	237
Super Project Plus	285
Timeline	235

FINANCIAL

Managing Your Money	\$109
Dollars N' Sense	107

ACCOUNTING

BPI Entry	\$299
Computer Associates (formerly IUS)	317
Great Plains	447
Open Systems (3.0)	417

MISC/UTILITIES

ASC II Pro	Low Price Call!
Carbon Copy	\$139
Concurrent PC DOS	179
Copy II PC	35
Crosstalk XVI	99
Fast Back	93
Microsoft Windows	67
Norton Commander	49
Norton Utilities	55
PC DOS 3.2	85
Prokey 4.0	77
Remote	99
Sidekick	47
Superkey	45
Traveling Sidekick	55
XTREE	39

2 NEW FREE CATALOGS. CALL TODAY! 1-800-645-3491

• Brand new **Programmer's Language and Utilities Guide** • A convenient and valuable listing of timesaving tools for the programming professional • Complete with product description.

• Brand new **Productivity Guide** • Full line catalog of software enhancements for the business professional • Full descriptions of templates, memory management, menu management, backup software, training, and much more.

Circle #400 on reader service card

MACHINE LEARNING

BY ANGELOS T. KOLOKOURIS

One approach to teaching computers to learn is with a language, such as Marvin's, that grows

IN AN ATTEMPT to make computers more accessible to humans, many researchers in the artificial intelligence field have been exploring ways to enable computers to learn. The motivation for machine learning is to have computers extract concepts and relations from databases or through interactive sessions with a user and then use them in any knowledge-intensive activity. Developing knowledge bases for expert systems applications is one such activity. Studying computer-based learning techniques will also give us a better understanding of our own mental processes.

A common method by which a machine learns is by proceeding from specific instances to general rules that more economically capture the content of the given instances. This form of inductive generalization is characteristic of learning from examples and improves on the performance of a knowledge-processing system by condensing a large base of its knowledge into a considerably smaller one. This reduction in size results in a more efficient search of the knowledge base.

When you take a closer look at the programs that learn from examples, you can distinguish two types: those,

called data-driven learners, that generalize by relying entirely on the data presented to them, and a group of more elaborate programs, called model-driven learners, that proceed by generating fairly general hypotheses that are subsequently tested against the given examples or against the user in a typical interactive session. In what follows I will contrast the model-driven learner with the data-driven learner and give an example of the former using a model-driven learner called Marvin. [Editor's note: The Prolog source code for Marvin is available on disk, in print, and on BIX; see the insert card following page 352 for details. It is also available on BYTEnet; see page 4.]

WHAT IS LEARNING?

To give you an idea of just what's involved in modeling learning with computers, I should examine just what learning is. The best definition of learning that I am aware of—that of Herbert Simon of Carnegie-Mellon University (reference 1)—is that "learning denotes changes in the system that are adaptive in the sense that they enable the system to do the same task or tasks drawn from the same population more efficiently the

next time." Taking a closer look at this definition, however, you may realize that it deals predominantly with skill acquisition or improvement, but not all learning is so concerned. Learning systems are those that are able to extract knowledge from raw data or through intersystem informative exchanges, including conversations with the user. Learning systems ought to have the ability not only to acquire knowledge in a cumulative form but also to absorb it.

MACHINE LEARNING STRATEGIES

The methodologies used in machine learning applications with some degree of success are rote learning, learning by being told, learning by analogy, and learning from examples. In rote learning the computer makes no special effort to learn. The elements of new knowledge are given to it, through programming or by accessing an external data file, and inferenc-

(continued)

Angelos T. Kolokouris, a native of Greece, holds a master's degree in physics from Penn State and is completing his Ph.D. at Temple University. He is cofounder of Expert Systems International (1700 Walnut St., Philadelphia, PA 19103).

FORMATTED DISKS

*Ready to use in your
IBM PC or compatible.*



ALF formats brand-name factory certified disks, and double-checks them for defects. You save the time and hassle of formatting disks yourself, and pay no more than for ordinary blank disks!

Call today, toll-free, for complete information:
1-800-321-4668

in Colorado, 303-234-0871

ALF Formatted Disks on these fine brands:



1315 F Nelson St.
Denver, CO 80215

Inquiry 12

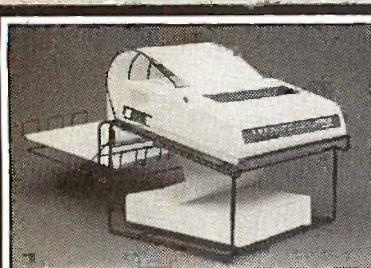

**The GRANDSTAND
PRINTER STAND AND TRAY**

- Folds & Stacks Automatically
- Fits ALL Popular Micro Printers
- Space Saving Operation
- Routes Cables Neatly



Grand Union

Micro Systems
P.O. Box 1880
Fallbrook, CA 92028
(619) 723-0882

Inquiry 143

Advertise your
computer products
through
BYTE BITS
(2" x 3" ads)

For more information
call Dan Harper at
603-924-6830

BYTE
70 Main St.
Peterborough, NH 03458

Inquiry 404

ing is not required. Rote learning relies entirely on memorization, and it is debatable whether programs in this category display learning at all. This simplistic learning function is demonstrated by a checkers-playing program that learns the board positions it evaluates in its look-ahead search. In learning by being told general knowledge is modified into a form that the machine can recognize. The learner transforms the advice given into a set of statements that directly relate to what it already knows. This incorporation of new knowledge may facilitate further explanatory paths in the system's operation. In learning by analogy the knowledge given to the computer is not directly relevant, and the computer must hypothesize analogous cases to assist in solving the problem at hand.

In learning from examples the computer proceeds from individual cases to general principles, from particulars to universals. The problem of concept learning can be seen as the task of developing a classifying rule from several examples of proper membership in the investigated class. Learning from examples is the most successful method of machine learning today and has the longest history. Categorization was seen by Aristotle as the most fundamental step toward learning. In his attempt to provide a formal framework for the study of the way people acquire and process knowledge, he noticed that it is by inductive generalization that people get to know the set of objects that figure in the domain of their activity.

In their quest for knowledge people seek answers to basic questions like why and what. While why-questions are answered through the use of deductive logic, what-questions (i.e., those that relate to the task of taking stock of the foundations of descriptive language) are answered through inductive methods. Since Aristotle's day inductive techniques have been controversial, particularly regarding the degree of unsupervised function to which they are entitled.

KNOWLEDGE REPRESENTATION

A related issue is representation. The properties of the objects you want to

account for must be described in a particular language that accommodates such descriptions. A problem arises when you want a learning system to operate in different environments. A way to get around it is by choosing a flexible enough language to which you can add domain knowledge that reflects the peculiarities of the chosen environment.

In the early years of research on learning systems, R. B. Banerji (reference 2) suggested that rather than choose a language that is confined by the structure of the objects it is used to describe, a better choice would be a language that can "grow." He proposed that such a language could be developed using the predicate calculus as a starting point. This type of language would enable a learning program to create descriptions by learning the domain knowledge. The upshot of this approach is that the language becomes richer as more knowledge is acquired. The learning system learns concepts that can be used in future learning.

DATA-DRIVEN LEARNERS

Here is a simple example of how a data-driven learning program functions. Assume that the data-driven learner is given the following data expressed in a Prolog-like syntax:

customer(X),profession(X,accountant),
lives__in(X,cleveland),buys(X,300).

customer(X),profession(X,lawyer),
lives__in(X,beverly__hills),buys(X,25000).

customer(X),profession(X,accountant),
lives__in(X,beverly__hills),buys(X,30000).

The data-driven learner would extract what is common to these expressions and give the following generalization:

customer(X),lives__in(X,beverly__hills),
buys(X,Z) and Z >= 25000.

This example uses one of the simplest generalization rules, referred to as the dropping condition rule. According to this rule, in order to generalize a conjunction you may drop some of its conjunctive conditions.

MODEL-DRIVEN LEARNERS

A model-driven learning program is characterized by its hypothesis forma-

(continued)

Aztec C ... The Best C

Frees the genius in you

You've got a great idea . . .

. . . you're ready to write your programs.

You don't want to be sidetracked by all the paperwork. With Manx Aztec C and the ingenious **make** function, your creative processes won't get bogged down in program administration and housekeeping. Manx Aztec C has the most sophisticated, hardworking program administrator available to you. Once you've described your project, adding new features or enhancements is simple. You never have to concern yourself with the repetitive, tedious task of rebuilding your systems.

The development process moves quickly. Compiles, assemblies, link edits . . . all finish in record time.

Manx Aztec C is the fastest, most efficient C development system in the industry. Benchmarks show it . . . reviews commend it . . . users praise it.

You're ready to test the program. You're ahead of schedule. The Manx Aztec C Source Level Debugger shows you the exact C language statement giving you a problem. You fix the problem quickly . . . you're still ahead of schedule.

You've got some time for fine tuning. The Manx Aztec C Profiler examines your program, tells you where the slow spots are and validates your test procedure. A few changes and it's exactly what you wanted.

You've made it!

Aztec C is available for MS-DOS/PC DOS. Call for details on Macintosh, Amiga, Apple II, CP/M-80, CP/M-86, TRS-80, ROM and others.

To order, or, for information

Call Today

1-800-221-0440

In NJ or outside the USA call
(201) 542-2121

30-day satisfaction guarantee. Special Discounts are available to professors, students, independent developers, and on a "trade-in" basis. Site licenses.

MANX

Manx Software Systems
One Industrial Way
Eatontown, NJ 07724

MS is a registered TM of Microsoft, Inc., CP/M TM DRI, HALO TM Media Cybernetics, PANEL TM Roundhill Computer Systems, Ltd., PHACT TM PHACT Assoc., PRE-C, Plink-86 TM Phoenix, db Vista TM Raima Corp., C-terp, PC-lint, TM Gimpel Software, C-free TM Faircom, Inc., Windows for C TM Creative Solutions, Apple II, Macintosh TM Apple, Inc., TRS-80 TM Radio Shack, Amiga TM Commodore Int'l.

Inquiry 197

" . . . a superb linker, a profiler, an assembler, and a set of development utilities are only the beginning of this package . . . performed admirably on the benchmarks, with short compile times and the best link times in this review . . . includes the most professional make utility . . . documentation is clear and complete. There is no doubt that this is a valuable and powerful programming environment." **Computer Languages Feb. '86**

" . . . execution times are very good, close to the best on most tests . . ." **PC Tech Journal Jan. '86**

" Easily one of the fastest compilers overall . . . library provides a lot of flexibility . . . generates small .EXE files." **Dr. Dobbs Journal Aug. '85**

C'Prime (Compiler, Assembler, Linker)	\$ 99.
Aztec C 86-d Developer's System	\$299.
Aztec C 86-c Commercial System	\$499.
PC ROM (8086, 68000, 8080, or 6502)	\$750.

Third Party Software for Aztec C: HALO, PHACT, C-tree, PRE-C, Windows for C, PC-lint, PANEL, Greenleaf, db Vista, C-terp, Plink-86, FirTime, C Util Lib, and others.

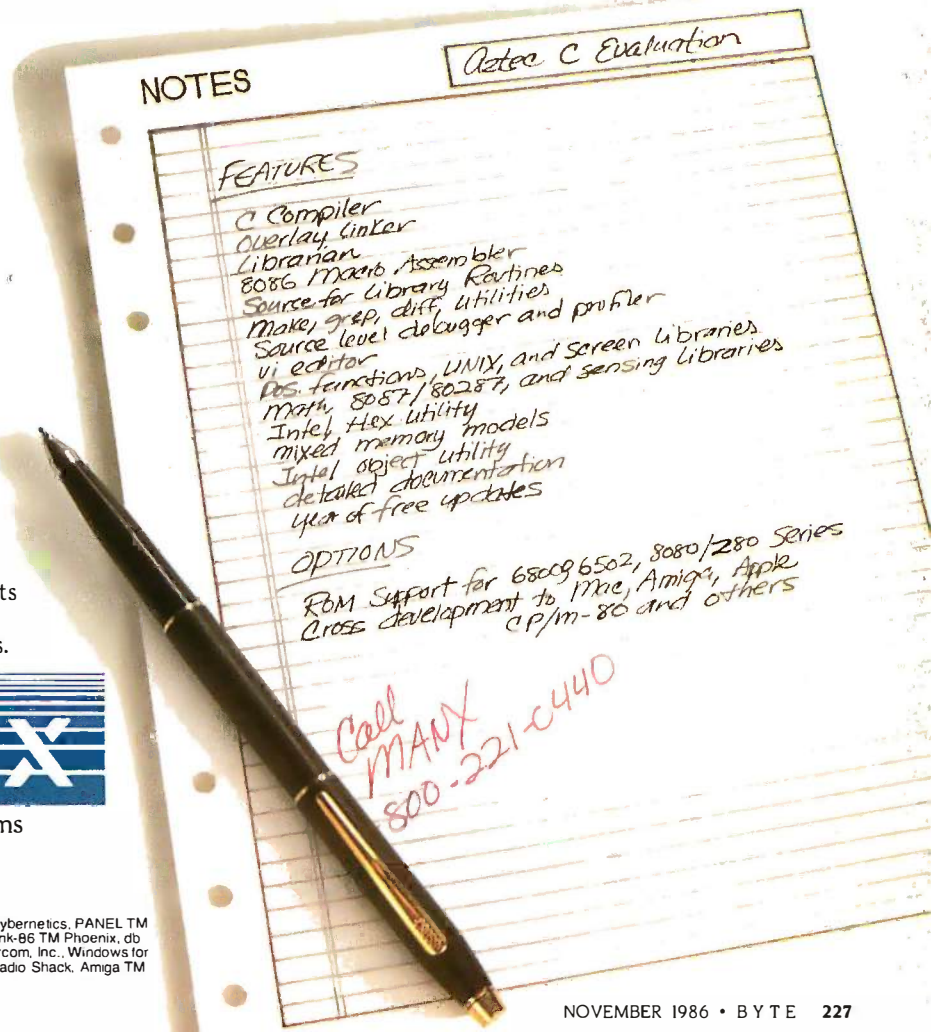

NOVEMBER 1986 • BYTE 227

WHO



YOU:

If you travel a lot you can benefit from the AT&T Card.

The AT&T Card will free you from coins and delays, give you an itemized record and AT&T's lowest rates for state-to-state calling, next to direct dialing. And it costs less than calling collect, or making coin calls out-of-state.

So, if you travel frequently, get the AT&T Card. It's as simple as dialing

1 800 CALL ATT, Ext. 229.



AT&T

The right choice.

MACHINE LEARNING

tion. Such programs form hypotheses that are then tested for verification against available data or through the assistance of the trainer.

From a general standpoint, the algorithm for a model-driven learner looks like this:

begin: develop a hypothesis

while hypothesis does not satisfy target concept *do* try another hypothesis that is more general or more specific depending on how the trial concept relates to the target concept.

Marvin's hypothesis formation differs from most other model-driven learners by taking advantage of what it already knows. Learned concepts that reside in memory are used to learn more complex concepts. Marvin develops concepts in much the way a human would; that is, the repertoire of concepts grows hierarchically.

EXPERT SYSTEMS

The expert systems applications at work today perform quite well in a limited domain and for routine rules of thumb in most cases. Enter the slightest novelty and deviation from the programmed knowledge and users get such discouraging answers as "This parameter has not been defined." Worse yet, the system cannot learn the new concept or relationship. Users are quickly frustrated by the expert system when they notice the wasteful paths it takes time after time trying to prove the same thing, not being able to improve on its problem-solving strategies, and, most important, not being able to learn from past errors. The knowledge-acquisition bottleneck can be eliminated by letting the expert system learn both rules and concepts in a more automated fashion. Such a system should also have the ability to acquire control techniques for optimizing its own processing. There are encouraging developments in all of these areas.

There is a danger that I may be overselling the automated part of learning and underestimating the difficulties involved. I would like to stress a simple point: For what the machine learns to be relevant it is necessary that humans stay close to the learn-

ing process. Also, for what is learned to be useful it must be scrutinized before it is used. This latter point is referred to by R. S. Michalski (reference 3) as the "comprehensibility principle." As for the question of relevance, even if you consider the seemingly simple case of inductive generalization, you immediately discover that a number of background assumptions go into the choice of direction along which generalization takes place. Paul Utgoff and T. Mitchell (references 4 and 5) use the term "bias" to describe that part of a learning program "which influences how the concept learner draws inductive inferences based on the observed training instances." It is impossible to capture in a computerized system all the human constraints and intentions, those apparent as well as the tacit. To assure greater cooperation between machine and humans in the process of learning, the system must display a good deal of transparency effected through flexible explanatory facilities.

MARVIN: A PROGRAM THAT LEARNS TO LEARN

Marvin, a machine learning program developed by C. Sammut (reference 6), pays heed to Banerji's suggestions for a language capable of growth. The description language that is used for Marvin is a subset of Horn clause logic. This language makes the learning and execution of a concept fairly easy because the concept is described in terms of a logic program.

Marvin depends on a human trainer to supply hierarchically structured sets of examples. The trainer presents Marvin with examples of a concept to be learned (the "target concept"), and Marvin generalizes a hypothesis (represented by a "trial concept") from the given examples. The search strategy that Marvin employs to capture the target concept is specific-to-general (i.e., starting from each example, the program creates a new trial concept that is a further generalization of the first example). To find out whether the hypothesis is a proper one, Marvin comes up with objects that are adequately described by the trial concept. These objects are in turn

(continued)

WHAT



DOES IT DO?

It's called the pound button. And it lets you make multiple calls faster when you use an AT&T Card.

Once you enter your AT&T Card number, the AT&T Network automatically remembers it. So between calls, just press the pound button and make your next call.

So, if you travel frequently, get the AT&T Card and save some time. Because time is something we can all use. Simply call

1 800 CALL ATT, Ext. 229



AT&T

The right choice.

What is the name of the concept? letter

Show me an example of letter: "A"

X is a letter if:

X is "A"

Show me an example of letter: "B"

X is a letter if:

X is "B"

.....
Show me an example of letter: "Z"

X is a letter if:

X is "Z"

Show me an example of letter: no

X is a letter if:

X is "A"

or X is "B"

.....
or X is "Z"

Do you want to teach me another concept? yes

What is the name of the concept? letter__list

Show me an example of letter__list: []

X is []

Show me an example of letter__list: [A]

The head of X is "A"

The tail of X is []

"A" is an instance of a letter.

The description can be generalized to:

The head of X is a letter

The tail of X is []

Is [B] also an instance of a letter__list? yes

[] is an instance of letter__list.

The description can be generalized to:

The head of X is a letter

The tail of X is a letter__list

Is [B A] an example of letter__list? yes

Show me an example of letter__list: no

The description of letter__list is:

X is a letter__list if:

X is []

or

The head of X is a letter

The tail of X is a letter__list.

Do you want to teach me another concept? yes

What is the name of the concept? append

Show me an example of append: ([],[A],[A])

X1 is []

The head of X2 is "A"

The tail of X2 is []

The head of X3 is "A"

The tail of X3 is []

[] is an instance of a letter__list.

The description can be generalized to:

The head of X2 is "A"

The tail of X2 is []

The head of X3 is "A"

The tail of X3 is []

X1 is a letter__list

Is ([A],[A],[A]) an instance of append? no

"A" is an instance of a letter.

The description can be generalized to:

X1 is []

The tail of X2 is []

The head of X3 is "A"

The tail of X3 is []

The head of X2 is a letter

Is ([],[B],[A]) an instance of append? no

The head of X2 is the same as the head of X3

The description can be restricted to:

X1 is []

The tail of X2 is []

The tail of X3 is []

The head of X2 is a letter

The head of X3 is the same as the head of X2

Is ([],[B],[B]) an instance of append? yes

[] is an instance of letter__list.

The description can be generalized to:

X1 is []

The tail of X3 is []

The head of X2 is a letter

The head of X3 is the same as the head of X2

The tail of X2 is a letter__list

Is ([],[B A],[B]) an instance of append? no

The tail of X2 is the same as the tail of X3

The description can be restricted to:

X1 is []

The head of X2 is a letter

The head of X3 is the same as the head of X2

The tail of X2 is a letter__list

The tail of X3 is the same as the tail of X2

Is ([],[B A],[B A]) an instance of append? yes

The description can be rewritten as:

X1 is []

X2 is a letter__list

X3 is the same as X2

Show me an example of append: ([A],[B],[A B])

.....
The tail of X1 is []

The head of X1 is a letter

The head of X3 is the same as the head of X1

X2 is a letter__list

The tail of X3 is the same as X2

Is ([B],[],[B]) an instance of append? yes

([],[X2, tail of X3]) is an instance of append

The description can be generalized to:

The head of X1 is a letter

The head of X3 is the same as the head of X1

(tail of X1, X2, tail of X3) is an append

Is [B A],[B],[B A B]) an instance of append? yes

The description of append is:

(X1,X2,X3) is an instance of append if:

X1 is []

X2 is a letter__list

X3 is the same as X2

or

The head of X1 is a letter

The head of X3 is the same as the head of X1

(tail of X1,X2,tail of X3) is an append

Figure 1: A session with the model-driven learner Marvin, wherein the trainer teaches Marvin the concepts letter, letter__list, and append. It is up to the trainer to present these concepts to Marvin in a hierarchical fashion. Note about append: Append joins a new letter__list onto the end of an existing letter__list so in the example of append, ([A],[B],[A B]), the letter__list [B] is appended onto the letter__list [A], resulting in the new letter__list [A B].

presented to the trainer.

If the trainer decides that the object is contained in the target concept (such an object is referred to as "consistent"), Marvin attempts a further generalization. If, however, the trainer decides that a particular object is not contained in the target concept (such an object is called "inconsistent") and there are no other possibilities for generalizing, Marvin takes into account the error of overgeneralizing and creates a new trial concept that is more restricted. A concept has been learned when all possibilities for generating trial concepts have been exhausted.

Marvin is composed of the following components:

- A description language.
- An interpreter. This interpreter for Marvin's language must recognize objects described by a concept and generate instances of the concept.
- An associative memory.
- A generalization procedure. This procedure creates a more general description once it is given a concept.
- A learning strategy. Marvin begins with an initial hypothesis and continues applying the generalization procedure until the target concept is learned.

The learning algorithm forms hypotheses that are tested for verification against available data or through the assistance of the trainer. The learning algorithm is given as follows:

1. Initialize. The example given by the trainer is described in a form of clausal logic. This makes up the initial hypothesis.
2. Generalize. Attempts are made to further generalize. If these attempts are proved unsuccessful, the learning process stops.
3. Test. The generalization is tested by constructing an object from the trial concept. If the trainer finds the object consistent, then go to 2.
4. Restrict. If the trial concept contains objects that are not to be found in the target concept, a more specific hypothesis is created. Go to 3.

THE DESCRIPTION LANGUAGE

Following Prolog, Marvin represents concepts using Horn clauses, that is,

expressions of the form $Q(X) \leftarrow P(X) \ \& \ R(X)$. The basic constructs of these expressions are predicates like $\text{father}(X,Y)$, interpreted as X is the father of Y . The choice of Horn clause logic means you can use a uniform way of describing sets of objects and relations among objects. Also, since concepts are represented as sets of Horn clauses, they can be executed as logic programs.

Suppose you want Marvin to learn the concept of New Yorker as a more specific case than that of a Manhattan resident. The concept could be given as

```
new_yorker(X) <-- human(X) &
                resides_in(X,manhattan) &
                walks_nervously(X).
```

While at work to learn concepts Marvin uses two types of memory: a long-term memory that is a database of descriptive Horn clauses like the one above and a short-term memory that contains only facts, that is, instantiated predicates like $\text{resides_in}(\text{francois,paris})$. The short-term memory contains descriptions of the trainer's examples. Such an example might look like this:

```
human(koch).
resides_in(koch,manhattan).
walks_nervously(koch).
```

A SESSION WITH MARVIN

Figure 1 shows the transcript of a session with Marvin where the trainer teaches Marvin the concepts of letter, `letter_list`, and `append` in that order.

At the outset, a distinction should be made between the syntactic repertoire of Marvin, which includes primitive constructs of lists, and semantic representations. Marvin's syntactic repertoire includes the properties of head and tail, which are separate from the concept of the semantic notion, list. Marvin has the ability to recognize when two objects are the same.

All concepts known are contained in Marvin's memory, which at the beginning of the session is empty. The trainer painstakingly gives Marvin every example of a letter and indicates that there are no other examples by replying to Marvin's query for another example of a letter with

"no." Marvin then presents its concept of a letter and asks if the trainer wants to teach it any other concepts. The interactive session continues with Marvin, and two incrementally more sophisticated concepts are learned, those of `letter_list` and `append`.

CONCLUSION

Professor Banerji and his colleagues of the Machine Learning Laboratory at St. Joseph's University are working on languages that are characterized by self-enrichment. One matter of particular interest is the way research in this area can be useful in future Prolog implementations that incorporate intelligent backtracking techniques. In a joint venture, the State of Pennsylvania through its Ben Franklin Partnership, St. Joseph's University, and Orphic Experts Inc. are in the process of developing learning programs that could prove of significance as enhancements for expert systems in the defense area in particular.

Finally, from what has been said in the course of this article you might get the feeling that I should be talking about machine-aided learning rather than machine learning. This goes along with the realization that despite the growing sophistication of its use, the computer remains just a tool for humans, at least for now. ■

REFERENCES

1. Simon, Herbert A., "Why Should Machines Learn?" in R. S. Michalski et al., eds., *Machine Learning I*. Palo Alto, CA: Tioga Publishing Co., 1983.
2. Banerji, R. B., "A Language for the Description of Concepts," in *General Systems 9*. Society for General Systems Research, University of Louisville, 1964.
3. Michalski, R. S., "Understanding the Nature of Learning: Issues and Directions," in R. S. Michalski et al., eds., *Machine Learning II*. Los Altos, CA: Morgan Kaufmann, 1986.
4. Utgoff, Paul E., "Shift of Bias for Inductive Concept Learning," in R. S. Michalski et al., eds., *Machine Learning II*.
5. Mitchell, T., "The Need for Biases in Learning Generalizations." Technical Report CBM-TR-117. Rutgers University, 1980.
6. Sammut, Claude, and R. B. Banerji, "Learning Concepts by Asking Questions," in R. S. Michalski et al., eds., *Machine Learning II*.

Think Fast.



Now think Toshiba T1100 PLUS. The IBM¹-compatible portable PC that puts full desktop PC power in a package small enough to fit in a desk drawer. And light enough to make an office out of any place there's a seat.

SPEED IS OF THE ESSENCE.

Computers can compute many times faster than our brain. But with many portable PCs, you can go out of your mind waiting for them to load a program, move around blocks of text, search through a data base or recalculate a spreadsheet.

Not so with the T1100 PLUS. Our 80C86 16-bit processor has 16-bit data paths and runs at 7.16 MHz. Combined with our 640KB of maximum memory capacity, it runs up to twice as fast. And that means you can get through your work faster. Whatever kind of work you do.

HOW SMALL IS IT?

Putting all this speed and power in a package only 12.1" W x 2.6" H x 12"D and weighing under 10 pounds was no small feat. We did it by using our unique gate array technology to reduce the number of ICs. Which gives you exceptional reliability as well as incredible portability.

IT BENDS OVER BACKWARDS.

O.K., it's fast, small and light. Which is enough in itself. But what else does the T1100 PLUS portable computer have going for it, you ask. Plenty, we say.

Ever had to squint or scrunch down to see what's going on with other portable PCs' screens? Our screen is a high-contrast, high-resolution LCD that shows 25 lines by 80 characters of text with 640 x 200 resolution. And it will even bend over backwards to

Now Think Small.

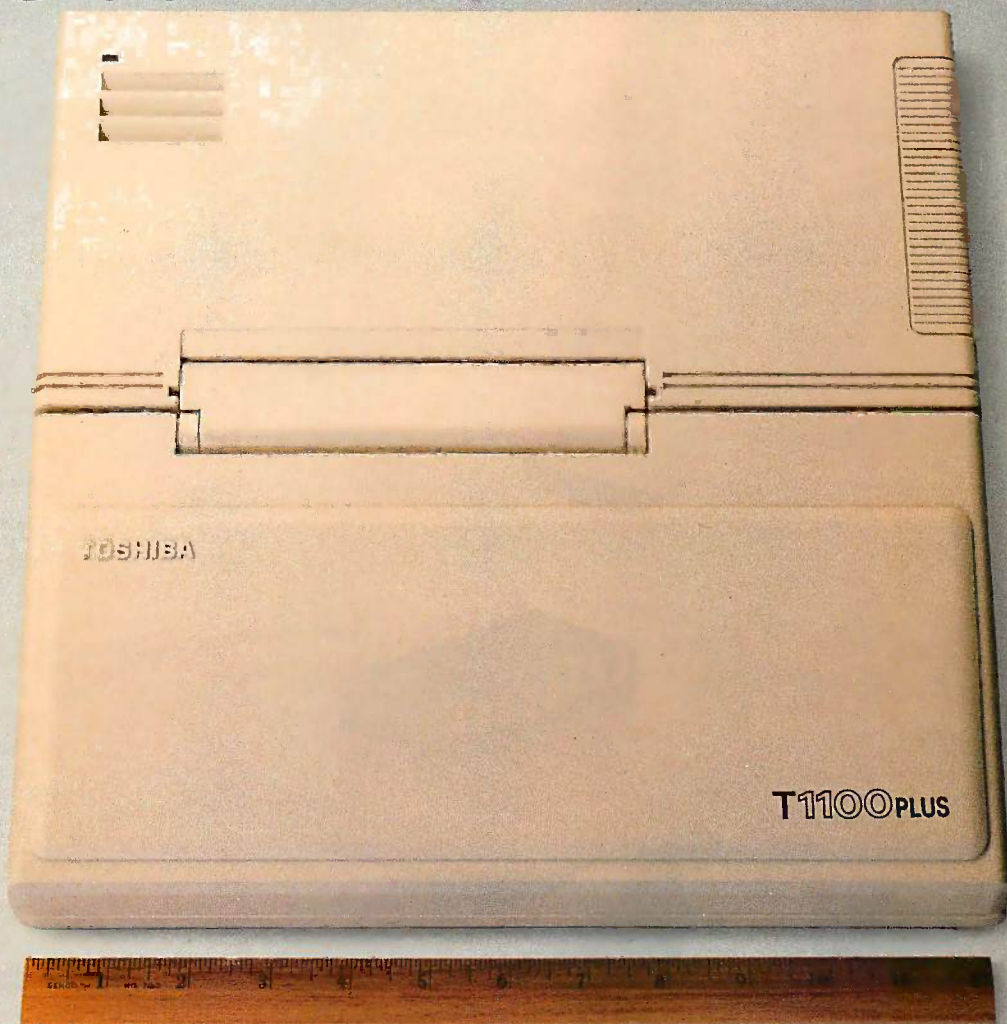

accommodate you by tilting a full 90 degrees.
STANDARDS THAT SET THE STANDARD.

The T1100 PLUS comes with a long list of standards including dual 720KB 3.5" disk drives, MS-DOS², serial, parallel and CRT ports, an IBM-compatible keyboard with 81 full-size keys, rechargeable NiCad batteries that last up to eight hours per charge, AC adapter, user's manual, MS-DOS manual and soft carrying case.

Also standard is SideKick³, the best-selling utility program that includes a notepad, calculator, autodialer, calendar and appointment scheduler. And our exclusive "Exceptional Care" Program. In the unlikely event

that anything goes wrong with your T1100 PLUS, we guarantee you prompt delivery of a replacement while yours is being fixed.*

Options for the T1100 PLUS include 300/1200 bps Hayes⁴-compatible internal modem, external 5.25" disk drive, Floppy Link to a desktop PC's 5.25" drive, IBM-compatible five-slot expansion chassis and automobile power adapter.

Is there anything we left out? Oh yes, the phone number for your nearest Toshiba computer and printer dealer. It's 1-800-457-7777. Please call to let us know you're thinking of us.

1. IBM is a registered trademark of International Business Machines Corp. 2. MS-DOS is a registered trademark of Microsoft Corp. 3. SideKick is a registered trademark of Borland Int'l, Inc. 4. Hayes is a registered trademark of Hayes Corp. *Requires no-cost enrollment in "Exceptional Care" Program.

In Touch with Tomorrow

TOSHIBA

Toshiba America, Inc., Information Systems Division

Inquiry 348

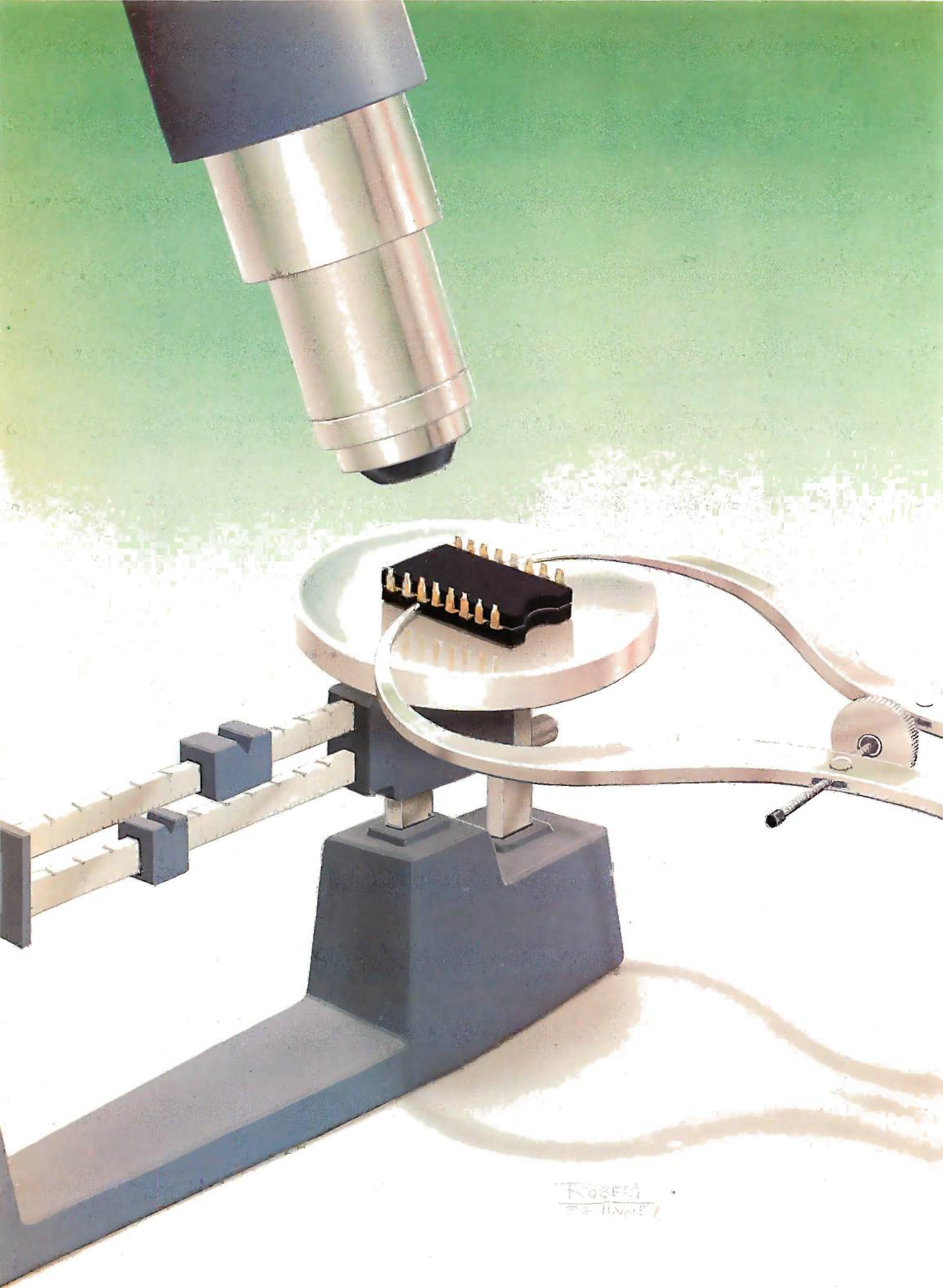

KOZEM
94 11/10/17

Reviews

REVIEWER'S NOTEBOOK <i>by Jon Edwards</i>	237
THREE IBM CLONES <i>by John D. Unger</i>	239
THE MACINTOSH PLUS <i>by Chris Crawford</i>	247
THREE 24-PIN DOT-MATRIX PRINTERS <i>by Robert D. Swarengin</i>	255
DIGITIZERS FOR DATA ENTRY <i>by Eldon D. Hearn</i>	261
TWO C COMPILERS FOR THE AMIGA <i>by Charlie Heath</i>	271
SPSS/PC+ <i>by Jeffrey M. Jacques</i>	279
AEGIS ANIMATOR AND AEGIS IMAGES <i>by Warren Block</i>	285
TURBO LIGHTNING AND STRIKE <i>by Ross Ramsey</i>	289
FILEPRO 16 AND FILEPRO 16 PLUS <i>by Richard Harkness</i>	297
REVIEW FEEDBACK	301

JOHN D. UNGER reviews three IBM PC clones: the Kaypro PC, the Epson Equity I, and the Multitech MPF-PC/700. He compares their performance and functionality, and he notes that although the hardware designs are markedly different, all three emulate the IBM PC well. He found the Kaypro PC to be the best value, while the MPF-PC/700's faster clock speed accounts for its high performance.

Chris Crawford examines the Macintosh Plus. He concludes that the computer solves most of the problems inherent in the original 128K-byte Macintosh by virtually eliminating disk swapping and providing more disk storage and RAM space. He and Tom Thompson, a BYTE technical editor, also compare four memory-expansion kits for the Macintosh Plus.

Robert D. Swarengin looks at three 24-pin dot-matrix printers. All three are fast, versatile, and provide excellent quality, but Robert notes that there is a wide range in functionality and price.

Eldon D. Hearn surveys eight digitizers. A single table summarizes the features and capabilities of the devices. The article explains the table and also provides information that should prove essential before you purchase a digitizer.

Charlie Heath compares two popular C compilers for the Amiga. Both Lattice C and Manx Aztec C68K have strengths and weaknesses, and either should suit your needs, but the Aztec C68K compiler scored well in the benchmarks. Charlie also praises the C68K compiler for providing source code for the library functions and for generating more compact code.

Jeffrey M. Jacques examines SPSS/PC+, an analytical software package. Jeffrey has found that the package provides a substantial but incomplete subset of SPSS-X, the mainframe version. He concludes that the package does almost everything you might want it to do, and at a reasonable price.

Warren Block was among the first to use Aegis Animator and Aegis Images. His review reveals that the Amiga is getting the fine software that its hardware deserves.

Ross Ramsey compares Turbo Lightning and Strike. Both products provide RAM-resident spelling checkers that correct your spelling as you write. Ross has found that, at least for him, the programs are less useful and more annoying when used with longer documents. Strike is less expensive, but you may require some or all of Turbo Lightning's options.

Finally, Richard Harkness recommends filePro 16 and filePro 16 Plus, two PC-DOS and MS-DOS relational database management systems. He notes that both are fast, flexible, and worth a long look.

A COMMAND PERFORMANCE

Your performance depends as much on your instrument as it does on your ability.

XyWrite III is a critically acclaimed word processor that extends your writing and editing range—on a simple memo or letter, a complex technical or legal document, or a multi-column script. With XyWrite III, you get nine windows, a redefinable keyboard, and many more features to support a truly fine performance.

A pianist couldn't perform if several seconds elapsed between pressing a key and hearing the note. You shouldn't wait precious seconds for your word processor to handle a command. XyWrite III processes your commands instantly, so you get more done in less time.

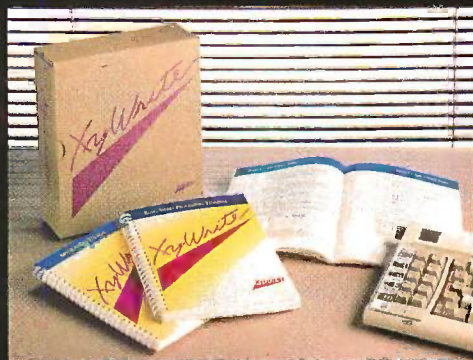

Enjoy the feel of a superior instrument when you sit down at the keyboard. Call (617) 275-4439 today and order our demo disk.

XyQuest

XyQuest, Inc.
3 Loomis Street, Bedford, MA 01730

R·E·V·I·E·W·E·R'S N·O·T·E·B·O·O·K

The MacWorld Expo in Boston was a big hit. The crowds were vibrant, and there were many impressive developments. The most obvious of these were in desktop publishing. Packages such as PageMaker (Aldus Corporation, 411 First Ave. S, Suite 200, Seattle, WA 98104, (206) 622-5500) and MacPublisher II (BSPI, 1260 Boylston St., Boston, MA 02215, (800) 556-0027) were in evidence, but they will undoubtedly be even more effective when they are marketed with larger screens for the Macintosh.

At the Expo we saw one such screen, The Big Picture from Levco (6160 Lusk Blvd., San Diego, CA 92121, (619) 457-2011). This upgrade for the Macintosh Plus or the 512K-byte Macintosh provides a 17-inch display with a 1024-by 808-pixel grid. It wasn't hard to imagine typesetting two facing pages simultaneously on this screen and future versions of the page-composition systems. To install The Big Picture, you connect a display controller to the 68000 with a clip-on connector.

IDT Systems (301 Bronxville Rd., Bronxville, NY 10708, (914) 968-7647) supplies MegaScreen, a video peripheral system for the Macintosh Plus with 1024-by 1024-pixel resolution. MegaScreen also uses an internally installed card. Both units provide 128K bytes of on-board video memory, and both manufacturers claim full compatibility with Macintosh software.

The most interesting application that we saw at the Expo was the latest version of FullPaint from Ann Arbor Softworks (308½ South State, Ann Arbor, MI 48104, (313) 996-3838). The application, which requires at least 512K bytes of memory to operate, allows you to paint on the entire screen and on up to four documents

at the same time. You can therefore cut and paste among several documents, and FullPaint is fully upward-compatible with MacPaint files. The program is also compatible with Switcher, digitizing tablets, and digitizing cameras.

The SCSI port on the Macintosh Plus is responsible for the proliferation of third-party hard disks for the computer. Perhaps the most interesting of these is the drive from ProApp (1475 South Bascom Ave., Suite 101, Campbell, CA 95008, (408) 559-3552), which you can also connect to a variety of other Apple computers, including the IIe, the IIc, and the earlier 128K- and 512K-byte Macintoshes. The drive hooks directly to the SCSI port, but you can also connect it to the floppy disk port on an Apple II. The best feature of the hard disk is that you can partition the drive to accommodate both a Macintosh Plus and an Apple IIe or IIc.

For the Amiga, I looked this month at MaxiPlan, a powerful spreadsheet from MaxiSoft (2817 Sloat Rd., Pebble Beach, CA 93953, (408) 625-4104). The software makes full use of the Amiga's environment. It supports multitasking, and with the mouse you can easily select and drag on cells, select the numerous options from standard pull-down menus, and generate full-color charts in a variety of styles and formats. Additional features allow you to easily use the application as a database manager, and the program has voice support for the blind.

Highways and Byways from New Directions Software (5259 Sepulveda Blvd., Suite 9, Van Nuys, CA 91411, (818) 784-9354) caught our attention. For IBM PC compatibles, the software allows you to plan your automobile trips and keep track of expenses quickly and effectively. There will be

three regional maps for use with the program (at press time only the western map was available, but the company says that central and eastern maps will be out by the end of the year), each for \$49.95. It was easy to generate routes, and I was impressed that the algorithm generated the same route regardless of whether I went from point A to point B or from point B to point A.

The software lists the route with reasonable directions, and you can obtain an estimate of how much time is involved. You can also vary a number of parameters including the season and the type of car you drive, and you can optimize the route for either time or distance. The product seems well suited for long-distance routing. Localities are not finely mapped, however.

Last month I discussed my working environment. Since then, I have added Cruise Control from Revolution Software (715 Route 10 E, Randolph, NJ 07869, (201) 366-4445), which Ezra Shapiro discusses in his column this month. I can also report that the software performs extremely well. At the DOS level and with PC-Write, my favorite word processor, the cursor moves about three times faster. More importantly, perhaps, I encountered no incompatibilities with any of my other RAM-resident software.

Also amazing is WildFire, a Zenith Z-151/-152/-161 speed kit from Software Wizardry (1106 First Capitol Dr., St. Charles, MO 63301, (314) 946-1968). The kit includes a V20, a plug-in daughterboard, and a new chip set that Software Wizardry claims will outperform a Z-158 at 8 MHz. I will install it this month in our Z-151 and report next month on the "new" system's performance.

—Jon Edwards
Senior Technical Editor, Reviews

12MHz SPEED plus A MEGABYTE FOR DOS!



THEY ALL NEED NUMBER SMASHER/ECM™

Turn your PC or XT into the machine it should have been! The 12 MHz Number Smasher/ECM is the fastest accelerator on the market. It is also the most powerful, providing a **true megabyte** for DOS!

To break the 640K DOS barrier MicroWay designed a Memory Management Unit (MMU) that is tailored to DOS plus a 2000 byte resident driver—MegaDOS™. MicroWay calls this breakthrough Extended Conventional Memory. When you type CHKDSK with the board installed, your system will report 1,036,288 bytes total memory and 1,010,016 bytes free! Any conventional DOS program can utilize a full megabyte for data or code without changing a byte.

Downloading a mainframe application? ECM memory runs with any program that uses DOS for screen services including RM and MS FORTRAN and MS and LATTICE C! This means you have an additional 384K available for oversized applications. Programs which write directly to the screen require a simple patch to adhere to the new standard. MicroWay has already developed patches for the Lotus, WORDSTAR and AUTOCAD screen drivers. Release 1A of 1-2-3 jumps from 535,516 to 916,444 bytes available and runs faster than Release 2 for most worksheets.

Number Smasher/ECM is 100% compatible with all hardware and software including EMS and EGA boards. The compatibility is a result of control: its speed is switch, keyboard or software selectable from 4.77 MHz to 12.0 MHz. Applications which have not been upgraded to ECM can still be run by setting DOS to 640K or 704K and using the memory above DOS for I/O enhancers.

Number Smasher/ECM runs floating point bound programs faster than an AT or any other 80286 based machine. In fact, Number Smasher's 12 MHz 8087 runs a factor of three faster than the standard 80287 on the AT, delivering up to 125 kflops. Software is included for RAM Disk, print spooler, and disk caching, which speeds up floppy and hard disks by a factor of 2 to 10!

Number Smasher/ECM is the most cost effective productivity tool you can buy. The base board which runs at 9.54 MHz comes with 512K and costs only \$599! The complete system which includes a motherboard accelerator, one megabyte of memory and a 12 MHz 8087 is just \$1199. Call today to discuss your particular configuration. Remember: *"The advantage of buying from MicroWay is outstanding personal service."* (PC Magazine, 6/10/86 - p. 162)

Micro Way

The World Leader in 8087 Support

P.O. Box 79, Kingston, Mass. 02364 USA (617) 746-7341
Tempo House, London, U.K. call 01-223-7662

Number Smasher, ECM and MegaDOS are trademarks of MicroWay, Inc. MicroWay is a registered trademark of MicroWay, Inc.



THREE IBM CLONES

BY JOHN D. UNGER

A trio of IBM PC clones from Kaypro, Epson, and Multitech

Three new IBM PCXT clones have recently appeared on the already crowded IBM PC clone market. Two are from longstanding computer hardware manufacturers Kaypro and Epson. The third clone, manufactured by Multitech, comes from Taiwan.

The \$1595 Kaypro PC is the only desktop IBM PC compatible that Kaypro is currently marketing. The Epson that I reviewed is the \$1295 Equity I. I also reviewed the \$1230 Multitech MPF-PC/700 DI.

I am intrigued by the different hardware approaches used by the three manufacturers to achieve compatibility with the IBM PC. Both the hardware design and the component layout vary markedly from computer to computer. However, the net results are similar, and all three micros emulate the IBM PC well.

The Multitech and Epson machines were limited in the amount of software that I could check for compatibility because they use the equivalent of IBM's monochrome adapter board and display. The Kaypro PC also has a monochrome monitor, but its multivideo board can display colors in shades of green as well as emulate the monochrome display of the IBM PC.

All three computers come with two 360K-byte double-sided double-density disk drives and 256K bytes of RAM. The Kaypro and Epson systems include a monochrome monitor, but Multitech did not include a monitor with the MPF-PC/700 that I reviewed; therefore, the Epson's monitor performed double duty during the



review. All the systems included the MS-DOS 2.11 operating system. The Kaypro PC comes bundled with an impressive array of MicroPro software (see page 240), and the Multitech system includes an intriguing optional operating system, Concurrent CP/M. Both the Multitech and the Kaypro systems would be suitable for use as small business or home computers, but the Epson system, because of its limited expansion capability and small power supply, would be better in a home environment.

DISPLAY

The Kaypro PC comes with its own multivideo board, which gives you the option of using three outputs: monochrome, RGB, and composite video. A memory-resident utility program

lets you switch between monochrome and color modes. The default mode at start-up is set by DIP switches on the video board. A green monochrome monitor comes standard with the Kaypro PC. This monitor uses a high-persistence phosphor that leaves a faint but noticeable ghost image on the screen when you scroll through text or play certain games.

You can run graphics programs that use color on this system; the colors are displayed as shades of green. The Multitech MPF-PC/700 has a standard CGA (color graphics adapter) board but no monitor. I did not have a monitor compatible with this type of video adapter, but Multitech provided me with a monochrome adapter that I was able to use with the Equity I's monitor. [Editor's note: The Multitech MPF-PC/700

now includes a high-resolution soft-white (K171 phosphor) 12-inch monochrome monitor in its standard configuration.]

The Equity I has a monochrome display board and monitor. This combination displays only text and the IBM graphics characters.

KEYBOARD

Both the Equity I and the Kaypro PC have IBM PC AT-style keyboards. The Kaypro PC's is complete with a System Request key, lighted indicators for the Caps, Scroll, and Num Lock keys, and it has a keyboard lock on the front

(continued)

John D. Unger (P.O. Box 95, Hamilton, VA 22068) is a geophysicist for the U.S. government who writes graphics software and uses computers to study the structure of the earth's crust.

REVIEW: THREE IBM CLONES

Name	Kaypro PC	Equity I	MPF-PC/700 D1
Company	Kaypro Corporation 533 Stevens Ave. Solana Beach, CA 92075 (619) 481-3900	Epson America Inc. Computer Products Division 2780 Lomita Blvd. Torrance, CA 90505 (213) 539-9140	Multitech Electronics Inc. 1012 Stewart Dr. Sunnyvale, CA 94086 (800) 538-1542
Size	19½ by 16 by 6 inches 30 pounds	14½ by 15 by 6 inches 23 pounds	17½ by 16½ by 6 inches 27½ pounds
Components			
Processor:	8088 at 4.77 MHz	8088 at 4.77 MHz	8088-2, switchable between 4.77 and 8 MHz
Memory:	256K bytes dynamic RAM (standard); expandable to 640K bytes on motherboard	256K bytes dynamic RAM (standard); expandable to 512K bytes on motherboard	256K bytes dynamic RAM (standard); expandable to 640K bytes on motherboard
Mass storage:	Two Canon MDD 531 360K-byte double-sided double-density 5¼-inch drives	Two Epson SD-500 360K-byte double-sided double-density 5¼-inch drives	Two Panasonic 360K-byte double-sided double-density 5¼-inch drives
Display:	High-resolution green monochrome 12-inch diagonal screen; compatible with IBM monochrome adapter and IBM color graphics adapter; composite, RGB, and monochrome video output connectors	High-resolution green monochrome 12-inch diagonal screen; monochrome display adapter (IBM compatible)	High-resolution soft-white 12-inch diagonal screen; color graphics adapter (IBM compatible)
Keyboard:	Detached QWERTY with 84 keys including 10 function keys and numeric keypad	Detached QWERTY with 83 keys including 10 function keys and numeric keypad	Detached QWERTY with 97 keys including 10 function keys, separate cursor keys, and numeric keypad
Expansion:	Three full-length and three half-length slots	Two full-length slots	Four full-length slots
I/O interfaces:	One RS-232C serial port (9-pin); one Centronics-compatible parallel printer port (25-pin); speaker (accessed from BASIC or assembly language)	One RS-232C serial port (25-pin); one Centronics-compatible parallel printer port (25-pin); speaker (accessed from BASIC or assembly language)	One RS-232C serial port (25-pin); one Centronics-compatible parallel printer port (25-pin); speaker (accessed from BASIC or assembly language)
Software	MS-DOS 2.11; GW-BASIC; WordStar; MailMerge; CorrectStar; StarIndex; PolyWindows Desk; Mite	MS-DOS 2.11; GW-BASIC	MS-DOS 2.11; Concurrent CP/M; MASM (Microsoft Macro Assembler)
Documentation	MS-DOS 2.11 user's guide, MS-DOS 2.1 programmer's reference manual; GW-BASIC 2.0 manual; software manuals for WordStar, MailMerge, CorrectStar, StarIndex, PolyWindows Desk, and Mite	User's guide; MS-DOS manual; GW-BASIC manual	MS-DOS 2.11 user's and reference guides; Concurrent CP/M user's and reference guides
Price	\$1595	\$1295	\$1230

SYSTEM FEATURES

MEMORY SIZE (K BYTES)

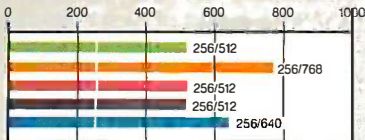

DISK STORAGE (K BYTES)

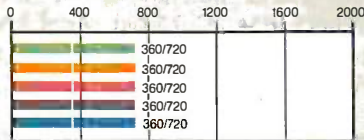

DISK ACCESS IN BASIC (IN SECONDS)

WRITE

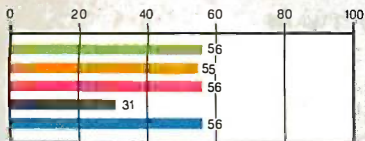

READ

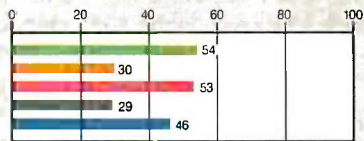

BASIC PERFORMANCE (IN SECONDS)

SIEVE



CALCULATIONS

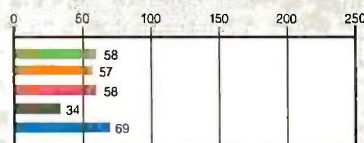

SYSTEM UTILITIES (IN SECONDS)

40K FORMAT/DISK COPY

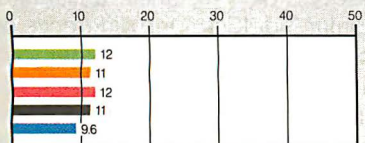

40K FILE COPY

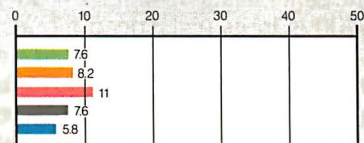

SPREADSHEET (IN SECONDS)

LOAD

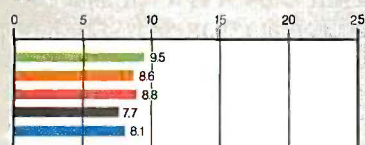

RECALCULATE

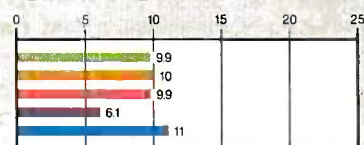

■ Epson Equity I ■ Multitech MPF-PC/700 (4.77 MHz) ■ IBM PC
■ Kaypro PC ■ Multitech MPF-PC/700 (8 MHz)

panel. The Equity I's keyboard lacks these features. The MPF-PC/700's ASCII keys are laid out similarly to the PC XT's, but the left Shift key is easier to reach and there is a larger Return key. The MPF-PC/700 also has a convenient separate cursor keypad located between the main keyboard and the numeric keypad. Heavy spreadsheet users will appreciate this arrangement. The feel of all three keyboards was good, but none has an audible click like the IBM keyboards. My favorite is the Equity I's, which is somewhat firmer than the other two, but I found no strong shortcomings with any of them.

HARDWARE AND LAYOUT

Both the Kaypro PC and the Multitech MPF-PC/700 are similar in appearance to IBM machines. The Kaypro PC is almost a duplicate of the PC AT, even down to the keyboard lock on the front panel. The Multitech MPF-PC/700 resembles the PC XT except for its color scheme and the hardware reset switch on the front panel.

The Epson Equity I has a much smaller footprint and more attractive styling than the other two machines. Epson uses flip-down panels on the front of the main unit. The on/off switch is behind one panel at the top right, and a larger panel beneath the disk drives conceals a hardware reset button and ten DIP switches that you use to configure the amount of RAM, the type of monitor installed, the number of floppy disk drives in the system, and whether the parallel and serial ports are enabled or disabled.

At first examination, all three computers seem to use a basic IBM-like layout for their internal components. However, a closer look reveals some important differences. The Equity I's small size means that internal components are tightly packed and there is room for only three expansion slots. Only two are available after a video board is installed. There is room for only two half-height disk drives, one of which can be replaced by a half-height hard disk, and they must be removed for access to the motherboard components, microprocessor chip, and RAM.

(continued)

The Equity I's power supply is rated at only 55 watts. Normally this would limit expansion capability, but since the machine has only three internal slots, the low power output is not critical.

The MPF-PC/700's layout is similar to a standard IBM PC XT's except that the two floppy disk drives are mounted on the removable top cover of the case rather than on the main frame of the unit. You have to handle the cover carefully when removing it because of the umbilical wires connected to the main unit. Both the MPF-PC/700 and the Kaypro PC have space on the main chassis to add an internal full-height hard disk drive in addition to the two standard half-height floppy disk drives.

The Kaypro PC's layout superficially resembles the IBM PC's. However, the Kaypro PC's motherboard is used only as a mount for the expansion slots. The microprocessor and its accessory chips reside on one full-length expansion card, and the RAM, disk controller circuits, and I/O ports are on another. A third full-length slot is taken up by the Kaypro PC's multi-mode video board. This layout still leaves three full-length and three half-length slots free for further expansion.

Putting the microprocessor and its ancillary chips on an expansion card makes the Kaypro PC instantly upgradable and is a guarantee against obsolescence. In fact, Kaypro is now advertising an 80286 processor replacement board that turns the Kaypro PC into an IBM PC AT clone. The only catch is that the Kaypro has an 8-bit data path between the processor board and RAM board because the expansion slots on the Kaypro PC are compatible with the IBM PC rather than with the AT's 16-bit data path. This degrades performance somewhat because the 8-bit bus needs more clock cycles to send the same information between the microprocessor and memory.

The hardware reset switch for the Kaypro PC is mounted on the microprocessor expansion board at the rear of the computer. It is more awkward to reach than the front-mounted reset switches on the Equity I and the Multitech MPF-PC/700.

The Kaypro PC's card-mounted serial port is a 9-pin connector like that found on the IBM PC AT. The Equity I and the MPF-PC/700 have standard IBM PC 25-pin serial and parallel ports mounted on their system motherboards.

INTERNALS

More differences show up here. First, the Equity I has no socket for an optional 8087 coprocessor, and although all three use the 8088 chip for their microprocessors, the MPF-PC/700 uses the 8088-2 version of this chip. This allows switching between clock rates of 4.77 and 8 MHz. The MPF-PC/700 handles changes in processor speed gracefully. You can change speeds either by running a short utility program that is included with the operating system software or by simultaneously pressing the Ctrl, Alt, and plus (+) keys. You can change the default processor speed at start-up by moving a shorting plug on the motherboard. A green LED on the front panel lights up when the MPF-PC/700 is in its high-speed mode.

The Kaypro PC that I reviewed was configured with three banks of nine 256K-bit RAM chips. This gives a total of 768K bytes of memory, but only 640K bytes are used by MS-DOS. The Kaypro PC comes with a RAM disk program that uses the extra 128K bytes of memory as well as any part of the regular 640K bytes.

To add memory beyond the standard 256K bytes in the Equity I, you have two options. Epson makes a 265K-byte piggyback board that mounts in a special system-board socket. This way you can have 512K bytes of memory in the Equity I without using one of the expansion slots. The second possibility is to add a standard IBM PC-compatible memory-expansion board and bring the system memory up to 640K bytes.

It should be possible to configure the MPF-PC/700 with 640K bytes on the motherboard, but the user's manual only describes how to set the machine up with 512K bytes of RAM. The Multitech user's guide shows how to configure the MPF-PC/700 with either 64K-byte or 256K-byte memory chips in two banks of nine chips.

Elsewhere the documentation states that 640K bytes of RAM can be installed on the system board. My review machine had room for 36 RAM chips in four banks of nine chips. Only one bank was populated with 256K chips.

The Kaypro PC is the only machine whose standard configuration includes both an internal clock and backup battery.

SOFTWARE

The Kaypro PC comes bundled with an impressive array of software, which makes this micro a good value for someone who is starting computing from scratch. This software is not a collection of freeware or little-known programs but useful, full-featured programs that almost eliminate the need to buy anything else for general home or business use. The only program missing is a spreadsheet.

The PolyWindows Desk software is published by Polytron Corporation and is a memory-resident desktop accessory program similar to Borland's popular SideKick. One difference between PolyWindows and SideKick is that you can choose to load as few or as many of the memory-resident features as you want with PolyWindows, thus conserving RAM. Mite is a communications software package from Mycroft Labs. It is a terminal emulation program that allows the Kaypro PC to communicate over bulletin boards and with other computers.

Multitech gives you the unusual option of choosing between two operating systems for the MPF-PC/700: MS-DOS 2.11 or Concurrent CP/M. [Editor's note: Multitech is now supplying MS-DOS 3.1 with its computers.] Most users will prefer MS-DOS because of its popularity and compatibility with PC-DOS and with IBM software, but the version of CP/M included with the MPF-PC/700 allows you to run MS-DOS applications from within the CP/M operating system. Concurrent CP/M also supports multiuser and multitasking processing, making it more versatile than MS-DOS for certain functions.

Multitech does not provide a BASIC interpreter, but Microsoft's MASM,

(continued)

LOGITECH MODULA-2/86 HOLIDAY PACKAGE

\$89 Price

- Separate Compilation
- Native Code Generation
- Large Memory Model Support
- Multitasking
- Powerful Debugging Tools
- Comprehensive Module Library
- Available for the PC and the VAX

Use LOGITECH MODULA-2/86 to decrease your overall development cycle and produce more reliable, more maintainable code.

LOGITECH MODULA-2/86 \$89

Includes Editor, Run Time System, Linker, 8087 Software Emulation, Binary Coded Decimal (BCD) Module, Logitech's comprehensive library, Utility to generate standard .EXE files. AND more!

LOGITECH MODULA-2/86 with 8087 Support \$129

LOGITECH MODULA-2/86 PLUS \$189

For machines with 512K of RAM. Increases compilation speed by 50%.

RUN TIME DEBUGGER (Source level!) \$69

The ultimate professional's tool! Display source, data, call chain and raw memory. Set break points, variables, pinpoint bugs in your source!

UTILITIES PACKAGE \$49

Features a Post-Mortem Debugger (PMD). If your program crashes at run-time the PMD allows you to analyze the status of the program and locate the error. Also includes a Disassembler, Cross Reference Utility, and Version that allows conditional compilation.

LIBRARY SOURCES \$99

Source code now available for customization or exemplification. Inquiry 187



\$199 Special Holiday Offer

Step up to the power of LOGITECH MODULA-2/86 at a saving of nearly \$100 off our usual low prices! We're offering a complete tool set including our compiler with 8087 support (for use with or without an 8087), our Turbo to Modula-2/86 Translator, Run Time Debugger, and Utilities in one holiday package at a special price!

WINDOW PACKAGE \$49

Build windows into your programs. Features virtual screens, color support, overlapping windows and a variety of borders.

MAKE UTILITY \$29

Figures out dependencies and automatically selects modules affected by code changes to minimize recompilation and relinking.

CROSS RUN TIME Debugger and ROM Package \$199

Still available at an introductory price!

TURBO PASCAL to MODULA-2 TRANSLATOR \$49

"Turbo Pascal... is a very good system. But don't make the mistake of trying to use it for large programs."

*Niklaus Wirth**

Our Translator makes it even easier for Turbo users to step up to Modula-2/86. It changes your Turbo source code into Modula-2/86 source, solves all the incompatibilities, and translates the function calls of Turbo into Modula-2/86 procedures. Implements the complete Turbo libraries!

Call for information about our VAX/VMS version, Site License, University Discounts, Dealer & Distributor pricing.

30 Day Money Back Guarantee!
To place an order call our special toll free number:

800-231-7717
in California
800-552-8885

YES I want to step up to LOGITECH MODULA-2/86!

Here's the configuration I'd like:

- | | |
|---|-------|
| <input type="checkbox"/> Special Holiday Package | \$199 |
| <input type="checkbox"/> Logitech Modula-2/86 | \$89 |
| <input type="checkbox"/> with 8087 support | \$129 |
| <input type="checkbox"/> Plus Package | \$189 |
| <input type="checkbox"/> Turbo to Modula Translator | \$49 |
| <input type="checkbox"/> Run Time Debugger | \$69 |
| <input type="checkbox"/> Utilities Package | \$49 |
| <input type="checkbox"/> Library Sources | \$99 |
| <input type="checkbox"/> Window Package | \$49 |
| <input type="checkbox"/> Make Utility | \$29 |
| <input type="checkbox"/> ROM Package | \$199 |

Add \$6.50 for shipping and handling. Calif. residents add applicable sales tax. Prices valid in U.S. only.

Total Enclosed \$ _____

Visa MasterCard Check Enclosed

Card Number _____ Expiration Date _____

Signature _____

Name _____

Address _____

City _____ State _____ Zip _____

Phone _____

 LOGITECH

Logitech, Inc.
805 Veterans Blvd.
Redwood City, CA 94063
Tel: 415-365-9852

In Europe:
Logitech SA, Switzerland
Tel: 41-21-879656

In Italy: Tel: 39-2-215-5622

LINK, CREF, and EXE2BIN programs for assembling and linking assembly language programs are included with the MS-DOS utility software.

The Equity I is bundled with MS-DOS 2.11 and GW-BASIC. As part of the operating system utilities, Epson provides menu-driven programs that format and copy disks and configure the serial port.

PERFORMANCE AND COMPATIBILITY

As the benchmark graphs show, there were no big surprises when the BYTE benchmark tests were run on these three micros. The results are similar to those obtained for the IBM PC. The exceptions are for the MPF-PC/700 running in its 8-MHz mode and for the Kaypro PC's BASIC Disk Access Read test. The former results are easily understood, but the Kaypro's increased performance in the Read test is less easy to decipher. It may be due to the way that the machine's file-read BIOS function is written.

In terms of day-to-day performance, you would not notice very many differences while using any of the three computers unless you had the MPF-PC/700 in its high-speed mode all the time. I had no problems running any of my IBM software in the 8-MHz mode.

All three micros are highly compatible with the IBM PC. Kaypro uses the well-known ROM made by Phoenix Software. Both Epson and Multitech have apparently developed their own versions of IBM's ROM.

I could not find any IBM software that would not run on these computers with the exception of games and graphics programs that must run in the color graphics mode. These could not be tested on the Equity I or the MPF-PC/700 because of their monochrome display boards.

As always, you should try your favorite applications program on the computer of your choice before you buy the machine.

DOCUMENTATION

Epson's manuals consist of two 8- by 10-inch three-ring binders that fit into one 5-inch-thick slipcase. The user's guide has clear instructions that help

a beginner get the Equity I up and running quickly. The MS-DOS manual is part of the same binder as the user's guide and is about average in terms of completeness and ease of use. The explanation of the operating system commands is clearer and the examples are better than those in the IBM DOS manual. The GW-BASIC manual is adequate.

Multitech includes four slim paperback volumes with the MPF-PC/700. One pair consists of user's and reference guides for MS-DOS 2.11; the other pair offers similar information for Concurrent CP/M.

The operating system manuals are copies of generic Microsoft and Digital Research documents. Much of the information specifically related to the MPF-PC/700 is duplicated in the two user's guides.

As you might expect with all its bundled software, the Kaypro PC has the largest number of manuals. All nine of them are inexpensively bound 7- by 9-inch paperbacks. Although the software manuals included for the MicroPro products are not complete reference manuals, they describe how to use the programs adequately. The manuals for Mite and PolyWindows Desk are written by their respective software publishers. The Mite manual is particularly well written and easy to understand. The presence of an MS-DOS 2.11 programmer's reference manual is a welcome addition for users who will be writing software for the computer.

SUPPORT AND SERVICE

The Equity I comes with a one-year warranty on parts and labor. Epson has a widespread network of dealers throughout the U.S., so obtaining service should not be much of a problem. The compactness of the computer and the difficulty of getting at the main circuit board makes the Equity I harder to work on than the other micros.

The Kaypro PC has a 90-day warranty period that covers all parts and labor. Purchasers are encouraged to have an authorized dealer service the computer, presumably the dealer who sold it. However, you can ship the machine to Kaypro directly. The

modular nature of the Kaypro PC makes servicing it easy.

Multitech's U.S. headquarters and service repair facilities are in Sunnyvale, California. They have technical experts on-site to answer owner's questions via a toll-free number. The technical staff proved to be both courteous and helpful when I called with questions concerning the use of some of the operating system utilities included with MS-DOS. The MPF-PC/700 comes with a six-month warranty on parts and labor, but you have to pay for your own shipping. For \$40, you can extend the warranty coverage for an additional six months. The computer uses common generic hardware and should be serviceable by any knowledgeable technician.

CONCLUSIONS

The Kaypro PC appears to be the best value of the three computers. Its only shortcoming is the lack of a high-speed (8-MHz) mode like the Multitech MPF-PC/700's. It has adequate internal space and power supply capacity for expansion. One big plus for the Kaypro PC is its removable microprocessor expansion card. This facilitates upgrading of this microcomputer as future options and enhancements become available. But the major advantage that puts the Kaypro PC ahead of the others is the software bundled with it. The actual value of these programs, even priced at discount levels, is in excess of \$400.

I found nothing seriously lacking in either the Multitech MPF-PC/700 or the Epson Equity I; they are both good solid IBM PC-compatible clones. Certainly, the Equity I's small footprint makes it well suited to situations where space may be limited.

The Multitech MPF-PC/700 represents a good hardware value for an average IBM PC clone, and its ability to run in an 8-MHz mode makes it the top performer of the trio. The question of how this machine will be marketed and serviced in the U. S. is open to speculation.

The Kaypro PC and Epson Equity I are being discounted fairly heavily, and it would be worthwhile shopping around for either of these machines. ■

LOGIMOUSE HOLIDAY GRAPHICS PACKAGE

\$99

LOGIMOUSE C7



\$219

NEW LOGIPAINSET-&-DRAW

To place a credit card order call our special toll-free number:

800-231-7717

Call toll-free in California:

800-552-8885

Just for the holidays we've wrapped up LOGIMOUSE and its Plus Software with Generic CADD and PCPaintbrush into the graphics package of the year. LOGIPAINSET-&-DRAW is the complete graphics toolkit for combining freehand and technical drawing.



LOGICADD - Generic CADD 2.0 and Dot Plot

Generic CADD is the sensational, new CADD package that offers the features and performance of high-priced at an unbelievably low price. The package also includes DotPlot, the add-on utility that turns your dot matrix printer into a plotter.

Use LOGIPAINSET-&-DRAW to design your holiday greeting, enhance your spreadsheets, graphs and memos, or create and personalize a map or mechanical. Just create your CADD drawing, import it into PC Paintbrush, and embellish it with paint sketches and fancy fonts.

At a saving of almost \$50 off our usual low prices, LOGIPAINSET-&-DRAW is a holiday package you can't afford to pass up.

LOGIPAINSET - PC Paintbrush

PC Paintbrush is the most advanced paint set available for the PC. It's the preferred choice of professional users, but with its icon menus for both graphics and text it's easy and fun for beginners as well. It offers complete graphic capabilities as well as 11 type fonts and a palette of 16 colors.



LOGIPAINSET-&-DRAW includes:

LOGIMOUSE C7 with Plus Software

LOGIMOUSE is the high resolution (200-dot-per-inch) mouse that is ideal for CADD and paint. It connects directly to the serial port of any IBM PC/XT/AT or compatible, with no pad or external power supply required. The Plus Package is our top-of-the-line mouse software featuring a pop-up menu system, an automatic mouse configurator, a unique mouse interface for Lotus 1-2-3, and a mouse based text editor.

LOGIMOUSE \$199 with Borland's Reflex

Reflex, Borland's amazing database management program, flies with LOGIMOUSE! We offer Reflex with LOGIMOUSE and the Plus Package Software at a very special price!

YES I want to add the power of LOGIMOUSE to my holidays!

- LOGIPAINSET-&-DRAW \$219
- LOGIMOUSE w/Driver 3.0 \$99
- LOGIMOUSE w/Plus Software \$119
- LOGICADD w/Logimouse & Plus Software \$189
- LOGIPAINSET w/Logimouse & Plus Software \$169
- REFLEX w/Logimouse & Plus Software \$199

For my computer model: _____

30-Day Money-Back Guarantee

VISA MasterCard Check Enclosed

Add \$6.50 for shipping and handling. Calif. residents add applicable sales tax. Prices valid in U.S. only.

Card Number _____ Expiration Date _____

Signature _____

Name _____

Address _____

City _____ State _____ Zip _____

Phone _____

DEALER INQUIRIES WELCOME



Logitech, Inc.
805 Veterans Blvd.
Redwood City, CA 94063
Tel: 415-365-9852

In Europe:
Logitech SA, Switzerland
Tel: 41-21-879656

In Italy: Tel: 39-2-215-5622

Inquiry 188

LOGIMOUSE is a registered trademark of LOGITECH. Lotus and 1-2-3 are trademarks of Lotus Development Corp. Reflex is a trademark of Borland-Analytica. Generic CADD is a trademark of Generic Software, Inc. PC Paintbrush is a registered trademark of ZSoft Corp.

LU6.2
LU6.2
LU6.2
LU6.2
LU6.2 + 2

Systems Strategies' cSNA/LU6.2, the fully portable software solution that gives your products true blue LU6.2 performance, now comes with two new pluses.

PLUS ONE: DIA/DCA

Supporting IBM's office automation architectures is a big plus for your products. With cSNA/DIA, your systems can access DISOSS applications, plus exchange documents with IBM's DIA-compatible office systems. Our cSNA/DCA package ensures compatibility with IBM's document formatting system.

PLUS TWO: SNADS

Adding our cSNA/SNADS software will enable your products to communicate on a SNADS network with delayed delivery services capability.

Of course, all of our IBM office automation support products are fully integrated with cSNA/LU6.2 and with our entire SNA product family, over the unique cSNA/engine.

EXCLUSIVE TEST PACKAGES

Our internal, proprietary test packages are now available to aid your implementations. Our Test 6.2 package con-

tains over 150 scenarios that verify LU6.2 functionality off-line. Our exercise packages, EX6.2/CICS and EX6.2/S36, systematically test products connected to a System/370 running CICS, or to a System/36 running SSP.

THE MOST IMPORTANT PLUS

We're committed to expanding our product line so that we continue to provide all the data communications software you need to keep pace with IBM's key developments. But we'll never lose sight of the most important plus: reliability. Our repeated success in the field, our porting track record, and our unmatched customer service and maintenance, along with a client list headed by IBM, Digital Equipment Corp., AT&T, ITT, and Sun Microsystems, are proof positive that you're getting the best IBM communications software available.

Call us today for more information about the communications pluses you need.

CALL: (212) 279-8400 ext. 444



Systems Strategies Inc.

An AGS Company

New York • San Francisco • London

Corporate Headquarters:

Systems Strategies, Inc., 225 West 34th Street, New York, NY 10001

IBM is a registered trademark of International Business Machines. System/370, System/36, CICS and SSP are trademarks of IBM Corporation. cSNA/engine is a trademark of Systems Strategies, Inc.



THE MACINTOSH PLUS

BY CHRIS CRAWFORD

The Macintosh has become the most polarizing computer in the industry, attracting ferocious loyalists as well as contemptuous detractors. But even its most ardent boosters have recognized shortcomings in the Macintosh: slow disk drives, lack of expandability, and the high price and slow speed of the hard disk drives designed for the system. Now Apple has released the Macintosh Plus, the first major redesign of the Macintosh.

OVERVIEW

The Macintosh Plus offers new disk drives with twice the capacity of the original Macintosh's (800K bytes versus 400K bytes), internal ROMs twice the size of the original ROMs (128K bytes versus 64K bytes), 1 megabyte of RAM compared to the 128K bytes in the original Macintosh, a new keyboard with a numeric keypad and cursor-control keys, and an SCSI port for hard disk drives. The Macintosh Plus is priced only slightly higher than the original Macintosh: \$2599. The system has no slots for expansion boards.

DISK DRIVES

The most important improvement in the Macintosh Plus comes from the new *double-sided* disk drives, which are faster and quieter. The speed increase is due to the reduction in seek times, which is made possible by doubling the effective size of each track.

The real significance of these new drives is that their capacity now more closely matches the natural demands of the Macintosh system. Consider the disk budget for one of the most com-

Extra memory and new disk drives correct many of the Macintosh's limitations



mon Macintosh applications: document preparation with MacWrite and MacPaint. A System File, Finder, and a good collection of fonts and desk accessories will consume 250K bytes of disk space. MacWrite and MacPaint together take up 130K bytes, leaving only 20K bytes of free space. This is insufficient to handle the system's needs for disk buffering of temporary files. This forces you into a variety of ungainly solutions. My approach was to keep three separate system disks: one for MacWrite, containing lots of fonts; one for MacPaint, with lots of desk accessories; and one for switching between the two, containing few fonts and few desk accessories.

These problems vanish with 800K bytes of disk space. You can keep a huge collection of fonts in all sizes, a

hefty pile of desk accessories, MacWrite, MacPaint, Switcher, and a nice Scrapbook, and still have leftover space for system use. The situation in which you create a MacPaint image and transfer it to a MacWrite document via the Clipboard, once a frustrating exercise in disk swapping, is now smooth and trouble-free.

NEW ROMS

The second important improvement in the Macintosh Plus comes from the new ROMs. Their doubled size allowed Apple programmers to make five broad types of improvements. First, the bugs in the old ROMs were corrected. Second, some routines that had been tightly coded in the old ROMs to save space have been re-coded so that they consume more ROM space but run

faster. Third, the new ROMs include some code that had been bumped out of the old ROMs for lack of space. Fourth, the new ROMs include the code to operate the double-sided disk drives. Finally, some new features have been added, including some new Toolbox calls. The Macintosh Plus can boot from a hard disk, no longer requiring a floppy disk for start-up. A disk cache is provided, which speeds up many operations.

The result of all this is an improvement in the speed of the system. The standard BYTE benchmarks shown on page 248 and the test results in table 1 do not tell the whole story, for a

(continued)

Chris Crawford (5251 Sierra Rd., San Jose, CA 95132) is a freelance computer game designer.

REVIEW: MACINTOSH PLUS

Macintosh Plus

Company

Apple Computer Inc.
20525 Mariani Ave.
Cupertino, CA 95014
(408) 996-1010

Size

Main unit: 13½ by 9½ by 11 inches;
16½ pounds
Keyboard: 2½ by 15½ by 6 inches; 2½
pounds

Components

Processor: 68000; 7.8336 MHz
Memory: 1 megabyte of RAM,
expandable to 4 megabytes; 128K bytes
of ROM; 256K bytes of user-settable
parameter memory
Mass storage: One 800K-byte double-
sided 3½-inch floppy disk drive
Display: 9-inch black-and-white built-in
bit-mapped screen; 512 by 342 pixels
Keyboard: Detachable 78-key with
keypad and cursor keys
Pointing device: Optomechanical
mouse

Optional Hardware

800K-byte double-sided 3½-inch
external disk drive: \$399
Imagewriter II printer: \$595

Documentation

Macintosh Plus user's manual

Price

\$2599

SYSTEM FEATURES

MEMORY SIZE (K BYTES)

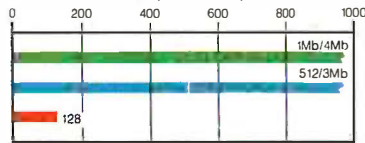

DISK STORAGE (K BYTES)

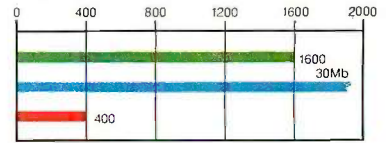

DISK ACCESS IN BASIC (IN SECONDS)

WRITE

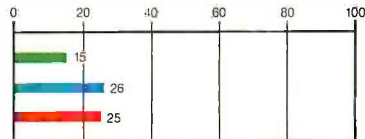

READ

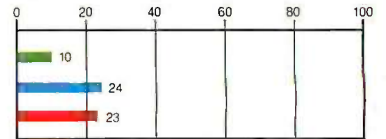

BASIC PERFORMANCE (IN SECONDS)

SIEVE

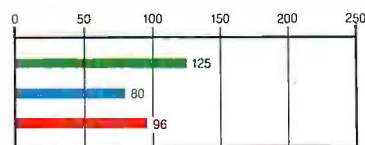

CALCULATIONS

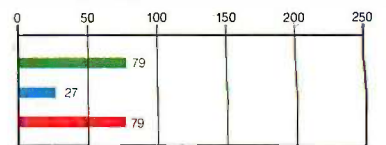

SYSTEM UTILITIES (IN SECONDS)

40K FORMAT/DISK COPY



40K FILE COPY

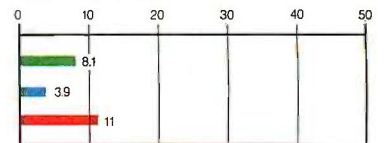

SPREADSHEET (IN SECONDS)

LOAD

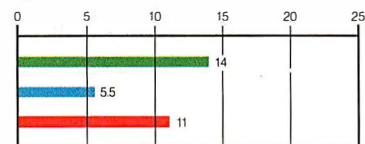

RECALCULATE

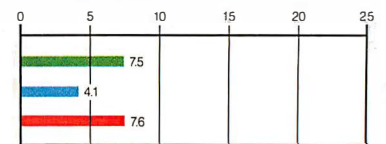

■ MAC PLUS ■ IBM PC AT ■ MACINTOSH

The Memory Size graph shows the standard and optional memory available for the computers under comparison. The Disk Storage graph shows the highest capacity for a single floppy disk drive and the maximum standard capacity for each system. The graphs for Disk Access in BASIC show how long it takes to write and then read a 64K-byte sequential text file to a blank floppy disk. (For the program listings, see BYTE's *Inside the IBM PCs*, Fall 1985, page 195.) The Sieve graph shows how long it takes to run one iteration of the Sieve of Eratosthenes prime-number benchmark. The Calculations graph shows how long it takes to do 10,000 multiplication and 10,000 division operations using single-precision numbers. The System Utilities graphs show how long it takes to format and copy a 40K-byte file

using the system utilities. The Spreadsheet graphs show how long it takes to load and recalculate a 25- by 25-cell spreadsheet in which each cell equals 1.001 times the cell to its left. For the 128K-byte Macintosh, the Sieve was modified to use integer variables, since the conventional Sieve program would not load into memory. The spreadsheet used was Microsoft's Multiplan 1.02. Microsoft BASIC 1.0 was used for the Disk Write and Disk Read benchmarks. On the Macintosh, the Disk Copy program was used for the 40K-byte File Copy benchmark. No Format/Disk Copy tests are done on hard disk systems. System .97 and Finder 1.0 were used for the Spreadsheet and Disk Access benchmarks, and System 3.0 and Finder 5.1 were used for the System Utilities benchmarks.

number of Macintosh-specific features also run much faster now. For example, QuickDraw, the collection of routines for drawing text and images on the screen, now operates from 30 to 500 percent faster than the old ROM version.

SCSI PORT

The SCSI port provided with the Macintosh Plus is designed for high-speed data transfer between the Macintosh and its peripherals. It is Apple's second try at its virtual-slot concept. Apple's original concept was too slow and too complex for practical operation. Hard disk drives, the primary target peripheral for the virtual slot, required a great deal of engineering effort to adapt to the virtual slot and performed poorly.

The SCSI port changes this situation. It is a true parallel port rather than a serial port and thus can run at 320K bytes per second as compared with the old virtual slots running at 230K bits per second—11 times slower. The result is that external SCSI hard disk drives attain speeds very close to that of internally mounted hard disk drives.

1 MEGABYTE OF RAM

With most microcomputers, additional RAM has very little value until someone writes software that explicitly takes advantage of that RAM. Fortunately, the Macintosh is blessed with a memory manager that stands between the applications program and the RAM, allocating blocks of RAM as needed. This means that a program designed for a 128K-byte Macintosh can freely use the additional RAM of a Macintosh Plus without any modification. Thus, many Macintosh programs will run faster in the megabyte of RAM that the Macintosh Plus holds. The extra memory can also be used with Switcher, a software RAM disk, or the disk cache. In each case, the speed improvement made possible by all that extra RAM is dramatic.

The real value of the full megabyte of memory, however, will be in its effect on future software development. Good software thrives on lots of RAM. Software makes the machine;

programs like MacWrite, MacPaint, Excel, and Helix are the real driving force behind the success of the Macintosh. We will see some truly amazing results when software developers create programs that utilize the full power of a 1-megabyte Macintosh.

Also significant for the Macintosh's future is the easy expandability of the machine to 4 megabytes. The 256K by 1-bit RAM chips are mounted on small circuit boards that plug into the motherboard. When 1-megabyte RAM chips become less expensive, expanding a Macintosh Plus to 4 megabytes will be almost as simple as changing a board on an Apple II. There are already several kits available that expand the Macintosh Plus to 2 megabytes (see the text box "Four Memory-Expansion Kits" on page 250).

KEYBOARD

Apple offers a new keyboard for the Macintosh Plus. It is very similar to the old keyboard and includes a numeric keypad plus cursor-control keys, the lack of which in the old keyboard had been the source of many criticisms.

I prefer the old keyboard; it takes up less space. The numeric keypad is of no value in my work and pushes the mouse's working area further to the right. The cursor keys are not yet recognized by most Macintosh software except for some Microsoft products. However, if you enter large amounts of numeric data, you will prefer the new keyboard.

HIERARCHICAL FILE SYSTEM

Associated with the release of the Macintosh Plus is the new Hierarchical

File System (HFS). This replaces the Macintosh File System (MFS). The difference between the two systems lies in the significance of folders. In MFS, a folder is merely a device for visually organizing the files on the desktop. From the point of view of MFS, the files inside a folder are just as accessible as the files on the desktop. Thus, MFS has difficulties keeping track of large numbers of files on a desktop; it consumes inordinate amounts of RAM and runs more slowly.

HFS treats folders as subdirectories whose contents are unimportant unless HFS is specifically directed to examine them. This parsimonious approach to file management is essential when dealing with the large number of files that an 800K-byte floppy disk or a 20-megabyte hard disk can hold.

COMPATIBILITY ISSUES

The release of any new machine generates compatibility problems, which can be either severe or minor. In the case of the Macintosh Plus, the problems seem to be minor.

Some incompatibilities arise with HFS. Programmers who took shortcuts in violation of Macintosh software standards created products that will not operate under HFS. These problems are easily solved, and most of the transgressors have already issued revisions of their software.

Aside from the HFS problems, I was unable to find any software compatibility problems. All of the programs that I tested ran well on the Macintosh Plus. Even the programs with weird copy-protection schemes ran

(continued)

Table 1: A quick test of system speed is to determine the configuration time to launch MacWrite from the Finder. While this is admittedly not useful as a serious benchmark, it can give a rough idea of the relative performance of the different Macintosh configurations. These timings, all in seconds, are accurate to within one-half of one second.

512K Macintosh with floppy disk	24.5
Macintosh Plus with floppy disk and no RAM cache	10.8
512K Macintosh with Apple HD-20 hard disk	10.5
Macintosh Plus with DataFrame 20 hard disk	7.2
Macintosh Plus with 512K-byte RAM cache (preloaded) and floppy disk	5.5
Macintosh Plus with RAM disk	3.7

FOUR MEMORY-EXPANSION KITS

BY CHRIS CRAWFORD AND TOM THOMPSON

Several kits are now available for adding an additional megabyte of memory to your Macintosh Plus (see table A). Installation is simple for anyone who is not squeamish about opening the computer. (The exception is the MacSnap Plus 2 kit, which is sold through a dealer who installs it for you.) The tool required to open the case, a long-handled Torx screwdriver, comes with three of the four kits.

Adding the extra memory is a matter of unfastening the original SIMMs (Single In-line Memory Modules, which are small printed circuit boards with

surface-mounted RAM chips) and clipping them onto the expansion kit's boards. In most cases, you'll have to clip a jumper to the Macintosh's address logic chips to complete the procedure. The cramped space inside the Macintosh means that with the extra memory installed, you usually cannot slide the motherboard back into the housing. In these cases you must force, or jump, the board back into its slots using a screwdriver. The exception is The MaxPlus's board, which will slide back into place if you've mounted everything correctly.

Since there are no components to unsolder or traces to cut, these expansion kits can be easily removed, returning the Macintosh to its original condition. (Three of the four kits tested were installed in the same Macintosh Plus at different times.)

All kits provided an additional megabyte of RAM as promised, and no problems were encountered during the normal eight-hour-per-day editorial workload.

Tom Thompson is a BYTE technical editor (One Phoenix Mill Lane, Peterborough, NH 03458).

Table A: Comparison of features for the four memory-expansion kits.

Name	Company	Contents of kit	Comments	Price
Plus Plus	Micro Conversions Inc. 1900 East Randol Mill Rd. Suite 103 Arlington, TX 76011 (817) 860-2291	1 megabyte of memory, jumpers, muffin fan, disk of software, Torx screwdriver, installation manual	Software contains Switcher and RAM disk. Motherboard must be jumped into case.	\$599
The MaxPlus	MacMemory Inc. 473 Macara Ave. Suite 701 Sunnyvale, CA 94086 (800) 862-2636	1 megabyte of memory, jumpers, piezoelectric fan, disk of software, Torx screwdriver, illustrated installation manual	Software contains RAM disk and print spooler. Motherboard slides into case.	\$499
One+One	Levco 6160 Lusk Blvd. Suite C-203 San Diego, CA 92121 (619) 457-2011	1 megabyte of memory, jumpers, piezoelectric fan, illustrated installation manual	No software. No Torx screwdriver. Motherboard must be jumped into case.	\$295; Torx screwdriver \$5 extra
MacSnap Plus 2	Dove Computer Corp. 1200 North 23rd St. Wilmington, NC 28405 (800) 622-7627	1 megabyte of memory, disk of software, Torx screwdriver, user's manual, illustrated installation manual, grounding strap, clamp to open case	Software contains RAM disk, Switcher, and print spooler. No jumpers needed. No fan. Motherboard must be jumped into case. Dealer installs kit.	\$599

well on the new disk drives.

The more serious compatibility problems come from the changes in the hardware. The peripheral sockets have been changed from the old DB-9 connectors to an unusual round connector. Moreover, the pin that supplied 5 volts of power has been removed; this cuts out such peripherals as ThunderScan and MacVision. Peripheral makers have scrambled to correct the problem. If you upgrade your old Macintosh, you may undergo some confusion and frustration trying to get new cables for various peripherals.

COMPLAINTS

Despite all the improvements of the Macintosh Plus, there are still some pitfalls. Why, for example, does a machine with a megabyte of RAM require you to do disk swaps when saving an 8K-byte ASCII file to a third disk, much less the 13 disk swaps I suffered through before hitting the reset button? Why is the new keyboard so high that I still need a palm rest?

A more serious complaint concerns the screen size. I don't refer to the physical size (9-inch diagonal) but rather to the pixel count (171,000), which has become too small for the system. The original Macintosh's screen requires only 21K bytes of RAM for its buffer. This is about right for a 128K-byte machine, as most systems devote about one-eighth of their RAM to screen buffering. However, the 171,000-pixel screen is far too small for a machine with a megabyte of RAM. The small screen has now become the primary limitation of the Macintosh.

TO UPGRADE OR NOT TO UPGRADE?

The owners of regular Macintoshes must now face the question of whether to upgrade their machines. Actually, the problem is tricky, for Apple offers three steps of upgrade: new ROMs and the double-sided disk drive for \$299, a new logic board with 1 megabyte of RAM and the SCSI port for \$599 for owners of 512K Macintoshes and \$799 for owners of 128K-byte Macintoshes and Macin-

toshes with non-Apple RAM upgrades, or the new keyboard for \$129.

I highly recommend the first upgrade to all Macintosh owners. It's inexpensive and gives you the two most important upgraded features of the Macintosh Plus. The improved disk drive alone is worth more than the cost of the upgrade.

The new logic board is another matter. It is expensive and will not have a great impact on the effectiveness of the machine. Your ideas with respect to hard disks will help you decide. If you already have a hard disk that plugs in through the serial port, it is probably best not to get the new main logic board, as your hard disk will no longer be connectable unless the manufacturer makes some sort of adapter available. If you have no hard disk and plan to get one soon, by all means do get the upgrade, since the SCSI hard disks are cheaper and faster than the hard disks coming through the serial port. If you have no interest in hard disks, there are cheaper ways to get a megabyte of RAM than the new main logic board.

Get the new keyboard only if you enter lots of numeric data.

CONCLUSIONS

The Macintosh Plus solves most of the problems of the original 128K-byte Macintosh. It almost eliminates the tedious disk swapping that infuriated so many users, and the disk drives are much faster. The machine has enough disk storage and RAM space to make it possible to effectively utilize the many powerful features of the Macintosh without agonizing delays. It makes hard disk systems fast, cheap, and truly practical on the Macintosh. It does all this while maintaining good compatibility with the old system at almost the same price that the original system cost when it was initially released. The only outstanding problem is the lack of slots for expandability; it remains to be seen whether the SCSI port truly solves that problem.

Here at last is a machine with the much-heralded Macintosh ease of use, yet with enough raw power to silence all the nagging complaints about poor performance. ■

800-222-8324

WOW!
What a
Super Special
SAVINGS!



Blowout

SUPER SPECIAL:
Equity I w/ Monitor
640 k memory.
20 meg Hard Drive
\$1095

**Win an
Epson
LX-86
Printer,
Details
Below**

Epson Guaranteed Lowest Prices

fx-286	Call 1-800-222-8324	Call
fx-85	Call 1-800-222-8324	Call
fx-86	Call	Call

Equity Series Computers
Equity I w/ Monitor from \$699
Equity II w/ Monitor from \$899

brother
M1509 NEW

- M-1109 \$195
- HR-15XL \$360
- HR-25 \$499
- HR-35 \$680
- Twinriter-5 Dual Head \$ Call

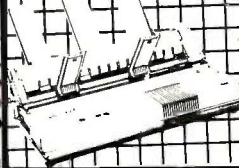

Hard Drive Specials



10 Meg
\$369
controller
& cables

20 Meg
\$375
controller
& cables

30 Meg
\$505
controller
& cables

Computers (IBM Compatibles)

IDS PC-XT 8088	Base Mono Color
IDS Turbo 8 Mghz	\$595 • 795 • 995
2 Drives MS-Dos	\$649 • 895 • 1095
IDS AT	
1 1/2 Meg Floppy/M/S Dos & 1495	1695 1895

Leading Edge	Call for Lowest Price
AT&T 6300	Call for Lowest Price
Epson Equity I, II, III	Call for Lowest Price

MONITORS	Sale on C.I. Accessories
<p>Samsung</p> <p>Amber TTL 12 \$69</p> <p>Green TTL 12 \$85</p> <p>Green Composite \$79</p> <p>Amber Composite \$79</p> <p>Mitsuba</p> <p>510A TTL Amber \$99</p> <p>w/Tilt & Swivel Stand</p> <p>160A Composite 12 \$99</p> <p>Amber w/Tilt & Swivel Stand</p>	<p>Floppy Disks Box of 10 Case of 100</p> <p>TOK ss/dd 11.95 115.00</p> <p> ds/dd 14.95 145.00</p> <p>Maxell ss/dd 11.99 115.00</p> <p> ds/dd 14.99 145.00</p> <p>IBM Parallel Cables \$10.00</p> <p>A Full Line of Ribbons. Epson. Brother. Sale on our full line of brand name IBM & compatible. Add on Cards - Call Inr Prices</p>

To Enter Contest, Send in a Self- Addressed Postcard to the address listed below. You must be 18 years . Winner will be announced in the February issue of this magazine.

VISA **1-800-222-8324** MasterCard

COMPUTERS INTERNATIONAL

6619 U.S. 1 Miami, FL 33143

IN FLORIDA CALL (305) 667-5936

CONSTANT COMMITMENT

THE ENGINE

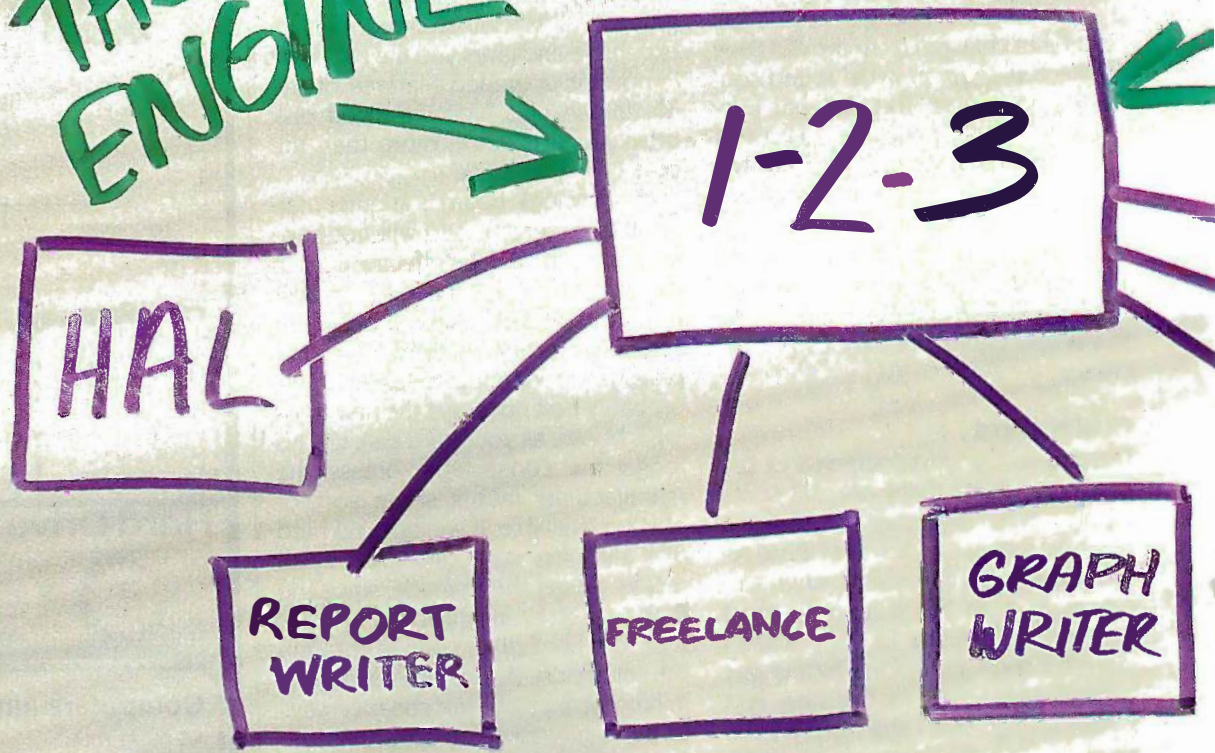

THE 1-2-3 SYSTEM



STANDARD EQUIPMENT

CONTINUOUS
INNOVATION

INDEPENDENT
SOFTWARE
DEVELOPERS

ETC.

ETC.

When 1-2-3® was first introduced it quickly became the best-selling, best-working software in the industry. Today it's practically an industry all by itself.

An example: there are more than 1000 independent software developers who have created and continue to create specialized applications for 1-2-3. . . steadily adding value to the product for people in all areas of business. Today 1-2-3 is the engine that drives an industry full of software tools designed for such specialized jobs as construction management, tax planning, business modeling and more.

Add to this Lotus supported companion products such as 1-2-3 Report Writer™, Freelance®, Graphwriter®—and soon-to-be available products such as Lotus HAL™ and others—and it's clear that you're looking at an entire *system* of products to help you work more productively with 1-2-3.

All of which makes 1-2-3 better than it ever was.

About a *thousand* times better, in fact.

Learn about the 1-2-3 system and how it can work for you. Talk to an authorized Lotus dealer.

Lotus 1-2-3

The business software integrating spreadsheet, graphics and database.

© 1986 Lotus Development Corporation. Lotus, 1-2-3, Freelance and Graphwriter are registered trademarks of Lotus Development Corporation. 1-2-3 Report Writer and Lotus HAL are trademarks of Lotus Development Corporation. *Lotus HAL is distinguished from HAL, which is a trademark of Qantel for its Hotel and Leisure Software.*

SYNCmodem™ is your SNA or BSC Gateway

Features:

- PC/XT/AT bus compatible
- Auto-dial/auto-answer
- Tone or pulse dial
- Supports Bisync or SDLC links

3 Models:

- 201
(2400 baud)
- 212AT/201
(1200 and 2400 baud)
- 208
(4800 baud)

Description:

SYNCmodem is an IBM PC, XT or AT bus compatible interface card capable of operating as a synchronous modem or as a synchronous interface card.

SYNCmodem is ideal for remote PC-to-mainframe or PC-to-PC communications. It comes fully integrated with 3780Plus™, CLEO-3270 SNA or BSC, and CLEO-5250 SNA software packages.

3780Plus allows fast and efficient file transfers, over common phone lines, between your PC and any micro, mini, or mainframe that supports 2780/3780 Bisync protocol.

CLEO-3270 SNA or BSC and CLEO-5250 SNA allow your PC to emulate a remote 327x or 525x terminal device. All you need is a phone line.

The 212/201 modem includes the Mirror asynchronous software package in addition to your selected CLEO SNA or BSC package.

For details call 1(800)233-CLEO.
In Illinois 1(815)397-8110.

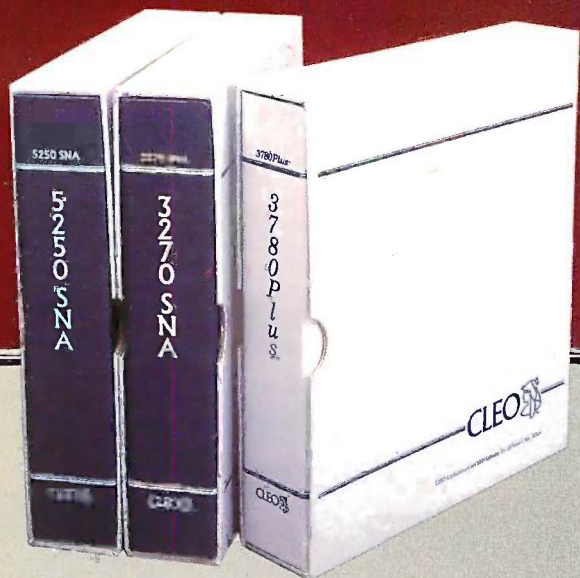

CLEO



CLEO Software
a division of Phone 1, Inc.
1639 North Alpine Road
Rockford, IL 61107
TELEX 703639

CLEO is a registered trademark of CLEO Software.
SYNCmodem and 3780Plus are trademarks of CLEO Software.



THREE 24-PIN DOT-MATRIX PRINTERS

BY ROBERT D. SWEARENGIN

A look at three quality printers with various features and prices

Printer shoppers look for the best combination of speed, versatility, output quality, and price. The 24-pin dot-matrix printers generally get high marks in the first three categories, but there is a wide range in functionality and price.

At \$1845, the state-of-the-art Nissho NP-2410 is not for low-budget operations. On the other end of the price range, the \$699 Toshiba P321 has fewer frills and is affordable for small businesses and some home applications. Between these two is the Fujitsu DL2400 for \$1195, with a color model available for \$1395. All three printers performed well during six weeks of testing.

Surprisingly, print quality was not a significant variable. Such judgments are always somewhat subjective, but output from the Toshiba P321 certainly compares favorably to that from the more expensive machines. In fact, I liked Toshiba's Courier 10, a font that is available in all three printers, the best. What do you get for more money? Speed, versatility, convenience, and durability, assuming it's reasonable to base the latter quality on size, weight, and print-head life.

FEATURES AND OPERATION

The Nissho NP-2410's front panel is deceptively simple, considering the number of features it has. Three LEDs indicate power on, on-line, and paper out. The first of six switches controls on-line and off-line. The Reset switch clears the 4K-byte buffer and updates



printer defaults, and TOF (top of form) advances a new page to a preset top of form. The FF (formfeed) switch feeds forms according to a preset length, LF (linefeed) advances the platen one line at a time (or continuously when you hold it down), and Sheet Load advances single sheets to the proper starting position.

The printer gets interesting when you discover the flip-open door just to the left of the main controls. A concealed panel offers a variety of options including seven fonts residing on two chips inside the printer. With a thumbwheel you select draft quality in 10, 12, 15, or 18 pitch or letter quality in Courier 10, Letter Gothic 12, or

Century, which has proportional spacing. You can also dial an optional plug-in dual-font cartridge or download a font from disk.

Once you've selected a font, more options await you. One slide switch changes print style from standard (roman) to italic; another gives emphasized print. Two additional switches let you select bidirectional or unidirectional printing and six or eight lines per inch. A thumbwheel lets you select ten form lengths ranging from 3 to 14 inches.

Finally, eight DIP switches behind a back interface panel provide more choices. The first four set on-line, skip perforation, automatic linefeed, and IBM or Epson LQ-1500 graphics. The remaining four switches let you select international character sets for eleven countries.

The Fujitsu DL2400 offers comparable features on its front panel that are also deceptively simple but not as easy to operate. The selection process requires a little more time and manipulation. An LED indicates power on. For other information, you cycle through the options on a 16-column LCD choosing different combinations from only four buttons that have three functions each. The standard functions are printed on the buttons them-

(continued)

Robert D. Swearengin (Department of Journalism and Printing, P.O. Box 1930, Arkansas State University, State University, AR 72467) is an instructor of journalism and a freelance writer.

selves: On-Line, FF, LF, and Reset. Pressing Reset in the on-line mode clears the 8K-byte buffer and initializes the printer.

When you hold it down, Reset becomes an Alt button and changes the button functions to the commands that are printed underneath them on the front panel. LF becomes Micro LF, which advances the paper only 1/180 inch for fine adjustments. FF becomes Load and sets new paper to the correct starting point for printing. On-line changes to Setup and activates a third set of commands printed directly over the buttons. On this Setup line, FF changes to Function and takes you through the main menu on the LCD: style setting, interface setting, save mode, setup listing, self-test, hex dump, and default setting. LF now changes to Item and lists a submenu for each function. The Reset button changes to Select and lets you pick options from the submenu. The On-Line button, labeled Exit in the Setup mode, simply puts the printer back on-line when you've finished setting parameters.

This process is confusing at first. My initial reaction was that too few buttons control too many functions, although after about an hour of practice I was changing setups with little difficulty.

Let's say you want to change from the default, Courier 10, to Draft 12. You first press On-Line (Setup) while holding down Reset (Alt); the LCD display changes from ON-LINE:READY to SETUP MODE, and then to FUNCTN:STYLE, which is the first display in the setup mode. Because this is the function you need, you don't have to press FF (Function) to go through the menu. You simply press LF (Item) until the display reads QUALITY:DRAFT, and press Reset (Select) to lock it in. Then you repeat the last two steps to select CHAR SP:12 CPI, press On-Line (Exit), and you're ready to print Draft 12.

If you want Draft 12 to be the new default setting, you can put it in the printer's nonvolatile EPROM using the save mode. In addition to Courier and Draft, you can also choose Prestige Elite or an attractive Compression 18 font.

Using the same process, you can change just about everything else from the front panel, including character sets, ten languages, print attributes (italic, bold, etc.), color, line spacing, page length, margins, interface specifications, and IBM/Epson graphics emulation.

The Toshiba P321 has a straightforward control panel with no frills or programming options, and it is therefore the easiest to operate for routine printing. [Editor's note: A model that has both parallel and serial interfaces is available for \$749.] However, you must rely on control codes and DIP switches to access most of its features. Four LEDs indicate power on, alarm, paper end, and select (on-line). Three switches for paper feed, top of page, and select/deselect complete the panel.

DIP switches 2 and 3, easily accessible inside the top cover, set type fonts, pitch, and several other printing options. You can select Draft, Courier, Prestige Elite, or an optional dual-font plug-in cartridge and set pitch at 10, 12, 16.7, or proportional spacing. Other switches control form length, a 256K-byte buffer, and the standard commands for carriage return, line feed, bidirectional printing, etc.

You can also choose character sets for IBM and seven languages. DIP switch 1 (available on the parallel and serial model) comes with a dual port and sets the interface, data bits, protocol, data rate, and parity.

Like the more expensive printers, the Toshiba P321 produces emphasized, expanded, italic, underlined, and bit-imaged graphics with control and characters codes. An optional kit for downloading fonts from disk is available for \$89; IBM graphics printer emulation is \$49. The basic printer comes with Toshiba escape sequences and Qume Sprint II daisy-wheel emulation.

SPEED AND QUALITY

Draft 10 and Courier 10 provide a reasonable comparison of speed and quality since all three printers share these fonts. Factory specifications are noted in parentheses next to the throughput measured with the BYTE benchmark test, 50 lines of 60 As at 6 lines per inch.

The Nissho NP-2410 printed Draft at 188 (300) characters per second and Courier at 108 (150) cps. The Fujitsu DL2400 printed Draft at 109 (180) cps and Courier at 49 (60) cps, and the Toshiba P321 printed Draft at 92 (180) cps and Courier at 41 (60) cps. Speed is not as critical with italic type because it's generally used in short measures, but I ran a test with Courier 10 italic out of curiosity. The Toshiba and Fujitsu printers ran at about the same speed, losing only 1 to 4 cps. However, the Nissho paused at the end of each line and slowed drastically to 25 cps—something to consider if you frequently print large blocks of italic type.

All three printers performed well on 10-page sliding-character tests, with no noticeable change in impression or alignment. All three produced quality output, as the type samples indicate. However, the letter-quality designation for Courier 10 on the Nissho NP-2410 is questionable. The type is not as dense as the Courier from the other printers, and a near-letter-quality rating might be more appropriate. In fairness, the Nissho prints letter-quality emphasized Courier 10 at 73 cps, which is considerably faster than the other two printers. It also does letter-quality Century, a denser face not resident in the others, at 100 cps. (See page 257 for a side-by-side comparison of features and prices.)

COMPLAINTS

The access cover on the Nissho NP-2410 is not hinged; instead, it attaches with two flexible straps and flops back in an ungainly fashion when opened. The result is too much play from side to side; you must align it carefully to snap it back in place and put the printer on-line. The paper guide is flimsy and the two sections tend to fall apart during installation, although it worked fine once it was attached.

Front-panel programming on the Fujitsu DL2400 is a bit complex; if you're a casual user or don't change modes often, you'll probably have to check the manual to refresh your memory. Furthermore, this manual is the

(continued)

REVIEW: 24-PIN DOT-MATRIX PRINTERS

	Fujitsu DL2400	Nissho NP-2410	Toshiba P321
Type	24-pin dot-matrix printer	24-pin dot-matrix printer	24-pin dot-matrix printer
Company	Fujitsu America Inc. Storage and Peripheral Products Division 3055 Orchard Dr. San Jose, CA 95134 (408) 946-8777	Nissho Information Systems 10855 Business Center Dr. Cypress, CA 90630 (714) 952-8700	Toshiba America Inc. Information Systems Division 2441 Michelle Dr. Tustin, CA 92680 (714) 730-5000
Size	7½ by 22½ by 15½ inches 44 pounds	6 by 23½ by 17 inches 41 pounds	6 by 16½ by 13 inches 20 pounds
Features	Wide carriage, tractor feed, 8K-byte buffer, IBM/Epson FX-80 graphics emulation, dual interfaces	Wide carriage, friction feed, 4K-byte buffer, IBM/Epson LQ-1500 graphics emulation	Standard carriage, friction feed, 256K-byte buffer; Qume Sprint 11 daisy-wheel emulation, parallel interface port
Graphics resolution:	180 by 360	180 by 360	180 by 360
Resident faces:	Draft, Courier; Prestige Elite, Compression	Draft, Courier, Letter Gothic, Century	Draft, Courier, Prestige Elite
Print-head life:	300 million characters	200 million characters	100 million characters
Ribbon:	Black: \$30; 15 million impressions Four-color: \$39.50; 3.6 million impressions	\$15; 15 million impressions	\$12; 1.6 million impressions
Options	Single-font cartridge: \$45 Single-bin sheet feeder: \$495 Dual-bin sheet feeder: \$695 Dual-bin sheet feeder plus envelopes: \$900	Dual-font cartridge: \$60 Serial port: \$100 48K-byte buffer: \$250 Bidirectional tractor feed: \$195 Single-bin sheet feeder: \$295 Dual-bin sheet feeder: \$595	Dual-font cartridge: \$69 Downloadable font kit: \$89 IBM graphics emulation: \$49 Tractor feed: \$99 Single-bin sheet feeder: \$219
Documentation	170-page user's manual; optional programmer's manual: \$15	80-page user's guide; 100-page technical manual	154-page user's manual
Price	Basic model: \$1195 Color model: \$1395	\$1845	Parallel-only model: \$699 Parallel and serial model: \$749

PRINT SPEED (CHARACTERS/SEC)

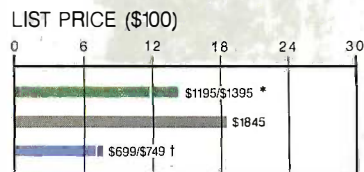
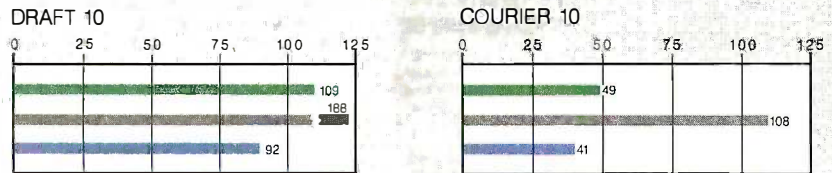

† Parallel and Serial * Color Model

Benchmark comparisons of the Nissho NP-2410, the Fujitsu DL2400, and the Toshiba P321 using 10-pitch Draft and 10-pitch Courier fonts. For each font, print speeds were determined by timing in seconds

how long it took to print 50 lines of 60 As. For more information on benchmark tests, see "The Art of Benchmarking Printers" by Sergio Mello-Grand, February 1984 BYTE.

weakest of the three; the programming information needs more detail, particularly the section on graphics. An optional programmer's manual costs \$15.

The Toshiba P321 advances the ribbon with a length of cord that stretches across the inside of the printer and wraps around a wheel underneath the carriage. For me, this was a trap. The manual's setup in-

structions say to remove the white "plastic tie wrap" to free the carriage for printing. Mine had no such wrap, and I assumed the company had switched to a cord, which I dutifully removed. The ribbon didn't advance when I started the printer, and I spent half an hour figuring out what was wrong and reinstalling the cord. After that, it worked fine. I was nervous about this low-technology hookup,

which reminded me of the dial cords on old radios, but I experienced no problems during operation.

PICK A PRINTER

Complaints aside, all three printers performed as advertised and eliminated most of my reservations about dot-matrix machines in general. The Nissho NP-2410 control panel beats any I've seen for features and ease of use. With its speedy output, wide carriage, and hefty proportions (6 by 23½ by 17 inches and 41 pounds), it should nicely handle high-volume processing. The print-head life is rated at 200 million characters. However, with a tractor feed and other options such as a serial port, you'll pay over \$2000.

With the Fujitsu DL2400 you'll sacrifice some speed, operating ease, and convenience for a much lower price tag, but it's also a wide-carriage, hefty machine (7½ by 22½ by 15½ inches and 44 pounds) with a print-head life of 300 million characters. Dual interfaces and a tractor feed are included in the \$1195 base price, an important consideration if you're watching your budget. The color model, which is \$200 extra, is also attractive: It prints black, yellow, magenta, cyan, violet, orange, and green from a four-color ribbon.

The Toshiba P321, with a print-head life of 100 million characters, weighs 20 pounds with its standard carriage and small footprint (6 by 16½ by 13 inches). Aside from the cord on the ribbon advance, it seems to be sturdily built. It has no special features, and you'll pay extra for tractor feed and such niceties as IBM emulation, the downloadable font kit, and the parallel and serial interface model. Nevertheless, in output quality and overall printing capability, it held its own against the more expensive printers. This one is a contender for small- to medium-volume users.

If you need reasonable speed, quality, and flexibility but don't want to pay for a laser printer, consider one of these printers as a viable alternative. Let the trade-offs between functionality, reliability, and price be your guide. You must make the final choice by assessing the costs and benefits for your particular application. ■

We Beat The Systems.

Display Telecommunications Corporation was named Best Small Business Exporter in Texas for 1986 because we offer the best IBM® PC clone available. We offer state-of-the-art components and our service reps are always accessible to answer your questions. Beat the systems with DTC.



MEGA-BOARD-XT™
The Industry Standard

MEGA-BOARD-AT™
80286 CPU

MEGA-NET™
Token-Passing Ring LAN • IBM NETBIOS Compatible



MULTIPLE INPUT / DUAL OUTPUT SWITCHING BUFFER

4 Computers In—2 Printers Out • Automatically routes Computer to Printer • Internal Buffering 64K or 256K

OEM QUANTITY PRICING AVAILABLE ON REQUEST

XT Bare Board	59.95
XT Assembled 256K	299.95
Mega-Case	69.95
Mega-Kit	775.00
DTC-2 BIOS	29.95
Power Supply	89.95
Switching Buffer	399.00

BIOS licensing.
FCC Class A Approval.

IBM is a registered trademark of International Business Machines Corporation.



MEGA-KIT™
Motherboard 256K • Case • 130W Power Supply • (2) ½ Height Floppy Disk Drives with Controller • Keyboard

BARE-BONES MEGA-KIT™
Same as Mega-Kit but without floppy Disk or Controller

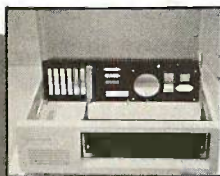

MEGA-CASE™
Flip Top (requires a power supply with a switch in the rear)



POWER SUPPLY
130 Watt • Rear Power Switch

Display Telecommunications Corporation

8445 Freeport Parkway • Suite 445 • Irving, TX 75063
1-800-227-8383 • For Technical Calls Only: 1-214-929-1382
TELEX 5106000176 DTC UD

Microcomputer Graphics™

Show and Conference

Javits Convention Center • New York City • December 17-19, 1986

Compare Thousands of Advanced Graphics Applications for PCs ... Micros ... Supermicros

Yesterday, advanced graphics cost six figures. And microcomputers were only for people who could type.

Today, the marriage of graphics and micros is improving the productivity of everyone who would rather use a mouse than a keyboard.

The Microcomputer Graphics Show & Conference lets you explore this revolution ... a revolution that is coming to every desktop and workstation.

See thousands of advanced graphics products. Compare sophisticated systems. Unleash the visual power of your PCs, micros, and supermicros.

Conference Focuses on Practical Solutions

Attend sessions on every aspect of microcomputer graphics: Micro-to-Mainframe Integration; Desktop Publishing; Software and Hardware Standards; Decision Support; Drafting & Design. Industry leaders guide you to practical management and implementation strategies.

FREE SHOW GUIDE AND SHOW TICKETS

To receive information call toll-free (800) 628-8185. (In New Jersey call 609-987-9400.) We'll send you a free guide to the newest microcomputer graphics products ... plus, FREE show tickets.

These are just a few of the products you'll find:

Microcomputers, Supermicros, PCs, Workstations; Hardware, Software, Systems, Services; Terminals, Monitors, Displays; Laser Printers, Plotters, Hardcopy Devices; Digitizers, Light Pens, Input Devices; Graphic Controllers, Processors, Adapter Boards. Also, applications and systems for: Desktop Publishing, Business Presentations, Statistical Analysis; Architecture, Construction, Facilities Design; Mechanical Design, Electronic Design; Visual Arts, Animation; and more.

CALL TOLL-FREE:

800-628-8185 In New Jersey call 609-987-9400
(8:30 a.m. to 5:30 p.m. Eastern Time)



SOTA Technology Announces ▶ MotherCard 5.0 ◀

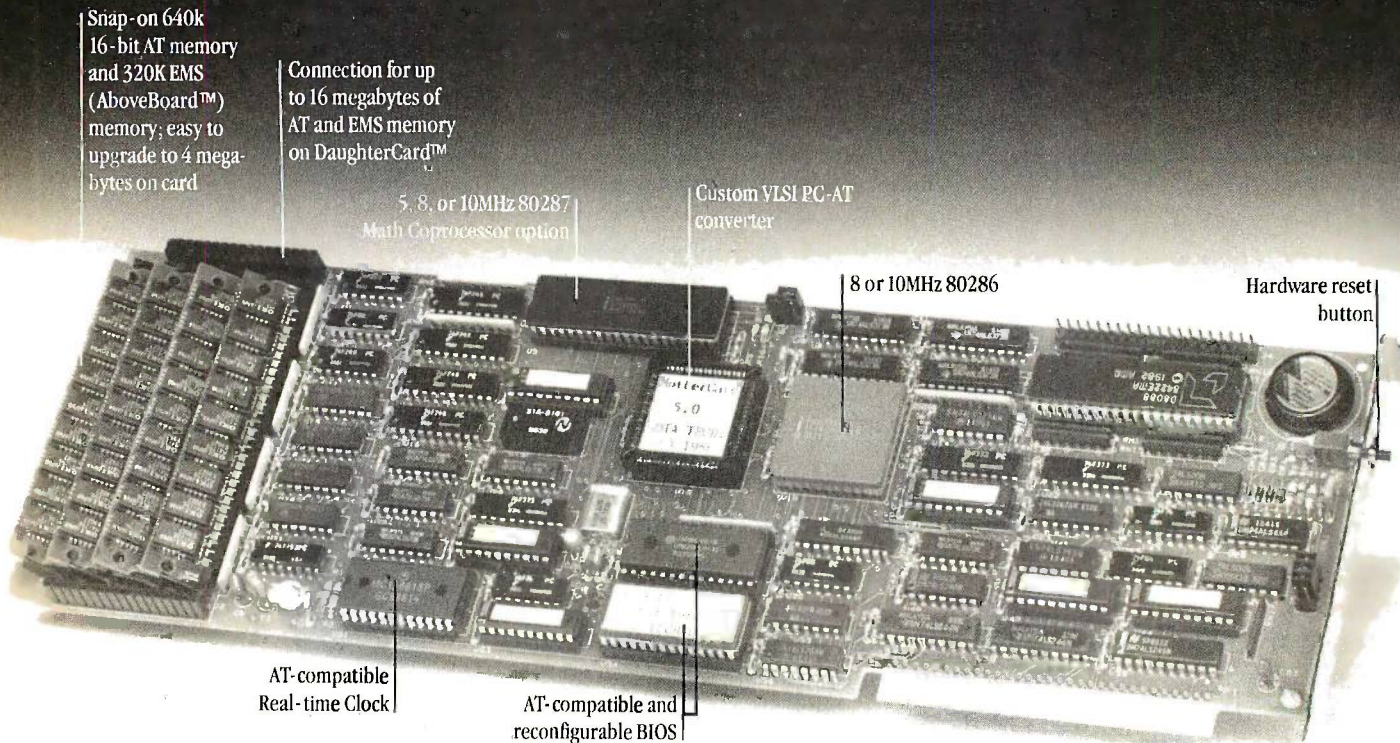

Snap-on 640k
16-bit AT memory
and 320K EMS
(AboveBoard™)
memory; easy to
upgrade to 4 mega-
bytes on card

Connection for up
to 16 megabytes of
AT and EMS memory
on DaughterCard™

5, 8, or 10MHz 80287
Math Coprocessor option

Custom VLSI PC-AT
converter

8 or 10MHz 80286

Hardware reset
button

AT-compatible
Real-time Clock

AT-compatible and
reconfigurable BIOS

**Put this board into your old PC
and get full AT hardware/
software compatibility.
Only \$995!**

Speed is everything

You started using a computer to get your work done faster. Now you'd like your computer to go faster, right?

Easy. SOTA Technology's *MotherCard 5.0* is the quickest and easiest way to upgrade your favorite old PC.

Easy to install: No hardware or software changes required.

Easy to use: simply run your same familiar programs. They just run *seven to ten times faster*.

And it's easy to buy: \$995 makes your current IBM PC system fully AT compatible; that's a lot less than you'd have to invest in any off-brand machine, set up the way your current system is configured.

SOTA's *MotherCard 5.0* is the easiest way to get *faster* and still keep your "old reliable" IBM system.

Compatible with all software.

An ingenious new concept of putting the machine BIOS (Basic Input Output System) into battery-backed RAM insures long-term compatibility with all your software.

You will not only be able to run all your tried-and-true PC software, but anything written specifically for the PCAT, as well.

Hardware compatibility, too!

The SOTA Technology *MotherCard 5.0* is compatible with any other board in your PC. EGA, CGA, LAN, internal modems and tape backup systems all work without a hitch.

The megabyte of 16-bit AT and EMS on-board memory can be expanded with our DaughterCard to anywhere from 2 to 16 megabytes.

Our complex VLSI PC-AT converter circuit handles any signal coming through that requires an I/O call on the system bus.

This allows the 286 to do its 16-bit work at full speed and still talk to the outside world over the 8-bit IBM PC bus.

Magic? No. This is the only way to be fully AT-compatible and still keep your reliable old equipment. And we're the only company doing it this way.

If any new "protected mode" DOS comes along, we know we'll be compatible. It's in the nature of the technology. And, as our name suggests, we deal with *State Of The Art Technology*.

Order your MotherCard 5.0 today! Money back guarantee.

While we are still establishing our dealer network, we want to make the *MotherCard 5.0* available to you without delay.

To order, just call SOTA Technology during West Coast business hours. You can use any major credit card or send a company purchase order or check.

SOTA Technology *unconditionally guarantees the MotherCard 5.0* against defects of workmanship or any compatibility problems. We will gladly replace any card or refund your money in full if you return it within 30 days after receipt.

**TO ORDER, CALL 800-237-1713
In California, call 408-245-3366.**

SOTA™

STATE OF THE ART TECHNOLOGY™

SOTA TECHNOLOGY, INC.

657 N. Pastoria Blvd, Sunnyvale, CA 94086

Inquiry 319

Trademarks: IBM, PC/XT/AT are trademarks of IBM Corp.

AboveBoard is Intel's. MotherCard, MotherCard 5.0 and DaughterCard are ours.

See us at Comdex, Booth S. 9408



DIGITIZERS FOR DATA ENTRY

BY ELDON D. HEARN

A digitizer is an electronic tablet used to enter the coordinates of specific points of graphic information into a computer. You point at the location on a map or drawing with a stylus or cursor and the coordinate data is automatically sent to your computer. Once installed, it's simple to use and usually accurate to within a few hundredths of an inch.

Table 1 lists the eight digitizers I have compared, with a compilation of each machine's attributes. The list contains 80 percent of the digitizer manufacturers in the U.S. My company's development laboratory has used at least one model of each digitizer.

PRICE

Several prices are listed in table 1 if a digitizer is available in more than one size. These prices include no options, although options can add substantially to the overall price of the digitizer. All sizes represent the active area of the digitizer. All manufacturers buffer the active area by various distances, so the overall size of the digitizer is somewhat larger. One model, the Microgrid series, is contained in a drafting table and is quite large. It can be turned vertically and used in that fashion.

RS-232C SERIAL PORTS

Some digitizers have more than one RS-232C port, some have parallel ports, and some have both. You will require the parallel port option if you need faster coordinate transmission. The Intelligent Digitizer (ID) series, the Microgrid series, and the Digi-Pad 5 series have their RS-232C serial ports configured as DCE (data communications equipment) or DTE (data terminal equipment). The ID series also

A survey of eight devices for entering graphics data into personal computers

has one 26-pin and one 50-pin printed circuit card connector for other applications.

SPECIAL CABLES

Every manufacturer will provide a cable that matches the digitizer to your computer for an extra cost. Some digitizers will operate without a specially prepared cable. A standard serial cable will provide all the necessary connections for the Microgrid series and the Numonics 2200/2400 series. The other digitizers require some variations in the cable wiring to attach to a computer.

The RS-232C standard has been followed by all manufacturers except Houston Instrument. Although its HIPAD digitizer is nonstandard, Houston Instrument will supply you with a cable, depending on your application, to make all the necessary connections between your digitizer and computer.

Program control of serial port pin 20 (DTR) in your program is essential. If pin 20 of the serial port is enabled, the computer will accept serial transfer with a digitizer that follows the RS-232C standard. Most communications programs do this. PC-Talk and Crosstalk will communicate with your digitizer if you set both the digitizer and the program to the same data rate, word length, parity check, and stop-bit parameters.

DATA FORMAT

All digitizers transmit their coordinates in either ASCII or packed

binary code. Packed binary can represent the same data but in a different binary format. This is optional on all but one digitizer, the HIPAD, and is switch-selectable. The form differs between manufacturers, but usually the x

coordinate precedes the y coordinate. In this article, the ASCII format will be assumed.

On most digitizers the coordinate format is set, but some digitizers allow certain switch-selectable options. An additional digit of x and y value may be optional, or a decimal point may be included somewhere within the formatted string. Usually, the more digits that are transmitted with each coordinate, the greater the resolution from that digitizer will be. All digitizers can send their coordinates in inches or millimeters, and that is also switch-selectable for all but the HIPAD digitizer.

Included somewhere in the coordinate format and transmitted from the digitizer is a one- or two-character code that represents the key you pressed at the digitizer cursor when you digitized that particular point. The location of the character generally is the first or last character transmitted. Even if you have a one-button cursor or a stylus, the character or characters are transmitted with each coordinate pair. On the ID series of digitizers, a tablet identifier is the first character transmitted, and it gives you the option of utilizing more than one tablet with your computer.

On some digitizers, particularly the ones that allow a relocatable origin, a plus sign or a minus sign precedes

(continued)

Eldon D. Hearn is president of Geocomp Ltd. (749 Van Gordon Court, Golden, CO 80401), which develops software products for the energy and mining industries.

the x and y coordinates. Some digitizers will transmit only a minus sign when the coordinate is negative, with an unsigned coordinate considered positive.

The coordinate format is controlled by a ROM or PROM chip within the digitizer. Some manufacturers can emulate their competitors' digitizers by replacing this chip with another that transmits the proper coordinate format. If you have a program that works with another digitizer but not yours, check with the manufacturer. They might have a replacement ROM that emulates that digitizer, and you might be able to use the program.

BINARY FORMAT

The binary format allows faster communication from the digitizer and is often used in conjunction with a parallel port. The transmission from the digitizer is in binary notation and requires fewer bytes to transfer a coordinate than an ASCII coordinate. However, its use complicates the interfacing of both digitizer and computer. Most digitizers have the capacity to overwhelm a good program with the ASCII format; thus, it seems unnecessary to complicate your interface with this option.

BIDIRECTIONAL COMMUNICATION

Most digitizers can transfer their coordinates via the RS-232C connection at 150 to 9600 bits per second. Usually the rate is set by toggling certain switches, but one of the digitizers, the Summagraphics MMI 201, will automatically sense the data rate of your computer.

Feedback to the digitizer is called bidirectional communication, and the function of automatically sensing the data rate is called autobaud by Summagraphics.

RESET SWITCH

The Numonics 2200/2400 series of digitizers and the HIPAD have a reset switch, a handy refinement. Without a reset switch, you must turn the digitizer off and then back on again to enable changes whenever the digitizer switches are changed. The ID series has a "clear" switch at the con-

troller to perform any switch change during power-up.

TEST DISPLAY

Some digitizers have a test display that will let you observe the coordinates sent by the digitizer to the computer. You can purchase an optional test display if your program doesn't write the digitizer coordinates to the monitor in either numerical or graphic form and you need to see the coordinates of the point you digitized.

COMMAND INPUT BUFFER

Some newer digitizers with bidirectional communication have a buffer that will accept commands you transmit to the digitizer. The Bit Pad Two and the MM series of digitizers have a 10-character buffer size. The Microgrid series has a 64-character buffer.

The Numonics 2200/2400 series, the Digi-Pad 5 series, and the GP-7 and GP-8 have an unknown buffer size. You can build a file within the buffer limit that contains the commands to preset the digitizer to your application. You can then transmit the file to the digitizer with a communications program such as PC-Talk or Crosstalk.

SWITCH-SELECT FUNCTIONS

There are only three digitizers that do not have the usual number of switches to preset for functions or modes. These are the MM series, in which jumpers are used, and the GP-7 and GP-8, in which some functions and modes can be picked from a command menu defined just above the active area of the digitizer. The only other switches that require setting on the GP-7 and GP-8 are the communication switches located in the controller box.

POWER SUPPLY

All the digitizers discussed in this review require 110-volt AC electrical power. The ID series' power supply is in its controller and is separate from the digitizer. All the other digitizers have a wall-mounted transformer that is part of the power plug. Only the Digi-Pad 5 series has an on/off switch on its power supply. The other digitizers require you to remove the

power supply from the outlet to power down. If you purchase one of the digitizers without an on/off switch, you may want to use an extension cord with an attached toggle to turn off your digitizer.

STYLUS/CURSOR

The Stylus/cursor category in table I has two entries for each digitizer. The first entry shows the number of stylus buttons with which the digitizer can be equipped. The second entry shows the number of cursor buttons available on the digitizer's cursor. An "S" indicates a stylus without any buttons. In the case of the Digi-Pad 5 series, "5" in the first entry indicates that a 5-button stylus is available. A 5-button cursor is indicated as "5" in the second entry.

Each of the digitizers listed in table I comes with either a stylus or a cursor as an option. These devices direct the point or points that the digitizer will transfer to the computer. When the stylus or cursor is close to the digitizer surface and you press the stylus or a cursor button, the digitizer will transfer to the computer the coordinates of the point under the stylus or the point located at the junction of the cross hairs on the cursor. If you need just the point's coordinates, a stylus is adequate. But if you need point identification along with the coordinates, you may want to choose a cursor with enough buttons to identify each category of each point you transfer. The Digi-Pad 5 series of digitizers provides a 1-, 5-, and 16-button stylus as well as a 1-, 5-, and 16-button cursor. With the multibutton cursor you can define a certain key to call your program or terminate your digitizing sequence. With a two-button stylus, you can use the switch on the outside of the barrel as a terminating switch.

MODES

All digitizers have three modes: point, switch stream, and stream. These modes are the same for all machines, although there are other modes such as incremental and remote. Point transfer by the digitizer is a function of its data rate. A digitizer set at 9600

(continued)

Table 1: Comparison of features for the eight digitizers. Included are the important features and options for the most commonly available models.

Name	Intelligent Digitizer (ID) series	Bit Pad Two	Microgrid series	MM series	2200/2400 series	HIPAD	Digi-Pad 5 series	GP-7, GP-8
Company	Summagraphics Corp. 777 State St. Extension Fairfield, CT 06430 (203) 384-1344	Summagraphics Corp. 777 State St. Extension Fairfield, CT 06430 (203) 384-1344	Summagraphics Corp. 777 State St. Extension Fairfield, CT 06430 (203) 384-1344	Summagraphics Corp. 777 State St. Extension Fairfield, CT 06430 (203) 384-1344	Numonics Corp. 418 Pierce St. Lansdale, PA 19446 (215) 362-2766	Houston Instrument Corp. 8500 Cameron Rd. Austin, TX 78753 (800) 531-5205	GTCO Corp. 1055 First St. Rockville, MD 20850 (301) 279-9550	Science Accessories Corp. 970 Kings Highway W Southport, CT 06490 (203) 255-1526
Price	\$2500 \$6000	\$499 (Both models)	\$2375 to \$5085	\$291; \$445; \$895	\$859 to \$6595	\$840	\$1045 \$6750	\$995 \$3175
Size (inches)	11 by 11 42 by 60	11 by 11 (Both models)	17 by 24 to 42 by 60	6 by 9, 11½ by 11½, 18 by 12	12 by 12 44 by 60	11 by 11	11 by 11 to 42 by 60	18 by 24 60 by 72
RS-232C serial ports	2	1	2	1	1	1	2	2
Special RS-232C cable	Yes	Yes	No	Yes	No	Yes	Yes	Yes
Parallel port	2	No	Optional	Optional	No	Optional	Yes	Optional
ASCII format	SS	SS	SS	SS	SS	Yes	SS	Yes
Binary format	SS	SS	SS	SS	SS	Yes	SS	Optional
Bidirectional communication	No	Yes	Yes	Yes	Yes	No	Yes	Optional
Reset switch	Yes	No	Yes	Yes (MM1812 only)	Yes	Yes	No	From menu
Test display	Yes	No	Yes	No	No	Yes	Yes	No
Command-input buffer	N/A	10 characters	64 characters	10 characters	Unknown	N/A	Unknown	Unknown
Switch-select functions	Yes	Yes	Yes	Jumpers Switches (MM1812)	Yes	Cable-selected	Yes	From menu
Power supply	In controller	Wall-mounted	Wall-mounted	Wall-mounted	Wall-mounted	Wall-mounted	Wall-mounted	Wall-mounted
Stylus/cursor	S 1, 4, 13	S 3, 4	1 3, 4, 16	1 3, 4	S 1, 4, 16	S 1, 4	1, 5, 16 1, 5, 16	S 1, 4
Modes	PT, SWST, ST	PT, SWST, ST	PT, SWST, ST	PT, SWST, ST	PT, SWST, ST	PT, SWST, ST	PT, SWST, ST	PT, SWST, ST
Coordinate alteration	Yes	Yes	Yes	Yes	Yes	No	Yes	No
Self-test	Yes	Yes	Yes	Yes	Yes	Yes	Yes	No
On/off switch	Yes	No	Yes	No	No	No	Yes	Yes
Origin	F & R	F (model 1103) R (model 1105)	F & R	F & R	F & R	F & R	F & R	F & R
Resolution (lines per inch)	100 to 200	100 to 508 (rel.mode) 400 to 508 (abs.mode)	200 to 1016	100 to 1000	1 to 1000	100 to 1000	SS 1 to 1000	100
Accuracy (inches)	.004	.025 .005	.010 .005	.025 to .005	.01 to .005	.01 to .005	.010 to .003	.01 to .005
Sampling rate (counts per second)	Potentiometer 1 to 100	SS 2 to 154	SS 2 to 200	SS 2 to 200	SS 8 to 200	SS 1 to 100	SS 1 to 200	SS 25 to 200
Weight (pounds)	11 105	7	(Installed in drawing table)	8	4.5 30	5	8 to 100	8 (GP-7); 12 (GP-8)
Special features	Configured serial ports DCE, DTE	Two modes of operation	Vertical use; numerous options	Autobaud; two modes of operation	Large menu area; easy access to switches	Easy mode setting	High accuracy	Low price; large area

The resolution of a digitizer is the smallest distance it can distinguish.

bps will stream more coordinate pairs than one that is set at 300 bps. (The word *stream* is used in the sense that one coordinate pair follows another until you terminate the transmission.) Point mode will transmit one coordinate pair to the computer for each press of the stylus or cursor button. Switch stream mode will stream the coordinate pairs to the computer only when you press and hold down the stylus or cursor button. Stream mode will stream the coordinate pairs until you power-down the digitizer. In the Modes category in table 1, point mode is abbreviated as PT, switched stream mode is SWST, and stream mode is ST.

The ID series of digitizers' controller has buttons that let you easily access these three modes. The Bit Pad Two, Microgrid series, MM series, 2200/2400 series, and the Digi-Pad 5 series let you set these modes by either physically changing the internal switches or transmitting a certain code to the digitizer. The HIPAD lets you set three modes from buttons located on the front of the digitizer. The GP-7 and GP-8 digitizers have a menu in front of their controllers from which you can choose two modes or reset to the default setting. The easiest settings are, of course, the settings made from the computer, but they are transitory and revert to the original switch settings when you turn off the digitizer.

COORDINATE ALTERATION

Coordinate alteration lets you change the coordinate format of the digitizer without changing the ROM chip. Alteration will operate on the ASCII or binary coordinate format whether the coordinates are in U.S. customary system or metric units. If no alteration is available for a particular digitizer, then "No" is indicated in the table. If alteration is available, "Yes" is used. The

ID series of digitizers has DIP switches that can select many differing coordinate formats such as adding another digit in *x* and *y* coordinates or including a decimal point at specific locations.

The Bit Pad Two machine has only two types of alteration: absolute mode and relative mode. If you set a certain switch, the digitizer will alter its coordinate format to include a plus or minus sign in the format. This is called relative mode. In relative mode the digitizer will report its coordinates relative to the preceding point that was digitized. In absolute mode, an origin is fixed at the lower left corner of the digitizer, and the coordinate format is changed accordingly. The relative mode is not available in binary format.

The Microgrid series is somewhat different in its alteration scheme. Both U.S. customary system and metric-unit formats are available in either high or low resolution. You can specify the format to include a decimal or a delimiter (a comma or any ASCII character) and to terminate the coordinate with either a carriage return or a carriage return and linefeed.

The MM series of digitizers' coordinate formats are dependent on the resolution setting on the tablet and whether you have set the tablet in delta mode. For the MM1201 digitizer, for instance, if you set the resolution between 1 and 508 lines per inch, the digitizer will output a coordinate pair that has one less significant digit than if you had set the digitizer's resolution above 1000 lpi. The MM961 digitizer outputs its coordinates just like the MM1201 but does so for resolutions from 1 to 1016 lpi. It too can be set in delta mode.

You can change the Numonics 2200/2400 series of digitizers' coordinate format only by sending host commands to the digitizer. By specifying certain commands, you can drop either the first or the last digit of the coordinate pair. You cannot enable the format by a switch.

The HIPAD digitizer's coordinate format is preset and cannot be changed or enabled by setting a switch. The Digi-Pad 5 series' coordinate format can be changed only in

the packed binary format of high and low resolution.

The GP-7 and GP-8 sonic digitizers' coordinate formats are also preset and cannot be changed by setting a switch. In stream mode the coordinate format will change to include a flag to indicate whether the stylus or cursor is near the digitizer surface.

SELF-TEST

Every digitizer except the GP-7 and GP-8 has a self-test function to test the digitizer's circuitry. The Numonics 2200/2400 series can also check the main PROM chip and identify its number and output. You usually invoke the self-test check by setting a switch or by transmitting a certain code to the digitizer.

ON/OFF SWITCH

The only digitizers that have a convenient on/off switch are the GP-7 and GP-8, the Microgrid series, the Digi-Pad 5 series, and the ID series. The switch on the latter is convenient only if you have placed the controller close by. The other manufacturers seem to want you to leave the machine turned on, for they have made no provision to power-down the digitizer other than by removing the power source from the wall outlet.

ORIGIN

You can get the Numonics 2200/2400 series and the Bit Pad Two digitizers with a fixed origin. The origin is permanently placed at the lower left corner of the digitizer, and the letter F is used in table 1 to designate a fixed origin. The letter R is used where the origin is relocatable. The MM series of digitizers has a relocatable origin, but the origin can be placed only at the upper or lower left corner of the digitizer. The Microgrid series of digitizers' origin defaults to the lower left but can be relocated anywhere within the active area. In cases where the digitizer defaults to some origin that can be relocated somewhere else on the digitizer by setting a switch, the abbreviation F & R is used.

RESOLUTION

The resolution of a digitizer is the smallest distance or movement that

the digitizer can distinguish. This distance is measured in lines per inch, and you usually can set it at particular switches within the digitizer. The greater the numerical resolution of a digitizer, the smaller the movement that can be detected and reported to the computer.

One digitizer, the Bit Pad Two, is configured so that its resolution differs when in absolute or relative mode. Most digitizers' resolutions vary from 1 to just over 1000 lines per inch. Digitizers with the highest resolution report their coordinate pairs in five significant figures. For a given digitizer of 60 by 72 inches, the coordinates would be reported as 60000, 72000 (inch units and ASCII format) plus or minus the accuracy of the digitizer. As you can see in table I, the higher-resolution digitizers are not necessarily the most expensive ones.

ACCURACY

The Accuracy category in table I lists the claimed accuracy for each digitizer. The accuracy of a digitizer is measured by how closely a point is reported as compared to its actual location on the grid.

SAMPLING RATE

On most digitizers you can set the sampling rate, or report rate, by a switch or a combination of switches on the digitizer or by transmitting certain codes to the digitizer from the computer. Rates of coordinate transmission depend on the digitizer's data rate. Usually data rates above the digitizer's capacity to transmit are ignored. You will attain the ability to transmit a maximum of 200 coordinate pairs per second only at data rates of 9600 bps and higher. The Numonics 2200/2400 series' sampling rate can be set to delay the transmission of each coordinate pair for as long as eight seconds in stream mode. The sampling rate of the ID series can be set by means of a potentiometer, or slide switch, located on the controller.

SPECIAL FEATURES

Each digitizer has certain special features that make it unique. The ID

series of digitizers will transmit coordinate pairs with high accuracy. It is easy to use, with all mode switches on the front of the controller and the on/off switch on the back. You should have an application program available for the digitizer before buying it because the serial interface is somewhat intimidating. The programmer will appreciate the ID series. One RS-232C port is configured as DCE and the other as DTE.

The Bit Pad Two is available in two models: the 1103, a low-accuracy model, and the 1105, a high-accuracy model. The two models are available in only one size, 11 by 11 inches. Both models have bidirectional communication. There is neither an on/off switch nor a reset switch. The sampling rate is switch-selectable. The sheer number of DIP switches can be overpowering at times, but an experienced programmer can work with more than one application without resetting a single switch.

The Microgrid series of high-accuracy digitizers are mounted in drafting tables. Sizes range from 12 by 12 inches to 42 by 60 inches. The series has bidirectional communication and switch-selectable sampling rate. The tablet also contains two RS-232C ports, one configured DTE and the other DCE. The table has a tilt top and can be used in the vertical position. Its origin is relocatable, and the tablet has a convenient on/off switch. All users will find the Microgrid series easy to operate. A standard serial cable will configure the tablet to an RS-232C serial port on the computer.

The MM series of digitizers is both a high- and low-accuracy series. Sizes range from 6 by 9 inches (MM691) to 11½ by 11½ inches (MM1201) and 18 by 12 inches (MM1812). The MM691 and the MM1201 have the autobaud function. The data rates of the MM1812 can be switch-selectable or selected by autobaud. The MM691 and MM1201 have a delta mode to provide coordinates relative to the last coordinate issued. This mode is called the relative-position mode on the MM1812. The MM1812 also provides a coordinate format called UIOF (universal input/output format), which is the beginning of format standar-

*Accuracy is measured
by how closely a
point is reported
compared to its actual
location on the grid.*

dization across the entire Summagraphics product line.

The MM691 and MM1201 are somewhat difficult to initially interface to a computer, but the MM1812 is more convenient.

The Numonics 2200/2400 series of digitizers can define a separate menu area of the digitizer, from which you can pick predefined symbols or functions. The number of columns and rows and cell width and height can be set anywhere within the active area of the digitizer. None of the other digitizers has this feature.

The Numonics 2200/2400 series also provides easy access to the DIP switches located inside the digitizers' cases. Simple slots provide open access to the switches without requiring you to remove the back of the digitizer. This is also true with some other digitizers.

Some of the HIPAD digitizer's mode switches are placed conveniently on the digitizer, giving you ready access to point mode, switch stream mode, and stream mode. A reset switch is also in this group of switches. You must remove the digitizer's power source from the wall outlet to power-down the unit.

The HIPAD is the only digitizer that has a nonstandard RS-232C communications port. Certain options must first be grounded to a particular pin before being enabled or disabled. The HIPAD transmits its coordinates with high accuracy in ASCII coordinates or in binary format. The HIPAD does not support bidirectional communication, but the tablet has a relocatable origin.

Initially the HIPAD may be difficult to interface, but the company support

(continued)



Let Lab Boss™ turn your IBM PC into a powerful instrument controller.

You can spend thousands of dollars for a dedicated instrument controller. Or a few hundred for a controller that's dedicated to you and your IBM PC.

Lab Boss™ from National Instruments puts you and your IBM PC (or compatible) firmly in charge of GPIB instruments. From sophisticated laboratory equipment, like digitizing oscilloscopes and spectrometers, to standard printers, plotters, tape drives and more. At data transfer speeds

that are the highest in the industry.

And Lab Boss products offer a direct data link from your measuring equipment to a full range of analysis software, including RS/1, Lotus 1-2-3, and Symphony. So you can easily report your findings on the same system you used for instrument control, data acquisition and analysis. Try that on a dedicated controller! So — you want to be the boss? Call National Instruments. 800/531-4742.



NATIONAL INSTRUMENTS

12109 Technology Blvd.
Austin, TX 78727 512/250-9119

is excellent. However, an experienced user may be disappointed by the lack of options. Houston Instrument's upcoming True Grid series of digitizers should rectify all the inadequacies of the HIPAD.

The Digi-Pad 5 contains a Z80A microprocessor. The company claims the digitizer also has a higher degree of sophistication due to its patented electromagnetic principle. The Digi-Pad 5 offers about the same options as the ID series, but with the added capability of bidirectional communication.

GTCO Corporation supports almost every coordinate format available in a digitizer. It supplies PROM chips that can emulate its competitors' formats. The stylus of the Digi-Pad 5 digitizer is unique. Certain configurations of a 1-, 5-, and 16-button stylus are available, including a Tilt option that lets you determine the tilt of the stylus with respect to the surface of the digitizer and ultimately the direction in which the stylus is angled. Thus, the stylus functions as an effective joystick. A pressure-sensitive stylus is also available.

The only digitizers that are exceptionally different from all the others are the GP-7 and the GP-8. They operate on a sonic principle with a sound transmitter located in the stylus and two receivers located some distance apart on the controller. To digitize a point you merely depress the stylus, which transmits a sound. The sound is picked up by the receivers on the controller, and the differences in the x and y coordinates are calculated. Adjacent to the controller is a menu area from which you can pick certain functions or modes with the stylus. The GP-7 and GP-8 are easy to set up and use.

CONCLUSION

Digitizers are the most effective method of transferring coordinate data from a map or diagram to a computer. Each of these digitizers offers some function or combination of options that makes it unique. Careful selection of the functions that best suit your applications is the only way to assure yourself satisfactory operation of your system. ■

Discover the true potential of laser printing.

Unleash The Power. It has harnessed the awesome energy of light. With that power, it will move mountains of work in minutes.

Introducing the Genicom 5010 Laser Page Printer; twenty-five percent faster than yesterday's laser printers. Printing everything from letters and legal size paper to transparencies—at 10 pages a minute. So fasten your seatbelt. And prepare for laser speed.

Superior Handling. When it comes to paper handling, the Genicom 5010 Laser is the printer to beat. It delivers double the standard input and 10 times the output capacity of other leading brands.

Handle big jobs easily with the 5010's automatic 200 sheet feeder. Shift into overdrive with a Genicom exclusive: an optional 50 sheet feeder cassette. There's even a manual feed slot, so you can print single sheets and transparencies without interrupting your work flow. And keep your work moving without a hitch, thanks to Genicom's efficient paper path.

But no matter what you feed the 5010, the result is laser perfect. Whether it's word processing that approaches typeset quality or high resolution graphics, the Genicom 5010 leaves nothing to the imagination.

It's Convertible. With Genicom's unique personality cartridges, the 5010 converts into multiple identities. Like a Diablo® 630, an IBM® Graphics Printer, or a Hewlett-Packard® LaserJet Plus for starters. Changing personalities is easy. Simply plug in a new cartridge. In seconds, the 5010 is up and running with any computer worth mentioning, plus the very latest laser software.

When it comes to print styles, the 5010 converts to your personality. Choose from a variety of fonts. Insert up to four font cartridges at once, and vary type styles within the same document.



Take Command. The 5010's prominent control panel is sophisticated simplicity. Just push a button to select fonts, input cassette, forms overlay, paper size, characters per inch, lines per inch and form feed. Even the 5010's diagnostic readout speaks your language, with a 32 character LCD that informs you of printer status in plain English.

Pass The Limit. Genicom designed the 5010 to surpass the standard limits for printer reliability. That's why the 5010's OPC drum and developer last 28,000 pages. And the toner cartridge has a 5000 page life, instead of just 3000 pages like other lasers.

Finally, Genicom backs its laser with a full year warranty on parts and labor. So stop by your nearby Genicom dealer today and discover what a true laser printer can do. Put a 5010 through its paces. You'll see the light.

For the Genicom dealer nearest you, call 1-800-437-7468. In Virginia, call 1-703-949-1170.

Diablo® is a registered trademark of Xerox Corporation. IBM® is a registered trademark of International Business Machines Corporation. Hewlett-Packard® is a registered trademark of Hewlett-Packard Company.



GENICOM

The Printers That Mean Business.
One Genicom Drive, Waynesboro, VA 22980

NEW DASH FOR YOU

Your old printer should look so good.

Introducing the ImagEnhancer™ PC add-on board. It enables ordinary monochrome or color dot matrix printers to produce high-quality, plotter-like graphics.

THE OUTPUT IS OUTSTANDING.

The ImagEnhancer is the perfect way to get presentation-quality graphs, charts and artwork from your old dot matrix printer.

What's more, it comes with a built-in 512K memory. So while your printer is printing one job, you can use your PC for another. Which will improve your productivity tremendously.

And of course, the ImagEnhancer works with the same computer products most everyone works with.

IBM® PCs, XTs, ATs or 100% compatibles

with graphics capability. Alps, Epson® or Epson-compatible monochrome or color dot matrix printers. And

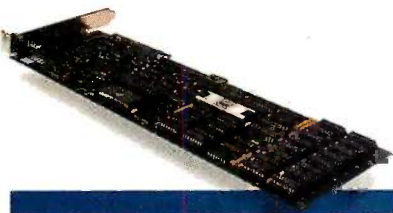

The ImagEnhancer PC add-on board brings plotter-like output to dot matrix printers.

Houston Instrument (DM/PL) plotter-compatible software, including Lotus® 1-2-3®, Symphony®, PFS®:Graph and Framework™, among others.

AND THE PRICE IS RIGHT.

At \$595*, the ImagEnhancer costs a fraction of what you'd pay for a new plotter. It's simple to install, too. And backed by a one-year warranty.

The ImagEnhancer is a product of Alps America, a U.S. subsidiary of Alps Electric Co., Ltd. of Japan, an International Fortune

GRAPH Sales I

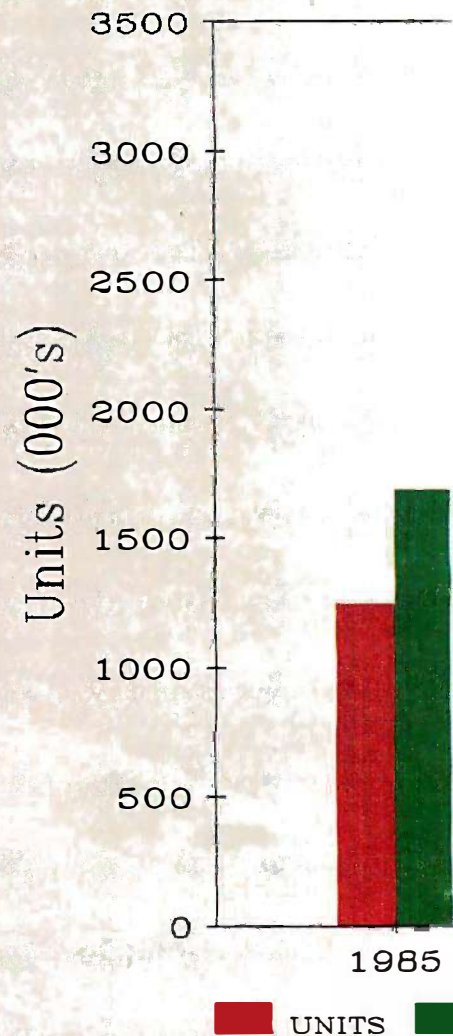

500 company. Other Alps America products include a full line of high-quality printers.

For more information, print samples, or the name of the dealer/distributor nearest you, write to Alps America, 3553 North First Street, San Jose, CA 95134. Or call (800) 828-ALPS. In California, (800) 257-7872. In Canada, (800) 858-2577.

Better yet, send in this coupon along with your payment. And teach your old dot matrix some new tricks.

Inquiry 15 for End-Users. Inquiry 16 for DEALERS ONLY.

R OLD DOT MATRIX.

ICS BOARD MARKET

recast - Office/Government

SEE US
AT COMDEX
BOOTH 7452, HILTON

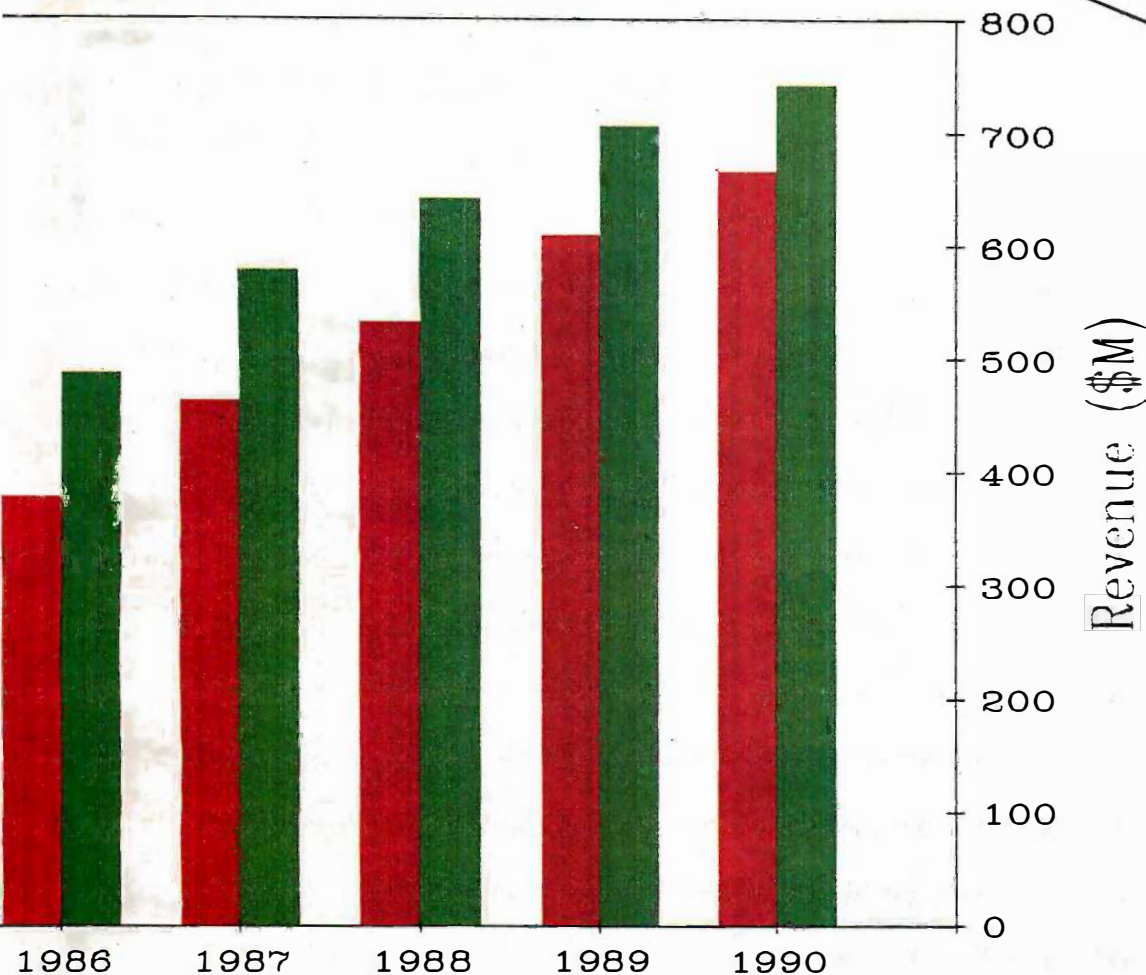

REVENUES

Source: Future Computing

This image was printed with an ordinary color dot matrix printer and the ImagEnhancer PC add-on board. With a monochrome printer, you get the same high resolution in black and white.

SO ORDER TODAY.

Name: _____

Address: _____

City: _____

State: _____ Zip: _____

Phone: _____

Send _____ ImagEnhancer(s) at \$595 each.*

*Add \$10.00 shipping and handling for each. California residents add 7% sales tax.
Offer available in U.S.A. only.

Method of payment (circle one):

Check Money Order **MASTERCARD** VISA

Card number: _____

Exp. date: _____

Signature: _____

Mail to: Alps America
3553 North First Street
San Jose, CA 95134
Or call (800) 828-ALPS
In California, (800) 257-7872

ALPS
AMERICA

Microprocessor Development Systems & In-Circuit Emulators



SA2000

Complete universal development system and in-circuit emulator for latest micro controllers.

- Cross assembler, Linker, Editor standard.
- Powerful software debugger plus Real-Time ICE.™

SA700-68000

Dedicated in-circuit emulator for 68000 Microprocessor.

- Most transparent 68000 emulation.
- Over 1/2MByte emulation Ram.
- Command files for software/prototype/production test.



	PROCESSOR (16bit)	PKG	SA710M	SA700-68000
INTEL	8086/88	DIP40P	○	
	80C86/88	DIP40P	○	
	80186/188	LCC/PGA	○	
NEC	μPD70108/116 (V20/30)	DIP40P	○	
	μPD70208/216 (V40/50)	PGA	○	
MOTOROLA	MC68000	OIP64P,PGA60P		○
	PROCESSOR (8bit)	PKG	SA2000	
ZILLOG	Z8CMOS (Z80, Z80A, Z80C)	DIP40P		○
	Z80H (Z80, Z80A, Z80B, Z80H)	DIP40P		○
	Z8 (Z8601/03/11/13-12R)	DIP40P		○
	SUPER-8 (Z8310-33)	DIP40/48P		○
INTEL	80C85, 8085AH-2	DIP40P		○
	8048 (8035/39/40/49/50AH)	DIP40P		○
	8051 (8031/51AH, 80C51)	DIP40P		○
MOTOROLA	MC6801 (6801/03-1)	DIP40P		○
	MC6809 (68A09, 68B09)	DIP40P		○
	MC6809E (68A09E, 68B09E)	DIP40P		○
HITACHI	MC68HC11	DIP48P		○
	HD6301V/6303R, HD63701V	DIP40P		○
	HD6301X/6303X, HD63701X	SDIP64P		○
	HD6301Y/6303Y, HD63701Y	SDIP64P		○
	HD6305U/V, HD63705V	DIP40P		○
	HD6305X/Y	SDIP64P		○
	HD6305Z, HD63705Z	FLAT80P		○
HD6309E	DIP40P		○	
NEC	HD61810B (HSP)	DIP40P		○
	μPD7807/08/09	SDIP64P,QUIP64P		○
	μPD7810H/11/14/16	SDIP64P,QUIP64P		○
MITSUBISHI	μPD78C10/11	SDIP64P,QUIP64P		○
	M50734SP	SDIP64P		○
	M50745	SDIP64P		○
ROCKWELL	M50747	SDIP64P		○
	R6502, 65002	DIP40P		○



SA710M

16-bit universal system analyzer and in-circuit emulator.

- Symbolic features include local variables, arrays, structures.
- Start/Stop trace without breaking.
- Stand-alone or Host operation.

*In U.S. SA2000 & SA710M with Zilog chip support can be purchased through Zilog or Sophia sales channel.

*ICE™ is a trademark of Intel Corp.

*No.3 universal MDS manufacturer in the world.

Call toll-free 1-800-824-9294 (outside CA.)
1-800-824-6706 (in CA.)

Sophia
systems™

U.S. & European Headquarters: Sophia Computer Systems, Inc., 3337 Kifer Road, Santa Clara, CA. Tel.(408)733-1571 Fax.(408)749-8172 95051.
Corporate Headquarters: Japan, Sophia Systems Co., Ltd. NS Bldg. 2-4-1, Nishishinjuku, Shinjuku-ku, Tokyo 163. Tel.(03)348-7000.



TWO C COMPILERS FOR THE AMIGA

BY CHARLIE HEATH

Two good C compilers by Lattice Incorporated and Manx Software Systems are available for the Commodore Amiga. Both compilers have their strengths and weaknesses, and both are suitable for professional software development.

LATTICE C

Lattice worked in conjunction with Commodore to develop its C compiler for the earliest software developers. One of the most important issues in programming the Amiga is having access to all the system library calls and data structures that the Amiga uses to access its graphics and multitasking resources. Fortunately, Lattice addressed this issue from the start; the result is a complete set of binding routines and include files that define all the Amiga data structures.

MANX AZTEC C68K

The Manx Aztec C68K compiler arrived later on the Amiga scene, and its first revision was made available this spring. However, Manx Software Systems was no newcomer to the world of 68000 C compilers; it already had a C compiler available for the Macintosh. The Manx Aztec C68K compiler for the Amiga generates fast, compact code and does it quickly.

BENCHMARK RESULTS

The benchmark results heavily favor Aztec C68K. For a comparison of the compiler and linker sizes, see table 1. For the timing results, see table 2. It is important to look at the reasons why the results are as they appear. The widest gap in benchmark results occurs in two areas: floating-point

An all-points comparison of Lattice C and Manx Aztec C68K

math and size of object code.

In size of object code, the Aztec C68K compiler consistently produces benchmark results that are less than half the size of programs compiled under Lattice C. In the BYTE benchmark tests, the Lattice C programs average nearly three times the size of Aztec C programs. Since I have a strong interest in code optimization, I looked closely at the output of both compilers. My conclusion is that the Aztec compiler should generally produce code about 20 to 33 percent smaller than equivalent code from the Lattice compiler.

Practically speaking, the size of output code from these benchmarks is largely determined by the size of the printf library function. Manx Software Systems has done a good job of creating a very efficient printf function, but if you want to measure the efficiency of the code that the Aztec C68K compiler generates, you should factor out that difference, particularly if you do not use printf in your code. The code size for a program with the single statement "Hello, world" is 4720 bytes with Aztec C and 14,508 bytes under Lattice C. This difference has little to do with the compiler used, except perhaps as a measure of how efficient the compiler is at building the linking libraries. If Lattice Incorporated wanted to improve its C compiler's benchmarks, it could optimize the compiler's printf function.

The other major difference in size of executable files produced is due to the Aztec C68K compiler's use of 16-bit offsets for addressing data and functions. The size of int makes very little difference in the size of the executable file (although it does make a big difference in the benchmarks for speed). The difference in executable file size comes from the addressing mode used for referencing variables and functions.

The Aztec C68K compiler reserves register A4 as a base-address pointer, which is used to index a 64K-byte data region. This allows the use of 16-bit offset addressing rather than 32-bit absolute addresses. The result is code that is about 25 percent faster and 33 percent smaller for every memory reference instruction. The same method is used for function addresses: Rather than using a 32-bit absolute address, a 16-bit program counter offset is generated for function calls.

This method of addressing is the single biggest difference between Aztec C and Lattice C in the size of code generated. An overlooked fact in this assessment is that the Lattice C compiler actually supports base-relative addressing as a compiler switch. However, with the current version of ALink, it is not possible to use this feature because Metacomco, the writer of ALink, did not include support for base-relative addressing in the object code specification.

(continued)

Charlie Heath (P.O. Box 561, Cambridge, MA 02140), a cofounder of MicroSmiths Incorporated, has developed several Amiga programs including TxEd, Mean 18, and Game-Maker.

Manx Aztec C68K

Type

C development package and debugger

Company

Manx Software Systems
P.O. Box 55
Shrewsbury, NJ 07701
(201) 542-2121

Necessary Hardware

Amiga 1000 with AmigaDOS; 256K bytes of RAM; one floppy disk drive

Copy-protected

No

Price

Aztec C68K Commercial version: \$499
Aztec C68K Developer version: \$299

Lattice C

Type

C development package and debugger

Company

Lattice Incorporated
P.O. Box 3072
Glen Ellyn, IL 60138
(312) 858-7950

Necessary Hardware

Amiga 1000 with AmigaDOS; 512K bytes of RAM; one floppy disk drive

Copy-protected

No

Price

Amiga C compiler: \$149.95
Amiga IBM PC cross-compiler: \$250

A couple of limitations arise when you use 16-bit offset addressing. The first is a generic limitation similar to the segmented address space of processors like the 8086; the second is an Amiga-specific issue based on the philosophy of Amiga memory management.

The first limitation is that when you use only 16 bits of address, you effectively limit the size of the addressed object to 64K bytes. This should be considered separately for code and data, since data is addressed as an offset from a base register, whereas code is referenced as an offset from the program counter. The Aztec C68K compiler and linker solves the code addressing problem by putting jump vectors into the data segment when you try to access a function that is outside the range of the current program counter. If the code is within range (32K bytes forward or backward), it is directly accessed. Otherwise, an equivalent data reference instruction is generated that jumps to a vector in the data segment. The data reference problem is more difficult to solve if you have a large data segment. The Aztec C68K compiler lets you combine modules compiled with small (program-counter-relative) and large (absolute) data segments, so it is possible to separate code into modules that reference only short-range data and modules that can reference any part of the data segment.

I am uncertain whether you can do the same with the Lattice C compiler, assuming it is possible to use its 16-bit addressing mode. This is because Lattice C uses register A5 as a base reg-

ister when you use short addressing and register A5 as a register variable if you compile without the 16-bit address switch. Since the base-relative data addressing relies on a fixed-base address register, I expect there would be problems combining relative and absolute addressing with Lattice C.

The second limitation to using 16-bit offset addressing with the Amiga is the basic philosophy of the memory manager. The Amiga executive has no provisions for making available memory contiguous once it has been allocated, and the result is that often the memory map has many small regions of free memory. The Amiga's scatter-loading philosophy stipulates that the program should deal with this fragmentation by loading into a set of smaller, noncontiguous regions rather than a single large region. However, without contiguous memory you can't use addressing with a 16-bit offset; you must fall back to a 32-bit absolute address. The linker must produce code and data with many small *hunks* (i.e., blocks of code or data with relocation information) rather than a single large hunk.

This issue is a problem with the Aztec C68K compiler and linker, although Manx Software Systems has assured developers that it will address this problem in the next revision. The current revision of the Aztec C68K linker produces only a single code segment and a single data segment. This means that if your program has 180K bytes of code, it is all put into a single hunk that must be loaded into a contiguous area of memory. If there is not enough contiguous memory, the program probably will not load; if it does, it might have trouble allocating a large area of contiguous memory for the Amiga's display.

The optimum size that hunks should be is subjective. The Lattice C libraries have too many hunks: In the current release, Lattice C has many segments that only load 4 or 8 bytes of code or data. For example, the SIEVE benchmark is split into about 40 hunks. Each hunk requires about 32 bytes of disk storage and about 16 bytes at run time to identify each hunk; thus, Lattice C's benchmarks have about 1200 bytes of overhead

Table 1: Sizes of files needed on disk for compiling and linking. All file sizes are in bytes.

Aztec C68K		Lattice C	
cc	64,776	lc1	108,528
as	36,888	lc2	113,228
ln	21,296	alink	28,572
<hr/>		<hr/>	
Total	122,960		250,328

THE 18 POUNDER

That's right!

18 pounds of BYTE magazine—a year's subscription delivered monthly to the person of your choice—plus a bonus issue dedicated to IBM PCs! And, the savings to you is **50% off the newsstand price!** A gift announcement will be sent in your name to the recipient. Order your gift subscription today and beat the holiday rush.

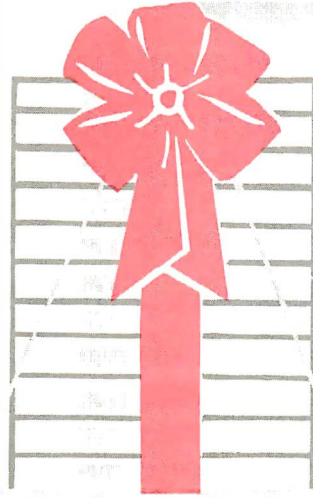

18

BYTE
THE SMALL SYSTEMS JOURNAL



YES! Please send a gift subscription to BYTE at the basic subscription rate of only \$21 for a full year (12 issues)—**a savings of 50% off the newsstand price of \$42.**

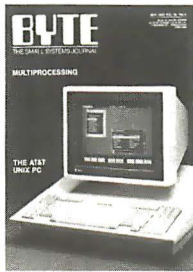

FROM: Name _____
Address _____
City/State/Zip _____

TO: Name _____
Address _____
City/State/Zip _____

Payment enclosed Bill me 46BGND

Charge to: VISA MasterCard

Account # _____ Expiration Date _____

Signature _____

Note: If you wish to give more than one gift subscription, simply list names and addresses for additional gifts on a separate sheet of paper and mail in an envelope with this card.

Please allow 6-8 weeks for processing.

BYTE
THE SMALL SYSTEMS JOURNAL



YES! Please send a gift subscription to BYTE at the basic subscription rate of only \$21 for a full year (12 issues)—**a savings of 50% off the newsstand price of \$42.**

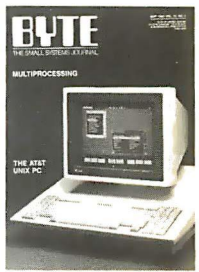

FROM: Name _____
Address _____
City/State/Zip _____

TO: Name _____
Address _____
City/State/Zip _____

Payment enclosed Bill me 46BGND

Charge to: VISA MasterCard

Account # _____ Expiration Date _____

Signature _____

Note: If you wish to give more than one gift subscription, simply list names and addresses for additional gifts on a separate sheet of paper and mail in an envelope with this card.

Please allow 6-8 weeks for processing.

BYTE
THE SMALL SYSTEMS JOURNAL



THE 18 POUNDER

That's right!

18 pounds of BYTE magazine—a year's subscription delivered monthly to the person of your choice—plus a bonus issue dedicated to IBM PCs! And, the savings to you is **50% off the newsstand price!** A gift announcement will be sent in your name to the recipient. Order your gift subscription today and beat the holiday rush.

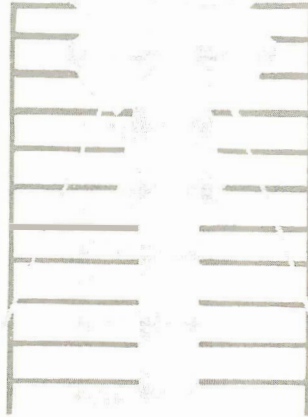

18

BYTE
THE SMALL SYSTEMS JOURNAL

**Mc
Graw
Hill**

NO POSTAGE
NECESSARY
IF MAILED
IN THE
UNITED STATES

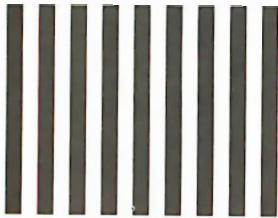

BUSINESS REPLY MAIL
FIRST CLASS MAIL PERMIT NO. 39 MARTINSVILLE, NJ

POSTAGE WILL BE PAID BY ADDRESSEE

BYTE Subscriptions
PO Box 597
Martinsville, NJ 08836-9956



NO POSTAGE
NECESSARY
IF MAILED
IN THE
UNITED STATES

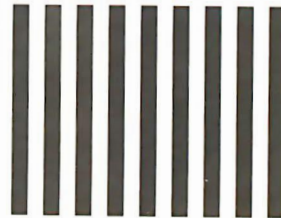

BUSINESS REPLY MAIL
FIRST CLASS MAIL PERMIT NO. 39 MARTINSVILLE, NJ

POSTAGE WILL BE PAID BY ADDRESSEE

BYTE Subscriptions
PO Box 597
Martinsville, NJ 08836-9956



just supporting the various hunks.

I'm looking forward to getting the Aztec C68K revision that lets you separate programs into hunks, but Aztec users beware: Your programs will get a bit fatter when you break them up into hunks.

In the floating-point math results, the Aztec C68K compiler produces results that are 10 to 20 times faster than Lattice C's. The difference, however, is simple: Lattice C uses double-precision IEEE math routines, which are very accurate but also very slow, compared with the Motorola single-precision FFP math routines that the Aztec C68K compiler uses (see the SAVAGE benchmark results in table 2). If your floating-point math requirements lean toward speed, Aztec C68K's use of the FFP routines is exactly what you need. However, if you need the IEEE precision, you'll need the Lattice C compiler.

What are the other big differences in the benchmarks? I've made little mention of speed, but the Aztec C68K compiler does very well in this area. The two compilers are about even, save for the advantages of using relative addressing, when using 32-bit integers. In fact, the Lattice C compiler does a better job of optimizing in terms of remembering intermediate results rather than recalculating them in two adjacent source-level statements. An example of this would be assigning values to an array of data structures. The Lattice C compiler would calculate the address of the referenced structure element once and use it as a base address for each of the assignments; the Aztec C68K compiler would recalculate the base address each time it was used, even if the same base address was used 10 times in a row.

Aztec C68K goes into overdrive for benchmark speed when you use 16-bit integers, particularly if you make appropriate use of register variables. This speed is best demonstrated in the Sieve benchmark, in which Aztec C68K finished in 2.6 seconds compared to 3.8 seconds using 32-bit integer size, which was identical to the time Lattice C posted.

The one benchmark that neither
(continued)

Table 2: Benchmark timing and file size results. All times are in seconds, and all file sizes are in bytes. A dash indicates that timings were not available. The benchmark programs are available from BYTEnet Listings at (617) 861-9764.

	Aztec C68K (16-bit)	Aztec C68K (32-bit)	Aztec C68K (16-bit with registers)	Aztec C68K (32-bit with registers)	Lattice C	Lattice C (with registers)
Sieve						
Compile	15	15	14	15	48	49
Link*	25(130)	24(130)	25(131)	25(130)	61	60(130)
Execute	4.6	5.8	2.6	3.8	5.8	3.8
File Size	5496	5508	5444	5456	16,320	16,284
Fib						
Compile	18	18	—	—	48	—
Link	24	25	—	—	60	—
Execute	19.6	22.6	—	—	22.7	—
File Size	5460	5468	—	—	16,280	—
Sort^b						
Compile	22	22	22	22	60	60
Link	26	26	26	26	61	61
Execute	9.3	9.8	7.9	8.9	9.6	8.5
File Size	9912	10,092	9836	10,016	20,800	20,756
Float						
Compile	18	—	—	—	49	—
Link	30	—	—	—	61	—
Execute	15.9	—	—	—	118.3	—
File Size	6840	—	—	—	16,772	—
Fileio						
Compile	24	—	—	—	55	—
Link	27	—	—	—	61	—
Execute	1812	—	—	—	2522	—
File Size	7004	—	—	—	17,332	—
Savage^c						
Compile	17	—	—	—	47	—
Link	32	—	—	—	62	—
Execute	9.9	—	—	—	234.5	—
File Size	6688	—	—	—	23,376	—
Accuracy						
	Lattice = 2.4999999996836e+03					
	Aztec = 2.72685551643371e+3					
	(perfect = 2.5000000000000e+03)					

* For Aztec C68K, the slower (parenthesized) time is the time required to link with the library on disk; the faster time was achieved using the RAM disk. For Lattice C, the slower time was the normal time, but the faster time was the result of including the keyword faster at the end of the linker command line.

^b It is necessary to increase the stack size to run this benchmark with either compiler. I used STACK 40000.

^c A floating-point math benchmark on the Amiga may be slower on the first execution because the libraries must be loaded from disk. Lattice C's size differential is partly due to the Mathtrans library; Aztec C68K uses the Amiga system run-time library, which is about 4.5K bytes. Lattice C uses its own double-precision IEEE routines in object code. The Savage benchmark is from *Dr. Dobbs' Journal*, September 1983, page 120.

compiler could do well in was Fileio. There are two problems in this area. The first problem is that AmigaDOS simply does not handle random disk I/O very well. The second is that the multitasking routines do not handle single-character I/O well.

I will explain the second problem first. In the multitasking environment, any disk I/O request must pass a message to the disk device driver, which then goes out and handles the request. Then the driver returns a message to the task that made the request. This same overhead occurs whether your request is for a single byte or for 100K bytes. In a multitasking environment, this overhead allows many different tasks to access the same disk and files concurrently without problems. The Fileio benchmark does a lot of single-character I/O operations, which is the worst-case performance category for the Amiga. A simple solution for programmers is to make requests for as large a chunk of data as possible at a time. The Amiga disk can pump data at about 8K bytes per second if you make requests for large blocks.

The first problem, random disk I/O under AmigaDOS, is actually two problems: AmigaDOS is slow, and the Amiga is a track-buffered machine. I can't explain AmigaDOS, but I can explain the track buffering: Any I/O read or write actually brings a whole track (about 15K bytes) of data into the machine. The Amiga is very efficient at doing that, with a raw data speed of about 20K bytes per second, but when doing random disk I/O this scheme runs counter to productivity.

A partial solution to the random disk I/O problem will probably be fixed soon: Amiga is preparing to release version 1.2 of AmigaDOS. I ran the Fileio benchmark with this version, and the results were more than twice the speed of the results obtained using version 1.1.

THE MANX AZTEC C68K PACKAGE

The Aztec C68K compiler has both a Developer version and a Commercial version. Both versions include the compiler and assembler, Manx's linker, the Amiga include files, a set

of example programs from public domain disks, and Manx's linker libraries.

The Developer version has the same compiler, assembler, linker, and library routines as the Commercial version. It has a suggested retail price of \$299.

The Commercial version has a set of utility programs and includes source code for the libraries and a set of extended library functions. Among the utilities are a MAKE facility, a debugger, and a vi-style text editor, as well as DIFF, GREP, and library and archive programs. Also included with the Commercial version is a year of free updates. The suggested list price is \$499.

I found the MAKE facility to be quite useful, although it is missing some features that are available in other MAKE programs. Also, I consider having the library sources indispensable for professional developers, both as a way of verifying that the libraries are doing exactly what you think they are and as a source of examples.

THE LATTICE C PACKAGE

Lattice Incorporated offers a native Amiga C compiler that has a suggested retail price of \$149.95 and an IBM PC cross-compiler that has a list price of \$250.

Included in both Lattice C compiler packages are the two passes of the compiler, LCI and LC2; the linker ALink; the Amiga include files; the Lattice linker libraries and start-up files, as well as some examples; and the Lattice Object Module Disassembler. Lattice also has a set of utility programs similar to those available in the Aztec C68K Commercial version, but Lattice sells them individually rather than as a package.

ALINK

ALink is the standard linker for the Amiga developed by Metacomco (which also developed AmigaDOS). It uses Metacomco's standard object code and library format.

ALink has a couple of major problems: First, it is extremely slow. Second, it has limitations based on available RAM that determine the size of the file that can be linked. That in itself

isn't so bad, except that it brings all the input modules, including libraries, into RAM for linking.

ALink creates one of the biggest differences between Lattice C and Aztec C68K in terms of development time. Since Manx Software Systems has its own internal object and library format, it does not suffer this problem. The result is a clear-cut advantage for the Aztec C68K compiler until somebody does something to solve the ALink problems.

Dale Luck at Amiga has implemented a partial solution for ALink; he discovered that ALink spent most of its execution time in allocating and deallocating memory. He came up with a quick fix (which is included in version 2.3) that you can invoke by adding the keyword `faster` to the end of your ALink command line. This doubles the speed of the link process. The only penalty is that ALink may not be able to run at this point because it grabs a single large chunk of memory at the start of execution.

Even with the faster option, the Aztec C68K's linker is about twice as fast as ALink, and linking is the slowest part of the development process. But it's a start.

DOCUMENTATION

The documentation that comes with both compilers is more like operator's manuals than anything else. Both include reasonable instructions for operating the various programs included with the packages and instructions for the various compiler switch options.

You'll need Amiga-specific information if you plan to write programs that go beyond the standard C library I/O functions. The Amiga technical manuals are the best set of references available for the Amiga.

RELIABILITY

Another issue to be considered is the reliability of these compilers. Fortunately, both get high marks, but you should take the precaution of allocating sufficient stack space when you compile with Lattice C by using the AmigaDOS `STACK` command. The Aztec C68K compiler comes on

(continued)

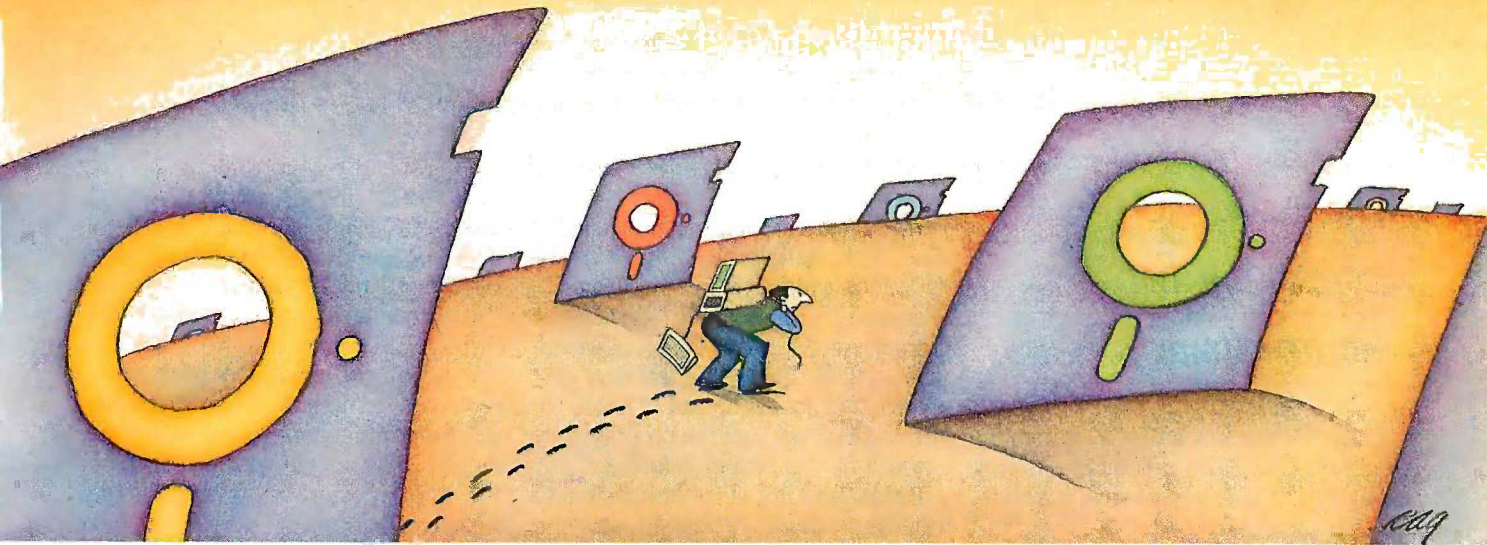

PROBLEM: There's just no easy way to move from one software program to another.

THE SOFTLOGIC SOLUTION: Software Carousel

Now you can keep up to 10 programs loaded and ready to run.

Hard to believe, but some people are happy with just one kind of PC software. Well, this is not a product for them.

But if you're someone who depends on many packages, all the time—someone who'd use several programs at once if you could, well now you can. With Software Carousel.

Why call it "Software Carousel"?

In some ways, Software Carousel works like the slide projector you're used to. You load a handful of pictures, view one at a time, then quickly switch to another. A simple idea, with powerful possibilities for computing.

Here's how it works. When you start Software Carousel, just tell it how much memory you have, load your software and go to work.

Need to crunch numbers? Switch to your spreadsheet. Need your word processor? Don't bother saving your spreadsheet file. Just whip over to your document and do your work. Snap back to your spreadsheet, and it's just like you left it.

With up to ten different programs at your fingertips, you'll have instant access to your database, communications, spelling checker, spreadsheet, word processor, RAM resident utilities, languages, anything you like.

Reach deep into expanded memory.

This could be the best reason ever for owning an expanded memory card, like the Intel Above Board, ASTRAMpage, or any

card compatible with the L/I/M Extended Memory Standard.

Software Carousel puts programs into this "high-end" memory for temporary storage when they're not in use. And switches them back out when you want them. It's fast, efficient, and easy.

If you want, Software Carousel will even use your hard drive for swapping. Just allocate a portion for storage, and go to work.

Sidekick, Superkey and Ready. All at the same time.

You know what happens if

you try loading two or more RAM resident utilities at once. You get crashed keyboards, frozen screens, all kinds of interference between programs fighting for control.

With Software Carousel, you can have as many accessories and utilities on-tap as you want. Just load different ones in different Carousel partitions. Since they can't see each other, they can't fight.

The easy way to maximize PC power.

With all this power, you might think Software Carousel is complicated and difficult to use. Not so. Set it up once, and it will remember forever. Better still,

Carousel will look for the programs you use most often, and optimize them for the quickest access.

Special holiday offer – free* SoftLogic software.

As a special holiday bonus, you can get another SoftLogic Solutions product free when you buy Software Carousel and Disk Optimizer—the software that speeds up your disk by cleaning up your files.

Take your choice of either Cubit or DoubleDOS.

See the coupon below for details. But don't wait. This offer expires December 31, 1986. SoftLogic Solutions products are available at your software dealer. Or by calling SoftLogic Solutions at 800-272-9900 (603-627-9900 in NH).

	4X	8X	12X	16X
Word Star	■	■		
1-2-3	■	■	■	■
BPI	■	■	■	■

With Software Carousel running in RAM, you can load a program and retrieve a file up to 15 times faster. Test conducted on an IBM XT.



Free Holiday Offer!

Buy Software Carousel and Disk Optimizer and get your choice of either Cubit—the software that packs more data onto less disk space—or DoubleDOS—the software that lets you and your computer work on two different tasks at once.

Enclose proof of purchase for Software Carousel and Disk Optimizer, both registration cards, this coupon, and \$5.00 (check or money order) for shipping and handling (UPS). Offer expires Dec. 31, 1986. Allow up to four weeks for delivery.

YES! Please send my free copy of DoubleDOS Cubit (check one)

Name _____

Address _____

City _____ State _____ Zip _____

SoftLogic Solutions, Inc.
530 Chestnut Street
Manchester, NH 03101
(800) 272-9900
(603-627-9900 in NH)

SOFTLOGIC
SOLUTIONS

 **Software Carousel \$49^{95*}** #64

*plus \$5.00 shipping and handling.

The Aztec C68K scores high in the benchmarks.

a CLI disk that has a STACK statement built into the Startup-Sequence script that should take care of any problems.

MISCELLANEOUS

One additional problem is the Aztec C68K's use of 16-bit integers. It is difficult to develop for the Amiga using 16-bit integers because the resident libraries expect 32-bit values as input arguments; thus, nearly all Amiga function calls must have casts to (long) when compiling using 16-bit integers.

On the other hand, Aztec C68K has a 32-bit compile mode that is very nearly identical to Lattice C in terms of the source files it will accept as input. For most of the public domain programs that are available, it is possible to compile them without modification using Aztec C68K's 32-bit compile option and the supplied 32-bit linking libraries.

Another problem is an issue with Aztec C68K's linker. The Amiga device drivers and libraries require a vector table offset by 4 bytes from the start

of an executable object file. Normally, the first code in library and device files is a safety net, MOVEQ #0, DO ; RTS, which protects you from accidentally running the device or library. Aztec C68K's linker, however, uses a JSR .BEGIN as the very first instruction in its output. This is intended to make sure the program gets started at the proper address.

Because of this, it is not possible to build libraries and devices with the current version of the Aztec C68K compiler. Manx Software Systems has assured developers that this problem will be solved in an update.

CONCLUSIONS

Both Lattice C and Manx Aztec C68K compiler provide tools for professional developers and hackers alike.

The Aztec C68K scores high in the benchmarks, particularly in terms of code size and compile/link time. High marks also go to Manx Software Systems for providing the source code for the library functions, which I consider essential for professional developers. Another big advantage in using the Aztec C68K compiler is that the programs needed for compiling require about half the disk space as those of the Lattice C compiler. (This includes the assembler, which is not a part of the Lattice C package.)

The Lattice C compiler scores high

in compatibility with public domain Amiga programs because most of the early programs for the Amiga were developed under Lattice C. Most of those programs can be compiled with Aztec C68K if you use the 32-bit option, but as of now if there is a problem with compiling; it is more likely a compatibility problem with the Aztec C68K. Lattice also scores high for already supporting the Amiga device driver object code format and for supporting the scatter-loading philosophy, which is important for large programs with a lot of graphic memory requirements. Lattice should also continue to benefit from its close relationship with Commodore.

Both compilers have room for improvement. Lattice needs to reduce the size of its compiler and needs to find a solution to the slow linking problems inherited from ALink. Lattice also needs to support relative addressing so its compiler can generate small code. Manx Software Systems' biggest problem is adapting its linker so it will work better with the Amiga's specific needs for scatter-loading of object code. Aztec C68K also needs to support device and library object code formats. I relish the thought of seeing a better code optimizer for the Aztec C68K, which should improve its already impressive benchmark results. ■

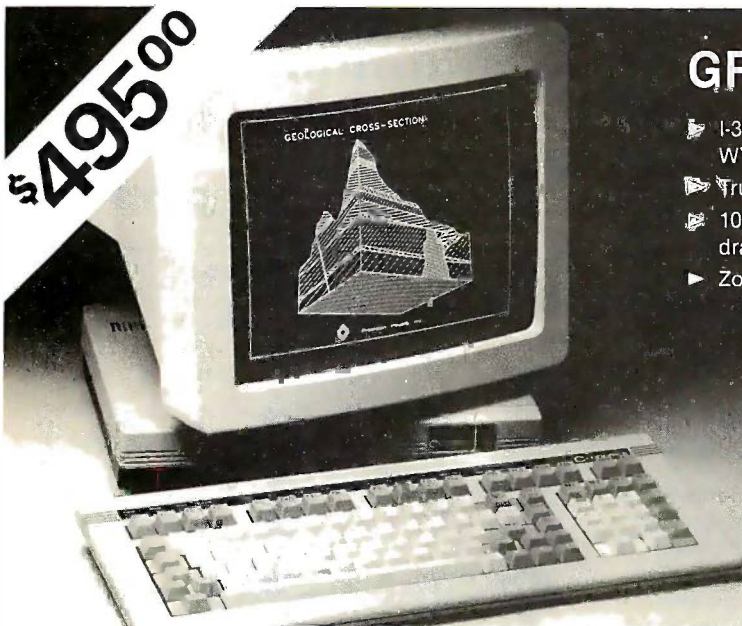

GRAPHICS FOR WYSE

- ▶ I-300 Graphics field upgrade for Wyse Technology's WY-50, WY-75 terminals
- ▶ True Tektronix 4010/4014 graphics emulation
- ▶ 1024 by 800 pixel display, 1,000,000 pixels per second vector drawing rate
- ▶ Zoom, pan, rich native command set, hardcopy capability



CODONICS

We Bring the Future into Focus

CLEVELAND CODONICS, INC.
18001 Englewood Dr. • Cleveland, Ohio 44130
(216) 243-1198

Tektronix, Wyse Technology, Codonics are registered tradenames

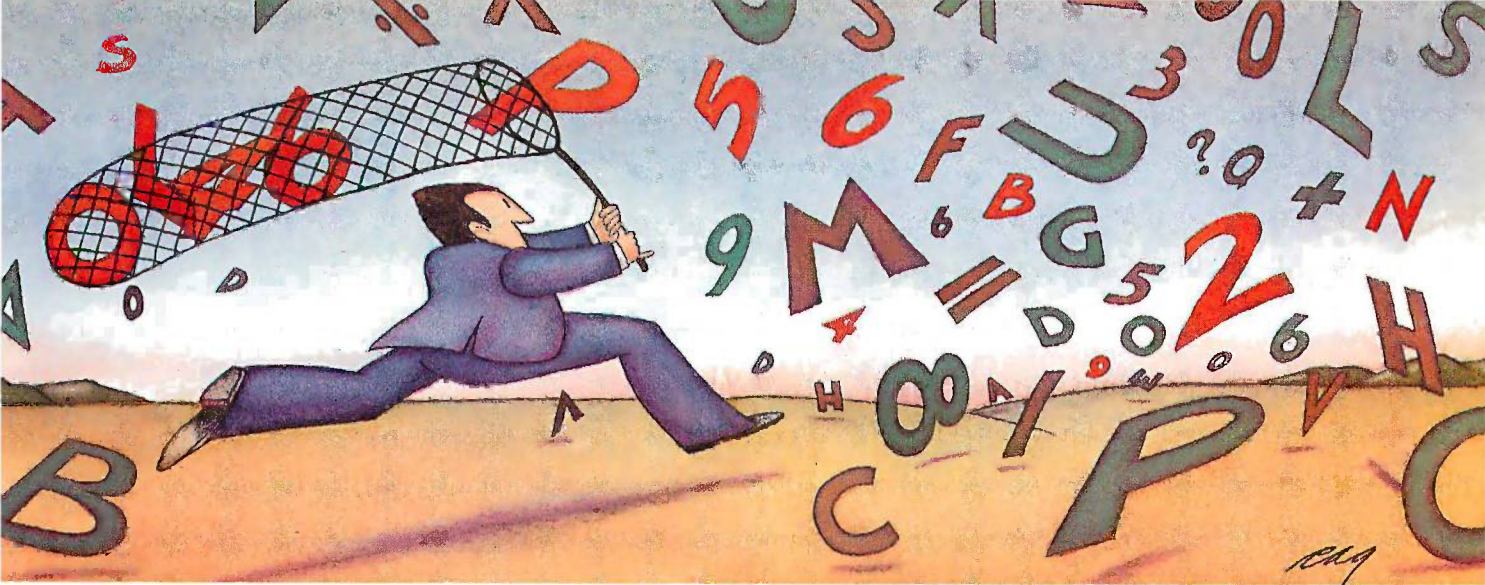

PROBLEM: The more experience your hard disk has, the harder it has to work.

THE SOFTLOGIC SOLUTION: Disk Optimizer™

Your hard disk will run faster when it's not chasing around after files.

Remember the old days when your hard drive was new? Remember that smooth, fast, slick performance? Those quick retrievals, rapid saves, lightning-like database sorts?

Well ever since, DOS has been doing its best to slow your hard drive down. Not by slowing down the motor, but by breaking your files up into pieces. Storing different chunks in different places. Data files, programs, overlays and batches that started out in one seamless piece are now scattered all over.

Loading is slower.
Sorting is slower.
Retrieving, backing-up.
Everything takes longer because your disk has to work harder.

Problem is, it's something that happens so gradually you may not notice the difference. At least, not until you see the dramatic improvement after using Disk Optimizer.

File fragmentation—It's a problem you can see.

Watch your hard drive the next time it reads or writes a file. Each "blip" of the LED means the drive-head is moving to another place on the disk—either to pick up or lay down another chunk of data.

And the truth is, head movement takes time. Far more time than actual reading and writing. What's worse, all this head movement causes extra wear and tear that can shorten the life of your drive.

Disk Optimizer—Tunes up your disk by cleaning up your files.

Disk Optimizer works by finding all the scattered pieces of your files and putting them

back together where they belong. Next time your drive reads it, there's just one place to look.

And the results are often dramatic. Reading and writing times may be cut by as much as two thirds. Database sorts that used to take hundreds of head moves now proceed quickly and efficiently. And since head movement is now at an absolute minimum, your disk drive will lead a longer, more productive life.

Analyze, scrutinize, optimize.

Before you optimize, you'll probably want to analyze. So Disk Optimizer shows you, in percentages, how much fragmentation has taken place—on the

entire disk, in individual directories, or for groups of files you specify using global or wildcard names.

Plus, there's built-in data security that lets you assign passwords to as many files or file groups as you want.

And the File Pecker gives you an inside look at the structure of files. It's a great way for non-programmers to learn more about computers, and a powerful tool for professionals who want to analyze the contents of their disks.

Get your hard drive back in shape—at a special low price.

When you think about it, it's simple. The longer you

own your hard drive, the more you come to depend on it. But the longer you wait to get Disk Optimizer, the less performance you'll have.

Special holiday offer—free* SoftLogic software.

Now, as a special holiday bonus, you can get another SoftLogic Solutions product free when you buy Disk Optimizer and Software Carousel—the software that lets you keep up to ten programs loaded and ready to run.

Take your choice of either Cubit or DoubleDOS.

See the coupon below for details. But don't wait. This offer expires December 31, 1986. SoftLogic Solutions products are available at your software dealer. Or by calling SoftLogic Solutions at 800-272-9900 (603-627-9900 in New Hampshire).

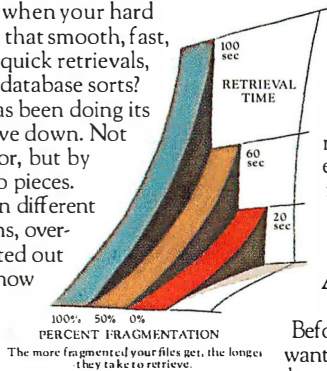

Free Holiday Offer!

Buy Disk Optimizer and Software Carousel and get your choice of either Cubit—the software that packs more data onto less disk space—or DoubleDOS—the software that lets you and your computer work on two different tasks at once.

Enclose proof of purchase for Software Carousel and Disk Optimizer, both registration cards, this coupon, and \$5.00 (check or money order) for shipping and handling (UPS). Offer expires Dec. 31, 1986. Allow up to four weeks for delivery.

YES! Please send my free copy of DoubleDOS Cubit (check one)

Name _____

Address _____

City _____ State _____ Zip _____

SoftLogic Solutions, Inc.
530 Chestnut Street
Manchester, NH 03101
(800) 272-9900
(603-627-9900 in NH)

**SOFTLOGIC
SOLUTIONS**

Disk Optimizer \$49^{95*} #64

*plus \$5.00 shipping and handling.

Unforgettable.

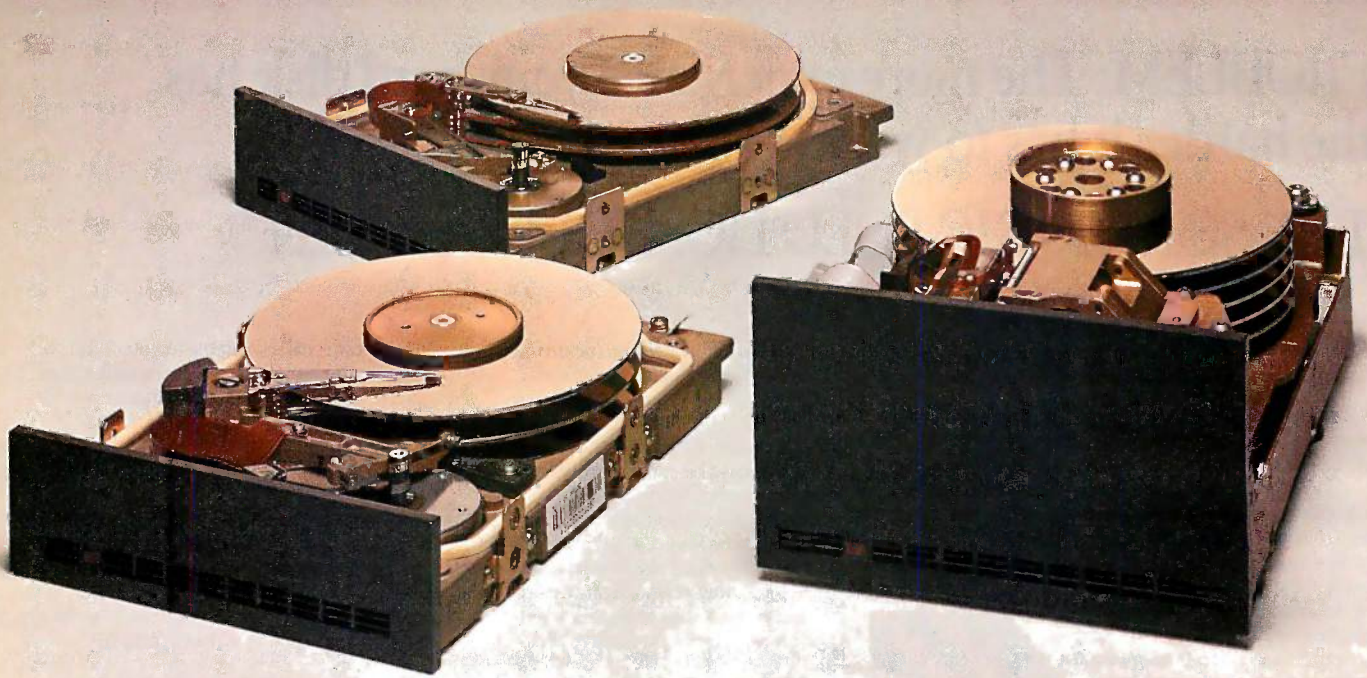

Disc drives should never forget one thing:
your important information.

At Seagate, we build our drives to protect
your data against all mishaps. And we put
each drive through a series of grueling tests
to make sure it doesn't forget.

That's why quality-conscious customers
have bought more than 3 million of our
5 1/4" hard disc drives.

● the next time you're looking for a new
computer, disc memory upgrade or add-on,
ask for Seagate by name.

It's all you need to remember:

Seagate Technology, 920 Disc Drive,
Scotts Valley, CA 95066. 800-468-DISC.
In California, 800-468-DISK.

 **Seagate**

Inquiry 296 for End-Users. Inquiry 297 for DEALERS ONLY.



SPSS/PC+

BY JEFFREY M. JACQUES

A high-quality analytical and statistical production tool

The SPSS/PC+ analytical software package by SPSS Incorporated consists of three modules: the base system and two options, Tables and Advanced Statistics. It is a substantial but incomplete subset of SPSS-X, its main-frame cousin. PC+ has word-processing and database management capabilities, but it shines in providing a wide variety of analytical tools, testing logical conditions, transforming data (such as logical IFs and calculating new values), and computing a wide range of descriptive and inferential statistics. It can do almost everything that you could want a sophisticated analysis package to do, and it does so with reasonable speed.

PC+ is a series of well-integrated FORTRAN, C, and assembly language modules organized in a three-level hierarchical structure. At the first level, the SPSSPC.COM file controls the links to DOS, command and data files, PC+ overlays, and other modules. On the second level, the secondary modules, written in FORTRAN, provide most data management and user links. This is where you set user-defined parameters, access HELP if you forget a command, execute statistics, and generate reports. The third level, written in C, consists of SPSS Incorporated's enhancements to the product, notably the full-screen editor, Review. Everything I ran with this system executed as expected with reasonable speed, error trapping, and user control. You even have the option of directing which of the statistical modules remain on disk and which can be deleted.

COMMANDS

PC+ has three basic types of commands: operation, data definition and manipulation, and procedure com-

mands. Usually, the operation commands will be listed first, followed by the data definition and manipulation commands, and then the procedure commands. Each command type is divided into two major sections: the keyword and the specifications. The keyword begins with a unique name, of which at least the first three characters must correspond exactly to a PC+ command. This tells PC+ which modules to load and which procedures to execute. The specifications contain any detailed information required by the command, such as variables or data; for example, TITLE 'TEST OF SPSS PC+'. The keyword TITLE indicates that you are setting up a title to appear on each page of your output, in this case, TEST OF SPSS PC+. The period at the end of the command, called a terminator, is required for each PC+ command.

Some commands may require several lines of code while others may need additional information. To invoke PC+ options, your command might look like this:

```
FREQUENCIES VARIABLES=AGE
INCOME
/FORMAT = CONDENSE
/HISTOGRAM
/STATISTICS = ALL.
```

In this case, FREQUENCIES produces a simple frequency distribution that lists each value, the number of times it occurred, the percent of the total, and a cumulative percent. The subcommands have similar uses: VARIABLES lists the variables that

this run of the procedure will examine, FORMAT structures the tabular display, HISTOGRAM produces a histogram for each variable, and STATISTICS computes and reports the requested statistics—in this case, ALL the summary statistics. These subcommands are generally required when you want the procedure to perform specific computations or produce one or more tables or charts. Most command names and subcommands are straightforward and follow this structure.

Commands can become quite long and complex since PC+ is command-driven. This is especially true if you create complex REPORTS or run complex REGRESSION analyses. Furthermore, you must explicitly follow the rules (e.g., syntax, naming conventions, and order of commands). In some cases, you may need to create command files several hundreds of lines long. Therefore, it is advantageous to create a separate command file and a separate data file for program execution.

EDITOR

The PC+ editor, Review, is a good, basic, easy-to-use full-screen editor that can hold up to 64K bytes of RAM, writing any overflow to disk. Review uses a Microsoft Windows approach with a split screen—the top half of the screen lists the end of your resulting output, if any, and the bottom half lists your log, or command, file. With a color monitor, the different windows are clearly defined and quite easy to work with.

(continued)

Jeffrey M. Jacques is a professor in the Department of Sociology, Criminal Justice, and Social Welfare at Florida A&M University (Tallahassee, FL 32307).

SPSS/PC+

Type

Statistical and analytical environment

Company

SPSS Incorporated
444 North Michigan Ave.
Chicago, IL 60611
(312) 329-2400

Format

Eighteen 5¼-inch floppy disks

Computer

IBM PC, XT, AT, or compatible with 384K bytes of RAM and a hard disk; DEC Rainbow-class computers similarly configured

Features

The base system contains the editor, Review. Its analytical system provides the following capabilities: frequency distributions, summary statistics, bar charts and histograms, contingency tables, breakdown of population by sub-population summary statistics, one-way analysis of variance, regression, multiple regression, and nonparametric procedures. The optional Tables module provides tabular output for single-variable and multiple-variable tables and summary functions and statistics. It gives you complete format control. The optional Advanced Statistics module enables discriminant analysis, factor analysis, cluster analysis, multivariate analysis of variance, repeated-measure analysis of variance, and log and linear models. Both Tables and Advanced Statistics require that the base system be installed.

Documentation

More than 1000 pages of well-developed information appropriately divided among applications, user's guide, and reference materials.

Price

Base system:	\$795
Tables:	\$295
Advanced Statistics:	\$295

If you forget any of the edit commands, you can easily get help in a window overlay by simply pressing the F1 key. With a color monitor, it is easy to tell the document characters from the Help menu; with a monochrome display, however, it takes some practice. In general, if you have worked with a full-screen editor before, you will be able to master Review in a couple of hours.

Alternatively, you may wish to create necessary files with your favorite word processor or spreadsheet software, as I did. Small fixed-format data files are probably best created with a standard spreadsheet package where you can PRINT a file to disk, eliminate all special characters and headers, and make sure that the output displays all the values in each record. Most spreadsheet packages are limited to approximately 250 characters per record, while PC+ can read as many as 1024 characters per record. Large data files are probably best created with a standard database program. You simply create a standard ASCII data file and make sure to note the beginning and ending location of each field so that you can define the data fields for PC+.

GETTING STARTED

To begin, you need to create a directory on your hard disk, load the SPSS/PC+ software from the 18 disks, and build a CONFIG.SYS file to increase the number of buffers and the maximum number of files that you can have open at one time. It is also helpful to build a batch (.BAT) file for easy access to PC+. Some knowledge of MS-DOS is essential.

PC+ analysis requires creating and manipulating several files: a command input file containing all your PC+ commands, a data file, an SPSS.LOG file that contains a list of all your commands and PC+'s action on each, SPSS.LIS, which contains a copy of what is displayed on the screen and can be printed, and SPSS.SYS, a systems file that contains the transformation of your data and data dictionary so that PC+ can process more quickly.

In addition, PC+ creates files for its own use, for instance, an active sys-

tems file for the data set being used or a command-summary file if you use the editor. More files are created if you use PC+'s portable files for export to mainframe SPSS-X systems or if you use PC+'s output files for writing your correlation matrices or transformed data. If you execute the command SHOW, you can see a listing of most filenames and conventions in a simple table. You can change these options with other commands.

BOOTING AND RUNNING

When you boot PC+, you will see its logo and then the SPSS/PC: prompt. The entry INCLUDE '\path \filename.suffix' retrieves all essential commands from your command file. As each command is read from the INCLUDE file, PC+ echoes it to the screen and then executes it. If you make any errors, PC+ will notify you by beeping and indicating the error's location and type, and sometimes even the offending characters.

To correct an error, you enter REVIEW. at the SPSS/PC: prompt to get to the editor. You use the cursor control keys to locate the error; then you correct it. Next, you MARK a BLOCK (indicate the beginning and end of the PC+ commands) and exit the editor. PC+ automatically notes the changes, lets you change the filename if you want, saves the marked block section of the file to disk, and reexecutes the commands. You don't need to delete any intervening PC+ comments. When you get the command file the way you want it, PC+ executes your commands and sends your results to the screen, printer, disk, or all three.

Review is particularly useful when you have to make a few corrections to a large and complex command file. It is also useful for browsing through the output listing file and examining the results of commands before you print them. While PC+ is not a traditional database manager, it can merge files, key on specific variables when joining files, sort a file, make simple retrievals and report listings, and develop complex reports as well as most database programs can.

The output of the PC+ system is

logically split between useful information about the command that is executed and the results of the execution. The maximum amount of appropriate information is on the screen at all times. If a table won't fit on one screen, PC+ divides the output at a logical place and prompts you that there is MORE information. It then displays a new screen if you press an input key.

You can also turn off the screen and print all results to a disk file or to the printer. Setting `PRINTER=ON` and `SCREEN=OFF` permits you to print the results without seeing the MORE information message. If you are familiar with mainframes or minicomputers, you may appreciate this option. You have full control of the length and width of the output so that you can change the page size to wide output (132 columns) and set an appropriate page length. (For such an output, you need to use the DOS MODE printer command as well as the PC+ commands `LENGTH` and `WIDTH`.)

PC+ can also share data with other software and other computers. Beyond writing results to an external ASCII file, it can share systems files and most of its commands with SPSS-X release 2.1 via a porting facility. Be prepared to make several changes in syntax and structure if you port just a copy of the command file, however.

You can impressively increase PC+'s execution speed if you convert all your ASCII data and command files to a systems file. Once created, this file brings substantial time savings in processing time and in the ease of using the interactive mode. With a `GET` command to identify which systems file to use and a procedure keyword and specifications to identify any unique run, PC+ can process your data and compute your statistics.

SPSS/PC+ AND SPSS-X

Using SPSS/PC+ is similar to using its mainframe/minicomputer cousin, SPSS-X, but there are also some notable differences. Working with both can be confusing. I found myself using commands that were not appropriate and having to use slightly different syntax. Here are some examples:

- Not all the procedure commands use the same keyword names. SPSS-X calls a temporary data modification `TEMPORARY` while PC+ calls it `PROCESS IF`. Similarly, SPSS-X uses `BREAKDOWN` to examine subpopulation means and standard deviations while PC+ uses `MEANS`. Although aliases are provided, there is no apparent reason to use two different command names to run the same procedure.

- Not all procedure commands use the same structure. PC+ commands require a slash when you issue a subcommand while SPSS-X commands do not.

- Some of the procedures available in SPSS-X (e.g., `RELIABILITY`) are not found in PC+, nor are some of the SPSS-X command options available in PC+. For example, `COMPUTE` doesn't allow statistical functions, and you cannot `RECODE` a set of values for one variable into a new variable.

- Even when the same command name or structure is found, it may not have the same options, or the options may mean different things (e.g., the logical expression `TRUE OR MISSING` is treated as `TRUE` in SPSS-X and as `MISSING` in PC+).

- PC+ requires a period at the end of a command; this is an error condition in SPSS-X. This will probably produce the most frustration for the experienced SPSS-X user.

- In PC+, a command continuation can begin in column 1 of the following line, while in SPSS-X use of the first character position is interpreted as the beginning of a new command.

- PC+ allows fewer possible variables in any one file—200—while SPSS-X allows access to many more.

- The `DATA LIST` command, which defines the specifications of the data file, is different in form, power, and options for the two programs. In PC+, data-file location is listed, data-file format is limited to fixed, free-field, or matrix (no hierarchical files are possible), and FORTRAN-like specifications are not accepted.

Despite these differences, PC+ has some nice features that are not available in SPSS-X. Most importantly, PC+ has an on-line HELP facility

where general information about commands, keywords, and their options is available. The `DISPLAY` command lists descriptions of all the variables in the active file (such as variable names, labels, and type). The `SHOW` command summarizes the `SET` command's chosen options and displays each on the screen. Finally, PC+ has on-line error prompting and the editor, `Review`.

WHAT'S MISSING

A real problem with PC+ comes from porting a mainframe program and trying to maintain its integrity on a microcomputer. First, PC+ relies exclusively on a command-driven mentality. It has no user prompts or simple menus. While help is available, PC+ erases the screen before giving you an answer. Thus, you cannot easily compare what you were doing with the available `HELP` options. It's easy to lose the thread of what you were working on and the appropriate fix.

In its attempt to keep mainframe integrity, SPSS Incorporated has lost touch with how many microcomputer users use desktop computers and what they expect of software in terms of user-friendliness and integration. While the access to powerful analytical routines is important, today's microcomputer user expects a user-friendly package. PC+ can't claim user-friendliness as long as it relies on a command-driven system.

Second, PC+ is missing some important application modules. Data entry is abysmal: It has no database data-entry system, not even a simple spreadsheet data-entry routine at the time of this writing. You can't invoke the on-screen editing capability for the processing options, even though it's listed in menu format. PC+ does not support either a subfile structure or a hierarchical file structure as SPSS-X does. PC+ can't easily select a subset of cases for analysis when you need to select on multiple variables but don't wish to permanently alter the file. (It has no easy access to the SPSS-X `TEMPORARY` command structure.) You can't use `ProKey` or `SuperKey` macros or Microsoft Windows if you are running the larger

(continued)

modules with many variables. SPSS Incorporated recommends that you remove all RAM-resident routines before entering the PC+ system.

WHAT YOU NEED

To run PC+, you need an IBM PC, XT, AT, or compatible microcomputer with a minimum of 384K bytes (more if you plan to run the Advanced Statistics option), a 10-megabyte hard disk, PC-/MS-DOS 2.1 or later, and a monitor. These are the minimum requirements. I recommend an IBM PC AT or compatible with 640K bytes, a 20-megabyte hard disk, a math coprocessor, a color monitor, and a high-speed printer. PC+ uses all available memory up to 640K bytes and requires extensive secondary storage; the complete package uses about 6.5 megabytes just to store its software. Computational scratch files and extensive outputs can consume another megabyte or two. A 10-megabyte hard disk is too small if you plan to use word-processing, spreadsheet, and database packages along with it.

As an analytical tool, PC+ is calculation-intensive and uses a math coprocessor extensively if you have one. This significantly speeds up execution time on a PC XT-class machine. A color monitor facilitates working with the editor, and a high-speed dot-matrix printer saves time since you

can easily produce large outputs.

While this is what I recommend, I used an IBM PC compatible running at 4.77 MHz, 640K bytes of RAM, a 20-megabyte Everex hard disk, MS-DOS 3.1, a color graphics adapter card, and a color monitor.

WHAT YOU GET

The \$795 SPSS/PC+ base system includes enough statistical power and reporting facilities to take care of the needs of most mid-level analysts. It contains everything from simple reporting and listing routines and descriptive statistical routines (such as frequency distributions, contingency tables, and bivariate correlation analysis), to simple and multivariate regression analysis. Although the base system comes with an editor, you may want to use your favorite word-processing, spreadsheet, or database software when building command and data files. The base system also comes with a tutorial disk.

Tables (\$295) produces high-quality tabular displays that you can incorporate directly into your word-processing document. Standard PC+ outputs are generally tightly structured with little user discretion on form and style. With Tables, however, you have more control. For example, with this option you can display frequencies, percentages, and summary statistics

for multiple variables in the same table; without it that information would take several pages. Even though Tables has this power, it is probably the most overpriced part of the package; if you are adept at using a word processor, you can create a similar structure fairly quickly by modifying the standard PC+ results.

Advanced Statistics (\$295) was designed for the advanced user. If you need to run factor or cluster analysis or just about any of the more typical complex procedures, you will find this option a reasonable investment.

The documentation for each package is well written and extensive. Each package comes with its own similarly structured manual, complete with step-by-step instructions, examples, a glossary, and an index.

CONCLUSION

SPSS/PC+ is a high-quality analytical production tool for IBM PC and compatible microcomputer systems. It does have its limitations, particularly when compared to its mainframe cousin, SPSS-X. For instance, it is not very user-friendly. But it does provide sophisticated statistical analysis along with a full-screen editor and data management capabilities. With its help function and on-line error prompting, PC+ can handle almost any analytical task you would need. ■

You already own a computer that can talk. Now let it.

Meet the Votrax Family of Voice Products.

- ★ **P.C. Dial/Log**
 - Televoice management system
 - Digitizes your voice
 - Saves and sends voice messages
 - Auto answer/Auto dial
 - Call store and forward
 - Message distribution
 - P.C. to P.C. communication
 - For IBM-PC, XT, AT and compatibles
- ★ **Votalker IB & AP**
 - Board level speech synthesizers
 - Unlimited vocabulary
 - Text-to-speech software
 - Voice mode selection switch
 - Speech filter selection switch
 - For IBM-PC, XT, AT and compatibles
 - For Apple II, IIE, II Plus and compatibles
- ★ **SC-01 - SC-02**
 - Phonetic speech synthesizer chips
 - Unlimited vocabulary

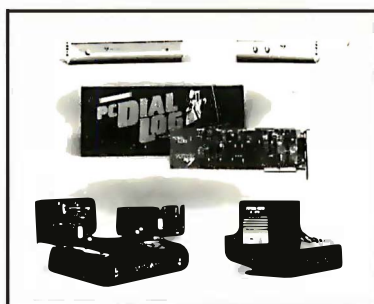

Now you can upgrade almost any personal computer and make it more powerful than ever, by giving it the power of speech.

- ★ **P.S.S. & T.N.T.**
 - Stand-alone speech synthesizers
 - Unlimited vocabulary
 - Text-to-speech
 - Parallel/RS-232 compatible
 - Exception word table
 - On-board music chip
 - Adaptable to most computers
- ★ **Votalker C-64**
 - Plug in speech synthesizer
 - Unlimited vocabulary
 - Text-to-speech
 - Rate, volume and pitch control
 - Three speaking modes
 - Free trivia game
 - For Commodore C-64/128
- ★ **Software Developers Welcome**
- ★ **Dealers and Distributors Welcome**



1394 Rankin, Troy, Michigan 48063
1-800-521-1350
In Michigan 313-588-0341
For a voice demonstration call
313-588-2926

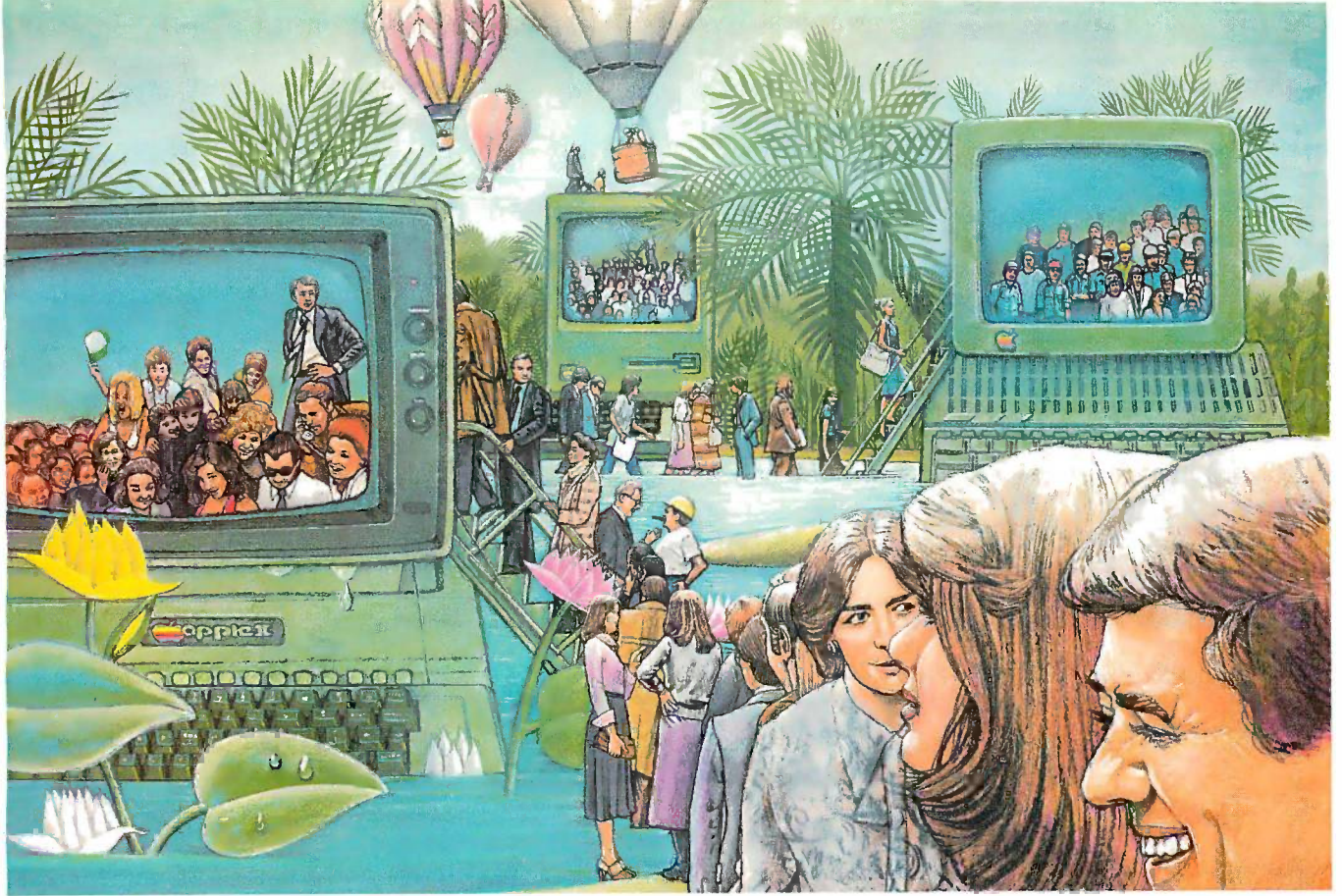

USE THE BRAINS YOUR APPLE WASN'T BORN WITH.

Right at your fingertips in CompuServe's Apple® Forums.

Join the CompuServe **Apple II and III Forum** to swap everything from tall tales to short cuts with other users, and explore thousands of classic programs stockpiled since 1979.

Swap programs and files with fellow Mac owners in our **Macintosh® Users Forum**. Questions? You'll get answers from the experts here!

Visit the **Macintosh Developers Forum**. Get updates to the "Inside Macintosh Software Supplement." Interact with the Mac "team" in Cupertino.

The **Apple User Groups Forum**, supported by Apple Computer, unites officers of Apple user groups—"ambassadors" for hundreds of thousands of Apple-active enthusiasts worldwide.

Easy access to free software, including FREE uploads.

• Download first-rate, non-commercial user-supported software and utility programs.

• Upload your own programs free of connect time charges.

• Take advantage of CompuServe's inexpensive weeknight and weekend rates (when forums are most active, and standard online charges are just 10¢ a minute).

• Go online in most major metropolitan areas with a local phone call.

• And receive a **\$25.00 Introductory Usage Credit** with purchase of your CompuServe Subscription Kit.

Information you simply can't find anywhere else.

Use the *Forum Message Board* to send and receive electronic messages, and pose specific questions to Apple owners.

Join ongoing, real-time discussions in a *Forum Conference*—with Apple luminaries like Bill Atkinson, Doug Clapp, Dan Cochran, Jean-Louis Gasse, Guy Kawasaki, Mark Pelczarski, John Sculley and Steve Wozniak.

Search *Forum Data Libraries* for free software, user tips, transcripts of previous CompuServe online conferences and more.

Enjoy other useful services like:

• **Popular Computer Magazines**—electronic editions, including *Apple Online* and other Apple-related publications.

• **Other CompuServe Forums**—supporting Jazz™ and other LOTUS® products, Microsoft®, MicroPro®, Borland International®, Ashton-Tate®, and other software.

All you need is your Apple computer and a modem ... or almost any other personal computer.

To buy your Subscription Kit, see your nearest computer dealer. Suggested retail price is \$39.95. To receive our free brochure, or to order direct, call 800-848-8199 (in Ohio, call 614-457-0802). If you're already a CompuServe subscriber, type GO MAUG (Micronetworked Apple Users Group) at any ! prompt to see what you've been missing.

CompuServe®

Information Services, P.O. Box 20212
5000 Arlington Centre Blvd., Columbus, Ohio 43220

800-848-8199

In Ohio, Call 614-457-0802

An H&R Block Company

Inquiry 77



One for all.



Affordable, Compatible, and Full-Color Capable!

Besides being the one printer for all the PCs pictured above, the OKIMATE® 20 is also the one for all your printing needs.

Want to spruce up your homework with colorful charts and graphs? The OKIMATE 20 is for you.

Need crisp "Near Letter Quality" printing for business correspondence?

The OKIMATE 20 is for you.

Maybe you want expanded or fine print, italics, underlining, superscripts, or subscripts? You guessed it, the OKIMATE 20 is for you, too.

In fact, no matter what you have in your PC, you can put it on paper with the OKIMATE 20.

With this versatile printer you

also get such high-end features as built-in type fonts, a 24-element printhead and the ability to make transparencies for overheads.

All at a very low-end price: \$268* complete with "Plug 'n Print"™ personality module.

For the name of the OKIMATE 20 retailer nearest you, simply call 1-800-OKIDATA.

*Suggested retail price. Dealer price may vary.

OKIDATA[®]
an OKI AMERICA company
We put business on paper.

Inquiry 234



AEGIS ANIMATOR AND AEGIS IMAGES

BY WARREN BLOCK

Aegis Development Incorporated's Animator is a software package for the Amiga that lets you create animated video sequences. Included in the package is Aegis Images, a full-featured paint program that works in conjunction with Aegis Animator. Images is also available separately.

Both packages need a minimum of 512K bytes of memory to operate, support multitasking under the Workbench, and use the IFF format developed by Electronic Arts to create files that can be used with other programs. Only one floppy disk drive is necessary because both programs are memory-resident. It is feasible to run both programs at the same time, although this requires at least a megabyte of memory.

AEGIS ANIMATOR

The Aegis Animator system is based on "tweens," which are short segments of time in an animation during which something happens. Imagine a square that rotates from one side of the screen to the other. Instead of defining this as several individual frames in which the square is shown in different positions, which is the traditional approach, you tell Animator where the square will be and how much it will have turned by the end of the tween. The program then takes care of redrawing it in the appropriate places to create the illusion of movement. This technique of tweening makes animation surprisingly easy—Animator does all the work.

MANIPULATING SHAPES

Shapes created with Animator are essentially lists of vectors, much like

Color graphics paint and animation software for the Amiga

Apple II shape tables. Because these shapes take fewer calculations to redraw than ordinary bit-mapped pictures, actions such as rotations and size changes can occur fast enough for real-time motion. Some shapes that Animator can create include polygons, lines, circles, and stars. (Rectangular items, called blocks, can also be created, but these are related to windows and masks, which I will describe later.)

Many options for manipulating shapes are provided, including rotating in the plane of the screen, around the x axis or the y axis, and changing a shape's size or color. You can combine several of these actions in a single tween to create very complicated movements. For instance, you can rotate and shrink a shape, creating the illusion of movement into the distance. You can view objects as solid shapes or in ghost mode, in which only their outlines are drawn. This makes it easier to work on objects that are overlaid by others.

A very impressive feature, called Morph, lets you change the shape of objects by moving the geometric points that compose them. You can even add new points to an object or delete those that already exist. It took me only seconds to create a star that "morphed" across a space into a smaller star during one tween. The resulting animation showed the star flowing like paint across the inter-

vening space and forming into the second star. It is a visual effect that, while difficult to describe, is familiar on the screen—it looks very much like an effect out of a cartoon.

CONTROL OF BLITTER OBJECTS

Aegis Animator is capable of creating bit-mapped objects (other than background pictures) or loading objects that have been created with a paint program like Aegis Images. These bit maps include, in the program's own terminology, blocks, windows, and masks. Both windows and masks are segments of bit-mapped drawings (masks are similar to windows, but are limited to one color); blocks are simply rectangular bit maps with no details. All three are blitter objects that can be moved about by the Amiga's blitter chip more quickly and smoothly than Animator's vector-drawn objects. Because they are bit-mapped shapes, however, rotations require too many processor calculations to allow them to be shown in real time.

COLOR

The Amiga is a color computer, and Animator, which works in the Amiga's 32-color low-resolution mode, is not lacking in this area. Colors can be defined, saved in a file, and then reloaded for an animation. You can fade a range of colors into another color so your latest animated epic can fade to black, white, or any other color at

(continued)

Warren Block (645 King St., Chadron, NE 69337) currently comprises the entire computer repair department of Chadron State College.

Aegis Animator and Aegis Images

Type

Animation software and paint program

Company

Aegis Development Incorporated
2210 Wilshire Blvd., Suite 277
Santa Monica, CA 90403
(213) 306-0735

Format

Two 3½-inch disks; not copy-protected

Computer

Commodore Amiga with at least 512K bytes of RAM and one floppy disk drive

Documentation

Inside Aegis Animator, 99 pages;
Inside Aegis Images, 84 pages

Price

Aegis Animator and Aegis
Images: \$139.95
Aegis Images: \$79.95

its completion. You can use the Spectrum function to create a rainbow of colors, while the Cycle function makes color go through a set of shades during a tween. The Range function creates a range of shades between two colors.

SCRIPTS

The complete set of tweens that makes up an animation is called a script. Script files are stored on disk as ordinary text files that are composed of instructions in Animator's own language. To execute an animation, the program actually interprets these files, very much like the intermediate p-code used by many Pascal compilers. You can even write programs in Animator's language: Information about it is available from Aegis Development Incorporated. While the speed lost in the interpretation process has been the downfall of several Pascal compilers, Aegis Animator often needs to be slowed down to keep complex movements from becoming so fast that only a flicker is displayed.

MEMORY USE

Script files don't use much memory, but the manner in which Animator runs them does: All the backgrounds and windows used by a script must be loaded into memory before that script can be executed. This is done so the real-time animation doesn't need to stop for disk access. For this reason, however, a script file that takes up only 18.2K bytes of storage space on disk actually needs more than 39K bytes to execute. In an Amiga with 512K bytes of RAM there is enough memory to create fairly sophisticated animations, especially if there is not more than one background picture, but another 512K bytes or more would definitely be helpful. If you plan on creating animations that will take more than two minutes of real time, plan on adding memory.

FAST MENU

To make using Aegis Animator easier, a Fast Menu is provided. This is a small window that contains icons representing menu choices. Clicking the mouse button on one of these icons

provides a shortcut to a menu selection.

At first it seems that this feature is more of an annoyance than anything else—the window continually gets in the way. However, as the program's operation becomes more familiar, the Fast Menu's usefulness grows more apparent. The window can be moved or closed if necessary, and it is much more intuitive and faster to click on an icon in the Fast Menu than to select a menu option from the menu bar at the top of the screen.

Useful utility functions abound in Animator, including Undo, to negate the last action taken; Move-In and Move-Out, to move objects behind or in front of others; control of elapsed time in a tween or for a whole script; and numerous others.

STORYBOARD EDITING

You edit scripts through Animator's Storyboard. When you select the Storyboard from the main menu or click on its icon in the Fast Menu, the screen is divided into nine equal windows. The script that was just being worked on is shown, scaled down, in one of these windows. Using Storyboard options, parts can be cut off a script, moved into their own windows, spliced together again, or deleted from memory altogether. You can execute these scaled-down scripts individually or several at a time. This certainly looks impressive, but as an editing function it is not really very useful.

AEGIS IMAGES

Aegis Images, the painting and drawing program that comes with Animator, has all the standard features you'd expect from this type of program. You can draw geometrically or freehand with different brushes in 32 colors. You can use any of 16 patterns to draw or fill figures or use custom patterns created with the built-in editor. The program slows down quite a bit when you use the patterns for drawing, however.

All these features are fairly standard; much more interesting are the unusual extras. You can frame a section of a drawing in a window and

(continued)

New GPS Series: Tek sets the pace with SmartCursors™ and push-button ease.

Work faster, smarter, with two new general purpose scopes from Tektronix. The four-channel, 100 MHz 2246 and 2245 set the new, fast pace for measurements at the bench or in the field. They're easy to use and afford, by design.

On top: the 2246 with exclusive integrated push-button measurements. Measurements are accessed through easy, pop-up menus and implemented at the touch of a button. Measure peak volts, peak-to-peak, \pm peak, dc volts and gated volts with new hands-off convenience and on-screen readout of values.

SmartCursors™ track voltmeter measurements in the 2246 and visually indicate where ground and trigger levels are located. Or use cursors in the manual mode for immediate, effortless measurement of waveform parameters.

Both scopes build on performance you haven't seen at the bandwidth or prices. Lab grade features include sweep speeds to 2 ns/div. Vertical sensitivity of 2 mV/div at full bandwidth for low-level signal capture. Plus trigger

Features	2246	2245
Bandwidth	100 MHz	100 MHz
No. of Channels	4	4
Scale Factor Readout	Yes	Yes
SmartCursors™	Yes	No
Volts Cursors	Yes	No
Time Cursors	Yes	No
Voltmeter	Yes	No
Vertical Sensitivity	2 mV/div	2 mV/div
Max. Sweep Speed	2 ns/div	2 ns/div
Vert/Hor Accuracy	2%	2%
Trigger Modes	Auto Level, Auto, Norm, TV Field, TV Line, Single Sweep	
Trigger Level Readout	Yes	No
Weight	6.1 kg	6.1 kg
Warranty	3-year on parts and labor including CRT	
Price	\$2400	\$1875

sensitivity to 0.25 div at 50 MHz, to 0.5 div at 150 MHz.

Accuracy is excellent: 2% at vertical, 2% at horizontal. And four-channel capability includes two channels optimized for logic signals.

Best of all, high performance comes with unmatched convenience. You can see it and feel it —in the

responsive controls and simple front-panel design, in extensive on-screen scale factor readouts, and in simplified trigger operation that includes Tek's Auto Level mode for automatic triggering on any signal. Start to finish, the GPS Series saves steps and simplifies tasks.

Get out in front! Call toll-free today to order, to get more details or a videotape demonstration.

1-800-433-2323

In Oregon, call collect 1-627-9000

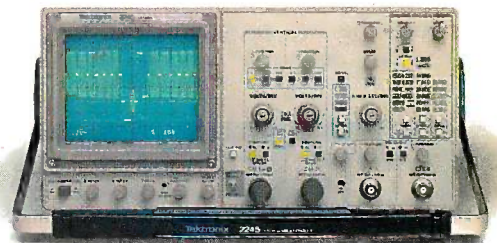
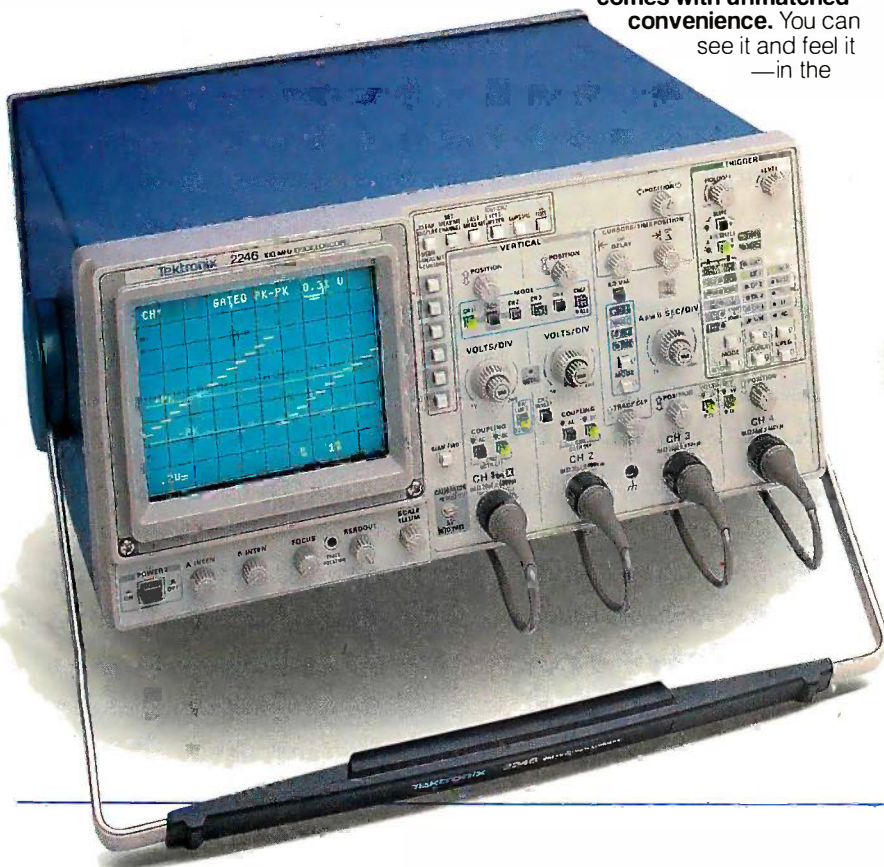

Featuring four channels, flexible triggering, extensive CRT readouts and push-button ease of use, the new Tek 2246 (left) and 2245 (above) bring high-quality, low-cost analysis to diverse applications in digital design, field service and manufacturing.

Tektronix®
COMMITTED TO EXCELLENCE

Inquiry 340

then rotate and scale it to different proportions. Using the Spread option, you can fill areas with a range of colors so that one color fades into the next. This can result in some spectacular visual effects with practically no effort. With the Wash and Smear features, colors can be mixed together like paint. The Antialias function smooths out rough edges around shapes by using color to simulate higher resolution. Parts of a picture can be used as a brush, and you can design special brushes with the built-in editor. You can cycle colors repeatedly through a range of shades to create animated scenes.

Window, mask, and color files created by Aegis Animator can be loaded into Aegis Images for editing, or you can simply use Images to create them in the first place. Although Images does not have Animator's Spectrum option, you can simulate it by creating a set of colors with Animator, saving them to disk, and then loading them into Images.

INTERFACE DIFFICULTIES

Aegis Images' user interface is somewhat more polished than Animator's, but its Fast Menu is not as useful, nor does it get in the way as often. A few difficulties arise from the difference between the two programs. For instance, to define a window with

Images, you click the mouse's Select button on the first corner, move the pointer to the second corner, and click the Select button again. In Animator, you click the Select button on the first corner and hold it down until the pointer reaches the second corner. This can cause confusion when switching between the two programs, but both Images and Animator have an Undo feature that can correct mistakes to some degree.

All in all, Images is a likable program that does what it should with no problems. There are lots of powerful options, and the user interface works smoothly, even if it is different from Animator's.

Both Animator and the copy of Images included on the distribution disk use the Amiga's low-resolution graphics mode (320 by 200 pixels). There is also a high-resolution version (640 by 200 pixels) of Images that you can obtain separately for \$10 extra. The low-resolution 32-color mode of the Amiga is good enough for most applications. With careful thought, you can avoid rough edges around shapes or make them less noticeable, and that is really all that a higher screen resolution accomplishes.

DOCUMENTATION

Included with the Aegis Animator/ Images package are two softbound

books, *Inside Aegis Animator* and *Inside Aegis Images*. Both are nicely done with good indexes and organization, but they have a nontechnical slant that is rather frustrating at times. For example, the only place that specifies that 512K bytes of memory is necessary to run the programs is the box that the package comes in.

SUGGESTIONS

There are only a few changes that I would like to see made to these graphics tools. More examples would be very helpful, especially scripts for Aegis Animator. Several are provided, but the addition of an entire disk of scripts for Aegis Animator and picture files for Aegis Images would improve things considerably. Perhaps more importantly, the two programs' user interfaces should be consistent to make switching between them less confusing.

CONCLUSIONS

Other than these two minor complaints, I was very pleased with this package's combination of performance and ease of use. If you want to create smooth and colorful animated video sequences on an Amiga, (for serious applications or just for fun) Aegis Animator and Aegis Images are just what you need to get the job done. ■

GREATER PERFORMANCE...AT HALF THE COST!

DATA I/O 29B™ COMPATIBILITY-UNDER \$1,500

Programming A World of Technologies

UNIVERSAL, GANG & SET PROGRAMMING FOR LAB AND LIGHT PRODUCTION

BYTEK ALWAYS SETTING HIGHER STANDARDS

- Supports MOS/CMOS EPROM/EEPROMs including Megabit devices. Options: Bipolar PROMs, Logic Array Devices, 40 pin Micro Chips, and GangCel
- Memory capacity to 1Mbyte, 64 bit wide programming, device type and parameters stored in non-volatile memory
- 3-Way device type selection: manually, auto ID or from menu
- 2-Way command execution: Function keys or menu
- Data I/O PROMlink™ and BYTEK PROMsoft™ compatible

25 Key-32 Character LCD display - Memory expandable to 1 Megabyte
RS232 PC Interface, Parallel Printer Port

Data I/O, PROMlink are trademarks of Data I/O, Inc.
MADE IN THE U.S.A.

21 Day No Obligation
Trial Period

\$1,495

COMPLETE
Model:
S125-GL

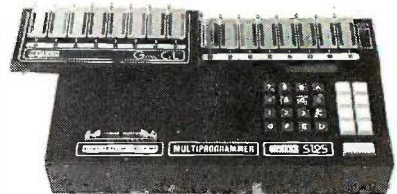

ORDER TODAY
800-523-1565 / In Fla. — 1-305-994-3520
Telex: 4998369 BYTEK



Mastercard or Visa Welcome



Instrument Systems Division • 1021 South Rogers Circle • Boca Raton, Florida 33431



TURBO LIGHTNING AND STRIKE

BY ROSS RAMSEY

Turbo Lightning, by Borland International, and Strike, by S & K Technology, are spelling checkers that correct your spelling as you write. Both programs are adequate spelling assistants, but each becomes less useful as your document becomes longer. When writing this review, for example, I found them to be more distracting than helpful.

If you write letters, memos, and other short notes or write notes online, you'll find either of these programs useful. For longer texts like articles and reports, you'll probably want a spelling program that lets you check an entire file at once.

At \$29.95, Strike is inexpensive and allows much larger user dictionaries than Turbo Lightning. [Editor's note: S & K Technology also sells *The Resident Speller*, a stand-alone spelling checker that you can buy together with Strike for \$99.95. The Resident Speller uses the Strike dictionary. It has maintenance programs that let you add and delete words from your dictionary and a utility that lets you print your dictionary. It also lets you check an entire file at once.] Turbo Lightning includes a thesaurus and has a larger starting dictionary than Strike. It also works better with other RAM-resident programs. It costs \$99.95.

AUTO-PROOFING

Strike and Turbo Lightning both have auto-proof modes that beep whenever you type a word they don't recognize. These beeps catch misspellings, typos, and words that aren't in the programs' dictionaries. Turning off the auto-proofing leaves only screen-at-a-time spelling help in Turbo Lightning, and either screen or para-

Two RAM-resident spelling checkers for IBM PCs and compatibles

graph checking in Strike. Both modes are tedious for documents that are longer than two or three screens.

When checking an entire screen at a time, each program highlights the words it can't find in its dictionary. The highlighting disappears at the next keystroke in Turbo Lightning, which can be frustrating if more than one word has been misspelled. You find yourself noting the first wrong word, moving the cursor to fix it, and then requesting another screen check to find the next trouble spot.

Strike's screen checking is more convenient. The highlighted words remained highlighted in WordStar, over which I tested Strike, until I moved to a new screen. This makes the words in question easier to find and correct, and it obviates the need for constantly rechecking the screen.

Once a mistake is spotted, the procedure is basically the same with both programs. By using either a series of commands or a menu system, you can check the spelling of a word. If it's not in the dictionary, you have the option of ignoring the word, adding it to the dictionary, or looking at a list of words that are spelled similarly, from which you can choose likely substitutes for your spelling.

Both programs can be either menu- or command-driven. With Turbo Lightning's installation program, you can change the command keys to your liking; Strike's command keys are

set and can't be changed.

Once the menus are on the screen, the actions for both programs are again similar: You check the word under the cursor, check the last word you misspelled, check everything on the screen (or,

in Strike, everything in the current paragraph), or change the program in which you're working; for example, from WordStar to WordPerfect. The biggest difference is in the help the menus provide. Pressing F1 at any time in the Turbo Lightning menu will provide context-sensitive help. Strike does not offer as much help.

COHABITATION

One critical test is whether a new RAM-resident program will get along with already existent RAM-resident programs and with applications software. In this area, Turbo Lightning is better than Strike.

Strike has no problem running alongside SideKick until you try to check the spelling of something in SideKick's notepad. I was forced to reboot the computer each time I tried it. Using SuperKey with Strike also created problems.

I do word processing with XyWrite III, which was introduced early this year in response to complaints that older versions wouldn't easily accommodate RAM-resident programs. I used it with SideKick and Turbo Lightning with no problems. However, it would not work with Strike. Strike worked well with WordStar, one of the eight word processors on its menu of

(continued)

Ross Ramsey (716 North Madison Ave., Dallas, TX 75208) is a writer who uses computers for word crunching and finances.

**Turbo Lightning
version 1.00A**

Type
RAM-resident spelling assistance program with thesaurus

Company
Borland International Inc.
4585 Scotts Valley Dr.
Scotts Valley, CA 95066
(408) 438-8400

Format
5¼-inch floppy disks

Computer
IBM PC, AT, XT, PCjr, or compatible; at least 128K bytes of RAM, 256K bytes preferred; two floppy disk drives or one floppy disk drive and one hard disk drive (preferred); PC-DOS or MS-DOS

Documentation
84-page user's manual; on-line help

Price
\$99.95

Audience
Those with relatively small writing outputs, such as letter writers or students.

Features
The thesaurus is extremely useful if you're looking for a new word to use. The dictionary offers numerous selections to anything it sees as a misspelling. It also works well with other RAM-resident programs.

choices. The eighth is "generic," which is worth a try if yours isn't listed.

Turbo Lightning lists 13 environments in its selection menu and allows you to build environments for programs such as XyWrite III that aren't listed. Strike offers no such tailoring. In addition, Turbo Lightning automatically changes environments as you work. If, for example, you call up SideKick while working with a word processor, it will automatically change to SideKick's environment.

DICTIONARIES

Turbo Lightning, with 83,000 words, has a bigger dictionary than Strike.

Strike version 1

Type
RAM-resident spelling assistance program

Company
S & K Technology Inc.
4610 Spotted Oak Woods
San Antonio, TX 78249
(512) 492-3384

Format
5¼-inch floppy disks

Computer
IBM PC or compatible; two floppy disk drives or one floppy disk drive and one hard disk drive; 128K bytes of RAM, 256K bytes of RAM to run other programs with it; PC-DOS or MS-DOS

Documentation
16-page user's manual

Price
Basic package: \$29.95
With The Resident Speller: \$99.95

Audience
Those with relatively small writing outputs, such as letter writers or students.

Features
Accommodates large user dictionaries and allows them to be added to the main dictionary.

Still, it beeps at you more often than Strike does. This is because Turbo Lightning's biggest RAM dictionary is 16,000 words. Sometimes it will beep because a word isn't in the RAM dictionary, only to tell you the spelling is correct after it's had a look at its larger disk-based dictionary. Turbo Lightning's manual has instructions for loading the entire dictionary into extended memory, but that wasn't possible on my 640K-byte Compaq Deskpro.

Since all of Strike's 50,000-word dictionary is loaded into RAM, it doesn't have the same problem. This is a distinct advantage if you have no hard

disk drive: While Turbo Lightning ties up one drive on a floppy disk drive-based system, Strike lets you load the memory and then use your drives for other applications programs. The trade-off is that Strike offers 40 percent fewer words overall. This causes problems of its own, both in what you'll find in the dictionary and in what the dictionary will suggest to you as alternatives to whatever you've typed.

Type the word *dingbat*, for example, and Strike will tell you it's an incorrect spelling. Ask for a list of substitutes, and it comes up with absolutely nothing. This is subjective, but Strike seems less able to find similar words than Turbo Lightning, and it often finds none. The word *musicality*, it tells you, is wrong, but it makes no suggestions about what might be correct. The same is true for words like *saxophone*, *incarceration*, and *snail*.

Turbo Lightning is much better at making suggested substitutions because it goes out of its way to find words for you. All but two of the words above, *dingbat* and *musicality*, are in the Turbo Lightning dictionary, and the substitutes offered for these two words are numerous. *Dingbat* is not offered, for instance, but there are 24 suggested words available in the Turbo Lightning screens, including close words like *dingiest*, *dingoes*, *dingily*, *dingier*, and *dingles*.

Turbo Lightning is so strong at suggesting other words that it's possible to get some extra help from it. Can't spell a word? Try anyway, and then ask for similar words. Chances are that Turbo Lightning will recommend the word you wanted in the first place but couldn't spell.

Both programs let you build dictionaries of your own, and Strike is clearly stronger in this area. Where Turbo Lightning allows user dictionaries of up to 2000 characters (about 300 words), Strike lets you set the size of the user dictionary to as high as 30,000 characters (about 4600 words). This requires more memory, but when the user dictionary becomes unwieldy, a couple of utilities that come with Strike allow you to first sort your personal word list and then add it to the main dictionary in highly

compressed form. It won't add words that are already in the main dictionary, and the result is a word list that more closely resembles your own.

To try this out, I took three articles I've written in the last year and turned them over to a utility called Makeuser. Strike took the articles, removed the numbers and all the punctuation except for dashes and apostrophes, got rid of all duplicate words, and alphabetized the list. Each article contained about 2000 words, and each pass through Makeuser took only a few seconds.

Next, I took the word lists to the word processor to get rid of everything I didn't want added to the main dictionary. I then made a backup of the main dictionary and activated another utility, Dictadd. It went through the word lists and added the 115 words that were not already in the main dictionary. This increased the size of the main dictionary by 499 bytes. My copy of Strike now includes all the words mentioned above as missing from the user dictionary.

It's easy to see how powerful a dictionary you can build in a short time just using your own files. This also decreases the number of beeps you have to listen to in the future.

Turbo Lightning's main dictionary can't be altered.

THESAURUS

One major difference in the two programs is Borland's inclusion of a thesaurus in the Turbo Lightning package. To me, this is the most useful feature of the program because I hate to stop writing to grab a reference book. The thesaurus may land me in a reference book anyway, but its convenience is valuable.

While the Turbo Lightning's dictionary can get in the way with its interruptions, the thesaurus is there only when you ask for it.

The thesaurus has 5000 keywords—words for which it has lists of synonyms. If you ask for a list while your cursor is on one of those 5000 words, a list appears right away. If you're not on one of the keywords, you get a list of words with similar spellings.

The word *cats*, for example, isn't a

*It's easy to see
how powerful
a dictionary you can
build in a short
time just using
your own files.*

keyword. But Turbo Lightning offers a list of 32 other words that might be close. One of them is *cat*, and the thesaurus offers five other alternatives: *feline*, *kitten*, *puss*, *kitty*, and *pussycat*.

It's not a full-fledged thesaurus complete with definitions, but it's helpful and convenient, and I found myself looking for alternative words more often when it was on-line.

CONCLUSIONS

Strike's price and adaptability combine to make it a strong program for people who don't use other RAM-resident programs. Turbo Lightning costs more, but it offers more help to those who want more options for misspelled words and to those who want an on-line thesaurus. *[Editor's note: As this went to press, Borland informed us that a new version, Turbo Lightning 1.02, understands possessives, adds programs to its environment, and improves performance in floppy disk drive systems.]*

Both programs are more useful on short documents than on long ones. If most of your writing involves letters and memos, these programs are probably preferable to stand-alone spelling checkers. If most of your writing time goes into longer documents, you should consider a stand-alone program.

In sum, Strike is much better at accommodating large user dictionaries like those required in many specialties. Turbo Lightning has a thesaurus and offers more options when a word has been spelled incorrectly. It also cohabits well with other programs, including RAM-resident software. Strike has problems in this area. ■

C & PASCAL PROGRAMMERS

Blaise Computing provides a broad range of programming tools for Pascal and C programmers, with libraries designed for serious software development. You get carefully crafted code that can be easily modified to grow with your changing needs. Our packages are shipped complete with comprehensive manuals, sample programs and source code.

C TOOLS PLUS

\$175.00

NEW! Full spectrum of general-purpose utility functions; windows that can be stacked, removed, and accept user input; interrupt service routines for resident applications; screen handling including EGA 43-line text mode support and direct screen access; string functions; and DOS file handling.

PASCAL TOOLS/TOOLS 2

\$175.00

Expanded string and screen handling; graphics routines; easy creation of program interfaces; memory management; general program control; and DOS file support.

VIEW MANAGER

\$275.00

Complete screen management; paint data entry screens; screens can be managed by your application program; block mode data entry or field-by-field control. Specify C or IBM/MS-Pascal.

ASYNCH MANAGER

\$175.00

Full featured asynchronous communications library providing interrupt driven support for the COM ports; I/O buffers up to 64K; XON/XOFF protocol; baud rates up to 9600; modem control and XMODEM file transfer. Specify C or IBM/MS-Pascal.

Turbo POWER TOOLS PLUS

\$99.95

NEW! Expanded string support; extended screen and window management including EGA support; pop-up menus; memory management; execute any program from within Turbo Pascal; interrupt service routine support allowing you to write memory resident programs; schedulable intervention code.

Turbo ASYNCH PLUS

\$99.95

Complete asynchronous communications library providing interrupt driven support for the COM ports; I/O buffers up to 64K; XON/XOFF protocol; and baud rates up to 9600.

RUNOFF

\$49.95

NEW! Text formatter written especially for programmers; flexible printer control; user-defined variables; index generation; and general macro facility. Crafted in Turbo Pascal.

EXEC

\$95.00

Program chaining executive. Chain one program from another even if the programs are in different languages. Shared data areas can be specified.

ORDER TOLL-FREE 800-227-8087!



BLAISE COMPUTING INC.

2560 Ninth Street, Suite 316 Berkeley, CA 94710 (415) 540-5441

LEADING EDGE AI BOOKS

General Artificial Intelligence Topics

Handbook of Artificial Intelligence Volumes I, II, & III

Edited by Avron Barr, Edward A. Feigenbaum and Paul R. Cohen

This series is the classic introduction and reference work to the field of artificial intelligence available today. As AI continues to grow in importance, the **Handbook of Artificial Intelligence** is more relevant than ever. The volumes explain the basic theory of artificial intelligence, with basic research gathered and reworked by the editors in a clear concise manner.

Volume I

409 pp (PB) 11811-4 (1981)

Volume II

450 pp (PB) 11813-0 (1982)

Volume III

650 pp (PB) 11815-7 (1982)

Designing the User Interface: Strategies for Effective Human-Computer Interaction

Ben Shneiderman, *University of Maryland*

A comprehensive survey of the issues in producing, managing, maintaining, promoting, training, and refining the user interface of interactive systems. The book provides an understanding of the complex interaction of people and machines. An excellent reference for those involved with interactive systems design.

304 pp (HB) 16505-8 (1986)

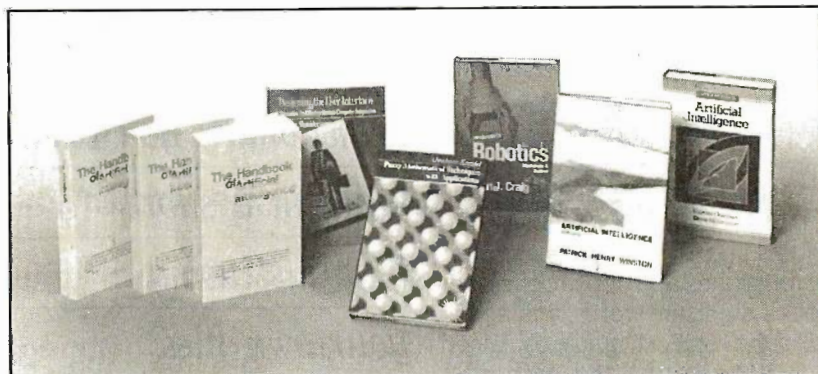

Fuzzy Mathematical Techniques with Applications

Abraham Kandel, *Florida State University*

This self-contained book presents the basic concepts of fuzzy set theory within a context of real-world applications. Some of the applications explained in detail are the manipulation of knowledge in expert systems, relational database structures, pattern clustering, modeling of uncertainty, and search trees.

274 pp (HB) 11752-5 (1986)

Introduction to Robotics: Mechanics and Control

John J. Craig, *Stanford University*

303 pp (HB) 10326-5 (1986)

Artificial Intelligence, Second Edition

Patrick Henry Winston, *Massachusetts Institute of Technology*

527 pp (HB) 08259-4 (1984)

Introduction to Artificial Intelligence

Eugene Charniak, *Brown University*, and Drew McDermott, *Yale University*

701 pp (HB) 11945-5 (1985)

Available at these fine bookstores:

ALABAMA

Madison Books
8006-B Madison Pike
Madison (205) 772-9250
Univ of Alabama Bookstore
Huntsville (205) 895-6600

CALIFORNIA

ASUCLA Student Store
308 Westwood Plaza
Los Angeles (213) 206-0763

B. Dalton Bookseller
357 Sunny Valley Mall
Concord (415) 825-0111

B. Dalton Bookseller
Mission Valley Center
San Diego (619) 291-0154

B. Dalton Bookseller
Montclair Plaza
Montclair (714) 624-9672

B. Dalton Bookseller
123 Del Amo Fashion Sq.
Torrance (213) 371-0157

B. Dalton Bookseller
Northridge Fashion Ctr.
Northridge (818) 993-9167

B. Dalton Bookseller
Cupertino Crossroads Ctr
Cupertino (408) 257-5530

B. Dalton Bookseller
200 Kearny Street
San Francisco (415) 956-2850

B. Dalton Bookseller
South Coast Plaza
Costa Mesa (714) 540-2191

B. Dalton Software Etc.
Gallery at South Bay
Redondo Beach (213) 214-0480

B. Dalton Software Etc.
C-6 Manhattan Village
Manhattan Beach (213) 546-7481

Cal Tech Bookstore
Mail Code I-51
San Pasqual Street
Pasadena (818) 356-6161

Clean Well Lighted Place
for Books
21271 Stevens Creek Blvd.
Cupertino (408) 255-7600

Cody's Books Inc.
2454 Telegraph Ave.
Berkeley (415) 845-7852

Computer Literacy
520 N. Lawrence Expwy
Suite 310
Sunnyvale (408) 730-9112

Huntley Bookstore
8th at Dartmouth
Claremont (714) 621-8168

Opamp Technical Books
1033 North Sycamore Ave.
Los Angeles (213) 464-4322

Pasadena Scientific
& Technical Bookstore
1388 East Washington
Pasadena (818) 794-4499

Printers Inc. Bookstore
310 California Ave.
Palo Alto (415) 327-6500

San Diego Technical Books
8290 Vickers, Suite B
San Diego (619) 279-4990

Stacey's
581 Market Street
San Francisco (415) 421-4687

Stacey's
219 University Ave.
Palo Alto (415) 326-0681

Stacey's
383 Sacramento St.
San Francisco (415) 397-7935

Stanford Bookstore
Stanford (415) 329-1217

Stanford Bookstore Palo Alto
135 University Ave.
Palo Alto (415) 327-3680

Technical Book Co.
2056 Westwood Blvd.
Los Angeles (213) 475-5711

UCSB Bookstore
University Center
Santa Barbara (805) 961-2082

UCSD Bookstore
Univ. of California at
San Diego
La Jolla (619) 452-6825

USC Trojan Bookstore
835 West 36th Place
Los Angeles (800) 826-3544
outside CA: (800) 354-9126

COLORADO

Auraria Book Center
955 Lawrence St.
Denver (303) 556-3230

B. Dalton Bookseller
Arapahoe Village
Boulder (303) 447-8718

B. Dalton Bookseller
715 16th Street
Denver (303) 623-6027

Tattered Cover Bookstore
2823 East Second Avenue
Denver (800) 821-2896
outside CO: (800) 833-9327

United Tech Books
249 Main St.
Longmont (303) 651-3184

CONNECTICUT
Univ. of Ct. Co-op
Storrs (203) 486-3537

Yale Co-op
77 Broadway
New Haven (203) 772-2200

DISTRICT OF COLUMBIA
Reiters Scientific &
Professional Books
2120 Pennsylvania Ave., NW
(202) 223-3327

GEORGIA

Georgia Tech Bookstore
350 First Dr. NW
Atlanta (404) 894-2515

HAWAII

Univ. of Hawaii Bookstore
2465 Campus Rd.
Honolulu (808) 948-8022

 Addison-Wesley

 Benjamin-Cummings

LEADING EDGE AI BOOKS

Programming Languages

Essential LISP

John Anderson, Albert Corbett, Brian Reiser, *all of Carnegie-Mellon University*

All the basic features of LISP are covered, as well as some applications in artificial intelligence. The book can be used with a variety of LISP dialects, but is based on the standard of Common LISP. An excellent self-study guide.

256 pp (PB) 11148-9 (1987)

Prolog Programming for Artificial Intelligence

Ivan Bratko, *E. Kardelj University J. Stefan Institute, Yugoslavia*

This book covers all the significant features of Prolog, while also providing a detailed account of artificial intelligence applications such as heuristic problem solving, symbolic manipulation, expert systems and game playing. In addition, the syntax and semantics of Prolog are fully discussed.

423 pp (PB) 14224-4 (1986)

A Prolog Primer

Jean B. Rogers, *University of Texas - Austin*

This is a thorough, pragmatic book that teaches how to program effectively in standard Prolog, via copious use of examples, problems, and solutions. Includes a thorough index and syntax summary.

219 pp (PB) 06467-7 (1986)

LISP, Second Edition

Patrick Henry Winston and Berthold K. P. Horn, *Massachusetts Institute of Technology*

434 pp (PB) 08372-8 (1984)

Programming Expert Systems in OPS5: An Introduction to Rule-Based Programming

Lee Brownston, Robert Farrell, Elaine Kant, *Carnegie-Mellon University*, and Nancy Martin, *Wang Institute of Graduate Studies*

471 pp (HB) 10647-7 (1985)

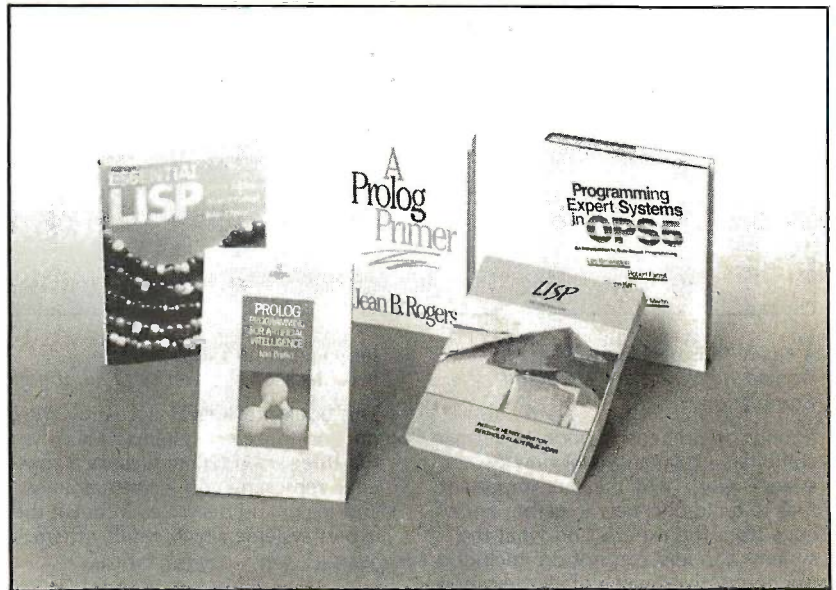

ILLINOIS

B. Dalton Bookseller
129 North Wabash
Chicago (312) 236-0201

B. Dalton Bookseller
645 N. Michigan Ave.
Chicago (312) 944-3702

B. Dalton Bookseller
Xerox Center
Chicago

Book Center/Illini Union
Univ. of Illinois
1401 West Green St.
Urbana (217) 333-0437

Follett's U of Illinois
Book & Supply
627-631 S. Wright Street
Champaign (217) 356-1369

Kroch's & Brentano's, Inc.
29 South Wabash
Chicago (312) 332-7500

Kroch's & Brentano's, Inc.
516 North Michigan Avenue
Chicago (312) 321-0989

Kroch's & Brentano's, Inc.
835 North Michigan Avenue
Chicago, (312) 943-2452

Kroch's & Brentano's, Inc.
105 West Jackson Blvd.
Chicago (312) 922-8056

Kroch's & Brentano's, Inc.
1711 Sherman Avenue
Evanston (312) 328-7220

Kroch's & Brentano's, Inc.
36 Old Orchard Center
Skokie (312) 675-7550

Kroch's & Brentano's, Inc.
80 Oakbrook Center
Oakbrook (312) 654-0340

Kroch's & Brentano's, Inc.
1028 Lake Street
Oak Park (312) 848-9003

Kroch's & Brentano's, Inc.
J-6 Evergreen Plaza
Evergreen Park (312) 424-9550

Kroch's & Brentano's, Inc.
18 River Oaks Center
Calumet City (312) 868-1666

Kroch's & Brentano's, Inc.
159 Lincoln Mall
Matteson (312) 481-6140

Kroch's & Brentano's, Inc.
106 Hawthorne Center
Vernon Hills (312) 367-0141

Kroch's & Brentano's, Inc.
E-108 Mall at Cherryvale
Rockford (815) 332-2405

Kroch's & Brentano's, Inc.
999 Elmhurst Road
Mt. Prospect (312) 259-5510

Kroch's & Brentano's, Inc.
J-108 Woodfield Mall
Schaumburg (312) 884-0888

Kroch's & Brentano's, Inc.
2284 Fox Valley Center
Aurora (312) 851-7773

Kroch's & Brentano's, Inc.
100 Orland Square
Orland Park (312) 349-0676

Univ. of Chicago Bookstore
970 E. 58th St.
Chicago (312) 962-7712

INDIANA
Follett's Purdue Bookstore
1400 W. State St.
W. Lafayette (317) 743-9642

KENTUCKY
University Bookstore
University of Kentucky
Student Center
Lexington (606) 257-6309

LOUISIANA

Ander's-The Bookstore
210 E. St. Mary Blvd.
Lafayette (318) 232-2087

The Bookstore
University of New Orleans
Lakefront

New Orleans (504) 286-6373

LSU Bookstore
Union Building
Baton Rouge (504) 388-5137

Tulane University Bookstore
Tulane University
New Orleans (504) 865-5917

MARYLAND

Johns Hopkins U. Book Ctr.
Barnes & Noble
Charles & 34th Streets
Baltimore (301) 338-8317

Maryland Book Exchange
4500 College Avenue
College Park (301) 927-2510

Univ. of Maryland Bookstore
Adele Stamp Bldg.
College Park (301) 454-5850

MASSACHUSETTS
Boston Univ. Bookstore
660 Beacon Street
Boston (617) 236-7415

Harvard Coop
1400 Massachusetts Ave.
Cambridge (617) 492-1000

Quantum Books
1 Kendall Square
Cambridge (617) 494-5042

SoftPro
Vinebrook Plaza
Burlington (617) 273-2919

Tech Coop
84 Massachusetts Ave.
Cambridge (617) 491-4230

University Store
Campus Center
University of Massachusetts
Amherst (413) 545-2619

MINNESOTA

B. Dalton Bookseller
103 City Center
Minneapolis (612) 332-9008

B. Dalton Software
32 Southdale Ctr.
Edina (612) 922-2293

B. Dalton Software
Rosedale Ctr.
Roseville (612) 631-8095

Minnesota Book Center
University of Minnesota
231 Pillsbury Drive SE
Minneapolis (612) 625-3005

LEADING EDGE AI BOOKS

Expert Systems

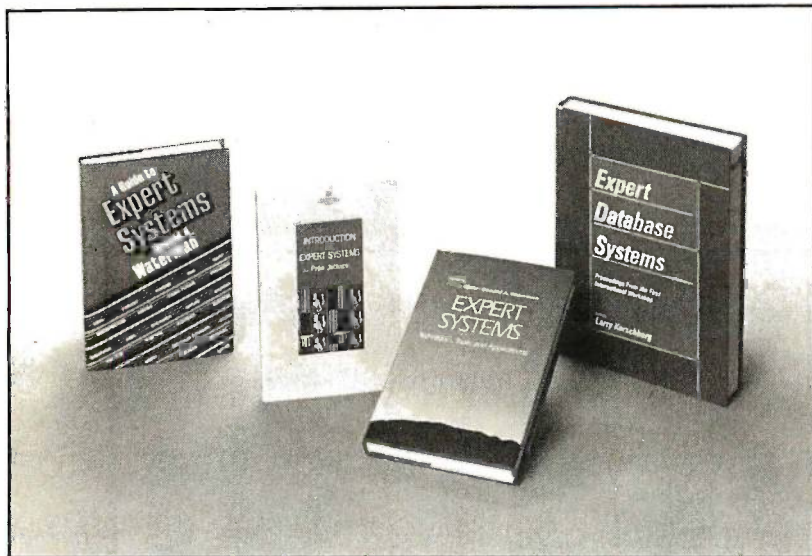

A Guide to Expert Systems
Donald A. Waterman, *The Rand Corporation*

In one comprehensive book, Waterman combines explanations of how expert systems work, why they are important, how to build one, how to gather knowledge from the experts and what the systems can and can not do. Included is a descriptive catalog of all the expert systems you can choose from.

419 pp (HB) 08313-2 (1986)

Introduction to Expert Systems
Peter Jackson, *University of Edinburgh*

This book provides an accessible introduction to expert systems. It surveys the three main techniques for knowledge representation — rules, frames, and logic; and describes in detail the expert systems which employ them.

246 pp (PB) 14223-6 (1986)

Expert Systems: Techniques, Tools and Applications

Editors Philip Klahr and Donald A. Waterman, *The Rand Corporation*

Expert Systems is a collection of papers that describe current techniques of expert systems development, building and applications. A clear technical description of some of the most recent achievements in expert systems is provided.

441 pp (HB) 14186-8 (1986)

Expert Database Systems

Edited by Larry Kerschberg, *University of South Carolina*

An excellent reference for researchers and practitioners. **Expert Database Systems** is a unique collection of papers gathered together from the First International Workshop on Database Systems held in 1984. The book provides an understanding of the central issues and architectures of the next generation of intelligent systems.

701 pp. (HB) 33270-7 (1986)

MISSOURI

Washington Univ. Campus Stores
Campus Box 1074
One Brookings Drive
St. Louis (314) 889-5500

NEW JERSEY

McGraw-Hill Bookstore
Hightstown-Princeton Road
Hightstown (609) 426-5749

Princeton University Bookstore
36 University Place
Princeton (609) 921-8500

NEW MEXICO

B. Dalton Bookseller
117 Winrock Ctr.
Albuquerque (505) 883-5180

NEW YORK

Barnes & Noble Bookstore
6 East 18th St.
New York City (212) 675-5500

Barnes & Noble
SUNY at Albany
1400 Washington Ave.
Albany (518) 457-510

Barnes & Noble
SUNY at Stony Brook
Student Union Building
Stony Brook (516) 246-3666

B. Dalton Bookseller
666 Fifth Ave.
New York (212) 315-4744

B. Dalton Bookseller
2422 Central Park Ave.
Yonkers (914) 779-8490

B. Dalton Bookseller
170 Broadway
New York (212) 349-3560

B. Dalton Bookseller
396 Avenue of the Americas
New York (212) 674-8780

Campus Connections/RIT
One Lomb Memorial Drive
Rochester (716) 475-2504

Cornell Campus Bookstore
Ithaca (607) 256-4111

Follett's Univ. Bookstore
SUNYAB/200 Lee Entrance
Buffalo (716) 636-3131

McGraw-Hill Bookstore
1221 Avenue of the Americas
New York City (212) 512-4100

NYU Bookstore
18 Washington Place
New York City (212) 598-2241

Rensselaer Union Bookstore
Sage & 15th Streets
Troy (518) 266-6555

Syracuse University Bookstore
303 University Place
Syracuse (315) 423-2426

Triangle Bookshop
403 College Ave.
Ithaca (607) 272-7111

University of Rochester
Barnes & Noble Bookstore
Frederick Douglass Bldg.
Rochester (716) 275-4011

NORTH CAROLINA

B. Dalton Bookseller
J-144 Crabtree Valley Mall
Raleigh (919) 787-1003

OHIO

Barnes & Noble Bookstore
Cleveland State University
2400 Euclid Avenue
Cleveland (216) 861-6464

Micro Center
1555 West Lane Ave.
Columbus (614) 481-8040

OKLAHOMA

Univ Center Bookstore
Central State University
Edmond (405) 341-2980

Oklahoma State Univ
Student Union Bookstore
Stillwater (405) 624-5238

OREGON

B. Dalton Bookseller
Washington Square
Portland (503) 620-3007

PENNSYLVANIA

B. Dalton Bookstore
Monroeville Mall
Monroeville (412) 373-3207

Drexel University Bookstore
33rd & Chestnut Streets
Philadelphia (215) 895-2861

Gene's Books
King of Prussia Plaza
King of Prussia (215) 265-6210

Univ. of Pennsylvania
Bookstore
3729 Locust Walk
Philadelphia (215) 898-7596

RHODE ISLAND

Brown University Bookstore
71 Olive Street
Providence (401) 863-3168

TENNESSEE

University Store
Memphis State University
University Center
Memphis (901) 454-2011

TEXAS

The Book Merchant
1810 Main St.
Austin (512) 461-5798

Bookstop
Highway 183 at Burnet Rd.
Austin (512) 461-5798

Bookstop
7555 Bellaire Blvd.
Houston

Bookstop
I-10 W. bet. Wurzbach
& Huebner
San Antonio (512) 697-0588

Bookstop
Preston Rd. at Forest Lane
Dallas (214) 363-5744

Brown Book Shop West
10290 Westheimer at West Belt
Houston (713) 783-2002

Majors Scientific Books
6632 South Main
Houston (713) 526-5757, 522-1361

N. Texas State Univ. Store
1315 W. Chestnut
Denton (817) 565-3194

PRNT Bookstore at Infomart
1950 Stemmons
Dallas (214) 746-3625

MORE LEADING EDGE BOOKS....

Software Engineering With Ada, Second Edition

Grady Booch, *Rational*

New edition of the best-selling book on Ada teaches the effective use of the language in a software engineering environment.

575 pp (PB) 30604-8 (1986)

Telecommunications Networks

Mischa Schwartz, *Columbia University*

Emphasizing quantitative performance evaluation of telecommunications networks and systems, this book details the dramatic changes in the field over the past two decades.

724 pp (HB) 16423-X (1986)

Programming Pearls

Jon Bentley, *AT&T Bell Laboratories*

Bentley has compiled, expanded, and revised the best of his articles to give a deeper understanding of important programming techniques and fundamental design principles.

200 pp (PB) 10331-1 (1986)

C By Dissection

Al Kelley and Ira Pohl, *University of California, Santa Cruz*

250 pp (HB) 36861-2 (1986)

Mystical Machine

John E. Savage, Susan Magidson, and Alex M. Stein, *all of Brown University*
320 pp (HB) 06462-6 (1986)

Relational Database: Selected Writings

C. J. Date
544 pp (HB) 14196-5 (1986)

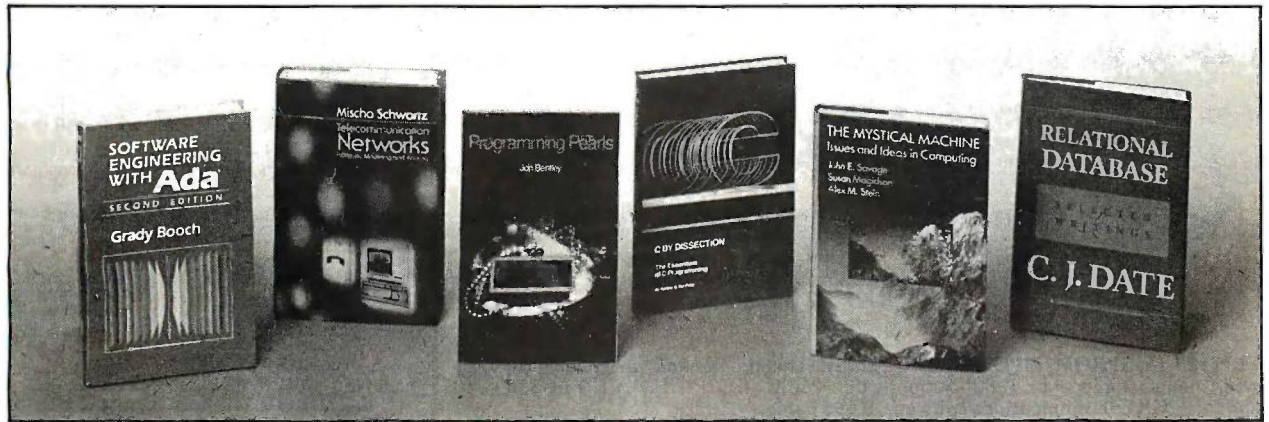

Rice Campus Store
Rice University
6100 S. Main St.
Houston (713) 527-4052

Southern Methodist Univ.
Bookstore
Student Center/3300 Dyer St.
Dallas (214) 692-2436

Taylor's Bookstore
5455 Beltline
Dallas (214) 934-1500

Texas A&M Bookstore
University Center
College Station (409) 845-8681

University Bookstore
University of Texas
500 S. Cooper
Arlington (817) 273-2785

University Co-op Society, Inc.
University of Texas
2246 Guadalupe Street
Austin (512) 476-7211

UTAH
Utah State University
Bookstore
UMC-02
Logan (801) 750-1681

VIRGINIA
B. Dalton Bookseller
Seven Corners Mall
Falls Church (703) 241-7505

WASHINGTON
B. Dalton Software Etc.
Bellevue Square
Bellevue (206) 455-9115

INTERNATIONAL BOOKSTORES

England
Blackwells
Broad Street
Oxford
OX1 3B
England

Dillon's Bookstore
82 Gower Street
London
WC1E 7JB
England

Heffers Booksellers
20, Trinity Street
Cambridge
CB2 3NG
England

W.G. Foyle Ltd
119/125 Charing Cross Road
London
WC2
England

Haigh and Hochland Ltd
The Precinct Centre
Oxford Road
Manchester
M13 9QA
England

John Smith and Son Ltd
57 St. Vincent Street
Glasgow
G2 5TB
Scotland

The Modern Book Co.
19-21 Praed Street
London
W2 1NP

Amsterdam
Scheltema Holkema En
Vermeulen BV.
Koningsplein 20
1017 BB Amsterdam
The Netherlands

J.A. Mayersche Buchhandlung
Ursulinerstrasse 17-19
D-5100 Aachen
West Germany

Libr. Int. Ulrico Hoepli
Via Ulrico Hoepli 5
20129 Milano
Italy

Offi-Lab
48, Rue Gay Lussac
75240 Paris Cedex 05
France

Freihofer A.G.
Weinbergerstrasse 109
CH-8003 Zurich
Switzerland

Scientific and Techn.
Book Centre
12 Rue De Neufchatel
1060 Brussels
Belgium

Hochschul. Buchhandlung
August Lachner
Theresienstrasse 43
8000 Muenchen 2
West-Germany

Librairie Payot
1 Rue De Bourgc
1002 Lausanne
Switzerland

Ver. Universitaetsbuchhandlung
Richard Wagnerstrasse 1
Postfach 270209
5000 Koln 1
West-Germany

C.L.U.P.
Piazza Leonardo Da Vinci 32
20133 Milano
Italy

Konrad Wittwer Booksellers
Konigstrasse 30
Postfach 147
7000 Stuttgart 1
West-Germany

NGLO-American Book Co.
Via Della Vite 57
00187 Rome
Italy

Singapore

Computer Book Centre Pte. Ltd.
109 North Bridge Road
Unit 06-12 Funan Centre
Singapore 0617.

Toppa Company (S) Pte Ltd
38 Liu Fang Road, Jurong Town
Singapore 2262.

Narosa Book Distributors
6 Community Centre
Panchsheel Park
New Delhi 110 017

Japan

Maruzen Company, Ltd.
3-10, Nihongashi 2-Chome
Chuo-Ku, Tokyo 103 Japan

Kinokuniya Company, Ltd.
177, Shinjuku 3-Chome
Shinjuku-ku, Tokyo 160-91 Japan

Sansendo Books Store Ltd.
1, Kanda Jimbocho 1-Chome
Chiyoda-ku, Tokyo 101 Japan

 Addison-Wesley



Benjamin-Cummings

THIRD GENERATION PROGRAMMERS FROM GTEK

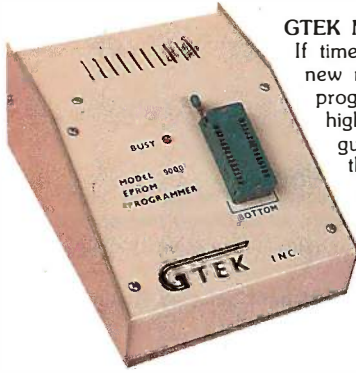

GTEK MODEL 9000 (E)EPROM/MPU PROGRAMMER
If time is money, then let us save some for you. The new model 9000, using its quick pulse algorithms, can program a 2764 in 10 seconds. The 9000 offers higher performance than the competition has even begun to think about. Baud rates to 57,600. Supports thru 1024K standard, 8 meg worldwide parts with adapter, Cypress proms, mpu's. NO personality modules. As with our other programmers, RS-232, ASCII data formats, and flexible hand-shaking make the model 9000 compatible with virtually any computer. Introductory price \$749.

MODEL 7228 (E)EPROM/MPU PROGRAMMER The standard by which other programmers are judged. With thousands in the field, the time proven 7228 has become our most popular programmer. Intelligent algorithms standard. Programs a 2764 in one minute. Supports devices thru 512K, mpu's, eeproms, cmos. NO personality modules. Price \$599



MODEL 7956 GANG (E)EPROM/MPU PROGRAMMER
The 7956 can program eight 2764's in one minute using intelligent algorithms. Standard support thru 512K, eeproms, cmos, mpu's. A must for production environments. Available in stand alone only configuration for \$979 or with RS-232 interface for \$1099

MODEL 7128 (E)EPROM/MPU PROGRAMMER The programmer that won't die. Thousands manufactured since 1982. Supports thru 256K. **PRICE REDUCED** to \$389 including free PGX communications software, a \$95 value.

MODEL 705 Motorola 68705 family programmer. Transfers object code to 28 and 40 pin mpu's. Single keystroke operation. \$299

MODEL 7324 PAL PROGRAMMER The 7324 has a built-in compiler. It supports 20 and 24 pin pals by MMI, NATIONAL, and TI, including the new shared product parts 20S10, 20RS10, 20RS8, 20RS4. It operates stand alone or via RS-232 with PALX communications package. Functionally tests parts after programming and securing. External compilers are supported thru JEDEC and AHS object formats. \$1499

MODEL 7322 Same as 7324 but no stand alone capability. \$1249

UTILITY PACKAGES

PGMX High Speed Communications Package. For IBM PC, AT and compatibles. Bi-directional data rates to a scorching 57600 bps. Provides flexible manipulation of Intel Hex files, both 8 and 16 bit formats, and binary files. Use with model 9000. \$149

PGX Utility Package. For PC DOS, CPM, TRSDOS, ISIS, MSDOS. Use with 9000, 7956, 7228, 7128. \$95

PALX Utility Package. Provides communication, download of Palasm source, JEDEC and AHS object files to models 7324, 7322, 7316 pal programmers. \$95

CROSSASSEMBLERS and SIMULATORS

You name the cpu, we've got the assembler. Simulators allow target software development and testing on your computer. Versions available for PC DOS, MSDOS, CPM. . Start at \$250

ERASERS—We stock both Ultra Violet Products and Spectronics for your selection.

MODEL	CHIPS	TIMER	LAMP	PRICE
DE4	8	N	Tube	\$80
PE14T	9	Y	Tube	\$139
C25	25	Y	Grid	\$350
C50	50	Y	Grid	\$600

ACCESSORIES

CABLES—serial	\$30
parallel	\$30
custom Call For Quote	
MODEL 481/482/483 8048 family adapters	\$98
MODEL 511/512 8051 family adapter	\$174
MODEL 755/756 8755 adapter	\$135

SPECIAL REQUIREMENTS? Call Us For A Quote On Custom OEM Programmers.

Run CPM Software
on Your IBM
or IBM
Compatible



Call GTEK's CPM Hotline
1-601-467-9019

If you are a CPM user who wants to convert to MSDOS or PC DOS or a PC user who would like access to the thousands of CPM programs in existence, here is the perfect solution to the problem: CPMulator from GTEK.

CPMulator is the only field proven emulator which emulates the complete Z-80 instruction set. Terminal attribute emulation is Televideo, Lear Siegler, or the ANSI standard. CPM .COM programs reside under PC DOS and are executable under PC DOS as well as 8086 programs.

Comes complete with COPYCPM, a disk conversion utility which allows transferring data and programs to and from 54 different CPM disk formats. Free CPM utility programs are also included.

For speed use the 8080 CPMulator along with the NEC V20 or V30 chip.

PRICE REDUCED

Z80 CPMulator, DR5PC-EMZ80	\$ 99.00
8080 CPMulator, DR5PC-EMV205	\$ 99.00*
Z80, 8080 CPMulator, DR5PC-EMZV205	\$149.00*
*Requires NEC V20 or V30.	
NEC V20 (5Mhz)	\$ 12.00

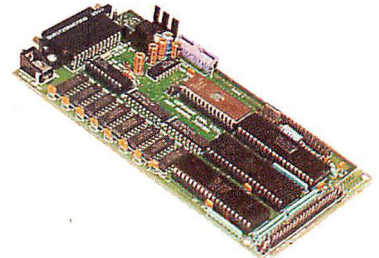

Single Board Computer Model 2010

- 64t to 256K bytes data or program ram.
- Use 2764 or 27512 eeprom or eeprom program memory.
- Uses single ended 9V @ 500 ma supply.
- Use 8031, 8032, 8751, 8752 mpu.
- 40 bit programmable I/O lines.
- Expansion interface connector.
- Baud rates to 57,600 baud.
- Built in 5 volt regulator.
- Built in rom monitor.
- Small — 3.5 x 7 inches.
- 8052AH basic option.

ONLY \$299.00 WITH MANUAL

MODEL 8014 PRINTER BUFFER/SWITCH
OK is \$99, 128K is \$339, and 256K is \$399

GTEK

Development Hardware & Software
P.O. Box 1346, Bay St. Louis, MS 39520 U.S.A.
(601) 467-8048; TELEX 315814 (GTEK UD), INC.

GTEK, PALASM, CPM, MS-DOS, PC-DOS, ISIS, TRSDOS, & CPEmulator are registered trademarks.



FILEPRO 16 AND FILEPRO 16 PLUS

BY RICHARD HARKNESS

The Small Computer Company's filePro 16 and filePro 16 Plus are database management systems that run under PC-DOS and MS-DOS and, in their multiuser versions, UNIX and XENIX. Other versions are available for several machines that are not strictly IBM PC-compatible.

Both programs are written in a combination of C and assembly language and are very fast, especially in the key operations expected of relational database management systems: sorting, selecting, and processing large groups of records (see the benchmark results in table 1). A hard disk is required, except with the Tandy 2000. With this machine's extra floppy disk capacity, it can, with a bit of disk-swapping, handle filePro 16 but not filePro 16 Plus.

The first version of filePro 16 was a highly popular database manager called Profile, a program for Radio Shack's line of 8-bit TRS-80 computers. It evolved and moved to the MS-DOS environment, picking up a new name, Profile 16, along with its enhanced capabilities. Profile 16 (designed for Tandy's Model 16 and 6000 machines) and filePro 16 are virtually identical.

FILEPRO 16 VS. FILEPRO 16 PLUS

Conceptually, filePro 16 Plus, which has more applications development tools, is geared toward software applications developers, while filePro 16 is well suited for end users who want to set up and manage a database. Optional transfer utilities port applications between operating systems (such as transferring files between

Database management software for MS-DOS and UNIX systems

single-user and multiuser systems), convert external data files to filePro 16 format, and transfer filePro 16 files to other formats such as DIF, SYLK, and ASCII.

The filePro 16 Plus program has a built-in feature that can treat external files as filePro 16 files. Both programs actually consist of two major building blocks: The first block is a sophisticated file manager, and the second block is a powerful programmable file processor. Many users may never need anything but the first block.

CAPACITIES

With filePro 16 you can have as many files as you have hard disk space, with up to 16 million records per file; 999 fields, 4608 characters, and 36 screens per record; and 200 processing elements per table. The filePro 16 Plus program provides 16,384 characters per record and 1000 processing elements per table.

CREATING A FILE

Operations in filePro 16 are menu-driven with a generous number of prompts throughout the program. To set up a file, you type the name you want it to have and, on a table provided, fill in a list of fields and lengths for each record. If you desire, the program will make a screen, a report format, and an index for you. You can build on this format as your needs grow.

You can make any modifications you want before adding data to a file. After adding data, you can add new fields only at the end of the existing fields. This prevents confusion of field numbers. If your records are lengthy, it's a good idea to always make a few reserved fields in the key segment: Simply type in a field number but set the length to zero. Information in the key segment is processed faster than information in the data segment, so it's desirable to put the most frequently sorted and selected fields in the key segment.

FIELD TYPES

As you define fields, you can specify an edit type for each field. By specifying the Phone edit, for example, the field will accept only numbers and will change an input of 1112223333 into (111) 222-3333 automatically. There are also date, time, and numeric edits to ease input and ensure data integrity. You can even customize your own edits.

CREATING INPUT SCREENS

Creating screens for data input with filePro 16 is a pleasure because it's done directly—you see exactly what you're getting at every step. Reverse video, simple line graphics characters, and automatic box drawing make drafting professional-looking screens easy.

You can use several useful system-maintained fields, which can be sorted and selected just like other

(continued)

Richard Harkness (1224 King Henry Dr., Ocean Springs, MS 39564) is a consultant pharmacist and a writer.

filePro 16 and filePro 16 Plus**Type**

Relational database management systems

Company

The Small Computer Company Inc.
41 Saw Mill River Rd.
Hawthorne, NY 10532
(914) 769-3160

Format

filePro 16: five 5¼-inch disks;
filePro 16 Plus: six 5¼-inch disks;
no copy protection

Computer

Single user: IBM PC, XT or AT; filePro 16: 384K bytes of RAM; filePro 16 Plus: 512K bytes of RAM; multiuser (XENIX or UNIX): IBM PC AT compatibles; AT&T Model 3B2 and Model 7300; Fortune 32:16XP; NCR Tower; Plexus computers; Tandy Model 16 and 6000

Documentation

Reference manual; tutorial manual; quick reference guide; installation manual

Price

filePro 16 for single user: \$495; filePro 16 Plus for single user: \$990; run-time versions available; single-user upgrade from filePro 16 to filePro 16 Plus: \$495; multiuser version prices vary according to computer and operating system

Audience

End users and applications developers

fields. Typing in @UD, for example, instructs the program to input automatically the date on which a particular record was last updated. Suppose you have several screens per record and a few common fields on each screen, one of which is a client's name. Entering the client's name on the first screen causes it to be automatically filled in on all the other screens. The protected field indicator, an exclamation point, can be used on all secondary screens to assure that this field cannot be altered except from the first screen. Using the must-fill indicator, a percent sign, makes sure critical data is typed in before the record can be entered. You can set a cursor path that takes the operator through the fields in a specified order.

OUTPUT FORMATS

Creating output formats for printing is similar to creating screens. You put the fields on a video form to indicate where you want them to appear on the printed form. The filePro 16 program lets you create formats for reports, labels, full-page forms (which can be tailored to match insurance, paycheck, and invoice paper forms), and free-form documents. You can also define processing-only formats for batch operations. You can set your sort choices as part of the format or decide on them later. Now you are ready to create empty records and fill them in. Password protection is optional.

INDEXES

You use the Index Maintenance mode to build indexes, which can be one of two types: automatic or demand.

Automatic indexes are maintained by the program, adjusting themselves dynamically as you add, delete, and change records. You might use an automatic index to keep your records in alphabetical order by client name, for instance. Any record is almost instantly available by typing in the first few letters of a client's name. Demand indexes, which have complex sorting and selection capabilities, can be used for inquiry and printing operations. You can base one index on another to narrow selections. There are eight sort levels. Sorts can be ascending or descending on numeric, time, date, and text fields.

SELECTION CAPABILITIES

The filePro 16 program's selection capabilities are impressive. Even a very imaginative user would be hard-pressed to find a need to release their full potential. You can select records by up to 72 criteria at a time. An extended selection table contains twelve lines for defining selection criteria. You can give the filled-in selection lines a name and save them as sets for regular use. Group labels relate the lines to each other by AND, OR, or the relationship codes. These codes include EQ, NE, GE, GT, LE, RG (for selecting ranges), CO (which means *contains*), and xxF (for comparing fields to themselves using a relationship code). At the bottom of a selection table is a selector sentence. Labeled selection lines can be further related to each other, or to other saved selection sets, in the selector sentence using AND, OR, and NOT. Previously saved selection sets can also be used in processing tables.

THE PROCESSING BLOCK

Processing is the block that creates complex interactive applications such as a full-featured accounting system. Similar to BASIC programming, processing uses IF and THEN elements and relationship codes. Three types of processing are available: input, automatic, and output, which is done during batch runs. You program commands into a processing table. There are 19 commands, including AVG, COPY, DELETE, END, GOSUB... RETURN, GOTO, TOT, and LOOKUP.

Table 1: These benchmarks were performed on a database of 1000 records of 100 characters each. Times to perform each function are rounded off to the nearest second.

Sort file on nonindexed field: 26

Access the last record in a nonindexed file: 22

Access the last record in an indexed file: instantaneous

Index a file: 64

which temporarily connects different files.

UNIQUE FEATURES

The filePro 16 program has several unique features. At the bottom of each screen within a record appears the message "F-Print Form." Pressing the F key and typing in the name of one of your output formats, such as a report, invoice, or envelope, immediately prints the specified form for that particular record. This is a handy feature that shouldn't be undervalued. Most other database managers can do this operation only through a batch process. User-defined menus automate any combination of functions. Pressing one key on such a menu causes the program to go through an unseen but complicated ritual of predefined sequential keystrokes.

One of my favorite features is called Associated Fields. You can relate several different fields by using a special code in Define Files mode. When you type this code instead of a particular field number, the program does a specified sort or selection on all the related fields during a single run.

For instance, as a consultant pharmacist, I set up a database of drugs, with one drug per record. I wanted to input information on adverse side effects for each drug. Here's a simplified version of what my associated fields looked like when I created them in Define Files mode.

Field
1—Drug name
2—A1) Adverse side effect
3—A1) Adverse side effect
4—A1) Adverse side effect
5—A1) Adverse side effect

I could now input four of the most common side effects for each particular drug. There might be several hundred drugs on file.

Suppose I needed to know all the drugs that had *dizziness* and *drowsiness* as side effects. Selecting on field A1 causes the program to search fields 2, 3, 4, and 5, calling up the records that have both *dizziness* and *drowsiness* listed in their side-effects fields.

Consider what would have to be

*filePro 16 Plus has
many added features
that are valuable for
applications developers.*

done using a conventional system: I would have to do a search through each of the four fields separately for *dizziness* and then do the same thing for *drowsiness*. Afterward, I'd have to manually search through all the records selected and eliminate those that didn't have both *dizziness* and *drowsiness* listed.

IMPROVEMENTS

Earlier versions of filePro 16 had a few gremlins: The file directory function did not display selection sets, processing types, and output formats; the program would occasionally hang up in Index Maintenance mode and require a warm reboot; and, over a length of time, the automatic indexes faltered in keeping records in the specified order. So far, with the latest version, I have not encountered any of these prior problems.

The filePro 16 Plus program has many added features that are especially valuable for applications developers. These features include customized help screens, a debugger for processing, increased speed due to precompiling of processing tables, 31 additional commands and functions for processing, more extensive error checking for processing functions, three more system-maintained fields, 12 additional user-menu command-line instructions, enhancements to the output functions, and filename qualifiers, which allow the use of the same file structure, screens, or reports for other files.

CONCLUSION

The filePro 16 and filePro 16 Plus programs are among the best of the microcomputer database management systems. They adequately fill the needs of end users and software developers and certainly deserve consideration. ■

A MESSAGE TO OUR SUBSCRIBERS

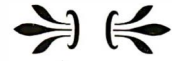

FROM TIME TO TIME we make the BYTE subscriber list available to other companies who wish to send our subscribers material about their products. We take great care to screen these companies, choosing only those who are reputable, and whose products, services, or information we feel would be of interest to you. Direct mail is an efficient medium for presenting the latest personal computer goods and services to our subscribers.

Many BYTE subscribers appreciate this controlled use of our mailing list, and look forward to finding information of interest to them in the mail. Used are our subscribers' names and addresses only (no other information we may have is ever given).

While we believe the distribution of this information is of benefit to our subscribers, we firmly respect the wishes of any subscriber who does not want to receive such promotional literature. Should you wish to restrict the use of your name, simply send your request to the following address.

BYTE MAGAZINE

ATTN: CIRCULATION DEPT.
ONE PHOENIX MILL LANE
PETERBOROUGH, NH 03458



**ORDER
LINE
800-354-7330**

LOWEST PRICES NO SURCHARGE ON BANK CARDS SILICON SPECIALTIES

ZENITH COMPUTERS
Always the
lowest prices.
Call us for
a quote.

HARDWARE

PRINTERS

Brother All Models	Save
Citizen MSP-10	\$260
MSP-15	\$379
MSP-20	\$319
MSP-25	\$475
Premier 35	\$475
Diablo D-25	\$509
635	\$1019

EPSON

All Printer Models Save

IBM Proprinter	\$399
Juki	
4100	\$369
4300	\$769
NEC	
3510, 3550	\$729
8810, 8850	\$1039
P5	\$969
P6	\$439
P7	\$619

OKIDATA

All Printer Models	Save
Panasonic 1080	\$195
1091	\$239
1092	\$305
1592	\$425
KXP3151	\$389

STAR MICRONICS

All Printer Models Save

Toshiba

321 Parallel & Serial	\$455	\$575
341 Parallel		\$929
P351 Parallel & Serial		Save
Laser Printer		Save

DISKETTES

Maxell MD-2 (Qty 100)	\$100
Sony MD/2 (Qty 100)	\$119

MONITORS

Amdex All Monitors	Save
NEC All Monitors	Save
Princeton Graphics	Save
Zenith All Monitors	Save

VIDEO TERMINALS

Qume QVT Green 101	\$299
QVT Amber 101	\$314
Wyse 30	\$299
50	\$419
75	\$559
Wyse 85	\$439
Wyse 350	\$859
Zenith Z-22	\$455
Z-29A	\$559
Z-49	Save

DISK DRIVES

Iomega Bernoulli 10 meg	\$1195
Bernoulli 20 meg	\$1595
Bernoulli 40 meg	\$2325

SEAGATE

20 meg w/Western I/O	\$385
----------------------	-------

PLOTTERS

Epson Hi-80 Save

MODEMS

Anchor Automation	\$235
Signalman Express	
Practical Peripherals	
Practical 1200 Baud	\$124

HAYES

All Modems	Save
Prometheus All Models	Save
US Robotics Courier 2400	\$349
Postward 1200	\$180
Microlink 2400	\$369

BOARDS

AST Advantage	\$329
Rampage AT	\$445
Rampage PC	\$239
Six Pack Plus	\$159
Hercules Color Card	\$149
Graphic Card	\$179
Intel	
Above Board PC (1110)	\$239
Above Board AT (2010)	\$329
Above Board PS/AT (2110)	\$369
Paradise Modular Graphic 06-1	\$239
Five Pak	\$115
Plus Development	
Plus Hard Card 20 Megabyte	\$669
Quadram	
Gold & Silver Boards	Save
Quadlink	\$329
Quadr EGA	\$359
Tec Mar Graphics Master	\$445
Captain No Memory	\$169

SOFTWARE

IBM PC AND 100% Compatibles

COMMUNICATIONS

CompuServe Starter Kit	Best Price	\$92
Crosstalk XVI		\$139
MS Access 1.01		\$76
PFS Access		\$92
Remote		\$83
Smartcom II		\$19

UTILITIES

Copy II PC	\$19
1 DIR	\$46
Fastback	\$86
Norton Utilities 3.1	\$48
Printworks	\$36
Sidekick	\$30
Sidekick (Unprotected)	\$47
Sidekick—Superkey (Bundle)	\$85
Travelling Sidekick	\$39
Turbo Pralog	\$54
Sideways 3.1	\$34
Superkey	\$39

PROJECT MANAGEMENT

Harvard Total Project Manager	\$262
Microsoft Project	\$219
Super Project Plus	\$239
Timeline 2.0	\$209

WORD PROCESSORS

LeadingEdge Word Processor	On Special	\$55
Leading Edge W/P w/Spell & Mail	On Special	\$249
Lightening		\$275
Microsoft Word 3.0		\$275
Multimate Advantage		\$76
PFS: Write w/Spell Checker		\$162
Wordstar w/Tutor		\$233
Wordstar Pro Pack		\$199

Word Perfect (Ver.4.1) \$199

Wordstar 2000 + 2.0 \$278

LANGUAGES

C Compiler (Microsoft)	\$249
Fortran Compiler (Microsoft)	\$195
Lotus C Compiler	\$242
Macro Assembler (Microsoft)	\$84
Pascal Compiler (Microsoft)	\$166
Quick Basic 2	\$55
Run C Interpreter	\$65
Turbo Pascal w/8087 & BCD	\$59
Turbo Database Tool Box	\$38

COMPUTERS

PC 1 Drive 256K	\$1199
XT 1 Drive 256K	\$1729
XT 1 Drive 20 Meg 640K	\$2169
AT/68	\$2849
AT/339	\$4449
COMPAG™	
Portable II—2 Drive	\$1649

PANASONIC

Business Partner Dual Drive	\$1008
Sr. Partner Dual Drive	\$1109
Exec. Partner Dual Drive	\$1759
Other models	Save

TOSHIBA

T-1100	\$1299
T-1100 Plus	Save
T-3100	Save

Zenith Computer Products
SAVE Up to 50%
All Models Save

KEYBOARDS

Keytronic 5151	\$159
----------------	-------

SPREADSHEETS

Lotus 1-2-3	Save
Multiplan	\$108
Spreadsheet Auditor 3.0	\$82
VP Planner	\$48

Supercalc 4 \$259

MONEY MANAGEMENT

Dollars & Sense w/Forecast	\$94
Tobias Managing Your Money	Save

DATA BASE MANAGEMENT

Clipper	\$329
Cornerstone	\$56
dBase II	Save
dBase III Plus	Save
Extended Report Writer	Call
KnowledgeMan II	\$249
Nutshell 2.0	Call
PFS: File	\$76
PFS: Report	\$67
Quickcode	\$138
QuickReport	\$138
Reflex	\$82
Think Tank	\$91

R:Base 5000
System V Call

TRAINING

Fight Simulator	\$28
PC Logo	\$75
Typing Instructor	\$28
Tuning Tutor III	\$28

INTEGRATIVE SOFTWARE

Enable 1.1	\$319
Framework II	Save
Smart Software System	\$389
Symphony	Save

GRAPHICS

Chartmaster	\$199
Diagram Master	\$185
Energraphics 2.0	\$269
In-A-Vision	\$249
Microsoft Buss Mouse	
w/PC Paintbrush 3.0	\$106
Microsoft Chart	\$164
Microsoft Serial Mouse	\$119
Newsroom	\$31
PC Draw	\$199
Click Art Personal Publisher	\$99
PC Mouse w/Dr. Halo II	\$99
PC Paint w/Mouse	\$115
PFS Graph	\$76
Printmaster	\$29
Signmaster	\$132
Turbo Graphics Tool Box	Save

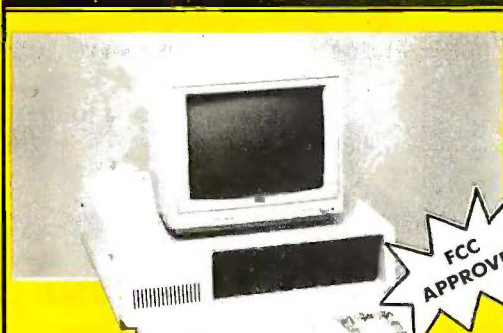

MNI SYSTEMS
Turbo PC/XT \$449

256 Memory, One 360K Brand Name Floppy Drive
135 Watt Power Supply, Slide Case, AT Style Keyboard
8 MHz Clock Speed, (Keyboard Selectable), 8 Expansion Slots

Product shipped in factory cartons with manufacturer's warranty. Please add \$10.00 per order for UPS shipping. Prices & availability subject to change without notice. Send cashier's check or money order... all other checks will delay shipping two weeks.

Circle 299 for MS DOS products. Circle 300 for all others.

SPECIAL
Over \$200 worth of
Paperback Software Programs
\$39 with each system

Turbo PC/XT w/256K & 1 Drive	\$449
Turbo PC/XT w/640K & 1 Drive	\$499
Turbo PC/XT w/640K & 2 Drives	\$599
Turbo PC/XT w/640K, 1 Drive & 20MG	\$929
MS DOS 3.2 w/GW Basic	\$ 75
ManGraphics Card with Software and Parallel Printer Port	\$ 75
Color Card with Parallel Print Port	\$ 69
Multifunction Card w/Software	\$ 75
Amber Monitor (TTL)	\$ 95
Amber Monitor w/Swivel Tilt	\$105
Color Monitor (RGB)	\$289
Sega Enhanced Graphics Card	\$235
I/O Card (Serial/Parallel)	\$ 39
I/O Card (Serial/Clock Calendar)	\$ 39
5151 Clone Keyboard	\$ 79



SILICON SPECIALTIES
2034 WEST SOUTHERN
MESA, ARIZONA 85202
602-969-0909

Circle 888

XEROX 6060

In the review of the Xerox 6060 (September BYTE), Wayne Rash Jr. stated that third-party monitors might be difficult to use with this machine. As you know, the Xerox 6060, the AT&T PC 6300, and the Olivetti M24 are similar machines. Therefore, any monitor that works with a PC 6300 will also work on an M24 and a 6060.

I went to an AT&T dealer to buy a color monitor for my PC 6300. They wanted \$945 for a 640 by 400-pixel color monitor. I thought this was expensive when similar third-party monitors for IBM clones were selling for half that price. I really wanted the NEC MultiSync monitor, but I was told by NEC and AT&T that it would not interface properly with my PC 6300.

Talking about this with a colleague, I was referred to a company in Fairfax, Virginia, that sells cables that allow third-party monitors to interface with an AT&T PC 6300.

I am happy to report that I bought both the NEC MultiSync monitor (\$510) and a cable (\$65) for a total cost of \$575, and it works great. For people who own an AT&T PC 6300, an Olivetti M24, or a Xerox 6060, there is an alternative.

MICHAEL RICCIARDI
Fairfax, VA

LEADING EDGE MODEL D PC

I was glad to see the review of the Leading Edge Model D PC (September). The Model D is a fine machine that deserves attention as an IBM PC or PC XT alternative. I work with Model Ds on a daily basis, and I am impressed by them.

Stan Miastkowski's article is already a bit dated. The Leading Edge Model D PC now comes with 512K bytes standard, upgradable to 768K on the motherboard. Of course, only 640K is available in main memory, but the extra 128K would do fine for a RAM disk.

You can now get the base unit with twin floppy disks for \$1295. For \$1495, you get not only the Leading Edge Word Processor, but the Twin Lotus 1-2-3 clone and a Leading Edge 300/1200-baud internal modem as well. A 30-megabyte hard disk model is now available for \$1995.

I have found the Model D to be very

reliable. Leading Edge had a bit of trouble with the CMI hard disks it previously used, but it quickly switched to Seagate hard disks, unlike IBM, who took more than a year to even acknowledge a problem with the hard disks in the PC AT. You can perk the Model D up with NEC's V20 chip. If you want more speed out of the unit, the only speedup card I have found that claims compatibility with the Model D is PC Technologies' 286 Express Card. Orchid Technology's and Mountain Computer's boards will work, but you have to disable caching, which defeats the speedup to a large extent.

We have two Model Ds on G/Net with a TeleVideo TeleCAT server, and they perform flawlessly. Worth noting is the 720-by-400-pixel monochrome graphics, ideal for an inexpensive CAD workstation (yes, it runs AutoCAD).

Quite simply, the Model D gives you more for the money.

JIM PALMER
Clarksville, TN

TURBO PROLOG

Readers familiar with the operation of Intel's 8087 numeric coprocessor may very well be astonished by Namir Clement Shammass's comment in his review of Turbo Prolog (September). He states that the benchmark tests, "by virtue of their speed, seem to automatically use the 8087 coprocessor, although the Turbo Prolog manual does not mention 8087 chip support."

First, the speeds in the table are not especially fast, even for a compiler without 8087 support. I have found Turbo Prolog's speed to be somewhat slower than that of Microsoft's Quick BASIC 2.0 (which has double precision and no 8087 support) when tested with the well-known Savage benchmark (see "The 8087/80287 Performance Curve" by Stephen R. Fried in BYTE's *Inside the IBM PCs*, Fall 1985). However, the speed is not terrible; either in benchmarks that use transcendental functions, Turbo Prolog is significantly better than Turbo Pascal version 2.0, but a little slower than version 3.0 (both with 6-byte real numbers and without 8087 support).

Second, I found no FINIT, FSCALE,

FPTAN, or FPATAN instructions when searching the code compiled from the author's test programs, which were downloaded via BYTenet Listings, or the compiled Prolog version of the Savage benchmark. You can easily find all these instructions when searching code compiled for the 8087 FORTRAN version of the Savage benchmark, however. The instructions above (with the possible exception of FSCALE) would be necessary in any program that evaluates arctangent, sine, or tangent using the 8087.

Third, it is generally true that for desirable features like 8087 support, if it isn't in the manual, it isn't supported.

DAVID R. CLARK
Garland, TX

FIVE LABORATORY INTERFACING PACKAGES

The July review entitled "Five Laboratory Interfacing Packages" by Patricia Wirth and Lincoln E. Ford was excellent. This article was very timely, since the company I work for is currently evaluating three laboratory packages. I was very surprised to see that the RS/I package by BBN Software Products Corp. (Cambridge, MA) was not reviewed.

RS/I was originally designed for the DEC VAX and PDP-11 systems, but it is now available for the IBM PC XT and PC AT. The \$2000 package includes spreadsheet tables, simulation of models, graphics, a command language, digital I/O sampling, example-based documentation, data manipulation (including sort/merge, curve fitting, and text editing), DOS file I/O, statistics, macro procedures, an RPL programming language with debugger, and call routines created by other compilers (FORTRAN and Pascal).

Please pass this information on to your readers. Anyone looking at laboratory packages should consider RS/I package.

KURT MARLEY
Scottsdale, AZ ■

REVIEW FEEDBACK is a column of readers' letters. We welcome responses that support or challenge BYTE reviews. Send letters to Review Feedback, BYTE, One Phoenix Mill Lane, Peterborough, NH 03458. Name and address must be on all letters.

Before you consider the new Hercules Graphics Card Plus, consider the technology behind it.

On July 1, Hercules™ introduced a product that will forever change the way information is displayed on a PC.

The product is called the Hercules Graphics Card Plus.

We gave it that name because it gives you the same hi-resolution text and 720x348 graphics that made the original Hercules Graphics Card famous.

Plus it gives you RamFont.™

RamFont is a radical new hardware mode that combines the speed of text mode with the flexibility of graphics mode.

And opens up a whole new world for software.

The world according to RamFont.

In the old days (before July 1), programs like Lotus® 1-2-3®, Symphony™, Framework™ and Microsoft® Word had to use graphics mode to display multiple fonts and variable text sizes, or to mix text with graphics.

But graphics mode is a whole lot slower than text mode. Up to eight times slower.

Enter RamFont.

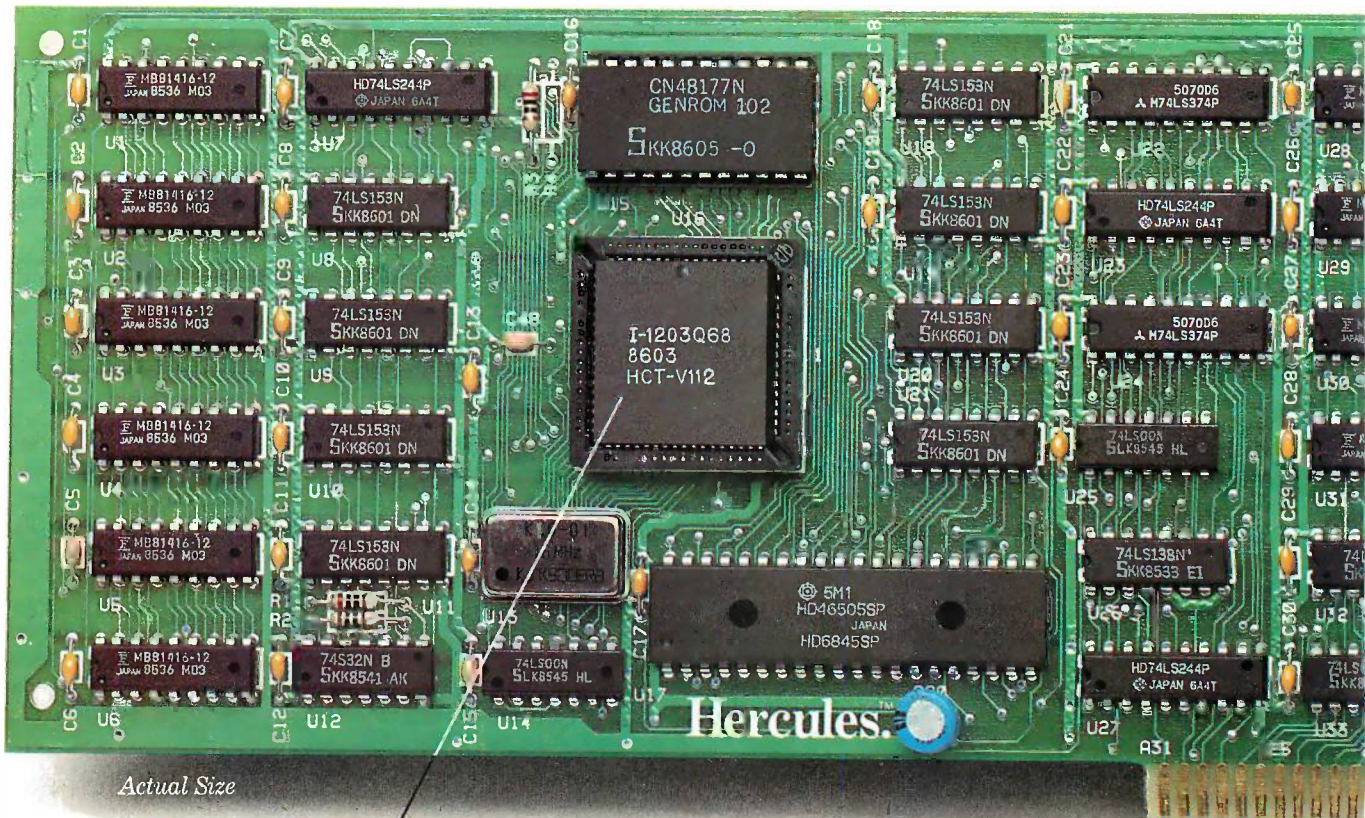

Actual Size

The heart of the Graphics Card Plus: the V112 microchip, Hercules' next generation video processor that makes the RamFont mode possible.

It lets all the programs we just mentioned (and plenty more in the future) do all the things we just described, all on one screen.

At precisely the same speed as text mode.

How RamFont works.

Like text mode, RamFont uses a 16-bit word to represent a character on the display.

Unlike text mode, however, the 48K RamFont mode uses a 12-bit character code instead of an 8-bit code.

Which allows you to choose from an astonishing 3072 different characters.

While setting the size of your screen cells from eight to nine pixels wide and from four to 16 scan lines tall.

To help you design your own RamFont characters and symbols, we've included a font editor called FontMan.™

Along with a set of 25 sample fonts to start your library.

And since the 4K RamFont mode can accept 8-bit character codes, running your text mode software with your favorite font is as simple as loading it into RAM.

Just for the record, RamFont supports

the standard character attributes of reverse, high-intensity, blink and underline.

Plus two new RamFont attributes: boldface and strike-through.

What price success?

While we're on the subject of technological breakthroughs, let's not forget the suggested retail price.

Think of it. You get everything the original card gave you.

Plus RamFont.

Plus FontMan.

Plus a free printer cable.

Plus a parallel printer port that you can now disable if there's a conflict with another port in your system.

All for just \$299—about half the price of the original Graphics Card.

If you haven't gone into shock, call 1-800-532-0600 ext. 212 for the name of an Authorized Hercules Dealer near you and we'll rush you our free info kit.

Hercules.™

We're strong on graphics.

Address: 2550 Ninth Street, Berkeley, California 94710 Ph: 415 540-6000
Telex: 754063

Trademarks/Owners: Lotus, 1-2-3, Symphony/Lotus; Framework/Ashton-Tate; Microsoft/Microsoft; Hercules, RamFont, FontMan/Hercules

Inquiry 145 for End-Users. Inquiry 146 for DEALERS ONLY.

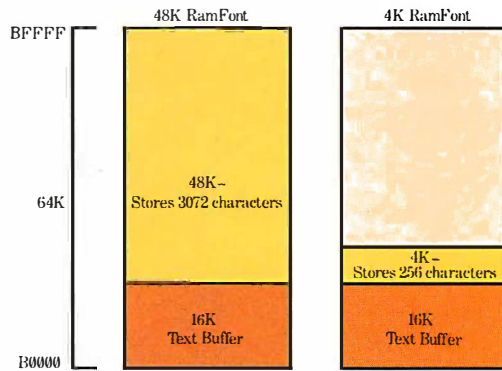

The new RamFont mode displays 3072 programmable characters at the speed of text mode, or replaces the standard character set with one of your choice in 4K RamFont mode.

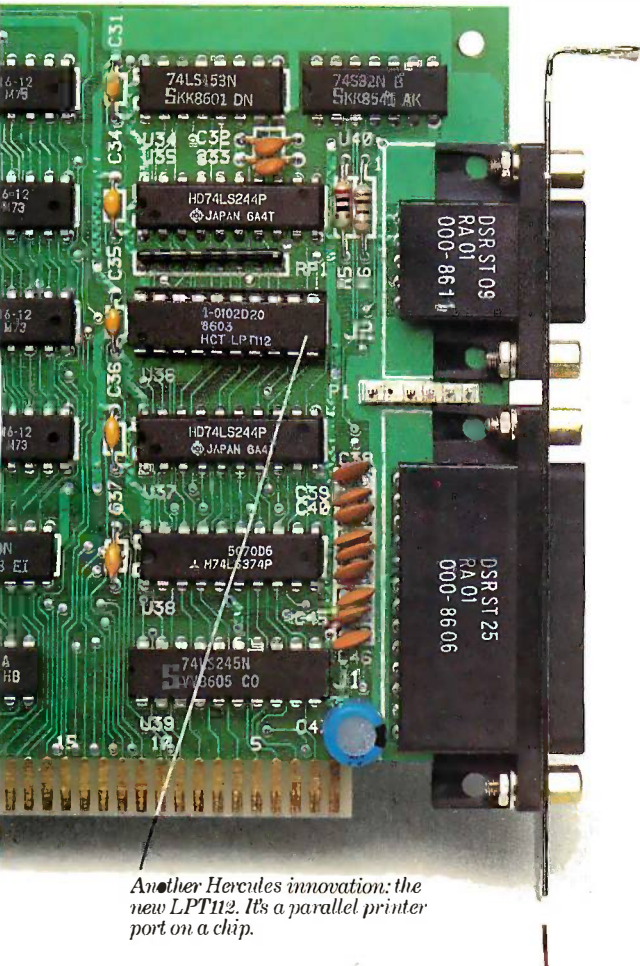

Another Hercules innovation: the new LPT112. It's a parallel printer port on a chip.

The first row of text is a line of cursive script, appearing to be a mix of Latin and possibly some non-standard characters or a specific dialect. It is the top line of the first paragraph.

The second row of text is another line of cursive script, continuing the first paragraph. It is the second line of the first paragraph.

The third row of text is a line of cursive script, appearing to be the start of a second paragraph. It is the first line of the second paragraph.



ROBERT
ESTIMNEY

Kernel

COMPUTING AT CHAOS MANOR:
A GRAPHIC DISPLAY
by Jerry Pournelle 307

ACCORDING TO WEBSTER:
68000 WARS: ROUND 3
by Bruce Webster 323

BYTE JAPAN: TECHNICAL CURIOSITIES
by William M. Raike 347

BYTE U.K.:
INTEGRATION ON A NEW SCALE
by Dick Pountain 351

APPLICATIONS ONLY:
RESIDENT HEADACHES
by Ezra Shapiro 361

MATHEMATICAL RECREATIONS:
PARADOXES OF PROBABILITY
by Robert T. Kurosaka 373

THE IMPORTANT MISSION for Jerry Pournelle this month was finishing up the report of the Sixth Meeting of the Citizens Advisory Council on National Space Policy. But computers were important here. Jerry says it couldn't have been done without BIX. Even though the report took up much of his time, he was able to do some playing around with computers. The area of particular interest this month was graphics, as Jerry installed EGA boards in Big Kat. He also looked at some new products, including the Tandy Model 200 and Reflex.

Some of you may have thought a knockout occurred in Round 2 of the 68000 wars in last May's According to Webster. Since the intervening months have seen a dearth of action, you logically might have assumed that the bout had ended. But the contest resumes this month with Round 3. Bruce's special focus this time is a comparison of four flavors of the Macintosh. Bruce also discusses Megamax C for the ST, HiSoft's DevpacST, Metascope for the Amiga, TxEd, and Turbo Pascal for the Macintosh.

In his concluding column for us, Bill Raike looks at some recent developments in Japanese computer technology. First, he discovers that vending machines are now offering on-line information. He then looks at a new computer from NEC, the PC-9801VM2E. This model, meant for the U.S. market, will allow its users to do Japanese-language word processing. Bill closes the column by describing the first Japanese-language BBS he has seen.

The subject of BYTE U.K. is wafer-scale integration of semiconductor devices. In this process, the whole wafer is used with the chips connected on the silicon. The leader in WSI research is Ivor Catt, a veteran of British electronics. Catt is now part of a company called Anamartic, which was formed to pursue and market WSI devices. The first commercial product incorporating this technology is now scheduled to appear in late 1987.

Ezra Shapiro looks at some memory-resident programs in Applications Only. Ezra begins with a cautionary message about this type of program. As a class, they cause as many problems as they attempt to solve. In fact, he has discovered that the more of them you use, the more likely you are to freeze your software, crash your system, or lose your data. He then looks at four such programs. His favorite is Cruise Control. Ezra closes the column by considering Works for the Macintosh.

Wow! We have a money-making article in the Kernel section this month. Watch out, *Fortune*. In his Mathematical Recreations column, Bob Kurosaka looks at some classic sucker bets and how they work. Even if you don't win any money, you will learn something about probability.

ARE YOUR DOCUMENTS

ALIEN?

If capturing text or images from paper documents is alien to you, our **SCANNING CONNECTION** is your best plan of attack.

In less than one minute, an image of your document can be read, stored, retrieved, processed, and output to a laser printer.

A version of Halo DPE® is provided for processing images. Photographs, books, articles, and drawings can be scanned and saved in compressed form.

The saved images can be combined with text in a wide variety of fonts and sizes. The completed document can be reproduced on a laser printer.

Images can be processed with our OCR software to produce text documents. Enhanced matrix matching is used for accurate character recognition. After the system is trained for each new typestyle, the matrix pattern is saved and reused.

A text editor is used to locate and correct scanning errors. The final document is stored in IBM DCA format with tabs, margins, indents, and line ends. The IBM DCA format can be read by most popular word processing programs.

We specialize in conversion systems and can transport your documents or images to most computer, typesetting, or word processing systems.



With our **DISKETTE CONNECTION** system you can read and write most 8", 5¼", and 3½" diskettes using a PC. We support systems from CPT, LANIER, NBI, WANG, XEROX, HONEYWELL, DG, DEC, and IBM.

Our **TAPE CONNECTION** system can read and write most 9-Track magnetic tapes using your PC. We can supply tape drives in several models at 800, 1600, or 6250 BPI. Tapes can be labeled and multivolume.

The price for a Canon IX-12 scanner, controller card, cable, and image software is **\$1195**. The optional OCR software is **\$595**. The price for an IBM 3117 flat bed scanner, controller card, and image software is **\$1395**. The price for an 8" diskette drive, controller card, cable, and utility software is **\$1195**. The optional software for word processing conversion is **\$695**. The price for a 9-Track 1600 BPI tape drive, controller card, cable, and software is **\$3495**.

Flagstaff Engineering

1120 W. Kaibab • Flagstaff, AZ
86001 • 602-779-3341 • telex 705609

In Europe contact Compusol
12 Rue Rosenwald • 75015 Paris
tel 530.07.37 • telex 205431F

Since 1982, we have installed thousands of diskette and tape conversion systems at customer locations around the world. We have written hundreds of software programs and designed dozens of hardware products to meet our customer's conversion requirements. We support our products because we developed them. Call us today for help in solving your conversion problems.



A GRAPHIC DISPLAY

BY JERRY POURNELLE

Jerry and Alex put enhanced graphics adapter boards in Big Kat

Well, it's done. The report of the Sixth Meeting of the Citizens Advisory Council on National Space Policy is finished. G. Harry Stine is polishing up additional materials to make it into a book—*America, A Spacefaring Nation Again* (Baen Books, Jerry Pournelle, G. Harry Stine, and Barbara J. Clifford, editors)—but the report is finished.

It simply couldn't have been done without BIX. Previous Council meeting reports have been influential, but they were largely confined to the results of the meetings themselves; and the meetings were all too brief. This one is different because it is as if the meeting went on for several weeks. We're just learning how to use electronic conferencing, but the results are already spectacular.

There is still much to learn. In particular, BIX needs more sophisticated indexing and retrieval features. All too often I had to search through big conferences loaded with chatter and irrelevancies in order to find the key document I needed. There needs to be a way to mark messages as "important" so that you can search only those. We also need ways for the conference moderator to take out a document, change it, and put it back in, leaving in its place a pointer to the update's location.

For many subscribers, BIX's main value is the amazing variety of easily available technical information: it's hard to think of a question that one or another of the BIX users can't answer. But I'm interested in developing the conferencing aspect. Probably the most intensive learning experiences of my life were graduate seminars; I don't see why something of the sort can't be put together electronically.

I'm convinced that computer conferencing will change our whole way of thinking about education.

EGA

The Council report came first, but we did manage to do some playing around. For one thing, my son Alex and I installed enhanced graphics adapter (EGA) boards in Big Kat, the Kaypro 286i AT clone.

Big Kat normally runs off a Hercules Color Card that is IBM Color Graphics Adapter (CGA)-compatible and plays into a 17-inch Zenith High Resolution Video Component System color monitor. By flipping a couple of switches, I can also make that monitor show me cable TV or the output of a VCR.

Big Kat ends up doing much of the computer work here. He's the test station for most MS-DOS software. He runs SuperCalc3 to do my expense reports. SideKick is installed, and I use that to keep my phone list, address book, and calendar and then print them all out with Traveling SideKick when I'm going on a trip. Most important, I suppose, is that Big Kat is set up as my main station for connecting to BIX, what with SuperKey BIX macros and all.

The Hercules/Zenith setup is good enough for all that, and for most games as well. What it isn't good enough for is writing. If I had to stare at those fuzzy letters for hours on end, I'd go out of my mind. Thus, when both Orchid Technology and Paradise Systems sent EGA boards, I was ready for the change.

I confess a certain fondness for Orchid. Their boards work—at least all the ones I've had here do—and installation has generally been painless. Actually, that isn't always true. Sometimes what happens is that Orchid sends me something; I try to get it to work; I call them and tell them my problems; and they change their documents and installation instructions. The result is that it's reasonably painless for my readers.

The Orchid EGA documents are clear enough and promised no difficulty. The Orchid EGA comes with a pair of little programs; you run the appropriate one to tell the board whether to be EGA or CGA. However, the Paradise board offered a more interesting feature, automatic switching between EGA and CGA. The board is supposed to figure it out for itself. That looked like a good idea. Also, the Paradise board is half-size; not that I'm short of full slots, but waste not, want not.

Installing the Paradise board—its formal name is AutoSwitch EGA Card—was simple enough. When we turned on Big Kat, he complained that something wasn't properly set up, and we had to boot with the F1 key. Everything then seemed to work fine. SideKick, SuperKey, the Logitech Logimouse software, and Ready! all came up, and all worked. We ran the Setup program that came with Big Kat, but when we tried to reboot we got the setup error again. I think we never did figure out what the machine was complaining about, since everything worked fine.

(continued)

Jerry Pournelle holds a doctorate in psychology and is a science fiction writer who also earns a comfortable living writing about computers present and future.

The Paradise board in CGA mode performs as advertised. The scrolling is flicker-free, just as they say. Text on the Zenith screen looked sharper and crisper to me; that may be an illusion, as I had no way to make direct comparisons. Games looked good, too.

ENTER EGA

It was then time to try something in EGA mode. We selected RIX Soft-

work's EGA Paint for the test. This is a good standard color paint program with some extra features. What made us choose it is the clear and simple documentation. It looked as if it wouldn't take much to get it running.

There was only one problem. EGA Paint needs 384K bytes of available system memory.

Alas, even though I begin with 655,360 bytes of total memory, what

with all the memory-resident programs I run, I don't have 384K bytes of available system memory. Now true, that's my fault. I have four different boards here that are supposed to let me put some of my memory-resident stuff in extended or expanded memory—that is, memory over and above the 640K bytes that DOS recognizes. My problem is that except for very brief tests I haven't installed one of them and got used to it.

Rather than install a new board and thus complicate things, we renamed the AUTOEXEC.BAT file that brings in SideKick, Ready!, and the other stuff and rebooted. Then we brought in EGA Paint.

The result was as expected. The Zenith screen went mad. The EGA board uses different sweep frequencies than the CGA-compatible Zenith. In general, you can't use the same monitor for EGA and CGA.

Fortunately, there are exceptions to that rule. Time, then, to bring in the NEC MultiSync color monitor.

NEC MULTISYNC

Installing the NEC MultiSync turned out to be the simplest thing in the world. The Zenith was still displaying rapidly moving garbage. We disconnected it and plugged in the NEC. The NEC itself had been running off the CompuPro PC Video board. The PC Video board is an S-100 board that emulates the IBM PC CGA, except that it's considerably sharper and doesn't flash when it scrolls; it's what allows CompuPro machines running Concurrent DOS to run a number of MS-DOS programs, including Lotus 1-2-3.

Anyway, we unplugged the NEC MultiSync from the CompuPro and plugged it into the Kaypro. Presto: an absolutely gorgeous picture came up on the screen.

We spent the next hour looking at some of the art provided in the RIX Softworks EGA Paint package and testing the Logimouse. Everything worked fine. Colors were really nice. Text embedded in the EGA Paint pictures looked good.

The next thing was to try a text editor with an EGA mode. I won't say

(continued)

See us at
COMDEX/Fall '86
 Riviera Hotel/Booth R-8031

Write Right with RightWriter®
 For Your IBM PC

THE Intelligent Grammar and Style Checker

RightWriter is a new tool to help you produce lean, powerful BUSINESS WRITING. RightWriter uses advanced artificial intelligence technology to flag errors in GRAMMAR, STYLE, USAGE, and PUNCTUATION. RightWriter is the first office automation package aimed at producing better writing, not more writing.

- **Messages are Inserted** directly into text to point out possible errors and problem areas.
- **Easy to Use** — only one command to learn, your word processor does the rest.
- **Works with Leading Word Processors** — including WordStar®, Volkswriter®, PFS:write®, MultiMate®, WordPerfect® and others.
- **Readability Index** — measures the reading grade level of the document using the D.O.D. standard Flesch-Kincaid formula.
- **Uncommon Word List** — lists misspelled, slang, and uncommon words.
- **Recommends** — never decides. RightWriter is a writing aid. The final decision is always left to you.

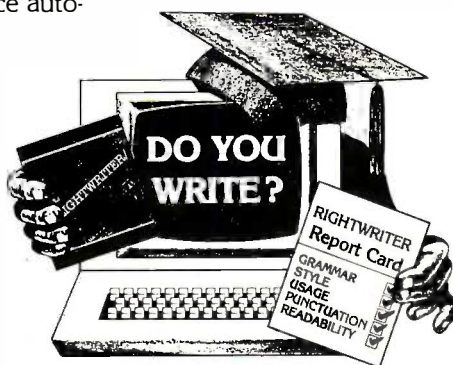

"...RightWriter is an idea whose time is long overdue."
 Phil Wiswell — PC Magazine

"RightWriter is an excellent, low-cost, eye-opening software package..."
 Inside Word Management

"The documentation is among the best I have seen."
 Jim Pile, Soft Sector

Price \$95.00

Available from your local dealer or:
 DECISIONWARE, INC./RightSoft Division
 2033 Wood St. • Suite 218
 Sarasota, FL 33577

**Call Toll Free 1 (800) 992-0244,
 In Florida 1 (813) 952-9211**

Add \$4 for shipping and handling.
 VISA & MASTERCARD accepted
30 Day Money Back Guarantee

THE NEW FACE FOR YOUR PC

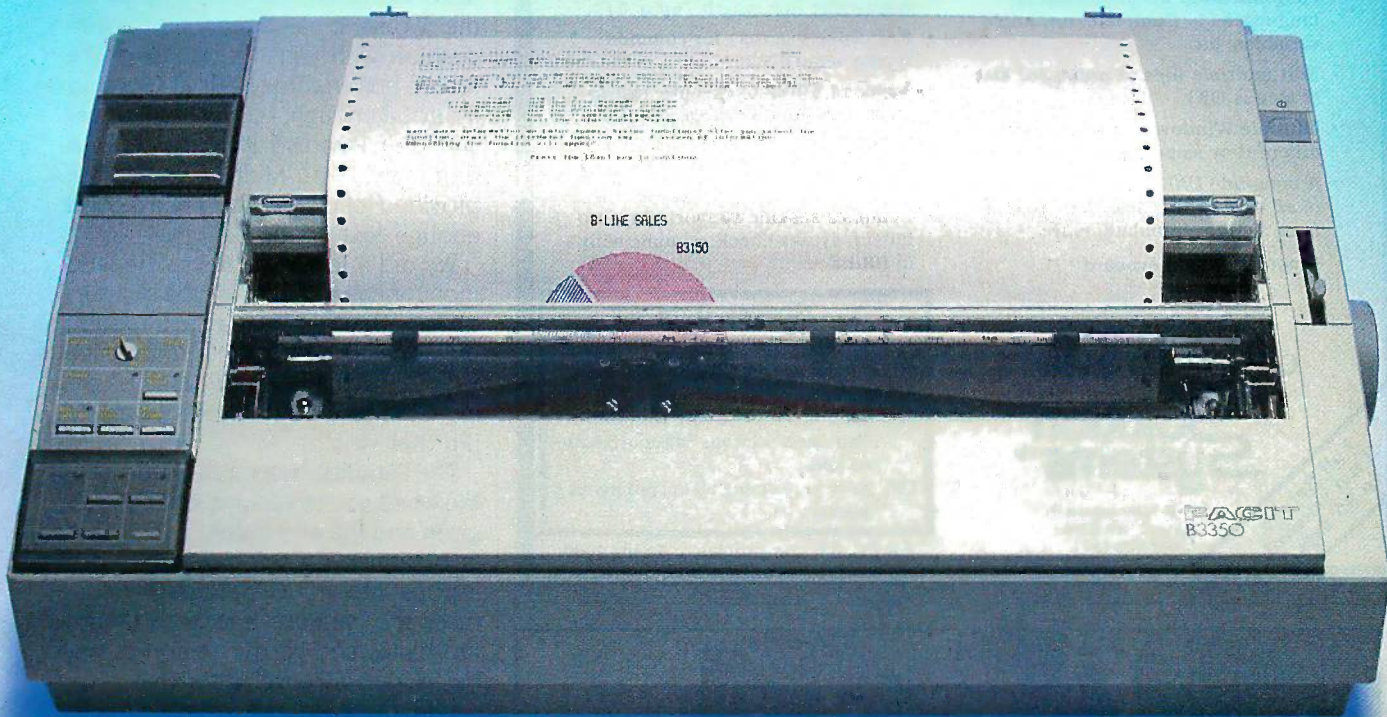

The new generation Facit B-line matrix printers not only provide all the printout options your office requires. They also give you extraordinarily easy access to these features.

Such as when you want to change from high throughput draft to perfect NLQ – just flick the rotary switch on the front panel. When you want to change font style – just plug in a new font card. When you need to change from continuous forms to cut sheets – the printer loads the paper for you.

And while the beauty of the B-line concept improves the impression made by your PC, the attractive design and low noise level make the printers perfect for every office environment, too.

FACIT

Inquiry 123

Head Office: Facit AB, S-172 91 Sundbyberg, Sweden. Phone: 46 8 764 30 00.
USA: Facit Inc. P.O. Box 334, Merrimack, NH 03054. Phone: (603) 424-8000

Check out the facts below and go for a test drive at your nearest Facit representative.

- B3100: 80 columns, 128 lines/minute* (250 cps)
 - B3150: 136 columns, 128 lines/minute* (250 cps)
 - B3350: 136 columns, 109 lines/minute* (200 cps), 18-needle printhead for 100 cps NLQ
 - Rotary switch for fast print quality selection
 - Easy operation with soft set-up in national language
 - Extensive paper handling – push/pull tractor, tear-off, automatic loading of single sheets. Optional single or double bin sheetfeeder
 - Low noise key
 - Facit, IBM Proprinter and Epson FX/JX emulations
 - Parallel and serial interfaces
 - 4-color option
 - Extra fonts by means of plug-in card
- * 80 col, 10 cpi.

IBM and Epson are reg. trademarks

AUSTRALIA: EAI Electronics Associates Pty Ltd, 427-3322. AUSTRIA: Ericsson Information Systems GmbH, 0222-613 641. BELGIUM: Ericsson S.A., 02-243 82 11. CANADA: Facit Canada Inc., 416-825-8712. CYPRUS: LBM (Lilytos) Ltd 51646 34. DENMARK: Facit A/S, 02-63 33 11. FINLAND: OY Facit, 90-420 21. FRANCE: Facit S.A., 1-4780 7117. GREAT BRITAIN: Facit 0634-40 2080. GREECE: Computer Application Co. Ltd., 01-671 97 22. HONGKONG: Gilman & Co. Ltd., 5-893 00 22. ICELAND: Gisli J. Johnsen HF 354-64 12 22. INDIA: Forbes Forbes Campbell & Co. Ltd., 22-20 48 081. IRELAND: Ericsson Information Systems Ltd., 75 30 93. ITALY: Facit Data Products S.p.A., 039-63 63 31. JAPAN: Electrolux (Japan) Ltd., 03-479-7570. KOREA: True Trading Co. Ltd., 2-783-3855-7. THE NETHERLANDS: Facit B.V., 3480-21784. NEW ZEELAND: Northrop Instruments and Systems, 501-801, 501-219. NORWAY: Ericsson Information Systems A/S, 02-35 58 20. PORTUGAL: Regisconta Sarl, 1-56 00 91. SINGAPORE: Far East Office Equip Pte Ltd., 745 82 88. SPAIN: Perifericos S.A., 4-57 90 81. SWEDEN: Ericsson Information Systems Sverige AB, 08-28 28 60. SWITZERLAND: Ericsson Information Systems AG, 01-821 59 21. USA: Facit Inc., (603) 424-8000. WEST GERMANY: Ericsson Information Systems GmbH, 0211-61 090.

"BRIEF is the most incredible editor I have ever seen."

Programs seem to effortlessly flow from my mind to the screen."
 — Glenn Ehrlich, Systems Engineer
 International Anasazi, Inc.

Tailor Program Editing to Your Style

- A high-level, readable Macro Programming Language - allows customization for programming languages . . . Complete, unlimited variables, etc.
- Edit multiple files of unlimited size (2 Meg is OK)
- Multiple Windows on screen with different or same file, fragments, etc.
- A bona-fide UNDO stack (up to 300) of all operations; deletions, reading files, search, translate, more.
- Reconfigurable keyboard
- Full "regular expression search" - wild cards, complex patterns
- Adjustable line length - up to 512.
- Keystroke macros - for common typing sequences
- Suspend BRIEF to execute, exit to DOS - run another program (like a compiler, dir, XREF, DIFF, or DEBUG) then resume BRIEF session
- Compiler-specific support like auto indent, syntax check, compile within BRIEF

Only \$195
 Call 800-821-2492

Solution Systems™

335-B Washington St.
 Norwell, MA 02061
 617-659-1571

Full Refund
 if not satisfied
 in 30 days.

Survey Data

- 88% of survey respondents were more productive with BRIEF than other editors.
- 50% were more productive with BRIEF than their previous editor in 5 hours or less.
- 72% were performing all operations in 2 hours.

For PC, AT, compatibles or Tandy 2000.

which one we used, because it wasn't a fair test; all I wanted was to get a couple of screens full of text and see what it looked like.

It looked fine. The NEC MultiSync isn't a perfect monitor. It's a matter of taste, of course, but it's too small for me. Worse, it has a tendency to pin-cushion with text—the edges of the screen bow inward like this) (. Even so, it's good enough. I could write books with the Paradise AutoSwitch EGA Card and NEC MultiSync monitor, provided, of course, that I had a good enough text editor.

We did a few more tests. The NEC monitor has a couple of little switches on top. One puts it in a "text mode"; that doesn't make much difference when it's doing EGA, but when it's doing CGA text, you definitely want to flip that switch.

The Paradise board has a little trouble when you're running an EGA program and flip into SideKick. SideKick is, of course, CGA-compatible. When it pops into an EGA program it confuses the Paradise board, and there are blinks and glitches before it settles down. All's well after that.

Alas, there was one insurmountable problem.

The Hercules Color Card has a parallel printer port on it. The Paradise AutoSwitch EGA Card doesn't. I use Big Kat's parallel printer port to connect to the HP LaserJet Plus (well, actually to Applied Creative Technology's Printer Optimizer, but it attaches to the LaserJet Plus). I can't live without a printer attached to Big Kat. I have a couple of boards that do have parallel ports on them, but it was just too late to install something new. Reluctantly, we put things back the way they were.

There's another problem. The Multi-Sync monitor really is too small. The screen is somewhat larger, but I measure no more than 11 inches diagonally in the actual video display area. Text in EGA mode is sharp enough that I *could* sit far enough away to see it without using the reading lenses in my bifocals, but it would be a strain.

Incidentally, whenever I write about eye comfort I am sure to get several letters suggesting that I get bifocals

(continued)



Introducing The Most Important Programming Development Since The Introduction Of C...

ADVANTAGE C++ For MS/PC-DOS, Exclusively From LIFEBOAT.

They say you can't be all things to all people. But Lifeboat's **ADVANTAGE C++** proves that you can be! This exciting new product, developed by AT&T, represents a major programming breakthrough.

ADVANTAGE C++

- Opens the door to object-oriented programming.
- Allows programs with greater resilience, fewer bugs.
- Lets you write reliable, reusable code that is easier to understand.
- Includes many enhancements to C, yet maintains full compatibility with existing C programs.
- Is the key to developing large and

sophisticated programs more productively.

- Has all the benefits of C, without its limitations.

ADVANTAGE C++ is now available for the most popular C compilers, Lattice C and Microsoft C.

Why be limited to just C... when you can have all these pluses! To order or obtain a complete technical specification sheet call: **1-800-847-7078**

In NY: 914-332-1875.

55 South Broadway Tarrytown N.Y. 10591

LIFEBOAT

The Full-Service Source for Programming Software.

A GREAT DEAL JUST FELL INTO YOUR



This is the one you've been waiting for:
The remarkable new BONDWELL 8.™ At
\$1595.00 retail, it is the lowest priced IBM
compatible lap-sized portable computer on the
market today.

It's a great deal for a small price. With built-in fea-
tures that include 512K RAM, 720K 3½" drive,
modem, back-lit LCD display, parallel and serial

ports, composite and RGB outputs, real time
clock and AC adapter.

High performance value. It's what you expect from
Bondwell's entire line of desktop, transportable,
and lap portable computers.

Order your BONDWELL 8 today at (415)
490-4300. Don't let a great deal slip through
your fingers.



TURBO PROGRAMMERS-

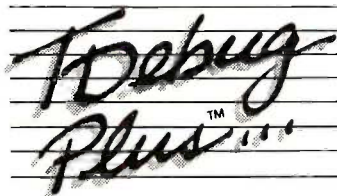

... CUTS DEBUGGING FRUSTRATION.

TDebugPLUS is a new, interactive symbolic debugger that integrates with Turbo Pascal to let you:

- **Examine and change variables** at runtime using symbolic names - including records, pointers, arrays, and local variables;
- **Trace and set breakpoints** using procedure names or source statements;
- **View source code** while debugging;
- **Use Turbo Pascal editor and DOS DEBUG commands.**

TDebugPLUS also includes a special MAP file generation mode fully compatible with external debuggers such as Periscope, Atron, Symdeb, and others - even on programs written with Turbo EXTENDER.

An expanded, supported version of the acclaimed public domain program TDEBUG, the TDebugPLUS package includes one DSSD disk, complete source code, a reference card, and an 80-page printed manual. 256K of memory required. Simplify debugging! \$60 COMPLETE.

TURBO EXTENDER™

Turbo EXTENDER provides you the following powerful tools to break the 64K barrier:

- **Large Code Model** allows programs to use all 640K without overlays or chaining, while allowing you to convert existing programs with minimal effort; makes EXE files;
- **Make Facility** offers separate compilation eliminating the need for you to recompile unchanged modules;
- **Large Data Arrays** automatically manages data arrays up to 30 megabytes as well as any arrays in expanded memory (EMS);
- **Additional Turbo EXTENDER tools** include Overlay Analyst, Disk Cache, Pascal Encryptor, Shell File Generator, and File Browser.

The Turbo EXTENDER package includes two DSSD disks, complete source code, and a 150-page printed manual. Order now! \$85 COMPLETE.

TURBOPOWER UTILITIES™

"If you own Turbo Pascal, you should own TurboPower Programmers Utilities, that's all there is to it." Bruce Webster, **BYTE Magazine**

TurboPower Utilities offers nine powerful programs: Program Structure Analyzer, Execution Timer, Execution Profiler, Pretty Printer, Command Repeater, Pattern Replacer, Difference Finder, File Finder, and Super Directory.

The TurboPower Utilities package includes three DSSD disks, reference card, and manual. \$95 with source code; \$55 executable only.

ORDER DIRECT TODAY!

- **MC/VISA Call Toll Free 7 days a week.**
800-538-8157 x830 (US)
800-672-3470 x830 (CA)
- **Limited Time Offer!** Buy two or more TurboPower products and save 15%!
- **Satisfaction Guaranteed** or your money back within 30 days.

For Brochures, Dealer or other Information, PO, COD - call or write:

TURBO
Power
3109 Scotts Valley Dr. #122
Scotts Valley, CA 95066
(408) 438-8608
M-F 9AM-5PM PST

The above TurboPower products require Turbo Pascal 3.0 (standard, 8087, or BCD) and PC-DOS 2.X or 3.X, and run on the IBM PC/XT/AT and compatibles.

*What I want is a
high-res color monitor,
like the MultiSync, but
14 to 18 inches in size.*

with the reading elements on top, or just get reading glasses and have done with it. I thank all of you for your concern. The fact is, though, that I've tried reading glasses, and it doesn't work. If I sat at the keyboard and did nothing else all day it would be different, but I can't and don't do that. I'm perpetually getting up to find a book or a magazine, or find my notes, or just to go out onto the balcony and water the plants. I've never got in the habit of keeping track of spectacles: if they're not on my nose, I'll never find them. If I had to change from reading lenses to regular bifocals, I'd probably lose both sets and be completely out of business.

What I really want is a high-resolution color monitor that works like the MultiSync but is between 14 and 18 inches in size. So far as I know there aren't any of those, but surely it's only a question of time.

I'm convinced that EGA will be the new business standard in a couple of years. If you're looking for a new monitor, you don't want to lock yourself into the older low-resolution mode. On the other hand, there's still a fair amount of essential software out there that runs only CGA, so you need something that can handle that. The NEC MultiSync makes a lot of sense.

MORE PARADISE

Paradise has two other short-slot boards that I could use. Both have parallel printer ports on them. One, the Color/Mono Card, is jumper-selectable (not automatic) to operate as either monochrome or CGA. The other, the Hi-Res Graphics Card, is said to "give you the highest resolution possible with standard monitors and popular off-the-shelf software" with flicker-free scrolling. With this board, the setups are done by using

switches rather than jumpers.

Installing the Hi-Res Graphics Card is as simple as installing any other card. The instructions are clear to the point of simplemindedness. I had no difficulty even late at night.

New brooms sweep clean. When I first installed it, I had the impression that the text on the Zenith 17-inch monitor was a bit sharper and brighter than it was with the Hercules board, but I certainly wouldn't want to bet on it. By next morning I was convinced otherwise; see below.

The parallel printer port works fine. When I first booted up, that wasn't necessarily the case. My first test was to print the screen; that seemed to work all right, but of course the Print Screen button doesn't send a formfeed, and the LaserJet doesn't print anything until it has either a full page or a formfeed. I have a file, HPINIT.BAT, that tells the LaserJet that paper is 66 lines long. It does that by "printing" an elaborate escape sequence, and incidentally sends a formfeed to the printer. When I did HPINIT I got what seemed a standard reply, but then the machine locked up, and I mean really locked up: it didn't even hear Ctrl-Alt-Del. I had to turn the power off.

When I turned it back on, everything worked. I've "printed" my HPINIT file six times, done screen dumps, printed files, and generally tested that printer port; no problems. I can't imagine what happened the first time.

I left the Paradise Hi-Res Graphics Card in Big Kat overnight with the system turned on. In the morning, all the text had moved over so far to the left that part of the first character on each line was gone. There's no horizontal hold adjustment on the monitor—notice how they've automated everything lately, and how inconvenient that is? Also, the letters seem fuzzy, much worse than with the older Hercules Color Card. I'm going back to the Hercules board.

It's always dangerous to generalize from a sample of one. The other Paradise board worked fine. Probably this board is out of adjustment. I tried to call Paradise, but after 11 rings I got

(continued)

THE PROGRAMMER'S SHOP

helps save time, money and cut frustrations. Compare, evaluate, and find products.

RECENT DISCOVERY

Baby 34, 36 RPG II by California Software - complete mini RPG environments for PC include compiler, editor (SEU), OCL processor. Screen gen., sort, data exchange, workstation I/O. Separate products for compatibility w/IBM System /38, /36, /34. PC \$1250

AI-Expert System Dev't

Arity System-incorporate w/C. MS \$ 295
 Experteach-Improved, samples PC \$ 399
 EXSYS - Improved. Debug, file & external program access. PC \$ 339
 Insight 2+ - dB2, language MS \$ 879
 LPA MicroProlog Intro w/ APES MS \$ 149
 LPA MicroProlog Prof. w/APES MS \$ 595
 Others: ESP (\$845), Expert Choice (\$449)

AI-Lisp

BYSO - Common, MacLISP compatible
 250+ functions, fast. PC \$ 150
 Microsoft MuLisp 85 MS \$ 199
 PC Scheme LISP - by TI. SCHEME has simple, "orthogonal" syntax. PC \$ 95
 TLCLISP - classes, compiler. MS \$ 225
 TransLISP - Good for learning MS \$ 85
 Others: IQLISP (\$155), UNX LISP (\$59), IQCLISP (\$269), WALTZ LISP (\$149)

AI-Prolog

APT - Active Prolog Tutor - build applications interactively PC \$ 65
 ARITY Standard - full, 4 Meg Interpreter - debug, C, ASM PC \$ 350
 COMPILER/Interpreter-EXE PC \$ 795
 With Exp Sys, Screen - KIT PC \$1250
 LPA MacProlog - Complete incremental compiler and an interpreter MAC \$ 295
 LPA MicroProlog - intro MS \$ 99
 LPA MicroProlog Prof. - full memory MS \$ 359
 Prolog-86 - Learn Fast MS \$ 89
 Prolog-86 Plus - Develop MS \$ 229
TURBO PROLOG by Borland PC \$ 69
 Others: Prolog-1 (\$95), Prolog-2 (\$859)

Editors for Programming

BRIEF Programmer's Editor - undo, windows, reconfigure PC Call
 EMACS by UniPress - powerful, multifile, MLISP. Source: \$929 \$299
 Epsilon - like EMACS PC \$169
 Kedit - like XEDIT PC \$109
 Lattice Screen Editor-multiwindow multi-tasking Amiga \$100 MS \$109
 PC/VI - Custom Software PC \$129
 PMATE - power, multitask 80/86 \$149
 SPF/PC - fast, virtual memory PC \$139

FEATURE

Sentinel - Hardware debugger \$269 -
 Sentinel is: Microsoft Codeview & Symdeb compatible. Extremely fast, 1 slot, breakout & reset switches, many features. PC \$269

Free Literature Compare Products

Evaluate products. Compare competitors. Learn about new alternatives. One free call brings information on just about any programming need. Ask for any "Packet" or Addon Packet □ AI □ ADA, Modula □ BASIC □ "C" □ COBOL □ Editors □ FORTH □ FORTRAN □ PASCAL □ UNIX/PC or □ Debuggers, Linkers.

Our Services:

- Programmer's Referral List
- Compare Products
- Helpfinda Publisher
- Evaluation Literature FREE
- BBS-7 PM to 7 AM 617-826-4086
- Dealers Inquire
- Newsletter
- Rush Order
- Over 700 products
- National Accounts Center

C Support-Systems

Basic-C Library by C Source MS \$139
 C Sharp - well supported, Source, realtime, tasks PC \$600
 C ToolSet - DIFF, xref, source MS \$ 95
 The HAMMER by OES Systems PC \$179
 Lattice Text Utilities PC \$ 95
 Multi-C - multitasking PC \$149
 PC LINT-checker. Amiga \$89, MS \$119
 SECURITY LIB - add encrypt to MSC. C86 programs. Source \$250 PC \$125

Fortran & Supporting

Forlib+ by Alpha - graph, comm. \$ 59
 MACFortran by Microsoft - full '77 \$229
 MS Fortran - well liked, solid \$219
 No Limit - Fortran Scientific \$119
 RM Fortran - enhanced "IBM Ftn" \$395
 Scientific Subroutines - Matrix \$149

MultiLanguage Support

BTRIEVE ISAM MS \$199
 BTRIEVE/N - multiuser MS \$469
 CODESIFTER - Execution PRO-FILER. Spot bottlenecks. MS \$109
 Dan Bricklin's Demo Program PC \$ 65
 HALO Graphics - 115+ device interfaces, rich, printer. Specify language interface PC \$219
 Microsoft Windows Software Development Kit PC \$399
 PANEL - data validation, no royalties Xenix \$539, MS \$229
 Pfinish Performance Analyzer MS \$249
 PLINK-86 - a program-independent overlay linker to 32 levels. MS \$249
 PLINK-86 PLUS - incremental MS \$369
 PolyLibrarian MS \$ 85
 PVCS Version Control MS \$329
 Screen Sculptor - slick, thorough PC \$ 99
 ZAP Communications - VT 100, TEK 4010 emulation, file xfer. PC \$ 95

Atari ST & Amiga

We carry full lines of Manx, Lattice, & Metacomco.

Call for a catalog, literature and solid value

800-421-8006

THE PROGRAMMER'S SHOP™

128-B Rockland Street, Hanover, MA 02339

Mass: 800-442-8070 or 617-826-7531 9/86

RECENT DISCOVERY

Unishell - Bourne UNIX shell script compiler translates to C and runs faster. Portable, hand optimizable code. Use as C program generator. PC \$395

C Language-Compilers

AZTEC C86 - Commercial PC \$499
 C86 by CI - 8087, reliable MS \$299
 Datalight C - fast compile, good code, 4 models, Lattice compatible, Lib source. Dev's Kit PC \$ 85
 HOT C - new, intriguing PC \$ 85
 Lattice C - from Lattice MS \$299
 Mark Williams - w/debugger MS \$399
 Microsoft C 4.0 - CodeView MS \$299
 Wizard C - full, fast. MS \$389

C Language-Interpreters

C-terp by Gimpel - full K & R, .OBJ and ASM, large prog. MS \$239
 INSTANT C - Source debug, Edit to Run-3 seconds, .OBJS MS \$389
 Interactive C - interpreter, editor PC \$225
 Introducing C - learn C quickly PC \$109
 Run/C Professional - MS \$189
 Run/C Lite - improved MS \$109

C Libraries-General

Blackstar C Function Library PC \$ 79
 C Essentials by Essential PC \$ 85
 C Food by Lattice-ask for source MS \$109
 C Scientific Subroutines -Peerless MS \$139
 C Tools Plus (1&2) PC \$149
 C Utilities by Essential - Comprehensive screen graphics, strings. Source. PC \$139
 C Worthy Library MS \$269
 Entelekon C Function Library PC \$119
 Greenleaf Functions - portable, ASM \$139
 PforCe by Phoenix - objects PC \$299

C Libraries-Files

FILES: C Index by Trio - full B + Tree, vary length field, multi compiler /File is object only MS \$ 89
 /Plus is full source MS \$349
 CBTREE - source, no royalties MS \$ 99
 CTREE by Faircom - no royalties MS \$339
 dbVISTA - full indexing, plus optional record types, pointers, Network.
 Object only - MS C, LAT, C86 \$159
 Source - Single user MS \$429
 Source - Multiuser MS \$849
 dBASE Tools for C PC \$ 79
 dbc Isam by Lattice MS \$199

FEATURE

386 Assembler/Linker - Native or Cross Development. Full Microsoft MASM compatible plus 386/387 extensions. PC \$495

Note: All prices subject to change without notice. Mention this ad. Some prices are specials. Ask about COD and PCs. All formats available. UPS surface shipping add \$3/item.

*I'm carrying both the
Tandy 200 and the NEC
PC-8201 on trips while
I make up my mind.*

"Paradise hold please," and after five more minutes on hold long distance I said to heck with it. There don't seem to be horizontal controls on the board, so it's unlikely they could do anything except replace it anyway.

**THE GREAT TANDY
ANNOUNCEMENT**

In the early days of the micro revolution, I developed considerable prejudice against Radio Shack. It wasn't unreasonable, being based on a number of experiences; but it's long past time I dropped it. Radio Shack has changed. In particular, they have completely revamped the quality control practices that distressed me. Tandy always had the potential to be a major player in the micro revolution. I think now the company is moving in the right direction.

In early July Tandy announced that on July 30 they'd make a *big* announcement at the Waldorf in New York. For weeks the micro press corps was abuzz with rumors, ranging from "they're going joint venture with AT&T" to "the mountain labors, and produces a mouse."

It wasn't a joint venture with AT&T, but it wasn't a mouse either. They announced five new machines. Radio Shack moved into the micro field in force, with machines to challenge Atari and Commodore on the low end and direct confrontation with IBM PC AT clones at the high end.

At the very low end is the Color Computer 3, which I suspect they're keeping in anticipation of big things happening on the CD-I (compact disk-interactive) front. CD-I, you may recall, is the next step after CD-ROM disk systems. It will be a disk reader that can double as a compact digital disk audio player. In addition, it will contain a 68000 microprocessor and be able to execute instructions from the

CD-I disk it is reading.

The OS-9 operating system is built into the CD-I standard; the Color Computer 3 uses OS-9. At \$219, the CoCo 3 is positioned nicely to become a standard monitor for CD-I systems when those become available.

As for their other machines, which range from what looks like a PCjr, only done right, to a full AT clone, we'll have to wait and see. The prices seem a bit high, but price isn't everything.

By the way, it's interesting to see that they've done another change of emphasis. For the past couple of years, the Tandy exhibits at shows have tried to hide any association with Radio Shack. This announcement was by Radio Shack, a Division of Tandy, and proud of it. That's another good move.

TANDY 200

The Tandy 200 came out during the "suppress Radio Shack" phase, I guess, since there's no TRS on it anywhere. (Could they be trying to get rid of TRS because everyone pronounces it "trash"?) There's no mention of "Radio Shack," either, except that in fine print the warranty says that "Radio Shack grants to customer" a license to "use the Tandy software. . ."

Anyway, the Tandy 200 is a lapboard. It has some similarities to the TRS-80 Model 100. The chief difference is that there are 16 lines instead of the 8 on the Model 100 or the NEC PC-8201 screen. You pay for this in weight (although the increase isn't all that significant) and convenience; the Model 200 has a flip-up screen, which makes it significantly harder to balance on your lap in an airplane. On the other hand, it's easier to use if you have a table at the right height.

Sixteen screen lines aren't enough, but one can live with it. After all, I write these columns and all my books on a 16-line CompuPro S-100 system that runs an ancient VDM memory-map video board. Alas, the Model 200 has only 40 characters per line. This keeps things readable—the Model 200 is perhaps not quite as readable as the Model 100 or the NEC, but the difference isn't much—

but it also makes writing harder.

There's another difference from the Model 100. The Model 200 has much nicer cursor arrow keys, reminiscent of the NEC PC-8201. Like the Model 100, the Model 200 has a built-in 300-baud modem. Other features include Multiplan in ROM and the built-in ability to add three banks of 24K-byte memory.

That really isn't enough memory for a long trip. One of the things I like a *lot* about my NEC PC-8201 is the external memory connector port. I especially like Purple Computing's Sidecar bank memory system: it gives me four banks of 30K bytes each, which is enough for a long trip. On the other hand, Traveling Software's Ultimate ROM II for the Model 200 has both LAPDOS and TS-DOS, meaning that you can connect a 3½-inch disk drive to the Model 200 and save your text on that. Since it's extremely unlikely that I'll ever do enough work on an airplane to use up the Model 200's 60K bytes or so of on-board memory, I could live with the memory limits; just carry a portable small disk drive in checked luggage and save at the hotel.

I'm not sure I can live with the 40-character lines. Unfortunately, the Model 200 has a different system for writing to screen than the Model 100 uses, which means that Traveling's Ultimate ROM II for the Model 200 does *not* have the 60 characters/line capability it gives you in the Model 100 or the NEC PC-8201.

As a result, I'm carrying both the Tandy 200 and the NEC PC-8201 on trips while I make up my mind. It makes me look like a nerd, but it does give me a chance to test the two machines.

I do find lapboard machines increasingly useful. Some of my readers report that they carry their lapboard machines literally everywhere, to appointments, in their cars, even to lunch. Some never use any other kind of machine, not by necessity but by choice. I can see why. Any of these would be better to write books and do taxes than anything I ever had prior to the micro revolution; and once you get used to using them, they keep logs and notes, handle ad-

CHAOS MANOR

dresses, and generally make your life run better.

In *The Mote in God's Eye*, Larry Niven and I postulated a society in which nearly everyone carried a "pocket computer" that served as both notebook and entry to a universal memory bank. It looks as if that's going to come much faster than I thought.

I can't really help you choose between the Model 100, the Model 200, and the NEC PC-8201. I do think that once you've got one, you'll wonder how you lived without it.

ATARI ST

There still isn't enough software, and in particular there is no acceptable text editor for it, but in my subjective opinion, the Atari ST is still the most exciting machine of the year.

Whenever I say that I get flak from the MacTribesmen, who descend with fire and sword. "You early on trashed the Mac because there wasn't enough software. Now you're praising the Atari before the good software comes out."

There's some justice in that. The Atari, for all its merits, has yet to come out with a text editor as good as MacWrite. I keep hearing rumors of WordPerfect, but whenever I inquire, it's always Real Soon Now.

There'd be more justice in the MacTribesmen's views if Apple had sold the early Macintosh for a reasonable price. Instead, you got to pay two grand for the 128K-byte Mac just so that you could send Apple \$995 for the upgrade kit, and you still didn't have color or a large-enough screen. Of course I didn't recommend the early Macintosh.

Nowadays Apple is market-driven rather than guru-driven, and it's a different story. The new Mac Plus is a good machine. On the other hand, I just don't see what the Mac can do that the Atari ST can't be made to do.

Certainly the Atari hasn't caught up with the Mac yet. There is some good software for the Atari, but not enough. Still, some, as we'll see in a moment, is so good that you might want to go buy an Atari ST just for those programs.

Atari continues to improve the ma-

(continued)

**THE ATARI
TEN COMMANDMENTS**

IIII

**"We shall create a computer
that sets a new standard for
speed and performance."** *Jack Tramiel*
ATARI CORP.

The revolutionary 1040ST™ has a sizzling clock speed of 8 MHz that the competition just can't touch. And the more speed your computer has, the less time you'll waste waiting for it to do its job.

It's what you would expect from a system driven by a powerful 68000 micro-processor.

Similarly, the 1040ST delivers one Megabyte of memory for you to work with, which is two to four times more than our competitors deliver.

And we've succeeded in creating this amazing combination of speed and performance for the incredibly low price of just \$999.

Which means the 1040ST sets new standards for speed, performance and price!

The ATARI 1040ST is at your computer retailer now.



ATARI®

© 1986, Atari Corp.
ATARI and 1040ST are TM's or reg. TM's of Atari Corp.

back issues for sale

	1985	1986
Jan.	\$4.25	
Feb.	\$4.25	\$4.25
March	\$4.25	\$4.25
April	\$4.25	\$4.25
May	\$4.25	
June	\$4.25	\$4.25
July		\$4.25
Aug.	\$4.25	\$4.25
Sept.	\$4.25	\$4.25
Oct.	\$4.25	\$4.25
Nov.	\$4.25	
Dec.	\$4.25	

SPECIAL ISSUES and INDEX

BYTE '83-'84 INDEX	\$1.75
1984 Special Guide to IBM PCs (Vol. 9, No. 9)	\$4.75
1985 INSIDE THE IBM PCs (Vol. 10, No. 11)	\$4.75

Circle and send requests with payments to:

**BYTE Back Issues
P.O. Box 328
Hancock, NH 03449**

Check enclosed

Payments from foreign countries must be made in US funds payable at a US bank.

VISA MasterCard

Card # _____ Exp. Date _____

Signature _____

The above prices include postage in the US. Please add \$.50 per copy for Canada and Mexico; and \$2.00 per copy to foreign countries (surface delivery). Please allow 4 weeks for domestic delivery and 12 weeks for foreign delivery.

Name _____

Address _____

City _____ State _____ Zip _____

Attention all FX80, FX100, JX, RX, & MX owners:
**You already own half of
 a great printer**

Dealer
 inquiries
 welcome.

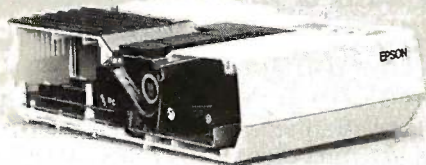

**Now
 Only
 \$79.95**

Now for \$79.95 you can own the rest. You see, today's new dot matrix printers offer a lot more.

Like an NLQ mode that makes their letters print almost as sharp as a daisy wheel. And font switching at the touch of a button in over 160 styles. But now, a Dots-Perfect

upgrade kit will make your printer work like the new models in minutes— at a fraction of their cost.

And FX, JX and MX models will print the IBM character set, too.

So, call now and use your Visa, MasterCard, or AmerEx. Don't replace your printer, upgrade it!

1-800-368-7737
 In California: 1-800-831-9772



Dots-Perfect™
Dresselhaus

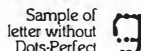

837 E. Alostia Ave., Glendora, CA 91740 Tel: (818) 914-5831
 An upgrade kit for EPSON FX, JX, RX, & MX printers

EPSON is a trademark of EPSON America, Inc.



Dysan diskettes are the ultimate in quality flexible recording media for flexible disk drives. They are certified to be 100% error free on-track and between tracks. Diskettes are tested on-track as well as between tracks for missing pulse, extra pulse, and modulation. Quality is built into each diskette from the inside out.

The ultra smooth disc surface is burished on both sides to promote longer media life, longer head and load pad life, as well as better recording and playback performance.

And to help introduce you to the Dysan quality standard we're running a special on their diskette product line.



What separates us from our competition? Simply a combination of the best service in the industry, highly competitive pricing, and an ever widening range of products. Above all we care about our reputation and we are willing to work on a lower margin while delivering what others only claim—and we do it all on a day-in day-out basis.

Every subscriber to **Byte** will receive our New 96-Page Winter Spring 1986/87 Catalog over the next few months. We hope to be your source for computer supplies & accessories. **Now with 15 pages of consumer/ industrial products.**

**Lyben
 Computer
 Systems**

**WATCH
 FOR
 OUR
 NEW 1986/87
 CATALOG**

1050 E. MAPLE RD. • TROY, MI 48083
 (313) 589-3440

chine, and I'm told that not long after you read this they'll have upgrades like a blitter (a hardware gizmo that makes graphics software faster and easier to write) and a math chip to speed up floating-point calculations; but there is still a crying need for some pretty basic software, particularly a good text editor.

There is also some pretty bad software out there.

ANTIC SOFTWARE

Antic is a software distributor run by people who like computers. In particular, they like the Atari ST, and they're publishing some great programs for it.

They also have some dogs, but I don't want to discourage you from dealing with them. Just be selective. This is a company that sells stuff so good you might want to get an Atari ST just to have something to run it on.

Let's get the deadwood out of the way first. Some of their "entertainment" software, such as Mom and Me and Murray and Me, is so corny I think I'd throw my Atari away if I knew I had to run them. These are computer "biotoons," described as "artificial personalities—sort of like artificial intelligence with a sense of humor." What they really are is a ghastly joke, and to add insult to injury they're copy-protected. Actually, I guess that part is just as well. Antic has some other games and gubbage I wouldn't recommend.

That's the deadwood. Now for the jewels.

Antic's CAD-3D is one of the best programs I've seen for the Atari or anything else. It's not a "real" CAD system, in that it doesn't have dimensions and some of the design features of professional CAD; but what it does have is the ability to do things in three dimensions.

With CAD-3D you can draw an object, then travel about as if you were riding a camera boom, so that you can look at the object from any angle. The object and light sources don't move; you do. Once you've seen all you want, you can then rotate the object itself. When that happens, the light and shadowing change.

To make drawing easy you can

CHAOS MANOR

define a shape, then "extrude" it to give it depth. You can spin objects to generate a solid of rotation. You can snap points to a grid, connect dots, and do many of the things one expects from a more expensive CAD program.

All this takes place on a small monochrome screen; but when you've got it all done the way you want, there's a "superview" command that generates the object, in color, for the full screen, so you can see it in all its glory. One of the items that comes with CAD-3D is Stonehenge (restored). Zoom in close or back off and see the whole thing. It's glorious by moonlight.

CAD-3D was written by Tom Hudson, the same programmer who did DEGAS for the Atari ST. That one is published by Batteries Included, and some of the artwork astonishes visitors here. When Hudson did CAD-3D, he included the ability to save a particular view/rotation of your CAD-3D object as a DEGAS file. You can then bring up DEGAS and call up your object to color it, add text, and do whatever you like to make a poster or a book page or whatever.

Between them, CAD-3D and DEGAS make the Atari ST worth owning.

Antic also sells Flash, a communications program for the ST. I've only just got it running. It seems to be about as versatile as Crosstalk. I've been tempted to set the ST up in a place convenient to my desk and use it as a major machine just to get used to it. What stopped me was the need for a good text editor and a communications program. Now that I have Flash, I only need a text editor. More on Flash another time.

Interestingly, although Antic's ghastly joke programs are copy-protected, both CAD-3D and Flash urge you to make backup copies and put the original in a safe place.

AMIGA AND ATARI

If I seem a bit more enthusiastic for the Atari ST than for the Amiga, there are a couple of reasons. One is that for all its faults—like the stupid menus that drop down whether you want them or not whenever you get any-

(continued)

SUNDAY 10-5

COMPUTERS

- AT&T 6300 640k 10 Meg Drive 1 Flop. w/Moni. \$1999.00
- COMPAQ 286-2 640K 30 Meg 286-3 1.2 Meg Flop. In Stock
- IBM PC 640K 2 Floppies. \$1049.00
- IBM PC 256K 10 Meg. Dr.
- SPERRY PC - IT 44 Meg \$1299.00
- LAP TOP COMP \$2549.99
- TOSHIBA T-1100 512K 1250.00
- T-1100 Plus 1400.00
- T-1100 Plus 640K CALL
- T-3100 CALL
- COMPAQ 286-2 640K CALL
- 286-3 1.2 MB Flop. In Stock

PRINTERS

- BROTHER HR15-XL 192
- HR-20 Dual 193
- CALL 193 Plus 310.00
- 675.00 292 Color Ptr
- In Stock 293 Color Ptr
- CALL 321
- In Stock 341
- 350.00 341
- 449.00 351

OKIDATA

- 289.00
- CALL 499.00
- CALL 599.00

TOSHIBA

- CALL 639.99
- CALL 900.00

MONITORS

- 144.99
- CALL 144.99
- In Stock 144.99
- CALL 399.99
- CALL 399.99
- 469.99
- 149.99
- 409.95
- 469.95

CITIZEN

- 175.00 Amdex 310-A
- CALL Amdex 600 Color
- 330.00 Amdex 722 Color
- In Stock IBM Color Moni.
- 410.00 NEC Multi-Sync
- CALL PGX HX-12
- CALL PGX HX-12E
- CALL PGX MAX 12
- CALL Taxan 630
- CALL Taxan 640
- 700.00 20 MEG

EPSON

- CALL 345.00
- CALL 450.00
- CALL 700.00

HARD DRIVES

- 300.00
- 350.00

COMPUTER: 1-800-874-1235

VIDEO: 1-800-223-6779

COMPUTER (718) 237-2828

S'nW ELECTRONICS & APPLIANCES

633 Bedford Ave, Bklyn, NY 11211

Hours: Mon-Thurs. 9-6
Fri. 9-2 Sun. 10-5 Sat. Closed

C.O.D. Accepted

- Credit Card Accounts charged at time of order
- add ship. hand. Ins. Limited
- Prices subject to change without notice
- Not responsible for typographical errors

GUARANTEED LOWEST PRICES

COMPUTER: 1-800-874-1235

VIDEO: 1-800-223-6779

COMPUTER (718) 237-2828

S'nW ELECTRONICS & APPLIANCES

633 Bedford Ave, Bklyn, NY 11211

Hours: Mon-Thurs. 9-6
Fri. 9-2 Sun. 10-5 Sat. Closed

C.O.D. Accepted

- Credit Card Accounts charged at time of order
- add ship. hand. Ins. Limited
- Prices subject to change without notice
- Not responsible for typographical errors

GUARANTEED LOWEST PRICES

COMPUTER: 1-800-874-1235

VIDEO: 1-800-223-6779

COMPUTER (718) 237-2828

S'nW ELECTRONICS & APPLIANCES

633 Bedford Ave, Bklyn, NY 11211

Hours: Mon-Thurs. 9-6
Fri. 9-2 Sun. 10-5 Sat. Closed

C.O.D. Accepted

- Credit Card Accounts charged at time of order
- add ship. hand. Ins. Limited
- Prices subject to change without notice
- Not responsible for typographical errors

DataSaver 400

Standby UPS

Power protection for the most powerful micro-computer systems with peripherals is here, now, with the 400 Watt DataSaver. Protect your investment in application software and hardware with reliable, continuous power. 90 and 200 Watt capacities and international models are also available.

Cuesta Systems Corporation

3440 Roberto Court
San Luis Obispo, CA 93401
TLX: 4949381 CUESTA

©1985, Made in U.S.A.

Write or call 805/541-4160
Dealer O.E.M. inquiries invited

where *near* the top of the screen—the Atari's GEM operating system works. AmigaDOS is incomplete, and some of its details are a matter of folklore, not documentation. If you like to amaze your friends, the Amiga is the machine; but you may also find that AmigaDOS will drive you nuts.

Not that there isn't some folklore in using GEM. I've only recently found out how to install things into the GEM

desktop. At least one key move is nowhere documented. Grr.

The AmigaDOS defects aren't crucial for users. Most Amiga application programs don't require that you do anything with AmigaDOS. Which is just as well.

My main reason for being just a little shy with the Amiga has nothing to do with the machine or its software. It's a good system, and the software

defects can and will be remedied, if not by Commodore then by the user community—provided that the Amiga survives.

That seems less problematical as I write this than it did a month ago. Commodore has had its Saturday Night Massacre, but the layoffs seem to have stopped, and the bankers who control the company seem willing to lend them more. One good year of sales and the Amiga is safe. Commodore also announced upcoming improvements.

I wish them well. It's a good machine; and as I've said before, I like the notion that Commodore will drive Atari to improve hardware, while Atari will drive Commodore to lower the Amiga's price; and the whole micro community benefits.

LITTLE COMPUTER PEOPLE

Little Computer People is a—I guess you have to call it a game—that runs on either the Atari ST or the Amiga. I understand there are versions for the Commodore 64 and Apple II, but I'm also told they're less interesting.

When you run the program, you discover that deep inside your computer there's a house, sort of like a dollhouse. If you watch that for long, a little computer person will appear to inspect it. Then he gets his suitcase and dog and moves in. About that time he turns to the screen and says something. Unfortunately, it's unintelligible.

Whatever it is must be interesting. I say this because I visited BYTE headquarters in Peterborough last week, and they had a machine set up with a little computer person in it. Stuck to the machine was a note threatening death and destruction to anyone who disturbed the computer or turned it off. This wasn't kindness. The BYTE staff was starving the little computer person.

It seems you have to feed them; this is done from the keyboard. The BYTE staff hadn't fed Henry, their little computer person, in a week. At least they think they hadn't. As it happens, I know two editors who took pity on Henry and snuck in to give him some food and water.

(continued)

THE ALTERNATIVE!

SAM 3001 AT



640K RAM, 6/8 MHZ, 1.2M FDD, F/H Disk Controller, 2 Serial Ports, Hi-Res RGB Board w/PP., 195W Power Unit & Keyboard. Monitor extra. Compatibility Guaranteed. FCC/VDE Certified. U.S. origin.



HiTech
International, Inc.
A KNK COMPANY

Order Desk
(800) 538-8157 National
(800) 672-3470 California
Ask for Dept. 864

1435 McCandless Drive
Milpitas, CA 95035
(408) 263-3300
TLX 501422 HIT

Copenhagen
242 54 10

London
01 640 9130

Nürnberg
0911 333923

Paris
(1) 45974529

SAM 3001 AT is a trademark of HiTech International Inc.

CM-1376

PGA compatible 13" RGB Analog Super High Resolution monitor. 4,096 color display with 640 x 480 lines of resolution.



CM-1370

Persyst "BOB"™ or Sigma 400L™ card compatible 13" RGBI Super High Resolution monitor. 16 color display with 800x400 lines of resolution.



CM-1370A

AT&T 6300™ and 6300 Plus™ compatible 13" RGBI Super High Resolution monitor. 16 color display with 800 x 400 lines of resolution.



CM-1365

CGA compatible 13" RGBI High Resolution monitor. 16 color display with 640 x 200 lines of resolution. Five position color display switch.



CM-1360

CGA compatible 13" RGBI High Resolution monitor. 16 color display with 640 x 200 lines of resolution. Three position color display switch.

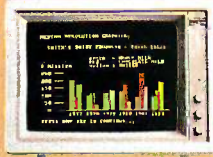

MM-1422G/A

MDA or Compaq™ compatible 14" High Quality Monochrome monitor. Amber or green display with 800 x 350 lines of resolution.



MM-1225G/A

Apple™, Atari™, or Commodore™ compatible 12" High Quality Monochrome monitor. Amber or green display with 800 x 350 lines of resolution.



MM-1222G/A

MDA compatible 12" High Quality Monochrome monitor. Amber or green display with 800 x 350 lines of resolution.

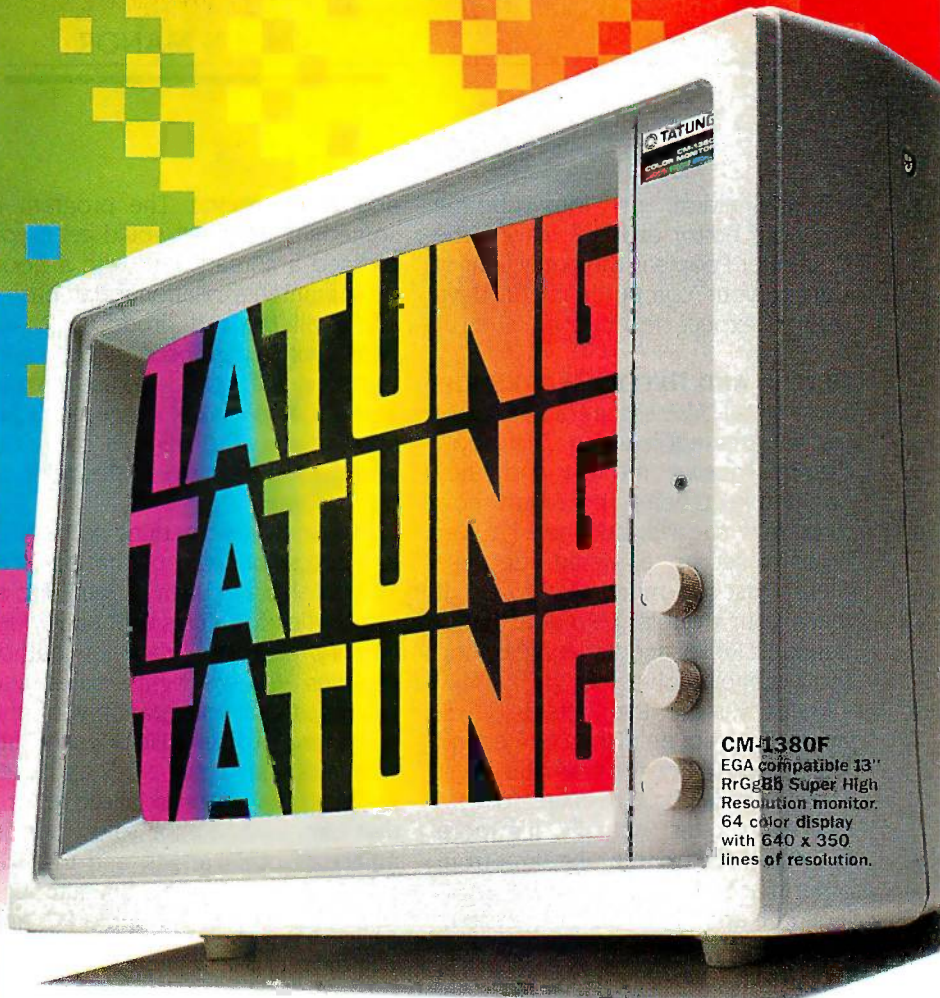
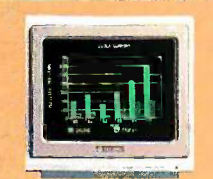

CM-1380F
EGA compatible 13" RrGgBb Super High Resolution monitor. 64 color display with 640 x 350 lines of resolution.

TATUNG MONITORS. We want to be number 1. That means we have to have a better product.

We do. Better, brighter image quality. Compatibility. The best value you'll find. A guarantee you'll never have to use. And choice...the chance to choose the monitor that meets your needs precisely. That's what it takes to be Number 1. That's just what Tatung offers.

No one gives you a wider range of monitors to choose from. No one offers more quality, more value, and service. That's

Tatung Quality Monitor Peripherals & Accessories: TEGA-22 Card, Cable-70, 12"MB-12 and 13"MB-13 tilt & swivel bases.

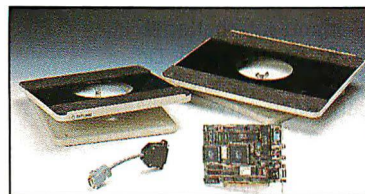

why more and more computer systems show their stuff on Tatung Monitors. For complete details and specifications, simply send us your business card, or call Angela Liu toll free: 1-800-421-2929 (Outside CA) (213) 979-7055 (In CA).

Persyst "BOB" is a registered trademark of Persyst Personal Systems Technology, Inc. Sigma 400L is a registered trademark of Sigma Designs, Inc. AT&T 6300 & 6300 Plus are registered trademarks of AT&T Information Systems. Compaq is a registered trademark of Compaq Computer Corporation. Apple is a registered trademark of Apple Computer, Inc. Atari is a registered trademark of Atari Corporation. Commodore is a registered trademark of Commodore Business Machines, Inc.



TATUNG

Inquiry 332 for End-Users.
Inquiry 333 for DEALERS ONLY.

Tatung Company of America, Inc. 2850 El Presidio St., Long Beach, CA 90810
In Northern California Call: Tatung Science and Technology, Inc., 708 Charcot Ave., San Jose, CA 95131 (408) 435-0140

Ken Sheldon, my long-suffering technical editor at BYTE, says Little Computer People is the equivalent of turning your computer into a Lava Lamp. I expect he's right.

REFLEX AND REFLEX WORKSHOP

Most small-business people I know just sort of muddle along. They know they're wasting money, and they ought to keep better records to show them how to save; but there's never time to set up a system because there's just too much else to do. If that's your trouble, help is at hand. Borland's Reflex and Reflex Workshop can probably solve your problem.

Reflex was the first "outside-developed" program published by Borland International. For the few who don't know, it's a database manager for IBM PCs and clones. Actually, it's more than that. Reflex will take data from other places, like Lotus 1-2-3, dBASE II and III, and PFS files; reorganize it;

and issue reports. The program is something like what you'd get if you crossed a spreadsheet with a good programmable relational database.

Like all Borland products, Reflex comes with a thick book that explains, in great detail, just how to use the program. It also makes suggestions for applications. The book is complete and darned near worth the price of the program.

The result is something so easy to use, and so bulletproof, that one major publisher, Jim Baen of Baen Books, uses Reflex for all his accounting: inventory, keeping track of author royalties, foreign rights, sales and returns—the whole panoply of the publishing business. He does the calculations with Lotus 1-2-3 and uses Reflex to generate specialized reports that can track author sales, performance of cover artists, and the like.

The interesting part is that although he's using only Reflex and a PC, and

has a very small administrative staff, he's selling as many books as many larger publishing houses. Moreover, the larger houses use big mainframe computers and employ dozens of people to foul up their records, and thus have unhappy authors, while Jim has one of the best reputations in the business.

I wish my other publishers would discover Reflex; and of course it's useful in other businesses. I can say, unequivocally, if you use a PC much at all, you should know about Reflex. Sooner or later you'll have an application.

If that weren't good enough, there's Reflex Workshop. Reflex does the job; Workshop shows you applications. The 400-page book that comes with Workshop has sections on creating accounting systems; inventory control; business expense reports; real estate management; production, operation, and quality control; and just a whole bunch of other stuff. Just reading this book can help a small business manager. The included disk contains Reflex templates for everything from schedule management to generating form letters. Between them, Reflex and Reflex Workshop may be the best bargain in software today. Highly recommended.

WINDING DOWN

I'm late with this, and probably over my space budget. The computer book of the month is Chris Devoney's *Using PC-DOS* (Que Corp., 1986). This is the best DOS book I know of. It covers everything and has lots of examples.

I should be home all next month, so maybe I can write some science fiction. Of course, General Graham is trying to involve me in setting up a graduate Space Academy, but maybe I can fob off most of that work on someone else. I probably won't, though. ■

Jerry Pournelle welcomes readers' comments and opinions. Send a self-addressed, stamped envelope to Jerry Pournelle, do BYTE, One Phoenix Mill Lane, Peterborough, NH 03458. Please put your address on the letter as well as on the envelope. Due to the high volume of letters, Jerry cannot guarantee a personal reply.

ITEMS DISCUSSED

AUTOSWITCH EGA CARD \$599
 COLOR/MONO CARD \$245
 HI-RES GRAPHICS CARD \$299
 Paradise Systems Inc.
 217 East Grand Ave. S
 San Francisco, CA 94080
 (415) 588-6000

CAD-3D \$49.95
 FLASH \$39.95
 Antic Software
 524 Second St.
 San Francisco, CA 94107
 (415) 957-0886

CITIZENS ADVISORY COUNCIL REPORT
 \$10 postpaid
 L5 Society
 1060 East Elm St.
 Tucson, AZ 85719

EGA PAINT \$79
 RIX Softworks
 18552 MacArthur Blvd.
 Suite 470
 (714) 476-8266

LITTLE COMPUTER PEOPLE . . \$35-\$50
 Activision
 PO. Box 7287
 Mountain View, CA 94039
 (415) 940-6044

NEC MULTISYNC MONITOR . . . \$899
 NEC Home Electronics (U.S.A.) Inc.
 Personal Computer Division
 1401 Estes Ave.
 Elk Grove Village, IL 60007
 (800) 323-1728

ORCHID EGA \$495
 Orchid Technology Inc.
 47790 Westinghouse Dr.
 Fremont, CA 94539
 (415) 490-8586

REFLEX \$149.95
 REFLEX WORKSHOP \$69.95
 Borland International
 4585 Scotts Valley Dr.
 Scotts Valley, CA 95066
 (408) 438-8400

TANDY MODEL 200 \$799
 Tandy Corporation
 1800 One Tandy Center
 Ft. Worth, TX 76102
 (817) 390-3011

The Prentice-Hall Personal Computer Book Club shows you how to

Get the Most From Your IBM PC



How can you zero in on those exceptional PC books that can make your job easier and more rewarding? Whether the PC is new to you, or you're busy modifying programs to suit your needs, you can count on the experts at the Personal Computer Book Club to offer you their choices from among the newest and best books from every leading publisher. We skim the cream right off the top, bringing you well-written, timely and comprehensive books on using your IBM or compatible to its full potential.

Start with the new edition of **INSIDE THE IBM PC** for just \$4.95

Enjoy Peter Norton's updated **INSIDE THE IBM PC** for just \$4.95 (plus shipping, handling and applicable sales tax). This lively 340-page bestseller by the best-known independent authority on the subject takes you on a tour of your PC, revealing how it works, what it can do and the mysteries, secrets and wonders of every model IBM PC. Review the basics and move on to master your microcomputer.

Get a **FREE BONUS BOOK** with trial membership.

We'll give you the \$15.95 **GUIDE TO LOCAL AREA NETWORKS** as a *free gift*, just for trying the Personal Computer Book Club. In non-technical language and clear illustrations, this comprehensive book teaches you how to set up a Local Area Network, no matter what size your business. You'll learn:

- what a Local Area Network is
- how to determine when you need one
- how to set one up, and solve cabling problems
- the differences between Star, Ring and Bus networks
- how data is sent and managed, and errors controlled
- interfacing with different networks
- security considerations
- the commercial availability of network hardware and software



Both essential books are yours, PLUS:

TREMENDOUS SAVINGS. You save \$32.95 on this special introductory offer, and keep saving 20-35% on every book thereafter.

SUPERIOR QUALITY. Each book is a publisher's original edition, carefully selected by computer experts who know the field.

THE CONVENIENCE OF SHOPPING BY MAIL. Every 3-4 weeks, you'll receive the PCBC Bulletin describing the Main Selection and Alternates. If you want the Main Selection, do nothing and it will come automatically. For an alternate selection (or none at all), mark your preference on the reply card and return it by the date specified. You'll always have at least 10 days to decide.

As a PCBC member, you are only obligated to purchase an additional 3 books during the next year, and may cancel at any time after that.

Card missing? Write to: Personal Computer Book Club, A Prentice-Hall Book Club, P.O. Box 442, West Nyack, NY 10995

SEND NO MONEY!



Personal Computer Book Club
A Prentice-Hall Book Club
P.O. Box 442
West Nyack, NY 10995

YES, please rush me **INSIDE THE IBM PC** and **GUIDE TO LOCAL AREA NETWORKS** for 10 day free trial. If not 100% satisfied, I'll return **INSIDE THE IBM PC** and owe nothing. The **GUIDE** is mine to keep, free. Otherwise, I'll pay just \$4.95 (plus shipping, handling and applicable sales tax, which are added to all shipments) and agree to purchase 3 more books during the next year, according to the terms of this offer. (Not valid without signature.)

Signature _____

Name _____

Address _____

City/State/Zip _____

For new members only, in the Continental USA and Canada. Subject to acceptance by PCBC.

BYTE 71-1 36966-0/D-5831-5 PC115-AA(5)



NOTHING DOWN.

Even the best of personal computers can have a bad day. Blackouts happen. Usually at the worst possible time.

But power interruptions don't need to be business interruptions. And lost power shouldn't result in lost data. Not with the POWERMAKER® Micro UPS from Topaz.

Designed specifically for hard disc and critical-use business systems, Powermaker Micro UPS ensures a continuous supply of smooth sine wave power even during

a total blackout.

And there's more. Powermaker Micro UPS also removes spikes and other error-producing transients from incoming power, protecting your PC's sensitive circuitry.

So, if your PC needs a little help once in a while, give it Powermaker Micro UPS protection. For nothing down. Call us today at (619) 279-0831, or contact your local Square D distributor.

TOPAZ®

A Subsidiary of Square D Company



68000 WARS: ROUND 3

BY BRUCE WEBSTER

The bout resumes again as Bruce looks at four flavors of Macintosh

It's late July as I sit and write this; later, in fact, than it should be. However, the minor distraction of having a new wife and five more kids has slowed me down a little. Did I mention that we're moving to a new house in a

week or so? One with a few more bedrooms and (hallelujah!) a private office. That should boost my productivity a little.

In the meantime, I'm sitting here in the family room, surrounded by computers (all of which are turned on, of course) and hoping that the oft-voiced rumors about ionized radiation from CRTs are just that: rumors. What have I got here? Four flavors of Macintosh: the original Mac, a Mac Plus (on loan from Apple), a HyperDrive 2000 (on loan from General Computer), and a Prodigy 4 (on loan from Levco); two flavors of Atari ST: a 520 (from BYTE) and a 1040 (on loan from Atari); one Amiga (again, from BYTE); and one Compaq (my own). I also have an Apple IIe, but it's up on the university campus right now. Out of all the computers here, the Compaq is the only non-68000 machine and, incidentally, the one I'm using to write this column. That might somehow be significant—but I doubt it. It probably just means that I'm too comfortable with NewWord 3 (a WordStar clone) to change.

So what's on tap for this month? True to form, I ran benchmarks on the four Macs, giving some real comparisons. I've got a look at some development software for the Atari ST and the Amiga, including a nifty 68000 assembler. I've also been playing with a beta copy of the Turbo Pascal compiler for the Mac and will have a brief report on that.

THE MACINTOSH PLUS

Well, Apple finally convinced me to upgrade the Mac 512K to a Mac Plus, which I did with some trepidation. I had heard numerous warnings about software incompatibilities, and such turned out to be the case. Right off the bat, I had to call Personal Computer Peripherals Corporation, the folks who are still graciously lending me a MacBottom hard disk, to get new boot software. You see, the MacBottom used to turn itself on automatically by sensing the +5-volt line in the serial port when you turned your Mac on. Apple, of course, dropped this line from the new serial ports on the Mac Plus. The new start-up program arrived quickly from PCPC and worked wonderfully. Better yet, I found I could partition the MacBottom into volumes that

used the old Mac filing system and the new hierarchical filing system. So I now have one 10-megabyte HFS volume and several 1- to 2-megabyte MFS volumes.

Second, I discovered that some of the Mac software I

had purchased more than two years ago (when I bought my original Mac) no longer worked, or worked erratically, on the Mac Plus. This included Microsoft Word (version 1.00), Multiplan (also 1.00), Dollars and Sense, and a few others. Sarah Charf at Microsoft graciously sent me a review copy of Excel to replace my rather antiquated version of Multiplan, but I have yet to receive an upgrade to Word, which has really limited my use of the Mac for word processing. On the other hand, most of my more recently acquired software works just fine, and it's nice having the 1 megabyte of RAM and the 800K-byte disk drives (along with the MacBottom hard disk).

Am I glad I traded in for a Mac Plus? Well, yes. Overall performance seems to be much better, I like the extra RAM and disk space, and it's nice to have the most recent model. To quote Oliver Wendell Jones (from "Bloom County"): "Hackers, as a rule, do not handle obsolescence well." If I were to buy a Mac off the shelf today, I'd get a Mac Plus.

MACINTOSH UPGRADES

Two firms, General Computer Company and Levco, are competing head to head in turning that little beige toaster on your desk into a high-powered workstation. Both upgrades—the HD 2000 from GCC and the Prodigy 4 from Levco—were shown at the MacExpo in San Francisco last spring (where I reported on them). Now both units are close to shipping, and both firms have been kind enough to lend me beta units for evaluation.

General Computer Company is famous for having brought out the first (and for a long time the only) internal hard disk for the Macintosh, the HyperDrive. While reviews for the HyperDrive have been mixed (see Gregg Williams's review in the December 1985 BYTE), GCC has still been able to capture a large share of the hard disk market for the Mac. However, growing competition has induced GCC to look at enhancing its product line, and the result is the HD 2000.

(continued)

Bruce Webster, a consulting editor for BYTE, can be reached c/o BYTE, P.O. Box 1910, Orem, UT 84057, or on BIX as bwebster.

Table 1: Benchmarks for four versions of the Macintosh, using a program written in TML Pascal. All figures are times in seconds, unless otherwise indicated.

	Mac 512K	Mac Plus	HD 2000	Prodigy 4
Performance				
sieve	4.8	6.7	4.3	1.2
matrix	5.9	7.6	4.8	1.6
sort	9.4	12.6	8.8	2.6
FLOPS (floating-point ops/sec: add, subtract, multiply, divide)	1578	1468	4651	10,480
Graphics				
vertical lines with skew:				
0	12.1	12.9	12.4	4.8
1	184.8	87.2	82.8	24.0
20	185.6	87.2	83.1	24.0
100	186.0	86.8	83.9	23.9
horizontal lines with skew:				
0	3.0	3.4	3.2	1.0
1	7.2	5.6	5.4	1.6
20	23.8	12.9	12.6	3.7
100	93.7	43.8	42.5	12.1
rectangles	23.8	17.8	17.4	9.1
circles	18.3	9.4	9.4	2.8
windows	13.6	14.4	13.9	4.4
text	16.6	12.9	11.7	3.2
I/O—Floppy Disk (128K-byte file in 512-byte blocks)				
write	40.5	14.1	12.1	6.7
read	7.3	7.8	7.8	5.8
random	50.9	37.3	36.6	34.5
I/O—Hard Disk (128K-byte file in 512-byte blocks)				
write	—	5.4	5.0	6.9
read	—	4.3	2.8	6.4
random	—	22.2	8.1	8.6

Table 2: Some C benchmarks for the four Mac versions, giving floating-point operations/second (FLOPS), Whetstones/second (WHETS), and Dhrystones/second (DHRYS).

	FLOPS	WHETS	DHRYS
Mac 512K	1476	7973	991
Mac Plus	1344	7278	772
HD 2000			
regular	4103	48,504	1106
HD special	15,801	130,719	—
Prodigy 4			
regular	9758	105,820	3201
HD special	45,467	271,493	—
P4 special	48,077	468,750	—

The HD 2000 consists of an internal 20-megabyte hard disk, a 1.5-megabyte increase in RAM, a 12-megahertz 68000 processor (to replace the Mac's), and a 68881 floating-point coprocessor (to speed up number crunching). Like the original HyperDrive, all this fits within the original Macintosh case, putting a lot into a little footprint. The system boots up from the hard disk automatically on power-up, so you don't have to go through any special procedure. A disk cache and a RAM disk are automatically created according to configuration information that you can modify using some of the system software.

The hard disk is organized into "drawers" that can be mounted or dismounted via a special desktop menu (which itself is installed using a desk accessory). Unlike some hard disk systems that partition the available disk space into fixed chunks, the drawers expand and shrink in size to accommodate the files they contain. It's possible to assign a password to a given drawer, allowing only authorized users to access it.

The strength of the HD 2000 appears to be the system software, which allows great flexibility in allocating space on the hard disk and in configuring the system to suit your purposes. The drawback—as we'll see in a little while—is that you don't get much of an improvement in performance.

As I have said before, the Prodigy 4 from Levco is for power freaks only. Though the price has come down about \$2000 from what Levco was quoting last spring, \$7000 is still a lot to pay for an upgrade to a \$2000 computer. But what an upgrade! For your bucks, you get the following: a 16.67-MHz 68020 processor, a 68881 math coprocessor, 4 megabytes of RAM using 1-megabit chips, and a 20-megabyte hard disk. This turns your desktop Mac into a machine that appears (by the benchmarks) to run rings around a VAX-11/780.

If system software is the strength of the HD 2000, it's the weakness of the Prodigy 4. The current boot sequence is awkward, though it apparently will be improved in the next Prodigy ROM revision. Configuration software is not particularly powerful nor flexible. Obviously, the folks at Levco have got to put more time and effort into this.

Now for the good stuff: benchmarks. Table 1 shows the results of running my benchmark program (written in TML Pascal) on a Mac 512K, a Mac Plus, the HD 2000, and the Prodigy 4. All but the Mac 512K had the new ROMs and the latest System and Finder. The overall winner is the Prodigy 4, usually by a wide margin. Note a few interesting trends. On straight performance benchmarks, the Mac 512K beats the Mac Plus, though I have no idea why. On the graphics, as reported a few months ago, the Mac Plus easily outperforms the Mac 512K, but the HD 2000 barely improves upon the Mac Plus. The Prodigy 4, on the other hand, beats the Mac Plus and the HD 2000 by a factor of two to four in performance and graphics and by almost a factor of two in some floppy disk benchmarks. However, the Prodigy 4 hard disk is slower than either the HD 2000 drive or the MacBottom on the Mac Plus.

Table 2 is a clearer indication of power differences. Three

(continued)

Now Available!

FIVE NEW MODELS

SHARE PRINTERS AND BUFFER PRINT JOBS WITH ONE VERSATILE UNIT

Print Master from BayTech is an intelligent printer controller that connects between your computers and printers. It allows you to share one printer automatically, contend for multiple printers automatically, or switch between several printers by sending a simple code, not by changing cables. Plus, Print Master's generous built-in buffer spools data until your printers can receive it.

Because Print Master is a very flexible device, you can set it up to fit your application, even if your application changes.

YOU SET UP THE IN-OUT PORTS

You configure Print Master's ports for any combination of printers and computers by answering questions from easy-to-follow menus. For example, with the ten port Print Master, nine computers can share one printer, eight computers can share two printers, seven computers can share three printers, and so on, to one computer which can share nine printers. You can also menu-select the disconnect time-out, form feeds, etc. and on serial models, the configuration of individual ports to translate for printers and computers using different configurations.

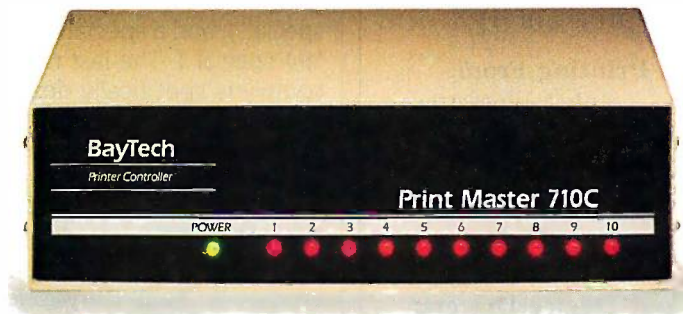

512K OR ONE MEGABYTE BUFFER KEEPS YOU WORKING INSTEAD OF WAITING

Since Print Master can accept data faster than your printer (up to 19.2KB serial or 5,000 characters per second parallel), you can send a print job to Print Master's standard 512K buffer and then go on to another project. All users connected to Print Master can send data to this common pool buffer, and they can be doing it simultaneously, even if no printer is available. Data is stored in the buffer until it can

be sent on a first-job-in first-job-out basis to the selected printer. If you need more memory than 512K, Print Master is optionally available with one megabyte buffer.

If several users are sharing one printer, printer sharing via Print Master is completely automatic. There are no codes to send. You simply perform your normal print operation. If you are sharing several identical printers, connection is also

automatic. Again, you perform your normal print operation and are connected to the next available printer on a first-come-first-serve basis. Print Master will send data to all printers simultaneously to keep your printers running at full capacity.

If you are sharing several different printers, such as a laser-jet, a dot matrix and a plotter, and you wish to select a specific printer, you do your normal print routine and also send a printer select code (which you can define yourself) before the first characters of your data. The data is then routed to the selected printer. It's that easy.

PARALLEL, RS-232C OR RS-422A MODELS

706A (6 parallel ports), \$795
706C (6 serial ports), \$795
708C (8 serial ports), \$895
710C (10 serial ports), \$995
706D (4 parallel/2 serial), \$795
708D (6 parallel/2 serial), \$895
706E (4 serial/2 parallel), \$795
708E (6 serial/2 parallel), \$895
710E (8 serial/2 parallel), \$995
708F (4 serial/4 parallel), \$895
710F (6 serial/4 parallel), \$995
All above models have standard 512K buffers.
Additional 500K buffer, \$249
RS422A for distances up to 4,000 feet now available on some models.

WANT DETAILS?

Call or write BayTech at P.O. Box 387, Highway 603, Bay Saint Louis, Mississippi 39520, USA. Telex 910-333-1618. Phone 601-467-8231 or

800-523-2702

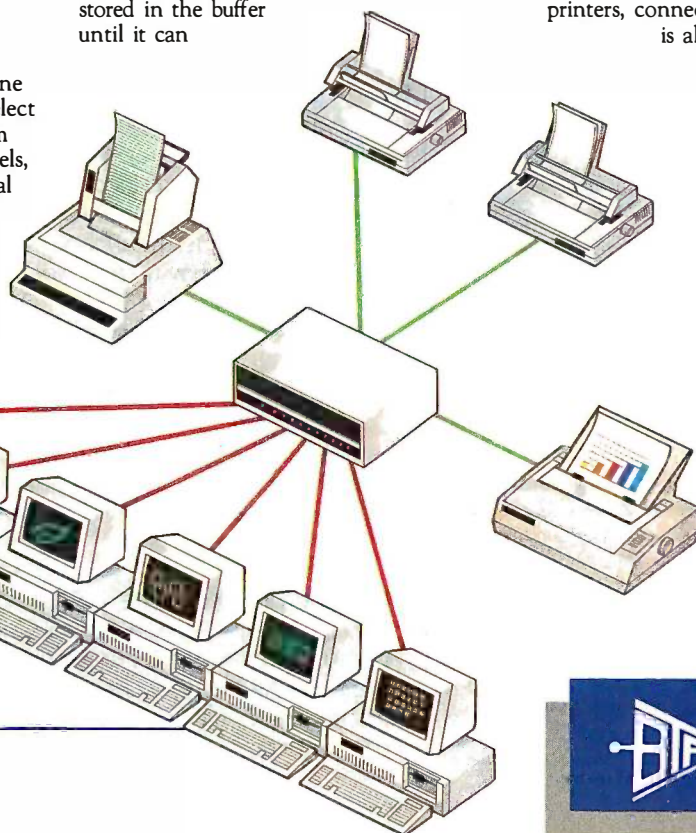

Typical application using the Model 710C

BTA BAY TECHNICAL ASSOCIATES, INC.
DATA COMMUNICATIONS PRODUCTS

AT LAST: Professional Typesetting Capability For PC Users

With **PC T_EX**TM — the best-selling full implementation of Professor Don Knuth's revolutionary typesetting program T_EX.

FINEST Typeset Quality Printing From:
 dot matrix laser phototypesetter

$$\sum_{i=1}^{\infty} \frac{1}{i} \begin{pmatrix} a_{11} & \dots & a_{1n} \\ a_{21} & \dots & a_{2n} \\ \vdots & \ddots & \vdots \\ a_{m1} & \dots & a_{mn} \end{pmatrix} \int_{-\infty}^{\infty} e^{-x^2} dx$$

WIDEST Range Of Output Device Drivers:

- Epson FX, LQ
- HP LaserJet*
- Toshiba
- Apple LaserWriter
- Corona LP-300*
- APS-5 phototypesetter
- Screen preview, with EGA or Hercules card

MOST COMPLETE Product Offering:

PC T_EX (not copy protected) includes the following:

- Our specially written *PC T_EX Manual*, which enables you to start using T_EX right away.
- Custom "macro packages" that provide formats for letters, manuals, technical documents, etc.
- The *L^AT_EX* document preparation system, a full-featured macro package for preparing articles, books, reports, etc., and *L^AT_EX User's Manual*.
- *A_MS-T_EX*, developed by the *Amer. Math. Society* for professional mathematical typesetting.

Site licenses, volume discounts, and interfaces to PC Paintbrush, PC Palette, FancyFont and Fontrix are also available.

PRICED FROM ONLY \$249.00!

(Printer drivers and interfaces additional.)

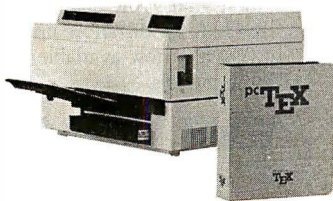

**Laser printer,
 fonts & software
 from \$2995.00**

For IBM PC/XT, AT or compatible, DOS 2.0 or higher, and 512K RAM. Hard disk required for printer drivers and fonts.
 *HP LaserJet and Corona require additional interface boards.

For more information call or write:

Personal T_EX, Inc.

20 Sunnyside, Suite H, Mill Valley, CA 94941 (415) 388-8853

This ad, with space for the photograph, produced by PC T_EX. Typeset on the Epson FX80, the Corona LP-300 laser printer, and the Autologic APS-5 phototypesetter.

T_EX is a trademark of the American Mathematical Society. Manufacturers' product names are trademarks of individual manufacturers.

ACCORDING TO WEBSTER

different programs were involved here: a floating-point benchmark, a Whetstone benchmark, and a Dhrystone benchmark. All were written in Mac (Consulair) C, and three versions were produced: a "generic" version for any Macintosh; a special version for the HD 2000 (labeled "HD special"); and a special version for the Prodigy 4 (labeled "P4 special"). The last two were produced using Mac C compilers specifically designed for each of the two machines. What's interesting is that the Prodigy 4 is (by deliberate design) able to run code specially produced for the HD 2000, but the reverse is not true. Furthermore, the Prodigy 4 runs the HD 2000 code two to three times faster than it runs on the HD 2000. As for the "VAX-on-your-desk" claim, note the Dhrystone benchmark for the Prodigy 4: 3201 Dhrystones/second. According to the source file for this benchmark, this exact same program runs at a clip of 1612 Dhrystones/second on a MicroVAX II and 2083 Dhrystones/second on a VAX-11/785. Not too shabby.

Would I recommend either one? In both cases, the issue is price/performance; that is, does the increased performance of the machine warrant the price? It probably doesn't for the HD 2000; even with the boost in floating-point calculations, there just isn't a sufficient increase in power to make it worth the price. The Prodigy 4 is simply out of the reach of most of us. On the other hand, for engineering and scientific firms looking to put high-powered workstations (like the MicroVAX) on individuals' desks, the Prodigy 4 can seem like a real bargain. Especially since the folks at Levco claim that they will be shipping UNIX for it by the time this sees print. Given a choice of one or the other, I'd choose the Prodigy 4—but I couldn't afford to put out the bucks for either one.

THE 1040ST

As I mentioned last month, an Atari 1040ST finally showed up at my front door, and I like it just as much as I thought I would. The 1 megabyte of RAM is great, TOS in ROM is great, the built-in disk drive and power supply are great. Given the development software that has shown up (discussed below) and the ST books from Abacus (discussed last month), I'm having a wonderful time writing code on the machine. I also got TOS in ROM for the 520ST, so now I've got two useful ST systems around the house. Right now, the 520ST is mostly occupied by my children, who spend vast amounts of time playing Time Bandit, Major Motion, and Mudpies, all games from MichTron Industries. (And I must confess that I've put in a few hours with Time Bandit and Major Motion myself.) Anyway, look for some Mac/ST/Amiga/IBM PC benchmarks in an upcoming column.

MEGAMAX C FOR THE ST

I finally—finally!—have a decent C development system for the Atari ST: Megamax C. Hippo C came and (mercifully) went; DR/Alcyon C was a pain to use and poorly documented; and I have yet to get my hands on a copy of Lat-tice C. Given Megamax C, I'm not sure if I really care to.

(continued)

The American Success Story:

Once upon a time, America lead the world in innovation, quality, engineering, and manufacturing with names like Edison, Ford, and Bell . . .

Once again America returns:

\$1125



CLUB AT Inc. Model 1800 out-performs the foreign AT-Compatible machines with...

PRICE...QUALITY...PERFORMANCE

- * Made in U.S.A.
- * A reputable manufacturer
- * Service in U.S.A.
- * Uses the latest version of Intel parts
- * 48 hours burn-in
- * Same day shipping

10 MHz, zero wait state
SI Rating 11.7 (version 3.00)

\$1495

Features:

- * 6/8/10 MHz, selectable with 8 MHz CPU
- * 10MHz option available
- * 1 MB of inboard memory (with 512K standard)
- * 8 I/O expansion slots
- * 1.2 MB floppy disk drive
- * 195 watt power supply, 110V/220V switchable
- * Touch-type keyboard
- * Fully compatible BIOS (written in U.S.A.)
- * Full documentation, operation manual with binder
- * Full one year warranty

Dealers and Corporate inquires are welcome

CLUB AT INC.

AT COMPATIBLE

SAME DAY DELIVERY

\$1125

**MADE IN U.S.A.
NOT A FOREIGN COPY**

Runs Xenix™
Auto Cad
NOVELL NETWORK
MULTI TASKING

SERVICED IN U.S.A.
Extended Warranty available



FREE

**Fully configured and tested
for your system requirements**

* One Year Limited Warranty
* Dealers and Corporate qty.
Discounts available

- * Free Set Up/Utility
- * 48 Hours Burn-in
- * 8/6 MHz, 8MHz CPU Chip
- * 1.2MB Floppy Drive
- * 195W Power Supply
- * Touch-type Keyboard
- * Fully Compatible BIOS, written in U.S.A.
- * W.D. Hard Disk/Floppy Disk controller
- * 512K RAM, expands to 1 MB
- * Clock/Calendar with Battery Backup
- * 3.3% faster than IBM AT
- * Full Documentation and Manual

- With 20MB Seagate 65MS 1/2 Ht. \$355
- With 20MB Seagate 39MS Full Ht. \$549
- G.W. Basic \$95
- DOS 3.1 \$85
- 80287-8 8MHz \$225
- 80287-5 5MHz \$195

CLUB CT Color AT compatible system

- * Basic System as above
- * Plus Color Display card and color monitor
- * High Quality
- * Fully Assembly and tested, no installation required

\$1599

CLUB CT Mono AT compatible system

- * Basic system as described above
- plus Monochrome Display card and IBM quality Monochrome monitor

\$1499

CLUB EGA Color AT system

\$1995

**IBM QUALITY
MONO-MONITOR**

IBM
Color
\$345



- * 12" screen
- * Nonglare
- * 800 x 350 resolution
- * FCC class 'B' approval

\$138

EGA MONITOR



- * 640 x 350
- * 640 x 200
- * EGA and CGA
- * FCC class 'B' approval

\$480

NEC MULTISYNC



- * 800H x 560V
- * No installation required
- * EGA, VGA, CGA compatible
- * Test Mode Switch

\$539

CLUB EGA GRAPHIC CARD

Quantity discounts available

- * Fully IBM compatible
- * 16 colors 640 x 350 resolution
- * 256KB video memory
- * Runs color/mono display
- * Parallel Port



Made in U.S.A.
Complies with FCC

\$249

**UNIVERSAL DISPLAY
ADAPTER**

Made in U.S.A.

\$248



- * Mono Display Hercules Compatible
- * 132 columns text, color or mono
- * Parallel port
- * One Year Limited Warranty
- * FCC class 'B' approval

**132 COLUMNS
HERCULES**



\$99

- * Printer Port
- * Monochrome Graphics
- * Software Switchable
- * Runs Lotus 12.3 Graphics
- * Run 132 x 44 column display
- comply with FCC class 'B'

6-PAC COMPATIBLE



CLUB 384 (for PC)

- * 0.384K Memory
- * Clock/Calendar
- * Parallel Port
- * Serial Port
- * Game Port and software
- * FCC class 'B' approved

\$88

CLUB TURBO



\$399

- * w/ 128K RAM
- * Runs 7 times faster than PC or 3.3% faster than the IBM AT
- * Runs 80287 math processor in 5MHz or 8MHz speed.

HIGH CAPACITY DRIVE



80MB \$1395
25 ms Access time or
CALL

MEMORY SHORT CARD



CLUB 576 (for PC, Portable)

- * 0.576K Memory
- * Short Card
- * Supports 64K/256K DRAM
- * Software

\$88

Made in U.S.A.

**MINI I/O for PC/XT
AT Version available**



\$89

- * Software
- * 2 Serial Port (2nd optional)
- * Parallel Port
- * Real time clock/calendar
- * Half size card

Made in U.S.A.

AT MEMORY CARD



CLUB 3000 \$155

- * 0.3 MB capacity
- * No Piggy back
- * split Memory addressing
- * 64K/256K RAM chips
- * One Year Limited Warranty
- * FCC class 'B' approved

Made in U.S.A.

**Manager's Choice
AT-Multifunction Card**



12MHz AT-Multifunction
Made in U.S.A.

\$179

- * 0.2MB Memory
- * 128K increment range
- * 2 serial port (1 option)
- * Game port
- * Self installing software
- * Runs at 12MHz

FLOPPY DISK DRIVE



- * 360K
- * Double density
- * Double density
- * Half height
- * TEAC/FUJITSU
- * IBM grey color extra

\$89

XT POWER SUPPLY



Complies with FCC.

- * Reliable
- * 135W
- * Direct replacement
- * One Year Limited Warranty

\$88

**MICROSOFT
COMPATIBLE MOUSE**



\$75

- * 200 Dots/inch
- * 3 Buttons/built in Microprocessor
- * Work with Auto-Cad
- * Mouse with DR. HAL-O

\$109

PRO KEYBOARD



5151

- * AT Style Keyboard w/LED
- * separate Numeric & Cursor keypad

\$88

DATA SWITCH MASTER



- * Share one printer by 4 computers or 1 computer to 4 printers
- * Printer Spooler for IBM
- * Cable included

\$88

FAST HARD DISK FOR PC/XT AND COMPATIBLE

39 ms access time

- * Auto Head Park
- * Boot from Hard Disk
- * 839 MS average access time
- * Quality Seagate drive
- * Special Western Digital Controller
- * Software and Manual included

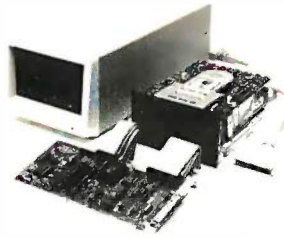

- 20MB Hard Disk Subsystem Seagate 4026
- 30MB Hard Disk Subsystem Seagate 4038
- 40MB Hard Disk Subsystem Seagate (available now)

	INTERNAL	EXTERNAL
20MB	\$659	\$759
30MB	\$759	\$859
40MB	\$859	\$959

FAST AT HARD DISK DRIVE

39 ms Access time

- * 39 MS access time
- * Linear Voice Coil Actuator
- * Boots from Hard Disk
- * Auto Head Parking
- * Cables, AT's iding rail and Software included
- * One Year Limited Warranty



20 MB 4026	\$549
30MB 4038	\$648
40MB 4051	\$699
80MB	\$1395

EVEREX Modem-Hayes compatible

Made in U.S.A. *FCC class B approved

- * Free Bitum Communication Software
- * 300/1200Baud
- * Half size/Half power
- * Excellent for Long Distance calls
- * One Year Limited Warranty

\$128

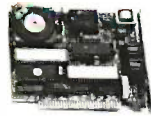

*2400 Baud CALL

CLUB XT Fully IBM XT Compatible

- * 8088 CPU, 4.77 MHZ
- * 640K Memory 756K Standard
- * 360K Floppy Drive
- * Floppy Disk Controller
- * 1.35W Power Supply
- * Legal Compatible BIOS
- * Option Math Coprocessor
- * Dimensions: 17.5 x 19 x 6.1
- * 8087 Coprocessor (option)

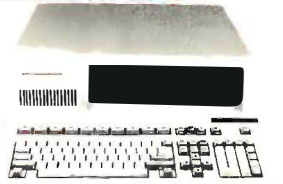

\$699

- * Electrical: 115V/220V
- * One Year Limited Warranty
- * Color: PC/XT Color
- * Quantity discounts available

20/30MB HARD DISK SUBSYSTEM

For PC Upgrade to XT

	INTERNAL	EXTERNAL
20MB	\$399	\$567
30MB	\$499	

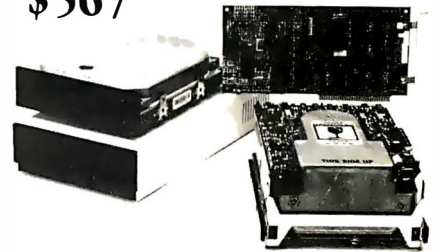

- * 20/30MB Seagate Hard Disk
- * Western Digital Controller
- * Boots from Hard Disk
- * 65MS access time
- * Manual, Cables, Hardware and Software included

With Floppy Controller add \$50

EXPANSION CHASSIS



- * 8 expansion slots
- * 1 half height drive space
- * No heat sink design
- * Round shielded cable
- * Most compatible chassis on the market

\$428

WEEKLY SPECIALS

	Qty. of 2
Seagate 4051	\$638
Fujitsu Floppy 360K	\$78
Teac Floppy 360K	\$85

64K DRAM

150ns (9pcs.)



\$9

256K RAM

150 ns (9pcs.)
120 ns (add \$9.00)



\$27

OTHERS

HARD DISK CONTROLLERS

* PC/XT Controller	\$90
* PC/XT Controller/Floppy Controller	\$140
* AT Controller/floppy Controller	\$170
* Compaq 286 Hard Disk Controller	\$188
* Floppy controller	\$49
* 25 Pin Serial Cable	\$18
* IBM Type Printer Cable	\$15
* Split Power Y-Cable	\$8
* IBM AT Bus Extender Card (good for test & debug)	\$30
* Data Switch Box	\$68

CHIPS

* EPROM 2764	\$6
* EPROM 27128	\$8

TAPE

	INTERNAL	EXTERNAL
* Teac	\$580	\$680
* Wangtek	\$747	\$827

SOFTWARE

* Communications BIT COM	\$49
* Graphics DR. HALO	\$49

ADD ON

* Kits for Mini I/O, 2nd Serial Port	\$25
* Kits for CLUB 2000, 2nd Serial Port	\$25

FREE MEMBERSHIP

CLUB AT INC.

46707 Fremont Boulevard, Fremont CA 94539

Quality and Volume is Our Business

All Sales Call (415) 490-2201

Fax No. 414-490-2687

DEALER SPECIALS

* 6/8 MHZ AT compatible computer	CALL
* AT HD, Floppy Controller (XT size)	\$160
* XT HD, Floppy Controller (XT size)	CALL
* AT keyboard	\$50
* AT power supply 192 watt	\$95
* Mini I/O	\$45
* Memory short card	\$40
* Two Drive Chassis	\$85
* Math Coprocessor	CALL

CHASSIS

- * W/ Power supply
- * For two drives



\$99

AT Hard disk/ Floppy controller



- * AT compatible
- * Western Digital chipset
- * XT Size Format

\$170

University P.O.'s are welcome
Corporate Buyer call for Neil Mehta

Quantity Discounts are available
Dealers are Welcome

ORDER BY MAIL: Check or Money Order, California add 6.5% Sales Tax

ORDER BY PHONE: C.O.D., Cashier Check, VISA, MASTERCARD, AMERICAN EXPRESS (3% Extra) or Approved Company P.O.

TERMS: Due to our Low Price, all sales are final. All prices are subject to changes and quantity may be limited and we reserve the Right to Substitute Equivalent Items. Unauthorized Returns are subject to 10% Restocking Fee. Call for RMA Numbers for Returns and Repairs. * All Prices are subject to change without notice.

IBM, Hercules, Bitcom, Acorn are Trade Marks of their Respective Companies. Limited Warranty: 1 Year parts and 6 months Labor

TOTAL CONTROL

with LMI FORTH™

ACCORDING TO WEBSTER

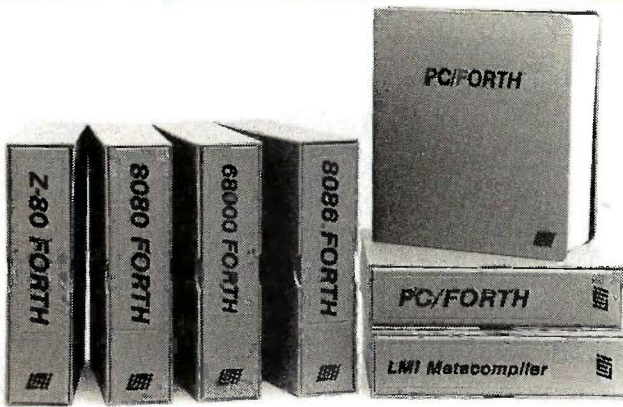

For Programming Professionals: an expanding family of compatible, high-performance, Forth-83 Standard compilers for microcomputers

For Development: Interactive Forth-83 Interpreter/Compilers

- 16-bit and 32-bit implementations
- Full screen editor and assembler
- Uses standard operating system files
- 400 page manual written in plain English
- Options include software floating point, arithmetic coprocessor support, symbolic debugger, native code compilers, and graphics support

For Applications: Forth-83 Metacompiler

- Unique table-driven multi-pass Forth compiler
- Compiles compact ROMable or disk-based applications
- Excellent error handling
- Produces headerless code, compiles from intermediate states, and performs conditional compilation
- Cross-compiles to 8080, Z-80, 8086, 68000, 6502, 8051, 8096, 1802, and 6303
- No license fee or royalty for compiled applications

For Speed: CForth Application Compiler

- Translates "high-level" Forth into in-line, optimized machine code
- Can generate ROMable code

Support Services for registered users:

- Technical Assistance Hotline
- Periodic newsletters and low-cost updates
- Bulletin Board System

Call or write for detailed product information and prices. Consulting and Educational Services available by special arrangement.

LMI Laboratory Microsystems Incorporated
Post Office Box 10430, Marina del Rey, CA 90295
Phone credit card orders to: (213) 306-7412

Overseas Distributors.

Germany: Forth-Systeme Angelika Fleisch, Titisee-Neustadt, 7651-1665
UK: System Science Ltd., London, 01-248 0962
France: Micro-Sigma S.A.R.L., Paris, (1) 42.65.95.16
Japan: Southern Pacific Ltd., Yokohama, 045-314-9514
Australia: Wave-onic Associates, Wilson, W.A., (09) 451-2946

Megamax C comes with a suite of programs: editor, compiler, linker, disassembler, code optimizer, librarian, and shell. It also has the requisite header files and libraries so that you can make calls to GEM AES, GEM VDI, GEM-DOS, BIOS, and XBIOS. The shell puts you into a custom menu (drop-down) environment that lets you quickly go from editor to compiler to linker to finished program. It even has delete-file and rename-file functions, though I wish it also had a copy-file function. I just move all the important stuff onto a 440K-byte RAM disk (on the 1040ST, of course), and the whole system screams along.

The program editor is the nicest I've seen on the ST and comes the closest of any of those to emulating some of the Mac program editors (like Bill Duvall's EDIT). You can have multiple windows open, editing multiple files. You can use the "click-drag" mouse function to select blocks of text and transfer code between files. You can set tabs and toggle auto-indent mode (something of an obsession with me). You can even set an "auto-save" mode that will automatically save your program out to disk every few minutes.

The compiler is fast, as is the linker. Running off a RAM disk, I was able to compile a 500-line program—including two header files—in about 6 seconds; linking the same took another 12. With the "make" option (which allows you to edit your own link-and-compile file, then just run that from the main menu), the time is even quicker. If errors occur during compilation, the shell is smart enough to put you back into the editor and open two windows: one for your source code file, and one for the errors listing. It makes debugging a lot quicker than it would be otherwise.

I'll save most of the benchmarks for a future column, when I can get a full suite up and running. But just for idle comparison with table 1, I got 3.9 seconds for sieve; 6.0 for matrix; 4.4 for sort; and 3406 floating-point operations/second. And that was not using register variables.

PRODUCT OF THE MONTH: HiSOFT DEVPAcST

I wasn't planning on having an assembler be the product of the month again, but that was before version 1.22 of HiSoft DevpacST showed up, along with a prerelease (version 0.16) of the Amiga version, DevpacAM. DevpacST is a complete 68000 assembly language development package, with an integrated editor/assembler, a debugger, a linker, the necessary include files, and a few sample programs. The 150-page manual comes in a small two-ring binder that lies flat; the manual itself is well written and well organized. And, as a welcome bonus, you get the *Motorola 68000 Programming Pocket Reference Guide*, a compact 120-page booklet listing all the 68000 instructions. The disk is not copy-protected, but then, not much development software is (thank heavens). The whole package costs only \$79.95.

Getting into the editor/assembler (GenST) is easy: Just double-click on the icon, and you're ready to go. You can now start typing in your program or load in an existing file. The editor itself is fast and fairly easy to use. It ac-

(continued)

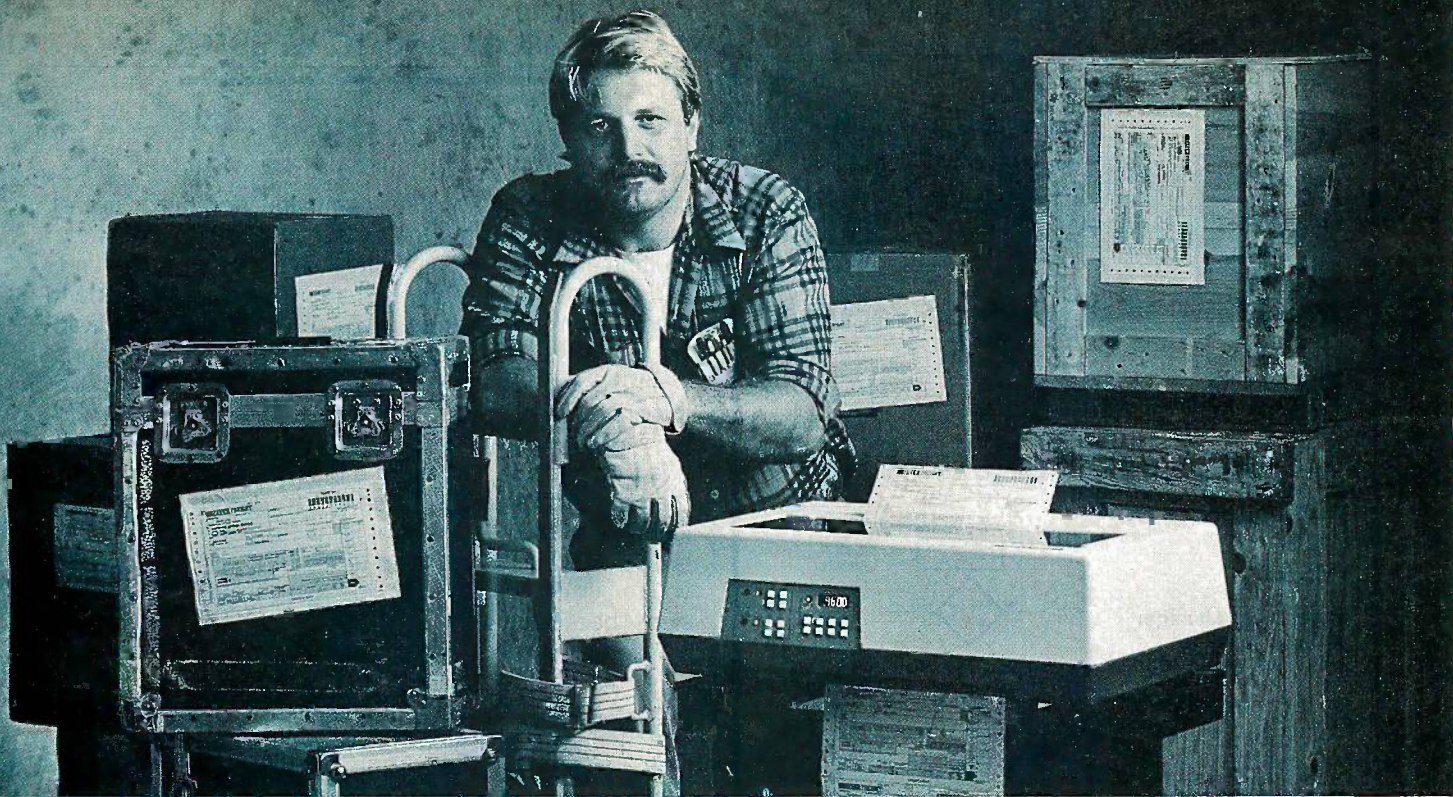

WORKING CLASS HEROES.

The Datasouth High Performance Matrix Printers.

Power. Toughness. Sticking to the job until the work gets done. These are some of the working-class virtues we build into Datasouth printers. Giving the DS 180 and DS 220

the proven ability to run around the clock, around the calendar, in some of the toughest applications imaginable.

That kind of blue-collar reliability is the result of a very advanced design

philosophy. One that created two hard-working matrix printers perfect for your medium-speed printing requirements, from 180 to 220 cps. Ready to take on multipart forms of up to 6 layers. Or produce Near Letter Quality text at 45 cps for word-processing applications. And although they're tough, Datasouth printers are easy to use, with front panel controls instead of dipswitches and jumpers.

Each and every DS 180 and DS 220 printer that comes out of our Charlotte, North Carolina plant has been put together and inspected by hard-working people who take a lot of pride in building the world's toughest printer right here.

Put a working-class printer to work for you. To find your nearest Datasouth distributor, call us at 1-800-222-4528.



Datasouth
AMERICA'S HIGH PERFORMANCE
PRINTER COMPANY

P.O. Box 240947, Charlotte, N.C. 28224, (704) 523-8500, Tlx: 6843018, DASO UW SALES: 1-800-222-4528, SERVICE: 1-800-438-5050, West Coast Office: (818) 702-9065

8080
Z80
6809

AMX

8086
8088
Now
68000

Real-Time Multitasking Executive

- No royalties
- Source code included
- Fault free operation
- Ideal for process control
- Timing control provided
- Low interrupt overhead
- Inter-task messages

Options:

- Resource Manager
- Buffer Manager
- Integer Math Library

■ Language Interfaces:

C	Pascal		
PL/M	Fortran		

■ DOS File Access:

CP/M-80	8086		\$ 800 US
IBM PC DOS	6809		950
	68000		1600
	Manual (specify processor)		75

AMX is TM of KADAK Products Ltd.
CP/M-80 is TM of Digital Research Corp.
IBM, PC DOS are TM of IBM Corp.

KADAK Products Ltd.

206-1847 W. Broadway, Vancouver, B.C., Canada V6J 1Y5

(604) 734-2796
Telex: 04-55670

Why Settle For An Impersonal Computer?



NEW

Add a powerful personalized user interface and voice control to any PC-DOS/MS-DOS application program using PRONOUNCE.

- Add "novice mode"
- Works with keyboard and any input device
- Add "expert mode"
- No programming required
- Integrate diverse programs using standard commands

Available with the new AT-speed ProVOX XT™ or separately starting at just \$695.



800-325-9206
or (206) 939-2321

cepts a subset of WordStar commands for cursor movement, as well as using the mouse and scroll bars. There are find and replace commands, a print-block command, and options to set tab length and toggle an auto-indent mode. It isn't a tremendously powerful or flexible editor, but it gets the job done nicely, and almost all commands can be done from the keyboard for those who don't like mice. I do have one major complaint, though. I can find no way of copying a block of text from one file to another. It is true that you can mark a block of text within a file, then move it, delete it, or save it to disk. But once you load in a different file, that block is "forgotten," and there is no mechanism for pulling text off the disk into the file you're currently editing. I hope that's fixed in future versions, because it's a real limitation.

The assembler is invoked from within the editor. It brings up a dialog box that lets you name an output file (if desired) and also indicate a listing destination (none, screen, printer, disk file). The assembler is quick and runs in two passes, the optional listing being generated during the second pass. You can pause the assembly by holding down the Alt key or abort it with the Esc key. Errors are listed as they are encountered. Once the assembly is done, any keystroke takes you back to the editor. If there were errors, you can then use the "Jump to Error" command to go to the errors in succession.

The assembler is full-featured, supporting the 68000 instruction set, complex expressions, a number of options (debugging information, macro expansion, case sensitivity, etc.), include files, alignment operators, printer commands, conditional assembly, macros with up to 10 parameters and with unique label generation, and so on. Labels can be just about any workable length; the first 16 characters are significant. You can choose to produce ready-to-run code or linkable code modules. In short, it has almost everything you'd want in an assembler.

Once you've produced working code, you need to exit GenST to run your program. What, then, if you have problems? Well, you can invoke MonST, the debugger that comes with DevpacST. When you run it, it brings up four displays on the screen: registers, memory, disassembled listings, and a command line. You can now set breakpoints, modify memory, single-step through your code, "interpret" an instruction (for example, make a trap call without having to single-step through the entire trap handler), disassemble areas of memory, and so on. If you included the D+ option in your source code, MonST pulls up the symbol table and uses your labels in the disassembly. The debugger is not as slick as Metascope (see below), but it still gets the job done. It uses a different location in RAM for its screen display, so it doesn't interfere with what your program writes to the screen (and vice versa). MonST actually comes in four flavors: GEM or TOS, and resident or user-invoked. All four versions are on the disk; you can choose the one that best suits your needs.

The linker (LinkST) supports the GST linker file format, but not the DR (TOS) format. The folks at HiSoft give three reasons for this: first, the DR spec wasn't made available;

(continued)

332 BYTE • NOVEMBER 1986

Inquiry 214

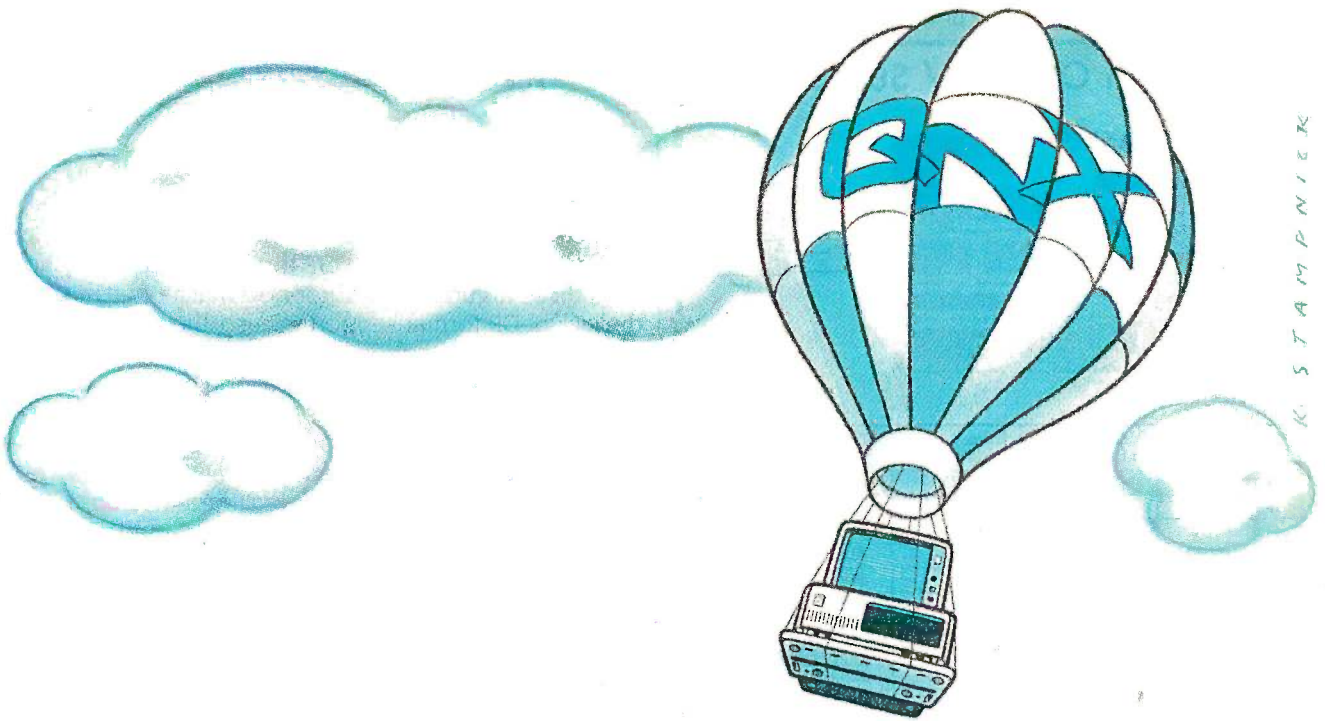

QNX: Other operating systems may never lift the PC to such heights.

QNX was the first operating system with multi-tasking, multi-user capabilities for the IBM PC and compatibles (1982). Then, once again, for the IBM AT and compatibles (1984). In 1984, QNX achieved integrated networking capability, something no other multi-user, multi-tasking operating system has achieved, or is likely to achieve, on IBM personal computers.

QNX consistently beats competitive operating systems to each new height in PC performance. Unlike other multi-user, multi-tasking operating systems, QNX is *not* UNIX-based. Being rigid and monolithic, UNIX architecture is difficult to adapt. By contrast, QNX is modular, based on message-passing, and easy to adapt. UNIX developers have had to preoccupy themselves with merely getting UNIX to work on the personal computer, while QNX, designed specifically for this environment, has enjoyed rapid and continuous growth.

QNX's superb performance and compact size is the result of one dedicated design team with a

common purpose and complete understanding of both the software and the environment in which it must run. Quick and efficient on a PC, QNX soars on an AT.

Of all multi-user, multi-tasking operating systems, only QNX provides unrestricted communications among all tasks anywhere on the network. Therefore, only QNX can implement true distributed processing, distributed file systems, and distributed devices, with no need for central file servers.

No one wants to abandon the tremendous amount of DOS software available. QNX does not force that choice. DOS 2.1 and 3.1 run as single-user tasks under QNX, even on the AT in protected mode.

With over 22,000 systems installed worldwide, QNX remains unsurpassed in PC performance.

We invite End Users, VAR's, OEM's and Software Developers to discover a whole new world of computing capabilities.

Multi-User	10 serial terminals per PC, AT.	C Compiler	Standard Kernighan and Ritchie.
Multi-Tasking	40 (64) tasks per PC (AT).	Flexibility	Single PC, networked PC's, single PC with terminals, networked PC's with terminals. No central servers. Full sharing of disks, devices and CPU's.
Networking	2.5 Megabit token ring. 255 PC's and/or AT's per network. 10,000 tasks per network. Thousands of users per network.	PC-DOS	PC-DOS runs as a QNX task.
RealTime	2800 task switches/sec (AT).	Cost	From US \$450. Runtime pricing available.
Message Passing	Fast intertask communication between tasks on any machine.		

For further information or a free demonstration diskette, please telephone (613) 726-1893.

The only multi-user, multi-tasking, networking, real-time operating system

QNX for the IBM PC, AT and compatibles.
By Quantum.

Unix is a registered trademark of AT&T Bell Labs. IBM PC, AT, and PC DOS are trademarks of IBM Corp.

Quantum Software Systems Ltd., Moodie Drive High Tech Park, 215 Stafford Road, Ottawa, Ontario, Canada K2H 9C1

Expansion Chassis / Sub-System

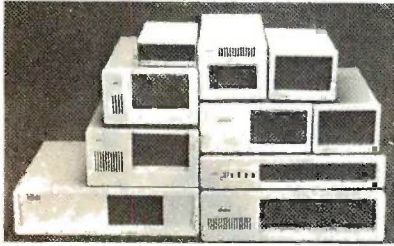

Specification

Model No.	No. of Slot	Space for 1/2 Height Drive	Power Supply (Watts)	Dimension D x W x H (cm)	Price
M-1*	0	1	50	30 x 15 x 6.5	\$139
M-2	3	3	100	42 x 25 x 16	\$299
M-3	5	3	100	39 x 30 x 15	\$239
M-4	12	2	100	40 x 39 x 14	\$289
M-5	0	2	45	39 x 18 x 15	\$149
M-6	0	1	50	26.5 x 18 x 13.5	\$169
M-7	5	2	100	38.5 x 30 x 13.5	\$299
M-8	0	2	45	39.5 x 18 x 13.5	\$149
M-9	0	2	60	38.5 x 49 x 9	\$249
M-10	8	4	135	43 x 49 x 14	\$239

*Extra space for a stand alone controller

EXT and RCV Adapters (Interface Computers & Chassis) . . . \$149

ORDER TOLL FREE: (800) 826-0267
In California Call (408) 434-0877
DEALER INQUIRIES INVITED
SOURCE ELECTRONICS CORP.

2380 Gume Dr., Ste. E
 San Jose, CA 95131

Telex: 279366 Fax: (408) 434-0539

ACCORDING TO WEBSTER

second, it appears (to them) that the DR format is "very restrictive"; third, (according to them) support from third parties is greater for the GST format. I don't know how valid those arguments are, nor how much of a limitation the lack of DR format support is. Also, the assembler lets you create only one module per binary file (though that module can have multiple XREFs and XDEFs), so you can't really build libraries with the assembler. Reference is made to using a "library creation program" to do the trick, but no such program is included with this version of DevpacST. On the other hand, I haven't had much occasion to use the linker, so I'm not really concerned.

By the way, the Amiga prerelease worked nicely. It had only the editor/assembler (GenAM), but that was enough for me to do a fair amount of coding, modifying a sample program that came with it (see below). I suspect it will be shipping by the time you read this; if so, consider it strongly for your Amiga assembly language programming needs.

DevpacST is a well-designed, well-implemented package with good documentation and an excellent price. It has done more to get me playing around with the ST than any other language or development system I've used to date, and the Amiga version threatens to do the same. As further proof of its utility, at least one commercial package for the ST—the arcade game Star Glider, written by Jez San and published by Rainbird Software—was developed entirely using DevpacST. HiSoft, and especially Andy Pennell, should be congratulated for a job well done.

METASCOPE

The Amiga version of Devpac came with a sample program that brought up a small window and displayed (in hexadecimal notation) the amount of free memory, updating it whenever the value would change. The source code had the comment, "Conversion to decimal is left as an exercise to the reader!" Fine, I thought, and I exercised myself, scouring a collection of 68000 texts for a binary-to-decimal routine. Unfortunately, most handled only 16-bit values, since the DIVU instruction on the 68000 is a 16-bit instruction, and I needed to be able to convert 24-bit values. However, the text *Programming the Macintosh in Assembly Language* (by James W. Coffron, Sybex, \$24.95) had a nice routine that handled 32-bit values by using a table of divisors. I keyed it in, adapting it as I went and dropping the sections that dealt with negative numbers. Unfortunately, the new, improved program (called FreeMem) insisted on dropping the last decimal digit: Instead of printing "181253 bytes free," it would print "18125 bytes free." And so I went to the bookshelf and dug out a hitherto unused copy of Metascope, a window-based debugger for the Amiga.

What a nice product. A quick scan through the manual—most notably Chapter 5, "Usage"—showed me how to set things up. When I ran Metascope, a status window appeared, showing me the contents of the 68000's registers (16 of them, plus the status flags). A few quick pull-down menu commands brought up a second window showing

(continued)

SOLID OAK COMPUTER FURNITURE

\$135*

- Computer Desk ... \$135
- Keyboard Slide \$ 25
- CPU Storage Unit . \$ 25
- Pencil Drawer \$ 25
- 48" Hutch \$ 30
- 20" Hutch \$ 20

Dimensions: 48"L x 20"D x 27"H
 (Other Dimensions Available)
 Order desk without a finish and save 10%
 *Plus Options and Shipping
 Satisfaction Guaranteed
 or Your Money Back

COMPUTER FURNITURE CRAFTSMEN

1812 Dan Court
 P.O. Box 10 Palm Bay, FL 32906
 1-305-725-2356

STATGRAPHICS®

Now!
Faster. More Procedures.
Improved Data Management!

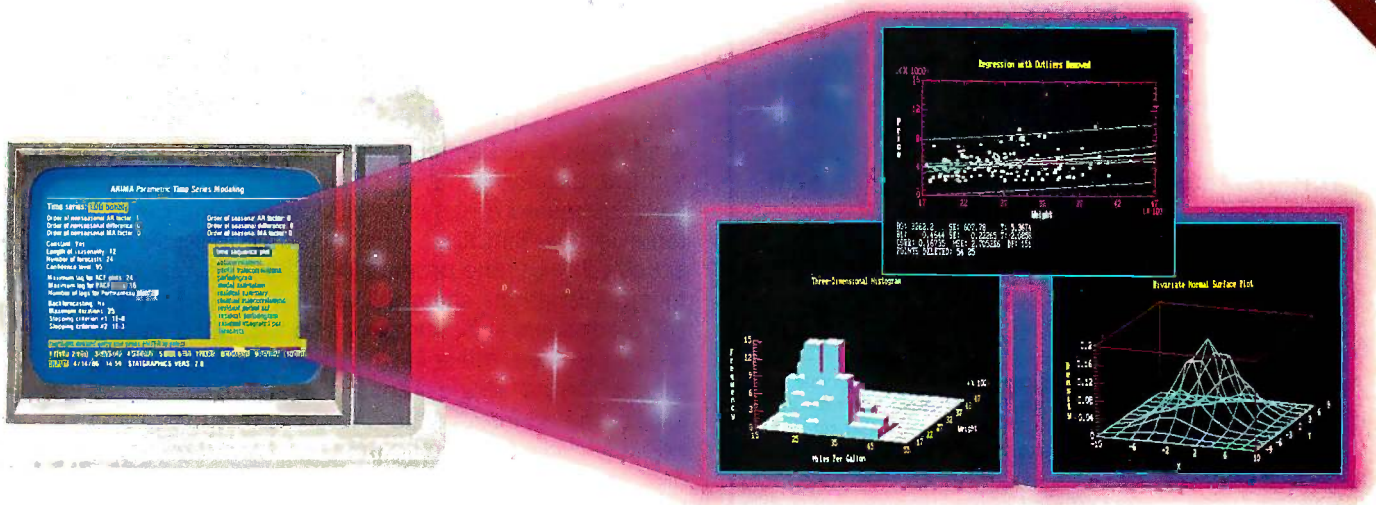

Powerful Statistics, Sophisticated Graphics In One Complete Software System

STATGRAPHICS from STSC is simply the most complete and powerful statistical software available for your PC. STATGRAPHICS integrates powerful statistics with high-resolution color graphics—in one single software system—to give you an extraordinarily powerful analytical environment.

"[STATGRAPHICS] is unusually complete as software systems go in terms of statistical capabilities."

(PC Week)

With more than 250 statistical and mathematical procedures, STATGRAPHICS offers you the power and precision of mainframe software—right on your PC. All the tools you need for comprehensive statistical analysis: ANOVA, complete regression analysis, experimental design, quality control procedures, multivariate techniques, nonparametric methods, and extensive forecasting and time series analysis, including Box-Jenkins.

"I've found STATGRAPHICS to be one of the most complete and easy-to-use statistics programs that I have come across."

(Whole Earth Software Catalog)

All this statistical power is even more valuable with STATGRAPHICS' unique interactive environment. STATGRAPHICS is completely menu-driven so you can get into your statistical analysis work quickly and be productive right from the start. You can easily go back and forth between your numerical and graphical analysis—change variables as many times as you want—and see the effect immediately.

You can also enter and access data easily. STATGRAPHICS has a full-screen data editor and interfaces with standard ASCII files, Lotus® 1-2-3® and Symphony® worksheets, and dBASE® files.

"Verdict: [STATGRAPHICS is] a model PC software system which will set standards for PC statistical software."

(PC User Magazine)

STATGRAPHICS offers you a wide variety of graphics capabilities to help you visually analyze your data—more options and more sophistication than any other PC statistical software. Included are histograms, two- and three-dimensional line and surface plots, scatter plots, time sequence plots, quality control charts, as well as bar and pie charts. STATGRAPHICS supports a wide range of graphics boards, printers, and plotters.

For the most complete, advanced statistical graphics software system available, order STATGRAPHICS today. To order, contact your local dealer. If they don't have it, tell them to call STSC toll-free.

(800) 592-0050

In Maryland or Canada call (301) 984-5123.

STATGRAPHICS—the best overall choice!

	Integrated Statistical Graphics	Direct Lotus & dBASE Interfaces	Menu-Driven	Minimum Hardware Required	Helpline Support	U.S. Suggested Retail Price
STATGRAPHICS	✓	✓	✓	Dual Floppy Disk	✓	\$795*
SPSS/PC +™	NO	NO	NO	10 Meg Hard Disk	✓	\$1385
SAS®/PC	NO	NO	✓	20 Meg Hard Disk	✓	\$2700+ Annual Maintenance Fee

Data compiled as of April 1986

SEE US AT COMDEX.

STSC

Inquiry 327

Available nationally through Softsel and distributors worldwide. Dealer inquiries welcome.

*International prices slightly higher. STATGRAPHICS, SAS, and dBASE are registered trademarks of Statistical Graphics Corporation, SAS Institute Inc., and Ashton-Tate, respectively. Lotus, 1-2-3, and Symphony are registered trademarks of Lotus Development Corp. PLUS*WARE and SPSS/PC+ are trademarks of STSC, Inc. and SPSS Inc., respectively.

A PLUS*WARE™ PRODUCT

DeSmet C

now with 32-Bit Pointer Option

C88 *still* \$109

The editors' choice for fast compilation and execution. The price/performance winner in all major C benchmarks since 1983. Includes Compiler, Assembler, Binder, Librarian, Execution Profiler and Full Screen Editor. Supports both disk and memory resident Overlays. Contains both 8087 and Software floating point support. Full STDIO library.

Large Case Option.....\$50

Makes a great C Compiler even better. Adds 32-Bit Pointers to C88 so you can utilize all of your PC. Groups scalar and static data for fast access. Supports the D88 debugger.

D88 \$50

Gain most of the benefits of an interpreter while losing none of the run-time speed of the C88 compiler. Display C source and variable contents during execution. Set breakpoints by function name or line number. Examine and set variables by name using C expressions.

order direct from:

C Ware Corporation

505 W. Olive, Suite 767, Sunnyvale, CA 94086 U.S.A.

(408) 720-9696 — Telex: 358185

We accept VISA, MasterCard & American Express

ACCORDING TO WEBSTER

a disassembled listing of FreeMem. I scrolled through until I found the binary-to-decimal routine (called BinToDec), clicked on the memory location of its first instruction, and used the Once command, which ran FreeMem until it hit that location. At that point, register A0 had the address of the string FreeMem was going to print in its own little window, so I clicked on the contents of A0 in the status window and used a menu command to create a memory window, displaying the memory at the string's location.

I also created a memory window showing the divisor table used by BinToDec. I then was able to single-step execution through the program, watching the registers and memory locations change. The loop counter (in register D2) didn't seem to be synchronized with the divisor table, so I let FreeMem run until it hit the start of BinToDec again, then I started single-stepping again. When BinToDec loaded the address of the divisor table into register A1, I double-clicked on the contents of A1 in the status window, changed the value to start at the second table entry, then let the program run. Sure enough, it worked this time. Got out of Metascope, got into GenAM, edited FreeMem, assembled it, then ran it. Fixed!

Metascope does a lot more than I've explained here. Other window types (breakpoints, hunks, symbols) can be created. Logging to disk is supported. Various forms of single-step and continuous tracing are available. Lots and lots of menu options are available for the different window types, more than I care to describe here and possibly more than I'll ever use (unless I get really adventurous).

What can't Metascope do? Well, Chapter 6 (entitled "Limitations") points out that Metascope can't debug any tasks or processes that your program might start; that it can't be used with programs that take over trap handling; that single-stepping through time-critical portions of code where your program must respond to the system or has seized control of certain resources can cause crashes; single-stepping through certain system routines can also cause crashes; and so on. In short, the Amiga system is a complex multitasking environment, and Metascope can't handle all possible situations in it. I'm not sure, though, if any debugger on the Amiga will be able to handle those problems. As far as I can tell, Metascope is the best debugger for the Amiga. It's easy to use, very flexible, and works well.

TxEd

Up until recently, most of my program editing on the Amiga has been done with the Lattice Screen Editor (LSE), with occasional use of ED or EDIT, the two system editors that come with the Amiga. Then Charlie Heath of Micro-Smiths Inc. sent me the latest version (1.3) of TxEd, and I've dropped the other three completely. TxEd is a fast, slick program editor that eases a lot of the pain of entering code on the Amiga. What's more, it's quite a bit smaller than LSE, using less disk space (or, for that matter, RAM).

Yes, get TxEd if you're editing almost anything on the Amiga. It has the usual functions, though it tends to use the right Amiga key (i.e., the red "A" key to the right of

(continued)



AUTOROUTER
NOW AVAILABLE
FOR ADDITIONAL \$975.00

EE DESIGNER™
CAE/CAD Integrated Software Package for
IBM PC, XT or AT **\$975**

At only \$975, no electrical engineer can afford to be without this end-to-end circuit design, simulation and PCB layout tool. You can pay up to 15 times more and still not get all the features offered by EE Designer—Schematic Capture...Circuit Simulation...PCB Layout. 30 day money back guarantee. Full purchase price refunded if not completely satisfied. Call 1-800-225-5669 today to order your package. Bank cards welcome.

VISIONICS
CORPORATION
1284 Geneva Drive
Sunnyvale, CA 94089

PERFORMANCE

THAT IS OUT OF THIS WORLD...

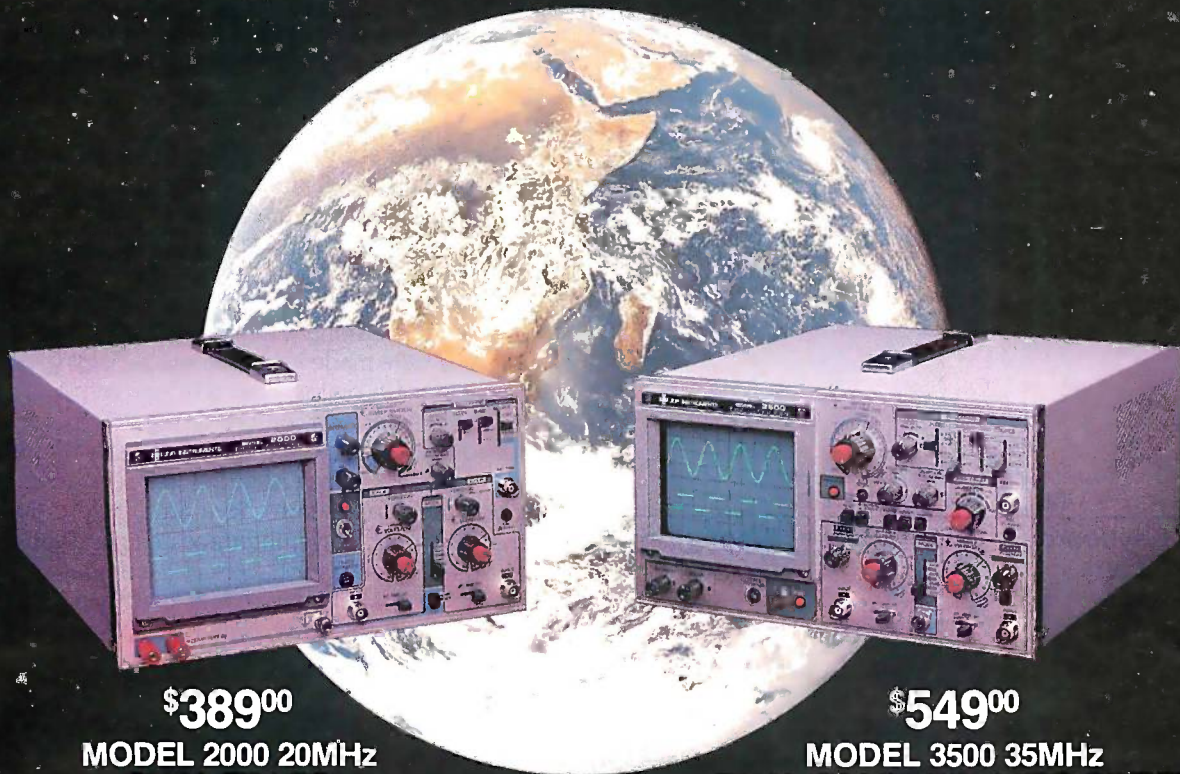

\$389⁰⁰

**MODEL 2000 20MHz
DUAL TRACE**

\$549⁰⁰

**MODEL 3500 35MHz
DUAL TRACE DELAYED SWEEP**

...AT A DOWN TO EARTH PRICE

At last! Truly affordable test equipment with no compromise in design, and features you would expect to find only on oscilloscopes costing hundreds of dollars more! JDR Instruments presents two, new, high-performance models backed by a two year warranty and technical support which is only a phone call away. Perfect for the technician or advanced hobbyist, both models feature Dual Trace capability and a variety of operating and triggering modes, including CH-B Subtract and X-Y operation.

MODEL 2000 has a 20 MHz bandwidth and 20 calibrated sweeps ranging from .2s to .2 μ s. A convenient built-in component tester provides additional diagnostic power.



INCLUDES TWO HIGH QUALITY
1x, 10x TEST PROBES

MODEL 3500 features a 35 MHz bandwidth and exceptional 1mV/DIV sensitivity. Delayed sweep and variable holdoff allow stable viewing of complex waveforms.

ORDER TOLL FREE
800-538-5000
800-662-6279 (CA)



JDR INSTRUMENTS

**1224 South Bascom Avenue
San Jose, California 95128 (408) 995-5430**

TEMPLATES & DUST COVERS

Overlays made of sturdy non-glare plastic, color coordinated to compliment your keyboard. Info Plate is designed to put commands and functions on your keyboard; therefore, allowing you better control and flexibility in using your favorite software. Corporate and Educational Discounts available. Call for quotations on custom templates.

ONLY \$12.20 each

plus \$1.80 Shp/Hld

Foreign Order \$17.00 S/H

VISA / MC / Chk / MO

* NC Residents add 5% Sales Tax



	KEY TRONIC 5151	NEW IBM PC/XT/AT ZENITH 200	NEW IBM XT/AT ENHANCED	AT&T 6300	NEW TANDY 1000 1000 SX
Lotus 1-2-3	X	X	X	X	X
Wordperfect 4.1	X	X	X	X	X
Multimate	X	X	X	X	X
dBASE III+	X	X	X	X	X
dBASE II	X				
RBASE 5000	X				
Wordstar	X				
Wordstar 2000	X				
DOS 2.1	X	X		X	X
DOS 3.1	X	X	X	X	
Microsoft WORD	X				
Samna Word	X				
Volkwriter Deluxe	X				
Blank do-it-yourself	X	X	X	X	X

CALL FOR AVAILABILITY OF ADDITIONAL TEMPLATES
A BETTER QUALITY PRODUCT AT A LOWER VALUED PRICE

Vinyl Keyboard Dust Covers

\$6.95 each + \$1.10 Shp/Hld

Key Tronic 5151 & 5153

AT&T 6300

IBM PC/XT/AT (ENHANCED)

Compaq, Zenith 200

Tandy 1000/SX & 2000

Satisfaction Guaranteed

INTERSTATE SOFTWARE

P.O. BOX 6536 DEPT.11
HIGH POINT, N.C. 27262

FOR ORDERS ONLY 1-800-992-2981

FOR NC AND INFORMATION

CALL (919) 869-5570

ACCORDING TO WEBSTER

the space bar) instead of the Control key for keyboard commands, making keyboard entry more difficult than it should be. If you have sufficient RAM available, you can start up another command-line interpreter, or even another instance of TxEd (which is an actual, complete copy of the program, not just two windows for the same edit session).

What do I like about TxEd? Just about everything. It's fast. It's easy to use. It does almost everything I want it to and, for you mouse haters, does most of it from the keyboard.

TxEd isn't perfect, though. Its greatest flaw is with the Open command, which lets you leave the file you're working on and start editing a new one. It does not save any changes you have made in the file you're leaving, nor does it warn you (via a dialog box) that you're going to lose those changes. Instead, before doing an Open, you are supposed to look at the top of the window, where it says "TxEd." If the "x" is uppercase (i.e., if it says "TXEd"), you know you are supposed to do a Save before doing the Open. Unacceptable user-interface design, if you ask me. I can just see some poor hacker at 3 a.m. hastily making changes to several files, confident that the program will compile and run this time, only to discover that a Save wasn't done before one of the Open commands and all the changes to a particular file are lost. I hope Charlie fixes this defect in the next version of TxEd.

My only other grumbles are more of a "wish list" variety. TxEd does support auto-indent, but to do it you have to hit the Enter key (over in the numeric keypad) rather than the Return key; as a proficient touch-typist I find that awkward, because I have to stop and think about what key to hit at the end of each line. I'd rather just have a menu selection that toggles auto-indent mode, as the editor in Devpac and many other program editors do. I also wish TxEd let you set the tab length (again, as Devpac does). TxEd assumes a tab length of eight, which for my taste is too long for C or Pascal and too short for assembly language.

Besides TxEd, a few other utilities are on the disk. Two programs, AmigaText and IBMText, are used to convert text files for transmission back and forth between an Amiga and an IBM PC. Another program, Relab, recreates the tab characters that ED (one of the system editors, remember?) converts into spaces for you. And the final program, PROFF, is a file-printing program that lets you insert formatting commands into TxEd files and have them come out nicely on your printer.

Despite my grumbles, TxEd is the best program editor I've seen for the Amiga. And it's only \$59.95 for the latest version along with the additional utilities.

TURBO PASCAL FOR THE MAC

Yes, Turbo Pascal for the Macintosh really does exist. I recently received a beta copy (1.00B) from Borland International and spent some time playing with it. It still has a few glitches and is not 100 percent Lisa Pascal-compatible yet, but it does provide the high-speed integrated

(continued)

The PC Tech Board Room Presents:



THE X16B NOW FEATURES 8 or 10 MHz operation with the 80186 CPU, 1 Megabyte of memory with no wait states, a real time clock, floppy disk controller for 4 drives - 360K/720K/1.2M. On board options: SCSI port, two serial ports, and 8087-2.

..... Price Reduced!! \$599.00
OEMs Note: Customs boards and ROM BIOS available.

Monochrome system w/ 2 floppies, 1 serial port, 135W P.S., keyboard, mono card w/ printer port, mono monitor \$1,345.00

THE 4 MEGGER BOARD is new leader in EMS boards. This 2/3 length card contains 4 megabytes of EMS memory which works with Symphony, MS-Windows, and others. It is supplied with a fast memory disk driver and works with the X16 or IBM PC/XT

..... Introductory Special!! \$850.00

THE MEMORIES BOARD has four universal byte-wide sockets which can accept RAMs, EPROMs, and EEPROMs up to 256K total. Also has optional Hex displays for diagnostics and status. Suggested uses are in diskless workstations, networked systems, diagnostics and customization of any PC. \$95.00

More To Come!!! We also sell systems, drives, power supplies, keyboards, etc. Call or write for complete list.



Customization Welcomed!!

(612) 345-4555

904 North 6th Street

Lake City, MN 55041



What if...

YOUR PRINTER WAS A SILENT PARTNER?

Hewlett-Packard presents the QuietJet and QuietJet Plus printers. One of them will make a perfect desktop partner for your personal computer. Because both printers are designed to give you ultra-quiet performance and high-quality printing. At prices you can afford.

Now you can carry on a normal office conversation—even a telephone conversation at your desk—without it sounding like you're calling from inside an auto repair shop. Because both printers are built around our low-decibel non-impact technology.

And they're as quick as they are quiet. You can print a standard letter in less than a minute (160 cps). With printing quality that's crisp, clean and easy to read.

Both QuietJet printers let you print everything from quick memos to exhaustive reports. And the wide-carriage QuietJet Plus also allows for larger spreadsheet printing. They work with just about all PC's, including our HP Vectra PC and other IBM-compatibles.

So if a silent partner sounds better than a noisy printer (and it does), check out our new QuietJet printers.

Call 1 800 367-4772, Dept. 276F for the name of the authorized HP dealer nearest you.

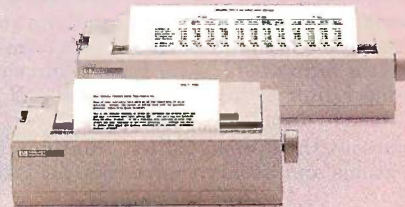

**HEWLETT
PACKARD**

Business Computing Systems

Inquiry 150

QuietJet printer and HP Vectra PC are trademarks of Hewlett-Packard. IBM PC is a registered trademark of International Business Machines Corporation. PG606BTX © 1986 Hewlett-Packard Co.

IF YOU STILL USE PAPER FORMS TRY FORMMANAGER II!

Name: John Smith Date: 07-15-86
 Address: 111 Beard Way
 City: San Francisco
 State: CA Zip: 94111

Prod No	Description	Price	QTY	Total
122-333-33	Gagger	10	100	100000
233-33-33	What is that	1	40	4000
				104000

Data file: Corder.dat F1 Help Page 1 of 1 Record # 12

MEET FORMMANAGER II. It can help automate your paper office. More than a data manager, FormManager II lets you generate forms and organize them easily. You simply lay out your forms on the screen and fill in the data. FormManager II can calculate the tax due, total amount or even set up conditional calculations. More than 26 mathematical functions are included.

FormManager II can print on pre-printed forms or just print on any plain paper. With a laser printer, you can even use different fonts on the same page.

HERE ARE SOME HIGHLIGHTS:

- Generate or use dBase III™ data files.
- Lay out forms on the screen with Forms Editor.
- Use the cursor keys to move from field to field.
- Fill in data easily with error checking.
- Print on pre-printed forms.
- Print on any plain paper with lines and boxes.
- Sort, search and modify any data records easily.
- Do complex calculation or even conditional statements.
- Report writer summarizes all your records.

SPECIAL LIMITED TIME OFFER ONLY \$99

Attention, MS FORTRAN, PASCAL, C Programmers, Forms Designer programming tool can save you time and effort producing professional screen forms. Don't struggle with the formatted I/O for screen data entry. Just use our Forms Editor to lay out the forms and call our library routines to do the job.

Comes with Forms Editor, runtime library, sample programs and library source code for PASCAL and C.

Only \$275.

To Order Call 408-262-1054

bit BIT Software, Inc.
 P.O. Box 360619
 Milpitas, CA 95035

dBase III is a trademark of Ashton-Tate, Inc.
 FormManager and Forms Designer are trademarks of BIT Software, Inc.

ACCORDING TO WEBSTER

ITEMS DISCUSSED

DEVPACST\$79.95
 Apex Resources
 17 St Marys Ct.
 Brookline, MA 02146
 (617) 232-9686

HYPERDRIVE 2000\$3200
 General Computer Company Inc.
 215 First St.
 Cambridge, MA 02142
 (617) 492-5500

LIGHTSPEED PASCAL\$125
 Think Technologies
 420 Bedford St.
 Lexington, MA 02173
 (617) 863-5595

MEGAMAX C\$200
 Megamax Inc.
 P.O. Box 851521
 Richardson, TX 75085
 (214) 987-4931

METASCOPE\$95
 Metadigm Inc.
 19762 MacArthur Blvd., Suite 300
 Irvine, CA 92715
 (714) 955-2555

PRODIGY 4about \$7000
 Levco Inc.
 6160 Lusk Blvd., #C-203
 San Diego, CA 92121
 (619) 457-2011

TML PASCAL 2.0\$99.95
 TML Systems
 4241 Baymeadows Rd., Suite 23
 Jacksonville, FL 32217
 (904) 636-8592

TXED\$59.95
 MicroSmiths Inc.
 P.O. Box 561
 Cambridge, MA 02140
 (617) 576-2878

development environment you've come to expect from Borland. I was able to convert several TML Pascal programs with just a few changes, mostly at the start of the program (with different compiler options), as well as some file I/O commands in the programs. Turbo uses Open() as opposed to TML's Assign(); also, Turbo does not (yet?) support file I/O using Get() and Put(), but instead uses the Read() and Write() commands just like Turbo Pascal on the IBM PC.

(continued)



THE GREAT ESCAPE!

FROM IVORY TOWERS AND
COLD COMPUTER ROOMS TO
THE WARMTH OF YOUR OFFICE.

Artificial intelligence for business
has arrived in a revolutionary new
product . . . Guru.

At last, artificial intelligence designed especially for business! Guru brings together expert system capabilities of artificial intelligence, the productivity of familiar business computing tools and the ease of communicating with your computer using menus, commands or plain English. All available in a single, integrated program.

Guru works like human experts, considering uncertainties, reasoning through forward and backward chaining, asking for more information when needed, and explaining its recommendations.

Guru's expert system works hand-in-hand with all the familiar business computing tools like spreadsheets, statistical analysis, business graphics and a programming language, always available for both expert consultation and your everyday business computing needs.

Best of all, you won't need to learn LISP or PROLOG or buy fancy computers. . . Guru runs on your PC and communicates in plain English! Guru is artificial intelligence that means business.

For more information, call or write Micro Data Base Systems, Inc./Marketing & Sales, P.O. Box 248, Lafayette, IN, 47902, 317/463-2581, Telex 209147 ISE UR.

GURU™

ARTIFICIAL INTELLIGENCE THAT MEANS BUSINESS.

It's Time To

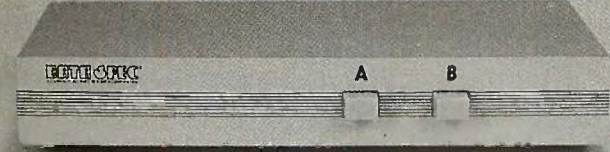

Switch Boxes

NEW SLIM DESIGN and a LIFETIME WARRANTY . . .
Two great reasons to make the switch.
Only 1 1/2" high, but still with the same high quality features you have come to expect from DATA SPEC Switch Boxes:

- Reinforced printed circuit boards
- Full shielding

- Durable metal construction
- Gold-plated contacts
- All pins switched

And now, backed by a lifetime warranty.
Visit your local DATA SPEC dealer and see our full line of slim style data switch boxes and other computer accessories.

See us at Comdex, Booth 8412.

DATA SPEC
A DIVISION OF ALLIANCE RESEARCH CORPORATION

THE ULTIMATE IN COMPUTER ACCESSORIES

20120 Plummer Street • P.O. Box 4029 • Chatsworth, CA 91313 • (818) 993-1202

In Japan: Call Data Spec Japan LTD., Tokyo, Japan, Tel. (03) 774-7741

IBM PC AT performance! PCjr price!

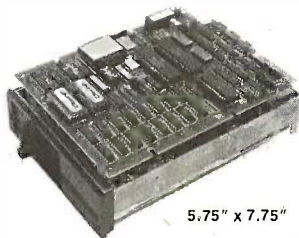

- ★ **AMPRO LITTLE BOARD/186**
 - 8Mhz 16 Bit 80186 CPU
 - 512K RAM— No Wait-States
 - 2 Serial Ports 50-38.4K Baud
 - Parallel Printer Port
 - 4 Drive Mini/Micro Floppy Controller
 - SCSI Bus Hard Disk Interface
 - DOS Compatible ROM-BIOS
 - Boots PC DOS 2.x, 3.x
- Computer Board Assembled & Tested w/Tech Manual & DOS Utilities . . . \$489.
- ★ **MS DOS 3.2 & GW BASIC** . . . \$89.
- ★ **DRI CONCURRENT DOS 4.1 Multi-User O/S** . . . \$319.
- ★ **512K EXPANSION BOARD (1Mb Total) 8087 Socket, Clock, 2 Channel RS232/422, Buffered Expansion Bus & More** . . . from \$149.
- ★ **AMPRO LITTLE BOARD (Z80)** same as 80186 Board but Z80A CPU, 64K RAM, 16K, EPROM, CPM 2.2, ZCPR3 & Manuals \$239. With SCSI Hard Disk Interface \$279.
- ☆ **ENCLOSURES w/POWER SUPPLY** . . . from \$99.
- ☆ **5.25" DS 360K FLOPPY DRIVE** . . . \$99.
- ☆ **3.5" DS 720K MICRO FLOPPY DRIVE** . . . \$139.
- ☆ **XEBEC OWL 10Mb SASI DRIVE w/Built-in Controller** . . . \$449.
- ☆ **SEAGATE ST225N 20Mb SCSI Low Power 1/2 Ht Drive** . . . \$599.
- ☆ **WYSE & KIMTRON TERMINALS** . . . from \$395.

Complete technical support. Complete systems available. Write or call for more information. Most orders shipped same day.

VISA, Mastercard, Money Order, COD. Checks allow two weeks. Purchase Orders welcome. Prices FOB Buffalo Grove, IL.

IBM PC AT, PCjr, PC DOS are trademarks of International Business Machines Corporation. Little Board is a trademark of Ampco Computers, Inc. Concurrent DOS is a trademark of Digital Research, Inc.

DISKS PLUS, INC. • 356 Lexington Drive • Buffalo Grove, IL 60089-2312
(312) 537-7888 • TLX: 650 249 2139 MCI UW.

DISKS PLUS

Distributors of Microcomputers and Accessories

Table 3: Some preliminary benchmark results for two Pascals for the Macintosh. The program tested consisted of about 660 lines of Pascal source code.

Turbo Pascal:	
compile to RAM:	3.8 seconds
compile to disk:	10.2 seconds
change, then run:	3.8 seconds
TML Pascal:	
xfer to compiler:	8.3 seconds
compile:	73.7 seconds
include files:	43.4 seconds
program itself:	30.3 seconds
xfer to link:	6.6 seconds
link:	33.0 seconds
xfer to run:	1.8 seconds
change, then run:	196.3 seconds

I suppose you're itching for some benchmarks. Well, I won't publish execution benchmarks, since I'm still using a fairly early beta version, but I will say that they were comparable to TML Pascal right down the line: faster for some routines, slower for others. The only place where TML had a clear advantage was in real arithmetic, where it was about twice as fast as Turbo Pascal (both were using the SANE library, too). However, some compile and link times for a program that was about 660 lines long are given in table 3.

A few important factors account for some of Turbo's speed. First, the library (unit) files are in a format that doesn't require any headers or declarations to be read in by the compiler. Second, the linking stage is integrated with the compiling stage. You can produce units (libraries) with Turbo Pascal; you can also link in external assembly language routines that follow the MDS format. You cannot, though, produce linkable object code. By comparison, TML Pascal allows you to produce either .ASM (68000 assembly language source) or .REL routines, lets you link in MDS format routines, and (with version 2.0) lets you create units. Also, Think Technologies has by now started shipping Lightspeed Pascal; look for a review of this in a few months. In short, Borland will have plenty of competition on the Macintosh. Look for Turbo Pascal to ship in mid-November, with a price of \$99.95.

IN THE QUEUE

Next month, I'll look at some hardware for the Amiga, software products you might want to consider for Christmas presents, and the latest in idea processors for the Macintosh. Until then, I'll see you on the bit stream. ■

Various folks helped in putting this column together, including Doug Gilbert at Levco; Elena Gonzales at General Computer; Doedy Hunter at Apple; Neil Harris at Atari; Jay Friedman at Consulair Corporation (who provided source for many of the benchmarks used); and Sandra, who's discovering what it's like being married to a computer freak, but who loves me anyway. Thanks, all.

C FEVER *catch it!*

It's becoming an epidemic . . . everyone is switching to C! First there were a few hackers, then came the college students, next the major software houses, and now the rest of the programming world. Programmers everywhere are infected with the desire for SPEED, POWER, and PORTABILITY.

It's time to face the inevitable. You're going to catch the fever too! When you do, give us a call. We've got the best cure — an illustrated guide to the C language, plus a complete program development system. Everything you need to master the C programming language . . . all at a price that's less than the cost of a book!

But don't let this price fool you. Our system is powerful; it compiles twice as fast as the others, is completely standard, and it's very easy to use. Most C compilers are designed for wizards. We have designed ours for you!

What do you get for a mere \$39.95?

• A 150 Page Book filled with sample programs, plus . . .

• A fast, standard, full featured C compiler that supports all data types and the latest features like bit fields, enumerations, structure assignment, and passing/returning structures.

• A loader linker that loads separately compiled files, searches libraries, and builds an executable program.

• An extensive library of more than 170 functions (including the standard C functions and the computer specific functions that provide direct access to the operating system and BIOS).

• Tools that allow you to optimize your programs for minimal space or maximum speed.

Works on all MSDOS/PCDOS and all CP/M Z80 COMPUTERS! (Not Copy Protected!)

The Powerful Mix
C COMPILER
Harness the Power of the C Language with this full featured Compiler
MDX software

Incredible Value
\$39.95
AT ONLY **With 30 Day**
Money-Back Guarantee

Operators are standing by . . . Please use this Number for **ORDERS ONLY!**

CALL TOLL FREE FOR RUSH ORDER DELIVERY!

1-800-523-9520

IN TEXAS, PLEASE CALL TOLL FREE 1-800-622-4070

For Technical Support Please call 1-214-783-6001

MIX Software, Inc. / 2116 E. Arapaho / Suite 363 / Richardson, Texas 75081

Or contact our Worldwide Distributors direct in:

Canada: Saraguay Software 1-416-923-1500 Switzerland: DMB Communication CH-1-825-53-29
Australia: Techflow 047-586924 France: Info/Tech 1-43-44-06-48

Split Screen Text Editor

an Incredible Value \$29.95
AT ONLY (Not Copy Protected!)
Works on all MSDOS/PCDOS and CP/M Z80 Computers

Our high powered editor is great for editing high level languages. It works just like Micropro's Wordstar, but macros allow you to create your own custom editor, and the split-screen feature lets you edit two files at the same time.

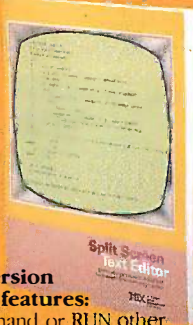

The MSDOS/PCDOS version is loaded with special features:

- Execute any DOS's MASM or M80 other programs from the editor.
- Quickly edit files as large as 300,000 characters.
- Compile MIX C programs directly from memory. The editor automatically positions the cursor to the first error in your program.



ASM UTILITY
an Incredible Value \$10
AT ONLY

Call assembly language routines from your C programs. The ASM utility works with Microsoft's MASM or M80 assembler. Macros make it easy! Works just as if you were calling a C function, and you can even call C functions from assembly language. Lots of useful assembly language functions are included as examples.

RUSH REPLY ORDER FORM!

SPECIAL OFFER!

Buy both for an even greater value!

SAVE \$14.95 Off Our Regular List Price!

Limited Time Only \$54.95
C Compiler & Text Editor

Please check method of payment:

Check Money Order MasterCard/VISA

Your Card #: _____

Expires _____

Shipping Charges: (No charge for ASM Utility)

In the U.S.A.: Add \$5.00 per Order.

In CANADA: Add \$10.00 per Order.

OVERSEAS: Add \$10.00 per Text Editor. Add \$20.00 per C Compiler. Add \$30.00 for combined C Compiler and Text Editor.

Operating System: (Check one)

CP/M Z80 MSDOS/PCDOS

Specify Your Computer Name _____

Specify Disk Format _____

NAME _____

Telephone A/C (_____) _____

Street _____

City _____

State _____

Country _____ ZIP _____

Description	Quantity	PRICE	Total Order
Split-Screen Text Editor	_____	\$29.95	\$ _____
C Compiler	_____	\$39.95	\$ _____
C and Text Editor (Special)	_____	\$54.95	\$ _____
ASM Utility	_____	\$10.00	\$ _____
Texas Residents Add 6.125% Sales TAX			\$ _____
Shipping Charges (See at Right)			\$ _____
TOTAL OF YOUR ORDER:			\$ _____

MDX software 2116 East Arapaho Suite 363 Richardson, Texas, 75081
Ask about our Volume Discounts! Call 1-214-783-6001

Power has never



looked this good.

Introducing the WYSEpc 286 and a brilliant new range of display options.

Now you can get higher speed and higher resolution, together, in extremely high style.

The WYSEpc 286 goes from "normal" speed to full 10 MHz throttle — *up to 25% faster than an IBM Personal Computer AT* — with the touch of a switch. A new lineup of graphics monitors lets you choose exactly the display capability you need.

Combine the WYSEpc 286 with the WY-530 monochrome or WY-630 color monitor and get outstanding performance. For enhanced color graphics, move up to the WY-640 EGA monitor. Or, bring CAD and desktop publishing applications into better focus, price-Wyse and pixel-Wyse, with the WY-700 high resolution graphics display (as shown with the WYSEpc 286 at left).

With the new WYSEpc 286, you can also choose the keyboard that's the best fit: either the standard AT-style, or the IBM Enhanced PC keyboard. And you get the complete compatibility you should expect in every other way, including more than 350 tested off-the-shelf software packages.

Up to 80 Mb of disk storage and 8 expansion slots give you

everything you need for the most demanding single-user applications, or to anchor the most effective, economical multi-user systems.



And behind this incredible display of power and versatility is a company that ships more terminals than anybody but IBM.*

Call toll-free or write, today, for more information.

WYSE

YOU NEVER REGRET A WYSE DECISION.



Please send me detailed information on the WYSEpc 286 and the entire Wyse product line.

Name _____ Title _____

Company _____ Phone _____

Address _____

City _____ State _____ Zip _____

Mail to: Wyse Technology, Attention: Marcom Dept. 286
3571 N. First Street, San Jose, CA 95134

Call 1-800-GET-WYSE B1186

Wyse is a registered trademark of Wyse Technology. WYSEpc 286, WY-640, WY-530, WY-630 and WY-700 are trademarks of Wyse Technology. IBM and Personal Computer AT are trademarks of International Business Machines Corporation. © 1986 Wyse Technology. *Dataquest 1985 terminal shipment update.

THE DIRECT APPROACH ALWAYS PAYS OFF.

CD/286™

- Runs at 6/10MHz
- 512K RAM
- Includes 1.2 Meg floppy drive
- AT-style keyboard
- Combined floppy/hard disk controller card
- 192 Watt power supply
- 80287 math coprocessor socket
- Complete operations manual

\$1295



HARD DISK KITS

For COMPAQ Portable

- Cables
- Instruction Manual
- Software
- 3½" Shock Mounted Winchester Hard Disk
- Hard Disk Controller
- 20 Meg

\$469



For IBM PC™

- Half height hard disk
- Western Digital controller
- Cables and instruction manual
- Boots from hard disk
- 20 Meg

\$389

For IBM AT™

- 40ms access time
- Full height hard disk
- Cables, mounting rails, and manual
- Boots from hard disk
- Uses AT controller (not included)

20 Meg Seagate for AT— **\$529**

30 Meg Seagate for AT— **\$629**

→ Half height hard disk **\$459**
→ 30 Meg w/RLL controller

20 MB Hard Disk Drive on a Card



- Low power consumption
- 3¼" hard disk
- Western Digital controller
- Easily installs in minutes

\$395

EGA Card



- 640x350, 16 colors
- 100% compatible with IBM EGA™ Card

\$229

MonoGraphics Card



- 720 x 348 resolution
- Hercules compatible
- Parallel port
- Serial port available as an option

\$89

Multifunction Card



- OK expandable to 384K
- Parallel port
- Serial port
- Clock/calendar

\$99

I/O Card

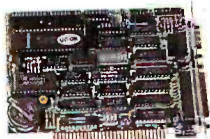

- Game port
- Parallel port
- Serial port (2nd optional)
- Clock/calendar

\$75

Internal Modem



- 300/1200 Baud
- Fully Hayes compatible
- Built-in speaker

\$119

External Modem \$139

Floppy Disk Drive

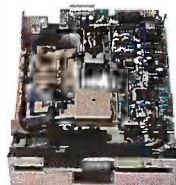

- Half Height
- DS/DD
- Beige or AT™ gray.

\$95

AT Multifunction Card



- OK expandable to 15 MB
- Parallel port
- Serial port (2nd optional)

\$159

EPSON®

Printers

LQ-800	\$609
LQ-1000	\$759
FX-286	\$575
FX-85	\$395



- 5160 AT Style Keyboard
- Made in USA

\$59



Math Co-Processors

8087	\$119
80287	\$195

WATCH FOR OUR INDUSTRY- LEADING SPECIALS!

AST® RESEARCH INC.

AST Advantage!™ w/128K	\$395
AST RAMpage!™ w/256K	\$259
AST SixPak™ w/384K	\$199

HERCULES®

Color Graphics Card w/parallel port	\$155
Monochrome Graphics Card	\$195

Hayes®

Smartmodem

1200	\$389
1200B	\$349
2400	\$695

IBM®

IBM PC-XT IBM PC-AT

- 256K RAM
- 1/360K floppy drive
- 256K RAM
- One 1.2 Meg floppy drive
- Dual floppy/hard drive controller

\$1695

\$2789

COMPAQ®

COMPAQ Portable

- 20 Meg Hard Disk

\$1995

MITSUBISHI® ELECTRONICS

EGA Monitor **\$449**

One year limited warranty. Visa and MasterCard accepted. UPS ground shipment prepaid in USA only. All brands are registered trademarks of their respective companies.



COMPUTER DIRECT

7801 North Lamar, Suite E-216, Austin, Texas 78752

(512) 459-4199

TOLL-FREE SALES CALLS, 1-800-225-5655

Inquiry 79

FAX (512) 454-0986

TECHNICAL CURIOSITIES

BY WILLIAM M. RAIKE

Vending machines now offer on-line information at bargain rates

At this time of the year, there's usually a lull in the announcement of new Japanese personal computers. I can't be sure whether it has something to do with the onset of the rainy season, or whether we're in between the two major Tokyo computer shows of the year; in any case, it gives me a chance to talk about some interesting sidelights, including some services and equipment you can find here in Tokyo that you would never see elsewhere.

A VENDING B-BOX

On a recent trip to Akihabara, the Tokyo district that serves as the mecca of consumer electronics, I happened to be walking through a showroom in one of the major computer department stores when I literally stumbled across still another coin-operated information service.

Vending machines appear everywhere in Tokyo, for everything from booze to batteries, but now they've got one for on-line data. The one on which I stubbed my toe was green and about the size of a Coke machine, with a sign proclaiming it to be a "B-Box." I never did find out what the name is supposed to mean, if anything, but it was easy to figure out how to work it. You insert a copper 10-yen coin (worth about 6 cents at the present rate of exchange) into the slot, look at the numbered menu and operating instructions on the color display screen, and make your selection using a keyboard that resembles the one on a Touch-Tone telephone. The machine then dials up a central computer and queries the database stored there.

The B-Box service is new, so there are only a hundred or so machines around town, concentrated in com-

mercial locations that cater to young people. The database at this time consists of information that's primarily of interest to younger people: part-time job opportunities, entry-level help-wanted announcements, and information on various special-interest schools and classes. The information is updated on a continuous basis. Your 10 yen buys you a 10- by 15-inch page of hard copy, in a clear 24- by 24-dot kanji font, printed by a kanji printer in about 30 seconds and ejected through a slot. The front of the form has the B-Box logo and promotional information printed at the head and foot of the page; the back is a printed flier containing a variety of advertising.

I've seen various public database terminals before, one of them located at the train station in Matsumoto to give free local travel information. But the B-Box is coin-operated and differs from the others in that the database is updated fairly frequently so that the information is quite current. I wouldn't be at all surprised to see a similar service offered sometime soon for locating apartments for rent; with Tokyo's chronic housing shortage, it would be a natural supplement to the weekly magazines that now fill that need.

THE NEC PC-9801VM2E IN THE U.S.

Many of the letters I receive from BYTE readers contain requests for information and assistance in finding a way to do Japanese-language word

processing in the United States. Faculty and students in Japanese-language departments at several universities have expressed a real need for that capability. Unfortunately, since I know of no adequate hardware and/or

software that can let the IBM PC and its work-alikes (or other computers available in the U.S.) handle Japanese, I've had to recommend that they contact someone in Japan to import a Japanese personal computer.

Evidently NEC, the largest personal computer manufacturer in Japan, has become aware of this potential market. The company recently announced that a version of its best-selling 16-bit personal computer, the PC-9801VM2, will be available shortly in the U.S. I've discussed NEC machines at length in earlier columns, so I won't go into detail here. In summary, though, this computer is based on NEC's V30 microprocessor, running at either 8 or 10 megahertz. (The V30 is completely software-compatible with the 8086 processor and also offers an on-chip Z80 emulation mode.)

The export model will be called the PC-9801VM2E (the E stands for "export"), will contain 384K bytes of RAM and two 1.2-megabyte floppy disk drives, and will be supplied with either a monochrome monitor or an optional color monitor. The machine comes with 192K bytes of graphics VRAM in addition to the standard RAM and supports 640- by 400-dot graphics. Kanji characters are dis-

(continued)

William M. Raïke, who has a Ph.D. in applied mathematics from Northwestern University, went to Japan in 1980 looking for 64K-bit RAMs. He has been there ever since as a technical translator and a software developer. He can be contacted c/o BYTE, One Phoenix Mill Lane, Peterborough, NH 03458.

*I came across my
first BBS in the
Japanese language
just the other day.*

played on the screen in a highly legible 16-dot font. The Japanese-language features include the JIS No. 1 and No. 2 kanji character sets, for a total of nearly 7000 kanji characters in addition to the alphanumeric and katakana character sets.

In order to provide a complete system suitable for Japanese-language processing, NEC is also going to supply an export model of one of its popular 24-pin kanji printers, the PC-PR201HE.

NEC will make the necessary modifications to the export models to ensure that they meet appropriate U.S.

safety standards and FCC emission standards.

In Japan, NEC sells Japanese-language versions of either the MS-DOS or CP/M-86 operating systems separately from the computer; presumably, the company will bundle an operating system with the computer for the export market. Be warned, though, that the PC-9801VM2 is not fully IBM-compatible, although it will run much MS-DOS software. Also, NEC hasn't said whether it will provide English-language documentation. In any case, the documentation is unlikely to be any better than the sorry lot that comes with the computer here in Japan. It will be interesting, too, to see what kind of support a foreign-language computer gets from NEC's U.S. sales and service organizations.

JAPANESE-LANGUAGE BBS

Another recent Akihabara discovery I happened upon had to do with bul-

letin board systems and computer networks. Although personal computer users in Japan have lagged behind their U.S. counterparts in using computers to communicate, that's been gradually changing. Besides U.S.-based services like BIX, The Source, CompuServe, and MCI Mail, which are accessible in Japan via the Japanese international telephone company's Venus-P public packet-switched network, a number of local English-language BBSs have been in existence for some time. But I saw my first one in Japanese just the other day.

One of the better computer department stores, Laox Computer Media, employs a technically competent sales staff. During a recent visit to their showroom to clear up a question or two, I noticed a brochure describing "LAOX NET," a "pasocom (personal computer) communication system." It turned out to be a BBS, running on an NEC PC-9801VM4, operated by the Laox store as a free ser-

Add these to your
IBM PC/AT and surpass
any other UNIX or Xenix
system.



**REAL UNIX
SYSTEM V-FREE!!**

vice to customers. Customers fill out an application at the store and receive an ID and password by return mail.

The board operates at either 300 or 1200 bits per second, and it offers bulletin board and electronic mail services. Text can be in either katakana alone or in conventional Japanese, which is a mixture of kanji characters and the hiragana and katakana phonetic alphabets. The ordinary alphanumeric character set is supported also, of course. Prompts from the system are all in katakana, however, making it possible for customers using terminals or computers with minimal or no kanji capability to communicate with the system.

Because communication between personal computers in Japan is in its infancy, Laox provides basic, easy-to-follow instructions for connecting an acoustic coupler, modem, or "modem-phone" (telephones incorporating primitive no-frills modems are available, although at outrageous prices

compared to customary U.S. prices). The store also provides details about logging on to its net using half a dozen different models of personal computers. Laox also sells the necessary communication software.

The salesman I talked to, Ishikawa-san, said that the system had been in operation for a little more than a month and that more than 200 users had registered. Usage is brisk. With two new companies planning to compete with NTT (the Japanese domestic telephone company), not to mention the imminent prospect of competition within Japan for international data communications business, it seems to me that the Japanese won't lag behind the U.S. for long in using personal computers for communications. In fact, a number of local banks have been experimenting for several months with allowing "pasocom" users to query on-line bank computers about the balance in their accounts, and such trends are likely to

continue despite the terrifying security implications.

I've got a question, though. In view of the limited choice, high prices, and primitive capabilities of Japanese-made modems sold here, why aren't any of the major U.S. brands sold here? For instance, the Hayes Smartmodem 2400 I bought in Chicago last year works perfectly here at both 1200 and 2400 bps, and it supports both Bell and CCITT specifications (i.e., U.S. and international telephone standards; Japan uses the latter) at 1200 bps. Time is short, though; some new and sophisticated modems now being designed should be on the Japanese market by early next year.

Because of business pressures and other reasons, this will be my last BYTE Japan column. My thanks and best wishes go to all the BYTE readers whose questions and encouragement made writing the column a pleasure and to the entire BYTE editorial staff for their efforts and enthusiasm. ■

Except this one.

Only BELL TECHNOLOGIES gives you the choice.

Convert your mild-mannered IBM PC/AT into a thunderbolt UNIX machine by adding BELL TECHNOLOGIES expansion products. Select from several hard disks, tape backup for every budget and performance need, multi-user RAM cards, serial port expansion cards, exclusive RamDisk™ technology and backup power systems.

Software options include both Xenix and UNIX (get Microport's UNIX System V free with a disk drive).

Or, if you don't need IBM's nameplate, skip all integration hassles and go straight to our powerhouse Multi-Purpose Engine. Designed to shrug off multi-user loads that kill consumer-grade ATs, our AT engine supports large hard disks, fast clocks and titanic RAM capabilities.

Procure The Engine pre-tested and pre-built with your choice of BELL TECHNOLOGIES products. Engines include your



choice of DOS or UNIX System V—no charge.

Either way, only BELL TECHNOLOGIES backs you with a decade of experience porting UNIX, creating UNIX computer systems and peripherals (including over 50 tape products), and the PC/AT savvy only an AT manufacturer can bring to bear. Call today and find out about the best business relationship in the PC/AT world—BELL TECHNOLOGIES.

44870 Osgood Road, Fremont, California 94539

Telex 3723620 BELLTECH

800-FOR-UNIX • 415-659-9097 (CA)

Bell Technologies

Setting UNIX systems standards the IBM compatible way.

*UNIX, and UNIX System V are trademarks of AT&T. Xenix is a trademark of Microsoft Corporation. IBM PC/AT is a trademark of International Business Machines Corporation. Bell Technologies Inc. is not affiliated with AT&T.

Why Do They Look So Different But Cost About The Same?

This is Toshiba 24 pin letter quality.

This is 9 pin printer quality.

When we developed the P321 and P341e 3-In-One™ dot matrix printers, we had just two goals in mind.

Superb 24-pin letter-quality reproduction. And a price that's as close as possible to standard 9-pin models.

One look at the print sample shows you we succeeded. So will one look at the price.

In fact, we were so successful, we gave these 24-pin printers with the 9-pin price a special name: *The Affordable Class*.

And we included features—starting with type font cartridge capability—that put them in a class by themselves.

Both the Toshiba P321 and P341e printers produce letter-quality documents at 72 CPS, drafts at 216 CPS and high-resolution graphics at 180 x 360 dpi.

Each printer has our industry-standard P351 command set for more sophisticated word processing and high-resolution graphics.

And each printer has standard application compatibility with the entire IBM-PC¹ line of products.

Options include downloadable disk capability and type font cartridges for an unlimited range of type styles, a one- or two-bin sheet feeder

as well as continuous forms tractor feeder.

The affordable and compact P321: If you're keeping an eye on the bottom line, we'd like to direct your attention to our P321. When it comes to virtually all business and correspondence needs, it fills the bill nicely.

You get letter-quality reproduction in a printer that looks great on the bottom line.

The affordable extended-carriage P341e: If you need to do full-size spreadsheets, you need our wide-carriage P341e.

Like the P321, the P341e uses our 24-pin printhead that lasts up to four times longer than other printheads, and has made us the number one seller in the business.

So buy a Toshiba Affordable Class P321 or P341e printer today. You'll get letters that look perfect every time.

*And a type font cartridge free.**

For the Toshiba printer and computer dealer nearest you, call 1-800-457-7777.

1. IBM-PC is a registered trademark of International Business Machines Corporation.
*Offer expires 2/15/87. See your Toshiba dealer for details. Or call 1-800-457-7777.

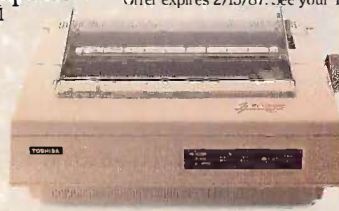

P321



P341e

In Touch with Tomorrow
TOSHIBA

Toshiba America, Inc., Information Systems Division

Inquiry 349



INTEGRATION ON A NEW SCALE

BY DICK POUNTAIN

Wafer-scale integration is starting to yield its first products

In 1984, at the height of his commercial success with home computers, Sir Clive Sinclair launched a pet project in Milton Hall, a converted country mansion not far from Cambridge. The project was called MetaLab, and its intent was to bring together a group of innovative thinkers to work on high-technology projects. Though he hoped the results might eventually redound to the glory of Britain and provide future products for Sinclair Research, MetaLab was not to be tied to schedules; Milton Hall was to become a center for blue-sky research, rather like an English Xerox PARC.

One of the first people to be recruited to MetaLab was Ivor Catt, an electronics engineer and teacher who is a veteran of British electronics, having joined in the heady postwar era when radar and the first digital computers were forging the industry. Catt worked for Ferranti in Manchester in the 1950s, when it was perhaps the world's leading center of computer technology. In the 1960s he worked for Motorola in the U.S. on high-speed logic interconnection and later returned to England to lecture in electronics.

During his long career, Catt arrived at a number of highly unorthodox design ideas and spent many frustrating years trying to get them accepted and implemented. The main strands of his thinking can be summarized as follows: He prefers serial to parallel architectures; he resents the performance penalties that are incurred by conventional chip packaging due to the mismatch of impedance between silicon circuits and printed circuit board tracks; he believes that fault tolerance should be incorporated into computers at the fundamental architectural level, rather than having it

added as an afterthought.

Synthesizing all these concerns, Catt came up with a plan for wafer-scale integration (WSI) of semiconductor devices. Wafer-scale integration just means that instead of slicing up the silicon wafers on which chips are made into individual devices and packing them into little plastic beetles, you use the whole wafer with the chips connected on the silicon. Unfortunately, wafers are never perfect because of defects in the silicon, and a proportion of chips do not work. Catt devised a novel serial architecture in which good devices are automatically recognized and connected in a one-dimensional array, while bad devices are locked out in somewhat the same way that an operating system locks out bad sectors on a floppy disk.

In the late 1970s and early 1980s when Catt was trying to sell this idea, corporations like IBM and Trilogy were having spectacularly expensive failures with WSI using conventional architectures, and these botched attempts gave the whole enterprise a bad name. Trilogy tried to get around the problem of bad chips by employing massive redundancy, duplicating and triplicating devices so that they could check each other's operation and produce answers by a majority "vote." Catt pithily summarizes this approach as "soaking the wafer in dollars."

In the late 1970s a team at Burroughs started to work on Catt-style WSI but never went beyond prototype wafers because of a change of man-

agement and company politics. After Catt moved to Milton Hall, the survivors of this team, led by Dr. Malcolm Wilkinson, also moved in, and the WSI project finally went ahead, funded by the success of the Sinclair

Spectrum.

We now arrive at the present day. Sinclair Research's fortunes have taken a tumble, and its home computer interests, including the Spectrum, have been sold to rival Amstrad. However, a new company called Anamartic Ltd. has been formed to pursue and market WSI devices (the word Anamartic derives, I am told, from the Greek for "without fault"). The general manager of the company is Malcolm Wilkinson, Ivor Catt is adviser to the engineering team, and Sir Clive is a nonexecutive director. The company is temporarily working from Milton Hall, pending a move to new premises, and is looking for second-round funding to go into full production.

THE WISPER 2

The first word of a product from Milton Hall came last year when Sinclair announced that a "solid-state Winchester drive" would be launched for his QL computer. This device never appeared, but its descendant will be the first product from Anamartic Ltd. (Milton Hall, Milton, Cambridge CB4 4AE, England, (0223) 862661).

A solid-state Winchester drive is basically a wafer full of RAM chips connected by a serial access path; to the computer it looks like a serial disk drive, but it has no moving parts and

(continued)

Dick Pountain is a technical author and software consultant living in London, England. He can be contacted at BYTE, One Phoenix Mill Lane, Peterborough, NH 03458.

so is potentially more reliable. A solid-state Winchester drive is also much faster than a magnetic Winchester drive, although slower than ordinary RAM by dint of the serial rather than parallel access.

Anamartic has working samples of a prototype 500K-byte wafer made in NMOS technology. One of these devices, the Wisper 1, is shown in photo 1; the 4-inch wafer is mounted alongside a small peripheral PCB holding the controller and ROMs for the operating software. The first commercial product, to be available in late 1987, will be a second-generation device code-named Wisper 2, which is built on a 5-inch wafer and can hold 7 megabytes. Multiple wafers can be stacked just like Winchester platters and share the same controller, so devices holding multiples of 7 (e.g., 28 megabytes, 70 megabytes) will be made.

The Wisper 2 has the following performance statistics: Its worst-case access time is less than 50 microseconds; its data-transfer rate is 2.5 megabytes per second; and its mean time between failures is more than 100,000 hours (for a 70-megabyte

unit). By contrast, a typical Winchester disk has an access time between 30 and 90 milliseconds, a data-transfer rate of around 150K bytes per second, and an MTBF of 25,000 hours, making Wisper 2 about 20 times faster as well as more reliable.

The robustness of the solid-state device should appeal to manufacturers of portable computers and computers that have to work in hostile environments, and the performance of the device is a great improvement over that of conventional disks. However, the economics of silicon fabrication are such that—initially, at any rate—the WSI solution will not compete on price per megabyte with Winchester disks (Anamartic will not reveal any prices, but they are likely to be more than a thousand dollars). Winchester makers with their Far Eastern volume manufacturing plants are currently engaged in a seemingly suicidal price war. Moreover, magnetic storage still has some tricks up its sleeve, like vertical recording techniques that will increase capacity by an order of magnitude at little extra cost.

In the short term, Malcolm Wilkin-

son sees the market for Wisper among minicomputer and mainframe manufacturers who wish to design disk-caching systems that bridge the gap between fast RAM and disk storage in both price and speed. The arrival of huge optical disks makes Wisper attractive as a high-speed buffer between the slow but cheap disk and fast, relatively expensive RAM. Nevertheless, with Clive Sinclair involved, I shall be very surprised if he doesn't find some way to get Wisper into a personal computer.

Wisper will be fabricated in CMOS technology (although the Catt principles work under any process), and its power requirements are sufficiently low that a battery backup can be used to preserve the contents in case of main power failure. A 70-megabyte Wisper could be kept safe for up to 60 hours by a lithium battery pack.

FAULT TOLERANCE

A Wisper wafer contains two main kinds of components. It has a number of conventional RAM arrays, built from standard one-transistor dynamic RAM cells just as if the wafer were going to be cut up into RAM chips. Between these RAM arrays lies a network of serial communication lines, and each RAM chip has a communications node associated with it. A node is connected to its own RAM and to the nodes of each of its four nearest neighbors. Figure 1 depicts a portion of a wafer, showing four nodes and RAM arrays.

When a newly fabricated wafer is to be tested and configured, an initialization program is run that sends signals to the first node. This node then tries to establish connection with each of its neighbors and, if it succeeds, tests them to see if they are fully operational. Control then passes to the next working node, which repeats the process. The algorithm used reminds me of a daft game that used to be popular in Commodore PET BASIC, where a worm finds its way around a maze, exploring each junction with its rapidly wiggling nose. The algorithm ensures that every good node is eventually found and that they end up all connected into a single snakelike path. The initialization program then

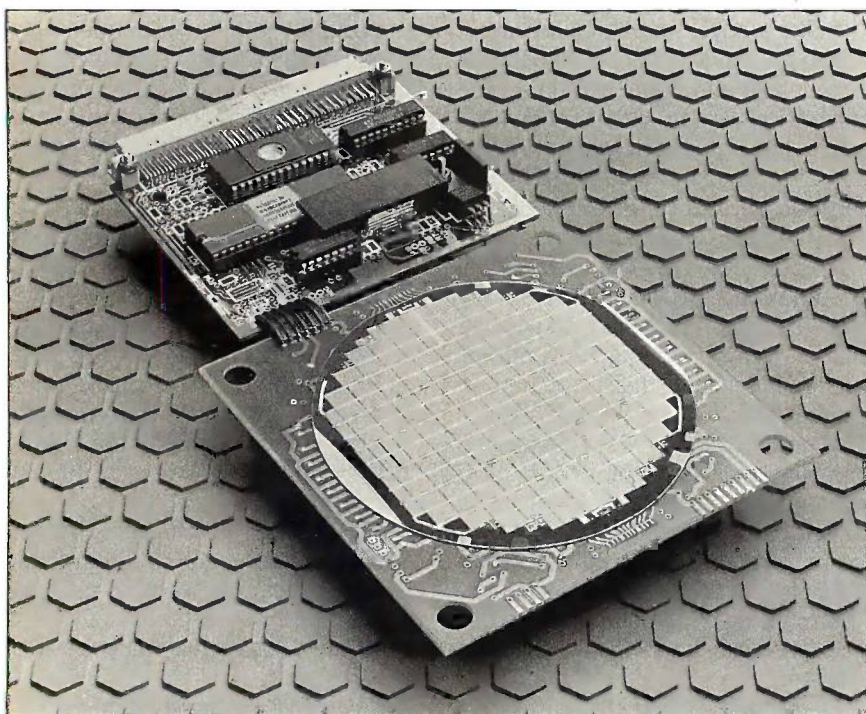

Photo 1: The Wisper 1, a prototype 500K-byte wafer. The 4-inch wafer is mounted next to a board holding the controller and ROMs for the operating software.

LISTINGS YOUR WAY!

It's easy. Now there are three ways to get source-code listings that go with BYTE articles—on disk, in print or on line.

ORDER BYTE LISTINGS ON DISK!

These magnetic disks contain listings of source code described in the issues of BYTE. Disks are available by annual subscription or as individual orders and in 11 popular disk formats. Order today!



FOR DIRECT ORDERING CALL TOLL FREE: 800-258-5485

Call: M-F, 8:30 a.m. to 4:30 p.m. Eastern Time

(603-924-9281 for New Hampshire residents)

For credit card orders only.

ORDER BYTE LISTINGS IN PRINT!

BYTE is now offering a supplement in print. In this supplement, you can now get printed versions of all source-code listings that go with BYTE articles.

LISTINGS ON DISK BYTE listings on disk are right for you if you want to compile or run programs quickly. Disks are now available by annual subscription as well as individual orders. BYTE offers listings in 11 popular disk formats. See the order card below.

LISTINGS IN PRINT This print supplement contains source-code listings described in the issues of BYTE. See order card below.

LISTINGS FROM BIX (BYTE Information Exchange) By joining BIX, you can download BYTE source-code listings for no additional connect-time charges. See BIX informational ad listed in Reader Service index in this issue.

BYTE LISTINGS ON DISK

IN USA:	Single Disks (one disk)	Annual Subscription (13 disks)	OUTSIDE USA:	Single Disks (one disk)	Annual Subscription (13 disks)
5 1/4 inch:	<input type="checkbox"/> \$8.95	<input type="checkbox"/> \$69.95 (Save \$46.40)	5 1/4 inch:	<input type="checkbox"/> \$10.95	<input type="checkbox"/> \$89.95 (Save \$52.40)
<input type="checkbox"/> IBM PC			<input type="checkbox"/> IBM PC		
<input type="checkbox"/> Apple II			<input type="checkbox"/> Apple II		
<input type="checkbox"/> Kaypro 2 CP/M			<input type="checkbox"/> Kaypro 2 CP/M		
<input type="checkbox"/> Tandy Mod 4			<input type="checkbox"/> Tandy Mod 4		
<input type="checkbox"/> MS-DOS 8 Sector	<input type="checkbox"/> TI Professional		<input type="checkbox"/> MS-DOS 8 Sector	<input type="checkbox"/> TI Professional	
3 1/2 inch:	<input type="checkbox"/> \$9.95	<input type="checkbox"/> \$79.95 (Save \$49.40)	3 1/2 inch:	<input type="checkbox"/> \$11.95	<input type="checkbox"/> \$99.95 (Save \$55.40)
<input type="checkbox"/> Apple Macintosh			<input type="checkbox"/> Apple Macintosh		
<input type="checkbox"/> Atari ST			<input type="checkbox"/> Atari ST		
<input type="checkbox"/> Amiga			<input type="checkbox"/> Amiga		
<input type="checkbox"/> HP 150			<input type="checkbox"/> HP 150		
8 inch:	<input type="checkbox"/> \$9.95	<input type="checkbox"/> \$79.95 (Save \$49.40)	8 inch:	<input type="checkbox"/> \$11.95	<input type="checkbox"/> \$99.95 (Save \$55.40)
<input type="checkbox"/> CP/M			<input type="checkbox"/> CP/M		

Please send me single disks in the format checked above for the following 1986 issues:

- | | |
|-----------------------------------|---------------------------------------|
| <input type="checkbox"/> January | <input type="checkbox"/> August |
| <input type="checkbox"/> February | <input type="checkbox"/> September |
| <input type="checkbox"/> March | <input type="checkbox"/> October |
| <input type="checkbox"/> April | <input type="checkbox"/> November |
| <input type="checkbox"/> May | <input type="checkbox"/> December |
| <input type="checkbox"/> June | <input type="checkbox"/> IBM PC Issue |
| <input type="checkbox"/> July | |

Name _____

Address _____

City _____

State _____ Zip _____ Country _____

Check enclosed MasterCard VISA

Credit Card _____

Exp. Date _____ Signature _____ Date _____

U.S. Funds enclosed (If ordering from outside the U.S. please remit in U.S. funds drawn on a U.S. bank. Thank you.)

NOVEMBER

BYTE LISTINGS IN PRINT

- IN USA:**
- January through June 1986 for only \$8.95.
- July through September 1986 for only \$6.95.
- October through December 1986 (available in November) for only \$6.95.
- All of the above 1986 issues for only \$18.00 (Save \$4.85).

- OUTSIDE USA:**
- January through June for only \$9.95.
- June through September for only \$7.95.
- October through December for only \$7.95.
- 1986 Annual Subscription for only \$21.00 (Save \$4.85).

The listings come in one convenient package. The first issue of the listings supplement will include listings for the first half of 1986. Thereafter, the list-

ings supplement will be published quarterly. Sign up now for an annual subscription and avoid the need to order every quarter.

Name _____

Address _____

City _____

State _____ Zip _____ Country _____

Check enclosed MasterCard VISA

Credit Card _____

Exp. Date _____ Signature _____ Date _____

U.S. Funds enclosed (If ordering from outside the U.S. please remit in U.S. funds drawn on a U.S. bank. Thank you.)

NOVEMBER

LISTINGS YOUR WAY!

It's easy. Now there are three ways to get source-code listings that go with BYTE articles—on disk, in print or on line.

LISTINGS ON DISK

BYTE listings on disk are right for you if you want to compile or run programs quickly. Disks are now available by annual subscription as well as individual orders. BYTE offers listings in 11 popular disk formats. See the order card below.

LISTINGS IN PRINT

This print supplement contains source-code listings described in the issues of BYTE. See order card below.

LISTINGS FROM BIX

(BYTE Information Exchange) By joining BIX, you can download BYTE source-code listings for no additional connect-time charges. See BIX informational ad listed in Reader Service index in this issue.



NO POSTAGE
NECESSARY
IF MAILED
IN THE
UNITED STATES

BUSINESS REPLY MAIL

FIRST CLASS MAIL PERMIT NO. 10 PETERBOROUGH, NH

POSTAGE WILL BE PAID BY ADDRESSEE

BYTE Listings

One Phoenix Mill Lane
Peterborough, NH 03458-9990



NO POSTAGE
NECESSARY
IF MAILED
IN THE
UNITED STATES

BUSINESS REPLY MAIL

FIRST CLASS MAIL PERMIT NO. 10 PETERBOROUGH, NH

POSTAGE WILL BE PAID BY ADDRESSEE

BYTE Listings

One Phoenix Mill Lane
Peterborough, NH 03458-9990



**FOR DIRECT
ORDERING CALL
TOLL FREE:
800-258-5485**

**Call: M-F, 8:30 a.m. to
4:30 p.m. Eastern Time**

**(603-924-9281 for New
Hampshire residents)**

**For credit card
orders only.**

stores a map of this path.

Having established a path of nodes through the chip, the program walks through the path, testing the RAM arrays themselves, and builds a map of working RAMs. Note that RAMs associated with nonworking nodes cannot be tested as they cannot be on the path; they may be good or bad, but they are forever inaccessible. Typically, up to 30 percent of the devices on a wafer are defective, so 10 megabytes' worth of chips will need to be fitted onto a wafer that is to end up as 7 megabytes. The communications nodes are much smaller than the RAM arrays, so fewer of them will be bad; otherwise, the technique could not work.

The final map of working RAMs and a path that connects them is stored in an EPROM on the controller board. Whenever the Wisper is switched on, software will use this map to connect all the components, which is accomplished in a fraction of a second. There are no fusible links or other permanent connections of any kind. This fact is quite frightening at first, until you realize that floppy and hard disks do exactly the same sort of thing with your files; you have no idea where the bits of a file are stored physically, but the operating system keeps track of them in software. What Anamartic has done is to push the same idea down to the level of physical storage.

The snakelike path through the Wisper is the serial data path by which data is moved to and from the memory. Data and addresses are interleaved and fed serially onto the wafer; they can be separated out again by timing considerations. The RAM arrays themselves, having received an address, work in normal parallel fashion organized by rows and columns. However, data being shifted out of the addressed RAM row remains in serial form and joins the bit stream flowing along the path. This means that access is slower than access to conventional RAM mounted on a parallel bus, and it also means that RAMs at the end of the path will take longer to access than ones at the beginning. The wafer behaves like a disk, even down to emulating head travel.

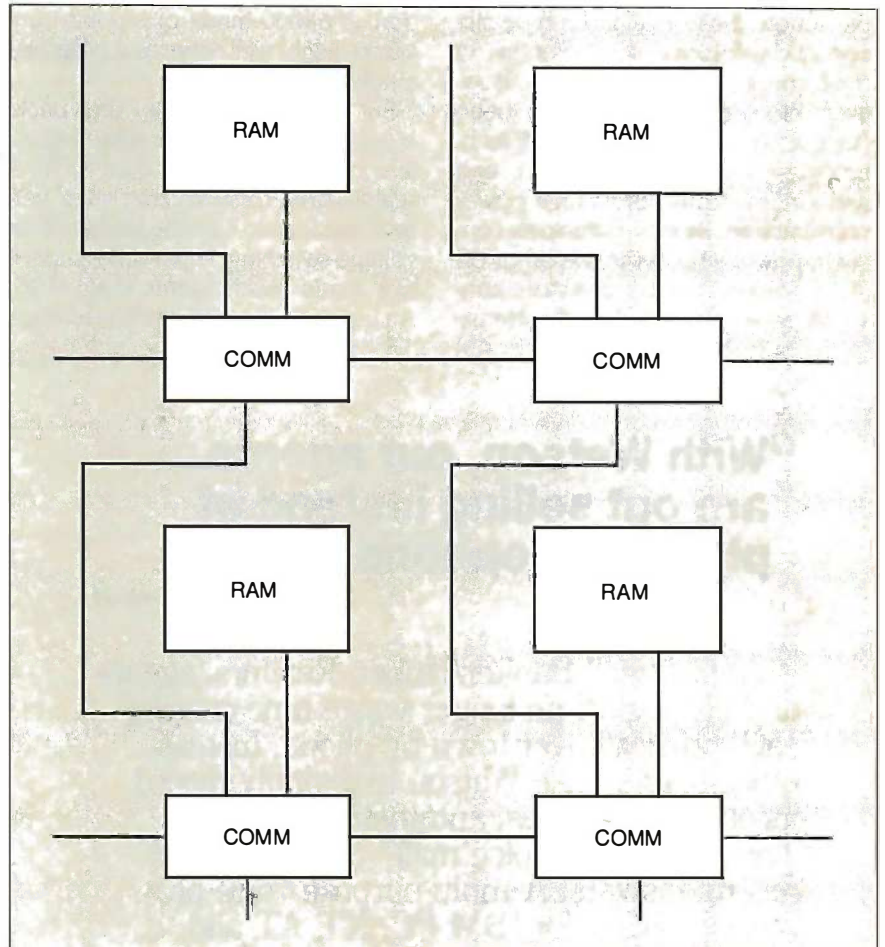

Figure 1: This diagram shows a portion of a Wisper wafer with four communications nodes and RAM arrays.

An important consequence of this wholly software-driven approach is that a Wisper can be reconfigured at any point during its life—if, for example, a wayward cosmic ray should knock out a RAM cell. By running the same initialization program and blowing a new EPROM, the device can be made usable again with a slightly reduced capacity.

THE FUTURE

It should be clear from the above that Catt's self-correcting technique is not dependent upon the process technology used to fabricate the wafer nor upon the nature of the devices connected to the communications nodes. Exactly the same sort of network could be used to connect an array of multipliers for signal processing, an array of general-purpose processors, or even exotic devices like charge-

coupled device light detectors. And the technique could be fabricated in NMOS, CMOS, emitter-coupled logic, or whatever, on silicon or gallium arsenide substrates. The only constraint is that the array must be linear (i.e., one-dimensional). Anamartic intends to capitalize on some of the possible options later, once the Wisper 2 has been established as a product.

A CMOS process was chosen for Wisper 2 because it is easy to get fabricated; all the major silicon houses have invested heavily in CMOS lines in recent years. However, Anamartic is researching a bipolar version of Wisper that offers several advantages. Bipolar technology is as old as the semiconductor technology itself; the original discrete transistors were bipolar devices made from sim-

(continued)

ple sandwiches of p- and n-type silicon. Today, bipolar is still familiar in the form of Schottky TTL parts. However, bipolar technology has been completely supplanted by MOS technologies for microprocessors and memories because of its high power consumption. Bipolar transistors consume power whether in the on or off state, whereas MOS transistors consume power only during the transi-

tion. A 68000 made of bipolar transistors might well serve as a programmable cigar lighter.

But apart from this drawback, bipolar technology has some attractive virtues. It is faster than MOS, it scales down to submicron sizes better, and being current- rather than voltage-switching, it can drive capacitive loads much better than MOS. Anamartic's Alan Sinclair (no relation

to Sir Clive), in association with the University of Southampton, has devised a novel low-power bipolar RAM cell that will be used in the next generation of WSI devices.

This RAM uses a single-transistor cell based on a silicon control rectifier that occupies little silicon area because it is organized vertically in layers. The bipolar process should be capable of starting at the 1-megabit integration level that conventional RAMs have just reached, but without any need for complex three-dimensional "trench-cell" techniques. Although dynamic, the bipolar RAM behaves almost like a static memory when it is read, producing a high output voltage that does not require amplification (hence saving components), and it has a lax refresh timing. These high voltage levels (together with the layered structure) also make the device quite immune to electronic noise. An added bonus is that it can be fabricated with only 7 masks, compared to 12 for the CMOS process.

This development should improve the cost per megabyte of WSI substantially. With the current Wisper design, there is a cost saving compared to conventional RAM because the wafer does not need to be sliced and packaged, but the silicon cost is exactly the same as for ordinary RAM of the same density. By going to bipolar, Anamartic believes that the silicon cost can be reduced to as little as half that of 1-megabit CMOS RAM.

All these features add up to a faster wafer holding 28 megabytes, at about half the silicon cost of the CMOS version. It will not, however, be ready for production for a couple of years; a demonstration device is planned for late 1987.

The ability of bipolar devices to drive capacitive loads will be important in image processing, one of Anamartic's future target markets. A wafer-scale array of simple processors, each performing part of a transformation, could be used to process continuous streams of video data at high speeds. Bipolar wafers could also be used directly as a video-frame

(continued)

"With Watson, our agents are out selling instead of playing telephone tag."

Charles C. Ashby, President
Huber, Realtors
Evansville, Indiana

At Coldwell Banker/Huber, Realtors, agents and office staff no longer waste time chasing each other all over town by phone. Instead, office staffers use Watson to digitally record incoming messages, automatically contact agents, deliver "voice mail" messages, and record answers. A multi-purpose voice processing option for IBM PC, XT, AT, and compatible computers, Watson costs only \$498 and has taken over two-thirds of Huber's telephone traffic.

For an ear-opening demo on how Watson can help you manage business communications better, call 1-800-6-WATSON. In Mass., (617) 651-2186.



Watson™

Natural MicroSystems Corporation

Watson is a trademark of Natural MicroSystems Corp. IBM PC, XT and AT are trademarks of International Business Machines Corp.

Princeton is the best choice in PC monitors.

When you're looking for a personal computer monitor, look at Princeton Graphic Systems. Our growing family of high quality personal computer monitors delivers compatibility, brilliant colors, high resolution, and dependability. Whether you're designing sophisti-

cated business graphics or number-crunching a financial spreadsheet. That's why Princeton is number one in the minds of more

and more personal computer owners every year.

For the very best in PC monitors, the choice is clear: Pick the company that's at the top. Princeton Graphic Systems.

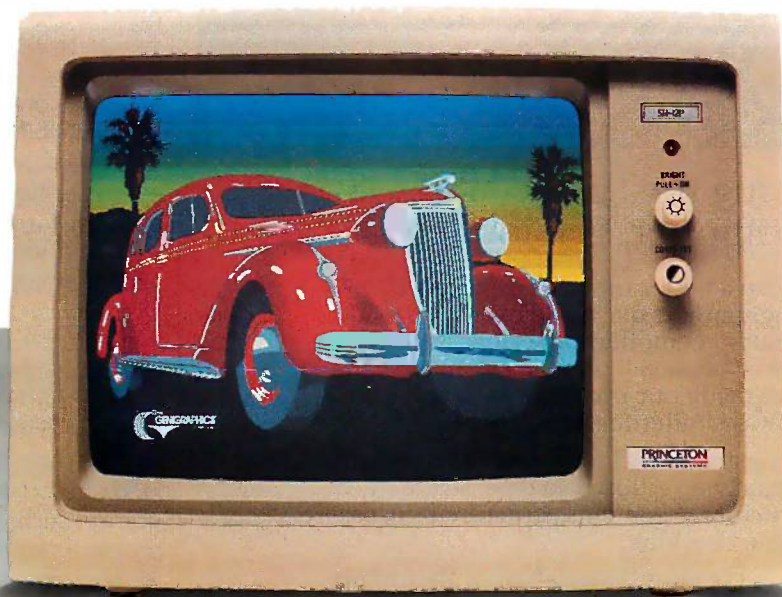

HX-12E. Our EGA-compatible monitor gives you 64 vivid colors. Extra sharp text and graphic displays. The finest dot pitch (.28mm) of any IBM-compatible enhanced monitor. Nonglare screen. Fully compatible with IBM's™ Enhanced Graphics Adapter (or equivalents).



SR-12P. Top-of-the-line analog color monitor features ultra high resolution (640 x 480), 4,096 colors for superb graphics. The finest dot pitch (.26mm) of any PGC-compatible monitor. Laminated nonglare panel.



HX-12. High resolution RGB color monitor with .31mm dot pitch gives you better graphics, better text than IBM's Color Monitor (5153). Nonglare screen. Voted "Best in the World" two years running in *PC World's* "World Class PC Contest".



SR-12. Super high resolution RGB monitor with a .31mm dot pitch. Compatible with Sigma Designs Color 400 board and others. Gives you 400 lines of resolution. Nonglare screen.



MAX-12. High resolution amber monitor. When used with an IBM-compatible monochrome adapter delivers 720 x 350 resolution. With an IBM-compatible color adapter, 640 x 200 resolution with 15 shades of amber. The monitor automatically adjusts to either card.



HX-9/HX-9E. Compact nine-inch high resolution RGB monitor. Perfect for workstations where space is at a premium. Both feature a .28 dot pitch and an etched dark glass screen. Ergonomic features like a built-in tilt/swivel base, nonglare screen, and a built-in green/amber switch. HX-9E is compatible with IBM's EGA (or equivalents).

All monitors come with free data and power cables.

Visit your local computer store today and ask about our full line of high-resolution color and monochrome monitors. Monitors that live up to the Princeton Graphic Systems tradition of quality, performance, and value.

Princeton Graphic Systems, 601 Ewing Street, Bldg. A, Princeton, NJ 08540; (609) 683-1660; TLX 821402PGSPRIN; (800) 221-1490, ext. 1104.

PRINCETON®

GRAPHIC SYSTEMS
AN INTELLIGENT SYSTEMS COMPANY

IBM is a trademark of International Business Machines, Inc. Color 400 is a trademark of Sigma Designs, Inc. QuadEGA+ is a trademark of Quadram Corp. Compaq is a trademark of Compaq Computer Corp.

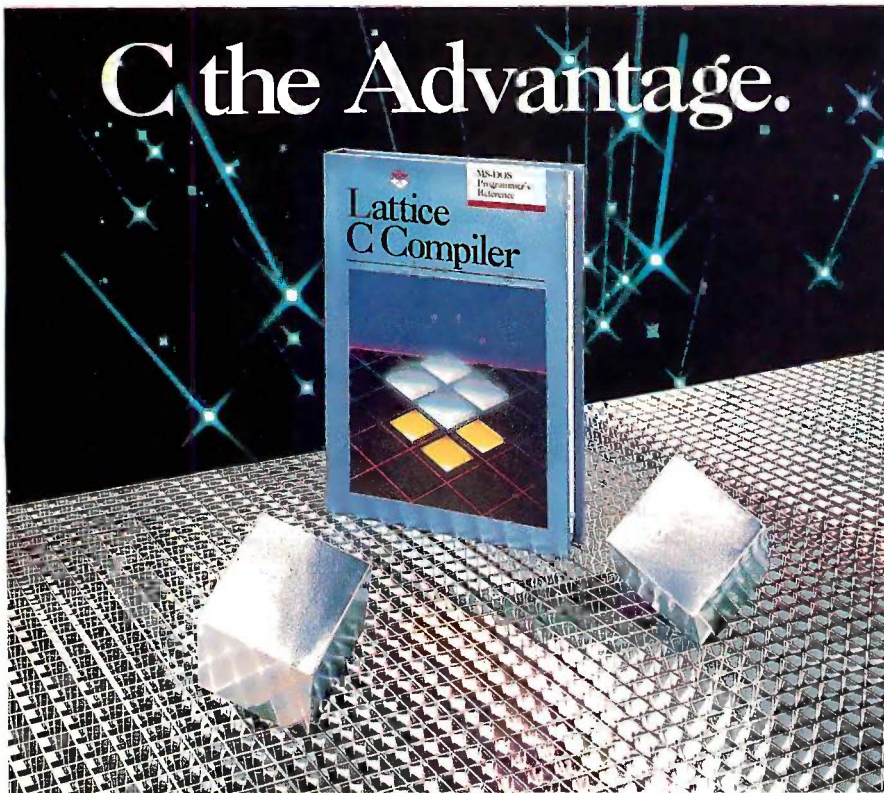

C the Advantage.

Introducing the Lattice[®] MS-DOS C Compiler, Version 3.

There's never been a better time to buy Lattice C. Professional programmers the world over have made Lattice C the standard compiler for serious MS-DOS programming. Now Version 3 offers even more of the features that have made our previous versions so popular. Our new compiler features include:

ANSI language constructs including, *unsigned* as a modifier, *void* data type, *enum* data type, structure assignments, structure arguments, structure returns, and argument type checking.

The compiler also contains better aliasing algorithms, more efficient code generation, and more flexible segmentation, in-line 8087 code generation, and 80186/80286 code generation.

The library contains more than 200 new functions, including: ANSI/UNIX/XENIX compatibility; extended support for MS-DOS; extended support for networking including file sharing, file locking, and I/O redirection; and flexible error handling via user traps and exits. Plus the library has also been re-engineered to produce much smaller executables.

Try the new Version 3 C Compiler from Lattice. Because C-ing is believing.



Lattice, Incorporated
 P.O. Box 3072
 Glen Ellyn, IL 60138
 312/858-7950 TWX 910-291-2190

INTERNATIONAL SALES OFFICES:
 Benelux: Ines Datacom (32) 2-720-51-61
 Japan: Lifeboat Inc. (03)293-4711
 England: Roundhill (0672)54675
 France: SFL (1)46-66-11-55
 Germany: (49)7841/4500 (49)8946/13290

store, whereas MOS would need expensive interfaces.

In this sort of application, another feature of WSI becomes important, namely, the low pin-out. Regardless of how many devices it contains, a serial wafer-scale component logically needs only two pins, In and Out (though in practice there are a few more). By contrast, modern microprocessors can have more than a hundred pins, and integrating hundreds of such chips would be a nightmare due to the explosively rising number of pin connections that have to be made. Interestingly, the Inmos Transputer arrived at a solution somewhat similar to WSI. The Transputer uses point-to-point serial connections for transmission of data, although when using off-chip memory, it still requires numerous pins. (It's fascinating to speculate how the Transputer would perform if it were integrated at wafer scale and whether Catt's linear-array approach could be adapted to cope with such two-dimensional networks.)

In principle, Anamartic's technology can be used to build linear arrays of general-purpose microprocessors with on-chip memory to execute parallel programs. However, not every kind of problem is amenable to solution on such a linear array; suitable problems are those that involve performing repetitive processing on a continuous stream of data. It's likely, therefore, that Anamartic will concentrate on small special-purpose processors for transforming the sort of data found in radar and audio and video applications.

I fervently hope that Anamartic can get the financial backing it requires to turn all these ideas into products. The technology looks feasible, and the story has an appealing romantic element in the shape of Ivor Catt's 15-year struggle to get his ideas accepted. However, the City of London is currently feeling sour toward high-technology investment in general, while the failure of Trilogy has unfairly tainted the name of wafer-scale integration inside the industry. At the time of writing (July), though, it seems that Anamartic has the backing to put Wisper 2 into production as a first step along the road. ■

We've taken the work out of doing Windows.

Microsoft® Windows is becoming the most popular operating environment for PC systems.

It's not surprising. Windows provides the foundation for an exciting new generation of applications that users are demanding. In addition, Windows handles many of the details involved in a software project allowing you to spend more time enhancing your application. That's why a growing number of corporate and independent software developers are building Windows applications.

The Microsoft Windows Software Development Kit is your key to this extraordinary new environment. It's packed with full reference documentation, libraries, utilities and sample programs. Together with our C Compiler or Macro Assembler, it's a comprehensive package that lets you make the most of your application.

Software with a new view.

Giving your applications the Windows treatment begins with a new look. The rich graphical environment allows you to rethink how you want your program to be presented on screen. It lets you mix text and graphics. You can incorporate multiple fonts in a variety of sizes, faces and styles. And it provides the basic building blocks that make it easy to create drop-down menus, dialog boxes, scroll bars, icons and more.

These features not only simplify your application design, but also provide the familiar interface that makes your software easier to learn and use.

Easing the data shuffle.

Of course, there's more to Windows than just looks. Now, different applications can work together. In concert.

The Windows Clipboard provides support for users to cut and paste information between your applications and others. Or you can use messages to establish "hot links" to transfer data automatically.

Upgrading made easy.

Windows' device independent design allows you to build your application today and take advantage of new technology as it becomes available. When new graphics cards, printers and pointing devices appear they can be used with your software, without modifying your code. Simply by installing the new driver.

Your window of opportunity.

The Microsoft Windows Software Development Kit is your fastest route to better applications. And with it, we also offer DIAL, our on-line technical support service to help you with the tough questions, and development courses that cover everything from using the dialog editor to memory management.

Find out how you can get your Microsoft Windows Software Development Kit. Pick up the phone and call (800) 426-9400. In Washington State and Alaska, call (206) 882-8088. In Canada, call (416) 673-7638. And we'll open the door to Windows.

The Microsoft Windows Software Development Kit includes:

- Dialog editor.
- Icon editor.
- Font editor.
- Resource compiler.
- Linker.
- MAKE (program maintenance utility).
- Symbolic debugger.
- Heap analysis utility.
- Sample programs.
- Windows libraries.
- Programmer's reference.
- Programmer's utility guide.

System requirements:

- 512K memory, DOS 2.0 or higher.
- Two double sided disk drives*
- Graphics adapter card.

*hard disk recommended

Microsoft® Windows Software Development Kit

The High Performance Software.

Microsoft is a registered trademark of Microsoft Corporation.

The fastest C

Your search for execution speed is over. The new Microsoft® C Compiler Version 4.0 is here. With blazing performance. We've added common sub-expression elimination to our optimizer that produces code that rips through the benchmarks faster than ever before.

"... the Microsoft performance in the benchmarks for program execution is the best of the lot overall!"
— William Hunt, *PC Tech Journal*, January, 1986*

But speed isn't the only edge you get with Microsoft C. Other advantages include a variety of memory models like our new HUGE model that breaks the 64K limit on single data items. Plus our NEAR, FAR and HUGE pointers, which provide you greater flexibility. All this allows you to fine tune your program to be as small and fast as possible.

"Excellent execution times, the fastest register sieve, and the best documentation in this review ... Microsoft Corporation has produced a tremendously useful compiler." — Christopher Skelly, *Computer Language*, February, 1986.

No more debugging hassles. Introducing CodeView. Free.

Now, for a limited time, we'll give you an unprecedented programming tool when you buy Microsoft C, free. New Microsoft CodeView™ offers the most powerful tool yet in

the war on C bugs. Forget the hex dumps. Now you can view and work with programs at any level you want. Use the program source, the disassembled object code, or

Microsoft C Compiler Version 4.00

Microsoft C Compiler

- Produces fast executables and optimized code including elimination of common sub-expressions. **NEW!**
- Implements register variables. **NEW!**
- Small, Medium and Large Memory model libraries.
- Compact and HUGE memory model libraries. **NEW!**
- Can mix models with NEAR, FAR and the new HUGE pointers.
- Transport source and object code between MS-DOS® and XENIX® operating systems.
- Library routines implement most of UNIX™ System V C library.
- Start-up source code to help create ROMable code. **NEW!**
- Full proposed ANSI C library support (except clock). **NEW!**
- Large number of third party support libraries available.
- Choose from three math libraries and generate in-line 8087/80287 instructions or floating point calls:
 - floating point emulator (utilizes 8087/80287 if installed).
 - 8087/80287 coprocessor support.
 - alternate math package — extra speed without an 8087/80287.
- Link your C routines with Microsoft FORTRAN (version 3.3 or higher), Microsoft Pascal (version 3.3 or higher) or Microsoft Macro Assembler.
- Microsoft Windows support and MS-DOS 3.1 networking support.
- Supports MS-DOS pathnames and input/output redirection.

Microsoft Program Maintenance Utility. **NEW!**

- Rebuilds your applications after your source files have changed.
- Supports macro definitions and inference rules.

Other Utilities

- Library Manager
- Object Code Linker
- EXE File Compression Utility.
- EXE File Header Utility.

C Benchmarks

	In seconds				
	Microsoft C 4.0	Lattice C 3.0	Computer Innovation C 2.3	Aztec C86 3.2	Wizard C 3.0
Sieve of Eratosthenes (register)	82.9	151.4	172.3	88.0	91.9
Copy Block	86.9	231.7	199.0	123.8	189.5

Run on an IBM PC XT with 512K memory

Microsoft CodeView

Window-oriented source-level debugger. **NEW!**

- Watch the values of your local and global variables and expressions as you debug.
- Set conditional breakpoints on variables, expressions or memory; trace and single step.
- Watch CPU registers and flags as you execute.
- Effectively uses up to four windows.
- Debug using your original source code, the resulting disassembly or both intermingled.
- Use drop-down menus to execute CodeView commands.
- Access the on-line help to lead you through CodeView's options and settings.
- Easily debug graphics-oriented programs since program output is kept separate from debugger output.
- Keyboard or optional mouse support.
- Enter in familiar SYMDEB or DEBUG commands.



you've ever seen.

both at the same time. Open a window to view CPU registers and flags. Watch local and global variables as well. All while your program is running.

CodeView gives you complete control. Trace execution a line at a time—using source or assembly code. Or set conditional breakpoints on variables, memory or expressions. CodeView supports the familiar SYMDEB command syntax, as you'd expect. Commands are also available through drop-down menus. Combine the new window-oriented interface with our on-line help and debugging has never been easier. Or quicker.

Take the \$5 CodeView tour.

You may find it hard to believe our debugger can do all we've claimed. So we're offering test drives. Five bucks will put you behind the wheel of a Microsoft C demo disk with CodeView.† See for yourself how fast debugging can get.

For more information about the CodeView demo disk, the new Microsoft C Compiler, a list of third party library support or the name of your nearest Microsoft dealer, call (800) 426-9400. In Washington State and Alaska, (206) 882-8088. In Canada call (416) 673-7638.

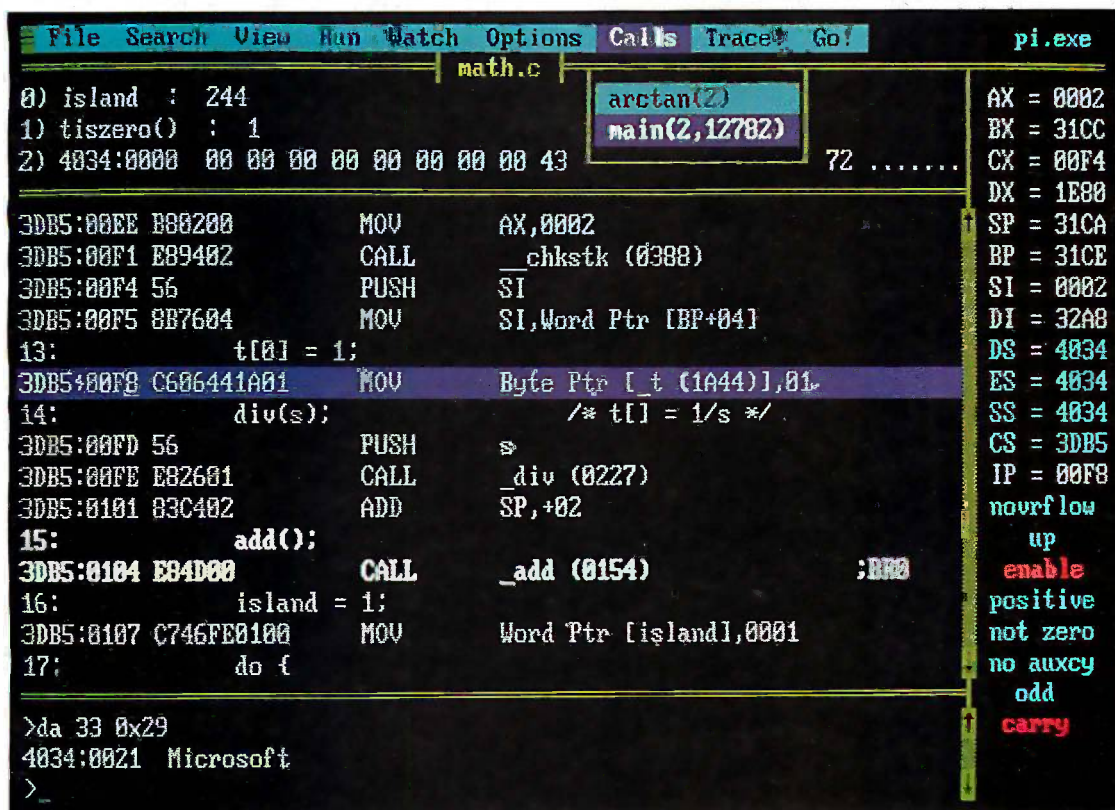

```
File Search View Run Watch Options Calls Trace Go! pi.exe
math.c
0) island : 244
1) tiszero() : 1
2) 4834:0000 00 00 00 00 00 00 00 43 72 .....

3DB5:80EE B80200 MOV AX,0002
3DB5:80F1 E89402 CALL _chkstk (0388)
3DB5:80F4 56 PUSH SI
3DB5:80F5 8B7604 MOV SI,Word Ptr [BP+04]
13: t[t] = 1;
3DB5:80F8 C606441A01 MOV Byte Ptr [t (1A44)],01
14: div(s); /* t[] = 1/s */
3DB5:80FD 56 PUSH s
3DB5:80FE E82601 CALL _div (0227)
3DB5:8101 83C402 ADD SP,+02
15: add();
3DB5:8104 E94D00 CALL _add (0154) ;000
16: island = 1;
3DB5:8107 C746FE0100 MOV Word Ptr [island],0001
17: do {

>da 33 0x29
4834:0021 Microsoft
>_

AX = 0002
BX = 31CC
CX = 00F4
DX = 1E80
SP = 31CA
BP = 31CE
SI = 0002
DI = 32A8
DS = 4034
ES = 4034
SS = 4034
CS = 3DB5
IP = 00F8
nowflow
up
enable
positive
not zero
no auxcy
odd
carry
```

Microsoft® C Compiler

The High Performance Software

Microsoft, MS-DOS and XENIX are registered trademarks and CodeView is a trademark of Microsoft Corporation. UNIX is a trademark of AT&T Bell Laboratories. IBM is a registered trademark of International Business Machines Corporation. †Offer expires 12/31/86.

The Diconix 150. So small, it's the one
PC printer you can take lightly. Anywhere.



DICONIX

A Kodak Company

3100 Research Boulevard
Dayton, Ohio 45420.

For the dealer nearest you, call
1-800-DICONIX Telex: 288-280

Inquiry 106



RESIDENT HEADACHES

BY EZRA SHAPIRO

It was the Great Crash of '86. I'd loaded seven TSR (terminate and stay resident) programs into RAM and was about to take a break by playing a round of Willy the Worm, a mindless shareware game. I never took that break; I typed "Willy," the screen blanked, and the system locked up. After several unsuccessful resets, I booted the Compaq from a floppy disk and discovered that about half my hard disk's file-allocation table had been turned to mush. Since I had done a backup three weeks earlier (there's another lesson here), it cost me two days of sweat to get the system back to normal. I have no idea what happened, and attempts to duplicate the crash have failed, but I'm forced to wonder about all those pop-ups.

Memory-resident programs for MS-DOS machines are multiplying like mosquitoes in a swamp. It wouldn't be so bad if MS-DOS (or Microsoft or IBM or somebody) offered the necessary facilities and standards to handle pop-up accessories in a straightforward fashion; but no, every developer has to reinvent the technology. As a result, the programs as a class are nasty, ill-tempered beasts that cause as many problems as they attempt to solve. Trying to evaluate them, I've learned a frightening rule: The more memory-resident programs you use, the more likely you are to freeze your software, crash your system, or lose your data.

While my testing has been neither faultlessly scientific nor absolutely comprehensive, it has certainly been valid in terms of the real world. My system is cleaner than 95 percent of the systems you'll find; even though every stand-alone application runs without a hitch (i.e., if it's going to run

Some MS-DOS pop-ups and Microsoft's Works for the Macintosh

at all on any machine), I have experienced every possible software disaster while playing with memory-resident programs.

Thus, it's impossible for me to say whether any specific program is truly safe to use; there are just too many variables to track: foreground applications, other pop-ups, versions of the operating system, etc., etc., etc. Everything interferes with everything else. So you're on your own when experimenting with the TSR programs mentioned below. (Good luck.)

Here are a few general guidelines. Don't load your system with more than one or two TSRs that are vital to the way you work; add a third or fourth and the odds of failure increase astronomically. Don't believe manufacturers' claims of universal compatibility; it's not possible, given the state of the art. Finally, expect to be disappointed.

For this column, I've pulled four TSR programs out of my growing pile of them. In the next few months, I'll try to get to as many of the others as makes sense.

CURSOR MADNESS

Of this month's products, I'm happiest with *Cruise Control* (Revolution, \$29.95), but I'm irritated that I need it.

Ever lean on a cursor key for a second and then watch in horror as the cursor sails across your screen to a spot well beyond where you wanted it to stop? *Cruise Control* is the answer. It makes your cursor *behave*.

For a small utility, its list of features

is impressive. You can adjust cursor speed to your taste, anywhere from a painful crawl to a whizzing blur. With "antiskid braking," the cursor stops instantly when you lift your finger from a key—no more cursor run-on. You can

have any key repeat automatically (at a reasonable rate) until you touch another. *Revolution* also throws in single-keystroke time and date stamps and a screen-blanking function to protect your monitor.

Cruise Control offers a selection of four strategies: one for most standard programs, a second for programs that set up their own internal keyboard buffers, a third for ported CP/M applications, and a fourth specifically for *WordStar*. It should run with just about anything:

I've used it extensively, mostly with *Framework* and a patched copy of *WordStar* for the PCjr, and it's delightful.

The reason I'm irritated about needing this program is because it does something I think the operating system should do. Dear old MS-DOS is caught with its pants down on this one.

TSR TEAMWORK

Next is *Referee* (Persoft, \$79.95), a group of three programs designed to simplify using TSRs. The ideas behind the product are really quite good, but I suspect the company may have taken on an impossible mission.

Referee lets you determine which memory-resident programs are active at any given moment. You tell it which TSRs you want running when you're using a particular piece of software.

(continued)

Ezra Shapiro is a consulting editor for BYTE. Contact him at P.O. Box 170040, San Francisco, CA 94117-0040.

PopDrop lets you unload TSRs from RAM without rebooting.

and it disables the others.

Let's say you want to have SideKick and ProKey available when you're at the DOS prompt, Ready! and Graph-in-the-Box in your spreadsheet, and Ready! and Strike in your word processor. First, you run a stand-alone program called REFEREE and give it lists of your applications and pop-ups. Next, you specify sets of TSRs for your applications. Persoft has done this part well; you can set up your combinations (what Persoft calls "RAM teams") in less than five minutes.

A second component, REFWATCH, is a TSR you load before any other memory-resident tools. REFWATCH monitors the DOS command line and

determines which TSRs should be activated or deactivated based on the information collected by REFEREE. The final program, SIDELINE, is a TSR that gives you a status check and allows you to enable or disable pop-ups from within your application.

In theory, then, you've got control over your TSR software. You can use what you want when you want it, and you can avoid conflicts between programs that use the same hot keys. However, in the absence of standards, you wind up with two more resident programs in the stack (REFWATCH and SIDELINE), and that means potential compatibility headaches.

Several of us at BYTE got copies of the product when it was released. I couldn't get it to work with Instant Recall, and my system froze every time I tried to use SIDELINE. Jon Edwards had no problems with SIDELINE, but he discovered that SuperKey could no longer communicate with SideKick. Then Dave Haskin at

Persoft called to say that Cruise Control was incompatible with Referee but was being fixed.

I like the crew at Persoft; they're organized, professional, and competent. When they say they intend to work their tails off to solve the compatibility problems, I believe them. I don't doubt that they'll get the program working smoothly with all the major pop-ups, and if that's what you want to run, Referee will be a great program for you. But there will always be a few obscure old programs and a couple of unorthodox new ones that will refuse to work with Referee, at least in its current form. If you tend to experiment, frustration lies ahead.

ANOTHER METHOD

PopDrop (InfoStructures, \$19.95) takes a less sophisticated approach to the question. It's merely a utility that lets you unload TSRs from RAM without rebooting your system, either one at a time or all at once.

In operation, it's a lot like the TurboPower Software TSRCOM utilities I wrote about last month. Unlike TSRCOM, a group of small public domain programs, PopDrop is a single piece of software, and as such is slightly easier to use.

Each time you invoke PopDrop, it places a small marker in RAM, allowing you to create layers of pop-ups between the markers. A second command clears out memory up to (or including) one or all of the markers. PopDrop also has a View command that shows you a map of memory, so you can tell which TSRs you've loaded. This strategy seems to work in most cases; the only problems I've had with either PopDrop or TSRCOM have been with very sensitive TSRs. The choice between the two is a coin flip; if you're more comfortable with commercial software, buy PopDrop. It works.

ELECTRONIC STICKERS

SmartNotes (Personics, \$79.95) is a good idea that's only slightly flawed in its execution. This TSR program provides a way to attach marginal notes to files; if you've scrawled comments on those little yellow sticky tags

(continued)

2 MB Turbo EMS in a single slot!

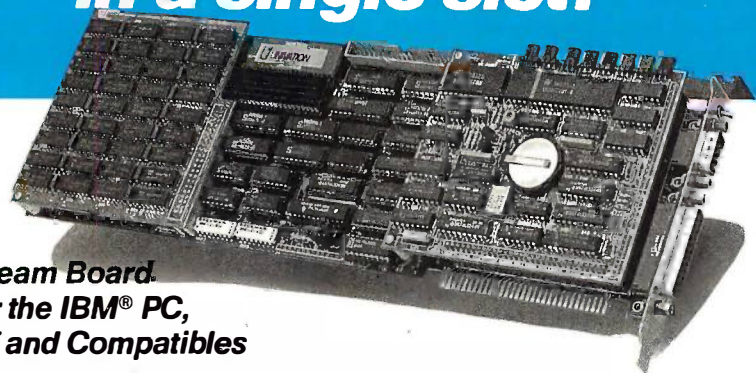

Dream Board. for the IBM® PC, XT and Compatibles

- 10 MHz speed triples system performance.
- Compatible with Lotus/Intel/Microsoft Expanded Memory Specification.
- Optional EGA or serial/parallel/clock module.
- Compatible with popular local area networks.

Call (outside California)
(800) 221-5842

 **UNIVATION**
System Solutions for Business

1231 California Circle
Milpitas, CA 95035
(408) 263-1200

TM: PC, XT, International Business Machine Corp.

SQUEEZE 10 TIMES AS MANY SPREADSHEETS ON A DISK. \$79.95.

Spreadsheets are wonderful tools, but they have three major drawbacks: they take up a lot of disk space, they take a lot of time to load and to save, and they're expensive to send electronically.

Introducing SQZ!™ from Turner Hall Publishing, the spreadsheet compaction utility that reduces the amount of disk space needed for Lotus 1-2-3® and Symphony™ spreadsheets by 80%-95%. And cuts retrieve/save time for floppy users.

SQZ! takes up less than 30K of RAM and runs co-resident in memory with DOS and the Lotus program. It works easily with popular memory-resident programs like Note-It™ and Sidekick™. In RAM, the spreadsheets remain the original size. Spreadsheets are automatically squeezed and unsqueezed during normal file saving and retrieving without loss of content.

SQZ! features a communications option that reformats spreadsheets so they can be sent over electronic mail services that normally only accept text files. And since the files are sent in compressed form, you can save 80%-90% in transmission time

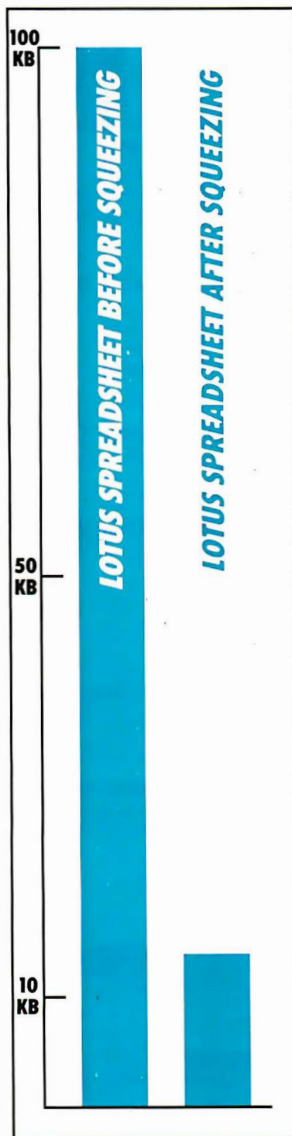

on your phone bill. And a password feature lets you encrypt files to protect them from unauthorized use.

SQZ! is simple to use. It's not copy-protected so hard disk users can install it easily. The user interface mimics Lotus'. You can even customize the defaults.

SQZ! runs on the IBM® PC, XT,™ AT,™ and 100% compatibles with any release of 1-2-3, Symphony and VP Planner.™ It's compatible with EMS memory expansion boards. Every package comes with a complete User's Manual, the program diskette, a Help Hotline number, and a 30-day money-back guarantee.

We also publish Note-It, the 1-2-3 documentation utility. Which, we're proud to say, was named 1985 runner-up Product of the Year by Infoworld.

Remember, when you're up to your ears in data, there's only one thing you can do. SQZ!

SQZ!

THE DATA SQUEEZER FOR LOTUS.

HOW TO ORDER.

Order SQZ! by phone. We accept MasterCard or Visa. Or fill out the coupon at the right and send it to us with a check or money order. Include \$2 shipping (\$12 outside USA). CA residents add \$5.60 sales tax. SQZ! comes with a 30-day, money-back guarantee.

 Turner Hall Publishing
10201 Torre Ave., Cupertino, CA 95014

1-800-556-1234 x527.
(In CA 800-441-2345 x527.)

SQZ! is also available at better dealers.

Please send me _____ copies of SQZ! at \$79.95, plus \$2.00 for shipping (\$12 outside USA). CA residents add \$5.60 sales tax. I enclose _____. Please charge my MasterCard or Visa.

Card # _____ Exp. Date _____

Name _____

Company _____

Address _____

City _____ State _____ Zip _____

Phone (_____) _____

BYT11086

SQZ! and Note-It are trademarks of Turner Hall Publishing. Lotus and 1-2-3 are registered trademarks, and Symphony is a trademark of Lotus Development Corp. Sidekick is a trademark of Borland International. IBM is a registered trademark of, and IBM XT and IBM AT are trademarks of International Business Machines Corp. VP Planner is a trademark of Paperback Software International. Program copyright Synex Systems Corp.

SEE US AT COMDEX FALL IN SOFTSEL BOOTH.

MORE OF THE BEST FROM MICRO MART AMERICA'S PC SPECIALIST!

Proline 286

- 80286 processor
- 10 MHz
- 256K standard (up to 1MB)
- video graphics card
- AT-style keyboard
- BIOS guaranteed
- 8 total expansion slots
- FCC licensed & UL approved

Color Graphics System \$1,449.00
Mono Graphics System \$1,495.00



Proline AT

- 80286 processor
- 8 MHz
- 360K floppy drive
- 512K standard (up to 1MB)
- video graphics card
- 12 total expansion slots
- BIOS guaranteed
- FCC licensed & UL approved

Color Graphics System \$1,925.00
Mono Graphics System \$1,975.00

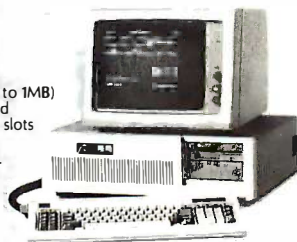

Proline XT

- 8088-2 processor
- 4.77 MHz - 8 MHz
- 256K standard (up to 640K)
- AT-style keyboard
- video graphics card
- 8 total expansion slots
- BIOS guaranteed
- FCC licensed & UL approved

Color Graphics System \$549.00
Mono Graphics System \$599.00



Monitor not included with PROLINE desk top systems, but we'll be glad to configure any system to your specific needs!!

MULTIFUNCTION BOARDS

We have a complete line of Multifunction Boards compatible with the PC, XT & AT and all compatibles.

AST SIX PAK, loaded w/384K	\$209
AST I/O MINI, short bid, serial, parallel, clock	CALL
QUADRAM Gold Quadboard, 384K, optional 2nd serial & parallel ports	\$439
TALLTREE J-RAM II and III	From \$125
INTEL ABOVEBOARD, PC & AT, NEW!	From \$235
THESEY FASTCARD up to 1 MB, Password Security for PC	From \$219

GRAPHICS CARDS

AST Preview, Hercules mono compatible	CALL
HERCULES Mono & Color Graphics Card	New Low Price!
TECMAR Graphics Master, HiRes Color & Mono supports Lotus	CALL
QUADRAM Quadcolor I & II color cards	
QUADRAM EGA, Includes 256K display buffer	\$359
STB EGA+ with 256K display buffer	\$319
STB Mono & Graphics Cards available	
Generic monographic cards	\$99
SIGMA Color 400 for PG5 SR-12	New Low Price!
PARADISE Multidisplay, mono & color, parallel	\$195
VIDEO 7 Vega EGA, best enhanced color graphics buy	\$309

FLOPPY DISK DRIVES

1/2 HEIGHT Disk Drives from Toshiba, Mitsubishi, & Teac: 360K & 1.2 Meg drives, PC, XT, & AT & compatibles

HARD DISCS

IRWIN 10MB internal tape back-up	\$429
IRWIN 20MB internal tape back-up	\$529
SYSGEN Complete line	Call for our special Sysgen pricing!
BERNOULLI TECHNOLOGY Hd disc Subsystems (20 & 40 MB)	From \$2095
SEAGATE 20 & 30 Meg. for PC/XT & PC/AT	CALL
PRIAM 40MB voice coil superfast hard drive	\$1249
PRIAM 60MB voice coil superfast hard drive	\$1595
TALLGRASS 25 through 80 MB Hard drive subsystems, including 60MB tape back-up	
WESTERN DIGITAL 10MB File card	\$539
WESTERN DIGITAL 20MB File card	\$629

SOFTWARE

ACCOUNTING

SORCIMI/US Complete line including windows

From \$295 each

SPREADSHEETS & INTEGRATED PACKAGES

SORCIMI/US SuperCALC 3, Vers. 2.1 \$209
SORCIMI/US SuperCALC 4 NEW

ENHANCEMENTS & UTILITIES

NORTON Utilities 3.1	\$50
ROSESOFT ProKey 3.0	\$79
COPY II PC	\$22
SOFTSTYLE Set FX+ and Printworks, printer control	
SIDEWAYS Inverts printout	\$35
BORLAND SideKick	\$32
BORLAND Superkey	\$42
BORLAND Lightning	\$59
FIFTH GENERATION Fastback	\$96

COMPILERS & LANGUAGE TOOLS

LATTICE C-Compiler \$249
MICROSOFT Complete line CALL
MICROSOFT Quick-Basic \$65
BORLAND Turbo Pascal, Toolbox & more From \$35/each

GRAPHICS

Z-SOFT PC Paintbrush, mouse graphics \$69
DECISION RESOURCES Diagram Master CALL

DECISION RESOURCES Sign Master	\$149
DECISION RESOURCES Chart Master	\$219
DECISION RESOURCES Map Master	\$239
MICROSOFT Chart	\$189
MICROSOFT Windows	\$65

COMMUNICATIONS

MICROSTUF Crosstalk XVI, Latest version	\$95
HAYES Smartcom II	\$85
MICROSOFT Access with windows	\$159

WORD PROCESSING

MULTIMATE Advantage	\$279
MICROSOFT Word, version 3.0	\$295
VOLKSWRITER, ver 3.0	\$159
SSI WordPerfect, version 4.1	\$229
MICROPRO Wordstar Professional	\$229
MICROPRO Wordstar 2000	\$229
MICROPRO Wordstar 2000 Plus	\$279

OFFICE & PLANNING

HARVARD Total Project Manager	CALL
SORCIMI/US Super Project	\$212
MICROSOFT Project, vers. 2.0	CALL

DATA BASE MANAGERS

Call For Unadvertised Data Base Managers	
MICRORIM Report Writer & Clout	CALL
MICRORIM R-BASE 5000	\$379
MICRORIM R-BASE System 5	CALL
MICROSTUF Infoscope	\$99
D BASE III PLUS	CALL!
BORLAND Reflex	\$75

PROTOCOL CONVERSION

SNA & BISYNC 3780, 5251, Mod 11 & 12, 3274, 3278	In Stock!
IRMA Complete line	From \$825

NETWORKING

QUADNET IX complete line

AVAILABLE

PRINTERS

DOT MATRIX

Complete line of EPSON printers	Special!
EPSON FX-85	\$389
OKIDATA 192, 193, Pacemark 2410	CALL
OKIDATA 292	\$449
OKIDATA 293	\$579

Due to continuing market fluctuations, pricing may drop daily.
Call for most current prices!!

(404) 449-8089 Orders Only 1-800-241-8149



America's PC Specialist

© Copyright 1986, Micro Mart, Inc. Technology Corporate Campus 3159 Campus Drive, Norcross, GA 30071
Prices and availability are subject to change without notice and are similar, but may vary at Micro Mart Retail Stores.

and stuck them to manuscripts or reports or walls, you've got the basic concept.

SmartNotes generates the equivalent of those stickers, in two sizes (5 lines by 23 characters and 10 lines at the same width) and half a dozen colors. The program attaches notes to text or spreadsheet cells by "remembering" the appearance of the relevant chunk of the screen; it's a form of pattern matching. Thus, not only can you annotate within an application, you can even add comments to your directory listings. Storage files can hold 50 notes, and they are completely independent of application-generated files.

I can see SmartNotes as the perfect product for any office where people must comment on a document before producing a final draft. This is the best way yet to suggest changes without having to alter an original.

Now for the quibbles. In all of Personics' promotional screen shots, notes are *always* attached to items to their left. It looks great because there's a little arrow in the upper left corner of each note calling attention to the flagged data. Unfortunately, that arrow is merely decoration—it's always there, pointing to the left, even if you're flagging an item to the right. This may seem like a trivial gripe, but it can get quite distracting.

Also, though the note editor is rudimentary, it does include word wrap. With a 23-character maximum width, word wrap is a lot more trouble than it's worth. I wish there were some way to shut it off.

Conclusion? SmartNotes is handy, particularly for team projects. Its flaws are easy to live with, the documentation is excellent, and the program is a breeze to run.

IN THE MAC CORNER

I'd call Works (Microsoft, \$295) for the Macintosh a wonderful piece of software if I could figure out the rationale behind its design. The product is a four-in-one integrated package that combines a word processor, a spreadsheet, a database manager, and a simple communications module. It will link databases and documents for an

(continued)

Sudden AT™ Death. What Would You Do?

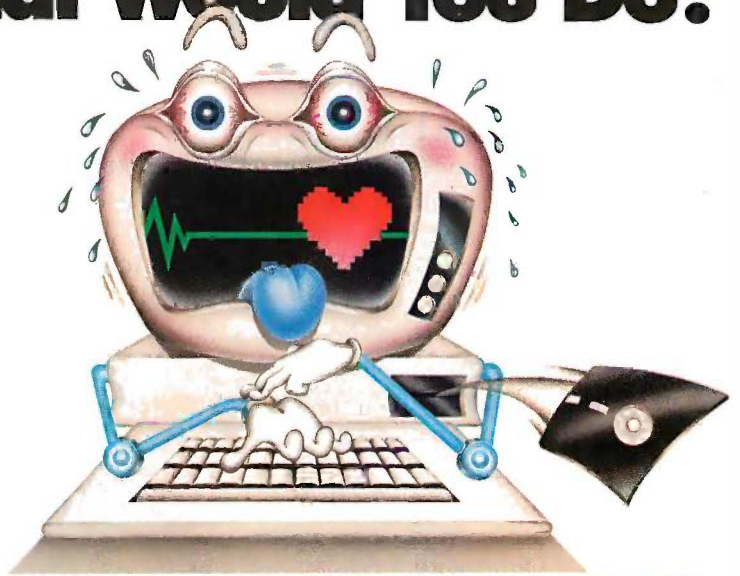

You turn on your AT™ computer and suddenly it starts to happen. Your computer starts gasping for information because your AT battery is dying. The simplest data, like the time and date, becomes a struggle. All vital signs start fading from the screen. Without action, the victim will soon lapse into unconsciousness.

What would you do?

Until recently you would have been powerless to save your AT computer. Replacement batteries were not readily available. All you could do was stand by helplessly as your computer's life source drained away. But now, with the help of IBC, you can resurrect your AT, by using IBC's simple method of CPR—Computer Resuscitation. Just plug in one of IBC's new Tadiran high-energy-lithium batteries, and your AT will have a new lease on life.

The Tadiran Replacement Battery from IBC saves you from an inevitable crisis. Every one of the million ATs, compatibles and clones in use today will face this emergency in the coming months. It could happen a few weeks from now, or maybe in a year. The lifespan of currently installed batteries varies from one month to 3 years.

Don't let time run out on your computer. Protect against down time!

Buy an IBC battery now, so you always have a back-up.

IBC Battery Features:

- Meets or exceeds all manufacturer's specifications
- Warranted for in-use life of 3 years
- 10-year shelf-life
- For IBM/AT, Compaq 286 series, and all other AT compatibles and clones
- Easy to install

If your computer should exhibit the following warning signs, you must take action immediately!

IBM/AT is a registered trademark of International Business Machines. Compaq 286 is a registered trademark of Compaq Corporation.

WARNING SIGNS

- Clock calendar function fades and disappears
- Configuration files vanish

Steps to Take In Case of Sudden AT Death

- Do not panic
- Do not move injured computer
- No need to call repairman
- No need to call manufacturer

Just call IBC, and you will get immediate shipment of your new Tadiran AT replacement battery. The life you save will be your computer's.

Corporate quantity discount available.

INSURANCE AGAINST AT COMPUTER FAILURE.

Don't delay. Order today.

Shipping \$3.00 per battery.

Please send me an IBC AT Battery for \$27.50 (CA residents add 6.5% for sales tax)

Name _____ Title _____

Company Name _____

Address _____

Make of computer _____

Check enclosed* Make money order or check payable to International Battery Corporation.

Mastercard or Visa # _____

Card expiration _____

*We need 7 working days for check to clear.

International Battery Corporation
6860 Canby Ave. # 113, Reseda, CA 91335 (TLX 6975427 +)
To order call: (800) 225-9359 CA
(800) 654-3790 US
Other inquiries call:
(818) 609-0516



How to tackle a 300 page monster.

Turn your PC into a typesetter.

If you're writing a long, serious document on your IBM PC, you want it to look professional. You want MicroT_EX. Designed especially for desktop publishers who require heavy duty typesetting, MicroT_EX is based on the T_EX standard, with tens of thousands of users worldwide. It easily handles documents from smaller than 30 pages to 5000 pages or more. No other PC typesetting software gives you as many advanced capabilities as MicroT_EX.

So if you want typesetting software that's as serious as you are about your writing, get MicroT_EX. **Call toll free 800-255-2550** to order or for more information.* Order with a 60-day money back guarantee.

MicroT_EX™ from Addison-Wesley

Serious typesetting for serious desktop publishers.

*Dealers, call our Dealer Hot Line: 800-447-2226
(In MA, 800-446-3399, ext. 2643.)

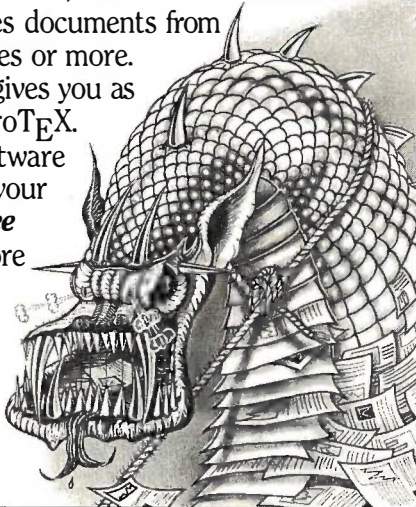

uncomplicated mail merge, turn spreadsheets and databases into good-looking business graphs, and spit out classy documents and database reports. Everything is clearly defined, true to the Mac interface, and professionally executed. Mac users will be particularly pleased to see that text does not lose attributes when moved between applications (an annoyance when you use the Mac's Clipboard with stand-alone programs).

In fact, I'd say that Works is perfect for 90 percent of what anybody does with a computer. But it is limited, and that's why I have my doubts. None of the individual pieces is as strong as other nonintegrated products, so I find myself coming up with a series of qualified recommendations.

Works is an excellent solution if your primary computer use is in an area outside the Big Four. If you use your Mac for programming, or graphic design, or something arcane, the package represents a good way to solve your basic writing and data-handling needs for less than you'd spend on stand-alones. And because the product is integrated, you don't have to mess with Switcher to have multiple functions loaded at the same time. I suppose this also means that Works would be terrific for first-time users and for businesses that don't have heavy-duty demands.

If you think you'd place heavy demands on one of Works' components, though, I'd recommend that you purchase a full-power product in that category. Whether you should buy Works to give you the other components is up to you; I don't have strong feelings either way at this level. On the other hand, if you need power in two or more of Works' categories, you'd be wasting your money if you bought it.

This program would be a knockout at \$100; at \$200 it would still be pretty nice. At nearly \$300, I find myself scratching my head about it; the same money could buy three top-grade programs for word processing, communications, and database management that would make Works look sick.

One final thing about the product

(continued)



FOCUS Computers

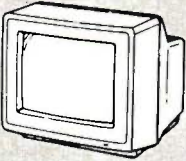

• COMPUTERS •	• MODEMS •	• PRINTERS •
<p style="text-align: center; font-weight: bold; font-size: 0.8em;">FREE INSTALLATION OF ANY ADDITIONAL BOARDS</p> <p style="font-weight: bold; font-size: 1.1em;">SHARP PC 7000</p> <p style="font-size: 0.8em;">Lightweight portable that's also a desktop</p> <ul style="list-style-type: none"> • Illuminated crystal display • Built in dual 5 1/4" floppy drives • 320 KB RAM expandable to 704 KB <p style="text-align: center; font-weight: bold; font-size: 0.8em;">SPECIAL FREE BONUS SHARP CASE WITH PURCHASE</p> <p style="text-align: center; font-weight: bold; font-size: 0.8em;">CALL FOR THE LOWEST PRICE</p> <p style="font-size: 0.8em;">BONDWELL XT compatible. Complete with 640K two 360K disk drives, keyboard, monochrome card, printer port, hi res monitor, GW basic, and DOS.</p> <p style="text-align: center; font-weight: bold; font-size: 0.8em;">SYSTEM PACKAGE ONLY \$869.95</p> <p style="text-align: center; font-size: 0.8em;">SERVICE NETWORK THROUGHOUT U.S.A.</p> <p style="font-size: 0.8em;">ORIGINAL IBM PC with 256K two IBM 360K disk drives, keyboard</p> <p style="font-weight: bold; font-size: 0.8em;">IBM NOW ONLY \$1049.95</p>	<p style="text-align: center; font-weight: bold; font-size: 0.8em;">• MONITORS •</p> <p style="font-size: 0.8em;">Amdek color 730 RGB/Analog/ Extra hi res. PGA Compat. 749.95</p> <p style="font-size: 0.8em;">Can't mention the name 13" RGB hi res. mfg. by Hitachi List 699.95 Now only 279.95</p> <p style="font-size: 0.8em;">NEC multi sync everything all in one monitor EGA/PGA/CGA/. . . NEW LOW 4109.95</p> <p style="font-size: 0.8em;">Xtron hi res T.T.L. monitor w/tilt base. 4109.95</p> <p style="font-size: 0.8em;">Princeton Graphics HX12 hi res color RGB 398.95</p>	<p style="text-align: center; font-weight: bold; font-size: 0.8em;">• COMPUTER BOARDS •</p> <p style="font-size: 0.8em;">Hercules color card 149.95</p> <p style="font-size: 0.8em;">Paradise EGA with auto switch, 359.95</p> <p style="font-size: 0.8em;">AST six pak plus, 384K 219.95</p> <p style="font-size: 0.8em;">Tecmar the Captain multi function 169.95</p> <p style="font-size: 0.8em;">Western digital 10 meg/ 20 meg LOW</p> <p style="font-size: 0.8em;">• Can't mention the name •</p> <p style="font-size: 0.8em;">Color graphics card 89.95</p> <p style="font-size: 0.8em;">Mono graphics card 109.95</p>

Focus Computers, 1303 46th St., Brooklyn, N.Y. Tel. (718) 871-7600. Open Mon.-Thurs. 10-7, Sun. 10-6, Fri. 10-3. Most orders shipped within 24 hours. Master Card, VISA, American Express gladly accepted. All prices in this ad reflect cash discount. New York State orders must add local sales tax. All merchandise available while supplies last. Price guaranteed subject to verifiable suppliers increases. Money back guarantee if returned within 14 days in mint condition with all papers and packing material intact. No returns accepted on open software.

Call Toll Free
1-800-223-3411

15,000 SAVED FROM CRASH.

No hysteria. No panic. No reports of data loss. No wonder more than 15,000 Alpha Micro users have chosen our Videotrax™ backup technology over streamer tape or floppies.

The best news is it's now available for the IBM® PC-AT, XT and true compatibles.

BETTER TO BE FAIL-SAFE THAN SORRY.

Exhaustive testing and long term use of Videotrax technology prove it more reliable than any other backup



High-tech. Open your PC and slide the controller board into any expansion slot. Low-tech. Hook up VCR to computer with standard connector cables.

option available. Even more reliable than the hard disk you're backing up.

At the heart of the system is a patented video tape controller board that employs a standard video cassette recorder for copying data. Which means Videotrax offers the sophisticated technology of today's VCRs. And the depend-

ability of a durable consumer good.

EASY DOES IT.

If you own a VCR, you already own half the system. And you already know how to use it. Or you might opt for the complete subsystem (controller board plus enhanced VCR) and experience the

Your basic video cassettes. Reliable, cheap, easy to find.



joy of its automatic, unattended backup capabilities.

Either way, our menu driven software, clear documentation and wide range of backup modes keep it simple: Insert a blank video cassette tape and follow the directions that appear on your screen.

You can copy or restore your entire hard disk, specific files, or only files modified since the last backup, while the system busily self-monitors for proper functioning.

And for the price of taping your favorite TV shows, you can record your most valued computer data. Up to 80MB can be stored on a single cas-

sette at less than a third of the cost of streamer tape.

Of course, if you ever require service, your authorized Alpha Micro dealer and our world-wide network of factory service centers will provide all the support you need.

For more information on how Videotrax can keep you off the crash course, call your local dealer or Alpha Micro at 1-800-992-9779 (in California call 1-800-821-0612).

VIDEOTRAX™

DATA BACKUP FROM ALPHA MICRO.



Corporate Headquarters: 3501 Sunflower, P.O. Box 25059, Santa Ana, CA 92799 © 1986, Alpha Microsystems. All rights reserved. IBM is a registered trademark of International Business Machines. U.K. Headquarters: Berkshire House, 56 Hershel St, Slough, Berkshire, Great Britain. European Headquarters: 130 Chaussée de la Hulpe, Box 14 1050 Brussels, Belgium.

8 YEARS OF GUARANTEED QUALITY & SERVICE

PC HARD
DISK KITS
20 MEGABYTES
IS20 \$429
30 MEGABYTES
IS30 \$525

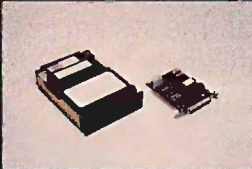
PC/AT
HARD DISK KIT
80 MEG HARD DISK
FREE SCSI PORT
IS80-S \$1995

PC, AT &
TANDY 1000
HARD DISK CARD
30 MEG HARD CARD
PCWD-30 \$795
TWD-30 \$795

HIGH CAPACITY
AT/XT
HARD DISK KIT
250 MEGABYTES
WITH SCSI PORT
IS250S \$4995

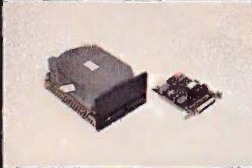
PC, AT &
TANDY 1000
HARD DISK CARD
21 MEG HARD DISK
FREE SCSI PORT
THC-21 \$675
PCHC-21 \$675





PORTABLE
FLOPPY DRIVE
CAPACITY: 720K
MF720P \$295

PC, AT &
TANDY 1000
HARD DISK CARD
20 MEG HARD DISK
PCWD-20 \$479
TWD-20 \$479



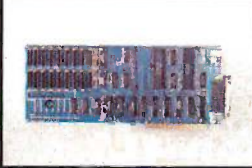

SCSI HOST
ADAPTER CARD
CONNECTS YOUR
PC TO 7 OTHER
DEVICES
SCSI-1 \$190

TAPE BACKUP
40 MEG INTERNAL
MT40 \$595
40 MEG PORTABLE
MT40P \$695

TANDY 1000
MULTI-FUNCTION
CARD
SERIAL PORT
DMA CONTRL
CLOCK 512K
TMF-1 \$269

TAPE BACKUP
60 MEG INTERNAL
MT60 \$795
60 MEG EXTERNAL
MT60E \$895

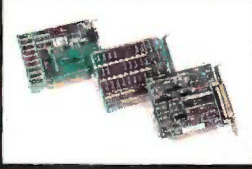
CALL FOR OUR
FULL LINE OF
HALF CARDS
COLOR GRAPHICS
MEMORY CARD
FLOPPY
CONTROLLER
CALL

LASERBANK
2000
2 GIGABYTE
LASER DRIVE
CALL



WITH ALL HARD DRIVES
DIRECT/ASSIST \$49.95
R/ASSIST \$49.95
LIGHT SPEED \$79.95
CACHE/ASSIST \$49.95

FREE

LASERBANK
400
200 MEGABYTES
LASER DRIVE
CALL



DATA TOWER
1 GIGABYTE
HARD DISK SYSTEM
CALL

APPLICATIONS ONLY

ITEMS DISCUSSED

CRUISE CONTROL\$29.95
(\$3.50 shipping)

Revolution Software Inc.
715 Route 10 E
Randolph, NJ 07869
(201) 366-4445

POPDROP\$19.95
(\$3 shipping)

InfoStructures Inc.
P.O. Box 32617
Tucson, AZ 85751
(602) 299-5962
orders: (602) 323-4600

REFEREE\$79.95

Persoft Inc.
456 Science Dr.
Madison, WI 53711
(608) 273-6000

SMARTNOTES\$79.95
(\$3.75 shipping)

Personics Corporation
2352 Main St.
Concord, MA 01742
(617) 897-1575
orders: (800) 445-3311;
in Massachusetts, (800) 447-1196

WORKS\$295
Microsoft Inc.
16011 Northeast 36th Way
Redmond, WA 98073
(206) 882-8080

makes me hesitant to endorse it. Works has no built-in macro language. Repetitive tasks cannot be automated, which is a big lack. This is most painful in the telecommunications module. As there are no facilities for creating log-on scripts, you're going to have to remember all your access codes and passwords with no help from Works. If Microsoft had implemented a control language like the one in Framework on the PC, or even some sort of "learn" mode, this could have been a spectacular program. Without it, Microsoft Works is merely okay. ■

ORDER LINE 800 228-0891
305 677-8333

0986

Inquiry 209

1 YEAR WARRANTY, 30 DAY MONEY BACK GUARANTEE

Micro Design International, Inc.

6985 University Boulevard, Winter Park, Florida 32792



What's black and blue and read all over... and yours for just

\$5.16

The Handbook of Computers and Computing

The latest edition of the most information-packed computing resource is the most convincing reason to try the Data Processing Book Service.

Don't take this book because it saves you \$72.34

You will save \$72.34 off the publisher's list price of \$77.50, but that's not the best reason to send for The Handbook of Computers and Computing.

Don't take this book because of the bonus gift.

When you accept The Handbook and trial membership in the Data Processing Book Service, we'll give you a handsome, gunmetal gray canvas portfolio with 4 roomy pockets, free. But that's not the best reason to respond.

Take this book for what it means to your career

The Handbook of Computers and Computing will help you catch up with the rapidly changing technology. 50 original articles by 52 experts are written for busy computer professionals like you, who need to keep current. Read what's new in Components...Devices...Hardware and Software Systems...Programming Languages (13 chapters!)...Procedures. Whether you're a systems designer, programmer, consultant, installations manager, system user or engineer, you'll depend upon this thorough, fully illustrated reference.

Try it for 15 days before you decide

Take 15 days to look over The Handbook. Then, if you can think of a better \$5.16 investment in your career, send it back and owe nothing. But if you're as convinced as we are, keep it and look forward to the full benefits of membership in the Data Processing Book Service.

Your savings have just begun

As a member, you'll save 20-35% off each book we offer. Every 3-4 weeks we'll present you with choices: Main Selection, Alternate or no book at all. You agree to purchase just 3 books during the next year.

Use the postage-paid Savings Certificate to get your Handbook and trial membership today!

YOURS FREE WITH TRIAL MEMBERSHIP!



When you enroll in the Data Processing Book Service, we'll send you this rugged, handsome canvas portfolio absolutely FREE. It's perfect for carrying your papers and materials.



Send no money! Mail coupon to:
Data Processing Book Service
Enrollment Center, Box 442
West Nyack, NY 10995



ENTER my request for this great book! 58-8 37704-4 DP104-AA(2)

Please rush me The Handbook of Computers and Computing (a \$77.50 retail value) and enroll me as a trial member in the Data Processing Book Service. After 15 day FREE examination, I may return it, cancel membership and owe nothing. If I keep the book, I'll pay just \$5.16 (plus shipping, handling and applicable sales tax) and agree to purchase 3 more selections during the next year, according to the terms of this offer.

BONUS GIFT: Send me the canvas portfolio FREE just for trying the Data Processing Book Service.

NAME _____

ADDRESS _____

CITY _____

STATE _____

ZIP _____

SIGNATURE _____

For new members only in the Continental USA and Canada. Subject to acceptance by DPBS.

(Cards missing? Write Data Processing Book Service, P.O. Box 442, West Nyack, NY 10995)

In 1950 America saw the future in Packard Bell.



America grew up listening to Packard Bell radios. Then Packard Bell television entertained the nation. Today Packard Bell has launched the products that provide American business

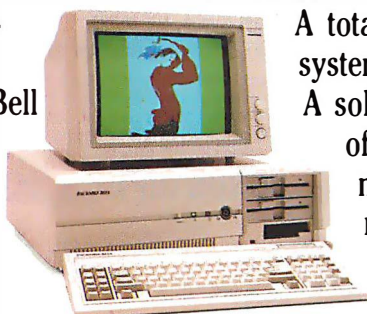

The VT 286 Business Computer. PC/AT compatible. Ultra fast, ultra reliable.

with a faster, more powerful, more reliable computer system.

A total business system solution. A solution capable of expanding, networking, multi-tasking, and of keeping pace with

software developments. It is a system so versatile it will optimize the hardware and software the user may have already invested in. It is, indeed, a total business system solution.



The EGA Color Monitor. Super high resolution. 64 color capability. EGA, CGA, MGA compatible.

In 1986 it still does.



As the future unfolds, Packard Bell will continue to develop the products and services needed by the business and professional user. Products that perform reliably, economically, and deliver the value not often provided



The 1200 or 2400 bps modems are Hayes compatible.

by major manufacturers.

America began listening to Packard Bell in 1929. Since then Packard Bell has become a familiar name...a name that has stood for quality. It still does. It always will.



The high speed laser printer provides superb letter quality at the rate of 8 pages per minute.

PACKARD BELL

America grew up listening to Packard Bell. It still does.

For more information call toll free:
1-800-521-7979 or 1-800-327-4499
6045 Variel Avenue
Woodland Hills, CA 91367
(818) 704-3905

Hayes is a registered trademark of Hayes Microcomputer Products, Inc.
IBM PC and AT are trademarks of International Business Machines Corporation.

Inquiry 243 for End Users. Inquiry 244 for VARS.

Six great reasons to join **BIX** today

- **Over 140 microcomputer-related conferences:**

Join only those subjects that interest you and change selections at any time. Take part when it's convenient for you. Share information, opinions and ideas in focused discussions with other BIX users who share your interests. Easy commands and conference digests help you quickly locate important information.

- **Monthly conference specials:**

BIX specials connect you with invited experts in leading-edge topics—CD-ROM, MIDI, OS-9 and more. They're all part of your BIX membership.

- **Microbytes daily:**

Get up-to-the-minute industry news and new product information by joining Microbytes Daily and What's New Hardware and Software.

- **Public domain software:**

Yours for the downloading, including programs from BYTE articles and a growing library of PD listings.

- **Electronic mail:**

Exchange private messages with BYTE editors and authors and other BIX users.

- **Vendor support:**

A growing number of microcomputer manufacturers use BIX to answer your questions about their products and how to use them for peak performance.

What BIX Costs. . How You Pay

ONE-TIME REGISTRATION FEE: \$25

Hourly Charges: (Your Time of Access)	Off-Peak 6PM-7AM Weekdays Plus Weekends & Holidays	Peak 7AM-6PM Weekdays
BIX	\$9	\$12
Tymnet*	\$2	\$6
TOTAL	\$11/hr.	\$18/hr.**

* Continental U.S. BIX is accessible via Tymnet from throughout the U.S. at charges much less than regular long distance. Call the BIX helpline number listed below for the Tymnet number near you or Tymnet at 1-800-336-0149

** User is billed for time on system (i.e. 1/2 Hr. Off-Peak w/Tymnet = \$5.50 charge.)

BIX and Tymnet charges billed by Visa or Mastercard only.

BIX HELPLINE

(8:30 AM-11:30 PM Eastern Weekdays)

U.S. (except NH)—1-800-227-BYTE

Elsewhere (603) 924-7681

See the BIX demo at
BYTE magazine's booth #362 at the Fall Comdex.



We'll
Send
You a

BIX User's Manual and Subscriber Agreement
as Soon as We've Processed Your Registration.
JOIN THE EXCITING WORLD
OF BIX TODAY!

JOIN BIX RIGHT NOW:

Set your computer's telecommunications program for full duplex, 8-bit characters, no parity, 1 stop bit OR 7-bit characters, even parity, 1 stop using 300 or 1200 baud.

Call your local Tymnet* number and respond as follows:

Tymnet Prompt

Garble or "terminal identifier"
login:
password:
mhis login:
BIX Logo—Name:

You Enter

a
byteneti <CR>
mgh <CR>
bix <CR>
new <CR>

After you register on-line, you're immediately taken to the BIX learn conference and can start using the system right away.

FOREIGN ACCESS:

To access BIX from foreign countries, you must have an account with your local Postal Telephone & Telegraph (PTT) company. From your PTT enter 310600157878. Then enter bix <CR> and new <CR> at the prompts. Call or write us for PTT contact information.

BIX

ONE PHOENIX MILL LANE
PETERBOROUGH, NH 03458
(603) 924-9281



PARADOXES OF PROBABILITY

BY ROBERT T. KUROSAKA

A survey of sucker bets and an analysis of how they work

Nonintuitive probabilities are all around us, leading to a proliferation of so-called sucker bets. In this column, I'll analyze some of the more popular ones and simulate a couple of them with BASIC computer programs.

How about a small, friendly bet? Four playing cards, two red and two black, lie facedown on the table. Without looking, you choose any two cards. I'll bet you \$1 that you pick one red card and one black card. Shall we play?

Since you hesitate, I'll explain the natural fairness of this game. Only two outcomes are possible: the colors match or they do not. Your probability of winning is therefore one-half. The game is fair since neither of us has an advantage. Ready to put your money down?

You won't be fooled that easily, right? Your sense of caution is admirable. I'll explain further. Three, not two, outcomes are possible: Both cards you select are red, both are black, or one is black and the other red. The colors match in two of the three cases. Thus, your probability of winning is two-thirds. The game is in your favor. Now will you play?

Your suspicious nature is beginning to annoy me. Very well, here is my final explanation. Four (count 'em, four) possibilities exist. Consider that the cards are chosen one at a time. Both cards could be red; both could be black; the first red, the second black; or the first black and the second red. The colors match in two of these four possible drawing sequences, giving you (again) a 50-50 chance of winning the bet.

Okay, I've listed all possible outcomes in three different analyses, and in every case, your chances of winning the wager are 50-50 or better. So how

about that friendly bet?

Did you accept the bet? If so, you have just been hustled.

Examine your chances more closely. When you choose the first card, it must be either red or black; the choice has no effect on your chances of winning. Now, of the remaining three cards, how many match the color of the card in your hand? Only one. Therefore, your probability of winning is only one-third (honest, this time!).

So what is wrong with the three previous analyses? To varying degrees, each of them is based on an incomplete listing of all possible outcomes. The incompleteness is subtle and therein lies the hustle.

Denote the four cards as r_1 , r_2 , b_1 , and b_2 . List all possible pairs of cards you can choose: (r_1, r_2) , (r_1, b_1) , (r_1, b_2) , (r_2, b_1) , (r_2, b_2) , (b_1, b_2) . Of the six possible outcomes, only two have matching colors. Your probability of winning is indeed one-third.

PHONE BOOK FOLLIES

Open a telephone book to any page and select any column. In that column, circle any 13 consecutive phone numbers. I will bet \$1 that at least two of the phone numbers end in the same two-digit number.

You may feel more confident about making this wager. After all, there are 100 possible two-digit numbers from 00 to 99. Thus, the probability of an exact match would seem to be 1 in 100. Even with 13 chances, it would seem unlikely to find a pair of matching two-digit numbers. But again,

intuition betrays us.

The sucker in this bet favors the possibility that no match exists among the 13 phone numbers. Let's analyze the probabilities of that happening. The first number on the list can be

any two-digit number and has no effect on the odds. The second number must not match the first; therefore, it must be one of the other 99 two-digit values; that probability is 99/100. The third number cannot match either of the first two numbers, leaving it 98 possible nonmatching numbers; that probability is 98/100.

The pattern continues down to the thirteenth number, for which only 88 possibilities exist (the other 12 having been taken already); its probability for not matching is 88/100.

The probability that no match exists among the 13 numbers is the product of the individual chance factors:

$$\frac{99}{100} \times \frac{98}{100} \times \frac{97}{100} \times \dots \times \frac{88}{100} \approx 0.442775$$

That is, you can expect to win your bet (no match) about 44.3 percent of the time, and I can expect to win the other 55.7 percent of the time. Simplifying it, my odds of winning are about 5/9. For a truly fair game, I should offer odds: my \$5 against your \$4, or \$1.25 against your \$1. Since our original bet was even money (1:1), I have a definite advantage. In 1000 such wagers, I can look forward to winning \$557 and losing \$443, showing a profit of \$114.

Altering the conditions so that you circle 20 numbers increases the probability of a match to 87 percent; 30

(continued)

Robert T. Kurosaka teaches mathematics in the Massachusetts State College system. He can be reached do BYTE, One Phoenix Mill Lane, Peterborough, NH 03458.

Listing 1: A BASIC program to illustrate the phone book bet and similar wagers. An abbreviated sample run is also shown.

```

10 OK=.99999          :REM Close enough to 1
20 PRINT "Calculate the probabilities for finding a
   match,"
30 PRINT "given C possible outcomes and taking N events."
40 INPUT "Enter value for C (>1)";C
50 IF C<2 THEN PRINT "Can't be.": END
60 PRINT "Enter a starting value for N, from 2 to ";C-1;
70 INPUT SV
80 IF SV<2 OR SV>=C THEN PRINT "Can't be.":END
90 PRINT "Table of probabilities given ";C;"possible
   outcomes."
100 PRINT "# of events   Probability"
110 FM$= " #####      #.#####"
120 FOR N=SV TO C-1
130 P=1
140 FOR J=1 TO N-1 STEP 1
150 P=P*(C-J)/C
160 NEXT J
170 PRINT USING FM$;N,1-P
180 IF 1-P>=OK THEN N=C-1
190 NEXT N
    
```

Calculate the probabilities for finding a match, given C possible outcomes and taking N events.
 Enter value for C (>1)? 100
 Enter a starting value for N, from 2 to 99 ? 10
 Table of probabilities given 100 possible outcomes.

# of events	Probability
10	0.371843
11	0.434659
12	0.496847
13	0.557225
...	...
41	0.999933
42	0.999960
43	0.999977
44	0.999987
45	0.999993

numbers gives a match probability of more than 99 percent.

Extending the bet to cover three-digit numbers gives results that are even more surprising. Circling only 38 numbers, the probability of finding a three-digit match is more than 50 percent; circling 70 numbers gives a probability of 90 percent that you will find at least one pair of matching three-digit numbers.

The familiar "Birthday Paradox" has a similar explanation in the laws of probability. Given a gathering of 23 people, the odds that at least two people share the same birthday (month and day) are, surprisingly, better than even (50.7 percent). For 24

people, the probability rises to 53.8 percent. With 41 people, the chance rises to 90.3 percent.

The paradox evaporates when we analyze the situation closely. For simplicity, we exclude February 29 birthdays and assume that birthdays are uniformly distributed among all 365 days in a year. That is, the probability of one's birthday falling on a particular date is exactly 1/365. The probability of two people *not* sharing a birthday is thus 364/365. Each additional person we consider adds another reducing factor to the probability that no birthdays are shared.

The program in listing 1 lets you explore the probability trends for this

general class of sucker bets. You specify the number of possible outcomes; the program shows the probability of a duplicate outcome occurring within a specified number of events.

CARD GAMES

Another class of sucker bets involves playing cards. Here's one of my favorites.

Two shuffled decks are on the table. I bet that among the first six cards in each deck are two identical cards. Your bet, if you choose to accept it, is that no duplicate cards will be found among the first six cards in the two decks. What are your odds?

We draw the first six cards from deck 1. In deck 2, the top card cannot be any of the previously drawn six cards; it must be one of the other 46 cards. The probability of a nonmatch is thus 46/52. The second card must not be any of the six noted cards; it must be one of the other 45 cards of the 51 remaining in deck 2. The probability of a nonmatch is 45/51. The pattern continues for the remaining four cards, giving a cumulative probability of

$$\frac{46}{52} \times \frac{45}{51} \times \frac{44}{50} \times \dots \times \frac{41}{47} \approx 0.4600933$$

Probability of a nonmatch after drawing six cards is about 46 percent, leaving a probability that a match will be drawn of about 54 percent (certainly enough for me to make a living on, if I can find enough suckers to take the bet).

Now suppose we have three shuffled decks on the table. I bet that among the top four cards of each deck will be found two identical cards. You bet that no matches will be found. Are your odds any better this time?

After drawing four cards from deck 1, the odds of not finding a match in four cards from deck 2 are, respectively, 48/52, 47/51, 46/50, and 45/49.

Drawing from deck 3, the first card cannot be any of the eight previously drawn cards; probability of that is 44/52. Probabilities for the next three cards not matching are 43/51, 42/50, and 41/49.

Multiplying the probabilities gives a

(continued)

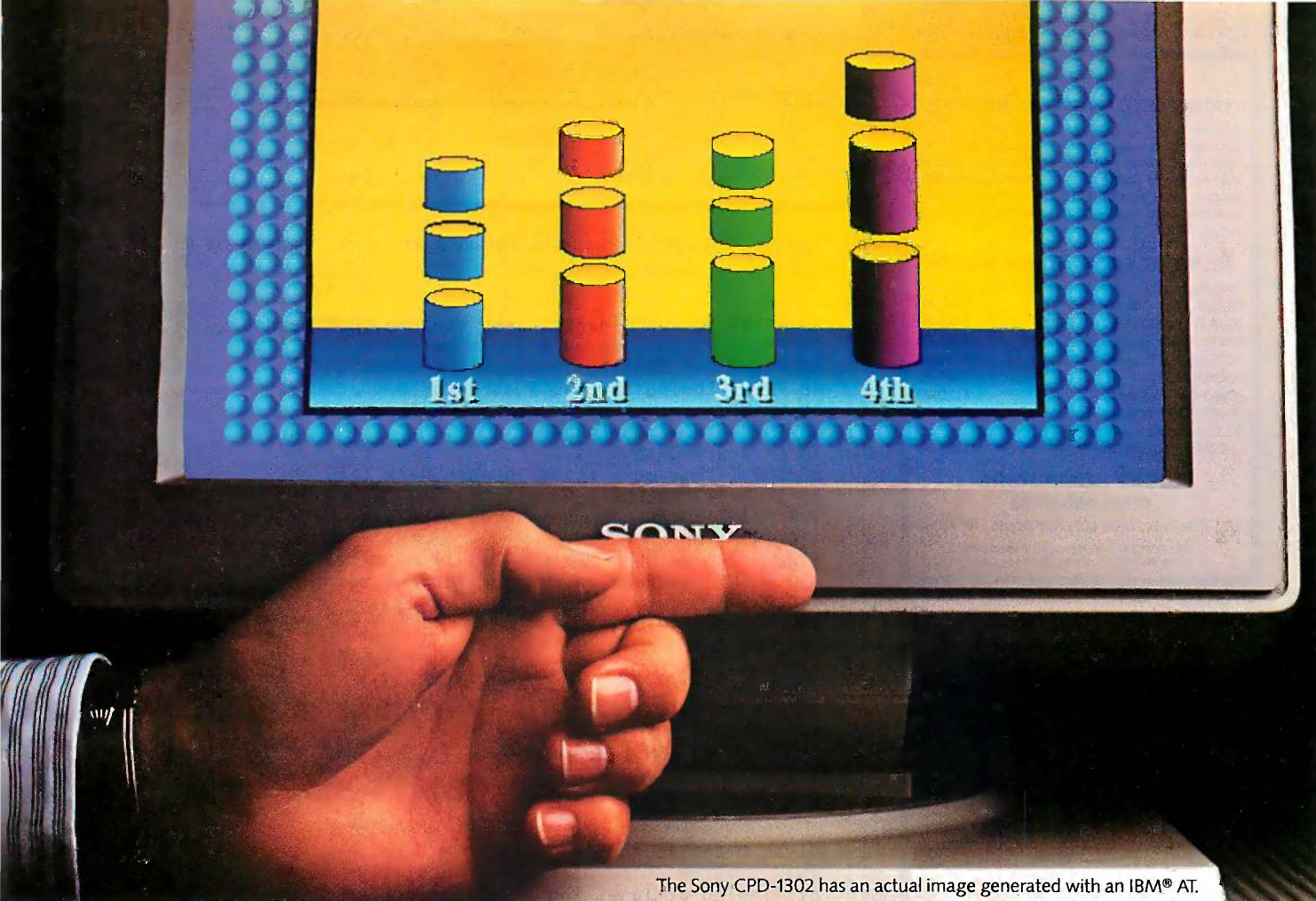

The Sony CPD-1302 has an actual image generated with an IBM® AT.

Look at the picture. It's got to be a Sony.

Why the leading name in living rooms is about to become the leading name in offices.

Since 1968, Sony has been delivering the brightest, sharpest color picture with its patented Trinitron® one-gun, one-lens picture tube.

Not only did that picture become the one by which all others are judged, it even received an Emmy.

Now that picture is setting new standards in the demanding world of personal computers.

25 years have gone into the making of this picture.

Every Sony advance in the quality of your TV picture has been applied to the improvement of your computer picture.

That's why a Sony monitor is so clearly superior to other monitors. And that's why you can get a brighter, sharper picture for your computer the same way you'd get one for your home.

Only Sony could give you 9 clear choices for better computer monitors.

Only Sony makes color computer monitors from 9" to 25", plus video projectors with



Sony CPD-9000
9" High-Resolution
Monitor



Sony CPD-1201
12" High-Resolution
Monitor



Sony CPD-1310
13" Medium-Resolution
Monitor



Sony KV-1311CR
13" Combination Computer
Monitor/Receiver



Sony KV-2011CR
20" Combination Computer
Monitor/Receiver



Sony KV-2511CR
25" Combination Computer
Monitor/Receiver



Sony VPH-1030Q1 & VPH-2030Q1
100" & 200" Multiscan Video Projector

Multiscan™ technology that display computer images on 100" and 200" screens with astonishing resolution.

So you can have Trinitrons from the smallest desk to the largest boardroom.

Sony's newest 13" Multiscan Monitor, the CPD-1302 shown above, works with CGA, EGA and even PGA graphics cards. It's a monitor that will not only give you dazzling high-resolution graphics, it's also compatible with the computer you're using now.

And several of these Sonys have the same, impressive .25mm Super-Fine Pitch™ Aperture Grille, giving them the highest resolution of any monitors in their class.

Sony even has monitors that are also remote-control Sony TVs.

In short, the standard for the brightest, sharpest picture in home, industry and broadcast is soon to be the standard for PC monitors.

Find out more: call Sony at 1-800-222-0878 (in N.J., 1-800-222-0879).

Trinitron Computer Monitors **SONY**
THE ONE AND ONLY.

© 1986 Sony Corporation of America. Sony, Trinitron, Multiscan, Super-Fine Pitch and The One and Only are trademarks of Sony. IBM is a registered trademark of International Business Machines Corp. Because the computer industry lacks standards, Sony does not and cannot make any warranty or representation with respect to performance of its monitors with each and every software or hardware option.

**GAT-286
COMPLETE SYSTEM—\$2195⁰⁰**

Includes one megabyte memory on board, 6 or 8 MHz, zero wait state, Phoenix BIOS; Disk drive controller with 2 floppy disk drives (1.2 M.B. and 360 K) and one 20 M.B. hard disk; monochrome monitor with adapter, serial/parallel ports; 200 W. power supply, keyboard, case, IBM PC/AT compatible. Certified to comply with FCC class B standards.

PC/XT/AT COMPATIBLE PARTS

- Seagate 30 M.B., High Speed Hard Disk **\$645.00**
- 20 M.B. Hard Disk Kit for PC/XT **\$395.00**
- 30 M.B. Hard Disk Kit for PC/XT **\$465.00**
- 135 W. Power Supply **\$ 65.00**
- I/O Card for XT or AT **\$ 75.00**
- LOGIMOUSE **\$85.00**
- 8087-3 Co-Processor **\$120.00**
- 80287-3 Co-Processor **\$215.00**
- XT Compatible System w/640 K, all ports & clock, 2 drives, monochrome monitor **\$825.00**

**LUCKY COMPUTERS
(214) 890-8110**

1701 Greenville, Suite 602, Richardson, TX 75081

IBM PC/XT/AT are Registered Trademarks of International Business Machines Corp.

Inquiry 190



**CREATE A
COMPUTER
NETWORK
for \$299.95**

with the MFJ-1294 Super Switch! This switch lets you interconnect 4 RS-232 devices with 4 other RS-232 devices simultaneously. **All eight devices can be working at the same time!** What you will have is a mini-networking system for the price of other companies' simple switches. And you never have to learn complicated software commands. Reliable and affordable port expansion is as simple as pushing a button. Has LEDs to monitor data lines. MOV surge protectors and transmit-receive buttons that allow 2-way communications. 30 day money back guarantee (less shipping & handling). 1 year unconditional warranty. Add \$6 shipping & handling. Free catalog, call toll-free **800-647-1800**

MFJ MFJ Enterprises, Inc.
921 Louisville Road
Starkville, MS 39759

Inquiry 206

**Printer (Data) switch \$45
Dealers & OEM Welcome**



- Metal case, beige color
- Push button or rotary switch
- 2 layer PC board, fully shielded
- Dimension: 1" x 4 1/4" x 8 1/2"
- All pin switched
- 1 year warranty

Switch box	DB25/Centronic	RS232 Miniature	
2 way switch	\$45/\$52	Gender changer MM, FF	\$7
2 way cross	\$65/\$73	Null modem	\$10
4 way switch	\$65/\$89	Jumper Box, Surge-protector	\$10
RS232 Break-out box/ db 25db switch/monitor swivel	\$99	Mini tester, Mini-patch box	\$12

Cable (Lifetime warranty) \$10 up

- UL approved, molded, double shielded, beige color
- D type connector with thumb screw (screwless)

Printer Cable (For IBM)	12'/15'/18'	\$12/\$14/\$16
Centronic Cable (male to male)	14'/18'	\$14/\$16
RS232 Cable (male to male)	12'/18'	\$12/\$14
RS232 Cable (male to female)	3'/8'/10'/12'	\$10/\$12/\$16/\$18

(25 line connected ones can be used as modem or extension cable)
XT Floppy/hard disk cable/AT h/f drive cable \$7/\$9/\$15

30 Day Money Back Guarantee
Terms: C.O.D. \$190
Handling fee \$3, plus shipping
California residents add sales tax

JACO Enterprises
1478 Poppy Way
Cupertino, CA 95014
TEL: (408) 996-0675

Inquiry 163

Listing 2: A BASIC program to simulate a class of bets involving two or more card decks. A sample run is included.

```

10 PRINT "Given D decks, each containing N cards,"
20 PRINT "this program calculates the probability"
30 PRINT "of finding at least two identical cards"
40 PRINT "among the top C cards of each deck."
50 PRINT
60 INPUT "How many decks (>1)";D
70 IF D<2 THEN END
80 INPUT "How many cards in each deck (>0)";N
90 IF N<1 THEN END
100 PRINT "Draw how many cards from each deck (1-";N;")";
110 INPUT C
120 IF C<1 OR C>N THEN END
130 PRINT "Successive chances for NOT matching..."
140 P=1
150 FOR J=1 TO D-1
160 FOR I=1 TO C
170 X=N+1-J*C-I
180 Y=N+1-I
190 PRINT USING "### / ### = #.#####";X,Y,X/Y
200 P=P*X/Y
210 IF P=0 THEN I=C: J=D-1
220 NEXT I,J
230 PRINT "Cumulative probability of a MATCH=";1-P
    
```

Given D decks, each containing N cards, this program calculates the probability of finding at least two identical cards among the top C cards of each deck.

How many decks (>1)? 3
 How many cards in each deck (>0)? 52
 Draw how many cards from each deck (1- 52)? 4
 Successive chances for NOT matching...
 48 / 52 = 0.92308
 47 / 51 = 0.92157
 46 / 50 = 0.92000
 45 / 49 = 0.91837
 44 / 52 = 0.84615
 43 / 51 = 0.84314
 42 / 50 = 0.84000
 41 / 49 = 0.83673
 Cumulative probability of a MATCH= .6396003

cumulative probability for not finding a match of 0.3603997, or about 36 percent. My chances for winning the bet are thus around 64 percent. I can live like a king on that.

The program in listing 2 calculates the odds for the general condition using *d* decks, *n* cards in each deck, and drawing *c* cards from each deck.

A POKER CHALLENGE

An unusual wager—which, alas, is not so easy to model with a computer program—involves some knowledge of the game of poker. Take any 25 cards from a shuffled deck. I bet I can form five poker hands that are as good as a straight or better: a straight

(five cards in sequence), a flush (five cards of the same suit), a full house (a three-of-a-kind and a pair), a four-of-a-kind, or a straight flush (five cards of the same suit in sequence).

I don't know the exact probability of success, but it is evidently very high, contrary to common sense. Try the game yourself, and you will be surprised at how seldom you fail. Think about ways to model the situation with a computer program. (Hint: Try sorting the cards first by suits; two flushes will always be found. Then look for a straight or a full house.)

I would be delighted to hear reports of your investigations into these and other sucker bets. ■

WHEN YOU NEED ACCESS TO FULL MEMORY, STRUCTURE, COMPATIBILITY WITH GW- & PC-BASICA, OR WHEN YOU NEED THE POWER AND FLEXIBILITY OF C OR PASCAL...



... You need BetterBASIC. The BetterBASIC compiler has become the standard by which other BASICs are evaluated. BetterBASIC is completely compatible with GW-BASIC and PC-BASICA when running on IBM PC's and true clones. You can load and run your existing BASIC programs in BetterBASIC. It uses standard MicroSoft syntax and gives you more than 150 additional statements such as XREF, DEFINE WINDOW, MAKE MODULE, and PROCEDURE. In benchmark comparisons, BetterBASIC is five times faster than interpreted BASIC. There is optional 8087/80287 math chip support, and an optional Runtime System to create stand-alone

EXE. files. BetterBASIC is not copy protected. Technical support is provided for all registered users. See for yourself why Dick Aarons of *PC Magazine* said "BetterBASIC may be the best of all BASIC programming worlds" and selected BetterBASIC as "Editor's Choice" (Oct. 29, 1985).

BetterBASIC	\$199
8087/80287 Math Chip Support	\$99
Runtime System	\$250
Sample Disk with Tutorial	\$10

Ask your dealer or call to order:

1-800-225-5800

In Canada, call 416-469-5244

Summit Software Technology, Inc.™

106 Access Rd. Norwood, MA 02062

BetterBASIC is a registered trademark of Summit Software Technology, Inc. IBM PC, XT, AT are registered trademarks of International Business Machines Corp. Microsoft is a registered trademark of Microsoft Corp. Tandy is a registered trademark of Tandy Corp.

Better BASIC™

**INTRODUCING
Virtual Memory Manager**

- Up to 4 Giga-Bytes of Array Space
- Breaks 64K Array Size Barrier
- Supports PC/AT™, L.I.M. Expanded Memory

\$99

**WHY BUY
OUR \$159
UNIX SYSTEM
FOR YOUR PC/AT
WHEN YOU
CAN GET THE
SAME THING
FOR A THOUSAND
DOLLARS MORE?**

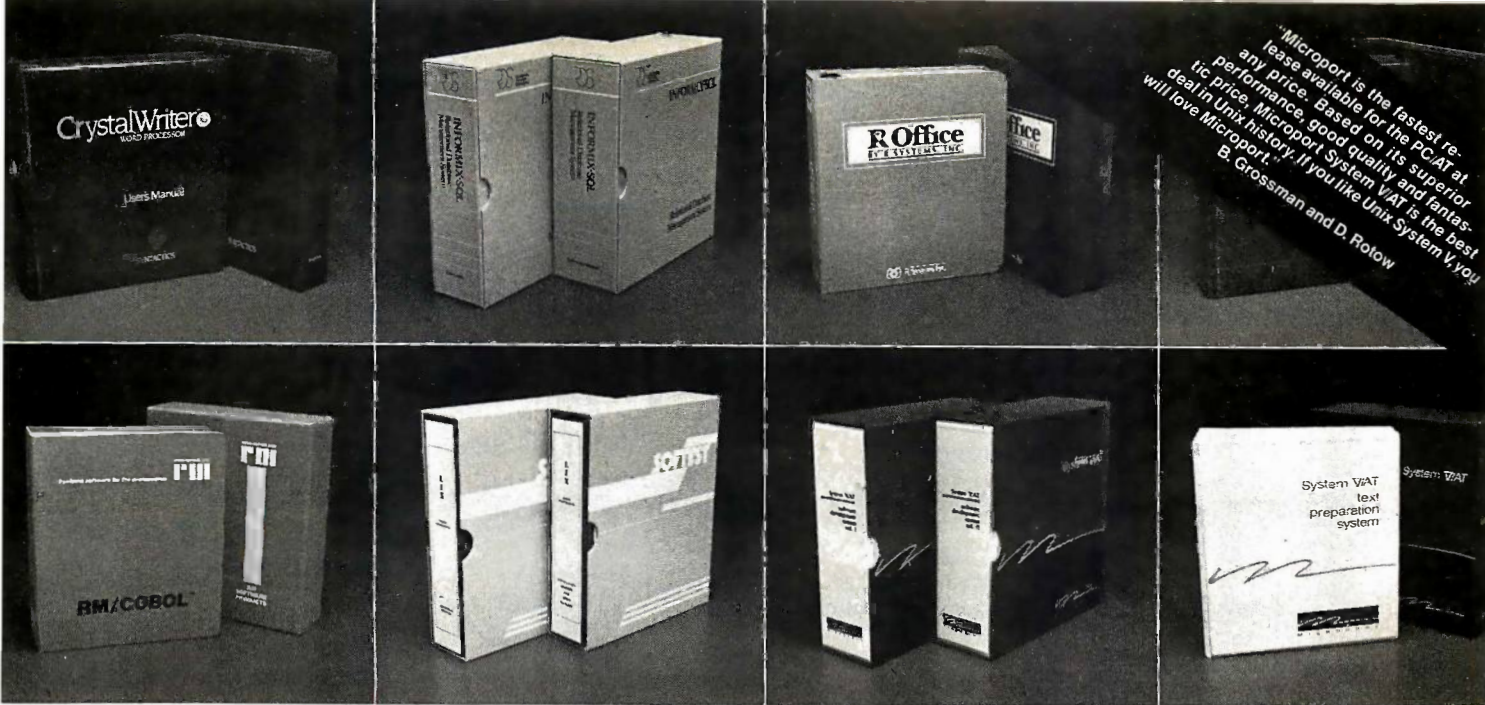

"Microport is the fastest release available for the PC/AT at any price. Based on its superior performance, good quality and fantastic price, Microport System V is the best deal in Unix history. If you like Unix System V, you will love Microport!"
 B. Grossman and D. Rotow

HERE ARE THE REASONS WHY.

Best-price Unix applications software. From the company that made a reality of best-price UNIX operating systems.

Business computing, word processing, database management, text preparation and software development—we've selected, developed and added value to the best. Once you've converted your PC/AT, with our System V, into a true multi-user, multi-tasking machine, you'll demand software that lets you get on with the tasks at hand.

CRYSTALWRITER PLUS

is a comprehensive word-processing system for the multi-user office. It allows concurrent use of files, layouts and printers, as well as supporting a full range of terminals.

INFORMIX SQL

is the relational-database-management system developers will choose for custom applications. It offers relational-database flexibility, interactive-database queries, a flexible design environment, automated functional menus, custom screen design and total format control.

R-OFFICE

ties a powerful word processor together with the file-management, table-spreadsheet, report-generation and desktop-management chores common to nearly every modern office.

R/M COBOL

is Ryan-McFarland's GSA certified implementation of the ANSI X3.23 74 standard. R/M COBOL is designed for serious business computing.

LEX

is a standalone system offering complete word processing capabilities, as well as utilities for adapting LEX to any type of video terminal or printer.

SOFTWARE DEVELOPMENT

from Microport. Our package was derived from the extensively-tested Portable C compiler. (The large-model code produced by the compiler is among the densest and fastest available.) These are true 286 compilers, making full and efficient use of the extended 286 instruction set. The package also includes the F77 Fortran compiler.

TEXT PREPARATION

from Microport. This package consists of the complete System V, Release 2 Documenter's Workbench (DWB), and includes both the new troff and the old troff. Drivers for the HP Laser Jet Printer and Apple's LaserWriter are also available.

These are but a few of our available packages. Virtually everything listed in AT&T's catalog can now, or will soon run with our operating system.

Regarding Our SYSTEM V operating system.

More than a look-alike, Microport's System V complies with AT&T's new binary standard and was derived from AT&T's own UNIX System V, Release 2 iAPX286. It thereby contains standard System V features the competitors don't support, such as the powerful symbolic debugger (SDB), the shell-layering job-control facility and the F77 Fortran compiler, as well as programming tools such as ctrace, cflow and bs. Over 200 utilities come standard to let you search and modify files, make use of electronic mail, calculate electronically, convert data and publish.

- 24 hour sale and support
- 90 day money-back guarantee
- Educational site licensing
- Commitment to AT&T source and binary standards

To order: Call either of our numbers below for today's price and product line quote (be sure to ask about our buy-two-applications-packages-and-get-RUNTIME-free offer).

You really wouldn't want to pay thousands of dollars more, would you?



M I C R O P O R T

MICROPORT SYSTEMS, INC.

4200 Scotts Valley Drive
 Scotts Valley, CA 95066
 408/438-UNIX (CA) or 800/PC2-UNIX

Inquiry 215

UNIX and DWB are trademarks of AT&T
 IBM and IBM PC-AT are trademarks of IBM CORPORATION.
 SYSTEM VAT is a trademark of MICROPORT SYSTEMS, INC.

80386 ST

Field Upgradable As Soon As The 80386 Is Available From Intel

ST/286-12™ MOTHER BOARD

ST for Superior Technology

\$1295. 12 MHz
One Year
Warranty Against
Manufacturers Defects

- Standard with Intel 80286
- Optional Upgrade to Intel 80386
- Up to 640K Ram on Board
- Clock/Calendar with Battery Back-up
- Complete with Enhanced Set-up Software
- Documentation Included
- Fits XT and AT Cases
- Supports AT and XT Boards
- Runs All Major Software Written For the IBM PC, PC/XT and PC/AT
- Available for Immediate Delivery
- Made in the U.S.A.

**80386
UPGRADE
only \$500**

CCI ST/286-12™

ST for Superior Technology

\$2395.

One Year
Warranty Against
Manufacturers Defects

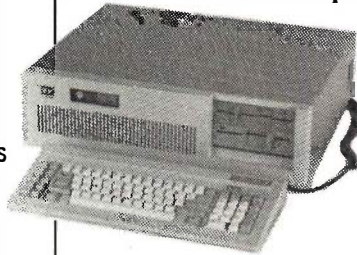

**80386 UPGRADE
only \$500**

**12 MHz
STANDARD**

INCLUDES: ST/286-12™ Mother Board, 640K of Ram, 1.2 Meg Floppy Drive, Western Digital Combined Floppy and Hard Disk Controller Card, AT Keyboard, 192 Watt Power Supply, Clock/Calendar with Battery Back-up, Intel 80286 Processor, Diagnostic and Enhanced Set-up Software, Documentation.

HARD DISKS

20 MEG SEAGATE KIT for XT Western Dig. Controller, Cables, Software, Mounting Hardware	\$445
30 MEG SEAGATE KIT for XT Adaptec Controller, cables, Software, Mounting Hardware	\$505
20 MEG SEAGATE for AT 40 MS Voice Coil, Cables and Rails	\$569
30 MEG SEAGATE for AT 40 MS Voice Coil, Cables and Rails	\$675
40 MEG SEAGATE for AT 40 MS Voice Coil, Cables and Rails	\$799
60 MEG PRIAM for AT 28 MS Voice Coil, Cables and Rails	\$1475
86 MEG TOSHIBA for AT 23 MS Voice Coil, Cables and Rails	\$1695

10 MHz

CCI ST/286™

ST for Superior Technology

\$1495.

One Year
Warranty Against
Manufacturers Defects



INCLUDES: ST/286™ Mother Board, 1 Meg of Ram, 1.2 Meg Floppy Drive, Western Digital Combined Floppy and Hard Disk Controller Card, AT Keyboard, 220 Watt Power Supply, Clock/Calendar with Battery Back-up, 80286 Processor, Documentation, Phoenix BIOS and Phoenix SETUP Software.

No charge for UPS ground shipping. No surcharge for MasterCard or Visa. Add 5% sales tax if a Florida resident.

Warranty work requires proof of purchase and return authorization number. Merchandise returned for credits subject to a 15% restocking fee.

COMPUTER CLASSIFIEDS, INC.



Sales Calls Outside Florida 1-800-331-5150
17830 State Road 9 • Miami, Florida 33162



Sales Calls From Anywhere in Country (305) 651-5853
Technical Support Calls (305) 651-0073 - Telex 510-600-7725

Intel, Hercules, Atronics, Western Digital, Seagate, Priam and Toshiba are trademarks of their respective companies. IBM, PC, IBM XT, IBM AT are trademarks of IBM Corporation. Some quantities may be limited. Computer classifieds reserves the right to substitute equivalent items. All prices are subject to change without notice.

Conducted by Jerry Pournelle

GAVILAN USERS GROUP

Dear Jerry,

I am writing in reply to a letter in your April column ("Gavilan Information, Anyone?" page 302).

Yes, there is Gavilan Portable Computer support. The Gavilan User Group and Gavilan Service Repair Center continue to profit from the fall of the Gavilan company. We number about 1500 owners throughout the world and we support our computer without company or retail assistance.

Persons wishing information on the Gavilan Portable can write or call

ROBERT W. BROWN
780 Manx Ave.
Campbell, CA 95008
(408) 379-2774

Glad to hear it. Gavilan was a pretty good machine. I very nearly bought one at surplus, but then I wondered what I would do with it. I can hardly write a lot about orphans!—Jerry

LAPTOP COMPUTERS

Dear Jerry,

I read the section "Traveling" in your July column with great interest. I am glad you are finally saying something about the power of small laptop systems. I have been using a Model 100-based system for home computing since March 1983, and I rarely need to use any other. (It also mates well with my Tandy 2000 at work.)

When I bought "Angus," I was looking for a replacement for my 48K TRS-80 Model I. I had originally intended to get an Osborne when I started shopping, but the laptop use of the Model 100 won out in the end. That Model 100 was one of the first on the market.

As soon as I could contact Larry Holmes, I added 8K to bring RAM to 32K. In early 1984 I added one of the early Holmes Engineering's Chipmunk 3½-inch disk drives, and this past Christmas I added Personal Computer Support Group's Super ROM.

The NEC-based system that you prefer for traveling is good. However, the lack of the Chipmunk and Super ROM make it less than it could be. Both the Tandy Disk Drive and Brother FB-100 store only 100K each under TS-DOS and must use the RS-232C port. The data transfer rate is limited to 9600 baud. Since it is a serially

accessed device, random access of the disk files is *not* possible, and file size is generally limited by the available free RAM.

On the other hand, the Chipmunk stores 360K, connects directly to the Model 100's main bus, and supports true random access of the disk files, which can be up to the full capacity of the disk.

Traveling Software's Ultimate ROM II is one of the best—but only a close second to PCSG's Super ROM. Lucid is a *much* better spreadsheet, and Write ROM is about the best formatter on the market. The Lucid-Data extension is, above all else, easy to use. Lastly, PCSG's outliner Thought is better than either ThinkTank or Idea.

WAYNE H. THOMPSON
Weatherford, OK

Thanks. I'm not familiar with the Chipmunk or PCSG systems. Certainly 360K and full file access would be preferable to the TS-DOS system I have, but for me LAPDOS gets the job done. Does the PCSG Super ROM give me 60-character lines? I find that once I have gotten used to having that much information on the screen I hate to go back to 40 characters.
—Jerry

Dear Jerry,

My introduction to BYTE and your writings began in January 1984 at the time of my first Radio Shack Model 100 purchase. Since then, I've acquired many more Model 100s and several PC-class machines for use in our business. Because I entered the revolution at this lower level I've formed a slightly different perspective than you have about the utility and role of microcomputer equipment. Simply stated: "If you can finish the work on the Model 100, don't start it on a PC."

This concept may be a derivative of Occam's razor or perhaps a first-user, first-machine rationalization. Either way, by extension, the PC is used like a mainframe for large files, routine batch jobs, or jobs requiring graphic output.

I've noted with interest the creeping utility of the NEC 8201 in both your own and your wife's work and recognize that you are now lined up to hit the "great organizational brick wall."

There you are in some foreign airport

with two pounds of SideKick printout and four pounds of computer that contains the built-in application software for telephone and appointment management, but without the necessary RAM files. It's a perfect picture of the brick wall: static paper files coupled with empty, but dynamic, management tools together taking twice the space and weight required.

It's not a pretty picture, but now that it is clear, the solution is obvious. Others have been here before you. With all due respect to Mr. Kahn, dump SideKick. Give Big Kat a rest. Put the NEC or the Model 100 on your desk. Use it all the time for appointments, phone calls, and electronic mail. Liberate yourself. Take the unit and a phone extension cord with you to your deck or yard on clear days and take it on all your trips. You will soon wonder why you put up with being anchored to your PC work area.

Now that you have mastered some of the techniques for moving files back and forth between the different machines, you can afford to dedicate some Model 100 RAM space to your phone numbers, log-on strings, appointments, due dates, expense details, received messages to review, pending messages to send next, and notes of all kind. This may still leave room for a normal day's output on your next novel.

The slim cursor keys on the Model 100 are compensated for by a convenient set of control-key combinations. I understand this set has roots going back to Electric Pencil, so you may already know them from other word-processing software you have used. They are listed in the Model 100 Owner's Manual together with others equivalent to the TEXT function keys and the command keys. Combined, these allow all operations except Paste from the keyboard.

Without comparative experience I would think that the Model 100's built-in modem (no extra cost) and TELCOM in ROM is a more convenient, economic, and reliable combination than the separate modem and RAM-based communication software in the NEC.

The Tandy 102 has replaced the Radio Shack Model 100. It's a half-inch thinner and weighs a pound less, probably in line with your new binder.

(continued)

Thankfully, airports now have pay phones that accept the direct-connect cable, which is much simpler to use than juggling the acoustic cups in a small space. I wonder if Tandy had anything to do with this important improvement?

Thanks for all the tips and entertainment. The Fact Cruncher demo was impressive and we have received the operating version for implementation in writing repair procedures.

TED MACKAY
San Diego, CA

You tempt me. You are not the only reader who uses a small laptop as the "only" computer.

I don't print out two pounds of Side-Kick. I do print out the calendar, year, month, week, and one for each day I'll be on my trip. Since I carry my shoulder bag with a logbook in it, adding a dozen sheets of paper is no problem. I haven't yet developed the habit of carrying the laptop everywhere, including to appointments and lunch. Perhaps I should. Certainly a number of readers do.

As to liberating myself from my present workstation, I think you have the wrong idea. I like it here in my cockpit surrounded by computers. Just at the moment I've got a hot game of Space Pirates going on Big Kat; just try that on your laptop machine!—Jerry

UCSD PASCAL

Dear Jerry,

UCSD Pascal was great for its time and even has a few things going for it today. It is very compact in p-code form and fits small micro systems like Apple II and Commodore 64 well. It is also extremely portable without hardware additions. I work in educational software and we write *big* programs completely portable to Apple, C-64, and IBM; just different assembly routines in libraries. In a couple of weeks (no kidding!) we could port all our applications to any major microcomputer our market demanded. Even the assembler syntax is standard across systems. Tons of segments, concurrency, strings, floats, and native code generation. UCSD is no slouch even today and supports a good number of languages. Have a look at the Pecan power system. It's not the be-all and end-all but it has no apologies to make to CP/M.

How come BYTE never liked the TI-99? It has a beautiful machine language, solid construction, nice BASIC, speech, sprites, device-independent I/O, etc. It has some shortcomings, just like everything else, but it was a pretty good machine, far better in all respects than the C-64, which came

out three years later. I just don't think it got a fair shake in BYTE.

I am running a I040ST at home and will make do until something with a 68020 and 4 or 8 megabytes gets cheaper. I see Atari doing for systems what Borland did for software—putting a realistic price on a quality product and driving the rest of the industry in a similar direction.

TONY A. G. BIGRAS
Victoria, B.C., Canada

I found UCSD Pascal hard to use, but I've always been quick to say that many people I respect disagree with me; and, of course, I much liked the Sage II computer, which used p-System as its operating system. As to whether p-System has any apologies to make to CP/M or vice versa, that, alas, is probably moot.

I don't know about BYTE, but I never cared much for the TI-99, in part because TI in those days was careful to tell all the hackers to drop dead. They wanted it kept a dark secret what was going on in their machines. They accomplished that goal.

I think you might be right on the money in your thinking about Atari. The Atari ST has as much bang for the buck as any computer around.—Jerry

ON YOUR OWN

Dear Jerry,

I am writing to you to let off a little steam about the American attitude toward the rest of the world. I do not expect you will agree with the views I express here because you are an American, but I decided to write anyway. The views expressed are purely my own but I know many of my colleagues feel the same way.

The first point is more general than the second and affects many British companies.

Several years ago, we bought a 68000 single-board computer from a company called Forward Technology Inc. It looked pretty good from the advertisement. When it arrived it was accompanied by a "Preliminary Manual," with the promise of a proper manual later. This manual was definitely a first attempt and there was a lot of information that was either missing or incorrect. Unfortunately, we did not know this at the time. After about two years, the project was abandoned and the board was put to one side. We had still not received the real manual and our letters and requests for information were all ignored.

In a recent clear-out of junk in the stock room I was given the board. My letters to Forward Technology were also ignored. I have found out a lot about the board by

disassembling the monitor, getting data sheets on the chips, and tracing tracks. It has been a long, hard struggle but I have found out that the board would have been suitable for the project it was originally intended for. The hardware is superb, but the firmware is awful, and the documentation is even worse. What a waste of money (the board was very expensive). The project was abandoned for the lack of a little information that Forward Technology already had. The attitude of this firm seems to be "We are happy to sell you the product, but after that you're on your own."

At work we have replaced our main computer system twice recently, once by choice, once by necessity. The first replacement came about because we wanted to replace an old minicomputer with something bigger and better. We bought a 68000 system from a company called Wicat Systems Inc. (an American company). What a disaster it was! The operating system seemed to be only half-written. After months of argument and many revisions of the software, we abandoned it. The attitude of this firm seems to be "We are happy to sell you the product, but after that you're on your own." This system was replaced by several computers from the firm Research Machines (a British company) and we have been very satisfied with them. They are always willing to help with information and software. What a difference.

These are just two examples. There are many others, but I am writing a letter, not a novel. For any new equipment our policy is now to buy British or Japanese. Although this policy may be more expensive, there are benefits that outweigh the expense.

The second point is that the U.S. government restrictions on the sale of high-technology products to Eastern Bloc countries are having an adverse effect on many British companies. A British exporter now needs two licenses—one from Whitehall and one from the United States—to sell anything outside the country.

I am not complaining about the aims of these regulations. I do not wish to sell equipment to Eastern Bloc countries. I am complaining about the way these regulations have been set up to give an unfair trading advantage to American firms.

The current export licensing regulations imposed by the U.S. government have brought an intolerable burden to bear on British companies trading in high-technology products of U.S. origin or British-made goods that include even the smallest proportion of U.S. components.

When initially made aware of the ex-

istence of these regulations, many people find it astonishing that British companies are being forced to comply even though not bound to do so by British law. The reason for this is simple: noncompliance rapidly leads to "blacklisting" and subsequent loss of supply of the products. So, once the British exporter has resigned himself to being bound by U.S. law and has set about applying for the necessary reexport approval from the U.S. Department of Commerce in Washington, DC, in respect of each and every export contract, he finds that his troubles have only just begun.

It is not just a question of filling out a form, sending it off, and receiving the necessary license a few days later, as we are accustomed to in the majority of cases when applying to our own department of trade in London. Filing the application with Washington is merely the beginning of a long and tedious trail of queries, referrals, and delays.

Should Washington not have a file on the nominated end user of the goods, then an interminable system of enquiry through the local U.S. embassy ensues. At best, an individual license application is granted

only after several weeks. At worst, months may elapse, resulting only too often in the frustrated cancellation by the customer and the ending of a valuable customer relationship, which may have taken months to build. Speed of delivery is one of the foremost advantages when competing for orders. How can British companies hope to survive in the disastrous climate of bureaucracy and delays, which affords massive advantages to competitors, both in America and in all other countries, where no restrictions are in operation at all? American companies can export directly from the U.S. under a general license and without any need to make individual applications for each contract. Clearly, the regulations are being used to give American firms an unfair trading advantage by placing intolerable restrictions on our high-technology firms.

Our export industry is being savagely disadvantaged as a direct result of the policy of a country widely accepted as our foremost ally! The American attitude generally seems to be "Screw the rest of the world."

PAUL MILLER
Gleadless, Sheffield, England

Thank you for your analysis. I haven't enough facts to be able to comment, but I'm glad to hear about this.—Jerry

THINKTANK, MACINTOSH VERSION

Dear Jerry,

You may recall me. I am "the only person on earth that (you) know of who was ever disappointed by a Living Videotext product." This came up at the word-processing panel at Westercon. I appreciate your comments regarding Mr. Winer's integrity, but the Macintosh version of ThinkTank has so many problems that they outweigh its benefits.

I think it would behoove you to take a hard look at the Mac incarnation of what is a wonderful program on the Apple II and the IBM PC. You will find multiple violations of the Mac interface, making the product jarring to use for Mac users. The screen shows a monofont, but all printing is done in a proportional font—what you see ain't what you get. Scroll bars are nonstandard. Indentation is specified in spaces rather than inches or points.

(continued)

PC Scheme— a simple, modern LISP for under \$100.

Texas Instruments presents PC Scheme, the \$95* solution to your symbolic processing needs.

Whether you're an experienced LISP user, or just beginning to discover the power of symbolic programming languages, PC Scheme is the right product for you. It runs on IBM® Personal Computers, as well as the TI Professional Computer family, including the Business-Pro™ computer.

Powerful features include an optimizing incremental compiler for ease of programming and fast execution; an EMACS-like editor; extensions for debugging, graphics, and windowing; DOS-CALL capability; and a programming system for the development of object-oriented

applications—all designed to work efficiently on personal computers.

To order, or for more information, call toll-free:

1-800-527-3500

*Suggested list price.

Business-Pro is a trademark of Texas Instruments Incorporated.
IBM is a registered trademark of International Business Machines Corporation.

**TEXAS
INSTRUMENTS**

Creating useful products
and services for you.

©1986 TI 261765-02

(What's a space in a proportional font?) There are bugs in the editor; spaces are spuriously generated or dropped, and the user doesn't always find out about it until the document is printed. The general appearance is that the Mac version is a hasty port from the IBM PC or Apple II version. What's more, LV wants \$35 for what is essentially some bug fixes (this is on top of the \$100 that I've already put up for the upgrade from the very limited ThinkTank 128 to ThinkTank 512). It should be noted

that Microsoft, Software Publishing, and even Apple Computer have provided bug fixes for their Mac software at no charge to the user.

I wrote to Peter Winer at LV about these issues in June 1985 and have never received a reply. As I've implied, the picture you have of Living Videotext may be incomplete and therefore inordinately positive. On the Mac, at least, ThinkTank is a great idea poorly executed.

Also, I would like to include more information about the L5 Society (the text of the Commercial Space Incentives Act, for example) in the Library section of my BBS (The Citadel, (818) 339-4704, 300/1200 baud, 8 data, 1 stop, no parity, 24 hours, 7 days). Is there a source of machine-readable or downloadable L5 information? To whom should I write for more information? I would like to use the BBS to further the goals of the Society, if it is at all possible.

By the way, does the terminal attached to Zeke display larger-than-life characters? I have often read and heard your complaints about the Mac's screen size. What puzzles me about this is that the characters on the screen are actual size. The only conclusion I can come to is that your usual monitor must be larger than life, which, I do grant, would be easier on the eyes.

FRED CONDO JR.
Covina, CA

WHAT'S THE SECRET DEBUGGING WEAPON USED BY EVERYBODY FROM BORLAND TO ORACLE? FREE 44-PAGE ANSWER FROM ATRON.

"WE COULDN'T HAVE DONE IT WITHOUT ATRON'S HARDWARE-ASSISTED SOFTWARE BUGBUSTERS."

This is the city saved by the Atron bugbusters. Your city. Full of wizards, with hundreds of millions of dollars invested in wringing every ounce of intelligence and performance out of your PC. It used to be plagued with the toughest software bugs known to mankind.

PLAGUES OF BIBLICAL PROPORTIONS

The first and most difficult plague was impossible to trap with software debuggers. These were voracious bugs which randomly overwrote programs, data, even the debugger. Nastiest were the ones that slipped in once every few hours, or changed their behavior after each new compile. Forty days and forty nights of recompiling, trying something else, caused many a would-be resident of the city to run screaming into the wilderness, never to be heard from again.

Second came the plague of not knowing where the program was, or where it had recently been. This compounded the first plague: How could anyone know what caused the random memory overwrites? Add to this random interrupts and timing dependencies, and you begin to understand *The Fear* that gripped the city.

Then came the last plague, which brought the wizards to their knees before they even started debugging. Their towering programs consumed so much memory, there wasn't enough room for their symbol table, let alone debugging software. Even if they could get past the first two plagues, this one killed their firstborn software.

ENTER THE HARDWARE-ASSISTED SOFTWARE BUGBUSTERS

The Atron solution came as a revelation: Monitor every memory reference and every instruction executed, by adding a hardware board to the AT or PC with an umbilical probe to the processor.

The result? Wham! The PC PROBE™ and the AT PROBE™ saved civilization as we know it. The first plague was cured with PROBE'S hardware-assisted breakpoint traps on reading, writing, executing, inputting and outputting. These could be done on single or ranges of addresses, and could include particular data values. All in real time. For a mere software debugger to attempt this, a 1-minute program would take 5 hours to execute.

The second plague, not knowing from whence you came, was cured with PROBE'S real-time trace memory. The history of program execution is saved on-board, in real time. Once a hardware trap has occurred,

PROBE displays the program execution in detail, including symbols and source code for C, Pascal, or assembly language programs. Which shows how out-of-range pointers got that way.

The third plague, not enough room for the debugging symbol table to be co-resident in memory with a large program, was cured with 1-megabyte of on-board, hidden, write-protected memory. System memory was then free for the program, keeping the symbol table and debugger safe from destruction.

When the job of bugbusting was done, the wizards used their PROBES as performance analyzers. So they could have both reliability and performance. So they could send only the best software into the field.

IF YOU AREN'T AN ATRON CUSTOMER, ODDS ARE YOU WON'T BE MAKING THE TOP-TEN LIST.

On any given week, at least nine of the top ten best-selling software packages on the Soft-Sel Hotlist come from Atron customers.

Ever heard of Borland? "Without Atron," says its president Philippe Kahn, "there wouldn't be a SideKick™, Turbo Lightning™, would be light-years away, and Turbo Prolog™ wouldn't be shipping today."

Ever use a spreadsheet? From Enable™ to Paradox™, their bugs were busted by Atron products.

Into DBMSs? Everyone from Ashton-Tate to Oracle owns at least one Atron bugbuster.

If you use a product from one of the companies in *The City*, you owe life as you know it to Atron. Our guess is that 99% of all PCs, XT's and AT's have at least one product debugged with Atron bugbusters.

FREE 44-PAGE BUGBUSTING BIBLE COULD MAKE YOU A PROPHET, AND YOUR COMPANY A PROFIT.

We've written a complete tutorial on state-of-the-art bugbusting. And it's yours, free for the asking. Full of examples and illustrations, it will show you how the wizards work their magic.

If you're tired of suffering the wrath of program bugs, call Atron today. You could be busting bugs, and sales records, tomorrow.



THE BUGBUSTERS

20665 Fourth Street • Saratoga, CA 95070 • 408/741-5900

Copyright © 1986 by Atron Corp. PC PROBE™ and AT PROBE™ Atron. The other fine companies mentioned throughout this advertisement own numerous trademarks. Advt. by TRBA.

I am not familiar with the Macintosh version of ThinkTank and have never used it, so I have no way to comment on that part of your letter. I'm certain I never recommended it for the Mac.

The L5 Society (1060 East Elm St., Tucson, AZ 85719) can probably furnish you with a machine-readable material. Write them; they are in need of reliable hackers.

My usual monitor is a 15-inch Hitachi and is indeed "larger than life." Thank heaven.—Jerry

PROINDEX

Dear Jerry,

Thanks for the mention of Proindex in your BYTE column. Proindex has not been available as a "shareware" product for the last two years. The program is now sold through advertisements in the backs of various IBM PC-specific magazines.

Proindex retails for \$89.95 and includes the indexing program, a program for merging separate indexes (Merge), and typeset documentation. The program may be ordered from

Elfring Consulting, Inc.
4N899 West Mary Drive
St. Charles, IL 60174
(312) 377-3520

Thanks again for the mention in your column.

GARY ELFRING
St. Charles, IL

My apologies; the original copy I had was shareware and I must have neglected to update my files.

I find Proindex quite usable, and I hope you sell a bundle of them.—Jerry

The Best of BIX is a brief look at the activity on BIX, the BYTE Information Exchange. The messages shown here are only a fraction of the thousands of messages each month from the many conferences on BIX. For information on joining BIX, see page 372.

AMIGA

The Amiga window is software-oriented this month with a discussion on VSprites, Bobs, and beam avoidance.

VSPRITES

amiga/softw.devlpmt #2292, from sduff (Stephen Duff)

I have seen the example hsprite.c in the listings section and had no trouble getting simple hardware sprites to work in my program. VSprites, on the other hand, are giving me some problems. I have tried following ROM Kernel Manual and still no VSprites. What is the proper procedure to display a VSprite? sduff

amiga/softw.devlpmt #2293, from cheath (Charlie Heath)
a comment to message 2292

All I've done is Bobs (blitter objects) and simple sprites. Haven't actually heard of anybody getting VSprites working, though it sounds like a few have tried without success!

amiga/softw.devlpmt #2294, from jmackraz (Jim Mackraz)
a comment to message 2293

The recommendation I've got here is "Don't use VSprites."
If I learn more, I will tell you.

amiga/softw.devlpmt #2298, from jsan (Jez San)
a comment to message 2294

Jim -
Don't VSprites work? If not, why not? Will it be fixed for v1.2? Or v1.3?

I was intending to knock up a quick 'Defender' game, using VSprites. But if they don't work, that doesn't look possible, does it!?

amiga/softw.devlpmt #2308, from Inoland (Leslie Noland)
a comment to message 2294

Uhh.. Jim,
While I understand that it is pointless to try to use something that doesn't work, I certainly hope that the response "Don't use VSprites" had an implicit "until we get the problem fixed" following it. I would hate to think that something that was repeatedly touted in reviews, advertising lit. (I seem to recall), documentation, etc. doesn't work and that A-C's official response is going to be that we simply shouldn't try to use it.

I realize that, though you are an A-C employee, you are not necessarily their spokesman and also that what you say here is informal in nature (unless explicitly rendered as a statement of policy), but I wish you would make this a bit more clear.

amiga/softw.devlpmt #2317, from jmackraz
a comment to message 2308

A little research appears to be paying off. VSprites are not recommended because they are not positioned relative to a ViewPort (screen) but rather the View (entire display). Thus, Simple Sprites are recommended, if you do not need the virtual (dynamically reassigned) characteristics.

I have located an example of VSprites in use, by Dave Lucas, and when he cleans it up and gets it to me, and if I can figure out how to upload to this net, I will do so.

Any suggestions on that, Charlie?

amiga/softw.devlpmt #2323, from rjmical (RJ Mical)
a comment to message 2308

Jim is right about using Bobs (in reference to the idea of using Bobs to move text around in the gadget editor). My original claim was that using Bobs would greatly simplify the programmer's effort. But using

(continued)

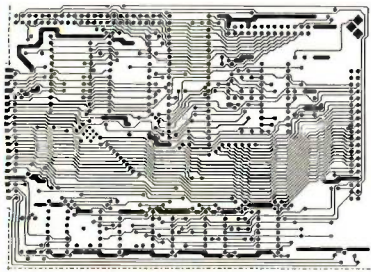

PCLO™
Printed Circuit Layout For The Amiga™

- High performance
- Semi-automatic routing
- Trace yield
- Autozip/dip/plgrid
- 288" sq.—2 layers
- Full silkscreen
- Utilizes color
- Area rotation
- Magnification (zoom)
- Surface stretch
- Dot matrix checkplot
- Camera rdy. std. plotters
- Powerful workspace operations
- 8-layer capability
- Object Libraries
- Multiple pad types
- 350 centers
- Block operations
- Abs. rel & local measurement
- Editing, move/copy, delete
- Global trace following
- Supports hard drive

System price — \$1024 / Functional sample disc \$75 (credit towards purchase)
PCLO © Soltec/Circuit, Inc. / Amiga © Commodore, Inc.

FIRST IN A SERIES OF ENGINEERING WORKSTATION PRODUCTS FROM
SOFT CIRCUITS, INC., 401 S.W. 75TH TERRACE
N. 1 AUERDALE, FL 33066, (305) 721-2707

Inquiry 302

AC/FORTRAN™ **AMIGA**

Mainframe quality, full feature **ANSI FORTRAN 77** compiler includes **Debugger**, Linker, Library Manager, Runtime Library, **IEEE** math, and **C** interface. Supports **Complex numbers**, **Virtual arrays**, **Overlays** and **Dynamic Linking**. Net copy protected. Available now, \$295. Turbo Amiga version also available.

AC/BASIC™ - Coming Soon

From the authors of **Microsoft BASIC** compiler for Macintosh, comes **AC BASIC** for the Amiga. Companion compiler to the **Amiga BASIC** interpreter. Has more features and includes a **Debugger**, includes **BLOCK IF**, **CASE** statement, and **STATIC** keyword extensions and executes up to **50x** faster. **AC BASIC** is the new **BASIC** reference for AC/68000 based personal computers. Net copy protected. \$295.

Telephone orders welcome

absoft **Atari**

Scientific Engineering Software
4268 N. Woodward, Royal Oak, MI 48072 (313) 549-7111
Amiga trademark of Commodore Amiga
Microsoft trademark of Microsoft Corp

Inquiry 2



RS232C IBM PC Compatible Paper Tape Transmitter/Model 612

Stops and starts on character at all speeds, uses manual control or X-on, X-off 90-260 volt, 50-60 Hz power. 50-9600 baud, up to 150 char/sec synchronous or asynchronous; gated internal or external clock, RS 232C, current loop or parallel output, reads 5-8 level tape, 7-11 frames per character, even or odd parity. Desk top or rack mount.

Addmaster Corporation, 2000 S. Myrtle Ave., Monrovia, CA 91016, (818) 358-2395, Telex 674770 Addmaster SGAB

Inquiry 5

Bobs also has the advantage of automatically eliminating visual unpleasantries as Bobs do beam-avoidance to create clean changing imagery. Someone wondered why 1.2 icons flickered when multiple Bobs were moved simultaneously. Don't know why that would be, but I suspect it's not a Bob problem and also not a Workbench problem. Probably something else was happening. For an example of many Bobs moving at once, see the Molly demo program from Amiga (don't know if this is still generally available).

I'm running 1.2 right now, and I drag multiple icons without any perceptible flicker. In fact, it looks pretty good!
RJ >:-{)*

amiga/softw.devlpmt #2325, from Jim_kent (Jim Kent)
a comment to message 2323

Hey RJ, you wouldn't happen to have any old VSprite stuff lying around? From what I hear the y sorting stuff and re-using all works OK, and that's the hard part. Is the problem just getting them to work with Intuition's slidable screens?

Also I've been wondering how Intuition has a solid background behind the last screen. When I was doing my own viewport/view manipulations, I always got garbage on the part of the screen not covered by a viewport.

amiga/softw.devlpmt #2326, from cheath
a comment to message 2323

Bobs do beam avoidance? That's news to me - the only way I've been able to keep Bobs from flickering is with double-buffered screen. One of the not-nice things about the bitmap architecture with blitter is that each bitplane is drawn before the next is started - so you often have a situation in which the display is updated while a large part of the screen is in transition. That sort of stuff doesn't happen without blitter so much, because the software can be written to do all the bitplanes in sync - so there is only a small part of the display that can look nasty at any given time.

ATARI ST

The Atari ST section begins with hard disk problems and a case of the seemingly simple disk crash and goes on to a thread on using Malloc() in C.

HARD DISK PROBLEMS

atari.st/tech #592, from chrIskuku (Christoph Kukulies)

Today it happened...

My hard disk (Atari grey box) suddenly showed 0 bytes in 0 items. It was heavy-loaded with lot of stuff, about 40 directories with about 1500 files or so, all in all, 15 Mb of the 20 available. Does anyone know how this could have happened (other than typing rm *)? Before I start to reformat it - does anybody have a utility to look at the hard disk blocks to eventually repair it? Help welcome.

atari.st/tech #593, from Jim_kent
a comment to message 592

If it's 0 bytes in 0 items it's just as likely that the driver has gotten lost. Have you tried re-installing the driver and changing resolution from Preferences? I hope that's it. I don't know of any utilities that look at the disk sectors directly.

atari.st/tech #600, from alexl. (Alex Leavens)
a comment to message 592

Bomp! Bomp! Bomp!

Another one bites the dust! :-)

Sorry, just couldn't help it. Same thing happened to me Saturday. It's reformat time (your FATs have gotten roached). Next time you format it, partition it into four 5-Mb logical drives--this locates the FATs in different places, and makes roaching of the entire disk much less likely. Then you can use say drive F to back up drive C.

Good luck.

atari.st/tech #605, from chrIskuku
a comment to message 600

Yes, I reformatted it already. Using Dust from Hippo, which allows you to look at disk blocks (sectors), showed me that some important sector was zeroed. By the way, this Disk Utility didn't work quite correctly because it said: "Not enough memory for FAT." So I gave up and reformatted it.

But, tell me, how can I partition the disk into different drives? Do I have to have a special program for this?

atari.st/tech #610, from nellharris (Neil Harris, Atari Corp.)
a comment to message 605

If your hard disk driver floppy did _not_ have the new format program which uses GEM and also partitions your drive, then your problem is that you're using old software for the driver -- contact Atari and get the latest disk right away!!!

atari.st/tech #629, from jtltsler (Jim Tltsler, Atari Corp.)
a comment to message 605

You can partition it yourself if you like Chris using the information in the Hitchhiker's Guide and your favorite sector editor (or FORTH). The zeroth sector contains the partition map with pointers to (up to) 4 partitions. Each of the partitions has a "boot sector" which contains the normal disk prototype BPB.

MALLOC

atari.st/c.language #179, from chrIskuku

I downloaded Tim's mallocer because I had problems with Malloc (gemlib). Now, although the mallocer works, my program still doesn't. I've #defined malloc __malloc and have written a function:

```
char *
__malloc(arg)
int arg;
{
    return( (char*)(Malloc((long)arg)));
}
```

to stay compatible with source code in respect to standard calls. I have a 1-meg machine, TOS (US) in ROM. My program is linked with gemstart.o gemlib aesbind vdbind libf, etc. After appl_init(), open_vwk(), I do some malloc()'s to allocate some nodes (only 200 bytes or so, application stuff). Asking available=malloc(-1L) tells me I have enough (xxxxx) memory. To verify this, I did just for testing a:

```
while(malloc(sizeof (struct node))nnodes++;
```

Totally in contradiction to what is expected by calculating from the value of available I now only get poor 132 or so nodes allocated (sizeof node is 18, but is not relevant).

Please don't tell me "use the L*T***E compiler. When such things can't be done with the dev-pack then

(continued)

Book your trip from start to finish.

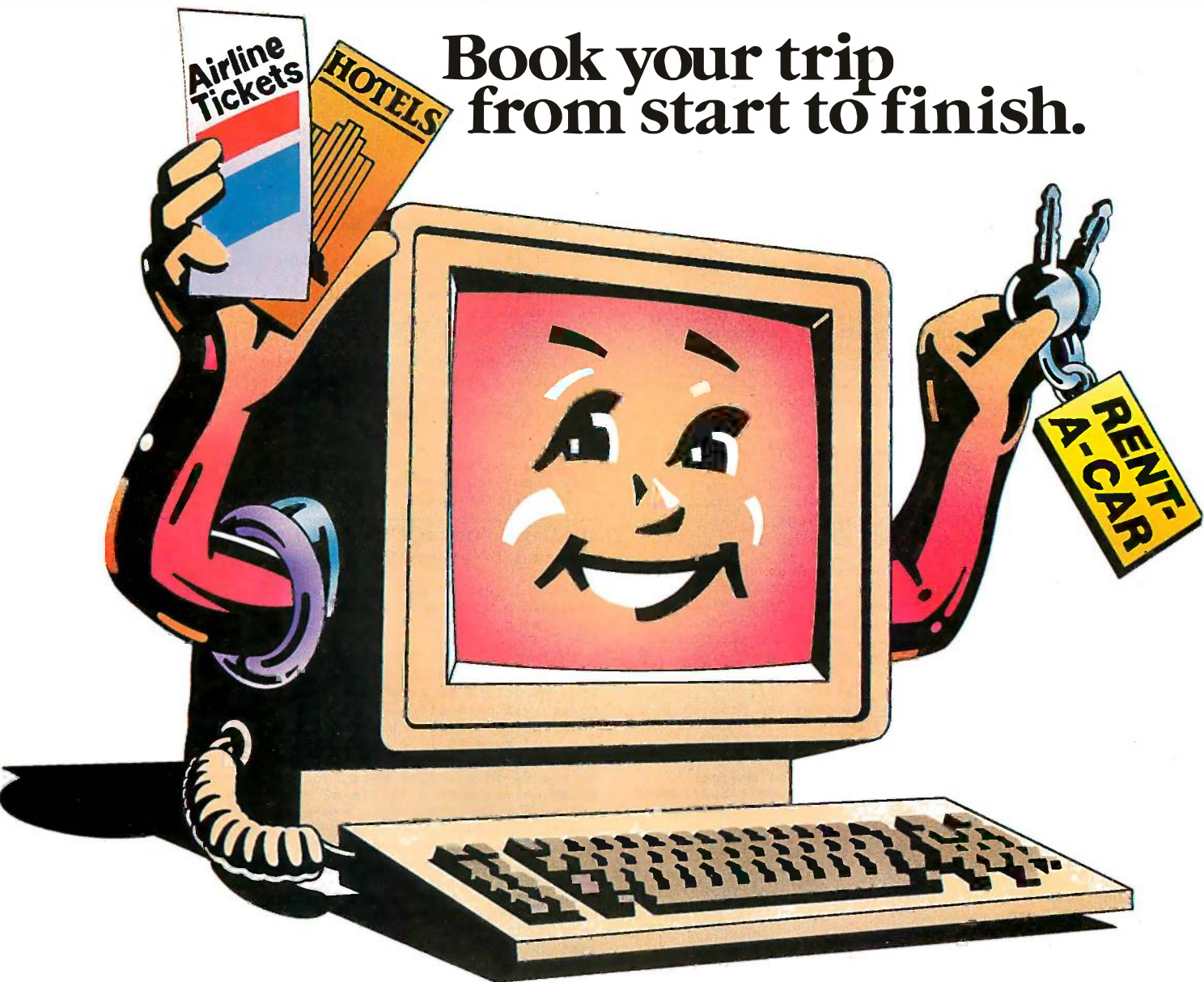

All on your own PC.

Now you can get quick information and *immediate reservations* for flights, hotels and rental cars with EAASY SABRE, the American Airlines personal reservations system.

EAASY SABRE lets you look directly at schedules and fares, 24 hours a day. On any type of PC that has a modem or on any kind of communicating terminal. And, all the help you need is available on line.

This special service will show you flights for over 650 airlines worldwide. And the quickest routes to almost any place you want to go.

It will also show you more than 13,000,000 fares. Our exclusive Bargain FinderSM feature assures that you'll get the lowest possible fares available for the seats you book.

In addition, you can reserve a room at more than 12,000 hotels — by name, by price or by location. You can also confirm a car from over 20 rental car companies. Look at your personal Advantage[®] account. And even check the weather in the city you'll be visiting.

Once your reservations are booked, EAASY SABRE lets you decide where to pick up the ticket — from your SABRE Automated Travel Agency or Corporate Travel

Office, at the airport, at an American Airlines City Ticket Office, by mail or from any other American Airlines authorized distribution channel.

Access the world's most sophisticated travel automation system. It's that simple. And economical. Because there's currently no surcharge for using EAASY SABRE. You just need to subscribe to one of the data networks listed.

For more information on subscribing to a network, call:

Dialcom, Inc. 1-800-258-3311	General Electric Information Services Company 1-800-433-3683
QuantumLink (for Commodore computers only) 1-800-392-8200	GENie [™] (General Electric Network for Information Exchange) 1-800-638-9636 Ext. 21

EAASY
SABRESM

SMAdvantage[®] is a registered service mark of American Airlines, Inc.

Atari should please explain why they called it "developer's package?"

Do you have any idea? Comments would be welcome.

atari.st/c.language #180, from sgrimm (Steve Grimm)
a comment to message 179

I always had trouble mallocing in a routine that uses local variables. Try removing the parameter (set a global variable and have your malloc look at that variable).

atari.st/c.language #181, from chriskuku
a comment to message 180

Thanks. Your tip sounded promising, but looking at my program, I saw that I've already done so. I call malloc(size) with size globally declared.

atari.st/c.language #184, from jim_kent
a comment to message 181

Chris - I've uploaded some memory management stuff into atari.st/listings. You probably would be best off getting Malloc to work somehow, but this might be a useful kludge to keep you going in the meantime.

atari.st/c.language #185, from chriskuku

Jim, thanks for your example listing. I'll try it as a last escape. Meanwhile, I've cut down the problem to a short example':

```

/* tstmallo.c CPK 4-JUL-86
 * this simple example shows my usage of Malloc
 * and it's mal(loc)function (if I haven't overlooked
 something).
 */
#include "osbind.h"
/* define some node stuff */

struct node {
    int x,y,z,pen;
    struct node *next;
};

struct node *first,*last;

main()
    
```

```

{
    int nnodes = 0;
    struct node *lastbutone;
    first = (struct node *) Malloc( (long)sizeof (struct
node));
    while( (last = (struct node *) Malloc((long)sizeof
(struct node))) ) {
        lastbutone = last;
        nnodes++;
    }

    printf("\n%d Nodes of size %d\nStart address
%08X\nLast address %08X",
        nnodes,sizeof(struct
node),first,lastbutone);
}
    
```

Maybe you can try it on your machine. I always get only about 100 nodes allocated and then finito. Any help welcome.

atari.st/c.language #186, from jim_kent
a comment to message 185

Chris - I just tried your code. I'm working with Megamax, a 520ST with a 1-meg upgrade and TOS in ROM, and a hard disk.

With me, it got 268 nodes before it quit. Curious thing is that when I added a character array to the node structure to make it bigger it still got 268 nodes. It allocated 268 512-byte nodes OK! I've heard from various sources there are problems with Malloc. I'm not sure if I get more nodes than you 'cause I've got a meg, newer ROMs, or better luck. Still, it's very easy to allocate more than 268 times. Have you tried malloc with a little m? Yep, I'm sure glad I've got some proprietary (er, now public domain, I guess) memory management routines. I've had a lot of problems with various mallocs and Mallocs on this machine. Actually, the routine I uploaded has been simplified to allocate out of an array. What I really do in my "real" code is Malloc(10K), and then add the pointer to my free list with a mfree(pt, 10K) when the free list gets empty. Did I say 10K, I meant 32K, so it'll have some blocks big enough to hold a whole screen!

I've heard that the Megamax Malloc works in a

(continued)

Lean & Mean!

Solapak ST Print Spooler/Ram Disk

NOW with the "Solapak ST" print spooler you can:

- print up to 8 files with separate printing qualities at one time.
- configure to any parallel printer with 32 user definable options.
- format your output, vary the print speed, pause/restart printing and much, much more...

The "Solapak ST" ram disk lets you:
- configure up to 1 Mb and 128 files.
- save time with a disk transfer rate of over 10 million bits/second.

"Solapak ST" is the fastest, most versatile and memory efficient professional print spooler and ram disk available for the ATARI ST. FREE CRT saver to help prevent image "burn-in". "Solapak ST" demo at your ST retailer or on BBS's nationwide.

\$39.95

Action Software - 69 Clementina St., San Francisco, CA 94105 - (415) 974-6638
Mail orders: please include \$3.00 P&H and Ca. residents add \$2.60 sales tax. VISA, MC OK.

FIND THE WIDEST RANGE OF DP WORKSTATIONS, ACCESSORIES & SUPPLIES IN THIS FREE GLOBAL GUIDE ←
...all at HUGE SAVINGS!



The GLOBAL GUIDE offers more variety than any office equipment, computer or software dealer, plus, toll-free order convenience. Use the Reader Service Number or dial 1-800-8-GLOBAL (That's 1-800-845-6225).

GLOBAL
COMPUTER SUPPLIES

45 South Service Road, Plainview, NY 11803

THE BEST QUALITY PC CASES

SOLETEK
THE BEST CHOICE

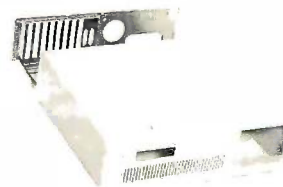

OUR SPECIAL FEATURES:

- Nickel Plated Whole Surface with Additional Insulated Enamel Coating
- EMI & ESD Shielded
- Extended Length Provide More Space For Inside Working
- Meet FCC Requirement
- PC Magazine LAB Tested

Call for Catalog & Price

SOLETEK INC.

1122-C2 W. WASHINGTON BLVD
MONTEBELLO, CA 90640 (213) 724-9005, 724-9006

CSS 286X

has the
power of

"MOTHER SUPERIOR"TM

MOTHER SUPERIORTM, from **CSS LABORATORIES, INC.**, is the most IBM ATTM compatible motherboard in the marketplace. **CSS Labs** has designed a truly superior family of motherboard meeting all IBMTM compatibility requirements at 10, 8 and 6 MHz. Our **MOTHER SUPERIOR** board, at 10 MHz is 45% **FASTER** than the IBM PC/AT.

Now you can get **MOTHER SUPERIOR** technology in two new personal computers-The **CSS 286ATM** and **CSS 286XTM**. Both systems incorporate the **MOTHER SUPERIOR** family of motherboards in configurations designed to meet your power, expansion and space saving requirements.

The **CSS 286XTM** is the size of the **XTTM**, giving you more power per square inch of Desktop. The **CSS 286ATM** is standard AT size, both are 6-10 MHz switchable.

**FOR DEALER AND OEM
VOLUME PURCHASING
INFORMATION CALL
(714) 540-4141 OR MAIL
YOUR RESPONSE CARD
NOW.**

IBM, AT, XT are registered trademarks of International Business Machines Corp. CSS 286A, CSS 286X are trademarks of CSS Laboratories, Inc.

CSS

LABORATORIES, INC.

2134 So. Ritchey Street, Santa Ana, California 92705
Tel: 714/540-4141 Telex: 3720012 FAX 714/540-2925

Inquiry 405 for End-Users.
Inquiry 406 for DEALERS ONLY.



See us at
COMDEX/Fall '86
November 10-14, 1986
Las Vegas Convention Center-West Hall
Las Vegas, Nevada
booth 876 & 975



similar way. I never got the Alcyon one to work properly. I forget if I got Lattice Malloc to work. I've never actually tried Megamax. It's kind of nice being able to peek at your own free list anyway for debugging, so since I got the sources, I use' em.

atarl.st/c.language #187, from sgrim
a comment to message 185

According to the GEMDOS manual, one program isn't supposed to malloc more than about 20 times, or pointers start to get messed up. Try mallocing one big block and accessing it as an array:

```
#define NUMSTRUCTS 100      /* The number of structures
you want in your array */
```

```
struct node *nodearray;
```

```
alloc()
{
  nodearray = (struct node *)
  Malloc((long)sizeof(node)*NUMSTRUCTS);
}
```

Hope that helps.

atarl.st/c.language #198, from tImpanton (Timothy Panton)
a comment to message 179

I don't know the answer to this one, I haven't played with Malloc for months (I wrote mallocer to test my 1-meg upgrade). However, looking at some code, I see I didn't trust casts in macros, i.e.,

```
Malloc((LONG) thing);
where thing is a word, I seem to have used
Malloc(lthing);
```

where lthing is a long, I'm not sure why; distrust of the preprocessor I guess.

My understanding of how Malloc() and malloc() differ is this:

TOS maintains a pool of memory. When a program starts up, it is allocated an amount of memory for code, data and stack. With GEMstart and GEMs this includes some extra to allow malloc to allocate from this area, and they include sbrk() which helps manage this allocation.

Appstart and acstart do not have this extra memory, nor do they include sbrk(), so malloc() can't be used. Malloc() is a TOS function which returns a pointer to free memory *outside* the programs area.

Thus, Mfree() really frees up memory for use by another program (say a print spooler accessory) whereas free() does not. free() in UNIX behaves the same way.

I haven't had any problems with malloc()ing too many times, but from the way TOS behaves in other areas (files, etc.) I can believe it.

IBM PC AND COMPATIBLES

The IBM section begins with questions on using ANSI.SYS for portability in a BASIC program. The end of this thread goes into a message from the BASIC conference for tips on calling assembly language routines and ROM BIOS functions from BASIC.

USING ANSI.SYS

Ibm.pc/other #229, from jbutner (Jeffrey Burtner)

Where can I find additional information on the use of ANSI.SYS? I am trying powerful {looking} features of ANSI.SYS to manipulate the screen in BASICA. Also, I could use a recommended reference for the interrupt codes and DOS calls available.

Ibm.pc/other #235, from feenberg (Daniel Feenberg)
a comment to message 229

Doesn't BASIC bypass MS-DOS for screen I/O and is not ANSI.SYS ignored by any BASIC program?

Ibm.pc/other #236, from richard (Richard Shuford)
a comment to message 229

ANSI.SYS is documented in the DOS Technical Manual, which, since version 2.1, has been a separate volume (and purchase) from the DOS User's Manual.

I don't normally recommend the following periodical, but the November 1985 issue of "PC World" contains an article beginning on page 244 (excerpted from "The Fully Powered PC" by B. L. Alperson, A. Fluegelman, and L. J. Magid) that discusses the use of ANSI.SYS.

However, it may not do you any good, because I suspect that BASICA may bypass the normal console drivers for much of its work; therefore, you may not be able to do much with ANSI.SYS in conjunction with BASICA.
.....RSS

Ibm.pc/other #237, from dmick (Dan Mick)
a comment to message 235

Not if you use OPEN to open a device and then write to it with PRINT#. I think the actual device changes from interpreter to compiler. In the interpreter I believe it's SCRIN: and in the compiler TRM: or CON: or mebbe CONS: I'm away from the machine that has the answer on its hard disk, but I know you can drive ANSI from both int. and comp. with the OPEN / PRINT# trick..

Ibm.pc/other #241, from btonkin (Bruce Tonkin)
a comment to message 229

Why are you using ANSI.SYS stuff from BASIC in the first place? Given that you already have LOCATE, CSRLIN, POS, COLOR, and SCREEN commands (not to mention graphics), it seems a little strange to me. Kinda like going back a few years to the days of dumb terminals.

Ibm.pc/other #242, from jbutner
a comment to message 237

That's exactly what I'm trying to do. I open "ANSI.SYS" as #1, then try to send my console output through it using IOCTL #1, etc. But I'm still not having a lot of luck; I keep getting a function error on my IOCTL line. It's very easy from Turbo Pascal, but my application must be written in BASICA or GW-BASIC. How about a way to clear to end of line or clear to end of screen for use in BASICA?

Ibm.pc/other #245, from richard
a comment to message 229

Perhaps if you are serious about complex applications, you should get the replacement, NANSI.SYS, from Hersey Microsystems.

Any implementation of the ANSI X3.64 standard is going to be a subset. I don't think that any real device could possibly use all the codes and be comprehensible. The full list of codes is there to provide a standard way of doing a certain group of functions. If your device doesn't do a given function,

(continued)

then it doesn't need to recognize the code for the function.

I observe that "ms.dos/long.messages" msg. 10 is the text of ANSIX364.TXT, a file I posted awhile back on BYTENet/Listings. Thank you for posting it locally, sir.

ibm.pc/other #247, from dmick
a comment to message 242

I know I didn't use IOCTL. The reason I did it was to make quick modifications to a CP/M public domain touch-type program that defined command strings to control the terminal and therefore ran on a lot of different systems. I kept the basic structure for portability and just changed the command strings to do ANSI functions, then changed all the PRINTs to PRINT #1s after I'd opened the device. In Zenith's BASICA (GW-BASIC) and I'll bet in IBM's too, one may use:

```
OPEN "CON" FOR OUTPUT AS #1
PRINT #1, CHR$(27) + "[2J";
```

to clear the screen. It works, bypassing BASIC's I/O. Of course, ANSI.SYS must be installed first. In the QuickBASIC compiler, the filename is different, I believe...but it works there, too. If I can get at the machine that has it next week, I'll post what name to use with QB. But I agree with Bruce...if you don't have to, use BASIC's functions...don't have to worry about having ANSI.SYS resident, and you can do more. You'll have to write a CLREOL and CLREOS function, but they're awfully easy to do.

ibm.pc/other #248, from jburtner
a comment to message 247

OK. I'll try your PRINT #1 method. But as for writing a CLREOL or CLREOS function, I'm missing the awfully easy part somewhere. Could you explain how to do it short of sending lines of spaces or nulls to the screen? (That is so sloooooowwww.)

Do you happen to know how to address the screen memory directly from the IBM BASIC (either GW-BASIC or BASICA)? Several of us have taken a whack at trying to read or write to it directly without much success. Our best guess is that BASIC is relocating it's memory (64K) in an area away from the screen so that we cannot reach it using POKE.

ibm.pc/other #249, from dmick
a comment to message 248

Well, what I was thinking of as far as CLREOL, etc., was printing spaces. You're right, that can be slow. An assembly subroutine would be quicker, and that's not so easy to do with the interpreter although it's a snap from the compiler.

As far as accessing display memory...any memory can be accessed with a combination of the DEF SEG and PEEK/POKE statements. PEEK, POKE, and several other statements that take addresses as arguments take 16-bit addresses which are considered offsets in the default segment. If unset by DEF SEG, this default segment is BASICA's data segment, where program source, variables, etc. are stored. VARPTR, for example, returns the offset of a variable in the variable table as a 16-bit offset into the default data segment. Thankfully, this is *not* the segment used for display RAM. Some interesting things could happen on-screen if it were! The segment address for mono video on IBMs is B000H; for color display adapters B800H. So to access video RAM, first do DEF SEG = &HB000 for mono machines or DEF SEG = &HB800 for color machines, then PEEK/POKE refer to video RAM. Be sure to reset this before you do anything like CALL or BLOAD or something else that requires an address, though.

Are you using the interpreter exclusively? Screen updating using spaces is a lot faster with the

compiler, and the newest for the IBM, QuickBASIC 2.0, should make a Turbo'er feel right at home.

ibm.pc/other #251, from jimkeo (Jim Keohane)
a comment to message 248

>CLREOL & CLREOS from BASIC

Jeff, see basic/programming #40 for assembler calls for QB posted by BTonkin. Also, see /programming #48 for some non-assembler means of making DOS and ROM calls. Specifically, there's a ROM call to scroll up or down a specified window on the screen. If you specify zero as number of lines to scroll, the whole window can be blanked. This can mimic a CLREOS or CLREOL if cursor is at col 1. If cursor at different column, you can still do a CLREOL by specifying a one-line window. CLREOS would be a full scroll zero of any lower lines.

ibm.pc/other #253, from bomb (Jerry McReynolds)
a comment to message 229

Jeff, to make a quick answer to your query about ANSI.SYS, yes, you can access the ANSI driver from BASIC.

You should have the system boot with the statement;

```
DEVICE=[D][PATH]ANSI.SYS
```

in your config.sys file. To access the driver from BASIC (or any language) all you have to do is write to the device "CON," which happens to be stdout. The driver that you install in your config.sys file will take precedence over the "Glass TTY" console driver that DOS installs.

The statement, OPEN "CON" FOR OUTPUT AS #1, will open the stdout file for writing. The statement, PRINT #1, "Hello", will print the word Hello at the current cursor position and also issue a Carriage Return Line Feed.

The complete subset that the ANSI.SYS driver supports is available to you through the PRINT #1 statement. The supported escape sequences are listed in the DOS Technical Reference Manual.

For example, suppose you wish to clear the screen, then position the cursor at line 12, column 20 and print the string "Enter Your Name Please:," the following example will do just that:

```
10 OPEN "con" FOR OUTPUT AS #1
20 PRINT #1, CHR$(27);"[2J";
30 PRINT #1, CHR$(27);"[12;20H";
40 PRINT #1, "Enter Your Name Please: ";
50 CLOSE #1
```

Line 10 will open the console device for writing.
Line 20 will clear the screen.
Line 30 will position the cursor at row 12, column 20.

Line 40 will print the string.
Line 50 will close the file.

Good luck, hope this tidbit helped.

P.S. - The escape sequence for CLREOL is named EL and is "ESC [k". Also note that the characters -are-case-sensitive.

ibm.pc/other #254, from jburtner
a comment to message 253

Yes, so I found out. So for any others who may have been watching (with interest or revulsion), here is the final set of commands that I've decided upon for inclusion in my program:

```
10 Open "CON" for Output As #1
20 ETB$=CHR$(27)+"[s"
25 FOR X=1 TO
24:ETB$=ETB$+CHR$(27)+"[k"+CHR$(27)+"[B":NEXT X
30 ETB$=ETB$+CHR$(27)+"[u"
```

(continued)

AT Power, Toshiba-Style.



The Toshiba T3100.



Try tucking *this* into a drawer when you're done! Until now, you had to be tied to your desk in a tangle of cables and hardware to get AT power. Toshiba's T3100, on the other hand, puts AT performance anywhere you want.

Toshiba technology improves on AT functionality: The T3100 gives you the power of an IBM® PC-AT™ in a lean, 15-pound computer that looks superb on your desk, and slips into a drawer when you don't need it. Take it home, take it to a meeting, take it around the world—wherever your work takes *you.*

Don't let its size fool you.

The T3100 is less than a third the size of the Compaq™ Portable II, yet every bit as powerful. It uses the same 80286 microprocessor as the AT, and is fully IBM-compatible, so you can share data with the other desktop computers in your office. The T3100's 10MB internal hard disk gives you ample storage for sophisticated applications. A dual-voltage power supply lets you plug in and go to work just about anywhere in the world. And Toshiba built in an advanced gas plasma screen, to give you the clarity and brightness of a CRT display—without the bulk.



Compact is as compact does: The T3100 is less than a third the size of the Compaq Portable II.

More memory for more applications.

The T3100's full 640KB RAM lets you work with the most popular IBM PC/XT™ and AT software: Integrated financial and analysis programs, large spreadsheets, lengthy documents, electronic filing and more. A built-in 720KB diskette drive handles the new industry standard 3½" diskettes. Each IBM-compatible pocket-sized disk holds *twice* as much information as a conventional 5¼" diskette! And you can easily transfer data to and from other desktop computers using Toshiba's optional external 5¼" diskette drive.

Trademarks: PC-AT, PC/XT—International Business Machines Corporation; Compaq—Compaq Computer Corporation; MS-DOS—Microsoft Corporation. Registered Trademarks: IBM—International Business Machines Corporation; Hayes—Hayes Microcomputer Products, Inc.; SuperKey and SideKick—Borland International, Inc.

"Big" system expansion options.

Like any full-function desktop system, the T3100 grows with your computing needs. Toshiba offers a full line of internal

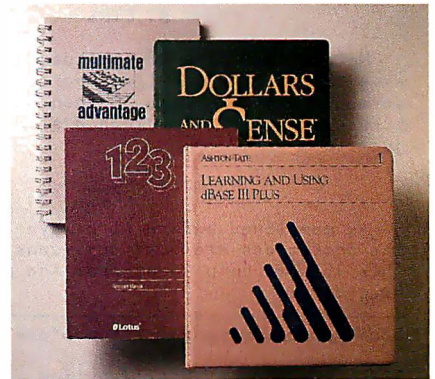

Software, everywhere: The T3100 runs the most popular applications written for the IBM PC/XT and AT.

and external options, including an expansion chassis with 5 IBM-compatible slots, and an internal 300/1200 bps Hayes®-compatible modem.

The next generation of computing is here. And it sure would look great on your desk. Or away from it.

Desktop computing will never be quite the same again, thanks to Toshiba's advanced CMOS and proprietary gate array LSI technology. The T3100 is backed by our reputation for high quality electronics, and by our 110-year commitment to technological excellence.

See where desktop AT power is headed.

The T3100 is *here now!* Call:

1-800-457-7777

for your nearest Toshiba dealer.

**Now!
Includes
SideKick®
and SuperKey®**



In Touch with Tomorrow

TOSHIBA

TOSHIBA AMERICA, INC., Information Systems Division

Specifications:

- IBM PC-AT compatible
- 80286 processor, running at 8MHz or 4 MHz
- 640KB RAM, extendable to 2.6MB
- Built-in 10MB hard disk
- Built-in 720KB 3½" diskette drive
- MS-DOS 2.11 operating system
- High-resolution gas plasma display
- IBM Color Graphics Adapter (CGA) compatible
- 80 × 25 character display
- 640 × 400 bit-mapped graphics display
- RGB, parallel, serial and external diskette drive ports
- Carrying case, MS-DOS,™ BASIC included
- Full-sized 81-key keyboard
- 110/220 VAC switch-selectable power supply
- 12.2" W × 3.1" H × 14.2" D
- All this—and only 15 pounds

```
40 ENQ$=CHR$(27)+"[s"+CHR$(27)+"[k"+CHR$(27)+"[u"
```

I may now clear the screen to the bottom at any time by locating at the position to clear from and:

```
PRINT #1,ETB$
```

Notice that line 20 includes the cursor position save function as the first part of my clear to end of screen function. Line 30 then returns to the original cursor position. To clear a single line to the end, I just:

```
PRINT #1,ENQ$
```

As mentioned before (I always learn the hard way!) the characters are VERY case-sensitive. I hope that this is some help to others. And many thanks to all who helped!

basic/programming #40, from btonkin

TITLE: QB screen scroll routine in assembler

```
title DSCROLL.ASM: A LINKABLE ROUTINE TO SCROLL THE SCREEN DOWN.
```

```
;THIS ROUTINE IS PASSED THE UPPER LEFT CORNER TO
;SCROLL. THE LOWER RIGHT CORNER IS PERMANENTLY
;SET TO ROW 22, COLUMN 79. THE ROUTINE WILL USE
;A BIOS CALL TO SCROLL ALL LINES IN THAT PAGE
;DOWN AND INSERT A BLANK LINE WITH NO ATTRIBUTES
;AT THE TOP OF THE SCREEN. THE TOP OF THE
;SCREEN WILL BE THE TOP LINE INVOLVED IN THE
;SCROLL. TO SCROLL THE WHOLE SCREEN, SET THE TOP
;LINE TO ZERO.
```

```
;(0). WRITTEN BY BRUCE W. TONKIN ON 9-18-85
;USING IBM'S MACRO-ASSEMBLER.
;COPYRIGHT (C) 1986, BRUCE W. TONKIN.
```

```
;YOU MAY USE THIS ROUTINE IN ANY WORK WITH OR
;WITHOUT ATTRIBUTION.
```

```
DATA SEGMENT WORD PUBLIC 'DATA'
STORAGE DW 16
DATA ENDS
DGROUP GROUP DATA
CODE SEGMENT BYTE PUBLIC 'CODE'
ASSUME CS:CODE, DS:DGROUP
PUBLIC DSCROLL
DSCROLL PROC FAR
PUSH BP ;SAVE BASE POINTER
MOV BP,SP ;SET UP TO ADDRESS OFF OF
;BP
MOV BX,[BP]+6 ;GET THE ADDRESS OF THE
;PARAMETER
MOV CX,0 ;ZERO CX REGISTER
ADD CX,[BX] ;PUT ROW ADDRESS INTO CX
MOV CH,CL ;MOVE ROW TO CH
MOV CL,0 ;SET COLUMN NUMBER TO ZERO
;FOR UPPER LEFT
MOV DH,22 ;BOTTOM ROW NUMBER
MOV DL,79 ;BOTTOM COLUMN NUMBER
MOV BX,112 ;SET ATTRIBUTE TO USE INTO
;BH
MOV AL,1 ;NUMBER OF LINES TO
;SCROLL, 0 MEANS ALL LINES
MOV AH,7 ;BIOS FUNCTION CALL
INT 010H ;INTERRUPT 10 HEX=16
;DECIMAL
POP BP ;RESTORE BASE POINTER
RET 2 ;RETURN AND REMOVE ONE
;PARAMETER FROM STACK
DSCROLL ENDP
CODE ENDS
END
```

DOS & ROM BIOS CALLS FROM BASIC

basic/programming #48, from jlmkoo

I read with interest the various ROM calls coded in

assembler posted by btonkin. Other languages I use have a general purpose call where the INT # is passed as well as the value of certain registers. I thought it would be nice to have such a routine in BASIC. Following is a first pass at it. It does not currently return the new reg values after the interrupt nor does it return the FLAG settings (used by some DOS calls). However, it should suffice for many uses.

Of the 3 "DEF FNxx" statements, the one for FNCC\$ is used to assign to a string an assembler routine that is built on the fly using the INT value passed as well as various register values. The other 2 FNxx's merely break up FNCC\$ into 2 pieces for easier handling.

The program below issues a Video INT 16 (&H10) with AH set to 6 for scroll up. When AL=0 (as it is in this example) the entire window is blanked. CX gives the upper left corner as 0,0 and DX gives the lower right corner as 10,40. BH specifies the attribute used to fill in new lines.

Since this is the first time I've played with assembler called from BASIC, I'll leave it to the more experienced to craft a version like:

```
100 CALL IR(IN,AX,BX,CX,DX,etc....)
```

Such a version could also return the register values after the interrupt as well as the flag settings.

- Jim Keohane

```
10 DEF FNA$(DS,BX,CX,DX,BP,SI,DI) =
MKI$(&H5655)+MKI$(&H61E)+CHR$(&HB8)+MKI$(BX)+CHR$
(&HB9)+MKI$(CX)+CHR$(&HBA)+MKI$(DX)
+CHR$(&HBD)+MKI$(BP)+CHR$(&HBE)+MKI$(SI)+CHR$(&HBF)
+MKI$(DI)+CHR$(&HB8)+MKI$(DS)
```

```
20 DEF FNBB$(AX,ES,IN) =
MKI$(&HD88E)+CHR$(&HB8)+MKI$(ES)
+MKI$(&HC08E)+CHR$(&HB8)+MKI$(AX)+CHR$(&HCD)+LEFT$(
MKI$(IN),1)+MKI$(&H1F07)+MKI$(&H5D5E)+CHR$(&HCB)
```

```
30 DEF FNCC$(IN,AX,BX,CX,DX,BP,SI,DI,DS,ES) =
FNA$(DS,BX,CX,DX,BP,SI,DI)+FNBB$(AX,ES,IN)
```

```
40 GOTO 60
```

```
50 I=VARPTR(S$):J=CVI(CHR$(PEEK(I+1))+CHR$(PEEK(I+2))):
CALL J:RETURN
```

```
REM AH=6,AL=0 to clear all,BH=attr,Dh=line 10,
DL=column
REM 40:clear window
REM Video INT 16 (Hex 10)
```

```
60 S$=FNCC$(16,&H600,&H4E00,0,&HA28,0,0,0,0,0):GOSUB 50
```

```
70 END
```

P.S. To issue Shift-PrtSc from BASIC code:
60 S\$=FNCC\$(5,0,0,0,0,0,0,0,0,0):GOSUB 50

P.P.S. I know Shift-PrtSc is in the BASIC manual already, I just wanted to give another example!

MACINTOSH/APPLE II

With this issue, the Macintosh window expands to become the Macintosh/Apple II window. The section begins with a long message on HFS and the Macintosh hard disk. The next thread covers the Apple II, with a question on loading and using files above the magic HIMEM limit.

HFS, YOUR HARD DISK, AND YOU

macIntosh/long.messages #29, from cglbson (Christopher Gibson)

(continued)

Osborne/McGraw-Hill Computer Books For IBM® PC Productivity

Using dBASE III PLUS™

by Edward Jones

You'll be in full command of all the new features of this powerful database software with Jones' expertise. Design, create, and display a dBASE III PLUS database; generate reports; use Query files; and plug into networking. A practical handbook for beginners and experienced users.

\$18.95, Order #0-07-881252-6, 516 pp.
7½ x 9¼

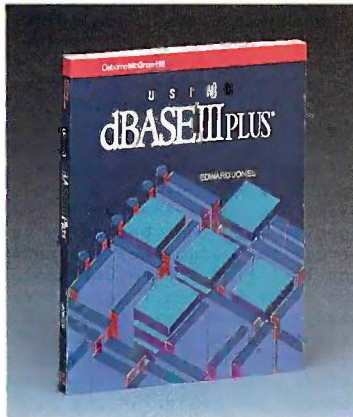

PC-DOS Tips & Traps

by Dick Andersen, Janice M. Gessin, Fred Warren, and Jack Rodgers

Here's an invaluable collection of helpful tips and clever solutions to troublesome traps for everyone using PC-DOS 2.1 or MS-DOS® 2.11. From initializing your system and formatting disks, to controlling peripherals and managing the DOS environment, you'll find an array of tricks and secrets.

\$16.95, Order #0-07-881194-5, 218 pp.
7½ x 9¼

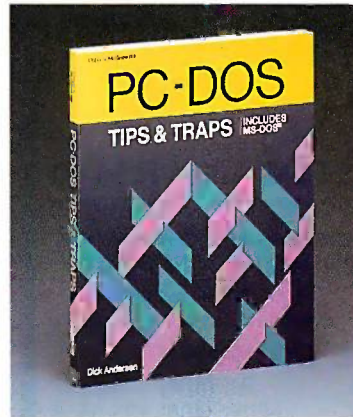

Advanced WordPerfect®: Features & Techniques

by Eric Alderman and Lawrence J. Magid

The source for ambitious users. Provides tools and concepts that you can use to take advantage of macros, paragraph numbering and outlining, indexing, and WordPerfect's mathematical capabilities. Covers WordPerfect integration with Lotus® 1-2-3, dBASE III, Sidekick, and ProKey.

\$16.95, Order #0-07-881239-9, 310 pp.
7½ x 9¼

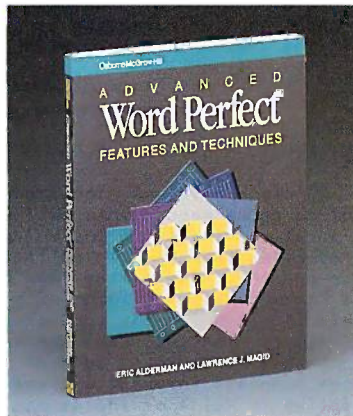

The Osborne/McGraw-Hill Guide to Using Lotus® 1-2-3; Second Edition

by Edward M. Baras

Master Lotus 1-2-3 upgrade, Release 2, with this comprehensive guide. Provides detailed descriptions of worksheet, database, and graphics functions for fundamental through advanced applications. Includes ready-to-use models.

\$18.95, Order #0-07-881230-5, 412 pp.
7½ x 9¼

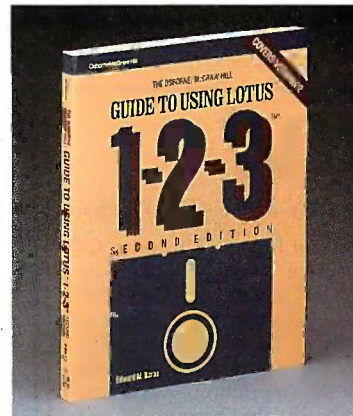

◆ Osborne/McGraw-Hill books are available at bookstores and computer stores everywhere.

◆ To order by mail, complete the coupon and send it to: Osborne/McGraw-Hill
P. O. Box 400
Hightstown, NJ 08520

◆ All orders must be prepaid and should include local tax.

◆ Checks, money orders, VISA and MasterCard are acceptable for payment. No postage or handling charges are required.

◆ Books will be shipped via UPS. Allow 4-6 weeks for delivery. Books will not be delivered to post office boxes.

This order is subject to acceptance by McGraw-Hill. Offer is good only in the U.S.A.

Osborne/McGraw-Hill
Copyright ©1986 by McGraw-Hill, Inc.

NAME _____
ADDRESS (No PO Box) _____
CITY _____
STATE _____ ZIP _____
INDICATE METHOD OF PAYMENT CHECK/MONEY ORDER
 VISA/EXP. DATE _____ MASTERCARD/EXP. DATE _____
CARD # _____
SIGNATURE _____
QTY _____ ORDER # _____ PRICE _____

Osborne/McGraw-Hill
PO Box 400, Hightstown, NJ 08520
Clip and send.
42-Q-015-7000-1

SUBTOTAL _____
TAX _____
TOTAL _____

NOVAS BEYOND IBM COMPATIBILITY
MORE POWER PLUS RELIABILITY

NOVAS TURBO 286 MOTHERBOARD

- Fewer ICs For Greater Reliability— Only 36 Compared to IBM's 131
- Dual Speeds—6 & 8 MHz—Keyboard or Jumper Selectable (10 MHz opt.)
- 4 Serial and 1 Parallel Ports On Board Option
- Expandable to 1 Megabyte RAM
- Complete with Setup Program
- AWARD BIOS
- Socket for 80287
- Rechargeable Battery On Board for Clock
- 0, 1 Wait State. Jumper Selectable. Hardware reset port.

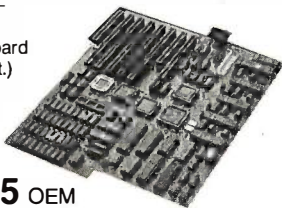

\$495 OEM

ALL AT ACCESSORIES AVAILABLE—CALL!

NOVAS 1000 EGA BOARD

- Supports EGA, CGA, MDA
- 640 x 350 Pixels EGA
- 640 x 200 Pixels Color
- 320 x 200 Pixels Color
- 720 x 350 Pixels Monochrome
- Parallel Port on Board
- 256K RAM on Board

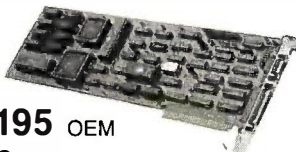

\$195 OEM

NOVAS TURBO 286

AT COMPATIBLE SYSTEM . . . \$1395.00

Includes: 640K, 6/8 MHz Turbo Speed (10 MHz opt.), 1 S/1 P, 1.2 Meg. Dr., W. D. Controller

COMPLETE NOVAS PC TURBO SYSTEMS AND COMPONENTS IN ANY CONFIGURATION—CALL FOR CURRENT PRICES

W. D. Controller for AT . . . \$180 192 W Power Supply . \$95
AT look-alike Case \$75 Keyboard for AT \$65

COMPUTRADE COMPANY

780 Trimble Road, Suite 605 Tel: (408) 435-2662
San Jose, CA 95131 Fax: (408) 435-5458

* IBM & AT are trademarks of International Business Machines Corp.

PC/VI

Full Screen Editor for MS-DOS (PC-DOS)

Looking for an Ultra-Powerful Full-Screen editor for your MS-DOS or PC-DOS system? Are you looking for an editor FULLY COMPATIBLE with the UNIX*VI editor? Are you looking for an editor which not only runs on IBM-PC's and compatibles, but ANY MS-DOS system? Are you looking for an editor which provides power and flexibility for both programming and text editing? If you are, then look no further because PC/VI IS HERE!

The following is only a hint of the power behind PC/VI: English-like syntax in command mode; mnemonic control sequences in visual mode; full undo capability; deletions, changes and cursor positioning on character, word, line, sentence, paragraph or global basis; editing of files larger than available memory; powerful pattern matching capability for searches and substitutions; location marking; joining multiple lines; auto-indentation; word abbreviations and MUCH, MUCH MORE!

The PC/VI editor is available for IBM-PC's and generic MS-DOS based systems for only \$149. For more information call or write:

Custom Software Systems
P.O. Box 678
Natick, MA 01760
617-653-2555

The UNIX community has been using the VI editor for years. Now you can run an implementation of the same editor under MS-DOS. Don't miss out on the power of PC/VI!

*UNIX is a trademark of AT&T Bell Laboratories.

• BEST OF BIX • **BIX** • BEST OF BIX • BEST OF BIX

If you have an HFS hard disk hooked up to your Mac or Mac Plus, then you must have noticed that whenever you reset your Mac without choosing Shut Down (such as hitting the reset button, a system bomb, or even an application doing a reset when it quits), the hard disk will perform some mysterious internal rebuilding, with furious disk accesses that can last up to two minutes before the familiar "Welcome To Macintosh" message appears. With a lot of puzzling, and more than a little help, the reason - and the solution - are at hand. But first, a short explanation is in order.

NON-TECHIE SECTION

Whenever a disk - any disk - is inserted into a drive, it is "mounted" by the ROM routine MountVol. While a hard disk is not inserted in the traditional sense, it goes through the same MountVol routine. One of the things the MountVol routine does is check for a special block of information called the Volume Control Block (VCB for short). Inside this is lots of information about the volume, depending on whether it's an HFS or MFS volume, a regular disk or a non-ejectable disk, etc. But the key to this shortcut lies in a special flag that basically tells the computer whether or not the volume was *properly* ejected and unmounted the last time the volume went "off-line." Depending on the value of this flag, the volume will either be mounted immediately (since the Mac assumes it's OK), or else (if on an HFS volume) it will begin to rebuild two special files the Finder uses to keep track of the volume. If this has completely left you behind, then I suggest you Control-K out right now, because it just gets worse, and besides, unless you have a pretty good grasp of what's going on behind the scenes, you should probably not be executing a routine that has you playing around in memory with a debugger.

SECTION OF TECHIE STUFF

BUT FIRST, A BIT OF HFS BACKGROUND

On any HFS volume, there are 3 structures to handle volume space management, file mapping, and file allocation. These are the Volume Bit Map, the Extents Tree File, and the Catalog Tree File. The Volume Bit Map and the Extents Tree File handle the equivalent job as the MFS volume allocation block map. The Catalog Tree File handles the equivalent job as the MFS file directory. The two trees are set up as B-trees, and each node consists of several types of records. For more complete information, see the new File Manager section in Vol 4 of Inside Macintosh.

Whenever the Mac recognizes that a disk has been inserted, the operating system calls the MountVol routine in the File Manager (the rest of this section assumes HFS volumes, unless specifically mentioned otherwise). One of the first things the MountVol routine does is to read in the volume information at the beginning of a volume, and build a copy of it in memory in a data structure called the Volume Control Block (VCB). Each VCB is a 178-byte non-relocatable block that contains volume-specific information. This block is documented (accurately) in volume 4 of Inside Macintosh. One of the fields in this record is an INTEGER field 'vcbAtrb'. Herein lies the key.

Before I get too specific, let me give a little general disclaimer: this stuff was gathered by a combination of insight, debuggers, and time. After many sessions of trapping, bombing, resetting, and interminable delays while our various HD's "rebuilt" themselves, we narrowed down the possibilities. After a few glances at the revamped File Manager section of Inside Macintosh Vol.4, we felt reasonably confident in our conclusions. But, these are not the words of you-know-who, and I not only ask, but encourage anyone who has the inclination to do so to please check my conclusions. I would always rather be proven wrong a

(continued)



30 Day Satisfaction Guarantee*

Not Copy-Protected

PC Outline!

the Best Memory-Resident Outline Processor



Outline!
is only
\$89.95
+\$5 shipping*
* CA residents add tax

COMPARE FOR YOURSELF

	<i>Outline!</i>	ThinkTank	Ready	MaxThink
OUTLINE FUNCTIONS:				
Outline structure	Y	Y	Y	Y
Autonumbering	Y	N	N	Y
Multi-line entries	Y	Y	N	Y
Sorting	Y	Y	?	Y
Numbering Formats	7	0	0	?
Outline Title	Y	N	N	N
Hide/Unhide	Y	Y	Y	Y
Save previous Hides	Y	N	N	?
Global Hide/Unhides	Y	N	N	N
Hide Paragraphs	Y	Y	N/A	?
Start new numbering	Y	N	N	N
Skip numbering	Y	N	N	N
Place Entry left/right	Y	N	N	N
Xfer between outlines	Y	N	N	N
EDITING FUNCTIONS:				
Full screen editing	Y	N	N	N
Margin Control	Y	N	N	N
Hanging indents	Y	N	N	N
Justification	Y	N	N	N
Centering	Y	N	N	N
Search/Replace	Y	Y	Y	Y
Block Copy/Move	Y	Y	N	Y
Xfer between windows	Y	N	N	N
On Screen Page Breaks	Y	N	N	N
Insert Page Breaks	Y	N	N	N
Tab Settings	Y	Y	N	N
Printer fonts	Y	N	N	N
Print any part	Y	N	N	?
MISC FUNCTIONS:				
Memory Resident Option	Y	N	Y	N
Pull-Down Menus	Y	N	N	N
Windows	9	1	1	1
Zoom Windows	Y	N	N	N
Macros	Y	N	N	N
Live Time/Date stamp	Y	N	N	N
Min. Memory Consumption	85k	256k	128k	?
Import from screen	Y	N	N	N
Export to application	Y	N	Y	N
Autosave	Y	Y	N	N

To Order PC *Outline!* Call Now

24 hours a day, 7 days a week

800-523-0764

in California

800-323-5335

C'est la difference!



If lines are busy or calling from out of the country call

408-559-4545

TELEX: 70414 (SBS NV UD)

*call for details

Brown Bag Software
2105 So. Bascom Ave.
Suite 164
Campbell, CA 95008
Inquiry 54

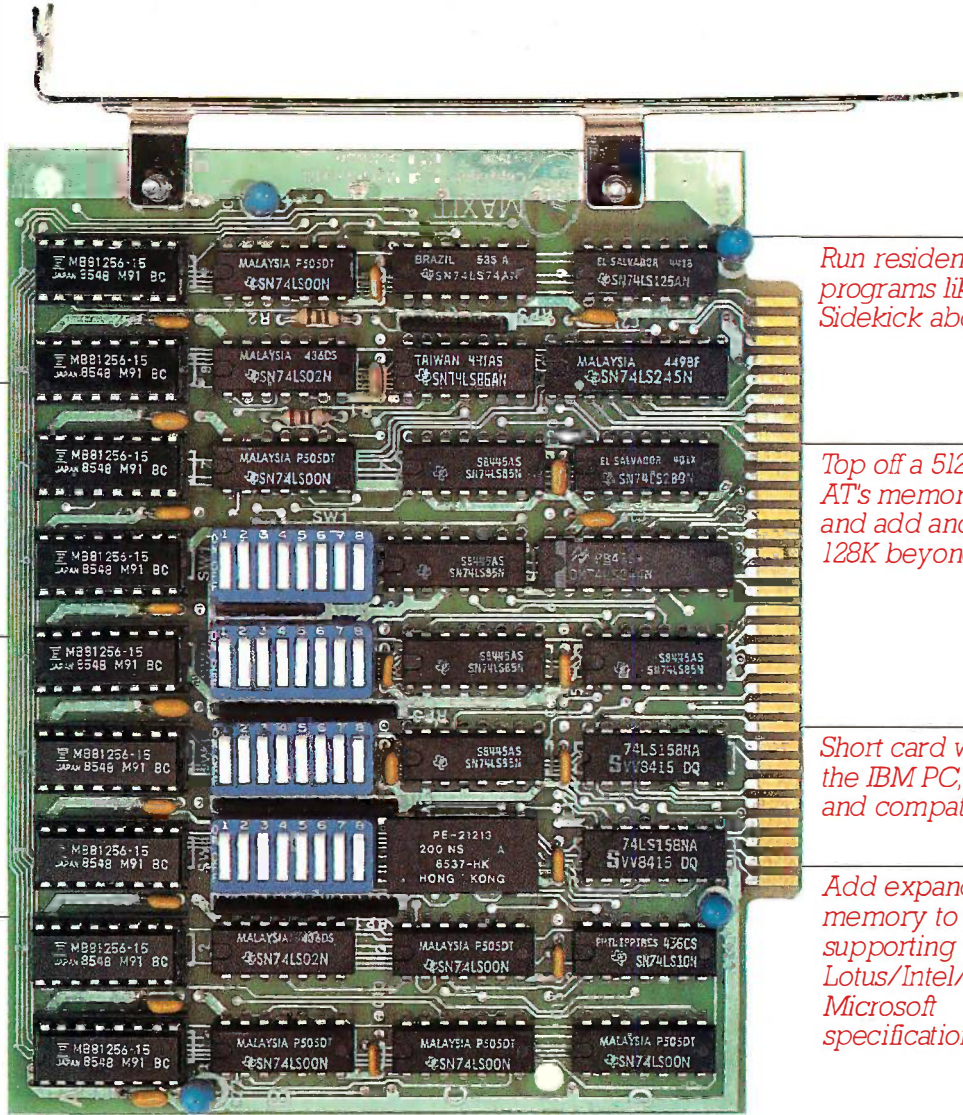

Add up to 96K above 640K to all programs, including PARADOX and 1-2-3

Parity-checked 256K with a one-year warranty.

Run custom software or the 3270 PC Control Program above 640K

Run resident programs like Sidekick above 640K

Top off a 512K IBM AT's memory to 640K and add another 128K beyond that.

Short card works in the IBM PC, XT, AT, and compatibles.

Add expanded memory to programs supporting the Lotus/Intel/Microsoft specification 3.2.

MAXIT™ memory works above 640K for only \$195.

Break through the 640K barrier.

MAXIT increases your PC's available memory beyond 640K. And it does it for only \$195.

MAXIT includes a 256K half-size memory card that works above 640K. MAXIT will:

- Add up to 96K above 640K to all programs.
- Run memory resident programs above 640K.
- Top off an IBM AT's memory from 512K to 640K.
- Expand 1-2-3 Release 1A or 2.0 worksheet memory by up to 256K.
- Add expanded memory above 640K to programs like Symphony 1.1.

Big gain — no pain.

Extend the productive life of your IBM PC, XT, AT or compatible. Build more complex spreadsheets and databases without upgrading your present software.

Installation is a snap.

MAXIT works automatically. You don't have to learn a single new command.

If you have questions, our customer support people will answer them, fast. MAXIT is backed by a one-year warranty and a 30-day money-back guarantee.

Order toll free 1-800-227-0900.

MAXIT is just \$195 plus \$4 shipping, and applicable state sales tax. Buy MAXIT today and solve your PC's memory crisis. Call Toll free 1-800-227-0900 (In California 800-772-2531).

We accept VISA, MC, AE, and DC.



Osborne McGraw-Hill
2600 Tenth Street, Berkeley, California 94710
Inquiry 201

MAXIT is a trademark of McGraw-Hill CCG software. IBM is a registered trademark of International Business Machines Corporation; 1-2-3 and Symphony are registered trademarks of Lotus Development Corporation. Sidekick is a registered trademark of Borland International, Inc.; PARADOX is a trademark of ANSA Software.

million times than screw up my hard disk even once. But, if this sounds overly willy-nilly, let me say this: I have personally used the shortcut below to avoid the hard disk tree restructuring many, many times. It has been used in many different situations, and we have yet to lose a byte of data. When applied with a reasonable dose of discretion, I don't think there is any reason to worry. So, if we are all in the proper mood of "controlled skepticism," let us continue:

Of the 16 bits in this field, Apple documents only 8 as follows:

Bit	Meaning
0-4	Set if inconsistencies were found between the volume information and the file directory when the volume was mounted.
6	Set if volume is busy (one or more files are open)
7	Set if volume is locked by hardware
15	Set if volume is locked by software

From our best efforts, however, the only bit WE find being changed is bit 8. We have tried again and again, and still bit 8 seems to come up every time. Basically, what we find is that this bit, ON DISK, is set to 1 if the volume was properly flushed and unmounted the last time the volume went off-line. This is done by the Eject routine, which goes into the VCB, sets that bit to 1, and then writes the block to disk. This is done just before the volume is unmounted, and I don't think that it is done by other routines, such as FlushVol, that don't explicitly call Eject (although Eject does call FlushVol).

To gain an insight into how the system worked from session to session, we examined that bit. As soon as the volume is mounted, and the VCB is read into memory, the bit is set to 0, and written back to disk. This way, if the volume should go off-line in any way that is not performed by the Eject routine, the block will not be updated, either in memory, OR ON DISK. I'll get to what happens when a disk is mounted with this bit set to 0. The important point here, especially for programmers, is that if the system bombs, or gets hit by a power failure, or is reset, either by the programmer's switch OR THE REBOOT COMMAND, the bit is left at 0, even if FlushVol was constantly called for safety (this is still a good idea, however, to help assure the integrity of your data files).

Anyhoos, when the MountVol routine is called, it checks that bit, and if it is zero, the MountVol routine gets the disk to start rebuilding these files, on the assumption that if the bit was not set, then the volume may have been left in some inconsistent state, so it's time to make sure, and build these trees from (probably) scratch. Due to the recursive natures of building the B-tree structures, this is most likely what is occurring when you try to boot or mount a volume right after you bomb or reset. On a 20- or 30-megabyte hard disk, this can take as long as two minutes. For developers, who usually follow the Edit-Compile-Run-Crash-Reboot cycle of writing programs, this time can quickly add up. (One quick note: this same action occurs on ANY HFS volume, even a floppy. But on a floppy, the time to rebuild these is much shorter, so you probably just haven't noticed it.) Now that you know what is happening, maybe we should examine how to avoid it, even under a bombing situation. ("Finally," I can hear you thinking, as a collective sigh of relief rises from the readers.)

THE SHORTCUTS AND FIXES
=====

The first method I will (briefly) examine is aimed at those developers who insist on having their programs

(continued)

**THE GENERAL DATACOMM
1200 Bps SUPER ACCURATE
ACCULINE PC MODEM**

AT COMPATIBLE • FULL FEATURED •
TWO YEAR WARRANTY

40% OFF

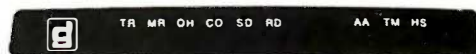

**\$226⁰⁰ Including Software
Call 1-800-523-1737**

Order now and receive a FREE
IntroPak Subscription to COMPUSERVE.

General DataComm

Offer valid through December 31, 1986.

METACOMCO

The quality source for Atari ST & Amiga software

**CAMBRIDGE
LISP**



**THE SYMBOLIC LANGUAGE
FOR ATARI ST and AMIGA**

An interpreter/compiler providing a complete
LISP development environment for \$199.95.

—also available—

- Macro Assembler - Professional development system ST - \$ 79.95
Amiga - \$ 99.95
 - BCPL - NEW! Full standard BCPL compiler - ST.....\$149.95
 - Lattice 'C' - The well known Lattice 'C' compiler - ST & Amiga.....\$149.95
 - Cambridge Lisp - The interpreter/compiler - ST & Amiga.....\$199.95
 - MCC Pascal - Fast ISO/ANSI standard compiler - ST & Amiga.....\$ 99.95
 - Metacomco MAKE - NEW! UNIX-like MAKE utility for the ST...\$ 69.95
 - MENU + - Best selling ST MENU generator.....\$ 29.95
 - Metacomco SHELL - NEW! Amiga's intelligent programming shell...\$ 79.95
 - Metacomco TOOLKIT - Smartest tools available for the Amiga....\$ 49.95
- Cambridge LISP is also available for CP/M-68K. Call for Sinclair QL products. Languages come with full documentation, libraries & screen editor. ST languages include MENU+ and provide full interfaces to GEM VDI and AES functions. Metacomco provides experienced technical support and keeps its customers informed of new products and upgrade releases.

METACOMCO
5353 #E Scotts Valley Dr.
Scotts Valley, CA 95066

Contact your local dealer or call:
Tel: (US) 800-AKA-META (CA) 800-GET-META
BIX: mhll Compuserve: 73247,522
Add 6 1/2% tax if CA resident

Registered trademarks: Lattice - Lattice, Inc; Atari ST - Atari; UNIX - Bell Labs; Amiga - Commodore Amiga.



NEW!



for Turbo Pascal Programmers

turboMAGIC™ turns your ideas into state-of-the-art programs.

Your productivity increased, or **your money back!**

Let your imagination run wild! It's easy with *turboMAGIC*. Input forms. Report forms. Help windows. Pop-up menus. Pull-down menu systems. And more! *turboMAGIC* will turn 15 minutes of your time into code that would take you hundreds of hours to write. Whether you're a professional or just a beginner, you need *turboMAGIC*.

It's **POWERFUL!** It's **FLEXIBLE!** It's **FAST!** It's **MAGIC!**

Wouldn't you like some magic? Order *turboMAGIC* today. Only \$99.00. You have nothing to lose with our 30-day full money-back guarantee. CALL NOW! 1-800-225-3165 (Outside Alabama, orders only) or 205-342-7026 (VISA & MC welcome, no PO, no COD)

Requires: Turbo Pascal 3.0 and an IBM PC/XT/AT or compatible 256k RAM minimum
Not copy protected



Sophisticated Software Inc.
6586 Old Shell Road
Mobile, AL 36608 (205) 342-7026

Trademarks:
Turbo Pascal — Borland International
WordStar — MicroPro International

NEW

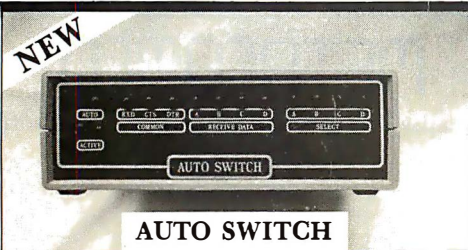

AUTO SWITCH



FOR RS100

ONLY



FOR CT100

The RS100 & CT100 auto switches are compact units that allow connection of a number of host computers to one or two printers, modems, or other peripheral devices.

The CT100 enables up to four computers to be connected to two parallel Printers (using the parallel ports). Either printer can be selected by command from the Host. The RS100 Version enables up to four computers to be connected via their serial ports to an RS232 Printer, using DTR.

On both models L.E.D. indicators let you know when the unit is active, and which routes are in operation. For the CT100, connections conform with centronics' standards. For the RS100 the following pins are used: Pin 1=Ground, Pin2=TX DATA, Pin3=RX DATA, Pin5=CTS, Pin20=DTR. Baud Rates selectable 300, 600, 1200, 2400, 4800, 9600 & 19200. 7 or 8 Bits with 1 or 2 stop Bits. Any parity accepted.

**ORDER NOW CALL 919-724-4013
OR MAIL YOUR CHECK TO:**

**BRAND NEW TECHNOLOGY INC
PO BOX 457 PFAFFTOWN NC 27040**

MONEY BACK IF AUTO SWITCH RETURNED IN 30 DAYS IN ORIGINAL CONDITION

reboot the Mac when you quit. (I hate that, but if you're gonna do it, now you don't have an excuse not to do it right!)

THE FIX

For the high-level programmer, the fix is relatively simple. The Reboot command DOES NOT perform this vital portion of the Eject routine. So, whenever your program is planning on rebooting the Mac, make sure you Eject ALL mounted volumes before you reboot. By doing this, you will avoid pi**ing off the poor people who are using your game.

THE SHORTCUT

So, what do you do if the Mac bombs, and you don't want to wait around while the hard disk does its thing? Try this simple routine (the essence of what it does is to call the Eject routine before you reboot, in order to flush the volume buffer and set the critical vcbAtrb bit):

First of all, you must have Macsbug installed on the Mac. Then, anytime you need to reboot, simply type the following commands (the ">" is the Macsbug prompt - don't type it).

```
> SM 10010 A017 0000 0000 FFFF
> PC 10010
> A0 10000      (that's "A-zero")
> T
> RB
```

Explanation of Debugger Commands

```
> SM 10010 A017 0000 0000 FFFF
    puts the Eject A-trap, ioNamePtr, and iovRefnum
    into memory.
```

*NOTE: this will only be correct if you boot from your hard disk. If you boot from floppy, or do not use a hard disk, this will not be valid. On the other hand, if you are floppy-based, it doesn't take very long to reboot, even if the attribute bit isn't set.

```
> PC 10010
    points the program counter to the A-trap
> A0 10000
    points the A0 register to the Paramblock
> T
    do the Eject routine
> RB
    reboot
```

As with any routine that deals with memory on the machine level, there may be unforeseen circumstances that could cause problems. This routine has been tested on the Mac Plus, with the Apple Hard Disk 20, and the MDIdeas SCSI Hard Disk 20 without any problems cropping up. However, I always suggest using prudence, and you should probably not use this routine if your application died in the middle of some massive file operation. Still and all, it has been very useful and dependable for me.

Please insert the massive legalistic disclaimer that Apple seems to be making the new standard for computer users here.

That's it! Good luck and have fun. Oh yes - feedback is ALWAYS solicited and appreciated!!

macIntosh/long.messages #30, from hedges (Tom Hedges, Fractal Software)
a comment to message 29

I find that just doing an 'ES' to the Finder followed *immediately* by a shutdown does the trick most of the time, and if the 'ES' fails, then I prefer that the HFS data structure *does* get rebuilt because things probably are really screwed up in memory.

(continued)

Train for the Fastest Growing Job Skill in America

Only NRI teaches you to service and repair all computers as you build your own 16-bit IBM-compatible micro

Now that computers are firmly established in offices—and in homes, too—the demand for trained computer service technicians surges forward. The Department of Labor estimates that computer service jobs will actually *double* in the next ten years—a faster growth rate than any other occupation.

Total systems training

No computer stands alone... it's part of a total system. And if you want to learn to service and repair computers, you have to understand computer *systems*. Only NRI includes a powerful computer system as part of your training, centered around the IBM-compatible Sanyo 550 Series computer.

As part of your training, you'll build this highly rated, 16-bit IBM compatible computer system, assemble Sanyo's "intelligent" keyboard, install the power supply and disk drive, interface the high-resolution monitor and dot matrix printer, even expand the memory from 128K to 256K RAM. It's confidence-building, real-world experience that includes training in programming, circuit design, and peripheral maintenance.

No experience necessary—NRI builds it in

Even if you've never had any previous training in electronics, you can succeed with NRI training. You'll start with the basics, then rapidly build on them to master such concepts as digital logic, microprocessor design, and computer memory. You'll build and test advanced electronic circuits using the exclusive NRI Discovery Lab®, professional digital multimeter, and logic probe. Like your computer system, they're all yours to keep as part of your training. You even get over \$1,000 worth of software, including the popular WordStar and CalcStar.



Your NRI total systems training includes all of this • NRI Discovery Lab® to design and modify circuits • Four-function digital multimeter with audio cassette training • Digital logic probe for visual examination of computer circuits • Sanyo 550 Series computer with "intelligent" keyboard and 360K double-density, double-sided disk drive • High-resolution monochrome monitor • RAM expansion module to give you powerful 256K memory • 120 CPS dot matrix printer with near-letter-quality mode • EasyWriter I, WordStar, CalcStar bundled software • Reference manuals, schematics, and bite-sized lessons.

Send for 100-page free catalog

Send the post-paid reply card today for NRI's 100-page full color catalog, with all the facts about computer training. Read detailed descriptions of each lesson, each experiment you perform. See each piece of hands-on equipment you'll work with and keep. And check out NRI training in other high-tech fields such as Robotics, Data Communications, TV/Audio/Video Servicing, and more.

Mail the postage-paid card today, and see how NRI can prepare you for advancement and new careers in the exciting world of electronics. If the card has been used, write to NRI Schools, 3939 Wisconsin Ave., Washington, D.C. 20016.



NRI is the only home study school that trains you as you assemble a top-brand microcomputer. After building your own logic probe, you'll assemble the "intelligent" keyboard...

... then install the computer power supply, checking all the circuits and connections with NRI's Digital Multimeter. From there, you'll move on to install the disk drive and monitor.

NRI SCHOOLS

McGraw-Hill Continuing Education Center
3939 Wisconsin Avenue, NW
Washington, DC 20016

We'll Give You Tomorrow.

IBM is a Registered Trademark of International Business Machine Corporation.



ROUTINES ABOVE HIMEM

apple/language #392, from Jrsmith (Anthony Smith)

I'm trying to install a routine above HIMEM. My installer lowers HIMEM by two full pages, installs the routine 1K above HIMEM, and marks the two pages the routine occupies in the system bit map. The routines work fine, but when I try to use the disk, I get a "no buffers available" error. I suspect that ProDOS needs to be told that its temporary buffer should be 512 bytes lower, but I'm not sure how to do that. I suspect it involves using SET_BUF and/or GET_BUF. I tried to use SET_BUF to lower it 512 bytes, but the temporary buffer has no reference number, so the MLI gives me the invalid reference number error. I'm sure the solution is pretty simple. Will someone tell me what it is?

Thank you.

apple/language #393, from mdavls (Morgan Davis)
a comment to message 392

No, you don't want to do it that way. If you're messing with BASIC.SYSTEM, you never do anything to the ProDOS system bit map. Only a SYS file (application/interpreter, etc.) should change that -- and since you're ultimately running under BASIC.SYSTEM, only *it* should change the system bit map.

What you want to do is use the BI's "getbuf" call. This allocates space for your machine language programs which will run while BASIC.SYSTEM is in memory. This call lets BASIC know where your routine will be so that when it needs a buffer, it will do so *below* your routine. As it is now, your protected bit map is causing BASIC to get errors when it tries to allocate a buffer where you've protected memory -- therefore, GETBUFR avoids this by letting BASIC *know* where available memory will be.

So how do you do it? It's really simple. First, calculate the number of 256-byte pages that your routine will need, and put that value into the accumulator. Then do a JSR GETBUFR (\$BEF5). If the carry bit comes back set, an error has occurred, and you can then just do a JMP ERRROUT (\$BE09) to let BASIC handle it. This would most likely occur in the off chance that you asked for more pages of RAM than BASIC could give to you, giving a NO BUF's AVAIL error.

If carry comes back clear, then your request has been granted. However, this is one more crucial point. When BASIC returns a clear carry, it also returns a value in the accumulator. This value is the most significant byte of the address where BASIC wants you to place your routine. For example, it might return \$92 if the address where your routine should go is \$9200.

Of course, this assumes that you have at your disposal some method of relocating your code to the address where BASIC specifies -- because there's no telling where this might be. If your program grows in size, the address will be lower in RAM, since BASIC will ask for you to put your routine as high into free memory as possible. It is also conceivable that someone else's machine language program has been loaded into high memory and is occupying space up there, causing BASIC.SYSTEM to issue your program an even lower address in memory. In short, you really need to have a front-end relocater *after* your call to GETBUFR so that your program will be placed correctly into memory.

If you don't have a code-relocating routine, don't worry. I've written one which takes up just 200 bytes, including all the calls and error handling with BASIC.SYSTEM. Unfortunately, I can't make this code available in source code form, due to restrictions imposed by BIX/Byte/MGH. However, there have been quite a few articles posted in Apple-related magazines

detailing the procedure. Even Beneath Apple ProDOS has a relocater (of sorts) for moving a 256-byte (or less) chunk of code.

For more information on allocating space with BASIC.SYSTEM, see the ProDOS programmer's bible: Beneath Apple ProDOS, page A30 "The TYPE Command." One of the ProDOS Technical Notes also details the use of GETBUFR, and its pal, FREEBUFR -- see "apple.dos/tips" for the appropriate Tech Note.

apple/language #410, from Jrsmith
a comment to message 393

Thanks alot mdavis. Your advice cleared up my problem instantly. The ProDOS Technical Reference Manual gives really lousy advice on that topic. The only place GETBUFR is even mentioned is in a revised memory map in the errata section.

Anyway. Now I have another problem. I've got the routine installed above HIMEM in space allocated by GETBUFR. It is supposed to open a file, then read it, etc. I use GETBUFR to find the file buffer (4 pages), then I store the address it gives me in the appropriate place in the global page and call OPEN through GOSYSTEM. It always returns with NO BUFFERS AVAILABLE or, if I do it twice in a row, with FILE BUSY. If I close the file, the FILE BUSY will usually go away and I'll get NO BUFFERS again. Sometimes the file won't close, however (from immediate mode). So, my main question is why the NO BUFFERS AVAILABLE? Does GETBUFR mark the pages in the system bit map? If it does, should it? Secondary question: Can you close a file using the immediate-mode CLOSE command that was opened with the MLI OPEN command? Is Level involved somehow?

apple/language #412, from mdavis
a comment to message 410

You ask some good questions. I'll answer them first, and then explain how one should go about handling disk functions with BASIC.SYSTEM from machine language.

GETBUFR doesn't mark pages in the bit map. I don't think it does, anyway. (It shouldn't!) It just lets BASIC know what memory it has allocated for other things, so that it won't trounce on anybody. Using CLOSE in immediate mode *might* close a file opened through GOSYSTEM, which also uses the parameter tables in BASIC.SYSTEM's global page, but I wouldn't count on it.

Here's how I do DOS functions from machine language with BASIC.SYSTEM. First, before your code calls GETBUFR, have it do this:

```

lda    $befb          ;save maximum HIMEM setting
sta    mytop          ;put it someplace safe
lda    #pages         ;ask BI for so-many 256-byte
                        ;pages

jsr    getbuf         ;c=0 means no error
bcc    ok             ;yikes, NO BUFFERS AVAIL
                        ;(most likely)
jmp    errout         ;boundary has lowest page
                        ;Bring BI's HIMEM down (so
                        ;that frebuf won't wipe us
                        ;out).

ok sta    $befb

```

Then, go ahead and move your code up to where GETBUFR says its okay. Now, when it comes time to do some file manipulation, you'll need to calculate how many pages of memory you're going to need, and thus can call GETBUFR for that space. e.g.:

```

lda    #5             ;1K + 256 bytes (5 * 256 =
                        ;1280)
jsr    getbuf         ;ask BASIC for the buffer
bcs    error          ;oops, c=1 means error!
sta    osysbuf+1     ;set OPEN param table buffer
                        ;to point to our buffer (for

```

(continued)

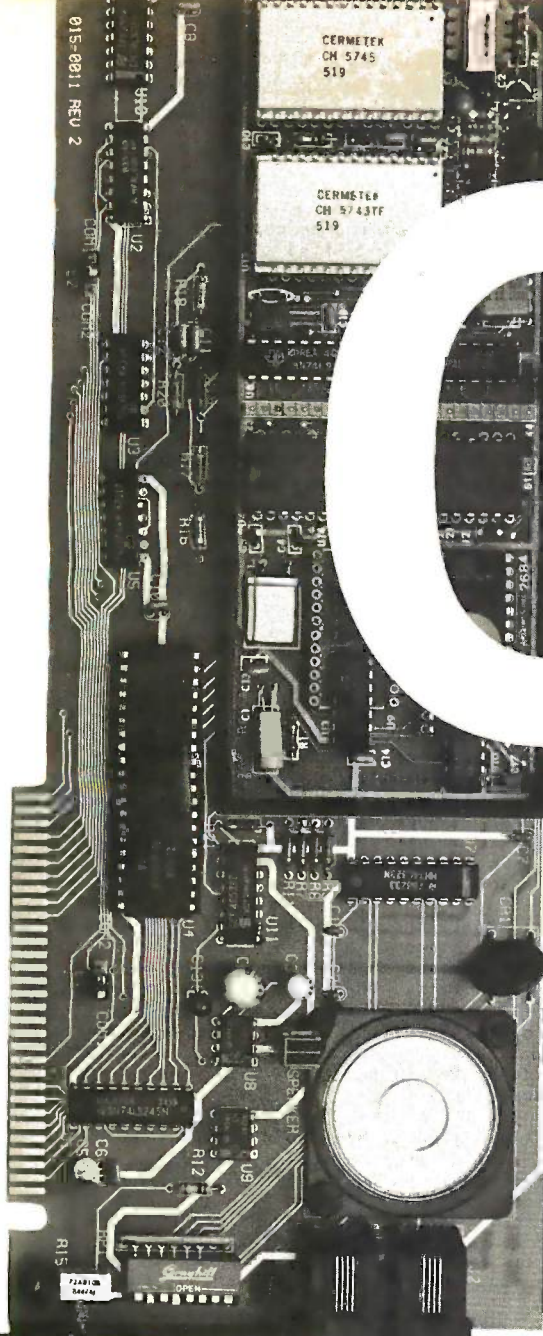

FINANCING

0%

FOR IBM

**1200 TPC
MODEM**

Let us help you finance your purchase at \$40 down and \$10 a month for 7 months / \$109

OR

Purchase your modem today at \$109 cash price and receive a \$30 rebate toward the purchase of Mirror™ software.

800 835-9009 IN CA
558-5741 OUTSIDE CA

name _____

business address _____

city _____ state _____ zip _____

business phone _____

MY PURCHASE CHOICE IS:

OUTRIGHT PURCHASE FINANCING

VISA

MASTERCARD ACCT. NO. _____ EXP. DATE _____

Calif. residents add sales tax, all USA orders add \$4 per modem for shipping and handling. (Canadian orders add \$10 per modem.) No C.O.D.'s or purchase orders accepted.

Subtotal _____

Shipping _____

TOTAL _____

I authorize you to charge my purchase to the account above for \$ _____ now, and \$ _____ per month for the next six months.

Signature _____

add Mirror™ communication software at \$69.95 to my purchase

SC

**Sunnyvale
Communications
Company**

1308 BORREGAS AVENUE
SUNNYVALE, CA 94088-3565

*30 DAY RETURN PRIVILEGE
(Offer expires Dec. 15, 1986)

```

;the 1K File Control Block
;[FCB])
adc #4 ;(carry is clear here) add 4
sta rwdata+1 ;to that
;set READ param table to
;point to just passed the
;FCB. We'll have 256 bytes
;to read/write.
ldy #0 ;set read/write count param
sta rwcountrwcount ;zero least significant byte
;($xx00)
iny ;(y=1)
sty rwcountrwcount+1 ;set MSB ($01xx), --> $0100
;= 256 bytes
    
```

This first asks BASIC for space for the File Control Block (needed when OPENING a file). Then it sets up the pointers for the OPEN and READ calls through the BASIC.SYSTEM Global Page tables. Onward...

```

lda #OPEN ;($CB) Let's open the file
jsr gosystem ;call big brother
bcs ferror ;if error on OPEN, release
;buffers
lda orefnum ;successful open! Save
;reference#
sta cfrefnum ;...for CLOSE
sta rwrefnum ;...for READ/WRITE
lda #READ ;($CA) Let's read 256 bytes!
jsr gosystem
bcs fcerror ;on error, close & free
;buffers
    
```

At this point, you can manipulate the data that you just read. The address of that data is going to be stored at RWDATA (\$bed7) in the BI global page, so you might want to copy the address into a zero page pointer for easy access. Now, for those errors:

```

fcerror pha ;save the error code
lda #CLOSE ;close the file
jsr gosystem
pla ;retrieve error code
ferror pha ;secondary entry if OPEN
;fails
jsr freebufr ;release those buffers
pla ;accum now contains error
;code
jmp errout ;let BASIC handle this
    
```

If you are processing a text file for displaying,

you might want to have special code check to see if the error is #5 (end of data), and if so, just close the file, but don't call ERRROUT.

Hope all this helps.

PS: Almost forgot! When you want to remove your program from memory, do this:

```

lda mytop ;restore the original HIMEM
sta $befb
jmp freebufr ;remove my code's buffers
    
```

apple/language #414, from mdavis
a comment to message 412

Oops, I just found some bugs in my somewhat-long message with all that source code. (I typed it in on the fly in about 15 minutes.)

The part that sets the RWCOUNT parameter to \$100 used "STA" instead of "STY".

Also, I never addressed what to do after you're done processing the file. First, obviously, you must CLOSE it. Second, you want to call FREEBUF to deallocate the 5 pages of memory you originally asked for. Note that this won't trounce your code (which was protected by using an earlier GETBUF call) because we changed the byte at \$befb to point to the memory page where our code starts — thus a FREEBUF call will deallocate any buffers *below* that.

This has been really hard to explain. I found it all just by accident anyway since, as was stated earlier, the first release of the ProDOS Technical Ref. manual never covered this. The best thing to do is to experiment on your own, until someone writes a decent book on how to do this stuff.

apple/language #416, from jrsmith
a comment to message 412

Thanks for the tip. I *had* been doing something wrong; however, I still have a problem. I didn't understand that in addition to the 1K FCB, you need another buffer for your data. I had requested a 1K buffer and then pointed both OPEN and READ's buffer pointers to its start. Now I have pointed OPEN to a 1K buffer and READ to another 1K buffer below that. I still get my old enemy NO BUFFERS AVAILABLE (on OPEN).

NEW FROM LOGICAL DEVICES INC:

PROMPRO-8X™ Model II

A stand-alone programmer starting at \$895.00 can put you in business to program EE/EPROMs PAL/PLDs,* Single Chip micros,* and Bipolar PROMs,* + EPROM IN-CIRCUIT EMULATION* capability that can speed up your development time considerably and an RS-232 communications port that lets you integrate it with your IBM PC as a total firmware and Logic development station.

All from a company with an excellent reputation for quality and service.

A UNIVERSAL DEVICE PROGRAMMER

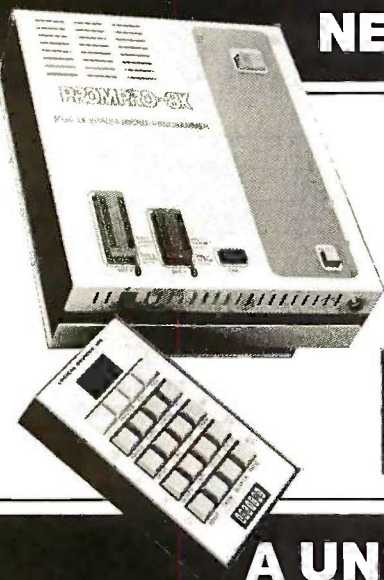

Pagetop is set to right above the buffers, where my program begins. Nothing is marked in the system bit map that shouldn't be. Any other ideas?

apple/language #417, from mdavis
a comment to message 416

Ah! Yes; you must ask for buffers for both the OPEN file's FCB (1K worth) and then you need a second buffer area for reading and writing your data. (You can pick the size that you need; I just used 256 bytes in my example.)

If you use GETBUFR to allocate a 1K FCB, you also should use it to allocate a data buffer as well. You can use areas for reading and writing like \$200 (the input buffer) since it's not reserved. You can usually get away with using BASIC's reserved 1K buffer space which it always maintains for its own use (like when it gets a CATALOG, or has to LOAD or SAVE a program, etc.).

Just keep playing with it, you'll get it. When you do, write a nice book for the those who are experiencing the same difficulties -- I'm just too darn busy!

ADA

Ada, the language mandated for most new programming by the Department of Defense, is coming under ever-closer scrutiny from microcomputer users. In the following excerpts from the Ada conference on BIX, various aspects of the language, from multiple definitions for operators to exception handling, are discussed.

PREDEFINED OPERATORS

ada/tips #1, from dshochat (David Shochat)

Here is a language point that I found kind of surprising. Maybe others will be surprised as well. Suppose you decide to define some types in a package:

```
package MY_TYPES is
  types FRUITS is (APPLE, GRAPE, PEAR);
```

```
....
end MY_TYPES;
```

Now you want to use type FRUITS someplace else, so you need a context clause:

```
with MY_TYPES;
```

Notice I didn't put in "use MY_TYPES;" Some people argue that for good maintainability, you "don't want to use 'use' all the time. This means that I need to prefix names defined in the package with the package name. So I declare:

```
FR1, FR2: MY_TYPES.FRUITS;
```

So far, so good. But now, in the executable part, I try to say:

```
if FR1 = FR2 then
```

....
The compiler should give a message saying something like:

"The "=" operator is not defined for the objects FR1 and FR2."

It turns out that the "=" operator is what the LRM (Language Reference Manual) calls "predefined" by the definition of the type FRUITS. So, if it is predefined, why can't I use it? The answer is that it is predefined AT THE POINT WHERE TYPE FRUITS WAS DEFINED. It's just as if you had put your OWN "=" operator definition right in there with the definition of type FRUITS. So the moral is, there are some times when you really do have to use a 'use' clause, since the syntax won't let you say:

```
if FR1 MY_TYPES.= FR2 then -- Syntax error!
```

Interestingly, you CAN do it if you use prefix notation:

```
if MY_TYPES."="(FR1, FR2) then -- Perfectly legal!
```

But I don't think anybody would really want to do it that way. Actually, this problem is probably most likely to come up with access types (pointer types), but it's important to realize that it isn't a problem that is specific to access types.

(continued)

LEADER IN DEVICE PROGRAMMING

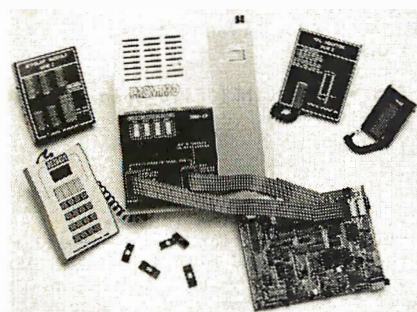

*some devices require optional adaptors.

FEATURES:

- Stand-Along/RS-232
- 512K bits RAM buffer
- EPROMs 2716-1 MEG
- Capacity: Two EPROMs (set programming)
- Accepts Intel, Mot. Hex files
- Accepts JEDEC files
- Optional Keypad/Alpha display
- Tilt stand and carrying handle
- Works with Exatron IC handler

also available: **UV ERASERS** and **GANG programmers.**

All products 100% made in U.S.A.

CALL 1-800-331-7766

Logical Devices Inc. 1321 NW 65th Place
Ft. Lauderdale, FL 33309

	TELEPHONE	TELEX
U.S.A.	(305) 974-0967	383142
Canada East	(514) 694-7710	05-823554
Canada West	(604) 291-8866	04-356533
England	0652-688626	527339
Italy, Ger., Swss	(02) 688-2141	845 79734
Australia	(03) 560-1011	790 35703
	(02) 736-1564	790 82635

WITH AN UNUSUAL PRICE TAG: \$895

ada/tips #2, from rbrukardt (Randall Brukaradt)

A similar problem to #1 here is that if you declare your own "&" operator, for instance (Function "&" (Left, Right : String) Return String;), it cannot be used infix outside of the declaring compilation unit.

If the above were to declare in a package specification, "A" & "B" used in the body would call the user-defined "&". But, if the same thing was written in some other package, the predefined "&" would be called, even if the declaring package was both WITHed & USED! This follows from the Ada visibility rules; direct visibility always has precedence over something named in a USE clause.

Since the predefined "&" is always directly visible (it is declared in Standard, the package that surrounds all compilation units), the user-defined one can never be used in an infix expression outside of its defining package. It also must always be selected (i.e., Pack_Name."&"("A","B")) when it is used.

Moral: There's always a surprise awaiting you when you use (or implement) Ada.

VARIABLE-LENGTH RECORDS

ada/other #26, from rguilmette (Ron Guilmette)

What I would like to know from the other Ada vendors is how else can you write standard conforming programs that deal with variable-length record files? This would seem to be the most reasonable and clear approach. One question: What does DEC VAX Ada do when a variant record type is used to instantiate DIRECT_IO? Will it allow you to do it? If not, why not? If so, how can it perform reliable seeks on such files?

ada/other #28, from rbrukardt
a comment to message 26

Programs using variable-length records in a file are by definition not completely "standard-conforming," simply because such I/O is not REQUIRED by the standard. You hit on the problems of implementing it; I only wonder how anyone can figure out a workable way to implement it. (The interaction between Ada Generics, Discriminants, and I/O is horrible.)

I personally would recommend using a package of your own design to do such I/O; then, if the system you are using supports the I/O directly, the package is easy to write. Otherwise, a version of the I/O supported by the implementation can be used without too much trouble. (Of course, if the implementation gives you NO way to do variable-length records, it ought to be junked!)

ada/other #31, from dshochat
a comment to message 26

It turns out that DEC will let you instantiate DIRECT_IO with an unconstrained record type, but it requires you to pass a "maximum record size" in bytes through the FORM parameter of the CREATE procedure. The FORM parameter is of type STRING and its meaning is totally implementation-dependent. Anyway, it works, but it turns out that what they do in this case is really use fixed-length records, with the fixed length being what you passed in the CREATE. This is essentially what some Pascals do (e.g., UCSD) when you make a file of a variant record type. A fixed record size is used, big enough for the worst case.

ada/other #32, from rguilmette
a comment to message 31

Thanks for checking that out. It seems like a very nearly reasonable implementation; however, don't you think that a truly intelligent implementation would

infer the maximum record length from the maximum length of the variant type used in the instantiation of DIRECT_IO? This is not a rhetorical question. I am interested in your thoughts.

ada/other #35, from dshochat
a comment to message 32

I agree with you in the case of a straight VARIANT record type. But consider something with a SIZE discriminant such as:

```
type VAR(SIZE : POSITIVE := 1) is
  record
    BUF : STRING(1..SIZE);
  end record;
```

If you tried to instantiate DIRECT_IO with that, the only thing the implementation could assume is that the maximum record size was POSITIVE*LAST (2**31 - 1 on the VAX) plus another 4 bytes for the discriminant. I've always thought it odd that a type definition like the one above doesn't have anyplace for you to commit to a maximum size. It must be hell to implement size discriminants.

EXCEPTION HANDLING

ada/general #82, from jdow (Joanne Dow)

How do you usually handle disk overflow deep in a program? The exception handling path allows you to recover gracefully (or as gracefully as possible) from that kind of error.
<^_^>

ada/general #84, from bhofkin (Bob Hofkin)
a comment to message 82

But you get kicked out of the code that faulted, with no simple way of restarting it. What would your exception handler look like for this disk overflow?

ada/general #85, from wheelock (Bruce Wheelock)
a comment to message 84

Disclaimer: I'm writing this from memory with my Ada manual elsewhere.

PROCEDURE FileOpener IS

```
  Flag : BOOLEAN := TRUE;
  FileName : ShortString -- A defined type of
                          length 30

BEGIN
  WHILE Flag LOOP
    BEGIN
      PUT_LINE("ENTER FILE NAME: ");
      GET_LINE(FileName);
      OPEN(MyFile,IN_FILE,FileName);
      Flag := FALSE;
    EXCEPTION
      WHEN OTHERS => PUT_LINE("File does not
        exist. Try again.");
    END;
  END LOOP;
END;
```

With this construct, an error in the imbedded BEGIN/END block will raise an exception. The exception handler will display the message and exit the BEGIN/END block, which takes the program to the END LOOP. The WHILE condition is still true, so the loop repeats, prompting for the file name and trying to open it. It will keep this up, in fact, until a legal file is entered. A more complicated exception handler would offer the option to exit the procedure instead of trying again.

Satisfied? ■

THE BUYER'S MART

A Directory of Products and Services

THE BUYER'S MART is a monthly advertising section which enables readers to easily locate suppliers by product category. As a unique feature, each BUYER'S MART ad includes a Reader Service number to assist interested readers in requesting information from participating advertisers.

RATES: 1x—\$475 3x—\$450 6x—\$425 12x—\$375
Prepayment must accompany each insertion. VISA/MC Accepted.

AD FORMAT: Each ad will be designed and typeset by BYTE. Advertisers must

furnish typewritten copy. Ads can include headline (23 characters maximum), descriptive text (250 characters maximum), plus company name, address and telephone number. Do not send logos or camera-ready artwork.

DEADLINE: Ad copy is due 2 months prior to issue date. For example: October issue closes on August 1. Send your copy and payment to THE BUYER'S MART, BYTE magazine, 70 Main Street, Peterborough, NH 03458. For more information call Karen Burgess at BYTE 603-924-3754.

ACCESSORIES

FREE CATALOG

Outstanding prices on computer accessories for your computer and workstation. Our catalog features a wide selection of quality products to meet all your accessory needs. Call or write today to receive your free catalog.

LINTEK COMPUTER ACCESSORIES
POB 8056, Grand Rapids, MI 49508
(616) 241-4040

Inquiry 718.

ACCESSORIES

Self-Inking Printer Ribbon

For users of Okidata and other open spool ribbon printers. Controlled Printout Devices are a new kind of printing ribbon that re-ink themselves, and will last 15 times longer than the ribbon you are now using. For further information please call or write.

CONTROLLED PRINTOUT DEVICES, INC.
POB 869, Baldwin Rd., Arden, NC 28704
(704) 684-9044

Inquiry 675.

ACCESSORIES

FABRIC DUST COVERS

Our 5th year protecting computers and peripherals with heavy poly/cotton covers.

BEST QUALITY — American made, custom work
BEST SELECTION — 6 colors, 1300 styles
BEST SERVICE — Fast, Toll Free, MC/Visa
BEST PRICES — \$8.95-\$36.95, Shipped Free
BEST VALUE — Monogram or Screening available

COVERS UNLIMITED

POB 381076 • Germantown, TN 38183-1076
800-821-7709 or 901-754-4465

Inquiry 676.

FREE CATALOG

Thousands of parts and new surplus electronic parts at super low prices. FAST ORDER PROCESSING AND SHIPPING (95% of all orders shipped within 48 hours).

CALL OR WRITE FOR A FREE CATALOG.

ALL ELECTRONICS CORPORATION
POB 20406, Los Angeles, CA 90006-0406
1-800-826-5432

Inquiry 655.

LOWEST PRICES ON DISKETTES

5¼" DSDD 39¢, High Density \$165.
3½" SSHD \$125, DSHD \$145.

- Lifetime warranty
- 100% error free
- Finest quality
- Add 3.00 shipping per 100. Minimum 100 diskettes. Send check or call. CA residents add 6½% sales tax. Same day shipping.
- Includes tyvek sleeves
- Reinforced hub ring
- Labels & write protect tabs

Data Bureau Inc.

1633 Westwood Blvd., Ste. 120, Los Angeles, CA 90024
213-479-0345

Inquiry 679.

COMPUTER PROTECTION PREVENTIVE MAINTENANCE KIT COMES COMPLETE WITH:

- CRT anti-static/glare cleaner
- Contact cleaner
- Air blaster for keyboards/printers & more
- 5¼" Disk head cleaner
- Non-abrasive cloths
- Simple How-To Booklet w/diagrams for: IBM'S, COMPATIBLES, TANDY, APPLES.

\$39.95 + \$4 S/H COD/M.O.
T & W COMPANY (213) 426-4595
226 Euclid Ave., #B, Long Beach, CA 90803

Inquiry 767.

SOFTWARE PACKAGING, DISKS

Cloth binders & slips like IBM's. Vinyl binders, boxes, and folders—many sizes. Disk pages, envelopes, & labels. Low qty. imprinting. Bulk & branded disks. Much More! Low prices. Fast service. Call or write for FREE CATALOG.

Anthropomorphic Systems Limited
376-B East St. Charles Road
Lombard, IL 60148
1-800-DEAL-NOW (312) 629-5160

Inquiry 657.

PRINTER RIBBONS

Guaranteed First Quality — Colors Available
Price each in quantity of

	3	6	12
C. Itoh Prowriter	\$6.85	\$5.95	\$5.00
Epson MX/FX/RX 70/80	7.55	6.55	5.50
IBM Proprietary Nylon	8.85	7.70	6.50
Okidata 182/192/193	9.90	8.60	7.25

Feel free to mix them up.

Printer Ribbon Supply

POB 920145 • Norcross, GA 30092
800-438-7745 In GA. 404-446-1547

Inquiry 742.

BAR CODE

PRINT BAR CODES ON PC

Print Bar Codes and Large Text Labels on PC with Epson/Okidata/IBM Printers - Code 39, 12of5, UPC, MSI, DOD-LOGMARS, AIAG. Text up to 1" tall. File input. Menu driven \$49-299. NEW! 8K Ram-Resident program prints bar codes from any user program or even word processor — \$179, (\$239 with large text).

Worthington Data Solutions

130 Crespi Court, Santa Cruz, CA 95060
(408) 458-9938

Inquiry 778.

COMPUTER PROTECTION

- UPS • LINE CONDITIONERS • ISOLATORS
- MODEM PROTECTORS
- AC POWER INTERRUPTERS

— HUNDREDS OF HINTS & PRODUCTS —
FREE CATALOG 1-800-225-4876

ELECTRONIC SPECIALISTS, INC.

171 So. Main St., POB 389, Natick, Mass 01760
1-800-225-4876

Inquiry 693.

COMPUTER SUPPLIES

- Printer Paper • Diskettes • Printer Labels • Anti-Glare Screens • Printer Ribbons • Storage & Accessories • Surge Protectors • Cleaning & Maintenance Products. Send for our Free Price List and Check our prices before you Buy. Call or Write

CALIFORNIA SUPPLY CENTER

POB 143, Dept. 7, Elk Grove, CA 95624
(916) 689-3037

Inquiry 670.

BAR CODE READERS

Program-transparent, Keyboard interface Bar Code Readers for IBM PC, AT and compatibles—\$485. Other wedge readers for IBM 3180, 3178, 3278, 5251, 5291, and RS-232 terminals. Portable Bar Code Readers from \$325. Programmable Hand-Held Portables—\$1200. Free PC print program with reader purchase. 30 day money-back guarantee on all products.

Worthington Data Solutions

130 Crespi Court, Santa Cruz, CA 95060
(408) 458-9938

Inquiry 778.

... SOFTWARE PUBLISHING. ...

GDS offers a wide variety of services that will help get your software to the market. Address your needs with GDS.

- IBM style cloth/vinyl 3-ring binders/slips
- Labels, sleeves, disk pages, bulk diskettes.
- Disk duplication with 100% verification.
- Shrink wrapping and product assembly.
- Quick turn-around.

A well packaged product can make the difference in making a sale. Call us now! VISA/MC.

GLENCO DEVELOPMENT SYSTEMS(312) 392-2492
3920 Ridge Ave., Arlington Hts., IL 60004

Inquiry 701.

Quality PC Accessories!

Our NEW Catalog includes every Accessory ANY PC USER might want! We have it All, from PC Stands to Monitor Pedestals, Travel Cases to Data Bank Watches, Switches/Cables to Chocolate Floppies, and even a PC Toolkit! Simply call or write for a complimentary copy of our latest catalog. Our products, service, and guarantees are simply the finest.

Tipz Direct, Inc. Simply Call 1-800-TO-ASK-US

P.O. Box 690, San Francisco, CA 94101-0690

1-800-862-7587 or 415-567-4067

Inquiry 771.

DATA INPUT DEVICES

Bar Code & Magnetic Stripe Readers for microcomputers & terminals, including IBM, DEC, AT&T, CT, Wyse, Wang. All readers connect on the keyboard cable & are transparent to all software. Low cost bar code print programs & magnetic encoders are also available.

TPS Electronics

4047 Transport, Palo Alto, CA 94303

415-856-6833 Telex 371-9097 TPS PLA

Inquiry 772.

THE BUYER'S MART

BUSINESS OPPORTUNITIES

VIDEO STORES

We need ambitious dealers in all U.S. states and Canada to market a powerful system to computerize video tape rental stores.

WINCHESTER DATA PRODUCTS INC.

3301-Executive Drive., #204, Raleigh, N.C. 27609

(919) 872-0995

Inquiry 777.

COMMUNICATIONS

VT102/52 TEK4014 VT220

Our terminal emulators turn your PC/AT/iy into a full featured terminal. Features include: local printing, ASCII & KERMIT file transfer, softkeys, DOS key, ANSI COLOR, 4014 graphics support. Guaranteed compatibility. Call today for free info packet.

General Micro Systems

P.O. Box 5330, Hopkins, MN 55343-1553

(612) 944-0593

Inquiry 700.

COMPUTER INSURANCE

COMPUTER OWNERS INSURANCE

Call toll free for coverages and premiums

- COMPUTERS OVERSEAS
- COMPUTERS YOU LEASE
- COMPUTERS YOU LEASE TO OTHERS

SAFWARE

The Insurance Agency Inc.

1-800-848-3469

IN OHIO (614) 262-0559

Inquiry 751.

DATA/DISK CONVERSION

TAPE AND DISK CONVERSIONS IBM MS-DOS CP/M

We provide prompt, accurate Tape-To-Disk, Disk-To-Disk, and Disk-To-Tape conversions. Most Disk-To-Disk conversions priced at \$14.00 your source disk. 1600 BPI Mag Tapes. EPROM Programming

Pick Up and Delivery

CREATIVE DATA SERVICES

1210 W. Latimer Ave., Campbell, CA 95008

(408) 866-6080

Inquiry 577.

CONVERT CP/M <-> MS-DOS

Read, write and format CP/M diskettes on an IBM PC or compatible. Over 115 CP/M formats on the menu and you can add your own. Use Convert to copy text and data files (such as WordStar and dBase II) between CP/M and MS-DOS. Or use it to manufacture CP/M diskettes.

Only \$69 from Selfware, Inc.

3545 Chain Bridge Rd., Suite 3

Fairfax, VA 22030

703-352-2977

Inquiry 756.

CONVERSION SERVICES

Convert any 9 track magnetic tape to or from over 700 formats including 3 1/2", 5 1/4", 8" disk formats & word processors. Disk to disk conversions also available. Call for more info. Introducing OCR Scanning Services.

Pivar Computing Services, Inc.

165 Arlington Hgts. Rd., Dept. #B
Buffalo Grove, IL 60089 (312) 459-6010

Inquiry 738.

DATA/DISK CONVERSION

DISK AND TAPE CONVERSIONS

High quality conversion services for Dedicated Word Processors, Mini and Microcomputers. Over 600 3 1/2", 5 1/4", and 8" formats. Also 800-1600BPI tape. Included: Wang, NBI, CPT, DEC, Vydex, Lanier, OS/6, Xerox, IBM Sys/34/36/38/5520, Mac, Victor, TRS, Apple, NSTAR, IBM PC/AT, HP, and most of the other microcomputers. We can convert directly into word processing software such as: DW3, WP, MS/WORD, WS, Samna, MM, PFS, and many others.

DATA FORMATS, INC. (408) 972-1830

Inquiry 681.

CONVERT TAPE TO DISK

We will transfer data from any 1/2" 9-track magnetic tape recorded at 1600 or 3200 bpi to 5 1/4" IBM PC floppies. Diskettes included. Quantity and repeat customer discounts. Fast turnaround. Disk to tape transfers also available. *Competitive Rates!*

Micro Data Services

5 Town and Country Village, Suite 774 • San Jose, CA 95128

(408) 980-7203

Inquiry 722.

AMERICA'S MOST ADVANCED DATA CONVERSION FACILITY:

1,000
formats.
Tape, disk,
mailing
lists, wp, opt.
scanning
& custom
reformatting.

Data Conversion Laboratory

(718) 939-4921

Inquiry 680.

Disk/Disk • Tape/Disk

Over 600 formats! 3 1/2, 5 1/4, or 8 inch disks; 9 track mag tape; 10 MB Bernoulli cartridge. Data base and word processor translation specialists.

Computer Conversions, Inc.

9580 Black Mountain Rd., Ste J

San Diego, CA 92126

(619) 693-1697

Inquiry 673.

DUPLICATING SERVICES

DISKETTE COPYING:

3 day turn around, security, quality, most popular formats.

MAG RABBIT/MICHIGAN

616-685-6186

Inquiry 719.

DUPLICATION SOLUTIONS

MEGASOFT has the answer to your Diskette Duplication needs no matter what the volume. We provide *DUPLICATION *COPY PROTECTION *TECHNICAL SUPPORT *PACKAGE ASSEMBLY & DISTRIBUTIVE SHIPPING. We supply *AUTOLOADERS *BULK DISKETTES. We guarantee *QUALITY *100% SATISFACTION *FAST TURN AROUND.

MegaSoft

P.O. Box 710, Freehold, NJ 07728

1-800-222-0490 201-462-7628 (in NJ)

DUPLICATING SERVICES

WESTERN TRANSDATA, INC.

Why risk duplicating your important programs on your computer. when our equipment is designed solely to duplicate disks & verify their perfection 100%? Over 600 formats. 3 1/2", 5 1/4", & 8". Plus serialization, copy protection, labeling, packaging, shrink-wrapping and fast, personalized service.

WESTERN TRANSDATA, INC.

1701 E. Edinger Ave. A-4

Santa Ana, CA 92705

714/547-3383 (collect)

Inquiry 776.

BLANKET SERVICES

Diskette duplication • Packaging • Stocking/Drop shipping • 48 hour delivery • SUPERLOK copy protection • No mastering fee • No charge for standard labels • Place a blanket order with releases as you need them for any quantity at a fixed price.

Star-Byte, Inc.

2564 Industry Lane, Norristown, PA 19403

215-539-4300

800-243-1515

Inquiry 764.

ENTERTAINMENT

Twelve Metre Challenge

Sailing simulation for one or two computers; develops creative, political, financial, investigative and technical skills. IBM PC XT AT and compatibles. DOS 2.1+ /384K/CGA/2FL or 1FL+HD. \$50. \$90 for two (req. for com). Add \$5 S/H. MA add 5%. VISA/MC

Greylock Software, Inc.

P.O. Box 730, Gt Barrington, MA 01230

413-528-5555

Inquiry 704.

FLOW CHARTS

FLOW CHARTING II HELPS YOU!

Precise flowcharting is fast and simple with Flow Charting II. Draw, edit and print perfect charts: bold and normal fonts, 24 shapes — 95 sizes; fast entry of arrows, bypasses & connectors. Fast Insert Line, shrink screen displays 200 column chart; 40 column edit screen for detail work, much more!

PATTON & PATTON

340 Lassenpark Circle, San Jose, CA 95136

1-800/672-3470, ext. 897 (CA residents)

1-800/538-8157, ext. 897 (Outside CA)

408/629-5044 (Outside the U.S.A.)

Inquiry 737.

HARDWARE

68020 COMPUTERS

Up to 14.5 Mbyte RAM, 258K ROM, 30 users, DMA floppy and SASI (SCSI), calendar/clock w/bat. backup, timer, real time multi-tasking, multi-user op. sys., basic assembler, screen editors, spreadsheet. Fits PC type cabinet. Mem. Prot. option, more.

From \$2195.00.

Other 68XXX computer systems from \$995.00.

AAA Chicago Computer Center

120 Chestnut Lane - Wheeling, IL 60090

(312) 459-0450

Inquiry 651.

M68000-SBC

Expandable single board computer with on board 10 MHz 68000, 20K SRAM, 32K PROM, two RS-232 serial ports, 16-bit parallel port, 5 counter/timers. Expansion for additional memory/Floppy Disk Controller board. Custom designs available. Price starts at \$89.95.

Educational Microcomputer Systems

P.O. Box 16115, Irvine, CA 92713

(714) 854-8545

Inquiry 692.

HARDWARE

POWERLINE GREMLINS?? POWER FAILURES??

The MEIRICK STANDBY POWER SYSTEM is the TOTAL SOLUTION to your powerline problems.
400 watt system - \$449;
800 watt system - \$795

MEIRICK Inc., POWER SYSTEMS DIV.

Box 298, Frisco, CO 80443 303-668-3251

HARDWARE

EPROM/EEPROM PROG. \$250

Programs 2716-27512, 25xx and 68764/66 eproms via RS-232. Also 874x micros and 28xxA & 52Bxx EEPROMs. Automatic baud rate select, built in help menus, no personality modules!

16 BIT I/O MODULE \$75

Low cost control via RS-232. Expands to 512!

INTELLITRONICS

P.O. Box 3263, Tustin, CA 92680

(714) 669-0614

Inquiry 710.

HARDWARE ADD-ONS

PC I/O BOARDS

- Four Port RS-232 w/software \$349.00
- RS-422/485 Serial \$149.00
- RS-232/422 with 24 Parallel I/O \$199.00
- RS-422 Synchronous \$299.00
- EPROM/RAM \$199.00
- A/D & Digital I/O \$299.00

Call About Custom Designed Boards

Sealevel Systems Inc.

P.O. Box 1808, Easley, SC 29641

(803) 855-1581

Inquiry 755.

HARDWARE/BLDG. CONTROL

POWERLINE MODEM

CASH REGISTERS, ELECTRONIC SIGNS, PC'S communicate over POWERLINE

RS232C, GE/EIA Consumer Electronic Bus Protocol, Hayes Compatible, 64,000 units on network, Data Compression, 1000 baud (CEBus spec), 40 CEBus commands, User Programmable Client Layer \$395.

AISI RESEARCH CORPORATION

Discovery Park, University of Victoria 3771A Haro Rd.
Victoria BC CANADA V8W 2Y2

(604) 477-1415

Inquiry 654.

HARDWARE GRAPHICS

HOUSTON INSTRUMENTS PLOTTERS

DMP 40/41&42 (1 Pen, A/B/C-D-size) \$966/\$2577
DMP-51/52/IMP (C, D-size 1/4-Pen) \$3881/\$5031

DIGITIZERS

Summagraphics MM1201 complete \$434
GITCO MD7-1212 complete \$602
Hitachi HDG-1111B Tiger II w/stylus \$735
Houston TG-1011 w/pwper & stylus \$670
Orchid TurboEGA & NEC Multisync \$1220
Artist 1 & Mitsubishi 19" monitor \$3113

L, large corp. & institutional PC's accepted O.A.C.
ARDEN SYSTEMS, INC. (213) 479-6707 ext.29
12335 Santa Monica Bl #240, Los Angeles, CA 90025

Inquiry 659.

LOAD CELL INTERFACE

Connects weigh scales to any computer via serial RS232, 423 or 422, several units individually addressable from single computer port. Directly programmable in Basic - Demo program included. High accuracy 40,000 count. Options include NEMA-4, shunt cal, 4 load cell summing. Price \$599.

SCALE-TRON INC.

P.O. Box 424, Lachine, Quebec, H8S 4C2

(514) 634-7032

Inquiry 753.

PC WHOLESALE CENTER F.C.C. APPROVED BASIC KIT

- * 640K Mother Board (OK) \$94.00
- * 5150 Keyboard \$46.00
- * 150W Po er Supply \$56.00
- * Case \$34.00

ALL FOR \$230.00, CALL FOR OTHER ADD-ON CARD.
* TTL Monitor \$80.00 * MGP \$60.00

SANFORD INC.

10413 Rockley Rd., Houston, TX 77099

(713) 879-0068

Inquiry 752.

USED APPLES & IBM's

Commodore C-128 — \$225.00

Laser 128 (new), Apple II+ and IIE — call

PC-XT Clone — \$475.00

Motherboards & accessories — call

We buy, sell, & horsetrade — Apple, IBM, & CBM.

SHREVE SYSTEMS

845 Lark Ave., Shreveport, LA 71105

318-865-6743 4-9 p.m. C.S.T. VISA/MC

Inquiry 758.

XT/AT COMPATIBLE HARDWARE

- AT1-1000 AT 8MHz M/B w/640KB \$629.
- AT1-1000-10 AT 10MHz M/B w 1MB* 849.
- ACS-1000 XT Turbo M/B* w/512KB/8MHz 395.
- clock calendar 2 serial, 1 parallel port
- MITSUBISHI CGA MONITOR 279.
- MITSUBISHI EGA MONITOR 399.
- MAXI SWITCH XT/AT Keyboard 69.
- TEAC 360K Floppy Drive 92.
- ZUCKER Mono/Graphic Card 86.

*American Made M/B

PC HOUSE

3706 Realty Rd., Suite 200, Dallas, TX 75244 (214) 241-5814

Inquiry 652.

THE ORIGINAL TEK 4010/4014/4027 GRAPHICS UPGRADE

for your ADM 3A/5, TVI 912, 925, 950, RG 512 or RG 1000. **\$299 - \$399** with full print schematics. A true bargain. All new.

RetroGraphics, Inc.

65 Commerce Road • Stamford, CT 06902

203-327-5000

Inquiry 780.

CHIP CHECKER

- 54/74 TTL & CMOS
 - 14-24 Pin Chips
 - 14/4000 CMOS
 - Two 24 Pin ZIF sockets
 - 9000 TTL
 - 3" and 6" IC widths
- Tests/Identifies chips with ANY type of output in seconds. Inexpensive software updates will be offered as new chips become available. For C128 and C64. **\$129 plus \$3.50 s+h.**

DUNE SYSTEMS

2603 Willa Dr., St. Joseph, MI 49085

(616) 983-2352

Inquiry 687.

APPLE COMPATIBLE PRODUCTS

IIE RAM/80 Column Boards, 64K \$39. 256K \$109. 512K \$139. 1.0MEG \$238. 256K-1.0MEG includes XME PLUSWORKS Sfrw. II+ 80 Col Bd \$49. IIE Keypad w/16 Keys \$39. II+e Cooling Fan w/surge protect \$29.95. Add \$3 Shipping. Write for complete list.

NEXO DISTRIBUTION

914 East 8th St., Ste. 109, National City, CA 92050

(619) 474-3328

Inquiry 732.

INFORMATION SERVICES

Turbo Pascal™ Software \$6
Join TURBO S.I.X. and gain access to programming utilities, communications, graphics, games, home/business applications and more. Over 35 disks available and growing. **\$19.95** for a lifetime membership (First TWO disks FREE) or **\$2.95** for current catalog.

TURBO S.I.X.

P.O. Box 8373, Dept B2, Waco, Texas 76714
3101 Mitchell, Waco, TX **(817) 753-2182**

Inquiry 774.

MEGABYTES OF MEMORY

Lowest Prices Guaranteed in US. Dealer Inq. Invited
Fully Populated 2MB Memory Boards

TALLTREE SYSTEMS — JRAM BOARDS

JRAM 2	\$134	OPEN 7
JRAM 3 Aboveboard	183	DAYS A WEEK
JRAM AT	183	MF 9-8
JRAM AT Aboveboard	239	S-S 9-6
JDISKETTE	135	VISA, MC, AE, CHOICE
JLASER I	275	703-847-4740
JMODULES	CALL	800-642-2395

Information and Technology Services, Inc.

HYPERION USERS

External expansion module for two 20M hard disks, and/or two IBM PC compatible serial ports. You may directly connect your own hard disks. Supports HyperRam or HyperRam Plus. From **\$145.00** depending on options.

Technovation Research

63 Widdecombe Hill Blvd. Ste. 1103

Weston, Ontario M9R 4B2

(416) 245-1656

Inquiry 770.

MAILING LISTS

Professional List Management

ArcList — mainframe mailing list management for the PC/XT/AT. Capacity 20 million names, automatic zip and state verification, print any label, custom charts and reports, merge-purge with excellent near-dupe recognition, match codes, postal presorting, Nth sampling, much more. **\$595**. Demo disk available. Take control of your list. Call for free brochure.

Arc Tangent, Inc.

923 Olive St., POB 2009, Santa Barbara, CA 93120
800-843-5928 (in CA. 805-965-7277)

Inquiry 658.

PROGRAM GENERATORS

WINDOW.LIB \$99.

An easy to use complete windowing system for programmers and writing in . . .

- BASIC IBM, M-S, CB86 . . . • C LATTICE, M-S . . .
- COBOL M-S, RMF . . . • PASCAL M-S, TURBO . . .
- FORTRAN M-S, RMF . . . dBase Clipper

Window editor included. Create callable pop-up menus, help screens. The line selector features auto reverse highlighting and cursor control. No royalties. Ask about our BIOS/DOS, LIB, VISA/MC.

GLENCO ENGINEERING (312) 392-2492
3920 Ridge Ave., Arlington Hts., IL 60004

Inquiry 702.

PUBLIC DOMAIN

THE BEST OF THE BEST!

Public Domain & User Supported Software for IBM PC or compatible. Word Processing, Database, Spreadsheets, Utilities, Games, Accounting, etc. 50 disk package \$205.00, or rent 2 wks. \$75.00. Info & Super Sampler Disk \$6.50, Deluxe Word Processor \$6.50, both \$12.00. MC/VISA

BLUE CIRCLE GROUP, INC.

Box 23502, Minneapolis, MN 55423

(612) 823-4111

Inquiry 662.

IBM, CP/M, MAC SOFTWARE

Over 2500 disks covering IBM/PCDOS/MSDOS, CP/M and Macintosh. All major public domain user groups represented. Priced from \$6 (US) disk (even lower in quantity). Fast service, shipped around the world. Call or circle inquiry #671 for our FREE 32 page minicatalog of highlights.

CANADA REMOTE SYSTEMS LIMITED
(1-800-387-1901) (1-416-231-2383)

Inquiry 671.

SOFTWARE FOR PENNIES

GET BEST AND LATEST PC-DOS, CP/M-80 AND CP/M-86 PUBLIC DOMAIN PROGRAMS FOR BUSINESS, PERSONAL, EDUCATION, SOFTWARE DEVELOPMENT, MODEMING, SCIENCE, AND MORE. AT LOW COST OF COPYING. 3-1/2, 5-1/4 AND 8" DISK FORMATS ARE SUPPORTED. SEND \$5.00 FOR CATALOG.

MULTIPATH, INC.

Box 395, Montville, NJ 07045

(201) 575-5880

Inquiry 730.

SOFTWARE ACCOUNTING

1986 TAX PREPARATION

Fast, easy to use package prepares and prints 1986 Federal Income tax returns using form 1040. Fully interactive, menu driven. Follows IRS forms. Supports 28 forms plus multiples. Fully integrated. MS/PC-DOS: 86 Prof. \$349; Pers. \$59; 85 Prof. \$30.

Dunphy Systems, Inc.

P.O. Box 326, Worthington, OH 43085-0326

614-431-0846

Inquiry 688.

TIME & BILLING

400 clients/20 partners/80 job & 40 out of pocket categories/20 areas of practice/fixed fee or hourly/more! Prints billing/statements/aged rec's/more! Free phone support. \$149 (VISA/MC/AMEX). MS-DOS/CPM-80. Other original software.

FREE catalogue.

MICRO-ART PROGRAMMERS

614 Alameda Padre Serra, Santa Barbara, CA 93103

(805) 962-0922 (24 hours)

Inquiry 721.

SOFTWARE ACCOUNTING

CUSTOM PAYROLL

All systems have multiple pay categories, calculation of all taxes, user defined deductions, 401(k) handling, many reports, paychecks, W-2 forms, and much more. Custom features are available. Prices start at \$695 for system, manual, and PC Basic source code.

Datasmith, Inc.

Box 8036, Shawnee Mission, KS 66208

(913) 381-9118

Inquiry 683.

dBASE BUSINESS TOOLS

- * General Ledger
- * Accounts Recvbl.
- * Order Entry
- * Sales Analysis
- * Purch Ord/Inventory
- * Accounts Payable
- * Job Costing
- * Job Estimating

\$99 EA. + s&h w/dBASE 2, 3 or 3+ SOURCE CODE

dATAMAR SYSTEMS Cred. Card-Check-COD

6809-B Conroy Court, San Diego, CA 92111

800-223-9963/CA 800-221-9964/(619) 278-8222

Inquiry 682.

SOFTWARE A.I.

OPSS+ for PC's & Mac's

OPSS+ by Computer*Thought is a quality implementation of OPSS for IBM PC, XT, AT's & compatibles and the Apple Macintosh Mouse controlled, menu driven development environment \$1,750 single qty. (Substantial educational, VAR & corporate discounts). Mention BYTE & get a free mouse or \$100 off until 12/31/86.

**** Distributed by JCL Systems ****
2508 Teakwood Ln. #100, Plano, TX 75075
(214) 867-0962 VISA, MC, MO & Checks accepted

Inquiry 713.

SOFTWARE/BUSINESS

FINANCIAL CALCULATOR

Memory resident calculator performs compound interest, NPV, IRR, bonds, depreciation. Prints financial schedules. Allows importing/exporting of data. Includes all HP-12C functions plus more. \$69.95 plus \$3 s/h.

K SOFTWARE HOUSE, INC.

Rt. 2 Box 83B1 Unionville, TN 37180

(615) 294-5090

Inquiry 715.

MILP88-MIXED INTEGER LP

A general-purpose system for solving mixed integer linear programs with up to 65 integers. 255 constraints 1255 variables. Solves problems by applying the branch and bound method. Menu-driven with many useful features similar to LP88. Req. IBM PC, 192K, \$99 with 8087 support, user's guide. VISA/MC.

EASTERN SOFTWARE PRODUCTS, INC.

POB 15328, Alexandria, VA 22309

(703) 549-5469

Inquiry 691.

PC-Write™ Shareware

Fast, powerful word processor/text editor for IBM PC. Mailmerge, split screen, ASCII files, macros. Supports proportional printing, laserJet, 300+ printers. \$10 for all software, tutorial/guide on diskette. OK to copy. Register for manual/support, \$75. Full 90-day guarantee. Version 2.7 with spell check soon: diskette pair, \$16; register, \$89.

Quicksoft (206) 282-0452 Visa/MC

219 First N. #224J, Seattle, WA 98109

Inquiry 748.

SOFTWARE/BUSINESS

PC-CHECKBOOK

Total checking at your fingertips! Quick & easy to use. Version 3.0 include: Auto Filing, 1000 Entries/Checkbook, File protection, Check Editing, Sorting by Date & Check No., Analysis Report, Screen Print, Sequential & by Category, POP-UP Prompters & Full Screen Help Menus. May be used as a Budget Manager. \$39.95 chk/MC/VISA.

DEB/SOFT APPLICATIONS

P.O. Box 35398, Houston, TX 77235

(713) 729-2362

Inquiry 684.

SAVE LEGAL FEES

157 time tested legal forms on disk, complete with menu driven system and editing and printing capability. Free copy of PC-Write word processor included. Forms written by a noted attorney and applicable nation-wide. \$129.95 plus \$7.50 shipping and handling.

LegalEase™ HDG Software, Inc.

54 Whitney St., Sherborn, MA 01770

617-651-1881

800-628-2828 x 706 for credit card orders

Inquiry 705.

dFELLER Inventory

Business Inventory programs written in modifiable dBASE source code.

dFELLER Inventory \$150.00

Requires dBASE II or III, PC-DOS/CPM

dFELLER Plus \$200.00

with History and Purchase Orders

Requires dBASE III or dBASE III Plus (For Stockrooms)

Feller Associates

550 CR PPA, Route 3, Ishpeming, MI 49849

(906) 486-6024

Inquiry 697.

DATA ENTRY SYSTEM

Heads-down data entry with two-pass verification for the PC/XT/AT & compatibles. Loaded with features like: Auto dup & skip, verify bypass, range checks, & table lookups. Fully menu driven only \$395. Call for free 30 day trial period.

COMPUTER KEYS

21929 Makah Rd., Woodway, WA 98020

(206) 776-6443

Inquiry 730.

PC-File III™ Version 4

Search, sort, browse, global changes, macros, mailing labels, format reports with selection & calculations. sub-totals, totals, averages, encryption. Exchange data with 1-2-3, WORD, WordStar. Over 190,000 users. \$59.95 + \$5 s/h. For IBM PC.

ButtonWare, Inc.

P.O. Box 5786, Bellevue, WA 98006

1-800-J-BUTTON

Inquiry 668.

PC-File/R™

All the power of PC-File III plus: Relational link to other databases, integrated letter writing & mailmerge, context sensitive pop-up help windows. New binary search retrieves data hundreds of times faster. \$149.95 + \$5 s/h.

ButtonWare, Inc.

P.O. Box 5786, Bellevue, WA 98006

1-800-J-BUTTON

Inquiry 667.

THE BUYER'S MART

SOFTWARE/CHURCH

RECORD OF CONTRIBUTIONS

An in depth system to account for contributions to the church - and more. Easy to enter/update/retrieve data. Prepares Reports/Statements on demand. For the IBM PC/XT or AT or compatibles. Excellent Documentation. **\$99.00 + \$5.00 S&H.**

MICRO-DYNAMICS OF TEXAS

P.O. Box 40691, Houston, TX 77240

(713) 896-9957

Inquiry 723.

SOFTWARE/GENERAL

SongWright III

Music Processor for IBM Compatibles

Prints quality lead sheets, songs, scores with text and symbols, multiple staves; transposes to any key; plays tunes. Screen graphics editor; IBM/Epson/Star printers. Send **\$49.95** or write for free sample output.

SongWright Software

Box 61107, Cherry Creek, CO 80206

(303) 691-4573

Inquiry 761.

SOFTWARE/GRAPHICS

PC TECHNICAL GRAPHICS

TEKMAR is a graphics library for the Tecmar Graphics Master. Similar to PLOT-10, includes WINDOW, VIEWPORT, AXIS. Support for HP, Hi plotters. Curve fitting, complete plotting program. Log, semi-log, multi-axis, 3-D, contours. Jerry Pournelle (Aug 86 Byte): "As good as any I have ever seen..." Demo disks, literature available.

Advanced Systems Consultants

21115 Devonshire St. #329, Chatsworth, CA 91311

(818) 407-1059

Inquiry 653.

ROMAR CHURCH SYSTEMS™

Membership 61 fields plus alternate address; labels, letters, reports any field(s). Offering-256 funds; optional pledge; statements; post to 255 x/year. Finance-G/L with budget; up to 500 sub-totals & 99 depts: month & YTD reports any time for any month. Size 2000 people/floppy, 25000 10 meg. Ad too short! Write!

Romar Church Systems, Attn: BMB

P.O. Box 4211, Elkhart, IN 46514

(219) 262-2188

Inquiry 750.

NEW Turbo Pascal™ Programs

Outstanding software. Full source code included! KEYMASTER, DESKMASTER: Pop Up desk organizers. Editor, macros, alarms, addr book/dialer, calculator, more! **\$49.95 + \$2 s&h** each. IBM PC & Comp. DICTIONARY TOOLBOX: Library to produce/manage bit compressed dict. **\$39.95.** Any MS-DOS Comp. CHESTER: Full featured Chinese checkers game using heuristic search. **\$22.00** IBM-PC & Comp. Visa/MC

A. I. SOFTWARE 512-928-2009

2200 Rogge Ln., Austin, TX 78723

Inquiry 650.

THE DGI TYPESHOP

will make text signs and overheads. It comes with 2 fonts and the many plot options will give your presentations that professional look. It offers a quick, economical alternative to typesetting—PLOTSETTING. Eleven optional fonts are available now. For the APPLE II or IBM computer and Hewlett-Packard or compatible plotters. **\$175.**

DECISION GRAPHICS, INC.

P.O. Box 2776-B, Littleton, Colorado 80161

(303) 796-0341

Inquiry 685.

Church Package

Parishioner Time, Talent and Treasure System program is written in modifiable dBASE source code.

- Contributions • Disbursements • Ledger
- Names with mailing labels
- Personal information database.

Requires dBASE II or III. PC-DOS/CPM-80 \$200.

Feller Associates

550 CR PPA, Route 3, Ishpeming, MI 49849

(906) 486-6024

Inquiry 698.

Princeton SuperType™

Turn your IBM PC compatible and printer into a powerful typewriter. Supports up to ten attributes such as bold, condensed, etc. Preconfigured for most popular printers or user installable. Operates in MEMORY RESIDENT or NORMAL modes. Tabs, margins, editing and more. Only **\$39.95.** Visa, MC

PRINCETON ECONOMICS, INC.

80 Main St. P.O. Box 456, Princeton, MA 01517

(617) 464-5474

Inquiry 741.

FORTRAN PROGRAMMER?

Now you can call 2-D and 3-D graphics routines within your FORTRAN program.

GRAFATIC: 75 callable routines for screen output. **\$135.**

PLOTMATIC: Pen plotter driver. **\$135.**

For the IBM PC, XT, AT and compatibles. We support a variety of compilers, graphics boards and plotters.

MICROCOMPATIBLES

301 Prelude Drive, Dept. B

Silver Spring, MD 20901

(301) 593-0683

Inquiry 727.

SOFTWARE/GENERAL

NEW INTEGRATED ENVIRONMENT AI FOR THE IBM PC

TOPSIS IS A FULL VERSION OF OPS5 WHICH RUNS UNDER MS-DOS, UNIX OR CP/M. A FAST, EFFICIENT EXPERT SYSTEM DEVELOPMENT TOOL.

PROTOTYPING: **\$125** PRODUCTION: **\$250**

PROFESSIONAL: **\$375** SHIPPING, ADD \$5

DYNAMIC MASTER SYSTEMS

POB 566456, Atlanta, GA 30356

(404) 565-0771 Telex #282923

Inquiry 689.

ESPAÑOL???

FREE!! If you have programs in SPANISH to sell, list them in the upcoming.

GUIA INTERNACIONAL DE
MICROSOFTWARE EN ESPAÑOL

to be distributed in 21 countries.

Send name of program, description (150 words max.), hardware reqs., price and address to:

MICROMUNDO INTERNATIONAL

249 Brand Blvd, Suite 387, Glendale, CA 91209

* We also translate software into Spanish

Inquiry 728.

MAPIT

Make your own MAPS!!

Simple to produce maps with your data. Includes most country and state outlines.

Any printer or HP plotter.

Only **\$95** for MS-DOS or PC-DOS

US County Outlines available for **\$95.**

QSC Box 778, East Lansing, MI 48823

(517) 641-4428

Inquiry 747.

—SOFTWARE ORGANIZER—

CYBER__CAT will catalog all those disks for You. —FAST and EASY to use! —MENU SCREEN driven! —Catalogs Floppy and Hard disk Ro t & Sub-dir. —Prints neat attractive Diskette Labels. —Finds any file in seconds. MS-DOS 2.0 2 DRV. **\$24.95 + 5%** tax in Florida. Visa/MC or Check.

CYBER__WARE Corp.

4411 Bee Ridge Rd, Suite S251, Sarasota, FL 33583

1-800-237-8400 x86 In FL 1-800-282-1469 x86

Inquiry 678.

US\$6 . . . INCLUDING DISK

Over 2,900+ software titles for IBM-PC, Apple II, Macintosh, Latest titles. Lots of hi-quality manuals. VOLUME DISCOUNTS.

- IBM-PC Light Pen c/w software: **\$65**
- 640K motherboard c/w full RAM: **\$200**
- PC mouse compatible: **\$65**

Lots of bargains, ram chips, etc. . . . Specify your computer type with \$1 note for our air-mailed catalog to:-

MICRO-WORLD, Dept BYTE

Towner POB 310, Singapore 9132

REPUBLIC OF SINGAPORE

Inquiry 729.

TI PRO + TURBO + GRAPHICS

UNLEASH YOUR TI PRO WITH TURBO 2.0 or 3.0 + TIGrafix GRAPHICS. TURTLEGRAPHICS, MUSIC, SCREEN & CURSOR CONTROLS & more routines than IBM TURBO. Use BASIC PICs w/o reprog. Convert IBM code to TI PRO. Source & doc included. TIGrafix **\$99.95**, + TURBO **\$149.95**, + TURBO 8087 **\$179.95.** SWITCH TO TURBO NOW!!!

ProWare, Inc.

1023 SE 36th Ave., Portland, OR 97214

VISA/MC/CHECK 7AM-7PM MON-FRI

(503) 233-4465

Inquiry 743.

SOFTWARE/GRAPHICS

GRAPHICS PRINTER SUPPORT

AT LAST! Use the PrtSc key to make quality scaled B&W or color reproductions of your display on any dot matrix, inkjet, or laser printer. GRAFPLUS supports all versions of PC or MS-DOS with IBM, Tecmar, and Hercules graphics boards. **\$59.95.**

Jewell Technologies, Inc.

4302 SW Alaska St., Suite 207, Seattle, WA 98116

(206) 937-1081

Inquiry 714.

MicroGANTT®

Control your project! You describe the work, MicroGANTT calculates the schedule and budget. Optimize the schedule interactively. Customize the reports. Sub-tasking, fixed and variable costs, multi-project resource allocation, unlimited size and scope GANTT, PERT, DOD-7000. Call or write for free catalog.

Earth Data Corporation

P.O. Box 13168, Richmond, VA 23225

(804) 231-0300

Inquiry 690.

3D INTERACTIVE GRAPHICS

Imagine 2D and 3D graphics in real time at **\$24.95.** Keyboard support, construct images, create sound. Required IBM PC/XT/AT/Compatibles, DOS 2.X, 3.X. CGA Support 8087/80287. MS or IBM Fortran, Basic, Pascal. Demo \$5 apply toward purchase. Please add **\$3 S/H.** In TX add 6.125% VISA/MC/CHECK/MO

Filtrex Research, Inc.

P.O. Box 820425, Houston, Texas 77282-0425

(713) 556-5747

Inquiry 699.

THE BUYER'S MART

SOFTWARE/GRAPHICS

SCIENTIFIC GRAPHS

SCI-GRAF produces high-res graphs (1680 x 1712 pixels) on Epson or IBM graphics printers. Supports log/linear scales, error bars, overlays, batch-mode operation. Very flexible data entry from disk or keyboard. User customizable. Requires DOS 2 or 3, 256K.

\$99.95 (Sorry, no credit cards)

Microcomputer Systems Consultants

32 West Anapamu, Suite 190, Santa Barbara, CA 93101

(805) 963-3412

Inquiry 725.

PUBLIC DOMAIN

→ PUBLIC DOMAIN SOFTWARE ←

50 AMIGA DISKETTES — \$8.50 each. 25 ATARI-ST DISKETTES — \$8.50 each. 490 IBM DISKETTES — \$4.25 each. 60 SANYO 550/555 DISKETTES — \$4.25 each. SAMPLE DISKETTE & CATALOG: AMIGA or ATARI-ST \$8 ppd. IBM or SANYO \$5 ppd. All prices include FREE SHIPPING! Visa/MC - No Extra Charge! 48 hr. Turnaround! Phone Orders Welcome! Quality Media Used!

Computer Solutions

P.O. Box 354 - Dept. B, Mason, Michigan 48854
1-800-874-9375 (M-F 10-5 EST) 1-517-628-2943

Inquiry 674.

SOFTWARE A.I.

EXPERT SYSTEM LANGUAGE

If you can use a spreadsheet, you can use KNOWOL, the Knowledge Oriented Language, to guide people in solving problems.

KNOWOL+ (Complete) \$99.95
KNOWOL (Introductory) \$39.95

Intelligent Machine Company

1907 Red Oak Circle, New Port Richey, FL 33553

(813) 844-3262

Inquiry 709.

SOFTWARE/LANGUAGES

Minnesota SNOBOL4 Language

Powerful string & data handling facilities. Interpreter compatible with mainframe SNOBOL4. 32K strings, 32 bit integers, 8087 for float & large memory model. Sample pgms include ELIZA. For >128K IBM PC & DOS or equivalent. Definitive "green" book by Griswold et al available.

Guide + 5 1/4" SSDD diskette \$44.95
Guide + diskette + "green" book \$59.95
"Green" book only \$26.95

Postpaid in USA. In NY add tax. VISA/MC (914) 271-5855

BERSTIS INTERNATIONAL
POB 441, Millwood, NY 10546

Inquiry 661.

Symbolic Profiler for Turbo Pascal

Find out where your Turbo Pascal program is spending all its time. Only \$49 plus S&H: \$3 US/Canada, \$7 Europe.

KYDOR COMPUTER SYSTEMS

1701 Greenville Avenue, Suite 505
Richardson, Texas 75081

(214) 669-1888

Inquiry 716.

HYPER C COMPILERS/TOOLS

Apple II ProDOS Professional compiler, CDOS compiler, ProDOS entry level compiler, 65C02 Assembly Language Dev. System, Macintosh compiler, full source code for both Apple II and Macintosh programming tools.

For further information/catalog contact:

WSM GROUP, INC. (602) 298-7910

P.O. Box 32005, TUCSON, AZ 85751

Inquiry 779.

SOFTWARE/LANGUAGES

SCREEN PROGRAM GENERATOR

SPG I creates BASIC program code quickly and easily. Design your screen directly and SPG I will generate the BASIC program code to handle the display and input of data. Controls use of color, editing, graphics, cursor movement and function keys. Generated code easy to modify / merge.

IBM PC & compatibles (28K)
\$75 + \$3.00 S&H (CA + tax)

Treebeard Software

5901 Warner Avenue, Suite 428
Huntington Beach, CA 92649

(714) 840-6939

Inquiry 773.

FORTRAN UTILITIES

CROSS-REFERENCE UTILITY: Mainframe grade symbol x-ref listing for variables, subprogram calls and labels. Variable map shows type, length, alloc, scope, usage tag, etc. All FORTRAN 77 compilers. \$49.95 + \$2.50 S&H.

UTILITY LIBRARY: Assembly language routines for screen, cursor, keyboard, time, sound, etc. MIS/IBM and IBM Pro/PM FORTRAN compilers. \$39.95 + \$2.50 S&H.

IBM PC with DOS 2.0 + VISA/MC/MO/check (2 wks)

PJN INTERNATIONAL

P.O. Box 201363, Austin, TX 78720

(512) 258-1235

Inquiry 739.

68020

Motorola compatible macro Assembler Package features linker, object librarian, symbol report generator with cross reference. Produces S-records and ROMable code. For CP/M-68K, MS-DOS \$750. Portable Source in C \$3500. AVAILABLE NOW.

Quelo, Inc.

2464 33rd Ave. W. Suite 173, Seattle, WA 98199
206/285-2528 telex 910-333-8171

Inquiry 746.

MACINTOSH DEVELOPERS

Dramatically decrease development time. Elegantly crafted compiled library routines for easy implementation of Mac interface. Graphics scrolling and printing, text editing, zooming windows and much more!

PASCAL EXTENDER* \$89.95

C EXTENDER* \$129.95

INVENTION SOFTWARE CORPORATION

P.O. Box 3168, Ann Arbor, MI 48106

313-996-8108

Inquiry 712.

ASSEMBLY LANGUAGE

FREE 8088 TUTOR Monitor

Learn 8088 assembly language using the new book, IBM PC-8088 *Assembly Language Programming*, by Richard E. Haskell. Order the book for \$25 plus \$3 S/H and get the powerful TUTOR monitor software free. Load and examine any disk file, disassemble any 8088 code, debug EXE files. Satisfaction guaranteed.

REHI Books

54 N. Adams, Suite 130-Y, Rochester Hills, MI 48063

(313) 853-1941

Inquiry 749.

SOFTWARE/SCIENTIFIC

ORDINARY/PARTIAL DIFFERENTIAL EQN SOLVER

FOR THE IBM PC & COMPATIBLES

MICROCOMPATIBLES INC.

301 Prelude Dr., Silver Spring, MD 20901

(301) 593-0683

Inquiry 726.

SOFTWARE/SCIENTIFIC

Affordable Engineering Software

CALL OR WRITE FOR FREE CATALOG
Circuit Analysis • Root Locus • Thermal Analysis • Plotter Drivers • Graphics • Signal Processing • Filter Design • Report Proofreader • Transfer Function Analysis.

BV Engineering

2200 Business Way Suite 207, Riverside, CA 92501

(714) 781-0252

VISA/MC

Inquiry 669.

SCIENTIFIC/ENGINEERING SOFTWARE/HARDWARE

Over 500 products from over 20 different manufacturers. To receive a catalog, send \$1.00 for shipping and handling to:

Scientific Computing

P.O. Box 125, 8962 E. Hampden Ave.
Denver, CO 80231

Inquiry 754.

DIGITAL SIGNAL ANALYSIS

Fourier Perspective II w/graphics. FFT/IFT, convolution, deconvolution, Hanning, Power Spectrum, Cross Correlation, 25 more. Graphics 2D and 3D. 8087 recommended, not required. Easy to use menus. FP II \$395 or FP I (FFT w/graphics only) \$149. Runs on PC, PC-XT, PC-AT.

Alligator Transforms Scientific Software

P.O. Box 11386, Costa Mesa, CA 92627

(714) 662-0660

Inquiry 656.

forMath® text-formatter

- Equations, matrices, ratios, integrals, diagrams
- Macros, fonts, Greek/math symbols
- Hyphenation, secn/eqn/ref numbering
- Indexes, table of contents, footnotes
- Dot-matrix, daisywheel, laser printers, all monitors

SHANTHA SOFTWARE INC.

50 West 97th St. Room 11N, New York City 10025

(212) 222-SNIP

Touchtone toll free: 950-1088-wait-FORMATH

Inquiry 757.

COMPLEX + RESICALC + MATRIX

- * **COMPLEX:** Pop-Up Calculator for Complex Numbers. incl. Spec. func, FFT, Polynomial Roots, Graphics, Full Progr Language \$25
- * **RESICALC:** Pop-Up Sci. Calculator \$15
- * **MATRIX:** LP, Regression, Sys of Eqns \$60
- * Free Shipping in U.S. for Cash or Check.

SoftTech Inc. 1-313-544-8544

14640 LaBelle, Oak Park, MI 48237

Inquiry 759.

► MATRIX 100 ◀

Perform multiple regression, solve simultaneous equations, invert matrices, etc. in BASIC or Fortran. "... very sound numerically... very powerful and very easy to use" — *OR/MS Today* 2/85. "Stanford Business Software deserves congratulations" — *PC Mag.* 5/14/85. Price \$80. 8087 support \$125; compiler support \$250; Fortran library \$175. (\$4 s&h).

STANFORD BUSINESS SOFTWARE, INC.

2672 Bayshore Parkway, Ste. 304

Mountain View, CA 94043

To Order Call (415) 424-9499

Inquiry 763.

THE BUYER'S MART

SOFTWARE/SCIENTIFIC

CROSS ASSEMBLERS for VAX VMS and PC/MS DOS New Low Prices

Relocatable Macro Cross Assemblers, Linkers, Librarians
Targeted to almost all Microprocessors
ENERTEC, INC.

BOX 1312, Lansdale, PA 19446

215-362-0966

MC/VISA

Inquiry 694.

SOFTWARE/TOOLS

METRICS FOR MANAGEMENT

ANALYZE reads your code & produces metrics on VOLUME, COMPLEXITY, PRODUCTIVITY & more! Management, QA/QC & Engineers gain valuable insight to scheduling, problem areas, testing, maintenance & compliance to standards. For IBM PC, Process **FORTRAN & "C"** \$495.00 + S/H. Add Ada for only \$200.00 more! MC/VISA

AUTOMETRIC INC.

891 Elkridge Landing Rd., Suite 350, Linthicum, MD 21090
(301) 859-4111

Inquiry 660.

STATISTICS

STATISTIX™

\$75 - Satisfaction guaranteed
A comprehensive, powerful, yet easy-to-use statistical analysis system for IBM PC/XT/AT's, Apple II's, and MS DOS machines. Clear 200p manual. Write for information.

NH ANALYTICAL SOFTWARE

801 West Iowa Ave., St. Paul, MN 55117

(612) 488-4436

Inquiry 733.

Digital Filter Tutor \$375 Kalman Filter Tutor \$850

Practical hands-on training courses that run on the IBM PC. Learn how to specify, design, tune, implement, analyze, and test filters. FREE demo disk available.

Engineering Tutorial Software

22338 Lull Street, Canoga Park, CA 91304

(818) 716-0816

Inquiry 696.

MODULA-2

REPertoire is the fastest selling M2 toolkit. New release includes DBMS, screen system, editor, & much more. \$19 for all LNKs & SYMs; \$89 with full (440K) source and 250p printed manual. MC/VISA/AMEX/COD. Call for free demo & manual on disk.

PMI

4536 SE 50th, Portland, OR 97206
(503) 777-8844 (24 hrs); BIX: pmi
In Europe: +47-6-97-00-40

Inquiry 740.

RATS! Version 2.0

RATS, the best selling Econometric software package, now includes daily and weekly data, a new easier to use 500 page manual, and many advanced features. Use RATS for time-series and cross-section regression, including OLS, ARIMA, VAR, logit, and probit. IBM PC or compatible. \$200. MC/VISA. Call for brochure.

VAR Econometrics, Inc.

P.O. Box 19334, Minneapolis, MN 55419-0334

(612) 822-9690

Inquiry 775.

ELECTRONIC CIRCUIT ANALYSIS

Has AC, DC, Transient and Fourier. Includes worst-case, Monte-Carlo, component sweeping. Macro models, transmission lines.

Electronic Circuit Analysis \$450.
EC-Ace \$95.

TATUM LABS

POB 698, Sandy Hook, CT 06482

(203) 264-3755

Inquiry 769.

POWERFUL FILE MANAGEMENT

I.D.T.'S FileManager® for people serious about their systems. No kid stuff—only powerful managing tools. File sort, copy, move, delete, search & change attributes. Undelete and clear files.

EDLIN enhancer & batch mode clean up and more. Menu driven. MC/VISA

\$34.95 (about 1/3 Norton's)

INTEGRATED DATA TECHNOLOGY, INC.

4775 Bunchberry Lane, Colorado Springs, CO 80917

ORDERS: 303-488-2583

Inquiry 708.

The Statistician

includes: Multiple Regression (Stepwise, ridge, all subsets, backward elimination)

- Time series analysis • descriptive statistics
- transformations • survey research • nonparametrics
- X-Y plots • ANOVA • random samples • data base
- data editor • search & sort • hypothesis tests

For IBM, MS-DOS, XENIX, CPM, TRS-DOS.

QUANT SYSTEMS

Box 628, Charleston, SC 29402

803-571-2825

Please call

TOLL FREE

1-800-334-0854

(Ext. 814)

Inquiry 745.

SOFTWARE/SORT

OPT-TECH SORT/MERGE

Extremely fast Sort/Merge/Select utility. Run as an MS-DOS command or CALL as a subroutine. Supports most languages and filetypes including Btrieve and dBASE. Unlimited filesizes, multiple keys and much more! \$149.

(702) 588-3737

Opt-Tech Data Processing

P.O. Box 678 - Zephyr Cove, NV 89448

Inquiry 734.

STOP BURNING PROMS

Burn n' Learn is out... The ROM Simulator is in. Plugs into your PC development system and simulates the 27xxx series ROMs. Features allow you to A(ssemble), U(nassemble) and E(nter) changes to code under dev. directly in your system, trap and locate execution addresses. No need to burn ROMs, code executes in RAM. The best low-cost dev. tool you will ever buy. Use with any microprocessor or microcontroller. Increase debug productivity 10 times or more. DEBUG utilities avail. for all microprocessors. Pays for itself the first time you use it. Order now at only \$695.00.

Protostar Instruments (714) 882-7910

749 Grayling Bay, Costa Mesa, CA 92626

Inquiry 744.

TRANSLATION/MACHINE

The TurboTranslator

Chinese <=> English. Eng/Pinyin in. Chinese/Eng/Pinyin out. Edit (char needs mouse)/export/import dict. 350+ chars hi qual, 6200+ (2.3Mb) to. No copy prot. IBM/Herc/etc graph card. IBM-PC & compat, 256K, 2 floppies. Aust \$85 (+ \$10 overseas). AMEX/MC/Visa.

SAVAGE SOFTWARE

Box 81, East Caulfield 3145,

Victoria, Australia

Inquiry 781.

SOFTWARE/SYSTEMS

CPM-80 LIVES on your PC

CP/Mulator puts a 4mhz 8 bit CP/M emulator in your IBM-PC for \$99. (\$3 s+h).

- A great 8 bit development system
- Saves expensive CPM-80 applications
- Increases PC speed 10% for 8088 programs
- Priced less than most software only products
- Uses no valuable board slots

Source Information

P.O. Box 2974, Warminster, PA 18974

VISA Phone (215) 441-8178 M/C

Inquiry 762.

STATISTICS

NUMBER CRUNCHER STAT SYS

Menu-driven. Multiple & stepwise regression, ANOVA, time series, discriminant cluster and factor analysis, principal components, scatter plots, histograms, t-tests, contingency tables, non-parametrics. Import export data. Spreadsheet, sort, join, merge. \$79. IBM PC/Mcintosh. Quantity discount.

NCSS-B

865 East 400 North, Kaysville, UT 84037

801-546-0445

Inquiry 731.

TYPSETTING

DESKTOP PUBLISHING

Laser Printer composition software to drive Cordata L300 with 76 PS fnts \$495. With add 14 PS Lndscp fnts \$695. For Canon LBP-8 A2, NCR, or HP LaserJet+ with 41 PS Prt or Lndscp fnts \$695. H & J, merge graphics, mix face & pt. size anywhere on any line, mult tab & col justification. Boxes & Rules.

Micro Print-X, Inc.

P.O. Box 581, Ballinger, TX 76821

(915) 365-2343

Inquiry 724.

SOFTWARE/TOOLS

PC-Type™

Fast, compact, capable & easy! Help panels, hands-on tutorial, macros, multiple-line headings & footings. DOS path support, print spooling, block operations, etc. ASCII files. Install program allows customization. \$59.95 + \$5 s/h. For 128K IBM PC.

ButtonWare, Inc.

P.O. Box 5786, Bellevue, WA 98006

1-800-J-BUTTON

Inquiry 668.

STATISTICS CATALOG!

If you need statistics for IBM PC or Apple II, call us and let our technical advisors help you find the statistics programs you need.

Write or call now to get a FREE catalog of statistics and quality control software.

HUMAN SYSTEMS DYNAMICS

9010 Reseda Blvd., Ste. 222

Northridge, CA 91324

(800) 451-3030 (818) 993-8536 (CA)

Inquiry 706.

UTILITIES

STILL RIVER SHELL

Visual shell for PC/MS-DOS. Point & Shot Power. V1.33. Only \$9 for shareware diskette. \$35 manual & diskette. MC/Visa accepted.

Bob Howard

PO Box 57, Still River, MA 01467

617-456-3699

Inquiry 663.

THE BUYER'S MART

UTILITIES

MEDIA MASTER PLUS

READ, WRITE, and FORMAT over 150 CP/M disks and run most CP/M-80 programs on your IBM PC! Two program package includes ZP/EM, a CP/M-80 emulator program that transforms your IBM PC into a 1.2 MHZ CP/M 2.2 computer. \$59.95 + \$3.00 S/H (CA 6%)

INTERSECTING CONCEPTS, INC.

4573 Heatherglen Ct., Ste. 10
Moorpark, CA 93021
(805) 529-5073

Inquiry 711.

UTILITIES

QUICKCACHE

Intelligent disk I/O mgmt. subsystem for PC/MS-DOS 2.xx & 3.xx. Capable of making programs run up to 14 times faster. All parameters dynamically alterable. LIM memory supported. 40 KB min. required. \$49.95 + \$5 s/h. VISA/MC. 30-day guarantee.

P. R. GLASSEL and ASSOCIATES, INC.

30255 Fir Trail, Stacy, MN 55079
612-462-1337

Inquiry 735.

UTILITIES

PADLOCK/PADLOCK II DISKS

PADLOCK furnishes the user with a method for providing protection against unauthorized duplication from DOS commands \$99. PADLOCK II disks come preformatted with finger-print and serialization. PADLOCK II disks offer superior protection. Ask about our HARD DISK protection with uninstall capability. MC/VISA.

GLENCO ENGINEERING

3920 Ridge Ave., Arlington Hts., IL 60004
(312) 392-2492

Inquiry 703.

SOURCE CODE LIBRARIAN & REVISION CONTROL SYSTEM

TLIB™ keeps ALL versions of your program in ONE compact library file, even with hundreds of revisions.

- 5 times faster than SCCS • LAN compatible
- Free public domain MAKE (with source) by L. Dyer

MS/PC-DOS 2.x & 3.x. \$99.95 + \$3 S&H. VISA/MC

BURTON SYSTEMS SOFTWARE

POB 4156, Cary, NC 27511
(919) 469-3068

Inquiry 665.

Automenu™ version 4.0

Create one menu system to run all your programs, batch files & DOS commands. "Insulates" novices; many options for power users. On-screen help, password protection, user-defined prompts. Written in assembler. 16K size. Over 8,000 satisfied users. Money back guarantee. \$46 + \$4 s/h. Chk/VISA/MC. Call or write for brochure.

Magee Enterprises

Dept. B13, 6577 Peachtree Industrial Blvd.
Norcross, GA USA 30092-3796
404/446-6611

Inquiry 720.

WARP-TEN or RAMback - 9.95

WARP-TEN is a programmable disk cache that speeds up your PC disk access's. RAMbak automates the saving of new or changed RAM disk files to floppy disks and/or hard disk subdirectories. PC, XT, AT, compatibles with 256K DOS 2.0 +. Introductory price is only 9.95 each. (MN Res. + 6%). Visa/MC/CHK

Software Brewing Company

P.O. Box 12094, St. Paul, MN 55112
612-636-2727

Inquiry 760.

?WHAT DOESN'T IT DO?

Resides under any software, print multi-fonts to any dot matrix & daisy wheel (Epson, Toshiba, etc.), a pop up 10 mem calculator, DOS services, printable calendar, date/time note pad, help pages, all user modifiable, 70Kb \$60 and IBM PC.

LCS (514) 279-5678

P.O. Box 956, Outremont, Quebec
Canada, H2V 4R8

Inquiry 717.

PAL FOR SIDEKICK!

Personal Appointment Locator automatically shows coming appointments, searches your file, maintains to-do list, automatically repeats appointments, examines multiple files. Resident alarm too! Only \$49.95. Cheap at twice the price!

PAL SOFTWARE

Ste. 12B 110 Green St., New York, NY 10012
212-334-9172

Inquiry 736.

CONCURRENT DOS BACKUP

BackPack™ runs like BACKUP/RESTORE and supports DOS and CP/M media as well as users. Backs up and restores up to 1000K/min. on an AT and 360K/min. on an XT. Supports release 4.1. Also available on CP/M-80 and CP/M plus. \$150.

Bright Light, Inc.

520 Fellowship Rd. #C301, Mt. Laurel, NJ 08054
(609) 778-0772

Inquiry 664.

HANDS OFF THE PROGRAM™

- Locks Hard Disk. - Restricts Floppy Use.
- Protects Subdirectories.
- Normal Use of DOS Commands and Application Software.
- IBM PC, XT, AT and True Compatibles.
- DOS V2.0 and Higher. Hard Disk System.
- Keep Other People HANDS OFF Your System

\$89.95 VISA/MC/MO/CK

SYSTEM CONSULTING, INC.

314 Canterbury Dr., Pittsburgh, PA 15238
(412) 963-1624

Inquiry 766.

UNLOCK YOUR PRINTER'S POWER WITH

THE PRESIDENT™

UNIVERSAL PRINTER INTERFACE

Lets you use ALL the features built into ANY PRINTER through ANY PROGRAM on IBM PC's or compat. Resident program uses only 3k of memory. Pop-up Help. Recommended by Epson, Okidata, MicroPro, etc.

CMB3 Technologies \$99.00

P.O. Box 3061, Walnut Creek, CA 94598
(415) 930-0470

Inquiry 672.

Attention Framework II Users

StopNL is a memory resident utility that ensures the Gray Plus and Minus keys always are always recognized as "DOWNLEVEL" and "UPLEVEL" by Framework II, even when Numlock is on.

StopNL is not copy protected, and costs only US \$15.00.

Stuart Huckin & Associates

6182 Golf Rd., Agassiz, B.C., V0M 1A0 Canada
(604) 796-9125

Inquiry 765.

Advertise your computer products
for as little as \$375
in THE BUYER'S MART.
For more information
call Karen Burgess at
BYTE 603-924-3754.

8MHz SUPER TURBO SYSTEMS

SUN-ST MONO SYSTEM

\$795



Dealers and Computer Groups
CALL FOR SPECIAL PRICE

- Two 360KB Disk Drives
- 640K RAM
- Hercules Compatible Mono Graphic Card (720x348)
- 12" High-Resolution TTL Mono Monitor
- 135W Power Supply
- AT Style Keyboard
- 4 Layer 8MHz CPU Board
- Keyboard Switchable to 4.77MHz
- Parallel Printer Port
- FCC Approved
- Fully Assembled & Tested
- 1 Year Limited Warranty (Parts & Labor)

SUN-EGA SYSTEM \$1325

- 2 Disk Drives
- 135W Power Supply
- 640K RAM
- AT Style Keyboard
- EGA Card (CGA+EGA+MDA)
- 14" R.G.B. EGA Monitor (EGA+CGA)

SUN-ST BASIC \$465

- 8MHz Turbo CPU
- 1 Disk Drive
- 135W Power Supply
- 256K RAM
- AT Style Keyboard

(Call for other configurations)

SUN-ST COLOR SYSTEM \$1059

- 2 Disk Drives
- 135W Power Supply
- Color G Card
- 640K RAM
- AT Style Keyboard
- 13" R.G.B. Color Monitor

SUN-286 SYSTEM \$1295

- AT Compatible 688MHz CPU
- 640K RAM
- 2.2MB FDD (1/2 HT)
- HDD/FDD Controller w/Cable
- 200W Power Supply
- Keyboard 5151 Compatible
- Assembled & Tested

SPECIAL SALE!!

- SUN-ST CPU (8MHz) \$165 (4 Layers, Switchable to 4.77MHz)
- Multi I/O Plus Card \$95 (Serial, Parallel, Clock, Calendar, Game Port, RAM Disk, Spool)

- EGA PACKAGE \$649 Qty. of 2 or more
- EGA Card (EGA + CGA + MDA) w/250K Display Buffer, 14" R.G.B. EGA Monitor (640x350, 0.31mm Dot Pitch)



SUNTRONICS, INC.
12603 Cimshaw Blvd Hawthorne CA 90250

1-800-421-5775
(orders only)
213-644-1140

STORE HOURS
MON - FRI 9:00am - 6:00pm
SATURDAY 10:00am - 5:00pm
Dealer & OEM Inquiries Invited

TERMS VISA MasterCard (No Surcharge) COD Cash or Check
Check VISA or MC Ref. Required. Show & Give Confirmation
P.O. accepted. Shipping & M.C. \$4.00 Ins. 2.00 plus \$5.00 Tax each
address in CA residents add CA Sales Tax \$10.00 Min. Order
WARRANTY 90 Days Warranty, Labor Parts Replacement Only
IBM is a registered trademark of International Business Machines

BYTE CONNECTION INC. (714) 778-6496

BOTTOM LINE PRICE BUSTERS! - "Who you gonna call?"

PERSONAL COMPUTERS

VICTOR VPC II (IBM XT Comp.), 640 K, 2 Drives, K.B.,	\$ 875
VICTOR V286 (IBM AT Comp.), 512 K, MS DOS 3.1, 1.2 MB Floppy, K.B.	\$1799
VICTOR V286 (IBM AT Comp.), all of the above with 20 MB HD,	\$2275
IBM PC XT, w/640K, IBM 360 Floppy, IBM 20 MB HD, K.B., Graphics Card, Monitor	\$2499
IBM PC AT #339, 512K, 1.2 Floppy, IBM 30MB HD	\$4385
IBM PC AT, w/512K, K.B., 20 MB HD	\$3150
IBM PROPRINTER XL	\$ 599
COMPAQ PORTABLE II with 512K, 80286 Processor, Two 360 Floppies	\$2795
COMPAQ DESK PRO, with 640K, Two 360 Floppies, Graphics Card & Monitor	\$1895
COMPAQ DESK PRO & PORTABLE 286, with 640K, 1.2 Floppy, 20 MB HD, Monitor	\$3895
For 86 MB, instead of 20 MB, add	\$ 995
AT & T 6300 PC, with 256K, K.B., Two 360 Floppies, AT & T Graphics Card & Monitor	\$1795
AT & T 6300 Plus, with 512 K, 1.2 Floppy, K.B., Graphics Card & Monitor	\$3495
SPERRY PC-IT, with 640K, 1.2 MB Floppy, 40 MB HD, K.B.	\$2999

PLOTTERS

CALCOMP 1043	\$7359	CALCOMP 1044	\$11,195
GOULD 6320 11 x 17	\$1647		
HI DMP 56	\$4595	DMP 51/52 MP	\$4095
DMP 40	\$ 899		
HP 7475	\$1659	HP 7580	\$8415
IO LINE 3700	\$3895	ZETA 836CS	\$13,295

DIGITIZERS

CALCOMP 12 x 12	\$ 709	44 x 60 w/16 Cursor	\$5099
HITACHI 36 x 48	\$4195		
HITACHI TIGER 11 x 11	\$ 675	HITACHI TIGER 15 x 15	\$1295
Houston Ins. TG 1011	\$ 549	HI TG 3036 (24 x 36)	\$3099
KURTA 12 x 12	\$ 595	KURTA 12 x 17	\$ 695
SUMMAGRAPHS 11x11	\$ 475	18 x 12	\$ 750

GRAPHIC CONTROLLERS & MONITORS

HITACHI HM 3719 & BNW 15	\$3290
HITACHI 1455 S & STB EGA	\$ 925
MICROVITEC 905CNO & GRAPHPORT D	\$2795
Taxan 640 & Color 400L	\$1030
Persyst BOB 18 & NEC 1401	\$1099
Galaxy 800 & Mitsubishi 6469	\$2995
Verticom CD-1 & M-16E	\$1950
BNW 121 Adapter	\$1950
Artist	\$2099
Conographics 400 & Mitsubishi 3479 LP	\$2295
Mitsubishi 1341 & Sigma 400	\$1050

SPECIAL OF THE MONTH - CAD System, Sperry IT,

640K, 40 MB HD, 80287 M.C., BOB 16, NEC 1401, Auto CAD, Summa Graphics, HI DMP 40 \$8985

(714) 778-6496

167 West Cerritos Ave., Anaheim, CA 92805 Open 9 - 6 PST

SOFTWARE

Accounting Package	\$ 495	AUTOCAD 2.5	\$2050
T & W VERSACAD	\$2099	CADVANCE	\$1950
ARMOR SYSTEM'S Excalibur & Plus Series			CALL
COMPUTER ASSOCIATE (IUS) A/R, A/P, G/L		EACH	\$ 330
UNIVAIR'S Dental Management & Medical Management-9000		CALL	
CYMA Medical, Chiropractic, Orthodontic, Dental Package			\$1625
Physician Micro Systems Package			\$1850
Hotel Information Systems Package			\$2450
MICROCRAFT, BALCONE, UNIVAIR		CALL	
(IBM Doctor Officer Manager)			\$2950

PRINTERS

BLAZER LASER PRINTER			\$1995
CITOH LQ24	\$ 899	D10-40	\$ 750
CITOH 8510 SP	\$ 399	C-10	\$ 475
CITIZEN MSP 15	\$ 415	MSP 25	\$ 525
CITIZEN PREMIER 35			\$ 515
CANON LASER PRINTER	\$2050	CORONA LASER	\$2350
DIABLO 835	\$ 950	INKJET 4020 D	\$1145
DIABLO LASER			\$3795
EPSON FX85	\$ 389	EPSON 286	\$ 550
HEWLETT-PACKARD LASER JET	\$2250	HP Plus	\$2995
HEWLETT-PACKARD 500 Plus			\$4150
NEC P560	\$ 995	P760	\$ 650
FUJITSU MAX 24	\$1175	MAX 24 COLOR	\$1275
FUJITSU DL 2400	\$ 959	DM 2400	\$ 859
DM 2200	\$ 499		
OKIDATA 193	\$ 549	293	\$ 599
OKIDATA 293			\$ 639
TOSHIBA P321			\$ 550
TOSHIBA P351	\$1095	P341	\$ 750

HARD DRIVES & BACK UP SYSTEMS

BERNOULLI BOX 10 + 10 / 20 + 20	\$1595/\$2095
SEAGATE 20 MB	\$ 450
SEAGATE 4038	\$ 695
SEAGATE 4051	\$ 850
HARD CARD 20 MB	\$ 599
MAXTOR/MICROPOLIS 85MB	\$1550
TEAC 20 MB Tape B/U	\$ 595
ARCHIVE 60 MB Tape B/U	\$ 850

CALL FOR WHAT IS NOT LISTED, WE GUARANTEE THAT YOUR CALL WILL NOT BE A WASTE. LEASING AVAILABLE.

No charges for testing and configuring equipment. Prices and availability subject to change without notice.

Compu\$ave

Call Toll Free: 1-800-624-8949

A DIVISION OF ADLANKO CORPORATION

MONITORS

Amdek 310A 143	Amdek 730 719
NEC Multisynch 569	PGS HX12E 499
Roland RGB 289	PGS MAX12 155
Samsung TTL 85	Taxan 630 419
Samsung Comp 72	Taxan 640 485
Teco 14" EGA 439	Taxan 760 CALL
Thom 31311SI 388	Wyse620 385
Thom 36382SI 369	Wyse640 539
B&H Quintar: 20"/RGB/832 x 630 CALL	
Mitsubishi 6920: 19"/1024x1024 1795	
Wyse 700: 15"/Mono/1280 x 800/Card 715	
Aydin/Hitachi/Nanao/Sakata/Tatung CALL	

MODEMS

Anchor Volksmodem 12 119
Anchor Lightning II: 2400 W/Software 299
Anchor Volks I: 1200 W/Software 119
Hayes Smartmodem 1200 368
Hayes 1200B: Half-Card W/Software 345
Incomm 2400: Upgradeable 4800 + 295
Prometheus Promodem 2400G 335
Prometheus Promodem 1200A: Apple 185
Racal-Vadic 2400V & PC 389
UDS 208 AB: 4800 Baud 935
US Robotics Courier 2400 378
Zoom 1200PC-XL: W/RAM & Software 229
AST/Codex/Novation/Ven-Tel CALL

COMPUTERS

AT&T 6300: 512K/20M Drive 2099
Cordata 400: Port. & Desk/2 Drives 1099
Cordata 400XT: Port. & Desk/20M 1475
Cordata AT: Portable/1.2M Drive CALL
Laser 128: Apple IIE Compatible 389
Sharp PC7000: Portable/2 Drives 1119
Sperry IT: 512K/1.2M Drive 1965
Sperry IT: 1M/44M Hard Drive 2899
Sperry Micro IT CALL
TeleCat 286: 512K/20M Dr/Monitor 2249
Toshiba 1100 + & 3100 Portables CALL
Wyse 1100: 256K/1 Drive 665
Wyse 1100: 256K/2 Drives 755
Wyse 286: 10 MHz/640K/1.2M Drive 1795
Wyse 286: 10 MHz/640K/20M Drive 2149
Zenith 181: Portable/512K/2 Drives 1675
Altos/NEC/Olivetti/Others LOW PRICES

TERMINALS

IBM 3161-11 478	Altos III 559
Kimtron KT7 435	Altos IV 355
Liberty Freedom I 379	Ampex 220 477
Televideo 905 289	Qume 202G 446
Televideo 955 439	Wyse 30 289
Televideo 9220 459	Wyse 50 369
Wyse 60 W/KB 469	Wyse 85G 435
Adds/DEC/Hazeltine/Visual/Zenith CALL	

DIGITIZERS

Kurta 1: 12 x 12 529	Hitachi 12 x 12 599
Kurta 1: 12 x 17 599	Summa 11 x 11 449
Kurta 2: 12 x 12 599	Summa 12 x 12 369
Kurta 2: 12 x 17 729	Summa 12 x 18 699
Kurta 3: 30 x 36 4615	Summa Mac 12 379
Houston Instruments: All Models CALL	

PLOTTERS

Amdek 100 525	Roland 880 925
Roland 101 295	Roland 980 1195
Roland 800 375	Taxan 710S 695
Houston Instruments: All Models CALL	

PRINTERS

Citizen 1200 179	Canon A60 469
Citizen MSP10 275	Canon Laser 1935
Citizen MSP15 375	NEC P6 445
Citizen Premier 469	NEC P7 609
Cordata Laser 2159	NEC CP6 559
Panasonic 1091 228	NEC CP7 739
Panasonic 1092 299	Okidata 192 306
Panasonic 1592 415	Okidata 192 + 365
Panasonic 1595 565	Okidata 193 + 549
Panasonic 3131 252	Star LV1210 179
Toshiba: All CALL	Star NX10 245
Diconix: 150 cps/50 NLQ/Portable 339	
Fujitsu 2100: Color/220 cps/Amiga 475	
Alps/Data Products/Diablo/Epson CALL	
Genicom/Juki/Tally/Televideo/TI CALL	
Buffers/Cables/Sheet Feeders SAVE	
Stands/Switch Boxes/Tractors CALL	

BOARDS

Artist I: Graphics/1024 x 768 1449
AST Rampage: PC-XT/256K 239
Hercules Monochrome Graphics 188
Orange Grappler + : Apple 69
Orchid Turbo EGA 589
PC Monochrome Graphics Card 85
Photon: Graphics/800 x 600 799
Sigma 400L: Graphics 395
Taxan 560: Graphics CALL
Tecmar EGA: Graphics 265
Wyse 440 EGA: Graphics 325
Intel/Microtek/Persyst/Quadram CALL
Practical/Thesys/Video7/Vutek CALL

WE ALSO CARRY ALL MAJOR PRINTERS
BOARDS, MODEMS, DRIVES, SOFTWARE
CABLES, KEYBOARDS, POWER DEVICES

DISK DRIVES

Archive Scorpion: 60M Tape Backup 795
Gamma Drives: Apple Compatible 119
IOMEGA Single 20M Bernoulli W/IF 1745
IOMEGA Dual 20M Bernoulli + 80M 4195
Seagate 20M Hard Drive W/Controller 388
Seagate 30M Hard Drive W/Controller 489

OTHER FLOPPY AND HARD DRIVES

Alloy • CDC • Corvus • Irwin • Maynard
Maxtor • Mitsubishi • Mountain • Sanyo
Panasonic • Priam • Shugart • Tallgrass
Tulin • Teac • Tecmar • Western Digital

**HOURS: MON - FRI 7AM - 6PM/SAT 9AM - 2PM
IN ARIZONA CALL (602) 437-4855**

CompuSave: 4207 S. 37th St., Phoenix, AZ 85040/ For Customer
Service Call (602) 437-4856/Prices Reflect Cash Discounts And Are
Subject To Change Without Notice/Minimum Shipping Charge \$4
Purchase Orders & Major Credit Cards Welcome

SEAMLESS File Transfer

Softerm PC provides a transparent
Micro-to Mainframe link using
Virtual disk drive specifiers
accessible from any DOS application
program. Memory resident.
Transfers files in background using
customizable communications
scripts. Includes 32 exact terminal
emulations.
For IBM PC/XT/AT, DG, NEC, HP,
Wang, TI, Gridcase, Tandy, Zenith
\$195 - Visa, MC, COD
Call 800-225-8590 orders/info.

SOFTRONICS

7899 Lexington Dr., Ste 210
Colorado Springs, CO 80918
(303) 593-9540 Telex #450236

Inquiry 307

\$99

HARD DISK CONTROLLER

**New Shugart Model 1610
5 1/4" Hard Disk Controllers**

EMULATES

- XEBEC S1410 (1610-3) Full
- DTC 510 (1610-1) 90 day
- SCSI (1610-4) Guarantee

WORKS WITH

- Micromint COM 180, SB180
- Wavemat Bullet
- AMPRO All Boards Manual
- Macintosh and
- Apple IIe Schematic
- ACS 1000 Only \$8
- ISI 5160

COMPUTER SURPLUS STORE

226 Phelan Avenue
San Jose, CA 95112
408-280-1740

Inquiry 84

PUBLIC DOMAIN SOFTWARE

isn't copyrighted. Thousands of useful
programs available for most computers from
user group libraries.

User Group Libraries	Rent	Buy
IBM PC Blue 220 Disks	\$230	\$450
Capitol-IBM 45 Disks	50	100
Sanyo UG MSDOS 80 Disks	85	165
Authors Showcase (IBM) 35 Disks	40	100
Amiga 75 Disks	80	250
Atari ST 35 Disks	40	125
Macintosh 85 Disks	90	275
CP M UG 92 Disks	45	200
SIG M UG 290 Disks	185	350
CBM 64 Gold 100 Disks	50	100
Apple DOS 120 Disks	65	200

Rental is for 7 days with 3 days grace for return.
Use your credit card, no deposit! Call for free catalog
or send Disk for free Directory of programs.

P.D. SIG. INC.
Master 2400 Santa Rita VISA
Card Las Vegas, Nevada 89109
(702) 732-0169

Inquiry 228



FORTRON CORPORATION

3225 SELDON CT., FREMONT, CA 94538

IN CALIF (415) 490-8171
TLX 559291 FORTRON
FAX (415) 490-9156

ORDER TOLL FREE: (800) 821-9771

We are honest, responsible and happy to help our customers

FORTRON Presents: THE DEPENDABLE ONES!

Quality power your computer can live with.
No other power supply can match all of these features.



150W
PC/XT \$119.00

- U.L. recognized
- Meets FCC Class B requirement
- With shielded power cord
- U.S. made connectors provide better connection to drives and CPU board
- Low noise DC fan
- OVP, OCP, short circuit protection
- Direct replacement for your PC, XT or AT power supply

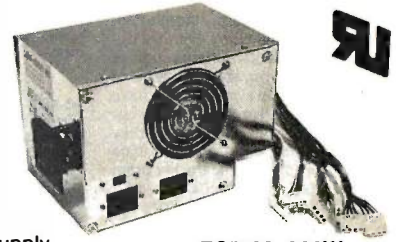

FC5192 200W
PC/AT \$179.00

100% 24 hr. burn-in and preshipment test. One full year warranty.

IBM® PC, XT, AT, Add-On Card

CPU Mother Board

Hayes® Compatible Modems

- Mono / Graphics / Printer
- Color Graphics Adaptor



- Hercules® compatible
- IBM® compatible
- Runs Lotus 1, 2, 3 Auto CAD, etc.

FC550
Mono Graphics \$99.00
FC520
Color Graphics \$95.00

Memory Expansion Cards

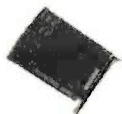

FC840 \$59.00
640K Memory Expansion
FC850 \$179.00
2MB Memory Expansion
(EMS) (OK on board)

Real Time Clock / RS232



- Battery Back-Up
 - To 9600 Baud
 - Software Included
 - With RS232 Port
- FC940** \$59.00
(clock only) \$49.00

Turbo XT \$149.00 (QK)



- IBM® compatible
- 4.7 - 8 MHz switchable
- Legal Bios, runs all major software
- 8 slots
- Optional 8087 co-processor
- Expandable to 640K memory



Internal

- 300 / 1200 Baud \$109.00
- 2400 Baud \$269.00



External

- 1200 Baud \$149.00
- 2400 Baud \$365.00

XT Multi-I/O, with Floppy Controller



- 1 Serial (2nd optional)
- 1 Parallel port
- 1 Game port
- Floppy controller

FC 740 \$99.00
w/o Floppy controller. \$89.00

PC AT Multi-I/O



- 1 Serial (2nd optional)
- 1 Parallel
- 1 Game port

FC1932 \$109.00

Floppy / Hard Disk Controller



- Floppy controller w/cable \$59.00
- WX-2 (W.D.) PC/XT hard disk controller \$135.00
- WA-2 (W.D.) PC/AT floppy / hard disk controller \$260.00

PC/AT Compatible \$599.00 (QK)

- IBM® AT compatible
- 80286 CPU
- 6 - 8 MHz clock speed
- Optional 80287 co-processor
- Expand. to 1024K memory
- 8 slots
- Legal Bios, runs all major software

EGA Card & Monitor



EGA Card \$219.00

- IBM® EGA, CGA, MDA compatible
- 256K Display memory



EGA Monitor \$449.00

- 640 (H) x 350 (V) Resolution
- 0.31mm Dot pitch

COMBO PRICE \$619.00

Monitor

Disk Drives & Tape Back-Up

Printers

Monochrome (TTL)

- Samsung 1254G \$ 85.00
- Tatung 1222A \$109.00
- Taxan 122 \$159.00

RGB Color

- Taxan 620 \$399.00
- Taxan 630 \$439.00
- Taxan 640 \$495.00
- Tatung 1360 \$335.00

EGA

- Taxan 760 \$469.00
- Tatung 1380F \$449.00
- Casper \$439.00

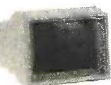

Floppy Disk Drives

- Teac 55BV \$ 95.00
- Teac 55GFV 1.2MB \$138.00
- JVC MDP-200 \$ 90.00
- Fujitsu M2551A \$ 90.00

Tape Back-Up

- 20MB \$579.00 / \$749.00 (Int./Ext.)
- 60MB \$799.00 / \$795.00 (Int./Ext.)

*20 MB Hard Disk Drive (w/controller & cable) \$389.00

Seagate Hard Disk Drives

- 10MB, 65ms \$295.00
- 20MB, 65ms \$315.00
- 20MB, 39ms \$550.00
- 30MB, 39ms \$625.00
- 40MB, 39ms \$745.00



- **TTXpress 80** \$ 89 (40cps, thermo, DC/AC op.)
- **C. Itah (Riteman Plus)** \$219 (120cps, dot matrix, NLO)
- **Riteman II** \$339 (160cps, dot matrix, NLO)
- **Riteman 15** \$479 (160cps, 15" wide carriage)
- **Citizen Premiers 35** \$479 (35cps daisywheel)

Panasonics

- **KX-P1080** \$219 (100cps, dot matrix, NLO)
- **KX-1091** (120cps) \$249 (33cps NLO)
- **KX-1092** (180cps) \$375 (38cps NLO)
- **KX-1592** (180cps) \$499 (38cps NLO)
- **KX-1595** (240cps) \$629 (51cps NLO)
- **KX-P3131** \$295 (17cps daisywheel)
- **KX-P3151** \$449 (22cps LQ parallel)

PC, XT Expansion Chassis

Drive Chassis

Cabinet & Keyboard

Provides Extra Expansion Slots for Your PC, XT less than 50% of the prices of IBM® Teclmar® Alloy® exp. chassis.



FC640 \$399.00
• w/5 slot bus board
• 100 W power supply
• Space for 3 drives

FC650 \$399.00
• w/8 slot bus board
• 150 W power supply
• Space for 4 drives

FC660 \$439.00
• w/12 slot bus board
• 100 W power supply
• Space for 2 drives

*System Interface Adaptor Included



FC610 \$129.00

- Built-in power supply, fan
- Space for 2 drives

U.P.S. \$279.00



When the AC power fails, it keeps your PC working



PC/XT **FC630A2** \$79.00 **PC/XT** **FC6301** \$79.00 **PC/AT** **FC620** \$99.00 **PC/AT** **FC6201** \$109.00



5151 Type PC/AT **FC437** \$95.00 **AT Type PC, XT/AT** **FC447** \$99.00 **Enhanced AT PC, XT/AT** **FC467** \$125.00

Huge inventory, Dealers and System Integrators please call for profitable discount prices.

Inquiry 131 for End-Users Inquiry 132 for DEALERS ONLY.

IT'S A FACT! SOME PC USERS ARE SNOBS!

OVER 600 PIECES OF
IBM-PC COMPATIBLE
SOFTWARE JUST
\$6.00 A DISK!
OVER 500 DISKS FULL
OF PUBLIC DOMAIN AND
USER SUPPORTED PROGRAMS

LONE STAR

S O F T W A R E

Some PC users are snobs!

In this day of Young Upwardly Mobile Professionals, some people won't even try our great software because of the status stigmas attached to it. Why, you ask? Because of some of the same status symbols that make some people want to drive BMW's and wear genuine ROLEX watches. "After all," they reason, "what if some one from the office saw me using a \$6.00 software program instead of the latest version of Star-Word-Perfect-Plus? I might loose my keys to the executive wash room or something."

We're sorry if you have fallen into this status trap. The truth is our modestly priced software is some of the best and most sophisticated you can buy anywhere at any price. Would it make you feel better if we increased our prices 50 times and added a fancy copy protection scheme?

Think big! Dare to be different! Why not just tell the other YUPPIE'S at the office that you're buying an ounce of gold with the difference you're saving. You may start a new trend, and may even corner the gold market at the same time!

Still not convinced? Well, here is just a sample of our ever growing library by category:

APPLICATIONS

GENEALOGY ON DISPLAY (#90)
GENEALOGY - FT (#240) From Pine Cones software.
LABELMAKER (#146) Our favorite label file and maker. Menu driven.
FAMILY HISTORY (#361) Family history, ancestor and descendant charts. Sample programs.
FORM LETTERS (#388) LOTS of samples of the most commonly used business letters. Modify!
PC-SPRINT (#507) Detailed instruction on how to double your computer's speed for less than \$50.00.
MSDOS-CPM/80 INTERFACE (#561) CPM lovers! This program allows you to transfer information between and emulate CPM and MSDOS.
NAME GRAM/BREAK DOWN/FOREWARD (#477) Discover the words inherent in your phone number, do great anagrams.
THE WORD DIGITIZED (#494, 495, 496) A cartographer's dream. Locate and display over 100,000 locations.
100 LETTERS (#300) Most commonly used form letters, and business applications at your fingertips.

COMMUNICATIONS

QMODEM (#310) Without a doubt the fastest and best communications software you can buy at any price.
PC-TALK (#16) The classic "Freeware" communication program.
RBBS (#212) Become a SYSOP and start a bulletin board.
FIDO NET (#333) Bulletin Board System. Perhaps the easiest to run.
PROCOMM (#499) Communication software that makes a hacker's dream come true.

DATABASE

VCR dBASE (#493) Keep track of those favorite VCR tapes that you never can seem to find when you want them.

DATABASE PROGRAMS

PC-FILE (#5) Perhaps the granddaddy of user supported database programs from Jim Button.
NEWBASE (#238) Menu driven database for the beginner.
PC-DBMS (#383) A relational database management system that provides on-line help and screen editing functions.
CREATOR (#339) Create, report and sort makes this a super database management system.
MAIL MASTER (#481) Easily sort, index, and list your multiple mailing data bases.

EDUCATION

EQUATOR (#249) A teaching tool for math, science and finance.
PC-TUTORIAL (#403) A first course in computer usage covering various aspects of MS-DOS. Good!
PC-PROFESSOR (#105) Learn BASIC the easy way. One of the best tutorials on BASIC.
PC-DOS HELP (#254) Type "help" for the DOS command you forgot.
PC PROMPT (#558) Fascinating on line memory resident DOS helper that also supports BASICA, EDLIN, DEBUG, and TURBO PASCAL.
PC-SPRINT (#507) Tutorial on how to triple your PC's speed.

FINANCIAL

PC-CHECK MANAGER (#275) Keeps multiple checkbooks in balance.
TAX FILE DBS (#295) Tax record keeping system that saves you money on April 15.
PORTSWORTH PACKAGE (#101) Evaluates your ever-changing stock portfolios.
PC-GENERAL LEDGER (#237) An exceptional accounting system. Used by some CPA's.
LOAN AMORTIZATION (#399) For output to screen or printer. Lots of on-line help.
MR. BILL (#469, 470) Prepare invoices, client report, audit trail, etc.
ANALYTIC CALC (#430-432) 3 disk set. Complete spreadsheet, database, graphics, word processor - fassst!
PC ACCOUNTING SYSTEM (#559, 560) General purpose ledger system that includes payroll, depreciation, accounts receivable/payable, inventory, processing 1099's and a good general ledger.
PC-PAYROLL (#565) Handle all payroll problems with this complete menu-driven payroll system. Includes taxes, reports, forms, etc.
SALESEYE (#501, 502) Never let another prospect or lead get away! Prints memos and letters as well.

GAMES

TOP GAMES (#274) The most requested arcade type games.
ARCADE GAMES (#293) Another goodie bag of top arcade games.
PC JR GAMES (#354) Games that will work only on PC JR. Combat, Dungeons and Dragons, Global Thermonuclear War.

MISC GAMES (#390) Good selection of educational, adventure, and arcade games.
PINBALL RALLY (#557) You asked for it! Here are three pinball games that vary in complexity, PINBALL, RAIN, TWILZONZ.
DND (#567) Dungeons and Dragons, this uses text characters instead of graphics.
REFLEX POINT (#487) Self styled action game similar to ROBOTECH cartoon series.

GRAPHICS

PC-KEY DRAW (#344-345) A small CAD system. Lots of demonstration files.
PC-PICTURE GRAPHICS (#136) Drawing package allows you to zoom, color, and store pictures.
PC-GRAPH (#418) Allows user to create graphics from PC-File report files.
PRESENT (#471) Professional slide shows are a snap with the advanced graphic features of this program. Includes a screen "capture".

LANGUAGE

CHASM (#10) Cheap assembler with tutorial.
XLISP (#148) Lisp language interpreter.
PROLOG & UNIFORM (#417) Complete with editor and documentation.
ESIE (#398) Build and generate an expert system in a flash.
P-BASIC (#381) BASICA work-a-like for clones, etc.
TINY PASCAL COMPILER BUILDER (#540) Learn to create your own Pascal Compiler and language compiler/savings and investment portfolio. User friendly!
SCREENCODE (#503) Build your screen applications and watch SCREENCODE generate the code for DBASE II and III, BASIC, and more.
VISIBLE PASCAL COMPILER (#510) Watch your program step through its routines as you learn to program it in PASCAL.
EXTENDED BATCH LANGUAGE (#124) Makes the PC do menial tasks you never thought possible.

MATH AND STATISTICS

EPISTAT (#88) Statistical analysis of small to medium-sized data samples.
STAT-TOOLS (#509) (1 of 2) Do single size experiments, studentized ranges, calculate the size of specific sample sizes.
STAT-TOOLS (#509) (2 of 2) Do calculations that require the entry of original observations, exact randomization tests, mean squares, etc.

MUSIC

PC-MUSICIAN (#127) Compose music on your PC, save and play again.
PIANO MAN (#279) Play your keyboard like a piano.

PRINTER UTILITIES

SIDEWAYS (#265, 411) Prints text sideways on an Epson printer.
SETPRTR (#79) Sets up Epson printer from a menu.
PRINTER UTILITIES (#411) Smorgasboard of utilities and tools.
EPSON PRINTER UTILITIES (#326) Spool, set up routines all designed for Epson codes.
BANNER (#386) Make long banners with large letters. Includes MS-FORTRAN source codes.
WSMMX80 (#526) Allows Word Star to print more ways than you imagined on an Epson/Compatible

printer. Useful for mathematical and scientific notation.

SPREADSHEET TEMPLATES

PC-CALC (#199) Fabulous 123 work-a-like from the author of PC-File.
LOTUS 1-2-3 TEMPLATES AND MACROS (#406, 414) Why spend hours writing your macros when these are ready made? Modify them yourself.

TEXT PROCESSING TOOLS

WORDSTAR AIDS (#375) Collection of the most useful utilities for the Wordstar user.
PC OUTLINE (#414) Create and collapse and outline. Great for plans, essays, etc.
PC-STYLE (#505) Better than your high school English teacher! Analyzes your writing ability.
POLYGLOT & LETTERFALL (#542) Two educational programs to match sentences, words, and definitions. Q&S's. Typing tutor is great!
SIDE WRITER (#523) Print your text files sideways. Allows the 132 column barrier to be broken. Great for large spread sheets.

UTILITIES

GINACO (#66) Polished routines written in basic for any beginner or expert. We love it!
ULTRA-UTILITIES (#133, 245) Recover lost files, modify sectors, etc. Like Nortons.
SYSTEMU (#250) Build a menu driven menu system. Excellent for hard disks.
PC-DESKMATES (#405) Better than Sidekick and all of the rest of the memory resident desktop utilities.
ALIGN (#217) Disk Alignment tool.
TOP UTILITIES (#273) All of the most requested utilities on one disk.
NUMZAP (#284) Removes line numbers from BASIC programs.
UNPROTECT (#414) Various routines to disconnect protection schemes.
PATCHES (#376) Make back up copies of some of the most popular commercial programs with this collection.
DOSMATIC (#498) Fabulous task-switching and menuing utility that allows several.
PC-TOOLS (#536) Lots of useful utilities with both EXE and "C" source code. BROWSE, DUMP, MERGE, WORD COUNT, ROFF, GREP, etc.
DBS-KAT (#537) Diskette cataloging system for archival purposes. Database can hold up to 9,999 diskettes and 16,000 files.
STILL RIVER SHELL (#481) An enhancement of the PC-DOS working environment. Faster and uses Key Commands.
PC-PROMPT (#558) The on-line mode makes this memory resident utility tops. Great for beginners and advanced users alike.

WORD PROCESSING

PC-WRITE (#78) Our most popular full featured word processor that is actually faster than Wordstar.
DICTIONARY (#378) Dictionary type spelling checker.
PC TYPE (#455) Jim Button's contribution to a full fledged word processor.
NEW YORK WORD (#528, 529) Powerful word processor that creates keystroke macros, split screen editing, mail merge and more. Watch out Micro-Soft!

Inquiry 189

ORDER FORM

LONE STAR SOFTWARE, INC. 2100 Hwy. 360, Suite 1204, Grand Prairie, Texas 75050, (214) 647-1010

No COD's or Purchase Orders
U.S. Funds Only
Foreign Orders add \$5.00
to all Shipping/Handling
We Warranty All Disks Against Defects
In Duplication

TOTAL # _____ × \$6 = _____

DISK DIRECTORY _____
(Explanation of all files & programs) × \$6 = _____

OTHER _____

SUBTOTAL _____

TEXAS RESIDENTS ADD 6% TAX _____

SHIPPING AND HANDLING _____
(1 @ \$1.00 and 50¢ for each additional disk)

PLEASE ENCLOSE CHECK WITH ORDER

ENTER DISK NUMBERS DESIRED:

1. _____	13. _____
2. _____	14. _____
3. _____	15. _____
4. _____	16. _____
5. _____	17. _____
6. _____	18. _____
7. _____	19. _____
8. _____	20. _____
9. _____	21. _____
10. _____	22. _____
11. _____	23. _____
12. _____	24. _____

SHIP TO: _____

CHARGE MY:

MASTERCARD VISA

CARD NO. _____

EXPIRATION DATE _____

SIGNATURE _____

©1986 Lone Star Software, Inc.

Power Control

110/220 AC by your IBM-PC

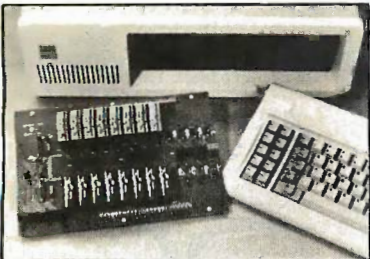

The boards allow you to Control/Monitor high voltage AC/DC power lines with your IBM-PC/XT/AT or compatible while providing optical isolation.

Q **QUA TECH, INC.**

478 E. Exchange St. Akron OH 44304
(216) 434-3154 TLX: 5101012726

Inquiry 272

RS-232

Communications Board



- For IBM-PC/XT/AT & comp.
- Dual RS-232C interface
- Optional software supports COM1, COM2, COM3, COM4
- Jumper selectable interrupts

Q **QUA TECH, INC.**

478 E. Exchange St. Akron OH 44304
(216) 434-3154 TLX: 5101012726

Inquiry 273

PC's & PERIPHERALS

QUANTITY BUYERS ONLY



TURBO XT CLONE 64K expandable to 640K, 135 watts P/S, keyboard FDC, 360 K disk drive fully burned & tested.

\$399.00 (3 Units Minimum)

AT CLONE 10/6 MHz switchable, 80286 CPU, 1 MB board U.S. made, 200 watts P/S, AT style keyboard, burned & tested.

\$999.00 (2 Units Minimum)

2400 Baud
Modem **\$189.00** (Qty. Only)

1200 Baud
Modem **\$ 85.00** (Qty. Only)

360 KB
Floppy Drive **\$ 67.00** (Qty. Only)

Color Graphics
Card **\$ 49.00** (Qty. Only)

Printer Cable **\$ 3.59** (Qty. Only)

XT Hard Disk
Cable Set **\$ 2.99** (Qty. Only)

20 MB Hard Disk Sub-System **\$359.00** (Qty. Only)

All of above prices are C.O.D. cash only. Prices and availability subject to change without notice.

CLONE FACTORY

(415) 656-5404

(213) 477-0447

(714) 731-5727

TWX: 5106003265

RS-422

Communications Board

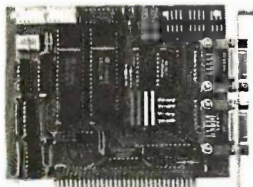

- For IBM-PC/AT/XT and compatibles
- Dual RS-422/RS-485 interface
- Differential drivers to 4000 ft.

Q **QUA TECH, INC.**

478 E. Exchange St. Akron OH 44304
(216) 434-3154 TLX: 5101012726

Inquiry 274

72 Digital I/O



PXB-721
Parallel Expansion Board

- For IBM-PC & Compatibles
- 72 Digital I/O Lines
- Simple Programming
- Uses One Expansion Slot
- Fast Delivery

\$195

Q **QUA TECH, INC.**

478 E. Exchange St. Akron OH 44304
(216) 434-3154 TLX: 5101012726

Inquiry 275

MODULAR DATA ACQUISITION



- For IBM & Compatibles
- Flexible and Inexpensive
- Money Back Guarantee
- Free Technical Support

Q **QUA TECH, INC.**

478 E. Exchange St. Akron OH 44304
(216) 434-3154 TLX: 5101012726

Inquiry 276

WAVEFORM SYNTHESIZER

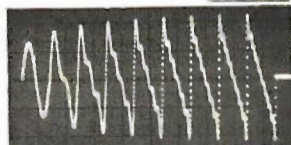

- For IBM-PC/XT/AT and compatibles
- Generates user-definable signal
- Up to 2000 points per envelope

\$795.00

Q **QUA TECH, INC.**

478 E. Exchange St. Akron OH 44304
(216) 434-3154 TLX: 5101012726

Inquiry 277

DiskMASTER[®]

The Ultimate Diskette Value ...



Discover The Difference ...

2 FOR 1 LIFETIME WARRANTY

- Performance exceeds ANSI specifications by 62.5%
- Each diskette 100% tested and certified error free
- 65% clipping level • Over 10 million passes per track
- Reinforced Hubs • Typek* (not paper) sleeves
- W/P tabs and ID labels

.38

5 1/4" - 48 TPI
DS-DD

Simply top Brand-Name Quality, made in the U.S.A. by a leading manufacturer. Factory polybagged in lots of 25.

1.19

DS-HD 96 TPI
IBM-AT Compatible

CentTech[®] Premium Quality Color Diskettes

- ✓ TIMELESS WARRANTY
- ✓ Performance exceeds A.N.S.I. specifications by 88%
- ✓ Each disk 100% tested and certified
- ✓ 14 COLORS for data organization
- ✓ Pkgs. of 10, tyvek sleeves, w/p tabs, and ID labels

SS-DD	QTY. 10 BOXES OR 100 DISKETTES	DS-DD
.74	5 1/4" Color, BOXED, 48 TPI	.98
1.39	3.5" Color, BOXED	1.95
.64	5 1/4" Color, BULK, 48 TPI	.88
1.30	3.5" Color, BULK	1.92
	High Density, Color, 1.6mb, IBM AT Compatible	1.95

Includes Tyvek sleeves, w/p tabs, ID labels
Call for excellent prices on other CentTech products



America's No. 1 Name-Brand Diskettes

- ✓ LIFETIME WARRANTY
- ✓ High quality and consistently reliable
- ✓ More rigid jackets than ever before

SS-DD	QTY. 5 BOXES	DS-DD
.74	5.25, 48 TPI	.99
1.35	3.5, 135 TPI	1.90
	DS-HD 96 TPI, IBM AT Compatible	1.95

Call for best 3M prices on head cleaning and data cartridges.

Nashua[™] Affordable Quality Incredibly Value Best Prices Ever!

- ✓ LIFETIME WARRANTY
- ✓ Factory Fresh in BOXES of 10 with sleeves, w/p tab, ID labels

SS-DD	QTY. 10 BOXES	DS-DD
.61	5.25, 48 TPI, box of 10	.65
1.25	3.5", 135 TPI	1.89
	High Density, IBM PC-AT Compatible	1.85

BULK SPECIAL OF THE MONTH Made in U.S.A.

- ✓ LIFETIME WARRANTY
- ✓ Exceeds ANSI specifications
- ✓ Includes Tyvek sleeves and w/p tab
- ✓ Hub Rings
- ✓ 100% tested and certified

5 1/4 DS-DD **35¢** OF 100 MULTIPLES

ORDERING INFORMATION

TERMS: Free use of VISA, Mastercard, and American Express. P.O. orders accepted from recognized corporations rated 3A2 or better, government and schools on net30. SHIPPING: Add \$3.00 per 100 diskettes or fraction thereof, add \$5.00 for COD orders.

PRICE PROMISE: We will better any lower delivered price on the same products and quantities advertised nationally.

Toll Free Order Line: **1-800-233-2477** Information Line: **1-801-561-0092**



199 Collage Avenue
Salt Lake City, Utah 84070
Hours 8am to 5pm (mtn. time)

TURBO PASCAL PROGRAMMERS Software Tools for Engineers and Scientists

IPC-TP-006 (\$74.95) - General Science and Engineering Tools - Over 100 of the most needed routines for use in Engineering and Science. Includes statistics, regression, engineering graphics (Hercules compatible), Fourier analysis, solution of equations, real and complex math, RS-232 support and much more. All source code provided.

IPC-TP-008 (\$99.95) - MetraByte Data Acquisition Tools - Turbo Pascal support for the MetraByte Dash-8, Dash-16, DDA-06, CTM-05, PIO-12, EXP-16 and DAC-02 data acquisition boards. Procedures are also provided for real-time graphics, PID control, thermocouple linearization and FFT's. Menu-driven programs allow you to start collecting data immediately with no programming. All source provided.

IPC-TP-017 (\$74.95) - DOS, BIOS and MS Mouse Tools - Every DOS and BIOS routine supported in DOS 3.1 has been implemented (over 170 routines in all) in this package. Read/Write/Format disks, access the real time clock, install interrupts, check the status of the a printer - all from within your program. Special Bonus: Microsoft Mouse Tools now included.

To order: Call (617) 444-7721 or write Quinn-Curtis, 49 Highland Ave., Needham, MA 02194. Mastercard, Visa, Company PO's, Personal checks, and COD orders accepted. Add \$5 to prices above for shipping outside of North America.

Inquiry 280

BAR CODES MADE EASY

PERCON[®] E-Z-READER[™]

NO SOFTWARE CHANGES with PC/XT/AT, AT&T 6300/7300, TeleVideo 905/955 keyboard, multi-user RS 232 interfaces • Auto-recognition of codes • Free phone support • 2 year warranty • Bar code printing software available.

Details or questions? Call us.

PERCON 2190 W. 11th Ave. Eugene, OR 97402 503/344-1189

HELP IS HERE !!!

Quit wearing out the pages of your software manuals! Mainframe and Mini users quit years ago. Now they use on-line HELP -- so why not step up and see what you've been missing? With **microHELP** you can have on-line access to the description and syntax for all your DOS commands and special programs. Novice DOS users find it a real aid in becoming familiar with DOS commands. Experts enjoy the increased productivity of having command information on-line.

- DOS 2.x and 3.x libraries supplied.
- Disk space requirements reduced using Huffman compression algorithm.
- A utility for adding new subjects to the library or for generating new libraries is provided.
- Complete source code to the access routines enable users to write programs that can access any library generated by **microHELP**. Great for program messages.
- Requires MSDOS or PC DOS 2.1 or later and 256k memory. Hard disk desirable but not required.

ONLY \$60.00 Checks and COD

VITAL SYSTEMS

P.O. Box 61738 • Palm Bay, FL 32906 (305) 723-1808

TRADEMARKS: microHELP (VITAL SYSTEMS), PC DOS (IBM), MSDOS (MICROSOFT).

Inquiry 364

64K ■ 128K ■ 256K

DRAMS

EPROMS

80287-10 ■ 80287-8 ■ 80287-3

8087-3 ■ 8087-2 ■ 8087-1

4416 ■ 4464

V-20 ■ V-30

BITTNER



ELECTRONICS



(714) 497-6200
CALL NOW FOR FREE CATALOG

Inquiry 44

Source Management

from S.C.E.

The **Seidl Make Utility** is a powerful product generation utility. When changes are made to source files, SMK executes the minimum set of commands needed to rebuild the product. SMK is loaded with features and performance you won't find in other Makes. \$99.95

The **Seidl Version Manager** is a set of tools and a full-screen, menu driven shell, that together form a state-of-the-art version control system. SVM maintains a complete revision history, speeds the edit-compile-test cycle, reconstructs product versions automatically, and much more. \$299.95 Only \$379.00 w/ SMK.

Dealer Inquires Invited.

M/C, VISA, C.O.D., accepted.

SEIDL COMPUTER ENGINEERING

3106 Hilltop Drive, Ann Arbor, MI 48103 (313) 662-8086

Inquiry 298

Flow Charting II[™]

FAST. SIMPLE. SPECIFIC.

Now build, update and print process flow and organizational charts easily, confidently.

- Readjust chart immediately after addition or deletion
- Travel quickly across a 120 or 200-column screen
- Move a single character or half a chart - instantly.

Present the true, current picture. Use Flow Charting II on your IBM[®] PC compatible system. General Motors, Bechtel, Touche Ross, Fairchild and 500 other major US corporations use it.

1-800/672-3470, ext. 897 Calif.

1-800/538-8157 ext. 897 National

408/629-5044 International

PATTON & PATTON

340 Lassenpark Circle
San Jose, CA 95136

IBM is a registered trademark of International Business Machine Corp.

Inquiry 250

NEW LOW PRICES!

NEW LOW PRICES!

DoKay

COMPUTER PRODUCTS, Inc.

ORDER TOLL FREE

(800) 538-8800

(CALIFORNIA RESIDENTS)

(800) 848-8008



RAMS

Table with 4 columns: Static/Dynamic, Capacity, Price. Includes items like 2114L, 2016, HM6116P, etc.

EPROMS

Table with 4 columns: Capacity, Price. Includes items like 2516, 2532, 2708, etc.

8088/8086 Up Grade

- V-20 5 Mhz 9.95
V-20 8 Mhz 12.95
V-30 8 Mhz 18.95
High Speed

DP-25 Solder Cup

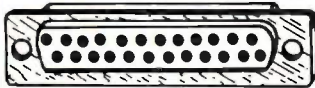

Male, Female, Hoods... 99¢ ea.

UV ERASERS

QUV-T8/1... \$49.95
ECONOMY Model



- Erases 15 EPROMS in 20 minutes
Plastic Enclosure

74LS00

Large table of 74LS00 series components and prices, including 74LS100, 74LS01, 74LS02, etc.

MEMORY EXPANSION KIT



41256 150ns \$2.89 each!

8000 8200 (continued)

Table of 8000, 8100, 8200, 8300, 8700, 80000 series components and prices.

Build An IBM PC XT \$532

- Compatible Computer
Motherboard XT... \$119
with Bios
150w Power Supply... \$69
1/2 Height Disk Drive... \$79
Floppy Controller Card... \$29
Case Flip-Top... \$29
5150 Keyboard... \$59
Monochrome Card... \$49
Monochrome Monitor... \$99
IBM PC XT Compatible \$532

IBM Accesories

- EGA Card... \$229
Turbo Mother Board... \$169
Mono Graphics Card... \$79
Memory Card... \$59
Multifuncion Card... \$79
Floppy Multi i/o Card... \$79
Color Graphics Card... \$69
1200b Modem Card... \$139
Teac 55 B (For IBM)... \$99
Fujitsu DS/DD (for IBM)... \$89
Joystick... \$29

Mac Upgrade Kit \$50



- 128K To 512K
Consists of:
(16) 41256, 150ns
(1) 74F253
(17) 16-Pin Sockets
Capacitors And Resistors

APPLE Accessories

- Parallel Card... \$49
Super Serial Card... 99
80-col Card II+... 149
80-col Card Iie 64K... 69
Z80 Card... 69
16K Card... 39
Cooling Fan... 39
Disk Drive (full)... 139
Disk Drive (half)... 129
Controller Card... 49
Joystick... 29

Table of 6500, 6500 A, 6500 B, 6800, 68800, 68000, Z-80, Z-80 A, Z-80 B, Z-80A (continued) components and prices.

POWER SUPPLY (Switching)

- +12V 0.4 Amp
-12V 0.3 Amp
+5V 5.5 Amp
19.95



1986 - THE IC MASTER - Your ticket to fast and easy IC selections

\$ 119.00

MACINTOSH, APPLE II, APPLE IIa and APPLE II+ are Trademarks of APPLE COMPUTER, INC. AT is a Trademark of IBM CORPORATION.

HOURS: Mon-Fri. 7:30 to 5:00

VISIT OUR RETAIL STORE
2100 De La Cruz Blvd.
Santa Clara, CA 95050
(408) 988-0697

ALL MERCHANDISE IS 100% GUARANTEED

DoKay

NEW LOW PRICES!

NEW LOW PRICES!

P.C. Computer Brokers Inc.

The Place To Buy Your Epson Printers

LX-86

List #349⁰⁰

\$229⁹⁵

420i

List #1995⁰⁰

\$995⁹⁵

FX-85

List #599⁰⁰

\$369⁹⁵

FX-286

List #799⁰⁰

\$499⁹⁵

FREE

Stand With Purchase

of any Epson Printer

LQ-800

List #799⁰⁰

\$519⁹⁵

LQ-1000

List #1095⁰⁰

\$719⁹⁵

Call Toll FREE

1-800-245-1455

THE MOST ESSENTIAL CARD FOR THE EQUITY I

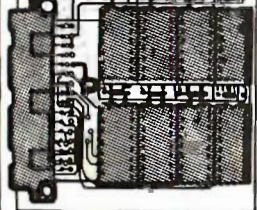

- Able to bring the mother board to 512K
- 1/2 the size of other cards
- Save up to \$70.00
- 3 year warranty Only

\$99⁹⁵

Call For Price On HS-80

EX-800

List #799⁰⁰

\$499⁹⁵

HI-80

List #369⁹⁵

\$369⁹⁵

EX-1000

List #995⁰⁰

\$689⁹⁵

LQ-2500

List #1595⁰⁰

\$1089⁹⁵

DX-35

List #650⁹⁵

\$650⁹⁵

Prices Subject to Change Without Notice

☐ Add 2.9% For Use of Visa, M/C & Choice. Add 5% For Use of Discover & Amer. Exp.

These Prices Are Good For Mail Order Dept. Only

P.C. Computer Brokers Inc.
3879 East 120th Ave.
Thornton, CO 80233
(303)450-6727

Call Toll FREE **1-800-245-4122**

P.C. MEMORY HOTLINE

Leader in Wholesale Pricing

SEAGATE, TANDON, OKI, AMDEK, TEXAN AND MORE

- 20MB Hard Drive HH \$255
- w/Controller \$345
- 30MB Hard Drive HH \$349
- w/Controller \$459
- 50MB Hard Drive HH \$629
- w/Controller \$819
- Floppy Drives HH \$66/99
- Controllers Call
- Monitor 12" Color 640x200 \$249
- Monitor 12" Color 640x400 \$319
- Printer Daisy Wheel 22 cps \$199
- Printer Daisy Wheel 40 cps \$299
- 4MB Memory Expansion Card \$199
- Modem 1200 Hayes Compatible \$ 99
- Color Graphics Card \$ 59
- Disk Head Cleaning Kit \$1.49

Please Call for Volume Discount
1-818-376-1440

Inquiry 99

COLOR

VT220 \$150

*plus your PC, XT, AT, or compatible

- ZSTEMpc-VT220 Smart Terminal Emulator
- Double high/double wide characters
- Full line graphics. Smooth Scrolling
- 2-way file transfers incl. XMODEM & KERMIT
- Full keyboard softkeys/MACROS. DOS access
- Data rates to 38.4 KB. High throughput
- CGA, Hercules, MDA, & EGA support
- 8-bit mode, downloadable fonts,
- user defined keys, full national/multinational modes
- ISO and attribute mapped color
- ZSTEMpc-VT220 \$150. 4010/4014 option \$99.
- Also available VT220 Style replacement keyboard
- ZSTEMpc-VT100 \$99. - Choice of the U.S. A/F
- 30 day money back guarantee. MC/VISA

KEA SYSTEMS LTD.
 #412 - 2150 W. Broadway
 Vancouver, B.C. CANADA V6K 4L9
 Support (604) 732-7411
 TELEX 04-352848 VCR

Order Toll Free (800) 663-8702

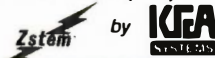

Inquiry 384

RS-232 to RS-422A CONVERTER

For Under **\$50!**

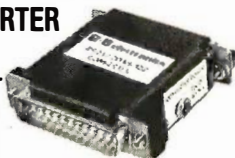

- Supports Transmit Data and Receive Data signals.
- Male 25 pin connector for RS-232C and female 25 pin connector for RS-422A. (Available with reversed conn. on special order). • Requires 12 Volts DC at 100 ma. Model 232PS Power Supply available @ \$14.95.
- Fully described in our latest catalog.

ORDER NOW! Model 422CON \$49.95
 Optional power supply \$14.95. Cash orders shipped postpaid. I.L. Res. add 6% sales tax. Visa and MasterCard accepted. Satisfaction Guaranteed. FREE fully illustrated newly revised catalog of interface & testing equipment. Phone: 815-434-0846

B & B electronics
 MANUFACTURING COMPANY
 1500W BOYCE, OTTAWA, IL 61350

Inquiry 35

NEW RELEASE

KEYSWAP 4.0 (tm)

Feature packed update for the power user
 A Keyboard Enhancer For the IBM PC, XT, AT*

KEYSWAP eliminates repetitive keystrokes and reduces data entry time.

- Over 40 new features
- Execute DOS commands thru windows
- Automatically cut and paste screen text
- Create custom windows for :
 - tutorials, help screens, demos & menus
- Organize your macros into groups by function
- On-line multi page macro editor
- Detailed On-line HELP
- Keyboard security lock
- Speed control and pause features
- Totally rewritten User's Manual (quick start)
- And much more

Prices: \$79.95 + \$3.00(s&h) MC&VISA, PO, COD, CK

Call or write for more Info. (617) 662-0856
 Rickerdate, Inc., PO Box 998, Melrose, MA 02176
 *Registered trademark IBM Corp.

Inquiry 286

American Semiconductor

THE BARE XT TURBO SYSTEM

\$399

"Looks, tests, and acts like an IBM, AND it's 100% compatible."

8087 \$119.00
 80287-3 175.00
 80287-8 239.00
 64K99
 41256K-150 2.39
 41256K-200 1.99

BABY AT \$499.00
 AT 1100
 V-20 14.00
 FLOPPY DD/DS 75.00

XT & AT ADD ON CARDS
 For AT, XT, Compaq, & Corona:

20M B Hard Drive \$299
 30MB Hi-Speed RLL KIT \$499

TO ORDER TOLL FREE CALL
1-800-237-5758, EXT. 819

Inside Florida Technical Line
 813-961-9444 1-813-961-5584

16520 N. Florida Ave., Lutz, Florida 33549
 Add 3.2% for VISA/MC purchases.

Inquiry 27

DYNAMIC RAMS

41256	100ns	\$4.85
41256	120ns	\$2.95
✓41256	150ns	◀\$2.69
4164	120ns	\$1.40
✓4164	150ns	◀\$1.10
4464	150ns	\$3.95

PROCESSORS			E PROMS		
8087-2	8MHz	\$159.00	27C256	250ns	\$6.50
8087-3	5MHz	\$115.00	27256	250ns	\$5.25
80287-3	6MHz	\$169.00	27128	250ns	\$3.95
80287-8	8MHz	\$ CALL	27C64	200ns	\$4.50
V-20	8MHz	\$ 12.75	2754	250ns	\$3.25
V-30	8MHz	\$ 14.00	2732A	250ns	\$4.25
STATIC RAMS			8000's		
6264LP-15	150ns	\$2.95	(Parts in stock)		

I.C. EXPRESS

15358 Valley Blvd., City of Industry, CA 91746
 Phone: 818-369-2688 (Mon-Fri • 8-5)
ORDER TOLL FREE
(800) 892-8889 • (800) 882-8181
 Outside California
 CALL FOR CURRENT PRICES & VOLUME DISCOUNTS
 Price Shown for Cash + MasterCard/VISA add 3% more.
 Prices are subject to change. Minimum order \$10.00.
 California residents must add 6.5% sales tax.
 Shipping & Handling: UPS Ground \$5.00, UPS Air \$7.00 (under 1 lb.)
 ALL MERCHANDISE IS 100% GUARANTEED.

Inquiry 157

DISK/RIBBON WAR

NOW ALL BULK DISKS CAN BE BOXED AT NO EXTRA CHARGE

5.25" DISKS (Minimum 30) BULK OR BOXED

ss/dd	.44
ds/dd	.49
ds/dd notchless	.59
ds/dd floppy	.59
ds/dd 10 hard sector	.69
ds/dd 16 hard sector	.69
ds/qd 96 tpi	.79
ds/qd 96 tpi 10 hard sector	.99
ds/qd 96 tpi 16 hard sector	.99
ds/hd 1.2mb for AT	1.49

RIBBONS (Minimum 3) Call it yours is not listed

Apple Imagewriter I, II, Prowriter	2.39	NEC Pinwriter P1/P2	4.99
Apple Imagewriter Multicolor	11.99	Okidata 82/83/92/93/801	.99
Commodore MPS 801	3.99	Okidata 84/94	2.19
Diablo Hytype II	2.99	Okidata 182/192	3.99
Epson LQ 800	6.99	Panasonic KXP 1090, 91, 92	6.29
Epson LQ 1000	9.99	Radio Shack LP, VI, VIII	2.99
Epson LQP 1500, Epson LX 80	2.99	Radio Shack LPVII	3.99
Epson MX/FX/RX 100/185	3.19	Star Gemini 10X/15X	.99
Epson MX/FX/RX 70/80/85	2.39	Star Radix 10	4.49
IBM Proprinter	3.99	Star Radix 15	5.49
		Toshiba P 1350	2.99

5.25" COLOR DISKS BULK OR BOXED

ds/dd color pack assortment A, B, or C †	.59
ds/dd color pack assortment A floppy †	.69
† Color pack assortment A: red, orange, yellow, blue, green.	
† Color pack assortment B: maroon, brown, dark blue, silver, gold.	
† Color pack assortment C: pink, med. blue, beige, white, light grey.	
† All colors are available separately, except floppys.	

FREE BONUS OFFER YOUR CHOICE

IF YOU ORDER	YOU GET	VALUE
100 DISKS	5 DISKS PUBLIC DOMAIN SOFTWARE FOR IBM/MAC OR APPLE OR	\$14.95
100 DISKS	HEAD CLEANING DISK	\$12.99
150 DISKS	DISK ORGANIZER (Holds over 20 disks, disk file, etc.)	\$19.99
200 DISKS	PRINTER STAND	\$29.99

3.5" DISKETTES BULK OR BOXED

ss/dd-Blue/Beige or Grey	1.39
ds/dd-Blue/Beige or Grey	1.59
ds/dd color pack A	1.69

8" DISKS BULK OR BOXED

ss/dd soft sector	1.49
ds/dd soft sector	1.69
ss/dd color pack, asst. A†	1.69
ds/dd color pack asst. A†	1.89

- FREE TYVEC SLEEVES, HUB RINGS, WRITE PROTECTS AND ID LABELS — 10 MIL JACKETS
- MAGNETIC TAPE — DISK PACKS AND CARTRIDGES — BEST PRICES — CALL
- QUALITY & SERVICE OUR #1 PRIORITY — BUY DIRECT — NO MIDDLE MAN — NO MUMBO JUMBO
- ALL ITEMS IN STOCK ALL THE TIME — SAME DAY SHIPPING — DISKS MADE IN THE U.S.A. — 70% CLIPPING

PUBLIC DOMAIN SOFTWARE — IBM COMPATIBLE — ONLY \$2.99 (MINIMUM 5)

3408) Still River Shell v. 1.33: Run DOS commands from a menu

223) Insults: Generate random insults on screen for the unsuspecting PC user.

1501) Chasm: Cheap Assembler

302) Q-Modem version 2.87: Fast modem software

402) Unprotect Protected Programs Disk: This disk gives you tips.

401) 8086, 8087, 8088 disassembler.

201) JetSet Flight Simulator: Turn your PC into the pilot's cockpit

101) PC-Write: Full screen word processor

109) Galaxy: This word processor is command compatible with WordStar, but also offers pull down menus for the forgetful or the novice.

308) ProCOM with random redial capabilities. (Hackers love this one!)

2808) PC-Outline version 1.08: Outline your papers, to-do lists, ideas, or strategies. Has an optional memory resident mode.

113-114) New York Word: a very powerful word processor that has too many features to list

237) Hack: A display oriented Dungeon and Dragons adventure game. This program was ported from a UNIX system and requires 256K RAM.

243) Pinball. This disk has three games which have been created using the program "Pinball Construction Set" by Bill Budge.

3425) MSDOS CPM/80 conversion. This program allows you to transfer data between various CP/M and MS-DOS formats.

3422) CTRLALT: This RAM resident utility is a must! Too many features to list here!

... and many more!

THE "CARETAKERS"™

10 disk library case 3.5" or 5.25"	.99
10 disk library case 8"	2.49
40 disk storage case 3.50" w/lock	7.99
50 disk storage case 5.25" w/lock	7.99
100 disk storage case 5.25" w/lock	9.99

ACCESSORIES

Drive head cleaning disk 3.5/5.25/8"	12.99
Tyvec sleeves white — 100 pk.	5.99
Tyvec sleeves color — 100 pk.	8.99
ID labels/write protect — 100 pk.	1.99
Disk mailer box (3/5.25") — 10 pk.	8.99
Disk mailer box (3/8") — 10 pk.	9.99
Disk organizer	19.99
Printer stand	29.99

Lifetime warranty on disks. Satisfaction guaranteed or money refunded within 30 days. Disks packaged in 10's — Minimum 30 disks. Checks (allow 10 days to clear), money orders, MasterCard, Visa, American Express, C.O.D. (add \$1.90). Purchase orders accepted from qualified public institutions, government agencies and well-rated companies, net 30 days. California residents add 6%. For information, call (619) 942-9998. Call for free catalog.

PRIVATE DEALER LABEL
AVAILABLE AT
NO EXTRA CHARGE

800-992-1992
NATIONAL

ORDER
TODAY

800-992-1993
CALIFORNIA

Over 200
Special Formats for
5 1/4" and 8"
from \$1.99 (Call)

U.S./DISK, INC.

Hours Mon. - Sat.
8:30 am - 4:30 pm
511 - 104 Encinitas Blvd.
Encinitas, CA 92024



the
giveaway.

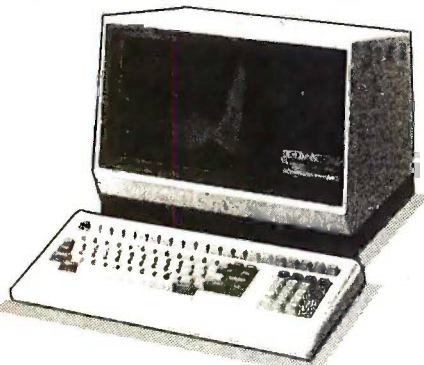

SANYO
MBC 1200

**FREE SOFTWARE
FROM MICROPRO**

- Thousands of FREE public domain software available
- COMPAT disk utility for over 50 CP/M formats—only \$39
- Professional accounting software available
- 20 meg harddrive optional

\$399

Special pricing for printers

**EDUCATIONAL
DISCOUNTS**

805/393-2247



For our catalog with complete details and prices, send \$2 to:
Micro Supply Organization, Inc.
4909 Stockdale Hwy., #180
Bakersfield, CA 93309

15% Restocking on Returned Orders

Visa & M.C. Accepted

\$91.00
Single Board Computer

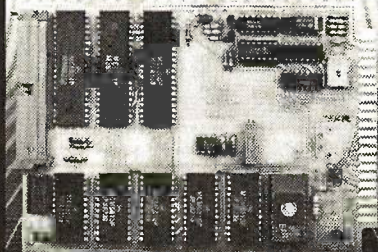

100 piece price, model MBC1205 (shown)

6800 MPU, serial I/O, parallel I/O, RAM, EPROM, 44-pin 4.5" x 6.5" PCB
EXPANSION MODULES: RAM, EPROM, CMOS RAM/battery, analog I/O, serial I/O, parallel I/O, counter/timer, IEEE-488, EPROM programmer, floppy disks, cassette, breadboard, keyboard/display.

WINTEK
Wintek Corp.
1804 South Street
Lafayette, IN 47904
317-742-8428

Inquiry 376

**ONE COMPUTER &
TWO PRINTERS?**

Stop Plugging & Unplugging!
use your choice of TWO printers from ONE parallel cable with the simple flick of a switch.



\$65.95
Plus \$3.25 Shipping

30 Day Money Back Guarantee
Model #2100

One Parallel Plug In... Two Parallel Plugs Out!
Connect any Standard Centronics Parallel Cable directly to the switch. Two 3 1/2' cables (included) attach to each printer.

Simply Call 1-800-TO-ASK-US! 8am-5pm PST
800-862-7587
(CA 415/567-4067)

To Order: Write or call Tipz Direct, Inc. Visa/MC or Money Orders please. Shipping within 48 hrs. via UPS.

Offering a FULL LINE of Switches, Cables, & Accessories

P.O. Box 690, San Francisco, CA 94101-0690 **Tipz** BYT-210

Inquiry 343

PC-WRITER T.M.

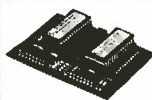

IBM PC GRAPHICS & LETTER QUALITY
Enhancement for Okidata ML82A/83A Dot Matrix Printers

- Plug-in module easily installs in printer.
- Draft (120 cps) & Letter Quality (30 cps)
- Elite character pitch
- Front panel access to all features
- Emulation of IBM PC Graphics printer
- Superscripts / subscripts
- Foreign / scientific characters
- Works with print screen key in graphics and text
- Prints all 228 display screen characters and box drawing symbols exactly as they appear on display (double line as well as single line box symbols)

Ask About OK-WRITER™ Okidata graphics for \$99 with many of above features

RAINBOW TECHNOLOGIES, INC.
17971-E Skypark Circle, Irvine, CA 92714
(714) 261-0228 Telex 386078
UK Distributer: X-DATA (0753) 72331

Inquiry 285

NO SHIPPING CHARGES
ORDER TOLL-FREE 800-824-3432
In California Call (818) 341-8833

DRIVES

1/2 Ht. IBM™ Compatible **89.99**
Tandon 100-2 **99.99**
Tandon 100-4 (96 tpi) **129.99**

SYSTEMS

PC/XT Compatible 499.99

- 640K on Motherboard
- Slide-In Case
- 1-1/2 HT. Floppy
- 135 Watt Power Supply
- Mono Card w/Printer Port
- 5150 Type Keyboard

→ **FCC APPROVED** ←

We carry a complete line of electronic components. Call or write for our free catalog!

NICORN ELECTRONICS
10010 Canoga Ave Unit B-8 Chatsworth CA 91311

Minimum order \$1000 — No shipping charges on prepaid orders — C.O.D. add \$3.00 — UPS Blue add \$3.00 — Call residents add 6% sales tax Personal checks held for clearance VISA MC

Inquiry 359

**TERMINAL
EMULATION**

Softerm PC emulates over 30 popular terminals including the:

- DEC VT102, VT220
- Data General D200, D410
- IBM 3101-20 (block mode)
- Hewlett-Packard 2622A
- Honeywell VIP7801, VIP7803

Guaranteed Compatibility

Call for free product brief!

\$195 MC-VISA-COD

For the IBM PC/XT/AT, DG, NEC, Wang, TI, Gridcase, Tandy, Zenith

SOFTRONICS

7899 Lexington Dr., Ste 210
Colorado Springs, CO 80918
1-800-225-8590/(303) 593-9540

Inquiry 308

**PC Compatible
CASH DRAWERS**



M-S CASH DRAWER

10711 Flower St., Stanton, CA 90680

(800) 544-1749

In California call:

(714) 821-1133

Inquiry 194



FROM THE ACP CIRCUIT SELLER

Advanced 286 \$1395⁰⁰
Advanced PC/XT \$549⁰⁰



20 Mb Upgrade \$449 20 Mb Mega card \$479
Package (1 Yr War) Plug-in 1 Yr War)

SEAGATE FOR AT

(Linear Voice Coil Activator)
20 Mb for AT \$499.00
30Mb for AT \$599.00
40Mb for AT \$799.00
(Inc. Cable & Mounting Rails)

IRWIN TAPE BACK-UP for AT \$399.00

PC UPGRADE SPECIAL

\$1495 SET OF (9) 64K RAMS
\$3695 SET OF (9) 256K RAMS
\$13995 8087 COPROCESSOR
\$16995 8087-2 COPROCESSOR
\$22500 80287 - 6-8 Mhz
\$26900 80287-8 - 10 Mhz
1200 Baud Hayes™ Comp. Modem
List \$299. ACP \$139⁰⁰
1200 (Ext.) \$149.00
2400 Baud (Int.) \$249.00

10Mb HARD DISK \$189.00

SYSGEN 20/20



• 20Mb Hard Disk
• 20Mb Tape Back-up
• New/Factory Box
• PC/XT/AT Comp.
• External Complete

Reg. Retail \$3300

ACP Only **\$888**

SEAGATE ST225 20Mb Hard Disk \$349.95

MS-DOS LAPTOP Sharp PC5000

Formerly sold for \$1995.
2800 in stock new in box w/factory warranty!
Vol. discounts available.
128K Bubble Printer \$79.00 Supercom \$59.00
Wordstar \$150.00 Superwriter \$88.00
Modem 300 Baud \$129.00 Color Plotter \$149.00
PFS File/Report \$99.00
Soft Carry Case \$129.00
Soft Key Plotter SW \$10.00
Soft Key Plotter SW \$35.00

SEAGATE ST4038-30Mb Hi-Speed, 40 mS, AT Compatible Drive \$599.00

Advanced PC/XT

- FCC/UL Approved
- IBM PC/XT™ Compatible
- (1) 360K Floppy
- 256K Expandable to 640K
- Serial, Parallel, LCD
- RGB Color Graphics
- Composite Video
- Mouse & Keyboard
- 10Mb Hard Disk (Add \$300⁰⁰)

HARDWARE

Advanced Cards
Largest Selection!



A210 Color/Printer/Graphics	\$88.00
A220 Color/Graphics/Video/Mouse	95.00
A230 Mono/Color/Graphics/132 Col	149.00
A231 Color/Mono (Runs 2 Monitors)	149.00
A240 Mono/Printer/Graphics	79.00
A250 Mono/Printer/Graphics/132 Col	119.00
A260 Mono/Printer	75.00
A271 EGA/256K RAM - Short Card	229.00
A320 384 Multi-function Card - OK	99.00
A330 Multi-function - Short Card	99.00
A340 Multi-function/Floppy	119.00
A350 640K RAM Card - OK	59.00
A410 Floppy Card - 2 Drives	39.00
A420 Floppy Card - 4 Drives	49.00
A510 Parallel/Serial, Optional Ser.	69.00
A520 Parallel Card	35.00
A530 Serial Card	49.00
A610 AT 2Mb Multi-function - OK	139.00
A612 AT 2.5Mb RAM Card	139.00
A620 AT 3Mb RAM Card	159.00
A630 AT Parallel/Serial, Optional Ser.	59.00
A640 AT Floppy/Hard Controller	249.00
A650 AT I/D Card - Ser/Par/Clk	55.00
A950 AT Motherboard - OK	499.00
A955 XT Motherboard - OK	119.00
A960 XT Turbo Motherboard - OK	139.00

AST - (1 to 2 Year Warranty)

AST5251-11	595.00
AST5251-12	495.00
RAMpage Expandable to 2Mb	Call
RAMpage AT Expandable to 2Mb	Call
(Both boards support EMS & EEMS)	
Advantage 128K	365.00

AST SPECIALS

REDUCED TO MOVE LIMITED SUPPLY

SixPak Plus w/64K	Only \$166.00
Including Sidekick 1.5 & DESKview	
SixPak Plus 384K	Only 219.00
Combo Plus - OK	Only 66.00
Combo Plus - 64K	Only 79.00
(Makes superior I/D Device)	
Reach Modem 1200 Baud	199.00
AST Colorgraphics Card	99.00
(Original Factory Box)	

HAYES - (2 Year Warranty)

Smartmodem 1200	\$385.00
-----------------	----------

HARDWARE

Smartmodem 1200B	349.00
Smartmodem 2400 (Int)	575.00
Smartmodem 2400B	535.00
Hayes Comp. 1200 (Ext)	169.95
Hayes Comp. 1200 (Int) w/SW	149.95
Hayes Comp. 2400 (Ext)	349.00

HERCULES

Hercules Color Card	\$166.00
Hercules Plus Graphics	NEW 239.00

INTEL - (5 Year Warranty)

Above Board PC, AT, PS New Price
FREE OFFER Windows thru 12-31
8087 or 80287 thru 9-30

KEYTRONICS

5150 Keyboard	\$159.95
5151 Deluxe Keyboard	169.95
5153 w/Touchpad	285.00
PC Jr. Numeric Keypad	29.95
NEW 101 Key	Call

MICROSOFT

Microsoft Mouse	\$139.00
Microsoft Bus Version	155.00

MOUSE SYSTEMS - (3 Year War.)

PC Mouse w/Paint Plus	\$138.00
PC Mouse w/Ready & Paint	148.00
ACP Mouse w/Keyboard	SALE 149.00

PROMETHEUS - (1 Yr. Warranty)

ProModem 1200 w/Mite (Int)	\$299.00
ProModem 1200B	259.00
Alphanumeric/Options Processor	79.00

TECMAR CLOSEOUTS

Call for Complete List	List	ACP
Speechmaster	\$395	\$195.00
1st Mate w/64K	389	169.00
Voice Recognition	995	269.00
3rd Mate	445	195.00
Powerlink 3270	1099	399.00
Phonegate 2400	695	295.00

PRINTERS

BROTHER	
M1109 Dot Matrix	\$249.00
M1509 Dot Matrix	399.00
DIABLO/XEROX	
620 Serial LQP	was 1495 now \$299.00
620 API LQP	349.00
620 D36 (36cps)	399.00
Tractor	was 395 now \$125.00
F-21 Sheet Feeder	was 896 now 199.00
630 Sheet Feeder	219.00
Cable for 620 (to IBM)	29.00
Diablo P-11 or S-11 100cps	129.95
Diablo P-31 or S-31 Wide	199.95

EPSON - (1 Year Warranty)

FX85 160cps NLQ	\$365.00
FX286 160cps Wide	\$499.00

TOSHIBA

P321 "3 in 1" LQ Printer	sale \$515.00
P351E 24 Pin w/Serial & Parallel	Call
New Toshiba Color Printer	Call

8 PEN PLOTTER - Limited Special

Roland DXY-800 Flatbed X-Y Plotter.
Formerly sold for \$995.00. While Supply lasts your price only \$499.00
Inc. Parallel/Serial Interface. IBM Compatible.
DXY 299.00

MONITORS

Samsung TTL IBM Green	\$88.00
Samsung TTL IBM Amber	98.00
ACP 12" Software TTL IBM	139.00
Mitsubishi RGB Color	259.00
TECA EGA Monitor	399.00
Roland CD240 HiRes Color	359.00

PRINCETON GRAPHICS

HX-12 RGB (640x240)	\$445.00
MAX-12E Amber TTL	175.00
SR-12	575.00
HX-12E (690x350)	545.00

Advanced 286

- FCC/UL Approved
- IBM AT™ Compatible
- 6/8 MHz SW Switchable
- 640K, 200 Watts
- 1.2 Mb Floppy Controller
- Floppy Controller
- Phoenix BIOS
- MS-DOS 3.2 (Add \$85⁰⁰)
- GW Basic (Add \$95⁰⁰)
- 30Mb 35mS HD (Add \$700⁰⁰)

EGA SPECIALS! EGA UPGRADE KIT

Includes:
NEC Multisync
ACP/EGA Card **\$71900**

NEC Multisync	\$599.00
ACP RGB Color/Teco. Tatung	399.00
RIX EGA Paint	59.00
Paradise Autoswitch	375.00
Genoa EGA	295.00
Orchid Turbo EGA	585.00
Quad EGA Plus, Quadram	365.00
Advanced EGA, 256K, Short Card	229.00
EGA Mouse	119.00

PGA SPECIALS

IBM Professional, Limited Quantity
IBM PGA Card, Regular \$2995 Sale 1195.00

HARD DISK CARDS

20Mb MEGA Card	\$479.00
20Mb Mountain Card	599.00

BEST BACK-UP

Use same back-up device we use at ACP.
AlphaMicro VCR Back-up Card \$399.00
AlphaMicro VCR 699.00

DISK DRIVES

Toshiba FDD4403 3 1/2" w/5 1/4" Bezel	\$129.00
Toshiba ND040 PC, XT 360K	95.00
Toshiba ND04E-G AT 360K	105.00
Toshiba ND08DE-G 12Mb	129.00
TEAC FD-55B	99.00

DISKETTES (Box of 10)

DS/DD for PC/XT (40tpi)	
• ACP Generic	\$6.00
• Verbatim Datalife	16.00
• Maxell MD-2	19.00
• Fuji	16.00
DS/Hi-Density for AT (96tpi)	
• Verbatim	\$32.00
• Maxell	35.00
• Fuji	26.00
SS/DD for Apple II etc.	
• ACP Floppy (Use both sides)	\$6.00
• Verbatim	14.00
• Maxell MD-1	17.00
• Fuji	14.00
Macintosh/IBM Conv. 3 1/2"	
• Maxell MF-2DD	\$52.00
Fuji MF-2DD (135tpi)	52.00
Fiji-Sort (75 Disks)	14.00
ACP 5 1/4" Disk Holder	9.00
ACP 3 1/2" Disk Holder	12.00
Head Cleaner 5/4" or 8"	9.00
Perfect Computercare Kit	29.00

★ Advanced Computer Products Inc.

TOLL FREE

800-854-8230

CA Residents **714-558-8813**

OUR POLICY

- No Surcharge for VISA or Mastercard.
- Volume purchasing agreements available.
- Orders subject to availability. • Supply limited on certain items.
- Pricing subject to change without notice.
- ACP Retail Store pricing may vary. Not responsible for typos.

Inquiry 9

Mail Order: P.O. Box 17329 Irvine, CA 92713
Retail: 1310 B E. Edinger, Santa Ana, CA 92705

**CORPORATE BUYERS - CALL
GILLES, LOUANE, MANDI, MIKE or DAVE**

DISK-KING®

Premium Quality Diskettes From the
Kings of Magnetic Media
Incredible Value!

WHY RISK THE UNKNOWN... when you can get premium quality disks from the Leader and Inventor of magnetic media... **for less!**

- * 100% tested & certified at 65% or higher clipping level*
- * 10 mil sturdy jacket * LIFETIME WARRANTY *

5.25" SS-DD-RH 48 TPI	38¢
5.25" DS-DD-48 TPI	38¢
5.25" DS-DD-RH 48 TPI	58¢
5.25" DS-HD-96 TPI	\$1.29
3.50" SS-135 TPI	\$1.15
3.50" DS-135 TPI	\$1.39

Factory sealed in lots of 25 Includes Tyvek® sleeves, user ID labels, w/p tabs and reinforced hub rings. Multiples of 100, lesser quantities add 10%.

FREE! Flip 'n File with 3.50" disks.
Flip 'n File / 15 only \$1.99 with each order
of a case (5 bx) 3M 5 1/4" disks!



FREE! Scotch CX-60 Cassette

SS-DD-RH plus \$2.00 rebate certificate inside each 3M 5 1/4" box	DS-DD-RH
75¢	97¢
\$1.39	\$1.99
DS-HD for the "AT"	\$2.05

(Quantities less than 5 bx, add 10%)



The Technology Whose Time Has Come
3M Data Cartridges

DC-100A	\$1.79	DC-300 XL/P	\$1.85
DC-1000	\$2.40	DC-600A	\$2.65

(Quantities less than 10, add 5%, Shpg. \$3.00/5 cartridges)



SUPER SPECIAL OFFER
BASF "Boxed Product"

SS-DD Qty less than 10 BX, add 10%	DS-DD
69¢	75¢
Pre-packaged in Plastic Storage case	79¢
\$1.29	\$1.87
DS-HD for the "AT"	\$1.95



UNBELIEVABLE PRICES!

Nashua



SS-DD Qty less than 20 BX, add 6%	DS-DD
\$5.95	\$5.99
\$11.90	\$16.90
DS-HD for the "AT"	\$16.99

COLOR DISKETTES

Premium Quality U.S.A. Made
Available in Rainbow &
many other color options

LIFETIME WARRANTY	Bulk	Boxed*
5.25" DS-DD 48 TPI	59¢	72¢
5.25" DS-HD 1.6 MB for the "AT"	\$1.75	\$1.89
3.50" DS-135 TPI C-1TOH Rainbow Color	\$1.79	\$1.89

*Boxed - pre-packaged 10 to a clear plastic library case.
Bulk - Polybagged 25 of a solid color. Included Tyvek® sleeves, user ID labels, w/p tabs and hub rings.

CALL FOR OUR SUPER LOW PRICES ON WIDE RANGE OF RIBBONS
DISK PACKS, COMPUTER TAPES & DISK STORAGE.

ORDER TOLL FREE 1-800-523-9681

TERMS: VISA, MasterCard, American Express. COD orders only add \$3.00. Prepaid orders deduct 2% cash discount. PO's accepted from corporations rated 3A2 or better, government and schools on 2%-0, net 30. FPO, APO, AK, HI, PR add 5% - No sales tax outside Utah! Minimum order \$30.00
Shipping: Add \$3.00 for 100 or fewer diskettes.

WE BEAT ANY PRICE!

Toll-Free Order Line: 1-800-523-9681
Telex: 755485
Inquiries & Info Line: 1-801-942-2273

DISK-COTECH

DISK-COTECH TECHNOLOGIES, INC.
2034 E. 7000 So. Salt Lake City, Utah 84121
Hours: 8 AM-6 PM (Mtn. Time) - Half day Saturday

DATAFLEX™

- Multi-user Database!
 - Powerful!
 - Multiple Operating System Compatibility!
 - Attractive Dealer Pricing!
 - Full Dealer Support!
- Dataflex is a trademark of Data Access
Dealer Inquiries Invited

COGITATE

24000 Telegraph Road
Southfield, Michigan 48034 USA
(313) 352-2345

Inquiry 72

ROMDISK

EPROM AND RAM DISK AND DRIVE EMULATORS
For the IBM PC* and Compatibles
APPLICATIONS

- Diskless control and communications systems
- Dedicated workstations - customized smart terminals
- Industrial control and manufacturing test systems

FEATURES

- Solid state speed, reliability and performance
- Self contained EPROM programming circuitry (simply copy a Master Disk to ROMDISK)
- Emulates a 9 sector, 40 track SSDD or DSDD diskette
- Compatible EPROM, Dynamic RAM and Static RAM versions
- Two autoboot modes and a file mode
- RAMdisk versions are battery backed up
- I/O mapped - does not occupy system RAM space

EPROM version PCA-1 (180K)	\$495
EPROM version PCA-2 (360K)	\$595
Dynamic RAM version PC DRAM-1 (180K)	\$495
Dynamic RAM version PC DRAM-2 (360K)	\$595
Static RAM version PC SRAM-1 (180K)	\$495
Static RAM version PC SRAM-2 (360K)	\$595



CURTIS, INC. 22 Red Fox Road
St. Paul, MN 55110 612/484-5064

*IBM PC is registered trademark of IBM Corporation

Inquiry 93

SAVE MONEY EPROM PROGRAMMER



APROTEK 1000 ONLY

\$265.00

COMPLETE WITH PERSONALITY MODULE

117 AC POWER-RS-232 CONNECT
-6 BAUD RATES - HANDSHAKE TO HOST
ALLOWS READ, WRITE, VERIFY & COPY
Comes complete with IBM-PC, Apple, or CPM (Specify Computer) Driver Program on Disc.

Programs the following 5 Volt 24 or 28 pin devices: 2716 series through 27512, 25xx series, 68764 plus others. Please Specify Personality Module desired with order. Additional Personality Modules only \$15.00 ea. Full 1 year warranty.

TO ORDER: CALL 1-800/962-5800 OR WRITE
APROTEK
1071-A AVENIDA ACASO Add
CAMARILLO, CA 93010 \$4.00 Shipping USA
Info: (805) 987-2454 VISA or MC Add 3%
We Accept Govt., School & Large Corp. P.O.s

Inquiry 30

PC/XT USERS!

- COGTREE Utilities by
Cogitate \$129.95
- LYNC by Norton-Lamber \$199.95
- DATAFLEX by Data Access...Varies
- RM/COBOL by Ryan/
McFarland Varies
- Universe by Omnitrend \$ 98.50
- Blue MacI by Cogitate \$599.00
- CadPower+ by Trilex \$995.00
- Softext Teaching Aids \$ 95.00
- PrintSet by Cogitate \$ 79.95
- CogiTAPE by Cogitate CALL!!
- Anti-Static Products Varies
- Uninterruptible Power
Backups Varies
- TeleVideo Software CALL!!

COGITATE

"A Higher Form of Software"
24000 Telegraph Road
Southfield, MI 48034
(313) 352-2345/Telex 386581

VISA/MASTERCARD ACCEPTED
Dealer Inquiries Welcomed

Inquiry 73

CHANGING SYSTEMS? What Happens to Your Data? Does JUST Media Conversion Solve Incompatibilities?

WHAT IF...

everything is changing, including your software, hardware, operating systems and media? What happens to your spreadsheet data and formulas, database structures and/or word processing documents and codes?

What do you do, and what is the cost?

We Make Incompatible Data Compatible!
The source can be mainframes, minis, micros, dedicated word processors or typesetters.
ADAPSO member.

CompuData Translators, Inc. 213-462-6222
6565 Sunset Bl., #301 Hollywood, CA 90028

Inquiry 75

Why waste time? ACCELERATE with VCACHE™

HARD DISK ACCELERATOR

- Caching eliminates repetitive disk accesses
- Use up to 15 Mb of extended/expanded or 500 Kb of standard memory

DISKETTE ACCELERATOR
SCREEN ACCELERATOR
FAST - FRIENDLY - SAFE
VCACHE

GOLDEN BOW SYSTEMS

\$65

Add \$3 for shipping/handling
California residents add 6% sales tax



2870 Fifth Avenue
Suite 201
San Diego, CA 92103
619/298-9349

Inquiry 141

PC COMPATIBLE SYSTEMS

WE CARRY A WIDE RANGE OF DESKTOP, LAPTOP & PORTABLES DESIGNED TO RUN THE SOFTWARE THAT FUELS TODAY'S BUSINESS.

"BIG BLUE CLONE"

NOT JUST AN ECONOMICALLY PRICED PC - WE'RE DOWN IN THE DIRT ON PRICE! LET'S MUD WRESTLE A DEAL FOR YOU ON A B.B.C. THAT'S "FCC" APPROVED WITH 1 YR LIMITED WARR. BASIC B.B.C.

256K TURBO W/ 8 SLOTS, 150W P/S, SLIDE CASE, SPKR & AT-STYLE K.B. \$424

CALL OUR SALES PROFESSIONALS FOR ADDITIONAL OPTIONS

ACS ET-286 10 MHz, 1Mb, CLK-CAL, 2P & 3S PORTS, CABINET, 200WP/S, KEYBOARD..... \$1,395



PC-400 512K, 2 FLPYS, 14" 640x400, 512K..... \$979
20Mb HARD DISK SYSTEM WITH 2 FLPYS..... \$1,369
ATD-B-Q 8MHz 80286, 640K, S, P, 1-2 FLPY..... \$1,549
ATP-B-Q PORTABLE..... \$1,829



256-640K, TURBO V20, 8 SLOTS, 360K FLOPPY, 150 W P/S, SLIDE CASE, SPKR, 8 SLOTS..... \$449
PC/IT 8MHz 80286, 1-2 FLPY, 512K 8 SLOTS..... \$1,198
PC/IT ENHANCED WITH 1 Mb & 40Mb H.D. DRV..... \$2,949
MICRO/IT BASIC SYSTEM..... \$1,799



1088-50 1Mb RAM, 50Mb HARD DISK, 50Mb TAPE DRIVE, XENIX..... \$11,399
688-256 USER, 25Mb H.D., XENIX..... \$4,099

NETWORKING

CALL FOR DEALER PRICING, INTEGRATION, AND/OR CONSULTATION.

COMPUPRO NET 100..... \$369



PC-SLAVE/18 1Mb, 8MHz, V20..... \$655
RTNX MSDOS 2.1..... \$109
ATNX MSDOS 3.1..... \$189



EARTH NET/PC ARCNET 1/2 CARD..... \$259
LAN-PC ARCNET FOR PC'S..... \$369
MS-286 8MHz 80286, 5 SLOTS, ARCNET I/F, 640K SCSI, AT TYPE ENCLOSURE & P/S..... \$1,719



ADVANCED NETWORK STARTER KITS, SERVERS, AND SOFTWARE..... CALL

PC/XT/AT BOARDS

STB R/IOGRANDE 128K-1.5Mb, P&S..... \$195
STB CHAUFFER RUNS RGB IN MONO..... \$189
STB ATTA-BYTE 0-384K FOR AT&T..... \$159
TECMAR MAESTRO 0-2.5Mb, S, P & TREAS. CHEST..... \$295
TECMAR CAPTAIN OK, S, P, CLK & TREAS. CHEST..... \$155
TECMAR EXPANSION CHASSIS II SLOTS, ETC..... \$639



6 PACK PLUS..... \$159
6 PACK PREMIUM..... \$350
RAMPAGE-AT..... \$480
ADVANTAGE..... \$359



INTEL ABOVE BOARD PCMB 1010 64 TO 512K. ALLOWS LOTUS, SYMPHONY, OTHERS TO RUN ABOVE 640K \$219
INTEL ABOVE BOARD-AT 128 TO 4Mb..... \$329
MACROTECH MSR-AT 0-3Mb RAM FOR IBM-AT @ 6, 8, 10, & 12MHz. NO WAIT STATES..... \$185-\$625

CAD

CORDATA FAST DRAFT 640x480 W/AUTOCAD 32 COLORS..... \$1,195
HANZON LP-3000+ LASER HP/GL PLOT. COM..... CALL

ACS GRAPHAX 20/20 2000 x 2000 RES. 2.5 MB, AUTOCAD COMPATIBLE..... \$1,595



DMP 41/42..... \$2,449
DMP 51/52..... \$3,699
DMP 56..... \$4,399
DMP 29..... \$1,899 DMP 40..... \$689
TRUE GRID DIGITIZERS
TG1005..... \$289
TG1011..... \$509
TG1017..... \$619

POWER SYSTEMS & ACCES.



ALL CABLES SOLD AT DEEP DISCOUNT..... CALL
S 4 4 CIRCUIT SURGE SUPPRESSOR..... \$19
S 10 6 CIRCUIT SURGE SUPPRESSOR..... \$29
P15 5 CIRC. MONITOR BASE W/MODEM PROT..... \$98
U1000 POWER SAVER 1000W U.P.S. (TOPAZ)..... CALL



BC-425 WATT S.P.S. 30 MIN..... \$419
BC-875 WATT S.P.S. 70 MIN..... \$825
BC-1000 WATT W/SELF CONTAINED BATT 40 MIN..... \$939

SAFE (SAFT) SPS1000 WATT SINE WAVE..... \$949
SOLA 750 WATT W/4500 WATT HI-INRUSH..... \$1,495

MONITORS & TERMINALS

NEC MULTISYNC..... CALL
TECMAR RGB HI-RES ZVM-1360..... \$498
ZENITY ZVM-1240 (IBM) FLAT SCREEN..... \$149
PRINCETON GRAPHICS ALL MODELS..... CALL



CM-1360 640x200 RGB, 13", GA SWITCH..... \$339
CM-1380F EGA 640x350 RES 13" G/A SWITCH..... \$450
TEGA-22 256K EGA 1/2 CARD..... \$245
1422A DUAL FREQ. TLT/SWIVEL, 14", G/A..... \$139



125 EMULATES WY-50 ETC., HIRES 14" GREEN/AMBER, 6 SCROLL RATES, IBM SELEC., K.B..... \$385
PC-TERM EMUL WY-50, TVI 925, IBM-AT KB, FOR MULTI-USER PC-SLAVE BOARDS..... \$419

WYSE 80..... \$475
LIBERTY FREEDOM ONE..... \$395

PRINTERS & BUFFERS



M-1109 100-25 CPS P & S, TRACTOR..... \$203
M-1509 180/45 CPS P & S W/TRAC..... CALL
M-1409 AS ABOVE 110 COL. PARA..... CALL
M-1709 240/50 CPS "PAPER PARK" Fx-286 & IBM PROPRINTER COMPAT..... CALL
HR-35 36CPS DAISY, WIDE CARR..... \$729
HR-20 20 CPS..... \$349
HR15XL 17 CPS DAISY WHEEL..... \$295
CITIZEN MSP-10..... \$309 MPS-15..... \$429
CITIZEN MSP-20..... \$349 MPS-25..... \$499
CORDATA LP-300 LASER W/WORDSTAR2000..... \$2,175
HANZON BUFFER 64K-256K S-S, S-P, P-S, P-P..... \$265
HANZON LP-3000+ LASER CAN EXECUTE HEWLETT-PACKARD GL PLOTTER COMMANDS..... CALL
STAR MICRONICS SR-15..... \$595
TOSHIBA P321 PARA. & SERIAL..... \$589
TOSHIBA P341..... \$899
TOSHIBA P351 PARA. & SERIAL..... \$1,199
OKIDATA..... CALL



DIABLO D25..... \$475 DIABLO 635..... \$815
DIABLO D80IF..... \$1,389
4045 LASER WITH COPIER & 512K RAM..... \$4,798
DIABLO 34 LQ..... \$939



PERSONAL SPEECH SYSTEM..... \$295

SCIENTIFIC/INDUST. BDS.

A/D 64-100..... \$315 A/D 64-PC..... \$396
D/A 64-100..... \$236 D/A 64-PC..... \$466
1018-PC 96 TTL INPUT LINES..... \$446

SCIENTIFIC SOLUTIONS (TECMAR)

IEEE 488..... \$239 LAB MASTER..... \$859

S-100 BOARDS

ONE STOP SHOPPING FOR ALL OF YOUR INTEGRATION AND POST SALE SUPPORT NEEDS. WE HANDLE CCS, COMPUPRO, DUAL, I.C.M., ILLUMIN. TECH., LOMAS, TELETEK, MULLEN, P&T, INDUST. COMP. DESIGNS, TARBELL, ETC. THIS MONTH'S SPECIALS ARE:

CONCURRENT DOS 4.1D..... \$495
CDOS 4.1E..... \$750
SPUZ 8MHz Z80, 256K, 4 USERS..... \$269
INTERFACER-3 8 SERIAL PORTS..... \$439
SYSTEM SUPPORT 1 WITH CLK. BATT. SERIAL..... \$289
DISK 1A 5" & 8" FLOPPY CONTROLLER..... \$439
DISK 3 5" HARD DISK CONTROLLER..... \$509
RAM 27 256K STATIC RAM..... \$446
COMPUPRO DISK DRIVE BRACKETS..... \$25
816/C2 SYSTEM..... \$7,279



DUAL: A1M-12 D/A CONVERTER..... \$545
DUAL: AOM-12 A/D CONVERTER..... \$509



MI-286 10MHz 80286 & 8MHz Z80H..... \$695
ST-II 1Mb STATIC RAM..... \$2,249
MSR-II 1Mb DYNAMIC RAM..... \$799

HARD DISK & TAPE DRIVES

PC-INSIDER, PC-OUTSIDER & AT-INSIDER HARD DISKS FOR IBM AND COMPATIBLES SET-UP TO BOOT FROM HARD DISK WITH ALL NECESSARY HARDWARE AND PC-STYLE CABINET FOR EXTERNAL DRIVES.

20Mb PC-INSIDER..... \$379
30Mb PC-INSIDER (SEAGATE ST-238)..... \$495
72Mb PC-IN/OUTSIDER 28 MSEC..... \$1,459
40Mb INT. SUBSYS. W/DISK 3..... \$1,419
80Mb INT. SUBSYS. W/DISK 3..... \$1,797
ALLOY FT-60 60MB @ 1.8Mb/Min, For PC Compat..... \$7.95
IRWIN 10Mb TAPE/PC or CP/RO - Requires CDOS..... \$389
TECMAR Q/C 60 AT INT 60Mb TAPE..... \$1,079

BARE WINCHESTER DRIVES

SEAGATE ST-225..... \$329
SEAGATE ST-4051 51Mb, 40mSEC, FH 5 1/4"..... \$789
QUANTUM Q540 43Mb, 45mSEC, FH 5 1/4"..... \$839
MICROPOLIS MC-1325 85Mb, 30mSEC, FH 5 1/4"..... \$1,239
MAXTOR XT-1140 140Mb, 30mSEC, FH 5 1/4"..... \$3,289
MAXTOR XT-2190 190Mb, 30mSEC, FH 5 1/4"..... \$3,895

FLOPPY DISK DRIVES

MITSUBISHI 2894 8"..... \$485
MITSUBISHI MF-501 48TPL..... \$95
MITSUBISHI MF-504 96 TPL..... \$149
TEAC FD558BV48TPI..... \$89
TANDON TM 50..... \$75

SOFTWARE

WE SELL ALL WELL KNOWN BRANDS. ORDER CORRECTLY! SOFTWARE IS NOT RETURNABLE!
NEWSTAR NEWWORD 2..... \$139
NEWSTAR NEWWORD 3 SPELL CHECKER, INDEXING, CONTENT TABLES, MACRO'S, SHORTHAND KEYBOARD, MULTI-TASKING..... \$269
BD SOFTWARE C COMPILER 8" SSSD 8 BIT..... \$95
MICROSOFT - ASHTON-TATE..... -38%
MICROPRO - MULTIMATE - P.F.S..... -41%
BORLAND INT'L TURBO PASCAL, ETC..... -41%
MOST OTHER PC PROGRAMS..... -41%

MODEMS



PROMODEM 1200..... \$255
PROMODEM 1200G..... \$178 2400G..... \$339
PROMODEM 300C - APPLE II C PIGGY-BACK..... \$75



MT224EH MNP ERROR CORREC..... \$529
MT224ER RACK MOUNT W/EDC..... \$495
U.S. ROBOTICS BLOW-OUT..... CALL

All merchandise new. Advertised prices are cash prepaid only. PO's from qualified firms & AM. Express: +.95.MC & Visa: +.98. COD's (+.99, \$5 min. fee) with Cashiers Check/MO, Bank Wires & APO's accepted. Shipping: minimum \$4 first 5lbs. Tax: AZ RES. ONLY add 6.5% sales tax. All returns subject to 20% restocking fee or credit towards future purchases. All prices & availability subject to change without notice.

TIMELINE INC.

CALL US FOR ALL YOUR NEEDS!

We have 10 Million I.C.'s in stock!

Minimum I.C. Order: \$200.00

Continental U.S.A (800) 872-8878	Order Desk (800) 223-9977	Inside California (800) 217-8912	L.A. & Technical Info (800) 217-8912	OEM INQUIRIES WELCOME
--	-------------------------------------	--	--	--------------------------

INCREDIBLE PRICE BLOWOUT!

MICROSCIENCE
10 Mb 1/2 HEIGHT
HARD DISK DRIVE

NEW! IN BOX!

AMDEK 13" Color Composite MONITOR
for Atari, Commodore & Apple Computers
Model: Color-I Plus -
Resolution: 260Hx320V
\$129.95
Only 250 Available!

Input Terminal:
Video in: RCA photo-Jack
Audio in: Mini earPhone Jack
15% Hx 17% Wx 15% D

Character Number: 1700 Characters (14 Characters x 25 Rows on 3x7 Dot Matrix)

MOTOROLA 7" DIAGONAL SCREEN HIGH RESOLUTION GREEN SCREEN MONITOR
Factory List \$280.00
\$29.95 4 for \$99.00
MODEL MD1700

-Flat Facelate
-900 lines at Center 650 lines at corners
-Operates from 12VDC at 1 Amp.
-Vertical input is 47 to 63 Hz.
-Horizontal input: 15.7 KHz (18.7 KHz optional)
-Video input signal: Positive white.
-Input termination 470 ohms ±
5%, 2.5V to 5.0V P-P
-Weight: 6lbs.

22 MHz TYPICAL BANDWIDTH
For split video ITTL input operation. Not composite video.

TEC MODEL 1550 PRINTER \$279.00

Centronics parallel and RS232 Serial ports
-15" carriage
-120 cps
-Tractor and friction feed
-Graphics

One of the largest manufacturers in the world has 125 of these prestigious printers in their overstock. We are extremely fortunate to be designated as their representative to market them.

AMDEK 13" Color Composite MONITOR
for Atari, Commodore & Apple Computers
Model: Color-I Plus -
Resolution: 260Hx320V
\$129.95
Only 250 Available!

Input Terminal:
Video in: RCA photo-Jack
Audio in: Mini earPhone Jack
15% Hx 17% Wx 15% D

Character Number: 1700 Characters (14 Characters x 25 Rows on 3x7 Dot Matrix)

MOTOROLA 7" DIAGONAL SCREEN HIGH RESOLUTION GREEN SCREEN MONITOR
Factory List \$280.00
\$29.95 4 for \$99.00
MODEL MD1700

-Flat Facelate
-900 lines at Center 650 lines at corners
-Operates from 12VDC at 1 Amp.
-Vertical input is 47 to 63 Hz.
-Horizontal input: 15.7 KHz (18.7 KHz optional)
-Video input signal: Positive white.
-Input termination 470 ohms ±
5%, 2.5V to 5.0V P-P
-Weight: 6lbs.

22 MHz TYPICAL BANDWIDTH
For split video ITTL input operation. Not composite video.

INFRARED REMOTE CONTROL

IBM PC/XT (OR JR.) KEY BOARD

LIQUIDATION! \$69.95 LIQUIDATION!

We are proud that we have been awarded the opportunity of offering these very unique keyboards. The original factory list was 259.00. We are blowing them out at an incredible price! Also, these are American made and not Taiwan clones. These can be operated by remote or attached to your computer. COMPLETELY IBM COMPATIBLE

ASTEC 65 WATT SWITCHING POWER SUPPLY

Dual Input voltage 115/230 VAC - Overvoltage protection - Short circuit protection - Dual Isolated +12V - Built-in EMI filter - Very compact size - UL/CSA/VDE approved - 100% thermal cycle & burn-in - High efficiency - Vacuum impregnated transformers - Convection cooling - Open PCB "L" bracket or boxed construction.

Dimensions:
8.0" - Length
4.4" - Width
2.4" - Height

SUPER DEAL! \$29.00

OUTPUTS:
Condition No.1
+5V DC @ 6.0A
+12V DC @ 1.5A
+12V DC @ 2.1A
-12V DC @ 0.25A

Condition No.2
+5V DC @ 5.0A (with two +12V outputs in parallel)
+12V OC (with two +12V outputs in parallel)
@3.5A (5.0A surge)
-12V DC @ 0.25A

MODEL No. AC9335-01

- HARD DISK DRIVES
- FLOPPY DISK DRIVES
- MINICOMPUTERS
- CRTs

PERFECT FOR POWERING:

PROGRAMMABLE SYNTHETIC SPEECH GENERATION BOARD
SSB-APPLE
\$59.00

PLUG COMPATIBLE WITH APPLE II MICROCOMPUTERS. Can be easily controlled by BASIC. Uses TMS5220 for Low-data-rate LPC encoding. +5V & -5V supplies only - TTL Compatible

INCLUDES: Software and Speaker

EPSON QX-10 MOTHERBOARD WITH VIDEO CARD & YOUR CHOICE OF - ASCII KEYBOARD (ENCLOSED) OR HASCII (BARE)
\$169.95

ONLY 250 SYSTEMS AVAILABLE!

Will work with any IBM compatible disk drive • CPU: µP780AC-1 (280A compatible, 4 MHz) • Memory-RAM: 256K on board • Video RAM: 128K on CRT board • C-MOS RAM • EPROM: 2/4/8K (for IPL) Clock, C-MOS real-time clock Interface. Serial and Parallel DMA: 7 channels. Interrupt levels: 15; Counter/timer, 6 channels Card slots: 5. Compatible with any TTL monitor. Weight: 10 lbs. with enclosed keyboard, 8 lbs. with bare keyboard.

KEPCO/TDK SWITCHING POWER SUPPLY
\$39.95

ONLY 250 AVAILABLE!

Model EFX 100T-3 100W • +5V @ 5A • -5V @ 1.5A • +12V @ 2.0A • -12V @ 2.0A • Input Voltage: 100 to 130V a-c or 200 to 260V a-c 47-440 HZ. Single phase • Brownout Voltage: 90V a-c/180V a-c • Fused Input/Output protected against short circuit. Dim. 9 1/2" x 4 1/4" x 2 1/4" H. Weight: 3 lbs. Spec included.

AMLYN 1860A HIGH CAPACITY DRIVE
5 1/4" DS/High Density
3.2 mByte Unformatted
2.3 Formatted
Takes 8" controller to operate.
\$129.00
Wt: 4lbs.

MODEL DM8112CX High Quality - Solid State 12" SANYO MONITOR
MONOCHROME- For use in: Surveillance, Industry, broadcast, education & data display.
AC 117V-60Hz-36W (0.4A)
Re-conditioned & fully tested - Composite video signal, sync. negative
\$49.95
Video amp. bandwidth 18 MHz
Display format: 1920 characters max. 80 char. x 24 lines (5 x 7 dot)
Scanning Frequency
Horizontal rate 15.78 KHz, Vertical rate 60 Hz
10 1/2 Hx 13 Wx 14 D"

"Spy in the Sky" Fairchild CCD122 1,728 ELEMENT * Linear Image Sensor \$29.95

*The Twilight Designed for page scanning applications including facsimile, (Optical Character recognition and other imaging applications which require high resolution and high sensitivity.

TANDON 848-2	199.95
REMAX FD480	59.95
RICOH RP1200 (Daisy Wheel)	349.95
SERIAL MODEM CABLE	7.95
CENTRONICS Parallel Printer cable	12.95
NASHUA Diskettes (box of 10)	8.00
4164-15 (min. 100 pcs.)	.89
5 1/4" DISK DRIVE CABINET	12.95
TELEPHONE HEADSET	3.95
12V ADAPTER (250mA)	2.50
ULTRASOUND DEVICE	3.95
5" MONITOR (B&W)	39.95

CLASSIC TECHNOLOGY CORPORATION 286 SPEED PAK FOR IBM PC & XT UP TO 10 TIMES PC SPEED \$695.00

Increases speed of PC/XT to make it 33% faster than an AT
-20-30% faster than boards that use cache
-Compatible with IBM Enhanced Graphics Adapter and the Lotus/Int above board
-Can run programs designed for the AT's and also PC/XT's
-No software patches needed
-Includes native mode
-Made in U.S.A.

10 MHz
13 Year Warranty

1490 W. ARTESIA BLVD., GARDENA, CA. 90247

Continental U.S.A. Inside California L.A. Area & Technical Info
(800) 872-8878 (800) 223-9977 (213) 217-8912

TIME LINE

Inquiry 342

Minimum Order: \$25.00. Shipping & handling charges via UPS Ground: \$.50/cb. UPS Air: \$1.00/lb. Minimum Charge: \$4.00. We accept cashiers checks, MC or VISA. No personal check COD's. Items reflect 5% cash or check discount. California residents add 6 1/2% sales tax. We are not responsible for typographical errors. All merchandise subject to prior sale. Phone orders welcome. Foreign Orders require special handling Prices subject to change without notice.

VISA MasterCard

38¢

Each

is all you have to pay for the best 5.25" Double Sided, Double Density diskettes to be found!

SuperStar™ and DISK WORLD!™ do it again: super-premium diskettes at the lowest prices to be found anywhere ...without lies, fraud, hokum or crazy deals.

The "Life Is Simple" price list for first-line, top-quality diskettes:

5.25" SSDD (P/N38002).....	38 ea.
5.25" DSDD (P/N38012).....	38 ea.
5.25" SSDD - 96TPI (P/N38022).....	68 ea.
5.25" DSDD - 96TPI (P/N38032).....	71 ea.
5.25" DSDD -HD (P/N38042).....	\$ 1.36 ea.
3.50" SSDD (P/N38052).....	\$ 1.39 ea.
3.50" DSDD (P/N38062).....	\$ 1.45 ea.

All prices quoted are for multiples of 100 each. Add 10% for orders of 50 each. All 5.25" diskettes are supplied with Tyvec™ sleeves, user ID labels and write-protect tabs. 3.50" diskettes are supplied with user ID labels.

Don't buy junk.

DISK WORLD!™ has always been the price and quality leader in diskettes.

Our SuperStar™ diskettes are fully certified to at least 65% clipping levels, far in excess of the ANSI and IBM™ standard of 40%.

Furthermore, SuperStar™ diskettes have jackets of at least 8-mils, as opposed to the 6-mil jackets offered by other low-priced brands. (And, believe us, jacket thickness makes a big difference in whether or not you will get read/write errors on your machine.)

SuperStar™ 3.50" diskettes are all licensed by Sony™ Corporation, the inventor of the 3.50" diskette standard, and meet their exacting standards.

All SuperStar™ diskettes carry a FULL LIFETIME WARRANTY against manufacturing and material defects.

Finally, all SuperStar™ diskettes are manufactured in the United States...not in Hong Kong, Taiwan, Pago Pago or other strange and exotic places where the standards of quality might not be quite as high.

In short, SuperStar™ diskettes are equal or superior to such famous brand names as 3m™, IDK™, Fuji™, Maxell™ and just about any other brand you can name!

SuperStar™ diskettes simply cost half as much or less.

The truth about diskette prices, brand names and some other unpleasant facts of life.

There are exactly two kinds of diskettes: good and bad.

The brand name...or absence of a brand name...on a diskette doesn't mean a thing in terms of quality.

Neither does the price.

For example, let's take a hard look at 3M™ diskettes, a brand which we have carried for more than three years.

During that time, we sold more than \$ 6,500,000 worth of these diskettes...and that's one hell of a lot of diskettes.

Until very recently, we were proud to market 3M™ brand diskettes. Now we don't advertise them and actively

discourage people from buying them.

Why?

Well, here's a quote from the July 21, 1986 *Business Week* magazine (page 107): "The disks have been plagued by quality problems recently..." according to one industry expert.

And a radical change in 3M's pricing policies has resulted in exactly the same diskette being sold at prices ranging from 29 to 89 cents, depending on who you were.

Not exactly a fair deal for anyone...except 3M™ which, according to *Business Week* earned a mere \$ 73,000,000 in profits on magnetic media in 1985...mostly at your expense and ours while "(t)he diskettes have been plagued by quality problems recently..."

Counterfeiting and The Hong Kong Connection.

If the life of a diskette purchaser weren't bad enough already, there are now two more problems to contend with.

Counterfeiting is the newest game in town for the "let's get rich quick" crowd.

At least two mail order companies are currently operating very comfortable businesses offering "famous brand name" diskettes at unbeatable prices.

The prices ought to be unbeatable, since these two companies simply take an inferior diskette and slip into a Tyvec™ sleeve which they have printed to be an exact duplicate of the "famous brand name", slap on a forged manufacturer's label to the diskette and make a very tidy profit...without regard to the harm they are causing the end user.

Finally, there is now a wave of cheap, poorly made diskettes pouring in from the Orient, mostly Hong Kong. We are not talking about reputable brands such as Sony™ or Fuji™; we are talking about diskettes which are being turned out in sweatshops on outmoded equipment with little or no regard for quality control.

They show up in this country under a variety of names at extremely attractive prices. Prices so attractive, in fact, that your savings on buying these diskettes may just about pay for the cost of replacing your drives after you use them for a while.

90,000 DISK WORLD!™ customers really tell the story.

DISK WORLD!™ serves more than 90,000 customers throughout the United States and now the world. More and more major corporations, universities and governmental bodies have switched over to our SuperStar™ brands because they recognize that SuperStar™...with DISK WORLD!'s integrity standing behind it...offer absolutely the best combination of HIGH-QUALITY and LOW PRICE.

In short, DISK WORLD!™ and SuperStar™ are unbeatable.

Over the past three years, we've sold more than 30,000,000 diskettes. Our return rate has been less than 1/10,000th of 1%.

Those two facts speak for themselves.

When every bit counts, it's SuperStar!™

We don't have to boast of imaginary factories employing "floppy phreaks", advertise diskettes for 39¢...if you buy 10,000 of them, offer "2 for 1" replacement guarantees or engage in any of the other hokum schemes designed to part you from your money.

Nor do we have to offer you "famous brand name" diskettes at inflated prices that don't offer you any more in quality, but do manage to support fleets of corporate jet aircraft and executive retreats in Minnesota and Canada.

We simply deliver the best for less.

More than a million diskettes a month flow out of our warehouse under the SuperStar™ "non-name". As noted, fewer than 1/10,000th of 1% of these are returned for any reason.

And that should say it all: SuperStar™ means far more for far less.

HOW TO ORDER:

ORDERS ONLY:

1-800-621-6827

(In Illinois: 1-312-256-7140)

INQUIRIES:

1-312-256-7140

FOR FASTEST SERVICE, USE NO -COST MCI MAIL. Our address is DISKORDER. It's a FREE MCI MAIL letter. No charge to you. (Situation permitting, we'll ship these orders in 24 hours or less.)

SHIPPING: 5.25" & 3.50" DISKETTES-Add \$ 3.00 per each 100 or fewer diskettes. **OTHER ITEMS:** Add shipping charges as shown in addition to other shipping charges. **PAYMENT:** VISA, MASTERCARD and Prepaid orders accepted. **COD ORDERS:** Add \$ 5.00 special handling charge. **APO, FPO, AK, HI & PR ORDERS:** Include shipping charges as shown and additional 5% of total order amount to cover PAL and insurance. We ship only to United States addresses, except as shown above. **TAXES:** Illinois residents add 7% sales tax.

DISK WORLD!, Inc.

629 Green Bay Road
Wilmette, Illinois 60091

COMPUTER TABLE
BUY DIRECT from DENMARK
 The **ADJUSTable...**
 at an
AMAZING PRICE!



\$129 + ^{UPS}
 (reg. \$249)

- Unrestricted Legroom
- Fits PC/AT/Portables/Macs
- Adjustable Height, Depth, Tilt
- Exceptional mobility w/optional Casters, \$20
- Also: Adjustable Chairs, Printer Stands, CRT Swing Arms
- Special Package: \$249 for COMFORT chair & ADJUSTable

• Next Day Shipping with VISA/MC
 • Thirty Day Money Back Guarantee

ORDER TOLL FREE
 ☎ **1-800-822-5301**

ACP

In Texas, call (713) 783-3881
 6776 Southwest Freeway • Suite 150 • Houston, Texas • 77074

Inquiry 6



Sure it's insured?

SAFWARE® Insurance provides full replacement of hardware, media and purchased software. As little as \$39/yr. covers:

- Fire • Theft • Power Surges
- Earthquake • Water Damage • Auto Accident

For information or immediate coverage call:
1-800-848-3469
 In Ohio call 1-614-262-0559

SAFWARE

SAFWARE, The Insurance Agency Inc.

Inquiry 293

9-TRACK MAG. TAPE SUBSYSTEM FOR THE IBM PC/XT/AT AND...



For information interchange, backup and archival storage, IBEX offers a 9-track, IBM format-compatible 1/2" magnetic tape subsystem for the IBM PC, featuring:

- IBM format 1600/3200 and 800 cpi.
- Software for PC-DOS, MS-DOS.
- Also for DEC, VAX, VME, S-100, RS-232, IEEE 488.

IBEX
 IBEX COMPUTER CORP.
 20741 Manilla St.
 Chatsworth, CA 91311
 (818) 709-8100
 TWX 910-493-2071

Write, phone or TWX for information

Inquiry 155

ICs PROMPT DELIVERY!!!
 SAME DAY SHIPPING (USUALLY)
 QUANTITY ONE PRICES SHOWN FOR SEPT. 21, 1988

OUTSIDE OKLAHOMA: NO SALES TAX

DYNAMIC RAM			
1Mbit	1000Kx1	100 ns	\$40.00
4464	64Kx4	150 ns	4.20
41256	256Kx1	100 ns	4.85
41256	256Kx1	120 ns	3.40
41256	256Kx1	150 ns	2.89
41128	128Kx1	150 ns	4.99
4164	64Kx1	150 ns	1.35
EPROM			
27512	64Kx8	250 ns	\$22.00
27C256	32Kx8	250 ns	6.50
27256	32Kx8	250 ns	5.25
27128	16Kx8	250 ns	3.95
27C64	8Kx8	200 ns	4.75
2764	8Kx8	250 ns	3.95
STATIC RAM			
43256L-12	32Kx8	120 ns	\$27.00
6264LP-15	8Kx8	150 ns	3.10

OPEN 6 1/2 DAYS, 7 AM-9 PM SHIP VIA FED-EX ON SAT.
 SUNDAYS & HOLIDAYS: SHIPMENT OR DELIVERY VIA U.S. EXPRESS MAIL

SAT DELIVERY INCLUDED ON FED-EX ORDERS RECEIVED BY: 24,000 S. Peoria Ave., (918) 267-4961
 Ft. P-One #13/12 lbs
 BEGGS, OK. 74421

MasterCard/VISA or UPS CASH COD
Factory New, Prime Parts
MICROPROCESSORS UNLIMITED, INC.
 24,000 S. Peoria Ave., (918) 267-4961
 BEGGS, OK. 74421

Please call for current prices because prices are subject to change. Shipping & insurance extra. Cash discount prices shown. Orders received by 9 PM CST can usually be processed by the next morning. Monday Federal Express Standard Air @ \$6.00, or Priority One @ \$13.00!

Inquiry 216

Serial ← ||||| → Parallel

NEW!



Convert What You Have To What You Want!

- RS232 Serial
- 8 Baud Rates
- Latched Outputs
- Centronics Parallel
- Handshake Signals
- Compact 3/4" x 4 1/4" x 1 1/2"

No longer will your peripheral choices be limited by the type of port you have available! Our new High Performance 700 Sarios Converters provide the missing link. Based on the latest in CMOS technology, these units feature full baud rate selection to 19.2K, with hand shake signals to maximize transfer efficiency. Detailed documentation allows simplified installation. Order the Model 770 (Ser/Par) or Model 775 (Par/Ser) Today!

only \$89.95

Butter Products Coming Soon!

Tigertronics
 INCORPORATED
 2734-C Johnson Dr.
 Post Office Box 3717
 Ventura, California 93006

Connector Cables \$10.00
 CA Residents 6% tax
 UPS Shipping \$3.00

CALL (805) 658-7466 or 658-7467
 For FAST Delivery

Inquiry 341

Get the whole story on graphics terminal emulation.



To find out more about software that lets your PC emulate TEKTRONIX™ 4105/67/79 and DEC VT100™ terminals, call or write:

GRAFFPOINT
 4340 Stevens Creeks Blvd., Suite 280,
 San Jose, CA 95129 (408) 249-7951

Inquiry 142

COMMODORE 128 & CP/M Users

WORDSTAR ^{EX}

WORDSTAR V. 2.26 or SuperCalc V. 1.12 or WORDPAC (incl. Grammatic and Spellguard) or Fortran with compiler.

\$39.00 each

Wordstar/SuperCalc includes a 763 page Osborne System Manual with extensive CP/M Tutorials as well.

Combination: Any 3 above for \$95.00.
 52 Page IBM PUBLIC DOMAIN \$4.00 List of 13,000 Programs.
 Also Catalog P.D. Software for IBM Apple, C-64, CP/M, MAC, Amiga, CoCo.
Ask about \$25 Special.

SPANISH FRENCH GERMAN \$95.00
 Version Menus for WS & SC, CP/M HELP.

800-221-7372 Don Johnson
PDSC-33 GOLD ST.-L3-NYC 10038

Inquiry 269

Beat the limits!

Vfeature™ DELUXE

Software for hard disks

- DOS partitions to 1 GIGABYTE
- Spans two drives in one bootable partition
- Supports big drives on AT and XT
- Secures data

GOLDEN BOW SYSTEMS

\$120
 \$3 shipping/handling
 California orders add 6%



2870 Fifth Avenue Suite 201
 San Diego, CA 92103
619/298-9349

Inquiry 140

UNIVERSAL EPROM PROGRAMMER

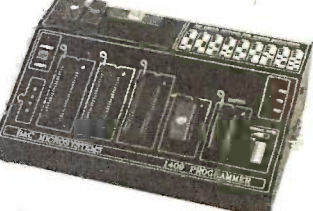

- * NO PERSONALITY MODULES REQUIRED
- * ON LINE HELP AND MENU SELECTION
- * ON BOARD 110/220V POWER SUPPLY
- * FAST PROGRAMMING MODE AT 6V VCC
- * BUILT IN EPROM ERASER W/TIMER
- * GANG PORT FOR FUTURE EXPANSION
- * SOFTWARE DRIVERS FOR MOST PCs
- * SUPPORTS ALL 5V EPROMS, EEPROMS AND INTEL MICROCOMPUTERS

1409C-33 \$545 1409C-34 \$695
 DRIVERS \$35 SHIPPING \$6
 VISA & MASTER CARD ACCEPTED

B&C MICROSYSTEMS
 6322 MOJAVE DR. SAN JOSE CA 95120
 PHONE (408)997-7685 TELEX 4995363

Inquiry 140

HUNTING FOR A GREAT DEAL?

HARD DISK DRIVE CARDS

Logic Array MegaCard!

NEW!

\$499

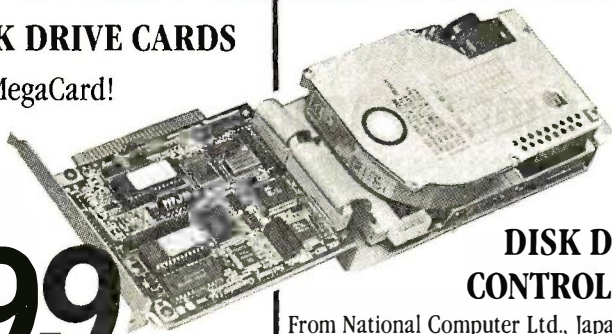

- Hard disk drive on a plug-in card gives PC or compatible the storage capacity of an XT
- Uses NEC technology for high reliability
- Fast, easy installation
- **two year guarantee**—parts and labor

21-Megabyte \$499
30-Megabyte CALL FOR PRICE

HARD DISK DRIVE KITS

(Half height, boots from hard disk—includes controller, cables, manual)

20-Megabyte \$415
40-Megabyte \$599

(with Disk Manager software)

On Track Disk Manager Software sold separately \$65

FLOPPY DISK DRIVES

360-K \$89
1.2 Megabyte, AT-Compatible \$129
1.2 Megabyte, PC-compatible
(enables your PC or XT to read and write AT-formatted diskettes)
was \$299—clearance price NOW \$129



EGA SOFTWARE

Rix EGA Paint \$49

DISK DRIVE CONTROLLERS

From National Computer Ltd., Japan's premier maker of controllers

- These compact AT-compatible controller cards are among the smallest available.
- Co-resident, IBM-COMPATIBLE

NDC 5126 AT Winchester only \$179
(a half card—so small you won't believe it's AT-compatible)
NDC 5125 AT Winchester/Floppy \$189
NDC 5127 XT Winchester only \$79
NDC 3011 SASI Controller \$91
DTC51 50CX Data Technology \$99



BOARD LEVEL PRODUCTS FROM MYLEX

Multifunction card
0-K \$82
384-K \$123
Envision I (mono/color/graphics) \$147
Envision II (mono/color/graphics, char. RAM enhanced modes) \$156
Color Adapter I \$77
Color Adapter II \$83
Business Master I (mon/par adapter, enhanced text modes) \$80
Business Master II (high-res. mon graphics, enhanced text modes) \$91
Enhanced Graphics Adapter \$279
(EGA, CGA, MDA, HGC compatible)
Advanced Graphics Adapter I \$345
(high-res. 800 x 600, CGA compatible)
Advanced Graphics Adapter II \$605
(with 80186 multi-processor)

CHIPS

256K D-RAM (set of 9) \$27
64K D-RAM (set of 9) \$9
V-20 (8 MHz) \$10.95

INTEL MATH CO-PROCESSORS

8087 \$125
8087-2 \$179
80287-6 \$225

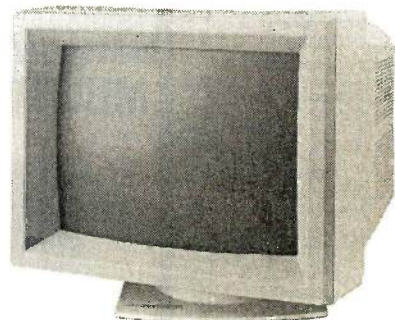

MONITORS

TTL Amber \$98
MultiSync CALL FOR PRICE

HERE'S HOW TO ORDER:

We accept Visa, MasterCard and American Express (no surcharge) and Money Orders. Minimum charge card order \$25. No sales tax outside California. (CA residents add 6% .)

Personal or company checks require three weeks to clear.

We insure all orders.

Shipping and handling minimum \$5 up to 3 lbs. within continental U.S. Call for shipping info on other orders.

Prices and availability may change.

Returns require authorization and are subject to restocking charge.

Normal manufacturers' warranties apply. Not responsible for typographical errors.

IBM, MultiSync, MegaCard, Mylex EGA Paint and On Track are trademarks of their respective companies.



18017 Skypark Circle, Suite L, Irvine, CA 92714

CALL 800-443-7355
In Calif. Call 800-345-4868
Tech Questions 714-250-3386

MON-FRI 7AM-5PM Pacific Time



**We pledge allegiance
to low prices and superior technical service.**

DISK DRIVE FLOPPY

Teac

FD55 B-V (half height 5 1/4" 360K DS/IDD floppy) \$99
FD55 F/G-V (half height 5 1/4" 1.2 MB black or grey faceplate) \$145

Toshiba

NO 040 (half height 5 1/4" 360K black face plate) \$109
NO 04DEG (half height 5 1/4" 360K grey face plate) \$111
NO 08DEG (half height 5 1/4" 1.2MB grey face plate) \$149

Fujitsu

Hall height 5 1/4" 360K black face plate floppy \$85

HARD DISK DRIVES

Seagate

ST225 20MB half height 65MLS with controller card \$395
ST225 20MB half height 65MLS no controller card \$345
NEW ST239 30MB half height 65MLS with controller card \$499
ST4026 20MB full height 30MLS no controller \$539
ST4038 30MB full height 30MLS no controller \$629
ST4051 40MB full height 30MLS no controller \$739
Western Digital controller card \$125

Control Data

9415-86 86MB full height 30MLS no controller \$1495
Disk Manager Software for formatting past DDS (33MB) \$100

TAPE BACKUPS

Irwin Magnetics

10MB INTERNAL TAPE DRIVE half height unit uses floppy controller \$499
20MB INTERNAL TAPE DRIVE for 286 COMPAQ and AT \$599

Everex

20MB INTERNAL TAPE DRIVE half height with controller \$573
60MB INTERNAL TAPE DRIVE half height with controller \$724

Alloy

60MB EXTERNAL TAPE DRIVE software, cables and controller \$741

Tape Cartridges/Scotch 3M

DC-500A cartridge tape (up to 60MB capacity) \$26
DC-1000 cartridge tape for Irwin tape drive \$19

MEMORY MULTIFUNCTION BOARDS

AST

SIXPACK PREMIUM 512 to 2MB Advantage w/128K \$356
(expandable to 3MB, S2,G for AT) \$356
RAMPAGE PC 256 to 2MB (EMS board w/deskview windowing software) \$234
RAMPAGE AT 512 to 2MB (EMS board 8MHz) \$445

PCA (4.77MHz XT Compatible)

640K, 2 floppies, mono monitor and monochrome graphics card, parallel port, keyboard, one year warranty, FCC Approved..... **\$775**

PCA TURBO (4/8 MHz XT Compatible)

640K, one floppy, 20MB, Parallel, Serial, Clock, Game, Keyboard, One Year Warranty, FCC Approved..... **\$995**

MULTITECH 900 10/6 MHz \$1550



- 10 or 6 MHz
- 1.2 MB Floppy
- Keyboard
- MS DOS 3.1
- 5 Half-height internal drive slots
- One Year Warranty
- Serviced Nationwide by TRW
- 512 to 1MB on motherboard

- Multitech Options**
- Softwhite monitor and monochrome graphics card **\$219**
 - Color monitor and color graphics card **\$359**
 - EGA monitor and EGA color graphics card **\$659**
 - Multitech 3 MB expanded memory card OK, P/S **\$219**
 - RAM Expansion, piggyback card **\$128**

MONOCHROME MONITORS

SAMSUNG TTL AMBER or GREEN \$85
AMDEK 310A TTL AMBER \$159
PRINCETON MAX 12 800 PIXIES \$155
MULTITECH Soft white, high res \$139

COLOR MONITORS

MULTITECH COLOR MONITOR, Amb/Gr/640X200 \$299
MULTITECH EGA \$430

Princeton Graphics

PL14 EGA 14" Multisync clone \$516
HX-12 31mm dot pitch, 640/240 \$442
HX-12 E 640/350 EGA \$539
SR-12 31mm dot pitch, 640/400 \$539
SIGMA 400 H \$460

Taxan

640 720/400, 31 dot pitch \$506
555 16 color card text/graphics \$149

N E C

MULTISYNC 15.75Khz to 35KHz horizontal scan \$569

VIDEO DISPLAY BOARDS

Hercules

GRAPHICS CARD mono \$194
COLOR CARD color w/parallel \$151

Clones

EVEREX EDGE color/mono 132 column \$239
EVEREX GRAPHICS EDGE color/mono 132 column \$239
GRAPHICS CARD Hercules clone \$99
COLOR CARD color w/parallel \$89
MULTITECH EGA \$241
PARADISE EGA/AUTO SWITCH \$410

BACK-UP POWER AND SURGE PROTECTION

Data Shield

500 W Backup Power Supply \$615
800 W Backup Power Supply \$693
1500 W Backup Power Supply \$1427

Clone

150 W POWER SUPPLY \$99
135 W POWER SUPPLY \$89

Curtis

DIAMOND (SURGE PROTECTOR 6 OUTLET wall) \$35
EMERALD (SURGE PROTECTOR 6 OUTLET cord) \$45
RUBY (SURGE/FILTER 6 cord) \$58

Kinsington

MASTERPIECE \$97
MASTERPIECE - PLUS \$131

CHIPS

256K SET \$29
128K SET \$40
64K SET \$10
8087 \$135
8087-2 \$158
80287 \$189
80287-B \$327

Talltree

JRAM 2 w/OK (Parallel 2MB capacity) \$142
JRAM 3 w/OK (for PC, EMS board, up to 2MB capacity) \$184
JRAM AT w/OK (Parallel 2MB capacity) \$190
JRAM 3 AT w/OK (EMS board, up to 2MB capacity) \$239

Clone Multi-Function

6 PACK compatible w/S, P, C, G, w/OK (up to 384K) w/software \$99

MULTIFUNCTION I/O BOARDS

DISK I/O operates 2 floppies, and G, S, P, C \$95
AT I/O, Parallel, Serial \$95

MODEMS

Hayes

SMARTMODEM 1200B INTERNAL (1200/300 baud w/SmartcomII) \$384
SMARTMODEM 1200 External (1200/300 baud) \$479
SMARTMODEM 2400 External (2400) \$630

Everex

EVERCOM Modem (1200/300 baud w/software) \$150

US Robotics

COURIER 2400 Baud Internal or External \$491

NETWORKS MULTI-USER

Alloy

PC-SLAVE/16 16 BIT SLAVE BOARD 8088-2 (8MHz Processor, 2 serial ports, 1 Mb Ram) \$895

12 Slot Expansion Chassis

225 Watt power supply \$1135
20' RS-232 Slave Cable \$39
ATNX ALLOY TERMINAL NETWORK EXECUTIVE SOFTWARE \$295
LINK RS-323 ASCII Terminal IBM Keyboard \$625

PRINTERS/DOT MATRIX

Citizen

(Epson & IBM Compatible)

MSP-10 160/140 cps dot matrix narrow carriage \$307
MSP-15 160/140 cps dot matrix-wide carriage \$414
MSP-20 200/150 cps dot matrix-narrow carriage \$347
MPS-25 200/150 cps dot matrix-wide carriage \$520

Epson

FX-85 160 cps, narrow carriage NLO \$434
FX-286 200 cps, wide carriage NLO \$579
LO 1000 24 Pin, 180 cps NLO 60 wide carriage \$830
LQ 800 24 Pin, 180 cps, NLO 60 narrow carriage \$630

IBM

Proprinter \$445
Proprinter XL Wide Carriage \$661

Okidata

ML 182 120 cps narrow carriage \$228
ML 192 160 cps NLO narrow carriage \$327
ML 193 160 cps NLO wide carriage \$529
ML 292 200 cps 100 NLO narrow carriage color \$614
ML 293 Dual 9 pin, 200 NLO wide carriage color \$803
2410/P/IBM 350 cps 175/185/wide \$1850

Toshiba

P-351 24 pin 288 cps wide carriage \$989
P-341 24 pin 216 cps wide carriage 180 NLO \$727
P-321 24 pin 216 cps narrow carriage \$442
P-351 C Color printer \$1178

Panasonic

KXP1091 120 cps, NLO 29 cps \$270
KXP1092 180 cps, NLO 33 cps \$348
KX1592 wide carriage, 180 CPS, NLO 38 cps \$480

N E C

P-5XL24 pin, 290 cps, 100 NLO color \$1071
P-6, P-7, 24 pin \$477/667

LASER PRINTERS

Hewlett-Packard

LASER JET PROFESSIONAL 8 pages per minute \$2357
LASER JET PLUS DPI graphics/SIP interface \$3053

PRINTERS/LETTER QUALITY

Brother

HR-15 17 cps \$368
HR-25 23 cps \$615
TWINWRITER DOT MATRIX 140 cps, LO 36 cps \$1063
M1509 180 cps/45 cps NLO \$420

N E C

ELF(18 cps) \$408
NEC 3550 (33 cps) \$799

Panasonic

KXP-3131 (17 cps) \$286
KX-P3151 Wide (22 cps) \$448

TERMS: WE ACCEPT C.O.D. CASHIER CHECK, VISA, MASTER CARD, 3% EXTRA ON AMEX, WIRE TRANSFERS, APPROVED P.O.'S, ALL EQUIPMENT CARRIES NEW FACTORY WARRANTY. PRICES ARE SUBJECT TO CHANGE. ANY RETURN ITEM MUST BE ACCOMPANIED BY A RETURN AUTHORIZATION NUMBER AND DESCRIPTION. IBM, COMPAQ, SEAGATE IS A REGISTERED TRADEMARK OF THEIR RESPECTIVE COMPANIES.



pcAmerican
Marketing, Inc.
17151 Newhope St., Suite 104, Fountain Valley, CA 92708

Inquiry 251

HOURS:
MONDAY — FRIDAY
8:30 — 5:30
SATURDAY
10:00 — 2:00

1-714-557-3903
CUSTOMER SERVICE

1-800-654-5365
SALES HOTLINE

1-714-557-3904
TECHNICAL SUPPORT

NEW EPROM PROGRAMMER



\$349

The EP-1 is a great value, here's why:

- IBM PC Software included or RS-232 to any computer
- ASCII Command driven operation; All intelligence in unit
- Reads, Programs, Copies over 150 types from 2716 to 27512
- Optional Intel microcontroller programming head
- Menu-driven Chip Selection; No Personality Modules
- Fast, Slow, Quick-Pulse Programming Algorithms
- Intel (8080 & 8086), Motorola, Tekhex, Straight Hex Files
- Splits Files By Base Address and Odd/Even (16 bit systems)
- Gold Textool ZIF IC Socket
- Over-Current Protection
- Full One Year Warranty
- UV Erasers from \$34.95
- Generate & Set Checksums
- B Baud Rates 300 to 38,400
- 5, 12.5, 21, 25V Programming

BP Microsystems
5325 Glenmont, Suite E, Houston, TX 77081
(800) 225-2102 (713) 667-1636

Inquiry 53

NEW!



SafeSkin™
KEYBOARD PROTECTOR

Remains in place during keyboard use. Prevents damage from liquid spills, dust, ashes, etc. Fits like a second skin, excellent feel. Available for: IBM-PC, AT, Apple (all), Compaq, Model 100, NEC 8201, C64, Zenith 150, DEC, Kaypro, KB5151, AT&T 6300, WYSE 50 and many others. Send \$29.95, check, M.O., Visa & MC include exp. date. Specify computer type. Dealer inquiries invited. Free brochure avail.

Merritt Computer Products, Inc.
2925 LBJ Fwy, #180 / Dallas, Texas 75234
(214) 339-0753

Inquiry 204

IBM-PC Schematic Design

A professional package enabling you to design, edit, print & plot electronic schematics. Supports "A" — "E" size sheets, over 2000 Unique Library Parts, Auto Panning, Part Rotation, 5 Zoom Levels, Rubberbanding, Powerful Macros, Hi-Res Color & Monochrome Graphics, Much More! \$495 Includes Everything.

Call or Write for Free Demo Disk.

Or CAD Systems Corporation
1049 S.W. Baseline St. Suite 500
Hillsboro, OR 97123
(503) 640-5007

EVASAN (415) 991-1051
P.O. Box 2143 Daly City, CA 94012

V - 20 8 mhz 9.50

Math Co-Processors
8087 - 2 8 mhz 142.00
80287 - 3 8 mhz 162.00

DYNAMIC RAMS		EPROMS	
1 MEC	100ns 60.00	27512	250ns 17.00
41256	100ns 4.65	27C256	200ns 7.00
41256	120ns 2.98	27C256	250ns 6.50
41256	150ns 2.65	27256	250ns 5.20
4164	120ns 1.10	27128	250ns 3.60
4164	150ns 1.00	2764	200ns 3.75
4464	120ns 4.25	2764	250ns 3.20
4464	150ns 3.95	2732A	200ns 3.90
4128	150ns 4.00	2732A	250ns 3.50

STATIC RAMS		
43256L	120ns	28.00
6264L	150ns	2.80
5564L	150ns	4.75
5565L	150ns	3.25
6116	150ns	1.45

TERMS AND CONDITIONS

- 1) PRICES SUBJECT TO CHANGE. PLEASE CALL FOR CURRENT & VOLUME PRICING.
- 2) MINIMUM ORDER - \$10.00
- 3) SHIPPING & HANDLING: UPS GROUND - \$3.00 (One Pound) UPS AIR - \$4.50 California Residents add 6.5% sales tax.
- 4) 3% SURCHARGE ON CREDIT CARD CHARGES.

ALL MERCHANDISE 100% GUARANTEED-PROMPT DELIVERY
CALL FOR PRICE LIST

Inquiry 122

IEEE 488 Interfaces

for instruments, plotters, printers, digitizers, PCs, Macintosh, etc.

Call or send for your **FREE** Technical Guide

LOtech (216) 439-4091

23400 Aurora Road
Cleveland, Ohio 44146
Telex via WUI 6502828064

Inquiry 162

Motion Control & Data Acquisition

on your IBM PC or Apple II and all compatibles



Smart 2 Axis Motion Controller: For many types of motors & encoders. New LC. (from HP) allows changes & monitoring on the fly. Optically isolated. W/SOFTWARE \$350.

Four Axis Stepper Driver: With SOFTWARE & motor for instant automation. \$95.

Fast A/D Board: With programmed gain, 650 KHz, 4 in puts. \$220. Complete Scope hardware & SOFTWARE \$500. Also: 12 Bit A/D, Relay Driver, Real Time Clock. Circuit developers Project Book \$25.

How do you do it? Use our Local Applications Bus, LAB 40. One host adapter (\$150) supports up to 8 boards, like those above, on a 50 ft. ribbon cable.

Please call (415) 755-1978 for free literature.

Computer Continuum
75 Southgate Ave., Suite 6
Daly City, CA 94015 (415) 755-1978

LIFETIME WARRANTY

Verbatim®
Special **12 PACK**
* 12 Pack Special 5 1/4" SSDD & DSDD

5 1/4" Disks	Digital Cassettes	3 1/2" Disks
S-Side 7.95 D-Den. *	T300.... 4.05 R300... 3.85 T450.... 5.55 DC30... 6.60 MI 50... 4.90 HD 10... 7.95	S-Side 12.95 D-Side 18.95
S-Side 15.75 D-Side 18.75 HIGH DEN. 20.95	HEAD CLEANERS 5 1/4" Kits... 4.75 5 1/4" Refills 7.00 8" Kits... 5.95 8" Refills 8.00	8" Disks S de 15.40 S-Side 17.95 D-Den. 20.95

Old Reliable Diskette Connection
* Delaware 1-800-451-1849
* Oklahoma 1-800-654-4058
* Nevada 1-800-621-6221

LIFETIME WARRANTY

3M

Call For Quantity Discounts

5 1/4" Disks	Data Cartridges	3 1/2" Disks
S-Side 7.95 D-Den. 9.95 D-Side 9.95 D-Den. 15.75 D-Side 19.75 HIGH DEN. 21.95	DC 100A 12.95 DC 1000 12.95 DC 300A 16.60 DC 300XL 19.55 DC300XLp 19.85 DC 600A 22.00	S-Side 13.95 D-Side 19.95
	HEAD CLEANERS 12.75 EA. 30 Cleanings	8" Disks S-Side 15.40 S-Side 18.95 D-Den. 20.95

Old Reliable Diskette Connection
* Delaware 1-800-451-1849
* Oklahoma 1-800-654-4058
* Nevada 1-800-621-6221

maxell®
FLOPPY DISKS

5 & 10 box Quantity Discounts

SUPER QUALITY

5 1/4" DISKS	3 1/2" DISKS
S-Side 7.95 D-Den. 9.95 D-Side 9.95 D-Den. 15.75 D-Side 19.50 HIGH DEN. 21.95	S-Side 12.95 D-Side 19.00
	8" DISKS S-Side 19.95 D-Side 21.95

LIFETIME WARRANTY

Old Reliable Diskette Connection
* Delaware 1-800-451-1849
* Oklahoma 1-800-654-4058
* Nevada 1-800-621-6221

VAR's OEM's RESELLER's

Save 20 to 40%

818-889-1256

IBM-PC* Logic Boards

- XT 640k Mother Board **\$78** ³²
(Fully IBM compatible, w/0k RAM)
- XT 640k Super Turbo **\$98** ²²
(Fully IBM compatible, w/0k RAM)
- AT Turbo Mother Board **\$474** ⁸⁶
(6 & 8 MHz AT, w/0k RAM)

IBM-PC* Components (Partial List)

- Mono/Graphics/Printer **\$50** ⁶¹
(Herc. Compatible interface card)
- Multi Disk I/O (2 Floppy) **\$57** ²³
(Ctrl, Par, Ser, Clk, Cld, Game)
- Hi Res Amber Monito (Tilt) **\$66** ¹²
swivel Base & Anti-glare Screen)
- Box/Chassis Flip Top **\$19** ⁰⁷
(IBM Compatible & Look-a-like)
- Power Supply (150w) **\$43** ⁷²
(FCC & UL Std.)
- 5160 Keyboard, AT style **\$48** ⁴⁰
(Hi-quality with great feel)
- Floppy Drive DS/DD **\$59** ⁸⁷
(Hi-quality w/Direct Drive motor)
- E G A Video Card **\$197** ²³
(Now affordable)
- E G A Monitor RGB **\$368** ²³
(720 x350 Multi Sync.)

ACS Imports, specializes in buying custom and standard electronics components to fit your specific needs. We have years of expertise buying and importing components from the Orient.

ACS will solve your sourcing needs.

Call: **818-889-1256**

ACS Imports, 5311 Derry Ave.#A
Agoura Hills, CA 91301
TLX 5106018224

COMDEX Riviera #8208

*IBM trademark International Business Machines
All prices are FOB Taiwan - Import Quantities

DOUBLE PLOTTER COLOR PRINTER LETTER CASSETTE RECORDER VOICE RE...
THE OPTION CAPACITY OF YOUR IBM PERSONAL COMPUTER

PC-XTRA

- DIRECT EXTENSION OF IBM PC BUS
- NO SOFTWARE CHANGES
- NO HARDWARE MODIFICATION
- STYLING CONSISTENT WITH IBM

Add all those special options that you've been wanting without worrying about filling your plug-in and back panel space



DEALER INQUIRIES INVITED.

\$549.00* F.O.B. SANTA ANA
*CALIFORNIA RESIDENTS ADD 6% SALES TAX.

P C HORIZONS, INC.
1701 E. Edinger, Ste. A6, Santa Ana, CA 92705
(714) 953-5396

Inquiry 242

PRINTER SHARING

HERE IS THE ECONOMICAL AND THE BEST SOLUTION

- Completely automatic operation
- Eliminates the need for manual switching or cable swapping
- May be used for other peripherals (i.e. plotters)
- Compatible with all computers using a standard CENTRONICS output
- Identifies active computer
- Totally transparent to the user

- Adjustable time-out delay from 1 to 25 seconds between two printings
- Form feed may be inserted (or not) between two successive requests
- Port number associated with requesting computer may be printed or not
- 8 kbyte standard buffer • 32 kbyte optional buffer
- Z80-A processor • Six models to choose from:

PMS 606: 2 computers to one printer/
8 kbyte buffer : \$149.00

PMS 607: PMS 606 with 32 kbyte buffer : \$219.00

PMS 610: 4 computers to one printer/
8 kbyte buffer : \$249.00

PMS 611: PMS 610 with 32 kbyte buffer : \$319.00

PMS 615: 8 computers to one printer/
8 kbyte buffer : \$349.00

PMS 616: PMS 615 with 32 kbytebuffer : \$419.00

We are also manufacturing a full line of **STD BUS** and educational products.

DEALER INQUIRIES INVITED
Visa, M.C. accepted, call toll free: **1-800-361-2572**
Protac Micro Systems Inc. 8990A, Tiers Canada Hwy. St. Laurent, Qc H4S 1M5
Tel. (514) 335-9555 Tel: 0525134/PROTEC

Inquiry 268

POWERFUL LOW-COST CONTROL WITH YOUR COMMODORE C64 OR C128



Universally applicable dual 6522 Versatile Interface Adapter (VIA) Board. Four 8-bit bidirectional I/O ports, eight handshake lines, four 16-bit timer/counters. IRQ interrupt capability. Expandable to four boards. With extensive documentation, application examples, and programs on disk. Order Model 64IF22. \$169 postpaid USA. Each additional \$149.

New 16-channel 8-bit fast A/D converter module. Requires above. Order Model 64IF/ADC0816. Only \$69.

Documentation package now available separately for examination. Credit against first order. \$30.

SCHNEDLER SYSTEMS
1501 N. Ivanhoe, Dept. B11, Arlington, VA 22205.
(703) 237-4796.

Inquiry 295

RAMS

256K (256K x 1)	150 ns	2.70
256K (256K x 1)	120 ns	2.90
256K (64K x 4)	150 ns	4.25
128K (128K x 1)	150 ns	4.40
64K (64K x 1)	150 ns	1.10
64K (64K x 1)	120 ns	1.35
6264LP-15 (8K x 8)	150 ns	3.15

EPROMS

2732A (4K x 8)	250 ns	4.05
2764 (8K x 8)	250 ns	3.35
2764 (8K x 8)	200 ns	3.75
27C64 (8K x 8)	200 ns	5.05
27128 (16K x 8)	250 ns	3.65
27256 (32K x 8)	250 ns	5.25
27256 (32K x 8)	200 ns	5.65

PROCESSORS

C8087-2	8MHz	150.00
C8087	5MHz	115.00
V-20	8MHz	12.00
V-30	8MHz	14.00

MicroTech

(206) 364-2209, 8-5 Mon.-Fri.
P.O.Box 27083, Seattle, WA 98125

Prices shown for ash. Prices subject to change. Call for current prices & volume discounts. Shipping & Handling: UPS ground \$2.00. air \$5.00 (under 1 lb.). Master Card/Visa add 3%. Wash. residents add 7.9% sales tax. Satisfaction guaranteed.

Inquiry 217

DATA ACQUISITION TO GO

INTERFACE FOR ANY COMPUTER

FREE IBM SOFTWARE



Connects via RS-232. Fully IBM compatible. Built-in BASIC. Stand alone capability. Expandable. Battery Option. Basic system: 16 ch. 12 bit A/D, 2 ch. D/A, 32 bit Digital I/O. Expansion boards available. Direct Bus units for many computers.

(201) 299-1615
P.O. Box 246, Morris Plains, NJ 07950

ELEXOR

Inquiry 118

TURBOLINK +

Now Add TURBO Prolog to your Pascal Code!

"TURBO Pascal hackers will like this program."
Jerry Pournelle
Byte Magazine

- Add 512K of TURBO Pascal* to your code
- Call up to 8 memory resident TURBO Pascal modules from programs written in:
 - BASIC, BASIC-A, Compiled BASIC
 - MS Pascal, C, MS FORTRAN
 - Standard, 8087 and BCD TURBO Pascal
 - TURBO Prolog
- Add TURBO Pascal's 8087, BCD and graphic capabilities to other languages
- Automatically generate TURBO Pascal compatible inline machine code.
- Use all TURBO Pascal variants in a single program
- Add AI capability to your Pascal programs
- For IBM PC and compatible

\$6995 Foreign orders add \$10.00

S&H included
VISA/MC: 1-800-835-2246 x123
KANSAS CALL: 1-800-362-2421 x123
Inquiries and Technical Information (303) 971-0729

PATHFINDER SOFTWARE, INC.
P.O. Box 43, Littleton, CO 80160
*TURBO Pascal and TURBO Prolog are trademarks of Borland International.

Inquiry 249



COMPUTERBANC

IBM COMPATIBLE HARDWARE

Multifunction card 384K, S.P. CLK **\$139**
AT Multifunction card OK-3MB ..\$175
MONOCROME graphics card ...\$79
Color Graphics card\$69
ComBo CARD ser, par, clock ..\$69
EXPANSION CHASIS 7 slots ..\$569
MULTI SERIAL 4 PORT\$89

DRIVES

20 MB Seagate drive\$399
 30 MB Seagate for XT\$499
 30 MB drive for AT\$649
 360 K Floppy for AT\$110
 Teac 55B\$109
 20MB Hard CardCALL

TAPE DRIVES

10 MB Irwin\$379
 20 MB Irwin\$429
 Everex Stream 20\$569
 Everex Stream 60\$899
 PeachtreeCALL
 Franklin 20MB\$399

BUSINESS SYSTEMS

IBM SOFTWARE

LOTUS 123CALL
 SymphonyCALL
SPREADSHEET Auditor89.00
ENABLE359.00
V P Planner55.00
ASHTON TATE FrameworkCALL
 dBASE IICALL
 dBASE III PlusCALL
REVELATION499.00
MOBS KnowledgeMan 2299.00
POWERBASE179.00
CLIPPER dBASE III Compiler355.00
LATTICE C COMPILER265.00
LET'S C Compiler49.00
SUPERCALC IV275.00
MULTIMATE249.00
 MULTIMATE ADVANTAGE269.00
SORCIM SUPERCALC III199.00
MICROSOFT Multiplan119.00
EXCEL245.00
 Word249.00
 Windows65.00
 Project239.00
 DOS 3 2 W/GW basic69.00
MACRO ASSEMBLER95.00
 Quick Basic65.00
FOX & GELLER Quickcode149.00
 QuickIndex76.00
 dUTIL 376.00
BORELAND TURBO PASCAL42.00
 Turbo Pascal W/BCD60.00
 REFLEX59.00
 LIGHTENING59.00
 SUPERKEY41.00
 SIDEKICK (unprotected)50.00
NORTON UTILITIES55.00
FASTBACK95.00
ASCII PRO Comm Software55.00
CROSSTALK XVI99.00
MIRROR Comm Software49.00
PEACHTREE Back to Basics199.00
BPI GENERAL ACCOUNTING299.00
OPEN SYSTEMSCALL
REAL WORLDCALL
ONE-WRITE PLUS149.00
ACCOUNTING PARTNER199.00
MONOGRAM DOLLARS & SENSE99.00
TOBIAS MANAGING YOUR MONEY99.00
DAC EASY ACCOUNTING45.00
PFS Professional File115.00
PFS Professional Write145.00
Websters New World Writer79.00
SATELLITE WORD PERFECT209.00
MICROPRO WordStar PRO249.00
 WordStar 2000 PLUS299.00
SAMNA Word III279.00
RBASE 5000359.00
RBASE System V370.00
SUPERPROJECT PLUS255.00

Multitech Accell 900 .**\$1550**
 6/10Mhz Switchable speeds
 89286 AT Compatible

20MB Turbo XT Compatible
\$999.00

2 Floppy XT Compatible
\$699.00

IBM AT 30MB**\$3200**
 6MHZ, 512K, Seagate 40MS
IBM XT 20MB**\$2299**
 Seagate, 256K, DOS, Monitor
COMPAQ COMPUTERSCALL
LEADING EDGECALL
SPERRY IT 44MBCALL
LASER 128 (IIC Compatible)CALL
LOCAL AREA NETWORKCALL

IBM HARDWARE

PRINTMASTER35.00
 BREAKTHROUGH TIMELINE235.00
 DECISION RESOURCES CHRTMSTER219.00
 ENERGRAPHICS w/plotter opt.289.00
 FUNK SIDWAYS36.00
 LIFETREE VOLKSWRITER 3149.00
 HARVARD TTL PROJECT MNGR285.00
 THINKTANK110.00

AST 6 Pack Plus w/384k215.00
 6 Pack PremiumCALL
 STB Companion PC 0-2 MB LIMS189.00
 Chauffeur monographics229.00
 EGA- Plus Color Board279.00
 JRAM 3CALL
 JRAM AT3CALL
 HERCULES Mono Graphics Plus199.00
 Color Card149.00
 INTEL Above Board 64K229.00
 ABOVE BOARD for AT359.00
 ORCHID Tiny Turbo469.00
 Turbo 286E W/1 Meg749.00
 Turbo EGACALL
QUADRAM EGA +379.00
PARADISE Modular Graphics Card199.00
 Autoswitch EGA388.00
Plus Hard CardCALL
130 WAT Power Supply79.00
 Thesis Fastcard III LIMS 0-2MB169.00
TALLGRASS W/TapeCALL
MOUNTAINCALL
ALLOYCALL
 Graphics Edge Card239.00
MOUSE SYSTEMS Mouse119.00
MICROSOFT Mouse w/stlwr.117.00
KOALA KAT137.00

MODEMS

ANCHOR Lightening 2400299.00
 Express 300/1200199.00
 Volkmodem 1200 (5 yr wrnty)139.00
 EXPRESS 1300/1200 (INTERNAL)149.00
HAYES 1200369.00
 1200B349.00
 2400CALL
PROMETHEUS 2400379.00
 Promodem 1200245.00
 Promodem 1200B170.00
 Promodem 1200A189.00
 Promoden 300 IIC79.00

MONITORS

AMDEK 300A139.00
 310A Hi-Res Amber149.00
 Color 600389.00
 Color 722 RGB 720 X 350CALL
PRINCETON GRAPHICS HX-12399.00
 HX-12E RGB 720X350489.00
 SR-12CALL
 MAX-12149.00
TAXAN: ALL MODELSCALL
 DT-H103 10" High Res RGB359.00
IBM COMPATIBLE Monochrome99.00
 Color RGB Monitor (640X200)269.00

PRINTERS

PANASONIC (2 yr warranty)
 KX-P1080199.00
 KX-P1091229.99
 KX-P1092299.00
 KX-P1592419.00
 KX-P1595 240 CPSCALL
 KX-P3131 17cps Daisey249.00
 KX-P3151 22 cps Daisey385.00
 Citizen MSP-10275.00

MSP-15389.00
 MSP-25CALL
STAR MICRONICSCALL
 EPSON LX-80Call
 FX-286for
 LO-800Best
 LO-1000Prices
BROTHER-1509369.00
 M-1409 dot matrixCALL
 M-1109 dot matrix205.00
 HR-20 Daisey wheel370.00
OKIDATA - All ModelsCall
TOSHIBA All ModelsCALL
CANNON Laser Printer1,999.00
HEWLETT PACKARD LAZER2,199.00
HOUSTON INSTRUMENTS PlottersCALL
 DigitizersCALL

APPLE

LASER 128 ComputerCALL
 APPLE Compatible Drive II99.00
 IIC compatible drive99.00
MAC Compatible 3 1/2 driveCALL
MICROSOFT Softcard II259.00
ASCII XPRESS (Communications)65.00
APPLEWORKS215.00
SPELLWORKS49.00
PRINT SHOP35.00
Mach III Joystick35.00
SYSTEM SAVER Fan69.00
VIDEO 7 IIC EnhancerCALL
VIDEX Ultratram165.00
APRICORN (Lifetime Warranty)
 Super Serial Imager75.00
 Graphics Interface65.00
 80 Column/64K75.00
EXTEND IT 64K55.00
KOALA SpeedKey99.00

Call for catalog. Thousands of products available. Volume discounts.



COMPUTERBANC

16783 Beach Blvd., Huntington Beach, CA 92647

Customer Service Call 714-841-6160



Technical Service Call 714-847-BANC



Orders Only
 OUTSIDE CALIFORNIA

800/332-BANC
714-841-6160

Cash prices indicated. We guarantee all items for 30 days. Within this period, defective merchandise returns must be accompanied by RMA number. All other returns will be subject to a 15% restocking fee. For prepaid orders, there will be a 3% shipping charge; 5% for UPS Blue Label; \$5.00 minimum; all orders outside U.S.A. at 15% shipping. California residents add 6% sales tax.

Prices subject to change without notice.
 ©Copyright 1985 COMPUTERBANC, All Rights Reserved.



PORTABLE ADDITIONS

DISK DRIVE 3 1/2", 1 3/4 lbs., battery oper. or A/C adaptor (incl.), 100K storage. With TS-DOS software \$229 Drive without software \$179

24K RAM CHIP—Tandy 200 \$65, 2/\$59 ea.

8K RAM CHIP—Model-102 \$9.95
Model-100 & NEC 8201/\$23 3/\$19 ea.

SIDESTAR—NEC Starlet \$399 \$199
128K Ram Disk Cartridge

SIDECAR—NEC PC-8201A \$259
128K cartridge (four 32K banks)

CALL TOLL FREE 1-800-732-5012
Calif: 805-987-4788
Canada: 604-856-8858, Australia: 02-419-8899

PURPLE COMPUTING VISA M/C & AMER. EXP.
420 Constitution Ave., Camarillo, CA 93010

Inquiry 270

SOFTWARE SENTINEL™

MUCH MORE THAN JUST PROTECTION



Because its original objective was to protect software from unauthorized use, it's called the SOFTWARE SENTINEL. But maybe we'll change the name to REVENUE GENERATOR since we've discovered its true value to our customers. But whatever we call it, everyone ends up with numerous benefits from this hardware key with unlimited "locks".

SOFTWARE DEVELOPER BENEFITS

- Prohibits unauthorized use of software
- No need for copy protection
- Algorithm technique (never a fixed response)
- Virtually unbreakable
- Higher level language interfaces included
- 100 times faster (1ms) than fixed response devices
- Minimal implementation effort
- Runs under DOS and Xenix, on IBM PC, AT, XT & compatibles

SOFTWARE USER BENEFITS

- Unlimited backup copies
- No floppy required with hard disk
- Pocket size
- Inexpensive
- Inoperable

EVALUATION KIT AVAILABLE
RAINBOW (1984) INC.
17971 SKYPARK CIRCLE SUITE E, IRVINE, CA 92714 (714)261-0228
Telex 386078

Inquiry 284

Super Buffer Bargain!



64K Only 89⁰⁰ !!!

Copy, Bypass, Reset... This Buffer does it all!!! Rugged Metal Case with LED's to indicate status!!! Reliable Parallel Operation with Multiple Copies AND Multiple Documents. A Real Bargain!

256K Only \$199⁰⁰ !!!

Call (918) 437-2600

Call for Best Price Cables and Switches!

No minimum. COD's accepted. Checks clear 2 weeks. 3% surcharge MC/VISA. Shipping and Handling \$5.00
Prepays to: POB 690958 • Tulsa, OK 74169-0958

MaxTech

Inquiry 96

IBM PC/VT220

EM220 • VT220, VT102 emulation
\$149 • File Transfer
• 132 Column modes
• Color Support
• Hot Key

TEK 4010/4014

EM4010 • Tektronix 4010 emulation
\$249 • VT220, VT102 emulation
• Picture files
• High resolution hardcopy
• Supports IBM, IBM Enhanced, Hercules, Tecmar and AT&T.

Diversified Computer Systems, Inc.



3775 Iris Ave., Suite 1B
Boulder, CO 80301
(303) 447-9251
Telex 9103800693 DCSINC

Trademarks: VT100 — Digital Equipment; IBM PC, XT — IBM Corp.

Inquiry 113

ROSE DATA SWITCHES



SHARE computers, printers, any parallel or serial device
ELIMINATE cable swapping
INEXPENSIVE way to network
COMPATIBLE with all computers.

Businesses, Schools, Homes

WE ALSO OFFER:
Data Buffers, Line Drivers, Modems, Protocol Converters, Parallel - Serial Converters, Cables, Computers, Printers, Disk Drives, and more.

AUTOMATIC - CARETAKER is ideal for a business or school to share a printer or modem among many computers. Operation is fully automatic with no software required.
Parallel or Serial 4 channels - \$295 8 channels - \$395

MANUAL - HARD SWITCH is operated with the flip of a switch. 2:2 and 2:4 models allow simultaneous communication.
Serial 1:2 - \$59 1:4 - \$99 2:2 - \$109 2:4 - \$169
Parallel 1:2 - \$79 1:4 - \$139 2:2 - \$119 2:4 - \$199
LED and spike protection on serial models add \$20.

CODE ACTIVATED - PORTER connects one computer to multiple peripherals. A software code selects the peripheral.
Parallel or Serial 4 channels - \$295 8 channels - \$395
Buffer option 64K - \$100 256K - \$250

REMOTE - TELEPATH connects multiple computers to multiple peripherals. A selector at each computer or terminal chooses up to 4 peripherals and displays busy status.
4:4 - \$495 4:8 - \$795 selector - \$39.

Give a Rose to your computer

ROSE ELECTRONICS (713) 933-7673
P.O. BOX 742571 MC & VISA Accepted
HOUSTON, TX 77274 Dealer Inquiries Invited
CALL US FOR ALL YOUR INTERFACE NEEDS

Inquiry 287

NEC PRINTERS

(1 Year Factory Warranty)

Pinwriter P5.....\$ 930
Pinwriter P5XL.....\$1075
Pinwriter P6.....\$ 450
Pinwriter P7.....\$ 615
Elf 350/360.....\$ 380
3510/15/30/50.....\$ 715
8810/15/30/50.....\$1040

Optional Forms Handling Devices CALL

QUALITY PRINTERS
8415 Cement City Road
Brooklyn, Michigan 49230
Phone: 517-592-3749

Inquiry 278



INI-10/AT

PC-AT EXPANSION CHASSIS

- Full 16-bit PC-AT bus
- 10 slots
- 250W power supply
- Two fans
- Direct extension of PC-AT bus
- No software changes needed
- Inexpensive, simple, attractive

Dealer Inquiries Invited.
List Price \$1,400.00

INI Computer Products
6915 Hightech Drive
Midvale, UT 84047
(801)561-1100
Contact Mark Jenkins

Inquiry 158

Heritage Systems Corp



HSC-9100
80 By 24
Or 25 Line
Alpha-numeric
Video Terminal
Card

ANSI X3.64/Other Terminal Emulations
50 To 38.4K Baud Serial Port
RS-232 Or TTL/CMOS Versions
IBM PC Compatible Keyboard Input
EEPROM Based On Screen Config
Composite or Separate Video
100 By 100mm Card 5V Only @ 200mA
\$139 TTL/CMOS \$149 RS-232

PO Box 10588,
Greensboro, NC 27404-0588
(919) 274-4818

Inquiry 147

LOW COST HIGH RESOLUTION DATA LOGGING for IBM PC/XT/AT®

15-Bit four input channel system
7 samples/second with hardware and menu driven software \$415

Expand system above by 15 analog input channels (64 max.)... \$165

Add thermocouple thermometry to above, 6 channels for..... \$175

Add 16-bit, 12,000 sample/second capabilities to above for... \$210

Call for quantity pricing or for quotes on custom hardware, software or complete systems.

LAWSON LABS, INC.
5700 Raibe Road
Columbia Falls, MT 59912
Phone: 406 387-5355



Inquiry 175

QUME DISK DRIVE

DS, DD, 360K for PC

\$69



Teac FD55 BV _____ \$109
Tandon TM100-2 _____ \$109
1.2 MB for AT _____ \$149

HARD DISK DRIVE \$349



10 MB Kit _____ \$349
20 MB Kit _____ \$399
20 MB hard disk card _____ \$449

HI-RES COLOR MONITOR

640 x 262, .38 dot pitch,
16 color, RGB, non-glare

\$269

By Hitachi includes cable & FREE Swivel Base!

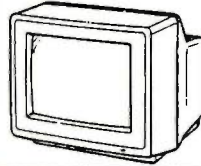

OMNI-READER TEXT SCANNER

\$179

List Price \$799

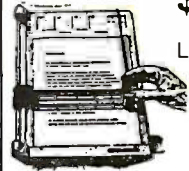

Reads and inputs type written text into your computer.

Uses a standard RS-232 serial port. Software & cable kit for IBM or Macintosh \$29

DAISYWHEEL PRINTER

- 22 cps, 2K buffer
- Diablo compatible
- Parallel & serial
- Proportional spacing

\$199

List Price \$499
Tractor — \$69
Sheet Feeder — \$129

20 MB HI-SPEED HARD DISK FOR YOUR AT

Limited quantity

\$399

30 MB Hi-speed _____ \$695
40 MB Hi-speed _____ \$895
70 MB Hi-speed _____ \$1695
120 MB Hi-speed _____ \$3395

PC Multifunction Cards

384K Jade Seven Pak w/0K, p, s, c, g, software \$99
384K Jade Seven Pak with 384K installed \$139
AST Six Pak Plus 64K \$159
AST Six Pak Plus 384K \$229
AST Six Pak Premium 512K \$389
AST Rampage 256K \$239
AST Rampage 2 MB \$699
Tall Tree JRAM-3 0K \$189
Tall Tree JRAM-3 2 MB \$599
Intel Above Board 64K \$279
Intel Above Board 2 MB \$599

AT Multifunction Cards

1.5 MB Jade-AT Pak w/0K, p, s, optional g, s \$199
1.5 MB Jade-AT Pak w/1.5 MB RAM installed \$399
AST Advantage-AT 128K \$349
AST Advantage-AT 3 MB \$989
AST Rampage-AT 512K \$469
AST Rampage-AT 2 MB \$749
Tall Tree JRAM-AT 0K \$169
Tall Tree JRAM-AT 2 MB \$599
Tall Tree JRAM 3-AT 0K \$239
Tall Tree JRAM 3-AT 2 MB \$699
Intel Above Board 128K \$399
Intel Above Board 4 MB \$1299

Networks

AST PC NET Board \$325
PC NET Starter Kit \$695

64K BUFFER FOR YOUR EPSON

Serial or parallel input Fits MX, RX, FX printers
Limited Quantity **\$99**

RGB Color Monitors

Hitachi 640 x 262 \$269
Magnavox 640 x 240 \$319
Quimax EGA 640 x 350 \$489
NEC Multisync 800 x 560 CALL
PGS HX-12 640 x 240 \$439
PGS HX-12E 640 x 350 \$529

Monochrome Monitors

Magnavox green TTL \$99
Magnavox amber TTL \$99
Amdek 310A amber \$149
Quimax 14" green T/S \$139
Quimax 14" amber T/S \$139
PGS MAX 12E amber \$159

PC or AT Video Boards

Hercules Color Graphics \$159
Jade Color Graphics \$89
Hercules Mono Graphics Plus \$199
JADE Monochrome Graphics \$99
Quad EGA+ \$359
JADE EGA+ \$239

SURGE/NOISE POWER STRIP

UL Listed, U.S. Made

\$12

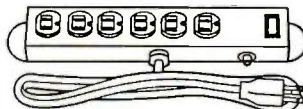

PC Power Supply

135 watt power supply \$69
150 watt power supply \$79

Plotters

Roland DXY-800 8 pen \$399
Houston Inst. PC 695 \$599
Houston Inst. DMP 40P \$849
Houston Inst. DMP 29 \$1699
Houston Inst. DMP 41/42 \$2495
Houston Inst. DMP 51/52 \$3795
Houston Inst. DMP 56 \$4495

1200 Baud Modem \$129

Internal 1200 baud card with software \$129
External 1200 baud \$139
Hayes 1200B internal card w/o software \$329
Hayes 1200B internal card w/Smartcom II \$359
Hayes Smartmodem 1200 \$389
Hayes 2400B internal card w/Smartcom II \$549
Hayes Smartmodem 2400 \$589

Iso-Bar

These industrial quality ISO-BAR's contain surge suppression circuitry & built-in noise filters plus a 15 amp circuit breaker.

6 socket, 1 filter ISO-BAR \$44
4 socket, 2 filter ISO-BAR \$59
8 socket, 4 filter ISO-BAR \$69
200W standby power supply \$269
425W standby power supply \$399
675W standby power supply \$599
1000W standby power supply \$899

Apple Accessories

IIc 1/2 high disk drive \$119
IIe 1/2 high disk drive \$99
IIe, II+ disk drive \$129
IIe 64K, 80 column card \$49
II+ 80 column card \$119
Grappler printer card \$89
II+ 16K RAM card \$39
II+, IIe printer card & cable \$49
II+, IIe cooling fan \$59

Microfazer Buffers

Expands to 64K (Parallel to 512K)
8K Parallel in/parallel out \$139
64K Parallel in/parallel out \$164
128K Parallel in/parallel out \$269
512K Parallel in/parallel out \$499
Your choice: serial in/serial out; parallel in/serial out; serial in/parallel out.
8K \$169 64K \$199

EPSON HOMEWRITER 100 CPS PRINTER \$189

PC Mouse

3 Button Mouse with pop-up software, serial \$99
PC Mouse w/Dr. Halo II \$119
Microsoft Mouse with PC Paintbrush software \$129

NO-SLOT CLOCK

Real time clock/calendar for your PC-XT or clone

\$49

High Speed APU Chips

8087-3 \$119 8087-2 \$159
80287-3 \$179 80287-8 \$269
NEC V-20 \$11 NEC V-20 \$14

JADE COMPUTER

PLACE ORDERS TOLL FREE!

Continental U.S.A. | Inside California
(800)421-5500 | (800)262-1710



4901 W. Rosecrans Ave. Box 5046
Hawthorne, CA 90251-5046

Prices at our six store locations will be higher.

We accept cash, checks, credit cards or purchase orders from qualified firms and institutions. Minimum prepaid order \$15.00. California residents add 6 1/2% tax. Prices & availability subject to change without notice. Shipping & handling charges via UPS Ground 50¢/lb. UPS Air \$1.00/lb. Minimum charge \$3.00.



pinecom™ IBM Compatibles

2 SPEEDS TURBO SYSTEM

FULLY IBM PC/XT COMPATIBLE 4.77/8MHZ



- 640K on Board RAM
- 2 Floppy Disk Drives
- Disk Controller Card
- 150W Power Supply
- FCC Type Slide Case
- 'AT' Style Keyboard
- 8 IBM I/O Slots
- 8088-2 Micro Processor
- 8087 Co-Processor Socket
- 4.77 MHZ/8MHZ Clock Selectable
- Monitor and Display Card Not Included

Fully Assembled and Tested **\$595⁰⁰**
(Other Options and Configurations Available, Please Call.)

PINECOM AT SYSTEM

FULLY IBM AT COMPATIBLE



- 8/6 MHZ Clock Selectable
- 80286 CPU
- 1.2 MGB Floppy Drive
- 200 Watts Power Supply
- Hard Disk/Floppy Disk Controller
- 512K RAM Expandable to 1 MGB
- Clock Calender w/Battery Backup
- 'AT' Style Keyboard

Fully Assembled and Tested **\$1229⁰⁰**
30 MGB (ST-4308) Hard Disk **\$620**
Other Options, See Below

* * * SPECIAL OF THE MONTH * * *

INFRARED REMOTE KEYBOARD

Now you can operate your PC/XT Computer as far as 25 feet away without any cable in between. State-of-the-art infrared wireless keyboard made in USA with top quality key switches by Cherry.



\$76⁰⁰

Unit comes with receiver (just plug into the keyboard input on your computer) and the transmitter is built inside the keyboard. Limited quantity available.

SALES ITEMS

- 20 MGB Hard Disk (Seagate ST-225) (79 MS) **\$280⁰⁰**
- Western Digital Hard Disk Controller Card WX-2 **\$110⁰⁰**
- 30 MGB Hard Disk For 'AT' (ST 4038) (39 MS) **\$620⁰⁰**
- Half Size Modem Card 300/1200 BPS Hays Compatible ... **\$135⁰⁰**
- 3 Button Mouse System with Software (Serial) **\$85⁰⁰**
- TTX 1411 RGB Monitor 14" 0.31 Dot 640 X 250 **\$330⁰⁰**
- Samsung 12" Monochrome TTL Monitor, Amber or Green . **\$89⁰⁰**
- Samsung 12" Monochrome Composit Monitor, Amber or Green **\$75⁰⁰**
- Monochrome Graphic Adapter with Printer Port **\$85⁰⁰**
- Color Graphic Adapter with 2 Composit Output **\$70⁰⁰**
- 0/576 K Max. RAM Expansion Card For PC/XT **\$45⁰⁰**
- Fujitsu 360K Half Height Floppy Disk Drive **\$88⁰⁰**
- Joystick with 2 Fire Buttons For IBM **\$18⁰⁰**
- 6 Outlets Power Strip with Surge Suppressor and Main Sw. . **\$12⁰⁰**
- 8087-3 Co-Processor Chip For XT (4.77 MHZ) **\$115⁰⁰**
- 8087-2 Co-Processor Chip For XT Turbo (8 MHZ) **\$168⁰⁰**
- 80287-8 Co-Processor Chip For AT (8 MHZ) **\$299⁰⁰**
- NEC V-20 Processor (Replace 8088) 40% Faster **\$13⁰⁰**

EGA ADAPTER AND MONITOR

EGA Adapter: **\$239⁰⁰**

- 100% IBM Compatible
- Displays 16 out of 64 Colors
- 256K RAM on Board For Video Memory
- Dual Scanning Frequencies (15.75 KHZ/21.85 KHZ)
- Works with Standard or EGA Color Monitors
- Light Pen Interface

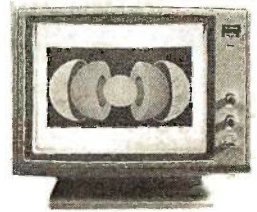

EGA Monitor: **\$439⁰⁰**

- 14" Black Matrix Non-Glare Screen
- EGA and CGA Compatible
- Dot Pitch 0.31 Band Width 25 MHZ
- Display 2000 Characters (80 X 25 Rows)
- 64 Colors Display in EGA Mode
- Dual Scanning Frequencies (15.75 KHZ/21.85 KHZ)
- Resolution =720 X 240 (15.75 MHZ)/720 X 350 (21.85 MHZ)

TRANS-NET™ LOCAL AREA NETWORK

The Most Easy-to-Use and Low Cost Local Area Network System For IBM PC/XT/AT or It's Compatibles

Features:

- Trans-Net Spool (Printer File Spooling)
- Trans-Net Mail (Electronic Mail Software)
- Enhanced Networking DOS Commands
- Multi-Tasking with High Performance
- Classroom Monitor
- No Dedicated File Server
- Hard Disk Sharing
- Floppy Disk Sharing
- Printer/Plotter Sharing
- Transparent to DOS
- File/Record Locking



\$279⁰⁰

Trans-Net 001 System: Network Interface Adapter, Utilities Software, Tap Box, 30 Feet of Trunk Cable (RS-422), Cable Terminators, Instruction Manual for Setting Up Basic Network System.

Specifications:

Topology: Distributed Bus
Data Rate: 1 MGA Bit/Sec
Distance: 4000 Ft Max.
Cabling: Standard Phone Twisted Pair Wire

Addressable Users: 255 Stations
Diskless Boot ROM for Stations
Operating System: MS-DOS 2.0 up

3 MGB MULTIFUNCTION CARD FOR 'AT'



#MF-3000
\$184⁰⁰

- User Expandable Up to 3 MGB with 128/512K Increments
- One RS-232 Serial Port (2nd Port Optional)
- One Parallel Printer Port
- One Game Port
- RAM Set (Each 512K) **\$108⁰⁰**
- 2nd Serial Port I.C. Set **\$26⁰⁰**
- Shipped With Zero K RAM

2 MGB RAM EXPANSION CARD FOR 'XT'



\$147⁰⁰ #MEMO-2000-XT

- Confirms to Lotus/Intel Expanded Memory Spect. (EMS)
- Up to 2048K Bytes of Expansion Memory
- Uses 64K or 256K RAM Chips
- Software and Instruction Manual Included
- Memory Set (Each 512K) **\$108⁰⁰**
- Shipped with Zero K RAM

4 SERIAL PORTS (RS-232) ADAPTER

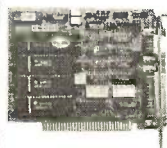

MS-400-XT
\$92⁰⁰
MS-400-AT
\$125⁰⁰

- 4 Serial Ports COM-1, COM-2, COM-3, COM-4
- Custom Fully Molded Serial Cabling and Mountings
- Short Card Design, Available For 'AT' or 'XT'

COPY II PC OPTION BOARD

"Copies Virtually All Protected Software"
For IBM XT/AT, Comes with Disk Back Up Utility, Copy II PC Board, Cable and Instruction



\$99⁰⁰

* * * DOOR TO DOOR DELIVERY TO EUROPE VIA UPS AIR * * *

PINE COMPUTER INC.

9690 Telstar Ave., Suite 204
El Monte, CA 91731

Phone: (818) 575-1882
Telex: 5106017376 PINECOM

TERMS: COD accepted on cashiers check or cash only, no credit card. Shipping charges for COD orders = 5% of total purchase, 2% for prepaid orders, minimum charge applied. Foreign orders require special handling, please ask for details. * IBM is registered trade mark of IBM Corp.

★ **FREE** ★

Media-Mate Diskette Holder

(\$15.00 value) with purchase of
Each 100 Diskettes from this ad
(Brand Names Included)

Presenting our own Brand

the **Best Diskette**

Produced by a major manufacturer
Millions have been sold—100% Guaranteed
(You may be using them now without knowing)
... So Why Pay More?

Best 5 1/4" Diskettes

DS/DD **.43 EA.**
DS/HD for AT **1.39 EA.**

Order in multiples of 100 only!

All Best 5 1/4" Diskettes are poly bagged in 20's
with tyvec sleeves, write-protect tabs and user ID labels.

Best 3 1/2" Diskettes

SS/DD **1.19 EA.**
DS/DD **1.59 EA.**

Order in multiples of 100 only!

All Best 3 1/2" Diskettes include user ID labels.

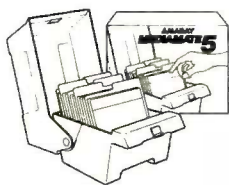

Holds 50 5 1/4"

A \$15.00 Value

★ **FREE** ★

with Each 100 Diskettes
or purchase separately
for **\$8.88**

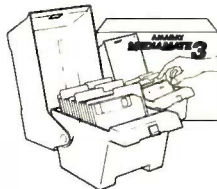

Holds 30 3 1/2"

U.S. made—Highest quality
Why pay more and settle for less?

Best
COMPUTER
SUPPLIES

2148-A Bering Dr.
San Jose, CA 95131
(408) 435-3866

TO ORDER, CALL TOLL FREE
1-800-351-BEST (2378)
1-800-451-BEST (in California)

Visa, Mastercard, C.O.D. or Prepaid. Corporations rated 3A2 or better, government agencies and schools may send in purchase orders on a net30 basis. Minimum order \$25.00. Shipping charges are \$3.00 per 100 diskettes (Minimum shipping order \$3.00) (within the continental U.S.). APO, FPO, AK, HI, PR and Canada Orders add 10% to cover PAL and Insurance. All other countries add 20%. C.O.D. Orders Add \$4.00. No Sales Tax outside California.

Satisfaction guaranteed on all products.

maxell

Boxed in tens

5 1/4" SS/DD.... **.89 Ea.**
5 1/4" DS/DD ... **1.09 Ea.**
5 1/4" DS/HD... **2.19 Ea.**
3 1/2" SS/DD... **1.39 Ea.**
3 1/2" DS/DD... **2.09 Ea.**

(Minimum order 20)

Free Media-Mate with each 100

Verbatim

Boxed in tens

5 1/4" SS/DD **.89 Ea.**
5 1/4" DS/DD... **1.09 Ea.**
5 1/4" DS/HD... **2.19 Ea.**
3 1/2" SS/DD... **1.39 Ea.**
3 1/2" DS/DD... **2.09 Ea.**

(Minimum order 20)

Free Media-Mate with each 100

Nashua

Boxed in tens

5 1/4" SS/DD.... **.69 Ea.**
5 1/4" DS/DD.... **.75 Ea.**
5 1/4" DS/HD... **1.79 Ea.**
3 1/2" SS/DD... **1.29 Ea.**
3 1/2" DS/DD... **1.89 Ea.**

(Minimum order 20)

Free Media-Mate with each 100

BONUS

Boxed
in tens

5 1/4" SS/DD— **.59 Ea.**
5 1/4" DS/DD— **.65 Ea.**

(Minimum order 20)

Free Media-Mate with each 100

7400

Part No.	1-9	10+	Part No.	1-9	10+
7400	29	19	7485	65	55
7402	29	19	7486	45	35
7404	35	25	7489	2.05	1.95
7405	39	29	7490	49	39
7406	39	29	7493	45	35
7407	39	29	74121	45	35
7408	35	25	74123	59	49
7410	35	25	74125	55	45
7414	49	39	74126	75	65
7416	45	35	74143	4.05	3.95
7417	45	35	74181	1.35	1.25
7420	35	25	74154	1.25	1.25
7430	35	25	74158	1.59	1.49
7432	39	29	74173	85	75
7438	39	29	74174	85	75
7442	55	45	74175	85	75
7445	79	69	74176	99	89
7448	89	79	74181	1.95	1.85
7447	89	79	74189	2.05	1.95
7448	2.05	1.95	74193	79	69
7472	75	65	74198	1.85	1.75
7473	45	35	74221	99	89
7474	45	35	74273	2.05	1.95
7475	45	35	74365	69	59
7476	45	35	74367	69	59

74LS

Part No.	1-9	10+	Part No.	1-9	10+
74LS00	29	19	74LS165	75	65
74LS02	29	19	74LS166	99	89
74LS04	35	25	74LS173	59	49
74LS05	35	25	74LS174	49	39
74LS06	1.09	99	74LS175	49	39
74LS07	1.09	99	74LS189	4.59	4.49
74LS08	29	19	74LS191	59	49
74LS10	29	19	74LS193	79	69
74LS14	49	39	74LS221	69	59
74LS27	35	25	74LS240	79	69
74LS30	29	19	74LS243	79	69
74LS32	35	25	74LS244	79	69
74LS42	49	39	74LS245	89	79
74LS47	99	89	74LS263	99	89
74LS73	39	29	74LS273	89	79
74LS74	35	25	74LS279	49	39
74LS75	39	29	74LS322	4.05	3.95
74LS76	55	45	74LS365	49	39
74LS85	59	49	74LS366	49	39
74LS86	35	25	74LS367	49	39
74LS90	49	39	74LS368	49	39
74LS93	49	39	74LS373	79	69
74LS123	59	49	74LS374	79	69
74LS125	49	39	74LS393	89	79
74LS138	49	39	74LS590	6.05	5.95
74LS139	49	39	74LS624	2.05	1.95
74LS154	1.09	99	74LS625	2.25	2.19
74LS157	45	35	74LS640	1.09	99
74LS158	45	35	74LS645	1.09	99
74LS163	59	49	74LS670	1.09	99
74LS164	59	49	74LS688	2.05	1.95

74S/PROMS*

74S00	29	74S188*	1.29
74S04	35	74S189	1.69
74S10	35	74S196	2.49
74S10	29	74S240	1.49
74S32	35	74S244	1.49
74S74	45	74S253	1.79
74S85	1.79	74S287*	1.49
74S86	35	74S288*	1.49
74S124	2.95	74S373	1.49
74S174	79	74S374	1.49
74S175	79	74S472*	2.95

74ALS

74ALS00	35	74ALS138	89
74ALS02	35	74ALS173	89
74ALS04	39	74ALS175	89
74ALS08	39	74ALS240	1.49
74ALS10	39	74ALS244	1.49
74ALS27	39	74ALS245	1.49
74ALS30	39	74ALS373	1.69
74ALS32	39	74ALS374	1.69
74ALS74	49	74ALS573	1.69

74F

74F00	39	74F139	89
74F04	39	74F157	95
74F08	39	74F193	3.95
74F10	39	74F240	1.39
74F32	39	74F244	1.39
74F74	49	74F253	99
74F86	59	74F373	1.39
74F138	89	74F374	1.39

CD-CMOS

CD4001	19	CD4081	25
CD4011	19	CD4082	25
CD4013	29	CD4093	35
CD4016	29	CD4094	89
CD4017	55	CD40103	2.49
CD4018	59	CD4503	35
CD4020	59	CD4510	69
CD4024	39	CD4511	69
CD4027	35	CD4515	89
CD4030	29	CD4518	75
CD4040	65	CD4520	75
CD4049	29	CD4522	79
CD4050	29	CD4533	79
CD4051	59	CD4541	69
CD4052	59	CD4543	79
CD4053	59	CD4553	4.95
CD4059	3.95	CD4555	79
CD4060	65	CD4566	2.49
CD4066	25	CD4572 (MC14572)	39
CD4069	25	CD4583	39
CD4070	25	CD4584	39
CD4071	25	CD4585	39
CD4072	25	MC14411	8.95
CD4076	65	MC14490P	4.49

COMMODORE CHIPS

For VIC-20, C-64 and C-128 Personal Computers

Part No.	Price	Part No.	Price	Part No.	Price
6502 MPU w/Clock	2.25	6529SPIA	4.95	6581SID	14.95
6507 8-Bit CPU	4.95	6551ACIA	3.29	*825100PLA	13.95
6508 w/RAM & I/O	8.95	6560VIC-L	10.95	8701 Clock Chip	9.95
6510CPU	9.95	6567VIC-IL	14.95	*8721PLA	14.95
6525TPI	7.95	6569VIV	14.95	NOTE: 82S100 = U17 (C-64)	
6526CIA	14.95	6572	14.95	*No Spec Available	

NEC V20 & V30 CHIPS

Replace the 8086 or 8088 in Your IBM-PC and Increase Its Speed by up to 40%!

Part No.	Price
UPD70108D-5 (5MHz) V20 Chip (Replaces the 8088)	\$ 9.95
UPD70108D-8 (8MHz) V20 Chip (Replaces the 8088-2)	\$11.95
UPD70116D-8 (8MHz) V30 Chip (Replaces the 8086 or 8086-2)	\$14.95

MICROPROCESSOR COMPONENTS

MICROPROCESSOR CHIPS		6500/6800/68000 Cont.		8000 SERIES Cont.	
Part No.	Price	Part No.	Price	Part No.	Price
D765AC	4.49	6843	2.95	8237-5	4.95
CDP1802CE	4.95	6845	2.95	8243	2.25
2661-3	5.95	6850	1.49	8250A	5.49
		6852	1.49	8250B (For IBM)	4.95
		68000LE	11.95	8251A	1.75
		68861PB	5.95	8253-5	1.95
				8254	2.95
				8255A-5	1.95
				8257-5	2.49
				8259-5	1.95
				8272	4.49
				8273-5	2.95
				8741	10.95
				8748	7.95
				8749	9.95
				8751	3.95
				8755	14.95

DYNAMIC RAMS

Part No.	Function	Price
4116-15	16,384 x 1	.89
4128 (Piggyback)	131,072 x 1	4.49
4164-150	65,536 x 1	1.15
4164-200	65,536 x 1	1.25
TM54416-12	16,384 x 4	1.49
8118	16,384 x 1	.69
41256-150	262,144 x 1	2.95
50464-15	65,536 x 4	4.95

STATIC RAMS

2016-12	2048 x 8	.89
2102	1024 x 1	.69
2102-2L	1024 x 1	.89
2114N	1024 x 4	1.95
2114N-L	1024 x 4	1.09
2114N-2	1024 x 4	1.05
2114N-2L	1024 x 4	1.49
21C14	1024 x 4	.49
5101	1024 x 4	1.95
6116P-3	2048 x 8	1.89
6116P-3	2048 x 8	1.95
6264P-12	8192 x 8	3.89
6264P-12	8192 x 8	4.25
6264P-15	8192 x 8	3.75
6264P-15	8192 x 8	3.75
65114	1024 x 4	4.49
43256-15L	32,768 x 8	24.95

PROMS/EPROMS

1702A	256 x 8	1.95
TMS2516	2048 x 8	4.95
TMS2532	4096 x 8	5.95
TMS2564	8192 x 8	8.95
2708	1024 x 8	4.95
TMS2716	2048 x 8	9.95
2716-1	2048 x 8	3.75
27C16	2048 x 8	4.95
2732	4096 x 8	3.95
2732A-20	4096 x 8	4.25
2732A-25	4096 x 8	3.95
2732A-45	4096 x 8	3.75
27C32	4096 x 8	6.49
2764-20	8192 x 8	4.25
2764-25	8192 x 8	3.75
2764A-25	8192 x 8	4.25
2764-45	8192 x 8	3.49
27C64	8192 x 8	5.49
27128-25	16,384 x 8	4.25
27128A-25	16,384 x 8	4.95
27C128-25	16,384 x 8	5.95
27256-25	32,768 x 8	5.95
27256-25	32,768 x 8	8.95
27312-25	65,536 x 8	19.95
68764	8192 x 8	15.95
68766	8192 x 8	16.95
74S387	256 x 4	1.29
74S471	256 x 8	4.95
82S123	32 x 8	2.49

LOW PROFILE (TIN) SOCKETS

Part No.	1-9	10-99	100+
8 pin LP	.11	.10	.09
14 pin LP	.12	.11	.10
16 pin LP	.13	.12	.11
24 pin LP	.25	.23	.19
28 pin LP	.27	.24	.21
40 pin LP	.29	.26	.23

WIRE WRAP SOCKETS (GOLD) LEVEL #3

Part No.	1-9	10-99	100+
8 pin WW	.59	.55	.49
14 pin WW	.65	.59	.55
16 pin WW	.69	.65	.59
24 pin WW	1.19	1.09	.99
28 pin WW	1.39	1.29	1.19
40 pin WW	1.89	1.69	1.55

- SOLDBTAIL STANDARD (GOLD & TIN) AND HEADER PLUG SOCKETS ALSO AVAILABLE -

SATELLITE TV DESCRAMBLER CHIP

The MM5321 is a TV camera sync generator designed to supply the basic sync functions for either color or mono-chrome 525 line/60Hz interlaced and camera video recorder applications. COLOR BURST GATE & SYNC.

MM5321.....\$11.95

DIGITAL TALKER™

DT1050 - Applications: Teaching aids, appliances, clocks, automotive communications, language translations, etc. The DT1050 is a standard DIGITAL TALKER chip encoded with 137 separate and useful words, 2 tones, and 5 different sentence structures. The words and tones have been assigned discrete addresses, making it possible to output single words or words concatenated into phrases or even sentences. The "voice" output of the DT1050 is a highly intelligible male voice.

The DT1050 consists of a Speech Processor Chip, MM54104 (40-pin) and two (2) Speech ROMs MM52164SSR1 and MM52164SSR2 (24-pin) along with a Master Word list and a recommended schematic diagram on the application sheet.

Part No.	Description	Price
DT1050	Digital Talker™	\$24.95

DT1057 - Expands the DT1050 vocabulary from 137 words to over 250 words. Includes two (2) ROMs and specs.

DT1057.....\$11.95

INTERISIL

Part No.	Price	Part No.	Price
FE0202D	12.95	7211PL (TTL)	6.95
FE0203D	12.95	7211MPL (Micro)	7.49
7106CPL	9.95	7216CJL	29.95
7106EV/KiL	49.95	7216DIU	24.95
7207CPL	11.95	7217JUL	10.95
7217EV/KiL	49.95	7217AFL	9.95
7224CPL	12.95	7224PL	12.95
7207AEV/KiL	6.95	7226AEV/KiL	99.95

74HC HI-SPEED CMOS

74HC00	25	74HC175	69
74HC02	25	74HC221	99
74HC04	29	74HC240	79
74HC08	29	74HC244	79
74HC10	29	74HC253	59
74HC14	49	74HC254	65
74HC32	29	74HC273	79
74HC74	39	74HC373	79
74HC75	39	74HC374	79
74HC76	45	74HC393	75
74HC85	79	74HC595	1.19
74HC06	35	74HC636	69
74HC123	89	74HC4040	89
74HC125	49	74HC4049	59
74HC132	49	74HC40	

UPDATE: Our 1987 Product Selection Guide is Here! 94 Pages of Components, Peripherals & More!

Mall Order Electronics • Worldwide
Jameco
ELECTRONICS

COMMODORE® COMPATIBLE ACCESSORIES



Now Compatible With C-128!
RS232 Adapter for VIC-20, C-64 and C-128

The JE232CM allows connection of standard serial RS232 printers, modems, etc. to your VIC-20, C-64 (excluding the SX-64 Portable), and C-128. A 4-pole switch allows the inversion of the 4 control lines. Complete installation and operation instructions included.

Plugs into User Port • Provides Standard RS232 signal levels • Uses 6 signals (Transmit, Receive, Clear to Send, Request to Send, Data Terminal Ready, Data Set Ready).

JE232CM. \$39.95

Voice Synthesizer VIC-20 & C-64
Plug-In - Talking in Minutes!

JE520CM. \$99.95

External Power Supply

CPS-10 (For C-64). \$39.95

Parallel Printer Interface
2K Buffer, Expandable to 10K!

MW350 (For VIC-20, C-64 & C-128). \$54.95

TRS-80® COMPATIBLE ACCESSORIES

E-X-P-A-N-D TRS-80 MEMORY

All kits come complete with documentation

TRS-80 MODEL I, III

TRS-16K3 200ns (Model III). \$5.95

TRS-16K4 250ns (Model I). \$5.49

TRS-80 COLOR AND COLOR II

TRS-64K-2. \$7.95

New models only - 41464's

TRS-CoCo-Incl. 2-50464's (\$10.95)

TRS-80 MODEL 4, 4P, AND 4D

TRS-64K-2. \$7.95

Expands Model 4 from 16K-64K or Model 4P and 4D from 64K-128K

TRS-64K-2PAL. \$14.95

Expands Model 4 from 64K to 128K

TRS-80 Model 100 • NEC • Olivetti

M100BK. \$19.95 ea. or 3 for \$54.95

TRS-80 Model 100 8K Expansion

NEC8KR. \$19.95 ea. or 3 for \$54.95

NEC Model PC-8201A 8K Expansion

OM108K. \$19.95 ea. or 3 for \$54.95

Olivetti Model M10 8K Expansion

TANDY 200

M200R. \$59.95 ea. or 2 for \$109.95

Tandy Model 200 24K Expansion

UV-EPROM ERASER

Erases all EPROMs. Erases up to 8 chips within 21 minutes (1 chip in 15 minutes). Maintains constant exposure distance of 1". Special conductive foam liner eliminates static build-up. Built-in safety lock to prevent UV exposure. Compact - 9.00" L x 3.70" W x 2.60" H. Complete with holding tray for 8 chips.

DE-4 UV-EPROM Eraser. \$69.95

UVS-11EL Replacement Bulb. \$19.95

DATA BOOKS

30003 National Linear Data Book (82). \$14.95

30009 Intersil Data Book (85). \$ 9.95

30013 Zilog Data Book (85). \$14.95

30032 National Linear Supplement (84). \$ 6.95

210830 Intel Memory Handbook (86). \$17.95

230843 Intel Microsystem Hndbk. Set (86). \$24.95

MUFFIN/SPRITE-STYLE FANS

MUF60. \$9.95

Torin Industries (4.68" sq., 60 cfm)

SUZ21. \$8.95

EG&G Rotron (3.125" square, 20 cfm)

11/86

1355 SHOREWAY ROAD, BELMONT, CA 94002

PHONE ORDERS WELCOME 415-592-8097 Telex: 176043

Shipping: Add 5% plus \$1.50 Insurance

California Residents: Add 6%, 6½% or 7% Sales Tax

Spec. Sheets - 50¢ each

Prices Subject to Change

Send \$1.00 Postage for a FREE 1987 JAMECO CATALOG

©1986 Jameco Electronics

NEW PRODUCTS!

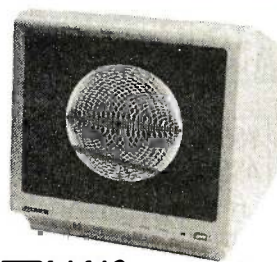

TTX™ 14" RGB Color Monitor
for IBM PC, XT and Compatible Computers

• Input Signal: (Video) RGB TTL Level and Intensity Signal; Sync: Separate TTL Level (positive or negative) • Scanning Freq.: (Hor.) 14.5KHz to 17.8K • Video Bandwidth: 18MHz • Resolution: 640 x 200 • Connector: DB 9-pin (incl.) • Power Consumption: 70 Watts • Size 14.6" H x 15.5" W x 13.6" D • Weight: 27 lbs. • TTX-1410 is compatible with the IBM-ICB and the IBM-EGA Cards (right)

TTX-1410. \$299.95

DISK DRIVE SALE!

MPI52S Double-sided 48TPI IBM PC/XT Compatible! \$69.95

TM100-4 Double-sided 96TPI QUAD Drive! \$59.95

ZUCKERBOARD



Expansion Memory Half-Card for IBM-PC, XT, Portable, Tandy 1200 and Compatible Computers

Expand your computer to its full capacity of 640K. It will accept either 64K memory chips (4164) or 256K memory chips (41256).

EM-100 Expansion Memory Half Card with 0K RAM. . . . \$59.95

EM-D RAM Disk and Printer Spooler Software. . . . \$39.95

ZUCKERBOARD

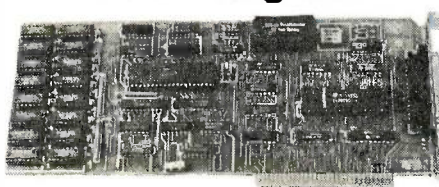

Multifunction Board with Clock Calendar for the Tandy 1000

The Zuckerboard Multifunction Board allows you to expand the memory on your Tandy 1000 to as much as 640K. The Multifunction Board comes complete with DMA Controller, RS232 port, a clock/calendar and RAM Disk Printer Spooler. The Zuckerboard Multifunction Board is made in the U.S.A. and comes with a standard 2 year warranty.

MTAN-256K Includes 256K RAM and Manual. \$179.95

MTAN-512K Includes 512K RAM and Manual. \$209.95

Expansion Memory Half-Card and Clock/Calendar for the Tandy 1000 - DMA Controller Chip on board!

TAN-EM256K Includes 256K RAM and Manual. \$ 99.95

TAN-EM512K Includes 512K RAM and Manual. \$129.95

Options for TAN-EM256K/512K

TAN-C Includes Plug-in Clock Option Chip (only). \$39.95

TAN-D Includes RAM Disk Spooler Software (only). \$39.95

3.5" Micro Floppy Disk Drive for Tandy 100 & 200, NEC8201A, IBM PC, XT, AT and Compatible Computers

Now your IBM PC or compatible can read and write the same disks as your portable!



Part No. Description Price

FD-103 Includes 3.5" Disk Drive, Cable, AC Adapter, Blank Diskette and Documentation. . . \$179.95

Software for the FD-103 Disk Drive (Software needed for operation)

TS1 Tandy 100 TSDOS Disk Operating System Software. . . . \$44.95

TS2 Tandy 200 TSDOS Disk Operating System Software. . . . \$44.95

TSN NEC PC8201A Disk Operating System Software. \$44.95

LAPDOS IBM PC, XT, AT and Compatible LAPDOS Disk Operating System Software. \$74.95

IBM® COMPATIBLE ACCESSORIES

83-KEY KEYBOARD

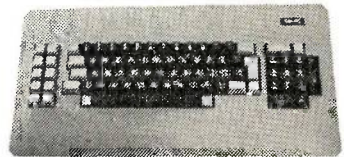

• Identical layout as original IBM PC Keyboard • Highly desirable case with palm rest • Complete with cable and data • JUST PLUG IN!

KB83. **SALE** \$29.95

Build an IBM PC/XT™ Compatible!

IBM-64K(2) 64K RAM Chips (18). \$ 19.90

KB-83 83-Key Keyboard. \$ 29.95

IBM-FCC Floppy Controller Card. \$ 39.95

IBM-Case Case. \$ 39.95

IBM-MCC Monochrome Card. \$ 69.95

IBM-PS Power Supply. \$ 69.95

FD55B Disk Drive. \$109.95

IBM-MON Monochrome Monitor. \$ 99.95

IBM-MB Motherboard. \$129.95

Regular List \$609.50

IBM™-Special (Incl. 9 items above) . . \$549.95

Additional Add-Ons Available!

IBM-KB 83-Key Keyboard. \$ 69.95

IBM-ENH Enhanced Keyboard. \$ 89.95

IBM-ICB Integrated Color Board. \$ 99.95

IBM-EGA Enhd. Graphics 256K RAM. . . . \$259.95

IBM-20MBK 20MB Hard Disk Drive. . . . \$449.95

IBM is a registered trademark of IBM Computers

NEW! Universal NEW! Printer Buffer

JOHNATHON FREEMAN DESIGNS

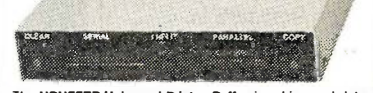

The UBUFFER Universal Printer Buffer is a hi-speed data buffer that accepts data at a high rate, and then outputs this data to your printer. You save valuable computer time. The UBUFFER can be connected to practically any computer or printer. There are four possible combinations: 1) Serial to Serial, 2) Serial to Parallel, 3) Parallel to Parallel, 4) Parallel to Serial. Manual included. Size: 9-1/3" L x 4-1/8" W x 1-1/2" H.

UB64K. \$199.95

UB256K. \$239.95

IBM Compatible! DISK DRIVES

Documentation Included



FD55B Teac 5¼" DS ½-Height. \$109.95

JU-455 Panasonic 5¼" DS ½-Height. . . . \$109.95

TM100-2 Tandon 5¼" DS Full-Height. . . . \$119.95

JMR 5¼" DISK DRIVE ENCLOSURES

Complete with power supply, switch, power cord, fuseholder and connectors.

DDE-1FH. \$59.95

Houses 1 Full-Height 5¼" Floppy Drive.

DDE-2HH. \$69.95

Houses 2 Half-Height 5¼" Floppy Drives - Vertical

HDDE-1FH. \$194.95

Houses 1 Hard Disk Drive

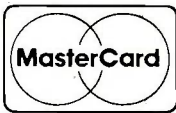

Send \$1.00 Postage for a FREE 1987 JAMECO CATALOG

©1986 Jameco Electronics

ATTAK-286™ MODEL 1A

HIGH SPEED 12 MHZ OPERATION SELECTABLE TO 6,8,10, and 12 MHZ!

- FULL IBM PC-AT* COMPATIBILITY!
- FULL MEGA-BYTE RAM CAPACITY!

100% DESIGNED, MANUFACTURED, ASSEMBLED AND TESTED IN USA!

AIT Corporation is a publicly traded company. Majority USA owned and traded on the OTC market under AITC



THOUSANDS SOLD WORLDWIDE!

Keyboard Interface same as PC-AT

FULL TIME PRODUCT SUPPORT AND SERVICE.

UNIQUE FEATURE!
Hardware Reset Switch

NEW!

VOLUME DISCOUNTS AVAILABLE!

0-1 WAIT STATES!

UNIQUE FEATURE!
Complete Set-Up Software in ROM BIOS (No Disk Required for Set-Up)

UNIQUE FEATURE!
Multi-Speed 80287 Numeric Processor Speed-Up Capability (Switch Selectable)

Triple Tested for 100% Quality Assurance!

Complete Documentation Package with Full Schematic Diagrams Included

Highest Quality Industrial Grade AMP Sockets!

ONLY!
\$499⁹⁵

OEM EVALUATION BOARD
Completely Assembled and Tested with all IC's and Components

- ATTAK-286™ MODEL I 24MHZ CALL
- ATTAK-386™ 32 BIT MICRO CALL
- CASES, POWER SUPPLIES, PERIPHERALS, ETC. . . CALL
- TURBO-SCOPE™ A/D BOARD \$99.95
- ATTAK-286™ MODEL 1A BARE BOARD \$99.95

- OK RAM
- 8 MHZ Version, Expansion to 12 MHZ

100% SATISFACTION GUARANTEED.
10 DAY MONEY BACK GUARANTEE IF NOT COMPLETELY SATISFIED!



ORDER NOW!
SAME DAY SHIPMENT!
(FOR IN STOCK ITEMS)

AIT CORPORATION ADVANCED INTELLIGENCE TECHNOLOGY

4100 Spring Valley Road
Suite 400
Dallas, Texas 75244
(214) 490-0344

TERMS: We accept cash, checks, money orders and credit cards. Prices and availability subject to change without notice. Shipping and handling charges via UPS ground 50¢/lb UPS air \$1.00/lb. Minimum charge \$3.00.

*IBM and IBM PC-AT are trademarks of International Business Machines

© 1986 AIT CORP.

LOOK what's Inside!

5 Complete Systems

Pricing!

XAT TURBO



The **XAT** is our most versatile and powerful system. Using Intel's 80286 processor, the system runs at 6 and 8 MHz with a true 16-bit data bus. Comes standard with a 3 meg Add-On board, 2 parallel & one serial port, monitor, keyboard, DOS 3.1, two 1/2 height DS DD 1.2 meg floppies.

XPC TURBO



This standard system is as compatible with IBM as it can be. Featuring a 4-layer motherboard, 8-slot expansion, up to 640K memory on the motherboard, and the 6.67 MHz TURBO mode. Also included, DOS 3.1, keyboard, 135 watt power supply, TTL 720 x 348 resolution video card, green or amber monitor, serial & parallel ports, Real Time Clock and software.

XTC TURBO

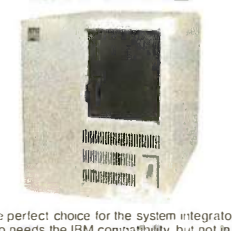

The perfect choice for the system integrator who needs the IBM compatibility, but not in the standard PC cabinet. This model features hinged and removable sides, up to 3 1/2 height peripherals out front, front mount AC switch and rear mount 135 watt power supply. Also makes an ideal "Host" or "File Server" unit in multi-user configurations!

XT jr.



The **XT jr.** is only junior in size! With up to 640K memory on the motherboard and four expansion slots, this stand-alone system is also great for workstations in a networking environment. It can be upgraded to the TURBO two speed motherboard and you can also add up to 2 serial & 2 parallel ports or any IBM compatible expansion card. A perfect word processing data entry system.

XPC Compact



This is truly the affordable portable, and we'll build it to your specifications. Need a 20 meg hard disk and 20 meg tape with 640K memory in your portable? No problem! The **XPC Compact** comes standard with a 9" amber TTL monitor, 135 watt P S 256K memory, two 360K drives, Real Time Clock/Calendar w battery Back-up, serial and parallel ports, and our TURBO Motherboard.

Amsterdam ■ 020-45-26-50

24 Add-On Cards

Germany ■

2 MB Expansion Board



This board satisfies the new approach suggested by INTEL and Lotus 1-2-3. Also may be used on our XT-SBC TURBO board for memory based at 0K.

Hard Disk Controller



This Western Digital controller handles 1 or 2 drives, 5 to 140 megabytes with minimum software configuration. Features DOS 2.1 & 3.1 compatibility, and ST-506 Interface.

384K Multi-Function



A Multi-function board featuring Parallel Port, Serial Port, Game Port, Real Time Clock/Calendar with Battery Back-up. Expand to 384K, all Cables, PrintSpooler and RAM Disk Software, and Manuals.

4 Meg Token Ring



Connect your workstation to an existing 4 Megabyte IBM token ring system or build up your own IEEE 802.5 standard system. The lowest possible cost for 100% industry standard compatibility.

AT H.D. & Floppy



This new Western Digital combo board with its hi-speed VLSI technology will give you a data transfer rate 50% faster than the existing combo board in the AT. Runs both 360K and 1.2 meg floppy disk drives.

Mono & Color Graphics



Supports two levels of graphics and text in composite monochrome or RGB color. Low resolution 320 x 200 pixel, high resolution 640 x 200 pixel.

7 PAK Multi-Function



Features Floppy Controller, Parallel Port, Serial Port (optional 2nd Serial), Game Port, Real Time Clock/Calendar with Battery Back-up, RAMdisk, Print-Spooler, all cables & manuals.

PROM Laser



Hi-speed algorithms will burn 2716, 2732, 2732A, 2764 (in 52 sec), 27128, 27256 EPROMS under software control right in your PC. Zero Force Insertion Sockets, Software, and Manual.

England ■

35 Components

Bombay ■ 357172

Motherboards

XAT TURBO

- RTC Calendar
- 6 & 8 MHz clock
- 8-slot expansion
- Intel 80286

XT-SBC

- 4.77 & 8 MHz clock
- Serial & Parallel
- 4-layer PCB design
- RTC Calendar

XPC TURBO

- 4.77 & 6.67 MHz
- 4-layer PCB design
- 8-slot expansion
- up to 640K Memory
- 8086 2 processor

XPC-XT

- Standard 4.77 MHz
- up to 640K memory
- 8-slot expansion
- standard 8088 CPU
- 8087 socket avail.

Power Supplies

XT 135 watt XT 150 watt

- 135w switching
- Whisper Fan
- Side AC switch
- +5V-15A -5V-5A
- +12V-1.2A -12V-5A

AT 200 watt XTC 135

- 200 Watt power
- Exterior AC switch
- 4 DC power conn.
- +5V-20A -5V-5A
- +12V-7.7A -12V-5A

Cabinets

The **XT jr.** cabinet is only 3" x 16.5" x 15" yet it will hold a standard XT compatible motherboard including a switching power supply. Front panel cut-out for a half-height floppy or hard disk.

Our **XPC-XT** cabinet has an 8-slot back panel with additional cut-outs for two RS-232 C ports. Features mounting for up to four half height peripherals.

The right choice for an external add-on cabinet! Add-on a floppy, tape back-up, or up to 33 meg of hard disk (half-height). Switching power supply is included.

Keyboards

AT

This Keyboard is standard equipment with all of our XAT systems, but the layout is so well liked, we're offering it here.

XT

Our volume purchases of these IBM style units allows us to lower the price once again.

5051

Now a fully electric unit at an affordable price. Features a 10 key numeric pad & a separate cursor pad.

Drives

Archive

Irwin

Maxtor

Memtek

Miniscribe

Panasonic

Seagate

TEAC

Tulin

3 Sub-Systems

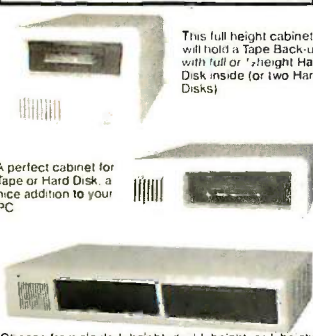

This full height cabinet will hold a Tape Back-up with full or 1/2 height Hard Disk inside (or two Hard Disks).

A perfect cabinet for Tape or Hard Disk, a nice addition to your PC.

Choose from single 1/2 height, dual 1/2 height, or 1 height with full height base. All Sub-systems include controllers, cables, software, and manuals.

3 Networks

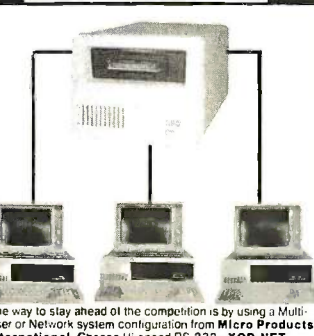

One way to stay ahead of the competition is by using a Multi-User or Network system configuration from Micro Products International. Choose Hi-speed RS-232, XOR-NET SDLC or Token Ring. Data transfer rates up to 4 megabytes second can be obtained.

Cassette Training



What is the Cassette Training concept? Using Interactive Audio Training to combine the advantage of classroom and self-teaching methods.

The Method: One audio track delivers a lecture explaining the program, while the second track emulates the keyboard actually running the student's computer. At frequent intervals the tape pauses automatically to allow the student keyboard input, which is monitored for accuracy by the MITS COED.

Int/Ext Modems

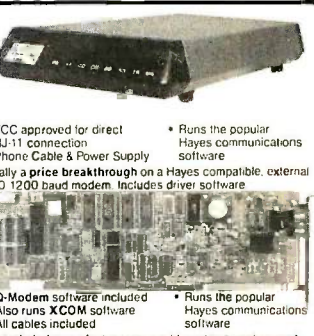

- FCC approved for direct RJ-11 connection
- Phone Cable & Power Supply
- Runs the popular Hayes communications software
- Finally a price breakthrough on a Hayes compatible, external 300 1200 baud modem. Includes driver software.
- Q-Modem software included
- Also runs XCOM software
- All cables included
- Runs the popular Hayes communications software

We included every feature you would want in a modem card. It's FCC registered for direct connection to your modular phone jack with the cord included.

California Digital

17700 Figueroa Street • Carson, California 90248

IBM Compatible Computer



\$495

Eclipse
DATA PRODUCTS

- 256K Expandable to 640K on Motherboard
- Double Sided Double Density Disk Drive
- IBM Type Keyboard (with LED indicators)
- Floppy Controller Card
- Eight Expansion Slots
- 135 Watt Power Supply

The Eclipse 16 is an outstanding value in IBM Compatible Computers. After careful research and evaluation we found it to be the most reliable unit.

Our computer includes some of the newest features available, such as the 4.7MHz, multi-layer motherboard with 256K of RAM upgradable on board to 640K. A generous eight expansion slots and 135 Watt power supply give you ample room and power for add-on boards. The enclosure has an easy-access flip top lid making upgrades a breeze. And our floppy controller supports up to four drives, so as many as three additional drives can be used. Finally, each computer is configured and fully tested before sending it to you.

Satisfaction Guaranteed! We're really excited about this new unit, and so sure you will be too... that you may return the Eclipse 16 for a full credit towards an IBM PC if you are not completely satisfied.

OPTIONS

20MB Hard Drive w/Controller.....\$495	RGB Color Monitor.....199
Additional Drive-Installed.....99	TTL Monochrome Monitor.....139
Irwin 10 Meg. Tape Back up.....489	Microsoft Mouse.....139
Upgrade from 256K to 640K RAM.....79	Upgrade from Floppy Controller to Disk I/O
8087 Math Co Processor.....119	2 drive controller, clock/cal., software
Color Graphics Card.....79	parallel, serial, and game ports.....79
Monochrome Graphics Card.....99	1200 Baud Internal Modem w/Software 179

21 Megabyte Gold Card

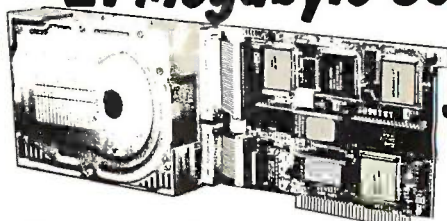

\$479

The fastest, lowest powered, longest warranted, most durable, highest capacity, most reliable, lowest priced HARD-DISK-ON-A CARD available in the world today.

- 65ms Access Time - Fastest Available
- Automatic Head Unloading - Protects Heads and Media
- 2K Sector Buffer - Increases System Throughput
- High Reliability: 28,000 hr. MTBF - No one else even close
- 15.5 Watt Power Consumption - Lowest Available
- 2 Year Warranty - Longest Available

WERE \$695... GET 'EM WHILE THEY LAST FOR JUST \$559 ~~\$479~~

NOW YOUR COMPUTER CAN READ!!

Omni-Reader... the first optical character reader designed and priced for the small computer

\$179



COPY:

- Manuscripts
- Contracts
- Articles
- Forms
- Invoices

APPLICATIONS:

- Mailing Lists
- Editing
- Data Base Management
- Transferring information between incompatible systems

Uses a standard RS-232 serial port hookup to interface easily with your computer.

1200 BAUD MODEMS



AVATEX 1200
\$99

This 300/1200 baud modem matches the design specs of the Bell 212A, feature by feature, bringing you reliability, impeccable transmission and easy operation. Hayes Compatible, except for "S" register. Communication software included.

The AVATEX 1200, at \$99, is a steal!

SMARTTEAM 1200



\$159

The Team 212A offers all the features of the Hayes Smart Modem 1200 for a fraction of the price. Now is your opportunity to purchase a 1200 baud modem at the price of a 300 baud modem.

ECLIPSE 2400
BAUD MODEM

\$299



- Hayes & Bell 212A/103 Compatible
- CCITT V.22, V.22 bis

The ECLIPSE 2400 modem is a microprocessor-based full or half-duplex modem incorporating the latest in high speed data communications capabilities. It also accommodates computers and terminals equipped with an RS-232 port allowing communication with other computers or timesharing systems either locally or remotely. Compatibility, Versatility and Performance are yours in a configuration designed to provide years of reliable operation.

MODEMS

Eclipse 1200 - 100% Hayes, with status lamps.	EDP-1200	149.00
Eclipse 1200B internal with software	EDP-1200B	139.00
Eclipse 2400 External, Hayes Compatible	EDP-2400	299.00
Avatec 1200 baud external, Hayes	AVA-1200	99.00
Hayes Smartmodem 2400 baud modem	HYS-2400	599.00
Fujitsu 2400/1200 baud auto everything.	FUJ-1935D	459.00
Team 1200 Hayes Compatible, 300/1200 baud.	TEM-1200	159.00
Smartteam 1200B IBM 1200 baud card	UTL-1200A	99.00
UltraLink 1200 data and voice on same line.	CTS-212AH	179.00
CTS 212AH 1200 baud, auto dial	CTS-212SFT	35.00
Terminal software for CTS 212AH	PRM-P1200	289.00
Prometheus 1200 super features	PRM-P1200B	279.00
Prometheus 1200B internal PC	SEL-MK6	49.00
Signalman Mark VI, 300 baud internal PC	HYS-212AD	369.00
Hayes Smart Modem 1200 baud, auto dial	HYS-1200B	339.00
Hayes 1200B for use with the IBM/PC, 1200 baud.	HYS-CHR232	199.00
Hayes Chronograph, time & date		

Seagate

\$299

20 MEGABYTE
WINCHESTER
HARD DISK DRIVE

Quantity Two



Five Inch Winchester Disk Drives

each two+

SEAGATE 225 20 Meg. 1/2 Ht.	329	299
SEAGATE 4026 26 M. 35mS.	759	729
SEAGATE 4051 51 M. 35mS.	995	959
FUJITSU 2242 55 M. 35mS.	1599	1529
FUJITSU 2243 86 M. 35mS.	2095	2019
RODIME RO-202E 27 Meg.	659	629
RODIME RO-203E 40 Meg.	995	959
RODIME RO-204E 53 Meg.	995	959
CONTROL DATA 94155-86 M.	1829	1779
MAXTOR XT1140 140 Meg.	2995	2929
HONEYWELL 85M. 27 mS.	1795	1695
TOSHIBA MK5670 M. 30mS.	1789	1729
TANDON 502 10 Meg.	419	379

- Winchester Controllers for IBM/PC
- XEBEC 1220 with floppy controller 229
- DTC 5150BX 139
- OMT1 5510 half card 139
- ADAPTEC 2070 RLL controller 189
- ADAPTEC 2010A 169
- WESTERN DIGITAL WD/1002 139
- SCSI/SASI Winchester Controllers
- XEBEC 1410A 5 1/4" foot print 219
- OMT1 20L 119

- Winchester Accessories
- Installation Kit with manual 10
- Winchester enclosure and supply 139
- Dual 20/34 cable set 25
- Switching power supply 49

TOLL FREE ORDER LINE
(800) 421-5041

TECHNICAL & CALIFORNIA
(213) 217-0500

California Digital

17700 Figueroa Street • Carson, California 90248

CHERRY INFRARED KEYBOARD \$119



The Cherry Switch Infrared wireless 84 key keyboard designed for use with the IBM/PC and XT series computers. The keyboard operates similar to the remote tuner of modern televisions, and transmits 20 feet line of sight to the computers IR receiver.

This wireless keyboard is ideal for classroom demonstrations or for use with projection screen television monitors. Includes IR keyboard and receiver module. Manufacturers suggested list was \$289 now available, while they last for only \$119.

FOUR PEN COLOR PLOTTER \$159



The manufacturer has asked us not to publish their name. But this four color plotter was produced by one of the World's largest makers of personal computers.

The 410 color plotter will connect to the serial port of virtually any micro-computer. Simple ASCII commands direct one of the four color pens to draw circles, arcs or ellipses on paper or transparency material up to 11 by 17 inches. The plotter is capable of producing the full upper and lower case alphabet along with seven international character sets. Text can be printed horizontal, vertical or diagonal in sizes from 1/16 to 6 inches, slanted forward or backward to 85 degrees.

Enlargements or reductions are achieved through elaborate firmware. Pen travel is four inches per second with .004" pen resolution. Standard pens are available in an assortment of 32 different colors and widths.

The ideal plotter for architecture, CAD engineering or graphic design. At \$595 it was a great buy, at \$159 it's a steal. Support packages for specific computers available. Manual only \$15 refundable upon purchase or plotter.

SONY 53W Floppy Disk Drive \$139



3 1/2" New IBM portable compatible

Bernoulli Box \$1595

was \$3540 now only



The Bernoulli Box by Iomega, features 10 and 20 megabyte removable cartridges, and delivers reliability, expandability, transportability, security and speed in one versatile subsystem. It lets you transfer megabytes of information safely and swiftly for primary or backup storage. Or combine several software programs onto a single cartridge for easy switching from one to another.

Reliable... the Box has incredible resistance to shock and vibration completely eliminating the possibility of head crash.

Expandable... grow at your own pace by adding inexpensive cartridges. When security is essential, don't lock up your system... just lock up the cartridges.

The Bernoulli Box delivers performance that often exceeds the best of hard disk speed and the convenience of floppy disks. At these prices don't be caught wishing you had one after a loss of irreplaceable data.

	List	Our Price
10+10 Meg. A2210H	\$3450	1595
20+20 Meg. A2220H	4540	2095
Bootable Controller	255	159
10 Meg. Cartridge	79	49
20 Meg. Cartridge	99	65

PLOTTERS

Four pen color plotter, 11 by 17 IBM/PC compatible	APL-410	\$159
Sweet "P" 100 (Comrex) 8 1/2 by 12"	COM-C1	\$159
Houston Instruments DMP29, 11 by 17, B size	HOU-29	1779
Houston Instruments DMP40, 11 by 17, B size	HOU-40	959
Houston Instruments DMP41 1/42 C/D 24 by 36	HOU-41	3779
Houston Inst. DMP51/52MP C/D, 14 pin plotting	HOU-51MP	4859
Houston Instruments DMP56, E size 34 by 44	HOU-56	4795
Houston Instruments PC695, 11 by 17 multi-pen	HOU-695	579
Roland DYX-101 flatbed 11 by 17	ROL-101	419
Roland DYX-800 11 by 17 multi-pen 8 color	ROL-800	899
CalComp 1043GT plotter	COP-1043	7899

DIGITIZERS • MOUSE

Hitachi Tiger Tablet 11 by 11"	HIT-TT2	615
Summagraphics Summasketch 12" fourbutton	SUM-SK12	399
Summagraphics SummaMouse 100 line resolution	SUM-MS	99
MicroSoft serial mouse with paint brush	MST-MS232	139
MicroSoft bus mouse card w/paint brush	MST-MSB	129

XEROX Sunrise Computer \$299



The Xerox Sunrise 1810 is by far the best value we have ever seen in a micro computer. This is a self contained battery and AC portable. The Sunrise was originally priced at \$295. Xerox has since elected to drop the computer from their product list. California Digital has purchased all the remaining inventory and is making it unit available at a fraction of its original cost.

This portable features a built in 80 column liquid crystal display, 64K of memory along with both RF monitor and television outputs. The internal 300/1200 baud modem includes an auto dial telephone assembly. The units has both centronics parallel and a serial port programmable to 19,200 baud. The self contained macro cassette is capable of capturing data from the keyboard as well as doubling as an recorder for dictating messages.

An optional full floppy disk drive module, pictured above, is available for only \$219. Also available, for \$59 is an 80 column printer that mounts in the drive module. The Sunrise features a CP/M operating system which allows the operator to use any CP/M program in Xerox 5 1/4" disk format and over 5000 CP/M programs available in public domain.

Dragon Computer \$89



Compatible with most Radio Shack Color Computer software. The world famous Dragon computer is now available in the United States. Manufactured by the Tano Corp. under license of the British Broadcasting Company.

The Dragon comes complete with 64K Byte of memory, serial modem port along with a Centronics printer interface. This unique microcomputer features Motorola's advanced 6805E microprocessor and comes standard with Microsoft Color Basic, data base manager, and a complete word processing package. The computer outputs color composite video along with RF. Video that allows the unit to be used in conjunction with any color television.

This is the ideal low cost computer to be used with any dial up information system such as the Source, EasyLink or any other time share service.

RGB Color Monitor \$199



The NEC JC-1401D is a 13" medium/high resolution RGB monitor suitable for use with the Sanyo M8C-550/555 or the IBM/PC. The monitor features a resolution of 400 dots by 240 lines. Colors available are Red, Green, Blue, Yellow, Cyan, Magenta, Black and White.

The NEC monitor carries the Lotus-Monroe label and was originally scheduled for use in their "Office of the Future" equipment. A change in Motorola's marketing strategy has made these units excess inventory which were sold to California Digital. We are offering these "new" RGB monitors at a fraction of their original cost. IBM/PC Computer compatible NEC-1401-PC. Also available 12" Amdek Color 1 composite \$159.

5 1/4" DISK DRIVE \$89



Quantity Two

TEAC FD55BV half height	109	99	89
TEAC FD55FV 96 TPI, half ht.	119	109	105
TEAC FD55GF for IBM AT	169	159	155
PANASONIC 455 Half Height	109	99	89
PANASONIC 465 1/2 Ht. 96TPI	139	129	125
TANDON 100-2 full height	129	125	119
MITSUBISHI new 501 half ht.	129	119	109
MITSUBISHI 504A AT comp.	169	159	155
QUME 142 half height	99	89	89
Switching power supply			49
Installation Kit with manual			10
Dual enclosure for 5 1/4" drives			59
34 pin edge connectors			5
Scotch head cleaning kit			19
Flip & File Storage tubs			15

QUME \$119



Eight Inch Single Sided Drives

QUME 841 single side	129	119	call
SHUGART 801R	359	359	354
SIEMENS FDD 100-8	119	115	109

Eight Inch Double Sided Drives

QUME 842 "QUME TRACK 8"	189	179	call
SHUGART SA851 R	495	485	475
OLIVETTI double sided	189	179	159
REMX RFD-4000	179	169	159
MITSUBISHI M2896-63 1/2 Ht.	459	449	409
Dual 8" enclosure with power and fan			259
Switching power supply			89
Installation kit with manual			10

Adeus Daisy Wheel \$159



The Adeus CP/2000, is a 22 character per second daisy wheel printer which accepts 96 character Diablo wheels and ribbons. This printer was manufactured by the Olympia Typewriter Company for Cosmo World USA. This unit will print 10, 12 and 15 characters per inch proportionally spaced with increments of 1/120". Bi-directional printing, 2 K/Byte buffer (expandable to 6K) and both serial and Centronics parallel interfacing make the Adeus CP/2000 an exceptional buy at only \$159. Original price \$595.

PRINTERS

MATRIX PRINTERS

NEC/PT 132 col. par. interface.	NEC-760	659.00
Star Gemini NL-15, 300cps., 136 col. 24 wirehead	STR-NB15	389.00
Star Gemini NX-10, 120 cps./30 cps NLO, tractor	STR-NX10	359.00
Citizen MSP 10/FT 160 char/sec	CIT-MSP10	259.00
Panasonic KX1091 120 cps. draft, 29 NLO tractor & friction	PAN-KX1091	259.00
Toshiba 351P/S, 240 char./sec. C4 wire head	TO351PS	1099.00
Toshiba 341P/S/E part, 180 cps. 24 wire head	TO341PSE	759.00
Oki data 182P/IBM parallel 90" paper	OKI-182P	299.00
Oki data 192A parallel interface, 160 char./sec.	OKI-192A	379.00
Oki data 84P parallel 15" paper	OKI-84P	695.00
Epson LX-80 10" 120 Char./sec.	EPS-LX80	259.00
Epson L8000 near letter quality	EPS-L8000	629.00
Epson FX85 160 cps. draft 32 cps. NLO, 240 dot/inch.	EPS-FX85	399.00
Epson FX286 132 col., 200 cps. 29 cps NLO, graphics.	EPS-FX286	599.00
Dataproducts B-600 3 band printer 600 LPM	DPS-B600	695.00
Pentronix P300 high speed printer 300 lines per minute	PTX-P300	3995.00
Printonix P600 ultra high speed 600 lines per minute	PTX-P600	5795.00

WORD PROCESSING PRINTERS

Starwriter F 10 (6400) parallel, 4.0 char./sec.	PRO-F10P	429.00
Same as above but 55 char./sec., 50 pin Diablo interface	PRO-F55P	559.00
NEC89 0.55 char./sec., serial interface	NEC-8910	1179.00
NEC8930 55 char./sec., par. interface.	NEC-8930	1179.00
NEC3550 popular printer designed for the IBM/PC	NEC-3550	819.00
Silver Reed EXP600, 25 cps. 10/12/15 pitch, serial/par.	SRD-EXP600	319.00
Silver Reed EXP800 same as 600 but 40 char./sec.	SRD-EXP800	729.00
Diablo 620 proportional spacing, horiz & vert. tab. 20 cps	DBL-620	299.00
Juki 6100, 18 char./sec.	JUK-6100	359.00
Juki 6300, 40 char./sec.	JUK-6300	689.00

Quick-Link 300 \$59



The Quick-Link 300 gives you an instant link to any dial up data base. Such as Dow Jones, Western Union or the Source. The Quick-Link has four programmable log-on keys, allowing the operator, with only one keystroke, to dial the data base, log-in and give the password. All this information is permanently stored in non-volatile RAM.

Features include video output to television or monitor, auto dial, auto-log, full sized keyboard, 300 baud modem and 1200 baud auxiliary printer port. All this is available for only \$59.

Shipping: First five pounds \$3.00, each additional pound \$5.00
 Foreign orders: 10% shipping, excess will be refunded.
 California residents add 6 1/2% sales tax. • COD's discouraged.
 Open accounts extended to state supported educational institutions and companies with a strong "Dun & Bradstreet" rating.



ZIMCO INTERNATIONAL, INC.

• IBM PC PACKAGE Dual Floppy	\$995
• 64k RAM CHIPS set of 9	\$8
• LOTUS SIGNAL	\$350
• IBM/APPLE/HARDWARE/SOFTWARE/ASK US!	
▶▶▶▶▶ BOARDS ▶▶▶▶▶	
• PARADISE EGA	\$350
• EVEREX Graphics Edge	\$235
• AST 6 PackPlus	\$150
• AST Rampage 256k	\$306
• HERCULES Graphics Card	\$179
▶▶▶▶▶ DRIVES ▶▶▶▶▶	
• SEAGATE 20m w/PCXT controller	\$385
• SEAGATE 30meg XT 40ms/FAST	\$439
• MOUNTAIN 20meg Hardcard	\$739
• PC/AT 30 meg 3 1/2"msec.	\$439
▶▶▶▶▶ PRINTERS ▶▶▶▶▶	
• CANON LaserJet A-1	\$1850
• EPSON FX286	\$489
• OKIDATA 192/193	\$339/459
• IBM PROPRINTER/XL	\$399/609
▶▶▶▶▶ MODEMS ▶▶▶▶▶	
• HAYES 1200/1200B/2400	\$359/348/559
• SUPERMODEM 1200 (Hayes comp.)	\$149

CALL for Catalog & latest PRICES

1-800-227-6647

For Technical Support & NYS
Call 718-479-7888
D&B# 130151913

Inquiry 383

IBM'S TOP OF THE LINE WORK STATION

~~\$799~~ while supply lasts **\$299**

It's a compact, lockable cabinet for convenient, secure storage.



We also carry:

- Color Diskettes
- Hi Density Diskettes
- Ribbons
- Paper
- Brother Printers

450 7th Ave. N.Y. N.Y. 10123
212-244-2960 DATANAMICS

Inquiry 103

BULK DISKETTES MAXELL

5 1/4 DS/DD 59¢

Price based on quantity of 250
Includes sleeves, labels and tabs

Quantities Limited Call Today!
800-222-0490
(In N.J. 201-462-7628)

Full service duplication facility
24 Hour Shipment

MEGAsoft

P.O. Box 710
Freehold, N.J. 07728

Inquiry 202

FREE CATALOG



Outstanding prices on computer accessories for your computer and workstation. Our catalog features a wide selection of quality products to meet all your accessory needs. Call or write today to receive your free catalog.

LINTEK COMPUTER ACCESSORIES
POB 8056, Grand Rapids, MI 49518
(616) 241-4040

Inquiry 179

SPEED IBM-PC/XT TO 700%



- Uses 80286 Processor
- Installs in Minutes
- Fits Short Slot
- Optional 80287 Processor

\$399

Computer-Age, Inc.
55 Fishry Street
Hartford, CT 06120
203-724-5100

VISA master charge AM-EX

Inquiry 87



3 COMPLETE HIGH END AT COMPATIBLE

FCC CLASS B CERTIFIED
FULL ONE YEAR WARRANTY

\$1150 (Qty. 2 & up)
Evaluation Unit \$1299

(IMMEDIATE DELIVERY*)
TO ORDER: CALL OR WRITE CNT MARKETING
(714) 839-3724

System includes:

- AT1 System Board w/8MHz INTEL 80286 CPU
- 640KB Memory expand to 1MB
- Hard disk and floppy controller
- 1.2 Megabyte floppy drive
- The most compatible BIOS on market
- Case
- 200W Power Supply
- AT Compatible Keyboard
- Battery, Speaker & System Keylock

8MHz zero wait state or 10MHz System add \$200

- Other parts available • Please call for details
- All orders C.O.D.—CA residents add 6% Sales Tax
- U.P.S. Shipping \$2500

CNT MARKETING
16580 Harbor Blvd., Suite J, Fountain Valley, CA 92708

AT is a Registered Trademark of IBM
All computers are fully assembled and tested in the U.S.A.

Inquiry 70

SOLAR POWER YOUR PC'S REAL TIME CLOCK NO MORE BATTERIES NOW FOR THE MAC TOO!

NEVER OPEN UP YOUR PC AGAIN TO REPLACE A HARD TO FIND AND EXPENSIVE BATTERY. FINALLY A PERMANENT SOLUTION. A SOLAR CELL/NICAD COMBINATION THAT REMAINS CHARGED IN ROOMLIGHT OR INDIRECT SUNLIGHT. LASTS A LIFETIME.—NOT A YEAR.

- * MODEL PC-60 FOR THE IBM-PC MULTI-FUNCTION CLOCK BOARDS OF VIRTUALLY ALL MANUFACTURERS. REPLACES THE 3 VOLT LITHIUM BATTERY. \$19.95
- * MODEL MAC-100 FOR THE APPLE MACINTOSH. REPLACES THE 4.5 VOLT ALKALINE BATTERY \$24.95

STAR TECHNOLOGY
P.O. BOX 606
RUSHLAND, PA 18956

ORDER TOLL FREE 24HRS—7 DAYS A WEEK
CALL 1-800-523-2445 EXT 305
IN PA CALL 1-800-346-7511 EXT 305

PA RESIDENTS PLEASE INCLUDE 6% SALES TAX.
PLEASE INCLUDE \$225 SHIPPING AND HANDLING

Inquiry 324

68020

FHL 20x30

- Multi-user/Multi-Tasking
- 32-Bit MC68020 — 12.5 MHz
- 2 to 30 Users
- 5 MByte to 14.5 MByte
- 32-Bit Expansion Bus
- Built-in SCSI/SASI w/DMA
- DIP Switches select Baud Rate
- Hard Drive (20MB to 150MB)
- 720Kb Floppy Drive
- Real Time Clock w/Battery Backup

• Software included: OS/68000; Basic; Word Processing; Spreadsheet; Utilities

• Options: MC68881 Coprocessor, 2MB/4 Serial Port Board, Memory Protection, Graphics Board Pascal and C

Prices from \$2195
Dealer Inquiries Invited

Frank Hogg Laboratory, Inc.
770 James St.
Syracuse, NY 13203
315-474-7856 TELEX 646740

Inquiry 404

Advertise your computer products through BYTE BITS (2" x 3" ads)

For more information
call Dan Harper at
603-924-6830

BYTE
70 Main St.
Peterborough, NH 03458

Inquiry 404

THE LATEST IN PC ENHANCEMENT PRODUCTS

ENHANCED GRAPHICS ADAPTOR

100% IBM COMPATIBLE—PASSES IBM EGA DIAGNOSTICS

- * COMPATIBLE WITH IBM EGA, COLOR GRAPHICS ADAPTOR AND MONOCHROME ADAPTOR
- * DISPLAYS 16 COLORS OUT OF 64 COLORS
- * COMES WITH 256K OF VIDEO RAM
- * DUAL SCANNING FREQUENCIES WORKS WITH STANDARD OR EGA TYPE RGB MONITORS
- * LIGHT PEN INTERFACE

**NOW ONLY
\$259.95**

EGA MONITOR

FULL ONE YEAR WARRANTY

- * EGA AND CGA COMPATIBLE
- * SCANNING FREQUENCIES:
15.75 KHz / 21.85 KHz
- * 14" BLACK MATRIX, NON-GLARE SCREEN
- * RESOLUTION:
640 x 200 / 640 x 350
- * .31 DOT, 25MHz
- * 16 COLORS OUT OF 64
- * TEXT SWITCH-GREEN/AMBER

\$499.95



20 MB HARD DISK SYSTEM

INCLUDES HARD DISK CONTROLLER, CABLES AND INSTRUCTIONS. ALL DRIVES ARE PRE-TESTED AND COME WITH A 1 YEAR WARRANTY.

\$389.95

AT MULTIFUNCTION CARD \$199.95

ADDS UP TO 3 MEGABYTES OF USER EXPANDABLE MEMORY

- * SHIPPED WITH ZERO K RAM, USER EXPANDABLE TO 1.5 MEGABYTES RAM ON BOARD, UP TO 3 MEGABYTES WITH OPTIONAL PIGGYBACK CARD
- * USES 64K OR 256K DYNAMIC RAMS
- * PARALLEL PORT & GAME PORT
- * SERIAL PORT
- * OPTIONAL SECOND SERIAL PORT

PIGGYBACK MEMORY CARD (NO MEMORY INSTALLED) \$49.95

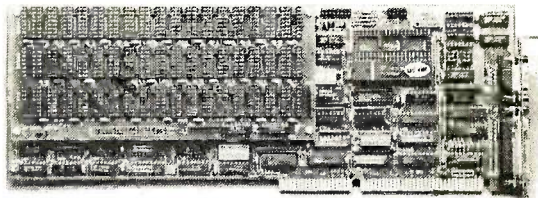

EXPANDED MEMORY CARD \$199.95

UP TO 2 MEGABYTES OF LOTUS/INTEL COMPATIBLE MEMORY

- * CONFORMS TO LOTUS/INTEL EXPANDED MEMORY SPECIFICATIONS (EMS)
- * SHIPPED WITH ZERO K RAM, USER EXPANDABLE TO 2 MEGABYTES
- * USES 64K OR 256K DYNAMIC RAMS
- * USE AS EXPANDED (EMS) OR CONVENTIONAL MEMORY, RAMDISK OR SPOOLER
- * SOFTWARE INCLUDES EMS DEVICE DRIVERS, PRINT SPOOLER AND RAMDISK

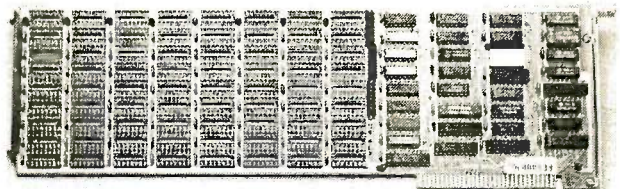

EPROM PROGRAMMER \$129.95

FOR IBM PC/XT/AT AND COMPATIBLES

- * PROGRAMS 27xxx SERIES EPROMS UP TO 27512
- * MENU DRIVEN SOFTWARE PROVIDED ON DISKETTE
- * AUTOMATICALLY SETS PROGRAMMING VOLTAGE
- * LOADS AND SAVES EPROM BUFFER TO DISK
- * READ, WRITE, COPY, VERIFY OR CHECK BLANK
- * DEBUG STYLE EDITOR FOR EASY MODIFICATION OF PROGRAM
- * SPLITS OR COMBINES EPROMS OF DIFFERING SIZES
- * INTERNAL CARD WITH EXTERNAL CABLE FOR A ZIF SOCKET

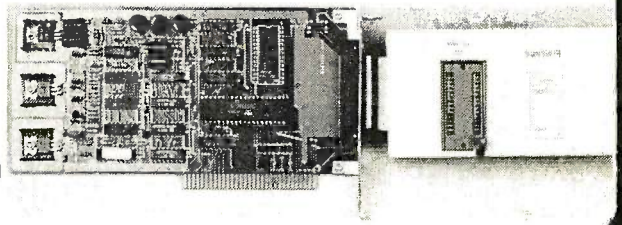

JDR Microdevices 110 Knowles Drive, Los Gatos, CA 95030
Toll Free 800-538-5000 • (408) 866-6200 • FAX (408) 378-8927 • Telex 171-110
Inquiry 167

© COPYRIGHT 1986 JDR MICRODEVICES

THE JDR MICRODEVICES LOGO IS A REGISTERED TRADEMARK OF JDR MICRODEVICES. JDR INSTRUMENTS AND JDR MICRODEVICES ARE TRADEMARKS OF JDR MICRODEVICES. IBM IS A TRADEMARK OF INTERNATIONAL BUSINESS MACHINES.

20MB HARD DISK SYSTEM ONLY \$389.95!

STATIC RAMS

2101	256x4	(450ns)	1.95
5101	256x4	(450ns)(CMOS)	3.95
2102L-4	1024x1	(450ns)(LP)	.99
2112	256x4	(450ns)	2.99
2114	1024x4	(450ns)	.99
2114L-4	1024x4	(450ns)(LP)	1.09
2114L-2	1024x4	(200ns)(LP)	1.49
2114L-15	1024x4	(150ns)(LP)	1.95
TMS4044-4	4096x1	(450ns)	1.95
TMM2016-150	2048x8	(150ns)	1.49
TMM2016-100	2048x8	(100ns)	1.95
HM6116-4	2048x8	(200ns)(CMOS)	1.89
HM6116-3	2048x8	(150ns)(CMOS)	1.95
HM6116LP-4	2048x8	(200ns)(CMOS)(LP)	1.95
HM6116LP-3	2048x8	(150ns)(CMOS)(LP)	2.05
HM6116LP-2	2048x8	(120ns)(CMOS)(LP)	2.95
HM6264P-15	8192x8	(150ns)(CMOS)	3.89
HM6264LP-15	8192x8	(150ns)(CMOS)(LP)	3.95
HM6264LP-12	8192x8	(120ns)(CMOS)(LP)	4.49

LP=Low power

DYNAMIC RAMS

4116-250	16384x1	(250ns)	.49
4116-200	16384x1	(200ns)	.89
4116-150	16384x1	(150ns)	.99
4116-120	16384x1	(120ns)	1.49
MK4332	32768x1	(200ns)	6.95
4164-200	65536x1	(200ns)(5V)	1.19
4164-150	65536x1	(150ns)(5V)	1.29
4164-120	65536x1	(120ns)(5V)	1.95
MCM6665	65536x1	(200ns)(5V)	1.95
TMS1614	65536x1	(150ns)(5V)	1.95
4164-REFRESH	65536x1	(150ns)(5V)(REFRESH)	2.95
TMS4416	16384x4	(150ns)(5V)	4.95
41128-150	131072x1	(150ns)(5V)	5.95
TMS4464-15	65536x4	(150ns)(5V)	6.95
41256-200	262144x1	(200ns)(5V)	2.95
41256-150	262144x1	(150ns)(5V)	2.95

5v=Single 5 Volt Supply

REFRESH=Pin 1 Refresh

★★★★HIGH-TECH★★★★

NEC V20 UPD70108 \$119.95

REPLACES 8088 TO SPEED UP IBM PC 10-40%

- * HIGH-SPEED ADDRESS CALCULATION IN HARDWARE
- * PIN COMPATIBLE WITH 8088
- * SUPERSET OF 8088 INSTRUCTION SET
- * LOW POWER CMOS

8MHz V20 UPD70108-8 \$13.95

8MHz V30 UPD70116-8 \$19.95

★★★★SPOTLIGHT★★★★

EPROMS

2708	1024x8	(450ns)	4.95
2716	2048x8	(450ns)(5V)	3.49
2716-1	2048x8	(350ns)(5V)	3.95
TMS2532	4096x8	(450ns)(5V)	5.95
2732	4096x8	(450ns)(5V)	3.95
2732A	4096x8	(250ns)(5V)(21V PGM)	3.95
2732A-2	4096x8	(200ns)(5V)(21V PGM)	4.25
27C64	8192x8	(250ns)(5V)(CMOS)	5.95
2764	8192x8	(450ns)(5V)	3.49
2764-250	8192x8	(250ns)(5V)	3.95
2764-200	8192x8	(200ns)(5V)	4.25
MCM68766	8192x8	(350ns)(5V)(24 PIN)	17.95
27128	16384x8	(250ns)(5V)	4.25
27C256	32768x8	(250ns)(5V)(CMOS)	10.95
27256	32768x8	(250ns)(5V)	7.49

5V=Single 5 Volt Supply

21V PGM=Program at 21 Volts

ORDER TOLL FREE

800-538-5000



SPECTRONICS CORPORATION EPROM ERASERS



Model	Timer	Capacity Chip	Intensity ($\mu W/cm^2$)	Unit Price
PE-14	NO	9	8,000	\$83.00
PE-14T	YES	9	8,000	\$119.00
PE-24T	YES	12	9,600	\$175.00

8000

8035	1.49
8039	1.95
8080	2.95
8085	2.49
8087-2	169.95
8087	129.00
8088	6.95
8088-2	6.95
8155	2.49
8155-2	3.95
8748	7.95
8755	14.95
80286	129.95
80287	199.95

6500

1.0 MHz

6502	2.69
65C02(CMOS)	12.95
6507	9.95
6520	1.95
6522	4.95
6526	26.95
6532	6.95
6545	6.95
6551	5.95
6561	19.95
6581	34.95

2.0 MHz

6502A	2.95
6520A	2.95
6522A	5.95
6532A	11.95
6545A	7.95
6551A	6.95

3.0 MHz

6502B	6.95
-------	------

CRT CONTROLLERS

6845	4.95
68845	8.95
6847	11.95
HD16505SP	6.95
MC1372	2.95
8275	26.95
7220	19.95
CRT5027	12.95
CRT5037	9.95
TMS9918A	19.95

CRYSTALS

32.768 KHz	.95
1.0 MHz	2.95
1.8432	2.95
2.0	1.95
2.097152	1.95
2.4576	1.95
3.2768	1.95
3.579545	1.95
4.0	1.95
4.032	1.95
5.0	1.95
5.0688	1.95
6.144	1.95
6.5536	1.95
8.0	1.95
10.0	1.95
10.738635	1.95
12.0	1.95
14.31818	1.95
15.0	1.95
16.0	1.95
17.430	1.95
18.0	1.95
18.432	1.95
20.0	1.95
22.1184	1.95
24.0	1.95
32.0	1.95

74LS00

74LS00	.16	74LS165	.65
74LS01	.18	74LS166	.95
74LS02	.17	74LS169	.95
74LS03	.18	74LS173	.49
74LS04	.16	74LS174	.39
74LS05	.18	74LS175	.39
74LS08	.18	74LS191	.49
74LS09	.18	74LS192	.69
74LS10	.16	74LS193	.69
74LS11	.22	74LS194	.69
74LS12	.22	74LS195	.69
74LS13	.26	74LS196	.59
74LS14	.39	74LS197	.59
74LS15	.26	74LS221	.59
74LS20	.17	74LS240	.69
74LS21	.22	74LS241	.69
74LS22	.22	74LS242	.69
74LS27	.23	74LS243	.69
74LS28	.26	74LS244	.69
74LS30	.17	74LS245	.79
74LS32	.18	74LS251	.49
74LS33	.28	74LS253	.49
74LS37	.26	74LS256	1.79
74LS38	.26	74LS257	.39
74LS42	.39	74LS258	.49
74LS47	.75	74LS259	1.29
74LS48	.85	74LS260	.49
74LS51	.17	74LS266	.39
74LS73	.29	74LS273	.79
74LS74	.24	74LS279	.39
74LS75	.29	74LS280	1.98
74LS76	.29	74LS283	.59
74LS83	.49	74LS290	.89
74LS85	.49	74LS293	.89
74LS86	.22	74LS299	1.49
74LS90	.39	74LS322	3.95
74LS92	.49	74LS323	2.49
74LS93	.39	74LS364	1.95
74LS95	.49	74LS365	.39
74LS107	.34	74LS367	.39
74LS109	.39	74LS368	.39
74LS112	.26	74LS373	.79
74LS122	.45	74LS374	.79
74LS123	.49	74LS375	.95
74LS124	2.75	74LS377	.79
74LS125	.39	74LS378	1.18
74LS126	.39	74LS390	1.19
74LS132	.39	74LS393	.79
74LS133	.49	74LS541	1.49
74LS136	.39	74LS624	1.95
74LS139	.39	74LS640	.99
74LS149	.99	74LS645	.99
74LS147	.99	74LS669	1.29
74LS148	.99	74LS670	.89
74LS151	.39	74LS682	3.20
74LS153	.39	74LS683	3.20
74LS154	1.49	74LS684	3.20
74LS155	.95	74LS688	2.40
74LS156	.95	74LS783	22.95
74LS157	.35	81LS96	1.49
74LS158	.29	81LS97	1.49
74LS160	.29	81LS98	1.49
74LS161	.39	25LS2521	2.80
74LS162	.49	25LS2569	2.80
74LS163	.39	26LS31	1.95
74LS164	.49	26LS32	1.95

HIGH SPEED CMOS

A new family of high speed CMOS logic featuring the speed of low power Schottky; (Sns typical gate propagation delay), combined with the advantages of CMOS: very low power consumption; super or noise immunity, and improved output drive.

74HC00

74HC: Operate at CMOS logic levels and are ideal for new, all-CMOS designs.

74HC00	.59	74HC148	1.19
74HC02	.59	74HC151	.89
74HC04	.59	74HC154	2.49
74HC08	.59	74HC157	.89
74HC10	.59	74HC158	.95
74HC14	.79	74HC163	1.15
74HC20	.59	74HC175	.99
74HC27	.59	74HC240	1.89
74HC30	.69	74HC241	1.39
74HC32	.69	74HC245	1.89
74HC51	.59	74HC257	.85
74HC74	.75	74HC259	1.39
74HC85	1.35	74HC273	1.89
74HC86	.69	74HC299	4.99
74HC93	1.19	74HC368	.99
74HC107	.79	74HC373	2.29
74HC109	.79	74HC374	2.29
74HC112	.79	74HC390	1.39
74HC125	1.19	74HC393	1.39
74HC132	1.19	74HC4017	1.99
74HC133	.69	74HC4020	1.39
74HC138	.99	74HC4049	.89
74HC139	.99	74HC4050	.89

74HC70

74HC70: Direct, drop-in replacements for LS TTL and can be intermixed with 74LS in the same circuit.

74HC70	.69	74HC166	3.05
74HC702	.69	74HC174	1.09
74HC704	.69	74HC193	1.39
74HC708	.69	74HC194	1.19
74HC710	.69	74HC240	2.19
74HC711	.69	74HC241	2.19
74HC727	.69	74HC244	2.19
74HC730	.69	74HC245	2.19
74HC732	.79	74HC257	.99
74HC774	.85	74HC259	1.59
74HC775	.95	74HC273	2.09
74HC7138	1.15	74HC367	1.09
74HC7139	1.15	74HC373	2.49
74HC7154	2.99	74HC374	2.49
74HC7157	.99	74HC393	1.59
74HC7158	.99	74HC4017	2.19
74HC7161	1.29	74HC4040	1.59
74HC7164	1.39	74HC4060	1.49

74F00

74F00	.69	74F74	.79	74F251	1.69
74F02	.69	74F86	.99	74F253	1.69
74F04	.79	74F138	1.69	74F257	1.69
74F08	.69	74F139	1.69	74F280	1.79
74F10	.69	74F157	1.69	74F283	1.95
74F32	.69	74F240	3.29	74F374	4.29
74F64	.89	74F244	3.29	74F374	4.29

8200

8203	24.95
8205	3.29
8212	1.49
8216	1.49
8224	2.25
8237	4.95
8237-5	5.49
8250	6.95
8251	1.69
8251A	1.89
8253	1.89
8253-5	1.95
8255	1.69
8255-5	1.95
8259	1.95
8259-5	2.29
8272	4.95
8279	2.49
8279-5	2.95
8282	3.95
8284	2.95
8286	3.95
8288	4.95

Z-80

Z80-CPU 2.5MHz 1.69

4.0 MHz

Z80A-CPU	1.79
Z80A-CTC	1.89
Z80A-DART	5.95
Z80A-DMA	5.95
Z80A-PIO	1.89
Z80A-SIO/0	5.95
Z80A-SID/1	

20MB HARD DISK SYSTEM ONLY \$38995!

CMOS		
4001	.19	14419 4.95
4011	.19	14433 14.95
4012	.25	4503 .49
4013	.35	4511 .69
4015	.29	4516 .79
4016	.29	4518 .85
4017	.49	4522 .79
4018	.69	4526 .79
4020	.59	4527 1.95
4021	.69	4528 .79
4024	.49	4529 2.95
4025	.25	4532 1.95
4027	.39	4538 .95
4028	.65	4541 1.29
4035	.69	4553 5.79
4040	.69	4585 .75
4041	.75	4702 12.95
4042	.59	74C00 .29
4043	.85	74C14 .59
4044	.69	74C74 .59
4045	1.98	74C83 1.95
4046	.69	74C85 1.49
4047	.69	74C95 .99
4049	.29	74C150 5.75
4050	.29	74C151 2.25
4051	.69	74C161 .99
4052	.69	74C163 .99
4053	.69	74C164 1.39
4056	2.19	74C192 1.49
4060	.69	74C193 1.49
4066	.29	74C221 2.49
4069	.19	74C240 1.89
4076	.59	74C244 1.89
4077	.29	74C374 1.99
4081	.22	74C905 10.95
4085	.79	74C911 8.95
4086	.89	74C917 12.95
4093	.49	74C922 4.49
4094	2.49	74C923 4.95
14411	9.95	74C926 7.95
14412	6.95	80C97 .95

7400/9000		
7400	.19	74147 2.49
7402	.19	74148 1.20
7404	.19	74150 1.35
7406	.29	74151 .55
7407	.29	74153 .55
7408	.24	74154 1.49
7410	.19	74155 .75
7411	.25	74157 .55
7414	.49	74159 1.65
7416	.25	74161 .69
7417	.25	74163 .69
7420	.19	74164 .85
7423	.29	74165 .85
7430	.19	74166 1.00
7432	.29	74175 .89
7438	.29	74177 .75
7442	.49	74178 1.15
7445	.69	74181 2.25
7447	.89	74182 .75
7470	.35	74184 2.00
7473	.34	74191 1.15
7474	.33	74192 .79
7475	.45	74194 .85
7476	.35	74196 .79
7483	.50	74197 .75
7485	.59	74199 1.35
7486	.35	74221 1.35
7489	2.15	74246 1.35
7490	.39	74247 1.25
7492	.50	74248 1.85
7493	.35	74249 1.95
7495	.55	74251 1.75
7497	2.75	74265 1.35
74100	2.29	74273 1.95
74121	.29	74278 3.11
74123	.49	74367 .65
74125	.45	74368 .65
74141	.65	9368 3.95
74143	5.95	9602 1.50
74144	2.95	9637 2.95
74145	.60	96502 1.95

74800		
74800	.29	74S163 1.29
74802	.29	74S168 3.95
74803	.29	74S174 .79
74804	.29	74S175 .79
74805	.29	74S188 1.95
74808	.35	74S189 1.95
74810	.29	74S195 1.49
74815	.49	74S196 2.49
74830	.29	74S197 2.95
74832	.35	74S226 3.99
74837	.69	74S240 1.49
74838	.69	74S241 1.49
74874	.49	74S244 1.49
74885	.95	74S257 .79
74886	.35	74S253 .79
74S112	.50	74S258 .95
74S124	.75	74S280 1.95
74S138	2.79	74S287 1.69
74S140	.55	74S288 1.69
74S151	.79	74S299 2.95
74S153	.79	74S373 1.69
74S157	.79	74S374 1.69
74S158	.95	74S471 4.95
74S161	1.29	74S571 2.95

DATA ACQ INTERFACE		
ADC0800	15.55	8T26 1.29
ADC0804	4.49	8T28 1.29
ADC0809	4.49	8T95 .89
ADC0816	14.95	8T96 .89
ADC0817	9.95	8T97 .59
ADC0831	8.95	8T98 .89
DAC0800	4.49	DM8131 2.95
DAC0806	1.95	DP8304 2.29
DAC0808	2.95	DS8833 2.25
DAC1020	6.25	DS8835 1.99
DAC1022	5.95	DS8836 .99
MC1408L8	2.95	DS8837 1.65

VOLTAGE REGULATORS		
TO-220 CASE		
7805T	.49	7905T .59
7808T	.49	7908T .59
7812T	.49	7912T .59
7815T	.49	7915T .59
TO-3 CASE		
7805K	1.59	7905K 1.69
7812K	1.39	7912K 1.49
TO-93 CASE		
78L05	.49	79L05 .69
78L12	.49	79L12 1.49
OTHER VOLTAGE REGS		
LM323K	5V 3A	TO-3 4.79
LM328K	Adj. 5A	TO-3 3.95
78H05K	5V 5A	TO-3 7.95
78H12K	12V 5A	TO-3 8.95
78P05K	5V 10A	TO-3 14.95

LINEAR		
TL066	.99	LM733 .98
TL071	.69	LM741 .29
TL072	1.05	LM747 .69
TL074	.69	LM748 .59
TL081	.59	MC1330 1.69
TL082	.99	MC1350 1.19
TL084	1.49	MC1372 6.95
LM301	.34	LM1414 1.59
LM309K	1.25	LM1458 .49
LM311	.59	LM1488 .49
LM311H	.89	LM1489 .49
LM317K	3.49	LM1496 .85
LM317T	.95	LM1818 8.25
LM318	1.49	LM1889 1.95
LM319	1.25	ULN2003 .79
LM320	see7800	XR2206 3.95
LM322	1.95	XR2211 2.95
LM323K	4.79	XR2240 1.95
LM324	.49	MPQ2907 1.95
LM331	3.95	LM2917 1.95
LM334	1.19	CA3046 .89
LM335	1.79	CA3041 .99
LM336	1.75	CA3082 .99
LM337K	3.95	CA3086 .80
LM338K	6.95	CA3089 1.95
LM339	.59	CA3130E .99
LM340	see7800	CA3146 1.29
LM350T	4.60	CA3160 1.19
LF353	.59	MC3470 1.95
LF356	.99	MC3480 8.95
LF357	.99	MC3487 2.95
LM358	.59	LM3900 .49
LM380	.89	LM3909 .98
LM383	1.95	LM3911 2.25
LM386	.89	LM3914 2.39
LM393	.45	MC4024 3.49
LM394H	5.95	MC4044 3.99
TL494	4.20	RC4136 1.25
TL497	3.25	RC4558 .69
NE555	.29	LM13600 1.49
NE556	.49	75107 1.49
NE558	1.29	75110 1.95
NE564	1.95	75150 1.95
LM565	.95	75154 1.95
LM566	1.49	75188 1.25
LM567	.79	75189 1.25
NE570	2.95	75451 .39
NE590	2.50	75452 .39
NE592	.99	75453 1.95
LM710	.75	75477 1.29
LM723	.49	75452 .79
H-T-O-5 CAN, K-T-O-3, T-T-O-220		

EDGE CARD CONNECTORS		
100 PIN ST	S-100	.125 3.95
100 PIN WW	S-100	.125 9.95
62 PIN ST	IBM PC	.100 1.95
50 PIN ST	APPLE	.100 2.95
44 PIN ST	STD	.156 1.95
44 PIN WW	STD	.156 4.95

36 PIN CENTRONICS		
MALE		
IDCEN36	RIBBON CABLE	6.95
CEN36	SOLDER CUP	4.95
FEMALE		
IDCEN36/F	RIBBON CABLE	7.95
CEN36PC	RT ANGLE PC MOUNT	4.95

INTERSIL		
ICL7106	9.95	
ICL7107	12.95	
ICL7660	2.95	
ICL8038	4.95	
ICM7207A	5.95	
ICM7208	15.95	

IC SOCKETS		
8 PIN ST	1.19	100+
14 PIN ST	.11	.09
16 PIN ST	.12	.10
18 PIN ST	.15	.13
20 PIN ST	.18	.15
22 PIN ST	.15	.12
24 PIN ST	.20	.15
28 PIN ST	.22	.16
40 PIN ST	.30	.22
64 PIN ST	1.95	1.49
ST-SOLDER TAIL		
8 PIN WW	.59	.69
14 PIN WW	.69	.52
16 PIN WW	.69	.58
18 PIN WW	.99	.90
20 PIN WW	1.09	.98
22 PIN WW	1.39	1.28
24 PIN WW	1.49	1.35
28 PIN WW	1.69	1.49
40 PIN WW	1.99	1.80
WW-WIREWRAP		
16 PIN ZIF	4.95	CALL
24 PIN ZIF	5.95	CALL
28 PIN ZIF	6.95	CALL
40 PIN ZIF	9.95	CALL
ZIF-TEXT TOOL		
(ZERO INSERTION FORCE)		

DIP CONNECTORS																
DESCRIPTION	ORDER BY	CONTACTS														
		8	14	16	18	20	22	24	28	40						
HIGH RELIABILITY TOOLED ST IC SOCKETS	AUGATxxST	.62	.79	.89	1.09	1.29	1.39	1.49	1.69	2.49						
HIGH RELIABILITY TOOLED WW IC SOCKETS	AUGATxxWW	1.30	1.80	2.10	2.40	2.50	2.90	3.15	3.70	5.40						
COMPONENT CARRIES (DIP HEADERS)	ICCxx	.49	.59	.69	.99	.99	.99	.99	1.09	1.49						
RIBBON CABLE DIP PLUGS (IDC)	IDPxx	---	.95	.95	---	---	---	---	1.75	---	2.95					

FOR ORDERING INSTRUCTIONS SEE D-SUBMINIATURE BELOW

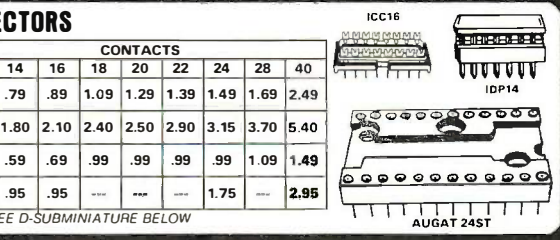

DIODES/OPTO/TRANSISTORS		
1N751	.25	4N26 .69
1N759	.25	4N27 .69
1N4148	25/1.00	4N28 .69
1N4004	10/1.00	4N33 .89
1N5402	.25	4N37 1.19
KBP04	.55	MCT-2 .59
KBUR8A	.95	MCT-6 1.29
MDA990-2	.35	TIL-111 .99
N2222	.25	2N3906 .10
PN2222	.10	2N4401 .25
2N2905	.50	2N4402 .25
2N2907	.25	2N4403 .25
2N565	.79	2N545 1.75
2N3904	.10	TIP31 .49

D-SUBMINIATURE										
DESCRIPTION	ORDER BY	CONTACTS								
		9	15	19	25	37	50			
SOLDER CUP	MALE	DBxxP	.82	.90	1.25	1.80	3.48			
	FEMALE	DBxxS	.95	1.15	1.50	1.50	2.35	4.32		
RIGHT ANGLE PC SOLDER	MALE	DBxxPR	1.20	1.49	---	1.95	2.65	---		
	FEMALE	DBxxSR	1.25	1.55	---	2.00	2.79	---		
WIRE WRAP	MALE	DBxxPWW	1.69	2.56	---	3.89	5.60	---		
	FEMALE	DBxxSWW	2.76	4.27	---	6.84	9.95	---		
IDC RIBBON CABLE	MALE	IDBxxP	2.70	2.95	---	3.98	5.70	---		
	FEMALE	IDBxxS	2.92	3.20	---	4.33	6.76	---		
HOODS	METAL	MHOODxx	1.25	1.25	1.30	1.30	---	---		
	GREY	HOODxx	.65	.65	---	.65	.75	.95		

ORDERING INSTRUCTIONS: INSERT THE NUMBER OF CONTACTS IN THE POSITION MARKED "xx" OF THE "ORDER BY" PART NUMBER LISTED.
EXAMPLE: A 15 PIN RIGHT ANGLE MALE PC SOLDER WOULD BE DB15PR

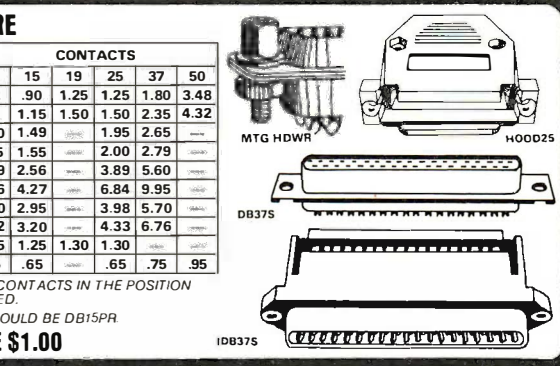

LED DISPLAYS		
FND-357(359)	COM CATHODE .362"	1.25
FND-500(503)	COM CATHODE .5"	1.49
FND-507(510)	COM ANODE .5"	1.99
MAN-72	COM ANODE .3"	.99
MAN-74	COM CATHODE .3"	.99
MAN-8940	COM CATHODE .3"	1.99
TIL-313	COM CATHODE .3"	.45
HP5082-7760	COM CATHODE .43"	1.99
TIL-311	4x7 HEX W/LOGIC .270"	9.25
HP5082-7340	4x7 HEX W/LOGIC .290"	7.95

DIFFUSED LEOS		
JUMBO RED	T1 1/4	100-UP
JUMBO GREEN	T1 1/4	.14
JUMBO YELLOW	T1 1/4	.12
MOUNTING HDW	T1 1/4	10 .09
MINI RED	T1	10 .09

IDC CONNECTORS					
DESCRIPTION	ORDER BY	CONTACTS			
		10	20	26	34

20MB HARD DISK SYSTEM ONLY \$38995!

BARGAIN HUNTERS CORNER

**20 MEG
FULL HEIGHT
HARD DISK DRIVE**
INCLUDES CABLE & CONTROLLER CARD

\$34995

SPECIAL ENDS 12/31/86

PAGE WIRE WRAP WIRE PRECUT ASSORTMENT

IN ASSORTED COLORS \$27.50
100ea: 5.5", 6.0", 6.5", 7.0"
250ea: 2.5", 4.5", 5.0"
500ea: 3.0", 3.5", 4.0"

SPOOLS

100 feet \$4.30 250 feet \$7.25
500 feet \$13.25 1000 feet \$21.95

Please specify color:
Blue, Black, Yellow or Red

EMI FILTER

\$4.95

- MANUFACTURED BY CORCOM
- LOW COST
- FITS LC-HP BELOW
- 6 AMP 120/240 VOLT



6 FOOT LINE CORDS

LC-2 2 CONDUCTOR .39
LC-3 3 CONDUCTOR .99
LC-HP 3 CONDUCTOR W/ STD FEMALE SOCKET 1.49

MUFFIN FANS

3.15" SQ ROTRON 14.95
3.63" SQ ETRI 14.95
3.18" SQ MASUSHITA 16.95

WIRE WRAP PROTOTYPE CARDS

FR-4 EPOXY GLASS LAMINATE WITH GOLD-PLATED EDGE-CARD FINGERS



IBM-PR2

IBM

BOTH CARDS HAVE SILK SCREENED LEGENDS AND INCLUDES MOUNTING BRACKET

IBM-PR1 WITH +5V AND GROUND PLANE . . . \$27.95
IBM-PR2 AS ABOVE WITH DECODING LAYOUT \$29.95

S-100

P100-1 BARE - NO FOIL PADS \$15.15
P100-2 HORIZONTAL BUS \$21.80
P100-3 VERTICAL BUS \$21.80
P100-4 SINGLE FOIL PADS PER HOLE \$22.75

APPLE

P500-1 BARE - NO FOIL PADS \$15.15
P500-3 HORIZONTAL BUS \$22.75
P500-4 SINGLE FOIL PADS PER HOLE \$21.80
7060-45 FOR APPLE IIe AUX SLOT \$30.00

SOCKET-WRAP I.D.™

- SLIPS OVER WIRE WRAP PINS
- IDENTIFIES PIN NUMBERS ON WRAP SIDE OF BOARD
- CAN WRITE ON PLASTIC; SUCH AS IC #

PINS	PART#	PCK. OF	PRICE
8	IDWRAP 08	10	1.95
14	IDWRAP 14	10	1.95
16	IDWRAP 16	10	1.95
18	IDWRAP 18	5	1.95
20	IDWRAP 20	5	1.95
22	IDWRAP 22	5	1.95
24	IDWRAP 24	5	1.95
28	IDWRAP 28	5	1.95
40	IDWRAP40	5	1.95

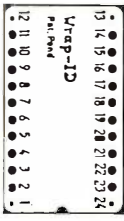

PLEASE ORDER BY NUMBER OF PACKAGES (PCK. OF)

ID WRAP 24

FRAME STYLE TRANSFORMERS

12.6V AC CT 2 AMP 5.95
12.6V AC CT 4 AMP 7.95
12.6V AC CT 8 AMP 10.95
25.2V AC CT 2 AMP 7.95

25 PIN D-SUB GENDER CHANGERS \$7.95



SWITCHING POWER SUPPLIES

PS-IBM \$89.95

- FOR IBM PC-XT COMPATIBLE
- 135 WATTS
- +5V @ 15A, +12V @ 4.2A
- -5V @ .5A, -12V @ .5A
- ONE YEAR WARRANTY



PS-IBM-150 \$79.95

- FOR IBM PC-XT COMPATIBLE
- 150 WATTS
- +12V @ 5.2A, +5V @ 16A
- -12V @ .5A, -5V @ .5A
- ONE YEAR WARRANTY



PS-130 \$99.95

- 130 WATTS
- SWITCH ON REAR
- FOR USE IN OTHER IBM TYPE MACHINES
- 90 DAY WARRANTY



PS-A \$49.95

- USE TO POWER APPLE TYPE SYSTEMS, 79.5 WATTS
- +5V @ 7A, +12V @ 3A
- -5V @ .5A, -12V @ .5A
- APPLE POWER CONNECTOR



PS-SPL200 \$49.95

- +5V @ 25A, +12V @ 3.5A
- -5V @ 1A, -12V @ 1A
- UL APPROVED
- ALUMINUM ENCLOSURE



CAPACITORS

TANTALUM

1.0µf	15V	.35	.47µf	35V	.45
6.8	15V	.70	1.0	35V	.45
10	15V	.80	2.2	35V	.65
22	15V	1.35	4.7	35V	.85
.22	35V	.40	10	35V	1.00

DISC

10µf	50V	.05	680	50V	.05
22	50V	.05	.001µf	50V	.05
27	50V	.05	.0022	50V	.05
33	50V	.05	.005	50V	.05
47	50V	.05	.01	50V	.07
68	50V	.05	.02	50V	.07
100	50V	.05	.05	50V	.07
220	50V	.05	.1	12V	.10
560	50V	.05	.1	50V	.12

MONOLITHIC

.01µf	50V	.14	.1µf	50V	.18
.047µf	50V	.15	.47µf	50V	.25

ELECTROLYTIC

RADIAL		AXIAL			
1µf	25V	.14	50V	.14	
2.2	35V	.15	10	50V	.16
4.7	50V	.15	22	16V	.14
10	50V	.15	47	50V	.20
47	35V	.18	100	35V	.25
100	16V	.18	220	25V	.30
220	35V	.20	470	50V	.50
470	25V	.30	1000	16V	.60
2200	16V	.70	2200	16V	.70
4700	25V	1.45	4700	16V	1.25

DATARASE EPROM ERASER \$34.95

- ERASES 2 IN 10 MINUTES
- COMPACT-NO DRAWER
- THIN METAL SHUTTER
- PREVENTS UV LIGHT FROM ESCAPING



1/4 WATT RESISTORS

5% CARBON FILM ALL STANDARD VALUES FROM 1 OHM TO 10 MEG. OHM

10 PCS same value .05 100 PCS same value .02
50 PCS same value .025 1000 PCS same value .015

RESISTOR NETWORKS

SIP 10 PIN 9 RESISTOR .69
SIP 8 PIN 7 RESISTOR .59
DIP 16 PIN 8 RESISTOR 1.09
DIP 16 PIN 15 RESISTOR 1.09
DIP 14 PIN 7 RESISTOR .99
DIP 14 PIN 13 RESISTOR .99

SPECIALS ON BYPASS CAPACITORS

.01 µf CERAMIC DISC 100/\$5.00
.01 µf MONOLITHIC 100/\$10.00
.1 µf CERAMIC DISC 100/\$6.50
.1 µf MONOLITHIC 100/\$12.50

WISH SOLDERLESS BREADBOARDS

PART NUMBER	DIMENSIONS	DISTRIBUTION STRIP(S)	TIE POINTS	TERMINAL STRIP(S)	TIE POINTS	BINDING POSTS	PRICE
WBU-D	.38 x 6.50"	1	100	---	---	---	2.95
WBU-T	1.38 x 6.50"	---	---	1	630	---	6.95
WBU-204-3	3.94 x 8.45"	1	100	2	1260	2	17.95
WBU-204	5.13 x 8.45"	4	400	2	1260	3	24.95
WBU-206	6.88 x 9.06"	5	500	3	1890	4	29.95
WBU-208	8.25 x 9.45"	7	700	4	2520	4	39.95



WBU-208

LITHIUM BATTERY AS USED IN CLOCK CIRCUITS

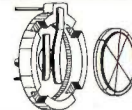

3 VOLT BATTERY \$3.95
BATTERY HOLDER \$1.49

NEW EDITION!

1986 IC MASTER
THE INDUSTRY STANDARD
\$129.95

Visit our retail store located at 1256 S. Bascom Ave. in San Jose, (408) 947-8881

JDR Microdevices
110 Knowles Drive, Los Gatos, CA 95030
Toll Free 800-538-5000 • (408) 866-6200
FAX (408) 378-8927 • Telex 171-110

© COPYRIGHT 1986 JDR MICRODEVICES Inquiry 169.

PLEASE USE YOUR CUSTOMER NUMBER WHEN ORDERING
TERMS: Minimum order \$10.00. For shipping and handling include \$2.50 for UPS Ground and \$3.50 for UPS Air. Orders over 1 lb. and foreign orders may require additional shipping charges - please contact our sales department for the amount. CA residents must include applicable sales tax. All merchandise is warranted for 90 days unless otherwise stated. Prices are subject to change without notice. We are not responsible for typographical errors. We reserve the right to limit quantities and to substitute manufacturer. All merchandise subject to prior sale.

THE JDR MICRODEVICES LOGO IS A REGISTERED TRADEMARK OF JDR MICRODEVICES. JDR INSTRUMENTS AND JDR MICRODEVICES ARE TRADEMARKS OF JDR MICRODEVICES. IBM IS A TRADEMARK OF INTERNATIONAL BUSINESS MACHINES. APPLE IS A TRADEMARK OF APPLE COMPUTER.

20MB HARD DISK SYSTEM ONLY \$38995!

DISK DRIVES FOR APPLE COMPUTERS

AP-150
\$99.95

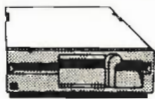

- 1/2 HT, DIRECT DRIVE
- 100% APPLE COMPATIBLE
- SIX MONTH WARRANTY

BAL-500
\$129.95

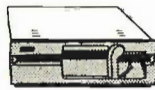

- TEAC MECHANISM-DIRECT DRIVE
- 100% APPLE COMPATIBLE
- FULL ONE YEAR WARRANTY

AP-135
\$129.95



- FULL HT SHUGART MECHANISM
- DIRECT REPLACEMENT FOR APPLE DISK II
- SIX MONTH WARRANTY

DOUBLE SIDED!

MAC535
\$249.95

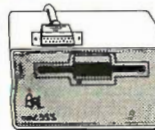

- 3.5" ADD-ON DISK DRIVE
- 100% MACINTOSH COMPATIBLE
- DOUBLE SIDED 800K BYTE STORAGE
- HIGH RELIABILITY DRIVE HAS AUTO-EJECT MECHANISM
- FULL ONE YEAR WARRANTY

AD-3C
\$139.95

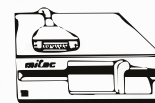

- 100% APPLE IIc COMPATIBLE, READY TO PLUG IN, W/SHIELDED CABLE & MOLDED 19 PIN CONNECTOR
- FAST, RELIABLE SLIMLINE DIRECT DRIVE
- SIX MONTH WARRANTY

DISK DRIVE ACCESSORIES
FDD CONTROLLER CARD \$49.95
IIc ADAPTOR CABLE \$19.95
ADAPTS STANDARD APPLE DRIVES FOR USE WITH APPLE IIc

KB-1000

\$79.95

- CASE WITH KEYBOARD FOR APPLE TYPE MOTHERBOARD
- USER DEFINED FUNCTION KEYS
- NUMERIC KEYPAD WITH CURSOR CONTROL
- CAPS LOCK
- AUTO-REPEAT



KEYBOARD-AP

\$49.95

- REPLACEMENT FOR APPLE II KEYBOARD
- CAPS LOCK KEY, AUTO-REPEAT
- ONE KEY ENTRY OF BASIC OR CP/M COMMANDS



EXTENDER CARDS

IBM-PC	\$45.00
IBM-AT	\$68.00
APPLE II	\$45.00
APPLE IIe	\$45.00
MULTIBUS	\$86.00

APPLE COMPATIBLE INTERFACE CARDS

EPROM PROGRAMMER \$59.95

MODEL RP525



- DUPLICATE OR BURN ANY STANDARD 27xx SERIES EPROM
- EASY TO USE MENU-DRIVEN SOFTWARE IS INCLUDED
- MENU SELECTION FOR 2716, 2732, 2732A, 2764 AND 27128
- HIGH SPEED WRITE ALGORITHM
- LED INDICATORS FOR ACTIVITY
- NO EXTERNAL POWER SUPPLY NEEDED
- ONE YEAR WARRANTY

16K RAMCARD

\$39.95



- FULL TWO YEAR WARRANTY
- EXPAND YOUR 48K APPLE TO 64K
- USE IN PLACE OF APPLE LANGUAGE CARD

BARE PC CARD W/INSTRUCTIONS \$9.95

IC TEST CARD

\$99.95



- QUICKLY TESTS MANY COMMON ICs
- DISPLAYS PASS OR FAIL
- ONE YEAR WARRANTY
- TESTS: 4000 SERIES CMOS, 74HC SERIES CMOS, 7400, 74LS, 741, 74H & 74S

300B MODEM \$49.95
FOR APPLE OR IBM

INCLUDES ASCII PRO-EZ SOFTWARE



- FCC APPROVED
- BELL SYSTEMS 103 COMPATIBLE
- INCLUDES AC ADAPTOR
- AUTO-DIAL
- DIRECT CONNECT

CABLE FOR APPLE IIc \$14.95

JOYSTICK CR-401 \$7.95

FOR ATARI 400, 800, 2600, VIC 20/64 AND APPLE IIe



\$895

DISKFILE
HOLDS 70 5 1/4" DISKETTES
\$995



POWER STRIP
UL APPROVED
15A CIRCUIT BREAKER
\$12.95



2 WAY SWITCH BOXES

- AVAILABLE IN SERIAL OR PARALLEL
- CONNECTS 2 PRINTERS TO ONE COMPUTER OR VICE VERSA
- ALL LINES SWITCHES
- PUSH-BUTTON SWITCHES MOUNTED ON PCB
- 3 FEMALE GOLD-PLATED CONNECTORS



AB-P CENTRONICS PARALLEL \$39.95
AB-S RS232 SERIAL \$39.95

MOLDED INTERFACE CABLES

- 6 FOOT, 100% SHIELDED, MEETS FCC
- IBM PARALLEL PRINTER CABLE 9.95
- CENTRONICS MALE TO FEMALE 14.95
- CENTRONICS MALE TO MALE 14.95
- MODEM CABLE FOR IBM 7.95
- RS232 SERIAL MALE TO FEMALE 9.95
- RS232 SERIAL MALE TO MALE 9.95
- KEYBOARD EXTENSION (COILED) 7.95
- APPLE II JOYSTICK EXTENSION 4.95

C. ITOH RITEMAN II PRINTER



- 160 CPS DRAFT MODE, 32CPS NLQ MODE
- 9 X 9 DOT MATRIX
- SUPPORTS EPSON/IBM GRAPHICS
- FRICTION AND TRACTOR FEEDS
- VARIABLE LINE SPACING AND PITCH

\$219.95

IBM PRINTER CABLE \$995
REPLACEMENT RIBBON CARTRIDGE \$1595

NASHUA DISKETTES DEALS

5 1/4" SOFT SECTOR DS/DD WITH HUB RINGS
\$990 **69c ea** **59c ea**
BOX OF 10 BULK QTY 50 BULK QTY 250

NASHUA DISKETTES WERE JUDGED TO HAVE THE HIGHEST POLISH AND RECORDED AMPLITUDE OF ANY DISKETTES TESTED ACCORDING TO "COMPARING FLOPPY DISKS", BYTE 9/84

DISKETTES NASHUA 5 1/4"

N-MD2D	DS/DD SOFT	\$9.90
N-MD2F	DS/QUAD SOFT	\$34.95
N-MD2H	DS/HD FOR AT	\$49.95

NASHUA 8"

N-FD1	SS/DD SOFT	\$27.95
N-FD2D	DS/DD SOFT	\$34.95

NASHUA 3.5"

N-3.5SS	3.5" SS/DD FOR MAC	\$32.95
---------	--------------------	---------

VERBATIM 5 1/4"

V-MD1D	SS/DD SOFT	\$23.95
V-MD2D	DS/DD SOFT	\$29.95
V-MD110D	SS/DD 10 SECTOR HARD	\$23.95

TEST EQUIPMENT FROM JDR INSTRUMENTS

DIGITAL MULTIMETER PEN DPM-1000
AUTO RANGING, POLARITY AND DECIMAL!

\$54.95

- LARGE 3.5 DIGIT DISPLAY
- DATA HOLD SWITCH
- FREEZES READING
- FAST, AUDIBLE CONTINUITY TEST
- LOW BATTERY INDICATOR
- OVERLOAD PROTECTION



20MHZ DUAL TRACE OSCILLOSCOPE MODEL 2000 \$389.00
35MHZ DUAL TRACE OSCILLOSCOPE MODEL 3500 \$549.00

FOR MORE INFORMATION ON THE OSCILLOSCOPES, CALL US FOR FREE PRODUCT BRIEFS.

BUILD STEVE GIARGIA'S INTELLIGENT EPROM PROGRAMMER

AS SEEN IN BYTE, OCT. 86

- STAND-ALONE OR RS-232 SERIAL OPERATION
- MENU SELECTABLE EPROM TYPES—NO CONFIGURATION JUMPERS
- PROGRAMS ALL 5V 27XXX EPROMS FROM 2716 TO 27512
- READ, COPY OR VERIFY EPROM
- UPLOAD/DOWNLOAD INTEL HEX FILES
- PROGRAMMER DRIVER USER MODIFIABLE

ONLY \$199

KIT INCLUDES PCB AND ALL COMPONENTS EXCEPT CASE AND POWER SUPPLY

5 1/4" FLOPPY DISK DRIVES

TEAC FD-55B 1/2 HT DS/DD (FOR IBM)	\$109.95
TEAC FD-55F 1/2 HT DS/QUAD (FOR IBM)	\$124.95
TEAC FD-55GFV 1/2 HT DS/HD (FOR IBM AT)	\$154.95
TANDON TM100-2 DS/DD (FOR IBM)	\$119.00
TANDON TM50-2 1/2 HT DS/DD (FOR IBM)	\$79.95
MPI-B52 DS/DD (FOR IBM)	\$79.95
QUME QT-142 1/2 HT DS/DD (FOR IBM)	\$79.95

8" FLOPPY DISK DRIVES

FD 100-8 SS/DD (SA/801 EQUIV)	\$119.00
FD 200-8 DS/DD (SA/851R EQUIV)	\$159.00

DISK DRIVE ACCESSORIES

TEAC SPECIFICATION MANUAL	\$5.00
TEAC MAINTENANCE MANUAL	\$25.00
1/2 HT MOUNTING HARDWARE	\$2.95
MOUNTING RAILS FOR IBM AT	\$4.95
"Y" POWER CABLE FOR 5 1/4" FDDs	\$2.95
5 1/4" FDD POWER CONNECTORS	\$1.19

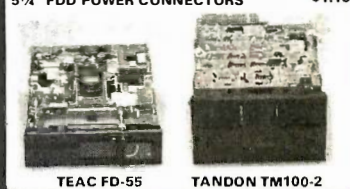

TEAC FD-55

TANDON TM100-2

DISK DRIVE ENCLOSURES

CAB-APPLE	APPLE TYPE CABINET W/OUT POWER SUPPLY	\$24.95
CAB-1FH5	FULL HT 5 1/4" BEIGE CABINET W/POWER SUPPLY	\$69.95
CAB-2SV5	DUAL SLIMLINE 5 1/4" CABINET W/POWER SUPPLY	\$49.95
CAB-2SV8	VERTICAL DUAL SLIMLINE 8" CABINET W/POWER SUPPLY	\$209.95
CAB-2FH8	HORIZONTAL DUAL FULL HT 8" CABINET W/POWER SUPPLY	\$219.95

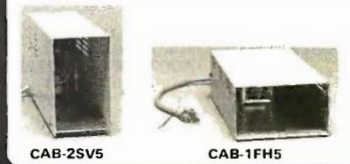

CAB-2SV5

CAB-1FH5

20 MEGA BYTE HARD DISK SYSTEM ONLY \$389.95!

SEAGATE ST-225 20 MB HARD DISK SYSTEM

INCLUDES HARD DISK CONTROLLER, CABLES AND INSTRUCTIONS. ALL DRIVES ARE PRE-TESTED AND COME WITH A ONE YEAR WARRANTY.

\$389.95

XT COMPATIBLE MOTHERBOARD

\$129.95

- 4.77 MHz 8088 CPU, OPTIONAL 8087 CO-PROCESSOR
- 8 EXPANSION SLOTS
- 0K RAM INSTALLED, EXPANDABLE TO 640K ON-BOARD MEMORY
- ALL ICs SOCKETED-HIGHEST QUALITY PC BOARD
- ACCEPTS 2764 OR 27128 ROMS

PRO-BIOS \$19.95

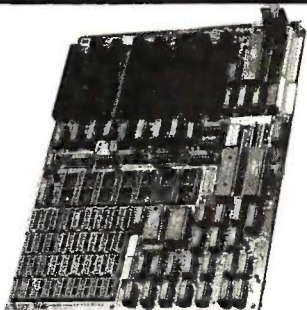

IBM COMPATIBLE INTERFACE CARDS

ALL WITH A ONE YEAR WARRANTY

MULTI I/O FLOPPY CARD

\$89.95

PERFECT FOR THE 640K MOTHERBOARD



- 2 DRIVE FLOPPY DISK CONTROLLER
- 1 RS232 SERIAL PORT; OPTIONAL 2nd SERIAL PORT
- PARALLEL PRINTER PORT
- GAME PORT
- CLOCK/CALENDAR
- SOFTWARE: CLOCK UTILITIES, RAMDISK, SPOOLER
- OPTIONAL SERIAL PORT \$15.95

MULTIFUNCTION CARD

\$84.95

ALL THE FEATURES OF AST'S 6 PACK PLUS AT HALF THE PRICE



- CLOCK/CALENDAR
- 0-384K RAM
- SERIAL PORT
- PARALLEL PORT
- GAME PORT
- SOFTWARE INCLUDED
- PRINTER CABLE \$9.95
- 64K RAM UPGRADE 9/511.61

COLOR GRAPHICS ADAPTOR

\$69.95

FULLY COMPATIBLE WITH IBM COLOR CARD



- 4 VIDEO INTERFACES: RGB, COMPOSITE COLOR, HI-RES COMPOSITE MONOCHROME, CONNECTOR FOR RF MODULATOR
- COLOR GRAPHICS MODE: 320 x 200
- MONO GRAPHICS MODE: 640 x 200
- LIGHT PEN INTERFACE

MONOCHROME GRAPHICS CARD

\$89.95

FULLY COMPATIBLE WITH IBM MONOCHROME ADAPTOR & HERCULES GRAPHICS



- LOTUS COMPATIBLE
- TEXT MODE: 80 x 25
- GRAPHICS MODE: 720 x 348
- PARALLEL PRINTER INTERFACE

MONOCHROME ADAPTOR

\$49.95

ANOTHER FANTASTIC VALUE FROM JDR!

- IBM COMPATIBLE TTL OUTPUT
 - 720 x 350 PIXEL DISPLAY
- PLEASE NOTE: THIS CARD WILL NOT RUN LOTUS GRAPHICS AND DOES NOT INCLUDE A PARALLEL PORT

FLOPPY DISK DRIVE ADAPTOR

\$34.95



- INTERFACES UP TO 4 STANDARD FDDs TO IBM PC OR COMPATIBLES
- INCLUDES CABLE FOR TWO INTERNAL DRIVES
- STANDARD DB37 FOR EXTERNAL DRIVES
- RUNS QUAD DENSITY DRIVES WHEN USED WITH JFORMAT

1200 BAUD MODEMS

HAYES COMPATIBLE, AUTO-DIAL, AUTO-ANSWER, AUTO RE-DIAL ON BUSY, POWER-UP SELF TEST, FULL ONE YEAR WARRANTY

MODEL 1200B*
 • INTERNAL DESIGN
 • 10 INCH CARD
 • SERIAL PORT INCLUDED

\$169.95

*FOR IBM, INCLUDES PC TALK III COMMUNICATIONS SOFTWARE

MODEL 1200H*
 • INTERNAL DESIGN
 • HALF LENGTH (5") CARD
 • INCLUDES SPEAKER

\$149.95

SMARTTEAM
 • EXTERNAL DESIGN
 • WITH POWER SUPPLY
 • LED STATUS INDICATORS

\$169.95

CRT MONITORS FOR ALL APPLICATIONS



LUXOR HI-RES RGB MONITOR
 MODEL 190-9528

- DIGITAL RGB-IBM COMPATIBLE
- 14" SCREEN
- 16 TRUE COLORS
- 25 MHz BANDWIDTH
- RESOLUTION > 640 x 262
- 31mm DOT PITCH
- CABLE FOR IBM PC INCLUDED

\$299.95



SAKATA COMPOSITE COLOR
 MODEL SC-100

- TOP RATED FOR APPLE
- 13" COMPOSITE VIDEO
- RESOLUTION: 280H x 300V
- INTERNAL AUDIO AMP
- ONE YEAR WARRANTY

\$169.95



CENTER SYSTEMS MONOCHROME
 MODEL KLM-1211

- IBM COMPATIBLE TTL INPUT
- 12" NON-GLARE SCREEN
- P39 GREEN PHOSPHORUS
- VERY HIGH RESOLUTION: 25 MHz BANDWIDTH 1100 LINES (CENTER)

\$99.95
 AMBER VERSION \$109.95

BUILD YOUR OWN 256K XT COMPATIBLE SYSTEM

- XT MOTHERBOARD **\$129.95**
- PRO-BIOS **\$19.95**
- 256K RAM **\$26.55**
- 130 WATT POWER SUPPLY **\$69.95**
- FLIP-TOP CASE **\$39.95**
- DKM-2000 KEYBOARD **\$59.95**
- 1/2 HEIGHT QUME DRIVE **\$79.95**
- FLOPPY DISK CONTROLLER **\$34.95**
- MONOCHROME ADAPTOR **\$49.95**
- MONOCHROME MONITOR **\$99.95**

TOTAL: \$611.10

MONITOR STAND



TILTS AND SWIVELS
ONLY \$12.95

IBM PRINTER CABLE



• DB25 TO CENTRONICS SHIELDED CABLE **\$9.95**

IBM STYLE COMPUTER CASE

AN ATTRACTIVE STEEL CASE WITH A HINGED LID FITS THE POPULAR PC/XT COMPATIBLE MOTHERBOARDS

- SWITCH CUT-OUT ON SIDE FOR PC/XT STYLE POWER SUPPLY
- CUT-OUT FOR 8 EXPANSION SLOTS
- ALL HARDWARE INCLUDED

\$39.95



IBM COMPATIBLE KEYBOARDS

DKM-2000 \$59.95

IBM-5151 \$79.95



- "5150" STYLE KEYBOARD
- FULLY IBM COMPATIBLE
- LED STATUS INDICATORS FOR CAPS & NUMBER LOCK
- 83 KEY - SAME LAYOUT AS IBM PC/XT KEYBOARD



- REPLACEMENT FOR KEYTRONICS KB-5151™
- SEPARATE CURSOR & NUMERIC KEYPAD
- CAPS LOCK & NUMBER LOCK INDICATORS
- IMPROVED KEYBOARD LAYOUT

POWER SUPPLY



NOW ONLY \$69.95

- FOR IBM PC-XT COMPATIBLE
- 135 WATTS
- +5V @ 15A, +12V @ 4.2A
- -5V @ .5A, -12V @ .5A

150 WATT MODEL \$79.95

DISK DRIVES TANDON TM50-2

\$79.95

- 1/2 HT DS/DD
- IBM COMPATIBLE
- EXTREMELY QUIET!

TEAC FD-55B	DS/DD	\$108.95
TEAC FD-55F	DS/QUAD	\$124.95
TEAC FD-558	DS/HD	\$154.95
QUME QT-142	DS/DD	\$78.95
MOUNTING HARDWARE		\$2.95
AT/RAILS		\$4.95

B·O·M·B

BYTE'S ONGOING MONITOR BOX

ARTICLE#	PAGE	ARTICLE	AUTHOR(S)	ARTICLE#	PAGE	ARTICLE	AUTHOR(S)
1	9	Microbytes	staff	15	193	Handling Conflicts in Data	Cuadrado.
2	29	What's New	staff				Cuadrado
3	52	Ask BYTE/Circuit Cellar		16	207	The Art of Deduction	Emond. Paulissen
4	65	Book Reviews	Ciarcia Hoffman. Kilov. McCormick	17	217	Rule-based Programming	Moskowitz
5	84	Product Preview: The Compaq Deskpro 386	Thompson, Allen	18	225	Machine Learning	Kolokouris
6	91	Product Preview: Lotus Manuscript	Stewart	19	239	Three IBM Clones	Unger
7	105	Ciarcia's Circuit Cellar: Build the GT180 Color Graphics Board, Part I: Basic Technology	Ciarcia	20	247	The Macintosh Plus	Crawford
8	115	Programming Insight: Extracting the nth Root from a Binary Number	Lau	21	255	Three 24-pin Dot-Matrix Printers	Swearengin
9	119	Programming Insight: Passing Filenames to Compiled BASIC	Hubanks	22	261	Digitizers for Data Entry	Hearn
10	127	Memory Management Units for 68000 Architectures	Zehr	23	271	Two C Compilers for the Amiga	Heath
11	137	The State of Soviet Microelectronics	Walton	24	279	SPSS/PC+	Jacques
12	149	Finding Rules in Data	Thompson. Thompson	25	285	Aegis Animator and Aegis Images	Block
13	161	A Bit-Mapped Classifier	Frey	26	289	Turbo Lightning and Strike	Ramsey
14	177	Predicting International Events	Schrodt	27	297	filePro 16 and filePro 16 Plus	Harkness
				28	307	Computing at Chaos Manor: A Graphic Display	Pournelle
				29	323	According to Webster: 68000 Wars: Round 3	Webster
				30	347	BYTE Japan: Technical Curiosities	Raike
				31	351	BYTE U.K.: Integration on a New Scale	Pountain
				32	361	Applications Only: Resident Headaches	Shapiro
				33	373	Mathematical Recreations: Paradoxes of Probability	Kurosaka
				34	385	Best of BIX	BiXen

BOMB Results

PROGRAMMING OBJECTIVES

Professor C.A.R. Hoare wins \$100 for his first-place August feature article "Mathematics of Programming." Winner of the \$50 bonus is Geoffrey A. Pascoe whose "Elements of Object-oriented Programming" placed second in

the readers' tally. Third-place mention goes to Ted Kaehler and Dave Patterson for "A Small Taste of Smalltalk." The \$50 award for first place in the quality lineup goes to Larry Tesler for "Programming Experiences." Congratulations to all.

N·E·X·T M·O·N·T·H I·N B·Y·T·E

THEME:

Graphics Algorithms promises to be a theme you'll find both fascinating and rewarding. As things now stand, the section will include articles on graphics quadratics, the Mandelbrot set, abstract mathematical art, Henon mapping with Pascal, Macintosh regions, creating free-form curves on your computer, and graphics terminal emulation.

FEATURES:

The new TMS34010 graphics chip; "The Effect of Nuclear Weapons on Computers"; and "Relaxation," a numerical method for simulating dynamic physical situations.

REVIEWS:

Three IBM PC AT work-alikes and the Laser 128 Apple II clone give us a look at four new computer systems. Also look for a comparative review of dozens of modems. A comparative review of Pascals for the IBM PC, along with reviews of three application programs: Flashcom, Stella, and Expert Edge.

CIRCUIT CELLAR:

Part 2 of Steve Ciarcia's major new graphics board construction project.

SPECIAL MC68000 SERIES:

Debugging Macintosh Applications

PROGRAMMING ARTICLES:

How to use DOS functions in a high-level-language program. "Approximating Integrals" and "A C Interface to ANSI.SYS."

PLUS Chaos Manor, According to Webster, BYTE U.K., Applications Only, Best of BIX, book reviews, What's New, Microbytes, and more.

A COMPUTER PROGRAM DELIVERED VIA SATELLITE!

The Computer Chronicles, a half-hour weekly television series brings you news and information from Silicon Valley and around the world.

Correspondent Stewart Cheifet and Gary Kildall, creator of CP/M cover today's headlines and the stories behind them.

Find out what is, what was and what will be, with the only computer program you're ever going to need. **The Computer Chronicles**, every week on a public television station near you.

(Check local listings for time and channel.)



Produced by KCSM, San Mateo, CA and WITF, Harrisburg, PA with funding from McGraw-Hill's **BYTE** magazine.

BYTE ADVERTISING SALES STAFF:

Dennis J. Riley, Advertising Sales Manager, One Phoenix Mill Lane, Peterborough, NH 03458, tel. (603) 924-9281

NEW ENGLAND

ME, NH, VT, MA, RI,
ONTARIO, CANADA & EASTERN CANADA
Paul McPherson Jr. (617) 262-1160
McGraw-Hill Publications
575 Boylston Street
Boston, MA 02116

ATLANTIC

NY, NJ, CT, NJ (NORTH)
Leah G. Rabinowitz (212) 512-2096
McGraw-Hill Publications
1221 Avenue of the Americas—
39th Floor
New York, NY 10020

Dick McGurk (203) 968-7111
McGraw-Hill Publications
Building A—3rd Floor
777 Long Ridge Road
Stamford, CT 06902

EAST

PA, KY, OH, IN (SOUTH),
MD, VA, W.VA, DE, D.C.
Daniel Ferro (215) 496-3833
McGraw-Hill Publications
Three Parkway
Philadelphia, PA 19102

SOUTHEAST

NC, SC, GA, FL, AL, TN
Maggie M. Dorvee (404) 252-0626
McGraw-Hill Publications
4170 Ashford-Dunwoody Road—
Suite 420
Atlanta, GA 30319

MIDWEST

IL, MO, KS, IA, ND, SD, MN, WI, NB, IN, MI
Bob Denmead (312) 751-3740
McGraw-Hill Publications
Blair Building
645 North Michigan Ave.
Chicago, IL 60611

SOUTHWEST, ROCKY MOUNTAIN

UT, CO, WY, OK, TX, AR, MS, LA
Kevin Harold (214) 458-2400
McGraw-Hill Publications
Prestonwood Tower—Suite 907
5151 Beltline
Dallas, TX 75240

SOUTH PACIFIC

SOUTHERN CA, AZ, NM, LAS VEGAS
Jack Anderson (714) 557-6292
McGraw-Hill Publications
3001 Red Hill Ave.
Building #1—Suite 222
Costa Mesa, CA 92626

Karen Niles (213) 480-5243, 487-1160
McGraw-Hill Publications
3333 Wilshire Boulevard #407
Los Angeles, CA 90010

NORTH PACIFIC

HI, WA, OR, ID, MT, NORTHERN CA,
NV (except LAS VEGAS), W. CANADA
Mike Kisseberth (415) 362-4600
McGraw-Hill Publications
425 Battery Street
San Francisco, CA 94111

Bill McAfee (415) 349-4100
McGraw-Hill Publications
951 Mariner's Island Blvd.—3rd Floor
San Mateo, CA 94404

WEST COAST SURPLUS AND RETAIL ACCOUNTS

Tom Harvey (805) 964-8577
3463 State Street—Suite 256
Santa Barbara, CA 93105

The Buyer's Mart

Karen Burgess (603) 924-3754
BYTE Publications
One Phoenix Mill Lane
Peterborough, NH 03458

BYTE BITS (2x3)

Dan Harper (603) 924-6830
BYTE Publications
One Phoenix Mill Lane
Peterborough, NH 03458

Post Card Mailings

National
Ed Ware (603) 924-9281
Bradley Browne (603) 924-6166
BYTE Publications
One Phoenix Mill Lane
Peterborough, NH 03458

International Advertising Sales Staff:

Mr. Hans Csokor
Publimedia
Reisnerstrasse 61
A-1037 Vienna, Austria
222 75 76 84

Mrs. Gurit Gepner
McGraw-Hill Publishing Co.
PO Box 2156
Bat Yam, 59121 Israel
3 866 561 321 39

Mr. Fritz Krusebecker
McGraw-Hill Publishing Co.
Liebigstrasse 19
D-6000 Frankfurt/Main 1
West Germany
69 72 01 81

Mrs. Maria Sarmiento
Pedro Teixeira 8, Off. 320
Iberia Mart 1
Madrid 4, Spain
1 45 52 891

Mr. Andrew Karnig
Andrew Karnig & Associates
Finnbodavagen
S-1 31 31 Nacka, Sweden
8-44 0005

Mr. Alain Faure
McGraw-Hill Publishing Co.
128 Faubourg Saint Honore
75008 Paris
France
(1) 42-89-03-81

Mr. Arthur Scheffer
McGraw-Hill Publishing Co.
34 Dover St.
London W1X 3RA
England 01 493 1451

Manuela Capuano
McGraw-Hill Publishing Co.
Via Flavio Baracchini 1
20123 Milan, Italy
02 86 90 617

Seavex Ltd.
400 Orchard Road, #10-01
Singapore 0923
Republic of Singapore
Tel: 734-9790
Telex: RS35539 SEAVEX

Seavex Ltd.
503 Wilson House
19-27 Wyndham St.
Central, Hong Kong
Tel: 5-260149
Telex: 60904 SEVEX HX

Hiro Morita
McGraw-Hill Publishing Co.
Overseas Corp.
Room 1528
Kasumigaseki Bldg.
3-2-5 Kasumigaseki,
Chiyoda-Ku
Tokyo 100, Japan
3 581 9811

Mr. Ernest McCrary
Empresa Internacional de
Comunicacoes Ltda
Rua da Consolacao, 222
Conjunto 103
01302 Sao Paulo, S.P., Brasil
Tel: (11) 259-3811
Telex: (100) 32122 EMBN

R·E·A·D·E·R S·E·R·V·I·C·E

Inquiry No.	Page No.	Inquiry No.	Page No.	Inquiry No.	Page No.	Inquiry No.	Page No.
2	ABSOFT 385	66	CLEVELAND CODONICS INC. 276	134	GENERIC SOFTWARE INC. 60	202	MEGASOFT 446
410	ACS IMPORTERS 434	67	CLONE FACTORY 419	135	GENERIC SOFTWARE INC. 60	203	MEGATEL COMPUTER TECH. 78
3	ACTION SOFTWARE 388	68	CLUB AT 327	136	GENICOM 267	204	MERRITT COMP. PRODUCTS 433
	* ADDISON-WESLEY RETAIL SALES GRP. 292-295	69	CLUB AT 328, 329	137	GLENCO ENGINEERING 200	205	METACOMCO 399
4	ADDISON-WESLEY EDU.MEDIA 366	70	CNT MARKETING 446	138	GLOBAL COMPUTER SUPPLIES 388	206	MFJ ENTERPRISES INC. 376
5	ADDMASTER CORP. 385		* CODEX CORPORATION 97	139	GOLD HILL COMPUTERS 140	207	MICRO COM SYSTEMS 133
6	ADJUSTABLE COMP. PROD. 430	71	COEFFICIENT SYS. CORP. 172	141	GOLDEN BOW SYSTEMS 426	208	MICRO DATA BASE SYS. 341
402	ADV. DIGITAL CORP. 28	72	COGITATE 426	140	GOLDEN BOW SYSTEMS 430	209	MICRO DESIGN INT'L 368
403	ADV. DIGITAL CORP. 28	73	COGITATE 426	142	GRAFPOINT 430	210	MICRO INTERFACES CORP. 55
8	ADV. INTELLIGENCE TECHN. 442		* COMPAQ COMPUTER CORP. 64A-H	143	GRAND UNION MICROSYSTEMS 226	211	MICRO INTERFACES CORP. 56
9	ADVANCED COMP. PROD. 425	75	COMPUTATA TRANSLATORS INC. 426	144	GTEK INC. 296	212	MICRO MART. INC. 354
10	AFTON COMPUTER 70		* COMPUPRO 130		* HARMONY COMPUTERS 61	45	MICRO PRODUCTS INT'L 443
11	AFTON COMPUTER 70	76	COMPUSAVE 416	145	HERCULES COMPUTER TECH. 302, 303	213	MICRO SUPPLY ORGANIZATION 424
12	ALF PRODUCTS. INC. 226	77	COMPUSERVE 283	146	HERCULES COMPUTER TECH. 302, 303	214	MICROPHONICS TECHNOLOGY 332
399	ALPHA MICRO 367	78	COMPUTER AFFAIRS INC. 420	147	HERITAGE SYSTEMS CORP. 436	215	MICROPORT SYSTEMS INC. 378, 379
13	ALPS AMERICA 124, 125		* COMPUTER CHRONICLES 454	148	HERSEY MICRO CONSULTING 197	216	MICROPROCESSORS UNLTD. 430
14	ALPS AMERICA 124, 125	395	COMPUTER CLASSIFIEDS 380	149	HEWLETT/PACKARD 159		* MICRORIM INC. 56, 57
15	ALPS AMERICA 268, 269		* COMPUTER CONTINUUM 433	150	HEWLETT/PACKARD 339		* MICROSOFT CORP. 53
16	ALPS AMERICA 268, 269	79	COMPUTER DIRECT 346	151	HITECH INT'L. INC. 318		* MICROSOFT CORP. 357
17	ALSYS LTD. 185	80	COMPUTER FRIENDS 196	152	HOUSTON INSTRUMENTS/AMETEK 21		* MICROSOFT CORP. 358, 359
18	AMDEK CORP. 153	81	COMPUTER FURNITURE CFTSMN 334	180	HUNTER SALES 431	217	MICROTECH 434
	* AMER. DESIGN COMPONENTS 187		* COMPUTER INNOVATIONS 45	181	HUNTER SALES 431	218	MICROWARE 198
	* AMERICAN AIRLINES 387	83	COMPUTER INNOVATIONS 47	154	IBC 365		* MICROWAY 167
21	AMERICAN COMP. & PERIPH. 136	193	COMPUTER LIBRARY 219	155	IBEX COMP. CORP. 430	219	MICROWAY 238
22	AMERICAN COMP. & PERIPH. 136		* COMPUTER MAIL ORDER 288A-D	156	IBM - (ISG) SERVICES 102, 103	153	MIND OVER MINORS 165
23	AMERICAN MICRO TECHNOLOGY 189	84	COMPUTER SURPLUS STORE 416	157	IC EXPRESS 422	220	MITAC INC. 90
24	AMERICAN MICRO TECHNOLOGY 189	85	COMPUTER WAREHOUSE 180	158	INI COMPUTER PROD. 436	221	MIX SOFTWARE 343
25	AMERICAN MICRO TECHNOLOGY 191	86	COMPUTER WAREHOUSE 180	159	INNOVATIVE SOFTWARE 144, 145	222	MULTI-TECH SYSTEMS 114
26	AMERICAN MICRO TECHNOLOGY 191	87	COMPUTER-AGE INC. 446		* INTECTRA INC. 143	223	MULTI-TECH SYSTEMS 114
27	AMERICAN SEMICONDUCTOR 422	88	COMPUTERBANC 435	160	INTEGRAND RESEARCH CORP. 198	226	NANTUCKET 39
28	AMERICAN SMALL BUSN. COMP. 75	89	COMPUTERS INTERNATIONAL 251	161	INTERSTATE SOFTWARE 338	227	NANTUCKET 39
29	AMPRO COMPUTERS INC. 74	90	COMPUTRADE COMPANY 396	162	IO TECH 433	230	NATIONAL INSTRUMENTS 122
401	A O ELECTRONICS. INC. 198	405	CSS LABS 389	163	IACO ENTERPRISES 376	229	NATIONAL INSTRUMENTS 266
30	APROTEK 426	406	CSS LABS 389	164	JADE COMP. PROD. 437	231	NATURAL MICROSYSTEMS CORP. 354
31	ARITY CORPORATION 186	92	CUESTA SYSTEMS 317	165	JAMECO ELECTRONICS 440, 441	232	NEC HOME ELECTR.USA 118
32	ARTEK CORP. 66	93	CURTIS. INC. 426	166	JDR INSTRUMENTS 337	233	NEC INFORMATION SYS. C.III
	* AST RESEARCH INC. 17	94	CUSTOM SOFTWARE SYSTEMS 396	167	JDR MICRODEVICES 447	234	OKIDATA 284
390	ATARI 64	95	DAC SOFTWARE INC. 33	168	JDR MICRODEVICES 448, 449		* ORCAD SYSTEMS 433
391	ATARI 165	97	DATA SPEC 342	169	JDR MICRODEVICES 450, 451	237	ORCHID TECHNOLOGY 121
392	ATARI 315	98	DATA SPEC 342	170	JDR MICRODEVICES 452	238	ORCHID TECHNOLOGY 121
	* AT&T COMM. PUBLIC PRGMS 228, 229	103	DATANAMICS INC. 446	394	JOHN WILEY & SONS 190	239	ORION INSTRUMENTS 216
	* AT&T INFORMATION SYS. 204, 205	101	DATASOUTH COMP. CORP. 331	171	KADAK PRODUCTS LTD. 332	240	OSBORNE/MCGRAW-HILL 395
34	ATRON CORP. 384	102	DATATECH ENTERPRISES CO. 192	384	KEA SYSTEMS 422	241	PC COMPUTER BROKERS INC. 422
385	AUTO SWITCH 400	104	DECISIONWARE INC. 308	173	LABORATORY MICROSYSTEMS 330	242	PC HORIZONS INC. 434
35	B&B ELECTRONICS 422	105	DECISIONWARE INC. 308	174	LATTICE. INC. 356	99	PC MEMORY 422
	* B&C MICROSYSTEMS 430	106	DICONIX 360	175	LAWSON LABS 436	228	PD. SIG. INC. 416
36	BARRINGTON SYSTEMS 25	107	DIGITALK INC. 77	176	LEADING EDGE PRODUCTS 23	243	PACKARD BELL 370, 371
37	BAY EXPRESS CO. THE 120	108	DISK WORLD! INC. 429	177	LIFEBOAT ASSOCIATES 310	244	PACKARD BELL 370, 371
38	BAY TECHNICAL ASSOC. 325	109	DISKTECH 426	178	LIGHT SPEED INC. 116	245	PANASONIC INDUSTRIAL DIV. 71
39	BELL TECHNOLOGIES 348, 349	110	DISKETTE CONNECTION 433	179	LINTEK COMP. ACCESSORIES 446	246	PANASONIC INDUSTRIAL DIV. 72, 73
407	BEST COMPUTER SUPPLIES 439	111	DISKS PLUS 342	184	LOGICAL DEVICES 404, 405	247	PARA SYSTEMS 51
408	BEST COMPUTER SUPPLIES 439	112	DISPLAY TELECOMMUNCTNS 258	185	LOGICAL DEVICES 404, 405	249	PATHFINDER SOFTWARE INC. 434
	* BEST WESTERN INT'L 64	113	DIVERSIFIED COMPUTER SYS. 436	400	LOGICSOFT 224A-F	250	PATTON & PATTON 420
42	BIT SOFTWARE 184	114	DOKAY COMP. PROD. INC. 421	187	LOGITECH INC. 243	251	PC AMERICAN MARKETING INC. 432
43	BIT SOFTWARE 340	115	DRESSELHAUS COMP. PROD. 316	188	LOGITECH INC. 245	74	PC INNOVATIONS 59
44	BITTNER ELECTRONICS 420	396	EASTMAN KODAK 211	189	LONE STAR SOFTWARE INC. 418		* PC NETWORK 192A-F
46	BLAISE COMPUTING INC. 291	116	ECHELON 116		* LOTUS DEVELOPMENT 14, 15	252	PC SIG 20
47	BLAISE COMPUTING INC. 291	117	ECOSOFT 206		* LOTUS DEVELOPMENT 252, 253	253	PC TECH 338
48	BONDWELL HOLDING LTD. C.II	118	ELEXOR INC. 434	190	LUCKY COMPUTERS 376		* PC'S LIMITED 384A-B
50	BORLAND INT'L C.II, 1	119	ELLIS COMPUTING INC. 203	191	LYBEN COMP. SYS. 316	255	PECAN SOFTWARE SYS. INC. 18
51	BORLAND INT'L C.II, 1	120	EVEREX SYSTEMS 174, 175	192	LYCO COMPUTER 183		PERCON 420
53	BP MICROSYSTEMS 433	121	EVEREX SYSTEMS 174, 175	194	M-S CORPORATION 424	257	PERSOFT INC. 8
54	BROWN BAG SOFTWARE 397	122	EVSPAN 433	195	MAGITRONIC TECHNOLOGY INC. 69	258	PERSOFT INC. 31
56	BUSINESS TOOLS INC. 213		* EXPOCONSUL INTERNATIONAL 259	196	MANX SOFTWARE SYS. 99	259	PERSONAL TEX INC. 326
	* BUYER'S MART SECTION 407-414	123	FACIT AB 309	197	MANX SOFTWARE SYS. 227	389	PINECOM 438
	* BYTE BACK ISSUES 315	128	FLAGSTAFF ENGINEERING 306	198	MARK WILLIAMS CO. 35		* POLYTEL COMPPROD.CORP. 168
404	BYTE BITS 226, 446	127	FLAGSTAFF ENGINEERING 306	199	MARK WILLIAMS CO. 37		* PRENTICE-HALL BOOK CLUBS 321
450	BYTE CONNECTION, THE 415	393	FOCUS ELECTRONICS 366		* MASTERCARD INT'L. INC. 194		* PRENTICE-HALL BOOK CLUBS 369
	* BYTE INFO. EXCHANGE (BIX) 372	131	FORTRON CORPORATION 417		* MAXELL DATA PRODUCTS 7	263	PRINCETON GRAPHIC SYS. 93
	* BYTE SUB. MESSAGE 299	132	FORTRON CORPORATION 417	96	MAXTECH 436	264	PRINCETON GRAPHIC SYS. 355
	* BYTE SUB. SERVICE 160	133	FOX SOFTWARE INC. 22		* MCGRAW-HILL NRI 401	265	PROGRAMMER'S SHOP 313
58	BYTEK CORPORATION 288	131	FRANK HOGG LABORATORY 446	200	MCGRAW-HILL SOFTWARE 54	266	PROGRAMMING LOGIC SYS. INC. 181
	* C WARE/DESMET C 336	397	GENERAL DATA COMM. 399	201	MCGRAW-HILL SOFTWARE 398	267	PROSOFT 43
	* CALIFORNIA DIGITAL 444, 445					268	PROTEC MICRO SYSTEMS 434
59	CANON U.S.A. 123					269	PUBLIC DOMAIN SFTCOPYING 430
60	CAPITAL EQUIPMENT CORP. 155					270	PURPLE COMPUTING 436
61	CAUZIN SYSTEMS 104					271	OIC RESEARCH 199
63	CHALCEDONY SOFTWARE 68					272	OUA TECH INC. 419
64	CHALCEDONY SOFTWARE 68					273	OUA TECH INC. 419
65	CITIZEN AMERICA 164					274	OUA TECH INC. 419
	* CLEO SOFTWARE 254					275	OUA TECH INC. 419
						276	OUA TECH INC. 419

TO GET FURTHER information on the products advertised in BYTE, either pick up your touch-tone telephone and use TIPS (if you are a subscriber), or fill out the reader service card. Either way full instructions are provided following this reader service index which is provided as an additional service by the publisher, who assumes no liability for errors or omissions. *Correspond directly with company.

BYTE READER SERVICE



NOVEMBER
46BRNX

Fill out this coupon carefully. PLEASE PRINT. Requests cannot be honored unless the zip code is included. This card is valid for 6 months from cover date.

I am requesting information for: Business Personal Both
I purchased this copy by Subscription

Name _____ (Company) _____
(Title) _____ (Company) _____
Address _____ Telephone _____
City _____ State _____ Zip _____

Newsstand, computer store, bookstore Country _____

1 23 45 67 89	111 133 155 177 199	221 243 265 287 309	331 353 375 397 419	441 463 485 507 529	551 573 595 617 639	661 683 705 727 749	771 793
2 24 46 68 90	112 134 156 178 200	222 244 266 288 310	332 354 376 398 420	442 464 486 508 530	552 574 596 618 640	662 684 706 728 750	772 794
3 25 47 69 91	113 135 157 179 201	223 245 267 289 311	333 355 377 399 421	443 465 487 509 531	553 575 597 619 641	663 685 707 729 751	773 795
4 26 48 70 92	114 136 158 180 202	224 246 268 290 312	334 356 378 400 422	444 466 488 510 532	554 576 598 620 642	664 686 708 730 752	774 796
5 27 49 71 93	115 137 159 181 203	225 247 269 291 313	335 357 379 401 423	445 467 489 511 533	555 577 599 621 643	665 687 709 731 753	775 797
6 28 50 72 94	116 138 160 182 204	226 248 270 292 314	336 358 380 402 424	446 468 490 512 534	556 578 600 622 644	666 688 710 732 754	776 798
7 29 51 73 95	117 139 161 183 205	227 249 271 293 315	337 359 381 403 425	447 469 491 513 535	557 579 601 623 645	667 689 711 733 755	777 799
8 30 52 74 96	118 140 162 184 206	228 250 272 294 316	338 360 382 404 426	448 470 492 514 536	558 580 602 624 646	668 690 712 734 756	778 800
9 31 53 75 97	119 141 163 185 207	229 251 273 295 317	339 361 383 405 427	449 471 493 515 537	559 581 603 625 647	669 691 713 735 757	779 801
10 32 54 76 98	120 142 164 186 208	230 252 274 296 318	340 362 384 406 428	450 472 494 516 538	560 582 604 626 648	670 692 714 736 758	780 802
11 33 55 77 99	121 143 165 187 209	231 253 275 297 319	341 363 385 407 429	451 473 495 517 539	561 583 605 627 649	671 693 715 737 759	781 803
12 34 56 78 100	122 144 166 188 210	232 254 276 298 320	342 364 386 408 430	452 474 496 518 540	562 584 606 628 650	672 694 716 738 760	782 804
13 35 57 79 101	123 145 167 189 211	233 255 277 299 321	343 365 387 409 431	453 475 497 519 541	563 585 607 629 651	673 695 717 739 761	783 805
14 36 58 80 102	124 146 168 190 212	234 256 278 300 322	344 366 388 410 432	454 476 498 520 542	564 586 608 630 652	674 696 718 740 762	784 806
15 37 59 81 103	125 147 169 191 213	235 257 279 301 323	345 367 389 411 433	455 477 499 521 543	565 587 609 631 653	675 697 719 741 763	785 807
16 38 60 82 104	126 148 170 192 214	236 258 280 302 324	346 368 390 412 434	456 478 500 522 544	566 588 610 632 654	676 698 720 742 764	786 808
17 39 61 83 105	127 149 171 193 215	237 259 281 303 325	347 369 391 413 435	457 479 501 523 545	567 589 611 633 655	677 699 721 743 765	787 809
18 40 62 84 106	128 150 172 194 216	238 260 282 304 326	348 370 392 414 436	458 480 502 524 546	568 590 612 634 656	678 700 722 744 766	788 810
19 41 63 85 107	129 151 173 195 217	239 261 283 305 327	349 371 393 415 437	459 481 503 525 547	569 591 613 635 657	679 701 723 745 767	789 811
20 42 64 86 108	130 152 174 196 218	240 262 284 306 328	350 372 394 416 438	460 482 504 526 548	570 592 614 636 658	680 702 724 746 768	790 812
21 43 65 87 109	131 153 175 197 219	241 263 285 307 329	351 373 395 417 439	461 483 505 527 549	571 593 615 637 659	681 703 725 747 769	791 813
22 44 66 88 110	132 154 176 198 220	242 264 286 308 330	352 374 396 418 440	462 484 506 528 550	572 594 616 638 660	682 704 726 748 770	792 814

BYTE's BOMB is your direct line to the editor's desk. Each month, the two top-rated authors receive bonuses based on your evaluation. First look at the list of this month's articles and corresponding article numbers (located on the page preceding the Reader Service list), then rate each article you've read as Excellent, Good, Fair, or Poor, based on your overall impression of the article, by circling the appropriate number in each column below. Your feedback helps us produce the best possible magazine each month.

Article No.	1	2	3	4	5	6	7	8	9	10	11	12	13	14	15	16	17	18	19	20	21	22	23	24	25
Excellent	1	5	9	13	17	21	25	29	33	37	41	45	49	53	57	61	65	69	73	77	81	85	89	93	97
Good	2	6	10	14	18	22	26	30	34	38	42	46	50	54	58	62	66	70	74	78	82	86	90	94	98
Fair	3	7	11	15	19	23	27	31	35	39	43	47	51	55	59	63	67	71	75	79	83	87	91	95	99
Poor	4	8	12	16	20	24	28	32	36	40	44	48	52	56	60	64	68	72	76	80	84	88	92	96	100

Article No.	26	27	28	29	30	31	32	33	34	35	36	37	38	39	40	41	42	43	44	45	46	47	48	49	50
Excellent	101	105	109	113	117	121	125	129	133	137	141	145	149	153	157	161	165	169	173	177	181	185	189	193	197
Good	102	106	110	114	118	122	126	130	134	138	142	146	150	154	158	162	166	170	174	178	182	186	190	194	198
Fair	103	107	111	115	119	123	127	131	135	139	143	147	151	155	159	163	167	171	175	179	183	187	191	195	199
Poor	104	108	112	116	120	124	128	132	136	140	144	148	152	156	160	164	168	172	176	180	184	188	192	196	200

BYTE READER SERVICE



NOVEMBER
46BRNX

Fill out this coupon carefully. PLEASE PRINT. Requests cannot be honored unless the zip code is included. This card is valid for 6 months from cover date.

I am requesting information for: Business Personal Both
I purchased this copy by Subscription

Name _____ (Company) _____
(Title) _____ (Company) _____
Address _____ Telephone _____
City _____ State _____ Zip _____
Country _____

Newsstand, computer store, bookstore

1 23 45 67 89	111 133 155 177 199	221 243 265 287 309	331 353 375 397 419	441 463 485 507 529	551 573 595 617 639	661 683 705 727 749	771 793
2 24 46 68 90	112 134 156 178 200	222 244 266 288 310	332 354 376 398 420	442 464 486 508 530	552 574 596 618 640	662 684 706 728 750	772 794
3 25 47 69 91	113 135 157 179 201	223 245 267 289 311	333 355 377 399 421	443 465 487 509 531	553 575 597 619 641	663 685 707 729 751	773 795
4 26 48 70 92	114 136 158 180 202	224 246 268 290 312	334 356 378 400 422	444 466 488 510 532	554 576 598 620 642	664 686 708 730 752	774 796
5 27 49 71 93	115 137 159 181 203	225 247 269 291 313	335 357 379 401 423	445 467 489 511 533	555 577 599 621 643	665 687 709 731 753	775 797
6 28 50 72 94	116 138 160 182 204	226 248 270 292 314	336 358 380 402 424	446 468 490 512 534	556 578 600 622 644	666 688 710 732 754	776 798
7 29 51 73 95	117 139 161 183 205	227 249 271 293 315	337 359 381 403 425	447 469 491 513 535	557 579 601 623 645	667 689 711 733 755	777 799
8 30 52 74 96	118 140 162 184 206	228 250 272 294 316	338 360 382 404 426	448 470 492 514 536	558 580 602 624 646	668 690 712 734 756	778 800
9 31 53 75 97	119 141 163 185 207	229 251 273 295 317	339 361 383 405 427	449 471 493 515 537	559 581 603 625 647	669 691 713 735 757	779 801
10 32 54 76 98	120 142 164 186 208	230 252 274 296 318	340 362 384 406 428	450 472 494 516 538	560 582 604 626 648	670 692 714 736 758	780 802
11 33 55 77 99	121 143 165 187 209	231 253 275 297 319	341 363 385 407 429	451 473 495 517 539	561 583 605 627 649	671 693 715 737 759	781 803
12 34 56 78 100	122 144 166 188 210	232 254 276 298 320	342 364 386 408 430	452 474 496 518 540	562 584 606 628 650	672 694 716 738 760	782 804
13 35 57 79 101	123 145 167 189 211	233 255 277 299 321	343 365 387 409 431	453 475 497 519 541	563 585 607 629 651	673 695 717 739 761	783 805
14 36 58 80 102	124 146 168 190 212	234 256 278 300 322	344 366 388 410 432	454 476 498 520 542	564 586 608 630 652	674 696 718 740 762	784 806
15 37 59 81 103	125 147 169 191 213	235 257 279 301 323	345 367 389 411 433	455 477 499 521 543	565 587 609 631 653	675 697 719 741 763	785 807
16 38 60 82 104	126 148 170 192 214	236 258 280 302 324	346 368 390 412 434	456 478 500 522 544	566 588 610 632 654	676 698 720 742 764	786 808
17 39 61 83 105	127 149 171 193 215	237 259 281 303 325	347 369 391 413 435	457 479 501 523 545	567 589 611 633 655	677 699 721 743 765	787 809
18 40 62 84 106	128 150 172 194 216	238 260 282 304 326	348 370 392 414 436	458 480 502 524 546	568 590 612 634 656	678 700 722 744 766	788 810
19 41 63 85 107	129 151 173 195 217	239 261 283 305 327	349 371 393 415 437	459 481 503 525 547	569 591 613 635 657	679 701 723 745 767	789 811
20 42 64 86 108	130 152 174 196 218	240 262 284 306 328	350 372 394 416 438	460 482 504 526 548	570 592 614 636 658	680 702 724 746 768	790 812
21 43 65 87 109	131 153 175 197 219	241 263 285 307 329	351 373 395 417 439	461 483 505 527 549	571 593 615 637 659	681 703 725 747 769	791 813
22 44 66 88 110	132 154 176 198 220	242 264 286 308 330	352 374 396 418 440	462 484 506 528 550	572 594 616 638 660	682 704 726 748 770	792 814

To get further information on the products advertised in BYTE, fill out the reader service card with your name and address. Then circle the appropriate numbers for the advertisers you select from the list. Add a first-class stamp to the card, then drop it in the mail. Not only do you gain information, but our advertisers are encouraged to use the marketplace provided by BYTE. This helps us bring you a bigger BYTE. The index is provided as an additional service by the publisher, who assumes no liability for errors or omissions.

PLACE
POSTAGE
HERE

BYTE

READER SERVICE
PO BOX 298
DALTON, MA 01227-0298
USA

PLACE
POSTAGE
HERE

BYTE

READER SERVICE
PO BOX 298
DALTON, MA 01227-0298
USA

Make a career move!

Get your own copy of BYTE!

Sharing is nice but not practical when you have to stay on the leading edge of microcomputer technology. From each BYTE issue theme to "MICROBYTES" and "Best of BIX", no other magazine—or group of magazines—can deliver you the vital technical information packaged in one issue of BYTE.

Don't rely on others for BYTE information—waiting on-line can be hazardous to your job. Make a career move! Have BYTE delivered to your door in your name. Use one of the adjacent cards to ensure your position in microcomputer technology.



For direct ordering call toll free weekdays 8:30am-4:30pm E.S.T.: 800-258-5485 (603-924-9281 for New Hampshire residents).

Welcome to BYTE Country!

For your own subscription to complete this card and mail.

BYTE, 

46BRNX

Name _____

Address _____

City _____

State _____ Zip _____ Country _____

- Bill me (U.S.A., Canada, Mexico only)
 Check enclosed (All checks must be payable in U.S. funds drawn on a U.S. bank.)

Charge to my MasterCard VISA

Card # _____ Expiration Date _____

Signature _____

Subscription Rates

	USA	Canada /Mexico
ONE YEAR:	<input type="checkbox"/> \$21 <input type="checkbox"/> \$23	
TWO YEARS:	<input type="checkbox"/> \$38 <input type="checkbox"/> \$42	
THREE YEARS:	<input type="checkbox"/> \$55 <input type="checkbox"/> \$61	

\$69 Europe (1 year-air delivery)
\$37 Europe and worldwide (1 year-surface mail)
 Air mail rates outside Europe available upon request.

Please allow 6-8 weeks for processing. Thank you.



BUSINESS REPLY MAIL

FIRST CLASS MAIL PERMIT NO. 39 MARTINSVILLE, NJ

POSTAGE WILL BE PAID BY ADDRESSEE

BYTE Subscriptions

PO Box 597
 Martinsville, NJ 08836-9956
 USA

NO POSTAGE NECESSARY IF MAILED IN THE UNITED STATES

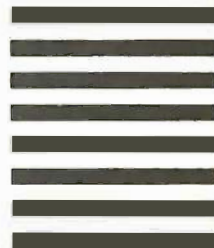

For your own subscription to complete this card and mail.

BYTE, 

46BRNX

Name _____

Address _____

City _____

State _____ Zip _____ Country _____

- Bill me (U.S.A., Canada, Mexico only)
 Check enclosed (All checks must be payable in U.S. funds drawn on a U.S. bank.)

Charge to my MasterCard VISA

Card # _____ Expiration Date _____

Signature _____

Subscription Rates

	USA	Canada /Mexico
ONE YEAR:	<input type="checkbox"/> \$21 <input type="checkbox"/> \$23	
TWO YEARS:	<input type="checkbox"/> \$38 <input type="checkbox"/> \$42	
THREE YEARS:	<input type="checkbox"/> \$55 <input type="checkbox"/> \$61	

\$69 Europe (1 year-air delivery)
\$37 Europe and worldwide (1 year-surface mail)
 Air mail rates outside Europe available upon request.

Please allow 6-8 weeks for processing. Thank you.



NO POSTAGE
NECESSARY
IF MAILED
IN THE
UNITED STATES

BUSINESS REPLY MAIL
FIRST CLASS MAIL PERMIT NO. 39 MARTINSVILLE, NJ

POSTAGE WILL BE PAID BY ADDRESSEE

BYTE Subscriptions
PO Box 597
Martinsville, NJ 08836-9956
USA



Make a career move!

Get your *own* copy of BYTE!

Sharing is nice but not practical when you have to stay on the leading edge of microcomputer technology. From each BYTE issue theme to "MICROBYTES" and "Best of BIX", no other magazine—or group of magazines—can deliver you the vital technical information packaged in one issue of BYTE.

Don't rely on others for BYTE information—waiting on-line can be hazardous to your job. Make a career move! Have BYTE delivered to *your* door in *your* name. Use one of the adjacent cards to ensure your position in microcomputer technology.



For direct ordering call toll free weekdays 8:30am-4:30pm E.S.T.: 800-258-5485 (603-924-9281 for New Hampshire residents).

Welcome to BYTE Country!

For your own subscription to **BYTE**, complete this card and mail.

46BRNX

Name _____
Address _____
City _____
State _____ Zip _____ Country _____
 Bill me (U.S.A., Canada, Mexico only)
 Check enclosed (All checks must be payable in U.S. funds drawn on a U.S. bank.)
Charge to my MasterCard VISA
Card # _____ Expiration Date _____
Signature _____

Subscription Rates

	USA	Canada /Mexico
ONE YEAR:	<input type="checkbox"/> \$21	<input type="checkbox"/> \$23
TWO YEARS:	<input type="checkbox"/> \$38	<input type="checkbox"/> \$42
THREE YEARS:	<input type="checkbox"/> \$55	<input type="checkbox"/> \$61

\$69 Europe (1 year-air delivery)
\$37 Europe and worldwide (1 year-surface mail)
Air mail rates outside Europe available upon request.

Please allow 6-8 weeks for processing. Thank you.



NO POSTAGE
NECESSARY
IF MAILED
IN THE
UNITED STATES

BUSINESS REPLY MAIL
FIRST CLASS MAIL PERMIT NO. 39 MARTINSVILLE, NJ

POSTAGE WILL BE PAID BY ADDRESSEE

BYTE Subscriptions
PO Box 597
Martinsville, NJ 08836-9956
USA

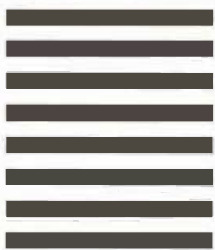



NEC'S PINWRITER P5XL HAS MADE BLACK A PRIMARY COLOR.

Our Pinwriter® P5XL printer has changed forever the way people look at dot matrix printing.

It's the first 24-pin dot matrix printer to use a letter-quality multistrike film ribbon—the same ribbon used in typewriters and letter-quality printers, such as our Spinwriter®. So for the first time in computer history there is a printer that honestly does everything. A printer that produces important letters and documents with crisp, black, true letter-quality printing. But with all the speed and graphics capability dot matrix printers are known for.

Dear Mr. Black:

Actual line printed
with a Pinwriter P5XL printer.

Fast, black letter-quality printing will be the primary reason many people will buy a P5XL printer. But there are plenty of other good reasons. In fact, it's the most versatile printer ever created for personal computers.

It can use an optional ribbon to print seven other colors plus black. And it has the best graphics resolution of any impact printer you can buy, due in part to our advanced 24-pin printhead. Plus it can print more type faces automatically than any other dot matrix printer. And it's quiet and fast.

You can also expect a P5XL printer to turn out millions of characters before it will need service because it has the highest reliability rating in the industry. And there's a nationwide network of NEC Customer Service Centers to take care of maintenance.

Now, while the Pinwriter P5XL performs a little black magic, you won't have to go in the red to buy it.

The Pinwriter P5XL is the latest addition to the most advanced and extensive family of 24-pin printers available. See it at your dealer or for an information package that includes actual print samples, call 1-800-343-4418 (in MA 617-264-8635).

Or write: NEC Information Systems, Dept. 1610,
1414 Massachusetts Ave., Boxborough, MA 01719.

**NEC PRINTERS. THEY ONLY STOP
WHEN YOU WANT THEM TO.**

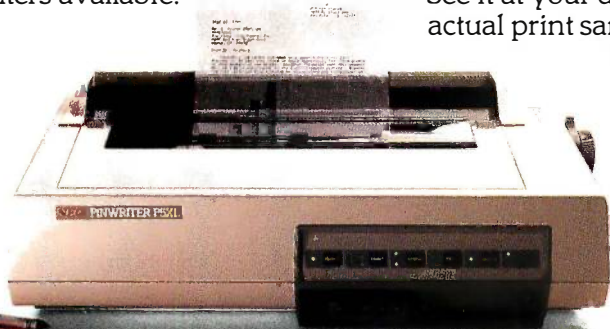

C&C Computers and Communications

The chevrons and serpentine designs are registered trademarks of Binney and Smith Inc., used with permission

NEC

NEC Information Systems, Inc.

Inquiry 233

TANDY... Better Again™

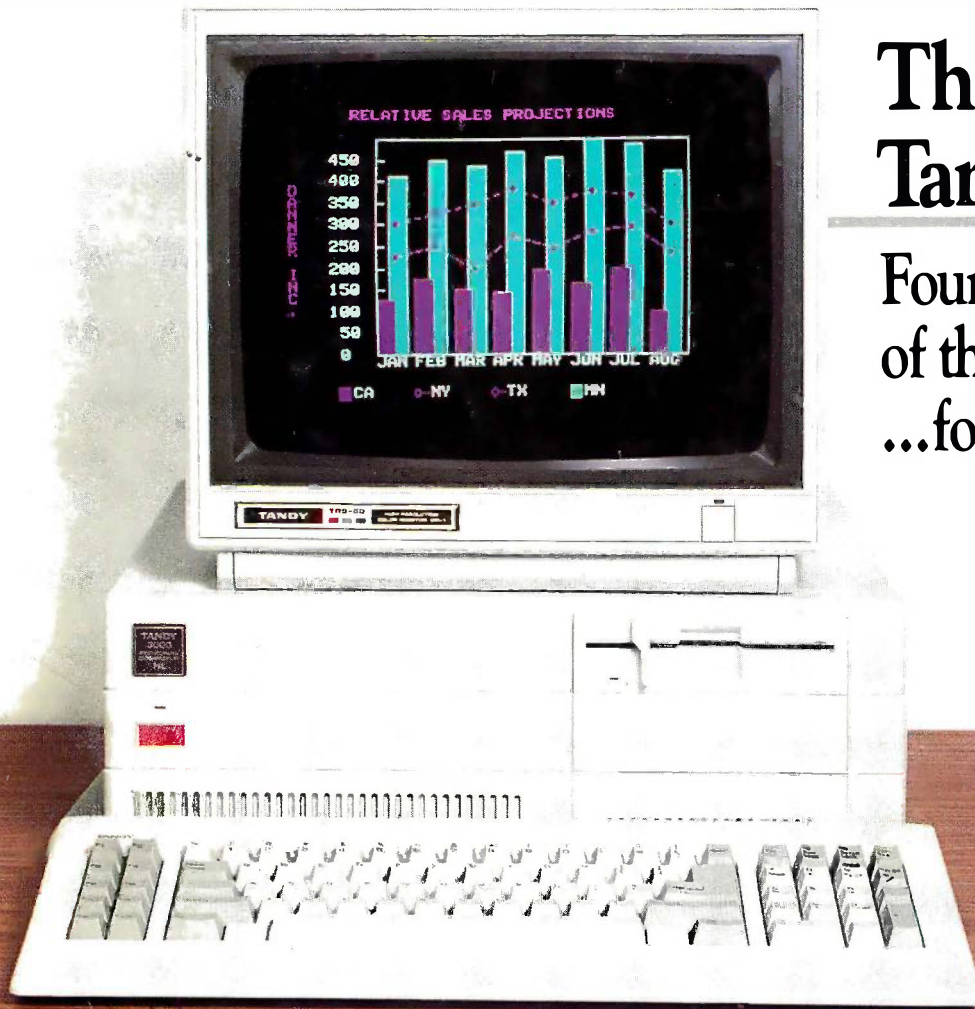

The New Tandy 3000 HL

Four times the power
of the IBM® PC/XT
...for less.

The Tandy 3000 HL isn't just compatible with IBM's PC/XT—it's better. Better because of its new 16-bit microprocessor that lets you process twice the data of IBM's older, 8-bit design. Better because it has nearly twice the clock speed of the PC/XT.

Better because you get more for less: only \$1699.

The Tandy 3000 HL's 512K RAM lets you run the software that you've grown accustomed to—at a much higher speed for greater efficiency. And you can expand with hard disk drives, modems, and more.

The high power and low price of the Tandy 3000 HL make it perfect for offices requiring several workstations. And the ViaNet local area network can bring your 3000 HLs together with your existing MS-DOS based computers. Users and departments can be more efficient.

Plus, the American-made Tandy 3000 HL is backed with total support, including our leasing, service and training plans.

Get the facts today, and you'll agree: the Tandy 3000 HL (25-4070) is your basic building block for total office automation.

Available at over 1200
Radio Shack Computer Centers and at
participating Radio Shack stores and dealers.

Radio Shack®
COMPUTER CENTERS

A DIVISION OF TANDY CORPORATION

Send me an RSC-17 Computer Catalog.

Mail To: Radio Shack, Dept. 87-A-369
300 One Tandy Center, Fort Worth, TX 76102

Name _____

Company _____

Address _____

City _____

State _____ ZIP _____

Phone _____

Price applies at Radio Shack Computer Centers and participating stores and dealers. Monitor sold separately. IBM/Registered TM International Business Machines Corp. MS-DOS / Registered TM Microsoft Corp. ViaNet/TM ViaNetix, Inc.