

# BYTE

THE SMALL SYSTEMS JOURNAL®

JUNE 1986 VOL. 11, NO. 6

\$3.50 IN UNITED STATES  
\$4.25 IN CANADA / £1.75 IN U.K.  
A MCGRAW-HILL PUBLICATION  
0360-5280

Computers  
and  
Music

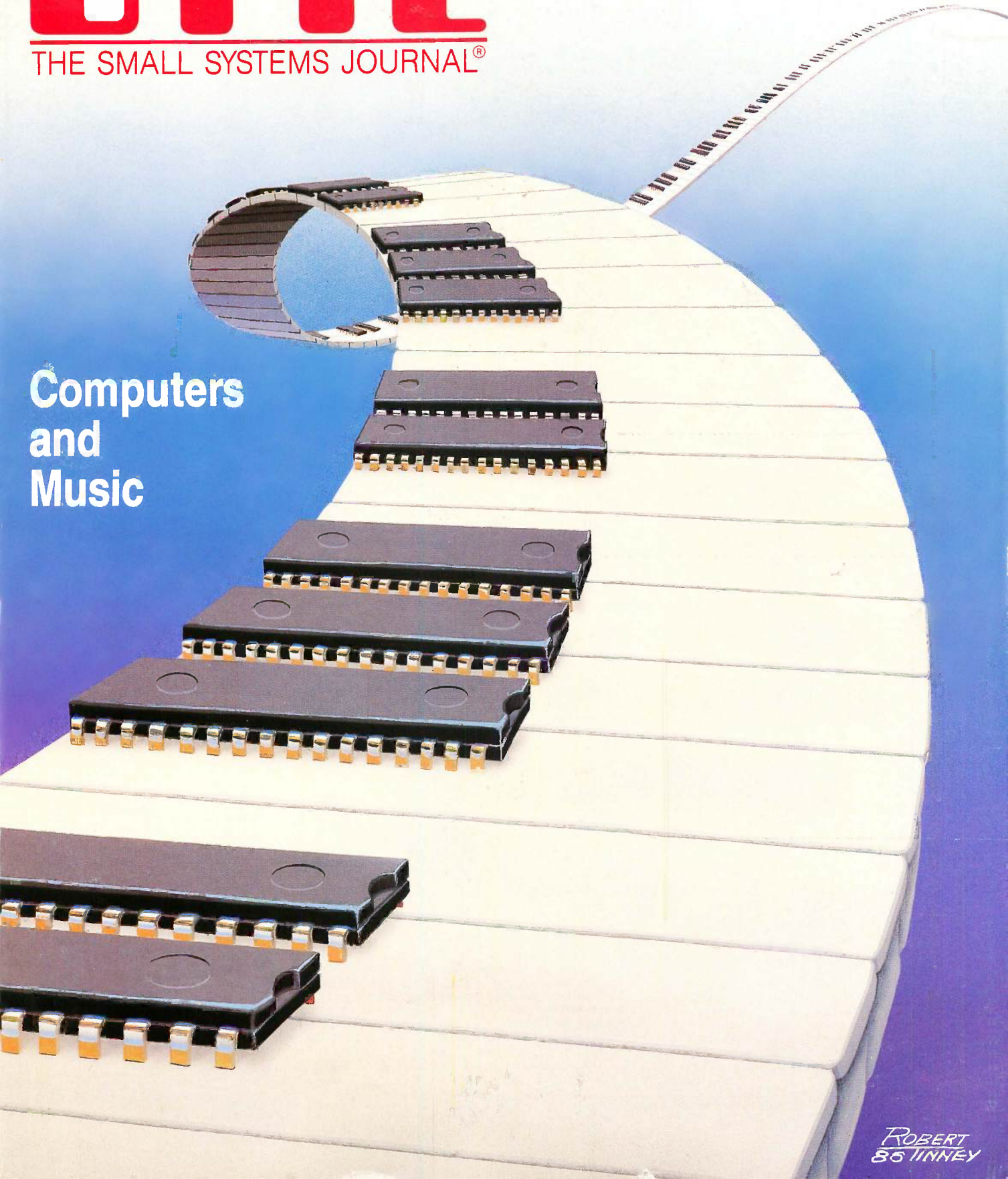

ROBERT  
85 TINNEY



# A single company has revolutionized the business of language, the language of business, and created the exciting new world of electronic reference works—Borland!

Which isn't bad for a 3-year-old Turbo Pascal,® our first product, now has more than half a million users, and has become a world-wide standard. And that was just the beginning.

Since then, the Turbo Pascal family has grown to a family of 9, and today we're announcing our *second language*, Turbo Prolog,™ the natural language of Artificial Intelligence.

We've also introduced amazing business productivity tools like SideKick,™ "Traveling SideKick," Reflex, The Analyst,™ and SuperKey.®

We broke new ground in 1985 with Turbo Lightning.™ It includes the Random House® dictionary and thesaurus. Turbo Lightning is the forerunner of a complete electronic reference library, newly joined by the Word Wizard,™ which solves the unsolvable twists, and boggles and challenges your mind. Word Wizard



also includes Turbo Pascal source code so you can figure out how the Turbo Lightning access system works.

And here is a brief synopsis of current offerings from the Borland library of history-making software . . .

## Turbo Pascal® 3.0

The fastest Pascal compiler, plus an integrated programming environment. Includes a free MicroCalc™ spreadsheet, and 1,200 lines of annotated source code, ready to compile and run. Minimum memory: 128K.

## Turbo Tutor®

Takes you from basic right through advanced programming concepts and techniques. Includes 300-page tutorial and source code for every example used in the reference manual. Minimum memory: 128K.

## Turbo Graphix Toolbox™

Lets you create high-resolution graphics. Includes tools for complex business graphics, easy windowing, and storing screen images to memory. Complete with source code on disk, ready to compile. Minimum memory: 192K.

## Turbo Database Toolbox™

Perfect complement to Turbo Pascal. Contains complete library of Pascal procedures that allows you to search and sort data and build powerful database applications. Minimum memory: 128K.

## Turbo Editor Toolbox™

It's all you need to build your own text editor or word processor. Provides all the routines—you decide which features you want. Source code included. Also includes the MicroStar™ text editor with pull-down menus and windowing. Interfaces directly with Turbo Lightning to let you spell-check your MicroStar files. Minimum memory: 192K.

## Turbo GameWorks™

Reveals the secrets and strategies of game theory. Includes source code so you can write your own games. Gives you *ready-to-play* Chess, Bridge, and Go-Moku, an ancient Japanese game that will provide hours of fascinating diversion. Even if you don't want to write your own games, it's a terrific value. Minimum memory: 192K.

NEW! NEW! NEW!



## Turbo Prolog™

The natural language of Artificial Intelligence, Turbo Prolog is our *second language* and the latest product in the

Borland software library. Turbo Prolog is a fifth-generation language, and probably the most powerful programming language ever conceived. Includes a 200-page reference manual and free GeoBase,™ a natural query language database with commented source code on disk, ready to compile. It's all you need to know about Artificial Intelligence at a Humanly Intelligent price. Minimum memory: 384K.



## Turbo Lightning™

An electronic reference library which includes the 80,000-word Random House Concise Dictionary and the 50,000-word Random House Thesaurus. Checks your spelling as you type. Gives you instant synonyms. Leads the revolutionary way in electronic publishing. Minimum memory: 256K.



## SuperKey®

Amazing keyboard enhancer for your IBM PC. With easy-to-write macros that can turn 1,000 keystrokes into 1.

Also includes powerful encryption technology that keeps confidential files confidential; locks your keyboard with secret password protection. (Because of encryption technology, SuperKey is under a US Government export ban.) Minimum memory: 128K.



NEW!

## Word Wizard™

Intriguing new addition to the Turbo Lightning Library.™ Solves unsolvable crosswords, and challenges your word skills and ability to break codes and ciphers. Scrambles, twists, turns, and boggles your mind. Includes Turbo Pascal source code and all the technical information you'll need to figure out the "nuts and bolts" of the Turbo Lightning access system. Minimum memory: 256K.



## SideKick®

Powerful desktop management program. #1 best-seller for the IBM® PC. Includes notepad, calculator, appointment scheduler, telephone directory and autodialer, and ASCII table. RAM-resident, it's always there to help, and stays in the background while you run other programs. One keystroke activates it. Minimum memory: 128K.



## Traveling SideKick™

BinderWare® that includes an organizer, a binder, a software program, and a report generator that picks your SideKick's electronic brain, then prints out your appointments, daily/weekly/monthly/yearly calendar, phone lists, mailing labels, or whatever else you need when you're away from your desk. It's the smart new way to take your computer with you without taking your computer with you. Minimum memory: 256K.



## Reflex, The Analyst™

Unique, easy-to-use database management and analysis. Shows your spreadsheet data from 1-2-3® dBase,® and others in five graphic forms—including bar charts, pie charts, scatter plots, line graphs, and stacked bar charts. Answers What If? questions. Minimum memory: 384K.

## Special Prices!

You can save even more—through September 1, 1986:

- Turbo Jumbo Pack—six Turbo products for only \$245.00. Turbo Pascal, Turbo Tutor, Turbo Graphix, Turbo Database Toolbox, Turbo Editor Toolbox, and Turbo GameWorks.
- SideKick and Traveling SideKick for only \$128.00.
- SideKick and Traveling SideKick and SuperKey, for only \$175.00.
- Turbo Lightning and Word Wizard for only \$149.95.



Step-by-step tutorial, demo programs with source code included!

# And now Borland introduces Turbo Prolog, the natural language of Artificial Intelligence.

**P**rolog is probably the most powerful computer programming language ever conceived, which is why we've made it our *second* language—and "turbocharged" it to create Turbo Prolog.™

Our new Turbo Prolog brings supercomputer power to your IBM® PC and introduces you step-by-step to the fascinating new world of Artificial Intelligence. And does all this for an astounding \$99.95.

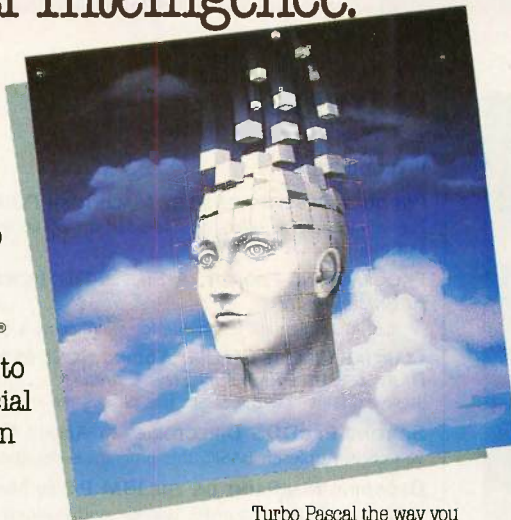

**Turbo Prolog is to Prolog what Turbo Pascal® is to Pascal!**

Our Turbo Pascal astonished everyone who thought of Pascal as "just another language." We changed all that—and now Turbo Pascal is the de facto worldwide standard, with hundreds of thousands of enthusiasts and users in universities, research centers, schools, and with professional programmers, students, and hobbyists.

You can expect at least the same impact from Turbo Prolog, because while Turbo Prolog is the most revolutionary and natural programming language, it is also a complete development environment—just like Turbo Pascal.

Turbo Prolog radically alters and dramatically improves the brave new world of artificial intelligence—and invites you into that fascinating universe for a humanly intelligent: \$99.95.

**Even if you've never programmed before, our free tutorial will get you started right away**

You'll get started right away because we have included a complete step-by-step tutorial as part of the 200-page Turbo Prolog Reference Manual. Our tutorial will take you by the hand and teach you everything you're likely to need to know about Turbo Prolog and artificial intelligence.

For example, once you've completed the tutorial, you'll be able to design your own expert systems utilizing Turbo Prolog's powerful problem-solving capabilities.

Think of Turbo Prolog as a high-speed electronic detective. First you feed it information and teach it rules. Then Turbo Prolog "thinks" the problem through and comes up with all the reasonable answers—almost instantly.

If you think that this is amazing, you just need to remember that Turbo Prolog is a 5th-generation language—and the kind of language that 21st century computers will use routinely. In fact, you can compare Turbo Prolog to

Turbo Pascal the way you could compare Turbo Pascal to machine language.

**You get the complete Turbo Prolog programming system for only \$99.95**

You get a complete Turbo Prolog development system including:

- The lightning-fast Turbo Prolog incremental compiler and the interactive Turbo Prolog editor.
- The 200-page reference manual which includes the step-by-step Turbo Prolog tutorial.
- The free GeoBase™ natural query language database including commented source code on disk—ready to compile. GeoBase is a complete database designed and developed around U.S. geography. It includes cities, mountains, rivers, and highways, and comes complete with natural query language. Use GeoBase immediately "as is," or modify it to fit your own interests.

So don't delay—don't waste a second—get Turbo Prolog now. \$99.95 is an amazingly small price to pay to become an immediate authority—an instant expert on artificial intelligence! The 21st century is only one phone call away.

**YES!**

I want the best

Turbo Prolog at only: **\$99.95**

To order by phone, or for a dealer nearest you, call (800) 255-8008 in CA call (800) 742-1133

Copies	Product	Price	Totals
—	Turbo Prolog†	\$99.95	\$
—	Turbo Pascal 3.0	\$69.95	\$
—	Turbo Pascal w/8087††	\$109.90	\$
—	Turbo Pascal w/BCD††	\$109.90	\$
—	Turbo Pascal w/8087, BCD††	\$124.95	\$
—	Turbo Database Toolbox	\$54.95	\$
—	Turbo Graphics Toolbox†	\$54.95	\$
—	Turbo Tutor	\$34.95	\$
—	Turbo Editor Toolbox†	\$69.95	\$
—	Turbo GameWorks†	\$69.95	\$
—	Turbo Lightning†	\$99.95	\$
—	Word Wizard†	\$69.95	\$
—	Rellex, The Analyst†	\$149.95	\$
—	SideKick†	\$84.95	\$
—	Traveling SideKick†	*\$69.95	\$
—	SuperKey†	\$69.95	\$
—	Turbo Lightning, Word Wizard†	*\$149.95	\$
—	SideKick, Traveling SideKick†	*\$125.00	\$
—	SideKick, SuperKey, Traveling SideKick†	*\$175.00	\$
—	Turbo Jumbo Pack†	*\$245.00	\$
—	Outside USA add \$10 per copy CA and MA res. add sales tax		\$
—	Amount enclosed		\$

Prices include shipping to all US cities; Carefully describe your computer system: Mine is:  8-bit  16-bit I use:  PC-DOS  MS-DOS  CP/M-80  CP/M-86 My computer's name and model is: \_\_\_\_\_

The disk size I use is:  3 1/2"  5 1/4"  8" Payment:  VISA  MC  Bank Draft  Check Credit card expiration date: \_\_\_\_/\_\_\_\_/\_\_\_\_

Card # \_\_\_\_\_

**NOT COPY PROTECTED AP15**  
**\*\*60-DAY MONEY-BACK GUARANTEE**

Name: \_\_\_\_\_

Shipping Address: \_\_\_\_\_

City: \_\_\_\_\_

State: \_\_\_\_\_ Zip: \_\_\_\_\_

Telephone: \_\_\_\_\_  
CODs and purchase orders WILL NOT be accepted by Borland. Outside USA make payment by credit card or International Postal Money Order.

\*Limited Time Offer until September 1, 1986

\*\*YES, it within 60 days of purchase this product does not perform in accordance with our claims, call our customer service department and we will gladly arrange a refund.

†IBM PC, AT, XT, PCjr, and true compatibles. PC-DOS (MS-DOS) 2.0 or later. Turbo Graphics requires IBM CGA Hercules Monochrome Card or compatible. ††16-bit only.

### Turbo Prolog 1.0 Technical Specifications Programming System Features

**Compiler:** Incremental compiler generating native in-line code and linkable object modules. The linking format is compatible with the PC-DOS linker. Large memory model support. Compiles over 2500 lines per minute on a standard IBM PC.

**Interactive Editor:** The system includes a powerful interactive full-screen text editor. If the compiler detects an error, the editor automatically positions the cursor appropriately in the source code. At run-time, Turbo Prolog programs can call the editor, and view the running program's source code.

**Type System:** A flexible object-oriented type system is supported.

**Windowing Support:** The system supports both graphic and text windows.

**Input/Output:** Full I/O facilities, including formatted I/O, streams, and random access files.

**Numeric Ranges:** Integers: -32767 to 32767; Reals: 1E-307 to 1E+308

**Debugging:** Complete built-in trace debugging capabilities allowing single stepping of programs.



4585 SCOTTS VALLEY DRIVE  
SCOTTS VALLEY, CA 95066  
(408) 438-8400 TELEX: 172373

Other Borland Products include Turbo Pascal, Turbo Turbo, Turbo Lightning, Turbo Database Toolbox, Turbo Graphics Toolbox, Turbo Editor Toolbox, Turbo GameWorks, SuperKey, SideKick, SideKick, The Macintosh Office Manager, Rellex, The Analyst, and Traveling SideKick—all of which are registered trademarks or trademarks of Borland International, Inc. or Borland/Analyst, Inc. Turbo Prolog and GeoBase are trademarks and Turbo Pascal is a registered trademark of Borland International, Inc. IBM and AT are registered trademarks of International Business Machines Corp. Copyright 1986 Borland International, Inc. BI-1042E

Inquiry 46 for End-Users. Inquiry 47 for DEALERS ONLY.





# C·O·N·T·E·N·T·S

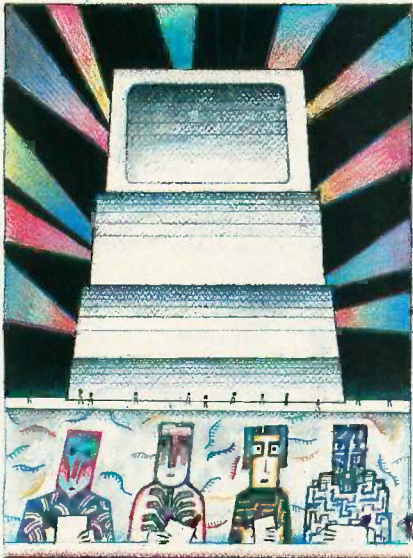

82



142

## FEATURES

<b>INTRODUCTION</b> .....	<b>82</b>
<b>PRODUCT DESCRIPTION: THE MACINTOSH PLUS</b> by Phillip Robinson .....	<b>85</b>
The enhanced Mac offers double-sided drives, an SCSI interface, a megabyte of RAM, and more.	
<b>PROGRAMMING PROJECT: A SIMPLE FILE-INDEXING SCHEME</b> by Bruce Webster .....	<b>92</b>
An easy-to-implement technique for maintaining a sorted file.	
<b>CIARCIA'S CIRCUIT CELLAR: ADDING SCSI TO THE SB180 COMPUTER, PART 2: BUS PHASES</b> by Steve Ciarcia .....	<b>107</b>
Steve explains how the SCSI's bus phases are managed by the NCR 5380 chip.	
<b>SORTING PRODOS DIRECTORIES</b> by Antonio C. Silvestri .....	<b>117</b>
Written in Applesoft BASIC, this program is designed to eliminate long catalog searches.	
<b>DECODING MACPAINT ON THE IBM PC</b> by Mark Anacker .....	<b>131</b>
A Pascal program to transfer, decode, and manipulate graphics.	
<b>PROGRAMMING INSIGHT: HILBERT CURVES MADE SIMPLE</b> by Michael Ackerman .....	<b>137</b>
Produce this elegant curve with a one-subroutine BASIC program.	

## THEME: COMPUTERS AND MUSIC

<b>INTRODUCTION</b> .....	<b>142</b>
<b>THE CHALLENGE OF MUSIC SOFTWARE</b> by Roger Powell .....	<b>145</b>
A professional musician describes the current status of computers in music.	
<b>DIGITAL MUSIC SYNTHESIS</b> by Robert A. Moog .....	<b>155</b>
An overview of the general attributes of musical sound and how to produce it.	
<b>DIGITAL SAMPLING ON THE APPLE MACINTOSH</b> by Christopher Yavelow .....	<b>171</b>
Some insight into digital synthesis and glimpses of available software.	
<b>MUSICAL FRACTALS</b> by Charles Dodge and Curtis R. Bahn .....	<b>185</b>
How to use fractal geometry to generate musical fractals.	
<b>A MIDI PROJECT</b> by Jay Kubicky .....	<b>199</b>
This MIDI interface with software for the IBM PC costs less than \$200.	
<b>MIDI PROGRAMMING</b> by Donald Swearingen .....	<b>211</b>
Turbo Pascal software tools for processing MIDI data stream information.	

## REVIEWS

<b>INTRODUCTION</b> .....	<b>228</b>
<b>REVIEWER'S NOTEBOOK</b> by Jon Edwards .....	<b>231</b>
<b>THE ATARI 520ST</b> by Eric Jensen .....	<b>233</b>
A good engine for bit-mapped graphics.	
<b>COMPAQ DESKPRO 286</b> by Stan Miastkowski .....	<b>243</b>
An IBM PC AT compatible with an 8-MHz switch.	
<b>TELE-286</b> by Wayne Rash Jr. ....	<b>251</b>
This IBM PC AT compatible from TeleVideo comes with a 44-megabyte hard disk drive.	

BYTE (ISSN 0360-5280) is published monthly with one extra issue per year by McGraw-Hill Inc. Founder: James H. McGraw (1860-1948). Executive, editorial, circulation, and advertising offices: One Phoenix Mill Lane, Peterborough, NH 03458, phone (603) 924-9281. Office hours: Mon-Thur 8:30 AM - 4:30 PM, Friday 8:30 AM - 1:00 PM, Eastern Time. Address subscriptions to BYTE Subscriptions, POB 590, Martinsville, NJ 08836. Postmaster: send address changes, USPS Form 3579, undeliverable copies, and fulfillment questions to BYTE Subscriptions, POB 596, Martinsville, NJ 08836. Second-class postage paid at Peterborough, NH 03458 and additional mailing offices. Postage paid at Winnipeg, Manitoba. Registration number 9321. Subscriptions are \$21 for one year, \$38 for two years, and \$55 for three years in the USA and its possessions. In Canada and Mexico, \$23 for one year, \$42 for two years, \$61 for three years. \$69 for one year air delivery to Europe, 17,100 yen for one year surface delivery to Japan. \$37 surface delivery elsewhere. Air delivery to selected areas at additional rates upon request. Single copy price is \$3.50 in the USA and its possessions, \$4.25 in Canada and Mexico, \$4.50 in Europe, and \$5 elsewhere. Foreign subscriptions and sales should be remitted in United States funds drawn on a US bank. Please allow six to eight weeks for delivery of first issue. Printed in the United States of America.



<b>Mix C</b> by Richard Grehan . . . . .	257
A full-featured C compiler with a very low price.	
<b>FOUR MIDI INTERFACES</b> by Roger Powell and Richard Grehan . . . . .	265
Available interfaces for the Commodore 64, IBM PC, Apple II, and Macintosh.	
<b>CONCERTWARE+ AND SONGPAINTER</b> by Mario Sergio Bernardo . . . . .	273
Two music programs for the Macintosh that have varying attributes.	
<b>THE KURZWEIL 250 DIGITAL SYNTHESIZER</b> by Christopher Morgan . . . . .	279
A system that offers sampling, sequencing, transposing, and more.	
<b>REVIEW FEEDBACK</b> . . . . .	289
Readers respond to previous reviews.	

## KERNEL

<b>INTRODUCTION</b> . . . . .	292
<b>COMPUTING AT CHAOS MANOR: COLOR AND CP/M</b> by Jerry Pournelle . . . . .	295
Jerry looks at the prospects for color and sees a future in CP/M.	
<b>BYTE U.K.: MODEM MYSTERIES REVEALED</b> by Dick Pountain . . . . .	319
Dick adds a WS3000 modem to his system.	
<b>APPLICATIONS ONLY: UPGRADE FEVER</b> by Ezra Shapiro . . . . .	329
Ezra talks about the latest versions of four familiar programs.	
<b>BYTE JAPAN: NEW TOOLS, NEW CHALLENGES</b> by William M. Raiké . . . . .	339
Bill gets used to two acquisitions: a modem and a C compiler.	
<b>ACCORDING TO WEBSTER: STORAGE FOR THE MASSES</b> by Bruce Webster . . . . .	347
Two mass storage devices get Bruce's attention.	

## BEST OF BIX

<b>AMIGA</b> . . . . .	367
<b>ATARI ST</b> . . . . .	372
<b>IBM PC AND COMPATIBLES</b> . . . . .	383
<b>MACINTOSH</b> . . . . .	387

<b>EDITORIAL:</b>	
MUSIC AND MIDI . . . . .	6
<b>MICROBYTES</b> . . . . .	9
<b>LETTERS</b> . . . . .	14
<b>WHAT'S NEW</b> . . . . .	29
<b>CLUBS AND NEWSLETTERS</b> . . . . .	48
<b>FIXES AND UPDATES</b> . . . . .	49
<b>ASK BYTE</b> . . . . .	50
<b>CIRCUIT CELLAR FEEDBACK</b> . . . . .	54
<b>BOOK REVIEWS</b> . . . . .	63
<b>EVENT QUEUE</b> . . . . .	78
<b>CHAOS MANOR MAIL</b> . . . . .	359
<b>DISKS AND DOWNLOADS</b> . . . . .	445
<b>BYTE'S ONGOING MONITOR BOX:</b>	
BOMB RESULTS . . . . .	446
<b>READER SERVICE</b> . . . . .	447

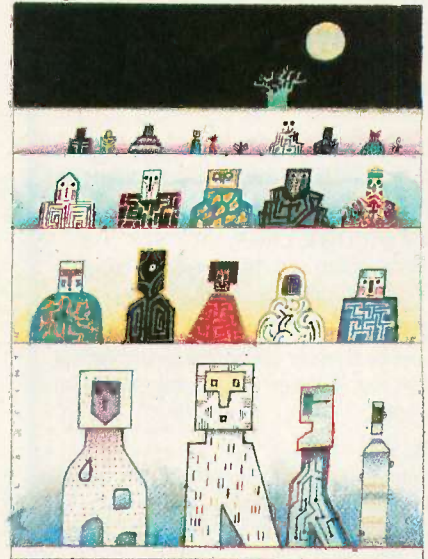

228



292

Address all editorial correspondence to the Editor, BYTE, POB 372, Hancock, NH 03449. Unacceptable manuscripts will be returned if accompanied by sufficient first-class postage. Not responsible for lost manuscripts or photos. Opinions expressed by the authors are not necessarily those of BYTE. Copyright © 1986 by McGraw-Hill Inc. All rights reserved. Trademark registered in the United States Patent and Trademark Office. Where necessary permission is granted by the copyright owner for libraries and others registered with the Copyright Clearance Center (CCC) to photocopy any article herein for the flat fee of \$1.50 per copy of the article or any part thereof. Correspondence and payment should be sent directly to the CCC, 29 Congress St., Salem, MA 01970. Specify ISSN 0360-5280/83 \$1.50. Copying done for other than personal or internal reference use without the permission of McGraw-Hill Inc. is prohibited. Requests for special permission or bulk orders should be addressed to the publisher, BYTE is available in microform from University Microfilms International, 300 North Zeeb Rd., Dept. PR, Ann Arbor, MI 48106 or 18 Bedford Row, Dept. PR, London WC1R 4EJ England.  Subscription questions or problems should be addressed to: BYTE Subscriber Service, POB 328, Hancock, NH 03449



# MetaComCo Languages

Atari ST • Amiga • QL

## LATTICE® C

The well known LATTICE® C compiler, full featured portable implementation.

## MCC PASCAL

An ISO/ANSI standard Pascal. A fast single pass compiler, ideal for commercial, educational and personal use.

## MCC ASSEMBLER

A professional standard macro assembler with many powerful features.

## CAMBRIDGE LISP

LISP interpreter/compiler providing a complete LISP development environment.

## BCPL

A powerful compiler offering the convenience of a high level language with the flexibility of an assembler.

## APL

Keyword and symbolic versions of this important language from MicroAPL.

## MCC BASIC

68000 BASIC interpreters and compilers from MetaComCo.

## MENU +

An easy to use program environment, with pull-down menus.

## TOOLKIT

Provides useful tools and utilities. From the people who wrote AmigaDOS.

Product	Atari ST	Commodore Amiga	Sinclair QL
Lattice C	\$149.95	*	\$129.95
Pascal	\$99.95	\$99.95	\$99.95
Assembler	\$79.95	*	\$49.95
Lisp	TBA	\$199.95	\$79.95
BCPL	TBA	TBA	\$79.95
APL	TBA	TBA	TBA
Basic	†	*	—
MENU +	\$29.95	TBA	—
TOOLKIT	TBA	\$49.95	—

\* = available from Commodore  
 † = available from Atari  
 QL Lisp includes interpreter only



**The Quality Source for 68000 Software**  
 5353 #E Scotts Valley Dr., Scotts Valley, CA 95066

Contact your local dealer or call:

Tel: US 800-AKA-META

Cal 800-GET-META, Eur (UK) 44-272-428781

Add 6.5% tax if CA resident.

Lattice: registered trademark of Lattice Inc.

Amiga and AmigaDOS: trademark of Commodore-Amiga Inc.,

Atari ST: registered trademark of Atari Inc.

Sinclair QL: trademark of Sinclair Research Ltd.

# BYTE

**EDITOR IN CHIEF**  
 PHILIP LEMMONS  
**MANAGING EDITOR, PRINT**  
 GENE SMARTE

**CONSULTING EDITORS**  
 STEVE CIARCIA  
 JERRY POURNELLE  
 BRUCE WEBSTER

**SENIOR TECHNICAL EDITORS**

G. MICHAEL VOSE, *Themes*

GREGG WILLIAMS

**TECHNICAL EDITORS**

DENNIS ALLEN

ION R. EDWARDS, *Reviews*

RICHARD GREHAN

GLENN HARTWIG

KEN SHELDON

GEORGE STEWART

JANE MORRILL TAZELAAR

TOM THOMPSON

CHARLES D. WESTON

EVA WHITE

STANLEY WZOLA

**ASSOCIATE TECHNICAL EDITORS**

MARGARET COOK GURNEY, *Book Reviews*

BRENDA McLAUGHLIN, *Applications Software Reviews, San Francisco*

**BYTE INFORMATION EXCHANGE**

GEORGE BOND, *Executive Editor*

DAVID BETZ, *Senior Editor*

TONY LOCKWOOD, *Associate Editor*

DONNA OSGOOD, *Associate Editor, San Francisco*

**NEWS AND TECHNOLOGY**

EZRA SHAPIRO, *Bureau Chief, San Francisco*

RICH MALLOY, *Senior Technical Editor, New York*

PHILLIP ROBINSON, *Senior Technical Editor, Palo Alto*

**ASSOCIATE NEWS EDITORS**

DENNIS BARKER, *Microbytes*

CATHRYN BASKIN, *What's New*

ANNE FISCHER LENT, *What's New*

**CONTRIBUTING EDITORS**

IONATHAN AMSTERDAM, *programming projects*

MARK DAHMKE, *video, operating systems*

MARK HAAS, *at large*

RIK JADRNIČEK, *CAD, graphics, spreadsheets*

ROBERT T. KUROSAKA, *mathematical recreations*

PHIL LOPICCOLO, *computers in medicine*

ALASTAIR J. W. MAYER, *software*

ALAN R. MILLER, *languages and engineering*

DICK POUNTAIN, *U.K.*

ROGER POWELL, *computers and music*

WILLIAM M. RAIKE, *Japan*

**COPY EDITORS**

BUD SADLER, *Chief*

FAITH HANSON

NANCY HAYES

CATHY KINGERY

PAULA NOONAN

IOAN VIGNEAU ROY

WARREN WILLIAMSON

**ASSISTANTS**

PEGGY DUNHAM, *Office Manager*

MARTHA HICKS

JUNE N. SHELDON

JUDY WINKLER

**ART**

ROSSLYN A. FRICK, *Art Director*

NANCY RICE, *Associate Art Director*

JAN MULLER, *Art Assistant*

ALAN EASTON, *Drafting*

**PRODUCTION**

DAVID R. ANDERSON, *Production Director*

DENISE CHARTRAND

MICHAEL I. LONSKY

VIRGINIA REARDON

**TYPOGRAPHY**

SHERRY MCCARTHY, *Chief Typographer*

LEN LORETTE

DONNA SWEENEY

**SENIOR VICE PRESIDENT/PUBLISHER**

HARRY L. BROWN

**PUBLISHER'S ASSISTANT**

BEVERLY JACKSON

**CIRCULATION (800-258-5485)**

ANDREW JACKSON, *Subscriptions Manager*

LAURIE SEAMANS, *Assistant Manager*

SUSAN BOYD

MARY EMERSON

LOUISE MENEGUS

AGNES E. PERRY

JENNIFER PRICE

JAMES BINGHAM, *Single-Copy Sales Manager*

CATHY A. RUTHERFORD, *Assistant Manager*

CLAUDETTE CARSWELL

KAREN DESROCHES

**ADVERTISING SALES**

DENNIS J. RILEY, *Director of Sales and Marketing*

SANDRA FOSTER, *Administrative Assistant*

**ADVERTISING/PRODUCTION 1603-924-6448**

LISA WOZMAK, *Supervisor*

ROBERT D. HANNINGS, *Senior Account Coordinator*

MARION CARLSON

KAREN CILLEY

LYDA CLARK

MICHELE JACKSON

WAI CHIU LI, *Quality Control Manager*

JULIE MURPHREE, *Advertising/Production Coordinator*

**MARKETING COMMUNICATIONS**

HORACE T. HOWLAND, *Director (603-924-3424)*

VICKI REYNOLDS, *Marketing Production Manager*

LISA JO STEINER, *Marketing Assistant*

STEPHANIE WARNECKY, *Marketing Art Director*

SHARON PRICE, *Assistant Art Director*

MICHELE P. VERVILLE, *Director of Public Relations (603-924-9027)*

WILBUR S. WATSON, *Operations Manager, Exhibits*

**RESEARCH**

PATRICIA AKERLEY, *Research Manager*

JULIE PERRON, *Market Research Analyst*

CYNTHIA DAMATO SANDS, *Reader Service Coordinator*

**FINANCIAL SERVICES**

PHILIP L. PENNY, *Director of Finance and Services*

KENNETH A. KING, *Business Manager*

CHRISTINE LEE, *Assistant*

VICKI WESTON, *Accounting Manager*

LINDA SHORT, *D/P Manager*

EDSON WARE, *Credit*

MARILYN HAIGH

DIANE HENRY

VERN ROCKWELL

JOANN WALTER

**PLANNING AND DEVELOPMENT**

MICHELE P. VERVILLE, *Manager*

FAITH KLUNTZ, *Copyrights Coordinator*

**PERSONNEL**

CHERYL HURD, *Office Manager*

PATRICIA BURKE, *Personnel Coordinator*

**BUILDING SERVICES/TRAFFIC**

ANTHONY BENNETT, *Building Services Manager*

BRIAN HIGGINS

MARK MONKTON

**RECEPTIONIST**

DONNA HEALEY



Officers of McGraw-Hill Information Systems Company: President, Richard B. Miller, Executive Vice Presidents: Frederick P. Jannott, Construction Information Group; Russell C. White, Computers and Communications Information Group; I. Thomas Ryan, Marketing and International, Senior Vice Presidents: Francis A. Shinal, Controller; Robert C. Violette, Manufacturing and Technology, Senior Vice Presidents and Publishers: Laurence Altman, Electronics Week; Harry L. Brown, BYTE; David J. McGrath, Construction Publications, Group Vice President; Peter B. McCuen, Communications Information, Vice President; Fred O. Jensen, Planning and Development.

Officers of McGraw-Hill, Inc.: Harold W. McGraw, Jr., Chairman; Joseph L. Dionne, President and Chief Executive Officer; Robert N. Landes, Executive Vice President and Secretary; Walter D. Serwatka, Executive Vice President and Chief Financial Officer; Shel F. Asen, Senior Vice President, Manufacturing; Robert J. Bahash, Senior Vice President, Finance and Manufacturing; Ralph R. Schulz, Senior Vice President, Editorial; George R. Elstinger, Vice President, Circulation; Ralph I. Webb, Vice President and Treasurer.

Editorial and Business Office: One Phoenix Mill Lane, Peterborough, New Hampshire 03458, (603) 924-9281

West Coast Offices: McGraw-Hill, 425 Battery St., San Francisco, CA 94111, (415) 362-6600

McGraw-Hill, 951 Mariner's Island Blvd., San Mateo, CA 94404, (415) 349-4100

New York Editorial Office: 1221 Avenue of the Americas, New York, NY 10020, (212) 512-2000

BYTE, BUTE, and The Small Systems Journal are registered trademarks of McGraw-Hill Inc.



# Circuit-Board-Artwork Software for the Design Engineer in a Hurry

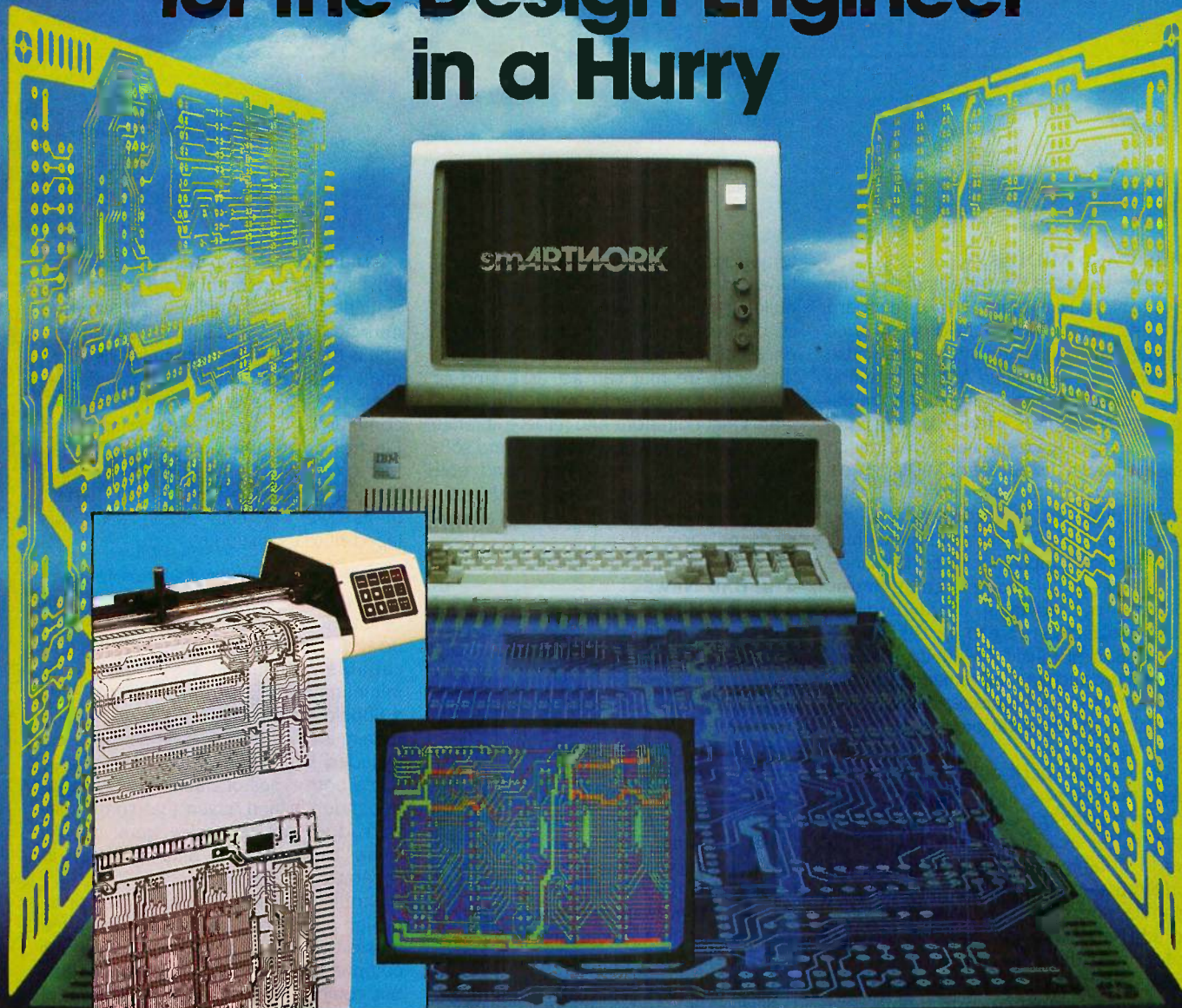

For only \$895, smARTWORK® lets the design engineer create and revise printed-circuit-board artwork on the IBM Personal Computer. You keep complete control over your circuit-board artwork — from start to finish.

Forget the tedium of taping it yourself or waiting for a technician, draftsman, or the CAD department to get to your project.

smARTWORK® is the only low-cost printed-circuit-board artwork editor with all these advantages:

- Complete interactive control over placement and routing
- Quick correction and revision
- Production-quality 2X artwork from a pen-and-ink plotter
- Prototype-quality 2X artwork from a dot-matrix printer

- Easy to learn and operate, yet capable of sophisticated layouts
- Single-sided and double-sided printed circuit boards up to 10 x 16 inches
- Multicolor or black-and-white display

#### System Requirements:

- IBM Personal Computer, XT, or AT with 256K RAM, 2 disk drives, and DOS Version 2.0 or later
- IBM Color/Graphics Adapter with RGB color or black-and-white monitor
- IBM Graphics Printer or Epson FX/MX/RX series dot-matrix printer
- Houston Instrument DMP-41 pen-and-ink plotter
- Optional Microsoft Mouse

#### The Smart Buy

At \$895, smARTWORK® is proven, convenient, fast, and a sound value. Call us today. And put it to work for yourself next week.



Wintek Corporation Inquiry 376  
1801 South Street  
Lafayette, IN 47904-2993  
Telephone: (317) 742-8428  
Telex: 70-9079 WINTEK CORP UD

In Europe contact: RIVA Terminals Limited,  
Woking, Surrey GU21 5JY ENGLAND,  
Telephone: 04862-71001, Telex: 859502

smARTWORK®, "Wintek" and the Wintek logo are registered trademarks of Wintek Corporation.



## **MUSIC AND MIDI**

Have you noticed the stir going on in the electronic music industry? Take keyboard synthesizers. A significant drop in price has been accompanied by a dramatic rise in capability and sound quality, opening the doors of musical exploration to multitudes of newcomers. We've also seen computer technology claim new territories in music through the advent of MIDI (musical instrument digital interface), a data-communications protocol that lets you join synthesizers and computers into small networks for composition or performance. MIDI has stimulated the entire music industry by providing a standard for hardware and software to be used for the production of music. Creativity, efficiency, and productivity are enhanced by the development of computer-based tools aimed at the mystical process of music generation.

The current specification for MIDI has been in existence for four years. It came about through the cooperation of music synthesizer manufacturers around the world, notably those from Japan and the United States. Essentially, a large group of manufacturers got together and decided to add serial data channels to all future electronic music instruments so that events generated on one instrument could be played on remote instruments connected via the MIDI cable. Layers of sound, for example, can be produced from a single keyboard controller by driving multiple sound modules equipped with MIDI inputs. By inserting a personal computer into the middle of all this sound-generating equipment, composers can record and manipulate scores much as word processors do text.

## **THE GOOD NEWS**

So we now have a data-communications standard for moving music event data between a computer and sound-generating hardware. We can buy instruments from different manufacturers and interconnect them at once. Older versions of music synthesizers, having no compatibility to any other device you might be using, were doomed to eventual obsolescence as newer products were released to replace them. Now it's different—what you get

tomorrow can be integrated with what you have today, and it's reasonable to consider building an elaborate system over a period of budget-controlled time. A variety of good MIDI software is now available. We find software that can act as a kind of digital tape recorder for music data; programs that edit, store, and retrieve libraries of synthesizer voice parameters; and software that can display, print, and edit scores rendered in traditional music notation. It's a heyday for musicians of all persuasions. Or is it?

## **THE BAD NEWS**

While the MIDI specification goes a long way toward unifying the tasks necessary to the production of music, it does not suggest any format for the storage of MIDI data files. Thus, developers of music software are on their own to adopt a structure for disk files containing MIDI performance data created by the software. And that is precisely what has happened during the development of today's MIDI music software: Each program on each computer produces a data file that cannot be instantly read by any other combination of hardware or software. Furthermore, few, if any, file-converter utilities are available to assist transportation of data between environments. (Of course, there is always the issue of differences among the underlying DOS formats for individual computers.)

## **A DATA FILE STANDARD**

Utility programs that convert music files from one manufacturer's product to another must be seen as only an interim measure. A better approach would see all the important players get together (in a fashion similar to the one that led to the MIDI 1.0 specification) and hack out a target format for file interchange. If software developers could produce a musical equivalent of the DIF standard used for database files in the business world, users operating in different computer and synthesizer environments would benefit immensely from expanded access to the large body of music data now being stockpiled. This tactic would also let existing products "speak" to future programs designed to use the target file format.

A number of obstacles present themselves when attempting to derive a convenient, universal method of organizing music data files. That's not to say that no one is trying. Besides continuing development on the academic level at universities like Carnegie-Mellon, Stanford, and MIT, commercial concerns like Roland and Electronic Arts have worked hard in an effort to establish useful guidelines toward the goal of increased music data sharing. In its own way, each organization has faced hurdles, including:

- Some computers have a lot more memory, speed, and display resolution than others. How can a file produced on a more powerful computer be rendered on a less capable machine? What should a minimum configuration consist of?
- Should graphic data for displaying common music notation or some derivative be included with MIDI performance data? Since both types of data might exist independently, and, given that some software does not recognize both, should these two kinds of data be kept in separate, parallel files?
- Should we go further and attempt to design a full-blown operating system for music that could be ported to various computer architectures? This is ambitious but could produce long-term benefits.

Naturally, other important points need to be ironed out. At this time, we invite software and hardware developers to plug in their irons. The success of the MIDI standard offers hope for a standard for file interchange. At the moment, the consumer is getting shortchanged by the inability to move data between music-processing programs. The audience for computer music software is growing larger and more sophisticated, and it's up to the leaders in music technology development to provide software standards. We at BYTE want to encourage all concerned to investigate the work already done and then have a series of formal conferences involving a variety of sources. It's not going to be easy, but it has to happen (and soon, too, because I have a lot of music data on IMSAI-8080 cassettes waiting to be up-loaded to my Amiga).

—Roger Powell, *Contributing Editor*





**maxell**<sup>®</sup>  
FLOPPY DISKS  
THE GOLD STANDARD



## Before you invest in a DEC\*VT240 terminal, consider the software alternative.

Stop and think about what you really need: A text terminal. Tektronix\* graphics. ReGIS\* graphics. File transfer capabilities. Communications.

Purchasing a state-of-the-art terminal may be one option, but Persoft has a smarter solution—**SmarTerm® 240**, the ultimate in terminal emulation software.

SmarTerm can do everything the state-of-the-art terminal can do—and more. That's why we call it **state-of-the-smart**.

With SmarTerm 240, the emulation is so exact you'll forget you're using a PC. It features superior text emulation, ReGIS graphics, Tektronix graphics, outstanding communications and file transfer capabilities.

You also get on-line help screens, remappable keyboard layouts and programmable softkeys which can simplify your most frequently performed tasks. You can even customize your own menus!

And because SmarTerm runs on your PC, you've always got a wealth of computing power right at your fingertips.

All SmarTerm products are backed by Persoft's strong technical support network. It's a service you expect from the industry leader in terminal emulation software.

No matter which terminal you're currently using—Data General Dasher\* D400, Tektronix 4010/4014, DEC VT100, VT125, VT220 or even the new VT240,



SmarTerm has a state-of-the-smart solution for you.

To find out more about the SmarTerm family of terminal emulation software, see your local dealer. Or contact: Persoft, Inc. 2740 Ski Lane Madison, WI 53713 (608) 273-6000 – Telex 759491

# STATE OF THE ART

# VS

# STATE OF THE SMART

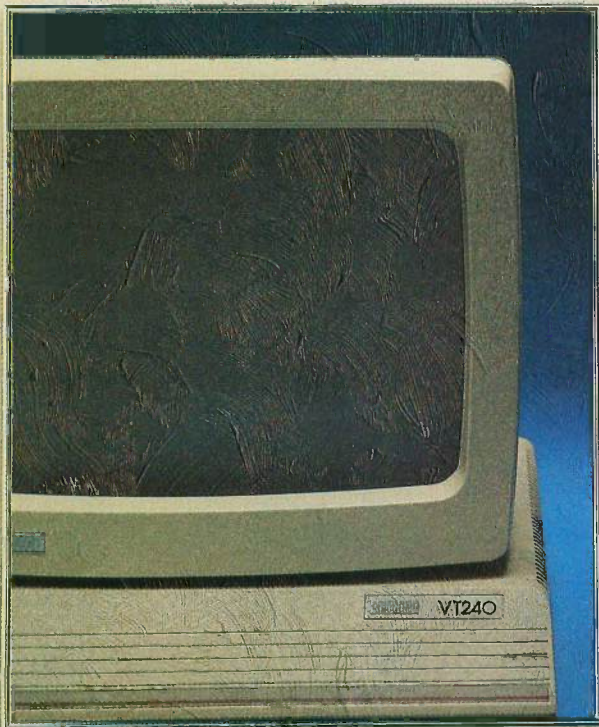

\*SmarTerm is a registered trademark of Persoft, Inc. \*DEC, VT and ReGIS, are trademarks of Digital Equipment Corp. \*DASHER is a registered trademark of Data General Corp. \*Tektronix is a registered trademark of Tektronix, Inc. © Persoft, Inc., 1986. All rights reserved.

# persoft

Inquiry 261



## **New Geometry Could Have Implications for Telecommunications**

---

Dr. Donald Kreher and Dr. Stanislaw Radziszowski, assistant professors at Rochester Institute of Technology's School of Computer Science and Technology, have discovered a non-Euclidean geometry that could enhance long-range satellite transmissions and telecommunications. The two professors used a new basis-reduction computer-search technique to find a simple 6-design, the smallest such design possible.

Researchers at the University of Nebraska discovered the first two 6-designs in 1984. According to Kreher, "We were able to find this third design because the computer-search technique that we created enabled us to search a larger space of possibilities than previously searched anywhere in the world." Kreher and Radziszowski solved complex 99-integer equations in 12 hours, a process that they estimate would take several million centuries of computer time if they used a "brute force" technique.

The new geometry could help in correcting transmission errors over long distances. According to Kreher and Radziszowski, scientists can use the geometry to construct code for error reduction. When errors are received, the geometry used to construct the code gets distorted. Distortion characteristics let the scientist find and correct the error.

## **"Teachable" Pattern-Recognition System on IBM PC AT**

---

Nestor Inc., a small research and development firm in Providence, RI, said it has successfully moved its prototype self-adaptive pattern-recognition system from a minicomputer to an IBM PC AT. The Nestor System, developed by two Brown University physicists interested in animal neuronal networks, is significant in that it must be taught, not programmed, to recognize new patterns. The system inherently makes use of parallel processing and distributed memory but currently emulates these capabilities on today's serial-processing computers. Interestingly, a spokesperson from Nestor claimed that the system runs just as fast on an AT as it did on an Apollo minicomputer, primarily because of the Apollo's graphics-processing overhead.

Nestor is currently investigating using a bit pad with its system to analyze free-form handwriting and is in negotiation to procure funding to develop a large-vocabulary voice-recognition system.

## **SIMMs: Denser Memories Through Packaging**

---

If you think that a circuit board jam-packed with 256K dynamic RAM chips is the ultimate in dense, solid-state memory, keep reading. The new generation of chip packages—leaded chip carriers (LCCs)—is making a splash in memory chips for microcomputers. Because these packages take up far less space than their predecessors, the venerable DIPs, computer designers can fit far more memory in the same space on a board. But the chip and system makers are going even further. They are mounting several LCCs on a long, narrow circuit card that has leads on one long side. That card, called a SIMM (single in-line memory module), can then be mounted vertically onto a standard circuit board.

The first well-known micro to use this form of memory is the Apple Macintosh Plus, which has a megabyte of RAM on four 256K-byte SIMMs. The SIMMs plug into special sockets and can be easily exchanged for 1-megabyte SIMMs to create a 4-megabyte Mac Plus.

One of the first semiconductor firms to announce SIMMs for the commercial market is NEC Electronics, Mountain View, CA. The NEC SIMMs come in five configurations: 256K by 4, by 5, by 8, or by 9 bits, and 1 megabyte by 1 bit. Both 120-ns and 150-ns access times are available. The SIMMs are standard epoxy-glass substrates with pins or edge connectors on one long side; they are based on 256K-bit dynamic RAMs in plastic LCCs.

*(continued)*



## Hannover Fair: Atari Shows PC Box, German Firm Announces Supercomputer

---

At the opening of the Hannover Fair in West Germany, Atari exhibited its IBM PC compatibility box for its 520ST and 1040ST computers. The box had its own 8088, a socket for an 8087, and 512K bytes of RAM. It connects to the ST via the DMA port. With the product's introduction at least several months away, Atari representatives wouldn't discuss pricing except to reaffirm the company's policy of producing in "high volume at low cost."

IP Systems, of Karlsruhe, West Germany, announced but did not show the TX2 series of supercomputers. The result of work done by researchers at Karlsruhe University, the parallel-configuration machine is based on the 80286 and has at least 16 chips. It can perform 10 million to 30 million instructions per second. The TX2 uses neither arrays nor vectors. Its parallel architecture is based on an extended tree structure. The machine represents a new type of parallelism that could apply to functions beyond the typical uses in floating-point math, for example, in the types of calculations used in expert systems, optimization, and other non-numeric tasks.

Toshiba exhibited three optical disk products it said will be available to consumers late this year. Toshiba also showed two plasma-screen laptop computers, the T2100 and the T3100, compatible with the IBM PC XT and AT, respectively. Ing. C. Olivetti also brought PC compatibles to the Fair. Sanyo showed for the first time its SPX-840 LED printer, said to rival laser printers in print quality and performance. The unit's method of printing involves electronic photography using an LED-array head and a selenium-tellurium photosensitive drum. Resolution is 400 dots per inch, and print speed is rated at 20 pages per minute.

A Norwegian company, Ask LCD, has come up with a flat-screen display for the IBM PC. At Hannover, it was suspended from a desk-mounted support arm. The unit measures 330 mm by 230 mm and is 25 mm thick. The screen surface is 250 mm by 160 mm.

Prospero Software, a British firm exhibiting at Hannover, announced a FORTRAN compiler for the Amiga and the Atari ST. Called Pro Fortran-77, it could help open up the 68000-based machines to technical and scientific applications.

## NANOBYTES

---

**Intel Corp.**, Santa Clara, CA, introduced the 80287-10, a 10-MHz version of its numeric coprocessor. The device operates at up to twice the speed of older versions. . . . In other Intel news, the company has enlisted the support of four software developers to provide compilers for its 80386 32-bit chip. **Silicon Valley Software**, Cupertino, CA, and **Green Hills Software**, Glendale, CA, said they will develop FORTRAN, C, and Pascal compilers for the 80386. **Ryan-McFarland**, Rolling Hills Estates, CA, said it's porting its standard FORTRAN and COBOL compilers to run on the chip. And **Language Processors**, Waltham, MA, announced it would develop COBOL, FORTRAN, C, Pascal, PL/I, RPG II, and BASIC compilers for the 80386. . . . **Apricot Computers**, Fremont, CA, said it will offer Microsoft's MS-DOS 4.0 as part of its XEN Multiuser System. . . . **NEC Electronics**, Mountain View, CA, and **Oki Semiconductor**, Sunnyvale, CA, have developed a CMOS version of NEC's  $\mu$ PD7720 Digital Signal Processor. The new chip, called the NEC  $\mu$ PD77C2 or the Oki M77C20, is a pin-for-pin replacement for the 7720 and draws only 24 mA, 80 percent less than its predecessor. . . . **PicTel Corp.**, Peabody, MA, has a desktop videophone system that transmits color video images over dial-up digital lines. PicTel said calls cost just twice that of ordinary phone calls, but the videophone setup costs \$150,000. . . . **SSI Software**, Orem, UT, unwrapped an operating shell for its WordPerfect and other SSI packages. WordPerfect Library is a RAM-resident program designed to enhance the performance of WordPerfect, MathPlan, and SSIData. . . . **Brown Wagh Publishing**, San Jose, CA, has released a word-processing program for the Amiga. Besides standard editing capabilities, Scribble provides four windows that can each hold a separate document. . . . **Personal Composer**, Honaunau, HI, has brought out version 2.0 of its Personal Composer music software. MIDI features include a 32-track recorder and a patch recorder. . . . Two United Kingdom companies have released products based on the Motorola 68020 32-bit CPU. **MicroAPL** of London launched a multiple-processor machine, the Aurora, that can handle as many as 64 users. Although it was designed to run the company's APL interpreter, it can be programmed in other languages. Another product using the VMEbus is the ET-68020 VME card from **Integrated Micro Products Ltd.**, County Durham. IMP said it has managed to make the 68020 run reliably at 25 MHz, at which speed it performs more than 10 MIPS in bursts. . . . **Apple Computer Inc.**, Cupertino, CA, is offering rebates to full-time teachers and college students who buy Apple hardware: \$75 on a IIc, \$150 on a IIe, \$175 on a 512K Mac, and \$200 on a Mac Plus. . . . **IBM's** PC Convertible is being built by robots at a plant in Austin, TX. The automated workers perform all assembly and test operations, and the assembly process reportedly takes 6 minutes.



# Next to your computer,

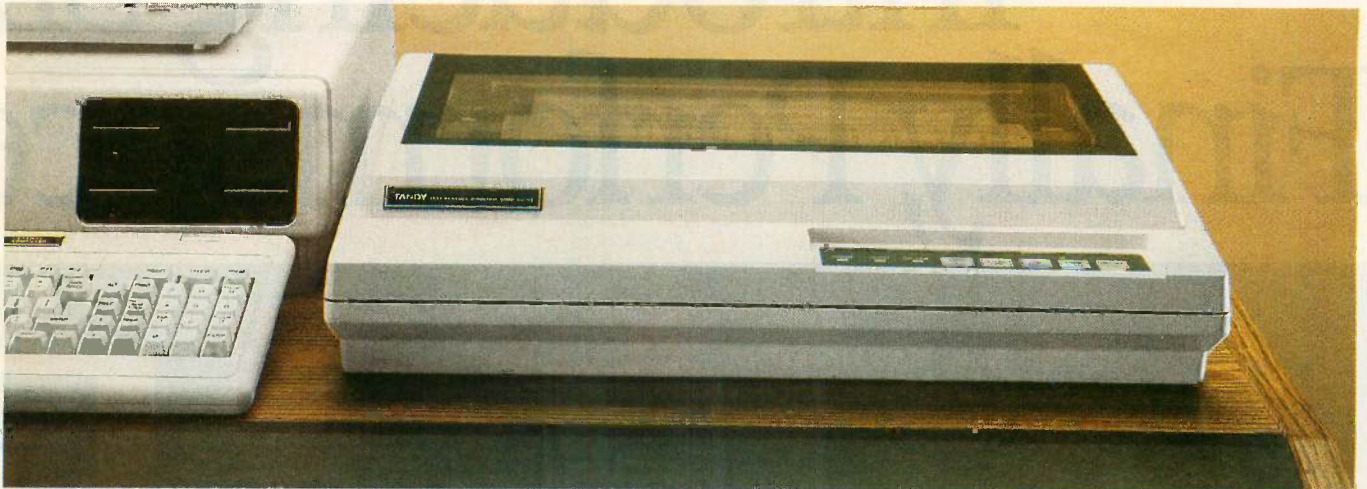

## nothing beats a Tandy® printer.

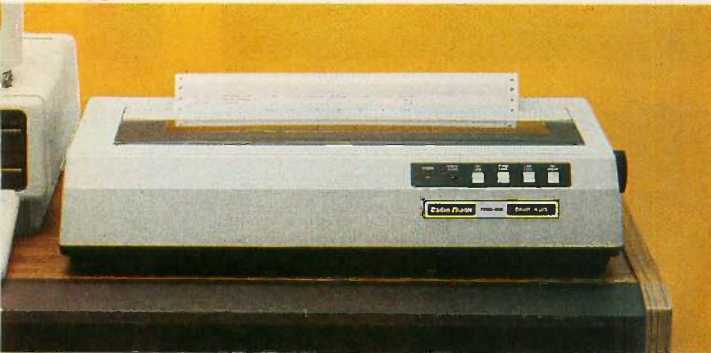

### Tandy printers make fine print quality, graphics and high performance affordable.

For your best value and selection in top-quality printers, shop your local Radio Shack Computer Center. We've got what you need, whatever your printing requirements.

#### Dot-matrix power for business

The DMP 2200 (26-1279, \$1695.00) gives you efficient, fast printing at 380 characters per second. It supports elongated, double high, bold, underline, super/subscripts, italics and double strike, plus bit-image graphics. It also has a built-in tractor for perfect paper alignment.

#### Versatile business printer

The DMP 430 (26-1277, \$899) is a 132-column dot-matrix printer with an 18-wire print head that delivers superior correspondence characters in a single pass. Choose from micro, italic

and double-high fonts, as well as bit-image graphics. In the draft mode, the DMP 430 delivers a fast 180 characters per second.

#### Low-cost, triple-mode personal printer

The DMP 130 (26-1280, \$349.95) lets you choose from word processing, data processing and dot-addressable graphics. Prints in four character styles: standard or italic cursive, in draft or correspondence modes.

#### Save time while printing

With a PTC 64 Printer Controller (26-1269, \$249.95), you can print one job while working on another. The "print buffer" accepts and stores information from your computer.

See the complete selection of printers and accessories at Radio Shack today.

**Radio Shack®**  
**The Technology Store™**

A DIVISION OF TANDY CORPORATION

**New 1986 Computer Catalog!**  
**Send me a copy.**

Mail To: Radio Shack  
Dept. 86-A-794  
300 One Tandy Center  
Fort Worth, Texas 76102

Name \_\_\_\_\_

Company \_\_\_\_\_

Address \_\_\_\_\_

City \_\_\_\_\_

State \_\_\_\_\_ ZIP \_\_\_\_\_

Phone \_\_\_\_\_

Prices apply at Radio Shack Computer Centers and at participating stores and dealers. All printers shown are IBM® compatible. The DMP 430 requires special order at some locations. IBM/Registered TM International Business Machines Corp.



# Introducing Six Finally, Performance

*WordStar® Write a letter while running up to eight other applications.*

MS-DOS File  
Send print output directly to printer

Quarterly Sales Report -- First Quarter, 1986

REGION	MANAGER	QMS	TRUCKS	TOTAL
Region 1	Linda Stevens	872	532	1,404
Region 2	Sam Newton	530	488	1,018
Region 3	Ralph Kapinca	671	658	1,329
Region 4	Kevin Stockdale	382	437	819
Region 5	Willy Peffy	522	433	955
Region 6	Sam Sloane	545	378	923
Region 7	Josh Miller	428	299	727
Region 8	Warren Bohrow	789	356	1,145
Region 9	Rob Rabowus	518	518	1,036
Region 10	Al Stone	887	587	1,474
Region 11	Robin Snyder	953	484	1,437
Region 12	Bruce Andersen	763	445	1,208
Region 13	Wesley Docker	658	472	1,130
Region 14	Doug Bradley	835	583	1,418
Region 15	Ken Speltzer	938	536	1,474
Region 16	Patty Cooper	928	489	1,417

04-Apr-86 09:28 PM

*Lotus 1-2-3® All releases of 1-2-3 run in SixPakPremium's DESQview™ windows.*

MS-DOS File  
Send print output directly to printer

MS-DOS File  
Send print output directly to printer

DATE	TIME	PRICE	QTY	TOTAL	AMOUNT
04/01/86	09:00	10.00	100	1000.00	1000.00
04/02/86	10:00	12.00	50	600.00	1600.00
04/03/86	11:00	15.00	20	300.00	1900.00
04/04/86	12:00	18.00	10	180.00	2100.00
04/05/86	13:00	20.00	5	100.00	2200.00
04/06/86	14:00	25.00	3	75.00	2300.00
04/07/86	15:00	30.00	2	60.00	2400.00
04/08/86	16:00	35.00	1	35.00	2435.00
04/09/86	17:00	40.00	0	0.00	2435.00
04/10/86	18:00	45.00	0	0.00	2435.00
04/11/86	19:00	50.00	0	0.00	2435.00
04/12/86	20:00	55.00	0	0.00	2435.00
04/13/86	21:00	60.00	0	0.00	2435.00
04/14/86	22:00	65.00	0	0.00	2435.00
04/15/86	23:00	70.00	0	0.00	2435.00
04/16/86	00:00	75.00	0	0.00	2435.00
04/17/86	01:00	80.00	0	0.00	2435.00
04/18/86	02:00	85.00	0	0.00	2435.00
04/19/86	03:00	90.00	0	0.00	2435.00
04/20/86	04:00	95.00	0	0.00	2435.00
04/21/86	05:00	100.00	0	0.00	2435.00
04/22/86	06:00	105.00	0	0.00	2435.00
04/23/86	07:00	110.00	0	0.00	2435.00
04/24/86	08:00	115.00	0	0.00	2435.00
04/25/86	09:00	120.00	0	0.00	2435.00
04/26/86	10:00	125.00	0	0.00	2435.00
04/27/86	11:00	130.00	0	0.00	2435.00
04/28/86	12:00	135.00	0	0.00	2435.00
04/29/86	13:00	140.00	0	0.00	2435.00
04/30/86	14:00	145.00	0	0.00	2435.00
05/01/86	15:00	150.00	0	0.00	2435.00
05/02/86	16:00	155.00	0	0.00	2435.00
05/03/86	17:00	160.00	0	0.00	2435.00
05/04/86	18:00	165.00	0	0.00	2435.00
05/05/86	19:00	170.00	0	0.00	2435.00
05/06/86	20:00	175.00	0	0.00	2435.00
05/07/86	21:00	180.00	0	0.00	2435.00
05/08/86	22:00	185.00	0	0.00	2435.00
05/09/86	23:00	190.00	0	0.00	2435.00
05/10/86	00:00	195.00	0	0.00	2435.00
05/11/86	01:00	200.00	0	0.00	2435.00
05/12/86	02:00	205.00	0	0.00	2435.00
05/13/86	03:00	210.00	0	0.00	2435.00
05/14/86	04:00	215.00	0	0.00	2435.00
05/15/86	05:00	220.00	0	0.00	2435.00
05/16/86	06:00	225.00	0	0.00	2435.00
05/17/86	07:00	230.00	0	0.00	2435.00
05/18/86	08:00	235.00	0	0.00	2435.00
05/19/86	09:00	240.00	0	0.00	2435.00
05/20/86	10:00	245.00	0	0.00	2435.00
05/21/86	11:00	250.00	0	0.00	2435.00
05/22/86	12:00	255.00	0	0.00	2435.00
05/23/86	13:00	260.00	0	0.00	2435.00
05/24/86	14:00	265.00	0	0.00	2435.00
05/25/86	15:00	270.00	0	0.00	2435.00
05/26/86	16:00	275.00	0	0.00	2435.00
05/27/86	17:00	280.00	0	0.00	2435.00
05/28/86	18:00	285.00	0	0.00	2435.00
05/29/86	19:00	290.00	0	0.00	2435.00
05/30/86	20:00	295.00	0	0.00	2435.00
05/31/86	21:00	300.00	0	0.00	2435.00

*Doug Jones® Monitor on-line stock quotations while working on other projects.*

C:PREMIUM PAGE 1 LINE 1 COL 01

Dear Mr. Austin,...

Thank you for inquiring about our new multitasking multitasking solution, SixPakPremium.

With SixPakPremium and DESQview™ it's easy to run up to 9 large programs on your PC - at once. DESQview will allow you to run virtually all popular programs, such as Lotus 1-2-3, concurrently, in "windows". Also, DESQview requires absolutely no new versions of your favorite software: it runs both conventional and our expanded memory programs simply and easily.

The SixPakPremium is superior to other multitasking products because it provides both conventional memory up to 640K and expanded expanded memory all the way up to 2 MB. With four SixPakPremium boards, your PC can have up to 8 MB of expanded memory.

The SixPakPremium also offers all of the features you've come to expect from ASI's popular multitasking products -- a parallel port, 2 serial ports, a game port, a clock/calendar, and ASI's standard 3-year warranty.

Small text at the bottom of the page containing legal disclaimers and trademarks for ASI Research, Inc., IBM, and other companies.



# PakPremium.<sup>TM</sup> Exceeds Demand.

Also Compatible With  
Original IBM<sup>®</sup> PCs & XT's

THE AST  
PREMIUM  
SERIES<sup>TM</sup>

Day	Mon	Tue	Wed	Thu	Fri	Sat
30	31	Name: COMPPOINT.APP				
6	7	Apr 14 1986				
13	14	1	Title: Sales Meeting			
20	21	2	10:30a Prepare for 10:00 meeting			
28	29	2	10:30a Sales meeting			
4	5	1	11:30a			
		1	12:00p Lunch w/ Joe			
		1	12:30p			
		1	1:00p			
		1	1:30p Call back Karen			
		1	2:00p			

*SideKick<sup>™</sup> Keep track of schedules with popular desktop management programs.*

NAME	COMPANY	TITLE	ADDRESS1	ADDRESS2	CITY	STATE	ZIP	COMMENTS	DATESORT
John Garcia	Quantitative Sciences		200 North High Street		Mountain View	CA	94035		12/29/85

*dBASE II<sup>®</sup>/dBASE III<sup>®</sup> Use any release of this popular data base to sort files while working on other applications.*

**SixPakPremium**, the new generation multifunction board designed for new generation IBM XT's, is here! Now one person and one PC have the power to meet the demands of business. AST's newest solution for new XT's, existing PCs, XT's and compatibles, SixPakPremium offers all the popular multifunction features plus two megabytes of expanded memory and the powerful software to use it.

**Premium Performance.** Now, run up to nine applications simultaneously. Sort a data base, write a letter, calculate a spreadsheet, monitor stock quotations and print labels... all at the same time... on the same PC! And, our windows let you view applications instantly.



SixPakPremium is fully compatible with all current PC applications, including expanded memory applications such as Lotus 1-2-3 Release 2.0. And DESQview, our multitasking/windowing environment is compatible with more than 200 of the most popular packages.

**Premium Features.** SixPakPremium offers up to two megabytes of expanded memory, two serial ports, parallel port, game port, battery-backed clock/calendar, DESQview and SuperPak<sup>™</sup> utilities.

**Premium Quality.** As the leader in PC enhancement, with over a million products shipped, AST is known worldwide for its highly reliable products.

**Make The Premium Choice.** For performance that exceeds demand, call our Customer Information Center (714) 863-1333. Or send the coupon to AST Research, Inc., 2121 Alton Avenue, Irvine, CA 92714.

**AST**  
RESEARCH INC.

Yes, I want to learn more about Premium Performance. Please send me your special SixPakPremium information package today!

Name \_\_\_\_\_

Title \_\_\_\_\_

Company \_\_\_\_\_

Address \_\_\_\_\_

City \_\_\_\_\_ State \_\_\_\_\_ Zip \_\_\_\_\_

Phone ( ) \_\_\_\_\_



## ATARI 520ST MEMORY UPGRADE

I recently completed the Atari 520ST 1-megabyte memory upgrade modification as outlined by Gert Slavenberg on page 372 of the February BYTE. (*Editor's note: Also, refer to the Atari/tech.st conference on BIX, message #239, and to ST.DOC from BYTEnet Listings.*) It wasn't as easy as expected, and I'd like to share my experience with those tempted to add 512K to their machine for \$50 worth of dynamic RAM and a few hours of free time.

After piggybacking the new 120-nano-second DRAMS, I quickly soldered them to the old ones using a 35-watt iron. The joints did not look that good, but I buzzed out the board with the ohmmeter and all connections passed. When I finally booted up, erratic operations resulted. Most common among these were

- Black balloons on screen with system keyboard dead
- Display filled with dots
- Double menu images

After taking some aspirin, I proceeded to troubleshoot the board. Could my problems be traced to those DRAMS, which get very hot, making a cold-solder joint "colder"? My suspicions were confirmed when I shorted the connections together, one by one, and rebooting or erratic symptoms were triggered. I was able to get the modification to work properly by resoldering every connection slowly and carefully with a 15-watt pencil iron, examining each joint with a magnifying glass.

Here now are some pointers I'd like to pass on to anyone attempting to complete this memory upgrade modification.

Note 1: The modification does not work with the 16 despiking caps unconnected.

Note 2: After turning on the power, try to copy the system disk in one pass instead of two. If this works, run the memory test program outlined below.

Note 3: If you have little experience in doing chip soldering and debugging, I strongly suggest not doing this modification yourself. While being a major improvement to the ST, it can easily destroy your computer.

A simple test of system memory from BASIC can be quite informative. Issuing

the command `x=free(0);print x` returned 529,492 bytes available on my system. This number may seem low, but without the added memory only small programs can be written.

The following is a diagnostic program to quickly test out memory, 1K at a time. This program writes zeros and ones from the end of 512K bank 1 past the end (FFFFF hexadecimal) of 512K bank 2.

```
5 rem memory test should run until
  address 1048574
6 rem test ability to write 0's and 1's to
  all blocks
10 for adr = 450000 to 2000000 step
  1024
20 bits = 0
30 GOSUB 200
40 bits = -32767
50 GOSUB 200
60 next
70 end
200 poke adr,bits
210 j=peek(adr)
220 print "address = ",adr,"data = ",j
230 if j <> bits then print "error ":stop
240 return
```

TOM DOLAN  
Flushing, NY

## SUPPORT NETWORK FOR THE HOMEBOUND

As someone who has been disabled since the age of five and who is currently telecomputing full time for a Fortune 500 insurance corporation, I would like to commend you for the excellent article "Working at Home with Computers" by Jane Morrill Tazelaar, which appeared in the March issue.

Disabled people are indeed creative, motivated, productive people. We have done excellent work in many fields over the years. We have been lawyers, doctors, teachers, and even a U.S. president. Now, thanks to the microcomputer and the modem, even the severely mobility-limited disabled person—the homebound person—is showing his or her potential.

Some of these men and women have expressed an interest in setting up a support network for homebound disabled workers. I think it is not only an excellent idea, but

it could open up new worlds for many of us homebound workers who are bright and creative but also terribly isolated. Therefore, anyone interested in being a part of such a network can write to me at *Disability News Online*, 257 Center Lane, Levittown, NY 11756. They can also reach me via CompuServe at 76505.656, via The Source at BCG138, or via PeopleLink at IQR860. I'd like to hear anyone's ideas, comments, or feelings about setting up such a network.

By the way, *Disability News Online* is a national newsletter by and for the disabled. It can be read on The Source by typing the following at the command prompt:

```
BASICV SFILES>BCG138>DISABILITY-NEWS-ONLINE.
```

ROBERT MAURO  
Levittown, NY

## PUTTING THE AMIGA TO GOOD USE

What's an Amiga good for? I seriously asked an Amiga salesman that question at a local Amiga Fest and the following conversation ensued.

He told me that the Amiga is the best personal computer ever made, and he asked me what I wanted a computer for. I said I was a scientist and did a lot of numerical work that required speed and accuracy. He explained to me how much faster the 32-bit 68000 Amiga is over the 8088 IBM PC family. I said that that may be and asked if the Amiga is faster or more precise than the 8087 in the IBM PCs. He admitted that the 8087 is faster and more precise, and maybe the IBM PC

(continued)

LETTERS POLICY: To be considered for publication, a letter must be typed double-spaced on one side of the paper and must include your name and address. Comments and ideas should be expressed as clearly and concisely as possible. Listings and tables may be printed along with a letter if they are short and legible.

Because BYTE receives hundreds of letters each month, not all of them can be published. Letters will not be returned to authors. Generally, it takes four months from the time BYTE receives a letter until it is published.



**ON BOARD 20**  
Hard Drive Card

**ON BOARD 10**  
Hard Drive Card

# A Hard Drive The Easy Way.

Turn your PC into an XT in seconds with OnBoard, Maynard's new hard drive card!

## So your PC needs a hard drive...

When you bought your PC, you never dreamed you'd need more than floppy drive performance. But now, both you and your PC are ready for more. In fact, there's just one reason you've been putting off getting a hard drive. Admit it. It's the installation. Cables and controller and all that.

Well, relax. OnBoard is here. The hard drive card that boosts your PC's storage capacity to rival any XT or AT\* on the block! OnBoard snaps easily into one of your IBM PC's expansion slots! Open your PC, plug in OnBoard, and close your PC. Just like that. Your PC will boot directly to OnBoard when you power up — no more floppy disk maneuvering.

## Powerful Self-Control.

If you already have a hard drive in your PC, OnBoard's controller card will double up and run both hard drives. Which helps keep your expansion slots open for other business.

## Lots of Head Room, Lots of Desk Room.

OnBoard puts up to 20MB of power into your PC, turning it into a hard drive heavyweight in seconds! If you need less storage but the same speed and fine performance, you can install OnBoard 10.



## Single-Slot Installation.

Simply snap OnBoard into expansion slot 1 of your IBM PC\* or XT, leaving all your other slots free for additional boards.

**OnBoard is designed to work in today's leading PCs and is available at the finest computer stores. Contact your local dealer or call us today for more information.**

\*IBM PC, XT, and AT are trademarks of International Business Machines®

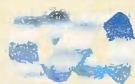

**Maynard Electronics**  
Shaping tomorrow's technology.

460 E. Semoran Blvd., Casselberry, FL 32707 305/331-6402



# ANTHROCART.™

## MOBILE...

*A key reason why people like the AnthroCart. Share your hardware. Move it around. Take it room to room or floor to floor.*

*AnthroCart. High-tech furniture for high-tech equipment. Space saver. Compact. Rugged.*

*The AnthroCart is designed to move. Designed so your workspace is as slick as your hardware,*

*Call us: 800-325-3841*



*Supports up to 150 lbs.  
All steel frame construction  
5 1/4 square foot footprint*



**Anthro Corporation  
Technology Furniture**  
3221 NW Yeon St.  
Portland, OR 97210

Anthro Corporation is a wholly owned subsidiary of Tektronix, Inc. Anthro is a registered trademark of Anthro Corporation.

## LETTERS

is better for mathematical work.

I said that I run my own business and would like to use a computer for accounting. How would the Amiga be for business work? More than anything, I need the computer to be reliable and error-free. I can't have the computer altering my accounting data. The salesman said the Amiga would be great for business use. I asked about error detecting or correcting memory, and he said the Amiga doesn't even have parity checks on memory.

That meant that a memory bit change could eat a hole in my business databases and I might not discover the error for months, and even then I won't know what happened. I can live with a computer that dies, but I can't allow it to take me with it. Business computers must have some kind of memory error detection and all the business computers I use have error detection and correction. In my opinion, lack of memory error detection rules the Amiga out as a business computer, especially since I can buy computers that do have memory error detection. The salesman admitted that this was a valid point.

I said that I do a lot of writing and could use a good word processor. The salesman said the Amiga would be a fantastic word processor. After seeing good Amiga graphics, how about some good Amiga text? Wow! The Amiga has the worst 80-column text quality I have ever seen on any computer. I couldn't write or program that thing for more than two hours without developing a bad headache. I suspect anyone could get around that problem by writing a word-processing program that uses the Amiga graphics to do the text. However, the lack of a connection for a monochrome monitor would rule out the Amiga as a good word-processing machine anyway. The composite video output would not make as good a monochrome display as a real monochrome output signal. For those of us who spend a lot of time looking at the tube, this makes a big difference. Well, Mr. Salesman didn't know quite what to say except that the graphics are fantastic.

Amiga graphics may be fantastic for a personal computer, but they are very mediocre for real graphics work. Amiga graphics are not good enough for image-processing work, and most engineering workstations in industry today have 1024-by-1024-pixel displays with 256 gray shades or colors per pixel. They cost a lot more, but the applications require it and nothing less will be productive.

So, back to my original question: What's an Amiga good for? I am not trying to pick on the Amiga, but it looks like Com-

*(continued)*



New! Windows-Compatible In·a·Vision 1.1

FREE Microsoft Windows!  
Limited Offer  
Microsoft Windows!

# Complex Drawing Made Easy

We created In·a·Vision just for you. The engineer who needs more productive drafting support. The designer who needs versatility for alternate ideas or quick revisions. The architect who needs to manage a variety of working drawings. And the businessman who needs first-class presentation materials as well as detailed flow charts and organization charts.

## Point. Click. Draw.

Now all you do to create complex technical drawings, systems designs, blueprints, diagrams, illustrations, and proposals is point, click and draw. With In·a·Vision's mouse support, windowing, icons,

and pull-down menus, you produce drawings more quickly, accurately and efficiently than ever before. In·a·Vision's advanced technology includes many features not found on comparable systems costing thousands more. For example, you can pan around in a user-definable drawing space up to 68" x 68" and zoom in on specific areas for

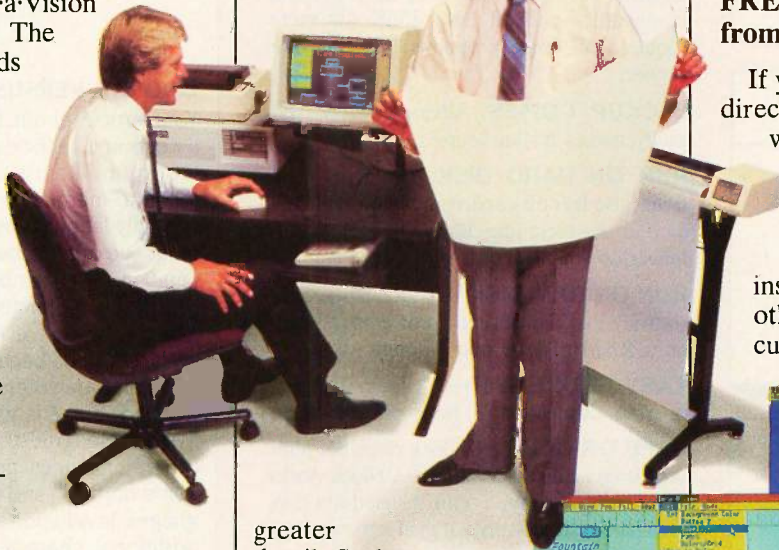

greater detail. Scale, rotate and dimension symbols, fill an area with your choices of pre-defined colors and patterns, as well as draw lines with multiple styles and widths. Other features include overlays, predefined and user-definable page sizes, rulers, grids, and templates to speed popular applications.

## Multi-tasking in a PC-based CAD system.

In·a·Vision uses multi-tasking to enable you to continue drawing while printing hard copies or edit multiple drawings simultaneously.

## FREE Microsoft® Windows from MICROGRAFX!®

If you purchase In·a·Vision directly from MICROGRAFX, we'll give you a free retail copy of Microsoft Windows so you can use In·a·Vision as part of a fully integrated working environment. Move instantly from In·a·Vision to other applications and back... cut and paste text and drawings

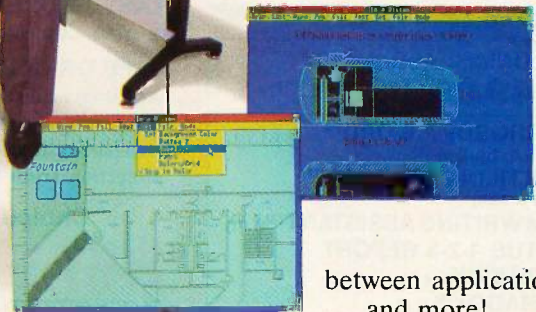

between applications... and more!

We're confident you'll agree — In·a·Vision will make your complex drawing tasks simple and make you more productive. Satisfaction guaranteed.

**TO ORDER  
CALL:  
800-272-3729**

Demo disk\* or brochure available to qualified customers. In Texas or for customer support, call (214) 234-1769.

MICROGRAFX, Inc., 1820 North Greenville Avenue, Richardson, Texas 75081.



**MICROGRAFX®**  
The Picture of Success.

Inquiry 225

(Most popular graphics cards, plotters, and printers supported.)  
Microsoft Windows-compatible. Call for specific operating environment requirements.

\* Demo requires MS Windows. Full demonstration system for users without Windows available for \$49.00.

In·a·Vision and MICROGRAFX are trademarks of MICROGRAFX, Inc.  
Microsoft is a trademark of Microsoft, Inc.



# UNlock™ Removes Copy Protection

## RUNS YOUR SOFTWARE ON ANY HARD DISK

Guaranteed to work only with programs below:

### UNlock ALBUM "A"

**\$49.95** (Plus \$4 ship/handling. Foreign orders \$10)

- LOTUS 1-2-3™ (1.A, 1.A', 2.0)
- dBASE III™ (1.0, 1.1, 1.2 & PLUS)
- FRAMEWORK™ (1.0, 1.1, II)
- SYSTAT™ (1.3 & 2.0)
- SPOTLIGHT™ (1.0 & 1.1)
- GRAPHWRITER™ (4.3 & 4.31)
- REALIA COBOL™ (1.2, 2.0)

### UNlock ALBUM "B"

**\$49.95** (Plus \$4 ship/handling. Foreign orders \$10)

- SYMPHONY™ (1.1)
- CLIPPER™ (Winter '84, Summer '85)
- ELECTRIC DESK™ (1.04)
- DOUBLEDOS™
- MANAGING YOUR MONEY™ (1.5 & 1.51)
- smARTWORK™ (1.0 REV 8 thru 10)
- DATA BASE MANAGER II™ (2.0, 2.02)

### UNlock ALBUM "C"

**\$49.95** (Plus \$4 ship/handling. Foreign orders \$10)

- MICROSOFT WORD™ (1.5, 2.0, 2.01)
- MULTILINK ADVANCE™ (3.02 & 3.03)
- IBM WRITING ASSISTANT™ (1.01)
- LOTUS 1-2-3 REPORT WRITER™ (1.0)
- PARADOX™ (1.0)
- PFS ACCESS™ (1984 Edition)
- THINKTANK™ (2.0)

### "Best of UNlock" ALBUM "D"

**\$74.95** (Plus \$4 ship/handling. Foreign orders \$10)

- MICROSOFT WORD™ (1.5, 2.0, 2.01)
- dBase III™ (1.0, 1.1, 1.2 & PLUS)
- LOTUS 1-2-3™ (1.A & 1.A', 2.0)
- SYMPHONY™ (1.1)
- FRAMEWORK™ (1.0, 1.1, II)
- CLIPPER™ (Winter '84, Summer '85)
- MULTILINK ADVANCE™ (3.02 & 3.03)

- Produce non-protected DOS copies from popular software programs
- For IBM® PC, XT, AT, compatibles

TranSec UNlock is a unique software copying disk that removes copy protection, providing standard non-protected DOS copies. UNlock runs on IBM® PC, XT, AT, and compatibles with at least 256K (or more required for some programs), DOS 2.1 or higher.

**BACKUP COPIES.** UNlock safely and easily makes backup copies.

**RUN ON HARD DISK.** Programs load faster, use less disk space and work with any hard disk, including Bernoulli Boxes. No longer do you need the original in drive "A".

**RUN ON RAM DISK.** UNlock is the only software that can run copy protected software on a RAM disk or micro-floppy.

**EASY TO USE.** 1) Type UNlock. 2) Select program destination. 3) Insert program disk.

**SAFE ORIGINAL.** UNlock does not alter your original distribution disk. UNlock works by creating a copy of your distribution disk on a hard or floppy disk. It then removes copy protection from the copy!

### Choice of the Critics!

**BYTE** "UNlock 4.7 defeats the latest Prolok and SuperLock type of copy protection scheme. It's menu-driven and works fine on the programs it's supposed to work on: Lotus 1-2-3, dBase III, Framework, Symphony, Paradox, and several others."

Jerry Pournelle, BYTE, Feb. '86

**PERSONAL COMPUTING** "UNlock has two particularly endearing characteristics: it works, and works simply. I was able to quickly produce unprotected copies of Lotus 1-2-3 release 2, Symphony 1.1, Microsoft Word 2.0, dBase III 1.1, and Framework II. These copies performed flawlessly, as did copies of these copies."

Christopher O'Malley, PERSONAL COMPUTING, April '86

**NEW! SPECIAL OFFER**  
"Best of UNLOCK"™

ORDER BY TELEPHONE TODAY!  
**1-305-474-7548**



# TRANSEC UNLOCK™

TranSec Systems, Inc., 1802-200 North University Drive, Plantation, FL 33322

Trademarks are the sole property of their respective owners. • UNlock is For Use Only to Improve the Useability of Legally Acquired and Operated Software.



## LETTERS

modore is caught in a sandwich (poker term). A poker sandwich is a situation in which you don't have a good enough hand to win high and you don't have the right cards to win low, but you definitely are contributing money to the pot. Amiga is too expensive for the average home computer, and it's not quite up to the IBM PC AT clones for business or scientific use. The most interesting thing about the Amiga will be the reason for its survival, if it survives.

RONALD R. MILLER  
Poway, CA

### DVORAK VERSUS QWERTY

Your article about the Dvorak keyboard ("Keyboard Efficiency" by Donald W. Olson and Laurie E. Jasinski, February) failed to mention one major limitation: It is highly language-specific for the English language only. To be used for the German language, for example, it would have to be drastically rearranged. This rearrangement can be applied even to the "standard" QWERTY that became QWERTZ for the German typewriters, because Y is barely needed, but Z is used quite often.

This holds true, to a varying degree, for other languages as well, like Italian or some northern and eastern European languages. In addition, these languages need additional characters that are not considered in the QWERTY or Dvorak keyboards. These characters occur quite frequently in these languages. For example, ä, ö, and ü together make up about 3 to 5 percent of the characters of German or Swiss German writing. (My computer does have these characters, but they are well hidden in the graphic-shifted set.) And once we get into languages other than European, the Dvorak layout might have to be modified into a completely new system. The QWERTY and its modified/expanded variants seem to be much more usable and have found their way to the remote corners of the globe. The more effective something is for a certain task, the more limited its scope, no matter what it is. Even human beings are this way.

A. METTLER  
Maluku, Indonesia

### MACINTOSH WINDOWS

While I'm not certain that the Macintosh windowing environment is the ultimate, I am sure that Alex Funk's proposals ("Copyrighting Icons," March Letters, page 14) are less intuitive and less useful.

His first complaint is about scroll bars. I have no idea what he means about going right to go up, unless he is referring to positioning the mouse over the scroll

(continued)





## Western Computer 286 Turbo™

### Standard Features

- IBM PC/AT Compatible with 512K RAM
- Up to 2 Megabytes of system memory on the main board
- Switch selectable 6 or 8 MHz operation with one wait state on memory access (80286-8)
- 6 or 8 MHz operation with no wait states on memory access available
- 6 or 10 MHz operation with one wait state (80286-10)
- One parallel port and Clock/Calendar on main board
- Mass storage options from 20 to 140 Megabyte Hard Disk Drives and 20 to 60 Megabyte tape backup systems
- EGA video options available for CAD/CAM, word processing, etc. . . .
- One year factory warranty

Western Computer has high quality computers at very competitive quantity pricing.

EUROPEAN HEAD OFFICE  
BELECTRONIC SA, RUE CENTRALE 43  
CH-1880-BEX, SWITZERLAND  
PHONE (025) 631250  
TELEX 456 168 ASWERBACK BELE CH.  
TELEX 756731 -

ANSWER BACK WESTERN COMP

**Western Computer**

*"For High Technology and Performance"*

## Western Computer XT Turbo™

### Standard Features

- IBM PC/XT compatible with 256K RAM on main board
- Up to 640K on board
- 4.77 or 8 MHz operation
- Two 360K Floppy Disk Drives
- Hercules compatible monochrome graphics controller (720 x 350) or IBM compatible color graphics adapter (320 x 200 - four colors or 640 x 200 - two colors) and parallel printer port
- Monochrome monitor (Composite or TTL input)
- IBM PC/AT style keyboard
- Various hard disk drive and tape backup options available

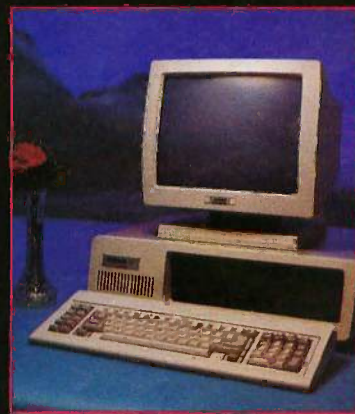

- One Year Factory Warranty

IBM®, IBM PC®, IBM AT® are trademarks of International Business Machines Corporation.

1381 WARNER AVE., WARNER CORPORATE PARK, SUITE B TUSTIN, CALIFORNIA 92680 U.S.A. (714) 259-7755

Inquiry 369 for End-Users. Inquiry 370 for DEALERS ONLY.



bar. Since this is the only way to indicate which window to scroll in multiwindow applications (like QUED), it's hard to see how this can be avoided. Although scroll bars do take up space (16 pixels of width), this is little more than 3 percent of the screen width (and you can often resize a window, so over half of this is off-screen).

I don't consider this a problem on the Macintosh, although it might be with graphics environments like GEM, which run on low-resolution screens. The little

box gives an instant visual indication of what part of the document the window portrays. A major deficiency of the alternate to scroll bars in ThinkTank was that there was no way to tell if you were at the end of a document. Funk's proposal gives no feedback to this problem. Neither does it give the ability to go instantly to an end of the document. Finally, I can't see how holding down an arbitrary key while moving the mouse is intuitive. What happens when you run out of room? The scroll bars

allow continuous scrolling.

When I resize a window, I want to be able to resize it precisely. Funk's proposal seems to be a way to get relative sizing (wave the mouse pointer around to make it bigger), rather than being able to position the window next to another. In any case, Apple's method gives visual feedback that a given window can be resized, rather than leaving the user wondering if he held down the wrong modifier key.

Funk's method for closing a window (waving the mouse pointer around with no keys held down) seems reminiscent of what I do when I want to make sure my mouse is clean and functional. Again, the close box for a window gives a visual cue that the window can indeed be closed, while if Funk's method failed, one would be left wondering if he hadn't "erased" the window vigorously enough.

What is a global zoom? That seems to imply zooming every window, which hardly makes sense. The new Macintosh ROMs do allow a window to have a zoom box, if Funk means a standard way of zooming.

I also wonder what a global abort is. Abort what? What kind of state should things be in after an abort? If Funk really wants to abort things, he can install the Programmer's Switch and press Reset.

Since, in the real world, people will be switching between different machines, it makes sense for different windowing environments to work similarly. (Since I learned the Macintosh first, I get very annoyed at the differences in the way GEM and the Amiga handle things.) I still can't figure out why Digital Research caved in to Apple's ludicrous claims to own the look I first saw on a Xerox Star. Perhaps Apple is considering the fact that they spent a lot of time and money developing a good user interface (rather than just coming up with something that seems good, as I believe Funk has), and they don't want someone stealing it. But any new product is going to be copied—just look at VisiCalc. What Apple needs to do is make sure their implementation is the best, rather than trying to cripple all others by making sure they're nonstandard.

DAVID DUNHAM  
Goleta, CA

### LENGTHENING SHORT DELAYS

The notes in the February "Best of BIX" indicate that some users were having problems involving shortened delays of one type or another when the NEC V20 chip was installed in place of an 8088. Perhaps they can benefit from my experiences in solving a similar problem operating under MS-DOS 2.00 and 2.11.

(continued)

## Why buy 3 packages to get a complete multi-user dBASE\* System?



\$2385

After all, FoxBASE is a compiler, an interpreter and a multi-user dBASE system all in one. That means single vendor support and no problems with product incompatibility.

Not only that, FoxBASE actually outperforms dBASE and other dBASE compiler products: its program execution speed is far superior to the competition and its compiler runs up to 60 times faster than other compilers. And FoxBASE is available

## FoxBASE™ does it better. For less.

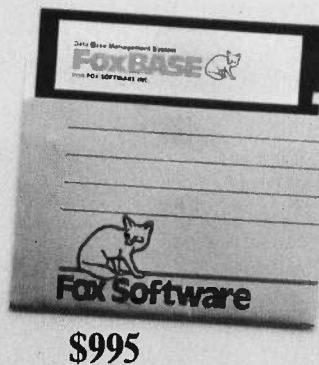

\$995

for the widest variety of machines and operating systems.

In addition, FoxBASE is interactive and 100% dBASE compatible (including full macro usage). The only thing you won't get is all those annoying dBASE bugs!

Best of all, FoxBASE costs less than half the other packages.

So call (419) 874-0162 now, and ask for a copy of our comparative analysis (including benchmarks). After all . . .

Nothing Runs Like a Fox.

**FOXBASE™** 

Fox Software, Inc.  
27475 Holiday Lane, Perrysburg, OH 43551  
(419) 874-0162

\*dBase is a registered trademark of Ashton-Tate FoxBASE is a trademark of Fox Software, Inc. Clipper™ is a trademark of Nantucket



# THE NO FRILLS PLOTTER

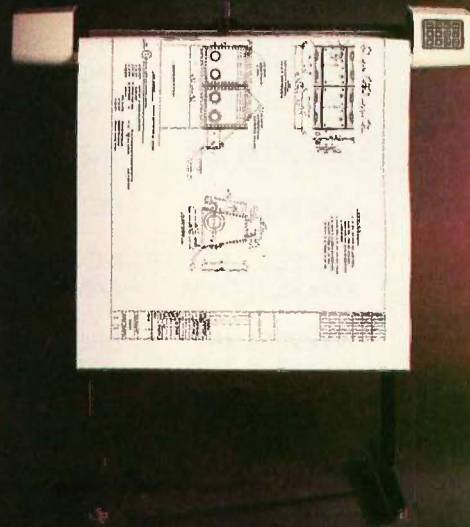

**E**nter the world of professional CAD applications with Houston Instrument's low cost DMP-41/42 series plotters. These single-pen plotters give you the features you need—C and D size plots, extensive software compatibility, and proven reliability—for a very affordable no frills price of \$3295.\*

The DMP-41/42 series' large C and D size formats are ideal for a wide range of CAD applications, from architectural elevations to assembly drawings. And a .005 inch resolution ensures crisp drawings on a variety of media—paper, matte film, or vellum.

Inquiry 155

With the DMP-41/42 series, you can choose from an impressive selection of off-the-shelf graphics software packages such as VersaCAD, AutoCAD, and CADKEY. Or, by using Houston Instrument's popular DM/PL™ language, you can create your own custom software and be assured of upward compatibility with Houston Instrument's entire line of plotters.

The DMP-41/42 series. The plotters that offer superb reliability, comprehensive graphics capabilities, and a no frills price. The proven performers for low-cost CAD.

For more information, call

1-800-531-5205 (512-835-0900 if in Texas), or write Houston Instrument, 8500 Cameron Road, Austin, Texas 78753. In Europe, contact Houston Instrument, Belgium NV., Rochesterlaan 6, 8240 Gistel, Belgium. Tel.: 32-(0)59-277445. Tlx.: 846-81399.

\*U.S. suggested retail price. Pricing subject to change. DM/PL is a trademark of Houston Instrument.

## houston instrument

A Division of **AMETEK**

JUNE 1986 • BYTE 21



For several months, I have used an NEC V20 in an NCR Decision Mate V, and recently the hardware clock rate was increased from the stock 5 MHz to 7.3728 MHz. The DMV uses a delay routine to allow time for the flex drive to get the motor started and to bring READY active.

After installing the V20, this delay was too brief and caused a "Drive not ready" error when the drive was accessed with the motor off. If (R)etry was pressed immediately, the drive was accessed normally (as the motor was already on) and READY was active by that time. An increase in the

hardware clock rate compounded the problem; however, a patch to the delay routine in IOSYS increased the delay after which it worked properly. This will not be a total solution for many users, because the DMV start-up routines are called from ROM using a Z80A, and the V20 has no control until after the operating system is loading. In most computers, the V20 always has control, so delay routines in ROM would be affected also.

MOTORCK is the routine in IOSYS that starts the drive motor, along with similar routines in FORMAT.COM and a special DMV utility called RDCPM.COM (for reading CP/M disks). Unassembling MOTORCK using Debug yields the results shown in listing 1.

Method #1—Use if the hardware clock rate is unchanged. Replace the AAM command with IMUL AL. IMUL AL executes in 80 or more cycles on an 8088, and only 38 on the V20, but provided enough delay for my system even though the delay was much shorter. The advantage of this method over #2 is that 8088 compatibility is retained; so if it works on your system, use it.

(continued)

Listing 1: The results of unassembling MOTORCK using Debug.

```

xxxx:2ED5 E413    IN    AL,13    ;get drive status
xxxx:2ED7 2401    AND   AL,01    ;test MOTOR ON bit
xxxx:2ED9 E614    OUT   14,AL    ;switch motor on
                ;if off
xxxx:2EDB 7501    JNZ   2EDE    ;delay if motor off
                ;(jump to2EDE)
xxxx:2EDD C3      RET                ;return if motor on
                ;—end MOTORCK—
xxxx:2EDE BBFFFF  MOV   BX,FFFF  ;# of passes to BX
xxxx:2EE1 D40A    AAM                ;8088 = 83 cycles
                ;V20 = 15 cycles
xxxx:2EE3 4B     DEC   BX        ;one less pass left
xxxx:2EE4 75FB    JNZ   2EE1    ;jump to 2EE1 if
                ;not last pass
xxxx:2EE6 C3     RET                ;end of last pass —
                ;return to 2EDD

```

# DREAMER<sup>®</sup>

An intelligent function keyboard

FOR USE WITH 1-2-3<sup>™</sup>, WordStar<sup>™</sup>, MultiMate<sup>™</sup>, DisplayWrite 3<sup>™</sup>  
Symphony<sup>™</sup>, WordStar 2000<sup>™</sup>, WordPerfect<sup>™</sup>

## NO MORE MEMORIZING FOR SOFTWARE COMMANDS

The Dreamer is an intelligent function keyboard. It is pre-programmed with over 550 software commands which it sends to the IBM PC at the touch of a single key.

The Dreamer's descriptive keys simplify the use of seven sophisticated business program: Lotus 1-2-3, Symphony, WordStar, WordStar 2000, MultiMate, DisplayWrite3 and WordPerfect.

Wouldn't it be easier to press a key "Bar" instead of typing "/ G T B V" to display bar chart in Lotus 1-2-3? or a key "Save File" instead of searching for "Ctrl K-S" to save a document in WordStar.

Increase your office efficiency by putting a Dreamer next to your PC system.

Dreamer is entirely a hardware device it will not occupy PC memory. It requires no memory-resident programs and there are no pre-boot disk necessary.

OEMs and VARs: Our professional engineers can re-program the Dreamer to fit your special application.

The Dreamer is available for IBM PC, XT, AT.

## DREAMER FEATURES:

- \* 20-key numeric pad with separate cursor controls.
- \* Lotus 1-2-3 100 commands      MultiMate 58 commands
- \* Symphony 191 commands      DisplayWrite 3 58 commands
- \* WordStar 58 commands      WordPerfect 58 commands
- \* WordStar 2000 58 commands

\* Template included for alternate command pages

\* Easy selection between command pages

\* Easy installation

\* Full 90-day warranty

\* Suggested retail price \$259



T.S. MICROTECH INC. (213) 644-0859 12565 Crenshaw Blvd. Hawthorne, CA 90250

Registered Trademarks: IBM, IBM PC, XT, AT, DisplayWrite 3-International Business Machines Corp. 1-2-3, Symphony-Lotus Development Corp. WordStar, WordStar 2000-MicroPro International. MultiMate-MultiMate International. WordPerfect-SSI

Inquiry 403 for End-Users.

Inquiry 404 for DEALERS ONLY.



# Ven-Tel's Half Card™ modem is in all the best computers. Here's why...

Ven-Tel gives you lots of reasons to buy our Half Card™ modem for your IBM PC or compatible. The Half Card™ is a complete system that lets you communicate with other PCs, mainframes, and databases effortlessly. It includes Crosstalk-XVI® software. It's reliable. It's got all of the features you want. And it's a good value.

## Do You Own One of These Computers?

Chances are you do. And if you're thinking of buying a modem, consider the Half Card™. Because of its small size, the Half Card™ fits in more computers, including all of the models we've listed here. The Half Card™ is small, so it fits in short slots or long. That means you can save your long slots for other expansion uses.

## Effortless Communication

Each Half Card™ comes with Crosstalk-XVI® communications software, by Microstuf. It's the easiest to use, whether you're a beginner or an old hand, and the most powerful. A full on-line help menu makes using Crosstalk® for the first time a snap. It can turn your PC into a terminal on a mainframe computer with its powerful terminal emulation feature. It will even operate your PC when you're not there. You can call into an information service such as The Source or Dow Jones News Retrieval, or transfer files and electronic mail, all at the touch of a button. The Half Card™ connects your computer to the world. Effortlessly.

## More Modem for Your Money

When you buy the Half Card™, you don't need anything else. The Half Card™ is a complete communications package that includes a full-featured modem and the best known software on the market. Complete easy-to-understand instructions with full technical support on installation and use. And a very competitive price. The Half Card™ with Crosstalk-XVI® software, retails for only \$549.

## Features

- 1200/300 baud auto-dial, auto-answer.
- Uses the industry standard "AT" command set.
- Runs with virtually all communications software, including Smartcom II and PC Talk III and integrated packages such as Symphony and Framework.
- Includes Crosstalk-XVI® software.
- On-board speaker and extra phone jack for easy switching from voice to data mode.
- Selective tone or pulse dialing; full or half duplex.
- Automatic answer on any ring.
- True ring or busy signal detection.

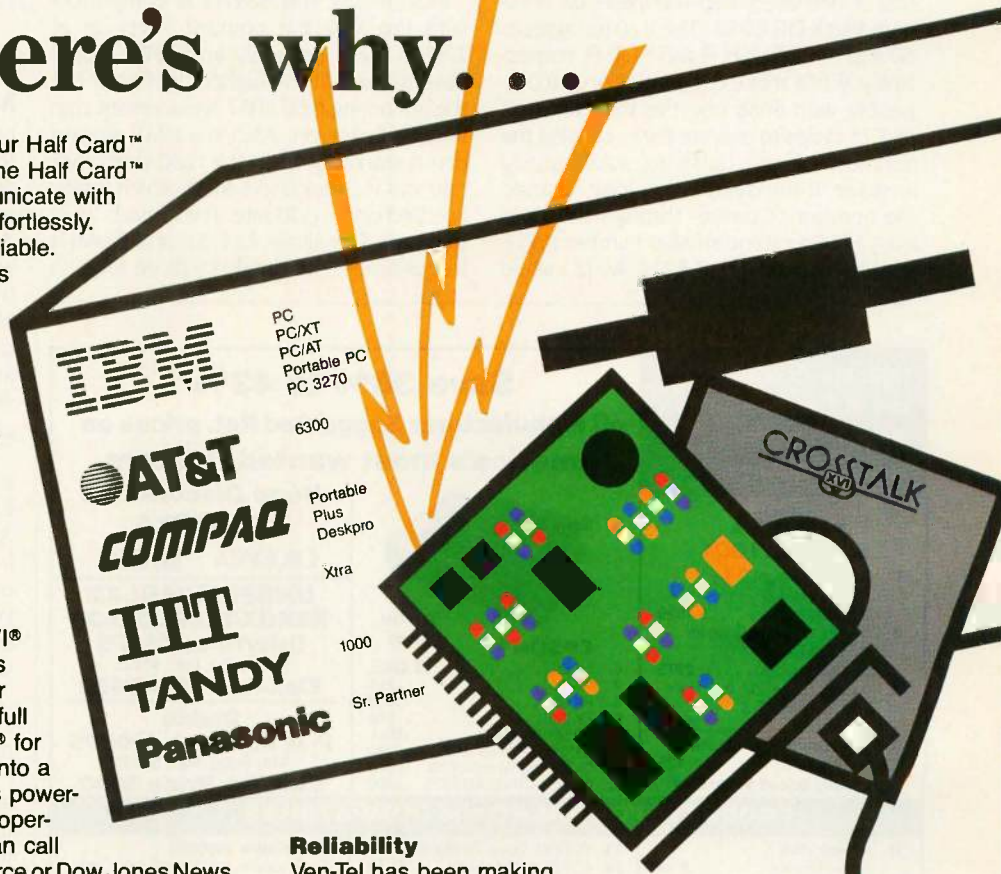

## Reliability

Ven-Tel has been making modems for 10 years. Our experience shows. Ven-Tel's Half Card™ only has about 70 parts, compared to almost 300 on other modems. We reduced the parts by building the first LSI modem chip using advanced switched capacitor technology. What that means to you is greater reliability and lower power consumption, so you can load up your PC with expansion boards and not worry about heat or power problems. And we back the Half Card™ with a full two-year warranty on parts and labor.

## You Can Buy the Half Card™ Anywhere

You can get the Half Card™ at ComputerLand, Businessland, the Genra Group, Entré Computer Centers, Macy's Computer Stores and other fine dealers nationwide. Also from Ven-Tel: the 1200 Plus™ an external modem and the PC Modem 1200™ an IBM internal with V.22 international capability.

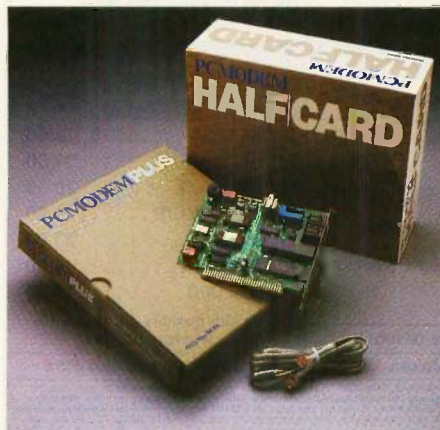

## Effortless Communication

# Ven-Tel Inc.

2342 Walsh Avenue  
Santa Clara, CA 95051  
(408) 727-5721

Crosstalk is a registered trademark of Microstuf, Inc. Smartcom II is a trademark of Hayes Microcomputer Products. Symphony is a trademark of Lotus Development. Framework is a trademark of Ashton-Tate.



**Method #2**—Use if the hardware clock rate is increased. Replace the AAM command with DB 60 61. The V20 recognizes 60 and 61 as PUSH R and POP R, respectively. While those commands are incompatible with 8088 use, the V20 takes 67 and 75 cycles to execute them, causing the duration of the delay to substantially increase. If the delay is too long, change the number of passes through the loop from FFFF to some smaller number (5FFF worked reliably at 7.3728 MHz, while

3FFF was marginal).

Incidentally, the 8087-3 is compatible with the V20 but couldn't keep up at 7.3728 MHz. Probably an 8087-2 would have worked at the higher clock rate, but the upcoming NEC 8087 replacement chip may be faster yet. Also, the DMV slowed down markedly when the hardware clock rate was increased to 8 MHz, which is why I settled on an odd rate. The crystals were purchased locally in 22.1184- and 24-MHz frequencies. The divide-by-three logic in

the clock circuitry yields clock rates of 7.3728 and 8 MHz, respectively.

**CHUCK STERLING**  
Las Cruces, NM

**MISLEADING STATEMENTS**

I'm writing this in protest of the JS&A ad that appeared in the March issue on page 403. The ad speaks of "the memory requirements of the monitor which in the Amiga can eat up [as] much as 70% of the unit's cycle time or speed." This just isn't true! The Amiga's memory runs at 14.2 MHz, and the 68000 and custom chips take turns accessing memory, as your past articles have explained. I think that you should read your ad copy a little more carefully.

Also, in the Atari 1040ST preview (March), you state that the Sieve of Eratosthenes runs in 85 seconds using Atari ST BASIC. My Amiga does the Sieve in 69 seconds with ABASIC and 57 seconds with AmigaBASIC. (I used your Atari version.) I'm not knocking the Atari. I wish that I could afford one, but when it is stated in the industry that the Atari is "faster" than the Amiga, I want to see proof. Actually, I expected much better results from the Atari on the Sieve.

I appreciate your coverage of the Atari and Amiga, and perhaps now the stagnation that has plagued the micro industry from the premature fixation on a standard will be overcome and we really will someday own "mainframes on a desk." (This stagnation happened in the TV industry, with the unfortunate result that we are stuck with 50-year-old technology.)

**RICHARD L. SMITH**  
Tampa, FL

**PROBLEMS WITH SMALLTALK**

Is Smalltalk a "dead" system? As a Smalltalk fan, I would like to think not. Unfortunately, my recent experience with Smalltalk-80 on a Xerox 1108 convinced me that it has some serious failings. More important, the lack of progressive improvements gave me the strong impression that active development ceased some time ago; I was working with a "dead" system.

It was the strong visual aspects of a product that I was designing that led to my selection of Smalltalk for prototyping. While the prototype was completed in the expected three months, the number of concessions I had to make to the system along the way left me unhappy. At first I put these down to my lack of familiarity with Smalltalk, but as my knowledge increased and the problems continued, it became clear that the system was the main source of the problems.

(continued on page 357)

**Here are 79 reasons to buy at Elek-Tek, not to mention the fastest delivery anywhere.**

**MEGA**  
**BERNOULLI BOX**

1. 10 meg 1/2 height Drive for IBM-PC/XT/AT & compatibles ..... \$ 1599
2. 20 meg 1/2 height Drive for IBM-PC/XT/AT & compatibles ..... 2275
3. 40 meg. (20 + 20) 1/2 Height Drive for IBM PC & compatibles ..... 2899
5. 10 meg cartridges for above (3 pak special) ..... 125

Interfaces priced separately

**Save 30% to 43%**  
**off Manufacturer Suggested Ret. prices on**  
**America's most wanted Printers**

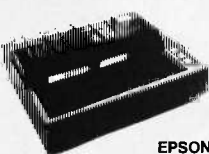

**EPSON®**  
FX 85

6. LX 80 ..... \$ CALL
7. RX 100+ ..... 299
8. FX 85 ..... 370
9. FX 286 ..... 550
10. LQ 800/1000 ..... CALL
11. DX10 Daisy Wheel 10CPS ..... 230
12. DX20 Daisy Wheel 20CPS ..... 320
13. Comrex CR420 400CPS ..... 900

**Huge Discount on**  
**TOSHIBA**  
**OKIDATA** *Star*

**UNBELIEVABLE!!!**  
**XEROX/DIABLO D-36**  
**DaisyWheel 35CPS**  
Mfr. Sugg. Ret. \$1495  
**Elek-Tek Price \$450**

**Diablo**  
**P-38 Dot Matrix 400CPS**  
Mfr. Sugg. Ret. \$1995  
**Elek-Tek Price \$600**

**PRODUCTS FOR IBM-PC and COMPATIBLES**

<ol style="list-style-type: none"> <li>14. <b>Amdtek 310A</b> Amber Monitor ..... \$ 150</li> <li>15. <b>Generic Multi</b> Multifunction Board .0K ..... 99</li> <li>16. <b>Generic Multi 384K</b> Multifunction Board 384K ..... 169</li> <li>17. <b>AST Six Pak +</b> Multifunction Board 64K ..... 225</li> <li>18. <b>AST Six Pak + (loaded)</b> Multifunction Board 384K ..... 290</li> <li>19. <b>Quadram Quadboard</b> Multifunction Board .0K ..... 195</li> <li>20. <b>Multi Board 64K/384K</b> ..... 215/260</li> <li>21. <b>Orchid Tech.</b> PC Turbo 186 ..... 350</li> <li>22. <b>ECCELL OK</b> ..... 399</li> </ol>	<ol style="list-style-type: none"> <li>23. <b>ECCELL Daughterboard</b> ..... 135</li> <li>24. <b>ECCELL I/O Board</b> ..... 99</li> <li>25. <b>Hercules</b> Monochrome Card ..... 299</li> <li>26. <b>Generic version of above</b> ..... 90</li> <li>26. <b>Hercules Color</b> Color Graphic Card ..... 155</li> <li>27. <b>Generic version of above</b> ..... 100</li> <li>27. <b>Novation 4905921</b> 1200B Int. No Software ..... 150 with MITE Software ..... 165</li> <li>28. <b>Novation 490605-1</b> 2400BPS inc. Mite Software ..... 540</li> <li>29. <b>Novation 490603</b> 1/2 Card Modem 2400 BPS No software ..... 425</li> </ol>	<ol style="list-style-type: none"> <li>30. <b>Novation 490603-1</b> As above inc. MS-DOS Software ..... 490</li> <li>31. <b>Hayes 1200</b> External modem ..... 380</li> <li>32. <b>Hayes 1200B</b> Internal modem w/software ..... 359</li> <li>33. <b>Hayes 2400</b> External modem ..... 599</li> <li>34. <b>Hayes 2400B</b> Internal modem w/software ..... 525</li> <li>36. <b>US Robotics Courier 2400</b> Ext. 2400B Smart Modem ..... 460</li> <li>37. <b>Toshiba ND 04D</b> 1/2 ht. DSDD Disk Drive ..... 105</li> </ol>
---	---	---

**38. SEAGATE**  
**Internal H.D. Subsystem**  
20 Megabyte ..... \$500

**39. Intel Above Board**  
All Products ..... CALL

**40. XIDEX Precision**  
**DS/DD Diskette 10pk/\$7.00**  
5 boxes minimum

**DISKETTES**

Dysan	maxim	3M	MEMOREX	ELEK-TEK
3 1/2" SSDD	20.00	19.00	21.00	—
DSDD	27.00	26.00	25.00	—
5 1/4" SSDD	15.00	12.00	11.00	—
DSDD	19.00	15.00	14.00	14.00 12.50
SSDD96TPI	24.00	22.00	23.00	—
DSDD96TPI	33.00	29.00	25.00	—
5 1/4" DSDDHD	33.00	28.00	26.00	—
(For IBM AT)				
8" SSDD**	22.00	32.00	22.00	—
8" DSDD**	26.00	27.00	24.50	—
**Unformatted				

Call for quantity pricing for 10 boxes or more.

**3M DATA CARTRIDGES**

73. DC100A	\$ 13.50
74. DC300A	17.50
75. DC300XL	20.50
76. DC300XL/P	21.50
77. DC600A	23.00
78. DC1000	14.50
79. DC2000	19.50

Call for quantity pricing for 10 cartridges or more.

**CALL TOLL FREE 800-821-1269 EXCEPT Illinois, Alaska CANADIAN TOLL FREE 800-458-9133**

Corp. Accts. Invntd. Min. Ord. \$15.00. Visa or MasterCard by Mail or Phone. Mail Cashier's Check. Mon. Ord., Personal Check (2 wks. to clear) Add \$4.00 1st Item. (AK, HI, PR, Canada add \$10.00 first item) \$1.00 ea. add'l shipg. & handl. Shipments to IL address add 7% tax. Prices subj. to change. WRITE FOR FREE CATALOG. RETURN POLICY: Defective Only. Most products replaced within 30 days of purchase with identical merchandise only. Computer and large parts replaced only when defective on arrival (within 3 work days of delivery). Other problems covered by mfr. warranty. ALL ELEK-TEK MERCHANDISE IS BRAND NEW, FIRST QUALITY AND COMPLETE. Delivery subject to availability. DUNS #09-716-0817

**ELEK-TEK, inc.** 6557 N. Lincoln Ave., Chicago, IL 60645  
(312) 631 7800 (312) 677 7650

24 BYTE • JUNE 1986

Inquiry 126



# High-Speed Animation on Your IBM PC!

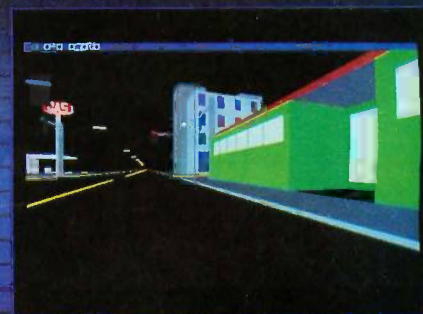
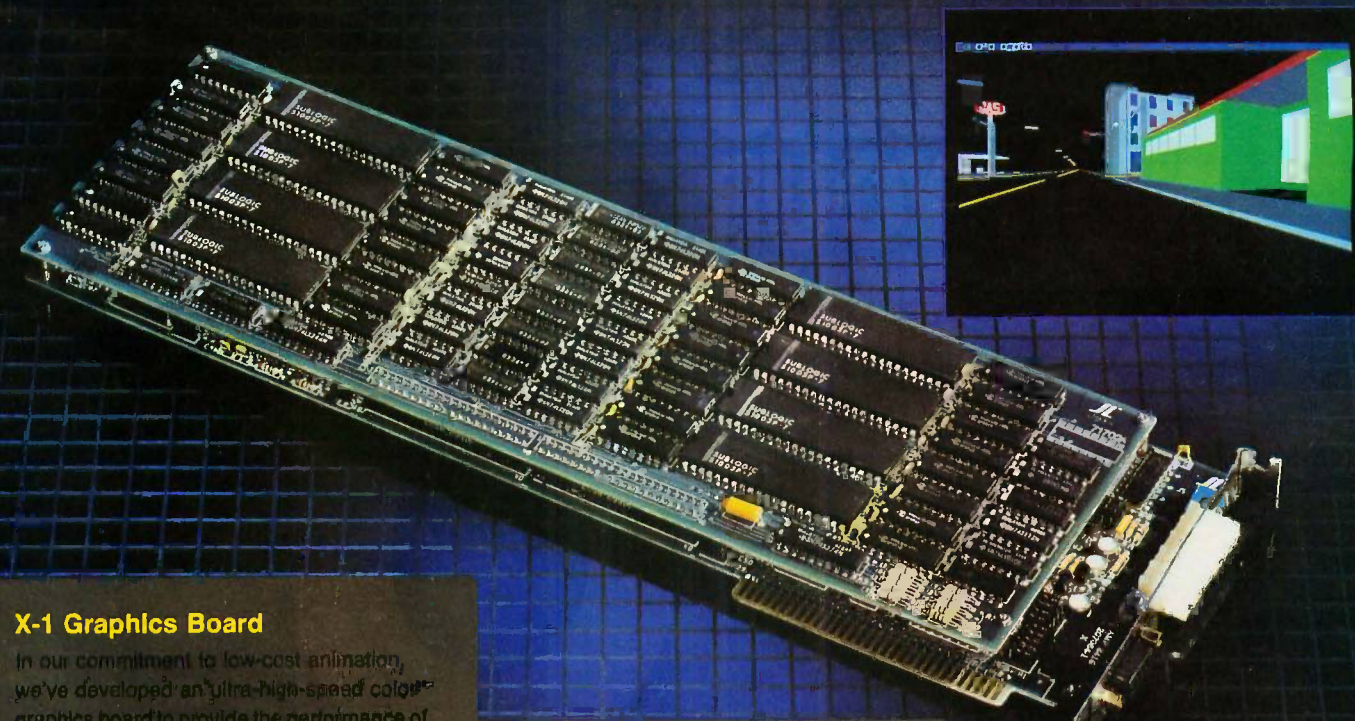
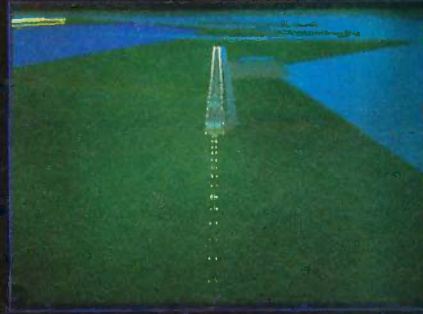

## X-1 Graphics Board

In our commitment to low-cost animation, we've developed an ultra-high-speed color graphics board to provide the performance of expensive dedicated graphics systems on an inexpensive, user-friendly IBM PC. This board's 400-million bits-per-second color-fill rate offers animation speeds never before available on a PC plug-in board (the X-1 is 10 times as fast as any other PC graphics card we've seen). The low-cost, high-performance X-1 Graphics Board opens up entirely new applications for microcomputer-based graphics.

## 3D Graphics Software for use with the Standard IBM Color/Graphics Adapter or X-1 Graphics Board

Our 3D Graphics software, the graphic drivers behind Jet and Microsoft Flight

Simulator, opens up new worlds of 3D and 2D animation. The program works with both the IBM Color/Graphics Adapter and the X-1 Graphics Board, so you can update your hardware at any time and maintain software compatibility.

Spans: The X-1 Graphics Board is available for \$2990, and requires an IBM PC or PC-compatible computer with minimum 128K RAM, PC-DOS or MS-DOS Version 2.0 or newer, and an X-1 compatible RGB display monitor.

The 3D Graphics software is available for \$995, and requires an IBM PC or PC-compatible computer with minimum 256K RAM, PC-DOS or MS-DOS Version 2.0 or newer, and either an IBM Color/Graphics Adapter or the X-1 Graphics Board.

Ask your dealer for details and a special hardware software demonstration, or call SubLOGIC directly for more information.

IBM is a registered trademark of International Business Machines Corp.

**subLOGIC**

Corporation  
713 Edgewood Drive  
Champaign, IL 61820  
(317) 359-8487 Telex: 200996

Order Line: (800) 837-4883  
(outside Illinois, New York, and Hawaii)

Input: 334



**YOUR  
COMPUTER LANGUAGE  
IS QUIETLY  
BREEDING REAL BATS  
IN YOUR  
BELFRY.**





# WE'RE OUT TO SAVE ONE MILLION FRUSTRATED PROGRAMMERS

You're on a roll, really pumped, writing the best code you have ever written and then—AAARGHHH!

Freeze dried in your tracks because the language you're using just won't let you achieve what you can conceive.

And you wanted to be a programmer.

So your choices are:

1) write around the problem by creating six pages of emetic code...

2) leave out that incredible idea that really puts your stamp of excellence on this program or...

3) get yourself a world class headache (or a stroke) by dropping into assembler.

Whatever you choose, by now you feel the language is out to get you—because it is.

Sure, no language is perfect, but you have to wonder, "Am I getting all I deserve?"

And, like money, you'll never have enough.

Pretty dismal, huh?

We thought so, too.

So we did something about it.

We call it CLARION.

You'll call it incredible.

With CLARION you can write, compile, run and debug complex applications in a New York afternoon.

Even if you're in Savannah.

It gives you the power and speed to create screens, windows and reports of such richness and clarity you would never attempt them with any other language.

Because YOU would have to write the code.

With CLARION you simply design the screens using our SCREENER utility and then CLARION writes the source code AND compiles it for you.

In seconds.

Likewise, you can use REPORTER to create reports. Remember, only CLARION can recompile and display a screen or report layout for modification.

And with no time wasted.

All the power and facilities you need to write great programs, faster

than you ever dreamed of.

Programs that are easy to use.

Programs that are a pleasure to write.

And to you that means true satisfaction.

You've coveted those nifty pop-up help windows some major applications feature. But you can't afford the time and energy it takes to write them into your programs.

That's the way it used to be.

So we fixed that, too.

CLARION HELPER is an interactive utility that let's you design the most effective pop-up help screens that you can imagine. And they're "context sensitive," meaning you can have help for every field in your application.

Unlike the other micro languages, CLARION provides declarations, procedures and functions to process dates, strings, screens, reports, indexed files, DOS files and memory tables.

Imagine making source program changes with the CLARION EDITOR. A single keystroke terminates the EDITOR, loads the COMPILER, compiles the program, loads the PROCESSOR and executes the program. It's that easy!

Our data management capabilities are phenomenal. CLARION files permit any number of composite keys which are updated dynamically.

A file may have as many keys as it needs. Each key may be composed of any fields in any order. And key files are updated whenever the value of the key changes.

Like SCREENER and REPORTER, CLARION's FILER utility also has a piece of the CLARION COMPILER. To create a new file, you name the Source Module. Then you name the Statement Label of a file structure within it.

FILER will also automatically rebuild existing files to match a changed file structure. It creates a new record for every existing record, copying the existing fields and initializing new ones.

Sounds pretty complicated, huh?

Not with CLARION's documentation and on-line help screens. If you are currently competent in Basic, Pascal or "C" you can be writing CLARION applications in a day. In two days you won't believe the eloquence of your CLARION programs.

Okay, now for the best part of all. You can say it in CLARION for \$295.00—complete. All you need is an IBM® PC, XT, AT or true compatible, with 320 KB of memory and a hard disk drive.

And we'll allow a full 30 day evaluation period. If you're not satisfied with CLARION, simply return it in its original condition for a full refund.

If you're not ready to take advantage of this no-risk opportunity, ask for our detailed 16 page color brochure. It vividly illustrates the elegance of CLARION. Consider it a preview of programming in the fast lane.

Either way, the call's a freebie.



SAY IT IN

# CLARION™

DEPT. A1BY/1

## 1-800-354-5444



BARRINGTON SYSTEMS, INC. • P.O. BOX 5580 • POMPANO BEACH, FL 33074 • 305/785-4555

IBM® is a registered trademark of International Business Machines Corporation. CLARION™ is a trademark of Barrington Systems, Inc. ©1986 Barrington Systems.

Inquiry 36



# 1 + 1 = 3



One IBM PC, XT/AT or compatible, plus one Advanced Digital PC-Slave II, now equals a complete 3-user (or more) system.

### *Do you need a true multi-user PC system?*

If so, read on. The Advanced Digital solution will simply add up in your favor.

To add two or more users to your IBM PC, XT/AT or compatible, just plug in our PC-SLAVE II and two low-cost monochrome monitors and keyboards. You can now run PC-DOS™ or MS-DOS™ on each user with PC-NET™ software to support your network. The end result is a true multi-processor system that allows each user to run independently on their own CPU and memory, yet sharing a common data base.

### *Do you need networking capabilities?*

The realm of IBM networks is only a step away with the



## PC Slave II™

The Ultimate Two-User IBM PC® Card

PC-Slave II and PC-NET software. An expanding network of multi-user PC's is truly cost-effective since you will be sharing data and communication between users and PCs. File and record locking are also provided so each user can run independently of others while still tied through the network.

### *Do you need additional users?*

Expand your existing supply of PC standalones into multi-user systems by simply adding more PC-Slave II's.

The PC-Slave II features two Intel 80188 CPU's @8Mhz, two 512Kb RAM per CPU and two monochrome/keyboard controllers all on a single board.

MS-DOS is a registered trademark of Microsoft  
PC-DOS, PC-NET are registered trademarks of IBM Corporation  
PC-Slave II is a registered trademark of Advanced Digital Corporation



To learn more about the multi-user solution contact:

**ADVANCED DIGITAL CORPORATION**  
5432 Production Drive  
Huntington Beach, CA 92649  
(714) 891-4004 (800) 251-1801  
Telex 183210 ADVANCED HTBH

**ADVANCED DIGITAL U.K. LTD.**  
27 Princes Street, Hanover Square  
London W1R8NQ-United Kingdom  
(01) 409-0777 (01) 409-3351  
TLX 265840 FINEST

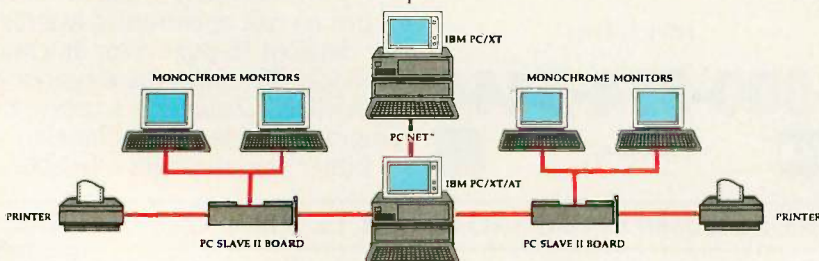



## IBM Introduces Laptop Computer

**I**BM's laptop computer, the PC Convertible, features a fold-up, removable, 80-column by 25-line liquid crystal display; two 3½-inch, 720K-byte floppy disk drives; and a rechargeable battery that can power the unit for 6 to 10 hours. Internally, the computer has a CMOS 8088 processor and 256K bytes of static CMOS RAM that can be expanded to 512K bytes. Other standard features are a 78-key keyboard, an AC power adapter, and software that includes SystemApps, a package with a scheduler, notepad, phone list, and calculator. The computer requires the recently announced DOS version 3.2.

According to IBM, the Convertible's performance is similar to that of the IBM PC, and in some tasks the laptop may be faster because of its static RAM. Reportedly, the static RAM also allows you to turn on the system and return to the same point in a program at which you turned the computer off.

Without the AC adapter the Convertible weighs 12.2 pounds and measures 15 by 12 by 2.6 inches. You can remove the LCD screen and attach a video display adapter (\$350) and either a 9-inch monochrome monitor (\$180) with a resolution of up to 640 by 200 pixels or a 13-inch RGB monitor (\$400) with 320 by 200 resolution. IBM says the computer's keyboard is compatible with other IBM PC keyboards. The laptop's keyboard includes an



The PC Convertible, IBM's laptop computer.



The Bondwell 8, an IBM PC-compatible laptop.

inverted-T cursor keypad and a function shift key that changes the cursor keys to Home, End, PgUp, and PgDn keys and sets up a slanted numeric keypad in the typewriter keys.

The back of the system contains a system bus connector to which you can daisy-chain a number of adapters. These include a parallel/serial adapter (\$195), the video display adapter, and a thermal-transfer dot-matrix printer (\$295) that

can run off the computer's battery or with the AC adapter. The printer operates at the rate of 40 cps and can print on copier, thermal, or thermal-transfer paper.

Other options include an internal 1200-bps modem (\$450) and battery charger (\$25). To allow easy transfer of data between existing desktop computers and the new machine, IBM is offering external 3½-inch floppy drives (\$395) for the IBM PC, XT, and AT and an internal 3½-inch floppy drive (\$190) that can be connected to IBM's new version

of the PC XT with a 20-megabyte hard drive.

Shortly after IBM unveiled the new computer, most major software firms announced the availability of their products in the same 3½-inch disk format that is used by the Convertible. Ashton-Tate, for example, announced 3½-inch versions of Framework II, dBASE III Plus, and MultiMate Professional Word Processor Series 3.3. Lotus Development Corp. announced 3½-inch versions of 1-2-3 and Symphony, scheduled to ship this summer and fall, respectively. Similarly, Microsoft Corp., which developed the MS-DOS 3.2 operating system for the Convertible, announced 3½-inch versions of Microsoft Word, Project, Chart, Access, and Multiplan as well as Windows and Microsoft programming languages.

A PC Convertible with 256K bytes of RAM is priced at \$1995; each additional 128K bytes of RAM costs \$195. A *Technical Reference Manual* sells for \$75, and a *Hardware Maintenance and Service Manual* costs \$150. Contact IBM Corp., Entry Systems Div., POB 1328, 5201 South Congress Ave., Boca Raton, FL 33432, (305) 982-3474. Inquiry 550.

## Bondwell's Laptop

**T**he Bondwell 8, an 11-pound portable computer that's compatible with the IBM PC, runs on a 4.77-MHz 80C88 micropro-

(continued)



cessor. The computer comes with 512K bytes of RAM, a built-in 720K-byte 3½-inch floppy disk drive, and a 300-bps modem. The portable's 80-character by 25-line backlit LCD displays graphics with a 640- by 200-pixel resolution and can be switched on and off to conserve power.

Other features include a built-in rechargeable battery pack that provides up to 8 hours of power, a real-time clock, RGB and composite color video outputs that are compatible with the IBM Color Graphics Adapter, an RS-232C serial port and Centronics parallel port, and a second disk drive port. A battery charger is included. The computer also comes with MS-DOS 2.11 and GW-BASIC 2.0 and runs all IBM PC-compatible software.

A second 3½-inch floppy disk drive and a 5¼-inch floppy disk drive are available as options.

The laptop is priced at \$1595. A second 3½-inch floppy drive sells for \$399.95, and a 5¼-inch floppy drive costs \$379.95. For more information, contact Bondwell, 3300 Seldon Court #10, Fremont, CA 94539, (415) 490-4300. Inquiry 551.

### Program for Computer-aided Mathematics

**M**athCAD, a software package for computer-aided mathematics, is designed for engineers and other technical users who need to perform numerical analysis and document the results. MathSoft says its program works like a text editor and lets you use a microcomputer as a scratch pad. You can enter and edit equations that appear on screen just as they would on paper; the software sizes brackets and fraction bars interactively as you enter an equation. MathCAD also

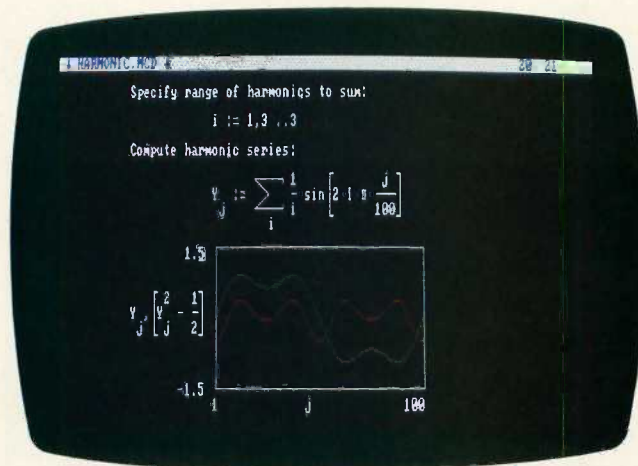

Screen shot of MathSoft's MathCAD.

automatically places exponents, subscripts, square roots, and summation signs in arbitrarily complex combinations.

After you've entered equations, you press the equal-sign key and the software computes the results, which are displayed as a number or a plot.

Math capabilities include real and complex numbers in all expressions, iterative calculations, full dimensional analysis and error checking for undefined variables and constants and radices that are improperly formed, hexadecimal and octal conversion, and variable names of any length. Plots correspond to mathematics and change as you modify equations. You can plot data as lines, dots, steps, crosses, or error bars.

MathCAD runs on the IBM PC line under MS- or PC-DOS 2.0 or later. It requires 384K bytes of RAM and a Hercules monochrome, IBM color, or IBM Enhanced Graphics Adapter card. The software works with Intel's 8087 and 80287 coprocessors. MathCAD sells for \$189. Contact MathSoft Inc., One Kendall Square, Cambridge, MA 02139, (617) 577-1017. Inquiry 552.

Marketing Dept., 6 Technology Dr., Bldg. #4, Andover, MA 01810, (617) 682-0500. Inquiry 553.

### Programmable Calculators Reside in PC Memory

**S**ymsoft has developed a pair of pop-up calculators that reside in 95K bytes of RAM and give your machine the capability to solve simple and complex mathematical problems. Pro/Sci, for engineering and scientific applications, and Pro/Biz, for business computations, let you exit the program you're working in, solve a formula, and then return to your program and bring the answer with you. And you can take a column of figures you've typed in one program and use them as part of a calculation without retyping them.

The primary differences between the two calculators are that Pro/Sci has options for displaying results in binary, octal, and hexadecimal and has trig and integration functions; Pro/Biz has predefined financial and date functions.

### Object-oriented LISP Runs on IBM PC AT

**L**ISP Machine Inc.'s ObjectLISP is an object-oriented LISP that runs under Golden Common LISP (from Gold Hill Computers) on the IBM PC AT. LMI says that unlike other object-oriented dialects, which are based on sending messages between objects, its version uses function calls. Because this "programming paradigm" uses the same syntax as normal LISP, you don't need to learn a separate syntax.

ObjectLISP's semantics don't distinguish between object classes and instances. The regular LISP environment is regarded as ObjectLISP's global object, and symbols are bound there to their ordinary global values. LMI says this function binding is similar to variable binding but associates a symbol with a definition instead of with a value.

ObjectLISP is written in, and is portable to any system that supports Common LISP. The software comes on a ½-inch magnetic tape with a user's guide and source code. A shipping and media charge of \$195 applies to the first copy, and you may make subsequent copies without obligation to LMI. Contact LISP Machine Inc.,

The calculators have two screens for computation: The main screen provides space for entering numbers, formulas, and values; the second screen replicates a calculator with an accounting-style tape output. Both programs have standard math functions, logic operators, constants, and conditional statements built in. They also offer functions for such calculations as standard deviation, variance, min/max, and averages. You can use as many as 10 variables and 100 characters (columns) per formula and loop groups of formulas in

(continued)



SuperKey, PC Magazine's "Product of the Year"

# Without SideKick, SuperKey, and Traveling SideKick, your IBM PC is only half-awake

It's sleepwalking instead of sprinting. Dawdling instead of dashing, because it's not getting the *supercharge* of a high-speed productivity booster like SuperKey, PC Magazine's "Product of the Year." Or the real-time desktop management of SideKick, the #1 best seller for the IBM PC. Or the electronic clout and Computer Age organizational skills of Traveling SideKick.

### SuperKey "macros" are electronic shortcuts to success

You avoid repetition like getting out of bed 47 times every morning, or cooking dinner 93 times every night—when once is obviously enough. But if you haven't yet discovered the time-saving power

of SuperKey, you'll find yourself typing the same set of keystrokes over and over again. Which makes no sense when a SuperKey macro cuts all that out. Macros are electronic shortcuts that can turn 1000 keystrokes into 1.

Aside from macros, SuperKey also gives you powerful encryption technology that scrambles your files and keeps confidential files confidential. It also lets you lock your keyboard, and fobs would-be intruders with secret password protection.



Combine the electronic wizardry of SuperKey with the practical efficiency of SideKick

The best way to get the most done in the shortest time is to put both SuperKey and SideKick to work. They're designed to work hand-in-hand, and their complementary talents are astounding.

### Traveling SideKick gets personal organizers out of the Stone Age into the Computer Age

If you have SideKick, you need Traveling SideKick—and if you don't have SideKick, you need them both! Traveling SideKick is a revolutionary new combination of binder and software, making a completely new category in personal organizers: BinderWare™. It prints out information that's already in your SideKick files, produces it in convenient familiar forms, then lets you

What SuperKey brings to the party includes time-saving macros, encryption, secret passwords, and programmable and re-programmable keys.

What SideKick brings includes a notepad with full-screen editing and wordwrap, a phone directory, autodialer, calculator, appointment scheduler, and ASCII table. (If you don't own a word-processing program, don't buy one, because with SuperKey and SideKick, you probably don't need one.)

Both SuperKey and SideKick work with your existing software, like Reflex™, 1-2-3®, MultiMate™, Wordstar®, Turbo Pascal®, and dBase®.

gather it all together into your Traveling SideKick binder and hit the road.

Traveling SideKick includes report-generating software which produces up-to-the-minute telephone lists, address lists, meeting schedules, travel itineraries, calendars, and much much more. It also includes instant reference maps, airline and hotel reservation numbers, international telephone codes, and currency units. You get preprinted daily/weekly/monthly/yearly calendar forms, alphabetized address book forms, and even a receipt envelope that clips inside your binder. You can order refills at any time.

### What's inside your Traveling Sidekick



TABLET OF EXTRA FORMS IN POCKET ON BACK FLAP, FOR USE IN ANY OF THE ORGANIZER SECTIONS.

ADDRESS BOOK SECTION PREPRINTED ADDRESS FORMS WITH TABBED DIVIDERS FOR EASY REFERENCE.

MISCELLANEOUS SECTION TO STORE ALL EXTRA PREPRINTED FORMS AND COMMONLY USED RECORDS.

ROLLER BALLPOINT PEN BLACK PEN THAT FITS IN FLAP FOR EASY ACCESS.

REFERENCE SECTION CONTAINS MAPS THAT SHOW AREA CODES AND TIME ZONES, TOLL-FREE NUMBERS FOR TRAVEL ACCOMMODATIONS, METRIC CONVERSION CHARTS.

FINANCE SECTION MULTI-USE LEDGER FORMS, RECEIPT LOG AND STORAGE ENVELOPE, CREDIT CARD INFORMATION.

CALENDAR SECTION YEARLY, MONTHLY, WEEKLY, AND DAILY ENGAGEMENT CALENDARS SUPPLEMENT THOSE YOU PRINT OUT WITH TRAVELING SIDEKICK.

PENDING SECTION A "TO BE CONTINUED" SECTION FOR CURRENT PROJECTS, MEETING NOTES, ETC.

CALCULATOR IN ONE OF TWO BUSINESS-CARD-SIZE STORAGE POCKETS.

TRAVELING SIDEKICK SOFTWARE GENERATES, UPDATES AND PRINTS YOUR ADDRESS AND CALENDAR FILES.

Buy one, buy two, or all three at spectacular savings

Sold separately—SuperKey is \$69.95, SideKick is \$84.95, and Traveling SideKick is \$69.95 (until September 1, 1988). Incredible values, but you can save even more. Here's how: SideKick and Traveling SideKick for only \$125.00; you save \$29.90! SideKick and Traveling SideKick and SuperKey, all three for only \$175.00; you save \$49.85!

Whichever combination you buy, you're boosting your productivity, joining the Computer Age, prodding your IBM PC awake, and getting it to do what it can do with the right kind of help—SuperKey, SideKick and Traveling SideKick!

**YES!** I want the best

To order by phone, or for a dealer near you, call (800) 255-8008 in CA call (800) 742-1133

### Rush me:

Copies	Product	Price	Totals
—	Trio	\$175.00	\$
—	SideKick and Traveling SideKick	\$125.00	\$
—	SideKick	84.95	\$
—	Traveling SideKick	*69.95	\$
—	SuperKey	69.95	\$

Outside USA add \$10 per copy CA and MA res. add sales tax \$

Amount enclosed \$

Prices include shipping to all US cities.

Payment: VISA MC Bank Draft Check

Credit card expiration date / /

Card #

You must have an IBM or true compatible running DOS 2.0 or later.†

My computer's name and model is:

The disk size I use is:  3 1/2"  5 1/4" TR15

**NOT COPY PROTECTED**  
**\*\*60-DAY MONEY-BACK GUARANTEE**

Name: \_\_\_\_\_

Shipping Address: \_\_\_\_\_

City: \_\_\_\_\_

State: \_\_\_\_\_ Zip: \_\_\_\_\_

Telephone: \_\_\_\_\_

CODs and purchase orders WILL NOT be accepted by Borland. Outside USA make payment by credit card or International Postal Money Order.

\*Limited Time Offer until September 1, 1988

\*\*YES, if within 60 days of purchase this product does not perform in accordance with our claims, call our customer service department and we will gladly arrange a refund.

†Minimum system requirements:

IBM PC, PCjr, XT, AT, or true compatible. Trio—384K, SideKick—128K, Traveling SideKick—256K, SuperKey—128K.



4585 SCOTTS VALLEY DRIVE  
SCOTTS VALLEY, CA 95066  
(408) 438-8400 TELEX: 172373

Borland products include Turbo Pascal, Turbo Prolog, Turbo Database Toolbox, Turbo Lightning, Turbo Graphics Toolbox, Turbo Tutor, Turbo ObjectWorks, Turbo Editor Toolbox, Word Wizard, Reflex, The Analyst, SideKick, SideKick, The Macintosh Office Manager, Traveling SideKick, and SuperKey—all of which are trademarks or registered trademarks of Borland International, Inc. or Borland/Analytica, Inc.

SideKick, SuperKey, and Turbo Pascal are registered trademarks and Traveling SideKick, Reflex, and BinderWare are trademarks of Borland International, Inc. or Borland/Analytica, Inc. IBM is a registered trademark of International Business Machines Corp. 1-2-3 is registered trademark of Lotus Development Corp. MultiMate is a trademark of MultiMate International Corp. Wordstar is a registered trademark of MicroPro International Corp. dBASE is a registered trademark of Ashton-Tate. Copyright 1988 Borland International. BI-1040C

Inquiry 48 for End-Users. Inquiry 49 for DEALERS ONLY.





order to run iterative calculations.

Pro/Sci and Pro/Biz run on IBM PCs or compatibles with 128K bytes of RAM and MS-DOS 2.1 or later. Each calculator costs \$99 (plus \$5 shipping). For more information, contact Symsoft, POB 4477, Mountain View, CA 94043, (415) 962-9500. To order, phone (800) 227-6703; in California, (800) 632-7979.

Inquiry 554.

## UNIX for \$99

**W**endin's multitasking, multiuser operating system for MS-DOS computers, PCUNIX, is packaged with a version of the Bourne shell, more than 70 commands, and complete source code for \$99. It can support two additional users on remote terminals connected to your machine's asynchronous communications adapters; as a multitasking system, it supports a mix of timeshared and real-time processes with an event-driven scheduler similar to that of a mainframe.

Wendin's microcomputer UNIX can run MS-DOS program images in both .COM and .EXE formats, and most MS-DOS system calls are translated to PCUNIX system services automatically and in real time. Extra system services for programming can be called from BASIC, FORTRAN, Pascal, C, and assembly.

The operating system, packaged on four disks, runs on the IBM PC family and compatibles with at least 384K bytes; it can be installed and run on a 5-megabyte hard disk. Contact Wendin Inc., Box 266, Cheney, WA 99004, (509) 235-8088. Inquiry 555.



The APC IV, NEC's 80286-based computer.

## Relational Database Language for Atari 520ST

**M**irage Concepts describes its H & D Base, a relational database management language for Atari's 520ST, as a dBASE II work-alike that's more than a storage and retrieval package. Providing almost 300 commands for manipulating data, the program can be used for building systems that handle inventories, accounts, and lists.

H & D Base works with most dBASE II command files and with all SDF and "delimited" data files. It lets you sort on any field to any level and provides full math capability on any field or variable. The number of records per file is limited only by disk capacity. You're allowed 97 fields per record, 250 characters per field, and 2000 characters per record. Numeric accuracy is eight digits.

The software incorporates a basic text editor, a help facility, a report generator, and a sample mailing-list program. H & D Base is not

copy-protected and sells for \$99.95. Contact Mirage Concepts Inc., 4055 West Shaw #108, Fresno, CA 93711, (800) 641-1441; in California, (800) 641-1442; in a foreign country, (209) 227-8369. Inquiry 556.

## NEC Announces AT Compatible

**N**EC Information Systems' Advanced Personal Computer (APC) IV is the firm's first computer specifically designed for the U.S. market and its first computer inherently compatible with the IBM PC family.

The APC IV uses a NEC equivalent of the Intel 80286 microprocessor with a switchable clock speed of 6 MHz or 8 MHz; an 80287 math coprocessor is optional. The computer can accommodate 10.5 megabytes of RAM, with up to 1 megabyte on the motherboard itself (640K bytes is standard). Other standard features include two serial ports, a parallel port, and eight expansion slots, of

which two are 8-bit full-size slots and six are 8/16-bit full-size slots. The APC's detachable keyboard has 84 keys and a numeric keypad. Display options include the Advanced Color Display monitor (\$800), which has a resolution of 800 by 560 pixels. The Power Graphics Display Monitor (\$1495), scheduled to be available next month, has 1120- by 750-pixel resolution. Both monitors have multiscan capability with a scan rate of 15.75 to 32 kHz.

The computer comes with a 1.2-megabyte floppy disk drive and can accommodate a total of five internal storage devices. Options include a second 1.2-megabyte floppy drive (\$350), a 360K-byte floppy drive (\$300), and 20- and 40-megabyte half-height hard disk drives, which cost \$1400 and \$1800, respectively.

NEC offers three optional graphics boards with the APC IV. The Color Graphics Board (\$225) supports 640- by 200-pixel resolution and is compatible with IBM's Color Graphics Adapter. The Advanced Graphics Board (\$525) is compatible with both the CGA and IBM's Enhanced Graphics Adapter, supports all of the EGA's modes as well as software written for the Hercules graphics board, and comes with 256K bytes of memory. NEC also offers the Power Graphics Board (\$995), which is compatible with IBM's Professional Graphics Adapter. Available next month, the Power Graphics Board provides a resolution of 1120 by 750 pixels and can display 16 colors from a choice of 4096 colors.

The APC IV sells for \$3795 with a single 1.2-megabyte floppy drive; \$4645 with a 1.2-megabyte floppy and 20-megabyte hard disk drive; and \$5045 with a 1.2-megabyte floppy and 40-megabyte hard disk

(continued)



Reflex, The Analyst upgrades and adds the new Reflex Workshop!

# Why running your business without Borland's Reflex and the new Reflex Workshop is an act of blind faith

Running a successful business isn't something you can do with your eyes shut, but no matter what business you're in, Reflex™ and the new Reflex Workshop™ give you all the tools and views to see what all the numbers look like.

*Using Lotus 1-2-3® or dBASE® without Reflex is like driving at night without lights*

Products such as 1-2-3 or dBASE can do the numbers for you, but you may still not get the picture—simply because they can't show you analytical graphs and pictures of your data, nor can they analyze and summarize all the information you manipulate like Reflex can.



*The best just got better. Introducing Reflex 1.1* **NEW!**

The new Reflex 1.1 with extended memory support allows you to manage huge databases of up to 8 megabytes of RAM, 32,000 records, and 250 fields per record with the now-legendary "Reflex Lightning Speed."

Furthermore, Reflex 1.1 with its EGA support displays 40 lines of information in its spreadsheet-style List View, compared to less than 25 lines displayed by traditional spreadsheets.

*Reflex gives you five graphic ways of looking at your data, five different ways of analyzing your information.*

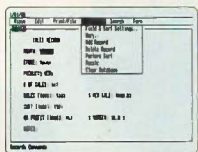

The **FORM VIEW** lets you build and examine your database.

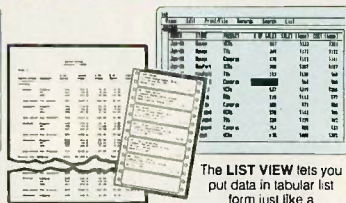

The **LIST VIEW** lets you put data in tabular list form just like a spreadsheet.

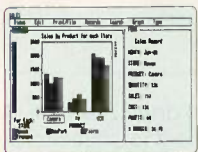

The **GRAPH VIEW** gives you instant interactive graphic representations.

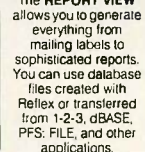

The **REPORT VIEW** allows you to generate everything from mailing labels to sophisticated reports. You can use database files created with Reflex or transferred from 1-2-3, dBASE, PFS: FILE, and other applications.

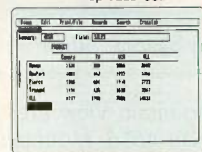

The **CROSSTAB VIEW** gives you amazing "cross-referenced" pictures of the links and relationships hidden in your data.

## SPECIAL OFFER!

*If you already bought Reflex 1.0, get Reflex 1.1 and the Reflex Workshop for only \$59.95*

Because you bought Reflex from us, you're "our kind of people." And since we're not the "take-the-money-and-run" kind of company, you can upgrade to Reflex 1.1 and the Reflex Workshop for only \$59.95. If you prefer to simply upgrade to Reflex 1.1, you can do that for only \$10.

## SPECIAL OFFER!

*You get Reflex 1.1 and the Reflex Workshop for only \$199.95\**

Sold separately, the new Reflex Workshop is \$69.95 and Reflex is \$149.95, totaling \$219.90—but you can get them both for a limited time only, at an amazing \$199.95. So act now, rush to your nearest dealer, call us, or clip the coupon and put Reflex 1.1 and the Reflex Workshop to work for you right away!

## NEW! Introducing the Reflex Workshop Only \$69.95

A major addition to Reflex, the new Reflex Workshop gives you a wide range of analytical tools written for specific applications. You can use these tools "as is" or modify them to suit your analytical and business needs. What you have to work with right away are 25 different tools:

### For Finance/Accounting:

- Business Expense Tracking
- Petty Cash Tracking
- Line of Credit Tracking & Analysis
- Accounts Receivable Tracking & Aging Analysis
- Purchase Order Entry & Analysis
- Purchase Order Tracking System
- Leasing Inventory Management
- Asset Inventory Tracking
- Cash Management Trial Balance

### For Administration:

- Membership Dues Tracking and Analysis
- Mail List
- Time Management
- Appointment Scheduling
- Applicant Tracking & Inquiry System
- Facilities Planning

### For Sales & Marketing:

- Sales Lead Tracking & Analysis
- Store Check Inventory Analysis
- Sales Analysis
- Trend Analysis
- Research Questionnaire Analysis

### For Production and Operations:

- Manufacturing Quality Assurance Tracking
- Assembly Repair Turnaround Tracking
- Commercial Real Estate Tracking & Analysis
- Project Scheduling
- Product Cost Analysis and Control

**“** The best database around . . . at any price.

Jean Lockwood,  
Computer Retail News

Everyone agrees that Reflex is the best-looking database they've ever seen.

Adam B. Green, InfoWorld

Reflex excels as an analytical tool . . . this program can become everyman's database manager.

Frank J. Derfler, PC Magazine

Borland has done it again.

Sheldon L. Richman,  
Washington Post

**YES!** I want the best

Send me Reflex and Reflex Workshop at:

**\$199.95\***

To order by phone, or for a dealer nearest you,

**call (800) 255-8008**  
in CA call (800) 742-1133

- Reflex/Workshop(s) at \$199.95\* \$ \_\_\_\_\_
- Reflex at \$149.95\* \$ \_\_\_\_\_
- Workshop at \$69.95\* \$ \_\_\_\_\_
- Upgrade to 1.1 and Workshop at \$59.95 \$ \_\_\_\_\_
- Upgrade to 1.1 at \$10.00 \$ \_\_\_\_\_

(you must return your disks)  
Outside USA add \$10 per copy  
CA and MA res. add sales tax \$ \_\_\_\_\_  
Amount enclosed \$ \_\_\_\_\_  
Prices include shipping to all U.S. cities  
†You must have an IBM or true compatible running DOS 2.0 or later.  
My computer's name and model is: \_\_\_\_\_

The disk size I use is:  3 1/2"  5 1/4"  
Payment: VISA MC Bank Draft Check  
Credit card expiration date \_\_\_\_\_  
Card # \_\_\_\_\_

**NOT COPY PROTECTED R15**  
**\*\*60-DAY MONEY-BACK GUARANTEE**

Name: \_\_\_\_\_  
Shipping Address: \_\_\_\_\_

City: \_\_\_\_\_  
State: \_\_\_\_\_ Zip: \_\_\_\_\_

Telephone: \_\_\_\_\_  
CODs and purchase orders WILL NOT be accepted by Borland.  
Outside USA make payment by credit card or International Postal Money Order.

\*Limited time offer until September 1, 1986  
\*\*YES, if within 60 days of purchase this product does not perform in accordance with our claims, call our customer service department and we will gladly arrange a refund.

†Minimum System Requirements:  
384K—Runs on IBM PC, AT, XT, and true compatibles. IBM Color Graphics Adapter, Hercules Monochrome Graphics Card or equivalent.  
Reflex works with Intel's Above Board AT and Above Board/PC, AST's RAMPage! and RAMPage! AT, Quadram's Liberty-PC and Liberty-AT, Tecmar's 640 Plus, IBM's EGA and 3270/PC, AT&T's 6300, and many others.



4585 SCOTT'S VALLEY DRIVE  
SCOTT'S VALLEY, CA 95066  
(408) 438-8400 TELEX: 172373

Borland products include Turbo Pascal; Turbo Prolog; Turbo Database Toolbox; Turbo Lightning; Turbo Graphix Toolbox; Turbo Tutor; Turbo GameWorks; Turbo Editor Toolbox; Word Wizard; Reflex; The Analyst; Reflex Workshop; SideKick; SideKick; The Macintosh Office Manager; Traveling SideKick; and SuperKey—all of which are trademarks or registered trademarks of Borland International, Inc. or Borland/Analytica, Inc.  
Reflex and Reflex Workshop are trademarks of Borland/Analytica, Inc. dBASE is a registered trademark of Ashton-Tate. Lotus 1-2-3 is a registered trademark of Lotus Development Corp. Above Board is a trademark of Intel Corp. RAMPage! is a registered trademark of AST Research Corp. Liberty is a trademark of Quadram Corp. Hercules is a trademark of Hercules Computer Tech. PFS: File is a registered trademark of Software Publishing Corp. IBM is a registered trademark of International Business Machines Corp.  
Copyright 1986 Borland International BI-1052

Inquiry 50 for End-Users. Inquiry 51 for DEALERS ONLY.





drive. All models are bundled with MS-DOS 3.1 and GW-BASIC. For more information, contact NEC Information Systems Inc., 1414 Massachusetts Ave., Boxborough, MA 01719, (617) 264-8000. Inquiry 557.

### Microcoded IBM PC Board

**D**esigned for building customized processors, the MVP Microcoded CPU/16 from Mountain View Press is an add-on board for the IBM PC that implements a high-speed microcoded processor. A wire-wrapped prototype of the board, which MVP demonstrated at the West Coast Computer Faire in April, ran one FORTH test program 50 times faster than an IBM PC alone. According to the company, the processor can execute over 2 million stack operations per second.

The card's 74-chip design includes a 16-bit ALU, two hardware stacks, an interface to the IBM PC, 128K bytes of static memory, a program counter, two 16-bit data registers, and room for 256 microcoded processor instructions. Each microcoded instruction is defined by up to eight 32-bit user-definable microcode instructions.

An Engineering Prototype Kit is available for \$1500, and a printed circuit board version should be available this month. MVP includes the following software with the wire-wrap kit: MVP FORTH/16, a word-oriented FORTH that executes directly in the processor; the MVP-FORTH Programmer's Kit; a Number Extensions package; a microcode assembler; a cross-compiler; a set of diagnostic programs; and source code for all the preceding software.

For more information, con-

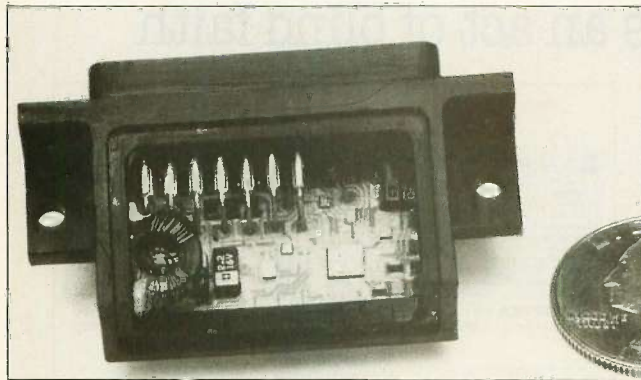

Rapitech Systems' Acticon serial connector.

tact Mountain View Press Inc., POB 4656, Mountain View, CA 94040, (415) 961-4103. Inquiry 558.

### Passport's Sequencer Runs on Apple, Commodore

**P**assport Designs has added to its MIDI Pro Series with Master Tracks, sequencing software that runs on the Commodore 64/128 and the Apple IIe/II+//Ic. The package provides real-time, step-time, and song modes.

In real-time mode, you have access to all 16 MIDI channels, with solo/mute on each track and unlimited overdubbing with the mix function. MIDI thru lets you hear any of 16 sound sources from your master keyboard. Advanced tape sync writes a variable tempo pulse to tape, reading tempo changes and allowing synchronization to visuals. The memory can handle 8000 events without loops or repeats.

The step-time editor lets you input and edit notes, rests, velocity, articulation, and tempo. You can also cut, copy, and paste phrases.

Song mode lets you assemble songs using sequences created in step time or real time. It also lets you build sequences as if

using a drum machine. As many as 256 sequences can be assembled using any of 256 steps. You can play back individual sequences in any order or tempo.

Master Tracks retails for \$249.95. Besides a computer, the software requires a Passport MIDI Interface or MIDI Pro Interface. Contact Passport Designs Inc., 625 Miramontes St., Suite 103, Half Moon Bay, CA 94019, (415) 726-0280. Inquiry 559.

### Single-Chip EGA Controller

**P**aradise Systems introduced the PEGA 1 video controller, a single-chip implementation of the IBM Enhanced Graphics Adapter standard, which currently requires a four-chip set on the IBM and other EGA boards. According to the company, the PEGA 1 will run all EGA-compatible software, including Microsoft Windows, and all previous software written for the IBM PC and compatibles. The chip supports high- and medium-resolution IBM monochrome and color graphics, Hercules monochrome graphics, Plantronics ColorPlus graphics, and

Paradise color simulation on a monochrome monitor.

Four main modules make up the 84-pin PEGA 1. These modules replace the five custom LSI parts on IBM's EGA board and a dozen supporting TTL circuits. The chip is available with a proprietary IBM-compatible video BIOS extension.

The PEGA 1 is available in sample quantities at a price of \$900 per sample; production quantities are slated for delivery by the end of the second quarter. For more information, contact Paradise Systems Inc., 217 East Grand Ave., South San Francisco, CA 94080, (415) 588-6000. Inquiry 560.

### Miniature Serial Interface

**R**apitech Systems has developed a standardized serial RS-232C connector that contains all of the circuitry usually found on a serial interface card. Called the Acticon connector, the device replaces the serial interface circuitry that, the company says, normally occupies 8 to 12 inches on a computer's motherboard or expansion board.

The Acticon connector is designed to attach to the memory bus on a motherboard through a series of pins along the bottom of the connector. The company says that the new connector will be incorporated into computers now being designed, and computers that use the connector may be available in less than a year.

The Acticon's patented design can be licensed by any computer manufacturer; licensing fees depend on volume. For more information, contact Rapitech Systems Inc., 75 Montebello Rd., Suffern, NY 10901, (800) 367-8749; in New York, (914) 368-3000. Inquiry 561.

(continued)



# THE F-15 JET FIGHTER. IF THE COMPUTER GOES DOWN SO DOES THE PLANE

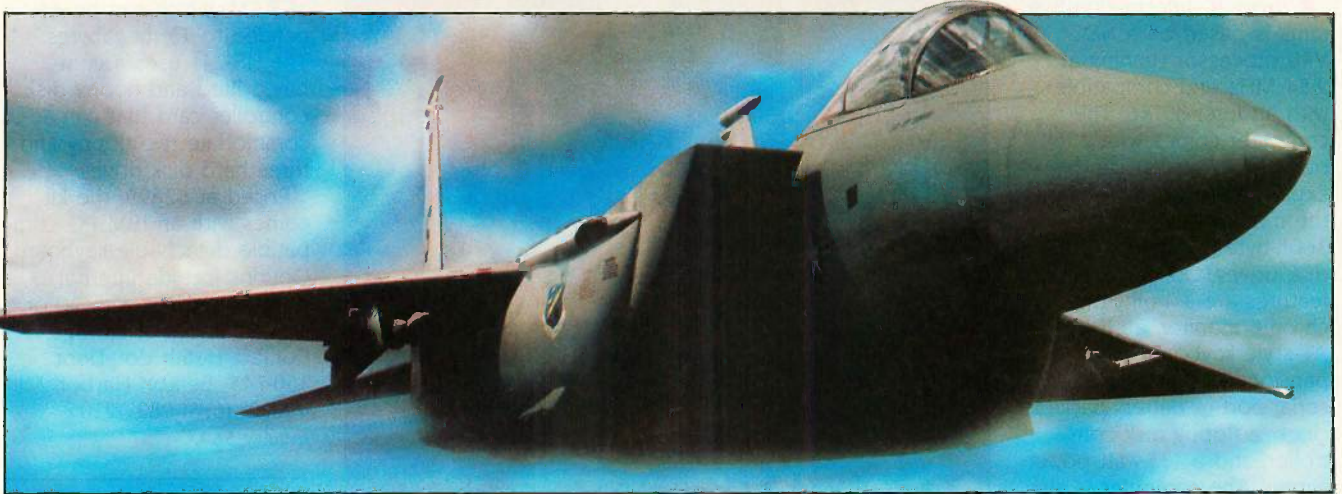

The F-15 served as a test bed for a flight control system written in the Ada language. Ada was designed to meet today's demands for a standard computer language, producing efficient, reliable and maintainable code.

## Does your compiler deliver?

Even if your programs don't do loops in mid air, and won't make a boom if they crash, you need a powerful programming language. It has to be easy to learn, structured yet flexible, compact and fast. Your programs should reflect the latest advances in hardware and software and be portable.

## Get your software off the ground!

Meet Ada. The DoD's new language of the future. Now you can run Ada on your MS-DOS or PC-DOS computer. Artek Ada is the most advanced Ada compiler for PCs.

## A new standard in software engineering

We invite you to learn, explore and use the most powerful general-purpose programming language ever, — with Artek Ada. Artek has approached the tradeoffs of Ada compiler design in a novel way. Modern software engineering techniques are applied to produce a state-of-the-art compiler.

## Artek Ada is available now

You can order the Artek Ada compiler now for only \$ 895.00 including a debugger and a screen editor. Outside the U.S.A. add \$ 20.00.

For orders or information call toll free: 1-800-PC-ARTEK, in New Jersey or outside the continental U.S.A. call (201)-867-2900, or write to our address.

VISA, MC and AMEX accepted.

New Jersey residents add 6% sales tax. Please pay with credit card or a bank draft in U.S. dollars drawn on a U.S. bank.

*Dealer and distributor inquiries welcome.*

Inquiry 28

## Artek Ada specifications

Artek Ada implements the Department of Defense 1983 Ada standard, including generics, derived types, overloading, packages, separate compilation, dynamic arrays, standard I/O, string handling, array and record aggregates and much more. The only major feature of Ada not implemented is tasking. Minimum hardware requirements are: IBM PC or a compatible computer, running MS-DOS or PC-DOS (2.0 or later version) with 384 Kb RAM and one double-sided floppy-disk drive. Artek Ada works with the IBM PC network. For further information see our information kit.

A demo diskette is available for \$ 29.95 (including p&p anywhere in the world). Ask for our free information brochure.

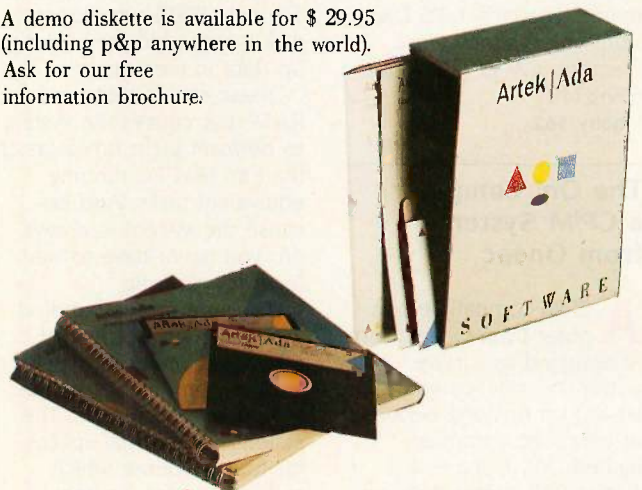

**A r t e k**

Artek Corporation 100 Seaview Drive Secaucus  
NJ 07094



## SYSTEMS

**NEC V40-based Computer**

**T**he JC LIPS computer from JC Information Systems is based on a NEC V40 processor running at 9.54 MHz and compatible with an Intel 80186. The computer comes with 256K bytes of RAM that can be expanded to 640K bytes on the motherboard and two 360K-byte half-height floppy disk drives. Other standard features are a 14-inch monochrome monitor, an IBM PC AT-style keyboard, eight expansion slots, an RS-232C serial port, a battery-backed clock, a floppy disk controller, and a 135-watt power supply. The computer is also equipped with a video display card that provides a parallel printer port and supports Hercules monochrome graphics and IBM-compatible color graphics.

The LIPS computer runs under MS-DOS versions 2.1 or 3.0 and later. The base model costs \$1495; models with hard disk drives, color monitors, and other options are also available. For more information, contact JC Information Systems, LIPS Division, 161 Whitney Place, Fremont, CA 94539, (415) 659-8440. Inquiry **562**.

**The On! Computer, a CP/M System from Oneac**

**A** CP/M-compatible computer from Oneac Corp. is designed to survive power-line glitches and to be left on for long periods of time. The computer, named On!, features a 4-MHz Z80 microprocessor and 2 to 4 megabytes of memory. The computer's memory, which is set up as a RAM disk, is intended to



The JC LIPS computer, based on a NEC V40 processor.

be the system's primary data storage device. The memory is backed up with a small battery, which Oneac claims can power the memory through outages of up to 12 hours. The system's 5¼-inch, 800K-byte floppy disk is intended for backing up data in memory.

Oneac claims that the RAM disk causes the system to perform eight times faster than an IBM PC running equivalent tasks. And because the system is always on, you never have to wait for it to warm up.

The computer is bundled with the New Word word processor, the ZCPR operating system, and a number of utilities and menus. The system has internal space for four modems, which makes it useful for unat-

tended bulletin board systems. The company says that On! is compatible with most CP/M software packages.

With 2 megabytes of memory, the On! computer sells for \$2000. It comes with a TeleVideo 955 terminal, which will be priced at less than \$599 (exact price was not available at press time). For more information, contact Oneac Corp., 27944 North Bradley Rd., Libertyville, IL 60048, (312) 680-5999. Inquiry **563**.

**Heath Introduces AT-Compatible Kit**

**H**eath's HS-241 Advanced PC Desktop Computer kit is compatible with the IBM PC AT and uses an Intel 80286 microprocessor running at 6 MHz. Standard

features include a serial and a parallel port, a single 1.2-megabyte 5¼-inch floppy disk drive, and 512K bytes of RAM, which can be expanded to 15 megabytes. The HS-241 uses a combined hard and floppy disk controller card that can accommodate two floppy and three hard disk drives.

Priced at \$2899, the kit comes with an IBM PC-compatible detachable keyboard. Options include internal hard disk drives with 20 or 40 megabytes of storage. Contact Heath Co., Dept. 150-745, Benton Harbor, MI 49022, (616) 982-3210. Inquiry **564**.

**Pick-based Multiuser System from Fujitsu**

**F**ujitsu Microsystems' System 2020 is an addition to the company's Series 2000 line of Pick-based multiuser computers. The 2020 runs on an Intel 80286 microprocessor and can accommodate eight users. It has 512K bytes of RAM that can be expanded to 1 megabyte and comes with a 54- or 86-megabyte (unformatted) hard disk drive. According to the company, the computer's operating system is fully compatible with Pick-based software and features a number of enhancements, including electronic mail, full-screen editing, and a calculator function.

Prices begin at \$8850 for the two-user system with 512K bytes of memory and 54-megabyte hard disk. Contact Fujitsu Microsystems of America, 3025 Orchard Parkway, San Jose, CA 95134, (408) 434-1160. Inquiry **565**.

(continued)



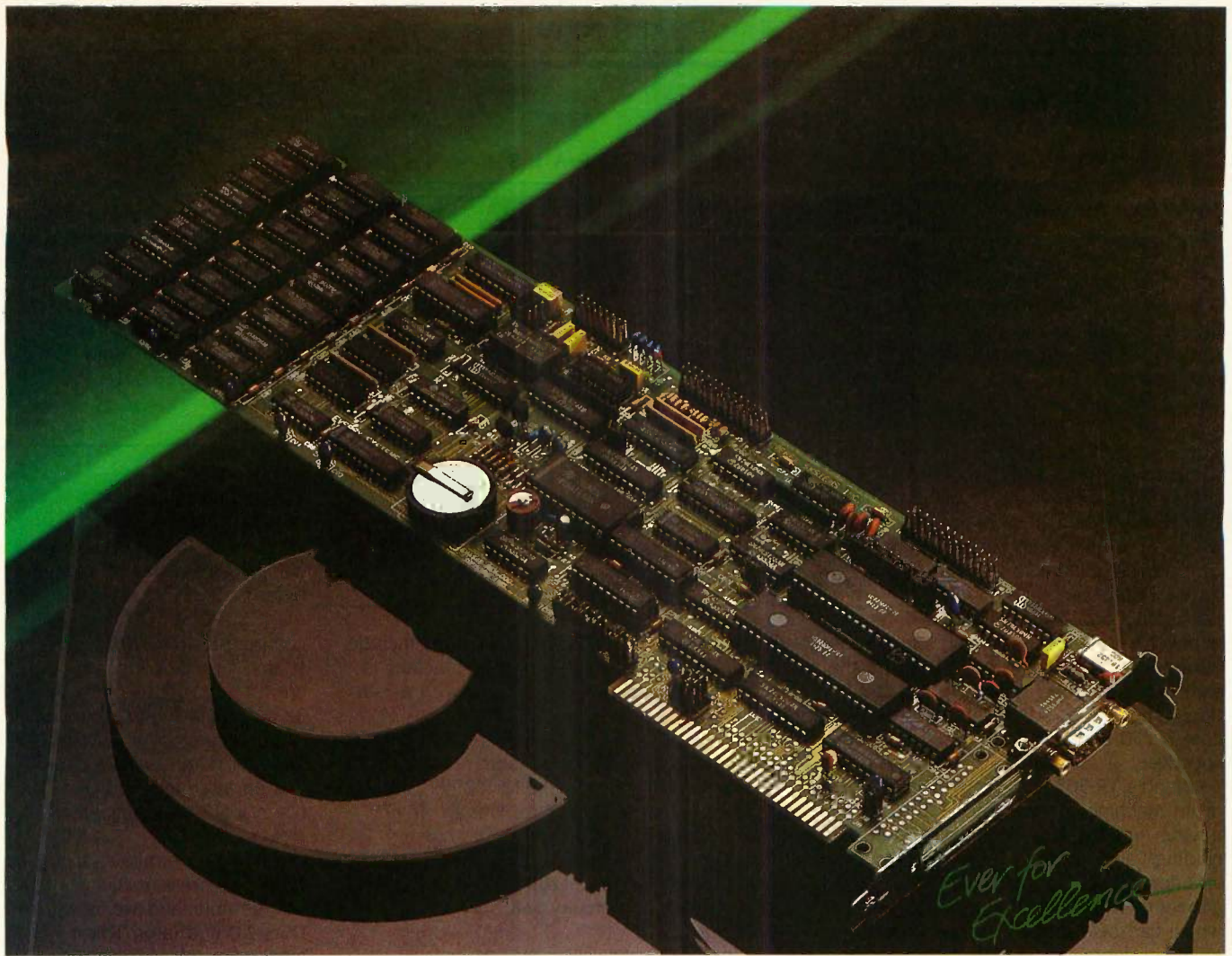

## Magic Card II ...Multifunction, \$199

The EVEREX Magic Card II is the multifunction card that has the features you want at a price you can afford. It can even take an original PC, with a 64K motherboard, to 640K of RAM. Installation is a snap with our unique TESTER program that runs independently and shows exactly where to install RAM and how to set the options.

Why pay almost twice as much to get less? EVEREX combines innovative engineering, technology, and quality manufacturing to bring you a quality product that outperforms the competition at a lower price. EVEREX engineering is the key ingredient that delivers QUALITY and FEATURES without sacrificing PRICE.

### Magic Card II in Action

See for yourself what the Magic Card II can do. Call EVEREX today for the name of the EVEREX dealer near you.

You'll be convinced that—  
EVEREX is EVER for EXcellence too!

**1-800-821-0806**

in California

**1-800-821-0807**

### Before you buy a multifunction card, check these features:

	EVEREX Magic Card II	AST Sixpak Plus
• Uses 64K or 256K Ram Chip	YES ✓	NO
• Battery Backed Clock/Calendar	YES	YES
• Parallel Port Standard- LPT1 - LPT3	YES	YES
• Two Serial Ports Standard- COM1 - COM4	YES ✓	NO
• Game Port Standard	YES ✓	NO
• Adds up to 576K RAM	YES ✓	NO
• RAM disk and print spooler software	YES	YES
• Available with zero RAM	YES ✓	NO
• Compatible with 8MHz operation	YES ✓	NO
• List Price	\$199 -0K	\$395 -64K

**EVEREX**  
EVER for EXcellence

48431 Milmont Dr. Fremont CA 94539  
(415) 498-1111

Magic Card II is a trademark of EVEREX SYSTEMS, Inc.  
SixPak Plus is a registered trademark of AST Research, Inc.



## PERIPHERALS

**Roland's Sound Samplers and Drum**

**R**oland announced two sound samplers, the S-50 and the S-10. Both can sample sounds with a resolution of 12 bits at a rate of 32K per second, yielding a bandwidth of 17 kHz. The S-10 can store 4 samples at a time and comes with a 49-key keyboard. The S-50 can store 61 samples, one each for its 61 keys. The S-50 also has an RGB and composite monitor connection that lets you connect a monitor to display information visually. Both samplers have MIDI connections. The S-10 and S-50 cost \$1250 and \$2695, respectively.

Roland's TR-505 MIDI drum machine can emulate a wide range of drums, including Latin percussion instruments. The machine also generates MIDI information, which can be captured by a MIDI sequencer, modified, and played back through the TR-505. The drum machine costs \$295.

Contact RolandCorp U.S., 7200 Dominion Circle, Los Angeles, CA 90040, (213) 685-5141. Inquiry 566.

**Dual Printer Buffer**

**T**he Proteus printer buffer and switch lets you connect two printers or other peripherals with parallel ports to your computer. The unit provides a buffer for each of the two peripherals. Both printers connected via Proteus can print at the same time, and you can switch between the two through software or manually by a switch on the front panel of the unit.

The device is available with 64K bytes or 256K bytes of memory. Each port is automatically allocated as



The TravelComm 1200 portable modem.

much memory as available, up to the maximum capacity of the buffer. With a 256K-byte unit, for example, if you print a 64K-byte file to one port, 192K bytes of memory are automatically allocated to the other port. Each port also has multiple copy capability.

A 64K-byte version costs \$199, and a 256K-byte version costs \$299. Contact Computer Friends Inc., 6415 Southwest Canyon Court, Suite #10, Portland, OR 97221. (503) 297-2321. Inquiry 567.

**Pocket-sized Modem**

**T**ouchBase Design announced the TravelComm 1200, a pocket-sized modem that communicates at 300 and 1200 bps. You can plug the 6-ounce modem directly into a computer's RS-232C port or connect it by cable to a computer via a standard RS-232C connector.

To dial, you type a phone number on your keyboard; when the modem receives two carriage returns, it turns on automatically and selects the communication rate. At the end of a connection, the modem turns off automati-

cally. Other features include a call-progress indicator and a 9-volt battery with a 3- to 6-month life.

The modem works with most portable computers and sells for \$299. Contact TouchBase Design, 1447 South Crest Dr., Los Angeles, CA 90035, (213) 277-1208. Inquiry 568.

**Robotics System**

**T**he Microbot ARMLAB System is a combination of textbooks, software, and hardware designed to teach robotics and automated manufacturing. Intended for use in junior high and high schools, college, and industry, the system leads students through robotics theory to the actual automatic manufacturing of small products.

The hardware includes two 5-axis, fully articulated robot arms; a vision system; CNC mill and lathe; rotary table; gravity feeder; conveyor; electronic and pneumatic experimenter's kits; speech system; and workcell safety barrier.

The texts include *Robot Literacy* and *Applied Robotics* by Dr. J. Larry Heath, *Robotics Workcells and Systems Interfacing* by Prof. R. Dean Eavey and

Dr. Heath, and *The Industrial Robot and Automated Manufacturing* by Dr. Del Kimbler. Prices start at \$1430. For more information, contact Microbot Inc., 453-H Raveldale Dr., Mountain View, CA 94043, (415) 968-8911. Inquiry 569.

**40-megabyte Tape Drive**

**T**he TD440 tape backup drive provides 40 megabytes of backup capacity for the IBM PC, XT, AT, and compatibles. The drive uses ¼-inch tape cartridges that are formatted into one 32-megabyte logical drive or two 17.8-megabyte drives. The unit comes with a cable and an interface card that fits in a short expansion slot.

The TD440 emulates a hard disk drive, is file-addressable, and works with DOS 2.0 and later. This means you can use DOS commands such as COPY and ERASE to manage data files and can also use the drive to store large spreadsheets or databases that might not fit on a hard disk. You can run programs directly from tape and store data on tape directly from an application program without exiting the program to use a separate backup utility. The company also provides a sector-by-sector backup utility that backs up a 10-megabyte hard disk in about 10 minutes.

The tape drive lists for \$1490. Contact Advanced Digital Information Corp., POB 2996, 10201 Willows Rd., Redmond, WA 98073, (206) 881-8004. Inquiry 570.

(continued)





Clipper is the fastest dBase III and dBase III-Plus™ compiler available. Nothing else comes close. When performance counts, experts rely on Clipper for more speed, more power, and more creative freedom. You can, too. Call for details.

- Clipper compiled programs run 2 to 20 times faster.
- No royalties...no runtime fees.
- Source code security.
- User defined functions.
- Arrays.
- Simple menu commands.
- Context sensitive help can be included with programs.
- More fields; more memory variables.
- Call C and Assembly programs.
- Complete debugging facilities.
- Multiple file relationships.
- IBM PC, XT, AT, 3270 compatible™.
- Multi-user capability.

**Clipper™**

**CLIPPER. THE dBASE COMPILER.  
A WINNING PERFORMANCE EVERY TIME.**



**Nantucket™**

Nantucket Corporation  
5995 South Sepulveda Boulevard  
Culver City, California 90230  
(213) 390-7923  
Outside California call toll-free:  
1-800-251-8438

dBase, dBase III, and dBase III Plus are trademarks of Ashton-Tate, Inc.  
IBM PC, XT, AT, and 3270 are trademarks of International Business Machines Corporation.  
Clipper and Nantucket are trademarks of Nantucket Corporation.



## ADD-INS

**Short-Slot EGA Board**

**S**igma Designs announced the SigmaEGA!, a high-resolution graphics board. Based on Sigma Designs' Color 350 board, the short-slot board supports software that runs with the IBM Enhanced Graphics Adapter (EGA), the IBM Color Graphics Adapter (CGA), the IBM Monochrome Display Adapter (MDA), and the Hercules Graphics Adapter. The board has 256K bytes of on-board RAM, which lets you run all EGA graphics modes without the need to add more memory.

The SigmaEGA! costs \$595. It works with all IBM monitors and compatible monochrome and color monitors and comes with PC Paintbrush, a graphics package by Z-Soft. Contact Sigma Designs Inc., 2023 O'Toole Ave., San Jose, CA 95131, (408) 943-9480. Inquiry 571.

**Tecmar's Music Synthesis Board**

**T**ecmar has announced a 16-oscillator music synthesis board for the IBM PC. Named the Music Synthesizer System, the new board uses what Tecmar calls harmonic interpolation synthesis to create up to 16 different notes in up to 16 different voices at one time. If fewer voices are needed, oscillators can be combined to form more intricate sounds. The board can hold up to 256K words of memory, where each word is 12 bits wide. This memory can be used to hold up to 256 wave tables, each comprising 1K words. The board can also play back sampled sounds that have been coded at the factory.

Output signals can be directed to either of two

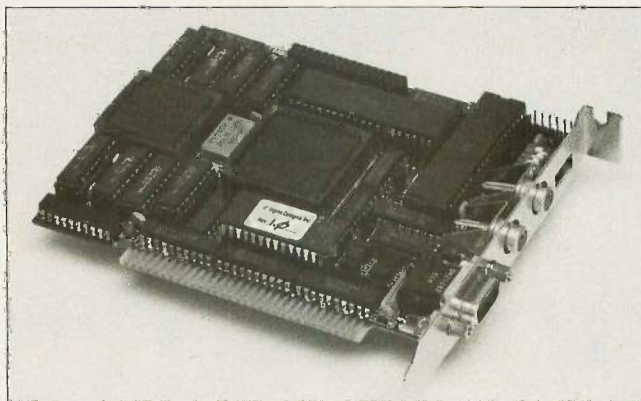

*The SigmaEGA! high-resolution graphics board.*

stereo output ports. Input can be from either the computer keyboard, an external piano-style keyboard, or an external MIDI interface. Under MIDI, the board can support up to 16 channels.

The Tecmar board includes software that allows it to function as a 64-track note recorder that can store up to 65,000 notes in a computer with 640K bytes of RAM. Up to four boards can be connected together, yielding 64 possible simultaneous sounds.

The Music Synthesizer System costs \$795 and should be available this month. It runs on IBM PCs and compatible computers with a minimum of 256K bytes of RAM, a graphics board, and at least one floppy disk drive. Contact Tecmar Inc., 6225 Cochran Rd., Solon, OH 44139, (216) 349-0600. Inquiry 572.

**Z80 Coprocessor Board for IBM PCs**

**E**arth Computers introduced the TurboSlave-PC, an 8-MHz Z80-based coprocessor board for the IBM PC, XT, AT, and compatible computers. The

board features 128K bytes of RAM, two serial ports, a port-mapped FIFO, on-board diagnostics, monitor EPROM, and the SLR Z80 assembler, Z80ASM.

The board can be configured as a coprocessor under MS-DOS and is supported by the TurboDOS operating system. Compatible with CP/M and MP/M programs, TurboDOS will support up to 16 terminals with TurboSlave-PC boards.

Suggested list price is \$395. For more information, contact Earth Computers, POB 8067, Fountain Valley, CA 92728, (714) 964-5784. Inquiry 573.

**Hard Disk Card Offers SCSI**

**T**he SCSI Hard Disk Card, from Micro Design International, is a 21-megabyte internal hard disk drive and SCSI interface for the IBM PC and compatible computers. The drive supports the ANSI X3T9.2 SCSI specification and is designed to plug into one and a half slots on the computer.

The SCSI section of the card can connect as many as six more SCSI peripherals, including internal or external tape or hard disk drives, optical disk drives, and printers.

The company also sells a version of the card for the Tandy 1000 computer. Both versions cost \$675. For more information, contact Micro Design International Inc., 6566 University Blvd., Winter Park, FL 32792, (305) 677-8333. Inquiry 574.

**AT-Compatible Card for Kaypro PC**

**K**aypro Corp. announced the 286 PC Card, which gives the 8088-based Kaypro PC compatibility with the IBM PC AT. The card retails for \$1065; if you trade in the Kaypro PC's 8088, the card costs \$799.

For more information, contact Kaypro Corp., POB N, Del Mar, CA 92014, (619) 481-4300. Inquiry 575.

**Add Megabytes to Mac Plus**

**T**he MaxPlus memory modules plug into the expansion sockets of the Macintosh Plus to provide 2 or 4 megabytes of RAM. According to the company, the modules require no special software and no hardware modifications and will work with all Macintosh power supplies.

Bundled with RAM disk and print spooling software, one set of modules provides 2 megabytes of RAM. MaxPlus costs \$499 for 2 megabytes of RAM and \$998 for 4 megabytes. Contact MacMemory Inc., 473 Macara Ave., Suite 701, Sunnyvale, CA 94086, (408) 773-9922. Inquiry 576.



# PERFORMANCE

THAT IS OUT OF THIS WORLD...



**\$389<sup>00</sup>**

**MODEL 2000 20MHz  
DUAL TRACE**

**\$549<sup>00</sup>**

**MODEL 3500 35MHz  
DUAL TRACE DELAYED SWEEP**

## ...AT A DOWN TO EARTH PRICE

At last! Truly affordable test equipment with no compromise in design, and features you would expect to find only on oscilloscopes costing hundreds of dollars more! JDR Instruments presents two, new, high-performance models backed by a two year warranty and technical support which is only a phone call away. Perfect for the technician or advanced hobbyist, both models feature Dual Trace capability and a variety of operating and triggering modes, including CH-B Subtract and X-Y operation.

MODEL 2000 has a 20 MHz bandwidth and 20 calibrated sweeps ranging from .2s to .2 $\mu$ s. A convenient built-in component tester provides additional diagnostic power.



INCLUDES TWO HIGH QUALITY  
1x, 10x TEST PROBES

MODEL 3500 features a 35 MHz bandwidth and exceptional 1mV/DIV sensitivity. Delayed sweep and variable holdoff allow stable viewing of complex waveforms.

**ORDER TOLL FREE**  
**800-538-5000**  
**800-662-6279 (CA)**

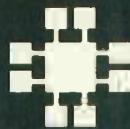

**JDR INSTRUMENTS**  
1224 South Bascom Avenue  
San Jose, California 95128 (408) 995-5430



**Modula-2 for Z80 CP/M**

**W**orkman and Associates is offering the FTL Modula-2 compiler for Z80 CP/M systems. A complete Modula-2, FTL has such features as separate compilation, procedures as parameters, open array parameters, and coprocesses.

The compiler supports real numbers with 15-digit accuracy, 2-byte integers from -32,768 to 32,767, and 2-byte cardinal numbers from 0 to 65,535. It does not offer a large integer type.

FTL provides version control through the linker, type checking between modules, and chaining between programs. It supports calls to the BIOS and BDOS of CP/M. The disk-based compiler directly creates Z80 code in the form of CP/M .COM files. Most of the libraries are written in Modula-2. The package's assembler is not compatible with other assemblers.

The editor's command structure is similar to WordStar's but adds the capability of editing three files simultaneously. You can customize the editor without getting into the source code: The install program lets you choose such characteristics as placement of the arrow key.

Workman says FTL conforms to the standard in the third edition of Niklaus Wirth's *Programming in Modula-2*.

FTL requires CP/M 2.2, 3.0, or later; a Z80; at least a 58K-byte transient program area; and one disk drive. Workman will supply the compiler on any of 190 CP/M disk formats.

For \$49.95, you get the compiler, linker, editor, assembler, library modules, library source code, manual,

and telephone support. Source code for the editor costs \$39.95. Or you can buy it all for \$79.95. Workman asks for no royalties on programs written in FTL. Contact Workman and Associates, 112 Marion Ave., Pasadena, CA 91106, (818) 796-4401. Inquiry **577**.

**Modula-2 in Source Form**

**M**odula-2 fans can now get the latest version of the compiler in source form. Modula Corporation says the new compiler, written by Niklaus Wirth, is faster because it's based on the single-pass principle. It can recompile itself in 80 seconds on a Lilith workstation, the company says.

The package includes the source to the compiler and a portable debugger in IBM PC or Lilith format, a copy of the third edition of Wirth's *Programming in Modula-2*, and technical reports on the structure of the compiler and debugger. The compiler consists of about 5000 lines of Modula-2 code.

Three versions are available: for the Lilith, the Motorola 68000 family, and the National Semiconductor 32000 family. The Lilith version produces M-code, a symmetric machine language for a pure stack computer. The other two versions have been derived from the M-code version.

Modula has ported the compiler to the IBM PC and the Macintosh.

The price for each compiler in source form is \$1000. Contact Modula Corp., 950 North University Ave., Provo, UT 84604, (800) 545-4842 or (801) 375-7400. Inquiry **578**.

**Multitasking OS for Atari ST**

**M**icro RTX is a multitasking operating system kernel for the Atari ST series. Because it's compatible with TOS, it can run regular ST programs. The system automatically handles input, output, and memory management in a multitasking environment. Programs can make standard TOS calls to perform I/O and memory management.

Once you've installed the operating system, the ST becomes a multitasking machine in which all activities are performed by processes running under Micro RTX. The number of active processes is limited only by available memory. The system uses round-robin scheduling to keep a process from consuming too much CPU time.

Micro RTX is priced at \$69.95. Contact Beckemeyer Development Tools, 592 Jean St. #304, Oakland, CA 94610, (415) 658-5318. Inquiry **579**.

**Library for C Programmers**

**P**forCe, a library package for programming in C, offers high-level functions for manipulating windows, screens of fields, and databases as objects. The object-oriented approach is designed to facilitate maintenance of modules and also to help you program in a structured style. Among the package's subsystems for handling complicated tasks are a database system with demand paging and B-trees to store access and index information; a windowing system; interrupt-driven communications; and background tasks. Source code is supplied for all functions and bundled utilities.

PforCe runs under MS-

and PC-DOS and can be used with Microsoft, Lattice, Computer Innovations, and Wizard compilers. It supports all memory modules of each compiler. The library costs \$395. Contact Phoenix Computer Products Corp., 320 Norwood Park S, Norwood, MA 02062, (617) 762-5030. Inquiry **580**.

**FORTRAN Utilities**

**F**ORTRAN Cross-Reference Utility, from PJN International, reads source files written in FORTRAN 77 and generates a program listing with symbol cross-reference maps of variables, subprogram calls, and labels for each subprogram. PJN says its software generates cross-reference maps with the same detail provided by mainframe compilers; for example, the variable cross-reference map also shows variable type, length, allocation (array/scalar), and scope (local/common).

FORTRAN Utility Library is a collection of assembly language subroutines that can give programs such capabilities as screen and cursor manipulation, direct keyboard access, command-line access, memory peek and poke, and sound generation. There's a version for Microsoft/IBM FORTRAN and one for Ryan-McFarland/IBM Professional FORTRAN compilers.

Both utilities run on IBM PCs and compatibles under DOS 2.0 or later. The cross-reference package requires 128K bytes. Cross-Reference Utility costs \$49.95. Utility Library costs \$39.95. (For each, add \$2 for shipping.) Contact PJN International, POB 201363, Austin, TX 78720-1363, (512) 837-2888. Inquiry **581**.

(continued)



**NEW RELEASE**  
EVEN MORE FEATURES

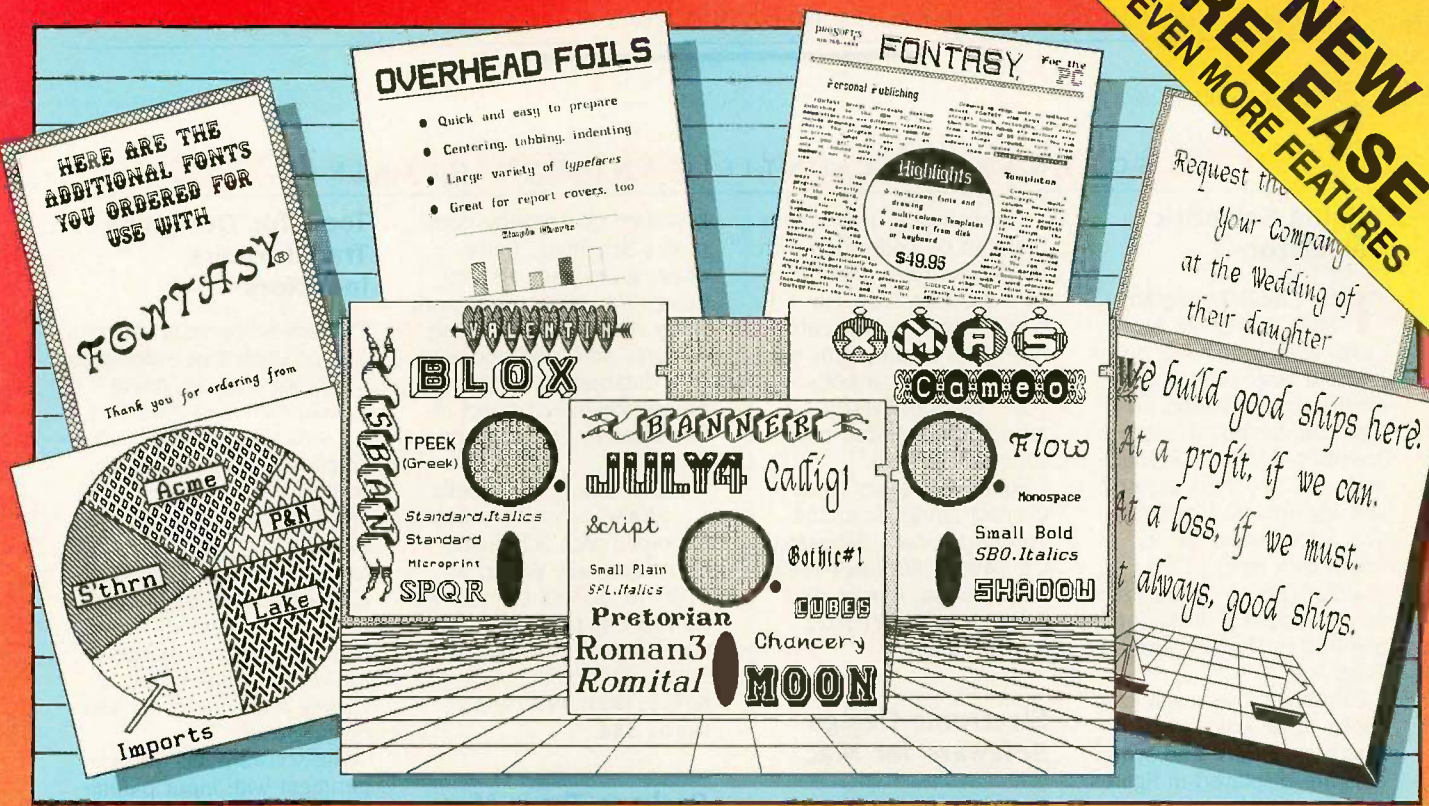

Fontasy printed all of these.

# See What You Can Do With

**P**resentations! Newsletters! Flyers! Signs! Overhead Foils! Invitations! Menus! Logos! Announcements! Banners! Layouts! When you need a goodlooking visual quickly you need FONTASY — superb typefaces and simple drawing in one easy-to-use package.

FONTASY gives you a "what-you-see-is-what-you-get" picture, as you type and draw on the graphics screen of your IBM-PC. You can create a page at a time, see a mini-picture of that page, print it, and save it on disk. Page size is limited only by memory, not by screen size.

## Features

Proportional space, justify, kern, bold-face, rearrange, magnify, black/white reversal, rotate, mirror image, lines, rectangles, ovals, draw, fill-in, undo (and un-undo), on-line help, 200-page book, and easy control from keyboard or mouse. Corporate licenses available.

Fonts, fonts, and more fonts! We have over 275 typefaces in our growing library, and will be happy to send you free print samples on request.

When you deal directly with the manufacturer (that's us), you pay rock-bottom distributor prices. If you order FONTASY now, we will give you 28 fonts (a \$50 value) at no extra charge. With so many features at such a low price, FONTASY belongs in your software library even if you already have a "font" program.



**\$69<sup>95</sup>**  
Includes 28 Fonts and free ClipArt.

## Equipment Needed

IBM-PC, XT, AT, or true compatible (Compaq, etc.) with IBM or Hercules graphics adapter and graphics monitor. 256K memory needed for partial pages, 448-640K recommended for full pages. Dot-matrix printer. Mouse optional. MS-DOS 2.00 or above.

FONTASY supports: IBM graphics printer, Proprinter; Epson FX, JX, LX, MX, RX, and LQ-1500; C. Itoh 8510, 1550, 1570. Pro-writer-Jr; H-P LaserJet, ThinkJet; Microline 92, 93; Gemini 10X, 15X; Radio Shack DMP 105-430, 2100; Toshiba 351, 1340-1351; Star; and most Epson-compatibles.

## Money-Back Guarantee

Fontasy is not copy-protected and has a 30 day money-back guarantee. So, take advantage of our breakthrough price and order now TOLL-FREE:

**1-800-824-7888, operator 669 (ORDERS ONLY)**

For further information and same day shipping, call: (818) 765-4444

**PROSOFT®**

7248 Bellaire Ave., Box 560  
No. Hollywood, CA 91603-0560

**FONTASY \$69.95**

Tax \_\_\_\_\_  
Shipping \_\_\_\_\_  
Total \_\_\_\_\_

Name \_\_\_\_\_ Company \_\_\_\_\_  
Address \_\_\_\_\_ Telephone \_\_\_\_\_  
City, State, ZIP \_\_\_\_\_  
Visa/MC \_\_\_\_\_ Exp. Date \_\_\_\_\_  
Computer \_\_\_\_\_ Memory \_\_\_\_\_ Printer \_\_\_\_\_

Terms: M/C, Visa, checks. Please add \$3.00 shipping and handling in U.S. or Canada, \$20.00 overseas, \$2.00 for C.O.D., and sales tax in Calif.



## Talking Scientific Calculator

The Calc-Talk program from Computer Aids Corp. combines voice output and large-print display on the Apple IIc and IIe. It turns the keyboard into a scientific-calculator keypad and provides trigonometric and logarithmic functions. The voice-output facility works with most of the popular speech synthesizers for the Apple II, including Slot-Buster, DecTalk, and the Echo line.

Calc-Talk causes each key-stroke to be voiced. Numbers, letters, and symbols are displayed in figures almost an inch high.

The software runs on a IIc or IIe with 128K bytes of memory and an 80-column card. It costs \$75.

Also, the company has released a new version of Braille-Talk, its talking text-to-braille translator. The enhanced edition is ProDOS-based and can translate 10 double-spaced pages in slightly more than 2 minutes. It costs \$125. Contact Computer Aids Corp., 124 West Washington, Lower Arcade, Fort Wayne, IN 46802, (800) 647-8255. Inquiry 582.

## Data Grapher for Scientists

Jandel Scientific has developed a program designed specifically for scientists who want to draw graphs and charts of data. Sigma-Plot, which runs on the IBM PC series and compatibles and works with HP-compatible plotters, can produce line, scatter, histogram, and bar charts. The program also features error bars, *log-log scales*, *semilog scales*, independent *x, y* plotting, cubic spline curve fitting, and linear regression.

The software uses menus that can be controlled with the keyboard or the cursor of a digitizer. Data can come from the keyboard, from files of programs such as dBASE II/III or Lotus 1-2-3, or from files of Jandel's Sigma-Scan measurement system.

Sigma-Plot costs \$350. Contact Jandel Scientific, 2656 Bridgeway, Sausalito, CA 94965, (800) 874-1888; in California, Alaska, and Canada, (415) 331-3022. Inquiry 583.

## Electronic Design Software for Mac

Advanced Engineering Solutions has released the second product in its ParaGenesis series of CAE software. Digital MacroScope lets you perform gate and functional-level digital simulations on a Macintosh Plus or a 512K Macintosh with an external drive.

The package enables you to run three types of simulation: 12-state logical, physical, and parametric. The 12-state mode resolves true, false, strong, weak, conflicting, and undefined logic states. The physical mode computes the gates' output rise and fall times from the source and sink current driving load and input capacitances. The parametric mode lets you vary voltages and temperatures and monitor power consumption in the network.

The package's Simulation Design Language includes state and parametric information that you can edit. You can describe logical blocks or use standard gates and MSI chips that are defined in the component libraries.

You can enter the circuit to be simulated from the

keyboard or from the company's Schematic Entry drawing program. As you design the circuit, Schematic Entry compiles a database of parts, pins, and nodes. This database automatically passes the interconnect information to Digital MacroScope.

Digital MacroScope sells for \$1000, or you can buy it packaged with Schematic Entry, normally priced at \$700, for \$1500. Contact Advanced Engineering Solutions Inc., 75 Manhattan Dr., Suite 302, Boulder, CO 80303, (303) 499-2910. Inquiry 584.

## Package Turns Mac into Speech Lab

MacSpeech Lab from GW Instruments converts the 512K Macintosh into a workstation for analyzing speech and testing people who are speech-impaired. The package lets you view, edit, play, and store speech. With GW's MacADIOS data-acquisition hardware, you can digitally record words at rates of up to 20,000 samples per second.

You can view time and frequency representations of speech at positions you select with the mouse. Segments within utterances can be amplified, offset, normalized, saved, and played. The software produces sound spectrograms showing the progression of frequency spectra with time. It also draws pitch plots to show the changes of frequency within an utterance.

A complete MacSpeech Lab consists of software (\$300), MacADIOS hardware (\$2500), and a Macintosh computer (\$2000). Contact GW Instruments, POB 547, Cambridge, MA 02142, (617) 577-1524. Inquiry 585.

## Tools for Designing Transformers, Inductors

Tech Software is selling a program that automates the process of designing transformers and inductors for switching power supplies. Applications include work with push-pull, single-ended, and flyback transformers or buck, boost, and filter inductors. The company says its product relieves engineers of having to perform long-hand calculations or checking vendor catalogs to choose magnetic cores and magnet wire.

The software lets you experiment with input parameter values (such as input power, core size, and number of windings) to find their effect on program outputs. Tech Software says magnetics modeling and automatic core selection are two essential features of these tools. The package uses design equations that determine core size, wire size, magnetization inductance, permeability, flux density, and air gap length. Lookup tables contain the physical parameters that characterize each magnetic core.

The software uses menu screens to take you through the design process. These screens show I/O parameters, engineering units, current values, and program options.

The package costs \$149 and runs on these machines: IBM PC series and compatibles with 128K; CP/M 2.2 computers with 64K; and Apple II+, IIe, and IIc computers with 64K. Contact Tech Software Corp., POB 3126, Redmond, WA 98052, (206) 483-9699. Inquiry 586.

(continued)





# FILE RECOVERY SYSTEM™

FOR THE IBM-PC

*"Brown Bag Software's™ File Recovery System™...  
more powerful than the Norton Utility Version 3.1."*

*—PC Magazine*

## We May Be Able To Save Your Job Or Your Life

# \$69.95

**Recover Erased Files**  
**Edit Any Spot On A Disk**  
**Change File Attributes**

**Fix A Damaged File**  
**Menu-Driven and "Goof-Proof"**  
**Context Sensitive Help**

**Recover Data From Physically Damaged Disks**  
**Works On Hard And Floppy Disks**

**YES YOU CAN RECOVER ERASED FILES.** Even\*.\* With Brown Bag Software's™ File Recovery System™ for the IBM-PC and compatibles, no programming experience required. If you can erase a file, you can restore it.

**MENU-DRIVEN** and "FOOL-PROOF..." Do you have "one-of-those" in your office...we do too! That's precisely why we developed Brown Bag Software's™ File Recovery System™ for the IBM-PC and compatibles! Our menu-driven system is a snap.

**FIX A DAMAGED FILE TOO!** Sometimes files can get "glitched," by a power spike, bumping into the hard disk, dropping the computer on the floor, etc. We understand. That's why we've included a full screen editor to repair any spot in any file, hidden or otherwise.

**IS IT HARD OR FLOPPY?** We don't care. We work with floppy disk, most hard disks, and most IBM-PC compatible computers.

**HELP IS ONLINE TOO!** We know that most people don't read manuals. (But we include a comprehensive one anyway.) And when you erase a file and need it recovered NOW, you're not in any frame of mind to pour through any manual. We understand. That's why we've put hand-holding online. Just hit the ? key and the help appropriate to where you are and what you want to do is immediately available. The only thing better would be two aspirins!

**OTHER HANDY TOOLS...HELP: WHERE'D THE FILE GO?** We provide menu-driven tools to change a file's attributes, change disk labels, modify screen color, locate a lost file that you know is somewhere on the disk, but it's lost in a maze of sub-directories (you forgot which).

**WITH YOUR CREDIT CARD, CALL NOW**  
**24 HOURS A DAY, 7 DAYS A WEEK**

## 800-523-0764

IF LINE IS BUSY OR YOU LIVE IN CALIFORNIA

**CALL: 408-559-4545**



## MIDI Studio for Amiga

**S**oundScape software combines MIDI, sampling, and multitrack recording on an Amiga computer. Mimetics says its program is actually an operating system that resides simultaneously with the Amiga's DOS and Workbench.

The main program consists of a multitrack music sequencer with an unlimited number of MIDI-compatible tracks. You can put each track in play, record, mute, thru, or "match" mode (Match mode can be used to learn or practice a piece of music; it stops playback until you've played the notes in the selected track.) A time-oriented editing system lets you cut and paste using a mouse.

SoundScape works with keyboards plugged into the second game port, the internal sound synthesizer, MIDI I/O, pitch followers, and the computer's keyboard. It costs \$149. Contact Mimetics, 16360 Stevens Canyon Rd., Cupertino, CA 95014, (408) 741-0117. Inquiry **587**.

## Object-oriented Drawing Program Runs on Atari ST

**E**asy-Draw, an object-oriented art program for the Atari ST, can be used to create business and presentation graphics, line drawings, and multiple-layer illustrations. The package lets you move and manipulate objects, copy them, rotate them, and stretch and size them. You can zoom in on any area, pick from predefined patterns, use shadowing, and use rules and grids.

The program provides two windows for working in. You can move and copy draw-

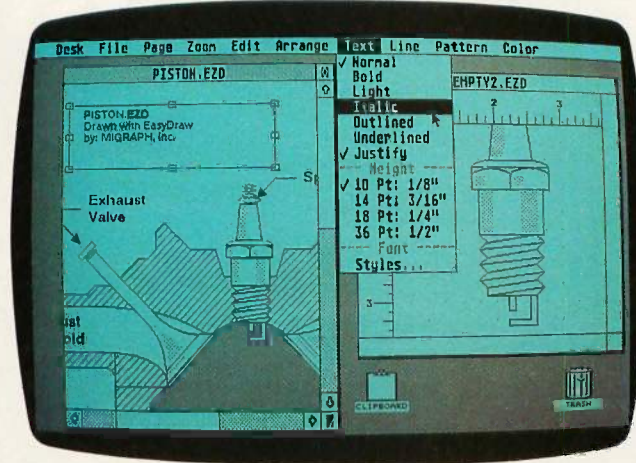

Easy-Draw, an object-oriented program for the Atari ST.

ings between windows. Easy-Draw uses high-resolution output for printing.

The software runs on a color or monochrome ST. Suggested retail price is \$149.95. Contact Migraph Inc., 720 South 333rd St. Suite 201, Federal Way, WA 98003, (206) 838-4677. Inquiry **588**.

## Music Plotter for Apples

**P**ersonal Music Engraver, described by developer Newgo Inc. as a professional music calligraphy program, automates the process of putting music to paper. The software, which works with an x, y plotter to produce music characters, runs on the Apple II+, IIc, and IIe.

Newgo says the program works like a word processor. It is smart enough to check

your "musical grammar" while you type, and it automatically displays notes with the correct stem length and direction. The editor lets you change, delete, or insert measures anywhere in any part. The package also lets you transpose notes, control page format (including spacing between staves and number of staves per page), set horizontal spacing, and use 10 font sizes. Personal Music Engraver can print complete scores (with an upgrade), lead sheets, charts, exercises, and templates with blank measures.

The program requires an XY plotter with DMPL-IV language (for example, the Houston Instrument PC-695 or DMP-29). Personal Music Engraver sells for \$1395; the upgrade that lets it produce complete scores costs \$29.95. Contact Music Graphics Inc., POB 22,

Winchester, VA 22601-0022, (703) 665-0239. Inquiry **589**.

## Mail Program for LANs Features Multimedia Messages

**P**CC/Systems has released cc:Mail for local-area networks of IBM PCs and compatibles. The software lets you write, store, send, and receive electronic messages that can consist of anything you can create with your microcomputer, including text, graphics, and data files. The program has a word processor and a graphics package, and it's capable of capturing screens from application programs; you can then edit these snapshots and insert them in your messages. Each message can combine as many as 20 text, graphics, and file items.

It takes one keystroke to send mail. You can request a receipt telling you when the recipient got the message. You can store mail in up to 100 personal folders, each of which can hold 500 messages. Mail can be exchanged between cc:Mail systems on dissimilar LANs. The software is designed to operate on networks with single or multiple file servers. Communications use X-PC error correction. All database files are encrypted.

The software runs under DOS 2.0 or later on IBM PCs and compatibles with at least 320K bytes of RAM and a Hayes or compatible modem. A 10-user starter version of cc:Mail for LANs costs \$995. Contact PCC/Systems, 480 California Ave., Suite 201, Palo Alto, CA 94306, (415) 321-0430. Inquiry **590**. ■

### WHERE DO NEW PRODUCT ITEMS COME FROM?

*The new products listed in this section of BYTE are chosen from the thousands of press releases, letters, and telephone calls we receive each month from manufacturers, distributors, designers, and readers. The basic criteria for selection for publication are: (a) does a product match our readers' interests? and (b) is it new or is it simply a reintroduction of an old item? Because of the volume of submissions we must sort through every month, the items we publish are based on vendors' statements and are not individually verified. If you want your product to be considered for publication (at no charge), send full information about it, including its price and an address and telephone number where a reader can get further information, to New Products Editor, BYTE, One Phoenix Mill Lane, Peterborough, NH 03458.*



# LOOKING FOR THE BEST VALUE IN PC/AT COMPATIBLES?



## INTRODUCING THE \$1495 A★STAR™

Looking for a lower priced, higher quality PC/AT compatible than our new A★Star™ is like looking for a needle in a haystack. You're more apt to come up with a case of hayfever.

A★Star gives you features you won't get from any other vendor. Not IBM. Not Compaq. Not even those foreign manufacturers. Features like a 220 watt power supply, eight available expansion slots and "network ready" multi-user operation. All for only \$1495. And that price includes a 1.2MB diskette drive, 512KB memory, a fixed disk/diskette drive controller, a tactile feedback keyboard (you'll love it!) and a 6/8MHz switch/software selectable 80286 CPU.

Best of all, A★Star is quality built right here in America by Wells American Corporation - an American Stock Exchange manufacturer. So now you

can buy with confidence from a vendor you can trust, just like you've trusted IBM. And you'll get a genuine, top quality product (not a cheap imitation) for a price even less than those "questionable" mail order clones. And if that's not enough, it's all money-back guaranteed!

The \$1495 Wells American A★Star.™



### A PC/AT FOR ONLY \$1495? THAT'S NOTHING TO SNEEZE AT!

[Hurry! This offer is limited.]

- I'm tired of sneezing! Have someone call me immediately to take my order.
- A★Star sounds terrific. Tell me more.

Name: \_\_\_\_\_

Company: \_\_\_\_\_

Phone: \_\_\_\_\_

Address: \_\_\_\_\_

City: \_\_\_\_\_

State: \_\_\_\_\_ Zip: \_\_\_\_\_



**Wells American**

803/796-7800 • TWX 510-601-2645  
Sunset Boulevard • West Columbia, SC 29169



# 3.5" DISK DRIVE

FOR YOUR PC OR COMPATIBLE

Supports the new IBM PC Convertible

**NEW PRODUCTS** MANZANA's line of 3.5 inch External Diskette Drives now includes new low-cost models which derive power from the host computer. These carefully designed peripherals run on IBM PC, XT, AT and many compatibles including AT&T 6300, Compaq, Tandy 1000. Prices from \$355.

All Manzana systems come with our sophisticated but easy-to-use software package . . . allowing you to read & write to many 3.5" formats including:

IBM Convertible, Toshiba T1100, HP110 & 150, Atari 520 ST, DG/One, GRiDCase, Kaypro 2000, Tandy 600.

Compatible with all DOS 2.0 and above.



**MANZANA . . . the Industry Pioneer in 3.5" Peripherals**

For more information, contact your dealer or call direct.

In Canada, please contact Quay Computer Corp. at (416) 629-1570



**MANZANA™**

P.O. Box 2117  
Goleta, CA 93118  
(805) 968-1387

# CLUBS AND NEWSLETTERS

**MICRO MUSICIAN.** 11514 Ventura Blvd. #A-3, Studio City, CA 91604. (818) 508-8079. Monthly news on software, hardware, synthesizers, and MIDI information. Annual subscription: \$22.

**INPUT/OUTPUT.** Box 248, Station B, Ottawa K1P 6C4, Canada. Quarterly newsletter promotes peaceful uses of technology, especially computer technology.

**THE SMART APPLE CLUB (TSAC).** 53 Hemlock Ave., Narragansett, RI 02882. Public domain library, newsletter, and BBS.

**GULF COAST COMPUTER CLUB.** POB 1104, Port Richey, FL 34288-1104. (813) 868-0176. Meetings twice a month.

**APPLE PORTLAND PROGRAM LIBRARY EXCHANGE (APPLE).** POB 1608, Beaverton, OR 97075. Monthly newsletter, public domain software. Send SASE.

**COMMODORE-PET USER GROUP (C-PUG).** John Palmer, 2308 Houma Blvd., Apt. 724, Metairie, LA 70001. Send SASE for more information.

**AVIATION AND COMPUTER ENTHUSIASTS (ACE).** Carl Bogardus, 1220 Birch Dr., Las Cruces, NM 88001. Open to all; \$5 annual dues includes quarterly newsletter.

**DELLASONTA COMPUTER CLUB.** 12 Jalan Tera, Bandung 40111, Indonesia. Special interest groups, regular meetings, monthly newsletter.

**MICROTHEATER.** Room 146, Fine Arts Center Building, University of Massachusetts, Amherst, MA 01003. (413) 545-0480. Free bimonthly newsletter for computerists in entertainment.

**68000 CLUB.** c/o Software Only, Meadow Park Plaza, 22753 Hawthorne Blvd., Torrance, CA 90505. (213) 373-0466. Newsletter, public domain library, tech support. Annual dues: \$25.

**PASADENA IBM USER'S GROUP.** Steve Bass, 711 East Walnut St., Pasadena, CA 91101. (818) 795-2300. Monthly meetings. Dues: \$2 per meeting.

**TECH CLUB.** c/o Software Only, Meadow Park Plaza, 22753 Hawthorne Blvd., Torrance, CA 90505. (213) 373-0466. News, library, and support for scientists, mathematicians, engineers, and programmers. Annual dues: \$25.

**DENVER AMATEUR COMPUTER SOCIETY (DACs).** POB 477, Wheat Ridge, CO 80034. Monthly newsletters and meetings.

**THE DELAWARE VALLEY DEC PC USER GROUP.** c/o MICRODOC, 815 Carpenter Lane, Philadelphia, PA 19119. Newsletter and meetings.

**BAY AREA NEC/MODEL 100 USER'S GROUP.** c/o Truly Portable, POB 2916, Oakland, CA 94609. Meetings, newsletter, public domain software library. Annual dues: \$10.

**SANYO USERS GROUP OF WASHINGTON.** Douglas Webbink, POB 2468, Fairfax, VA 22031. (703) 323-9663. Monthly meetings, newsletter, public domain library, SIGs; \$15 annual dues.

**DIGITAL ENCRYPTION STANDARD USERS GROUP.** R. M. Richardson, POB 1065, Chautauqua, NY 14772. (716) 753-2654. Newsletter for microcomputer cryptoanalysts. Send SASE for details.

**MATAMATA COMPUTER CLUB.** C. James Elliot, Alameda Junior High School, 1211 Calle Luna, Santa Fe, NM 97501. Logo for students on HP 110 and Apple computers.

**PUBLIC DOMAIN CLUB.** POB 6877, Dept. 3, Hollywood, FL 33021. Free Apple and IBM public domain programs. Club membership free with first order.

**THE III MAGAZINE.** 3201 Murchison Way, Carmichael, CA 95608. (916) 485-6525. Published monthly; support for Apple III loyalists. Annual subscription: \$40. ■

CLUBS AND NEWSLETTERS is an acknowledgment of new clubs and newsletters received at BYTE. Allow at least four months for your club's mention to appear. Send information to BYTE, Clubs and Newsletters, One Phoenix Mill Lane, Peterborough, NH 03458.



## Apple Inside Apple

Vol. 2, No. 2

We're just not making Macintosh™ computers like we used to make them.

We're making them better.

Now they're twice as powerful. They're more expandable. And they're significantly faster.

We call our newest Macintosh, Macintosh Plus.

By Plus, we refer to a full

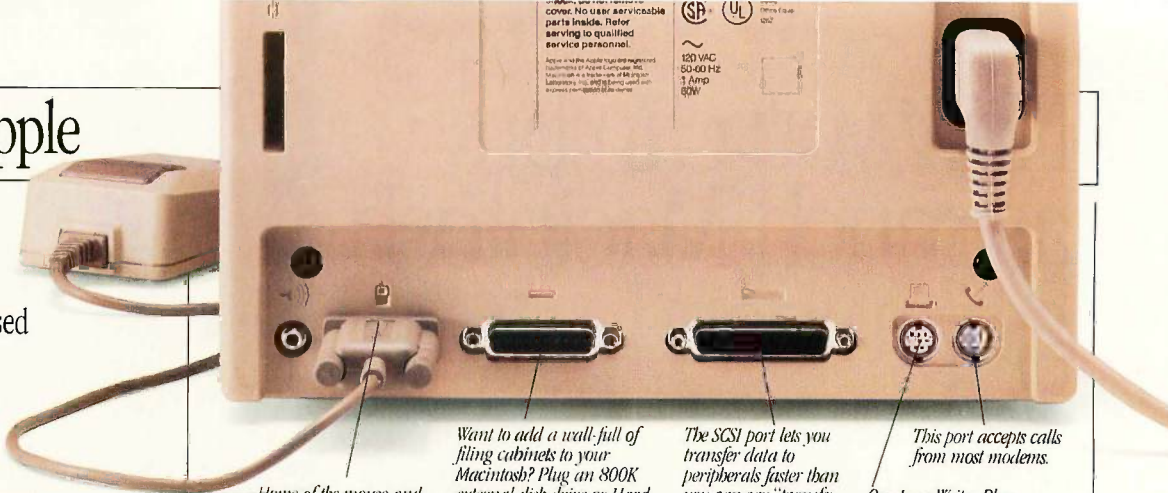

Home of the mouse and other cursor tools.

Want to add a wall-full of filing cabinets to your Macintosh? Plug an 800K external disk drive or Hard Disk 20 here.

The SCSI port lets you transfer data to peripherals faster than you can say "transfer data to peripherals."

This port accepts calls from most modems. Our LaserWriter Plus printer goes here.

By Plus, we refer to its new, 800K double-sided disk drive, that allows you to store twice as much by using both sides of a floppy.

By Plus, we refer to 128K of

And by Plus, we refer to the added cursor keys and a built-in numeric keypad that let you do your adding, subtracting, guessing and bottom-lining without lifting your hands from the keyboard. Or your eyes from the screen.

But to fully understand the biggest turn-around in Macintosh Plus engineering, all you need do is turn around any Macintosh Plus.

And behold, a Small Computer Systems Interface port.

# Look what our own engineers did behind our back.

megabyte of RAM that gives Macintosh the power to take advantage of the most powerful software programs ever driven with a point and click.

ROM that makes Macintosh perform more efficiently. And a sophisticated hierarchical filing system that enables you to find things faster than you used to lose them.

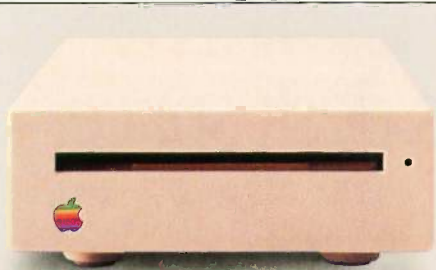

## Is there enough storage space in your office?

It's only 7 $\frac{7}{8}$  x 1 $\frac{7}{8}$  x 4 $\frac{3}{4}$  inches on the outside, yet big enough to store over 400 pages of data on the inside.

We're talking, of course, about our new and faster 800K external disk drive.

Like the internal drive in our new Macintosh Plus, our external drive also uses 800K double-sided 3 $\frac{1}{2}$ " disks. Which virtually eliminate the words "disk is full" from the Macintosh vocabulary.

And you can even daisy chain an extra external drive off an Apple® Hard Disk 20, giving you the capacity to work at extraordinary speeds with larger documents.

Like your own personal copy of the Des Moines white pages.



Macintosh Plus

Better known in computer circles as a SCSI port.

The SCSI port not only allows you to transfer data six times faster, but lets you connect up to seven high-speed peripherals at once. Including hard disks and tape drives.

Needless to say, we've given ourselves a considerable kick in the backside.

And if you read on, we'll show you how to turn the Macintosh that's sitting on your desk into the Macintosh sitting on this page.



# Now you can buy as much Macintosh as you need.

Now that there's more than one Macintosh to choose from, you're probably wondering which one to choose.

Well, for you power-mongers out there, we recommend the Macintosh Plus. The computer whose powerful features adorn the previous page.

But if you don't need a full megabyte of memory, we recommend the newly enhanced Macintosh 512K.

By enhanced, we mean we've taken our Macintosh 512K and added an 800K internal disk drive and 128K of internal ROM.

Which makes it more than capable of handling all your computing chores. Even though it costs considerably less than a Macintosh Plus.



*Macintosh Plus Disk Drive Kit.*

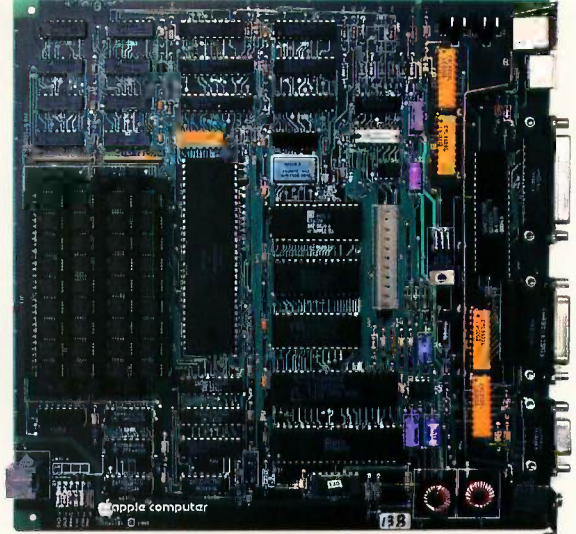

*Macintosh Plus Logic Board.*



*Macintosh Plus Keyboard.*

And should the day come that you want to sort out a database faster than you can take a sip of coffee, you can always upgrade from a 128K, a 512K or enhanced 512K to a Plus.

All at once. Or a little at a time.

We recommend you start with the Macintosh Plus Disk Drive Kit. That's where we install the new 128K of ROM, the hierarchical filing system and the 800K internal

disk drive (Of course, the enhanced 512K already has these features).

After that, you can bump your RAM up to 1Mb with the Macintosh Plus Logic Board Kit. And add a new rear housing and SCSI port.

And finally, you can attach our keyboard that comes with the keypad and cursor keys.

The point being, the more you put into a Macintosh, the more you get out of one.

## Disk space vs. desk space.

It used to be, adding a hard disk to your computer meant giving something up: a big chunk of desktop.

Enter the new Apple Hard Disk 20. Since it has the same footprint as Macintosh Plus, it fits directly beneath it.

This not only makes Macintosh Plus a few inches taller, but about 25 times bigger. Because you can install all the programs you currently keep on floppy disks on the Hard Disk 20's disk. So you

don't have to swap disks to switch applications.

And the Hard Disk 20's Winchester, 20-megabyte technology allows you to cut and paste, switch from application to application, and access information up to three times faster than you can using floppy disks.

The Hard Disk 20 really gives you the best of two worlds.

You get more disk space to work with. And more desk space to work on.



*Apple Hard Disk 20.*



# Meet the press.

Here's all the news that's fit to print about our new LaserWriter™ Plus printer.

For starters, it isn't just a printer. It's also a computer.

Inside is the same Motorola 68000 microprocessor that's inside Macintosh Plus. Not to mention a hefty 15-megabyte of RAM and a full megabyte of ROM.

And inside the ROM is POSTSCRIPT®, the page description language that is quickly becoming the industry standard.

Translated, this means LaserWriter Plus can quickly and

POSTSCRIPT also allows the LaserWriter Plus to generate dozens of different type styles from its 11

Writer Plus to generate hundreds of different type sizes, too. So you can create legal documents with fine print as fine as 4-point. Or banners with blocks of type as big as 720-point.

But those aren't the only pluses to the LaserWriter Plus.

When you hook one up to a Macintosh Plus, you become the proud owner of one of our Desktop Publishing Plus™ systems. A system that virtually puts a design studio, a type house and a print shop on your desk. Which means your newsletters, flyers, forms and manuals will stand out in a world full of typewritten pages thick with white-out.

We could easily go on and on. Instead, we'll let our LaserWriter Plus speak for itself in the form of the output pictured to the left.

While they may look like the handiwork of a professional artist, typesetter, and printer, we assure you they were created with nothing more than a LaserWriter Plus, a Macintosh Plus and software like our own MacDraw™ and MacPaint™, Microsoft's Word and Excel, and Aldus' PageMaker.

And an ordinary pair of human hands.



Put this LaserWriter Plus printer together with a Macintosh Plus and you get a design studio, a type house and a print shop that fits on 3.1 square feet of desk.

ABCDEFGHIJKLMN**OPQRSTUVWXYZ**  
 abcdefghijklmnopqrstuv**wxyz** ITC Avant Garde Gothic

ABCDEFGHIJKLMN**OPQRSTUVWXYZ**  
 abcdefghijklmnopqrstuv**wxyz** ITC Bookman

ABCDEFGHIJKLMN**OPQRSTUVWXYZ**  
 abcdefghijklmnopqrstuv**wxyz** Helvetica Narrow

Some of the new faces you'll be seeing around the office.

quietly print an amazing 300 dots per inch, and give you complete control over every single dot on the page. Which allows you to cover an entire page with virtually any combination of near typeset quality text and high resolution graphics.

built-in typeface families. Including popular business faces like Helvetica®, Times®, Palatino® and ITC Avant Garde Gothic®. And more families are becoming available all the time.

POSTSCRIPT allows the Laser-





# How the people who run things, run things.

If there's one thing every business person can use more of, it's power.

Which is why you'll be happy to hear that the most powerful personal computer software being written, is being written for Macintosh computers.

Take Excel from Microsoft, for example. It's the first spreadsheet program to combine automatic macros, user-defined functions, array-handling and two-way data

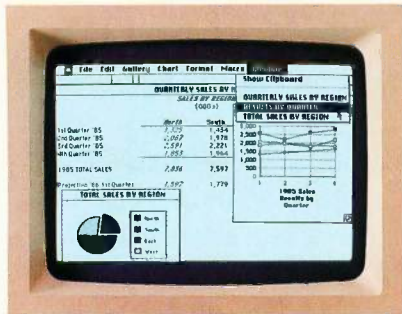

Excel from Microsoft.



Omnis 3 from Blyth.

file compatibility with Lotus 1-2-3 in one program.

Omnis 3 from Blyth is a relational database program that lets you create your own pull-down menus, on-screen buttons and dialog boxes. As well as share files over our AppleTalk™ Personal Network in the multi-user version.

And while we're on the subject of sharing, we should tell you that we've entered into a working relationship with what we consider

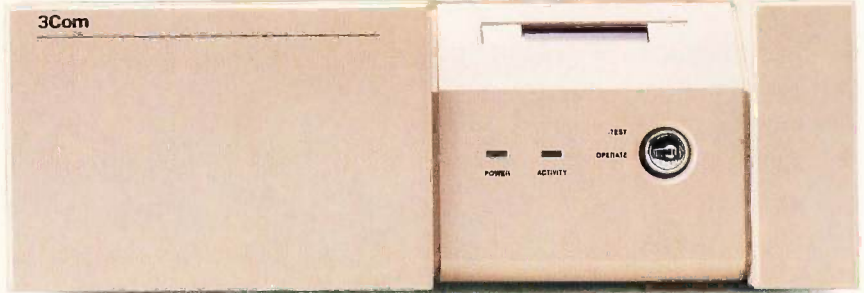

3Server from 3Com.

to be one of the highest ranking disk servers on the market. 3Server from 3Com.

For the uninitiated, disk servers are storage devices that allow your Macintosh Plus to share information and other services

with other computers over a network.

Which, in conjunction with the powerful new software we described earlier, makes it a lot easier to start running your business.

Instead of chasing after it.

## Here's our new business card.

Now you can automate your office without draining your company's checking account down to the right side of the decimal point.

With our new Apple Business Credit Card.

As the name suggests, it's a credit card for your business, issued in your company's name.

Make an initial purchase of \$2,500, and it gives your company a line of credit that can be applied towards the Apple products of your choice.\*

With the Apple Business Credit Card, there's never a down payment on anything you buy. It's possible to get credit approval in 24 hours. And you don't have to pay any interest if you pay your balance within 30 days.

To apply, visit any participating authorized Apple dealer.

The Apple Business Credit Card. Don't leave the office without it.

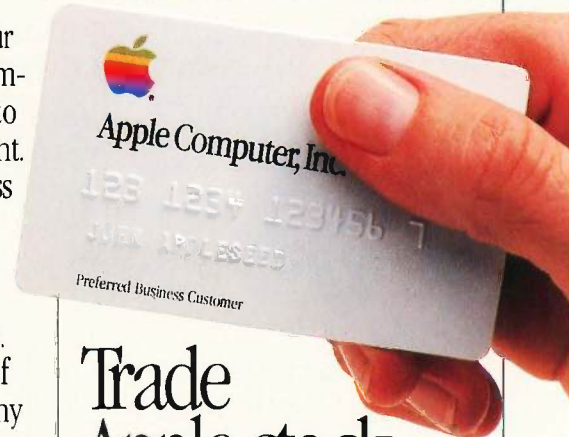

## Trade Apple stock.

If you own a Lisa® or a Macintosh XL computer, this is your lucky day.

Because from April 14th to August 29th, you can trade-in these computers for a Macintosh Plus and a Hard Disk 20 at the suggested retail price of only \$1498.

So bring your authorized Apple dealer your Lisa and Macintosh XL computers.

And trade them for the stock on his shelf.



© 1986 Apple Computer, Inc. Apple, the Apple logo and Lisa are registered trademarks of Apple Computer, Inc. LaserWriter, MacDraw, MacPaint, AppleTalk and Desktop Publishing Plus are trademarks of Apple Computer, Inc. Macintosh is a trademark of McIntosh Laboratory, Inc. and is being used with its express permission. Helvetica, Times and Palatino are registered trademarks of Allied Corporation. ITC Avant Garde Gothic is a registered trademark of International Typeface Corporation. PostScript is a trademark of Adobe Systems, Inc. Microsoft is a registered trademark of Microsoft Corporation. PageMaker is a trademark of Aldus Corporation. Lotus and 1-2-3 are registered trademarks of Lotus Development Corporation. Omnis 3 is a registered trademark of Blyth Software, Inc. 3Server is a trademark of 3Com Corporation. \* Subject to credit approval. For an authorized Apple dealer near you, call (800) 446-3000. In Canada, call (800) 268-7796 or (800) 268-7637.



# FIXES AND UPDATES

## BYTE'S BUGS

### Three Wrong Notes

Three wrong notes in the April Editorial we must correct:

Computers and music is not the theme of the July issue; it's the theme of the June issue, the one you're reading right now. Look at it this way: You don't have to wait another month.

Keyboardist Roger Powell, a member of

Todd Rundgren's group Utopia, developed MIDI *sequencer* software, not MIDI *squeezer* software. The package, called *Texture*, runs on the IBM PC. (You can contact Roger at POB 328, Rhinebeck, NY 12572.)

And the editor of *Electronic Musician* is Craig Anderton, not Craig Anderson. Sorry, readers. Sorry, Roger. Sorry, Craig.

### Sorry, Wrong Number

In the April Fixes and Updates, in the table of addresses and telephone numbers relating to computer conferencing systems, we gave the wrong number for the New Jersey Institute of Technology. (NJIT runs the Electronic Information Exchange System.) The correct number is (201) 596-3437. Our apologies.

## BYTE'S BITS

### Hawaii Calling

The organizers of the Twentieth Annual Hawaii International Conference on System Sciences are seeking papers for their proceedings. HICSS, slated for next January 6-9 in Kona, is sponsored by the University of Hawaii and the University of Southwestern Louisiana, in cooperation with the ACM (Association for Computing Machinery) and the IEEE Computer Society. The stated purpose of the meetings is "to provide a forum in which quality researchers and practitioners in the information, computer, and system sciences can exchange ideas, techniques, and applications."

Topics for papers should focus on architecture (including high-performance personal machines, knowledge-based systems, and VLSI and technology issues); software (including design tools, environments, alternative language paradigms, and models of system and program behavior); and applications (including health care systems, legal information processing, and DSS model management).

The deadline for abstracts has passed, but full papers may be submitted until July 7. Notification of accepted papers will be mailed in September. For more information on the conference, contact Ralph H. Sprague Jr., conference cochairman, at the following address:

College of Business Administration  
University of Hawaii  
2404 Maile Way, E-303  
Honolulu, HI 96822  
(808) 948-7430

### Nauseating

We get thousands of press releases every month, announcing all sorts of products. Some of the products sound an awful lot like some of the other products, and some of the names sound an awful lot like some of the other names. So we paused a bit when we read the release describing the Nauseater. We certainly can't explain it to you as well as the folks at MachoTech Industries can; hence, we quote their announcement.

"The Nauseater is a flashlight-type device that creates a slight feeling of queasiness in the stomach of any person in its path. The proprietary Nauseater design (patent pending) utilizes a low-powered, frequency-modulated laser humanely engineered to create just the desired effect."

MachoTech suggests you might want to use this device when waiting for a table in a restaurant. Aim it at a couple "linger-

ing over coffee" and one of them will say, "Honey, I'm feeling squeamish. Let's leave."

The Nauseater (which is also spelled the Nauseator) is priced at \$7995. And for the nervous kind of guy, MachoTech sells the Anti-Nauseater, a "belt-worn device which is a must for anyone who doesn't own a Nauseater." Only \$995.

Uh, but before you rush out to buy, keep in mind that the announcement is dated April 1.

### Houston Atariists BBS

HASTE (Houston Atari ST Enthusiasts) is operating a public domain bulletin board system running on a 520ST with an upgraded memory of 1 megabyte. The group has an electronic newsletter that's available for downloading. The telephone number of the HASTE BBS is (713) 955-9532.

### How to Access and Use BYTEnet Listings

To access BYTEnet Listings, call (617) 861-9764. When you get the carrier tone, enter two or three carriage returns so that our software can determine your operating parameters.

Optimum modem settings are 8 bits, 1 stop bit, and no parity at full duplex, or 7 bits, 1 stop bit, and even parity at half duplex. Acceptable operating speeds are 300 or 1200 bps. At this time, BYTEnet Listings does not sup-

port 2400-bps transmissions.

The BYTEnet Listings software itself is menu-driven. Programs may be downloaded using ASCII, Kermit, Tele-Link, and XMODEM protocols.

BYTE listings are also available on BIX. After connecting with the system, type join listings at the main prompt. (For more information on BIX, phone (800) 227-2983 between 8:30 a.m. and 11:00 p.m. Eastern time, weekdays.)



## Conducted by Steve Ciarcia

### COMPAQ QUESTIONS

Dear Steve,

I am not very hardware-oriented, but I enjoy your articles very much, especially the one on keeping power-line pollution out of your computer (December 1983). After reading your article, I went straight to Radio Shack and purchased a voltage-transient surge protector. Since we do not have much lightning here (mostly irregular current supply), will this device protect my Compaq computer adequately?

Also, do you know of any board that would transform my Compaq into a telex machine so I can send telexes without dedicated equipment?

DANIEL POHORYLES  
Herzlya, Israel

*The transient surge-protection device will protect your computer equipment from transients produced by lightning as well as those produced by the switching of equipment connected to the same power line. If your area suffers from frequent brownouts (sudden drops in the supply voltage) or power outages, I would suggest that you purchase an uninterruptible power supply (UPS). A number of UPS manufacturers advertise in BYTE.*

*To send and receive telex messages, you require a serial port, modem, communications software, and access to either Western Union EasyLink or the MCI Mail Network. Both networks provide access to the international telex system as well as the ability to send hard-copy letters and electronic messages to other network subscribers. Additional information regarding these services can be obtained by contacting*

MCI Mail  
2000 M St. NW, Suite 300  
Washington, DC 20036  
(800) 424-6677

Western Union  
9229 LBJ Freeway, Suite 234  
Dallas, TX 75243  
(800) 527-5184

(Western Union)  
Ministry of Communications  
POB 23179

Tel Aviv 61231, Israel  
(972.3) 28 12 61  
(972.3) 29 53 33

—Steve

### TYPEWRITER CONVERSION

Dear Steve,

I have a Sperry/Remington Redactron word processor. I would like to convert the IBM Series 60 typewriter to stand alone as a letter-quality printer. Do you know of a company that has plans or parts to do the conversion? I can do it from scratch, but I would rather save time.

DENNIS A. POLLOCK  
Albuquerque, NM

*Here is the name and address of a company that advertises interfaces for your IBM Series 60 typewriter:*

California Micro Computer  
933 Warbler Ave.  
Fountain Valley, CA 92708  
(714) 964-9301

—Steve

### APPLE RESOLUTION

Dear Steve,

I have an Apple II+ and feel envious of the 560-dot horizontal resolution available on the Apple IIe. I've had my Apple now for years, and I have accumulated coprocessor cards, etc., that use their own memory rather than the Apple's memory.

I am interested in any modification to the Apple II+ that would permit true 560-dot horizontal resolution, either by allowing the display of both high-resolution screens at once or some other means. I am specifically interested in hardware modifications that would allow dots to be independently addressable.

THOMAS DONALDSON  
Canberra, Australia

*The Apple IIe gets its 560-dot horizontal resolution by bank-switching the two banks of video RAM and alternately displaying both banks slightly offset from each other. This produces the single image from the two 280-dot images. Since the Apple II+ lacks the alternate bank of memory at the high-resolution screen addresses, there is no practical way to*

*duplicate the effect.*

*While it is possible to rapidly switch between the two high-resolution pages on the II+, it isn't possible to offset the pages horizontally to double the resolution as with the IIe.*

*The colors displayed by the Apple II+ are determined by whether or not a given dot is on, the horizontal coordinate of the dot (even or odd column), whether or not an adjacent dot is on, and whether or not the high bit of the byte that dot occupies in memory is on. Because of this, an individual dot cannot be changed without changing adjacent dots. I know of no simple hardware modification that will alter this. Smooth animation is achieved on the Apple by shifting all the dots in the animated image. In order to smoothly move an image across the screen, seven different bit-mapped shapes are required for each image. For information on this type of animation, see the article "A New Shape Subroutine for the Apple" by Richard T. Simoni Jr. in the August 1983 BYTE. Also refer to Apple Graphics and Arcade Game Design by Jeffrey Stanton (1982, The Book Company, 11223 South Hindry Ave., Los Angeles, CA 90045).—Steve*

### FREE BYTES

Dear Steve,

I am currently using an IBM PC XT with two floppy disk drives, and I am programming in Pascal, CBASIC, and FORTRAN. I

(continued)

IN ASK BYTE, Steve Ciarcia answers questions on any area of microcomputing. The most representative questions received each month will be answered and published. Do you have a nagging problem? Send your inquiry to

Ask BYTE  
c/o Steve Ciarcia  
POB 582  
Glastonbury, CT 06033

Due to the high volume of inquiries, personal replies cannot be given. All letters and photographs become the property of Steve Ciarcia and cannot be returned. Be sure to include "Ask BYTE" in the address.

The Ask BYTE staff includes manager Harv Weiner and researchers Eric Albert, Bill Curlew, Ken Davidson, Jeannette Dojan, Jon Elson, Roger James, Frank Kuechmann, Dave Lundberg, Edward Nisley, Dick Sawyer, Andy Siska, and Robert Stek.



# MARK WILLIAMS' CSD SOURCE DEBUGGER

Those who insist on C compiler performance  
are very big on Mark Williams.

And the compiler is just part of our total C Programming System.

NEW 3.0  
ENHANCEMENTS

These and other powerful utilities now *included* in the C Programming System:

- make: compiles only what's necessary from multiple modules, a powerful programming discipline
- diff: identifies differences between two files
- m4: macroprocessor expression editing and substitution
- egrep: extended pattern search
- MicroEMACS: full screen editor with source

#### COMPILER FEATURES

- Runs under MS-DOS
- Full Kernighan & Ritchie C with recent extensions including void and enum
- Register variables for fast, compact code
- Full UNIX™ compatibility and complete libraries
- Large and small memory models
- MS-DOS linker compatibility
- 8087 Support
- One-step compiling
- English error messages
- ROMable code
- Linker, assembler, archiver
- Extensive third party library support

#### csd C SOURCE DEBUGGER

- Debugs at C source level without assembly language
- Separate evaluation, source, program and history windows
- Can execute any C expression
- Capabilities of a C interpreter, but runs in real time
- Set trace points on any statement or variable

Mark Williams' C compiler has earned a place in some very big companies for some very good reasons: it proves the benchmarks right with the speed, code density, consistent performance and expert support required in professional development environments.

But a total development tool shouldn't stop with compiling. Or go on and on with extras that add up and up.

Only Mark Williams' C Programming Systems *includes* the csd C Source Debugger with true source level debugging to speed your programming job.

And only Mark Williams' new 3.0 version *includes* utilities like "make" to make quick work of even the largest projects.

From source code to final product, only one takes you all the way: Mark Williams' C Programming System. All for only \$495. Ask about our 60-day money back guarantee when you call

**1-800-692-1700 to order today.\***

You'll be big on the total C Programming system from Mark Williams, too.

 Mark Williams Company

1430 West Wrightwood  
Chicago, Illinois 60614



Listing 1: Assembly language routine to determine free disk space.

```

mov     DL,drive      ;drive=0 - default drive
                        ;drive=1 - A drive
                        ;drive=2 - B drive

mov     AH,36H
int     21H
cmp     AX,0FFFFH    ;If AX returns FFFF, then drive...
                        ;...designation was in error

je      error
mov     sec_clust,AX  ;AX contains number of sectors...
                        ;...per cluster

mov     free_space,BX ;BX contains free space in clusters
mov     bytes_sec,CX ;CX contains bytes/sector

ret
error:
ret
    
```

haven't been able to determine how many bytes are free on the disk from within a program. Do you know of a routine in any of the above languages or assembly language that can solve my problem?

Also, I am interested in adding a removable hard disk subsystem to my computer. I have seen many ads for such systems in BYTE, but I don't know anything about their compatibility, reliability, and speed. What is your opinion on some of these devices?

AHMAD RAZA  
Lahore, Pakistan

You can determine free disk space in FORTRAN or CBASIC by calling an assembly language subroutine that uses DOS function 36H (DOS 2.0 or higher). In Pascal, you can write a procedure in assembly language or use a built-in DOS interrupt function call and retrieve the results directly from the AX, BX, and CX registers.

An assembly language code fragment to get the disk's free space is shown in listing 1. In order for this code to work, you must set up addressing in the call-

(continued)

Listing 2: Sample FORTRAN code to call the routine in listing 1.

```

INTEGER*2 CLUST,SEC,BYTE
INTEGER*4 FREE
CHARACTER*1 DRIVE
DRIVE=CHAR(1)
C SUBROUTINE DISK IS DEFINED IN LISTING 1
CALL DISK(DRIVE,CLUST,SEC,BYTE)
FREE=CLUST*SEC*BYTE
    
```

OEM DESIGN/DEALERS WELCOME!! **ALPHA CONCORD**  
**99% Hayes compatible 300/1200 MODEM**

**BEST ON THE MARKET** ONLY ★ \$139  
 • Auto dial, auto answer (tone or pulse)  
 • 8 status indicators & switch selectable  
 • Auto speed selection (0-300, 1200 bps)  
 • Speaker with volume control  
 • Aluminum case, with adaptor **6 MONTH WARRANTY**  
 Modem board completely assembled, & guaranteed, 5 minutes assembly.



SEMI-ASSEMBLED **103/212A** \$129  
 Add 5% Shipping Charge  
**NEW !! 2400 MODEM**

**SEMI-ASSEMBLED 2400 MODEM \$299**

**BUILD YOUR PORTABLE XT/AT XT PORTABLE \$199**  
 (Price includes only case, full size keyboard.)  
 (9" monitor, 130 watt power supply extra.)  
 (Fit mega XT/AT m-board & standard cards.)

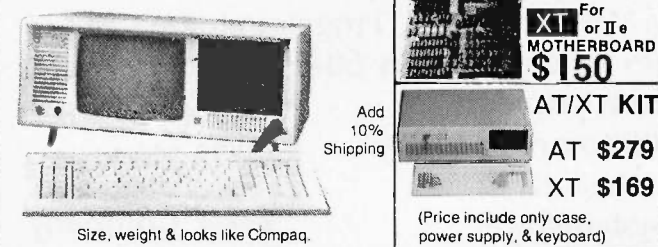

CONCORD Technology Ltd.  
 47 W. Broadway, Van., B.C. Canada V5Y 1P1  
 Ph. (604) 879-3555 or 879-7419

Replacement & 99% Compatible  
**AT COMPATIBLE MOTHERBOARD**

\$550 For XT or IIe  
**MOTHERBOARD \$150**

**AT/XT KIT**  
 AT \$279  
 XT \$169  
 (Price include only case, power supply, & keyboard)

**FACTORY PRICES ON AT/XT or IIe cases, cards, keyboards (minimum 25) \$Call**

**PC - GUARD**

TOTAL DATA SECURITY

- \*Protects your data from illegal users.
- \*Impossible to access the system with a DOS diskette.
- \*Up to 16 users with ID codes and passwords.
- \*Automatically locks the system after a none activity period of time.
- \*Automatic screen saver.
- \*Audible alarm if an illegal user tries to access the system.
- \*Is a total hardware protection system.
- \*Low cost
- Data Protection System.**
- \*Fully compatible with the IBM PC, XT, AT and compatibles.



For more information and orders call (809)767-0065

VISA, MASTERCARD or COD cashier check.  
 IBM PC, XT, AT are registered trademarks of International Business Machines Corp.

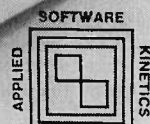

Applied Software Kinetics  
 El Centro 1,  
 Local 1, Muñoz Rivera 800  
 Hato Rey, Puerto Rico 00918



# Mark Williams

Now the biggest name  
in C compilers comes in a size  
everybody can afford.

Let's C.<sup>™</sup>  
\$75

Introducing Mark Williams' \$75 C compiler. Want to explore C programming for the first time? Or just on your own time? Now you can do it in a big way without spending that way. With Let's C.

This is no little beginner's model. Let's C is a powerful programming tool, packed with all the essentials of the famous Mark Williams C Programming System. The one chosen by Intel, DEC, Wang and thousands of professional programmers. The one that wins the benchmarks and the reviewers' praise:

**Mark Williams Let's C**

- For the IBM-PC and MS-DOS
- Fast compact code plus register variables
- Full Kernighan & Ritchie C and extensions
- Full UNIX™ compatibility and complete libraries
- Small memory model
- Many powerful utilities including linker, assembler, archiver, cc one-step compiling, egrep, pr, tail, wc
- MicroEMACS full screen editor with source
- Supported by dozens of third party libraries
- Upgradeable to C Programming System for large scale applications development

Let's C Benchmark Done on an IBM-PC/XT, no 8087.  
Program: Floating Point from BYTE, August, 1983.

Exec Time in Seconds

Let's C	134.20
MS 3.0	347.45

*"(This compiler) has the most professional feel of any package we tested..."—BYTE*  
*"Of all the compilers reviewed, (it) would be my first choice for product development."—David W. Smith, PC WORLD*

And now for more big news. Get our revolutionary csd C Source

Debugger for just \$75, too. You can breeze through debugging at the C source level ignoring clunky assembler code.

Affordable, powerful, debuggable. Mark Williams Let's C is the big name C compiler at a price you can handle. Get your hands on it now.

Use this coupon or charge by calling toll-free:  
1-800-MWC-1700. In Ill. call 312-472-6659.

**ORDER NOW! 60-DAY MONEY BACK GUARANTEE!**

**Mark Williams Let's C**

Please send me:

\_\_\_\_\_ copies of Let's C and \_\_\_\_\_ copies of csd (C Source Debugger) at \$75 each. (Ill. residents add 7% sales tax.)

Check  Money Order  Visa, MasterCard or American Express

Name \_\_\_\_\_

Address \_\_\_\_\_

City \_\_\_\_\_ State \_\_\_\_\_ Zip \_\_\_\_\_

Card # \_\_\_\_\_ Exp. Date \_\_\_\_\_

Signature \_\_\_\_\_ BY066



1430 West Wrightwood  
Chicago, Illinois 60614

Inquiry 205



ing program for the drive designation and the returned variables, sec\_\_clust, bytes\_\_sec, and free\_\_space. These can be multiplied together on return by the calling program to get the free bytes.

The sample FORTRAN code in listing 2 determines free space in drive A.

Your compiler manuals should give the information necessary to call assembly language subroutines, and you can get more information about using the DOS INT 21H functions from the IBM DOS

Technical Reference Manual.

The Bernoulli Box is reputed to be an excellent device, as are the removable hard disk drives you mention. The Bernoulli Box is a little slower than the others, and I believe its disks are a little less expensive. All are compatible with the PC XT.—Steve

**IBM PC AT BUS**

Dear Steve,

I was disappointed to find that the ar-

ticles in BYTE's *Inside the IBM PCs* issue did not include any information on the PC AT bus. I haven't been able to find any information on this bus. Bookstores have a tremendous range of material on PC software but nothing on the PC hardware design. I am interested in adding a PC-type bus to my SB180 single-board computer. I'd like to be able to plug in a high-resolution monochrome controller, an internal modem board, or any of the other boards designed for the PC. Can you help?

PETER LAUGHINGWOLF  
Santa Rosa, CA

IBM publishes detailed technical information on its personal computers in the hardware technical reference manuals. The company publishes a separate manual for each model and sells them through authorized IBM dealers and IBM Product Centers. The Graphics Display Controllers used in the PC AT are the ones made for the PC. The AT has a couple of PC-type expansion slots for display boards and other compatible PC add-ons, so if you want to add a PC Graphics Display Adapter to your SB180, you need only the PC bus information. This is available in the PC Technical Reference Manual and has also been published in a number of books and magazines.

—Steve ■

**CIRCUIT CELLAR  
FEEDBACK**

**INSTALLATION PROBLEMS**

Dear Steve,

Regarding your December 1983 article ("Keep Power-Line Pollution Out of Your Computer"), I've already installed metal-oxide varistors in a Radio Shack four-outlet power strip. I also have a six-outlet strip that is riveted together—this makes it tough to get inside the assembly to install MOVs. Any ideas? Radio Shack now carries an SNR-20A130K MOV, catalog #276-568. Is it adequate as a substitute?

I'd like to hook the Osborne up to a Prowriter printer via the Osborne's serial port (the Prowriter uses a parallel interface). I have read Alan Wilcox's "Serial to Parallel" article in the August 1983 issue of *Dr. Dobbs' Journal*, but I need some help. All I need is a simple serial-to-parallel box that will work with the Osborne.

AMER NELSON  
Seattle, WA

(continued)

**ALL OF OUR PRODUCTS  
ARE OF THE FAMILY  
PART OF THE SAME TREE**



**COMPATIBLE, DEPENDABLE & AFFORDABLE**

"...masterpiece of IBM imitation  
...minor masterpiece of the  
circuit designer's  
art."



MEGA-BOARD-XT™

Lee Konowe, American  
Software Club, Ridgefield, Ct.

"The most compati-  
ble IBM clone  
I've ever worked  
with."



SWITCHING BUFFER



MEGA-KIT

Winn L. Rosch, Cloning Your Own  
PC, PC Magazine, July 10, 1984.

■ **MULTIPLE INPUT/  
DUAL OUTPUT  
SWITCHING BUFFER**

4 computers in—2 printers out  
• Automatically routes com-  
puter to printer • Internal buf-  
fering 64K or 256K

■ **MEGA-BOARD-AT™**  
80286 CPU • Our own  
DTC-AT-BIOS

■ **MEGA-BOARD-XT™**  
The industry standard with our  
DTC-XT-BIOS

■ **MEGA-NET™**  
Token-passing ring LAN • IBM  
NETBIOS Compatible

**OEM QUANTITY PRICING  
AVAILABLE ON REQUEST**

XT Bare Board	59.95
XT Assembled 256K	299.95
Mega-Case	69.95
Mega-Kit	750.00
DTC-XT-BIOS	29.95
Power Supply	89.95
Switching Buffer	399.00

**AT-BIOS and XT-BIOS licensing.**

IBM is a registered trademark of International Business Machines Corporation.

**Display Telecommunications Corporation**

8445 Freeport Parkway • Suite 445 • Irving, TX 75063  
1-800-227-8383 • For Technical Calls Only: 1-214-607-1382  
TELEX 5106000176 DTC UD

*Thanks for making us 1986 Small Business Exporter of the Year  
for the state of Texas.*



Color 400  
Now Supports  
AutoCAD<sup>®</sup> and VersaCAD<sup>®</sup>

# Princeton SR-12 and Sigma Designs Color 400 "The Ultimate in Graphics Resolution and Performance"...

PC Products June 1985

**SR-12 and Color 400. A brilliant combination for super-high resolution graphics and a crisp character display.**

For a brighter, sharper display with your IBM PC, XT, or AT, here's a team that can't be beat. The SR-12 super-high resolution RGB monitor from Princeton Graphic Systems and Color 400, the advanced color graphics adapter card from Sigma Designs.

**A Revolution in Resolution.** Begin by snapping the Color 400 into your PC. Without any software modification, text suddenly becomes readable. Graphics turn sharper and cleaner. Jagged edges smooth out, and annoying flicker fades away. Color 400 automatically *doubles* the number of lines on standard line software. It allows true high

resolution display of Lotus 1-2-3 and Symphony charts, graphics from Dr. Halo, CadPlan, Lumena 400, and others. Also, create dazzling business charts in 16 vibrant colors with Paintbrush 400, included with the card. Enjoy fully formed, monochrome quality characters in text mode. For word processing, spreadsheet, CAD/CAM, or pro-

fessional design applications, Color 400 is the answer to your graphic needs.

**Turn on SR-12 for the impressive**

**results.** The SR-12 displays your Color 400 image with unmatched clarity and brilliant color. Because the SR-12 combines a .31mm dot pitch tube and a non-glare screen with an incredible 640 x 400 non-interlaced resolution, you get a flickerless image that's as crisp and clean as a personal computer can produce.



SR-12

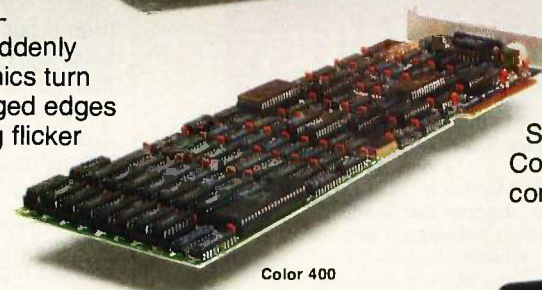

Color 400

See how impressive this state-of-the-art image can be on your own PC system. Visit your local retailer today and ask about this new color graphics team. Princeton Graphic Systems' SR-12 and Sigma Designs' Color 400. An unmatched, brilliant combination.

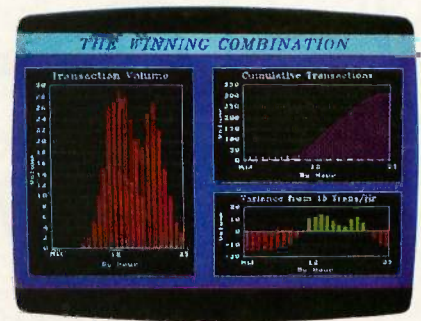

**COLOR 400**



SIGMA DESIGNS, INC., 2023 O'Toole Avenue, San Jose, CA 95131  
(408) 943-9480 Telex: 171240



Princeton Graphic Systems, 601 Ewing Street, Bldg. A, Princeton, N.J. 08540  
(609) 683-1660, Telex: 821402 PGS PRIN, (800) 221-1490 Ext. 2204

Graphic Screens courtesy Mouse Systems, Inc. and Forthright Systems, Inc.

IBM PC, PC XT, and PC AT are registered trademarks of International Business Machines, Inc.  
AutoCAD is a registered trademark of Autodesk Inc. VersaCAD is a registered trademark of T and W Systems, Inc.



# Escape the Programmer's Prison



Do you feel imprisoned by your IBM PC? Do you spend too much time wrestling with a rigid, unyielding programming language? Are you tired of clumsy programming tools that straight-jacket your creativity instead of liberating it?

If so, you're ready for Methods—a Smalltalk, object-oriented programming system for the IBM-PC and compatibles that sets you free from the constraints of other languages. Until you program with Methods, you don't know just how quick and creative programming can be on the IBM PC.

Methods is . . .

. . . high-performance object-oriented programming. A powerful, language-compatible subset of Smalltalk-80™.

. . . a toolkit of over 100 classes—easily-customized software building-blocks for rapid, incremental development of real-world applications.

. . . an open-ended, window environment that encourages exploration while allowing recovery from any error.

. . . extensively documented in a four-part manual for everyone from beginners to experienced programmers—the perfect introduction to Smalltalk programming.

. . . ideal for software prototyping, simulation, databases, advanced user interfaces, and numerous AI applications.

Methods also offers easy access to DOS, a powerful directory/file browser system, remote UNIX™ access, an object-oriented shell for DOS programs, and much more.

Methods requires DOS and 512K RAM on IBM PC's (including AT) or "compatibles," and can be used with or without a mouse.

**digitalk inc.**

5200 West Century Boulevard  
Los Angeles, CA 90045 (213) 645-1082

Available from Digitalk for \$250. Outside U.S. add \$15.00 for shipping and handling.

California residents add sales tax.

Educational and dealer discounts available.



IBM is a trademark of International Business Machines Corporation.  
Smalltalk-80 is a trademark of Xerox Corporation.  
UNIX is a trademark of Bell Laboratories.

Inquiry 112

## CIARCIA FEEDBACK

To install MOVs in your riveted power strip, you need to drill out the rivets. The Radio Shack MOV you mentioned will work fine.

The article in Dr. Dobb's Journal is what you need if the Osborne supports the use of the CTS (clear to send) signal, usually found on pin 5 of the RS-232C connector. This requires provision of the necessary hardware and software by Osborne—check your manual.

Another way of controlling the data is by sending XON/XOFF codes back to the computer—often found as Control-S and Control-Q on many computers. An article describing a circuit for this appeared on page 225 of the April 28, 1983, issue of Electronic Design.—Steve

### POWER

Dear Steve,

I design industrial control equipment. The company I work for has a steel-fabrication shop with a lot of heavy-duty electrical equipment. The utility bill for this shop is around \$5000 a month. I was asked to look into the possibility of reducing this monthly cost.

I first looked at the cost calculations and found that the amount due is *not* calculated by multiplying the total kilowatt-hours used by the cost per kilowatt-hour; things like kilowatt demand and periodic averaging are primary factors in the calculations. The utility company was hesitant to discuss these subjects in detail. From what they did say, it seems that the current drawn is averaged every 15 minutes, and the highest average is used to determine the kilowatt demand factor. Also, if an average of any previous month is higher than any of the present month, the higher value is used. With all this equipment, it's obvious why the bill is so high.

I decided to build a power monitor, similar to the ones you described in the September 1984 and July 1985 Circuit Cellar articles. I am dealing with 440-V AC three-phase power; the monitor therefore requires three sensing resistors. I made three sensing resistors (out of steel bolts) of 0.001 ohm each and three calibrated precision rectifiers. I would like to get an analog graph of the current waveforms. Do you have any suggestions?

Do you know of any way to reduce the heavy currents drawn from the line at turn-on? I have devised a way to reduce surges in single-phase circuits using rapidly switched capacitor devices to source current pulses when required, but this particular device is not applicable with three-phase circuits.

Also, I would like to know the power

(continued)



# WHY COPY ON A FLOPPY?

When you store all your files on floppy disks, problems pile up. First, there's time. You waste lots of it, transferring data. There's space. You sacrifice it to stacks of disks. And then, there's your mind. You lose it trying to find lost floppies.

And if you get sloppy, forget it. A scratch, a cigarette ash or punching the wrong key can cause electronic amnesia, wiping out days of hard work.

With the new NCR PC6, you're now protected. The PC6 offers a backup tape drive that insures you against data loss.

It's super fast and super compact. You can back up a 10MB hard disk in roughly 8 minutes—more than an hour faster than with floppies. And one small tape cartridge stores as much as 27 floppy disks.

What's more, the NCR PC6 runs virtually every important software program. It's megafast, has high resolution graphics, and is designed to grow as you grow.

So droppy your floppies. You're in better shape with tape. Especially with NCR.

For your nearest NCR dealer, call toll-free 1-800-544-3333\*.

**A BETTER PERSONAL COMPUTER.  
IT'S EXACTLY  
WHAT YOU'D EXPECT FROM NCR.**

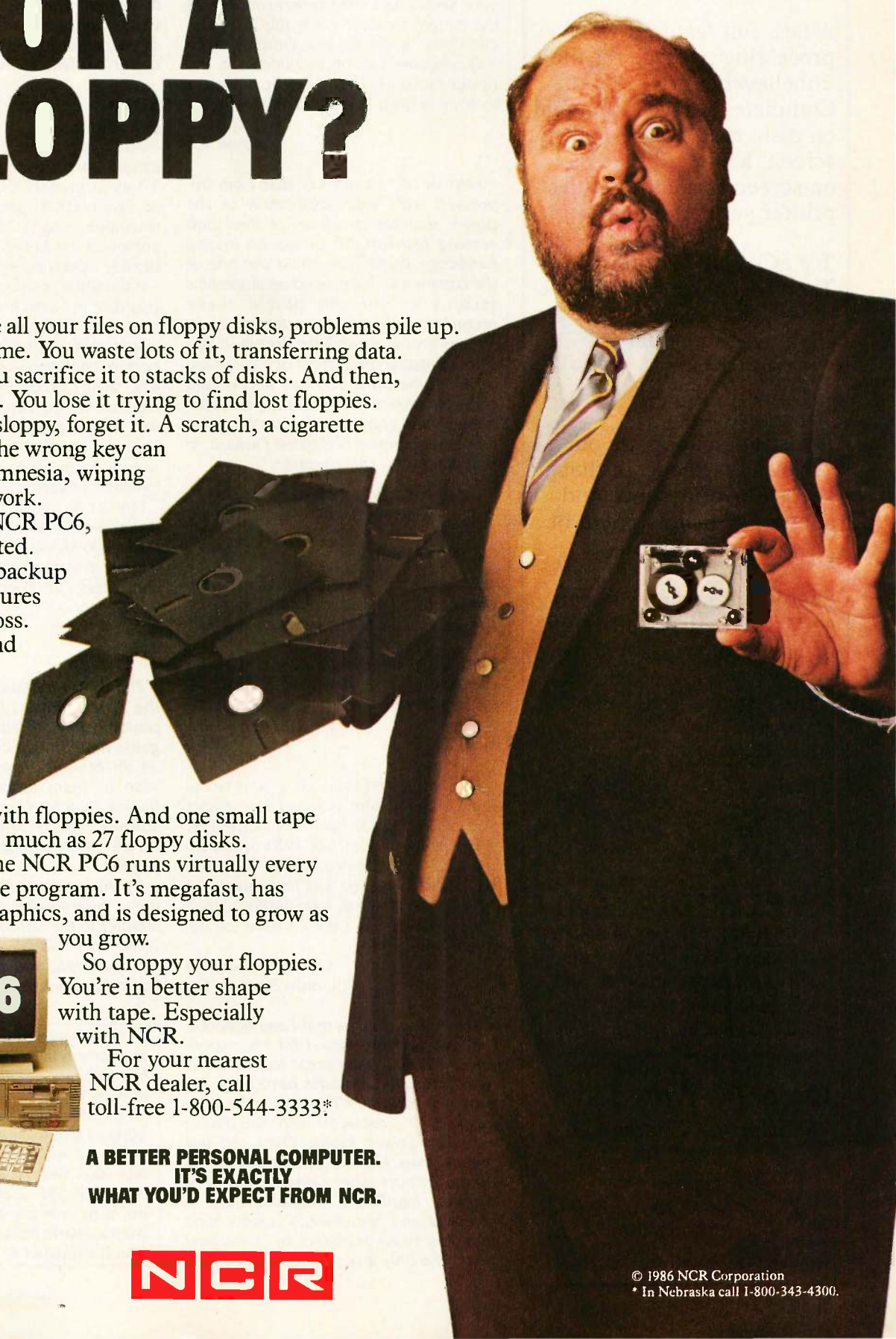

**NCR**

© 1986 NCR Corporation  
\* In Nebraska call 1-800-343-4300.



## Try It. Then Buy It. PC-Write.™

A fast, full-featured word processing package for the unbelievable price of \$10. Complete. You get a manual on disk, mail merge, split screen, keyboard macros, on-screen formatting, full printer support, and more.

Try PC-Write for \$10. Then register for \$75 to get:

- latest diskette
- printed manual
- two updates
- phone support
- newsletter

Registration supports our "shareware" concept that keeps our prices low, and allows our development of PC-Write enhancements.

Shareware means you can get PC-Write from a friend or user group to try, and give away copies yourself. Then register if you like it. No risk!

Byte  
June 1986

NOW  
Version 2.6

with our great new manual, expanded formatting options, HP LaserJet+ support, and extended directory still \$75. Prices going up July 1, 1986.

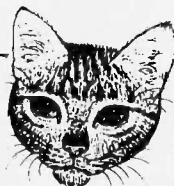

Order PC-Write Today.  
Satisfaction Guaranteed.

*Quicksoft*™

(206) 282-0452  
219 First N. #224y  
Seattle, WA 98109



## CIARCIA FEEDBACK

rating of the jumbo paper clip resistor of your September 1984 power monitor. In the current monitor in the July 1985 Circuit Cellar, you state that currents up to 100 amperes can be monitored; is the power rating of the paper clip sufficient to keep it from heating at this current?

DALE NASSAR  
Amite, LA

*First of all, let me say that I am impressed with your application of the power monitor circuit using steel bolt sensing resistors. To obtain an analog hard-copy graph, you could use one of the commercial high-speed oscillographic recorders. You can obtain these recorders with a wide variety of chart speeds and input voltage ranges. If you want to record the current of each phase at the same time, you can also obtain these recorders with multiple pen capabilities. One commercial source for this type of equipment is Hewlett-Packard. In Louisiana, you can contact*

*Hewlett-Packard Company  
3229 Williams Blvd.  
Kenner, LA 70062  
(504) 443-6201*

*Reducing the heavy current drawn from the line by a large three-phase motor at turn-on would wind up being a major job, and I couldn't attempt it here.*

*My paper clip was good for about 20 A continuous and 100 A with low-duty cycle.—Steve*

### BSR X-10

Dear Steve,

I am interested in building your Home Run Control System. However, I remember you did not speak favorably of the BSR X-10 system in your July 1983 article on the RTC-4 real-time controller. What has happened to change your mind about the BSR X-10 units? If they have improved their modules, how can I tell if I have the updated units?

CLIFTON WOOLMAN  
Colorado Springs, CO

*The BSR problems that I mentioned in that article were based on my experiences several years prior to that time. Since then, the modules have been improved significantly. The triac in the lamp modules was replaced with one having a higher power rating. Over the last several years, I have not had one fail, and others report the same thing. The original appliance modules had a solenoid and microswitch combination that has been replaced by a latching relay. The only way you could tell if your*

*modules are the older types would be to take them apart and examine them. If you bought them within the last couple of years, however, you should have the newer models.—Steve*

### SB180

Dear Steve,

Along with about 2 million other Americans, I own a computer that runs CP/M 2.2 as its primary DOS (the computer is an Epson QX-10, and it has a nice high-resolution display). I'd love to upgrade my computer for faster speed and a more flexible operating system.

If the SB180 can be adapted as an out-board or in-board (my Epson has expansion slots) upgrade for CP/M machines, it would really put a crimp in Big Blue's bottom line by inhibiting sales to people who would otherwise dump their CP/M machines to get better performance. I resent IBM's stifling of innovation in the field. An upgrade board with the SB180 would do more to shift the marketing toward innovation.

I'm not technically competent in electronics—even so, your purpose came through loud and clear. You stimulated my interest in learning (rather than just using) computers; I've ordered ZCPR3 to explore this system.

MICHAEL LASKY  
Brooklyn, NY

*Thank you for your kind words about the SB180. While I haven't had the opportunity to work with the QX-10, I would guess that it might be possible to install an SB180 in it. However, you would be wise to team up with an electronics hacker to determine the true feasibility. You just might be able to salvage the disk drives, power supply, keyboard, and display.*

*By the way, look for an article on adding a high-resolution graphics display adapter to the SB180. It should come out some time this fall.*

*I hope that you continue using and learning about computers.—Steve ■*

*Over the years I have presented many different projects in BYTE. I know many of you have built them and are making use of them in many ways.*

*I am interested in hearing from any of you telling me what you've done with these projects or how you may have been influenced by the basic ideas. Write me at Circuit Cellar Feedback, POB 582, Glastonbury, CT 06033, and fill me in on your applications. All letters and photographs become the property of Steve Ciarcia and cannot be returned.*



## News about the Microsoft Language Family

### Your Microsoft® FORTRAN Programs Can Call Microsoft C Library Routines

Microsoft FORTRAN's long-established history includes powerful scientific subroutines drawn from a vast user community. Microsoft C has a rich operating systems background, strong string and bit manipulation support, and growing strength in the program portability arena. The following demonstrates how easily one can call C functions from a FORTRAN program.

Spawnlp creates and executes a child process. In this example, we suspend the parent program while the child program executes. When the child program terminates, the parent program resumes execution.

Spawnlp is declared in C as follows:

```
int spawnlp (mode, path, arg0, arg1, ..., argn)
int mode; char *path, *arg0, ..., *argn;
```

We declare the interface to FORTRAN with this program fragment:

```
integer*2 spawn
interface to integer*2 function spawn [c, varying, alias: 'spawnlp'] (mode)
integer*2 mode
end
```

Spawn is the function name we will use from FORTRAN. We declare the return type of spawn to be integer\*2. [c] indicates the C language. [varying] tells that a variable number of arguments may be passed. An [alias] is used because the C name for the function spawnlp has 7 characters; names in FORTRAN are only significant to 6 characters. The string arguments are undeclared in the interface and assumed to be passed from FORTRAN by value.

The function can now be invoked as follows:

```
i = spawn(0, loc('exemod'c), loc('exemod'c), loc('demoexec.exe'c), int4(0))
```

The C spawnlp function expects addresses of strings, not actual characters, so we use the LOC() function. C strings differ from normal FORTRAN strings; we specify these by the "c" after each closing quote. We use INT4(0) to pass the last parameter, a C NULL pointer (32-bit integer zero).

Starting with the release of Microsoft FORTRAN 3.3, Pascal 3.3, Macro Assembler 4.0, and C Compiler 3.0, these Microsoft languages are designed so libraries and subprograms written in any one can be used in any other. Any C routine (not just spawn) can be interfaced to FORTRAN. And they are supported under both MS-DOS® and XENIX®, for additional program portability.

For more information on the products and features discussed in the Newsletter,

**write to:** Microsoft Languages Newsletter  
16011 NE 36th Way, Box 97017, Redmond, WA 98073-9717

**Or phone:**  
(800) 426-9400. In Washington State and Alaska,  
call (206) 882-8088. In Canada, call (416) 673-7638.

#### Latest DOS Versions:

Microsoft C Compiler	3.00
Microsoft COBOL	2.10
Microsoft FORTRAN	3.31
Microsoft Macro Assembler	4.00
Microsoft Pascal	3.31
Microsoft QuickBASIC	1.02

Microsoft, XENIX and MS-DOS are registered trademarks of Microsoft Corporation.

Look for the Microsoft Languages Newsletter every month in this publication.



# Xerox makes a better pie.

Lasography is the most revolutionary invention to hit the office since xerography.

**Lasography makes the difference.** Xerox was responsible for both.

But while xerography faithfully copies your documents, Lasography actually lets you create original documents.

And that means more than producing a laser-sharp pie chart.

Lasography means creating graphics that make your point more forcefully. It means writing better letters and more memorable memos.

It means not only manipulating your data in ways you've never dreamed of. It means printing on paper exactly what you've created on the screen.

Your documents won't just look better. They'll be better.

Taken separately, these products equal or surpass any on the market.

Taken together, they become a whole new way of working. And to keep your Lasographic system working, you can call on the team that invented it. Team Xerox.

Any way you slice it, you're better off with a Xerox pie than an IBM pie. Or even an Apple pie.

**TeamXerox**

**2** Mix text and graphics any way you like on the Xerox 6085 Professional Computer System. Create new charts. Write. Edit. Re-edit. Draw a pie an Apple can never match.

**1** Select your ingredients from hundreds of sources. Your mainframe computer. Any database. Other workstations. Even other networks in your office.

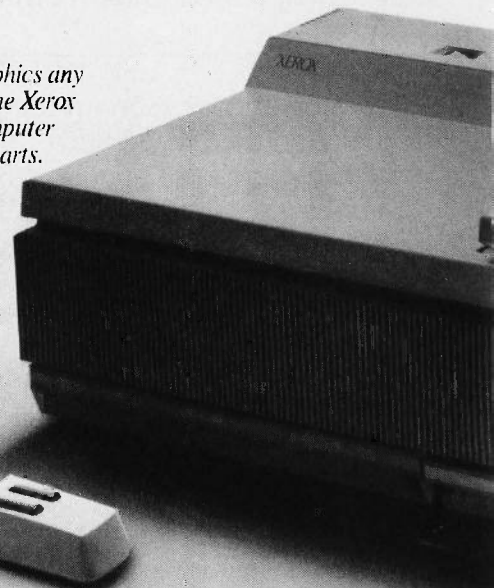
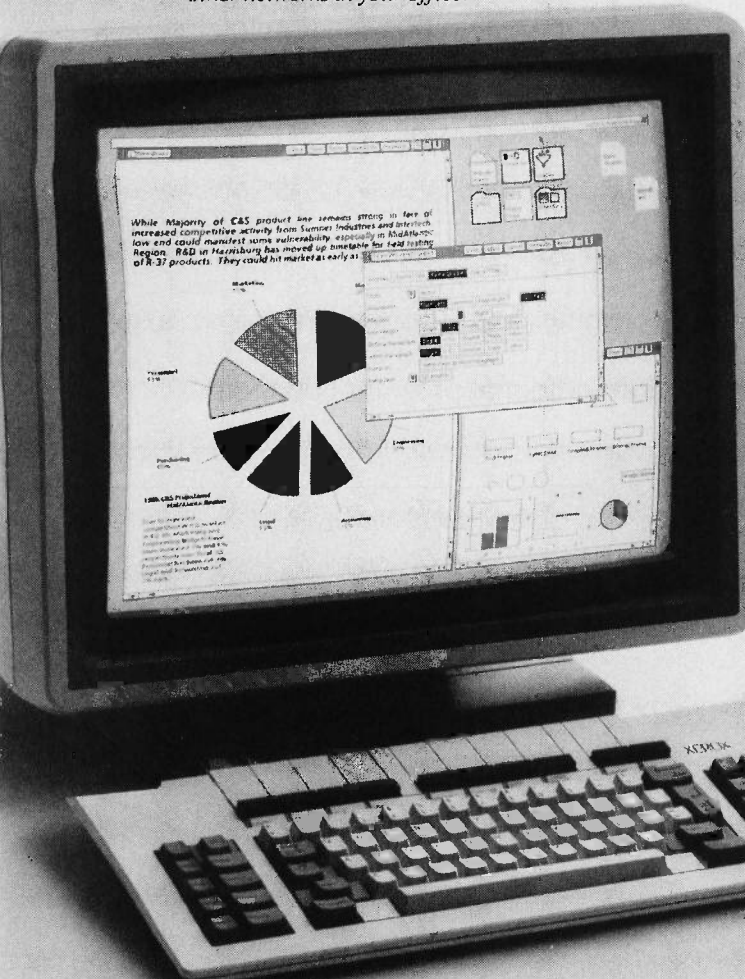

FOR MORE INFORMATION ON THE XEROX 4045 LASER CP AND THE 6085 PROFESSIONAL COMPUTER SYSTEM. CIRCLE CODE 380 ON THE READER SERVICE CARD.



XEROX® and the identifying numbers are trademarks of XEROX CORPORATION.  
 IBM® is a registered trademark of International Business Machines Corporation.  
 Apple® is a registered trademark of Apple Computer Inc.

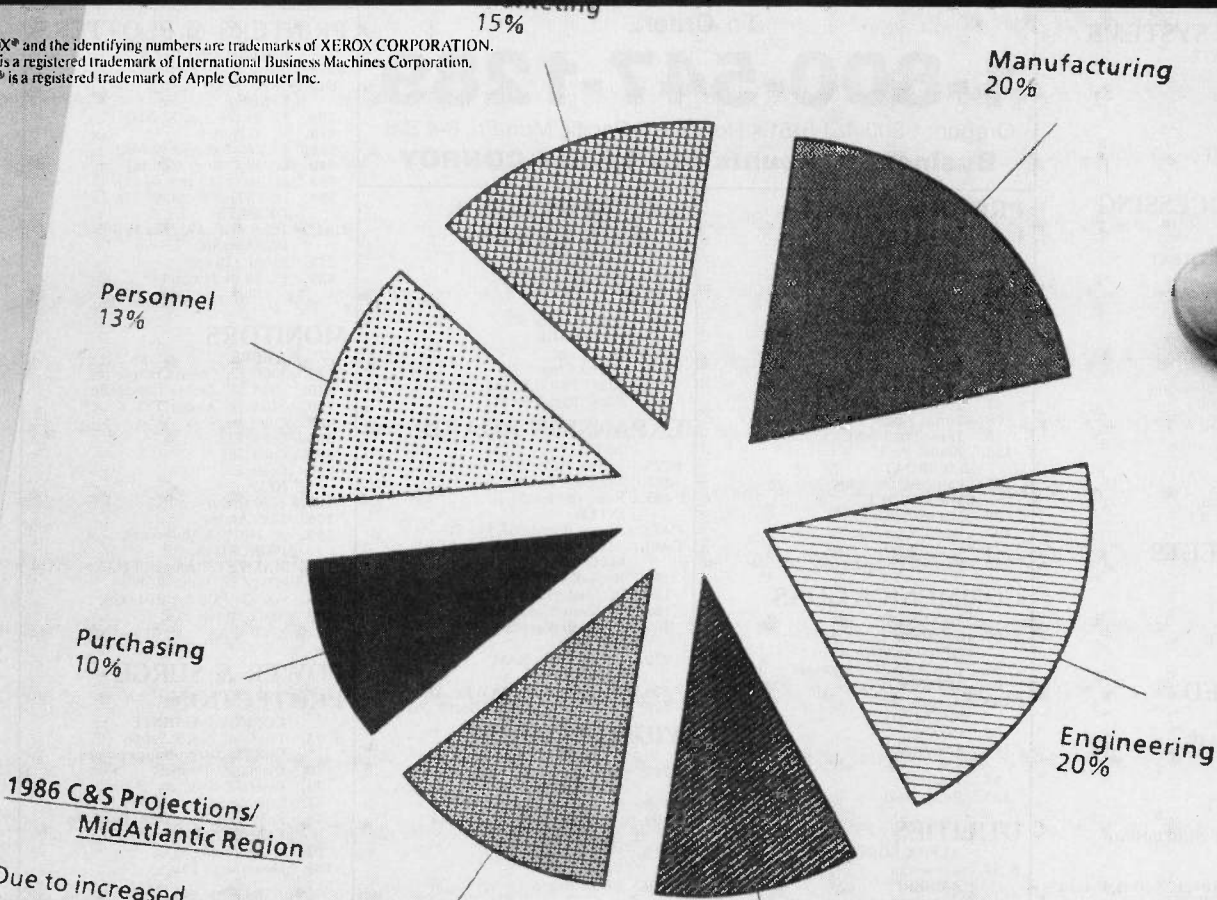

**1986 C&S Projections/  
MidAtlantic Region**

Due to increased competition in this market in 4Q '85, Marketing and Engineering budgets have been increased 3% and 4% respectively over fiscal '85. Personnel has been cut 3%. Legal and Accounting, cut 2% each.



**3** *In the blink of an eye, an original pie. Whatever you've created on the screen, the Xerox 4045 Laser CP can create on paper. Laser-sharp. Laser-perfect.*

For information call Team Xerox, your local Xerox sales office or: **1-800-TEAM-XRX ext. 160A**

Please send me more information on Xerox Lasography. Send this coupon to: Xerox Corporation, P.O. Box 24, Rochester, NY 14692.

- The Xerox 6085 Professional Computer System
- The Xerox 4045 Laser CP
- Please have a sales representative contact me.

NAME _____		TITLE _____	
COMPANY _____			
ADDRESS _____		CITY _____	
STATE _____	ZIP _____	PHONE _____	

If you can't wait, call:  
**1-800-TEAM-XRX ext. 160A**

160A 1-800-832-6879 ext. 160A 192 6/86



# Put Us To Work For You

## DATABASE SYSTEMS

- ASHTON-TATE
- \$399. dBase III+ BORDLAND
- 65. Reflex
- MICROMIM
- 379. R-Base 5000 NANTUCKET
- 359. Clipper

## WORD PROCESSING

- DAC
- \$ 39. Easy Word LIVING VIDEOTEXT
- 59. Ready
- 109. Think Tank MICROSOFT
- 245. Word MICROPRO
- 85. Easy
- 179. WordStar 3.3
- 249. WordStar Professional
- 295. WordStar 2000+ MULTIMATE
- 65. Just Write
- 229. Multimate
- 245. Executive
- 289. Advantage SSI (Satellite)
- 235. WordPerfect 4.1

## SPREADSHEETS

- LOTUS
- \$335. 1-2-3
- MICROSOFT
- 124. Multiplan PAPERBACK
- 65. VP Planner

## INTEGRATED PACKAGES

- ASHTON-TATE
- \$415. Framework II LOTUS
- 459. Symphony MICROSOFT
- 65. Windows SOFTWARE PUBLISHING
- 57. Proof
- 75. Report
- 84. File, Write, Graph, Access or Plan QUARTERDECK
- 65. Desqview

## GRAPHICS

- DECISION RESOURCES
- \$155. Sign Master
- 209. Diagram Master
- 235. Chartmaster
- 245. Map Master GRAPHICS COMMUNICATION
- 215. Freelance
- 329. Graphwriter Combo MICROGRAFX
- 109. Draw
- 115. Windows Draw (Req. Windows)
- 229. PC Draw
- 275. In-A-Vision MICROSOFT
- 199. Chart

## ORDERING INFORMATION

- Mail to: 12060 SW Garden Place Portland, OR 97223
- We also carry products for the Apple II series and Macintosh
- Most orders shipped Federal Express Standard Air.
- Shipping Charges:
  - US and Puerto Rico add 3% (\$5 minimum)
  - Canada add 12% (\$15 minimum)
  - Foreign add 18% (\$25 minimum)
  - APO, FPO & other US Territories add 6% (\$10 minimum)
  - Call for rates on monitors, printers, and systems
- We immediately honor cashier's checks, Fortune 1000 and Government checks. We must hold others for clearing.
- Advertised prices reflect a discount for Conroy-LaPointe credit card or cash. Add 3% for Visa, MasterCard or American Express.
- Prices subject to change without notice.
- Customer Service Department: 503-620-9877 8-5 Pacific Mon-Fri
- Foreign & Local Sales: 503-620-9878

**Conroy-LaPointe Computer Stores**  
Independently owned and operated by Conroy-LaPointe Computer Stores, Inc.

- San Francisco, CA 415-982-6212
- Seattle, WA 206-455-0206
- Portland, OR 503-620-5595

To Order:

# 1-800-547-1289

Oregon: 1-800-451-5151 • Hours: 6-6 Pacific Mon-Fri, 8-4 Sat  
**Business Accounts Call 1-800-4-CONROY**

## PROGRAMMING LANGUAGES

- BORLAND
- \$ 22. Turbo Tutor
- 32. Turbo Toolbox
- 35. Turbo Graphix Toolbox
- 40. Editor Toolbox
- 46. Turbo Pascal
- 46. Traveling Sidekick
- 59. Turbo New Pack
- 63. Turbo Prolog
- 65. Turbo Lightning
- 78. Turbo Pascal w/8087 & BCD
- 79. Traveling Sidekick Combo
- 155. Jumbo Pack
- LIFEBOAT
- 285. Lattice C Compiler
- MICROSOFT
- 99. Macro Assembler
- 199. Pascal Compiler
- 275. C Compiler
- 229. Fortran Compiler

## COMMUNICATIONS

- HAYES
- \$107. Smartcom II KENSINGTON
- 95. Easy Link Mail Manager MICROSOFT
- 169. Access MICROSTUF
- 105. Crosstalk
- 169. Transporter VM
- 95. Relay
- 135. Relay Gold

## UTILITIES

- ALPHA SOFTWARE
- \$ 57. Keyworks
- AMBER
- 40. Homebase BORLAND
- 46. Superkeys
- 52. Sidekick (copiable) CENTRAL POINT
- 23. Copy II PC
- 23. PC Tools
- 81. PC Option Board FIFTH GENERATION
- 105. Fastback FINOT GROUP
- 64. Keep Track FUNK
- 39. Sideways NORTON
- 59. Utilities ROSESOFT
- 80. Prokey

## PERSONAL FINANCE

- MECA
- \$ 85. Managing The Market
- 109. Managing Your Money MONOGRAM
- 109. Dollars & Sense SIMON & SCHUSTER
- 55. J. K. Lasser Money Manager TIMEWORKS
- 75. Personal Financial Planner

## PROJECT MANAGEMENT

- HARVARD
- \$289. Total Project Manager MICROSOFT
- 265. Project

## ACCOUNTING

- BPI
- \$325. GL, AR, AP or Payroll DAC
- 39. Easy Payroll
- 55. Easy Accounting EVERGREEN
- 165. One-Write-Plus REAL WORLD
- 339. GL, AR, AP, PR, Inv or Payroll

## MEMORY CHIPS & COPROCESSORS

- RAM CHIPS
- \$ 13. 64K, 200 NS Kits
- 14. 64K, 150 NS Kits
- 36. 256K Kits
- 49. 128K Kits for AT HAUPPAGE
- 119. 8087 Chip
- 175. 8087-2 Chip
- 229. 80287 Fast 5 for AT
- 349. 80287 Fast 8 for AT

## EXPANSION BOARDS

- AST
- \$275. SixPak Plus, 384K
- 395. Rampage for PC
- 495. Rampage for AT INTEL
- CALL Above Board 64K For PC
- CALL Above Board 128K for AT MAGNUM
- 95. EconoRAM 384K
- 139. PC MasterCard No RAM
- 189. PC MasterCard 384K
- 325. PC MasterCard 1.5 MB ORCHID
- 279. Conquest No RAM TALLTREE
- 279. JRAM AT3, No RAM for AT
- 279. JRAM 3, 256K EMS Board, PC

## VIDEO BOARDS

- EVEREX
- \$265. The Edge HERCULES
- 159. Color Graphics
- 309. Graphics Card QUADRAM
- 419. EGA+ Board VIDEO 7
- 429. VEGA Board

## DRIVES & TAPE BACKUPS

- CDC Floppy Drives
- \$ 95. Half Height 360K
- 119. Full Height 360K IRWIN
- 549. 10 MB Tape Backup Kit MOUNTAIN
- 899. 20 meg DriveCard Hard Disk SEAGATE Hard Drives
- 489. 20 meg for PC
- 649. 20 meg for AT
- 789. 30 meg for AT SYSGEN
- 1085. 60 MB Internal Tape Backup
- 1150. 60 MB External Tape Backup
- 1225. 20 MB Hard Disk, 20 MB Tape (PC)
- 1999. 30 MB Hard Disk, 60 MB Tape (AT) TEAC Floppy Drives
- 99. 55-BV Half Height 360K
- 175. 1.2 MB Floppy Drive For AT

## INPUT DEVICES & DIGITIZERS

- HITACHI
- \$969. Tiger Tablet II (4 Buttons) KEYTRONICS
- 185. KB 5151 Keyboard
- 319. KB 5153 Keyboard MICROSOFT
- 129. Mouse
- 139. Serial Mouse MOUSE SYSTEMS
- 129. Mouse With Software & PC Paint

## MODEMS

- HAYES
- \$419. 1200 External
- 379. 1200B Internal
- 629. 2400 External
- 579. 2400B Internal US ROBOTICS
- 299. Password 1200 External
- 499. 2400 External
- 499. 2400 Internal

## PRINTERS & PLOTTERS

- ENTER COMPUTER
- \$299. Sweet P 100 Plotter
- 849. Sweet P 600 Plotter EPSON
- 389. FX 85 160 cps, 32 NLQ
- 419. HI 80 Plotter
- 599. FX 286 200 cps, 40 NLQ
- 649. LQ 800 180 cps, 60 LQ
- 795. LQ 1000 180 cps, 60 LQ, 15" OKIDATA
- 995. LQ 1500 200 cps, 67 LQ, 15" OKIDATA
- CALL 182 S or P, 192 S or P, 193 PANASONIC
- 275. P1091 120 cps,
- 439. P3151 Daisywheel

## MONITORS

- AMDEK
- \$125. 300G 12" Green Composite
- 135. 300A 12" Amber Composite
- 159. 310A 12" Amber TTL
- 409. Color 600
- 549. Color 722
- 609. Color 725
- 795. Color 730 NEC
- 125. 1280 Green
- 125. 1285 Amber
- 599. JC 1401P3A Multisynch PRINCETON
- 179. MAX 12 12" Amber TTL
- 459. HX-12 12" Color RGB
- 559. HX 12e RGB for IBM-EGA
- 599. SR-12 Hi Res RGB

## POWER & SURGE PROTECTION

- CONROY-LAPOINTE
- \$ 93. 130 Watt Power Supply CURTIS Surge Suppressors
- 30. Diamond, 6 outlets
- 35. Emerald, 6 outlets, 6' cord
- 47. Sapphire, 3 outlets, RFI filter
- 55. Ruby, 6 outlets, cord, RFI Filter KENSINGTON
- 92. MasterPiece
- 129. Masterpiece Plus

## DISKETTES & ACCESSORIES

- CONROY LAPOINTE DISKETTES
- \$ 16. DS/DD 10
- 119. DS/DD 100
- 219. DS/HD 10 for AT
- 279. DS/HD 100 for AT GENERIK DISKETTES
- 11. DS/DD 10
- 89. DS/DD 100
- 28. DS/HD 10 for AT
- 269. DS/HD 100 for AT DYSAN
- 29. DS/DD 10 MAXELL
- 19. DS/DD 10
- 34. DS/HD 10 for AT

# LASER 128

Apple IIe, IIc Compatible

**\$599** With Monitor & Software

- 128K RAM, 32K ROM
- 65C02 CPU
- 5 1/4" Floppy Drive
- 1 Expansion Slot, IIe
- 1 Parallel, 2 Serial Ports
- External Drive Port
- Numeric Keypad
- 4 Cursor & 10 Function Keys
- Supports Double Hi Res
- Mouse/Joystick Port

**\$995** With Monitor, Printer, 2nd Drive, Software B39

# Conroy-LaPointe



# B·O·O·K R·E·V·I·E·W·S

MUSICAL APPLICATIONS OF MICROPROCESSORS, 2nd edition  
Hal Chamberlin  
Hayden Book Company  
Hasbrouck Heights, NJ:  
1985  
802 pages, \$39.95

COMPUTER MUSIC: SYNTHESIS, COMPOSITION, AND PERFORMANCE  
Charles Dodge and Thomas A. Jerse  
Schirmer Books  
New York: 1985  
381 pages, \$29.95

FOUNDATIONS OF COMPUTER MUSIC  
Curtis Roads and John Strawn, eds.  
The MIT Press  
Cambridge, MA: 1985  
712 pages, \$50

ELECTRONIC AND COMPUTER MUSIC  
Peter Manning  
Oxford University Press  
New York: 1985  
291 pages, \$29.95



anyone interested in computer music applications.

The author offers background material on the goals, history, and practice of music synthesis: fundamental sound parameters, tape and voltage-control (analog) methods, direct computer synthesis, and the growing role of computers in sound processing. Although the material is not new, it represents a fairly good overview of basic sound synthesis issues. A brief history of microprocessors and microcomputers and a detailed discussion of the 6502 and 68000 is also included.

## ANALOG

If you're constructing and interfacing to your own analog sound synthesis system, Chamberlin's discussion of computer-controlled analog synthesis will delight you. He details analog system hardware down to the level of transistors and operational amplifiers. While some

readers may not be excited by discussions of MOSFET switches and R-2R resistive ladders, those with solid technical backgrounds will find a great deal of useful material. However, I found this discussion to be the most expendable. Chamberlin seems indecisive about the level of detail he wants to expose readers to. As a result, he combines a variety of topics under the general heading of controlled analog synthesis and even includes a discussion of vector and raster display devices (with circuit diagrams). I doubt many people are interested in constructing their own digital-to-analog converters, but there is material here for those who are. In the end, however, much of this section seems vaguely dated in an era when

(continued)

---

## MUSICAL APPLICATIONS OF MICROPROCESSORS

Reviewed by Donald Swearingen

The second edition of Hal Chamberlin's *Musical Applications of Microprocessors* might be more accurately titled *Sound Synthesis from A to Z* because the contents speak more to seasoned electronic and computer music practitioners than computerists. The book is filled with a myriad of esoteric subjects ranging from the characteristics of operational transconductance amplifiers to the properties of binary arithmetic. While the book's basic orientation is often more in line with an engineering background than that of a musician, *Musical Applications* is nevertheless valuable for



# ACCESS TO FULL MEMORY, STRUCTURE, COMPATIBILITY WITH GW- & PC-BASICA, AND WITH THE POWER AND FLEXIBILITY OF C OR PASCAL

BetterBASIC runs existing GW-BASIC/PC-BASICA programs on IBM PCs and true clones yet gives you structure and access to full memory. BetterBASIC has more than 150 statements in addition to the standard Microsoft syntax. There is optional 8087/80287 math chip support. The Runtime System creates stand-alone EXE files. Call us or ask your local dealer for...

**Better  
BASIC™**

**1-800-225-5800**

In Canada, call 416-469-5244

**Summit Software Technology, Inc.™**  
106 Access Rd. Norwood, MA 02062

BetterBASIC is a registered trademark of Summit Software Technology, Inc. IBM PC is a registered trademark of International Business Machines Corp. Microsoft is a registered trademark of Microsoft Corp.

sound synthesis is becoming almost exclusively the province of all-digital devices.

## DIGITAL

The largest and by far the most useful section of the book focuses on digital sound synthesis and modification. If your primary interest is digital signal processing, this section provides a strong basis, both theoretical and practical, to explore this increasingly prevalent technology. With an eye to the trade-offs between hardware and software to best solve signal-processing problems, Chamberlin takes us on an enlightening excursion through topics central to the discipline. These include digital-to-analog and analog-to-digital conversions, digital filtering (including the simulation of reverberation), digital tone generation, and signal analysis.

In his discussion of the conversion between real-world analog signals and their numerical equivalents in digital form, Chamberlin includes an excellent overview of the difficulties involved in attempting to preserve the fidelity of the audio signal as it moves from one representation to the other. Since ultimately we perceive sound in analog form, the results of our processing of the digitized signals will of course be limited by the quality of the hardware handling the conversion. Chamberlin's discussion makes it clear that it is no easy matter to provide high-fidelity signals and that there is no one "best" approach to overcome all the difficulties inherent in the process.

The discussion of digital tone-generation techniques covers a range of useful methods, from simple table lookup to FM synthesis. Here, too, Chamberlin reminds us of the constraints imposed on our programming methods by the requirement that the signals must ultimately be converted to analog form: In the digital world we can never really ignore the fact that we are working with signals that have been sampled (or generated) in discrete time increments rather than continuously. From the generation of simple sine tones to the methods of percussive tone generation, Chamberlin provides the background to realize these functions entirely in software. However, with respect to the speed limitations of microprocessors faced with real-time signal-processing requirements, he includes a handy discussion on replacing some digital signal-processing algorithms with actual digital hardware, highlighting the trade-offs between execution speed and system complexity.

Chamberlin introduces us to digital filtering using models for the digital equivalents of several analog filters. With signal flow graphs, he shows how to construct digital filters of many types and characteristics: state-variable, all-pass, notch, etc. Included are models for a practical filter for "concert hall reverberation" and a parametric chorus generator. I was struck by the relative simplicity of the digital filters as compared with their more complex (and correspondingly more difficult to implement) analog cousins.

If you're interested in digital signal analysis, you may find Chamberlin's treatment of the subject brief; nonetheless,

*(continued)*



# THE PROFESSIONAL'S CHOICE

<b>Lotus 1-2-3 \$319</b>	<b>Lotus Symphony \$449</b>	<b>dBase III Plus \$369</b>	<b>FrameWork II \$369</b>	<b>MultiMate \$219</b>	<b>Word Perfect 4.1 \$209</b>
----------------------------------	-------------------------------------	-------------------------------------	-----------------------------------	----------------------------	---------------------------------------

## Software

### Word Processing Editors

FANCY FONT	\$119
FINAL WORD II	\$219
MICROSOFT WORD	\$239
MULTIMATE	\$219
MULTIMATE	\$219
ADVANTAGE	\$269
OFFICE WRITER/ SPELLER	\$239
PFS: WRITE	\$ 89
SAMNA WORD III	\$259
THINK TANK	\$109
TURBO LIGHTNING	\$ 59
VOLKSWRITER 3	\$159
VOLKSWRITER SCIENTIFIC	\$259
WORD PERFECT 4.1	\$209
WORDSTAR 2000	\$249
WORDSTAR 2000+	\$289
WORDSTAR PRO	\$259
XYWRITE III	\$239

### Database Systems

ALPHA DATA BASE MANAGER II	\$179
CLIPPER	\$359
CONDOR III	\$339
CORNERSTONE	\$259
DBASE III PLUS	\$369
KMAN 2	\$269
PARADOX	\$499
PFS: FILE/PFS: REPORT	\$169
POWERBASE	\$189
Q & A	\$199
QUICKCODE III	\$159
QUICKREPORT	\$159
R BASE 5000	\$359
REFLEX	\$ 59
REVELATION	\$499

### Spreadsheets/ Integrated Packages

ENABLE	\$349
FRAMEWORK II	\$369
JAVELIN	\$549
LOTUS 1-2-3	\$319
MULTIPLAN	\$135
OPEN ACCESS	\$259
SMART SYSTEM	\$489
SPREADSHEET	\$ 99
AUDITOR	\$ 99
SUPERCALC 3	\$209
SYMPHONY	\$449

### Graphics

CHARTMASTER	\$219
DIAGRAM MASTER	\$199
EXECUVISION	\$249
ENERGRAPHICS	\$179
FREELANCE	\$209
GEM DRAW	\$149
GRAPHWRITER COMBO	\$299
IN-A-VISION	\$259
MS CHART NEW OVERHEAD EXPRESS	\$189
PC DRAW	\$139
PC PAINTBRUSH	\$209
PFS: GRAPH	\$ 89
SIGNMASTER	\$ 89
SIGNMASTER	\$149

### Project Management

HARVARD TOTAL	\$279
PROJECT MANAGER	\$279
MICROSOFT PROJECT	\$249
PROJECT SCHEDULER NETWORK	\$339
SUPERPROJECT + TIMELINE 2.0	\$269
SUPERPROJECT + TIMELINE 2.0	\$259

### Communications/ Productivity Tools

CROSSTALK	\$ 99
PROKEY	\$ 85
KEYWORKS	\$ 59
RELAY GOLD	\$149
REMOTE	\$109
SMARTER	\$Call
SMARTCOM II	\$ 99
SUPERKEY	\$ 49

### Statistics

SPSS/PC	\$575
STATPAK-NWA	\$299
STATPAC GOLD- WALONICK	\$399
SYSTAT	\$419

### Desktop Environments

DESK ORGANIZER	\$ 69
GEM DESKTOP	\$ 39
SIDEKICK	\$ 39

### Network Applications

DBASE III LAN PAK	\$599
KMAN 2	\$899
OPEN SYSTEMS	\$459
R BASE 5000	\$799
REVELATION	\$999
WORD PERFECT	\$450

### Languages/Utilities

CONCURRENT DOS	\$179
C86 C COMPILER	\$299
FASTBACK	\$ 99
LATTICE C COMPILER	\$289
MARK WILLIAMS C	\$319
MICROSOFT C COMPILER	\$249
MS BASIC COMPILER	\$249
MS FORTRAN	\$229
NORTON UTILITIES	\$ 59
QUICK BASIC	\$ 75
TURBO PASCAL	\$ 49
XENIX	\$Call

### Accounting

BPI	\$299
GREAT PLAINS	\$479
IUS EASYBUSINESS	\$309
ONE WRITE PLUS	\$159
OPEN SYSTEMS	\$409
PEACHTREE	\$259
REAL WORLD	\$389
STAR ACCOUNTING PARTNER II	\$529

### Display Boards

HERCULES GRAPHICS CARD	\$299
HERCULES COLOR CARD	\$159
PARADISE COLOR/ MONO	\$169
PARADISE MODULAR GRAPHICS	\$259
QUADRAM EGA+	\$379
SIGMA EGA 350	\$379
SIGMA COLOR 400	\$449
STB EGA PLUS	\$399
TECMAR GRAPHICS MASTER	\$469
TECMAR ULTRA PAK	\$429
TECMAR ULTRA PAK-S	\$369

### Emulation Boards

AST 5251-11 +	\$649
AST 5251-12	\$489
AST BSC	\$489
AST SNA	\$599
CXI 3278/9 Plus	\$649
IRMA	\$799
IRMALINE	\$999

### Modems

AST REACH 1200	\$359
HAYES 1200	\$389
HAYES 1200B	\$349
HAYES 2400	\$579
HAYES 2400B	\$549
TRANSNET 1000	\$279
VENTEL 1200 HALF CARD	\$369
WATSON	\$319

### Mass Storage/Backup

EXCEL STREAM 60 TAPE (INT)	\$899
IOMEGA BERNOULLI BOX-10+10	\$2389
IRWIN 310A 10MB TAPE (EXT)	\$850
IRWIN 110D 10MB TAPE (INT)	\$479
MAYNSTREAM 60MB TAPE (INT)	\$1199
MOUNTAIN DRIVECARD 20MB	\$899
PLUS HARDCARD 10MB	\$689
PRIAM 42MB AT	\$1295
SYSGEN SMART IMAGE 20 MB (INT)	\$625
TALLGRASS	\$Call
TECMAR QIC-60AT TAPE (INT)	\$1199

### Monitors

AMDEK 600/722	\$429/539
NEC MULTISYNC	\$599
PRINCETON HX-12	\$449
PRINCETON MAX-12E	\$179
PRINCETON SR-12	\$579
PRINCETON HX-12E	\$539
PRINCETON HX-9	\$529
TAXAN 122 AMBER	\$159
TAXAN 630/640	\$469/539

### Networks

AST PC NET	\$Call
ORCHID PC NET	\$Call
3 COM	\$Call

### Printers/Plotters

BROTHER TWINWRITER	\$939
DIABLO	\$Call
EPSON FX-85	\$399
EPSON FX-286	\$589
EPSON LQ-800	\$589
EPSON LQ-1000	\$729
HP 7475A	\$Call
JUKI 6300	\$699
NEC 3550	\$869
OKIDATA 192	\$379
OKIDATA 193	\$519
TI 885	\$1025
TOSHIBA P321	\$565
TOSHIBA P341	\$829
TOSHIBA P351	\$1069

### Input Devices

KEYTRONIC 5151	\$179
KOALA	\$109
MICROSOFT MOUSE	\$129
PC MOUSE W PAINTPLUS	\$139

### Accessories

CURTIS SURGE PROTECTORS	\$Call
DATASHIELD BACKUP POWER	\$Call
GILTRONIX SWITCHES	\$Call
MASTERPIECE PLUS	\$135
MICROFAZER INLINE BUFFERS	\$Call
TRIPPLITE BACKUP POWER	\$Call
256K RAM SET	\$ 39
8087 MATH CHIP	\$135
80287 MATH CHIP	\$199

<b>NEC Multisync NEW \$599</b>	<b>Mountain Drivecard 20 NEW \$899</b>	<b>Quadram EGA NEW \$379</b>	<b>Princeton HX-12E \$539</b>	<b>J RAM AT-3 \$239</b>	<b>IRMA Board \$799</b>
--	--	--------------------------------------	---------------------------------------	-----------------------------	---------------------------------

\*CALL FOR SHIPPING COSTS



## LOWEST PRICE GUARANTEE!!

We will match current nationally advertised prices on most products. Call and compare.

free!

Diskette Library Case with your order



# 1-800-221-1260

In New York State call (718) 438-6057

### TERMS:

Checks—allow 14 days to clear. Credit processing—add 3%. COD orders—cash, M.O or certified check—add \$5.00. Shipping and handling UPS surface—add \$3.00 per item (UPS Blue \$8.00 per item). NY State Residents—add applicable sales tax. All prices subject to change.



MON.-THURS. 9:00 AM-8:00 PM  
SUN. & FRI. 9:00 AM-4:00 PM

# Softline

Softline Corporation  
P.O. Box 729, Brooklyn, N.Y. 11230  
TELEX: 421047 ATLN UI  
FAX: 718-972-8346



**ORDER  
LINE  
800-354-7330**

# LOWEST PRICES NO SURCHARGE ON BANK CARDS

## SILICON SPECIALTIES

**ZENITH COMPUTERS**  
Always the  
lowest prices.  
Call us for  
a quote.

### PRINTERS

Anadax All Models	Save
Brother All Models	Save
Cannon Laser Printer	\$2099
Citizen MSP-ID	\$255
MSP-15	\$349
MSP-20	\$319
MSP-25	\$485
Premier 35	\$409
Datsouth All Printer Models	Save
Diablo D-25	\$529
635	\$1079
Other Printer Models	Save

Silver Reed	
EXP400 Parallel	\$179
EXP550 Parallel or Serial	\$409
EXP800 Parallel or Serial	\$619
Toshiba 321	Save
P351 Parallel & Serial	\$969

### TOSHIBA

321 Parallel	Save
321 Serial	Save
341 Parallel	\$829
341 Serial & Parallel	\$879
351 Serial & Parallel	\$985

DISKETTES	
Maxell MD-2 Plastic Box (Qty 100)	\$125
Sony MD/2 (Qty 100)	\$120

MONITORS	
Amdax All Monitors	Save
NEC All Monitors	Save
Princeton Graphics	Save
Zenith All Models	Save

VIDEO TERMINALS	
Qume QVT Green 101	\$299
QVT Amber 101	\$314
Wyse 30	\$299
50	\$419
75	\$559
Wyse 85	\$439
Wyse 350	\$859
Zenith Z-22	\$455
Z-29A	\$559
Z-49	Save

EPSON	
All Printer Models	Save
6100	\$349
6300	\$669
NEC	
3510, 3550, 3515, 3530	\$729
8810, 8830, 8850	\$1039
PS, P6, P7	Save
Elit 360	\$379
Elit 370	\$379

OKIDATA	
All Printer Models	Save
Panasonic 1080	\$219
1091	\$235
1092	\$309
1592	\$429
KXP3151	\$399

STAR MICRONICS	
All Printer Models	Save

TRAINING	
Flight Simulator	\$29
Typing Instructor	\$28
Typing Tutor III	\$28

INTEGRATIVE SOFTWARE	
Enable 1.1	Save
Framework II	Save
Smart Software System	\$399
Symphony	Save

GRAPHICS	
Chartmaster	\$205
Diagram Master	\$189
Energraphics	\$159
In-A-Vision	\$249
Microsoft Bus Mouse w/PC Paintbrush 3.0	\$107
Microsoft Chart	\$169
Microsoft Serial Mouse	\$120
Newsroom	\$32
PC Mouse w/Paint Plus	\$119
PFS Graph	\$76
Printmaster	\$30
Sigmastar	\$134
Turbo Graphics Tool Box	\$30

UTILITIES	
Concertware Plus	\$36
Copy II Mac	\$19
Music Works	\$45
Pro Print w/cable	\$56
Sidekick w/Phone Link	\$56
Smooth Talker	\$49

SPREADSHEETS	
Chart	\$72
Click On	\$44
Multiplan	\$110

TRAINING	
MasterType	\$28
Mind Prober	\$26
Typing Intrigue	\$25
Typing Tutor III	\$33

COMMUNICATIONS	
Smartcom II	\$84

COMMUNICATIONS	
CompuServe Starter Kit	Best Price
Crosstalk XVI	\$92
MS Access	\$145
Remote	\$92
Smartcom II	\$83
UTILITIES	
Copy II PC	\$19
1 DIR	\$47
Fastback	\$87
Norton Utilities 3.1	\$48
Sidekick	\$30
Sidekick (Unprotected)	\$47
Sidekick - Superkey (Bundle)	\$85
Sideways 3.1	\$34
Superkey	\$39
Travelina Sidekick	\$39
PROJECT MANAGEMENT	
Harvard Total Project Manager	\$262
Microsoft Project	\$229
Super Project Plus	\$237
Timeline 2.0	\$219

DATA BASE MANAGERS	
Business File Vision	\$199
File Maker	\$96
1 Know It's Here Somewhere	\$33
Microsoft File	\$110
Omnis III	\$243
Overvue 2.0	\$144
Think Tank 512	\$96

LANGUAGES	
Basic 2.0	\$87
Consulair C w/FP (New Ver)	\$255
Experloga	\$75
Microsoft Fortran	\$170
Microsoft Logo	\$73

MONEY MANAGEMENT	
Dollars & Sense	\$78
Dollars & Sense Forecast Module	\$38
Mac Home Accountant	\$72

UTILITIES/COMMUNICATIONS	
Copy II Plus	\$19
Pin Point	\$35
Sideways	\$30
Turbo Pascal (Rep. cP/m)	\$35
Crosstalk	\$94
TRAINING	
FLT Sim II	\$32
Typing Tutor II	\$29
DATA BASE MANAGEMENT	
PRS: File	\$68
PRS: Report	\$68

WORD PROCESSORS	
Appleworks	\$189
Bank Street Writer	\$39
Bank Street Speller	\$39
PRS: Write	\$68
Think Tank	\$75
Word Perfect	\$79
Wordstar Professional (Rep. cP/m)	\$259
SPREADSHEETS	
Supercalc 3A	\$98
PFS: Plan	\$68
Multiplan	\$55

### HARDWARE

MODEMS	
AT&T	
4000 External	\$309
Anchor Automation	
Anchor Express	\$235

HAYES	
All Modems	Save
Prometheus All Models	Save
US Robotics Courier 2400	\$389
Password 1200	\$180
Microlink 2400	\$379

COMPUTERS	
Zenith Computer Products	
SAVE up to 50%	
Z-158 All Models	Save
Z-138 All Models	Save
Z-148 All Models	Save
Z-171	Save
Z-200	Save

PANASONIC	
Sr. Partner Dual Drive	\$1599
Exec. Partner Dual Drive	\$2129

TOSHIBA	
T-1100	\$1389

WYSE	
Wyse pc 1100-1	\$979
Wyse pc 1100-20	\$1539

### SOFTWARE

#### IBM PC AND 100% Compatibles

WORD PROCESSORS	
Leading Edge Word Processor	\$48
Leading Edge W/P w/Spell & Mail	\$95
Lightening	\$55
Microsoft Word 2.01	\$228
Multimate 3.3	Save
PFS: Write w/Spell Checker	\$76
Wordstar Pro Pack	\$233

Word Perfect (Ver. 4.1)	\$196
Wordstar 2000 2.0	\$233
Wordstar 2000 Plus 2.0	\$278

LANGUAGES	
C Compiler (Microsoft)	\$227
Fortran Compiler (Microsoft)	\$203
Lattice C Compiler	\$242
Macro Assembler (Microsoft)	\$87
Pascal Compiler (Microsoft)	\$174
Quick Basic	\$57
Run C Interpreter	\$82
Turbo Pascal 3.0	\$38
Turbo Database Tool Box	\$30

### MACINTOSH

ACCOUNTING	
Palantrix G/L	\$74
Palantrix A/P	\$74
Palantrix A/R	\$74
Peachtree G/L	\$84
Peachtree A/R	\$84
Peachtree A/P	\$84
Rags to Riches-3 Pack (G/L, A/P, A/R)	\$247

ACCESSORIES	
Mac Tote Carrying Case	\$56
Mac/Vison	\$166
MouPad (by Moustrak)	\$7
Printer Ribbon	\$6
The Easel	\$12
Packet Rack	\$9

DISKETTES	
SONY Disks (10 Pack) S.S.	\$18
SONY Disks (10 Pack) D.S.	\$27

DISK DRIVES	
Alpha Omega Turbo 10	\$515
Turbo 20	\$515
Turbo 30	\$675
Imega	
Bernoulli Boxes for IBM	Save
Bernoulli Boxes for Macintosh	Save
Paradise Macintosh Hard Disk	Save

BOARDS	
AST Advantage	\$389
Rampage PC	\$299
Six Pack Plus	\$219
Hercules Color Card	\$149
Graphic Card	\$305
Intel	
Above Boards	Save
Maynard Hardcard	\$549
Paradise Modular Graphic 06-1	\$239
Five Pak	\$115
Quadram	
Gold & Silver Boards	Save
Quadlink	\$329
Quad EGA+	\$365
Tec Mar Graphics Master	\$445
Captain No Memory	\$155

PLOTTERS	
Epson Hi-80	Save
KEYBOARDS	
Keytronics 5151	\$159

SPREADSHEETS	
Lotus 1-2-3	Save
Multiplan	\$112
Spreadsheet Auditor 2.0	\$82
VP Planner	\$49
Supercalc 3(Ver. 2.1)	\$179

MONEY MANAGEMENT	
Dollars & Sense w/Forecast	\$94
Tobias Managing Your Money	Save
DATA BASE MANAGEMENT	
Clipper	\$339
dBase III Plus	Save
Extended Report Writer	\$79
KnowledgeMan II	\$279
Nutshell 2.0	\$95
PFS: File	\$76
PFS: Report	\$67
Quickcode	\$138
QuickReport	\$138
Reflex	\$55
Think Tank	\$92
R:Base 5000	\$319

WORD PROCESSORS	
Hayden Speller	\$45
Microsoft Word	\$110
MacSpell Plus	\$53
Mac Lightening	\$49

INTEGRATED SOFTWARE	
Helix 2.0	\$212
Microsoft Excel	\$228

GRAPHICS	
Accessory Pack I	\$22
Click Art	\$28
Mac Draft	\$139
Mac Pic #1 & 2	\$28
Mac The Knife III	\$28
Ready Set Go 2.1	\$96
Video Works	\$55

### APPLE

GRAPHICS	
Clip Art #1	\$16
Clip Art #2	\$21
Newsroom	\$32
PRS: Graph	\$68
Printshop	\$29
Printshop Companion	\$23
MAC Draw	\$149
MONEY MANAGEMENT	
Dollars & Sense	\$68
Managing your money	Save



**SILICON SPECIALTIES**  
2034 WEST SOUTHERN  
MESA, ARIZONA 85202  
602-969-0909

Many other titles available.

CKS-88

Product shipped in factory cartons with manufacturer's warranty. Please add \$10.00 per order for UPS shipping. Prices & availability subject to change without notice. Send cashier's check or money order... all other checks will delay shipping two weeks.

Inquiry 309 for MS DOS Products. Inquiry 310 for all others.



It is indicative of the discipline's broad scope of application. As with the filters, we are given the basis for an all-digital approach to the problem. The section on digital synthesis and modification concludes with a brief history and discussion of several music software systems. The bulk of the discussion centers on several algorithms and programs developed and used by Chamberlin in his own computer music applications.

The final section of the book concentrates on the design and workings of several real-world (commercially available) synthesizers and concludes with the author's view of the future of computer music synthesis.

In sum, the range of topics in the book is impressively comprehensive, though their treatment is not always as detailed as you might wish. For instance, if your interest in computer music has been piqued by the recent proliferation of MIDI (musical instrument digital interface) equipment, you will be disappointed by the all-too-brief discussion of this important subject. On the other hand, newcomers to the field of computer music should be prepared for a challenge in assimilating the book's many technical details.

Although I found the analog discussion dated, the hardware versus software issues weighted too much in the direction of hardware, and I would have liked to see more algorithms and fewer circuit diagrams, the information contained in *Musical Applications* is useful and instructive. You would have to collect many reference works to amass the details provided in this single volume.

Donald Swearingen (100 Valencia St. #261, San Francisco, CA 94103) is a freelance software developer, consultant, and musician.

**COMPUTER MUSIC: SYNTHESIS, COMPOSITION, AND PERFORMANCE**

Reviewed by Randall Graves

Judging from the level of mathematics used in *Computer Music: Synthesis, Composition, and Performance*, the intended reader will be significantly more a computer enthusiast than a musician. Charles Dodge and Thomas A. Jerse recommend their book as a class text, but I think most music students would have a hard time with much of the material. I envision the prime reader to be a personal computer hobbyist who would like to try some fairly involved exercises in musical physics.

This volume covers most of the commonly used methods of music synthesis, and the level of detail enables a reader to imagine what a variety of waveforms will sound like. This task is not left to the reader's imagination, however, as the authors supply several references to commercial music examples.

**ISSUES**

Several temperaments and the relative harmonic structures of the intervals contained therein are explored, but the authors withhold opinions on their merits or applica-

(continued)

**ATTN: XT, AT CLONE INTEGRATORS & DEALERS**

**WE KEEP EVERYTHING IN STOCK**

- REASONABLE PRICES
- RELIABLE QUALITY
- TRY OUR SERVICE ←

**POWER SUPPLY - U.L. Recognized, Meet FCC Class B**

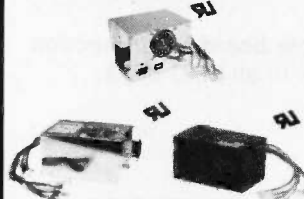

- U.L. file #E-101115(s)
- 115/230V AC
- IBM® standard pin-out or Faraday® pin-out
- OVP, OCP
- One year warranty

**ADD-ON CARD - For XT, AT & Compatibles**

<p><b>FC 1930 (PC AT)</b></p> <ul style="list-style-type: none"> <li>• 1 EIA RS-232 port [2nd optional]</li> <li>• Centronics port</li> <li>• With game port</li> <li>• With cables</li> </ul> <p>(AT Multi I/O)</p>	<p><b>FC 1730 (PC AT)</b></p> <ul style="list-style-type: none"> <li>• 1 EIA RS-232 port [2nd optional]</li> <li>• 128K to 1.5 MB memory</li> <li>• Expandable to 3MB (optional) piggyback board</li> <li>• Game port</li> </ul> <p>(Multifunction card for AT)</p>
<p><b>FC 740 (XT)</b></p> <ul style="list-style-type: none"> <li>• 1 serial port [2nd optional]</li> <li>• 1 Centronic port</li> <li>• Clock/calendar</li> <li>• w/floppy controller</li> </ul> <p>(XT Multi I/O)</p>	<p><b>FC 550 (XT / AT)</b></p> <ul style="list-style-type: none"> <li>• 80x25 text mode</li> <li>• 720x348 graphic mode</li> <li>• Run Lotus 1-2-3 auto cad. etc.</li> <li>• IBM® compatible</li> </ul> <p>(Mono/Graphic w/printer)</p>
<p><b>FC 940 (XT)</b></p> <ul style="list-style-type: none"> <li>• RS-232C port</li> <li>• To 9600 baud</li> <li>• Battery back-up</li> </ul> <p>(RS232/clock)</p>	<p><b>FC 230 (XT)</b></p> <ul style="list-style-type: none"> <li>• Control 4x5 1/4" F.D.D</li> <li>• IBM® compatible</li> </ul> <p>(Floppy controller)</p>

**KEYBOARD - FCC Approved**

<p><b>FC 427</b> (5150 Type) PC XT</p> 	<p><b>FC 437</b> (5151 Type) PC XT</p> 	<p><b>FC 447</b> PC AT</p> 
--	--	--

**COMPUTER CHASSIS - For XT or AT**

 FC 620	 FC 630 A-2
--	---

**FORTRON**      **ORDERS ONLY: (800) 821-9771**  
 3225 SELDON CT.      IN CALIF.: (415) 490-8171  
 FREMONT, CA 94538      TELEX: 559291 FORTRON U.D.



# JUST THE FACTS . . .

## The Finest Products Too!

### SMD; SCSI; ESDI Multifunction CONTROLLERS and Memory Systems

For all PC, XT, AT, RT, and compatible applications

**Facts:** NMS was and is first to:

1. Bring you **SMD disk controller** and systems with 2.4mb/sec data rates and 17ms access times (8000A)
2. Provide **SMD/SCSI single board, multifunction controller** compatible with all SMD disks

supports up to eight SCSI devices

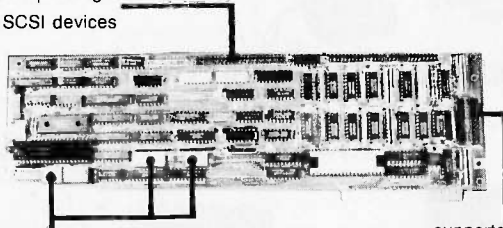

switch selectable DMA, port address

supports any 2 SMD disks

3. **Break the 32mb DOS limitation**
4. Bring you storage of up to 1,600mb
5. Bring you file by file back up in quarter inch tape systems
6. Bring you **1,000mb of laser optical storage** that really does work
7. **Support all major networks** including Novell
8. Provide selection of **5 1/4 inch and 8 inch memory systems**
9. Bring all of the above to the **PC-AT and RT**
10. NMS provides the widest selection of, high capacity, high performance, disk/tape/laser optical memory systems and controllers

**You can buy our controllers . . . .**  
or complete memory systems

WHAT'S NEXT? . . .

See us at the New York PC Expo!

**OH YES . . . Fact #11 . . .**

No one is developing technology like NMS

**CALL US TODAY**  
**415-443-1669**

TWX 9103866006  
TELEX 821892 NMS UD

The finest controllers and memory systems for:

Microvax  
Multibus

**National  
Memory  
Systems**  
CORPORATION

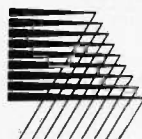

Livermore, California

tions. This rather aloof and cool presentation gives the book a somewhat stuffy feel.

A very good section covers the conversion of analog waveforms to digital equivalents and back again, along with the various integrating types of functions used to approximate the original signal when less than complete digital sampling is used. If your main interest is digital audio, you will find this section enlightening.

The thorough discussion of the ear and the hearing process contains sufficient examples to make clear some basic principles of "voicing." Voicing is the arrangement of pitches within a musical piece so that a listener does not tire from inappropriate clustering of pitch groups.

### BASICS

Dodge and Jerse explain how the basic concepts of synthesis are interrelated. The components include amplitude envelopes, harmonic spectrums of different waveforms, and various styles of modulation, and the authors handle them in a manner that does not require a great knowledge of physics. Given the approach of the book, however, they should have included some examples of how to implement these functions in software. The advent of FM synthesis has caused many companies to rethink their hardware products, and a very good section in this book on FM will help both the computer owner and the user of performance-oriented synthesizers (such as the Yamaha DX series) to understand the programming nature of their instruments.

Subtractive synthesis is covered both conceptually and practically with the role of filters extensively discussed using mathematical computation and algorithmic examples. Music students might have trouble with this section, but I recommend it for an enhanced understanding of harmonic spectrums.

### GAINS AND LOSSES

I found the chapter on speech synthesis useful only for synthesizing telecommunication recordings. I think a general reader would be more interested in sampling and musical-capture techniques whereby the limitless articulations of the human voice could be used as a direct source and, if desired, processed with a computer for a variety of effects.

Once a musical example is composed, the next thing I want is high-quality production of the sound, and that requires a good delivery system. The psychoacoustics involved in hearing a replay of a computer music score and the actual delivery itself are the focus of a section that appealed to me greatly. Some very practical help was offered in these areas, which also introduce some electronic signal processors for composition enhancement.

For my purposes, this book is strictly a reference. I would point the novice computer synthesist to a more example-oriented work. The few functional examples here are all in FORTRAN, which would not likely be the language of most personal computer owners, and they would require translation. The comprehensive glossary, however, is

(continued)



“While Symphony® and Framework™ approach the functionality of Open Access®, neither delivers the full punch”

Kenneth M. Landis  
Wang Solutions

OPEN ACCESS Comparison Chart	OPEN ACCESS												
	Database	Form Query	Report Generator	Query Processor	Relational Database	Graphics	3-D Graphics	Spreadsheet	Goal Seeking	Word Processor	Communications	Time Management	Price
Lotus 1-2-3	✓				✓	✓							495 <sup>00</sup>
Symphony	✓	✓	✓		✓	✓		✓	✓				695 <sup>00</sup>
Framework	✓		✓	✓	✓	✓		✓	✓				695 <sup>00</sup>
<b>Open Access</b>	✓	✓	✓	✓	✓	✓	✓	✓	✓	✓	✓	✓	<b>395<sup>00*</sup></b>

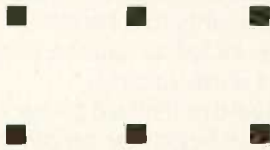

# O-P-E-N ACCESS

INTEGRATED SOFTWARE

**\$395\***

The bottom line is this: compare all you get with Open Access—a powerful Relational Database, Spreadsheet, Graphics, Word Processing, Time Management and communications—add in a new low price and you’ll see why you can’t afford to compromise any longer.

But just in case you don’t need all that *Open Access* has to offer . . . yet . . . we offer *Open Access® Entry™* for just \$195. You get all the Open Access modules on a less sophisticated level, plus all the documentation necessary for upgrading to a complete *Open Access* package. Call today.



SOFTWARE PRODUCTS INTERNATIONAL

10240 Sorrento Valley Road ■ San Diego, CA 92121

**619 / 450-1526**

FOR YOUR AUTHORIZED DEALER OR DISTRIBUTOR

\*U.S. Version only

Open Access and  are registered trademarks of Software Products International, Inc.; Lotus, 1-2-3 and Symphony are registered trademarks of Lotus Development Corp.; Framework is a trademark of Ashton-Tate.



# DRIVE INN

Enclosure & power supplies for  
**FLOPPY,  
WINCHESTER,  
TAPE DRIVES,  
SINGLE BOARD  
COMPUTERS  
& S-100 SYSTEMS**

8 inch  
5 inch  
3 inch

Call or write  
for free  
catalogs &  
application  
assistance



**INTEGRAND**  
RESEARCH CORPORATION

8620 Roosevelt Ave. • Visalia, CA 93291  
209/651-1203

We accept BankAmericard/Visa  
and MasterCharge

## BOOK REVIEWS

doubly useful, as it assumes the reader is new to the terminology. I recommend this book as an additional reference to an existing computer music library, but not as a first or only work on the subject.

*Randall Graves (542 East 400 S, Springville, UT 84663) is a programmer/analyst for Dynix Inc. of Provo, Utah. He composes, records, and performs electronic music.*

### FOUNDATIONS OF COMPUTER MUSIC

Reviewed by Stan Czarnik

In *Foundations of Computer Music*, editors Curtis Roads and John Strawn bring together 36 articles demonstrating that the evolution of the "intelligent instrument" is destined to continue. The book is intended for both informed hobbyists and computer music professionals, but the sheer clarity of the contributions should quiet the fears of anybody curious enough to pull the book off the shelf.

### THE BINARY BEAT

Computer music follows from a technology capable of representing sonic events in the form of binary digits. Indeed, digital conversion is what distinguishes computer music from its analog ancestor, electronic music. The first section of *Foundations* amounts to a survey of various digital-synthesis techniques, including additive synthesis, frequency modulation, and waveshaping.

The roots of the additive method go back to the ancient Greeks. This technique begins by decomposing sound in much the same way as a prism decomposes light into its primitive spectral components. The digital representations of these elements can then be transformed into highly precise analog signals, or the representations can be manipulated by the composer to make musical sounds never before heard. As contributor Neil Rolnick tells us, the restrictions imposed by additive synthesis forced his computer music team to do certain things "awkwardly or not at all."

These difficulties are overcome to some extent by newer modes of control described by Curtis Roads in two elegant articles on waveshaping and granular synthesis. Waveshaping operates directly on the waveform. The key to waveshaping is known as the transfer function, which can be thought of as a line on a grid with values between  $-1$  and  $+1$  on the horizontal axis and corresponding values on the vertical. Granular synthesis is another way of working with the waveform, only this time with little pieces of it. The number of ways in which grain samples can be rearranged using a computer is endless, and the results are entirely unique. By systematic grain deletion a sound can be made to "evaporate" or, by reversing the process, coalesce and crystallize from the inside out.

### DEDICATED TO MUSIC

Some sections of *Foundations* are devoted to computer music hardware and software, and joint consideration

(continued)



# Two great reasons to buy Turbo Pascal™

## System Builder™ \$99<sup>95</sup> and Report Builder™ \$75<sup>00</sup>

From the Designer Series™ by Royal American Technologies.

### Now, experience the magic of 5th generation software.

It's a state-of-the-art program generator that automatically builds a relational database application for you in just seconds. You just paint your screen and datafile layouts.

SO EASY... ideal for entry level "coders" to produce relational database systems without coding. (Entry level guide with sample On-disk systems is provided.)  
SO POWERFUL... it provides programming professionals with more flexibility and horsepower than any development tool on the market (guide is provided.)



"I think it's wonderful... prospective buyers should seriously consider DESIGNER even before dBASE III."

*Mr. Greg Weale  
Corporate Accounts Manager,  
Computerland*

"We used DESIGNER last year to program a major application. It saved our programmers so much time. We now use DESIGNER instead of dBASE III as our development standard?"

*Mr. Peter Barge, Director  
Services Division, Horwath & Horwath*

"DESIGNER has resulted in significant time savings... We use it on classical database applications?"

*Mr. Andy Rudevics, Director  
Andrasoft Corporation*

#### REPORT BUILDER CYCLE:

- Key in the report parameters on screen
- Print your listings
  - New report format for reference
  - Report element layout
- Key in the report data elements on screen
- Report Builder automatically writes the program code and links it to your datafile
- Print your listing
  - Report program source code listings
- Compile the report builder code using the Turbo Pascal™ compiler
- Attach the new report module to your system menu

#### SYSTEM BUILDER CYCLE:

- Paint the menu screens
- Paint the application screens
- Define the datafile(s) on the screen
- System Builder automatically writes the program code and combines the datafiles into a relational database
- Print your listings
  - Program source code listing
  - Datafile layouts
  - Self-documenting program (includes screen schematics)
- Compile the System Builder code using Turbo Pascal™ compiler
- Start using the completed system

Press a key, wait 6 secs\*

Press a key, wait 6 secs\*

\*System Builder will generate 2,000 lines of program code in approximately 6 seconds.

#### REPORT BUILDER FEATURES:

- Automatically generates Indented, Structured Source Code ready for compiling Turbo Pascal (no programming needed)
- Automatically interfaces to a maximum of 16 Datafiles created with System Builder
- Supports Global Parameters such as Headings, Footers, Lines Per Page, Print Size and Ad Hoc Sorting
- Produces reports containing an unlimited number of Sub-Headings, Sub-Totals and Totals
- Page breaks on Sub-Totals
- Report Builder will generate Report Programs which can contain Report Elements not just restricted to Data Elements. Reports can also include Text Strings, Variables or Computed expressions containing references from up to 16 Datafiles
- Use range input screens produced by System Builder to allow End Users to select portions of a report as needed (i.e. specific account ranges can be requested)
- Produces standalone Report Modules
- Easy-to-use Interface Program to access dBase Files

#### SYSTEM BUILDER FEATURES:

- Automatically generates Indented, Structured, Copy Book Source Code ready for compiling with Turbo Pascal (no programming needed)
- Paint Application and Menu screens using Keyboard or Microsoft Mouse™
- Finished Application screens all use System Builder's In-Line machine code for exceptional speed
- Use fully prompted Screen Guidance Templates™ to define up to 16 Datafiles per application, each record having an Unlimited Number of fields
- Define up to 16 Index Keys per application database
- Paint functions include:
  - Center, copy, move, delete, insert or restore a line, Go straight from screen to screen with one keystroke
  - Cut and paste blocks of text screen to screen
  - Draw and erase boxes, Define colors and intensities
  - Access special graphic characters and character fill
- Supports an unlimited number of memory variables
- File Recovery Program Generator to make fixing of corrupted datafiles an automatic process
- Automatically modifies datafiles without loss of data when adding/deleting a field
- Menu Generator with unlimited Sub-Menu levels
- Experienced developers can modify the System Builder
- Develop systems for Floppy or Hard Disk
- Modify System Builder's output code to include External Procedures, Functions and Inline Code
- Easy-to-use Interface to access ASCII and dBase Files

**VARS, System Integrators and Dealers, let's work together. Your inquiries are always welcome. (415) 397-7500.**

**Royal American Technologies  
201 Sansome, Suite 500  
San Francisco, CA 94104**

**(800)654-7766  
California (800)851-2555  
Ask for Operator 105.**

Please rush me: \_\_\_\_\_ copies of SYSTEM BUILDER at \$99.95 per copy; \_\_\_\_\_ copies of REPORT BUILDER at \$75.00 per copy. I've enclosed \$5.00 for postage and handling. California residents add 6% sales tax.

Name \_\_\_\_\_

Address \_\_\_\_\_

City \_\_\_\_\_

State \_\_\_\_\_ Zip \_\_\_\_\_

Phone \_\_\_\_\_

Payment:  Check  Money Order

Cashiers Check  AMEX

VISA  MASTERCARD

Expiration date \_\_\_\_\_

Card Number \_\_\_\_\_

Signature \_\_\_\_\_

**30-Day Money-Back Guarantee.** Not copy protected. \$10 restocking fee if envelope is opened.

System Requirements—System Builder/Report Builder: IBM PC/XT/AT<sup>1</sup>, or similar, with minimum 256K RAM, dual floppy drives, or hard disk, color or monochrome monitor, MS<sup>2</sup> or PC DOS<sup>1</sup> version 2.0 or later, Turbo Pascal Version 2.0 or later (Normal, BCD or 8087 versions).

<sup>1</sup>Trademarks of International Business Machines Corp.

<sup>2</sup>Trademark of Microsoft Corp.

<sup>3</sup>Turbo Pascal is a registered trademark of Borland International.

<sup>4</sup>dBASE is a registered trademark of Ashton-Tate.

SYSTEM BUILDER PERFORMANCE (Typical 10 screen 8 file/index application)		
TASK	SYSTEM BUILDER	DBASE III™
Planning and Design	60 minutes	60 minutes
Screen Painting	15 minutes	3 hours
Programming	2 minutes	10 hours
Elapsed time to completed system	1 hour and 17 minutes	14 hours

**ROYAL AMERICAN Technologies Corporation™**





# Introducing the Classic PC/XT/AT Multiuser System.

It's the multiuser system that gives you what you've been looking for. Full IBM PC™ software and hardware compatibility. High-speed performance. Cost savings.

It delivers full DOS 3.1 compatibility. You can run all popular PC/XT programs.

Even single-user programs run in true multiuser mode. And you can run new programs created for multiple users and networking with more sophisticated record-locking, including dBase™, RBase 5000™, Open Systems™,

Word Perfect™ and more.

It's *fast!* Three users run at mere AT speed, five users run at XT speed.

It's a true multiuser system, with DOS 3.1 record locking and file sharing. You have all the benefits of a multiuser system; Data, software and peripheral sharing. Better communication. Enhanced efficiency.

Each user is a *complete PC*. Simply connect an IBM or IBM compatible monitor and keyboard to your PC/XT/AT and you've added a new user with up to 640K. Each user runs independently while able to share files, records, programs and peripherals with other users.





Get your hands on the multiuser system you've been waiting for . . . the CLASSIC PC/XT/AT Multiuser System.

Visit your local Computerland today or call us for the name of your nearest dealer. For more information call 800/ 392-8324, in CA 800/ 338-0777. **CLASSIC TECHNOLOGY CORPORATION**, 2090 Concourses Dr., San Jose, CA 95131, 408/434-9333.

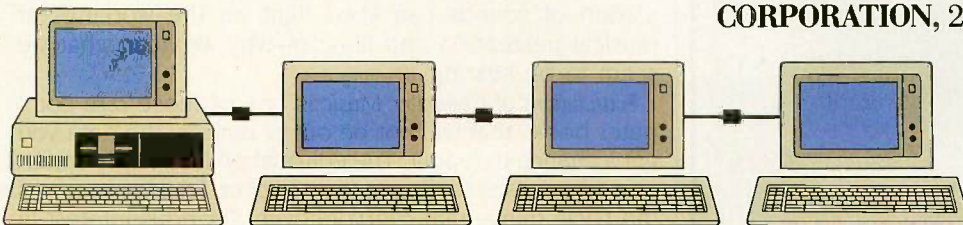

And to top it all off, it's 40% the cost of LANs. Now you can add more users to your existing PC/XT/AT instead of buying more PCs and LANs.

In a word, it's *it* . . .



**CLASSIC...**

Everything you always wanted in an IBM.



8080  
Z80  
6809

# AMX

8086  
8088

Now

68000

## Real-Time Multitasking Executive

- No royalties
- Source code included
- Fault free operation
- Ideal for process control
- Timing control provided
- Low interrupt overhead
- Inter-task messages

Options:

- Resource Manager
- Buffer Manager
- Integer Math Library

■ Language Interfaces :

C	Pascal
PL/M	Fortran

■ DOS File Access :

CP/M-80	
IBM PC DOS	

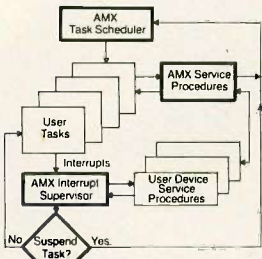

AMX is TM of KADAK Products Ltd.  
CP/M-80 is TM of Digital Research Corp.  
IBM, PC DOS are TM of IBM Corp.

<b>AMX for 8080</b>	<b>\$ 800 US</b>
8086	950
6809	950
68000	1600
Manual (specify processor)	75

**KADAK Products Ltd.**

(604) 734-2796  
Telex: 04-55670

206-1847 W. Broadway, Vancouver, B.C., Canada V6J 1Y5

seems appropriate. This is because of a noteworthy trend in the creation of intelligent musical instruments: What once went into software is now going into hardware—the design of dedicated real-time music computers.

One reason for this phenomenon is speed. The execution of computer music in real time calls for as much processing power as performers can get their hands on. This was one major impulse behind the well-known Structured Sound Synthesis Project (SSSP) at the University of Toronto. This need for speed is also behind the appearance of Chuck Hastings's piece on do-it-yourself emitter-coupled logic (ECL), some of the quickest stuff around. The project described is a 24-bit stored-micro-program computer capable of 900,000 fixed-point multiply instructions per second.

Another reason for turning to hardware involves the nature of musical composition, as Otto Laske points out. Rarely does a composer stick very long to a "top-down" or "bottom-up" approach to the material. Abrupt shifts between different musical perspectives lie closer to the norm. A change desired in the "feel" of a score may require subtle notational alterations; by the same token, replacing four eighth notes with eight sixteenths may affect the feel. This kind of flexibility is very difficult to get in musical software. Section III, "Software Systems for Music," shows how complicated it can be to get around this problem.

The joker in the pack is John Myhill's progress report on the creation of a "semistochastic music language, a computer program designed to produce sequences of frequencies that are neither random nor non-random." Entirely random "music" is noise. No problem there. But what is nonrandom music? Myhill found the answer lies in periodicity: In a nonrandom series of sounds, any given sonic duration "says something" about the duration that follows it. Myhill can now program a computer to make polyrhythmic music in which one voice becomes increasingly coherent while another voice disintegrates.

### PERCEPTIONS

Roads and Strawn end the book with three articles focusing on how computers can not only help create music but understand it as well. Stephen McAdams and Albert Bregman, for example, explain how the automated manipulation of sounds can shed light on the workings of musical perception and illusion—why we hear what we seem to be hearing.

*Foundations of Computer Music* is one of those rare computer books that will not be out of date by the time you get a chance to read it. The editorial philosophy is underscored consistently from cover to cover. *Foundations* covers the basic things that everyone with a serious interest in the automation of music needs to know before breaking new ground in this realm of limitless possibility.

Stan Czarnik (2716 West Evergreen Ave., Chicago, IL 60622) is a teacher, musician, and technical writer whose hobbies include experimenting with high-voltage electricity.

(continued)

## ENHANCED GRAPHICS ADAPTER

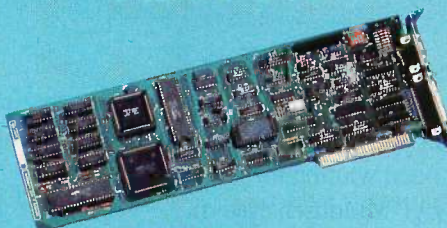

### SEGA Board

- On Board 256K Display Memory
- Compatible with the IBM EGA, CGA & MDA
- Works with Monochrome, RGB & Enhanced Color Monitors
- Runs the software supporting IBM EGA card

SEGA Board	\$395
SEGA with EGA Monitor	\$895

Order Toll Free (800) 826-0267  
In California Call (415) 651-3355

SOURCE ELECTRONICS CORP.  
45277 Fremont Blvd., #6  
Fremont, CA 94538

IBM is a registered trademark of International Business Machines, Inc.



# THE \$1,000,000 SWITCH IS ON!

LAN Versions Available

## SHARE THE EXCITEMENT!

Frustrated by the limitations of your current software? Try KnowledgeMan/2, the "Friendly Superpower." We think you'll be so excited by its power and flexibility you'll never go back to your present dead-end software. In fact, if you let us know why you prefer KnowledgeMan/2, you could be a winner in our "\$1,000,000 Switch!"

From accounting to manufacturing to sales, KnowledgeMan/2 is a data base management system providing familiar business computing features in one highly-fused software package:

- Extensive relational data base management
- Spreadsheet features
- Spur-of-the-moment inquiries
- Forms management
- Statistical analysis
- Data security
- Programming language and much more

Enhance your business presentations and communications with fully-integrated options for color graphics, text processing, forms painting, report generation, remote communications, mouse processing, natural language processing, and others. Versions for local area networks are also available.

For the beginner, KnowledgeMan/2 has our extensive menu system with supporting help screens and easy-to-use documentation. The experienced user may turn off the menus to use KnowledgeMan/2's power through its time-saving command language or procedural language. Everyone can use the optional natural language features to ask for information in plain English.

For details on how you can enter "The \$1,000,000 Switch," see your local dealer or write or call: mdbs/Marketing and Sales/P.O. Box 248/Lafayette, IN 47902; 317/463-2581.

**KNOWLEDGE**  
**man/2**<sup>®</sup>  
THE UNIVERSAL KNOWLEDGE MANAGEMENT SYSTEM

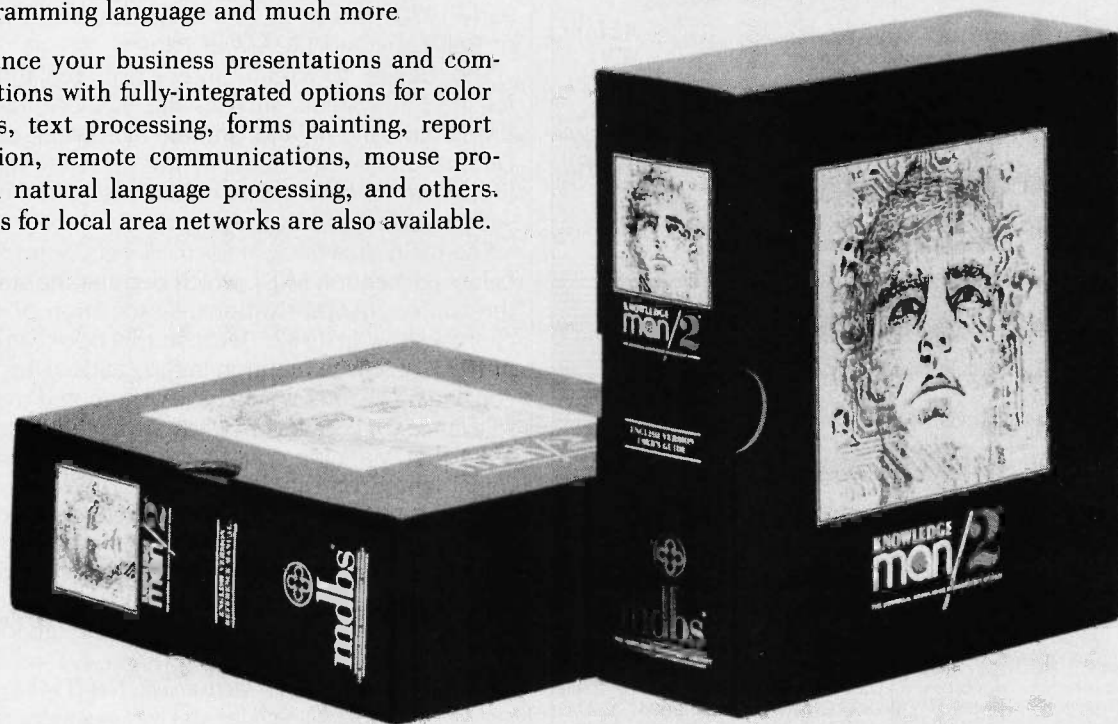

"mdbs" and "KnowledgeMan/2" are registered trademarks of Micro Data Base Systems, Inc.



# IBM PC AT performance! PCjr price!

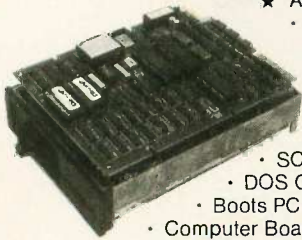

- ★ AMPRO Little Board/186
  - 8Mhz 16 Bit 80186 CPU
  - 512K RAM—No Wait-States
  - 2 Serial Ports 50-38.4K Baud
  - Parallel Printer Port
  - 4 Drive Mini/Micro-Floppy Controller
  - SCSI Bus Hard Disk Interface
  - DOS Compatible ROM-BIOS
  - Boots PC DOS 2.x, 3.x
- Computer Board Assembled and Tested with Tech Manual and DOS utilities... **\$499**

- ★ DRI Concurrent DOS 4.1 Multi-User O/S... **\$395**
- ★ Expansion Board for 512K (1Mb total) 8087-2 Socket, Real-Time Clock, 8530 SCC 2 Channel RS232/422, Buffered Expansion Bus and more... from **\$295**
- ★ AMPRO Little Board (Z80) Same as 80186 board but Z80A CPU, 64K RAM, 16K EPROM, CP/M 2.2 & ZCPR3 and manuals... **\$239 (\$279 w/SCSI)**
- ☆ Enclosures w/Power Supply... from **\$99**
- ☆ Floppy Drives... call for current price
- ☆ Xebec Owl SCSI Drive—Low power 1/2 Ht Drive w/built-in Controller 10/20Mb... **\$499/\$649**
- ☆ Terminals: WYSE, QUME, KIMTRON... from **\$395**
- ☆ Power supplies, cables, connectors in stock

Complete technical support. Assembled systems available. Write or call for free catalog. Most orders shipped same day.

VISA, MasterCard, Money Order, C.O.D. Checks allow two weeks. Purchase orders and bids welcome. Prices F.O.B. Prairie View, IL.

IBM PC AT, PCjr, PC DOS are trademarks of International Business Machines Corporation. Concurrent DOS is a trademark of Digital Research, Inc. Xebec Owl is a trademark of Xebec, Inc.

**DISKS PLUS INC** 15945 West Pope Blvd.  
Prairie View, IL 60069  
(312) 537-7888

## BOOK REVIEWS

### ELECTRONIC AND COMPUTER MUSIC Reviewed by Gregory Lent

In this informative treatise on the history of electronic music, Peter Manning takes us back to 1897, when the Dynamophone was patented by Thaddeus Cahill in Holyoke, Massachusetts. It was the first fully developed sound-generator system that was operated via a keyboard. It weighed 200 tons and cost \$200,000. Numerous interactions between composers and scientists prior to 1945 are highlighted at the beginning of the book. The four sections that follow cover developments from 1945 to 1960, new horizons in electronic design, the electronic repertory from 1960, and the digital revolution. A bibliography and lengthy discography are included, but unfortunately this historical perspective does not mention MIDI.

After World War II, the revival of the arts was accompanied by advances in technology that provided incentives for American institutions to support the development of electronic music. In Europe, Pierre Schaeffer's experiments led to the discovery of the amplitude envelope (attack, body, and decay). This work includes such technological leaps as the birth of the transistor in the 1950s and the first voltage-controlled synthesizer. The book contains figures showing frequency and amplitude controls, waveforms, etc., that assume the reader has a background in the science of sound. Conversely, there are also basic, almost mundane, descriptions of hardware, such as how joysticks were used to control some early synthesizers.

Computers become the focus of the book in the digital revolution section, with descriptions of hardware, languages, and the history of how computers were used to synthesize music. It seems that most of the work in the early 1970s was done at universities, with the exception of Bell Labs and IRCAM in Paris.

The desire to create interactive, real-time facilities resulted in systems such as the VOCOM, developed at EMS Studio in England, and the Synclavier, developed at Dartmouth College. Other synthesizers are discussed, although most have more memory or have been superseded since this book was written.

The main drawback of *Electronic and Computer Music* is its failure to mention MIDI, which became the standard after the winter NAMM (National Association of Music Merchants) show in 1982. Because this book was published in 1985, at least a mention in the "outlook for the future" concluding chapter would have contributed to its historical relevance. Of course, MIDI has advanced so rapidly since 1982 that Manning could have written another book of equal length on that topic alone.

Overall, this book is an excellent reference on the history of electronic music from the late nineteenth century to the mid-twentieth century. It fails, however, to bring the reader up to the present—an insurmountable task in an industry that doesn't stand still long enough for analysis. ■

Gregory Lent (POB 721, Peterborough, NH 03458) is a musician and composer currently working with the Synclavier and other MIDI-equipped instruments.

**IBM® PC/XT COMPATIBLE** **STOCK 23-640**

**DO-IT-YOURSELF KIT—NO SOLDERING**

**ATTN DEALERS:**  
Send Us 3 Vendors' Names From Which You Now Purchase on Your Company Letterhead w/a Copy of Your Resale Card

NOW ONLY  
**\$47500**  
KIT  
You Assemble  
**YOU SAVE!!!**

**ALL YOU NEED IS A SCREW DRIVER!!**

■ PC/XT Compatible 8-Slot Motherboard

■ W/256K RAM & ERSO BIOS on 640K Motherboard (8088 16-Bit 4.77 MHZ)

■ Floppy Disk Controller Card, up to 2 drives

■ One 360K DS/DD Slim Drive

■ Easy Assembly - No Soldering

■ 135W Power Supply

■ Keyboard... Similar to Keytronics 5150

■ Flip-Top Case

■ 90 Days Warranty on Parts & Labor

■ 134-Page Computer Instruction Manual

■ Monitor Optional

OUTSIDE CALIFORNIA

**1-213-329-3384 • 1-800-231-6491**

NO COD, No Open Account - Only Prepaid or Credit Card Orders. Add 10% Shipping & \$2.00 Handling Fee. Credit applied if freight is less than 10%  
California Residents Add 6½% Sales Tax

**ASK FOR OUR 24-PAGE CATALOG**

**MORE® Computer**

DEPT. BYTE/MAG • P.O. BOX 2320  
GARDENA, CALIF. 90247-0320  
OPEN: 8:30 - 5:00 Monday - Friday

Sorry, No Walk-In Orders - Strictly Mail Order Only.  
IBM® is a registered trademark of Int'l Bus. Machines Corp.



# The price of power just went down.

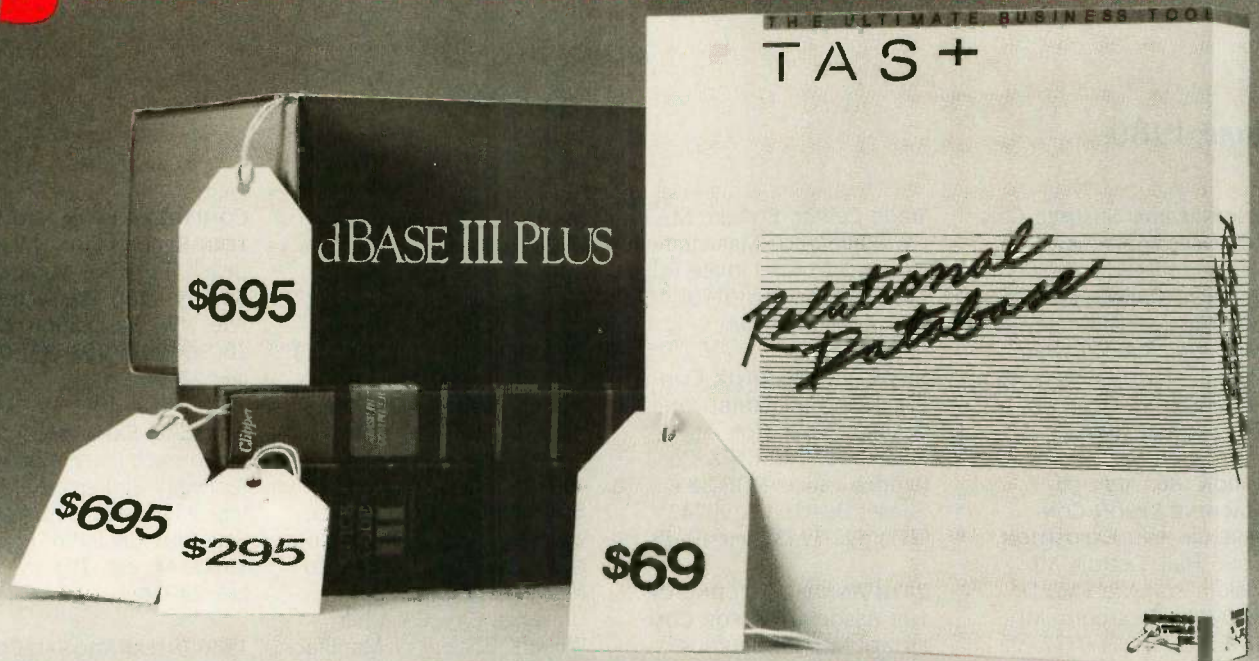

## Before you buy DBase III, QuickCode and Clipper, look at TAS-Plus

TAS-Plus just made it faster, easier and cheaper to build database applications. TAS-Plus combines the power of a Relational Database with the ease of a Program Generator. Then TAS-Plus adds a Runtime Compiler to produce lightning-fast finished code. Look at what TAS-Plus gives you:

- Relational Database**
- 4th Generation Language**
- Screen Painter**
- Program Generator**
- Report Writer**
- Source Code Editor**
- Runtime Compiler**

TAS-Plus gives you power where it counts. You can store up to 65,000 records, open up to 16 files at a time and enter up to 10,000 characters per record. TAS-Plus even reads your old DBase files.



The following are registered trademarks of these companies: TAS-Plus, The Accounting Solution, Business Tools, Inc.; DBase III, Ashton-Tate; CP/M, Digital Research; IBM PC/XT/AT, International Business Machines Corp.; QuickCode, Fox & Giller; Clipper, Nantucket Inc.

© Copyright 1986 Business Tools, Inc.

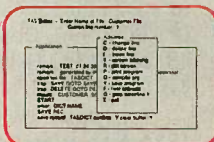

## TAS-Plus writes the program for you

With TAS-Plus, you can start building professional database applications on day one. Just "paint" the screen the way you want and TAS-Plus writes the program for you. You can even paint using different colors or graphic characters. And custom reports are just as easy.

TAS-Plus has over 86 commands and 200 options available in its Source Code Editor, so you won't run out of room to grow.

### Easy to use features

Add new databases quickly and easily. Add, change or delete records without any programming at all. Browse through your database and see multiple records on the screen at the same time. Restructure capability allows you to change existing databases without loss of any data.

## All this for just \$69

TAS-Plus would be respectable at any price, at \$69 it's awesome.

## 30 day Money Back Deal

TAS-Plus comes with a 30 day money back guarantee (less \$15 handling fee). TAS-Plus is available for the IBM PC/XT/AT and fully compatible computers. Limited versions available for CP/M and non-IBM machines.

## Order Today 1-800-648-6258

Call our Toll-Free Hotline. Use your VISA, MasterCard or American Express to order today. For information or Washington residents call 1-206-644-2015.

## TAS+™

**NOT COPY-PROTECTED**

**YES! Rush me the following items.**

Qty.	Item	Price	Subtotal
1	TAS+	\$69	
	Shipping add \$8 USA, \$25 outside USA		Shipping _____
	WA res add \$5.59 Tax		Tax _____
			Amount Enclosed _____ (US funds only)

Name: \_\_\_\_\_

Shipping Address: \_\_\_\_\_

City: \_\_\_\_\_

State: \_\_\_\_\_ Zip: \_\_\_\_\_

Telephone: \_\_\_\_\_

Payment:    VISA    MC    AMX    Check

Credit Card Expiration Date: \_\_\_\_\_

Card Number: \_\_\_\_\_

Name on Card: \_\_\_\_\_

BUSINESS TOOLS INC.  
4038-B 128th Ave. S.E., Suite 266  
Bellevue, Washington 98006  
(206) 644-2015





# E·V·E·N·T Q·U·E·U·E

## June 1986

ENGINEERING SUMMER CONFERENCES, Ann Arbor, MI. Engineering Summer Conferences, College of Engineering, The University of Michigan, 300 Chrysler Center, North Campus, Ann Arbor, MI 48109, (313) 764-8490. *June-August*

VISION '86: APPLIED MACHINE VISION CONFERENCE AND EXPOSITION, Cobo Hall, Detroit, MI. Vision '86, One SME Dr., POB 930, Dearborn, MI 48121, (313) 271-0777. *June 3-5*

1986 NATIONAL EDUCATIONAL COMPUTING CONFERENCE (NECC '86), San Diego, CA. NECC '86, University of San Diego, School of Education, Alcalá Park, San Diego, CA 92110, (619) 260-4539. *June 4-6*

THIRD ANNUAL CONFERENCE ON WRITING FOR THE COMPUTER INDUSTRY, Plymouth, NH. Dr. Richard Chisholm, Reed House, Plymouth State College, Plymouth, NH 03264, (603) 536-1550, ext. 301. *June 7*

ASSOCIATION OF SMALL COMPUTER USERS IN EDUCATION 19TH ANNUAL SUMMER CONFERENCE, Myrtle Beach, SC. Jack Cundiiff, Horry-Georgetown Technical College, Conway, SC 29526. *June 9-11*

NATIONAL DATABASE & 4TH GENERATION LANGUAGE SYMPOSIUM, New York, NY. Software Institute of America Inc., 8 Windsor St., Andover, MA 01810, (617) 470-3880. *June 9-12*

NETWORK MANAGEMENT/TECHNICAL CONTROL, World

Trade Center, Boston, MA. CW/Conference Management Group, 375 Cochituate Rd., Framingham, MA 01701, (617) 879-0700. *June 9-12*

SUMMER 1986 UNIX CONFERENCE AND EXHIBITION, Atlanta Hilton Hotel, Atlanta, GA. USENIX Conference Office, POB 385, Sunset Beach, CA 90742, (213) 592-3243. *June 10-13*

24TH ANNUAL MEETING OF THE ASSOCIATION FOR COMPUTATIONAL LINGUISTICS, Columbia University, New York, NY. Don Walker (ACL), Bell Communications Research, 445 South St., MRE 2A379, Morristown, NJ 07960, (201) 829-4312. *June 10-13*

CLINICAL LABORATORY COMPUTER SYMPOSIUM, Ann Arbor, MI. Betty Phillips, The Towsley Center for Continuing Medical Education, Box 057, The University of Michigan Medical School, Ann Arbor, MI 48109-0010, (313) 763-1400. *June 12-13*

C '86—INTERNATIONAL COMPUTER EXHIBITION COLOGNE: COMPUTER, SOFTWARE, ELECTRONICS, Cologne, West Germany. KölnMesse, POB 210760, D-5000 Cologne 21, West Germany; telephone: (0)221-821-1; Telex: 8873426 mua d; in the U.S., Hans J. Teetz, German American Chamber of Commerce Inc., 666 Fifth Ave., New York, NY 10103, (212) 974-8836. *June 12-15*

IF YOU WANT your organization's public activities listed in *BYTE's Event Queue*, we need to know about them at least four months in advance. Send information about computer conferences, seminars, workshops, and courses to *BYTE, Event Queue*, One Phoenix Mill Lane, Peterborough, NH 03458.

MANAGING INFORMATION SYSTEMS EFFECTIVELY, University of Western Ontario, London, Ontario, Canada. Canadian Information Processing Society, 243 College St., 5th Floor, Toronto, Ontario M5T 2Y1, Canada, (416) 593-4040. *June 15-20*

SYNERGY '86: CONFERENCE ON FUNCTIONAL INTERFACING FOR COMPUTER-INTEGRATED MANUFACTURING (CIM), Universal City, CA. Cheri Willetts, Society of Manufacturing Engineers, One SME Dr., POB 930, Dearborn, MI 48121, (313) 271-1500, ext. 374. *June 16-18*

1986 NATIONAL COMPUTER CONFERENCE (NCC '86), Las Vegas, NV. NCC '86, American Federation of Information Processing Societies (AFIPS), 1899 Preston White Dr., Reston, VA 22091, (800) 622-1986. *June 16-19*

FACULTY INSTITUTE ON STUDENT CENTERED COMPUTER EDUCATION—COMPUTERS: TOOLS FOR PROBLEM SOLVERS, Lincoln, NE. Mindy Brooks, Union College, Lincoln, NE 68506, (402) 488-2331. *June 16-20*

SECOND ANNUAL COMPUTER USERS CONFERENCE FOR DELAWARE TEACHERS, Delaware State College, Dover, DE. Dr. William J. Geppert, Department of Public Instruction, Townsend Building, POB 1402, Dover, DE 19903, (302) 736-4885. *June 18*

COMPUTER VISION AND PATTERN RECOGNITION, Miami Beach, FL. IEEE Computer Society, 1730 Massachusetts Ave. NW, Washington, DC 20036-1903, (202) 371-0101. *June 22-26*

AUTOCAD EXPO '86, McCormick Place, Chicago, IL. Peggy Steffens, Autodesk Inc., 2320 Marinship Way, Sausalito, CA 94965, (415) 332-2344, ext. 703. *June 24-26*

1986 INTERNATIONAL CONFERENCE ON COMPUTERIZATION OF MEDICAL RECORDS: SECOND GENERATION OF PATIENT INFORMATION SYSTEMS, San Francisco, CA. Institute for Medical Record Economics, 121 Mount Vernon St., Boston, MA 02108, (617) 523-4449. *June 25-27*

CAD AND ROBOTICS IN ARCHITECTURE AND CONSTRUCTION, Marseille, France. Viviane Bernadac, IIRIAM/CMCI, 2, Rue Henri Barbusse, 13241 Marseille cedex 1, France; telephone: 91 91 36 72; Telex: Mistel 440860. *June 25-28*

1986 CARNAHAN CONFERENCE ON HARMONIZING TECHNOLOGY WITH SOCIETY, Lexington, KY. John Jackson, Electrical Engineering Department, University of Kentucky, Lexington, KY 40506-0046, (606) 257-3926. *June 26-27*

FORESTRY MICROCOMPUTER SOFTWARE SYMPOSIUM, Morgantown, WV. Division of Forestry, West Virginia University, Morgantown, WV 26506, (304) 293-2941. *June 30-July 2* ■



# Aztec C ... The Best C

## Frees the genius in you

You've got a great idea . . .

. . . you're ready to write your programs.

You don't want to be sidetracked by all the paperwork. With Manx Aztec C and the ingenious **make** function, your creative processes won't get bogged down in program administration and housekeeping. Manx Aztec C has the most sophisticated, hardworking program administrator available to you. Once you've described your project, adding new features or enhancements is simple. You never have to concern yourself with the repetitive, tedious task of rebuilding your systems.

The development process moves quickly. Compiles, assemblies, link edits . . . all finish in record time.

Manx Aztec C is the fastest, most efficient C development system in the industry. Benchmarks show it . . . reviews commend it . . . users praise it.

You're ready to test the program. You're ahead of schedule. The Manx Aztec C Source Level Debugger shows you the exact C language statement giving you a problem. You fix the problem quickly . . . you're still ahead of schedule.

You've got some time for fine tuning. The Manx Aztec C Profiler examines your program, tells you where the slow spots are and validates your test procedure. A few changes and it's exactly what you wanted.

You've made it!

**Aztec C is available for MS-DOS/PC DOS. Call for details on Macintosh, Amiga, Apple II, CP/M-80, CP/M-86, TRS-80, ROM and others.**

To order, or, for information

**Call Today**

**1-800-221-0440**

In NJ or outside the USA call  
**(201) 542-2121**

30-day satisfaction guarantee. Special Discounts are available to professors, students, independent developers, and on a "trade-in" basis. Site licenses.

# MANX

Manx Software Systems  
One Industrial Way  
Eatontown, NJ 07724

MS is a registered TM of Microsoft, Inc., CP/M TM DRI, HALO TM Media Cybernetics, PANEL TM Roundhill Computer Systems, Ltd., PHACT TM PHACT Assoc., PRE-C, PLink-86 TM Phoenix, db Vista TM Raima Corp., C-terp, PC-lint, TM Gimpel Software, C-tree TM Faircom, Inc., Windows for C TM Creative Solutions, Apple II, Macintosh TM Apple, Inc., TRS-80 TM Radio Shack, Amiga TM Commodore Int'l.

" . . . a superb linker, a profiler, an assembler, and a set of development utilities are only the beginning of this package . . . performed admirably on the benchmarks, with short compile times and the best link times in this review . . . includes the most professional make utility . . . documentation is clear and complete. There is no doubt that this is a valuable and powerful programming environment." **Computer Languages Feb. '86**

" . . . execution times are very good, close to the best on most tests . . ." **PC Tech Journal Jan. '86**

" Easily one of the fastest compilers overall . . . library provides a lot of flexibility . . . generates small .EXE files." **Dr. Dobbs Journal Aug. '85**

<b>C'Prime (Compiler, Assembler, Linker)</b>	<b>\$ 99.</b>
<b>Aztec C 86-d Developer's System</b>	<b>\$299.</b>
<b>Aztec C 86-c Commercial System</b>	<b>\$499.</b>
<b>PC ROM (8086, 68000, 8080, or 6502)</b>	<b>\$750.</b>

Third Party Software for Aztec C: HALO, PHACT, C-tree, PRE-C, Windows for C, PC-lint, PANEL, Greenleaf, db Vista, C-terp, PLink-86, FirstTime, C Util Lib, and others.

NOTES

FEATURES

C Compiler  
Overlay linker  
Librarian  
8086 Macro Assembler  
Source for library routines  
Make, grep, diff, utilities  
Source level debugger and profiler  
vi editor  
Dos functions, UNIX, and screen libraries  
Math, 8057/80287, and sensing libraries  
Intel hex utility  
mixed memory models  
Intel object utility  
detailed documentation  
year of free updates

OPTIONS

ROM support for 6800/6502, 8080/280 Series  
Cross development to Mac, Amiga, Apple  
CP/M-80 and others

Call  
MANX  
800-221-0440



# Simply put: **THE™** highest quality and best value in computer products anywhere.

**THE™** commitment to our customers is compatibility, quality, value, service and support

**THE™** backs every product with a **45 DAY MONEY BACK GUARANTEE**

and a **FULL 1 YEAR PARTS AND LABOR WARRANTY**

## THE™ MULTI 384

This multi-function card features 0-384K memory, a parallel printer port, a serial port for communications, a clock/calendar with battery backup, and a software bonus that includes RAMdisk and other utilities. Retail Price \$155.00

**\$72.00\***

Special Wholesale Price



**BEST BUY**

Functional Clone of AST™ SixPackPlus

## THE™ COLOR CARD

100% compatible with the IBM™ colorcard with display modes of 80x25 alphanumeric and 320x200 graphic. Retail Price \$105.00

Special Wholesale Price **\$60.00\***

## THE™ 576K MEMORY +

Supports 0-576K of available memory and is compatible with all IBM™ PC's. Retail Price \$66.00

Special Wholesale Price **\$37.00\***

## THE™ PRINTERFACE

Supports all text and graphics features and is fully compatible with third party software. Retail Price \$29.00

Special Wholesale Price **\$18.50\***

## THE™ MODEMS

100% Hayes compatible

### THE™ 1200 COM EXTERNAL

This self-testing 1200 BPS modem comes with auto answer, auto dial, auto redial and a built-in speaker. Retail Price \$275.00

Special Wholesale Price

**\$129.00\***



### THE™ 1200 COM INTERNAL

Features auto answer, dial and redial, with a built-in speaker, RS 232-C serial port and PC Talk III. Retail Price \$255.00\*

Special Wholesale Price

**\$119.00\***

### THE™ 2400 COM EXTERNAL

Eight times the speed of a 300 BPS unit makes this 2400 Baud modem truly affordable, and we've made it truly compatible. With auto answer, auto dial, auto redial, and a built-in speaker with volume control. Retail Price \$519.00

Special Wholesale Price

**\$277.00\***

## THE™ H720 MONO

This monochrome graphics card with printer port features 100% IBM™ and Hercules™ compatibility, at a fraction of their prices. Retail Price \$155.00

**\$73.00\***

Special Wholesale Price



**BEST BUY**

Functional Clone of Hercules Graphics Card

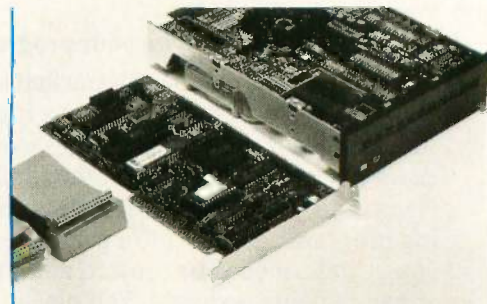

## THE™ 20MB HARD DISK

Featuring a formatted 20MB half height IBM™ PC compatible internal disk drive, controller card, connecting cables and installation manual.

Retail Price \$675.00

Special Wholesale Price

**\$395.00\***

## THE™ MULTI I/O

Feature for feature, **THE™** matches the AST™ I/O + and comes up a winner, with serial/parallel and game ports standard, (a second serial port optional), a clock/calendar, RAMdisk and print spooler. Retail Price \$110.00

**\$60.00\***

Special Wholesale Price

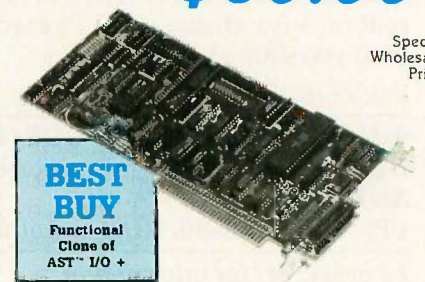

**BEST BUY**

Functional Clone of AST™ I/O +

## THE™ 2MB RAM

This Intel™ spec board will give you up to 2MB's of expanded memory. Enough to run memory intensive software such as Framework, Symphony and Microsoft™ Windows. Retail Price \$225.00

Special Wholesale Price

**\$129.00\***

## THE™ EGA PLUS

With 256K and parallel port is ideal for high resolution graphics display of Microsoft Windows,™ AutoCAD,™ and other graphic software. IBM™ EGA compatible. Retail Price \$485.00

Special Wholesale Price

**\$269.00\***

\*All Items Subject to Availability—Members Pay 8% Over Wholesale Prices Plus Shipping

**Thompson, Harriman and Edwards Computer**



# THE™

Thompson, Harriman and Edwards  
Computer Products Company Ltd.

## THE™ PC + COMPUTER

THE™ + is compatible with all business, professional and personal software written for the IBM™ PC. It will also enhance your productivity with its ability to switch to an 8 megahertz clock rate, enabling you to run your software twice as fast as the IBM™ PC. THE™ PC+ also comes standard with an "AT" style keyboard, correcting the inefficiencies found by IBM™ on their regular PC keyboard. 640K standard on the mother board will allow you to run memory intensive programs such as Lotus 1-2-3, DBase III and Framework without adding extra memory cards. Plenty of power, with a 135 Watt source and lots of room for expansion with 8 card slots is also standard. Base unit includes: 640K RAM, Computer with One 360K 5¼" Floppy Drive, Dual Turbo Clock Speed, 8 Expansion Slots, 135 Watt Power Supply, "AT" Style Keyboard, Full 1 Year Warranty and 45 Day Money Back Guarantee!

Retail Price \$829.00

Special Wholesale Price

**\$469.00\***

All THE products in this special sale are offered thru

## PC Network

\*All prices in this ad are wholesale—PC Network Members pay wholesale + 8% and shipping.

CALL TOLL FREE B376

**(800) 621-SAVE**

In Illinois (312) 280-0002

THE MOST INCREDIBLE  
LIMITED TIME OFFER IN  
COMPUTER HISTORY, FROM  
THE™ and PC NETWORK...

# THE™ PC

640K RAM,  
IBM™ PC  
compatible,  
360K 5.25"  
Disk Drive,  
Turbo Speed,  
"AT" Style  
Keyboard



Special Wholesale Price

# \$469.00\*

TM—Registered Trademarks of IBM/AST Research/Microsoft/Hercules/Hayes

Products Company Ltd.

Dealer Inquiries Call THE™ at (312) 642-9626  
319 West Ontario Street, Chicago, Illinois 60610







# COMPLETE SYSTEMS

(Optional local warranty service available in most major metro areas)

## IBM PC BASE SYSTEM

IBM PC w/256K  
Floppy Drive Controller  
2 Double Sided Double  
Density Disk Drives  
Mix and Match with  
your Favorite Monitor  
and Printer!

**\$1,159.00\***

CUSTOM  
CONFIGURATIONS  
WELCOME



## IBM PC HARD DISK SYSTEM

IBM PC w/256K  
Floppy Drive Controller  
1 Double Sided Double  
Density Disk Drive  
Half Height Hard Disk

w/20MB  
**\$1,499.00\***

CALL FOR  
LATEST IBM  
ANNOUNCEMENTS

## PORTABLE HARD DISK SYSTEM

256K/1 Floppy/Hard Disk



**\$1,999.00\*** w/20MB

call for 10MB

## DESKPRO SYSTEM

256K CPU/1 Floppy/Hard Disk



**\$1,940.00\*** w/10MB

**\$2,025.00\*** w/20MB

APPLE IIc



APPLE IIe



MACINTOSH SYSTEMS



## 64K IBM PC MEMORY EXPANSION KITS

Quantity Discounts Available.

Guaranteed for Life!

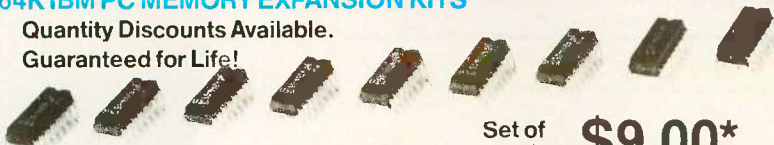

Set of 9 Chips **\$9.00\***

## DISKETTES

Guaranteed for Life!

Brand name diskettes  
available in boxes of 10  
or in bulk packs of 50

5 1/4" DS/DD

**\$8.95\***

Bx. 10 Bx. 50

ea. **.59\***

5 1/4" SS/DD

**\$7.95\***

Bx. 10 Bx. 50

ea. **.47\***

3 1/2" SS/DD

**\$15.95\***

Bx. 10

Free Flip & File Case

## 1/2 HEIGHT DS/DD DISK DRIVES

The Network buys direct and makes fantastic deals with manufacturers like MPI/Tandon/CDC/Shugart/Qume/TEAC and others to bring you fantastic prices on Name Brand drives for your PC/AT/XT/jr/Compatible.

**\$85.00\***

Quantity Discounts Available

## INTERNAL PC HARD DISK

Low Power/Automatic Boot. Works on standard PC's and Compatibles. Includes drive/controller/cables/mounting hardware and instructions.

Full one year warranty!



10MB

**\$340.00\***

20MB

**\$395.00\***

Quantity Discount Available



**\$280.00\***

WordPerfect

**\$180.00\***

ea.

MultiMate™

\*Members pay 8% above this wholesale price plus shipping.

CALL TOLL FREE 1-800-621-S-A-V-E (orders and memberships)

In Illinois call (312) 280-0002 Validation code: B366

Customer Service and Order Status (312) 280-1567

TM & R - Registered trademarks of IBM/COMPAQ/APPLE/AST Research/LOTUS/Multimate Int./OMEGA. Inquiry 258

# PC NETWORK

SEE WHY OVER 150,000 HAVE JOINED  
MAKING US THE NATION'S #1 SOURCE  
FOR EVERYTHING IN COMPUTING

- **Our 600 Page Wholesale Catalog**  
Over 30,000 products priced at Wholesale + 8%. Anything you will ever need at a Consistent low price...
- **Quarterly Catalog Updates**  
Your Catalog is never obsolete! Keep on top of the newest products and latest price changes.
- **The Printout**  
Our newsletter gives you fantastic specials along with unbiased analysis of new products and industry trends.
- **10 Day Returns on any Hardware!!**  
If you don't like any hardware product—for any reason—return it for a refund.
- **1000 + Title Rental Library**  
14 to 30 day rentals on over 1000 different titles. Try before you buy!!
- **Size, Strength and Stability**  
The Network has over 150 employees, 45,000 square feet of office and warehouse space, inventory valued in excess of \$15,000,000 and is ranked the largest computer product supplier in the nation! Our commitment is to serve our customers and our 90% repeat business rate is proof!!
- **OnLine™ Bulletin Board**  
Download "Freeware" from the nation's largest single concentration of Public Domain software available! Get tied into the nation's largest technical information network! Place orders, get tech support or contact customer service from the Network's OnLine,™ not just a bulletin board but a complete customer information network.

CALL TOLL FREE  
1-800-621-S-A-V-E

(Orders—Membership and Advice!)

In Illinois call (312) 280-0002

Your Membership Validation Number **B366**

You can validate your membership number and, if you wish, place your first money-saving order over the phone by using your VISA, MASTERCARD or AMERICAN EXPRESS. Our knowledgeable sales consultants are on duty Mon.-Fri. 8:00 AM to 7:00 PM, SAT. 9:00 AM to 5:00 PM CST.

PERSONAL COMPUTER NETWORK  
320 West Ohio  
Chicago, Illinois 60610

Call now...Join the PC NETWORK and start saving today!  
Customer Service and Order Status (312) 280-1567  
8:30 AM to 4:30 PM, Mon.-Fri. CST



## PC NETWORK • MEMBERSHIP APPLICATION

**YES!** Please enroll me as a member in the PC Network™ and send my catalog featuring thousands of computer products, all at just 8% above DEALER WHOLESALER PRICES. I will also periodically receive "THE PRINTOUT," a special up-date on merchandise at prices BELOW even those in my wholesale catalog, and all the other exclusive, money-saving services available to Members.

366

I am under no obligation to buy anything. My complete satisfaction is guaranteed. Please check (✓) all boxes that apply:

### Basic Membership with optional 14 Day Evaluation.

- One-year membership for \$8
- Two-year membership for \$15 (Save \$1)
- Business Software Evaluation Library for \$25 add'l. per year—with 14-day returns
- Games Software Evaluation Library for \$10 add'l. per year

### Special V.I.P. Membership with optional 30 Day Evaluation.

- One-year membership for \$15
- Two-year membership for \$25 (Save \$5)
- BOTH Business and Game Software Evaluation Libraries for \$30 add'l. per year—with 30 day returns
- \*V.I.P. members may receive advance notice on limited quantity merchandise specials

Bill my credit card:  VISA  MasterCard  American Express

Account Number:

Exp. Date \_\_\_\_\_  
mo. year

Check or money order enclosed for \$\_\_\_\_\_

Name \_\_\_\_\_

Address \_\_\_\_\_

City \_\_\_\_\_ State \_\_\_\_\_ Zip \_\_\_\_\_

Telephone (\_\_\_\_\_) \_\_\_\_\_

My computer(s) is:  IBM PC  IBM-XT  IBM-AT  Apple II  Macintosh  Other \_\_\_\_\_

Signature \_\_\_\_\_  
(Signature required to validate membership)



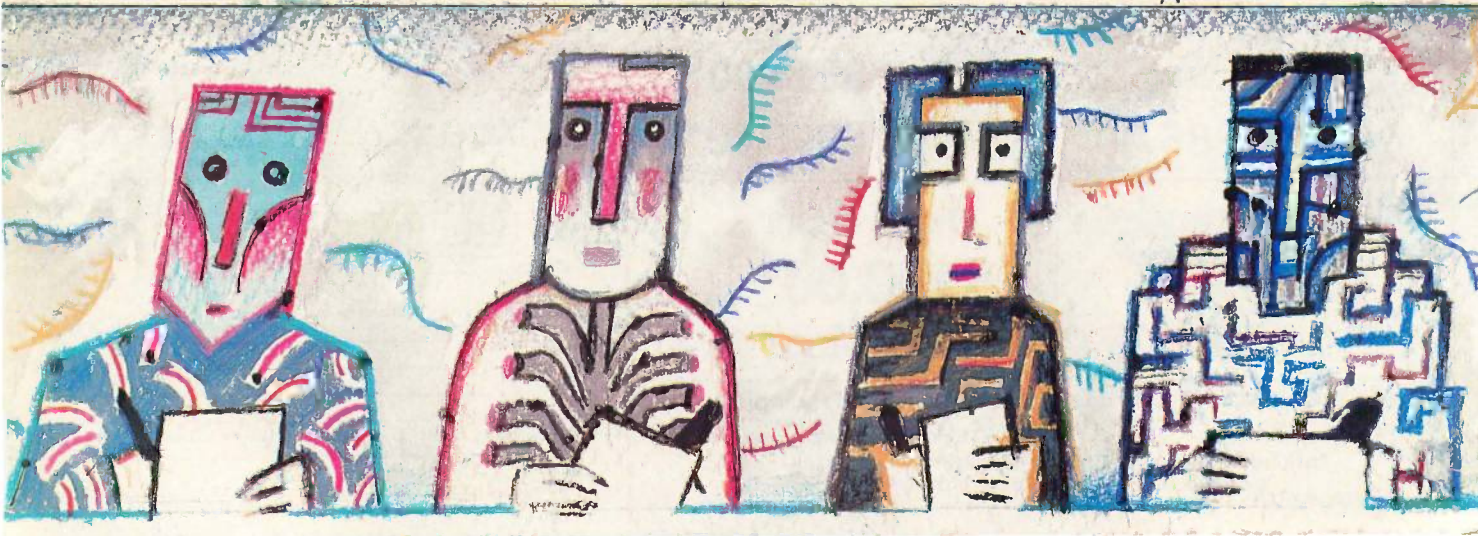
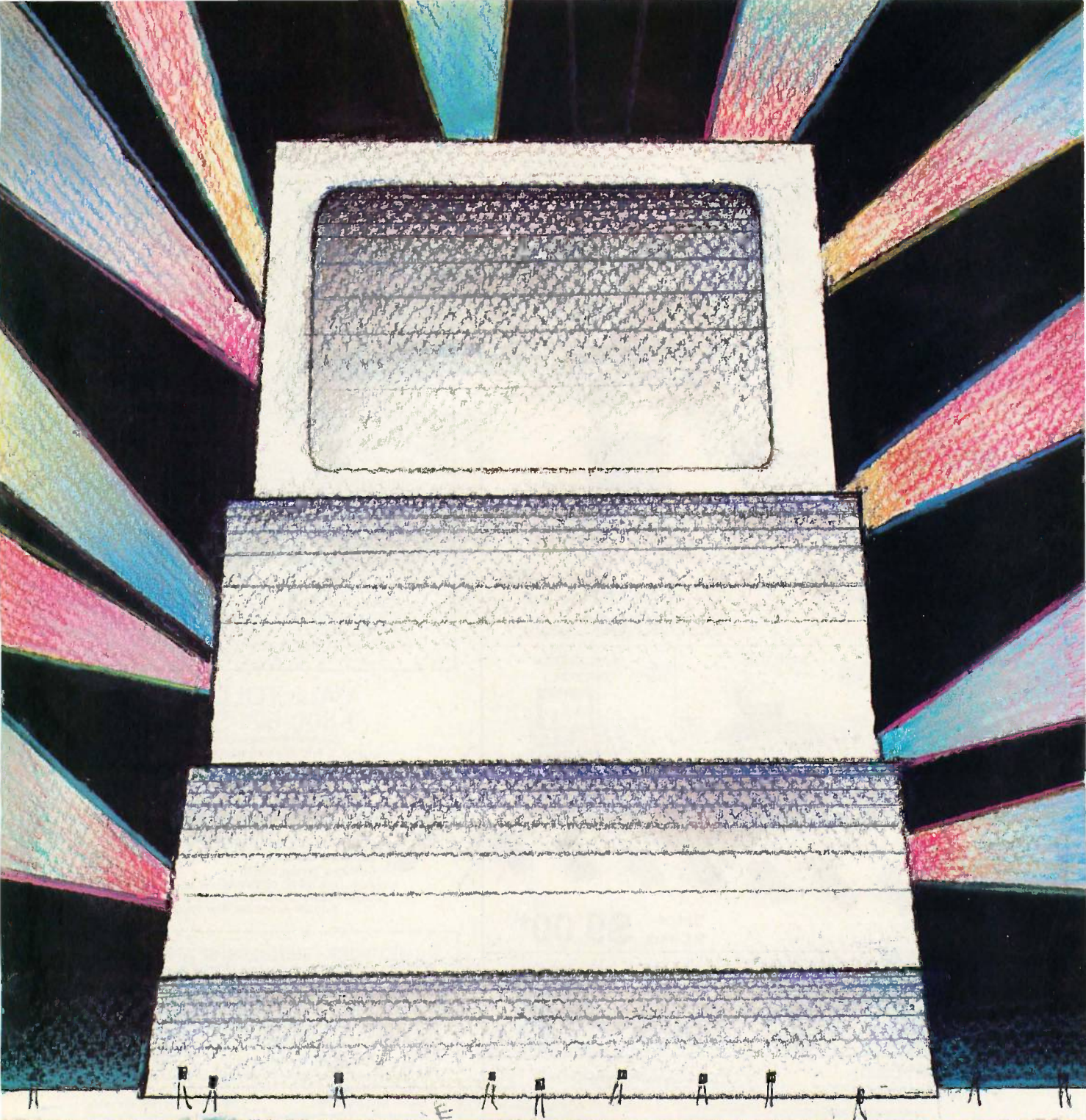



# Features

---

<b>PRODUCT DESCRIPTION:</b>	
<b>THE MACINTOSH PLUS</b>	
<i>by Phillip Robinson</i> .....	85
<b>PROGRAMMING PROJECT:</b>	
<b>A SIMPLE FILE-INDEXING SCHEME</b>	
<i>by Bruce Webster</i> .....	92
<b>CIARCIA'S CIRCUIT CELLAR:</b>	
<b>ADDING SCSI TO THE SB180 COMPUTER,</b>	
<b>PART 2: BUS PHASES</b>	
<i>by Steve Ciarcia</i> .....	107
<b>SORTING PRODOS DIRECTORIES</b>	
<i>by Antonio C. Silvestri</i> .....	117
<b>DECODING MACPAINT ON THE IBM PC</b>	
<i>by Mark Anacker</i> .....	131
<b>PROGRAMMING INSIGHT:</b>	
<b>HILBERT CURVES MADE SIMPLE</b>	
<i>by Michael Ackerman</i> .....	137

---

IN THE PRODUCT DESCRIPTION that leads off this month's Features section, Phillip Robinson introduces us to the Macintosh Plus. This enhanced Mac offers double-sided drives, an SCSI interface, a megabyte of RAM, and a larger, faster ROM, among other welcome additions.

This month's Programming Project is an easy-to-implement technique for maintaining a sorted file that Bruce Webster discovered while working on a mailing list program. He hopes that it will save beginning programmers time and frustration and help others improve their programming skills.

In the Circuit Cellar, Steve Ciarcia concludes his project for adding an SCSI interface to his single-board computer. Following up on last month's tutorial, Steve now discusses in greater detail the SCSI bus's operational characteristics: the bus phases and how they are managed by the NCR 5380 chip.

The program that Antonio Silvestri outlines in his article is designed to eliminate long catalog searches by sorting the valid filenames in the volume and subordinate directories of the Apple ProDOS disk. Written in Applesoft BASIC, the program provides you with extensive visual feedback as it reads, sorts, and updates a disk.

If you are faced with the problem of transferring graphics created on a Macintosh to an IBM PC, you'll want to read "Decoding MacPaint on the IBM PC" by Mark Anacker. His Pascal program decodes and displays MacPaint images on the PC, and, once you've accomplished the initial translation of the graphics, writing additional program code to manipulate the images is relatively easy, says Mark.

Looking for a less complicated way to draw a Hilbert curve, Michael Ackerman set out to write an Applesoft BASIC program that would have only one subroutine with a single entry point. In this month's Programming Insight you can examine his program for producing this elegant curve.



# Pick a card and get \$50.00

Putting your money on a Hercules™ Graphics Card or a Hercules Color Card has always been a safe bet.

After all, Hercules is the industry standard in high resolution graphics hardware. And we back each of our cards with a full two-year warranty.

Which explains why we've already sold more than 500,000 cards to owners of IBM® PCs, XTs, ATs and many compatibles.

But there are still some people out there who have yet to buy a Hercules card.

So we're sweetening the pot.

Between now and August 31, when you buy a Hercules Graphics Card or a Hercules Color Card,



we'll send you a check for \$50.00.

See your local Hercules dealer. When you've made your best deal, ask him for one of our rebate applications and send it in with your Purchaser Registration Card and dated sales receipt.

We'll pay off in short order. Your Hercules card, on the other hand, will pay off for a lot longer than that.

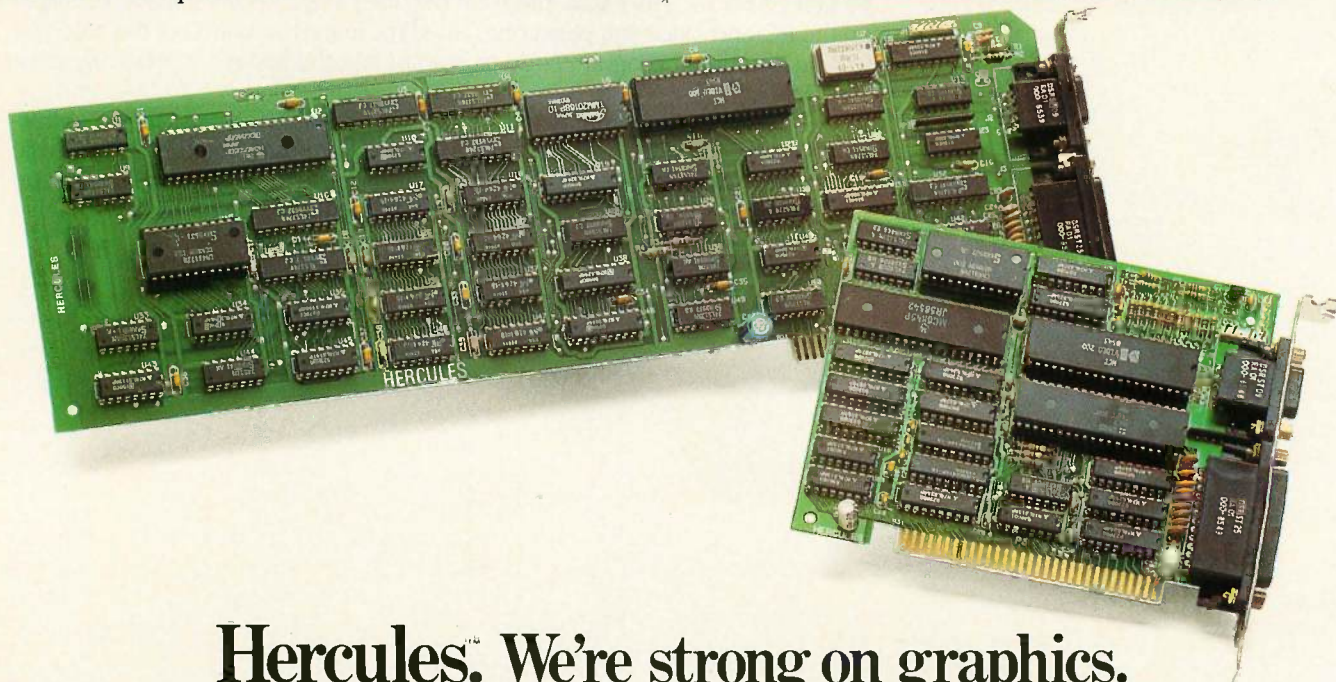

## Hercules.™ We're strong on graphics.

Trademarks/Owners: Hercules/Hercules Computer Technology; IBM/IBM. Offer valid in the United States, U.S. Territories and Canada from May 1 through August 31, 1986. Rebate application, accompanied by Purchaser Registration Card and dated sales receipt must be sent to Hercules Rebate Offer, PROMARK Depot, P.O. Box 3947, Milford, CT 06461-0397 no later than September 15, 1986. Applications received after that date will not be honored. Rebate will be paid in the same currency in which the card was purchased. Offer void where prohibited, taxed or restricted. Dealers are not eligible to claim rebate. Offer limited to one rebate per product serial number and original Purchaser Registration Card. Each rebate must be applied for on an individual basis. Other application constitutes fraud. Rebate offer applies to Hercules Graphics Card (model GB102) and Hercules Color Card (model GB200). Other Hercules products are not eligible. Allow 6-8 weeks for redemption. For additional information in the United States call (800) 532-0600 ext. 708. In Canada call (800) 323-0601 ext. 708.



BY PHILLIP ROBINSON

# THE MACINTOSH PLUS

*It has more memory,  
double-sided disks,  
and an SCSI interface*

*Editor's note: The following is a BYTE product description. It is not a review. We provide an advance look at this product because we feel that it is significant. A complete review will follow in a subsequent issue.*



The Macintosh introduced personal computer users to technology that has now become commonplace: bit-mapped displays, 3½-inch floppy disks, and iconic desktop environments. The Macintosh Plus adds welcome double-sided drives, a megabyte of RAM, an industry-standard SCSI interface, a numeric keypad, and a larger, faster ROM of operating system routines. The Mac Plus is also much faster than the 512K Mac, partly because of new software routines and partly because of the additional RAM. One feature that the 512K Macintosh had—free MacWrite and MacPaint software—is missing from the Mac Plus. Both programs are available separately for \$125 apiece.

## SYSTEM DESCRIPTION

Most of the technical details in BYTE's February 1984 description of the original, skinny (128K-byte) Macintosh are still apt descriptors for the Mac Plus. It is a desktop, 7.8336-MHz 68000-based microcomputer in a small-footprint case containing a built-in 3½-inch floppy disk drive and a 9-inch diagonal, bit-mapped, monochrome display of 512 by 342 pixels. It doesn't have any expansion slots, and it

*(continued)*

Phillip Robinson is a senior technical editor for BYTE. He can be contacted at BYTE/McGraw-Hill, 951 Mariner's Island Blvd., 3rd Floor, San Mateo, CA 94111.



doesn't have a cooling fan. It possesses a number of I/O ports, a detachable keyboard, and a mouse.

**KEYBOARD**

At first glance, the Mac Plus keyboard looks like a Mac keyboard with an added numeric keypad on the right

side. But there are other changes as well: Four cursor keys are located at the bottom right of the alphabetic section; there is only one Option key; the Enter key is placed with the numeric keypad; and the Return key is larger than on previous Macs. Other adjustments in key size and position

are minor. Incidentally, the cursor keys aren't recognized by all applications or even by the Mac's own desktop.

**RAM**

The Macintosh Plus has two main circuit boards, analog and digital. Although the analog board is little changed from the 512K Mac design, the digital board has been thoroughly modified. It is still designed around the 68000 CPU, but it has more RAM and more ROM—both socketed—than previous Macintoshes.

One full megabyte of RAM sits on the Macintosh Plus digital board. This memory takes up less space and consumes less power than the 512K in the Fat Mac. Apple's engineers accomplished this by employing four CMOS SIMMs (single in-line memory modules), each of which holds 256K bytes in eight 256K-bit CMOS dynamic RAMs. These RAM chips are enclosed in surface-mount packages and then soldered onto tiny PC (printed circuit) boards.

The RAMs most of us are familiar with are packaged in DIP cases. Surface-mount packages are smaller, so more chips can be squeezed into less PC board space. They are called "surface-mount" because the legs don't have to stick through a PC board to be soldered on the opposite side (as DIPs are). Instead, the legs fold over and contact the same side the chip packages sit on. For the Mac Plus, these packages are soldered onto four small boards that insert at an angle—and overlap—into special sockets on the Mac Plus digital board.

When 1-megabit surface-mount CMOS DRAMs are available, it will be relatively easy for manufacturers to create SIMM strips that hold a full megabyte. Such strips could replace the current Mac Plus SIMMs to upgrade the system to 2 or 4 megabytes of RAM. Applications that follow Apple's design rules can use all of the additional RAM.

**ROM**

With 128K bytes of ROM code, the Macintosh Plus has twice what the 128K and 512K Macs had. The old 64K-byte ROM contained equal parts

*(continued)*

**IN BRIEF**

**Name**

Macintosh Plus

**Company**

Apple Computer Inc.  
20525 Mariani Ave.  
Cupertino, CA 95014  
(408) 996-1010

**Price**

\$2599

**Microprocessor**

Motorola 68000, 32-/16-bit microprocessor (32-bit internal data path and registers, 16-bit external data bus) running at 7.8336 MHz

**Main Memory**

1 megabyte of RAM, expandable to 4 megabytes in the future  
128K-byte ROM containing operating system code  
256-byte EEPROM for user-settable parameters

**Display**

9-inch diagonal built-in screen that displays bit-mapped 512 by 342 pixels

**Sound**

Four-voice sound from 8-bit D/A conversion (22-kHz sampling rate)

**Disk Memory**

800K-byte 3½-inch double-sided floppy disk drive built-in

**Keyboard**

Detachable 78-key typewriter-style keyboard plus numeric keypad and cursor keys; offers 2-key rollover and software mapping

**Clock/Calendar**

CMOS custom chip built-in with 4.5-volt battery

**Ports**

Two RS-232C/RS-422 serial ports with maximum speed of 230,400 bps  
SCSI port capable of 320K-byte-per-second communications  
Mouse port (for mechanical mouse)  
External disk port  
Synchronous serial keyboard port  
Loudspeaker jack

**Optional Peripherals**

800K-byte 3½-inch double-sided floppy disk drive  
Imagewriter dot-matrix printer  
Apple Modem 1200 (300/1200-bps modem)  
Hard Disk 20, 20-megabyte hard-disk drive (operates through serial port)

**Bundled Software**

System tools



# The largest selling 1200 bps modem just got smaller.

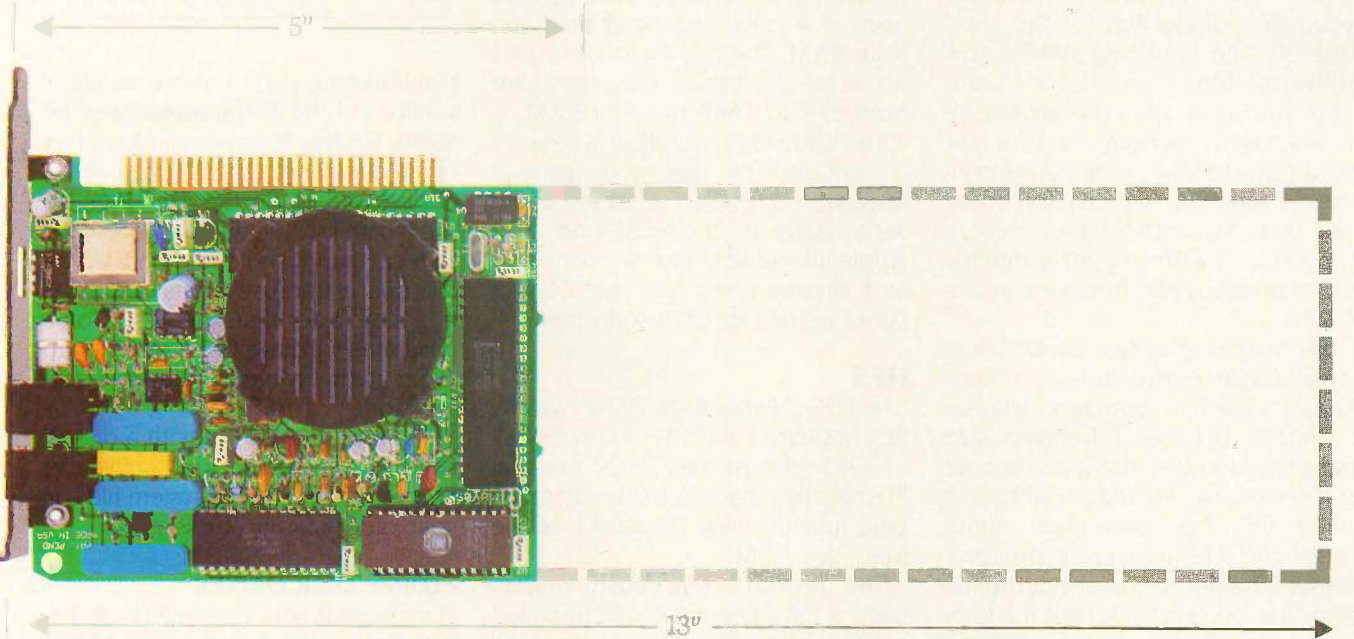

©1986 Hayes Microcomputer Products, Inc.

## The new Hayes Smartmodem 1200B

Now you can get a lot more out of your PC, by putting a little more in. Our new Hayes Smartmodem 1200B includes the same quality and advanced features that have made it the leading 1200 bps modem. Now, advances in Hayes technology allow us to make it available in a size that fits either full slots or a "single" half slot.

That's important news if you have an IBM®, AT&T®, Compaq®, Tandy® or other compatible computer with half slots. It means with a Smartmodem 1200B, you can free up one of your full slots for an additional function, such as color graphics,

more memory or networking. Or, if you prefer, you can continue to use the new Smartmodem 1200B in one of the full slots. Hayes makes it easy and versatile to fit your needs.

There are many good reasons for choosing Hayes. Our new space-saving Smartmodem 1200B is one of them. Hayes Smartcom II®, the industry's best selling communications software, is another.

Smartcom II for the IBM and compatibles makes short work of

communicating, while allowing you to take full advantage of the sophisticated capabilities of your Smartmodem 1200B. Together, they create a powerful, yet easy-to-use, communications system for your PC. They're made for each other, and customized for IBM PC's.

The best reasons of all for choosing Hayes are the "built-in" benefits. Advanced technology. Unsurpassed reliability. And a customer service organization that's second to none.

So, when you see your authorized Hayes dealer ask for the largest selling 1200 bps modem. Smartmodem 1200B. And remember. Now it's smaller, too. Hayes Microcomputer Products, Inc. P.O. Box 105203, Atlanta, GA30348. (404) 441-1617.

# Hayes®

Say yes to the future

Inquiry 151



of Macintosh operating system, QuickDraw graphics routines, and the User Interface Toolbox. The 128K ROM keeps trimmed and optimized versions of those routines, adds new routines, and holds some routines that used to sit in the disk system files.

QuickDraw—which draws everything you see on a Macintosh display—was rewritten to be faster. New ROM drivers were written for the double-sided disk drives and for the Hard Disk 20. The operating system now allows the Mac Plus to boot from a hard disk, a feat the previous Macintoshes couldn't perform. And the new ROM has numeric computation routines: Applications aren't forced to have their own such routines and can depend on floating-point arithmetic and transcendental functions in the ROM.

The operating system shows up in some subtle environmental effects. An icon called a "zoom box" toggles a window between full-screen size and whatever other size it was last set to. There is also an additional choice under the View pull-down menu: Small Icon. This menu selection preserves the information about the file type that icons provide, but it allows many more icons to fit onto a single display.

The System file is listed as version 3.0, and the Finder is version 5.1. Most programs should work with both old and new ROMs, but the 128K ROM

routines are still being integrated into the calls from applications software.

#### DESK ACCESSORIES

The Control Panel desk accessory contains some new controls. The biggest change is the addition of a RAM cache controller that lets programs load, run, and quit up to twice as fast as conventional operational methods. Frequently used routines can be read from disk only once and then run from RAM. The cache can be turned on or off and can employ anywhere from 32K to 768K bytes of RAM.

The Choose Printer desk accessory is replaced by the more general Chooser that lets you select any of the serial ports or the SCSI port. The AppleTalk network is now connected and disconnected via the Control Panel instead of Choose Printer.

#### HFS

The HFS (Hierarchical Filing System) first appeared in Finder 5.0 in the fall of 1985 with Apple's HD20 external 20-megabyte hard disk drive. It is now built into the new Finder 5.1 of the Mac Plus ROM.

The previous Macintosh Finders used a flat filing system (now called MFS for Macintosh Filing System). All files were listed in a single directory. Now the HFS puts files within directories and subdirectories, just as MS-DOS does for many microcomputers. You move through the directories by

## The Mac Plus's

*3½-inch floppy drives*

*are double-sided and*

*can read and write*

*800K bytes per disk.*

manipulating slightly more complex versions of the dialog boxes used by earlier Finders. You can pull down lists of the directories—shown iconically as nested folders on the Mac Plus—to see a path list. The number of files the HFS can handle is limited only by the disk space. Because it runs from ROM it is also faster than the MFS. Some programs will have to be rewritten to avoid path problems with the sub-directories of HFS.

The Mac Plus comes with a disk of system tools that includes an Installer utility for updating the system files on your older start-up disks.

#### FLOPPY DISK DRIVES

The original Mac depended on 3½-inch floppy disk drives, built by Sony, that recorded 400K bytes on a single side of the disk. The Mac Plus drives are still 3½-inch Sonys, but they are double-sided and so can read and write 800K bytes per disk. They can also read and write the single-sided format of the older drives. In effect, the double-sided disks provide more than twice the effective space of the old 400K-byte drives because much of the 400K was occupied by system files.

The Sony drives use a special, variable-rate rotation scheme where the spin of the disk depends on the track being accessed. The new drives use the same scheme but are twice as fast as the old drives for reading and writing. The transmission speed between the drives and the Mac (about 500,000 bits per second) hasn't changed.

#### PORTS

The biggest change in ports from the 512K Mac to the Mac Plus is the ad-

*(continued)*

## LASERWRITER PLUS

Because Apple is so interested in "desktop publishing," it was no surprise that the Mac Plus wasn't the only enhanced product introduced in January. Apple also introduced the LaserWriter Plus, an enhanced version of the laser printer described in the February 1985 product preview "The Macintosh Office" by John Markoff and Phillip Robinson. Based on the popular Canon laser engine, this printer provides 300-dpi images from the PostScript printing codes sent by a Macintosh.

The LaserWriter Plus has a full mega-

byte of ROM instead of the half-megabyte in the LaserWriter. The extra ROM contains seven font families to add to the four families harbored by the LaserWriter. The new typefaces are Avant Garde Gothic, Bookman, Helvetica Narrow, New Century Schoolbook, Palatino, Zapf Chancery, and Zapf Dingbats. The LaserWriter Plus's driver supports the 128K Macintosh and offers downloadable fonts. The LaserWriter Plus costs \$6798. The LaserWriter price dropped to \$5999; for \$799 you can buy a Font Kit that will upgrade the LaserWriter to the Plus.





# The only time our competitor's display can match ours.

All color monitors basically look the same. Until you turn them on. That's when their true colors really show. That is, if it's a Taxan. You see, the Taxan 630 RGB color monitor is so advanced, no one can match its high performance. Or its low price.

What's behind all this is the Taxan 555 Super Color Graphics Board. Interface it with the 630 and you'll get the superior performance you need for all your business applications software. Like dBASE III. Lotus 1-2-3. Wordstar. And Symphony.

With pixel resolution of 640 x 400 and a .37mm dot pitch, you'll get the sharpest text and graphics you've ever seen. An O that really looks like an O. And colors so vivid, so true, they make the competition look drab by comparison. What's more, Taxan gives you a 24.75 Khz horizontal scanning frequency. Compared to 15.75 Khz, it's no wonder our competitors can't keep up with us.

Best of all, the Taxan 630 and 555 board are compatible with the IBM PC, AT and XT, the Compaq Portable and Deskpro, and other IBM compatibles. The 630 is also compatible with AT&T 6300 computers and boards.

But we didn't stop there. The Taxan 630 even gives you a choice of four text color modes. So if your eyes are tired of looking at amber, you can switch to green. White reverse. Or white on blue.

The Taxan 630 has everything you could ever want in a color monitor: Superior performance. High-resolution. And compatibility. Plus, it won't strain your eyes. Or your budget. And because it comes from Taxan—the leader in quality, technology and innovation—you know it's reliable. Which makes it a color monitor that's truly worth looking into.

So go see the Taxan 630 for yourself. And you'll see a display that makes the others pale by comparison.

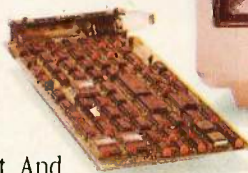

## TAXAN

18005 Cortney Court, City of Industry, CA 91748  
(818) 810-1291.



# Vantex Professional \$49.95 Word Processor

## EXTRA FAST • FEATURE RICH

**General:** Document based • Unlimited document size • Integrated spelling-checker (with suggestions) using an updatable 90,000 word dictionary • True split-screen • Flexible main-edit screen: invoke or dismiss, in any combination, the Command Line, Tab Line, text borders, and Information Line. Change the onscreen left and right margins. • Eight sorted directory-list formats (with one-letter commands to load, copy, delete, and search) • 30 user-settable defaults (blinking or non-blinking cursor, automatic backup, automatic timed save, etc.) • Macros (700 keystrokes per set) • Automatic ASCII import and export (makes for a solid program editor)

**Entering Text:** Distinction between paragraph and line (lines may be 255 wide) • No-hassles insert mode • Both ordinary and "magic diamond" cursor movement • Automatic paragraph reform • Decimal, right-justify, and begin-column tabs (storable in document) • Set boldface, underline, superscript, subscript, italics, and strike-through (unrestricted overlap)

**Manipulating Text:** Highlighted block-mode. Move and copy (with repetition, and across split-screen), delete, sort (by number or alpha), print, and quality (bold, underline, etc., upper-case, etc.) • Flexible column manipulations (move, copy, delete, fill) • Full backwards-forwards search-replace (case, word) singly or globally (plus special functions to search for format-objects, excessive paragraph-blanks, etc.)

**Printing:** Preview page-breaks before printing (visible, scrollable, hard and soft page-breaks) • Super-easy format-control screen (automatic storage anywhere into document of automatically spelled-out format-objects) • Valuable format-control features include margins, justification, microjustification, single, double or triple line spacing, "rows needed", paragraph indents, padding and split-minimum; line headings and centering; row numbering, selectable strike-through and hard-blank characters, multiple headers and footers with variables for page-number (Arabic, letter, Roman), document, dates and time. • Full widow-orphan control, including tables • Controllable print-queue • Multiple printers and ports • Edit while printing • Integrated Mail Merge • Selective page print • Drivers for Epson, Diablo 630, and other popular printers. Complete instructions allow the user to create new drivers or modify old ones.

**Miscellaneous:** Redefinable keys • DOS-pathname support • Context-sensitive Help • Word, character, keystroke counts • Balance parentheses and brackets • Documentation fields • Document-summary utility • Word frequencies • Printed manual • Not copy protected

**Minimum requirements:** IBM PC/XT/AT or true compatible, monochrome or color, one disk drive, 256K and DOS 2.0 or 2.1 (or 320K and DOS 3.X)

\$49.95 Introductory Offer  
Add \$5.50 Shipping & Handling  
N.J. Residents add 6% Sales Tax

Send orders to/or call

**VANTEX DATA SYSTEMS**

P.O. Box 507, Chatham, N.J. 07928

Call 1-800-524-2838

In New Jersey call 1-201-635-5686



Epson is a registered trademark of Epson Corporation. Diablo is a registered trademark of Xerox Corporation. IBM is a registered trademark of International Business Machines.

## MACINTOSH PLUS

# The SCSI interface communicates at 320K bytes per second— about 10 times faster than the old serial port.

dition of the SCSI port for fast communications. The other ports have been moved around, and some have different connectors. The external disk port can handle single-sided or double-sided floppy disk drives as well as the HD20 hard disk drive. The audio jack, the mouse port, and the external disk drive port retain their shape and size but have been moved.

The two serial ports typically used for modem and printer connections now employ mini DIN-8 connectors instead of the 9-pin D-type connectors used before. The new circular connectors eat up less room—a necessity with the addition of the large SCSI connector.

### SCSI

The 128K and 512K Macintoshes relied upon an Apple-specific serial port that communicated at 230,400 bps using the Zilog 8530 SCC (serial communications controller) chip. Apple hoped that the general-purpose serial port would lead to "virtual slots," with add-on devices attached to the serial port instead of inserted within the computer. Unfortunately, the port just didn't have enough speed for many peripherals, including hard disks, tape backup systems, and scanners. So the Mac Plus design team looked around for a faster, more standard interface.

SCSI is an industry-standard, parallel, system-level interface bus for connecting peripherals to a variety of personal computers. It descended from the old SASI disk drive standard to become ANSI X3T9.2. Many peripherals such as hard disk drives already contain SCSI interfaces. All the Macintosh Plus needs to use those peripherals is the proper software drivers.

Up to seven devices can be daisy-chained to the single Mac Plus SCSI port. If any SCSI devices are attached to the Macintosh Plus, at least one of them must be switched on for the Mac Plus to start.

The Macintosh Plus SCSI interface is designed around an NCR 5380 SCSI controller IC and communicates at 320K bytes per second: about 10 times faster than the old serial port. It uses an 8-bit parallel data connection, a variety of control lines, and a parity line for error checking.

### UPGRADES

Apple devised a thorough upgrade program for those who have 128K or 512K Macintoshes and want Mac Plus power. You upgrade a system by buying and installing special kits.

The first kit—\$299—includes the new 128K ROM and an internal double-sided disk drive. This drive replaces the single-sided drive and is only available to be installed by certified Apple dealers. (External double-sided floppy disk drives sell for \$499.) This kit can be installed in Macs that have third-party RAM additions, but Apple doesn't guarantee that the upgraded Mac will be able to use all of the third-party RAM.

The second kit—\$599 for 512K Macs and \$799 for 128K and third-party-enhanced Macs—contains a new digital logic board and a new backpanel. The board replaces the old digital board. You need the panel with this kit because the new set of port connectors on the Mac Plus demands differently placed and sized openings.

The third so-called kit—\$129—is simply the Mac Plus keyboard.

The only way to get the new ROM is to buy kit 1. And you cannot use kit 2—the digital logic board—without kit 1: The new digital board is built for a system with the 128K ROM and the double-sided internal drive.

The 512K Macintosh suggested retail price was dropped to \$1999; the 128K Macintosh is no longer available from Apple. For Lisa or Macintosh XL owners, from April 15 through August 31, 1986, you can ante up \$1498 and your machine and receive a Macintosh Plus with an HD20. ■



NOW YOU CAN CREATE PROFESSIONAL PRESENTATIONS FOR LESS THAN \$1.00 PER SLIDE... USING SOFTWARE YOU ALREADY KNOW.

LIKE LOTUS 1-2-3 OR SYMPHONY.

SALES BY MONTH

	JAN	FEB	MAR	APR	MAY	JUN
NORTH	20	33	30	27	25	25
SOUTH	15	24	23	29	15	20
EAST	23	16	14	21	8	15
WEST	5	13	7	9	3	11
TOTAL	63	86	74	86	51	71

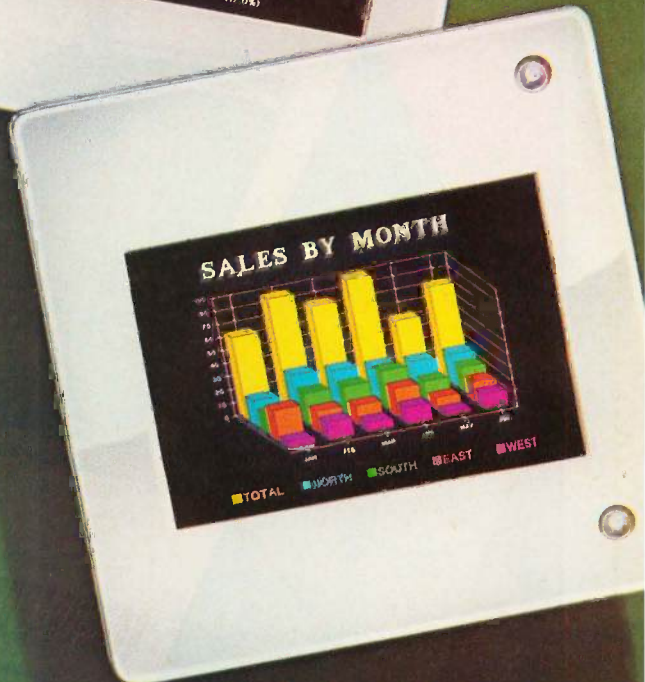
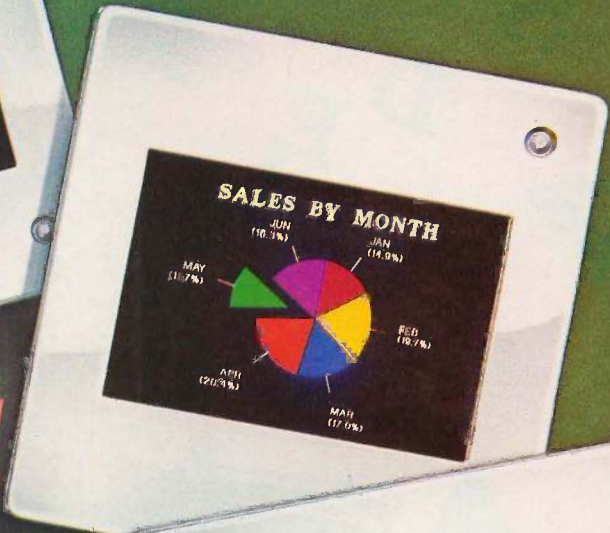
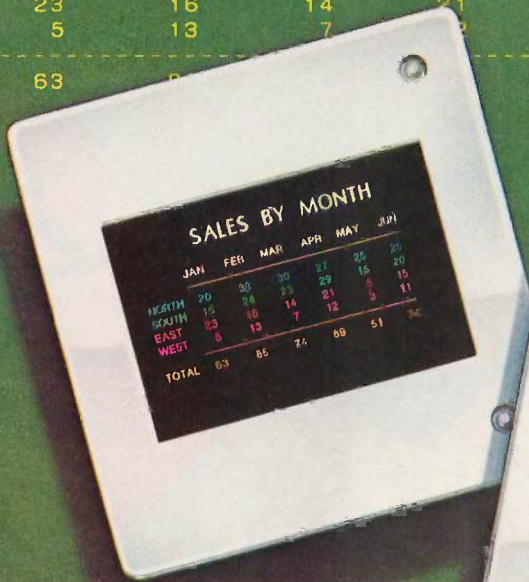

Develop your ideas on Lotus, Microsoft Chart, WordStar or other popular software programs as you normally would. Then put the Bell & Howell slide printer to work, creating a professional presentation without leaving your desk.

The Bell & Howell Color Digital Imager™ IV works directly with your PC like a printer. It creates enhanced slides with the software you're using, so there is nothing new to learn.

The CDI-IV produces slides for less than \$1.00 each and will pay for itself in a few presentations.

**SPECIAL INTRODUCTORY OFFER**

See a demonstration of the CDI-IV slide printer at a dealer near you and get a **free** Popcorn Desktop™ organizer program worth \$49.95. Call now for more information.

**1-800-223-5231**  
EXT. 59.



**BELL + HOWELL**

Bell & Howell Company, Quintar Division, 411 Amadola Avenue, Torrance, CA 90501. Free offer good while supplies last. Lotus, 1-2-3 and Symphony are trademarks of Lotus Development Corporation. WordStar is a trademark of MicroPro International Corporation. Microsoft Chart is a trademark of Microsoft Corporation. Popcorn Desktop is a trademark of C.E.O. Management, Inc. Bell & Howell, BELL+HOWELL, and Color Digital Imager are trademarks of Bell & Howell Company. © Copyright Bell & Howell Company 1986, all rights reserved.

Inquiry 408 for End-Users.  
Inquiry 409 for DEALERS ONLY.

All slides shown were created directly from the same Lotus spreadsheet using the CDI-IV and are unretouched.

1  
2  
3  
4  
5  
6  
7  
8  
9  
10  
11  
12  
13  
14  
15  
16  
17  
18  
19  
20







## A SIMPLE FILE-INDEXING SCHEME

BY BRUCE WEBSTER

---

*Learn how to maintain a sorted file and also  
improve your programming skills*

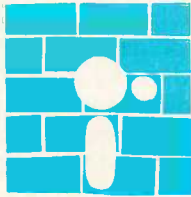

This month's programming project is a simple, easy-to-implement technique for maintaining a sorted file. It's the kind of thing programmers discover on their own; I did so while working on a mailing-list program some years ago. Given the large numbers of new programmers out there, this article just might save some of you time and frustration.

The article has a second purpose as well, again geared toward those of you who are just getting your feet wet in programming. An excellent way to improve your programming skills is to study code written by others. This exposes you to solutions—both big and little—that others have hit upon, new approaches you may not have thought of. And you can even learn from others' mistakes. I trust that the short code examples in this article will help you—though I hope you will find few mistakes to learn from.

### THE PROBLEM

Let's say you have an application of some sort—mailing list, database, sales information—that requires you to keep files of records in a certain order. The order is based on some portion of the record, called the key. The records are arranged so that

the keys are ordered. For example, if the keys are names, they'll probably be in alphabetical order; if they're numbers, they'll be in numerical order.

You may be wondering why keeping the records in order is important. It has to do with searching for a given record, and, frankly, sometimes it isn't so important. If there aren't many records, you can just do a sequential search on the unsorted records by starting with the first record and looking at each until you find the one you want. Of course, you're going to have to look through the entire list to discover if the one you want isn't there—but that's why you do this only if the list is short.

As the number of records increases, the benefits of keeping the records sorted also increase. At the very least, sequential searches become, on the average, a little faster: If the record you're looking for isn't in the list, you'll know that as soon as you hit a record that would normally come after it. For example, if you were looking for "SMITH" and got to "SMYTHE," you could end your search, since "SMITH," if it were present, would have already been found.

Better still, though, is using a binary search to find the desired record. In a

*(continued)*

Bruce Webster is a consulting editor for BYTE. He can be contacted c/o BYTE, POB 1910, Orem, UT 84057, or on BIX as *bwebster*.



binary search, you jump to the middle of the list you're looking at and see if that's the record you're looking for. If so, you stop. Otherwise, you divide the list in half and pick the upper or lower half, depending upon whether the desired key is less than or greater than the one found. You then jump to the middle of that list and repeat the whole procedure. This continues until you either find the key you're looking for or your list has shrunk to a length of one, in which case the desired key is not in the list.

The advantage of a binary search is readily apparent. If you are searching through  $n$  sorted records, a sequential search will average  $n/2$  comparisons, while a binary search will require, at most,  $n \log 2$ . Actual numbers mean more: For a list of 1000 records, a sequential search will average about 500 comparisons; a binary search will require, at most, 10 comparisons.

One problem with sorting your list involves the size of the list itself. If the

file isn't large in size, you can keep all the records in memory, as an array or a linked list. This lets you add and delete records, as well as keep the list sorted, with little trouble. However, if the list gets too big to fit in memory, you'll have to store the list out on the disk. Since sorting usually requires swapping items in the list around, this could mean a lot of disk reads and writes. And if you're adding or deleting records, things can rapidly go from bad to worse since you may have to "shuffle" large numbers of records to accommodate the changes. How, then, do you deal with—and keep sorted—a large file and/or a file with a lot of records?

### THE SOLUTION

The answer is quite simple: Don't sort all the records, just the keys. To do this, you create an index list. Each item in the list contains a key and its corresponding record number. You keep this list sorted and in memory.

To find a record, you do a binary search on this list, then you use the record number to read in the corresponding record from the disk. You can easily sort and update the index list since it's always in memory. You access the disk only when you need to actually read or write a specific record.

There are complications. If the key isn't much smaller than the record itself, this approach is pointless. For example, each record might contain just a name and a phone number, with the name as the key. The index list will then be almost as large as the actual record list—in which case, your best bet is some research into disk-based sorts and merges and an investment in a fast hard disk.

Deleting records can also cause complications. The simple solution is to delete the entry in the index list, then delete the record in the file by moving all the records that follow it forward by one. Of course, that means a lot of disk I/O, especially if the deleted record is near the start of the file. However, since the disk file isn't sorted, a faster approach is to copy the last record in the file into the position of the now-deleted record.

Even with this approach, another complication occurs: How do you know where the "active" records end and the "deleted" records begin? For example, if you have 100 records in your file and you delete 10 of them, you will still have 100 records sitting out in your file; it's just that the last 10 won't mean anything. That's not a problem until you close the file, then reopen it later. The difficulty is resetting the "end-of-file" marker. Most Pascal implementations have no easy way of doing that, short of writing a new copy of the file. That will work, but if the file is very large, it will take time and disk space. Another solution is to set aside the first record in the file as a "header" record and store in it the number of active records; that's what I will use here.

### THE IMPLEMENTATION

The implementation given here is neither complex nor overly developed. Most of you are going to be

*(continued)*

Listing 1: Global definitions and declarations.

```

const
  IndexMax      = 1000;
  RecCountErr   = -2;
  NewFileCreated = -1;
  NoError       = 0;
  RecordNotFound = 1;
  NoMoreRoom    = 2;
  AlreadyExists = 3;
  OutOfRange    = 4;

type
  Keytype      = string[40];
  FileStr      = string[80];

  DataRec = record
    case Boolean of
      True   : (NumRecs : Integer);
      False  : (Key      : Keytype;
                theRest  : Whatever;
                { this represents the rest of your data fields } );
    end;

  IndexRec = record
    Key      : Keytype;
    Num      : Integer;
  end;

  IndexList = array[1..IndexMax] of IndexRec;

var
  KList      : IndexList;
  DFile      : file of DataRec;
  MaxRec     : Integer;
  
```





# HOW PEOPLE WITH COMMON INTERESTS FIND AN INTERESTING COMMON GROUND.

**Presenting CompuServe Forums. Where people from all over get together, without even leaving home.**

Now thanks to CompuServe Forums, computer owners are sharing common interests by talking to each other through their computer keyboards. *Software users, computer enthusiasts, ham operators, french cooks, fire fighters, science fiction lovers and other special interest groups* are already in touch, online.

Because when you subscribe to CompuServe, you're able to reach people who want to talk about the things you do. As many people as you like. For as long as you like. Whenever you wish.

Join a conversation already in

progress or start one on your own. Ask questions. And get answers.

All it takes is a modem, most any personal computer and CompuServe.

**Forum members across the country are as close as a local phone call.**

You can go online with just a local call in most major metropolitan areas. And normal usage fees for weekday nights and weekends are just 10¢ a minute.

**Of special interest to all Forum participants is software that's FREE for the taking.**

Public domain software. For all sorts of activities, from games to business programs. And it's just as easy to copy a piece of software as it is to participate in a Forum.

**Become a CompuServe subscriber and get a \$25 Usage Credit to start you off.**

Becoming a subscriber is as easy as contacting your local computer dealer. Or you can call us and order direct. Suggested retail price is \$39.95.

And if you'd want more information about CompuServe, we'll be happy to send you a free brochure. Because with all that CompuServe offers—we think it's in your best interest.

## CompuServe®

Information Services, P.O. Box 20212,  
5000 Arlington Centre Blvd., Columbus, OH 43220

**800-848-8199**

In Ohio, call 614-457-0802

An H&R Block Company



able to take what you see here and develop it into what you need. I've written it in (almost) standard Pascal; the only assumptions I've made are that a built-in procedure, `Seek`, exists that moves the file pointer to a particular record and that the first record is 0; that is, `Seek(DFile,0)` will position the file pointer at the first record in the file.

Listing 1 shows the global declarations—constants, data types, and variables—for these routines. An arbitrary limit (`IndexMax`) on the number of records has been set; I'll mention a few ways around setting this limit later on. Also, four different error codes (used in the routines) are defined.

The data types are then defined. `Keytype` and `DataRec` are whatever you want them to be; this is, after all, your application. You can even rename the field `Key` in `DataRec`, but if you do, you need to change one statement in `InitStuff`:

```
KList[Index].Key :=
TRec.new name;
```

Since that's the only place in these routines that this field is actually referenced, everything else can stay the same.

You'll notice that `DataRec` is a variant record. It has two sets of fields occupying the same space; that is, the field `NumRecs` occupies the same space as the field `Key`. This is done so that you can use the first record in the file to keep track of the number of active records in the file. Since `NumRecs` and `Key` occupy the same space, the size of each `DataRec` record is not increased by the definition of `NumRecs`. Also, note that the field `theRest` is not an actual field; I just put it there to represent whatever data fields you might define for the record.

Three global data structures are declared in the variable section. `KList` is the list of keys and record numbers; it's an array that will be kept sorted at all times. `DFile` is the actual file of records that are being written or read. `MaxRec` is the current number of records being used.

File I/O routines vary between Pascal implementations, especially

(continued)

Listing 2a: File I/O routines specific to Turbo Pascal.

```
{compiler-specific file I/O routines
these procedures are specific to Turbo Pascal. If you
are using another Pascal compiler, you will need to
modify them appropriately. Note that Turbo Pascal does
not support the standard routines GET and PUT, but instead
uses READ and WRITE.}

{$I-} { turn off I/O error checking }

procedure FRead(RNum : Integer; var Rec : DataRec;
               var Error : Integer);
{   reads record #RNum into Rec }
begin
  if (RNum < 0) or (RNum > MaxRec)
    then Error := OutOfRange
  else begin
    Seek(DFile,RNum);
    Error := IOResult;
    if Error = NoError then begin
      Read(DFile,Rec);
      Error := IOResult
    end;
    if Error > 0
      then Error := 100 + Error
    end
  end; { of proc FRead }

procedure FWrite(RNum : Integer; Rec : DataRec;
                var Error : Integer);
{   writes record #RNum into Rec }
begin
  if (RNum < 0) or (RNum > MaxRec)
    then Error := OutOfRange
  else begin
    Seek(DFile,RNum);
    Error := IOResult;
    if Error = NoError then begin
      Write(DFile,Rec);
      Error := IOResult
    end;
    if Error > 0
      then Error := 100 + Error
    end
  end; { of proc FRead }

procedure FOpen(FileName : FileStr; var Error : Integer);
{
tries to open FileName; if it doesn't exist, creates
it with the appropriate header record
}
const
  TurboNoFile = 1; { "no file" error code for Turbo Pascal }
var
  IOCode      : Integer;
  TRec        : DataRec;
begin
  Assign(DFile,FileName);
  Reset(DFile);
  IOCode := IOResult;
  if IOCode = TurboNoFile then begin { file doesn't exist }
    FillChar(TRec,SizeOf(TRec),0);
    Rewrite(DFile);
    TRec.NumRecs := 0;
    FWrite(0,TRec,Error);
```



PROGRAMMING PROJECT

```

Close(DFile);
Assign(DFile,Filename);
Reset(DFile);
IOCode := IOResult;
if IOCode = NoError
  then Error := NewFileCreated
end;
if IOCode <> NoError
  then Error := 100 + IOCode;
end; { of proc FOpen }

procedure FClose(var Error : Integer);
{ closes file }
begin
  Close(DFile);
  Error := IOResult;
  if Error > 0
    then Error := Error + 100
end; { of proc FClose }

{$I+} { turn on I/O error checking }

```

Listing 2b: File I/O routines specific to UCSD Pascal.

```

{compiler-specific file I/O routines
these procedures are specific to UCSD Pascal. If you
are using another Pascal compiler, you will need to
modify them appropriately. }

{$I-} { turn off I/O error checking }

procedure FRead(RNum : Integer; var Rec : DataRec;
               var Error : Integer);
{ reads record #RNum into Rec }
begin
  if (RNum < 0) or (RNum > MaxRec)
    then Error := OutOfRange
  else begin
    Seek(DFile,RNum);
    Error := IOResult;
    if Error = NoError then begin
      Get(DFile);
      Error := IOResult;
      if Error = NoError
        then Rec := DFile^
    end;
    if Error <> NoError
      then Error := 100 + Error
  end
end; { of proc FRead }

procedure FWrite(RNum : Integer; Rec : DataRec;
               var Error : Integer);
{ writes record #RNum into Rec }

```

(continued)

**CentTech** Premium Quality Diskettes

- ✓ TIMELESS WARRANTY
- ✓ Performance exceeds A.N.S.I. specification by 88%
- ✓ Each disk 100% tested and certified
- ✓ 14 COLORS for data organization
- ✓ Pkgs. of 10, tyvek sleeves, w/p tabs, and ID labels

SS-DD	QTY. 10 BOXES 5.25"	DS-DD
<b>.78</b> EA. ....	Color, 48 TPI .....	<b>1.03</b> EA.
<b>.99</b> EA. ....	Color, 96 TPI .....	<b>1.19</b> EA.
<b>High Density, Color, 1.6mb, IBM AT Compatible .....</b>		<b>2.29</b>

**CentTech Bulk**  
Includes Tyvek sleeves, w/p tabs, ID labels

SS-DD	QTY. 100 5.25"	DS-DD
<b>.71</b> .....	Color, 48 TPI .....	<b>.91</b>
<b>.88</b> .....	Color, 96 TPI .....	<b>1.08</b>

Subtract .05 per disk for black disks



America's No. 1 Name-Brand Diskettes  
Free! Headcleaning Disk  
\$2/box rebate on H/C

- ✓ LIFETIME WARRANTY
- ✓ High quality and consistently reliable

SS-DD	QTY. 5 BOXES	DS-DD
<b>.78</b> 5.25, 48 TPI .....		<b>1.08</b>
<b>.78</b> 5.25, 48 TPI with H/C Kit .....		<b>1.08</b>
<b>1.49</b> 5.25, 96 TPI .....		<b>1.89</b>
<b>1.49</b> 3.5", 135 TPI .....		<b>2.14</b>
<b>1.85</b> 3.5", 135 TPI w/Flip'n'File .....		<b>2.39</b>
<b>DS-HD 96 TPI, IBM AT Compatible .....</b>		<b>2.20</b>

<b>3M Headcleaning Kit</b>		
	Plus \$2.00 Rebate .....	<b>6.99</b>
<b>3M Data Cartridges</b>		
	QTY. 5	QTY. 10
<b>DC-100A</b> .....	12.10	11.99
<b>DC-1000</b> .....	12.40	12.29
<b>DC-300XLP</b> .....	19.00	18.80
<b>DC-600A</b> .....	20.25	19.99

**Nashua**™ Affordable Quality  
Incredible Value  
Best Prices Ever!

- ✓ LIFETIME WARRANTY
- ✓ Factory Fresh in BOXES of 10 with sleeves, w/p tab, ID labels

SS-DD		DS-DD
<b>.69</b> .....	5.25, 48 TPI, box of 10 .....	<b>.74</b> EA.
<b>1.59</b> .....	3.5", 135 TPI .....	<b>2.19</b>
<b>High Density, IBM PC-AT Compatible .....</b>		<b>2.09</b>

**BULK** Made in U.S.A.  
Namebrand Quality  
at Affordable Prices

- ✓ LIFETIME WARRANTY
- ✓ Every diskette 100% tested and certified
- ✓ Performance exceeds A.N.S.I. specifications by 62.5%
- ✓ Packaged in boxes of 100 diskettes with tyvek sleeves, w/p tabs, ID labels

SS-DD	QTY. 100	DS-DD
<b>.55</b> EA. ....	5.25, 48 TPI .....	<b>.69</b> EA.
<b>.69</b> EA. ....	5.25, 96 TPI .....	<b>.89</b> EA.
<b>High Density, IBM PC-AT Compatible .....</b>		<b>1.89</b>

Call for our low priced ribbon and disk storage boxes

**ORDERING INFORMATION**

TERMS: Free use of VISA, Mastercard, and American Express. P.O. orders accepted from recognized corporations rated 3A2 or better, government and schools on 2% net 30. PAYMENT: Add \$3.00 per 100 diskettes or fraction thereof, add \$3.00 for headcleaning kit or dozen ribbons, add \$3.00 for COD orders. PRICE PROMISE: We will better any lower delivered price on the same products and quantities advertised nationally.

Toll Free Order Line: **1-800-233-2477** Information Line: **1-801-942-6717**



199 Cottage Avenue  
Salt Lake City, Utah 84070  
Hours: 8am to 5pm  
(mtn. time)



```

begin
  if (RNum < 0) or (RNum > MaxRec)
    then Error := OutOfRange
  else begin
    Seek(DFile,RNum);
    Error := IOResult;
    if Error = NoError then begin
      DFile^ := Rec;
      Put(DFile);
      Error := IOResult
    end;
    if Error > 0
      then Error := 100 + Error
    end
end; { of proc FRead }

procedure FOpen(FileName : FileStr; var Error : Integer);
{ tries to open FileName; if it doesn't exist, creates
it with the appropriate header record }
const
  UCSDNoFile = 1; { "no file" error code for UCSD Pascal }
var
  IOCode      : Integer;
  TRec        : DataRec;
begin
  Reset(DFile,FileName);
  IOCode := IOResult;
  if IOCode = UCSDNoFile then begin { file doesn't exist }
    FillChar(TRec,SizeOf(TRec),Chr(0));
    Rewrite(DFile,FileName);
    TRec.NumRecs := 0;
    FWrite(0,TRec,Error);
    Close(DFile,Lock);
    Reset(DFile,FileName);
    IOCode := IOResult;
    if IOCode = NoError
      then Error := NewFileCreated
    end;
    if IOCode <> NoError
      then Error := 100 + IOCode;
  end; { of proc FOpen }

procedure FClose(var Error * Integer);
{ closes file }
begin
  Close(DFile,Lock);
  Error := IOResult;
  if Error > 0
    then Error := Error + 100
end; { of proc FClose }

{$I+} { turn on I/O error checking }

```

those for opening and closing files. Also, standard Pascal does not define a method for random access of files, though almost every microcomputer-based Pascal compiler does. In addition, Turbo Pascal—which has the largest installed base of compilers—does not support the standard Pascal routines Get and Put.

Because of this, I wrote four routines—FRead, FWrite, FOpen, and FClose—to handle all the compiler-specific code. FRead lets you read a specific record (in the range 0..MaxRec) from DFile. FWrite, in much the same manner, lets you write out to a specific record, again in the range 0..MaxRec. FOpen accepts a

filename and tries to open it as DFile. If the file does not exist, it creates it, writing out a header record with NumRecs = 0. Likewise, FClose closes DFile. All four routines return an error code in Error, either one of those defined in the global constant section or a system I/O error code. If the latter is returned, an offset of 100 is added so as not to confuse, say, system I/O error 1 (whatever that may be) with RecordNotFound.

Listings 2a and 2b contain working versions of these routines for Turbo Pascal and UCSD Pascal, respectively. If you're using a different Pascal compiler, you'll have to write your own versions, though chances are they'll look pretty much like these routines.

A quick note on record numbers. The header record is assumed to be record 0, the first record in the file. All the data records are stored as records 1 through MaxRec. Both Turbo Pascal and UCSD Pascal consider the first record in a file to be record 0; however, some Pascal compilers consider the first record to be record 1. To adjust for this, just add 1 to RNum in your call to Seek in FRead and FWrite, that is, Seek(DFile,RNum + 1). If you make the change here, you can leave the rest of the program alone.

Listing 3 contains the routines InitStuff and CleanUpStuff. InitStuff should be called before doing any I/O on a given file. You pass InitStuff the name of the file you want to work with; it then calls FOpen and reads through all the records, building the list of keys and record numbers in KList. It then calls SortIndexList (also in listing 3), which sorts KList using a simple selection sort algorithm. CleanUpStuff saves the current number of active records in the header record (0), then closes the file by calling FClose. Both routines return error codes, so that your program can detect and handle any problems.

Listing 4 has three key routines: FindKey, GetRecord, and PutRecord. FindKey does a binary search on KList and returns the location in KList corresponding to the key passed to it. If no key matches, it returns -1.

(continued)



## PROGRAMMING PROJECT

Listing 3: Initialization and cleanup routines.

```

procedure SortIndexList;
{sorts the array KList using a selection sort technique}
var
  I,J,Min      : Integer;
  Temp         : IndexRec;
begin
  for I := 1 to MaxRec-1 do begin
    Min := I;
    for J := I+1 to MaxRec do
      if KList[J].Key < KList[Min].Key
      then Min := J;
    Temp := KList[I];
    KList[I] := KList[Min];
    KList[Min] := Temp;
  end;
end; { of proc SortIndexList }

procedure InitStuff(FileName : FileStr;
                   var Error : Integer);
{
  sets everything up for indexing system. This assumes
  there are no more than IndexMax (=1000) records, and the
  records are numbered 1..IndexMax. Record #0 is the header
  record and is used to store the current number of records
  actively being used in the file
}
var
  Indx,TErr    : Integer;
  TRec         : DataRec;
begin
  Error := NoError;
  FOpen(FileName,Error);
  if Error <= NoError then begin
    MaxRec := 0;
    FRead(0,TRec,TErr);
    Error := TErr;
    MaxRec := TRec.NumRecs;
    for Indx := 1 to MaxRec do begin
      FRead(Indx,TRec,TErr);
      if TErr > 0
      then Error := TErr;
      KList[Indx].Key := TRec.Key;
      KList[Indx].Num := Indx;
    end;
    SortIndexList;
  end;
end; { of proc InitStuff }

procedure CleanUpStuff(var Error : Integer);
{
  this just does an orderly shutdown and should be called
  before you leave your program (or open another data file)
}
var
  TRec         : DataRec;
begin
  TRec.NumRecs := MaxRec; { save out # of records }
  FWrite(0,TRec,Error);
  FClose(Error);
end; { of proc CleanUpStuff }

```



# STOP SOFTWARE PIRACY . . .

. . . with one of our  
new sophisticated copy  
prevention products.

## NEW

### For Hard Disk Protection

- Fixed Disk Locker

### For Disk Security

- High Level Security
  - PADLOCK II DISK
  - SAFEGUARD DISKS
  - COUPON DISKS

### Low Level Security

- User Installable Protection
  - PC-PADLOCK

Why should your valuable data  
or useful software program  
become available in the  
Public Domain?

Call or write for  
more information.

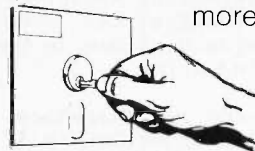

## GLENCO ENGINEERING INC.

3920 Ridge / Arlington Hts., IL 60004  
(312) 392-2492



Listing 4: Basic record-access routines.

```

function FindKey(Key # Keytype) : Integer;
{
looks for Key in KList; returns location in KList
if found; otherwise returns - 1
}
var
  L,R,Mid      : Integer;
begin
  L := 1; R := MaxRec;
  repeat
    Mid := (L+R) div 2;
    if Key < KList[Mid].Key
      then R := Mid-1
      else L := Mid+1
  until (Key = KList[Mid].Key) or (L > R);
  if Key = KList[Mid].Key
    then FindKey := Mid
    else FindKey := -1
end; { of proc FindKey }

procedure GetRecord(Key : Keytype; var Rec : DataRec;
  var Error : Integer);
{
looks through KList for Key; if found, returns in Rec.
It and the routines that follow assume the procedure Seek
for random access of the file of records.
}
var
  Item      : Integer;
begin
  Error := NoError;
  Item := FindKey(Key);
  if Item > 0
    then FRead(KList[Item].Num,Rec,Error)
    else Error := RecordNotFound
end; { of proc GetRecord }

procedure PutRecord(Rec : DataRec; var Error : Integer);
{
writes Rec out to the file. If a record with that
key already exists, then overwrites that record;
otherwise, adds the record to the end of the file.
If there's no more room for records, exits with an
error code
}
var
  Item      : Integer;
begin
  Error := NoError;
  Item := FindKey(Rec.Key);
  if Item >= 0
    then FWrite(KList[Item].Num,Rec,Error)
  else if MaxRec < IndexMax then begin
    MaxRec := MaxRec + 1;
    FWrite(MaxRec,Rec,Error);
    KList[MaxRec].Key := Rec.Key;
    KList[MaxRec].Num := MaxRec;
    SortIndexList
  end
  else Error := NoMoreRoom
end; { of proc PutRecord }

```

*The code for this  
project was written  
with conversion to  
C in mind and  
should be pretty  
easy to port.*

GetRecord calls FindKey to get the record number and, if found, reads it in from DFile and passes it back to the calling routine in Rec. PutRecord tries to write Rec out to DFile. It checks to see if a record with Rec.Key already exists; if so, Rec gets written out to that position. Otherwise, if there's enough space left, it puts the record at the end of DFile and adds the appropriate entry to KList (which is then resorted). If there's no room left, PutRecord returns an error code to the calling routine.

Listing 5 has two higher-level routines: AddRecord and DeleteRecord. AddRecord won't let you overwrite an existing record. If a matching key is found, it returns with an error code; otherwise, it just calls PutRecord. DeleteRecord checks to make sure that a record with the requested key exists, then it deletes that record from DFile and from KList. The file deletion is done by copying the last record in the file over the record being deleted. If the last record is the one being deleted, no movement is done. The appropriate entry is removed from KList, with all following entries shuffled forward, and MaxRec is decreased by 1.

A note for C users: This code was written with conversion to C in mind and should be pretty easy to port. You'll probably use fseek() for your random access, which requires a byte offset from the start of the file. Because of this, you may want to set up KList with byte offsets instead of record numbers. You can do this by changing the assignment to KList[Index].Num in InitStuff and

*(continued)*



# THE NEW PRIMAGE™ 100 "DAISYGRAPHER"™ PRINTER SYSTEM!

● 100 CPS ● GRAPHICS ● TRUE LETTER QUALITY ● EASY LOADING

Now you can get a complete printer system (printer plus a two bin cut sheet and envelope feeder) that gives you true letter quality printing at 100 CPS AND sharp, accurate bit mapped GRAPHICS. Forget about the near letter quality printers at premium prices with their exorbitant costs of ownership, service charges and supplies.

The Primage™ 100 "DAISYGRAPHER"™ Printer System is the answer! Quality, Reliability, and Easy Loading Sheet Feeders all add up to a cost effective printer system. The user friendly Primage™ 100 "DAISYGRAPHER"™...spirited with office automation! Engineered to endure! Call Toll Free 800-821-0066 (in New York 516-585-8200) for more information and location of the dealer nearest you!

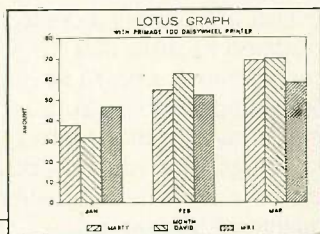

ACTUAL  
SAMPLE  
PRINTOUTS

AutoCAD

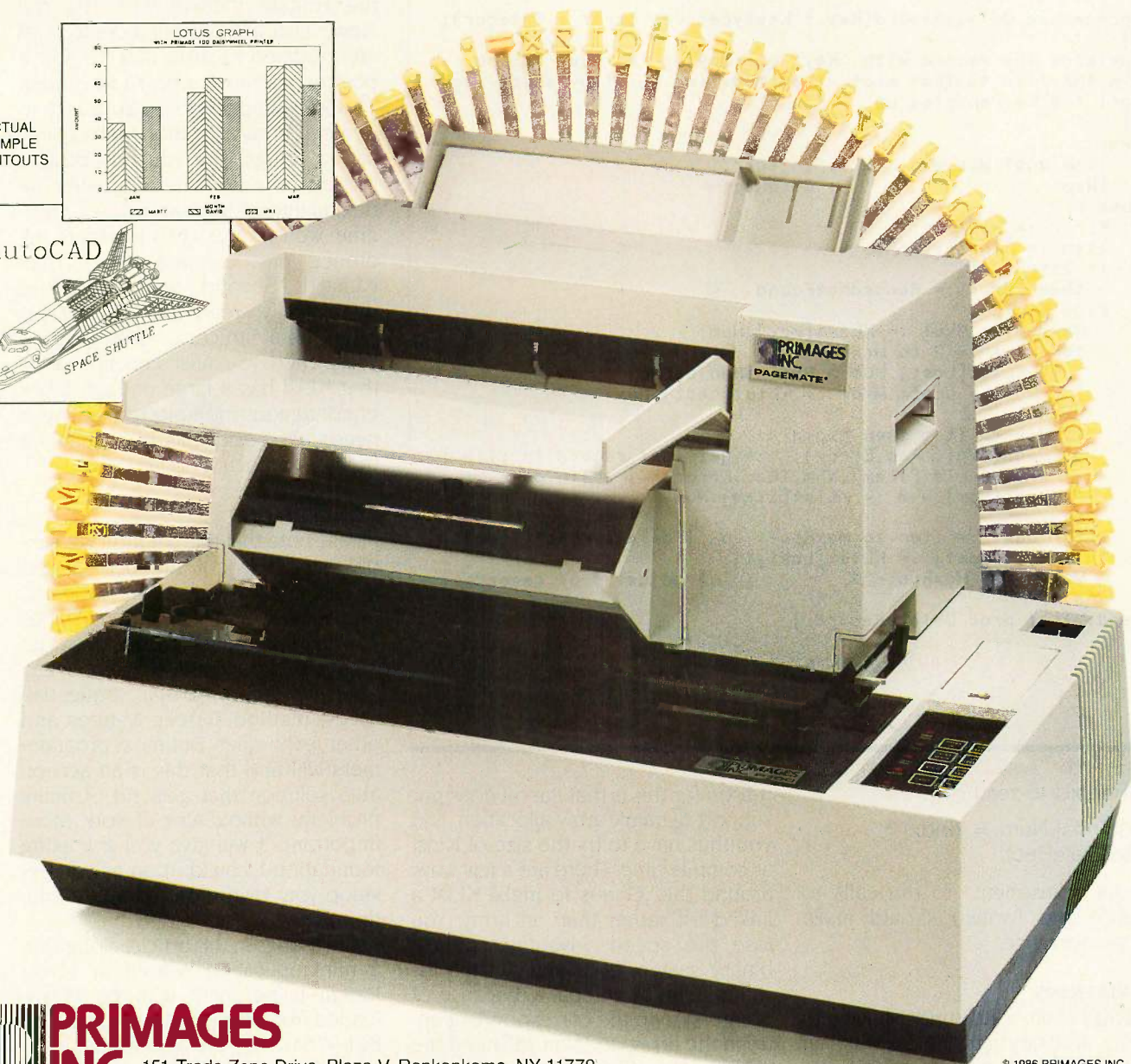
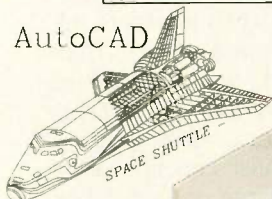

**PRIMAGES  
INC.**

151 Trade Zone Drive, Plaza V, Ronkonkoma, NY 11779  
(516) 585-8200 TELEX: 221674 FAX: (516) 585-2134

© 1986 PRIMAGES INC.  
SHOWN WITH PAGEMATE® III



Listing 5: Higher-level record-access routines.

```

procedure AddRecord(Rec : DataRec; var Error : Integer);
{
adds a record to the file. If a record with the same
key already exists, then exits with an error code
}
var
  Item          : Integer;
begin
  Error := NoError;
  Item := FindKey(Rec.Key);
  if Item > 0
  then Error := AlreadyExists
  else PutRecord(Rec,Error)
end; { of proc AddRecord }

procedure DeleteRecord(Key : Keytype; var Error : Integer);
{
deletes the record with 'Key' by copying the last record
in the file to that slot, then modifies KList by shuffling
all the key entries up
}
var
  Item,Last,Max,MVal      : Integer;
  TRec                   : DataRec;
begin
  Error := NoError;
  Item := FindKey(Key);
  if Item = -1
  then Error := RecordNotFound
  else begin
    Max := 1; MVal := KList[Max].Num;
    for Last := 2 to MaxRec do
      if KList[Last].Num > MVal then begin
        Max := Last; MVal := KList[Last].Num
      end;
    if Max <> Item then begin
      FRead(MVal,TRec,Error); { get last record in file }
      FWrite(KList[Item].Num,TRec,Error); { write over it }
      KList[Max].Num := KList[Item].Num
    end;
    for Last := Item to MaxRec-1 do { delete KList[Item] }
      KList[Last] := KList[Last+1];
    MaxRec := MaxRec - 1 { adjust # of records }
  end
end; { of proc DeleteRecord }

```

PutRecord to read

$KList[Indx].Num = (Indx) * \text{sizeof(DataRec)}$ ;

Similar adjustments to the calls to fread() and fwrite() should make things work fine.

#### VARIATIONS

You may chafe a little under having to set an arbitrary limit (IndexMax) on the number of records. The main

reason for this is that Pascal does not support dynamic array allocation, and you thus have to fix the size of KList at compile time. There are a few ways around this. One is to make KList a linked list rather than an array. You lose the speed advantage of the binary search, each entry in the list will take up more space (because of pointers) than the corresponding entry in the array, and you will need the additional code and data-type defini-

tions to support the linked list. On the other hand, you not only get rid of the arbitrary limit, but if you have a small number of records, you allocate only as much space for the list as needed, instead of always setting aside space for the entire array.

A trickier approach involves these modifications to the declarations:

```

type
  IndxList = array[1..1] of IndxRec;
  IndxPtr = ^IndxList;
var
  KList : IndxPtr;

```

You now create KList on the heap in the routine InitStuff with the call New(KList), and all references to KList are modified to show that it's now a pointer, for example, KList^[Indx]. This is a somewhat dirty approach to dynamic array allocation and requires several things. First, you must be able to turn off range checking when indexing into KList; that way, your program won't bomb when you try to reference any element other than KList[1]. Second, you must not dynamically create (using New) any other data structure after creating KList. Third, you must somehow verify that KList has a large enough block of contiguous memory to meet your needs. As I said, this is definitely a tricky approach.

#### CONCLUSIONS

Please note that this solution is a simple one. It is not the best or the fastest, but it is one of the easiest to understand and implement. Once you've mastered it, you can always go on to explore the indexed sequential-access method, virtual sequential-access method, B-trees, M-trees, and other techniques. But most programmers will find that this is an acceptable solution that gets rid of many problems without a lot of work. More important, it will give you a working foundation to build upon as you develop your own more complex solutions.

The listings in this article, along with a miniapplication written in Turbo Pascal using them, can be downloaded from BYTenet Listings at (617) 861-9764. They are also available on disk (see page 445). ■



# A CROSSTALK<sup>®</sup> XVI Klone FOR \$49<sup>95</sup>

The Closer You Look, the Better We Look!



**FEATURING**  
Foreground/Background Communications

**MIRROR** is the mirror image of Crosstalk XVI V3.6, the industry standard in data communications software for small business computers. **MIRROR**'s design closely reflects Crosstalk XVI's menus, commands and features. In fact, if you have used Crosstalk XVI before, you will feel right at home with **MIRROR**. The one thing you will not find reflected in **MIRROR** is Crosstalk XVI's \$195.00 price. Because we control the reflection, **MIRROR** costs only \$49.95.

If you are new to data communications, it makes sense to go with the industry standard in data communications software, but why pay the industry standard price. **MIRROR** lets you have the industry standard at 1/4 the price. If you or your company have already standardized on Crosstalk XVI, then consider **MIRROR** for future purchases and upgrades, you'll realize significant savings, without sacrificing on quality, standardization or features.

## MIRROR<sup>™</sup> WILSOBS

**THE RIGHT DATA COMMUNICATIONS  
CHOICE FOR ANY USER!**



1210 East Park Avenue  
Tallahassee, Florida 32301  
For Information Call:  
1-904-878-8564  
TLX: 6714280 KLON

**\$49.95**

Site Licensing Available  
60-Day Money-back Guarantee  
Not Copy Protected

To Order Call Toll-Free:



National:

**1-800-538-8157**  
Ext. 848

California:

**1-800-672-3470**  
Ext. 848

**\$49.95**, plus \$5.00 postage/handling  
(\$8.00 for COD orders) ea.

Florida residents must add 5% sales tax  
Overseas orders: Add \$18.00 for shipping.

MIRROR is available for the IBM PC/XT/AT and compatibles and requires MS-DOS 2.0 or higher.

MIRROR, KloneWare and SoftKlone are trademarks of SoftKlone Distributing Corporation. Crosstalk XVI and Microstuf are registered trademarks of Microstuf, Inc. HAYES is a registered trademark of Hayes Microcomputer Products, Inc., Wordstar is a registered trademark of Micropro International.

**DISTRIBUTED IN CANADA BY:**  
Saraguay Software Distributors  
121 Avenue Road, Suite 202  
Toronto, Ontario, M5R 2G3  
Ph: (416) 923-1500

### For New Users, MIRROR Provides:

- Menu/Command Driven
- Complete Crosstalk XVI V3.6 Compatibility
- New User Script File (Enables you to sign-on to your favorite online service in minutes)
- Auto-dial/Auto-answer
- Alphabetized Help-Command Summary
- Money Saving Offers From Online Information Services

### For Experienced Data Communications Users, MIRROR Provides:

- Complete Background Operation (concurrent operation/memory resident)
- Programmable Script/Command Language (Crosstalk XVI V3.6 compatible with extensions)
- Extended Error-checking Protocol Support (XMODEM-single, XMODEM-multi-file, Crosstalk, HAYES and KERMIT)
- Integrated Wordstar-like Text Editor
- Multiple Terminal Emulations (VT-100/52, IBM 3101 Teletype 912C/920/925, TI 940, ADDS Viewpoint, ADM-3A)
- Enhanced Individualized Password Protection





# The world's first music computer now has a broader repertoire.

When we introduced the CX5M™ computer, it was the only computer dedicated to compose, record and play music.

And it's still the only music computer with an FM digital tone generator built into it. The same kind used in our famous DX synthesizers. So you get full, rich, authentic instrument sounds.

Now the CX5M is back for its first curtain call. With a broader repertoire.

## THE SOFTWARE HAS GROWN.

As you know, a computer is only as powerful as its software. And the CX5M started with some powerful software. Like the FM Voicing program, the FM Composer program, the FM Music Macro program and the DX7™ Voicing program.

Now, with TeleWord™, the CX5M can do words as well as music. This powerful word processing/telecommunications program has such features as global search and change, cut-and-paste text transfer and on-screen page layout. As well as auto-dialer with re-dial function, computerized "phone book" with 50-entry capacity and complete adaptability to all 300- and 1200-baud operations.

So whatever you create with TeleWord's word processor (or other CX5M programs), you can send to computers anywhere in the world.

But back to the world of music with the new MIDI Recorder program. With its four banks, each containing four recording tracks, you can use this program



to compose and arrange music in step-time or real-time from any MIDI keyboard. Edit. Then synchronize playback through DX synthesizers or FM tone generators such as the TX7.

And if you have an RX11, RX15 or RX21 digital rhythm machine, get the new RX Editor program. Because it makes programming easier and more versatile.

Other new programs include DX21 Voicing, Keyboard Chord Master, Keyboard Chord Progression and Guitar Chord Master. Even a Graphic Artist program. As well as second generation FM Music Composer, FM Voicing and FM Music Macro programs. And all the other MSX™ software that MSX computers like the CX5M can run.



MIDI Recorder program.  
Graphic Artist program.



### THE HARDWARE HAS GROWN.

But the CX5M's hardware is not about to be overshadowed by the software.

Not with such new additions as the SFG05. This module has an FM tone generator with 46 of its own preset voices, an 1800-note sequencer and room for 48 user-programmed voices.

Add the SFG05 to the CX5M and use either the YK01 or YK10 keyboards and you've got a real-time synthesizer. Or with any MIDI keyboard, it becomes a slave module with all the rich, accurate sound of FM digital.

To increase the storage capacity of your CX5M, add the new FD05 or FD03 Micro Floppy Disk Drives.

Each uses 3.5-inch floppy disks for fast access and high storage capacity. And the MSX-DISK

BASIC language is built into the disk drive interface cartridge.

All you need now is a printer and a mouse.

Which is why we have the PN101 dot-impact printer. It doesn't need any special paper to print out your letters, compositions, voice data and other music data to hard copy.

And the MU01 Mouse that you can use to move the cursor around quickly and execute most commands without having to go to the CX5M's keyboard.

### THE PRICE HASN'T.

Yet with all this going for it, the basic CX5M computer doesn't go for any more than it did at its debut.

See your Yamaha Professional Products dealer. Or write: Yamaha International Corporation, Professional Products Division, P.O. Box 6600, Buena Park, CA 90622. In Canada: Yamaha Canada Music Ltd., 135 Milner Avenue, Scarborough, Ontario M1S 3R1.



**YAMAHA**

Inquiry 381

CX5M and TeleWord are registered trademarks of Yamaha International Corporation.  
MSX is a registered trademark of Microsoft Corporation.  
The music sheet was produced using the Graphic Artist program.

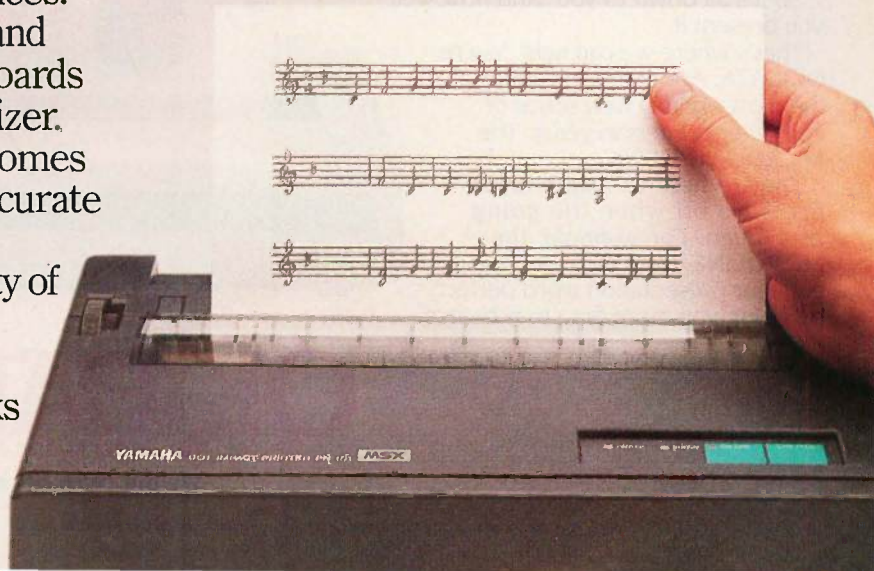





# A THOUSAND JOBS ARE RIDING ON THIS PRESENTATION. AND THE PRESENTATION IS RIDING ON YOU.

You've analyzed the research. You've agonized the numbers. And plugged in every "what if" scenario ever invented. Now all you have to do is convince the powers that be that you're right.

So it's all down to you. And how well you present it.

That's where we can help. We're OKIDATA. And we're introducing the most exciting new series of computer printers in years. The MICROLINE® 290's.

They're here to take a lot of pressure off when the going gets tough. For example, the MICROLINE 290's will help you get your presentation word perfect by giving you more time to rehearse.

That's because they print presentation quality reports twice as fast as other printers in their class.



And everyone will know you've done your homework due to the more impressive report you'll leave behind. More impressive with beautiful crisp text, important points highlighted in color, bold lead-ins, numbers underlined and full color charts to top it off.

We could go on, but, when a thousand jobs are riding on your presentation, we don't think you need a million reasons to know we're the best people to put it on paper for you.

So remember . . . when you need all the help you can get, our new MICROLINE 290's can be there when you need them. Call 1-800-OKIDATA today for the dealer nearest you.

**OKIDATA®**  
an OKI AMERICA company  
We put business on paper.



## ADDING SCSI TO THE SB180 COMPUTER PART 2: BUS PHASES

BY STEVE CIARCIA

*How bus phases are managed  
by the NCR 5380 chip*



In this second half of my article on the SCSI bus, I will discuss in greater detail its operational characteristics: the bus phases and how they are managed by the NCR 5380 chip (see photo 1). I will even step through what happens if we issue a command to a hard disk attached to the bus and request the disk to write a sector of information. Be warned, though, that things will get intricate, and I urge you to keep last month's article on hand as a reference.

### **BUS PHASES**

The bus protocol can be divided into the following phases: bus free, arbitration, selection, reselection, command, data in, data out, status, message in, and message out.

The arbitration, reselection, and message-out phases are used only in systems that support multitasking. Since the SB180 BIOS supports a single-user/single-tasking system, these phases are not supported. Also, in a single-user/single-tasking system, the message-in phase is used only for sending the command complete message.

In my upcoming descriptions of these phases, I will follow the common SCSI usage and refer to the host as the initiator and the peripheral device as the target. The

directions in and out are always used with respect to the initiator.

### **BUS FREE**

Bus free, as you might guess, is the idle state of the SCSI bus. No device is actively using the bus, and it is available for subsequent users.

### **ARBITRATION**

Systems using the COMM180 with the current SB180 BIOS enter the selection phase directly without going through the arbitration phase. On systems that support multiple hosts or the disconnect/reconnect capability (a configuration not supported by the current SB180 BIOS), this phase is used to decide which device gains access to the bus when two or more devices request use of the bus at the same time.

Once the bus is determined to be free, a device may wish to arbitrate with other devices for use of the bus. For systems in which only one device initiates bus activity, the arbitration phase is optional and need not be implemented. A device places

*(continued)*

*Steve Ciarcia (pronounced "see-ARE-see-ah") is an electronics engineer and computer consultant with experience in process control, digital design, nuclear instrumentation, and product development. He is the author of several books about electronics. You can write to him at POB 582, Glastonbury, CT 06033.*



*Each device has an ID between 0 and 7 that corresponds to one bit on the data bus.*

the bus in the arbitration phase by asserting the  $\overline{\text{BSY}}$  signal and the appropriate bit on the data bus that indicates that device's ID. Since up to eight devices can use the bus, each device is assigned an ID between 0 and 7 that corresponds to one bit on the data bus. For example, if a device's ID was 3, it would assert bit 3 on the data bus along with  $\overline{\text{BSY}}$  during arbitration.

A device loses arbitration if it detects either  $\overline{\text{SEL}}$  true or a higher-priority ID active after allowing for an arbitration delay. Bit 7 is the highest-

priority device. If a device loses arbitration, it must wait until the next bus free phase before reentering arbitration.

If after allowing for an arbitration delay and a higher-priority ID is not active, that device wins arbitration and asserts  $\overline{\text{SEL}}$ . This indicates to all other arbitrating devices that arbitration has been won, causing them to release the bus.

#### SELECTION

When the initiator has determined that the SCSI bus is free,  $\overline{\text{SEL}}$  is asserted, and the initiator enters the selection phase, which is optional for single-user/single-tasking systems like the SB180. The selection phase is used to establish a communications link between the initiator and a target device for the purpose of performing an SCSI command. Where a host computer needs to write a sector of information to a disk drive, the host, acting as an initiator, would select the appropriate disk drive to perform the command.

An SCSI target is considered selected when  $\overline{\text{SEL}}$ , the target bus device ID, and, optionally, the initiator bus device ID are active. When these conditions are met, the selected target asserts  $\overline{\text{BSY}}$ , and the selection phase is complete. If the target is not ready to be selected (e.g., it may be running a power-up or reset sequence), it cannot assert the  $\overline{\text{BSY}}$  line. In this case, the SCSI specification recommends that the initiator abort the attempted selection if the target does not respond within 250 milliseconds. This time-out is especially important because a nonexistent device will act as one that is not ready to be selected.

#### INFORMATION TRANSFER PHASES

The remainder of the bus phases are collectively referred to as information transfer phases. The selected target device controls the flow of information with the initiator by setting the signals  $\overline{\text{MSG}}$ ,  $\overline{\text{C/D}}$ , and  $\overline{\text{I/O}}$  to the proper information transfer phase. These signals, known as phase signals, are used to determine the type of information being transferred and the direction of the data. Table 1 describes how the phase signals are coded.

These phases are used to transfer the necessary data and control information to complete an I/O operation. For each byte of information transferred, the following sequence of actions (called a REQ/ACK handshake) is required.

First, the target sets the phase lines (see table 1) to the desired bus phase and asserts the  $\overline{\text{REQ}}$  signal either to request data from the initiator or to send data to the initiator; the direction is determined by the  $\overline{\text{I/O}}$  signal. ( $\overline{\text{I/O}}$  is true for in and false for out.) If the data is being sent from the target to the initiator, the data is asserted on the SCSI bus at this time.

Next, in response to the  $\overline{\text{REQ}}$  signal, the initiator asserts  $\overline{\text{ACK}}$  to send data to the target or accept data from the target. If the data is being sent from the host to the target, the data is presented on the SCSI bus at this time.

The target, in turn, will deassert  $\overline{\text{REQ}}$ , and the initiator will respond to

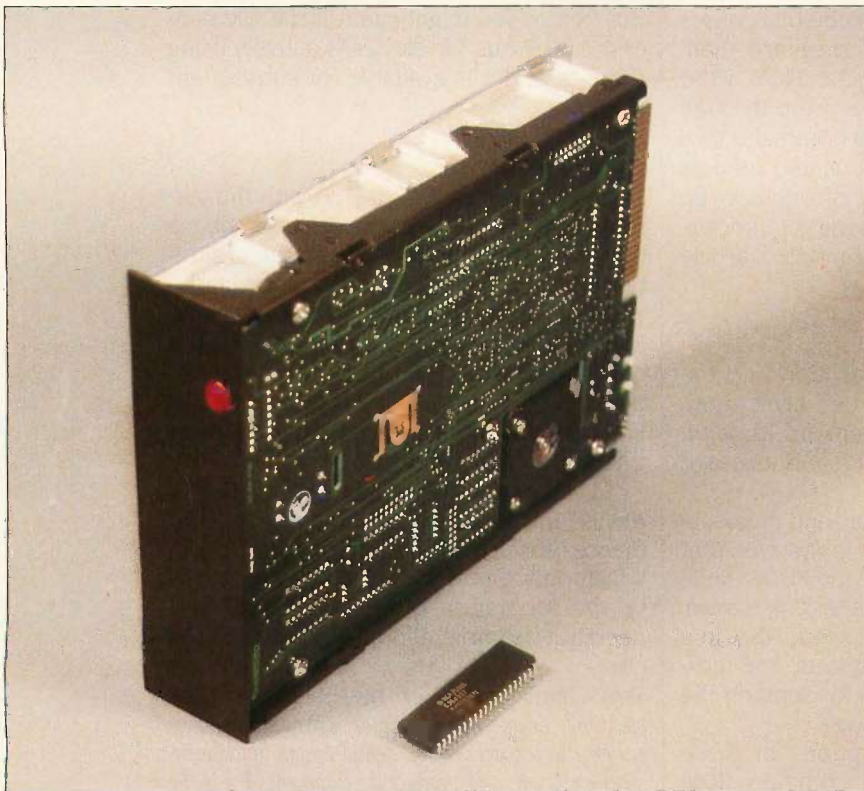

Photo 1: The NCR 5380 SCSI chip, shown here next to an SCSI-compatible 10-megabyte hard disk drive.



a deasserted  $\overline{REQ}$  by releasing  $\overline{ACK}$ .

This handshake is referred to as the asynchronous data transfer and is used in all the information transfer phases I will discuss below. A different handshake sequence is in effect when the synchronous transfer mode is used. However, since the COMM180 does not support this mode, I will not cover it.

**COMMAND**

An SCSI bus enters the command phase when  $C/\overline{D}$  is asserted while  $\overline{MSG}$  and  $I/\overline{O}$  are inactive. This phase is used to inform the target device of the  $I/\overline{O}$  function to be performed. The command blocks defined in the SCSI proposed standard are 6, 10, or 12 bytes in length. The length is determined by the group code located in the first byte of the command block.

**DATA**

The data phases are entered by deasserting  $C/\overline{D}$  and  $\overline{MSG}$ . The state of the  $I/\overline{O}$  line determines the direction of the data transfer. SCSI is a block-oriented bus, and data is usually transferred in segments. Consequently, when a computer is communicating with a disk drive via an SCSI bus, the data segment size is usually chosen as a multiple of the physical sector size.

**STATUS**

The status phase is entered when the target asserts  $C/\overline{D}$  and  $I/\overline{O}$  while  $\overline{MSG}$  is inactive. The target uses this phase to transfer a status byte to the initiator at the termination of each command.

**MESSAGE**

The message phase is entered by asserting  $\overline{MSG}$  and  $C/\overline{D}$ ;  $I/\overline{O}$  determines the direction of the message. This phase provides a means of managing the SCSI bus in complex system configurations. Only the command complete message is required in all SCSI designs. SCSI-bus devices indicate their ability to support messages other than command complete by asserting or responding to the  $\overline{ATN}$  signal.

**TYPICAL SASI TRANSFER**

To give you a greater appreciation for the SCSI bus, I will examine in detail

Table 1: The SCSI bus phase signals and what they mean.

Phase	$\overline{MSG}$	$C/\overline{D}$	$I/\overline{O}$
data out	0	0	0
data in	0	0	1
command	0	1	0
status	0	1	1
unspecified	1	0	0
unspecified	1	0	1
message out	1	1	0
message in	1	1	1

Table 2: The address location of the NCR 5380's internal registers. The R/W column indicates whether the register is read only, write only, or read/write.

Register name	Address lines			R/W
	A2	A1	A0	
current SCSI data	0	0	0	R
output data	0	0	0	W
initiator command	0	0	0	R/W
mode	0	1	0	R/W
target command	0	1	1	R/W
current SCSI bus status	1	0	0	R
select enable	1	0	0	W
bus and status	1	0	1	R
start DMA send	1	0	1	W
input data	1	1	0	R
start DMA target receive	1	1	0	W
reset parity/interrupts	1	1	1	R
start DMA initiator receive	1	1	1	W

what occurs when a computer requests a disk drive to write a sector of information. I'll take the case of the computer and disk drive communicating through a SASI bus first, and then I'll look at a full SCSI implementation.

**SELECTION PROCESS**

Since the system contains a single host and the peripherals are not capable of disconnection and reselection, the host is the only bus master and can enter the selection phase without arbitrating. It does this by asserting  $\overline{SEL}$  and the data bit of the device being selected (the disk drive). The peripheral device operating as a bus target asserts  $\overline{BSY}$  to complete the selection process.

To accomplish this with the NCR 5380, you write the bus device ID of the controller to the output data register. Then, to assert this ID bit onto the SCSI bus, you set the assert data bus bit in the initiator command reg-

ister to a 1. Finally, you set the assert  $\overline{SEL}$  bit, also found in the initiator command register, to activate the  $\overline{SEL}$  line as described above. (Refer to table 2 and figure 1.)

$\overline{SEL}$  and the ID are concurrently active, and only a  $\overline{BSY}$  from the controller is needed to complete the selection process. The SB180 BIOS polls the current SCSI bus status register waiting for the  $\overline{BSY}$  signal to become active. If  $\overline{BSY}$  is not asserted within 250 ms, the attempted selection is aborted.

If everything is operating properly,  $\overline{BSY}$  will go active, and the processor resets the assert  $\overline{SEL}$  bit in the initiator command register to 0. It then resets the assert data bus bits in the initiator command register to zeros.

**COMMAND PHASE**

Once connected, the target asserts the  $C/\overline{D}$  signal, indicating command

(continued)



phase, and then asserts  $\overline{\text{REQ}}$  to request the first byte of the command block. The first byte (byte 0) of the 6-byte command block contains the operation code 0A hexadecimal for the write command (see figure 2). The initiator sends the first byte by completing the REQ/ACK handshake and waits for the target to request the next byte. Upon receipt of the operation code, the target determines how many bytes to request from the initiator and decodes the operation to be performed. Using the REQ/ACK handshake, the initiator sends the remaining portion of the command block.

The information contained in bytes 1 through 3 of the command block provides the logical unit number and the logical block address (by incorporating the idea of a logical unit number, the SCSI protocol allows a single controller to control several physical disk drives). The logical block address is consequently converted by the target into the physical head, track, and sector locations to be addressed on the disk drive. Byte 4 contains the transfer length that specifies the number of logical blocks to be transferred. One logical block is often the size of the physical sector on the disk drive. The last byte of the command block, byte 5, is the control byte, which may contain vendor-unique information.

The firmware now polls the current bus and status register looking for the command phase and  $\overline{\text{REQ}}$  to be asserted. Once the bus is in the proper phase, the software writes an 02 hexadecimal to the target command register. The 5380 will not allow data to be asserted on the SCSI bus unless the contents of the target command register reflect the current SCSI bus phase.

The command block can be transferred with the 5380, using programmed I/O, pseudo direct memory access, or normal DMA operation. Due to the small number of bytes to be transferred, the BIOS uses the pseudo DMA mode, which acts as programmed I/O operation but does not require the SCSI REQ/ACK handshake to be implemented overtly in the software. It therefore requires

fewer I/O operations.

To implement this mode, the system asserts the DMA mode bit in the mode register of the 5380, sets the assert data bus bit in the initiator command register, and writes the

start DMA send register. When the CPU addresses the start DMA send register with a write strobe, the 5380 begins the DMA process by asserting the DRO signal to request the first byte of information to be transferred.

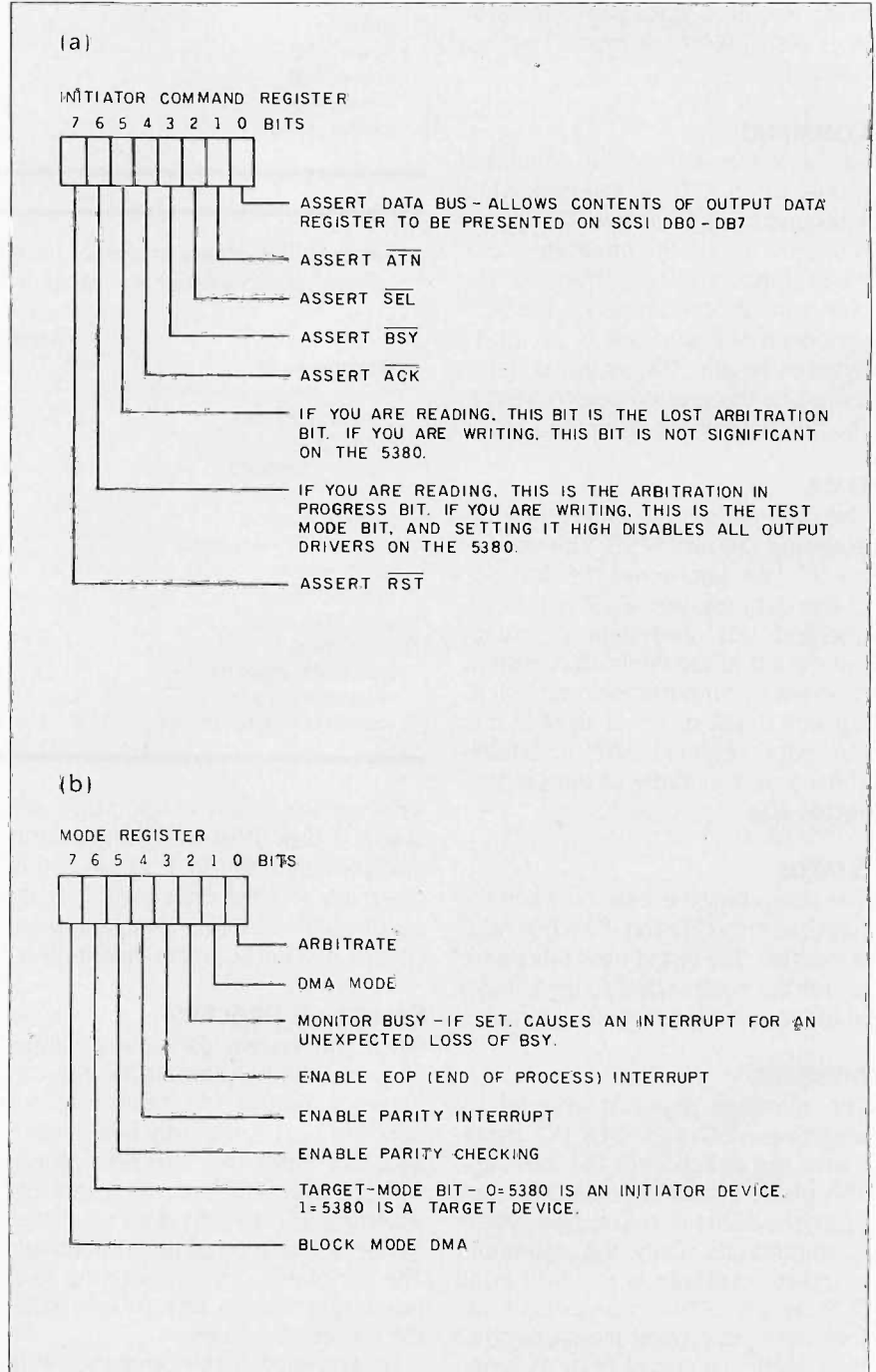

Figure 1: Internal detail of some of the 5380's more important registers: (a) The initiator command register; (b) the mode register; (c) the target command register; (d) the current SCSI bus status register; and (e) the bus and status register. Refer to table 2 for address locations.



(The data written to the start DMA send register is not significant.) This initialization sequence is identical to normal DMA operation. The primary difference is that the DMA channel is not controlling the transfer of data.

the CPU controls the transfer. The CPU samples the DRQ signal by reading the DMA request bit in the bus and status register. If this bit is active, the CPU knows that the 5380 is ready to receive data, and the first

byte of the command block is written to the output data register at I/O address F0 hexadecimal.

Once the data is written, the 5380 loads the data onto the SCSI bus and asserts  $\overline{ACK}$ . In response to  $\overline{ACK}$ , the target reads the data on the SCSI bus and deasserts  $\overline{REQ}$ . The 5380 subsequently requests the second byte of data from the CPU by issuing the next DRQ. (This also sets the DMA request bit. BIOS polls this bit before issuing the next byte.) After the 5380 receives the second byte from the CPU, it deasserts the SCSI  $\overline{ACK}$  signal, which has remained active since the first transfer. Subsequent to  $\overline{ACK}$  going false, the disk controller issues the second  $\overline{REQ}$ . The cycle above is repeated for the remaining bytes of the command phase.

As you can tell from the above description, the  $\overline{ACK}$  signal asserted for the sixth command byte will remain asserted until an additional byte is issued to the 5380 or it is reset by other means. The SCSI bus, according to the proposed standard, cannot proceed to the next bus phase until  $\overline{ACK}$  is deasserted. The SB180 BIOS resets the  $\overline{ACK}$  signal by resetting the DMA mode bit in the mode register.

**DATA-OUT PHASE**

Having received the command block, the disk controller knows the location the data will be written to and performs a seek operation to position the heads over the proper track. Since the seek operation requires many milliseconds to complete, higher-performance controllers disconnect from the SCSI bus at this point and reconnect once the head is properly positioned. However, SASI designs remain connected to the host for the duration of the seek. When the head is properly positioned, the target changes the information transfer phase to data out and requests the initiator to send the number of bytes specified in byte 4 of the command block.

While the seek is being performed by the attached disk drive, the SB180 BIOS prepares the 5380 and DMA channel 0 of the Hitachi 64180 for the data-out phase. The DMA channel is programmed to respond to DMA re-

(continued)

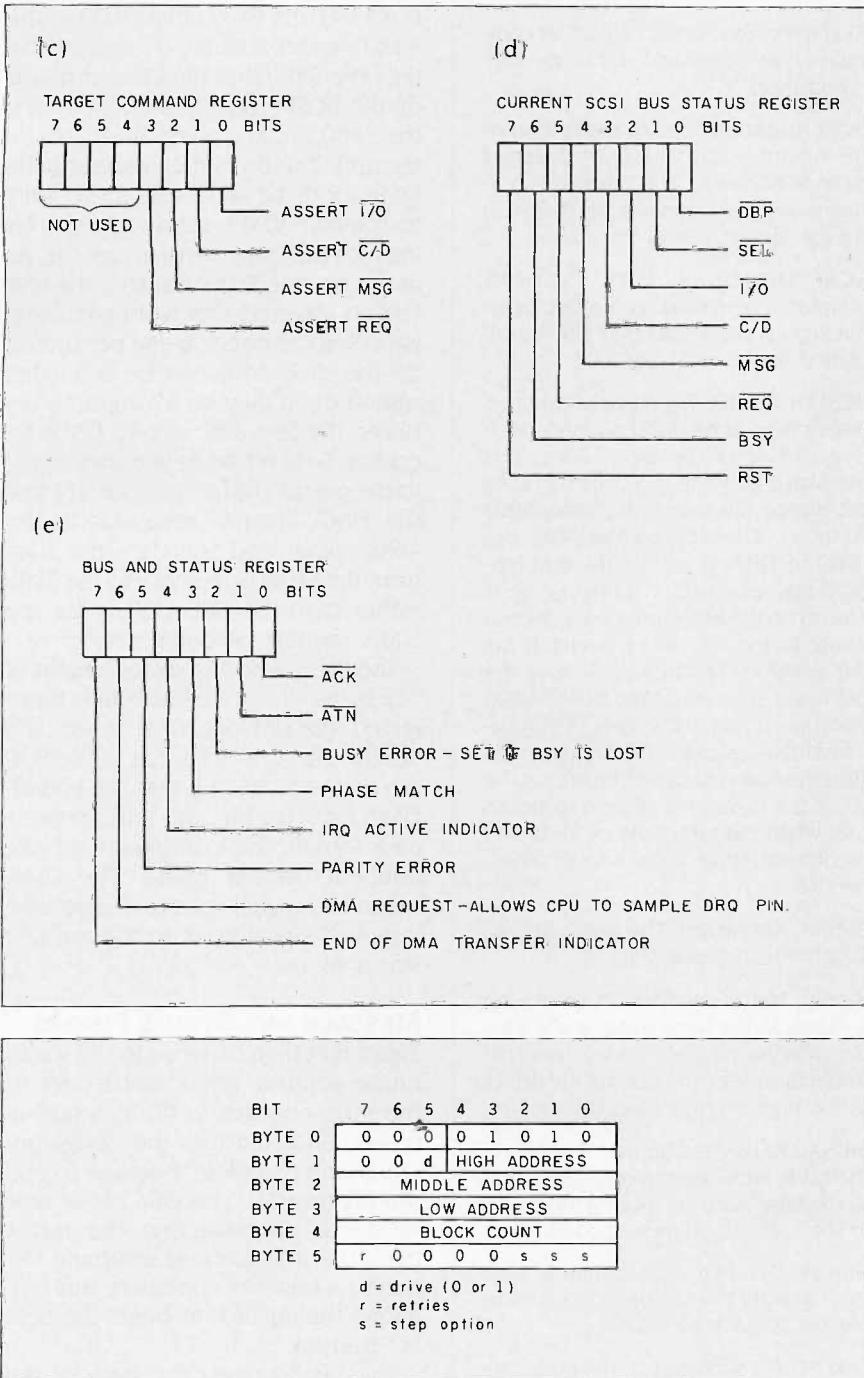

Figure 2: Format of the write command. The op code (0A hexadecimal) is in the lower 5 bits of the first byte. The command's group code, which indicates how many bytes compose the command, is in the first byte's upper 3 bits.



# GLOSSARY

**BYTE:** Eight bits of data.

**CONNECT:** This function occurs when an initiator selects a target to start an operation.

**DISCONNECT:** This function occurs when a target releases control of the SCSI bus, allowing it to go to a bus free phase. This can be done at the end of an operation or when a target releases the bus during an operation (such as during a seek).

**INITIATOR:** An SCSI device (usually a host system) that requests an operation to be performed by another SCSI device. For this system, the NCR 5380 on the COMMI80 is the initiator.

**LOGICAL UNIT:** A peripheral device addressable through a target.

**LOGICAL UNIT NUMBER:** An encoded 3-bit identifier for the logical unit.

**LUN:** Abbreviation for logical unit number.

**PERIPHERAL DEVICE:** A piece of equipment that can be attached to an SCSI bus, for example, a disk, streaming tape, optical disk, or printer.

**RECONNECT:** This function occurs when a target reselects an initiator to con-

tinue an operation after a disconnect.

**RESERVED:** Bits, bytes, fields, and code values that are set aside for future standardization.

**SCSI ADDRESS:** The representation of the unique address (0 to 7) assigned to an SCSI device. This address is normally assigned and set in the SCSI device during system installation.

**SCSI DEVICE:** A host computer adapter, a peripheral controller, or an intelligent peripheral that can be attached to the SCSI bus.

**SCSI DEVICE ID:** The bit-significant representation of the SCSI address referring to one of the signal lines. This translates into one SCSI bus bit being set during the selection phase. Table A shows which bit on the SCSI bus (DB0 to DB7) is set for the different SCSI addresses. This configuration is placed on the bus during the selection phase to indicate which device is being selected. The bits set to x in the fields are set to 0 by the SBI80 BIOS because it supports only a single-user/single-tasking environment. On systems that support multitasking, the ID of the initiator is also asserted so that when the target disconnects and reconnects, it will know who to reconnect to.

**SIGNAL ASSERTION:** The act of driving a signal to the true state.

**SIGNAL NEGATION:** The act of driving a signal to the false state or allowing the cable terminators to bias the signal to the false state (by placing the driver in the high-impedance condition).

**SIGNAL RELEASE:** The act of allowing the cable terminators to bias the signal to the false state (by placing the driver in the high-impedance condition).

**STATUS:** One byte of information sent from a target to an initiator upon completion of each command.

**TARGET:** An SCSI device that performs an operation requested by an initiator.

**VENDOR-UNIQUE:** Bits, fields, or code values that are vendor-specific.

Table A: SCSI device IDs and their corresponding bits on the data bus.

SCSI address	SCSI ID							
	D	D	D	D	D	D	D	D
	B	B	B	B	B	B	B	B
	0	1	2	3	4	5	6	7
0	1	x	x	x	x	x	x	x
1	x	1	x	x	x	x	x	x
2	x	x	1	x	x	x	x	x
3	x	x	x	1	x	x	x	x
4	x	x	x	x	1	x	x	x
5	x	x	x	x	x	1	x	x
6	x	x	x	x	x	x	1	x
7	x	x	x	x	x	x	x	1

quests from the 5380 by fetching data from a defined memory location and writing this data to the output data register of the 5380 (at I/O address F0 hexadecimal).

With the DMA mode bit reset and the assert data bus bit still active in the 5380, the BIOS writes a 00 to the 5380's target command register. This tells the 5380 that the current phase on the SCSI bus is data out (if it isn't, the 5380 issues a phase mismatch interrupt). The BIOS then reasserts the DMA mode bit and issues an I/O write to the start DMA send register; this initiates the DMA transfer process. As in the pseudo DMA transfer, the first DRQ is asserted after writing this register. Since the seek being performed by the disk drive can be a lengthy operation, it may be a long time between the first and second DMA requests. Data is transferred identically to the pseudo DMA mode except that the DMA channel responds to the DRQ signal and transfers the data from the SBI80's memory to the 5380 rather than the CPU polling for the DMA request bit being active.

The BIOS supports sector lengths of 512 bytes. When the last byte is transferred, the DMA channel asserts the TEND0 signal, which is fed to the EOP pin on the 5380. This sets the end-of-DMA bit in the bus and status register and signals the completion of the data-out transfer phase. The DMA mode bit is again reset to deassert the last ACK signal prior to the ensuing status phase.

## MESSAGE AND STATUS PHASES

The target then switches to the status phase, sends a "good" status code to the host, changes to the message-in phase, and transfers the obligatory command complete message to end the I/O transfer. The BSY line is now released, disconnecting the target from the initiator and returning the bus to a bus free condition. Bus free allows the initiator to begin the next I/O transfer.

The SBI80 reads the data of the status and message-in phases, using the pseudo DMA method previously described. In each case, the assert data bus bit is reset and the target command register is updated to the



proper phase before reading the data from the 5380.

### SCSI TRANSFER

Now for the SCSI version of the example. The SCSI bus differs from SASI in that it supports multiple bus masters through bus arbitration, and the disconnection and reselection of target devices are supported through the optional message-in and message-out bus phases.

In full SCSI implementations, the arbitration phase precedes the selection phase so that a device can gain control of the SCSI bus. When the selection phase is entered, the host asserts  $\overline{SEL}$ , its device ID, the target's device ID, and the  $\overline{ATN}$  signal. The host presents its own device ID so that the target can know which device performed the selection. This is important in case the target disconnects from the SCSI bus for a lengthy I/O operation—it must know which host to reselect (this might be a multiprocessor system). The presence of the  $\overline{ATN}$  signal informs the target of the initiator's desire to send a message and that the initiator is capable of supporting more than the mandatory command complete message. If the target is capable of supporting the additional messages required for disconnection and reselection, it responds by entering the message-out phase. Otherwise, the target replies by entering the command phase described in the SASI example.

Once the target issues  $\overline{REQ}$  for the message-out phase, the initiator sends an identify message to the target. The identify message establishes a physical path between the initiator and the target for a particular logical unit and notifies the target of the initiator's ability to support disconnection and reselection. This message is also used by the target to reestablish the physical path with the initiator in a subsequent reselection.

After the identify message is transferred, the target requests the command block from the initiator by entering the command phase. (I will use the write command for this example, as I did in the SASI example.) If we assume that the write command will require the disk drive to perform

a time-consuming seek operation, once the target receives the command from the host, it will disconnect from the SCSI bus. This frees the bus for other I/O operations. To disconnect from the bus, the target switches to the message-in phase and issues a disconnect message to the initiator. If the target was transferring several logical blocks of information and decided to disconnect between segments, it would issue a save data pointer message before issuing the disconnect. After the message is sent across the bus, the target releases  $\overline{BSY}$  to complete the disconnection.

Although the target has broken the physical path with the host, the logical connection is maintained through the use of data pointers supported by the initiator. This concept is referred to as a logical thread. As long as the bus is free, the host can establish as many logical threads as can practically be supported by the system. Data pointers must be maintained for each logical thread.

When the head of the disk drive is positioned over the correct track, the target attempts to reestablish the physical path with the initiator by arbitrating for use of the SCSI bus. Once

it has gained control of the bus, it reselects the host to complete the write command. When the reselection phase is complete, the target enters the message-in phase and sends the identify message to inform the initiator which logical unit is reconnecting. Since the initiator may have started several I/O operations, it performs an implied restore data pointer message to continue the I/O operation at the point of disconnection.

After the identify message has been transferred, the bus operation proceeds identically to the SASI example. Data-out, status, message-in, and bus free operational phases are consecutively performed on the SCSI bus, completing the write command.

### IN CONCLUSION

You'll be seeing many computers and peripherals that are SCSI bus-compatible in the future, from peripheral manufacturers and the Circuit Cellar as well (see photo 2). In the early days of personal computing, it was enough for me to design projects that connected to a user's parallel port. Since then, however, personal computing has evolved to include a cornucopia

*(continued)*

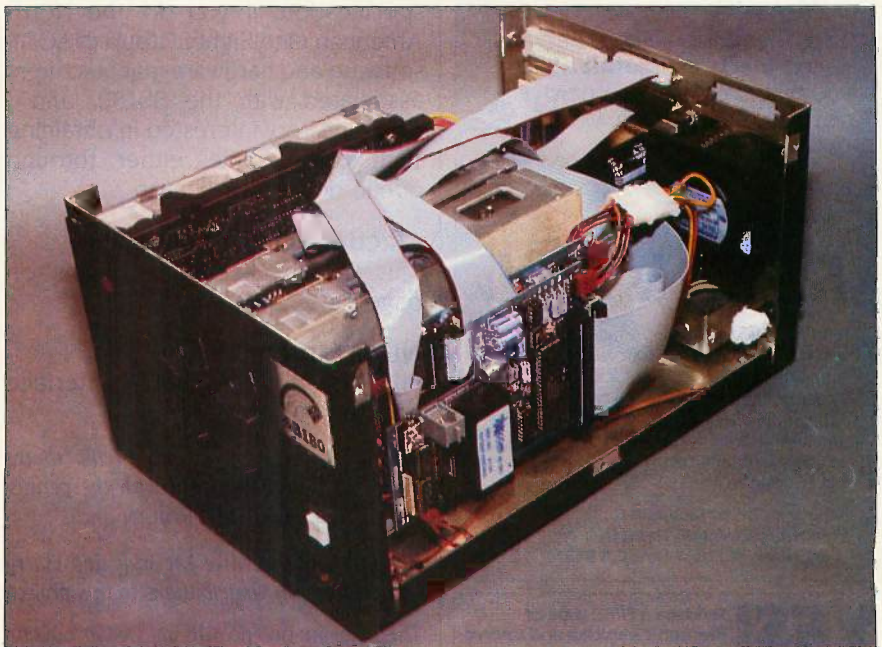

Photo 2: The complete COMM180 board installed in a functioning SB180 computer system. The SCSI controller chip (note white outline) can be seen next to the larger MOSART modem chip.



# MIDI EVERY MONTH!

Don't stop now! If you're enjoying this special **Byte** issue on Computers & Music and want to take your interest further, here's the magazine that will take you as far as you want to go:

## Electronic Musician



**Electronic Musician** is your complete guide to the use of electronic musical instruments and personal computers in the creation and recording of music.

Edited by musician-author Craig Arderton, **Electronic Musician** brings you both basic and advanced articles that de-mystify MIDI, Music Software, and Synthesizers.

Now you can face the music every month and enjoy it!

## FREE Issue!

Send for a free issue and reserve your one-year subscription at the special introductory rate of \$14.95 (\$24.95 foreign). You'll save over 50 percent off the single copy price. If you're not completely satisfied with the first issue, simply write "cancel" on our invoice and that will be the end of the matter. The first issue will be yours to keep.

Send coupon or facsimile to:  
**Electronic Musician, Dept. B**  
 2608 Ninth St., Berkeley, CA 94710

**YES!** Send me a FREE issue of **Electronic Musician** and reserve my one-year subscription.

Name \_\_\_\_\_  
 Address \_\_\_\_\_  
 City \_\_\_\_\_  
 State \_\_\_\_\_ Zip \_\_\_\_\_

## CIRCUIT CELLAR

*I expect that the  
 SCSI standard will  
 be heartily adopted.  
 I am looking forward  
 to using it again.*

of backplane buses and interface standards that makes writing articles more like the Bus of the Month club. Presenting a project that is specifically IBM PC-compatible negates its value to Atari or Macintosh owners.

I expect that the SCSI standard will be heartily adopted. I for one am looking toward my next opportunity for using it.

### SOFTWARE BLACK BELTS TAKE NOTICE

The current SB180 BIOS supports single-user/single-tasking systems. With thousands of SB180s in use among the software gurus of the world, no doubt one of you is going to implement the higher-level SCSI functions while I'm still drafting the specification. If you do, the North American One-Eighty Group (NAOG), software and hardware manufacturers associated with the SB180, and I would be very interested in obtaining such driver code, either through public domain or license.

### CIRCUIT CELLAR FEEDBACK

This month's feedback begins on page 54.

### NEXT MONTH

I'll look at peripheral interface adapters. ■

*Diagrams and information specific to the NCR 5380 are reprinted with the permission of National Cash Register Inc.*

*Special thanks to Mike McBride and Harry Mason for their contributions to this project.*

There is an on-line Circuit Cellar bulletin board system that supports past and present projects. You are invited to call and exchange ideas and comments with other Circuit Cellar supporters. The 300/1200-bps BBS is on-line 24 hours a day at (203) 871-1988.

The following items are available from

The Micromint Inc.  
 25 Terrace Dr.  
 Vernon, CT 06066  
 (800) 635-3355 for orders  
 (203) 871-6170 for information

1. SB180 computer board with 256K bytes of RAM. Complete with user's manual and ROM monitor. Assembled and tested.

SB180-1 ..... \$369  
 2. Complete SB180 computer board with 256K bytes of RAM, user's manual, ROM monitor, and the Z-System, including ZRDOS, ZCPR3, an editor and utilities, BIOS source, ROM monitor source, ZAS assembler, ZDM debugger, and user's manuals. Provided on four 5¼-inch SB180 format DS/DD disks. Assembled and tested.

SB180-1-20 ..... \$499

3. COMM180 SCSI-only expansion board for the SB180 computer with hard disk BIOS upgrade (board can be upgraded to include the modem at any time). Complete with user's manual. Software supplied on 5¼-inch DS/DD SB180 format disk. Assembled and tested.

COMM180-S ..... \$150

4. COMM180 1200-bps modem and SCSI expansion board for the SB180 computer with TERM3 and hard disk BIOS upgrade. Complete with user's manuals. Software supplied on two 5¼-inch DS/DD SB180 format disks. Assembled and tested.

COMM180-M01-S ..... \$479

SCSI hard disk drives, enclosures, cable sets, and various SB180 enhancement products are now available. Call for a price list.

Please include \$10 (on items 1 and 2) or \$6 (on items 3 and 4) for shipping and handling in the continental United States (\$4 additional for Canada), \$15 for surface or \$35 for air mail elsewhere. Connecticut residents please include 7.5 percent sales tax.

**Editor's Note:** Steve often refers to previous Circuit Cellar articles. Most of these past articles are available in book form from BYTE Books, McGraw-Hill Book Company, POB 400, Hightstown, NJ 08250.

*Circuit's Circuit Cellar, Volume I* covers articles in BYTE from September 1977 through November 1978. *Volume II* covers December 1978 through June 1980. *Volume III* covers July 1980 through December 1981. *Volume IV* covers January 1982 through June 1983. *Volume V* covers July 1983 through December 1984.

To be included on the Circuit Cellar mailing list and receive periodic project updates and support materials, please circle 100 on the Reader Service inquiry card at the back of the magazine.



# SOLID CITIZENS.

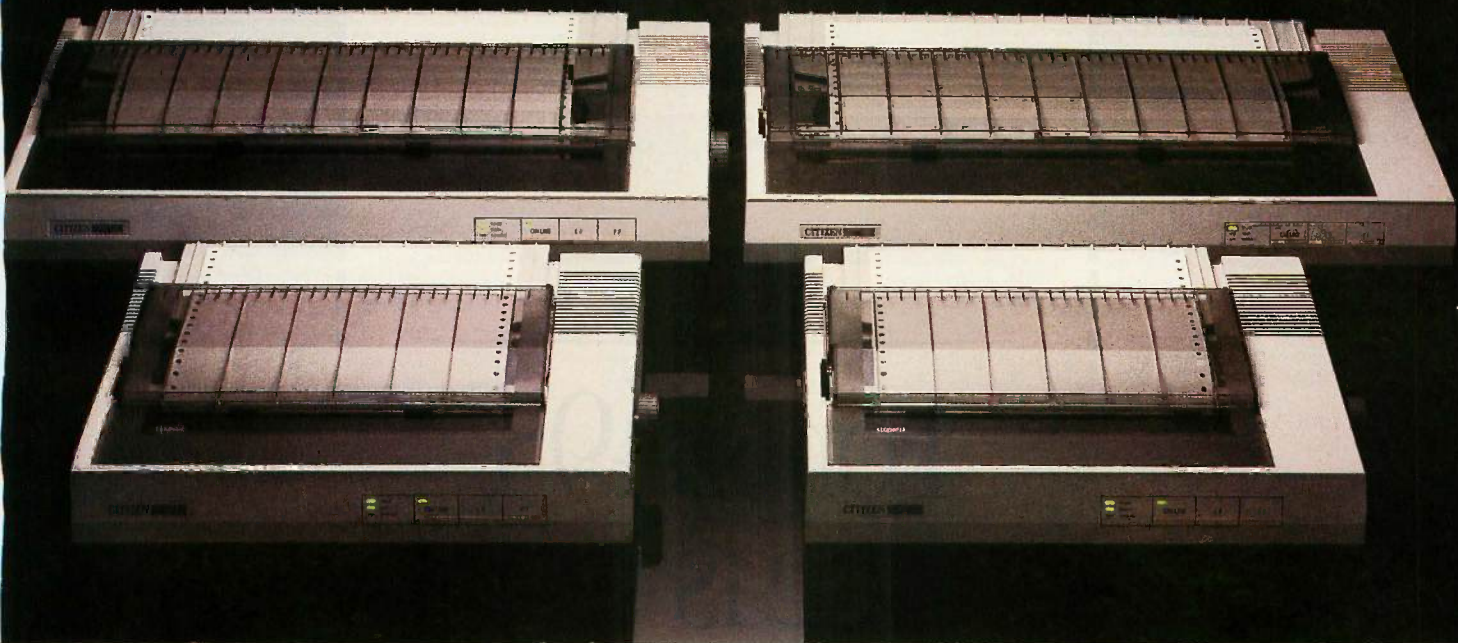

Presenting four upstanding Citizens who give faithful service above and beyond the call of duty. Citizen™ dot matrix printers, precision-engineered by the people who've become a wristhold word in fine, precision-engineered watches.

The Citizens are sleek, quiet, and reliable. They're extremely easy to use. And feature a unique push-feed paper system that makes paper loading a breeze. What's more, the Citizens are IBM®- and Epson®-compatible. Can print graphics.

Can dash out output at 160 cps (40 cps correspondence-quality) or a blazing 200 cps (50 cps correspondence quality). And offer a comprehensive 18-month warranty on *all* parts and labor, including the print head.

The Citizen MSP-10/15 and MSP-20/25. Four solid reasons to stop by your dealer.

And watch what the Citizens can do for you.

For more information, call 1-800-556-1234, Ext. 34.

In California, 1-800-441-2345, Ext. 34. Or write Citizen America Corporation,  **CITIZEN™**  
2425 Colorado Avenue, Santa Monica, CA 90404.





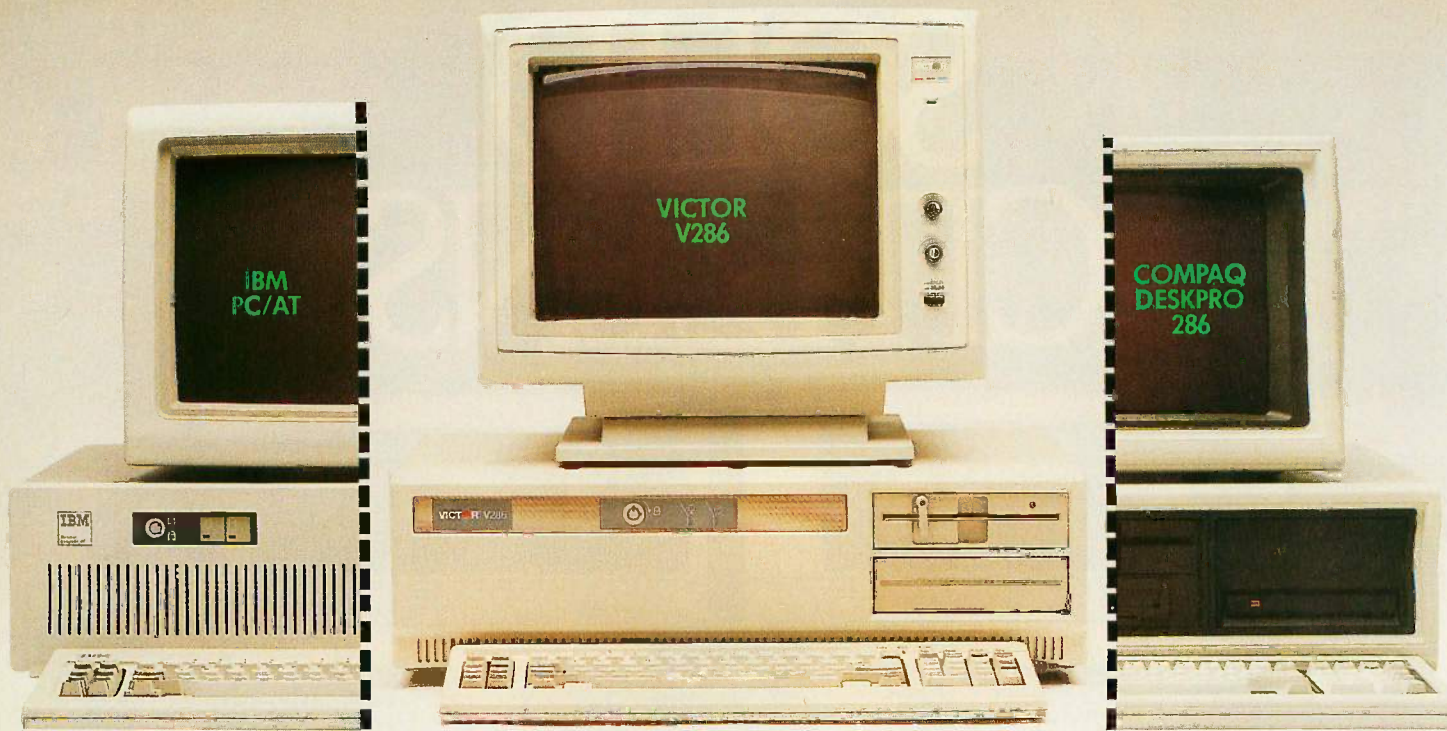

For \$2495,\*  
 what you see is what you get.

MANUFACTURER	SUGGESTED RETAIL PRICE*	PROCESSOR SPEED	EXPANSION SLOTS	MONEY-BACK GUARANTEE †
VICTOR V286	\$2495	6 to 8Mhz	8	YES
IBM PC/AT	\$4705	6Mhz	6	NO
COMPAQ DESKPRO 286	\$4244	6 to 8Mhz	6	NO

The simple fact is, you get more with the Victor V286.™ More speed. More features. More for your money. You also get more peace of mind. Because the Victor V286 comes complete with nationwide servicing through Xerox.® And a 30-day **Money-Back Guarantee**, an offer you won't see from anyone else. You won't see any software compatibility problems either. The V286 runs most every program faster than the IBM, but a flip of a switch will slow it down to mirror the AT and let you run the most finicky programs flawlessly. We've also equipped the V286 with features IBM considers options. Features you'll consider necessities. You can even expand the memory to 1 MB without using option boards. Those are just a few of the reasons the Victor V286 should be your next computer. For a more complete picture, and your nearest Victor dealer, call Marty at 1-800-248-5252.

\* DOES NOT INCLUDE MONITOR OR VIDEO BOARD.

Totals for comparably equipped models as of 3/26/86. IBM and IBM Personal Computer AT are trademarks of International Business Machines Corporation. COMPAQ and COMPAQ DESKPRO are trademarks of COMPAQ Computer Corporation.

† Available from participating dealers.

116 BYTE • JUNE 1986

**VICTOR**®

Scotts Valley, CA (408) 438-6680

Inquiry 362



# SORTING PRODOS DIRECTORIES

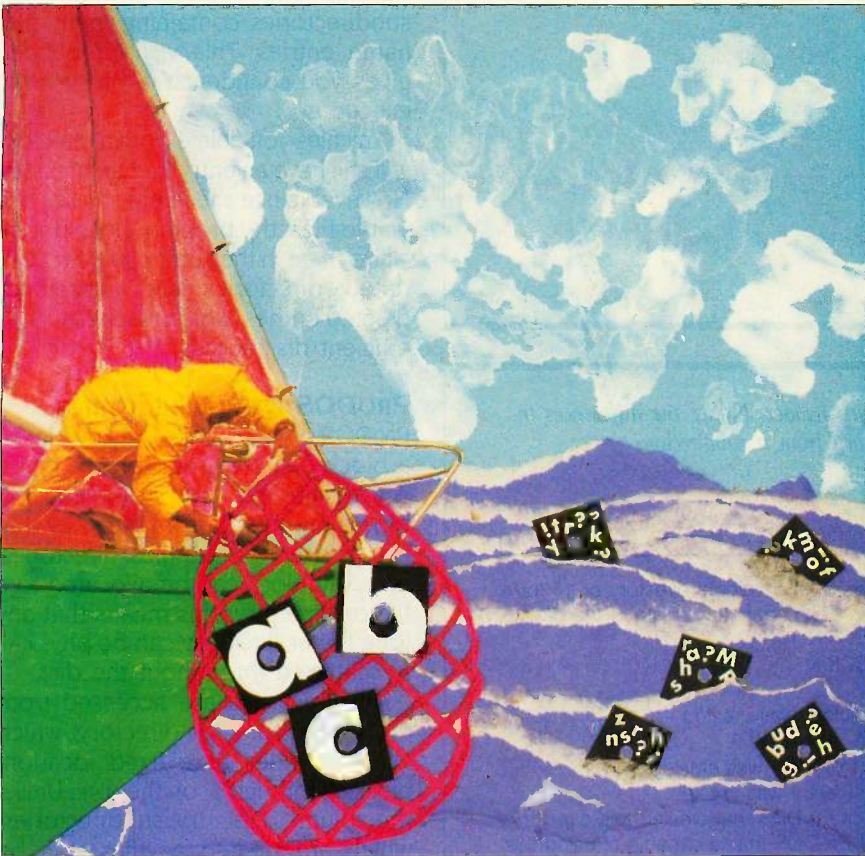

## *Sort subdirectories and files for cleaner catalogs*

**I**f you use Apple ProDOS, you have probably discovered that as files are added to and deleted from a disk its directory becomes filled with filename entries that the CATALOG command displays in a chaotic order. This is because ProDOS directories are simply built

sequentially—the operating system does not sort by filename. Thus if you forget the exact spelling of a filename, you must catalog the disk and inspect each filename until you find the one you want. This procedure can be a nuisance when you are examining a long catalog, but many micro users take this in stride and dismiss it as part of operating a personal computer.

The program I describe in this article is designed to eliminate long catalog searches by sorting the valid filenames in the volume and subordinate directories of the ProDOS disk. It also permanently stores the sorted filenames on the disk so that an alphabetically sorted directory is displayed each time you request a catalog.

### **PROGRAM FEATURES**

ProDOS, Apple's Professional Disk Operating System, is more sophisticated than its older but respected counterpart, DOS 3.3. Among ProDOS's features are an enhanced command set and support of a hierarchical directory structure that allows separate directories to coexist on the same disk. My program, for Apple IIc, IIe, and II+ computers with 64K bytes of RAM, will individually sort the volume, or root, directory and any of its subordinate directories that reside

*(continued)*

Antonio C. Silvestri is a professor of computer and information science at Springfield Technical Community College in Springfield, Massachusetts. He is also president of Systems Consultants Inc. (955 Sumner Ave., Springfield, MA 01118-2146), an engineering company that specializes in the design of computer hardware and software interfaces that control manufacturing machinery.



**Table 1: The format of a ProDOS directory block.**

Byte Offset in Directory Block	Entry Description
000-001	Block number of the previous directory block (low byte first). These bytes equal 0 if this is the first directory block.
002-003	Block number of the next directory block (low byte first). These bytes equal 0 if this is the last directory block.
004-042	Directory entry #1 or, if this is the first block of the directory (bytes 000 and 001 equal 0), the directory header.
043-081	Directory entry #2
082-120	Directory entry #3
121-159	Directory entry #4
160-198	Directory entry #5
199-237	Directory entry #6
238-276	Directory entry #7
277-315	Directory entry #8
316-354	Directory entry #9
355-393	Directory entry #10
394-432	Directory entry #11
433-471	Directory entry #12
472-510	Directory entry #13
511	<Not Used>

**Table 2: The format of a ProDOS directory header. Notice the differences in some bytes that distinguish a volume directory from a subdirectory.**

Byte Offset in Directory Header	Description
00	The high 4 bits equal 15 for a volume directory or 14 for a subdirectory. The low 4 bits equal the length of the directory name.
01-15	Directory name in ASCII.
16-23	Reserved.
24-25	The date that this directory was created (format:MMMDDDDD YYYYYYMM).
26	The minute at which this entry was created.
27	The hour at which this entry was created.
28	The version number of ProDOS that created this directory.
29	The lowest version of ProDOS that is capable of using this directory.
30	Directory access code.
31	The number of bytes occupied by each directory entry. This byte equals 39.
32	The number of entries that can be stored in each block. This byte equals 13.
33-34	The number of active files in this directory not including the directory header.
35-36	If this is a volume directory, these bytes specify the block where the volume bit map is located. If this is a subdirectory, these bytes specify the block in which the entry defining this subdirectory is located.
37-38	If this is a volume directory, these bytes indicate the size of the volume in blocks and equal 280. If this is a subdirectory, byte 37 is the directory entry number within the block specified in bytes 35 and 36. Byte 38 contains the number of bytes in each entry of the parent directory and equals 39.

on a ProDOS disk.

I wrote the program in Applesoft BASIC because speed is not important. The routine also includes some machine language code that is poked directly into memory.

To create a user-friendly utility, I have provided extensive screen output that allows you to monitor program execution. The routine takes some time to read, sort, and update a disk, particularly when you are working with a disk with numerous subdirectories containing many file-name entries. This visual feedback gives you confidence in the utility's execution.

Any files you delete from a directory will still have an entry in that directory. However, since these entries are not viable files, the program does not include them in the sorting process. Updated directories are purged of deleted entries, which results in more efficient disk access.

## PRODOS DISK DIRECTORIES

ProDOS organizes disk files by blocks, a block being a group of 512 bytes. An initialized ProDOS disk has 280 blocks numbered from 0 to 279 that can be used to store files, directories, etc. Any block can be allocated to a file or directory; this means that any long file or directory can be physically scattered throughout the disk.

All directories are accessed from the volume or root directory, which always resides at a fixed location, blocks 2 through 5, on the disk. Unlike the volume directory, subdirectories, which are treated as files, can be stored anywhere on the disk.

Since each directory block can hold thirteen 39-byte file entries, the volume directory can contain up to 52 entries. These entries describe a file's attributes by specifying its name, type, size, and disk location. The format of a directory block is shown in table 1.

The first block allocated to the volume directory (or a subdirectory) is called the key block and is arranged slightly differently than succeeding directory blocks. The 39-byte entry that normally describes the first file in the block is instead used to describe the directory itself. This entry is called the directory header. The



format of a directory header is shown in table 2.

The remaining directory entries represent binary, text, Applesoft program, or subdirectory files. The offset byte map for these entries is shown in table 3. To determine what type of file a particular entry corresponds to, simply examine the file-type code that appears at offset 16 within the entry. Table 4 lists a few of the most common file-type codes.

**DISK INPUT/OUTPUT**

Data transfers to and from the disk occur on a block basis using the ProDOS MLI (machine language interface) protocol. This standard makes it simple for you to write small assembly language programs to perform disk I/O functions.

A typical subroutine to invoke disk I/O looks like this:

```
JSR $BF00
DB  command_index
DB  low_para_addr
DB  high_para_addr
BCS error
```

ProDOS's entry point is at BF00 (hexadecimal). Command\_index is the command number assigned to a ProDOS function. Low\_para\_addr and high\_para\_addr are, respectively, the least significant byte and the most significant byte of the address of the parameter list associated with the command. The parameter list contains the values of variables that the command needs to execute properly.

After ProDOS executes the command, control passes to the instruction immediately after the 3 bytes that follow the JSR instruction. If an error occurs in processing the command, ProDOS sets the carry flag—hence the BCS instruction as shown in the example.

The MLI command to read an individual block on a disk is command number 128. To write a block, you issue command number 129. The parameter lists for these two commands are identical and are constructed as shown in table 5.

Short machine language routines can be safely loaded at 300 (hexadecimal)

(continued)

Table 3: The format of a ProDOS directory entry.

Byte Offset in Directory Entry	Description
00	The high 4 bits equal 0 for an inactive file or nonzero for an active file. The low 4 bits equal the length of the directory name.
01-15	Entry name in ASCII.
16	File-type code (refer to table 4).
17-18	If this entry is a subdirectory, these bytes specify the location of its key block. If this entry is a standard file, this entry points to the first block where file data is stored.
19-20	File size in blocks.
21-23	File size in bytes.
24-25	The date that this file was created (format:MMMDDDDDD YYYYYYYM).
26	The minute at which this file was created.
27	The hour at which this file was created.
28	The version number of ProDOS that created this file.
29	The lowest version of ProDOS that is capable of using this file.
30	File access code.
31-32	If this entry specifies a binary file, these bytes contain the load address for the file. If this entry specifies a random-access text file, these bytes contain its record length.
33-34	The date on which this file was last modified (format:MMMDDDDDD YYYYYYYM).
35	The minute at which this file was last modified.
36	The hour at which this file was last modified.
37-38	The key block number of the directory that holds this file entry.

Table 4: Some important ProDOS file-type codes.

File-Type Code	Catalog Mnemonic	File Description
001	BAD	Bad block file
004	TXT	ASCII text file
006	BIN	Binary file
015	DIR	Directory file
252	BAS	Applesoft program file
255	SYS	ProDOS system file

Table 5: The format of the parameter list used in ProDOS MLI calls to read and write disk blocks. (For disk block read and write calls, the first byte—the number of parameters—is always 3.)

Byte #	Contents
1	Number of parameters
2	Disk slot and drive to be accessed (128 * drive # + 16 * slot #)
3	Low byte of the address of a 512-byte data buffer
4	High byte of the address of a 512-byte data buffer
5	Low byte of the block number to be accessed
6	High byte of the block number to be accessed



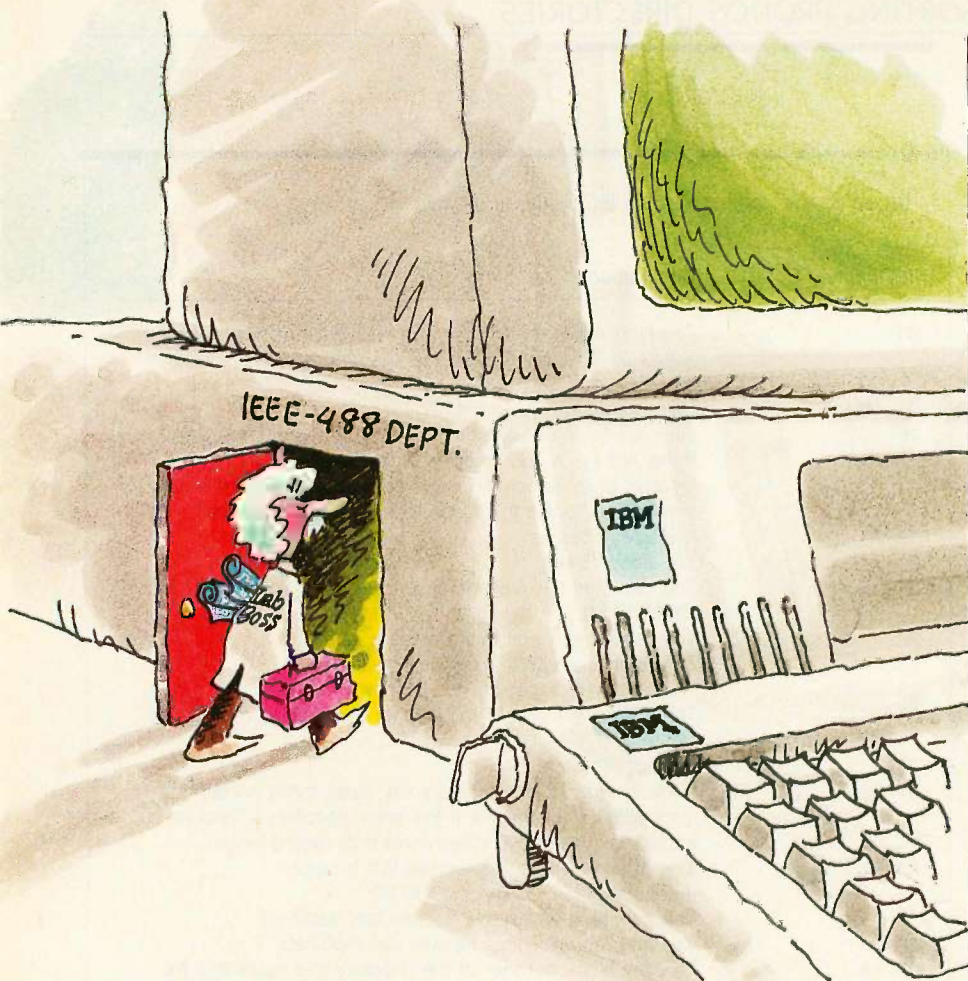

## Let Lab Boss™ turn your IBM PC into a powerful instrument controller.

**Y**ou can spend thousands of dollars for a dedicated instrument controller. Or a few hundred for a controller that's dedicated to you and your IBM PC.

Lab Boss™ from National Instruments puts you and your IBM PC (or compatible) firmly in charge of GPIB instruments. From sophisticated laboratory equipment, like digitizing oscilloscopes and spectrometers, to standard printers, plotters, tape drives and more. At data transfer speeds

that are the highest in the industry.

And Lab Boss products offer a direct data link from your measuring equipment to a full range of analysis software, including RS/1, Lotus 1-2-3, and Symphony. So you can easily report your findings on the same system you used for

instrument control, data acquisition and analysis. Try that on a dedicated controller! So — you want to be the boss? Call National Instruments. 800/531-4742.

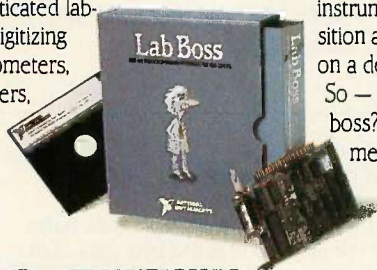

**NATIONAL  
INSTRUMENTS**

12109 Technology Blvd.  
Austin, TX 78727 512/250-9119

imal) since ProDOS reserves only a few bytes toward the end of this memory page for its own purposes.

You must allocate a 512-byte block in memory for block transfers. A program can make use of the buffer that is assigned for ProDOS activities. This buffer is pointed to by the contents of page zero locations 115/116 and is usually found at 38400 (9600 hexadecimal).

### THE SORTING TECHNIQUE

The task of sorting a single directory involves three main steps. First, directory blocks are read into memory from the disk and the active directory entries are placed in an array. Next, the array is sorted by an algorithm such as the bubble sort algorithm. Finally, the sorted array of directory entries is written back in blocks to the original directory locations on the disk.

You have to modify this technique in order to sort a disk with a hierarchical directory structure. You must have a data structure such as a stack to keep track of subdirectory entries as they are encountered in the sorting process.

Each time a subdirectory entry is encountered, information about the subdirectory is saved on the stack. This information includes the key block location of this subdirectory as well as the path name of its parent directory. After sorting a directory, the program pops the next directory to be sorted, if one exists, from the stack. The information removed from the stack will be sufficient to repeat the three-step sorting process on this current directory. The entire sorting process ends when no directories are left on the stack.

### THE BUBBLE SORT ALGORITHM

Although there are more efficient array-sorting techniques, the bubble sort method is one of the easiest to program. The bubble sort is so named because it causes elements to "bubble" upward in the list being sorted. The routine moves through a list, comparing adjacent pairs of elements one at a time. If it finds an element that is greater than its higher-

*(continued)*



# Build your own programming powerhouse

## With the Power System™ from Pecan, you can now create the ideal environment for your programming needs.

Whether you're an experienced programmer or an enthusiastic newcomer, the right program development environment is essential to creating software that effectively delivers the capabilities you need. The optimum development environment includes your choice of language compilers, an integrated system of basic programming capabilities, and a specially selected group of utilities which fulfill your own unique requirements.

## Start with a full-featured development environment

With the Power System from Pecan, you start with one of four compilers: Choose Pecan's powerful and highly versatile UCSD Pascal® or build your system on our BASIC, FORTRAN-77 or Modula-2 compilers. (Additional language compilers are on the way.) With your Pecan compiler, you get a total program development environment which delivers a full range of integrated development capabilities, including:

- Sophisticated text editor
- Versatile print utility
- Easy-to-use file management system
- Program library manager
- Special program execution utilities
- Turtlegraphics

With other program development systems, you'd have to purchase



some or all of these capabilities separately. With the Power System from Pecan, they're standard equipment.

## Add the specialized capabilities you want

Developing specialized software calls for the right tools. Pecan offers a wide selection of optional program development aids to help you write programs that work just the way you want. These tools include:

- Program debugger
- Keyed file access (KSAM)
- Automatic print spooler
- Assemblers and cross assemblers
- Speed and space optimizer

These and Pecan's many other development aids

## Run programs on virtually any mini or micro

The programs you develop through the Power System are completely portable. This means that a program you write on one computer can actually be run on another—even if the second computer is not compatible with the first. No other program development environment gives you this kind of flexibility.

## Total programming power at a price you can afford

Build your ideal programming powerhouse today. For the incredibly low introductory price of only \$79.95, you get the complete Power System with its important program development capabilities, including the compiler of your choice. You can add a second Pecan compiler for just \$59.95, or select two additional compilers for only \$99.95. Once you have the Power System, you can then customize it as your programming requirements demand—with Pecan's powerful development aids.

Order the unique Power System—available exclusively from Pecan—by mail today. Or call us at 1-800-63-PECAN. You won't find a better price/performance value anywhere. And you'll never build a better program development environment—no matter what price you pay.

enable you to build your own "customized" Power System, a system which is ideally suited to your individual programming needs.

## Create multi-language programs

Some languages are better for certain kinds of programming than others. For this reason, the Power System lets you write part of any given program in UCSD Pascal, additional parts in BASIC, FORTRAN-77 and Modula-2. All you need is a Pecan compiler for each language you want to use. Once you've written your program, it can then be executed exactly as if you'd written it all in one language. Only the Power System from Pecan offers you this capability.

# PECAN™

The UCSD Pascal Company  
Pecan Software Systems, Inc.  
1410 39th Street, Brooklyn, NY 11218  
718-851-3100

# THE POWER SYSTEM

The Power System from Pecan \$79.95 (for PC-DOS, MS-DOS, AMIGA, APPLE, ATARI ST, MACINTOSH, RAINBOW, TANDY, as well as most popular 8/16/32-bit systems).  
Price includes 8087 support and BCD on PC/compatible.

Please send me \_\_\_\_\_ copies of the Power System for my \_\_\_\_\_ (Operating System) \_\_\_\_\_ which runs under \_\_\_\_\_ (Name and model of computer)

Include Pecan's UCSD Pascal®  BASIC  FORTRAN-77  Modula-2 (Available Summer 1988)  compiler.

(First compiler of your choice, included with your order. For a second compiler, add \$59.95; for two additional compilers, add \$99.95.)  
My disk size is 3 1/2" \_\_\_\_\_ 5 1/4" \_\_\_\_\_ 8" \_\_\_\_\_  
Total amount (NYS add appropriate tax) \_\_\_\_\_ Bank Draft \_\_\_\_\_  
Payment by \_\_\_\_\_ VISA \_\_\_\_\_ MC \_\_\_\_\_ US Bank Check \_\_\_\_\_

Card Number: \_\_\_\_\_ Credit Card Expiration Date: \_\_\_\_\_

Mail to: Pecan Software Systems, Inc.  
1410 39th Street  
Brooklyn, NY 11218  
ITT Telex No. 494 8910  
CompuServe Code 76703, 500

Name \_\_\_\_\_ Zip \_\_\_\_\_  
Shipping Address \_\_\_\_\_ State \_\_\_\_\_  
City \_\_\_\_\_ Telephone \_\_\_\_\_

Call or write for UNIX, VAX or other Power System versions—and ask about our other powerful programming development aids.  
SCHOOLS: Contact us for special educational discounts.  
To place an order, call toll-free, or enclose your check with this coupon. Please add \$2.50 per copy of the Power System within the U.S. Foreign orders add \$10, and make payment by bank draft payable in US dollars on US bank. New York State residents add appropriate sales tax.

UCSD Pascal  
Not copy protected  
60-day money-back guarantee

CREDIT CARD ORDERS  
CALL TOLL-FREE  
1-800-63-PECAN  
(NYS) 1-800-45-PECAN

AMIGA is a trademark of Commodore Electronics LTD

APPLE & MACINTOSH are trademarks of Apple Computer Corp

ATARI ST is a trademark of Atari Corporation.

RAINBOW is a trademark of Digital Equipment Corporation

TANDY is a trademark of Radio Shack

UCSD Pascal is a registered trademark of The Regents of University of California



Listing 1: The ProDOS Catalog Sort Routine.

```

10 REM          PRODOS CATALOG SORT ROUTINE
20 REM          ANTONIO C. SILVESTRI
30 REM          SYSTEMS CONSULTANTS INC.

40 CLEAR: TEXT: HOME: DB = PEEK(115) + 256*PEEK(116)
50 FOR I=768 TO 792: READ H: POKE I,H: NEXT
60 DIM DIM NA$(55), ST$(30), ST$(30), DL(10): N = 0:
  V = 2: V$ = "": GOSUB 460

70 VTAB 2: HTAB 6: PRINT "PRODOS FILENAME SORT UTILITY":
  VTAB 9: HTAB 10: PRINT "INSERT DISK IN ";:
  FLASH: PRINT "DRIVE 1";: NORMAL: PRINT:
  HTAB 9: PRINT "HIT ANY KEY TO CONTINUE"
80 POKE - 16368,0: WAIT - 16384,128: POKE - 16368,0

90 HOME: PRINT "SEARCHING FOR VALID FILENAMES": PRINT
100 IF N <= 0 THEN 450
110 GOSUB 480: BL = V: HE = V: HE$ = V$: CO = 0: BC = 0
120 POKE 791,BL - 256*INT(BL/256): POKE 792,INT(BL/256):
  POKE 776,128: CALL 768: IF PEEK(786) <> 0 THEN
  PRINT "ERROR IN READING BLOCK NO. "; BL: STOP
130 BC = BC + 1: DL(BC) = BL
140 FOR J=0 TO 12: IF J <> 0 THEN 180
150 IF BL=HE THEN DR$ = "":
  FOR I=0 TO 38: DR$=DR$ + CHR$(PEEK(DB + 4 + I)): NEXT:
  HE$ = HE$ + "/" + MID$(DR$,2,PEEK(DB+4)-16*
  INT(PEEK(DB+4)/16)): PRINT "READING DIRECTORY: "; HE$
160 PRINT "BLOCK NO. "; BL: READ"
170 IF BL = HE THEN 210
180 IF PEEK(DB + 4 + J * 39)=0 THEN PRINT "D";: GOTO 210
190 PRINT ". ";: CO = CO + 1: NA$(CO) = "":
  FOR I=0 TO 38:
  NA$(CO)=NA$(CO)+CHR$(PEEK(DB+4+J*39+I)): NEXT
200 IF ASC(MID$(NA$(CO),17,1))=15 THEN
  V = ASC(MID$(NA$(CO),18,1)) +
  256*ASC(MID$(NA$(CO),19,1)): V$ = HE$: GOSUB 460
210 NEXT J: PRINT: X = FRE (0):
  BL=PEEK(DB+2) + 256*PEEK(DB+3): IF BL <> 0 THEN 120

220 IF CO=0 THEN HOME: VTAB 10: FLASH:
  PRINT "***WARNING**"; CHR$(7):: NORMAL:
  PRINT "NO FILENAMES CAN BE FOUND": GOTO 290
230 IF CO=1 THEN 290
240 HOME:VTAB 10:PRINT CO;" FILENAMES FOUND";: HTAB 29:
  PRINT "NOW ";: FLASH: PRINT "SORTING": NORMAL:
  NX = CO
250 VTAB 17: HTAB 8: PRINT "FILENAMES HAVE BEEN PLACED"
260 VTAB 17: HTAB 7 - LEN(STR$(CO - NX)): PRINT CO - NX
270 FLAG = 0: FOR I = 2 TO NX:
  IF MID$(NA$(I),2,15) < MID$(NA$(I-1),2,15) THEN
  H$ = NA$(I): NA$(I) = NA$(I-1): NA$(I - 1) = H$:
  FLAG = 1
280 NEXT: X = FRE(0): NX = NX - 1:
  IF FLAG = 1 AND NX <> 1 THEN 260

290 HOME: PRINT "STORING PURGED AND SORTED DIRECTORY":
  PRINT
300 A = 1: B = 0: FOR J = 1 TO BC
310 PRINT "NOW FORMING BLOCK NO. "; DL(J)
320 IF J = 1 THEN AX = 0: GOTO 340
330 AX = DL(J - 1)
340 IF J = BC THEN BX = 0: GOTO 360
350 BX = DL(J + 1)
360 POKE DB,AX-256*INT(AX/256): POKE DB+1, INT(AX/256):
  POKE DB+2,BX-256*INT(BX/256):
  POKE DB+3, INT(BX/256): POKE DB+511,0

```

(continued)

positioned neighbor, it exchanges these elements. The algorithm compares the next two elements and exchanges them if required. This process of comparing and exchanging positions continues throughout the entire list.

If any exchanges are made, the list is processed again. However, not all the elements need to be included in subsequent passes. Since each pass assures that the largest-valued element has been moved to the end of the list, time need not be wasted on checking these elements. When no exchanges are made in a pass through the list, it is sorted.

### THE BASIC PROGRAM LISTING

The program is given in listing 1. [Editor's note: The ProDOS Catalog Sort Routine and a short test routine are available for downloading from BYTEnet Listings at (617) 861-9764 and are also obtainable on disk; see page 445 for details.] Lines 40 through 60 perform program-initialization tasks, which include setting the variable DB equal to the address of the I/O data buffer and poking the MLI interface routine into memory. Line 60 defines some important arrays such as NA\$, which is used to store directory entries.

Line 60 also defines and initializes a stack that is implemented using the stack pointer variable N and arrays ST and ST\$. Array ST holds the block numbers of subdirectory key blocks, while ST\$ stores the path names of a subdirectory's parent directory. The GOSUB 460 instruction pushes values on the stack and starts the sorting process with the volume directory. Lines 70 and 80 give you the opportunity to remove the program disk and insert in drive 1 the disk to be sorted. The program issues a prompt and waits for a key press before continuing.

Line 100 checks the status of the stack: If it is empty, execution halts; if not, line 110 executes the GOSUB 480 instruction to pop the stack. Line 120 reads the retrieved directory block into the data buffer, and lines 130 through 200 extract directory entries from the buffer and store them in array NA\$. Notice that line 200 ex-

(continued)



# Now! Tek quality and expert advice are just a free phone call away!

**The industry standard in CRT performance.** Crisp, easy-to-read, bright CRT; 14kV accelerating potential, provides high writing rate and small spot size. Full size 8x10 cm display for measurement accuracy.

**Display controls are flexible and easy to use.** Separate intensity controls reduce blooming in alternate sweep mode. Focus tracking minimizes control adjustment and BEAM FIND eliminates confusion.

**Vertical system provides measurement assurance.** Flat transient response and high accuracy ensures true reproduction of your signals. Fast risetime and high bandwidth is well suited for a variety of measurement.

**Perform delayed sweep measurements accurately and easily.** Both sweeps can be displayed alternately making differential measurements easy and accurate (1%). An interlocking SEC/DIV control simplifies set-up.

**Stable hands-off triggering.** P-P AUTO detects signal peaks, then sets the trigger level for you. Display asynchronous signals using VERT MODE triggering. Independent TV field and line selection.

**Front panel laid out by function for ease of use.** Color coding aids the user in operation. Functions and modes are placed logically. All nomenclature is clearly labeled, and protected behind a scratchless Lexan surface.

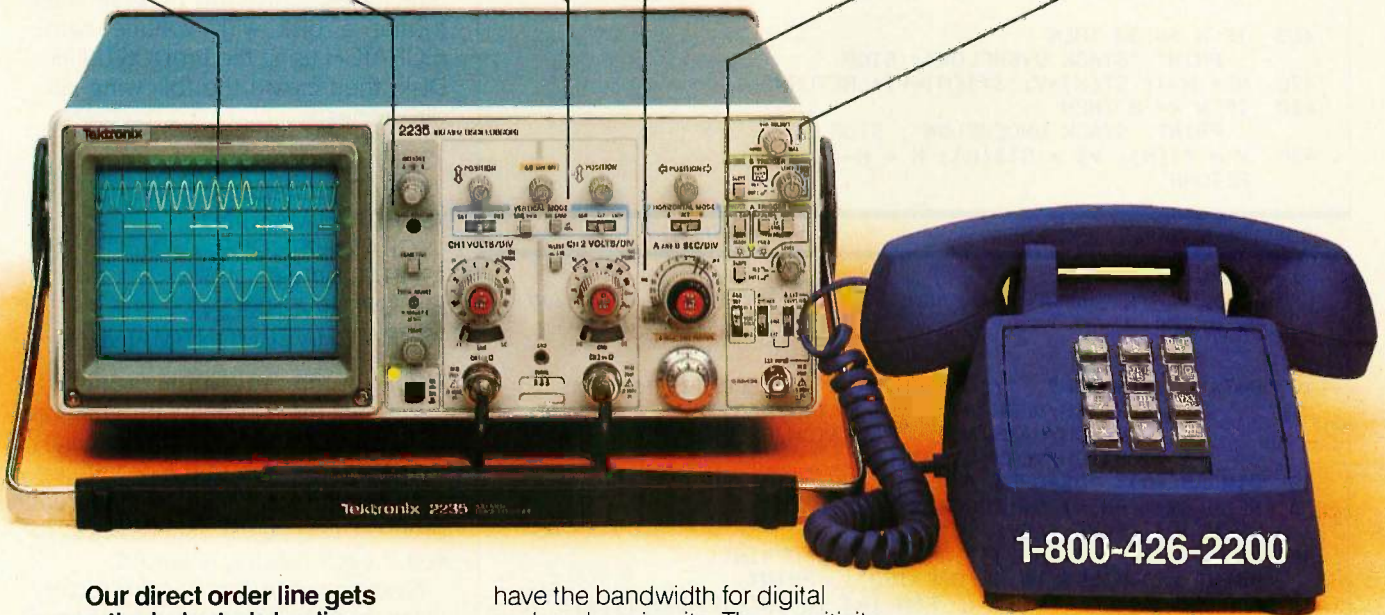

**1-800-426-2200**

**Our direct order line gets you the industry's leading price/performance portables... and fast answers from experts!**

The 60 MHz single time base delay 2213A, the 60 MHz dual time base 2215A and the 100 MHz dual time base 2235 offer unprecedented reliability and affordability, plus the industry's first 3-year warranty\* on labor and parts, CRT included.

**The cost: just \$1275 for the 2213A, \$1525 for the 2215A, \$1750 for the 2235.**† Even at these low prices, there's no scrimping on performance. You

have the bandwidth for digital and analog circuits. The sensitivity for low signal measurements. The sweep speeds for fast logic families. And delayed sweep for fast, accurate timing measurements. All scopes are UL Listed and CSA approved.

**You can order, or obtain literature, through the Tek National Marketing Center.** Technical personnel, expert in scope applications, will answer your questions and expedite delivery. Direct orders include comprehensive 3-year warranty\*, operator's

manual, two 10X probes, 15-day return policy and worldwide service backup.

**Order toll free: 1-800-426-2200, Ask for Rick.**

In Oregon, call collect: (503) 627-9000. Or write Tektronix, Inc. P.O. Box 1700 Beaverton, OR 97075

**Tektronix®**  
COMMITTED TO EXCELLENCE



```

370 IF J = 1 THEN
FOR K=1 TO 39: POKE DB+3+B*39+K,ASC(MID$(DR$,K,1)):
NEXT: PRINT ". ";:B = B + 1
380 IF A <= CO THEN
FOR K=1 TO 39:
POKE DB+3+B*39+K,ASC(MID$(NA$(A),K,1)): NEXT:
PRINT ". ";: GOTO 400
390 FOR K=1 TO 39: POKE DB+3+B*39+K,0: NEXT: PRINT "Z";
400 A = A+1: B = B+1: IF B < 13 THEN 380
410 PRINT: PRINT: B = 0:
POKE 791,DL(J)-256*INT(DL(J)/256):
POKE 792, INT(DL(J)/256): POKE 776,129: CALL 768
420 IF PEEK(786) <> 0 THEN
PRINT "ERROR IN WRITING BLOCK NO. ";DL(J): STOP
430 NEXT J: GOTO 90
440 DATA 169, 0, 141, 18, 3, 32, 0, 191, 0, 19, 3, 176,
1, 96, 238, 18, 3, 96, 0, 3, 96, 0, 150, 0, 0
450 END

460 IF N >= 30 THEN
PRINT "STACK OVERFLOW": STOP
470 N = N+1: ST(N)=V: ST$(N)=V$: RETURN
480 IF N <= 0 THEN
PRINT "STACK UNDERFLOW": STOP
490 V = ST(N): V$ = ST$(N): N = N-1:
RETURN
    
```

Listing 2: This program creates a scratch disk that you can use to test the sort program of listing 1.

```

10 DATA "/SCRATCH", "/SCRATCH/MASS", "/SCRATCH/RHODE",
"/SCRATCH/VERMONT", "/SCRATCH/MASS/NY",
"/SCRATCH/MASS/NJ", "/SCRATCH/RHODE/PA",
"/SCRATCH/VERMONT/MAINE"
20 DIM A$(40): D$=CHR$(4): ONERR GOTO 100
30 READ H$: PRINT D$;"PREFIX ";H$:
PRINT D$;"SAVE TESTFILE"
40 J=0: L=INT(40*RND(1))+1: PRINT: PRINT:
PRINT L;" FILES TO BE CREATED": PRINT
50 FOR K=1 TO L: TY$="": FOR I=1 TO INT(10*RND(1))+1:
TY$=TY$+CHR$(65+26*RND(1)): NEXT: X=FRE(0)
60 PRINT K;" ";H$+"/"+TY$: PRINT D$;"OPEN "+TY$:
PRINT D$;"CLOSE "+TY$: IF RND(1) < .30 THEN J=J+1:
A$(J)=TY$
70 NEXT K
80 PRINT J;" FILES TO DELETE": IF J=0 THEN 30
90 FOR I=1 TO J: PRINT D$;"DELETE "+A$(I):
PRINT I;" ";H$+"/"+A$(I): NEXT: GOTO 30
100 END
    
```

explicitly checks each entry to see if it is a subdirectory. If it is, the program pushes that subdirectory's information onto the stack.

After the program processes each directory block, line 210 checks to see if that block is the last block of the current directory. If not, execution loops back to line 120 to read and process the next block; otherwise execution continues with line 220.

When program execution reaches

line 220, variable CO contains the number of directory entries stored in NA\$, DR\$ contains the directory header, BC contains the number of blocks in the directory, and array DL contains the actual block numbers that form the directory.

Lines 220 through 280 perform the bubble sort of array NA\$. Lines 290 through 430 write the sorted array back to the disk. After the program has written the directory to the disk,

the entire procedure is repeated by a jump to line 90.

### TESTING THE UTILITY

Because you are dealing with a program that directly accesses disk blocks, you should take care to verify that the copy you have acquired (either by typing or downloading) works properly. One small error can destroy a disk containing weeks of hard work. Listing 2 gives a small program you can use to test the utility.

This program creates a dummy disk with a random number of active and inactive entries stored in different subdirectories. To use this program, first format a disk with volume name /SCRATCH using the ProDOS Utilities Disk, then create the following subdirectories:

```

/SCRATCH/MASS
/SCRATCH/MASS/NY
/SCRATCH/MASS/NJ
/SCRATCH/RHODE
/SCRATCH/RHODE/PA
/SCRATCH/VERMONT
/SCRATCH/VERMONT/MAINE
    
```

Then run the program in listing 1.

Now run the sort utility program on this disk. This will give you a chance to get accustomed to the prompting. If the utility runs with no apparent problem, catalog each subdirectory to see if each catalog is sorted.

Next, go into each subdirectory using the PREFIX command and type LOAD TESTFILE. TESTFILE is the BASIC program that created the dummy disk and is stored in each subdirectory. If you can successfully load TESTFILE from each subdirectory without I/O errors, go through the following final test, which checks if data can be stored on the disk. Try to store a dummy program in each subdirectory, then reload the stored programs and verify that they are uncorrupted. If you can successfully store programs on the disk, this proves that all data pointers on the disk are intact and that the utility works reliably. ■

### BIBLIOGRAPHY

Little, Gary B. *Inside the Apple IIe*, Bowie, MD: Brady Communications, 1985.  
 ProDOS *Technical Reference Manual*, Apple Computer Inc., 1983.



**SO YOU THINK  
YOU KNOW ALL  
THE REASONS  
TO DUMP  
YOUR OLD  
PRINTER?**



# WELL, HERE'S ONE MORE REASON.

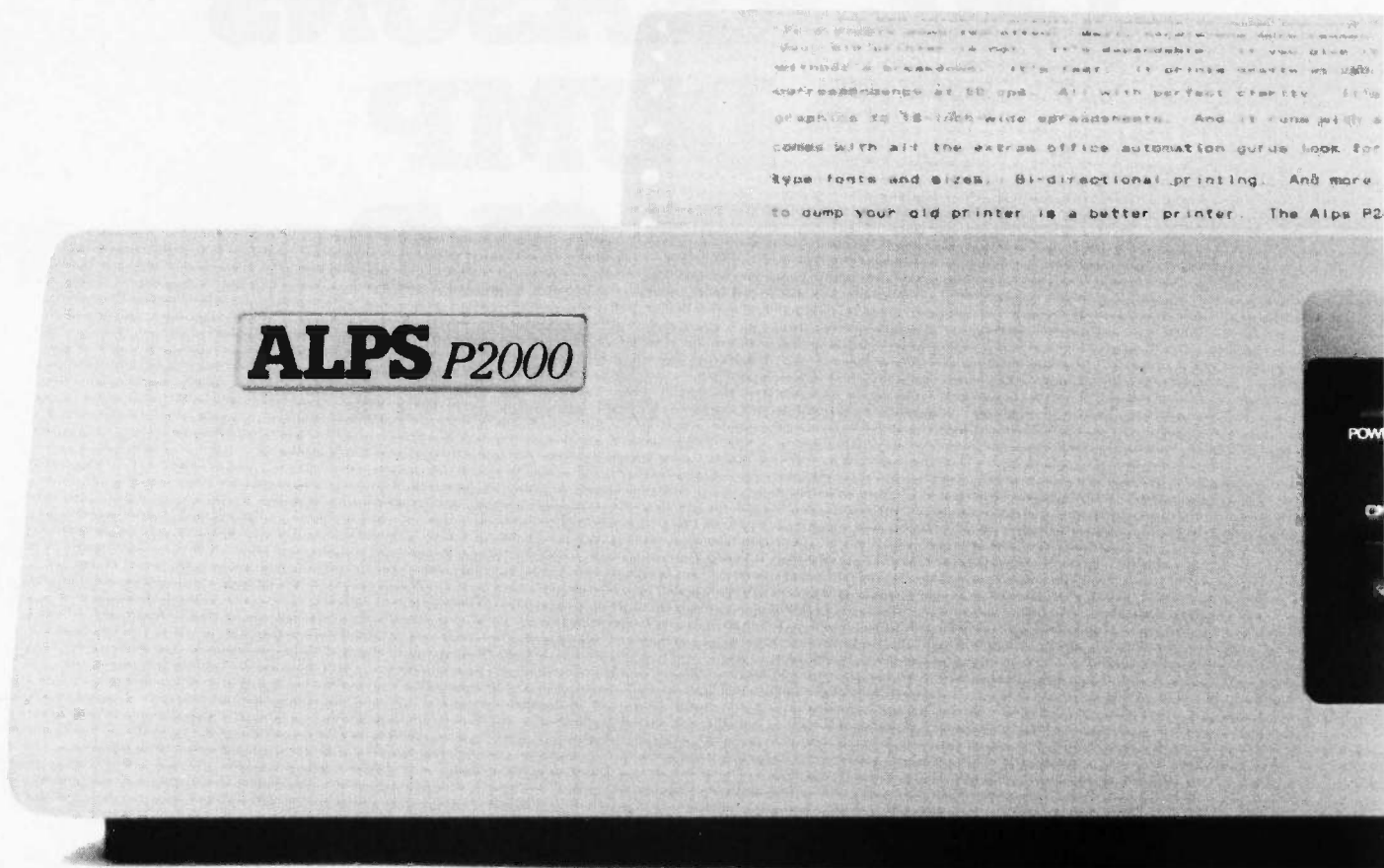

You can think of plenty of reasons to dump your old printer.

It's too slow. Too finicky. Too limited. Or it's simply down too often.

Well, here's one more reason.

The new Alps P2000 Dot Matrix Printer. It's everything your old printer's not.

It's dependable. If you give it reasonable care, it'll give you five or more years without a breakdown.

It's fast. It prints drafts at 250 cps. Memos at 125 cps. And near letter quality correspondence at 50 cps. All with perfect clarity.

It's versatile. It prints everything



AND HERE'S  
THE BIGGEST  
REASON.

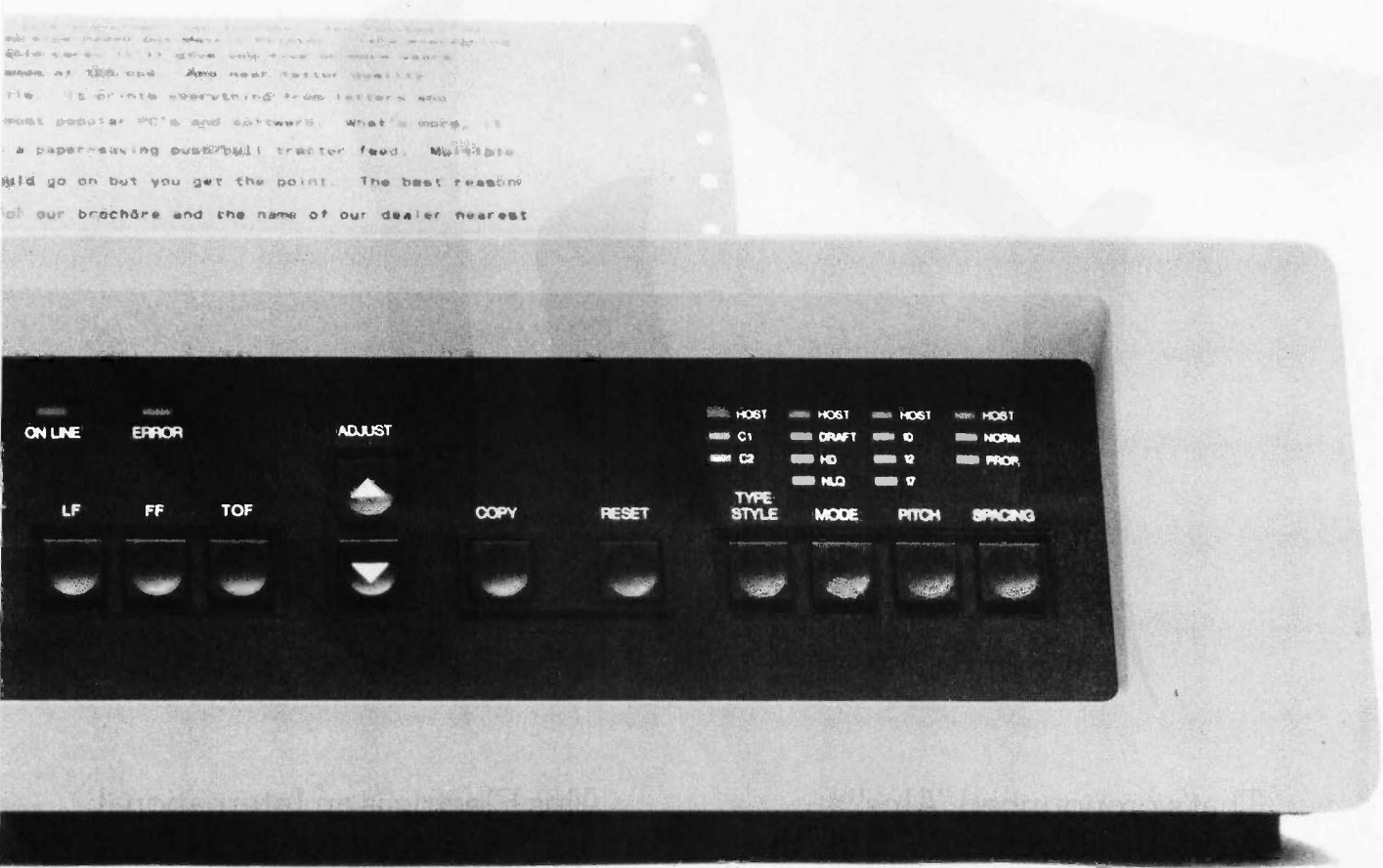

from letters and graphics to 16-inch wide spreadsheets. And it runs with all the most popular PCs and software.

What's more, it comes with all the extras office automation gurus look for. Like a paper-saving push/pull tractor feed. Multiple type fonts and sizes. Bi-directional printing. And more.

We could go on. But you get the point. The best reason to dump your old printer is a better printer.

Especially one from a better printer company.

The P2000.  
From Alps.

**ALPS**  
AMERICA



# AND HERE'S THE BIGGEST REASON.

ALPS

That's pronounced "Alps."

As in Alps Electric Co., Ltd., the Japanese company that manufactures the new Alps P2000™ Dot Matrix Printer. Which happens to be the perfect PC printer for companies who've outgrown their old ones.

Fine. But who's Alps Electric? And what difference does it make?

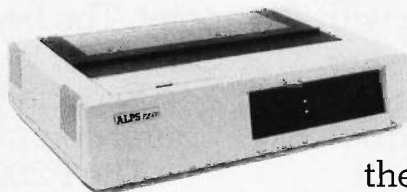

Alps Electric is an International Fortune 500 company. A \$1.5 billion manufacturer of computer and electronic products.

A company that has been making computer printers for a decade and selling them in countries throughout the world. Including this country (under the brand names of major computer manufacturers).





What's more, Alps Electric is the parent company of Alps America, the company that sells, services and supports Alps printers in America.

And the difference all that makes is this.

Whether you're buying one printer or a thousand, you really ought to buy them from a solid, experienced company you can depend on.

Which is exactly what we are.

Alps. Now that you know how to say it, perhaps you'd like to dial it. **(800) 828-ALPS**. In California, call (800) 257-7872.

Better yet, send us the attached coupon for a free Alps P2000 demonstration.

One given in plain English.

**ALPS**  
AMERICA



# CAD — \$299 !

Finally you can get a complete CAD package at a reasonable price! For only \$299, ProDesign II provides the advanced features you get on CAD systems costing thousands of dollars. But there is another, very important reason you should get ProDesign II. ProDesign II is very unique among CAD packages. It is easy to learn and use. When we call ProDesign II "The Easy to Use CAD System", we're not joking. You will be productive with ProDesign II in an hour or two instead of a week or two.

What else does ProDesign II offer? Compatibility. Compatibility with over 100 printers. Compatibility with over 50 plotters. Compatibility with most graphics adapters, digitizing tablets, and mice. Compatibility with most display adapters. Compatibility with any software that can produce HP plotter commands. Compatibility with mainframe CAD systems (IGES). All at no extra charge!

What additional hardware do you need? None! An IBM PC compatible and 512K RAM is all you

need. ProDesign II produces high resolution drawings on your dot matrix printer — better than .005" resolution on an IBM/Epson compatible printer. In fact, the drawings on this page were printed on a \$299 dot matrix printer! You don't have to get a mouse or digitizing tablet. ProDesign II is designed for easy and efficient keyboard use. You won't even need a math coprocessor, although it is supported. From a small drawing on a dot matrix printer to an E-Size drawing on a large plotter, ProDesign II is the one to use!

**ProDesign II**  
Affordable, Compatible, and Usable!

Where can you get ProDesign II?  
See your local computer dealer, or contact:

**American Small Business Computers**

118 South Mill  
Pryor, OK 74361  
(918) 825-4844

Inquiry 23

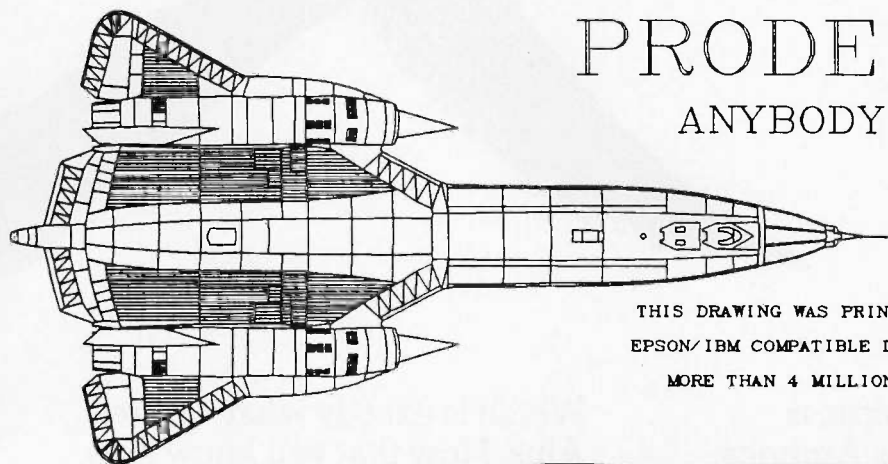

## PRODESIGN II

ANYBODY CAN DO IT!

THIS DRAWING WAS PRINTED ON AN ORDINARY  
EPSON/IBM COMPATIBLE DOT MATRIX PRINTER.

MORE THAN 4 MILLION DOTS PER PAGE!

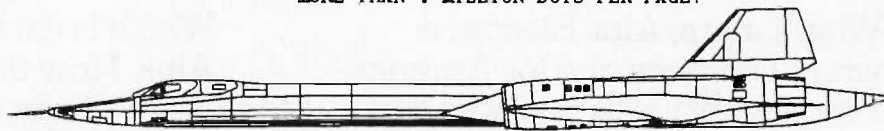

DRAWN USING PRODESIGN II  
THE EASY TO USE CAD SYSTEM  
ONLY \$299!

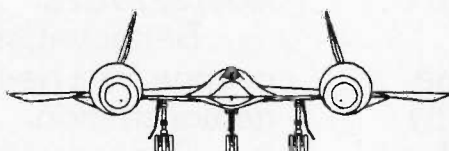

## SR-71 BLACKBIRD

WORLD'S FASTEST JET - 3500+ MILES PER HOUR



# DECODING MACPAINT ON THE IBM PC

*Transfer graphics  
created on the  
Macintosh and  
manipulate them  
on your PC*



**Y**ou would be hard pressed to find two more dissimilar systems than the IBM PC and the Apple Macintosh—especially when it comes to graphics. And that can be a problem in an office where both systems are used. With a little effort, however, you can bring them closer together.

I've written a Pascal program for the IBM PC called MacView that decodes and displays MacPaint images on your PC display. [Editor's note: MacView, which was written in Turbo Pascal, is available for downloading from BYTEnet Listings at (617) 861-9764. It is also available on disk; see page 445.] Moreover, this software provides the foundation to a bridge between Macintosh and PC graphics; once Macintosh graphics are translated for the PC, it is relatively easy to write additional program code to manipulate the images.

First, of course, you must get the MacPaint file from the Mac to the PC. For the Mac, you can use a communications package such as MacLink or MacTerminal. For the PC, nearly any of the common asynchronous PC communication packages will do. As for connecting the Mac to the PC, you could use a dial-up modem link, but a direct cable between the two machines is best. Figure 1 is a cable schematic for a direct hookup.

Once you have completed the transfer, the MacPaint file can be decoded.

(continued)

Mark Anacker (4920 200 Southwest A204, Lynnwood, WA 98036) studied computer science at Seattle Pacific University.



## DECODING MACPAINT

Each image occupies 720 horizontal scan lines of 72 bytes each, for a total of 51,840 bytes. Each byte represents 8 horizontal points on the screen, with the highest bit to the left (see figure 2). A 1 bit indicates a dark pixel, and a 0 indicates a white one.

To save disk space, however, MacPaint stores its images in a compressed bit-map format—reducing the image data to only about 10K bytes. (The subsequent decoding, which requires a great deal of processor power, is the reason the Mac takes so long to bring an image up on the screen.) The bytes in each scan line are encoded into two types of

records: mixed-data and repeating-data (see figure 3).

A mixed-data record consists of a byte indicating the record length (from 1 to 72 bytes) and the raw data. This type of record is used when each byte in a scan line is different from its neighbor. Such a record actually takes up one more byte than the original scan-line data.

Repeating-data records are more efficient. Most images consist of repeated bit patterns, which can be represented easily with just a byte that indicates the number of bytes to repeat, followed by the actual bit pattern. This method allows you to com-

press as many as 127 bytes into as few as 2 bytes. And you can store a single scan line using a combination of mixed-data and repeating-data records. The eighth bit in the first byte of the record, the counter byte, distinguishes the record type; specifically, that bit is set to indicate a repeating record.

In addition to image data, the first 512 bytes of a MacPaint file contain some header information and the bit maps of the paint patterns that are displayed along the bottom of the MacPaint screen. For our purposes, that information is not necessary, and MacView begins reading the MacPaint file at the 513th byte.

As MacView reads the MacPaint file one byte at a time, it decodes the mixed-data and repeating-data record types. Since the Mac has a black-on-white display, the program must flip the bits with a NOT operator to make the image appear the same on a PC. The program then puts the resulting bits in a buffer that can be accessed via an array of pointers.

Once the image is in the buffer, the program displays part of it on the screen. I chose to write the image

*(continued)*

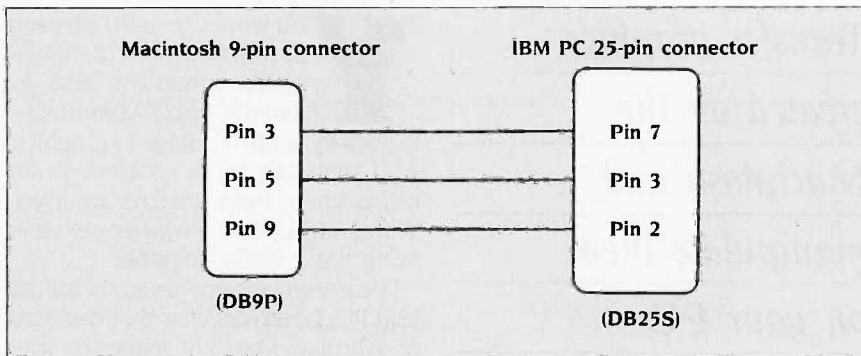

Figure 1: Schematic for direct cable hookup.

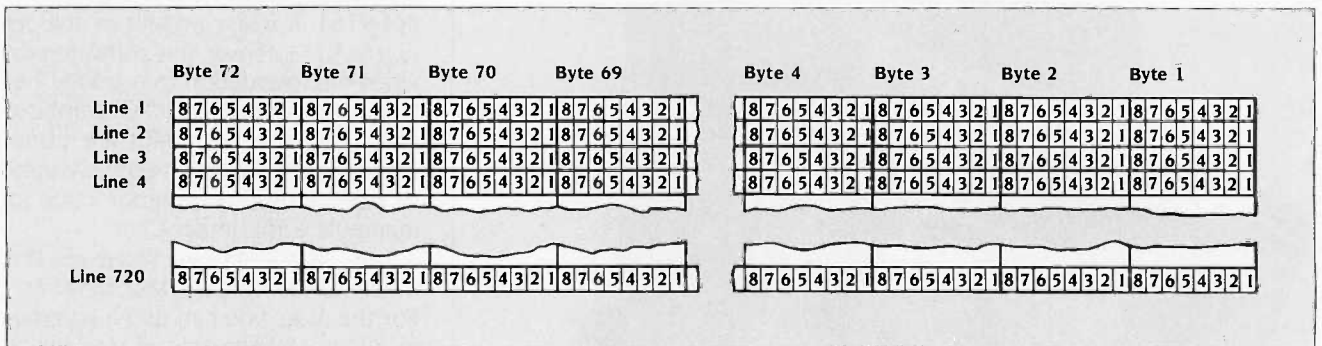

Figure 2: The bit-mapped layout of a MacPaint image contains 51,840 bytes.

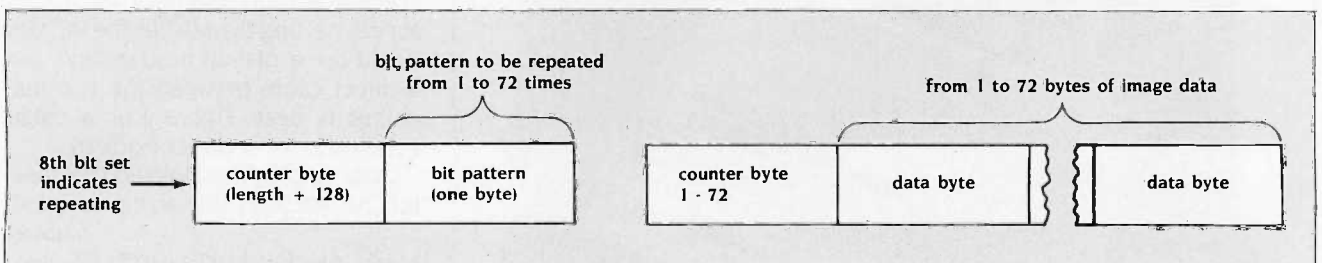

Figure 3: Left, repeating-data record; right, mixed-data record.



Turbo Pascal® Source Code Included

# Borland's new Turbo Editor Toolbox, "Best of the Year" award winner, lets you build your own word processor for only \$69.95!

**T**urbo Editor Toolbox™ lets you build the best of all word processors into your own word processor. All the modules, techniques, instructions, and Turbo Pascal source code are at your fingertips. You'll quickly learn how to integrate editor procedures and functions into your programs, or you can use Turbo Editor Toolbox "as is," because it has everything.

### You get Turbo Pascal source code and everything you need to build your own word processor

The modules, the manual, ready-to-compile source code, and a full-featured word processor called MicroStar™, which we probably ought to sell separately because it's an excellent text editor. But anyway, you get it free as part of our new Turbo Editor Toolbox. (Maybe this is why Jerry Pournelle of BYTE magazine recently wrote that "Borland International is a public benefactor. The company continues to pour out good, well-documented products at reasonable prices.") Your free MicroStar includes a complete pull-down menu user interface which you can use "as is," or you can modify it for inclusion in your Turbo Pascal programs.

As well as MicroStar, you also get a complete editor ready to include in your programs. Windows, block commands, and memory-mapped screen routines come with it.



### How to turn good stuff into great stuff—maybe even green stuff!

With your new Turbo Editor Toolbox, you can make WordStar® behave like MultiMate™. You can support windows just like Microsoft's® Word. And do it as fast as WordPerfect® does it. In other words, you can do what they should have done. You just go in there, tinker, fiddle, fool around, and come up with your own version—which will be the best word processor you've never seen before. (And if you want to sell it, go for it; we're not the kind of company that'll send bean-counters and ambulance-chasers after you for royalties.)

### How to do windows without jamming your fingers back in your wallet

State-of-the-art "windowing" techniques are part of our new Turbo Editor's repertoire. Sophisticated but easy-to-learn techniques let you design your word processor to show several documents—or several parts of the same document—all at once.

Turbo Editor Toolbox lets you open the windows you want—wherever you want them—at a price that won't make you want to jump out of them.

### You get a lightning-fast editor, innumerable features, and a 60-day money-back guarantee\*\* for only \$69.95

For only \$69.95, you can build your own word processor and make it do whatever you want it to do. This already popular new program is just one more way that Borland helps you help yourself. So call us or the dealer nearest you. All the telephone numbers and ordering information are in the adjacent coupon.

### Standard Turbo Editor Toolbox features include:

- Wordwrap
- UNDO last change
- Auto-indent
- Find & Find/Replace with options
- Set left and right margins
- Block mark, move and copy
- Tab, insert and overstrike modes, centering, etc.
- Multiple windows
- Multitasking
- RAM-based editor
- Paging, scrolling and text display



*Vive la différence*

4585 SCOTTS VALLEY DRIVE  
SCOTTS VALLEY, CA 95066  
(408) 438-8400 TELEX: 172373

Borland products include Turbo Pascal; Turbo Prolog; Turbo Database Toolbox; Turbo Lightning; Turbo Graphix Toolbox; Turbo Tutor; Turbo GameWorks; Turbo Editor Toolbox; Word Wizard; Rellex; The Analyst; SideKick; SideKick; The Macintosh Office Manager; Traveling SideKick; and SuperKey—all of which are trademarks or registered trademarks of Borland International, Inc. or Borland/Analytica, Inc.

MicroStar is a trademark of Borland International, Inc. WordStar is a registered trademark of MicroPro International Corp. MultiMate is a trademark of MultiMate International Corp. Microsoft is a registered trademark of Microsoft Corp. WordPerfect is a registered trademark of Satellite Software International. Copyright 1986 Borland International BI-1055

Inquiry 395 for End-Users. Inquiry 396 for DEALERS ONLY.

“The new Turbo Editor Toolbox is the Turbo Pascal source code to just about anything you ever wanted a PC-compatible text editor to do, along with a really excellent book of instructions on what text editors are and how to use the Toolbox to build a custom text editor . . . you can't afford to be without this.”

Jerry Pournelle, BYTE Magazine, discussing Turbo Editor Toolbox, to which he gave his "Best Of The Year" Award”

# YES!

 I want the best

Rush me Turbo Editor Toolbox at:

## \$69.95

To order by phone,

or for a dealer near you,

**call (800) 255-8008**

in CA call (800) 742-1133

Send me \_\_\_\_\_ Turbo Editor Toolboxes at \$ \_\_\_\_\_

Outside USA add \$10 per copy

CA and MA res. add sales tax \$ \_\_\_\_\_

Amount enclosed \$ \_\_\_\_\_

Prices include shipping to all U.S. cities

Payment:  VISA  MC  Bank Draft  Check

Credit card expiration date \_\_\_\_/\_\_\_\_/\_\_\_\_

Card # \_\_\_\_\_

\*You must have an IBM or true compatible running DOS 2.0 or later.

My computer's name and model is: \_\_\_\_\_

The disk size I use is:  3 1/2"  5 1/4" TE15

**NOT COPY PROTECTED**  
**\*\*60-DAY MONEY-BACK GUARANTEE**

Name: \_\_\_\_\_

Shipping Address: \_\_\_\_\_

City: \_\_\_\_\_

State: \_\_\_\_\_ Zip: \_\_\_\_\_

Telephone: \_\_\_\_\_

CODs and purchase orders WILL NOT be accepted by Borland. Outside USA make payment by credit card or International Postal Money Order.

\*\*YES, if within 60 days of purchase this product does not perform in accordance with our claims, please call our customer service department and we will gladly arrange a refund.

†Minimum System Requirements: 192K  
Runs on IBM PC, XT, AT, PCjr... and true compatibles









# LOOK WHAT'S IN IT FOR YOU!

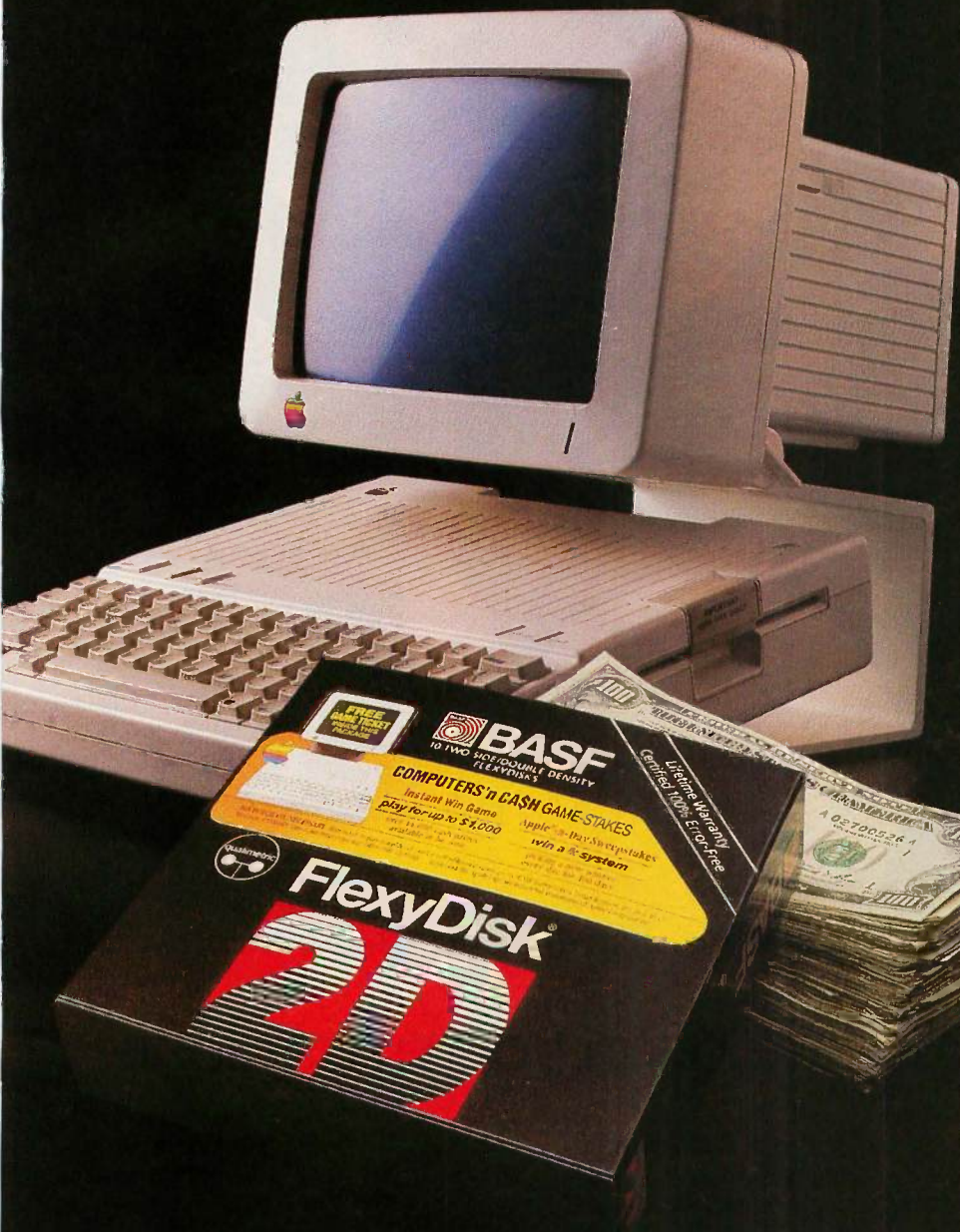

Now more than ever, there's more for you when you buy BASF Qualimetric™ FlexyDisks®. There's a special two-part game ticket that not only gives you 100 chances to win an Apple® IIc Computer in our Apple-a-Day Sweepstakes, but is also an exciting scratch-off game with 14,110 chances to instantly win cash prizes up to \$1,000. What else is in it for you? Only the best...the BASF FlexyDisk, certified 100% error-free and warranted forever. See your BASF dealer today and look for the specially-marked boxes of 5.25" and 3.5" BASF FlexyDisks.



## BASF

Inquiry 39

## DECODING MACPAINT

*The one thing MacView can't handle is the difference in aspect ratio between the PC and the Mac.*

directly to the graphics adapter memory for faster performance and easier scrolling. You can scroll the image using the cursor keys, shifting the section of the image currently displayed. In this way you can quickly view the entire picture. When you scroll up or down, however, the image moves two scan lines at a time, which is due to the way the graphics memory is organized. So that you know what part of the image you are viewing, the program displays the number of the top scan line in the upper right corner of the display.

The one thing my program can't handle is the difference in aspect ratio between the two systems. The pixels on the Mac screen are square, while the PC's are rectangular. This means that the images on the PC screen appear vertically stretched. Of course, you could compensate somewhat for the aspect ratio by skipping every other scan line when the image is displayed, but doing so causes a loss of detail. Some IBM PC compatibles—particularly those that use LCDs, which inherently use square pixels—may correct the aspect ratio problem.

I wrote the program in Pascal for speed, but you could translate it into BASIC or another language as well. But no matter what language you use, once you've made sense out of a MacPaint image on your IBM PC, you can begin to do things with it. I have written programs that enlarge and compress the images as well as print them on an IBM PC-compatible laser printer. I also use the large hard disk on my PC to archive the MacPaint images. There's really no limit to what you can create when you combine the graphics of the Macintosh and the IBM PC. ■



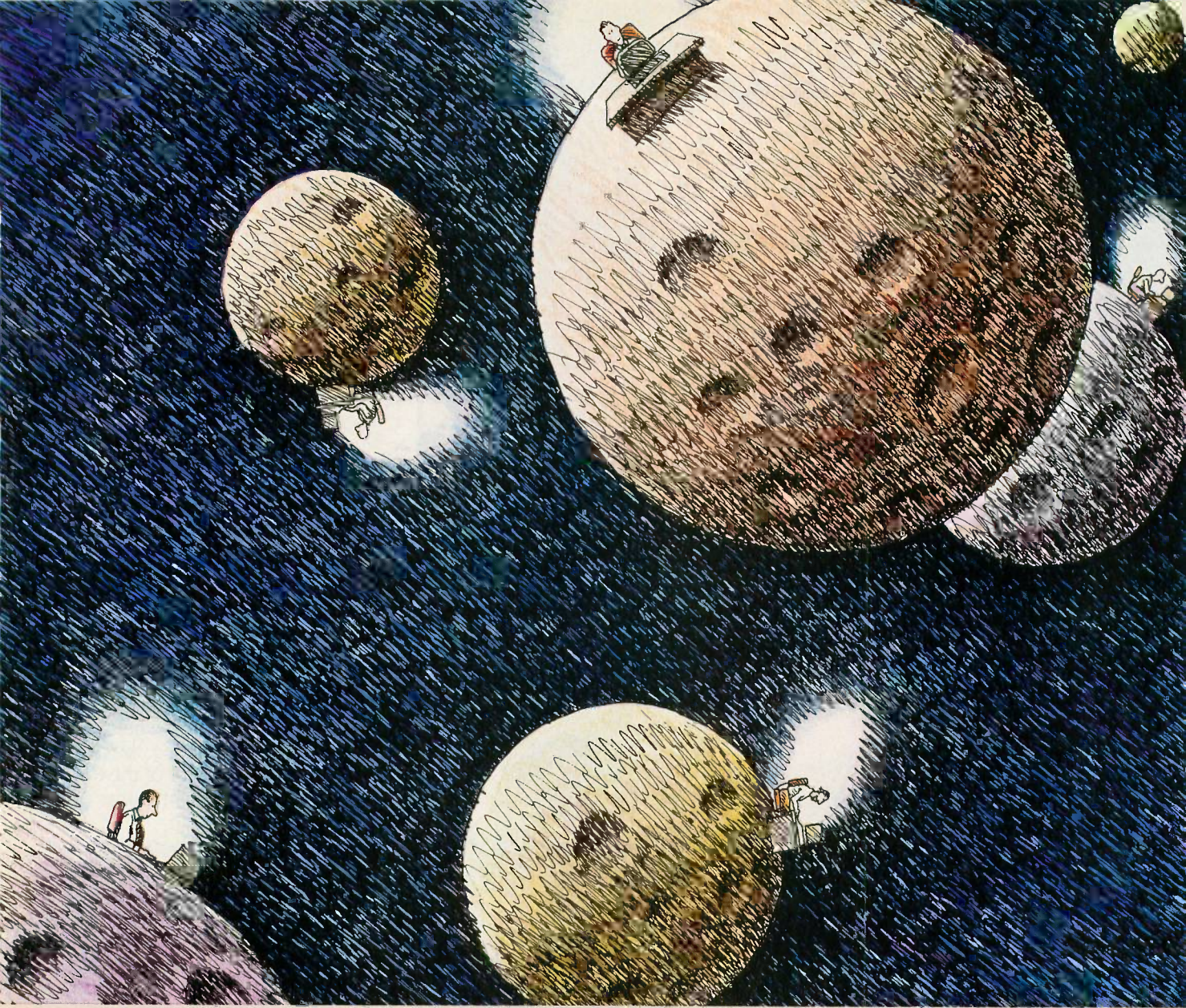

## With Network Revelation<sup>®</sup>, you're not alone.

Span the void that separates you from other PC's. Be as one with a universe of data. Be a true network with Network Revelation.<sup>®</sup>

Network Revelation is more than a relational database management system. It's a complete applications environment for most microcomputer networks. That's not dreaming about the future. It's low-key raving about a capability of the present.

With Network Revelation, you can send and receive data on local area networks and remote file servers. Rev's data dictionaries let you add or restruc-

ture fields at will, saving ages of programming time. And our menu-driven applications generator and procedural language are eons ahead of other databases.

The possibilities are infinite. Distributed processing systems linking worlds. Accounting, inventory and order entry systems connected for instant access to data by a galaxy of users. And your data is secure with complete file or record locking.

REVELATION co-exists with MS-DOS.<sup>™</sup> So you can transport Lotus 1-2-3,<sup>™</sup> Multiplan<sup>®</sup> or other data from

PC to PC—using IBM<sup>®</sup>'s new PC Network or any network hardware running Novell NetWare.<sup>™</sup> You can even evolve files from primitive, single-user databases into a powerful Rev application.

Encounter the future of distributed data processing today. Revelation costs just \$950\* And a four-user upgrade to Network Revelation is only \$495\* So call us and we'll arrange for an unforgettable demonstration with a Cosmos rep in your area.

MS<sup>™</sup> and Multiplan<sup>®</sup> of Microsoft Corporation.  
1-2-3<sup>™</sup> of Lotus Development Corporation.  
NetWare<sup>™</sup> of Novell, Inc. IBM<sup>®</sup> of International Business Machines.

\*Suggested U.S. list price.

# COSMOS<sup>™</sup>

Cosmos, Inc., 19530 Pacific Highway S.

Seattle, WA 98188, 206-824-9942



# HILBERT CURVES MADE SIMPLE

BY MICHAEL ACKERMAN

*This one-subroutine BASIC program uses  
only global variables*

IF YOU ARE INTERESTED in fractal shapes, you are probably familiar with the Hilbert curve. It was among the first of many wild but "self-similar" shapes that astonished mathematicians around the turn of the century.

Hobbyists have discovered the beauty of David Hilbert's creation, and several have written programs to draw it on the high-resolution screens of personal computers. Unfortunately, most of the programs that produce the curve are quite complicated. The demonstration program that comes with the Apple Pascal system contains a procedure that itself contains two more procedures. I had a difficult time following the program's logic.

Niklaus Wirth, author of the Pascal and Modula-2 programming languages, includes a Hilbert curve program in his book *Algorithms + Data Structures = Programs* (Prentice-Hall, 1976). While this program is easy to understand, it contains four procedures that call each other again and again. I decided that there had to be a simpler way to

*(continued)*

Michael Ackerman (1539 Van Dyke Rd., San Marino, CA 91108) is a senior majoring in history at the University of California at Santa Barbara.

Listing 1: A simple Applesoft BASIC program to generate Hilbert curves.

```

1 GOTO 1000
2 REM *****
3 REM * HILBERT BY MICHAEL ACKERMAN - 8/27/85 *
4 REM *****
100 RDER = RDER - 1
110 TURN = - TURN
120 TEMP = DY:DY = - TURN * DX:DX = TURN * TEMP
130 IF RDER > 0 THEN GOSUB 100
140 X = X + DX:Y = Y + DY: HPLLOT TO X,Y
150 TURN = - TURN
160 TEMP = DY:DY = - TURN * DX:DX = TURN * TEMP
170 IF RDER > 0 THEN GOSUB 100
180 X = X + DX:Y = Y + DY: HPLLOT TO X,Y
190 IF RDER > 0 THEN GOSUB 100
200 TEMP = DY:DY = - TURN * DX:DX = TURN * TEMP
210 TURN = - TURN
220 X = X + DX:Y = Y + DY: HPLLOT TO X,Y
230 IF RDER > 0 THEN GOSUB 100
240 TEMP = DY:DY = - TURN * DX:DX = TURN * TEMP
250 TURN = - TURN
260 RDER = RDER + 1
270 RETURN
1000 TEXT:HGR:HCOLOR=3: INPUT "ORDER <1-7>";RDER
1010 POKE 49234,1
1020 DY = 192 / 2 ^ RDER
1030 TURN = - 1
1040 DX = X = Y = 0
1050 HPLLOT X,Y
1060 GOSUB 100
1070 END
    
```



draw this elegant figure.

Since recursive programs are hard enough to follow, I decided to write an Applesoft BASIC program that would have only one subroutine with a single entry point. The final program (see listing 1) not only helped me to understand the Hilbert curve better, but also let me use some interesting programming tricks. [Editor's note: HILBERT.BAS is available on BYTEnet Listings at (617) 861-9764. The program is also available on disk (see page 445).]

A first-order Hilbert curve is very simple (see figure 1) and can be drawn by following the rough outline shown in table 1. I inserted four recursive calls into this outline so that the procedure could draw higher-order curves. These calls are conditional on the variable ORDER, which is decremented each time the procedure calls itself and incremented each time the procedure issues a return. Thus, the number of nested gosub statements is determined by the original value of ORDER (see table 2).

The final refinement was to insert commands to swap left for right. To understand this, it might be useful to compare a first-order curve (figure 1) to a second-order curve (figure 2). The first line segment in the first-order curve is horizontal, but the first segment in the second-order curve is vertical. In a third-order curve (figure 3), it is horizontal again. To remedy this flip in orientation, the program includes the variable TURN, which in-

**Table 1:** A rough outline for generating first-order curves.

```
turn left
draw forward
turn right
draw forward
turn right
draw forward
turn left
```

**Table 2:** A modified procedure showing the placement of recursive calls.

```

hil      ORDER = 2
        ORDER = ORDER - 1
        turn left
        gosub hil if ORDER > 0
        draw forward
        turn right
        gosub hil if ORDER > 0
        draw forward
        gosub hil if ORDER > 0
        turn right
        draw forward
        gosub hil if ORDER > 0
        turn left
        ORDER = ORDER + 1
        return
    
```

dicates a left turn when it equals 1 and a right turn when it equals -1. It also includes commands to invert TURN each time the curve routine flips direction.

You may notice that both table 1 and table 2 are almost palindromes;

that is, they read the same backward as forward. The main subroutine in the BASIC program in listing 1 (lines 100 through 270) is palindromic as well. This symmetry is visible in the Hilbert curve itself. You can take a curve of any order and fold it so that one half exactly covers the other.

Another advantage of this program is that it runs well without using local variables. Both Pascal programs that I referred to earlier depend on local variables, which are neatly stored each time a procedure calls itself and restored when it issues a return. This program has only global variables, which are not stored automatically. The other BASIC implementations of the Hilbert curve that I have seen store variables in arrays each time the programs recur. This program eliminates the need to store variables by making sure that all relevant variables have the same values at the beginning and end of the main routine.

Since the program outline in table 1 has two left turns and two right turns, you end up pointing in the same direction you started in. ORDER also remains the same in table 2 because it is first decremented, then incremented. In listing 1, TURN is inverted four times, so it too is the same upon leaving the routine as it was upon entering. Most important, the variables are not changed by the GOSUB statements because they call only the routine itself. ■

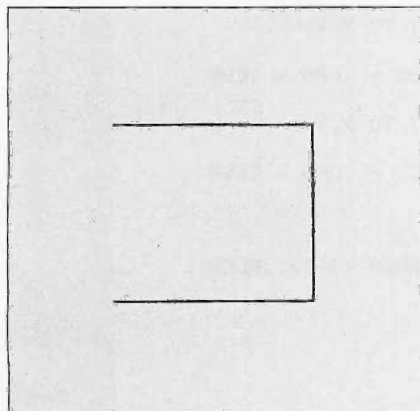

**Figure 1:** A first-order Hilbert curve. Note that the first line segment is horizontal.

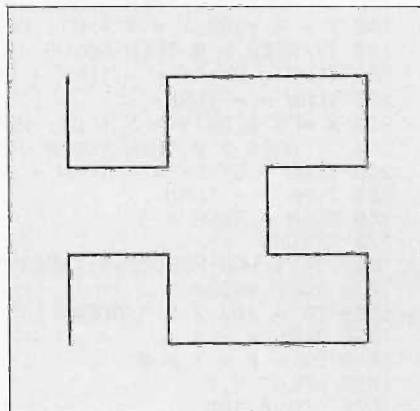

**Figure 2:** A second-order Hilbert curve. Note that the first line segment is vertical.

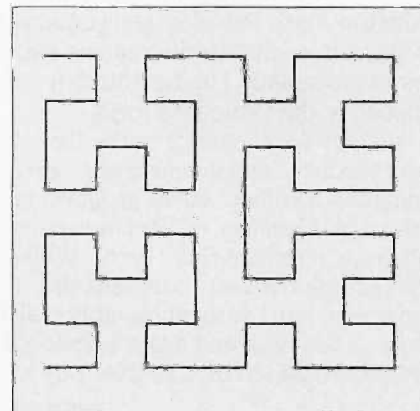

**Figure 3:** A third-order Hilbert curve. Note that the first line segment is horizontal again.





# NUMBER SMASHER™

**Triple your PC speed for only \$599!**

## 8087 Upgrades™

MicroWay is the world leader in 8087 support. Our 8087 development software has been in use since 1982. By 1984 we had become Intel's 97th largest OEM account. When you buy from us, you can be confident that you will receive the 8087 chip designed for your PC and that our unique diagnostics will instantly verify that your processor works correctly as installed. Call for current prices.

## 287Turbo™

This card plugs into the 80287 socket on your AT or COMPAQ, doubling the 80287 clock from 4 to 8 Mhz. It does not change the 80286 clock speed or affect your warranty. The card comes with an 8 Mhz 80287 and has provisions for faster crystals as better 80287s become available. It also has a reset button and circuit that provide a hardware alternative to CTRL-ALT-DEL. 287Turbo with Diagnostics and Reset ..... **\$395**

## Number Smasher™

Number Smasher gives you AT speed and 100% compatibility with all PC software and hardware. It comes with a 10 Mhz 8086 and 512K of no wait state RAM. Most are shipped with an optional matched 10 Mhz 8087 and 128K daughterboard. The card runs programs a factor of 2.5 to 4.0 faster than the PC, XT or compatibles it runs in. Other features include FASTROM, a Ram Disk, Print Spooler and Disk Cache. Revision 2 of the Smasher is designed and manufactured by MicroWay in the U.S.A. and has the best service and support of any accelerator card.

## MegaPage™

MicroWay's "Lotus/Intel" extended memory card has all the features of the others plus one: it uses low power, cool running CMOS DRAM. Ask for our pamphlet "Extended vs Expanded Memory" and learn why MegaPage is the right card for you. MegaPage with 2 Megabytes CMOS ..... **\$549**



Inquiry 229

*The World Leader in 8087 Support*

P.O. Box 79, Kingston, Mass. 02364 USA (617) 746-7341  
Tempo House, London, U.K. call 01-223-7662

Number Smasher, MegaPage and 287Turbo are trademarks of MicroWay, Inc. MicroWay is a registered trademark of MicroWay, Inc.





# Ada just moved into a smaller place.

We have some very good news for you.

You can now get a validated, full Ada<sup>®</sup> compiler for the IBM<sup>®</sup> PC AT. From the people who designed the Ada language. For just \$3,000.

Which means you and your company can now program in Ada without tying up a big, expensive computer.

And you should program in Ada. And not just because the DoD says so.





1432 Main Street, Waltham, MA 02154

- Send me more information about the Alsys PC AT Ada compiler.
- Send me more information about Ada.

Name \_\_\_\_\_

Title \_\_\_\_\_

Company \_\_\_\_\_

Address \_\_\_\_\_

City \_\_\_\_\_ State \_\_\_\_\_ Zip \_\_\_\_\_

Telephone \_\_\_\_\_

The DoD mandates Ada for their software principally because Ada is considerably easier and less expensive to maintain.

Does more reliable and easier to maintain code sound attractive to you? If not, just look at how your programmers are spending 80% of their time.

People who know Ada are calling it "the only logical language for the eighties and nineties." The point is, they're not thinking of

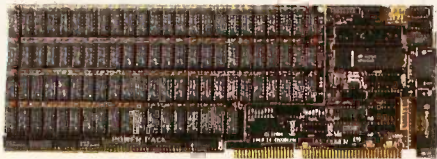

Ada & 4-MB of memory\* for the price of 4-MB of memory.

Ada as "the DoD language." It's simply because Ada supports good, solid software engineering practice.

And now you can try full Ada programming for less than the cost of a two week training program.

The Alsys™ Ada compiler for the PC AT is not only validated, it's actually written in Ada. And produces code so efficient it executes faster than C or Pascal on tested benchmarks.

And if that's not enough, the Alsys PC AT Ada compiler runs in protected mode. So you can use the full amount of memory available to the PC AT. This means you can run a program using

up to 16 megabytes of memory for code and data without worrying about DOS, overlays and all that stuff.

Lastly, this compiler comes with a 4-megabyte memory upgrade board. That, by itself, is worth the price of admission.

At this point, we suspect you might be tempted to pull out a credit card and give us a call.

Or at least fill out the coupon.

Write: Alsys, Inc., 1432 Main Street, Waltham, MA 02154, U.S.A., Telephone: (617) 890-0030, Telex: 948536.

In France: Alsys, S.A., 29, Avenue de Versailles, 78170 La Celle St. Cloud, France, Telephone: 33(1)3918 12 44, Telex: 697569.

In England: Alsys, Ltd., Partridge Hse, Newtown Road, Henley-on-Thames, Oxon RG9 1EN, England, Telephone: 44 (491) 579090, Telex: 846508.



Knowledge is good. Especially when it's free.

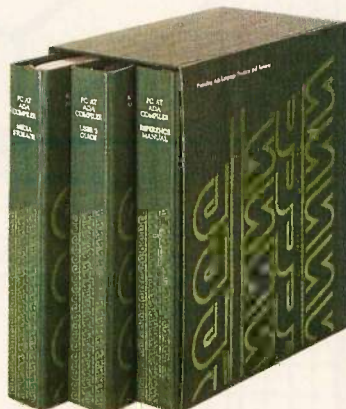

Ada® is a registered trademark of the U.S. Government (Ada Joint Program Office). IBM® and PC AT are registered trademarks of International Business Machines Corporation. Alsys™ is a trademark, service mark, and trade name of Alsys S.A. \*Memory board manufactured by Profit Systems, Inc.



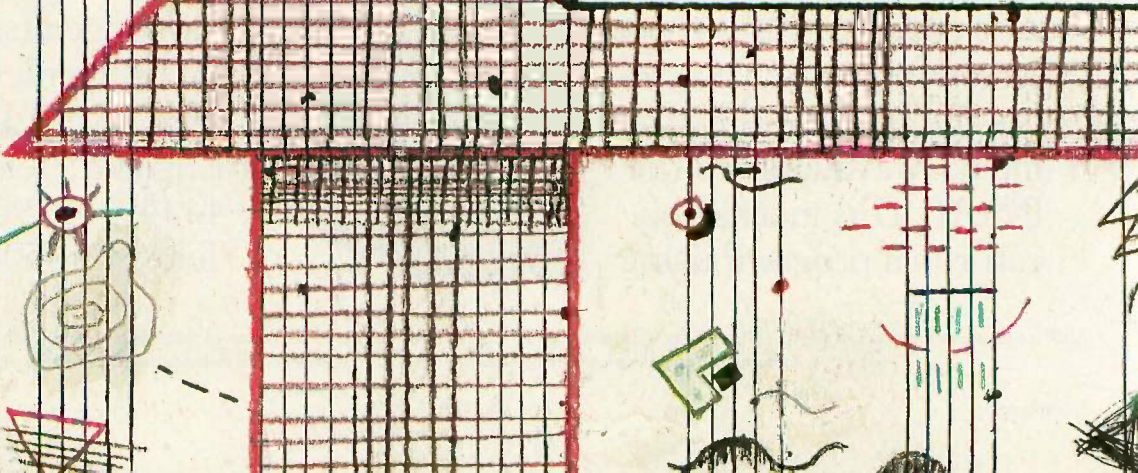
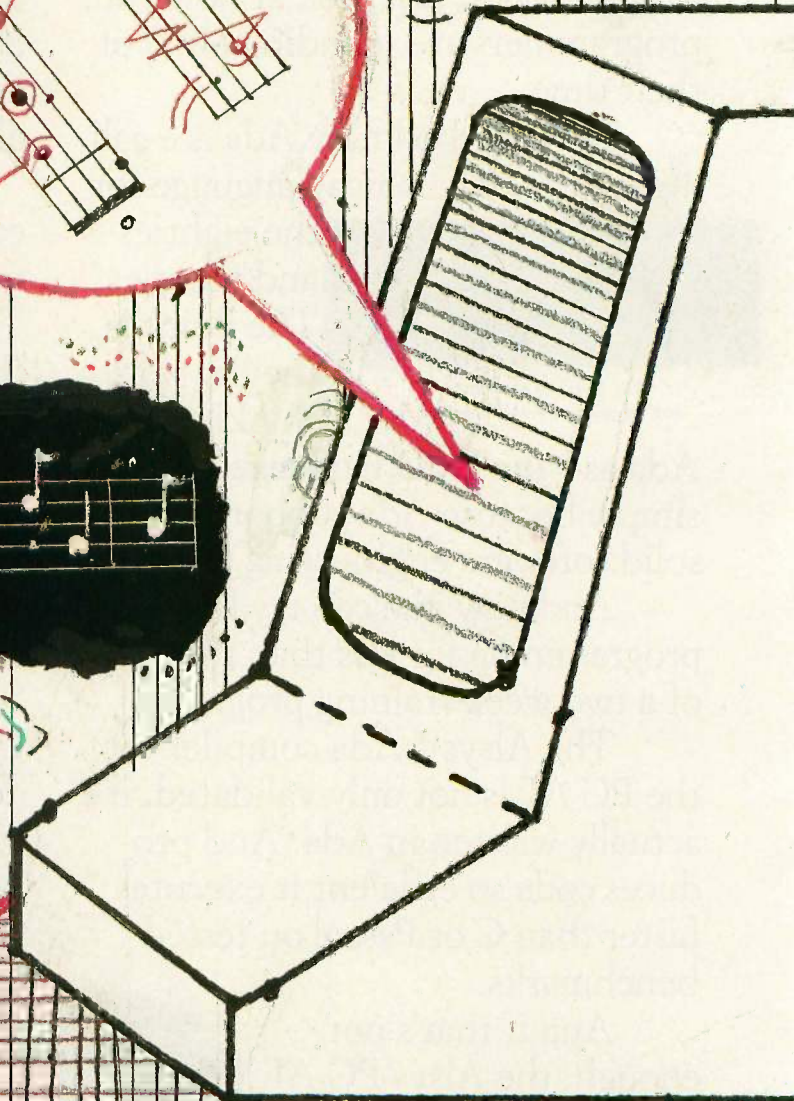
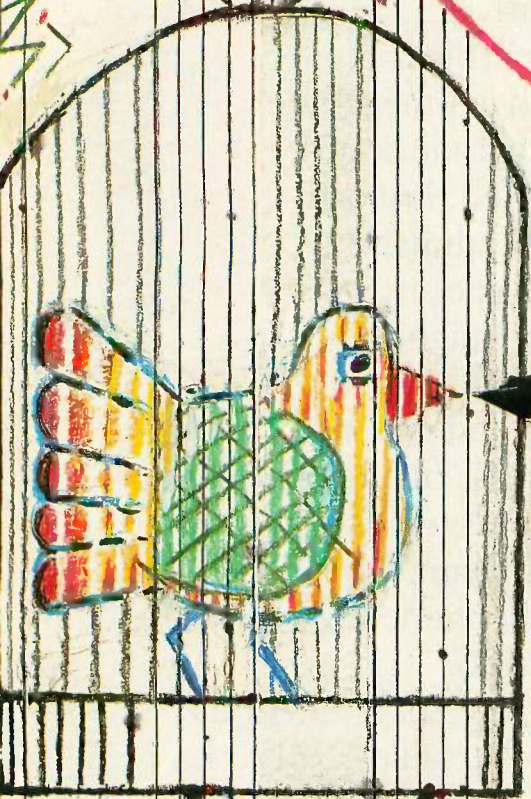
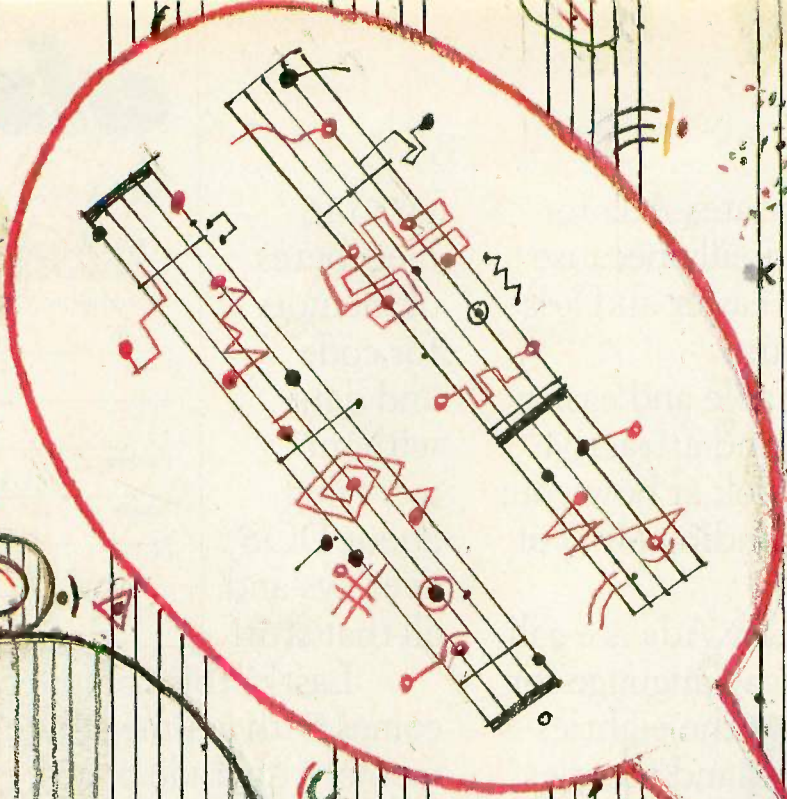



# Computers and Music

---

<b>THE CHALLENGE OF MUSIC SOFTWARE</b> <i>by Roger Powell</i> . . . . .	<b>145</b>
<b>DIGITAL MUSIC SYNTHESIS</b> <i>by Robert A. Moog</i> . . . . .	<b>155</b>
<b>DIGITAL SAMPLING ON THE APPLE MACINTOSH</b> <i>by Christopher Yavelow</i> . . . . .	<b>171</b>
<b>MUSICAL FRACTALS</b> <i>by Charles Dodge and Curtis R. Bahn</i> . . . . .	<b>185</b>
<b>A MIDI PROJECT</b> <i>by Jay Kubicky</i> . . . . .	<b>199</b>
<b>MIDI PROGRAMMING</b> <i>by Donald Swearingen</i> . . . . .	<b>211</b>

---

THE LAST TIME BYTE PRESENTED a Computers and Music theme issue was back in April 1980. Developments in that area have been so dramatic since then—particularly in the last two years—that we decided a concentrated look at computers and music was long overdue.

Many of our readers are already aware of the growing enthusiasm generated by the MIDI (musical instrument digital interface) specification; new software and MIDI-compatible devices seem to appear daily. However, if you need an introduction to what the infusion of computers into the art of musicmaking is going to mean, refer to our lead article, "The Challenge of Music Software" by Roger Powell.

"Digital Music Synthesis" is an overview of the different techniques currently used by today's popular synthesizers. It is authored by Robert Moog, whose name is synonymous with music synthesizers.

Christopher Yavelow offers more insight into the realm of digital synthesis, in particular, digital sampling on the Macintosh. He even provides us with enticing glimpses of some available sampling software.

Fractals are always turning up in unusual and interesting places in the computer world. We often find them associated with graphics, but Charles Dodge and Curtis Bahn introduce us to another application in "Musical Fractals."

We are particularly happy to present Jay Kubicky's "A MIDI Project." Not only does the author give an overview of the software end of MIDI and include the schematic for an IBM PC MIDI hardware interface, he also throws in multitrack MIDI recording and playback software.

Finally, Don Swearingen returns with a software follow-up to his MIDI recorder article, which appeared in the Fall 1985 special issue *Inside the IBM PCs*. This time, Mr. Swearingen shows us some Turbo Pascal software tools for modifying MIDI data stream information after it has been captured in your computer's memory.

Other related articles in the Reviews section include an excellent review of the Kurzweil 250 by former BYTE editor in chief Chris Morgan and a look at four MIDI interfaces by Roger Powell and myself. Mario Sergio Bernardo reviews the capabilities of two music software packages for the Macintosh, ConcertWare+ and SongPainter. In addition, four books dealing with computers and music are critiqued in this issue's Book Reviews section.

The industry is changing far too rapidly for us to examine every aspect of computers and music, but I would like to take this opportunity to point out Roger Powell's appearance on the masthead as a contributing editor. We are fortunate to have someone with Roger's considerable talents associated with BYTE, and we hope to call on him regularly to provide ongoing coverage of computers and music.

—Richard Grehan, Technical Editor



# ENGINEERED TO EXCEED INDUSTRY STANDARDS

Tech PC Desktop computers are engineered to exceed industry standards. Each unit is housed in an attractive and sturdy steel case designed to blend in with the office or home environment and at the same time protect the system components from damage. The units' built in fans are designed for maximal cooling and minimal noise. A full compliment of expansion slots and extra capacity power supply give each of the Four Desktop models the ability to add additional accessory boards and peripherals to the unit without difficulty. The Intel 8088 and 80286 micro-processor based motherboards used in the Tech Personal Computers meet or exceed IBM compatibility standards with respect to processing speed and memory capabilities. All of the four desktop models are designed to function for a wide variety of people in a wide variety of situations.



**TECH PC DESKTOP COMPUTERS** are available now in 4 different base models:

**TECH PC/XT DESKTOP** .....\$ 749

Options:  
**Tech PC/XT with 20MB Hard Disk** ..\$1249  
**Tech PC/XT with 20MB Hard Disk, Monochrome Monitor, Hercules® Compatible Mono/Graphics Card** .....\$1449

**TECH TURBO PC/XT DESKTOP** .....\$899

Options:  
**Tech Turbo PC/XT Desktop with 20MB Hard Disk** .....\$1399  
**Tech Turbo PC/XT 20MB Hard Disk, Monochrome Monitor, Hercules® Compatible Mono/Graphics Card** .....\$1599

**TECH PC/AT DESKTOP** .....\$1699

Options:  
**Tech PC/AT with 20MB Hard Disk** ...\$2099  
**Tech PC/AT with 20MB Hard Disk, Monochrome Monitor, Hercules® Compatible Mono/Graphics Card** .....\$2299

**TECH TURBO PC/AT DESKTOP** .....\$1799

Options:  
**Tech Turbo PC/AT Desktop with 20MB Hard Disk** .....\$2199  
**Tech Turbo PC/AT with 20MB Hard Disk, Monochrome Monitor, Hercules® Compatible Mono/Graphics Card** .....\$2399

All **TECH PC DESKTOPS** available with tape backups, hard disks up to 280 megabytes, networking systems, and hundreds of other hardware and software accessories.

**TECH PERSONAL COMPUTERS** is a full service manufacturer of Micro Computer Products and offers a complete line of Desktop, Portables and Multi-User Computer Systems as well as an accessory line of over one hundred enhancement products. **TECH PERSONAL COMPUTERS** are all backed by a full one year warranty with additional maintenance coverage and extended maintenance contracts available through Mohawk Data Sciences. For more information concerning hundreds of MDS Service Centers throughout the United States, contact **TECH PERSONAL COMPUTERS** at (714) 754-1170.



## TECH PC

714/754-1170

2131 S. Hathaway, Santa Ana, California 92705

TELEX: 272006 Answer Back-TECH FAX: 714/556-8325

Inquiry 342 for End-Users. Inquiry 343 for DEALERS ONLY.



# THE CHALLENGE OF MUSIC SOFTWARE

BY ROGER POWELL

*An overview of the current state  
of computers in music*

THE MID-SIXTIES marked the beginning of an exciting new era in the field of music. At that time, both Dr. Robert Moog at his Trumansburg, New York, laboratory and Dr. Max Mathews at Bell Laboratories in New Jersey were creating electronic tools for the production of music. The Moog Synthesizer, although not the only device of its kind under development at that time, became universally accepted as a valid musical instrument, revolutionizing the electronic sound industry. But the Moog and other analog synthesizers are based on analog building blocks like oscillators, filters, and amplifiers—circuits that may tend to drift out of calibration, especially under environmental stress.

In another camp, Dr. Mathews and his colleagues were exploring the possibilities of digital sound reproduction using a general-purpose computer equipped with a D/A converter. They reasoned that sound could be sampled at regular intervals, much like a motion-picture camera snapping frames of images. The resulting stream of audio data represents a plot of the amplitude over time and can

be faithfully "played back" by sending the data back out of the computer through the D/A converter. (This is the principle behind today's compact disk technology.) Of course, the cost and size of computing equipment at that time posed a serious deterrent to the average musician's or composer's desire to use computer techniques in his or her art. And, similarly, the early analog synthesizers were bulky, expensive instruments whose most natural environment seemed to be the university laboratory, a domain not normally frequented by the musically inclined. However, the economic barrier between sophisticated electronic tools and musicians no longer exists in today's world of high-performance personal computers and the new generation of music synthesizers, which now includes MIDI, a communications standard for music.

MIDI represents a formal set of hardware and software rules for sending and receiving musical-event data between computers and synthesizers. Music data such as notes or other performance parameters such as pitch-bending are typically input by the

musician using a keyboard synthesizer equipped with a MIDI hardware interface. This MIDI hardware encodes the key depressions and transmits them serially at 31,250 bits per second over the MIDI port. The output of this port may be connected to the input of another MIDI port that is either attached to a computer or another synthesizer. The ability to "slave" remote synthesizers to the movements occurring on a master instrument is reminiscent of the antiphonal design of early pipe

*(continued)*

Roger Powell (Magnetic Music, POB 328, Rhinebeck, NY 12572) is a professional musician and computer programmer. He has been involved with music synthesis as a consultant for the Moog Synthesizer Company and Bell Laboratories, where he was introduced to computer music. A longstanding member of Todd Rundgren's band Utopia, Roger has also played keyboards for David Bowie and Meat Loaf and has released two solo synthesizer albums, *Cosmic Furnace* (Atlantic, 1973) and *Air Pocket* (Bearsville, 1978). Recently, Roger has been producing his own line of MIDI-related software tools for music, including *Texture*, a 24-track MIDI sequencer for the IBM PC.



organs found in the world's great cathedrals. The organist, seated at the console, could control distant multitudes of pipe ranks located throughout the building.

If you insert a computer into this network, data from the master instrument can be collected, stored, analyzed, and passed on to other devices. Here it's important to distinguish between musical-event data and

sound-sample information. The MIDI standard currently focuses on slower-moving performance data like that which the musician's keyboard movements describe. Musical notes consist of key numbers and times of depression and release updating on the order of seconds and milliseconds. Sound samples, on the other hand, represent a quantification of an analog signal, and the data rate for

any degree of high fidelity must approach the order of microseconds. MIDI encodes control signals that may be used to drive external sound-generating devices or fed into music-processing software.

While performing, a musician normally does more than just activate the notes to be heard. Personal inflections may be added by varying the "touch" or velocity with which keys are struck. Other devices on the synthesizer may influence the brilliance of the sound or produce a steady vibrato. All these parameters are defined in the MIDI standard, although not all are implemented in every synthesizer. Continuous controller devices such as pitch-bend and modulation wheels generate large quantities of inflection data. Musicians must use these devices judiciously to avoid clogging the MIDI serial channel or using excessive memory when recording into the computer. Nevertheless, the Japanese and American synthesizer manufacturers who cooperated to design the MIDI specifications were wise to include the ability to "capture" these multiple dimensions of a real-time musical performance as rendered on a MIDI-equipped instrument.

Once the synthesizer, performer, and computer have established a MIDI link, the musical process is open to deeper exploration through software utilities that manipulate musical phrases. Of the many applications programs that are presently offered to musicians, the largest category could be described as "sequencers"—programs that act as tapeless, multi-track recorders allowing you to create layers of sound data one track at a time. Using the virtual tracks established in software, a single musician/composer can build and refine musical structures in the same way that an author uses word-processing software to create literary works. Sequencer programs generally offer a rich set of editing and transformation functions for massaging music data into shape. There are cut-and-paste operations that allow you to move fragments of melody and rhythm around to desired locations earlier or later in the piece, copy functions for repeated phrases,

(continued)

## Hassle-Free Programming...

### JCL FOR IBM® VSE SYSTEMS A Self-Teaching Guide

Ruth Ashley  
Judi N. Fernandez

Using the proven STG format of reviews, self-tests, objectives, and exercises, this guide to the operating system that controls IBM's new 4300 series will enable application programmers to handle virtually any communication and control requirement encountered on the job. \$12.95

### THE 80286 ARCHITECTURE

Stephen P. Morse  
Douglas J. Albert

An in-depth guide to Intel's new 80286 and 80287 microprocessors, the chips used in IBM's PC/AT and many compatibles. Shows how to program the chips to perform a wide range of business, scientific, and microcomputer applications. \$24.95

### FILE FORMATS FOR POPULAR PC SOFTWARE A Programmer's Reference

Jeff Walden

Unlock the complex file formats of programs like Lotus 1-2-3, Multimate, and dBase. With this information—difficult to find and impossible to get in one place—you can easily move information, intact, from one software program to another. \$24.95

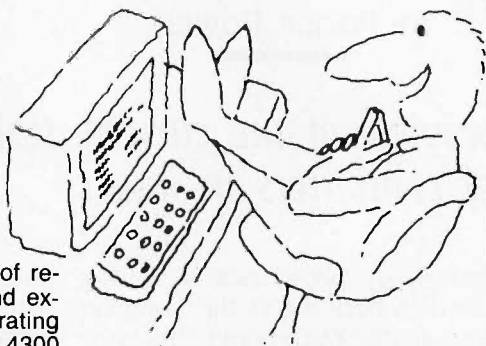

Coming soon —  
two new titles on  
expert systems...

### EXPERT SYSTEMS APPLICATIONS

Paul Harmon

### PROGRAMMING EXPERT SYSTEMS

Brian Sawyer and  
Dennis Foster

Available now at your local bookstore. For a complete list of Wiley's computer titles, write to Gwenth Jones, Dept. 6-0970.

### JOHN WILEY & SONS, INC.

Business/Law/General Books Division  
605 Third Avenue, New York, N.Y. 10158.

Prices subject to change and higher in Canada

**WILEY PRESS**  
**COMPUTER BOOKS**





# PROGRAMMED FOR PROFIT.

NOW THE PANASONIC® SOFTWARE DEVELOPMENT TOOL MAKES IT EASY TO CREATE CUSTOM SOFTWARE—AND CUSTOMERS—FOR OUR NEW HAND-HELD COMPUTER.

Introducing the Panasonic Software Development Tool (SDT) for our new 16-bit hand-held computer, the Panasonic® Personal Partner™.

Designed to help you create new customers by providing them with custom software, the SDT provides you with a programming environment which allows you to design, develop and de-bug custom ROM-based software on the Panasonic® Exec. Partner™, Sr. Partner™ and other IBM-PC\* compatible computers.

You'll be writing software for our one-of-a-kind Personal Partner. It's the two-pound computer with the power of a desk-top, an 8-line by 80-character display

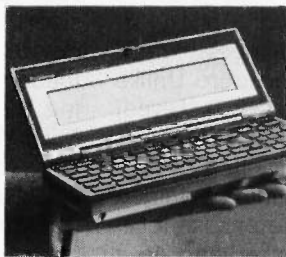

and the option of expanding up to 128K memory. The Personal Partner even has an optional 1200/300 baud modem for mainframe communication (available 2nd half 1986).

The Personal Partner provides your clients with the on-site answers they need. And the optional 80-column battery-operated printer makes it possible for them to create professional, computerized presentations wherever they are.

When you develop software for the Personal Partner with the Panasonic SDT, you know you're programmed for profit.

Send for more information on the SDT, or call:

**1(201)392-4645**

Name \_\_\_\_\_

Company \_\_\_\_\_

Address \_\_\_\_\_

City \_\_\_\_\_ State \_\_\_\_\_ Zip \_\_\_\_\_

Panasonic Computer  
Products Division  
333 Meadowlands Pkwy.  
Secaucus, NJ 07094

**Panasonic**  
Office Automation **OA**

B686

\*IBM is a registered trademark of International Business Machines, Inc.



## *Most popular music features repetition of a few basic phrases.*

transpose utilities for shifting the key signature, and other tools modeled after the text-editing environment. Beyond this, some programs have commands to assist composing using algorithmic methods. This set of tools performs extended manipulations on the phrases stored in memory; melodies may be rotated (end notes of phrase appear at beginning), inverted (high notes become low notes and vice versa), and compressed or expanded (pitch range of melody made narrower or greater). Note and performance streams of several tracks may be merged into one for dense patterns, and phrases may be overlapped with delays for echo effects. Most popular pieces of music feature repetition and variation of a few basic phrases. The task of the composer is to develop these fragments into a seamless whole. By assigning the mechanical work of actually moving and altering the note patterns to the computer, a high degree of spontaneity can be achieved during the creative process.

Music data can be represented graphically in several different ways, each with its own benefits and drawbacks. Common music notation—the normal character set of music symbols that musicians can read—provides a well-proven methodology and is an obvious choice for an operator interface given its large user base. There are roughly 80 symbols that you should know to be able to decipher a musical score. Half of these symbols are used frequently, suggesting that some counterpart of the NAPLPS graphic-communications standard could be adopted for low-level music-graphics applications. The formatting of music data to a video screen seems straightforward until you want to translate real-time performance data into common notation. The problem is that a human cannot play the prescribed notes of a musical

score precisely on time or for the exact duration indicated, forcing the computer that is reading the incoming events to make decisions about note values and placement. The process of composing is reversed here (decomposing?) and the software has to make musically appropriate decisions regarding the player's intentions. Dr. Roger Dannenberg of Carnegie-Mellon University has made significant progress in the development of real-time heuristic techniques in this area. He has produced algorithms that actually can follow a musician's performance and continuously ascertain the proper rhythmic context, speeding up and slowing down as a human accompanist might react to the actions of a soloist. This information can also be used to draw a screenful of music notation entered via a MIDI host instrument.

In some applications, common music notation is either unsuitable or unnecessary and is replaced by other display means. Simple list editing of timed events may be sufficient, or you may be presented with a piano-roll-type notation where note events are shown as vertically spaced lines and dashes indicating pitch and duration. This depiction more accurately shows the exact timing relationships between notes and doesn't require familiarity with objects like stems and dotted 32nd notes indigenous to standard notation. Ideally, you would like the ability to switch-select the appropriate view and produce hard copy to match. I suspect that future software will support such options.

In a professional or semiprofessional studio environment, it is often necessary to synchronize the playback of tape machines and computer sequencers to run in tandem. The motion-picture industry has been synchronizing sound to film for years and has developed a time-code protocol called SMPTE (Society of Motion Picture and Television Engineers) specifically to assist that procedure. Unlike simple FSK (frequency-shift keyed) sync signals used to drive sequencer devices from tape, each block of SMPTE signal bits contains a unique time stamp to facilitate precise location for sound or film editing. In a

sound lab, one track of a multitrack tape will be "striped" with SMPTE code for the length of the musical selection. Although MIDI does not recognize SMPTE directly, any time code may easily be translated into a MIDI-format message (the song position pointer) that the software may use to find a point in the score data. Several companies now manufacture units to read SMPTE and generate the MIDI location data. By using only a single track of tape, a computer sequencer can be "clocked" and made to send its data to an ensemble of synthesizers, freeing the other tape tracks for sounds that must be recorded through microphones (vocals, guitars, flutes, etc.). Instruments can be played by the computer as the final master tape is created (mixdown) preventing the loss of fidelity caused by analog-tape limitations.

MIDI has become useful in other applications in the sound and entertainment industry. MIDI control has been built into mixing consoles for automating computer-controlled mix-downs. A special MIDI interface can control stage lighting, both spotlight and laser-oriented. The growth in the use of MIDI-controlled equipment has also made it clear that the MIDI standard needs to be developed further to accommodate the things imaginative people have envisioned for it. Bandwidth will have to be increased or multiport interfaces will have to be designed to overcome the bottleneck that occurs at 31,250 bps when many devices are interconnected. Data delays are noticeable in large systems, especially when devices are "thru"-connected (chained). Several manufacturers produce MIDI data-distribution boxes to help eliminate this particular problem.

You may have the impression that MIDI is useful only to those with access to keyboard-controlled synthesizers, but, in fact, there exists a device that can track the sounds made by acoustic instruments (including the human voice) and produce MIDI data signals. By using such a pitch-to-MIDI converter, instrumentalists or vocalists can access electronic music tools without having to

*(continued)*



ONCE IN A LIFETIME A NEW PRODUCT APPEARS ON  
THE HORIZON THAT SHINE ABOVE ALL OTHERS

# THE CREATOR™

APPLICATION GENERATOR

by Advanced Development Technologies

★ FOURTH GENERATION PRODUCTIVITY

★ ELIMINATE DATABASE MANAGEMENT SYSTEMS

★ A COMPLETE APPLICATION  
GENERATION ENVIRONMENT

★ DEVELOP APPLICATIONS IN LESS TIME

★ REDUCE CODE REQUIREMENTS  
BY 90 PERCENT

★ TRAPS ERRORS WITH DETAIL ANALYSIS

★ MULTIPLE FILE ACCESS  
WITHOUT PROGRAMMING

★ 99 INDEXES PER DATA FILE

★ AUTOMATIC RECORD LOCK

★ UNLIMITED FILE AND  
RECORD SIZE

★ PRODUCES COMPLETE  
DOCUMENTATION

**\$99**

MASTERCARD/VISA

## INCLUDES:

- Internal Expression Compile
- Relational File Structure
- ISAM File Access Method
- Screen and Report Generator
- Rich Library of Functions
- Data Dictionary
- System and User Defined Variables

For Only \$99 The **CREATOR™** Lets You Develop Applications Without Being Bugged Down By A Lot Of Code. Regardless Of How Simple Or Sophisticated The Applications, Save Hundreds Of Hours Of Programming By Using This Advanced Method Of Application Development. Manages All Phases Of Program Development:

- Program Generation
- Database Definition
- Screen And Report Formation
- Multiple Levels of Menus.

A Complete Development System Available For IBM, PC, XT, and AT Requires 256K RAM Includes Unlimited Run Time

**800-528-6060**

**EXT. 239**

CHECKS AND MONEY ORDERS ACCEPTED

©THE CREATOR™ IS A TRADEMARK OF  
**ADVANCE DEVELOPMENT TECHNOLOGIES**

2720 N. 68th St., Suite 5379

Scottsdale, Arizona 85257

**602-945-1375**

Inquiry 10

IBM PC, XT, AT is a  
Copyright of International  
Business Machines, Inc.



# CopyWrite

## BACKS UP IBM PC SOFTWARE

Hundreds of the most popular copy-protected programs are copied readily. CopyWrite needs no complicated parameters. It needs an IBM Personal Computer, or an XT or an AT, 128k bytes of memory, and one diskette drive. CopyWrite will run faster with more memory or another drive.

CopyWrite is revised monthly to keep up with the latest in copy-protection. You may get a new edition at any time for a \$15 trade in fee.

CopyWrite makes back up copies to protect you against accidental loss of your software. It is not for producing copies for sale or trade, or for any other use that deprives the author of payment for his work.

To order CopyWrite, send a check for \$50 U.S., or call us with your credit card. We will ship the software within a day.



**Quaid Software Limited**

45 Charles Street East  
Third Floor  
Toronto, Ontario M4Y 1S2  
(416) 961-8243

Ask about ZeroDisk to run copy-protected software from a hard disk without floppies.

learn keyboard techniques. The act of playing or singing into the converter causes standard MIDI signals to be generated and sent to a receiving MIDI port on a synthesizer or computer. A flutist, for example, may control a bass-guitar sound on a synthesizer. The educational paths opened by the pitch-to-MIDI converter include intonation training, sight-reading drills, music theory, and tutoring of instrumental techniques—in short, the learning of any traditional instrument can be enhanced to make the process more enjoyable and effective.

The history of MIDI software development can be compared to that of business software. During the early period, business software consisted of a host of stand-alone programs, each fulfilling a particular task such as word processing or telephone communications. Later, integrated packages were produced that combined the most useful programs into one. MIDI software is currently undergoing the transition from a plethora of stand-alone products to integrated programs that combine the features of sequencing, notation, and synthesizer voice librarians. As in the business world, not everyone will be drawn to an integrated package—some may prefer to use a collection of favorite single-job programs installed into a desktop or workbench environment. In any case, the issues of music data structures and file compatibility gain more and more importance as the industry evolves. At this time, unfortunately, the musical-score data produced by most programs cannot be shared by other programs, a factor that limits the usefulness of the data generated. Imagine the consequences if there were no accepted standard format for ASCII text files! Of course, music files are far more complex than simple text files and a standard is more difficult to design, although not impossible. Getting software developers to agree on a proposed standard is another matter.

The chief focal point of computer software up to now has been the visual aspect. With computer hardware designers and manufacturers now realizing the advantages of combining sound and visuals, you can ex-

pect more emphasis on this previously overlooked asset in the form of more sophisticated internal sound generation for personal computers.

For example, software that allows creation of animated musical storyboards is already available for Commodore's Amiga computer. These storyboards may be used in designing motion-picture scenarios or actually producing complete video animation segments accompanied by a professional-quality sound track.

There is little doubt about the stimulating effect that MIDI has had on the electronic music field; activity among manufacturers and consumer musicians is at an all-time high. It's hard to stay abreast of the new developments in MIDI hardware and software occurring every few months. The ultimate beneficiary of this technological onslaught is the average person who has always wanted to experiment with music but felt there were too many financial and psychological obstacles. By increasing the productivity of professionals, the developers of music software have also provided affordable, comprehensible tools for the amateur. Flexible software can extend the useful life of musical equipment by allowing older gear to be used with newer instruments. A user can realistically plan to build a system piece by piece over a period of time and not be forced to discard last year's model because it can't talk to the newcomers. For these promises to be fulfilled, awareness of what's available and what it can do must increase among the targeted end users. This awareness must then grow into a two-way communications channel between the developers of software and the artists who use it. The realm of music is no longer off-limits to anyone with a personal computer. ■

#### BIBLIOGRAPHY

- Buxton, W., and G. Fedorkow. *The Structured Sound Synthesis Project*. Toronto, Ontario: University of Toronto, 1981.
- Chamberlin, Hal. *Musical Applications of Microprocessors*. Rochelle Park, NJ: Hayden Book Co. Inc., 1980.
- Computer Music Journal*. Boston, MA: MIT Press.
- Mathews, M. V., et al. *Technology of Computer Music*. Boston, MA: MIT Press, 1969.



# Orchid's TurboEGA™

## The world's fastest EGA



**FREE  
MS WINDOWS**



**TurboEGA**

## Introducing the only Enhanced Graphics Adapter with Pcturbo™ speed.

The experts agree: the EGA is the breathtaking new graphics standard, but the sophisticated software written for it places a big burden on the PC's processing speed. Beautiful graphics, crisp text, but too slow.

Everyone else rushed their EGAs to the market, but Orchid Technology took the time to do it right. Orchid's TurboEGA™, from the inventors of PC TurboProcessing, packs a high-speed Turbo and an EGA into one slot, for the world's fastest EGA.

### Graphics with Speed

TurboEGA makes IBM PCs and XT's run faster than an AT. It brings dazzling speed to sluggish graphics programs. All types of software run faster, so you finish more quickly. Transparent to the user, you won't know it's there until you see its speed.

We are so confident that our TurboEGA is the ultimate graphics card that we decided to give away a free copy of Microsoft's Windows with each TurboEGA\*. Even Microsoft recommends that you run Windows on an AT. Now Orchid's TurboEGA gives you AT speed so XT users can use this number one windowing software at the speed they demand.

### The Complete Solution

Only Orchid puts this much performance into one slot and comes fully loaded with 256K of RAM, so there's no hidden cost. TurboEGA is the complete graphics solution.

Pick up the phone and find out how you can have the EGA the competition wishes they had: Orchid's TurboEGA, the world's fastest.

If you have an AT or a system with 80286 speed, ask about the Orchid EGA™—four graphic-card compatibility in one slot.

### Features:

- Powered by 7.2MHz 80286
- Optional 5 or 8MHz 80287
- 256K of on-board RAM
- Four graphics modes: EGA, CGA, MDA, Hercules
- Supports the long list of EGA software:
  - Microsoft Windows & Word
  - Lotus 1-2-3 & Symphony
  - Topview
  - Framework
  - Chart-Master
  - AutoCAD
  - PC Paint Plus
  - and more...



47790 Westinghouse Dr.  
Fremont, CA 94536  
415/490-8586  
Tlx: 709289

TurboEGA, Orchid EGA, and Pcturbo and trademarks of Orchid Technology. All other product names are trademarks of their manufacturers. CGA screen by PC Paint Plus.

\*Offer good only on TurboEGA purchases until July 31, 1986.



At last, the world's  
best-selling portable computer  
has a little competition.



It's 30% smaller



17% lighter

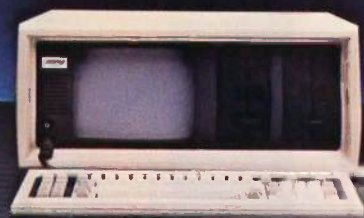

400% faster



# Introducing the remarkable new COMPAQ PORTABLE II



**N**ow there's a portable personal computer so small, so light, and so fast it defines a new industry standard. From the same company that set the standard—COMPAQ®

The new advanced-technology COMPAQ PORTABLE II™ has all the advantages of the world's best-selling full-function portable—the original COMPAQ Portable—plus it's even more portable. And it's far more powerful than most desktop computers.

With its 80286 microprocessor, the COMPAQ PORTABLE II can run all the popular business software written for IBM® Personal Computers. At speeds *three to five times faster* than the COMPAQ Portable, IBM PC/XT™, and other compatibles.

## It's more computer in less space

Never before has a computer this small been capable of so much. Making the COMPAQ PORTABLE II 30% smaller and

17% lighter—with no reduction in monitor size and a big gain in functionality—was an engineering triumph. The result is a full-function, advanced technology personal computer that's easy to take on business trips or carry from desk to desk.

## A computer for now and for the future

The COMPAQ PORTABLE II excels in compatibility. And because of its standard 360-Kbyte diskette drive format, your data diskettes will be fully interchangeable with other COMPAQ, IBM, and compatible personal computers.

Expandability? An optional 10-Megabyte fixed disk drive stores over 5000 pages of data; the optional 20-Megabyte fixed disk drive, twice that. RAM expands to 2.1 Megabytes without an expansion slot, and with one expansion slot RAM can expand to 4.1 Megabytes. Since interfaces for the most popular peripherals are already built in, the two expansion slots can be

used for *connecting* your computer to others: add a modem, a networking board, or a board for communicating with your mainframe.

## No compromises

The COMPAQ PORTABLE II puts tremendous computing potential within the grasp of every computer user. It's backed by the service and the support of over 2900 Authorized COMPAQ Computer Dealers worldwide. Plus, it's made by the undisputed world leader in portable personal computers. And for that title, there's no competition.

For the name of the dealer nearest you, call toll-free 1-800-231-0900 and ask for Operator 16. In Canada, call (416) 449-8741. In Europe, telex 84117898630AB; 898630 COMPAQ TTX D.

IBM® is a registered trademark and IBM PC/XT™ is a trademark of International Business Machines Corporation. ©1986 COMPAQ Computer Corporation. All rights reserved.

It simply works better.

**COMPAQ**  
**PORTABLE II™**



# Make Stat Magic

MORE!  
STATS. POWER  
IMPROVED!  
FILE HANDLING. REPORTING

## Statistics, reports and plots happen magically with SPSS/PC+™ —the enhanced and expanded Statistical Package for IBM PC/XT/AT's\*:

SPSS/PC+ is the most comprehensive statistical program for performing simple or complex tasks. For nearly 20 years, SPSS Inc.'s reputation and reliability as the leading producer of mainframe statistical and reporting software is unsurpassed. SPSS/PC+ carries this reputation into the PC environment.

**SPSS/PC+ — Fully integrated:** report writing, plotting, file management, communications with mainframes. Statistics: descriptives, crosstabulation, multiple regression, ANOVA. Simple facilities allow transfer of files between SPSS/PC+ and programs like Lotus 1-2-3, dBASE III, and SAS.®

**SPSS/PC+ Advanced Statistics™** — Factor, cluster, discriminant and loglinear analyses, MANOVA.

**SPSS/PC+ Tables™** — Presentation-quality tabular reporting. Produce stub and banner tables. Handle multiple response survey data. Control content and layout completely.

SPSS/PC+ documentation is rated Number One by both novices and experienced analysts. SPSS Inc. also offers a full training schedule and a customer support hot-line.

To order, contact our Sales Department at

**312/329-3500**

SPSS Inc., 444 N. Michigan Avenue,  
Chicago, IL 60611, 312/329-3500.  
In Europe: SPSS Europe B.V., 4200 AC  
Gorinchem, The Netherlands,  
Phone: +31183036711  
TWX: 21019.



**SPSS inc. PRODUCTIVITY RAISED TO THE HIGHEST POWER™**

\*SPSS/PC+ runs on the IBM PC/XT/AT with hard disk. Contact SPSS Inc. for compatible microcomputers.

IBM PC/XT and PC/AT are trademarks of International Business Machines Corporation. dBASE III is a trademark of Ashton-Tate. 1-2-3 is a trademark of Lotus Development Corporation. SAS is a registered trademark of SAS Institute, Inc. SPSS, SPSS/PC+, SPSS/PC+ Tables, and SPSS/PC+ Advanced Statistics are trademarks of SPSS Inc. for its proprietary computer software.



# DIGITAL MUSIC SYNTHESIS

BY ROBERT A. MOOG

*The many different shapes of the waveform of the present*

MUSIC IS ONE of the most information-rich (wide-bandwidth) forms of human communication. A compact disk, for instance, uses nearly 1.5 megabits per second to faithfully transmit a stereo recording, as opposed to the several hundred bits per second needed to transmit a written message as fast as you can read it. Only video, the faithful transmission of which requires over 50 megabits per second, has a significantly higher information density.

Music is also a highly structured form of human communication. The hierarchy of a piece of music may be as deep as that of the federal bureaucracy: Notes, phrases, lines, sections, and movements are carefully arranged to heighten and clarify the intent of the music.

These two general properties of music, wide bandwidth and complex structure, happen to match the information-handling capabilities of today's personal computers. In addition to the personal computer's wide bandwidth (or high speed) and information-organizing and -processing capabilities, you can access a growing list of instruments, accessories, and components designed specifically

to produce musical tones in response to high-level digital instructions. These devices owe their existence to rock 'n' roll, the consumerization of digital audio, and dramatic advances in LSI (large-scale integration). They employ a wide variety of sound-producing techniques, each with its own set of features and limitations. This article discusses the general attributes of musical sound and how to produce it, the capabilities of specific sound synthesis techniques, how musicians are using these techniques, and what you can expect the future to bring to digital music.

## **THE PROPERTIES OF MUSICAL SOUND**

Music is an arrangement in time (and, to a lesser but still important extent, in space) of a collection of sonic events generally called notes. This is actually a subjective description of music. We hear individual notes only because our ears and mind pick acoustic information apart into events that we perceive to be distinct. What actually exists outside our ears is an ongoing series of vibrations of the air. The graph of air pressure versus time

is the waveform, an unbroken pattern, present even in the quietest of sound-proof rooms. The ratio between the height of a sound waveform that you can barely hear and one that is so loud that it begins to hurt is about one to a million. That's about 120 decibels. Music, speech, and other normal sounds occur in the upper 60 dB of your hearing range.

You can describe any waveform that tends to repeat as a collection of frequency components, each one of which has a sine waveform. This is the spectrum of a sound.

Thus, any sound has two complementary, equivalent representations: its waveform and its spectrum. The waveform is the sound's time-domain representation; the spectrum is its frequency-domain representation. Together they are capable of fully describing a sound. The relation of the waveform to the spectrum is

*(continued)*

*Robert A. Moog is vice president of new product research at Kurzweil Music Systems (411 Waverly Oaks Rd., Waltham, MA 02154). Known as the developer of the first commercial electronic music synthesizer, he has a Ph.D. in engineering physics from Cornell University.*



described by a mathematical relationship called the Fourier theorem.

The waveform of a very simple sound—for example, a tone from a laboratory audio oscillator—does not change with time. Real musical sounds, however, are never steady. They constantly change as they evolve. Piano tones, for instance, begin loud and bright and then decay to silence in a complex way that's characteristic of the instrument. These variations are essential determinants of the sound's characteristic tone color. They are neither entirely random nor entirely regular, nor are they undesirable deviations from a perfectly steady tone.

In the early days of musical acoustics, the importance of the details of a tone's evolution was not generally recognized. Acoustics textbooks often showed a single cycle of a waveform and labeled it violin or oboe. Musical-instrument engineers now recognize that, in determining a sound's tone quality, or timbre, the

steady-state waveform takes a back seat to the parameters that describe how sound changes as it evolves. For this reason, many synthesis techniques are important primarily because they allow important parameters of the generated sounds to be precisely and continuously varied. The exact shapes of the sound-parameter variations may be generated explicitly by a musician's real-time control or may be determined by a set of function generators that are connected to, but separate from, the sound-waveform generator itself.

Figure 1 illustrates this notion. The rightmost block indicates the audio-waveform generator, which produces the audio waveform itself. It may, for instance, be an analog synthesizer module, a hard-wired digital oscillator, or a waveform-generating routine run by a microprocessor. The block to its left represents the control-function generators, a set of time-varying function generators whose outputs continuously control the properties of the

audio waveform. In general, the control functions are simpler and more slowly moving than the sound waveform and are often (but not always) produced by software routines.

The leftmost box on the bottom, representing coefficients and boundary conditions, produces the commands that specify the shapes of the control functions. Generally (but not always) these commands are a brief set of time-invariant numbers that provide the initial boundary conditions and coefficients of the control functions. Finally, the box on the top, real-time control, represents time-varying functions of arbitrary shape, such as those that a musician may wish to impart by hand. Real-time control may change the coefficients of the control functions or may be added to the control functions themselves to directly modify the sound waveform.

Figure 2 shows one specific example of this type of control hierarchy. The waveform generator is an analog

(continued)

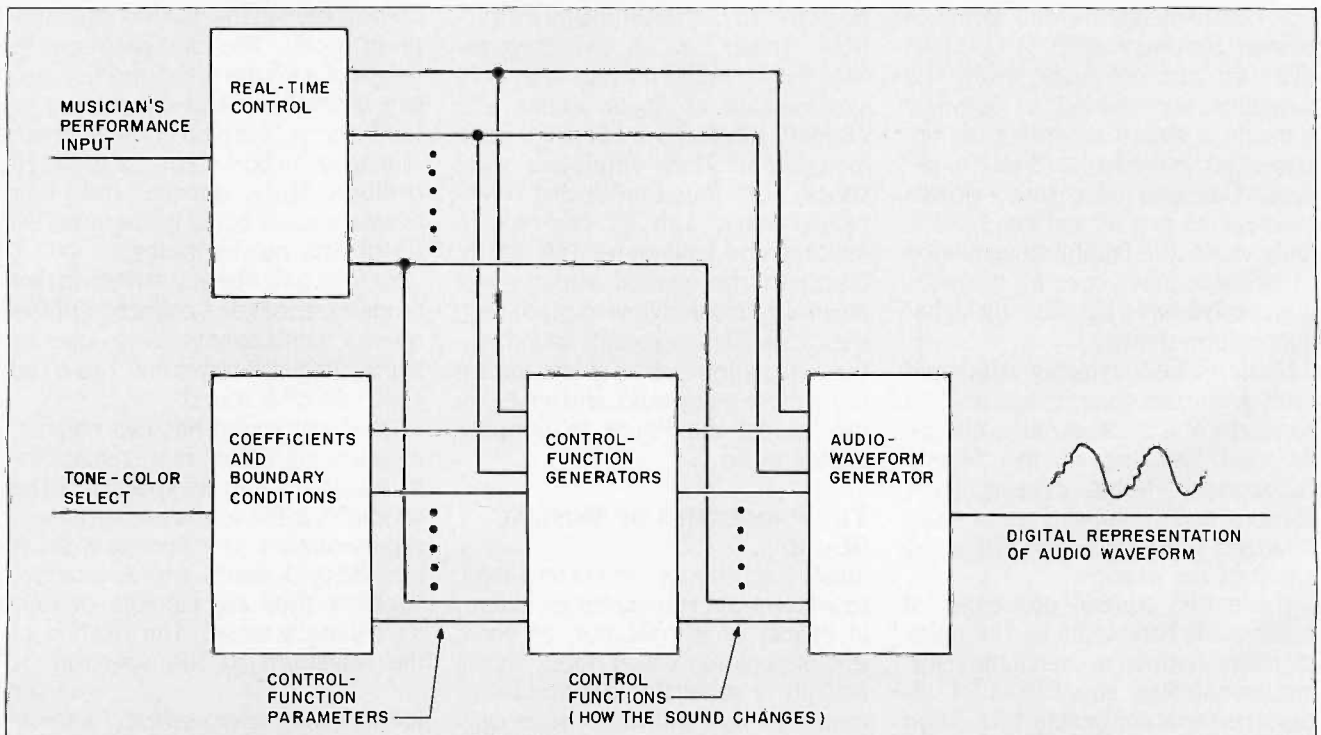

**Figure 1:** Control hierarchy of a typical sound synthesis system. The audio-waveform generator produces an evolving waveform in response to a set of slowly varying control functions. The control-function generator produces control functions in response to a set of numerical coefficients and boundary conditions. The real-time

control module allows the musician to shape continuous changes, either in the waveform itself or in the control-function parameters. The coefficients and boundary-conditions module defines the perceived tone color, while the real-time control module enables the musician to "play" the system.



# PC 3780 FILE TRANSFERS STAY ON THE TRACK



- Download Into Filing Assistant (Option)
- Easy to Use  
Fast and 100%  
Error Free

- Emulation 2780/3780/3740  
All Features
- File Transfer, RJE
- PC to PC
- PC to Any Mainframe  
(Using above Protocols)
- Unattended or Attended  
Auto Pilot, Remote Startup
- Call Using Interface with User  
Application Program, Basic, Cobol,  
Pascal, C, Etc.
- Uses Standard IBM Hardware  
(BSC Board)
- Changeable Translate  
Tables

TO ORDER TOLL FREE  
1-800-826-7839

Inquiry 338

## \$149

305/372-9332

Telex 4947306

# TDT GROUP INC.

444 BRICKELL AVE., #902,  
MIAMI, FLORIDA 33131



voltage-controlled oscillator (VCO) coupled to a voltage-controlled amplifier (VCA). Control functions consist of a low-frequency oscillator (LFO), two exponential rise-and-fall—or envelope (ENV)—generators, and slowly varying functions that control another VCA. The tone setup is a “tone-color preset” whose numbers give the time constants of the envelopes and the frequency of the LFO output. The real-time control is a keyboard controller whose outputs give the VCO’s center frequency (musical pitch) and provide the trigger that starts the ENVs. The resultant tone has a frequency modulation (vibrato) that builds up at the rise time of the first ENV output; the tone itself builds up at the rise time of the second ENV output.

### **DIGITALLY CONTROLLED ANALOG CIRCUITRY**

The first synthesizers were analog. In analog synthesizers, VCOs produce

waveshapes such as sawtooth and square because they are easy to produce and are rich in harmonics—spectrum components whose frequencies are whole-number multiples of the waveform’s repetition frequency. One or more VCFs (voltage-controlled filters) alter the relative strengths of the harmonics, thereby modifying the overall brightness or quality of the sound. VCAs dynamically shape the amplitude of the tone as well as the amplitudes of control signals. The resultant class of tone colors from analog synthesis includes some interesting approximations of traditional instrumental sounds. More commercially important, however, were new sounds that fit into the emerging electronic pop music of the sixties and seventies. Smooth pitch glides of swept VCOs, the vocal-like “wow” sounds of swept VCFs, and the fat, rolling sound of several sawtooth waveforms at nearly the same frequency became basic weapons in the

rock ‘n’ roll keyboardist’s arsenal.

Microprocessor-controlled analog synthesizers first appeared commercially just eight years ago and continue to be popular today. The Oberheim Xpander, for example, is an advanced six-voice instrument with its own self-contained microprocessor-based programming panel (see photo 1). The Xpander is specifically designed for sophisticated communication with the outside world through MIDI. In fact, you can activate virtually all of the Xpander’s panel features externally through Oberheim’s MIDI system-exclusive code set. The panel features provide complete control over 15 analog operating parameters per voice (one of which is a 15-position filter-mode selector), as well as literally hundreds of microprocessor-computed control functions. Thus, although the actual generation and modification of the Xpander’s musical tones are performed by analog circuitry, the amount of control that is accessible via MIDI gives this instrument (and many other contemporary analog synthesizers as well) the same order of programmability and versatility as many all-digital synthesizers.

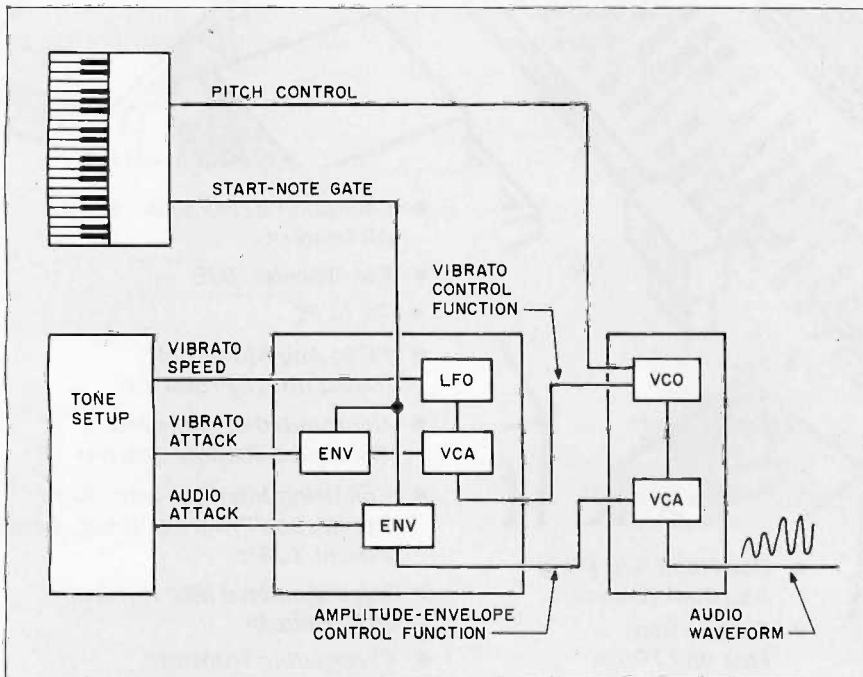

**Figure 2:** A simple analog-synthesis control hierarchy. The audio waveform is produced by a voltage-controlled oscillator (VCO) followed by a voltage-controlled amplifier (VCA). There are three control functions: a number from the keyboard that tells which key is pressed (which pitch to produce), a slow periodic wave that builds in amplitude to provide delayed vibrato, and an amplitude-shaping envelope (ENV) function. The tone setup provides values for vibrato speed, rate of vibrato buildup, and rate of audio-tone buildup. A gate signal that goes on when a keyboard key is pressed starts the two ENV function generators.

### **PHASE DISTORTION: THE CASIO CZ SERIES**

About three years ago, Casio introduced the CZ-101, the first in its line of fully digital, fully programmable synthesizers (see photo 2). It is a four-voice multitimbral instrument that has some similarity to analog synthesizers, both in the way it is programmed and in the sorts of sounds that result.

Like analog sound chains, the CZ algorithm has one parameter that determines the tone’s pitch, a second that determines its brightness or tone color, and a third that determines its overall loudness. The main difference between the CZ and analog synthesizers lies in exactly *how* the tone’s brightness is shaped. In the analog world, the VCF performs brightness control. Analog filtering is a frequency-domain operation, which, in analog technology, is no harder than time-domain operations.

The digital world, however, generally avoids frequency-domain operations



because of the expensive hardware required to perform the many high-precision multiplications per waveform point. The time-domain operation of waveshaping, on the other hand, can achieve the same sort of spectral variation as dynamic filtering with little or no multiplication. Casio engineers designed their algorithm to produce waveforms whose shapes can be swept continuously from pure sine to one of eight user-selectable high-brightness "analog sound-alikes." The algorithm centers around a look-up table in which the instantaneous amplitude of a cycle of a sine wave is plotted against uniform increments of the sine wave's phase angle. When a pure sine-wave output is desired, the phase angle is advanced in equal increments per unit time; when a waveform of higher harmonic content (i.e., a somewhat distorted sine wave) is desired, the phase angle is incremented first more rapidly, then more slowly, during each cycle. Figures 3a and 3b show how the resultant waveform changes as the rate at which the phase angle changes is modulated during a single cycle. Casio calls this algorithm PD, for phase distortion.

By using the concepts of analog synthesis as a starting point but employing an algorithm that is efficiently matched to the capabilities of digital technology, the Casio CZ series instruments offer the musician many stock synthesizer effects, with the versatility and accuracy of control that you associate with any well-designed microprocessor-based operating system, at a low price. The CZ-101, for instance, sells for less than \$500, an amount that, just 10 years ago, would barely have bought a medical minimum analog synthesizer with one voice and no program memory.

### FM SYNTHESIS: THE YAMAHA DX SERIES

Frequency modulation (FM) is the variation of the frequency of one repeating waveform, the carrier, by an amount proportional to the instantaneous amplitude of a second waveform, the modulating wave. The simplest application of FM is the modulation of one sine wave with another.

(continued)

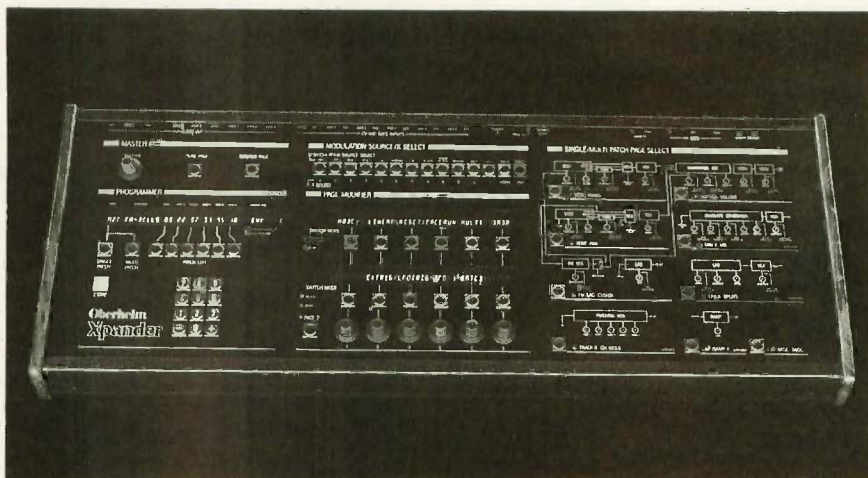

Photo 1: The Oberheim Xpander microprocessor-controlled analog synthesizer.



Photo 2: The Casio CZ-101 phase-distortion, programmable digital synthesizer.

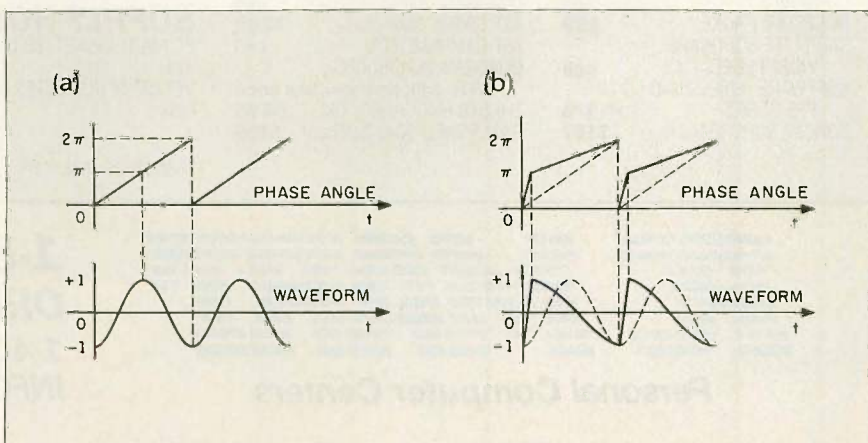

Figure 3: Changing an audio waveform by varying the rate at which a sine lookup table is read out; (a) shows a constant rate of readout, while (b) shows a readout whose rate changes twice per cycle, distorting the sine wave into a sawtooth waveform.



# MEETING YOUR COMPUTER NEEDS FOR OVER A DECADE

## TURBO XT

Dual Spd CPU,  
2-FD, 640K  
Grn Monitor,  
complete

**\$995**



## AT&T† 6300

2-FD, 256K,  
Keyboard, AT&T  
Hi-Res Mono  
Monitor

**\$1,795**



## IBM\* PC

2-FD, Graphics  
mono monitor,  
256K, list 2810

**\$1,679**



## IBM\* AT-Enhanced

20-Megabyte Hard  
Disk, 1.2-MB FD,  
512K, Keyboard,  
Amber Monitor

**\$3,995**



**Complete systems  
shipped overnight.**

## SOFTWARE

ANDREW TOBIAS MANAGING YOUR MONEY	<b>\$129</b>
ASHTON TATE FRAMEWORK	<b>\$439</b>
ASHTON TATE dBASEIII plus	<b>\$429</b>
BORLAND SIDEKICK	<b>\$39</b>
BORLAND TURBO PASCAL	<b>\$45</b>
BORLAND TURBO LIGHTNING	<b>\$45</b>
BORLAND SUPERKEY	<b>\$35</b>
BORLAND REFLEX	<b>\$59</b>
CLIPPER dBASE COMPILER COMPUTER ASSOCIATES	<b>call</b>
IUS Acctg Series from	<b>\$299</b>
DECISION RESOURCES CHARTMASTER	<b>\$239</b>
DECISION RESOURCES SIGNMASTER	<b>\$189</b>
DECISION RESOURCES DIAGRAMMASTER	<b>\$259</b>
DIGITAL RESEARCH GEM DRAW/COLLECTION	<b>call</b>
DIGITAL RESEARCH GEM COLLECTION	<b>call</b>
FUNK SOFTWARE SIDEWAYS	<b>\$48</b>
HARVARD TOTAL PROJECT MANAGER	<b>call</b>
HAYES SMARTCOM II	<b>\$89</b>
IBM DISPLAYWRITER III	<b>\$369</b>
LATTICE C-COMPILER	<b>\$298</b>
LIFETREE VOLKSWRITER DELUXE	<b>call</b>
MICROSOFT WINDOWS	<b>\$179</b>
MICROSOFT WORD	<b>call</b>
MICROSTUFF XTALK XVI	<b>\$99</b>
MULTIMATE latest	<b>call</b>
MULTIMATE ADVANTAGE	<b>call</b>
NORTON UTILITIES	<b>\$59</b>
OPEN SYSTEMS ACCOUNTING SERIES	<b>call</b>
ROSESOFT PROKEY	<b>\$99</b>
SATELLITE SOFTWARE WORDPERFECT 4.1	<b>call</b>
SOFTWARE PUBLISHING CO. PFS SERIES from	<b>\$79</b>
SORCIM SUPERCALC III	<b>\$197</b>

## MASS STORAGE

<b>floppy drives</b>	
MITSUBISHI 1/2ht 360k (bl/gry)	<b>\$98</b>
MITSUBISHI 1/2ht 1.2 mb (gry)	<b>\$147</b>
TANDON TM100-2	<b>\$125</b>
TOSHIBA 1/2 ht.	<b>call</b>

### Internal hard drives

All hard drives complete with controllers, mounting hardware & instructions. All are formatted, tested & have 1 year warranty.

SEAGATE 10MB	<b>\$497</b>
SEAGATE 20 MB	<b>\$596</b>
SEAGATE 30 MB	<b>call</b>
SEAGATE 20 MB for AT	<b>\$689</b>
SEAGATE 30 MB for AT	<b>\$796</b>
PRIAM 40MB/60MB	<b>\$1395/1595</b>
PRIAM 40MB/60MB for AT	<b>\$1425/1625</b>

### disk cards

HARDCARD 10MB/20MB	<b>\$625/895</b>
CMS 10MB/20MB	<b>call</b>
MOUNTAIN 10MB/20MB	<b>call</b>

### disk subsystems

BERNOULLI BOX 20MB/40 MB	<b>\$2695/3595</b>
SYSGEN FLATPACK	<b>call</b>
TALLGRASS all models	<b>call</b>

### tape drives

IRWIN 10MB/20MB inter.	<b>call</b>
IRWIN 10MB/20MB exter.	<b>call</b>
TALLGRASS 4060	<b>call</b>

## BOARDS

<b>multifunction</b>	
QUADRAM QUADPORT AT	<b>\$119</b>
QUADRAM LIBERTY	<b>call</b>
QUADRAM EMS+	<b>call</b>
AST SIXPAK 384k	<b>\$288</b>
AST RAMPAGE XT/AT	<b>call</b>
QUADRAM QUADBOARD 384k <b>call; new low, low price</b>	
THESYS FASTCARD V Ok	<b>NEW!</b>
RAM BOARD 384k half card	<b>\$169</b>

### video/graphics

AST PREVIEW	<b>\$289</b>
HERCULES COLOR	<b>\$188</b>
HERCULES GRAPHICS	<b>\$319</b>
IBM COLOR	<b>\$198</b>
IBM MONOCHROME	<b>\$198</b>
QUADRAM EGA + COLOR CARD w/par.	<b>\$399</b>
QUADRAM QUADCOLOR I MONOCHROME GRAPHICS Herc comp.	<b>call</b>
	<b>\$198</b>

### network

ORCHID PCNET	<b>call</b>
QUADRAM QUADNET IX	<b>call</b>

### emulation

AST 5251 mod 11/12	<b>call</b>
DCA IRMA	<b>call</b>

## MONITORS

<b>monochrome</b>	
AMDEK 310a	<b>\$168</b>
IBM MONOCHROME	<b>\$224</b>
PRINCETON MAX 12	<b>\$178</b>
QUADRAM AMBERCHROME	<b>\$166</b>

### color

AMDEK 600/772	<b>call/\$528</b>
IBM ENHANCED COLOR	<b>\$594</b>
PRINCETON HX12/H12E	<b>\$436/\$526</b>
QUADRAM QUADCHROME II	<b>call</b>
QUADRAM ENHANCED Color	<b>NEW!</b>

## MODEMS

HAYES 1200/1200B	<b>\$398/329</b>
HAYES 2400/2400B	<b>\$596/526</b>
US ROBOTICS PASSPORT 1200/2400	<b>call</b>
PEACHTREE P1200 exter.	<b>\$196</b>
VENTEL 1200 w/XTALK	<b>call</b>

## SUPPLY HOUSE

PC MART DISKETTES box	<b>\$18</b>
case	<b>\$159</b>
VERBATIM DISKETTES box	<b>\$28</b>
case	<b>\$258</b>

Specialists in complete computer systems for business applications.

## PRINTERS

<b>dot matrix</b>	
BROTHER HR1509	<b>\$398</b>
EPSON LX-80	<b>call</b>
EPSON FX-85/FX-286	<b>call</b>
EPSON LQ-800/LQ-1000	<b>call</b>
IBM PROPRINTER	<b>\$425</b>
OKIDATA 182	<b>\$268</b>
OKIDATA 192/193	<b>\$399/545</b>
OKIDATA 2410	<b>call</b>
TOSHIBA 321	<b>call</b>
TOSHIBA 341/351	<b>\$859/1159</b>

### laser/letter quality

BROTHER HR15	<b>\$198</b>
BROTHER HR25/HR35	<b>\$568/798</b>
CORONA LP300	<b>\$2995</b>
EPSON DX20/DX35	<b>call</b>
IBM QUIETWRITER II	<b>\$1259</b>
QUADRAM QUADLASER	<b>in stock!</b>

### plotters

HOUSTON INSTRUMENTS	<b>call</b>
all models available for quick delivery	

## MISCELLANEOUS

MOUSESYSTEMS PC MOUSE w/PAINT	<b>\$159</b>
MICROSOFT MOUSE serial/bus	<b>\$129</b>
KEYTRONICS 5151/5153	<b>call</b>
AT Keyboard	<b>\$149</b>
QUADRAM MICROFAZER 8k	<b>\$129</b>
QUADRAM MICROFAZER II	<b>New!</b>
TRIPPLITE ISOBAR	from <b>\$45</b>
TRIPPLITE UPS 400w/800w	<b>call</b>
CURTIS PROTECTORS	from <b>\$29</b>

## CHIPS

64k/128k/256k	<b>call for market price</b>
	<b>call for market price</b>
8087/80287	<b>call for market price</b>

\*Registered Trademark

†Some systems available to qualified accounts only.



Personal Computer Centers

1485 Northeast Express NE • Atlanta, GA 30329

Visit our showrooms in Atlanta, Charlotte, Durham and Raleigh

**SALES • SERVICE • FINANCING • DELIVERY • SUPPORT**



The mathematical expression that describes this is  $W(t) = P \sin (At + I \sin Bt)$ . This equation tells us that waveform  $W$  is a sine wave of peak amplitude  $P$  and frequency  $A$  and is being sped up and slowed down a peak amount  $I$  at a frequency  $B$ .  $A$  is the carrier frequency,  $B$  is the modulating frequency, and  $I$  is called the modulation index.

The spectrum of  $W$  is a series of sidebands, or sum and difference frequencies:  $A \pm B$ ;  $A \pm 2B$ ,  $A \pm 3B$ , and so on. Calculation of the amplitudes of each of the sidebands requires an understanding of Bessel functions, which are mathematical functions describing how the amplitude of a harmonic changes. This is a complex subject in itself. The general results of these calculations, however, can be stated simply.

1. As  $I$  increases, the amount of energy in  $A$  goes down, and the amount of energy in the sidebands goes up.
2. As  $I$  increases, more and more frequencies become audible. In other words, the bandwidth of the total spectrum of  $W$  increases.

If you set the modulating frequency  $B$  equal to the carrier frequency  $A$ , the sideband frequencies are then whole-number multiples, or harmonics, of the carrier frequency. Starting with two sine-wave generators and tying the instantaneous frequency of one to the instantaneous amplitude of the other, you can generate a single complex tone with a large number of harmonics. Furthermore, you can change the overall harmonic content of the tone simply by varying one parameter, the modulation index  $I$ . By invoking this simple algorithm that operates in the time domain, you gain convenient control over the sound's spectrum.

The Casio PD algorithm uses time-domain processing to generate and control harmonics too. But the advantages of FM over PD lie in what you can do in FM by changing the ratio between the carrier and modulating frequencies.

Most acoustically generated musical sounds have a complex internal motion that makes them interesting and

pleasant to listen to. An important part of this motion is due to the slight deviations in the frequencies of the harmonics from "perfect" whole-number ratios with the fundamental pitch. For instance, the harmonics of a piano tone are all slightly sharp (high). Translated into the time domain, this means that a piano waveform does repeat exactly every cycle but changes slowly and continuously

as the tone evolves. The ability to detune the harmonics by slightly shifting the modulating frequency gives FM the ability to generate a wide variety of continuously changing waveforms that musicians often describe as warm, fat, or acoustic. Serious synthesists prize this capability and spend a lot of time exploiting it.

(continued)

## Say Hello To PC Dial Log Votrax's Tele/Voice System



# PC DIAL LOG

PC Dial Log™ by Votrax gives the IBM™ PC and compatibles full voice management capabilities. Consisting of an expansion card, software, and a cable for connecting a Touch-Tone™ phone to your computer, PC Dial/Log enables your PC to: record and save voice messages; answer up to 40\* incoming calls and take messages;

distribute a voice memo to as many as 150\* numbers; log Touch-Tone™ responses; and the list goes on and on. You also can assign Touch-Tone™ 4D numbers, define calling hours of outgoing messages; create message distribution lists and a phone directory; and leave or change messages for others from remote locations. In short, it's an economical way to eliminate phone tag and keep in touch better with everyone.

If the telephone plays a big part in your life and you're interested in getting the most from your telecommunications, investigate PC Dial/Log at your local dealer or contact Votrax, Inc. directly. With models starting at just \$495, you can't afford not to. Interface software package available for your specific applications.

- Other Votrax Products**
- PSS T-N-T Stand-Alone Devices
  - IBM, Apple II, Commodore 64 Plug In Board Synthesizers
  - Votrax Speech Chips



**VOTRAX, INC. THE VOICE PEOPLE**  
1394 Rankin Troy, Michigan 48033-4074  
(313) 588-2050 TWX-8102324140 Votrax/TRMI

Call Votrax at (800) 521-1350



The advantages of FM were understood by analog-synthesizer designers, but the analog technology of the sixties and seventies did not permit accurate, wide-range, and efficient production of FM waveforms. John Chowning was one of the first people to experiment with digital production of FM sounds. Using a research computer at Stanford University in the early seventies, he systematically explored the relationships between the values of the coefficients of the FM algorithm ( $A$ ,  $B$ , and  $I$ ) and the resultant tone colors. His work led to the development of a series of commercial keyboard instruments by Yamaha, the latest of which are the DX and TX series digital synthesizers. One of these, the Yamaha DX-7, has become enormously popular among electronic keyboardists; well over 100,000 DX-7s reportedly have been sold.

In the DX-7, the basic algorithmic element is a digital oscillator whose output is shaped by a four-segment envelope. Yamaha calls this element an "operator." Six operators are

available for each voice; the complete instrument can simultaneously produce up to 16 voices. The musician may choose one of 32 preprogrammed algorithms, which are configurations of operators. Figure 4a shows what an operator is; figure 4b is an example of a simple algorithm; and figure 4c is an example of a more complex algorithm.

## HARMONIC SYNTHESIS

The most powerful of all synthesis techniques, and the least amenable to intuitive exploration, is harmonic synthesis. This is where the musician explicitly specifies the amplitude envelope and frequency of each harmonic of the tone. In theory, harmonic synthesis is the only way to accurately synthesize arbitrarily complex, pitched tones. In order to do it, however, you have to specify as many as 100 or more harmonic amplitude envelopes for every tone color.

In the mid-seventies, Dr. Hal Alles of Bell Laboratories developed a sophisticated music system based on

harmonic synthesis. The harmonics were generated by incrementing through a high-precision sine-wave lookup table at different rates. The problem became how to shape the amplitudes of all those harmonics without spending a fortune on high-speed multipliers. Alles's solution was ingenious: For every harmonic, read out two sine waves that are of the same frequency but displaced by a slowly varying phase angle. Subtract one from the other. The result is a sine wave whose amplitude is determined by the phase angle.

Alles's design eventually entered the marketplace as the computer-based General Development System and later as the Synergy, a keyboard synthesizer with limited internal programming capability but with a computer interface that provides full programming access (see photo 3). Few people ever met the programming challenge of these instruments. One person who did is Wendy Carlos, perhaps best known as the producer

(continued)

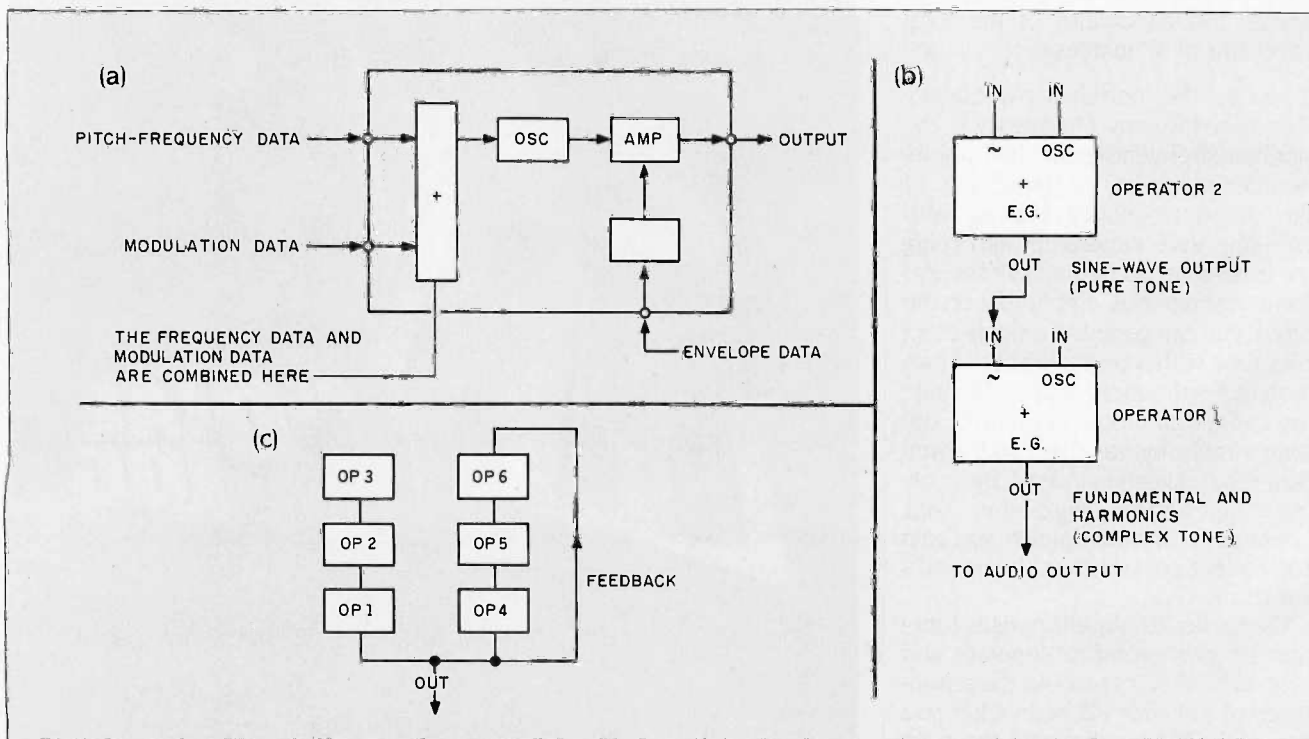

Figure 4: FM waveform-generating building blocks used in Yamaha DX and TX instruments: (a) shows the basic "operator," which you can think of in analog terms as containing a control-summing circuit, oscillator, amplifier, and envelope generator; (b)

diagrams a simple FM algorithm in which one operator modulates the frequency for another; (c) contains a more complex FM algorithm using six operators.



# You've chosen Reflex.<sup>TM</sup> Now choose the fast way to learn it:

**FastStart REFLEX:** the only way to produce as you learn. Only McGraw-Hill's FastStart has the advanced technology that lets you really use your software from the moment you open the package. As soon as you start learning, you start producing databases, reports, graphs, and charts—anything you've bought REFLEX to do! And only McGraw-Hill puts a training window right on REFLEX—actual on-screen instructions that guide you through the program.

**FastStart REFLEX:** the fun and fast way to learn. Only FastStart leads you gently through three levels of training: beginning, advanced, or expert. Each lesson builds on the last, painlessly reinforcing what you've

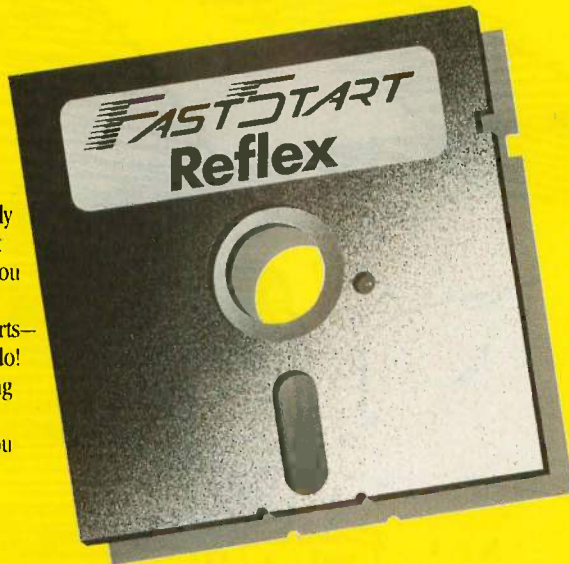

learned as you go. And all along, you're actually using REFLEX. With the help of FastStart, even the most inexperienced user can start producing with REFLEX, fast.

FastStart is also available for Lotus 1-2-3,<sup>TM</sup> dBase II,<sup>®</sup> and DOS.<sup>®</sup> In fact, FastStart tutorials are being created for all the most popular software programs. Look for FastStart dBase III,<sup>TM</sup> MultiMate,<sup>TM</sup> SuperCalc<sup>®</sup> 3, and Symphony<sup>TM</sup> soon. No matter how complex the program, FastStart makes learning simple.



To order, call toll-free (800) 421-0833, Ext. 288 (in California, (800) 662-6222) or send in the coupon to:

**McGraw-Hill**  
Training Systems  
P.O. Box 641, Del Mar, CA 92014

## The fastest way to save up to \$30:

**Yes! I want to start producing! Send me:**

FastStart REFLEX, regularly \$69.95 Now \$39.95

FastStart Lotus 1-2-3, regularly \$79.95 Now \$59.95  
(Compatible with Release 1A)

FastStart dBase II, regularly \$64.95 Now \$49.95

FastStart dBase III, regularly \$69.95 Now \$59.95

FastStart DOS 2.0/2.1, regularly \$59.95 Now \$49.95

Name \_\_\_\_\_

Street Address \_\_\_\_\_

City \_\_\_\_\_ State \_\_\_\_\_ Zip Code \_\_\_\_\_

My check is enclosed       Please bill me or       Charge my \_\_\_\_\_ Phone \_\_\_\_\_

Card # \_\_\_\_\_      Visa \_\_\_\_\_ MasterCard \_\_\_\_\_

Signature \_\_\_\_\_      Exp. Date \_\_\_\_\_

Please send me more information on your FastStart tutorials.

**Offer expires July 31, 1986**

Offer good in USA only. Outside USA, contact your local McGraw-Hill representative.

B686

**FastStart:**  
the fast way  
to learn  
your software.

REFLEX is a trademark of BORLAND Analytica, Inc. MS-DOS is a registered trademark of Microsoft Corporation. dBase II, dBase III, and MultiMate are trademarks of Ashton-Tate. Lotus 1-2-3 and Symphony are trademarks of Lotus Development Corporation. SuperCalc 3 is a registered trademark of Computer Associates International, Inc.



HI, HONEY!

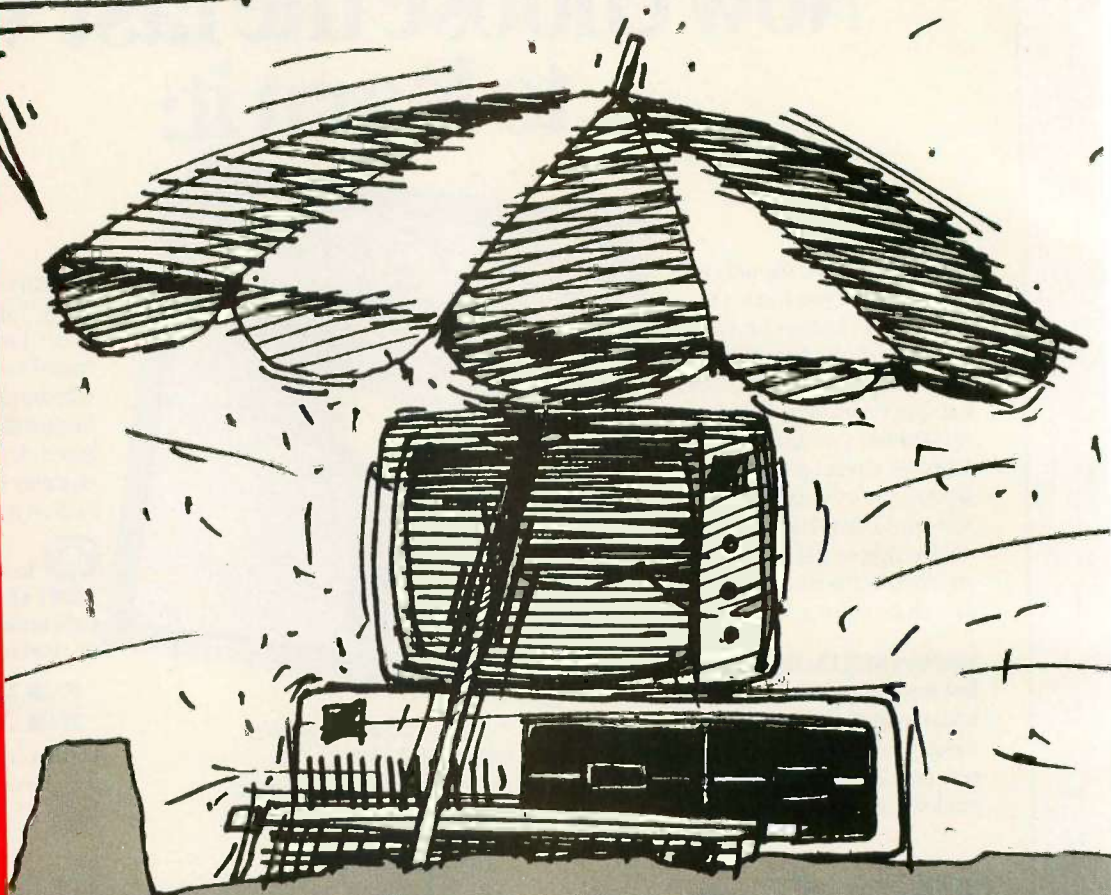

Honeywell synchronous  
VIP emulation and file  
transfer (FTF an option).  
Compatible with Topview.  
Honeywell VIP  
asynchronous emulation  
and file transfer.  
Compatible with Topview.

ASYNCHRONOUS     \$399  
SYNCHRONOUS       \$499

TO ORDER PHONE TOLL FREE  
1-800-826-7839

**TDT**  
GROUP INC.

Rivergate Plaza, 444 Brickell Ave  
Suite 902, Miami Florida 33131  
Telephone 305/372-9332, Telex 4947306

**Connections IBM PC—Honeywell mainframe.**

DPS 4, 6, 7, 8, LEVEL 6, 66, ETC.



of *Switched-on Bach*. A few years ago, Wendy combined her programming skills with unique musical intuition to develop a set of orchestral-like tone colors for the Synergy. She spent some 3000 hours over a two-year period to develop the sounds, which have been made available to Synergy owners. These sounds can be heard on Carlos's record *Digital Moonscapes* (the compact disk is Columbia MK 39340).

More recently, harmonic synthesis is being used in commercially available musical instruments whose sounds are preprogrammed by the manufacturer. One example is the Kurzweil 150, a MIDI-controlled expander that produces high-quality piano and similarly complex sounds by using proprietary synthesis techniques in addition to harmonic synthesis. Another recently announced product along the same lines is the Roland MKS-20. Both instruments provide the musician with access to a few global sound parameters but not to the fine details of the envelopes of the individual harmonics, which are factory-programmed.

### SAMPLING INSTRUMENTS

A sampling instrument records, encodes, and stores one or more musical sounds from the external "real world" and then replays those sounds on command. Some sampling instruments—for example, the Kurzweil 250 (see photo 4 and "The Kurzweil 250 Digital Synthesizer" by Christopher Morgan on page 279)—use proprietary data-compression schemes to reduce the amount of waveform memory without degrading the quality of the sound. All, however, produce their sounds from completely general digital representations that allow any sound short enough to fit in the instrument's memory to be played back. The differences among the various sampling instruments lie in the sound quality an instrument's hardware is capable of and in the sound modification and manipulation algorithms it can perform.

Some musicians assert that sampling instruments are not really synthesizers because the waveforms are not generated by algorithms. I don't

believe that algorithmic generation of waveforms is a necessary feature of synthesizers. The term synthesizer means "to produce by combining separate elements." The more sophisticated sampling instruments enable the musician to mix waveforms, reverse their direction in time, displace them both in time and in frequency, and impart slow frequency modulation and complex envelopes. All of these are perceived as "separate elements" that the musician combines at his or her discretion. Ergo,

sampling instruments are definitely synthesizers.

### CHIP-LEVEL SYNTHESIS HARDWARE

There are also some music synthesis chips available if you would like to experiment with high-quality music synthesis but would rather build it yourself.

Complete high-performance analog functional modules exist as single chips that require a minimum of sup-

(continued)

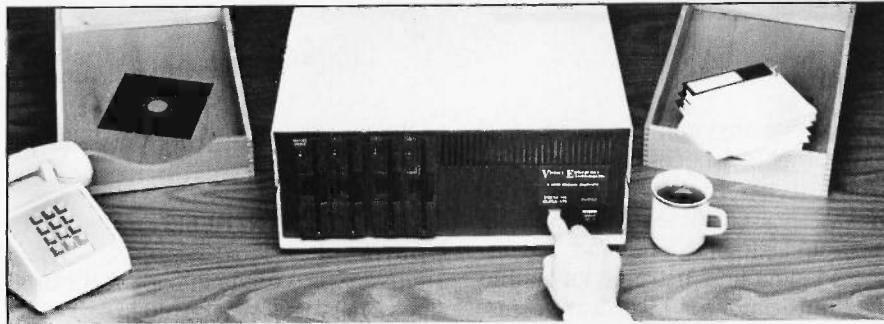

Photo 3: Wendy Carlos, in her studio, illustrating the Synergy, Hal Alles's harmonic-synthesis synthesizer. (Photo by Vernon L. Smith.)



Photo 4: The Kurzweil 250 sampling synthesizer, which includes an optional user-sampling program.





## Copying diskettes will never be easier than pushing one button.

While your computer is busy doing other things, your Victory Duplicator can be making as many as eight copies of a diskette at once — producing up to 400 copies in an hour. DualMaster™ models can even make multiple copies of two different diskettes simultaneously. Just insert the diskettes and press one button.

### Copy different formats, flawlessly.

An automatic format analysis program makes it possible for the Victory Duplicator to

copy virtually any 5¼, 3½ or 8-inch diskette. The system tests for quality and accuracy at every stage of the process.

### It practically services itself.

Each drive has a separate controller to maximize up-time. Simple diagnostics to verify drive alignment and industry standard drives allow you to maintain your system without waiting for outside service.

### All at an attractive price.

Victory Duplicators offer fast copying, serialization,

copy protection, a communications port, a four-month warranty and much more — all for one low price.

### Call 1-800-421-0103.

Call today for more information. (In Texas, call 512-450-0801.)



### VICTORY ENTERPRISES

Technology, Inc.

8910 Research Blvd., Suite B2  
Austin, Texas 78758

©1986 Victory Enterprises Technology, Inc.

port circuitry. Voltage-controlled oscillators, filters, and amplifiers, and an assortment of other musical functions, are available from Curtis Electromusic and Solid State Microtechnology. You program these chips with analog-control voltages, so you will need a high-resolution (at least 12-bit) multi-channel D/A converter to go between your computer and the chips. The chip outputs are high-quality audio.

In the class of digitally controlled synthesis chips, there are programmable waveform generators that accept high-level mode-select and frequency commands and deliver waveform points in real time. The Cybernetic MicroSystems CY360, for instance, generates all the stock synthesizer waveforms, and much more, over the audio and subaudio frequency range.

If you'd like to try your hand at some sampling hardware, consider the Oki MSM 5218 real-time data-compression/expansion chip. Used with a conventional audio A/D converter and a modest amount of support circuitry, this chip reduces a 12-bit data stream (representing the uncompressed audio waveform) into a 3- or 4-bit data stream for efficient storage in your computer's memory and then restores the audio to its 12-bit glory upon playback.

There are many more chips that fulfill music synthesis functions. Many are proprietary designs that are used in commercial products. Generally, neither the applications data nor the chips are available to experimenters. For those of you who enjoy reverse-engineering custom LSI, that's an irresistible challenge.

### SOFTWARE MUSIC SYNTHESIS ALGORITHMS

Most music synthesis devices use dedicated high-speed hardware to produce sound waveforms in real time. If you are interested in synthesizing music off-line at slower than real time, you need little more than a personal computer with plenty of memory and a high-quality D/A converter to turn the computer's waveform data into audio. This is where synthesis programs come into play.

(continued)

# The 10-minute expert.

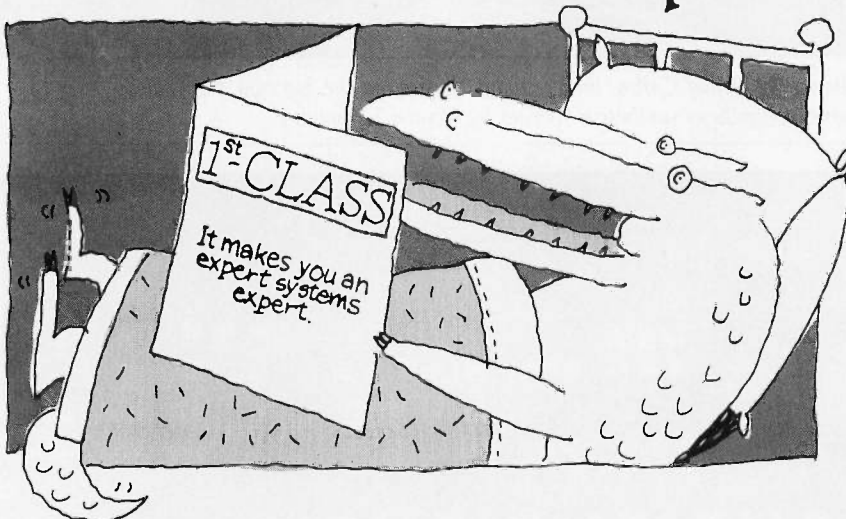

### 1st-Class™ expert system development program.

You can learn to use it in minutes, yet it can build systems of thousands of rules.

**Easy.** As simple to use as a spreadsheet.

**Sophisticated.** Captures expert know-how, works

as decision support, makes diagnoses, controls programs and equipment, and more.

**Talks with software.** Takes data from databases or spreadsheets.

**Tells all.** Tells how decision was reached and gives probabilities of success.

**Finds correlations.** Even makes predictions from confusing data.

**1st-Class. Only \$495.** Demo disk available, \$20. Call 617/653-5093 for literature or to order. For IBM-PC



Programs in Motion  
10 Sycamore Road  
Wayland, MA 01778



# STATGRAPHICS.<sup>®</sup> ONE KEYSTROKE TURNS LIFELESS DATA...

**NEW  
VERSION 1.1**

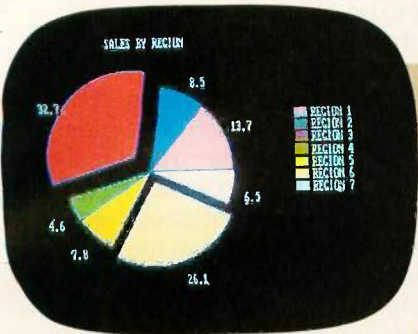

DATA: UNCLASSIFIED (STATGRAPHICS) (Data Editor) (Version 1.1) (Date: 10/1/80) (Number of Data: 14)

Time	X	Y	Temperature	Relative Humidity	Wind Speed	Wind Direction
1	1000	1000	10.0	2.810	42000	
2	1000	1000	10.0	2.672	20500	
3	1000	1000	10.0	2.765	26000	
4	1000	1000	10.0	2.721	11670	
5	1000	1000	10.0	2.848	10425	
6	1000	1000	10.0	2.830	65000	
7	1000	1000	10.0	2.702	10250	
8	1000	1000	10.0	2.712	27500	
9	1000	1000	10.0	2.829	31000	
10	1000	1000	10.0	2.911	78000	
11	1000	1000	10.0	2.744	12000	
12	1000	1000	10.0	2.812	22700	
13	1000	1000	10.0	2.841	50700	
14	1000	1000	10.0	2.775	15000	

Length: 150 N 150 N 100 N 100 N 100 N 100 N  
 Time: N N N N N N N  
 (Center of Mass) (Unit: Distance 1)  
 \* HELP \* SAVE \* PRINT \* ACQUIRE \* DESCRIBE \* DESCRIBE \* TEST \* SORT \* PRINT \* PRINT \* PRINT \*  
 INPUT: PRM:MAH:1 10/01 02:58:00 PM VERSION:1.0

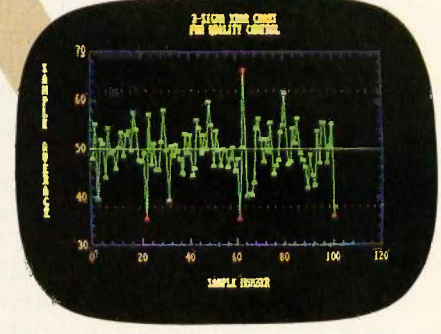
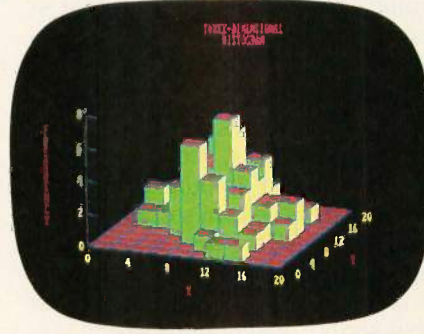
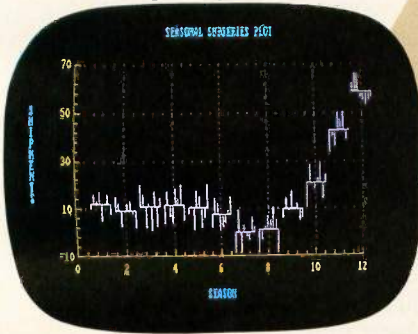
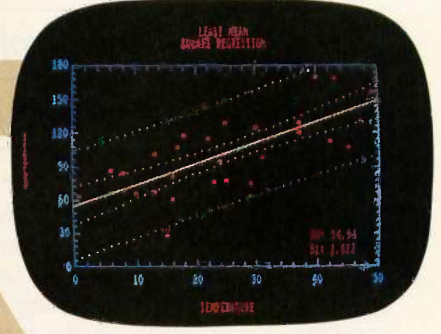

## INTO VITAL STATISTICS.

Data. You live with it every day. What you need are the tools to make it come alive. Comprehensive analytical tools. Mathematical precision. And graphics capabilities to broaden your insights—to help you visualize, analyze, and communicate your findings quickly and convincingly.

And now you've got it. With STATGRAPHICS—a new PLUS\*WARE™ product from STSC. STATGRAPHICS is the only PC software to fully integrate a wide variety of statistical functions with high-resolution color graphics. Giving you the power and precision you used to find only with mainframe software.

STATGRAPHICS' unique interactive environment allows you to generate graphs from within the statistical procedures. You can change a variable and see the effect—immediately. So your job is easier and you're more productive.

### MORE OPTIONS FOR MORE COMPREHENSIVE ANALYSIS.

STATGRAPHICS features over 250 functions for analyzing data—including analysis of variance, regression analysis, experimental design, quality control procedures, multivariate techniques, nonparametric methods, and extensive forecasting and time series analysis.

It also lets you enter data at the keyboard or access data stored in standard ASCII files, LOTUS® 1-2-3 worksheets, and DIF files used by other popular software packages.

### TELL A CLEARER, MORE DRAMATIC STORY.

STATGRAPHICS includes a wide variety of graphics programs such as two and three-dimensional line and surface plots, bar and pie charts, histograms, time sequence plots, and quality control charts.

The graphics are supported on color and monochrome graphics boards, dot-matrix printers, and pen plotters for presentation quality graphics.

### SOPHISTICATED STATGRAPHICS IS SURPRISINGLY SIMPLE TO USE.

STATGRAPHICS is completely menu-driven, and includes a comprehensive user's guide, online HELP screens, tutorial, and handy reference card. And STSC's HELP-Line is only a phone call away—giving you ready access to our staff of technical experts.

### TAKE A LOOK AT STATGRAPHICS.

### AND LOOK NO FURTHER.

STATGRAPHICS is the most advanced statistical graphics software available for PC's. And the complete system is just \$695.

To order STATGRAPHICS, or for more information, contact your local dealer or call 800-592-0050 (in Maryland, 301-984-5123). Or write STSC, Inc., 2115 E. Jefferson St., Rockville, MD 20852. Major credit cards accepted.

Inquiry 330

**Problem-solving at the speed of thought.**

**STSC**  
A Contel Company

STATGRAPHICS operates on IBM PC's and compatibles under DOS, Version 2.0 or later. A minimum of 384K RAM, a graphics adapter and compatible monitor, and two double-sided disk drives or a hard disk are required. An 8087 math coprocessor and 512K RAM are recommended. STATGRAPHICS is a registered trademark of Statistical Graphics Corporation. PLUS\*WARE is a trademark of STSC, Inc. LOTUS is a registered trademark of Lotus Development Corporation.



*Pressure-sensitive  
keyboards will allow  
keyboardists to control  
every note expressively.*

Vosim, which stands for voice simulation, is a program that assembles waveforms from single sine cycles to create a wide variety of vocal-like tones. You specify three slowly varying control parameters: the number of sine cycles per waveform cycle, the time spacing between the sine cycles, and the rate at which the sine cycles die out within a single waveform cycle.

The Karplus-Strong algorithm provides an easy way of synthesizing sounds that evolve from bright to muted, like a plucked string. You start with a wave table of a single waveform cycle, then read the numbers out to create the sound. As you take a number from the table, you replace it with an average of that number and the one that was pulled out before it. This smooths out the sound waveform

as it evolves, thereby reducing the high-frequency content of the sound.

FM produces a waveform by varying the rate at which numbers from a sine-wave table are read out. A wave table is a one-dimensional array. If you used a two-dimensional array of numbers instead and superimposed a closed, or almost closed, curve on that array, you could read numbers from it by following the curve. By changing the shape, size, and position of the curve, you change the resulting waveform. This is called "synthesis by functions of two variables." This is a wide-open area for exploration and would certainly yield sounds that we haven't heard yet.

#### TRENDS FOR THE FUTURE

As semiconductor memory prices continue to drop, it becomes feasible to increase the amount of memory devoted to waveform storage in sampling synthesizers and control-function storage in harmonic synthesis instruments. In both cases, the achievable sound quality improves.

Along with semiconductor memory, bulk data storage prices are dropping dramatically. In particular, the storage capacity of CD-ROMs (over 500 megabytes) allows instrument manufac-

urers to supply enormous sound libraries for any digital synthesizer, but especially for sampling synthesizers. In the near future, we can expect CD-ROMs to be common components in many types of synthesizers.

As the synthesis capability and sound quality of synthesizers continue to grow and the hardware goes down in price while traditional acoustic instruments continue to go up in price, microprocessor-based musical instruments will assume an increasingly larger role in our everyday music making. The next few years will see wide acceptance of home synthesizers, complete with authentic simulations of traditional tones, user-friendly operating systems, and provision for computer interfacing through MIDI.

More and more musicians of all persuasions will come to regard computers as basic music-production tools. Music will be composed directly on the monitor screen, and publication-quality scores will be generated on a laser printer.

Finally, the proliferation of high-performance, 16-bit microprocessors enables musical-instrument designers to build in sensitive, real-time performance control. More and more keyboards will be pressure-sensitive, allowing keyboardists to control every note expressively. And, as musicians accept the idea of pressure-sensitive keyboards, adventurous experimenters will design and build multi-dimensional user interfaces, allowing musicians to control several tone parameters with each finger. An example of this potential exists today in the Notebender (see photo 5), a keyboard on which each key moves up and down *and* back and forth, thus allowing the player to continuously control two parameters of each key that he or she plays.

The popular attitude is that there is something subhuman and mechanical about digital electronics. Today's musicians know that just the reverse is true—that the fantastic capabilities of microprocessors and synthesizers, and all the devices they connect to, offer musicians new and exciting resources, greater human control, and heightened creative potential. ■



Photo 5: The Key Concepts Notebender keyboard with two axes of touch sensitivity. (Photo by Jonathan Goell.)



# CD ROM

## THE NEW PAPYRUS

A fascinating, one-of-a-kind book on the emerging compact disc read-only memory technology. Published in conjunction with Microsoft's First International CD ROM Conference, CD ROM: THE NEW PAPYRUS includes 44 newly commissioned articles from today's leading CD ROM authorities. Every facet of CD ROM technology is thoroughly examined: hardware, software, applications, publishing systems, marketing, the user interface, and opportunities for the future. Included is introductory information for those new to CD ROM technology as well as technical information for CD ROM specialists. Edited by Steve Lambert and Suzanne Ropiequet. Foreword by William H. Gates.

626 pages, 9-1/4 x 7-3/8  
hardcover, ISBN 0-914845-75-6, \$34.95  
softcover, ISBN 0-914845-74-8, \$21.95

*The current and future state of the art.*

Microsoft Press  
16011 NE 36th Way, Box 97017  
Redmond, WA 98073-9717

MICROSOFT.  
P R E S S





Leonardo Da Vinci was not only a great artist, he was also a great engineer and architect. His innovative designs which blended art, science and technology stressed efficiency and detail and were years ahead of their time. Today, Da Vinci's spirit lives on in QDP Computer Systems' new and

# VIVA DaVINCI!

QDP PRESENTS  
THE ULTIMATE IN GRAPHICS CARDS

exciting graphics card. . . VIVA!

VIVA was designed for PC graphics software developers by providing graphics primitives in hardware, increasing productivity and reducing application development time.

VIVA was designed for graphics software users by providing compatibility with existing PC/AT software packages, ultra high resolution color and vastly increased drawing speed over standard graphics cards.

VIVA, like Da Vinci, is now the new standard by which all other graphics cards must be measured. This is VIVA.

- **Compatible with IBM, PC/XT, PC/AT and clones.**
- **On-board video multiplexer**  
*Allows a single monitor to be used for both normal text and graphics. Simply plug the output of your standard color graphics card into VIVA's input port. The display selection is controlled through software.*
- **On-board 16 bit graphics coprocessor**  
*Performs all screen drawing and display functions at high speed leaving your computer's CPU free to perform other tasks.*
- **Use with standard IBM color TTL RGB monitors.**
- **Supports analog RGB monitors on the basic card.**  
*(You get ultra high resolution color that is normally only available on mini and main-frame computers.)*
- **Standard resolution of 640 by 400, 16 colors with 128K of video ram on the Silver Card.**
- **Maximum resolution of 1024 by 1024, 16 colors with 512K of video ram on the Gold Card.**
- **Expansion connector:**  
*Allows upgrades which extend and enhance the features of the basic card—no more obsolete hardware. Planned extensions include:*
  - 256 colors (8 bits/pixel) displayable from a palette of 262,144 colors.
  - 512 colors (9 bits/pixel) displayable from a palette of 16,777,216 colors.
- **Display characteristics are fully programmable**
  - Interlaced mode allows use of low cost monitors.
  - Non-interlaced mode for flicker-free display
  - Display size up to 1024 by 1024 (40MHz bandwidth.)
- **Flash hardware enable/disable on 4 colors (Layers) allows any of 4 specified layers to be temporarily "disabled" i.e., erased, then later can be "enabled", i.e., put back on the screen without being redrawn. This greatly increases speed of use.**
- **Light pen input port.** (Permits a light pen to be used as a pointing or pick device)
- **Hardware pan and zoom support.** (Allows smooth panning, and zoom up to 16 times magnification)
- **Compatible with existing software including AutoCAD, p-cad, VERSACAD, MasterCAD, etc.**
- **Software support.** Planned software includes Tektronix emulation, Graphics support library.

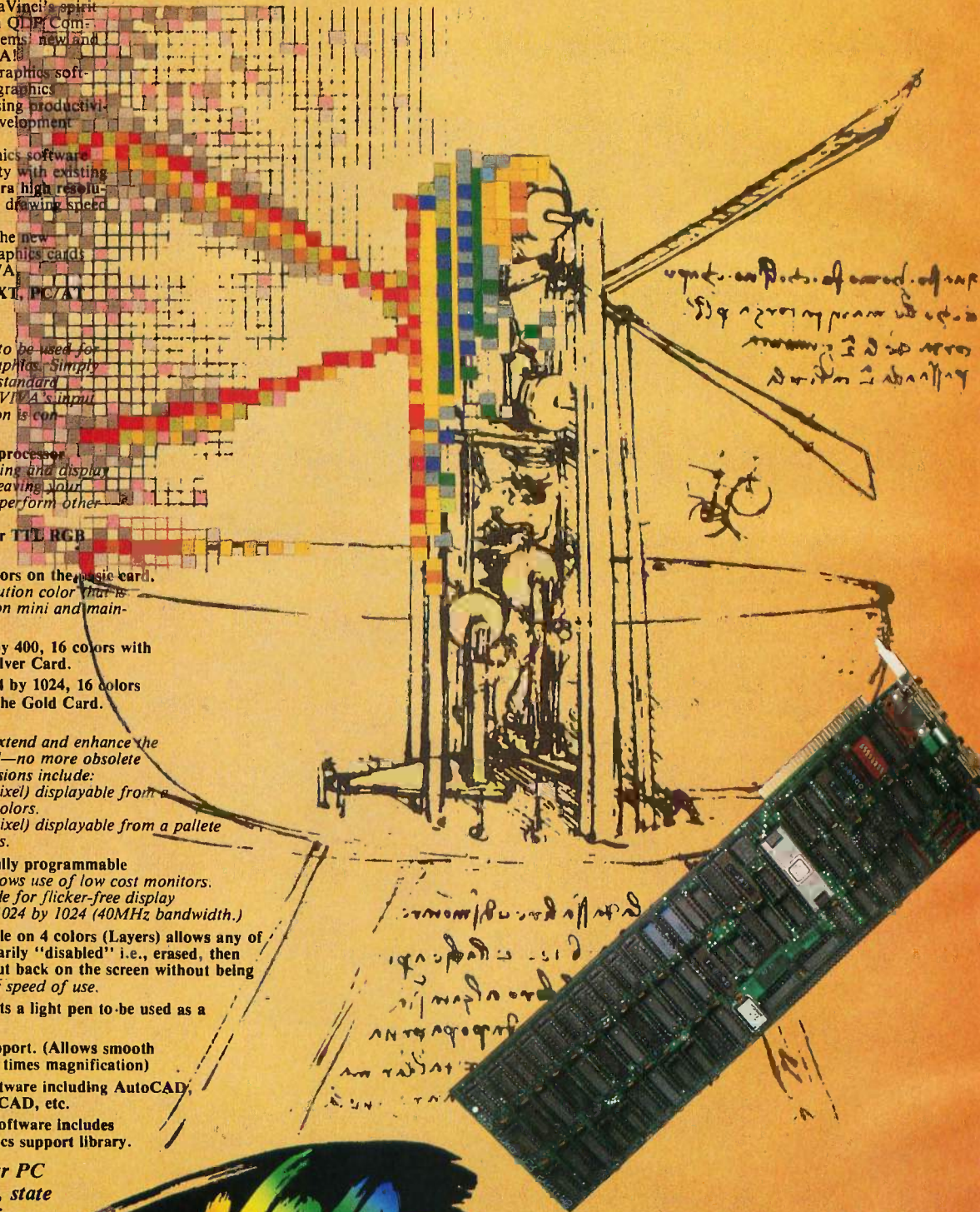

Get VIVA and bring your PC to life! VIVA is versatile, state of the art quality at a price you can afford. Call today and we'll be there—QDP! VIVA Da VINCI!



This card accepted by over 3 million PCs nationally.

Inquiry 281



QDP Computer Systems, Inc.  
10330 Brecksville Road  
Cleveland, Ohio 44141  
(216) 526-0838 Telex 241596  
Cable: Quasdata, Brecksville

p-cad is a trademark of Electronic Design Automation • AutoCAD is a trademark of Autodesk Inc. • VERSACAD is a trademark of T&W Systems, Inc. VIVA and MasterCAD is a trademark of QDP Computer Systems, Inc. • IBM is a trademark of International Business Machines



# DIGITAL SAMPLING ON THE APPLE MACINTOSH

BY CHRISTOPHER YAVELow

## *Uses of digital sampling for music applications*

THE APPLE MACINTOSH is widely accepted as the best microcomputer for musical applications. If sheer numbers of software and hardware products alone are taken into consideration, the past year's nearly four dozen releases would provide ample evidence that this micro is the computer of choice for developers of musicware. Contributing to this fact are the Mac's high-resolution screen graphics, extra-friendly user interface, 32-bit MC68000 microprocessor running at 8 MHz, functional internal synthesizer, and portability.

Microcomputers are used to control sound that they produce themselves or to control other sound-generating devices. In either case, microprocessors are used with oscillators to create sounds for musical use. Sound can be created through additive or subtractive synthesis, FM synthesis, and waveshaping. Digital sampling and wave-table lookup are two similar techniques (see reference 1). In addition, analog oscillators can be placed under digital control and digital oscillators can be operated through analog control.

Both sound generation and sound control may play a role in computer music applications, of which there are five fundamental categories:

1. Score editing: to copy and edit musical scores for eventual printed output.
2. Performance: providing control of an external sound-generating device.
3. Sound laboratory: as a sound-generating/editing/analyzing device.
4. Composition/CAC (computer-aided composition): to generate or assist in the musical composition.
5. Music education: for a variety of CAI (computer-aided instruction) purposes.

All of these types of applications are currently supported by Macintosh musicware.

### **MACINTOSH MUSIC SOFTWARE**

The first wave of Macintosh musicware focused primarily on score editing and secondarily on control of the Macintosh's internal four-voice synthesizer. Score editing, or using a Macintosh to deal with musical notes in a manner analogous to word process-

ing, was released with varying degrees of success within Mark of the Unicorn's Professional Composer, Great Wave's ConcertWare, Utopian Software's MacMusic, Triangle Resources' MusPrint, South Bay's Music Character Set, Shaberazam's Music Type, and Hayden's MusicWorks. While only Mark of the Unicorn's Professional Composer provides score editing and printing capabilities on the level and quality demanded by serious musicians, other products such as ConcertWare, MacMusic, and MusicWorks offer integrated manipulation of the Macintosh's internal synthesizer and score editing (reference 2).

The current second wave of music software for the Macintosh is focusing on using the Macintosh to control external sound-generating devices. The three-year-old industry standard for communication between com-

*(continued)*

*Christopher Yavelow (POB 821, Cambridge, MA 02238) is a professional performer/composer of computer-assisted music whose works have received awards in 19 international competitions.*



puters and musical instruments that use microprocessors is MIDI. The primary concern of MIDI is the recording of sequences of notes, including information about pitch, timing, on velocity, off velocity, patch change, and various front-panel synthesizer controls. As the term suggests, MIDI sequencers allow for this information to be played back precisely through an external sound-generating device or synthesizer. In addition, because MIDI data consists entirely of numerical information, this data can be edited and manipulated in real time or as files at the composer's convenience (reference 3).

MIDI sequencer software offering both MIDI in and MIDI out is available with Mark of the Unicorn's Performer, Southworth's Total Music, Opcode's MIDIMAC Sequencer, Musicworks' MegaTrack, Great Wave's ConcertWare+ MIDI version, Creative Solutions' StudioMac, and Assimilation's MIDI Composer. Electronic Arts'

Deluxe Music Construction Set and Hayden's MusicWorks offer MIDI out only. Some packages (e.g., Performer, Total Music, ConcertWare+, Deluxe Music Construction Set, and MusicWorks) provide for the conversion of MIDI data into conventional music notation, or sheet music. Finally, Musicworks Inc. markets a utility program called MIDIWorks, which converts files to and from the various formats used by the different manufacturers (reference 4).

The possibility for special "system-exclusive" (i.e., synthesizer-specific) information is also built into the MIDI specification. Through system-exclusive data, MIDI may also be used to edit patch parameters for specific synthesizers, usually of the FM synthesis-based variety. Opcode Systems markets a patch editor for the Yamaha DX/TX series and Casio CZ series of synthesizers. Patches may be saved to Macintosh disks providing storage space for up to 50 or more banks of

patch information at a fraction of the cost of RAM cartridges. Musicworks Inc. has released a Macintosh-based patch librarian program storing and manipulating patches from the Yamaha DX/TX series, and Opcode sells librarian software for practically all the major brands of synthesizers.

An even more recent development is the provision that allows passing digitally sampled information via MIDI for subsequent waveform editing. Both Emu's Emulator II (using Digi-design's Sound Designer) and Ensoniq's Mirage (using Blank Software's Sound Lab) offer this capability. Other sampling keyboard manufacturers such as the renowned Kurzweil are following suit using both MIDI and non-MIDI communication (references 5 and 6).

Last but not least, the Macintosh is a flexible sampling machine in its own right. The remainder of this article will be concerned with the sound-sampling capabilities of the Macintosh and the various uses of sounds digitized thereby.

### MACINTOSH SOUND HARDWARE CAPABILITIES

To understand the Macintosh in its aspect as a sound-sampling device, you must first consider the hardware. The Apple Macintosh generates sound in three ways. All Macintoshes come with a built-in ROM-resident sound driver that consists of three different synthesizers:

1. The four-tone synthesizer, which can produce four tones simultaneously and utilizes 50 percent of the microprocessor's time.
2. The square-wave synthesizer that does just what it implies, using about 2 percent of the processor's time.
3. The free-form synthesizer that is used to generate complex music and speech and requires about 20 percent of the processor's time.

Of these three possibilities, only items 1 and 3 have serious musical applications. Furthermore, when considering the Macintosh as a sampling machine, an application may utilize the free-form synthesizer or send sound samples to the built-in audio

(continued)

# It's Time To

**NEW SLIM DESIGN and a LIFETIME WARRANTY . . .**

Two great reasons to make the switch. Only 1½" high, but still with the same high quality features you have come to expect from DATA SPEC Switch Boxes:

- Reinforced printed circuit boards

- Full shielding
- Durable metal construction
- Gold-plated contacts
- All pins switched

And now, backed by a lifetime warranty. Visit your local DATA SPEC dealer and see our full line of slim style data switch boxes and other computer accessories.



# Switch Boxes

**DATA SPEC**  
A DIVISION OF ALLIANCE RESEARCH CORPORATION

THE ULTIMATE IN COMPUTER ACCESSORIES

20120 Plummer Street • P.O. Box 4029 • Chatsworth, CA 91313 • (818) 993-1202



We have over 1000 Software and hardware items in stock. Shipments on almost all items within 24 hours!



**FREE SOFTWARE!**  
With over \$100 purchase you will receive a free diskette for your IBM PC with label maker, checker game and banner programs.

Call for programs not listed

Technical & Other Info. (602) 246-2222

# TOLL-FREE ORDER LINE 1-800-421-3135

## SOFTWARE

### ---DATA BASE MANAGERS---

Clipper	\$345
Clout 2	129
Condor III	310
Fox and Geller Quickcode	145
Fox and Geller Quickreport	145
Knowledgeman II	299
K Paint	60
K Graph	135
K Text	105
K Report	135
Nutshell	Call
PFS: File	78
RBase 5000	329
Think Tank	93
Tim IV	169

### ---WORD-PROCESSING---

Easy (Micro Pro)	89
Leading Edge w/Merge/Spell	75
Microsoft Word 2.01	229
Multimate 3.31	Call
Multimate Advantage	Call
Oasis Word Plus	85
Peachtext 5000	145
PFS: Write	78
Random House Spell Checker	36
Samna III 3.0	265
Volkswriter 3	Call
Word Perfect 4.1	199
Wordstar	170
Wordstar Propac	238
Wordstar 2000	238
Wordstar 2000+	285

### ---SPREADSHEETS---

Microsoft Multiplan	115
PFS: Plan	78
Supercalc III 2.1	Call
VP Planner	69

### ---ACCOUNTING---

BPI Accounts Payable	299
BPI Account Receivable	299
BPI General Accounting	299
BPI Payroll	299
Cyma	Call
Dollars and \$ense	95
Tobias Managing Your Money	94

**TCS. Big Four equivalent of Peachtree Series 4** - Specially augmented and customized for your IBM PC Terminal and Printer - GL, AR, PA, AP, CP/M-80, CP/M-86 for PC XT, DOS 1.1, 2.0.  
Each Module \$65 For All Four \$249

### ---INTEGRATED---

Enable	Call
Smart Software	Call

### ---TRANSFER PROGRAMS---

Crosstalk XVI	89
Hayes Smartcom II	88
Microsoft Access	149
Move-It	79
Remote	89

### ---GRAPHICS---

Chartmaster	206
Dr. Halo II	99
Energraphics w/o Plotter	170
Energraphics w/Plotter	220
Fancy Font	129
Fontrix	99
Freelance	199
Graphwriter/Combo	310
Microsoft Flight Simulator	30

Printshop	\$36
PFS Graph	78
Signmaster	135

## INCREDIBLE VALUE!

Nationally advertised boards for IBM PC and most compatibles at giveaway prices. **1 year warranty**  
Keyboards (similar to 5151) .... \$89  
Monochrome Board w/Printer Port ..... \$79  
Graphic Board with parallel port (similar to Hercules Graphics) \$95  
Expansion Board 0 to 576K .... \$42  
Multifunction Board w/game port (similar to AST Six Pack) .... \$99  
Four Drive Floppy Controller ... \$45  
Color Card without printer port. \$79  
Color Card with printer port .... \$89  
**MULTITECH IBM Compatible**  
Computer 256K, dual drives, 8MHz, Ports-parallel -2 serial-clock-game, 5151 type keyboard, 6 month warranty..... \$995

### ---LANGUAGES---

Lattice C Compiler 3.0	Call
Run C Professional	169
Microsoft C Compiler	235
Microsoft Fortran	209
Microsoft Macro Assembler	89
Microsoft Pascal Compiler	78
Microsoft Quick Basic	59
Multi Halo	140

### ---UTILITIES---

Copy II PC	19
Copy II PC Board	79
Copywright	45
Desqview	59
Fastback	95
Norton Utilities 3.1	52
PC Tools	19
Prokey 4.0	75
Superkey	35

### ---PROJECT MANAGEMENT---

Harvard Total Project Manager	269
Microsoft Project	235
Super Project Plus	Call

## HARDWARE

### ---HARD DRIVES---

Bernoulli 20 MB 1/2 ht.	2269
Seagate 20 MB Internal w/Controller	439

### ---MODEMS---

Anchor Express	235
Hayes 1200	Call
Hayes 1200B w/Software	Call
Hayes 2400	599
U.S. Robotics Courier 2400	Call
U.S. Robotics Password 1200	Call

### ---RAM---

64K 150NS Chips (Japan - Set of 9)	11.50
256K Ram Chips (Set of 9)	32

### ---BOARDS---

AST Advantage	359
---------------	-----

## HARDWARE

AST Sixpack (384K)	Call
Hercules Color Card	145
Hercules Graphics Card	299
J RAM III (Tall Tree)	Call
J RAM III AT (Tall Tree)	Call
J Lazer (Tall Tree)	Call
Paradise Five Pak	119
Paradise Modular Graphics Card	249
Quadram Board with Par/Ser and Game Port	199
Quadcolor I	185
Sigma Maximizer Multifunction	149
STB Chauffeur Board	249
STB EGA Plus	320
STB Mono Board	155
AB Parallel Print Switch w/cables	75
Mini Micro Parallel Print Buffer	69
IBM 120 Watt Power Supply	83

### ---COMPUTERS---

Corona PC	Call
Sperry PC Mono 256K Dual Drive Serial Port, Clock, MS/DOS 2.11	Call
ITT Computers PC Compatible 256K Dual Drive, Mono, MS/DOS	Call
ITT XP 80286 IBM/PC Compatible, 512K, 10 MB Winchester, 3 times faster than an XT. 30% faster than an AT.	Call

Sharp Portable	Call
----------------	------

### ---PRINTERS---

**FAST! ALL NEW PRINT SELECT PROGRAM VERS. 2.0**  
Written in assembly language for most MS-DOS computers. With purchase of any printer you will receive at no charge this menu driven program to set print characteristics or to make your computer function as a correcting typewriter. Retail value \$35.

<b>CITIZEN</b>	
MSP-10	255
MSP-15	355
MSP-20	329
Citizen 120D	169
Premiere 35 Daisywheel	415
<b>EPSON</b> - Call on all models	
<b>JUKI</b>	
Juki 6100	349
Juki 6300	685
<b>NEC</b>	
3550	785
8850	1135
P5 Parallel	995
Elf 360	398

<b>OKIDATA</b> - Call on all models	
<b>PANASONIC</b>	
1091	239
1092	316
1592	435
KXP3151	410
<b>STAR MICRONICS</b> - Call for prices	
<b>TOSHIBA</b>	
1340	460
P351	975
P341	799

### ---MONITORS---

AMDEK	Call for price
Taxan 121 Green	Call
Taxan 122 Amber	Call
Princeton Max 12	159

**TERMS:** Add 3% for C.O.D. orders. Shipping on most software is \$5.00. AZ orders +6% sales tax. Personal check - allow fourteen (14) days to clear. Prices are subject to change. We accept purchase orders from authorized companies. All returns are subject to our approval. There will be a 20% restock charge.

No Charge for MasterCard or Visa



TOLL-FREE ORDER LINE 1-800-421-3135

## WAREHOUSE DATA PRODUCTS

2701 West Glendale Ave. • Phoenix, AZ 85051

Hours 7 A.M. to 5:30 P.M. M.S.T. - Mon. thru Fri.  
Saturday 10:00 A.M. to 3:00 P.M.

We do not guarantee compatibility



output jack in a unique way to exceed the four-voice limit that item 1 seems to imply.

Due to hardware limitations, the highest frequency the Macintosh can currently produce is 11,116 Hz. *Inside Macintosh* (reference 7) gives the following explanation for this limitation: The sound driver and disk-motor speed-control circuitry share a 740-byte buffer, of which the sound driver uses the 370 even-numbered bytes. Every horizontal retrace interval (i.e., every 44.93 microseconds, when the beam of the video screen moves from the right edge of the screen to the left), the MC68000 automatically fetches 2 bytes from this buffer and sends the high-order byte to the speaker. Thus, all frequencies generated by the sound driver are multiples of this 44.93-microsecond period. The highest frequency physically possible for the sound driver is twice this period, or 89.96 microseconds, which translates to a frequency of 11,116 Hz. Likewise, every vertical retrace interval (every

16.6 milliseconds), the sound driver fills its half of the 740-byte buffer with the next set of values.

These limitations notwithstanding, the Macintosh also comes with a built-in monophonic audio output jack that can be attached to any standard stereo system or cassette.

**INTRODUCTION TO DIGITAL SAMPLING**

Digital sound sampling is a new enough field that an explanation of the technique might be in order. It can be easily understood by making an analogy to motion pictures. In a film, many consecutive still photographs of a continuous (analog) motion are projected rapidly to recreate the illusion of continuous motion. Sound also exists within an analog continuum, and sound sampling, or digitizing, captures a specified number of "snapshots" of a sound that are subsequently played back at a rate typically between 5000 and 100,000 samples per second in order to recreate the original sound (see figure 1).

Regarding questions of fidelity of the reproduction to the original, both sound and film share common concerns. You must consider two factors with respect to sound sampling: rate and resolution. To clarify these two considerations, I will return to the motion-picture analogy. The size of a single frame in a film represents its resolution and thus places actual physical limitations on the fidelity with which a film can reproduce visual information. Varying degrees of quality are dependent upon whether 8mm, 16mm, 35mm, or 70mm film is used to capture the still photographs of analog motion. Working hand-in-hand with resolution is the rate of speed at which the still photographs are projected. Typical 35mm film used in commercial movie houses is projected at 24 frames per second, and the general audience accepts this rate as adequate to achieve the illusion of continuous motion.

Sampling rate and resolution play an even larger role in determining the degree of credibility within the do-

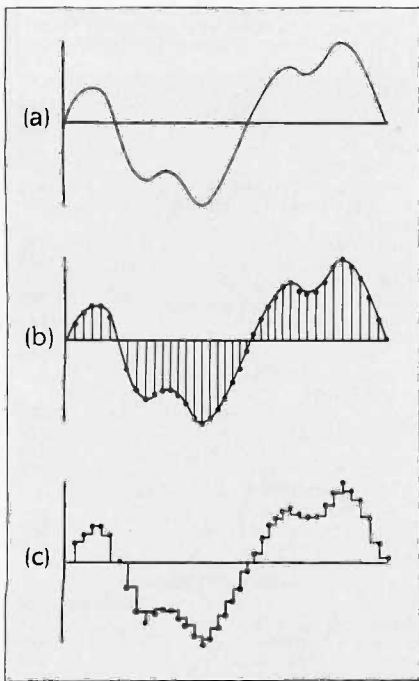

Figure 1: Digital sampling of an analog sound wave: (a) The analog wave; (b) digital samples taken of the wave; (c) digital reconstruction of original waveform.

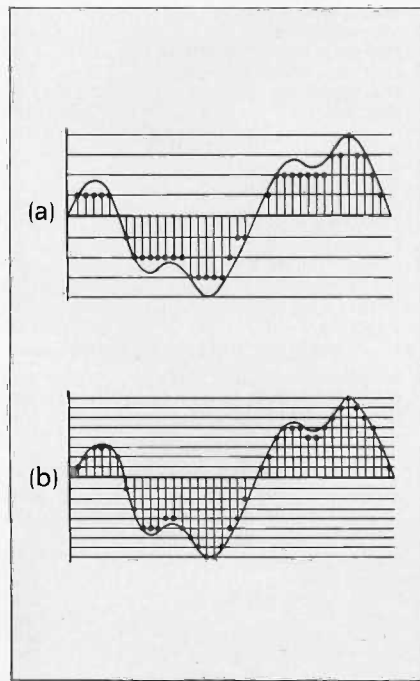

Figure 2: The number of digital values used to represent samples affects the accuracy of the reproduction of the sound wave. Note the difference in the reconstruction of the waveform, even though the sampling rate is identical.

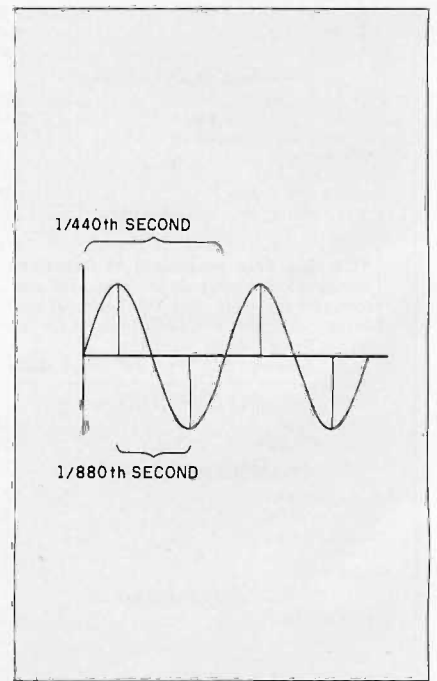

Figure 3: A minimum of two samples are required to represent a sound wave.



main of sound reproduction. Average listeners are far less forgiving than film-goers. The "size" (or resolution) of each sound sample is analogous to the size of film in a motion picture. Since a single sample consists of the measurement of an analog (i.e., continuous) voltage via an A/D converter, using a larger range of numbers for measuring this voltage permits a more accurate representation of the voltage. Digital computers use binary bits to represent numbers, so the maximum number of bits available for each measurement will determine the highest number of voltages that can be represented and thus the incremental range within which all measurements must be scaled. The largest number that can be represented by 8 bits is 256; thus, 8-bit sampling requires that all voltages be rounded off to only 256 different values. Twelve-bit sampling offers resolution to 4096 different steps and 16-bit sampling provides a range of 65,536 (see figure 2). Theoretically, each additional bit adds approximately 6 decibels to the signal-to-noise ratio. However, in practice, many sampling devices periodically send an additional 4, 6, or 8 bits of data along with their samples for the purpose of providing additional information about the sound's waveform. This process may raise the dynamic range considerably.

The rate at which sound samples are captured, as well as how fast they are output, is almost as important as sample resolution when considering the fidelity of a digitally sampled sound to the original analog signal. According to Nyquist's theorem, a minimum of two samples per sound wave is necessary to represent a given sound wave. Therefore, to represent a pure sound with a frequency of 440 Hz (cycles per second), you are required to sample that sound at a minimum rate of 880 samples per second (see figure 3). In reality, most sounds are complex waveforms with overtones extending well beyond the average human range of hearing, or 20,000 Hz. Thus, for the accurate reproduction of most musical sounds, a minimum sampling rate of 40,000 samples per second would be op-

timum. On the other hand, the degree to which overtones of frequencies higher than 10,000 to 12,000 Hz contribute to one's perception is debatable. These high overtones are of such low dynamic intensity (i.e., volume) that many people argue that a sampling rate of 25,000 samples per second is adequate. As a reference point, the fundamental frequency of the highest note on a piano (C8) is 4186 Hz.

**SAMPLING WITH THE MACINTOSH**

The hardware capabilities of a Macintosh computer limit the sampling rate to approximately 22,000 samples per second with an 8-bit resolution. The internal speaker of the Macintosh is unable to handle sound of this quality, although the backpanel monophonic audio output jack can send a signal of this quality to an external amplifier such as a typical home stereo system. For purposes of comparison, most CDs (compact disks) use a 44.1-kHz sampling rate with 16-bit sample resolution.

At the time of this writing, there are three sampling packages available for the Apple Macintosh. All products include both software and the necessary A/D-converter hardware. MacNifty's SoundCap is a low-cost hobbyist/hacker-oriented product with distinct third-party applications. GW's MacADIOS is a high-end digitizer geared toward scientific laboratory applications. Finally, the Berkeley Mac Users' Group markets a low-cost do-it-yourself digitizer kit. Due to the fact that the purpose of this article is to ex-

amine computer music applications, MacADIOS will be described only briefly.

**MACADIOS**

MacADIOS (Macintosh Analog/Digital Input/Output System) is a professional hardware/software package consisting of a waveform-oriented, general-purpose data-acquisition system providing oscilloscope, spectrum analysis, and XY recorder functions. In the oscilloscope function, 25 milliseconds of analog voltage data sampled at a rate of 20,833 samples per second is plotted on the screen three times per second. Other applications are limited only by the available RAM. Uses include controlling and monitoring scientific experiments and processes. The hardware provides four analog voltage outputs (12 bits), eight analog voltage inputs (12 bits), 16 digital outputs, 16 digital inputs, timer, programmable clock, and a 20,833-values-per-second maximum sample rate (see photo 1).

Included with the hardware is a general-purpose data-acquisition program called MacADIOS Manager. This software provides a Monitor Window, a Graphic Editor Window, a Value Editor Window, and a View 4 Window (similar to a programmable four-trace digital oscilloscope). In some applications, three snapshot windows may be opened to allow the user to quickly view waves in low resolution. The software can also produce sonograms in seconds and spectrograms in minutes. Fifty routines are provided

*(continued)*



Photo 1: The MacADIOS digitizer unit.



for executing highly specific tasks with MacADIOS from a user's C or Microsoft BASIC program (see figure 4).

**MACNIFTY AUDIO DIGITIZER WITH SOUND CAP SOFTWARE**

The MacNifty audio digitizer package consists of a hardware digitizer (A/D) and associated SoundCap software. The hardware includes an RCA audio input jack, a 1/8-inch remote-control jack, a gain control, and a 9-pin male connector with cable for the Macintosh's modem or printer RS-232C ports. The primary SoundCap program was developed by Fractal Software. Other secondary applications

included in the package are Sound-Init, BeepInit, Type Writer, and Sound-Play.

The primary software, SoundCap, permits 8-bit sampling at four sampling rates: 22, 11, 7.4, and 5.5 kHz. Therefore, the Nyquist frequencies (the highest recordable frequency) are 11, 5.5, 3.7, and 2.75 kHz, respectively. Because fewer samples are taken for slower sampling rates, as the Nyquist frequency drops, the maximum sampling duration increases. With 512K-byte RAM, sampling at 22 kHz will allow 15 seconds of sound to be recorded. The lower sampling rates will permit 30, 45, and 60 seconds of

sampled sound, respectively. Owners of Macintoshes with more than 512K RAM can expect longer sampling durations limited only by the amount of linear RAM available to SoundCap for usage. Once sounds have been sampled, an option to save the soundfile using data compression is provided for conserving disk space. Furthermore, an option to save the soundfile as a "Studio Session" (discussed below) instrument is available. In addition, you can open standard Studio Session instrument files for precise editing in SoundCap (see figure 5).

SoundCap's main screen displays five mode buttons. The buttons are labeled with icons representing record, playback, oscilloscope, reverb, and spectrum-analysis modes. Pressing the record button with the mouse pointer presents you with a request for a record duration to be specified in seconds and milliseconds. Pressing playback initiates playback. The other three buttons address real-time functions. One use of the real-time oscilloscope mode is to allow you to take accurate record levels prior to sampling. The reverb mode turns the Macintosh into a real-time digital reverberator and also permits you to test out reverb parameter settings prior to applying them to a soundfile (an operation that cannot be "undone"). The real-time spectrum analyzer may be used to ascertain the optimum sampling rate for the sound being recorded. Spectra are displayed as a bar chart—the vertical axis represents amplitude, and the horizontal axis, frequency ranging from 0 to 9740 Hz. The user may specify the resolution, in samples (128, 256, 512, or 1024), used for the Fourier transform.

Sampled sounds are displayed graphically on the main screen, with amplitude as the vertical axis and time as the horizontal axis. The sound may be both horizontally scrolled through or "zoomed" into or out of for viewing more samples on the screen at once. As you zoom into the sound at various resolutions, the waveform's amplitude envelope (attack or growth, sustain, and decay

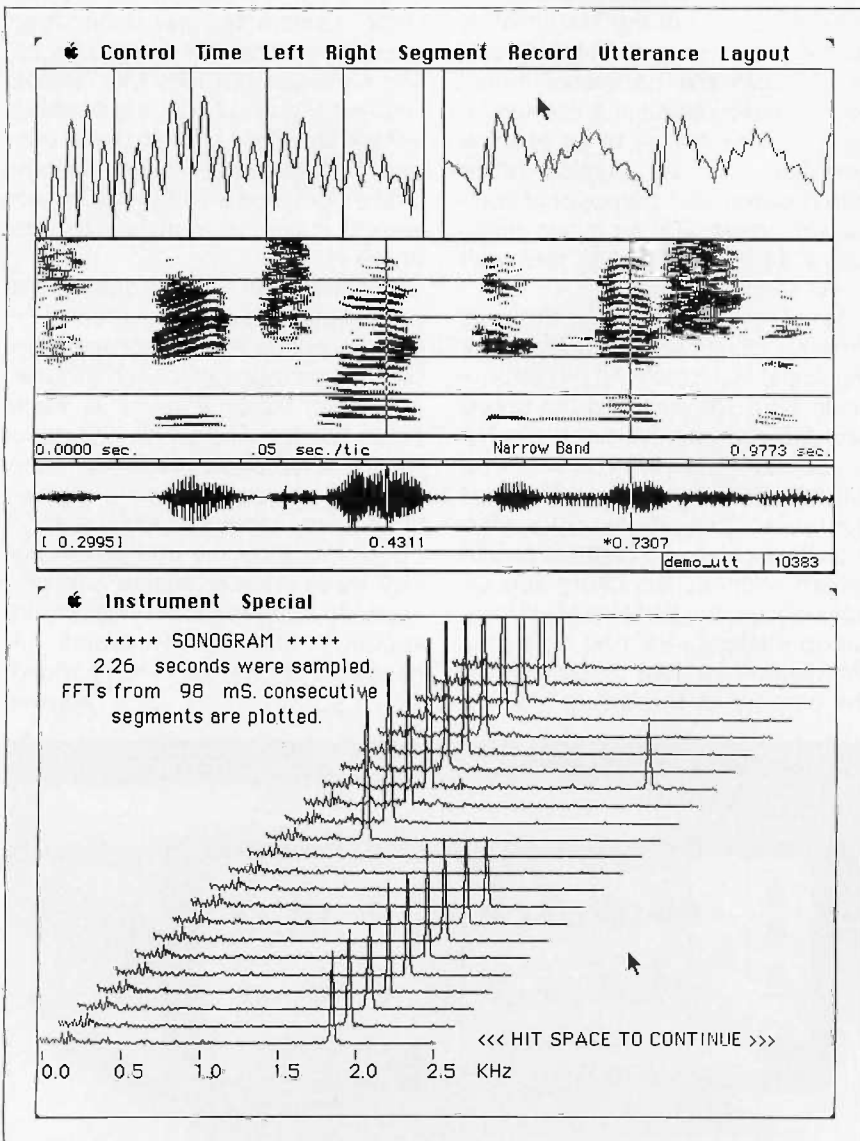

Figure 4: Two of the many screens of MacADIOS.

(continued)



PC Magazine  
Product of the Year

# Macro Assembler

The quickest. Bar none.

Our Macro Assembler has long been the most complete package on the market. Now it's also the fastest. Three times faster than before. And faster than anyone else. Period.

Of course, it's still the most powerful assembler on the market. It supports the standard 8086/8087 opcodes. And the new 186/286/287 instruction set. So you can make the most of the new machines.

Debugging is quicker, too. Thanks to our interactive symbolic debugger, SYMDEB. Now you can refer to variables and source code instead of getting lost in hex dumps. And this debugger also works with Microsoft languages like C, FORTRAN and Pascal. So now you can set breakpoints and trace execution — using source code for reference.

```
-v .10
10: DO 10 I = 1, 8191
11:   .10  FLAGS(I) = .TRUE.
12:   DO 91 I=1, 8191
13:     IF (.NOT. FLAGS(I)) GO TO $1
14:     PRIME = 1 + I + I
15:     FORMAT(IX, I6)
16:     COUNT = COUNT + 1
17:     K = I + PRIME
-bp .14 "u"
-g
14: PRIME = 1 + I + I
1AET:0069 A16240 MOV AX, [4062] ;BRG
1AET:006C 03C0 ADD AX, AX
1AET:006E 40 INC AX
1AET:006F A36440 MOV [4064], AX
16: COUNT = COUNT + 1
1AET:0072 FF066040 INC Word Ptr [4060]
17: K = I + PRIME
-v 4062
0001h 00000001 (1) " "
16: COUNT = COUNT + 1
```

Cut your development time dramatically. Microsoft Macro Assembler's Symbolic Debug utility lets you debug your Macro Assembler programs, or debug your Microsoft C, FORTRAN or Pascal programs using your original source code or the resulting disassembly. For example, you can set breakpoints on line numbers and observe the contents of variables or expressions.

SYMDEB is just part of our complete set of utilities. Tools that make programming as fast as it should be. There are the linker and library managers you'd expect. Plus a new version of MAKE, our maintenance utility, with improvements like macro expansions and inference rules.

We've also revised the manuals. Our new Macro Assembler has a lot to offer, so we added more examples. Now our manuals are

not only thorough, they're clearer than ever before.

For quick development and assembly, the choice is obvious. Microsoft. There's nobody faster.

## Microsoft® Macro Assembler Version 4.0 for MS-DOS®

### Macro Assembler

- Fastest macro assembler for MS-DOS computers.
- Supports the 8086/8087/8088 and the 186/286/287.
- Define macros.
- Conditional assembly.
- Optional case sensitivity for symbols.
- 100% upward compatibility from earlier versions of both the Microsoft and IBM® Macro Assemblers.

### Interactive Symbolic Debug Utility

- Source level debugger for programs written in Microsoft Macro Assembler, C Compiler, FORTRAN, and Pascal.
- Screen swapping helps debug highly visual applications.
- Set breakpoints on line numbers and symbols.
- Single step to follow program execution.
- Disassemble object code.
- Display and modify values.
- Full I/O redirection.

### Program Maintenance Utility

- Rebuilds your applications after your source files have changed.
- Similar to UNIX™ MAKE utility.
- Supports macro definitions and inference rules.

### Library Manager

- Create, organize and maintain your object module libraries created with Microsoft languages.
- Set page size from 16 to 32678, to create compact and granular libraries.

### Object Code Linker

- Simple overlaying linker combines relocatable object modules created using Microsoft languages into a single program.
- Load Map generation.
- Specify from 1 to 1024 segments.

### Cross-Reference Utility

- Creates a cross-reference listing of the definitions and locations of all symbols used in an assembly language program, which makes debugging programs easier.

### Microsoft EXE File Compression Utility

- Packs EXE files for smaller size on disk and faster loading at execution time.

### Microsoft EXE File Header Utility

- Display and modify EXE file header, allowing you to tune the stack size and initial memory allocation.

For the name of your nearest Microsoft dealer call (800) 426-9400. In Washington State and Alaska, call (206) 882-8088. In Canada, call (416) 673-7638.

# Microsoft

The High Performance Software™

Microsoft and MS-DOS are registered trademarks and The High Performance Software is a trademark of Microsoft Corporation. IBM is a registered trademark of International Business Machines Corporation. UNIX is a trademark of AT&T Bell Laboratories.



phases) becomes evident.

Sounds may be modified in a number of ways. Dragging over a portion of the sound with the mouse selects that region for editing and changes the edit region into reverse video. In this manner, regions of samples may be cut, copied, and pasted anywhere in the soundfile in the normal Macintosh fashion. A second horizontal scroll bar at the bottom of the screen (referred to as the "scratch bar") may be used to finely adjust the output speed of the samples and thus the pitch.

Once a soundfile or region of a soundfile has been selected for editing, a number of operations may be applied to it. Accessing the Sound Effects menu presents you with 12 options for sound modification. Sounds or portions thereof may be reversed or amplified. In the latter case, you can specify the coefficient by which all sample values will be multiplied for amplification. Reverb and flange operations may be applied to the selected region. You can also specify reverberation parameters, delay (in milliseconds), echo loss fraction, and regeneration normalization. In addition, the flange delta may be defined in terms of a specified number of samples. The amplitude envelope of

a selected region of samples may be ramped up or down and the sound may be retuned via the scratch bar. Retuning recomputes the samples at the selected rate. Other edit operations include transferring sound to the clipboard for subsequent mixing within the same or a different soundfile. Mixing is accomplished through additive synthesis. Silence or digitally simulated "white noise" may be inserted at any point in a soundfile or may be used to replace a portion of a sound.

Finally, two time-consuming edit operations may be performed on a soundfile or region thereof. Sound may be "downsampled" to one of the available lower sampling rates for purposes of reducing the size (in kilobytes) of a soundfile. Also, a "low-pass" operation may be applied to the sound while downsampling in order to eliminate frequencies that exceed the Nyquist frequency of the lower sampling rate.

The Options menu is where you set amplification, reverberation, and flange parameters as well as the number of repetitions of the soundfile (similar to looping an analog tape). Through this menu, it is possible to specify a sustain loop in the soundfile of up to 6 seconds. A sustain loop

repeats a selected portion of the soundfile indefinitely and is of particular use when sampled sounds are to be sustained for varying rhythmic durations in a musical context. This is an absolute necessity when saving sound files as "instruments" in the Studio Session format discussed below.

**USES OF MACINTOSH-SAMPLED SOUNDS**

Sound sampling is in its infancy and thus provides fruitful territory for a wide range of applications. Many of the uses for sampled sounds have yet to be imagined by innovative *thinkers*. I will discuss a few of the current applications in the following paragraphs.

**PITCH RECOGNITION AND TRANSCRIPTION:** Developers of Macintosh sampling software consider pitch recognition and subsequent automatic transcription into conventional music notation (CMN) to be inevitable. The relatively simple conversion of this information into MIDI data would allow easy control of much more complex sound-generating devices or an expensive dedicated sampling keyboard such as the Kurzweil 250.

Through digital sampling, the Kurzweil 250 can credibly recreate all the sounds of a full symphony orchestra, including any single instrument or combination of instruments. Through pitch recognition and MIDI conversion, it would be possible to access these sounds without using a piano-style keyboard. Vocalists could control an entire symphony orchestra in this way as well. The implications inherent in the freedom for creative expression brought about by the separation of instrumental technique from sound source are just beginning to be realized (reference 8).

**VOICE RECOGNITION AND REPRODUCTION:** Other ideas related to pitch recognition include MacNifty's plans for voice recognition through its audio digitizer. Using FFT (fast Fourier transform) spectral data captured by SoundCap, it is hoped that the Macintosh will eventually become responsive to a library of voiced commands.

The ability to sample the human

(continued)

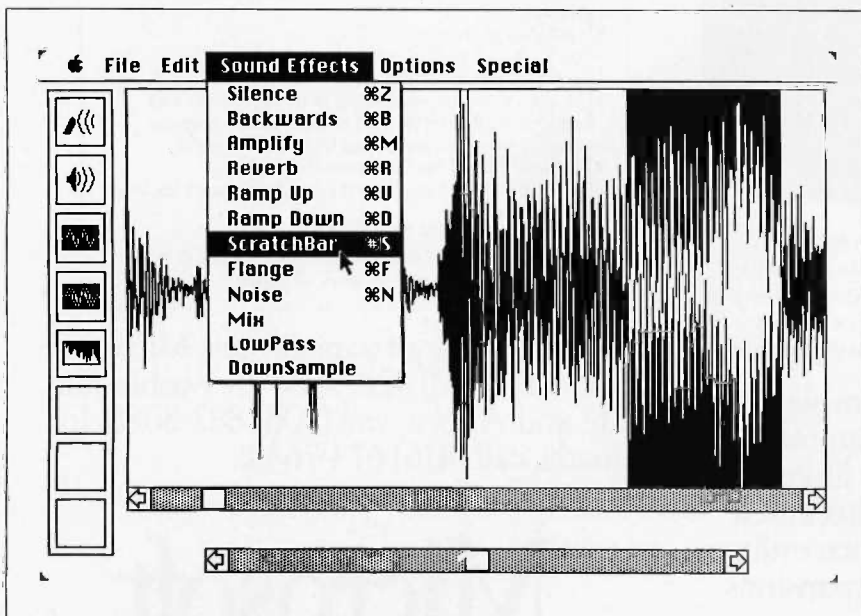
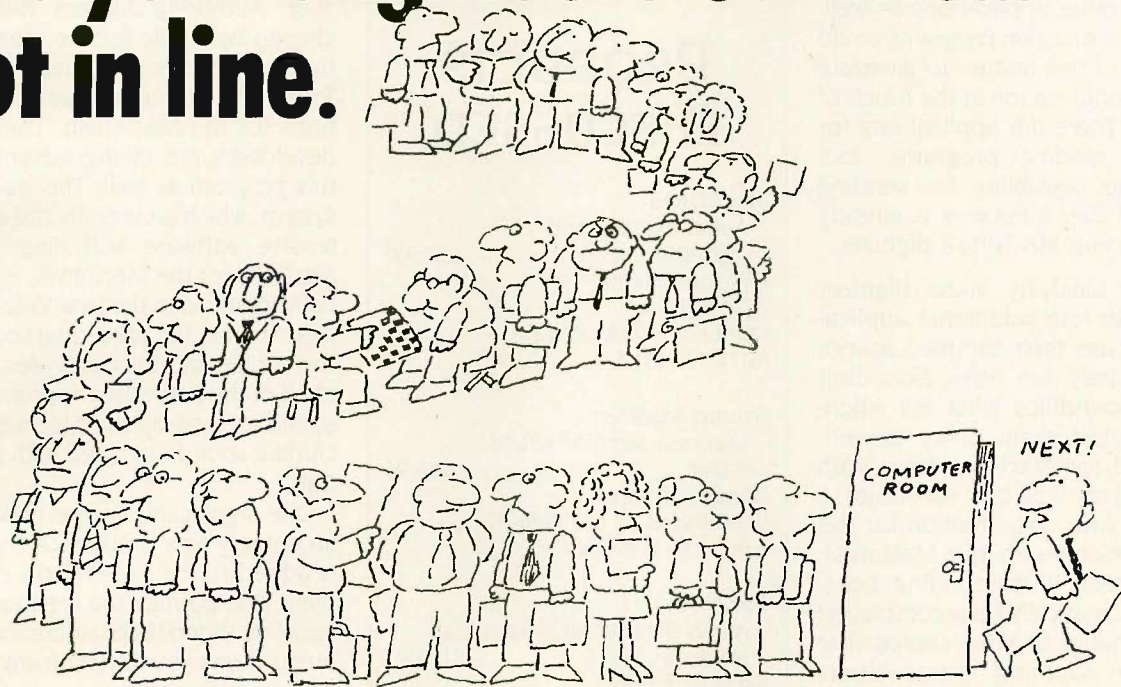

Figure 5: The main screen of MacNifty's SoundCap for editing of sounds sampled with the MacNifty audio digitizer.



# MICRO CAP and MICRO LOGIC put your engineers on line... not in line.



## MY OWN WORKSTATION

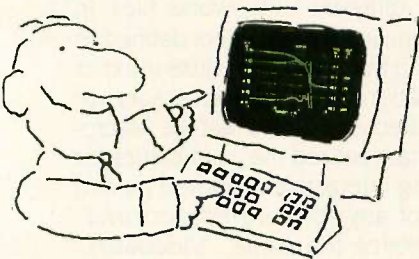

How many long unproductive hours have you spent "in line" for your simulation? Well, no more. MICROCAP and MICROLOGIC can put you on line by turning your PC into a productive and cost-effective engineering workstation.

Both of these sophisticated engineering tools provide you with quick and efficient solutions to your simulation problems. And here's how.

## MICROCAP: Your Analog Solution

MICROCAP is an interactive analog circuit drawing and simulation system. It allows you to sketch a circuit diagram right on the CRT screen, then run an AC, DC, or Transient analysis. While providing you with libraries for defined models of bipolar and MOS devices, Opamps, transformers, diodes, and much more, MICROCAP also includes features not even found in SPICE.

MICROCAP II lets you be even more productive. As an advanced version, it employs sparse matrix techniques for faster simulation speed and larger net-

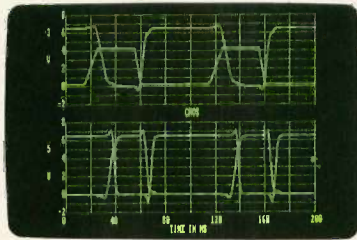

"Typical MICROCAP Transient Analysis"

works. In addition, you get even more advanced device models, worst case capabilities, temperature stepping, Fourier analysis, and macro capability.

## MICROLOGIC: Your Digital Solution

MICROLOGIC provides you with a similar interactive drawing and analysis environment for digital work. Using standard PC hardware, you can create logic diagrams of up to 9 pages with each containing up to 200 gates. The system automatically creates the netlist required for a timing simulation and will handle networks of up to 1800 gates. It provides you with libraries for 36 user-defined basic gate types, 36 data channels of 256 bits each, 10 user-defined clock waveforms, and up to 50 macros in each network. MICROLOGIC produces high-resolution timing diagrams showing selected waveforms and associated delays, glitches, and spikes—just like the real thing.

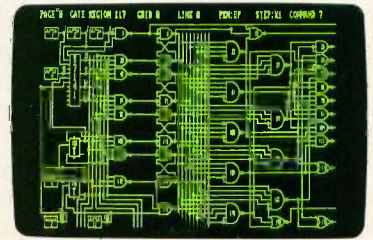

"Typical MICROLOGIC Diagram"

## Reviewers Love These Solutions

Regarding MICROCAP . . . "A highly recommended analog design program" (PC Tech Journal 3/84). "A valuable tool for circuit designers" (Personal Software Magazine 11/83).

Regarding MICROLOGIC . . . "An efficient design system that does what it is supposed to do at a reasonable price" (Byte 4/84).

MICROCAP and MICROLOGIC are available for the Apple II (64k), IBM PC (128k), and HP-150 computers and priced at \$475 and \$450 respectively. Demo versions are available for \$75.

MICROCAP II is available for the Macintosh, IBM PC (256k), and HP-150 systems and is priced at \$895. Demo versions are available for \$100.

Demo prices are credited to the purchase price of the actual system.

Now, to get on line, call or write today!

## Spectrum Software

1021 S. Wolfe Road, Dept. B  
Sunnyvale, CA 94087  
(408) 738-4387

Inquiry 326



voice has other applications as well. Language instruction programs could make use of this feature to illustrate correct pronunciation at the touch of a button. There are applications for children's reading programs, too. Finally, the possibility for sending voice mail over a network is already a reality using MacNifty's digitizer.

**FUN:** The MacNifty audio digitizer comes with four additional applications that use their sampled soundfiles in purely fun ways. SoundInit does to soundfiles what Bill Atkinson's public-domain utility ScreenMaker did for MacPaint files. With ScreenMaker, you can substitute a screen of your own creation for the normal Welcome to the Macintosh startup screen. With SoundInit, boot-up will automatically be accompanied by a soundfile of your choice that could be anything from Albert Einstein saying "Good morning, let's get down to serious business," spliced together in SoundCap from old videotapes, to the full orchestral introduction to Wagner's "Flight of the Valkyrie" (as is the case with Silicone Beach's Airborne game).

BeepInit allows for similar personalization of the Macintosh's beep sound. Instead of a dull computer beep, you can substitute anything from a digitized "Oops!" to the opening notes of Jimi Hendrix's Purple Haze. Finally, the application Type Writer allows the injection of user-sampled sounds at each keyboard strike, providing for different sounds to be played through the space bar and return keys. With an ironic sense of humor, the developers have included sample files for this purpose that substitute the sounds of a noisy keyboard, space bar, and carriage return typical of an IBM Selectric typewriter.

**ANIMATIONS:** The latest version of MacroMind's popular VideoWorks program, which is currently published by Hayden Software, includes the option to import sampled soundfiles for synchronization with user-created animations. VideoWorks permits the quick and easy creation of Walt Disney-quality animations. The original release supported adding a

## PRODUCTS DISCUSSED

### MACADIOS

Audio digitizer and software ..... \$2500

GW Instruments  
POB 547  
Cambridge, MA 02142  
(617) 577-1524

### STUDIO SESSION

Digitized sampled sound editor ..... \$89.95

Bogas Software  
(Distributed by the Kette Group;  
see address below)

### MACNIFTY

Audio digitizer with SoundCap software ..... \$129.95

Kette Group Inc.  
16860 Shingle Creek Parkway  
Suite 110  
Minneapolis, MN 55430  
(800) 328-0184

synchronized soundtrack from a selection of 80 melodies and sound effects provided in the program. Sounds could be synchronized to animation in two ways. First, a sound or melody could be selected to play at a designated point, from beginning to end, at its original tempo and pitch. Secondly, sounds could be "synergistically interfaced" with the animation, in which case the position and motion of a specific sprite (animated object) would affect the pitch and/or tone quality of the sound attached to it.

The new VideoWorks lets you incorporate up to 16 digitizer soundfiles in the VideoWorks music palette for soundtrack use. Other new features include the ability to import whole music files from MacroMind's MusicWorks application (mentioned above) and the ability for speech synthesis through use of either of the two available Macintosh speech drivers: First Byte's SmoothTalker or Apple's own MacinTalk.

**SOFTWARE AUTHORIZING SYSTEMS:** MacroMind's VideoWorks Guided

Tour Authoring System has been chosen by Apple for the creation of the company's popular "Guided Tours" of various software applications for the Macintosh. Third-party developers are taking advantage of this program as well. This authoring system, which is currently the only extensive software authoring system available for the Macintosh, is essentially identical to the new VideoWorks described in the preceding section of this article and thus provides access to all of the innovative approaches to sound offered by the Macintosh, including sounds sampled with SoundCap.

One significant feature makes this an entirely new product: A Do menu is added to the VideoWorks environment that permits the creation of interactive VideoWorks animations. This menu allows you to define any VideoWorks object (sprite) as a button for branching to other parts of the same VideoWorks animation or to altogether different VideoWorks files. In addition, any screen object defined as a button may be set to cause another application or desk accessory to open. Because of this feature, MacroMind has realized the possibilities for creating interactive animated guided tours of any software product available, hence the name "VideoWorks Guided Tour Authoring System." This title is perhaps a misnomer, since the program is equally applicable for extending the range of interactive educational software to include truly astounding possibilities. At least one third-party developer is currently using this system to author a software-based interactive music-theory instruction program.

**Music:** At the time of this writing, only one music software application makes use of soundfiles sampled with SoundCap. This program is Bogas Software's Studio Session, and its implementation of digitized sounds is truly fascinating. Studio Session has undergone some name changes throughout its development, having first been titled Sideman and later Jam Session. The developers consider their package to be "the MusicWorks

(continued)



# For you, good is just not good enough.

*For serious programmers, good isn't good enough. You need the best ... the best tools, the best advice and the best support.*

*At Lifeboat, we've been selling to programmers since 1976, so we know quality when we see it. And we're committed to a full-service program that goes beyond just selling you the best software at competitive prices. Our expert staff can help you decide which programs are best for your needs and provide you with all the technical support you may require. You can rely on Lifeboat for the complete solution to your programming needs.*

## LANGUAGES

### Lattice C New 3.0 Version

The best selling C Compiler has been upgraded to give you more functions and features. Lattice C 3.0 contains 200 new library functions, better code generation, support for new data types (void, enum, unsigned char, unsigned long), support for the 80186/80286 instruction set and the ability to generate in-line 8087/80287 instructions. Lattice C is the C Compiler for professional developers.

### RUN/C—The C Interpreter Upgraded Version

Learn C the natural way with RUN/C. The user interface is similar to BASIC with easy familiar commands. The new 2.0 version of RUN/C comes with a full-screen editor and other enhancements.

### RUN/C Professional New

All RUN/C's capabilities plus powerful features for program development. Load your favorite object libraries with RUN/C Professional. Contains a full-screen editor and source code debugging facilities.

### Mark Williams C Programming System

A complete C development environment.

### Pro Pascal

A truly standard Pascal. Produces fast, tight code with plenty of compile time options and simple one-line commands.

### BetterBASIC New Version

Now you can program in BASIC and use the full memory of your PC, create structured programs using functions and procedures, make your own library modules and more. Now compatible with Microsoft BASIC.

## LANGUAGE UTILITIES

### Plink86 Plus

An overlay linkage editor for linking 8086/8088 object modules. Supports an unlimited size file, unlimited number of modules and up to 4095 hierarchical overlays stacked as many as 32 levels deep. Plink86 Plus contains new features for memory caching, library allocation, file merging and overlay reloading.

### Pfif86 Plus

A symbolic and source level advanced debugger for programming professionals.

## C-SPRITE

Symbolic debugging at both source level and machine level. Monitor your program by setting breakpoints, examining registers and variables, or single-stepping through code. Handle a set of commands as a macro. C-SPRITE and the Lattice C Compiler are a natural pair for program development and debugging.

## BASTOC

A BASIC to C translator for the BASIC programmer who wants to upgrade to C.

## EDITORS

### LSE

A powerful yet inexpensive full-screen editor designed for efficiency and ease of use. Its speed is optimized by writing directly to video memory. The Lattice Screen Editor provides a multi-window environment, ability to reprogram keys, support for keyboard macros, an undo command, an error tracking mode, on-line help and more.

### VEDIT Plus

A full-screen text editor for program development and word processing. It contains powerful features including use of macros, on-line help facility, paragraph formatting, and file comparison.

### Pmate

The programmer's editor with an extensive macro command language. Compile in the background while you continue to edit files.

### EMACS

Customizable editor including windowing, multi-tasking and special modes for C and Pascal.

## FUNCTIONS

### C-Food Smorgasbord

Library of time saving utility functions including a BCD package, an IBM PC BIOS interface, level 0 I/O functions, a terminal independence package and more.

### Essential C Utility Library

Over 300 functions, with special attention given to screen handling, windows and business graphics. Source code is included.

## PforCe Brand New

An optimized library of an impressive 400 plus functions and subsystems. Included is a window management system with overlapping or tiled windows and a database system with B-tree file structure. Several pre-coded screens including "Lotus" style are supplied. And there's much more! Routines for interrupt driven communications, background tasks, and string/table parsing, along with functions for field/screen editing and validation are all part of this superbly written and documented software. Complete source code is included.

## The Greenleaf Comm Library

A library of over 120 communication routines. Contains functions to create interrupt driven routines or perform direct I/O to multiple Comm Ports. Its strengths are in asynchronous communications, interrupt mode, modem control, XMODEM, XON/XOFF and flow control. Interfaces with Lattice, Microsoft, Wizard, Desmet, CI86, Aztec and Mark Williams C compilers.

## The Greenleaf Functions

A mature library of over 200 functions. Version 3.0 offers all new indexed documentation, with an abundance of examples. Source code included.

## GRAPHICS and SCREEN DESIGN

### GSS\*CGI GRAPHICS New

The GSS Computer Graphics Interface is designed for creating high performance graphics-based applications. GSS\*CGI speeds up application development and provides compatibility with a wide range of peripherals. It's the only CGI implementation that provides true device-independence for both raster and vector graphics. Language bindings are available to support development of GSS\*CGI based applications using Lattice C, Microsoft C, FORTRAN, Pascal, BASIC Compiler and Macro Assembler. Products in the GSS\*CGI GRAPHICS line include the GSS Graphics Development Toolkit, the GSS Kernel System, the GSS Plotting System and the GSS Metafile Interpreter.

### Essential Graphics New

A brand new graphics library for C programmers with the emphasis placed on ease of use and portability. No royalties.

### Multi-Halo

Library of over 200 graphics functions, supporting all of the popular graphics boards.

### Panel

A powerful tool for interactive screen design.

For more information on these and other products in our complete line call:

**1-800-847-7078 In NY: 914-332-1875**

# LIFEBOAT

**The Full-Service Source for Programming Software.**

## INTERNATIONAL SALES OFFICES

Australia:  
Fagan Microprocessor Assoc.  
Phone: (61) 3699-9889  
Canada: Scantel Systems  
Phone: (416) 449-9252  
England: Grey Matter, Ltd.  
Phone: (44) 364-53499  
Italy: Lifeboat Assoc., S.p.A.  
Phone: (02) 656-841  
Japan: Lifeboat Japan  
Phone: (03) 293-4711  
Spain: Micronet, S.A.  
Phone: (34) 1-457-5056  
The Netherlands:  
GIGA Computer Products  
Phone: (31) 10-771846  
SCOS Automation BV  
Phone: (31) 20-106922

Inquiry 186

The names of products listed are generally the trademarks of the sources of the products.

©1986 Lifeboat Associates

Lifeboat  
55 South Broadway  
Tarrytown, NY 10591



of sampled sounds," referring to MacroMind's largely intuitive music editing program that uses the Macintosh's internal synthesizer for playback.

Bogas's package includes a music editor (Studio Session Editor) and both the player (Studio Session Player, see figure 6) and a miniplayer (which allows for a larger number of soundfiles or instruments to be saved on a

single disk by sacrificing some of the animated graphics of the main player application). With Studio Session it is possible to play back pitched music in six parts through the Macintosh's internal speaker or through an external sound system connected to the Macintosh's audio output. The software uses linear interpolation to recompute the sampled soundfiles at various pitches.

Several disks included with the package provide nearly 70 pre-sampled instruments, and you can edit these or create new instruments using MacNifty's SoundCap (discussed above). The program can access up to 16,000 different instruments, although between 20 to 25 seems to be a practical limit for the 512K Macintosh.

Music is entered using the Studio Editor program, which functions in two modes. In the note-editing mode, notes and symbols may be dragged from a palette containing 32 items. The cursor assumes the symbol of the selected item until a new symbol is selected. Note values range from a whole note to a triplet 32nd note, and putting them on the staff is as easy as point and click with the mouse. Note placement is facilitated by the fact that the cursor jerks to both horizontal and vertical grid steps. The horizontal grid steps correspond to insertion or replacement locations and the vertical grid corresponds to musical half-steps on the staff. During editing, each instrumental voice is thought to be a separate track, with up to six tracks possible. Regions of tracks may be looped for up to 999 repetitions, and loops of varying length may be occurring at different places on separate tracks simultaneously. Loops, which are represented by musical repeat signs, are nestable for up to 10 levels. Cut, copy, and paste operations are supported, as are transposition and the insertion of tempo indications on the score and in real time.

The second type of editing provided by the Studio Editor is called block editing and is extremely innovative. It uses a database approach to the organization of musical ideas and the manipulation of musical data on the phrase level. I have repeatedly stressed the necessity for incorporating database-like library, sorting, and searching operations in MIDI sequencer software, but it seems that the first constructive implementation of this concept is destined to come to us from the sampled sound world.

The block-editing mode lets you view your musical composition in a display similar to a Multiplan spread-

## ATRON BUGBUSTERS GREASE BORLAND LIGHTNING

"If I were starting a software company again, from scratch, Atron's AT PROBE™ would be among my very first investments. Without Atron's hardware-assisted, software debugging technology, the flash of Turbo Lightning™ would be a light-year away!"  
Philippe Kahn, President, Borland

### HOW BORLAND DOES SO MUCH, SO WELL, SO FAST

We asked Borland International president Philippe Kahn to share his secrets for rapidly taking a good idea and turning it into rock-solid reality. How does the Borland team do so much, so well, so fast?

He begins, "I remember when Atron used the June 24, 1985 *Wall Street Journal* chart of top-selling software in an ad." [Note: At that time, seven of the top ten software packages were created by Atron customers; it's now now nine out of ten.] "SideKick was number four, and I let Atron quote me in saying that there wouldn't have been a SideKick without Atron's hardware-assisted debuggers.

"You might say lightning has literally struck again. Turbo Lightning made number four on

*SoftSel's Hotlist* within weeks of its introduction! And again, I say we couldn't have done it without Atron debugging technology.

"Cleverly written code is, by definition tight, recursive, and terribly complex," he continues. "Without the ability to externally track the execution of this code, competent debugging becomes very nearly impossible."

Concludes Philippe, "And after Turbo Lightning was solid and reliable, Atron tuning software turned our Probes into performance analyzers. How do you think we greased our lightning?"

Philippe, along with a couple million or so of your satisfied customers, we say congratulations on yet another best-selling product. We can't wait to see what awesomely useful technology will come shooting out of Borland International next.

### HOW BUGBUSTERS KEEP YOU FROM GETTING SLIMED

The AT PROBE is a circuit board that plugs into your PC/AT. It has an umbilical which plugs into the 80287 socket and monitors all 80286 activity.

Since AT PROBE can trace program execution in real time, and display the last 2048 memory cycles in symbolic or source-code form, you can easily answer the questions: "How did I get here?" and "What are those silly interrupts doing?"

It can solve spooky debugging problems. Like finding where your program overwrites memory or I/O - impossible with software debuggers.

You can even do source-level debugging in your favorite language, like C, Pascal or assembler. And after your application is debugged, the AT PROBE's performance measurement software can isolate performance bottlenecks.

Finally, the AT PROBE has its own 1-MByte of memory. Hidden and write-protected. How else could you develop that really large program, where the symbol table would otherwise take up most of memory.

### LOOK AT IT THIS WAY.

History shows that non-Atron customers don't stand a very good chance of making the Top Ten list. Lightning really does have a way of striking twice!

The PC PROBE™ is \$1595 and the AT PROBE is \$2495. So call Atron today. You can be busting some really scary bugs tomorrow. And maybe, just like Borland, you can also bust some records.



20665 Fourth Street • Saratoga, CA 95070 • 408/741-5900

Copyright © 1985 by Atron Corp. PC PROBE™ and AT PROBE™ Atron, SideKick™ and Turbo Lightning™ Borland International, Inc. Adv. by TRIA, 408/258-2708.





sheet. Phrases are labeled with one of 32 descriptive names (16 of which may be user-defined). The names of the phrases appear in the various spreadsheet cells in the proper spatial (i.e., temporal) relationship to one another. It is possible to zoom in or out of this display from 2-bar resolution to 4-bar or 16-bar resolution. Phrases are stored in the phrase

library, which may hold up to 16,384 phrases. Sorting and searching are available by specifying type, meter, phrase length, or multiple search criteria. Phrases may be dragged with the mouse into the spreadsheet-like block editor display. In addition, phrases may be dragged around and placed into new juxtapositions within the block editor itself in a manner and

philosophy similar to dragging headings and text windows around in Living VideoText's ThinkTank idea processor. A "draft play" window on the left of the screen includes the options of real-time soloing or muting for individual tracks with the click of a mouse. In the block editor display all looped phrases display all their repetitions, but saving the file compacts the loops (see figure 7).

Such an approach to musical composition is truly ground-breaking. The ability to organize musical ideas in database fashion fosters creativity and experimentation by allowing us to view our musical ideas on a more global level. Bogas Software must be wholeheartedly commended for having the foresight to take the first step in unlocking a door to the true creative potential of a microcomputer.

**CODA**

The possibilities opened up by the capability of sound sampling with a personal microcomputer interpenetrate many different disciplines, both musical and otherwise. New and far-reaching applications for these techniques are being discovered every day. As with any creative tool in its infancy, with respect to applications of sound digitizing it is safe to say that the best may be yet to come with regard to music composition. ■

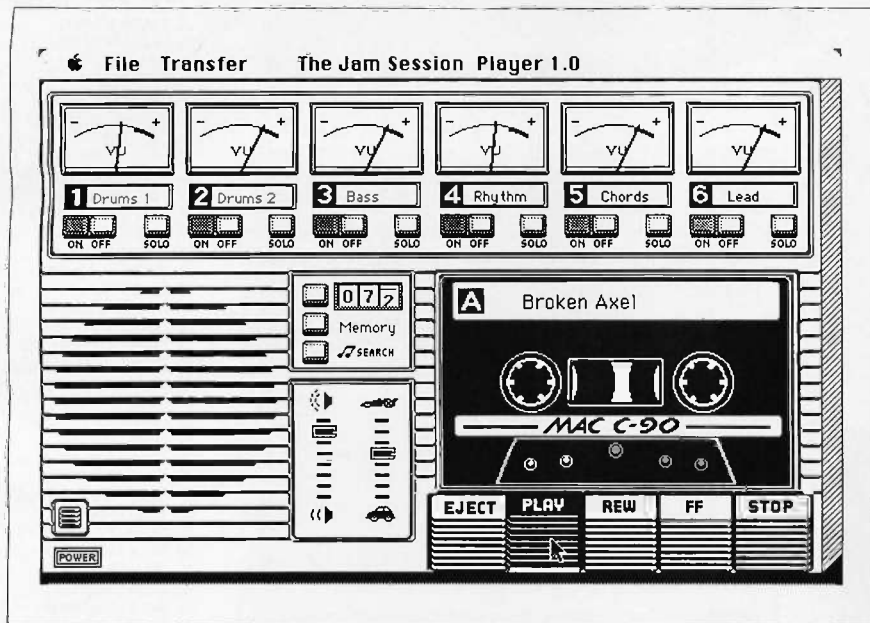

Figure 6: Bogas Software's Studio Session Player with animated cassette recorder emulation.

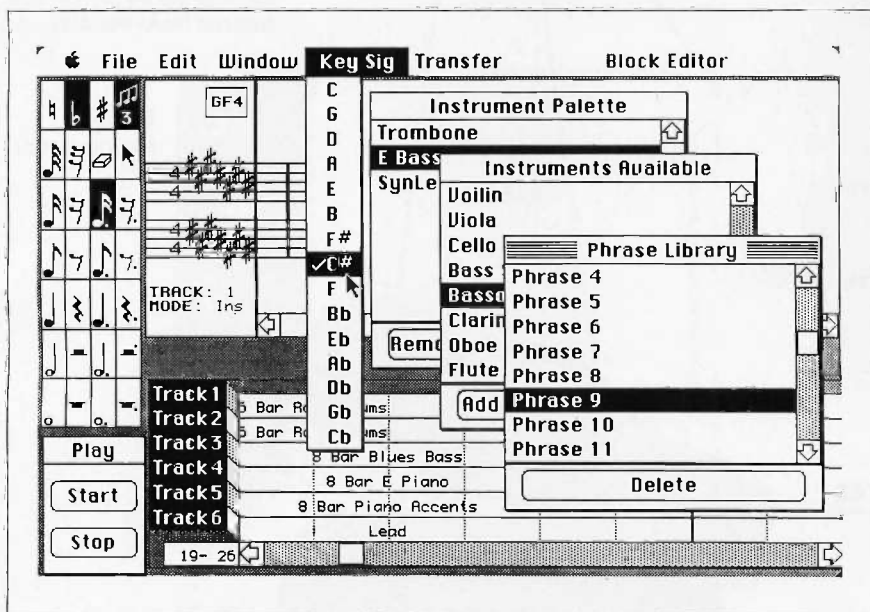

Figure 7: Bogas Software's Studio Session Editor showing typical database menus.

REFERENCES

1. Roads, Curtis, and John Strawn (eds.). *Foundations of Computer Music*. Cambridge, MA: The MIT Press, 1985.
2. Yelow, Christopher. "Music Software for the Apple Macintosh." *Computer Music Journal*, vol. 9, no. 3, 1985, page 52.
3. Loy, Gareth. "Musicians Make a Standard: The Phenomenon of MIDI." *Computer Music Journal*, vol. 10, no. 1, 1986.
4. Yelow, Christopher. "MIDI and the Apple Macintosh." *Computer Music Journal*, vol. 11, no. 4, 1986.
5. Milano, Dominic. "Digidesign Sound Designer Emulator II Software." *Keyboard*, vol. 11, no. 10, 1985, page 112.
6. Aikin, Jim. "Sound Lab from Blank Software for the Ensoniq Mirage." *Keyboard*, vol. 12, no. 1, 1986, page 126.
7. *Inside Macintosh*. Cupertino, CA: Apple Computer Inc., 1985.
8. Byrd, Donald and Christopher Yelow. "The Kurzweil 250 Digital Synthesizer." *Computer Music Journal*, vol. 10, no. 1, 1986.



From the Father of Personal Computers Comes...

# A New Set of Building Blocks For The Creative Mind.

*Introducing DataBlocks™ – A Modular Computerized  
Personal Control System.*

**Dr. Ed Roberts,**  
creator of the first  
personal computer, the  
Altair, introduces a new  
functional concept for  
Robotics and Computer  
Enthusiasts, OEM's  
and Engineers.

The DataBlocks A-II™ modular  
control system features stackable  
modules (blocks), which plug  
together in any customized  
combination.

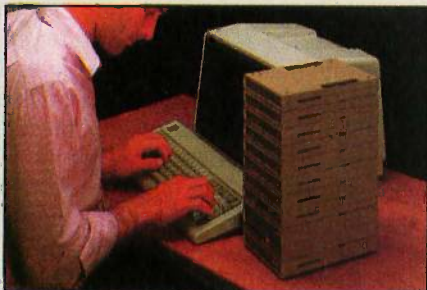

The A-II Control System interfaces with any  
standard data terminal or terminal program.

The unique DataBlocks  
hardware, coupled with its user-  
friendly PCL™ (Process Control  
Language) make monitoring and  
personal control of virtually any  
device or function, easier and more  
affordable.

To order your A-II control  
system and a free software tool kit,  
call today: DataBlocks toll-free  
1-800-652-1336. Georgia residents  
call 1-912-568-7101.  
VISA and Mastercard accepted.

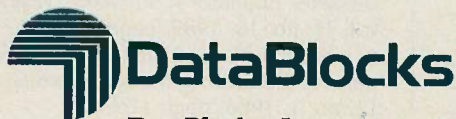

**DataBlocks, Inc.**  
579 Snowhill Road  
P.O. Box 449  
Alamo, GA 30411  
Inquiry 104

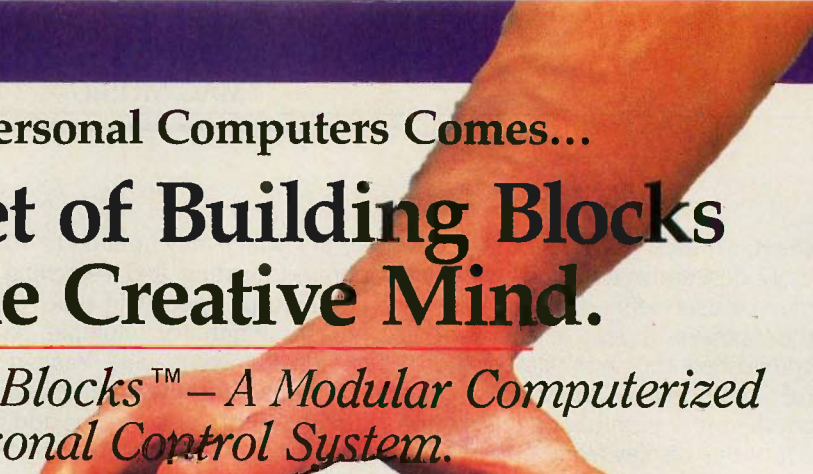

- Available blocks include:**
1. Central Processor Unit
  2. System Memory
  3. PROM/RAM Memory
  4. RAM Disk
  5. PROM Disk
  6. PROM Programmer
  7. Parallel Input/Output
  8. Dual Serial I/O
  9. Stack Power Supply
  10. Floppy Disk Controller
  11. Floppy Disk Drive
  12. Hard Disk Controller
  13. Hard Disk Drive
  14. Voice Synthesizer
  15. Voice Recognition
  16. Control Master
  17. Interrupt Expander
  18. Stack LCD Display
  19. Stack CRT Controller
  20. Stack Graphics Control
  21. Stack Relay
  22. Stack 16 channel A/D
  23. Stack Dual D/A Driver
  24. Stack Dual D/A
  25. Stack 1Amp Driver
  26. Stack 4Amp Driver
  27. Stack Wire Wrap Board
  28. Slave Relay
  29. Slave 16 channel A/D
  30. Slave Dual A/D Driver
  31. Slave Dual D/A
  32. Slave Universal
  33. Slave LCD Display
  34. Slave Parallel I/O
  35. Slave DC Driver 1Amp
  36. Slave DC Driver 4Amp
- Specifications subject to  
change without notice.

Starter set (not shown) from \$480.  
Additional blocks from \$100.

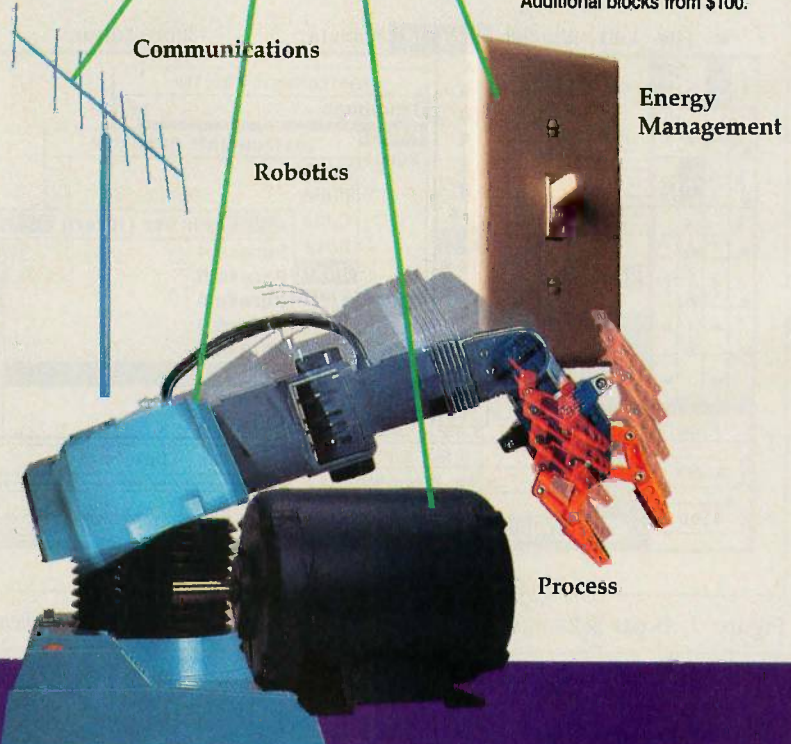



# MUSICAL FRACTALS

BY CHARLES DODGE AND CURTIS R. BAHN

*Mathematical formulas can produce musical  
as well as graphic fractals*

FRACTAL GEOMETRY has exerted a strong influence on a remarkable variety of disciplines in recent years. The sciences are using fractal structures to study a diverse range of phenomena from turbulence to bone structure. In the arts, fractal geometry provides computer graphics with unprecedented possibilities for creating a new universe of visual forms, many of which have an astoundingly realistic, natural look. In music, you can employ the same principles to take advantage of a panoply of new relationships.

In *The Fractal Geometry of Nature* (see reference 1), Benoit Mandelbrot is careful to point out that the realistic and natural-appearing fractal graphics are not modeled on photographs of nature; rather, they are graphics of mathematical relationships that come surprisingly close to resembling occurrences in nature. So it is with examples of computer-aided composition. They do not sound like rock, or bebop, or symphonies. Rather, they embody abstract relationships that assume the characteristics of certain kinds of music.

There are a number of parallels between computer graphics and computer music. Discussions about frac-

tals and computer graphics usually distinguish between the high-resolution pictures made on powerful institutional computers and those made at home. The same schism exists between highest-quality sound synthesis and home synthesis.

This article discusses some of the basic techniques of computer-aided musical composition and includes some programs for generating musical fractals on home computers. [Editor's note: The programs WHITE.BAS, BROWN.BAS, I.OVERF.BAS, VARIATN.BAS, and RANDOM.BAS are written in MSX BASIC using MUSIC MACRO commands for the Yamaha CX5-M music computer. Their source code is available for downloading from BYTEnet Listings at (617) 861-9764. They are also available on disk (see page 445).] The output of the software shown in this article is a list of commands for the computer's internal synthesis hardware rather than actual music. Other details can be found in the text box "About the Programs" on page 196.

## A LONGSTANDING RELATIONSHIP

Since the time of ancient Greece, Western music has embodied propor-

tions and abstract numerical relationships. There are many examples. A famous motet of 1436, *Nuper Rosarum Flores* by Guillaume Dufay, uses the same relations of tempo between its sections as the ratios in size between parts of the Florentine cathedral for whose dedication it was composed. Numerology played a part in certain choices of elements in some of the religious music of J. S. Bach.

In our own era, Bela Bartok, the great Hungarian composer and folk music expert, used the Fibonacci numerical series to govern pro-

(continued)

Charles Dodge is the director of the Center for Computer Music (Brooklyn College, CUNY, Brooklyn, NY 11210). He has a B.A. from the University of Iowa and an M.A. and a D.M.A. from Columbia University. He is a recognized composer of computer music and coauthor of *Computer Music: Synthesis, Composition, and Performance*.

Curtis R. Bahn is a research assistant and student at the Center for Computer Music. He is also an adjunct assistant professor teaching computer music at NYU. He attended Interlochen Arts Academy, has a B.A. from Indiana University, and is currently working on his M.A. at Brooklyn College.



WE TOP IBM BEAUTIFULLY



**I**BM's Personal Computer is the standard of the industry, but a Thomson monitor gives your IBM's great body a beautiful face. A Thomson monitor atop your IBM simply outperforms the IBM Color Display.

Here's proof:

Who is Thomson? Thomson is a six billion dollar multi-national company. Unlike our competition, we design and build our own monitors with stringent quality control. We offer monochrome or color monitors from TV-grade to high resolution.

FEATURE	THOMSON .38mm COLOR	IBM COLOR DISPLAY	BENEFIT
Dot pitch (in mm)	.38	.43	Superior resolution
Screen	Non-glare	Glare	Less eyestrain
Switch for green/amber text	Yes	No	Improved legibility
All major controls up front	Yes	No	Greater convenience
Warranty	1 yr.	90 days	Greater confidence
List Price	\$549	\$680	A bargain

Call 1-800-325-0464. In California call 1-213-568-1002 (Monday-Friday, 9 a.m. to 5 p.m. PST) for your local Thomson dealer, and start looking at a beautiful face.

**THOMSON**   
A SIGHT FOR SORE EYES.™

© 1986 Thomson Consumer Products Corporation 5731 W. Slauson Avenue, Suite 111, Culver City, CA 90230

Thomson is a trademark of Thomson S.A. IBM is a registered trademark of International Business Machines Corp. IBM model number 5153. List prices in effect on February 18, 1986.



FREE

FANTASTIC,  
PRECISE,  
ANIMATED  
SOFTWARE  
GRAPHICS.  
FREE! WHEN  
YOU BUY A  
THOMSON  
MONITOR.

*The much-prized Show Partner™ software. It gives you scrolls. Wipes. Fades. Brilliant screen performances. Normally, Show Partner costs \$149. But you can get it free when you buy a Thomson CM36382SI or CM31311SI high-resolution color monitor.*

*See your Thomson dealer for details. And hurry! This offer is for a limited time only.*

**THOMSON**   
A SIGHT FOR SORE EYES.™

Show Partner is a trademark of Brightbill Roberts and Company, Ltd. and distributed by The Marketing Channel. Thomson is a trademark of Thomson S.A.

© 1986 Thomson Consumer Products Corporation

portions in a number of his works. More recently, Charles Dodge's computer music composition *Earth's Magnetic Field* (Nonesuch Records, 1970) interprets an index of solar radiation's effect on the magnetic field surrounding the earth to create its melodic and rhythmic activity.

In the mid-fifties, Lejaren Hiller and Loren Isaacson wrote their first programs for computer-aided composition (see reference 2) and Max V. Mathews created his widely used algorithm for the digital oscillator (see reference 3). Today, computer-based audio synthesis, processing, and recording pervade all styles of music. Even classical concert music now includes a wide variety of computer music, as evidenced by the New York Philharmonic's three-day minifestival of computer music within its landmark contemporary music festival, Horizons '84.

After an initial flurry of activity in computer-aided composition (CAC), however, musicians and engineers have concentrated on digital synthesis and processing of sound. Only recently have a number of composers begun to reexamine some of the possibilities of CAC. If you define computer-aided composition as the use of a computer program to calculate some aspect of a musical score, you can eliminate the common misconception that the words "computer music" are limited to the computer performance, or realization, of music composed in the past (by this definition, "switched-on" classics are not new compositions but new realizations). A composer commonly uses computer programs to compose and then makes electronic realizations of the composition on the computer. You can describe this process as computer-realized CAC.

There is an obvious analogy between this and the field of computer graphics, in which you use computer programs to create visual structures to be realized by computer technology. Because of the parallel structures within the two fields, you can adapt recent applications of Benoit Mandelbrot's fractal geometry to computer graphics (see reference 4)

for use in computer-aided composition.

#### COMPOSING BY COMPUTER

Using the computer to compose raises a number of issues about the nature of the creative process and the nature of music itself. Many of the best musicians in various epochs have incorporated mathematical relationships into their music. No one would argue, however, that all you need for effective composing is a well-developed mathematical technique. Any musical application of mathematical relationships must take into consideration the interactions of the basic elements of musical texture: pitch, rhythm, loudness, and tone quality. The way in which a composer structures these basic elements determines to a large degree the nature of the music created. Figures 1b, 2b, and 3b come from random processes that provide the means of choosing values for some of the necessary building blocks. Figure 4c is a musical fractal that elaborates and builds on the elementary motivic structure shown in figure 4b. All the examples given use the 12-tone equal-temperament pitch collection. Mapping the results of the programs given onto different pitch collections will make a most significant difference in the sound of the music.

Three types of random processes are often associated with CAC. These processes have been widely applied to the choice of compositional parameters—pitch, for example. You can characterize each process by its *power-density spectrum*, the variation of the random sequence's energy versus its frequency. The spectral characterization applies only to the random variable's sequence of values; it says nothing about the acoustical spectra of the music's actual sounds. These spectra depend on the characteristics of the instruments—electronic or otherwise—used to play them.

The first and most basic random process is white noise, which by definition has a flat spectrum. This means that its spectral energy is dispersed evenly with the frequency, and thus it varies with the frequency

(continued)



# DO IT YOURSELF IBM XT/AT COMPATIBLE SYSTEMS

Introducing XT64 Basic System

- 640K Motherboard
- 135 Watts Hard Disk Ready Power Supply
- Color Graphic Card
- One DS/DD Slim Drive
- Floppy Disk Controller
- Assembly Instruction



**\$595.00**

## POWER SUPPLY, CASE



- ★ 135 Watts Hard Disk Ready Heavy Duty Power Supply . **\$65.00**
- ★ Flip Top Metal Cabinet With Built In Speaker . . . . **\$45.00**

## XT/AT KEYBOARD



- ★ Enlarge Return, Shift & Control Key & LED Indicators for Caps, Num Lock & Scroll Lock **\$65.00**

## FLOPPY DISK DRIVE

- Pop-Up Mechanism
- Direct Drive Brushless Spindle Motor
- High Speed Data Access
- All Japanese Name Brand



**\$85.00**

## MOTHERBOARD

- 640K Motherboard
- IBM XT Fully Compatible
- 8088 CPU
- 8 I/O Slots
- Turbo 8 MHz Optional

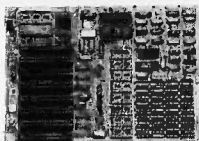

- ★ W/O Memory Chip . . . . . **\$120.00**
- ★ W/Memory Chips . . . . . **\$188.00**

## MONITOR, ADD-ON CARDS

- ★ High Res. TTL Green/Amber . **\$95.00**
- ★ High Res. Color Monitor . . . **\$310.00**
- ★ Disk I/O Card for 2 Disk Drives W Serial, Parallel, Game Port & Clock . . . . . **\$108.00**
- ★ Color Graphic Card . . . . . **\$70.00**
- ★ Monochrome Graphic Card . . . **\$90.00**
- ★ Floppy Disk Controllers . . . . **\$35.00**

## JM SYSTEM INC.

1580 Industrial St., Los Angeles, CA 90021

**\* IMMEDIATE DELIVERY \***

Please Call For Our Special Dealer Price  
Mail Orders Hot Line

**(213) 624-9986**

European Customers Contact:  
Hong Kong Office - FAX No. 7988360  
U.S. Office FAX No. (213) 624-8826

IBM XT AT Are Registered Trademarks of  
International Business Machines Corp.

## MUSICAL FRACTALS

in a  $1/f^0$  relationship. Figure 1a shows a graph of the power-density spectrum of white noise (see reference 5). Figure 1b is a musical example made by selecting pitches and rhythms at random using the white-noise mathematical relationship. The range of pitches used is the two octaves above middle C, using all chromatic pitches of 12-tone equal temperament. The four rhythmic values used are the quarter, the half, the dotted-half, and the whole note. The music notation shows conventional pitch and rhythmic values, along with bar lines and meter signatures.

As with all our BASIC language programs, we used the internal clock to seed the random generator, resulting in a completely new sequence on each run. Regardless of the seed, a passage of music generated by white noise exhibits little internal coherence

or relatedness. If you generate white-noise music several times with the program in listing 1, you will notice that the melody is different each time. If you use the diatonic-pitch collection (the pitches of a major scale), for example, and a different group of rhythmic values, you get other melodies as well.

A random variable, whose next value is generated by adding a Gaussian-distributed random variable with a mean value of 0 to the current value, creates noise with a spectrum of  $1/f^2$ . Figure 2a shows a graph of  $1/f^2$  noise, sometimes called Brownian noise. Due to the Gaussian distribution, small changes in value are more likely than large ones. Figure 2b is an example of Brownian music. We chose the same ranges of pitch and rhythmic values to project the musical line that we selected for figure 1b. The Brown-

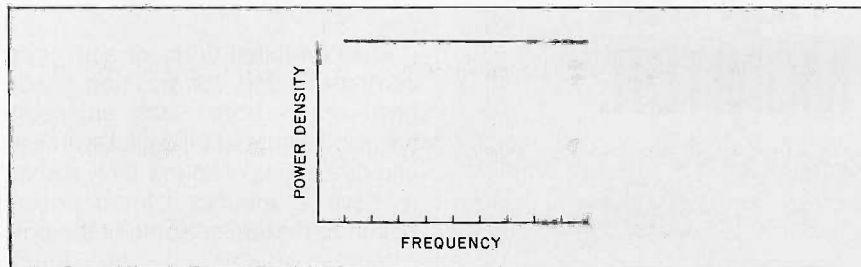

Figure 1a: The power-density spectrum of white, or  $1/f^0$ , noise.

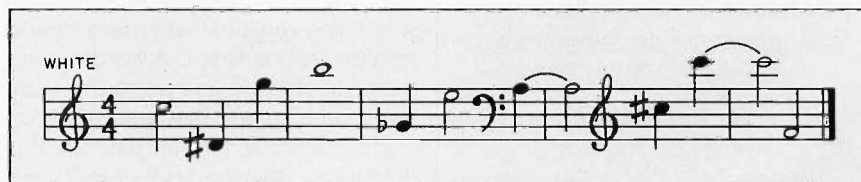

Figure 1b: A musical example created by random selection of pitches and rhythms using the white-noise mathematical relationship.

Listing 1: *WHITE.BAS*, a program to generate white noise.

```

10 _INIT:_INST(1)
20 X=RND(-TIME)
30 FOR X = 1 TO 25
35 REM notes in range of 25 to 120
40 N = INT(RND(1)*95)+25
45 REM lengths in range of 1 to 4
50 L = INT(RND(1)*4)+1
60 _PHRASE(1, "L=L; ", "N=N; ")
70 NEXT X
80 _PLAY(1,1)
90 _WAIT(1)
100 INPUT "AGAIN"; DD:GOTO 80
    
```



ian music moves along from one pitch to another within a small span of intervals. The music seems to wander around with no clear direction. The code in listing 2 will generate Brownian music.

Both white noise and Brownian noise are members of a class of processes called *fractional noises*, whose spectrum diminishes following the formula  $1/f^y$ , where  $0 \leq y \leq 2$ . A particularly interesting case occurs when  $y = 1$ , also known as  $1/f$  noise. Figure 3a contains a graph of the power-density spectrum of  $1/f$  noise. Surprisingly, the  $1/f$  relationship occurs naturally in a great many ways: as variations in annual amounts of rainfall, in patterns of sunspot activity, and as noise in electronic devices, to name only a few. In fact, physicists Richard F. Voss and John Clarke analyzed several recordings of non-random music in various styles and found the loudness and frequency distribution was nearly  $1/f$  (see reference 6). Figure 3b shows a musical line with the same range as figures 1b and 2b but with a  $1/f$  correlation between successive pitches and rhythms.

Values in a sequence generated by the  $1/f$  formula correlate logarithmically with past values. Thus, for example, the averaged activity of the last 10 values has as much influence on the current value as does that of the last 100, the last 1000, and so on. This remarkable property means that the process has a relatively long-term memory. In fact, it has the best memory of any fractional noise-generating formula.

Figures 1b, 2b, and 3b show monophonic (single-line) music. Since most Western music is polyphonic (more than one line), these examples are perhaps better for illustrating the differences among the generating processes than for creating compositions. Because of  $1/f$ 's superior memory, lines of music generated with  $1/f$  noise, such as the one shown in figure 3b, have the best overall musical effect of the lines created using fractional noises. Relating note and rhythm choices to both the recent past and the more distant past seems

(continued)

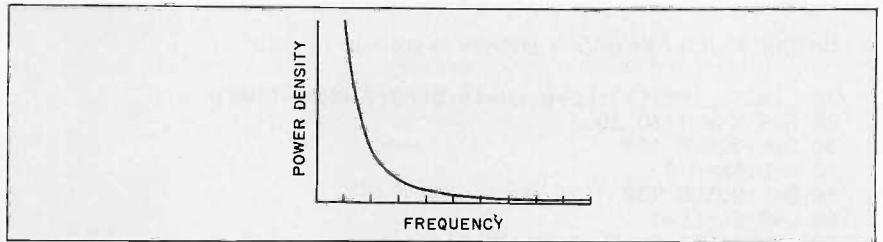

Figure 2a: The power-density spectrum of Brownian, or  $1/f^2$ , noise.

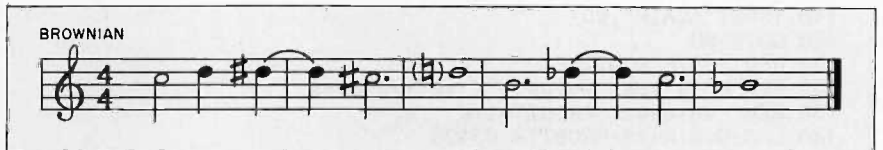

Figure 2b: An example of Brownian music using the same range of pitches and rhythms as figure 1b but with the Brownian formula.

Listing 2: *BROWN.BAS*, a program to generate Brownian noise.

```

10 _INIT: _INST (1)
20 X=RND(-TIME)
30 N=60:L=2
40 FOR X = 1 TO 25
50 R=3:GOSUB 130:N=N+D: REM R varies the range
60 IF N>120 or N<25 THEN N=N-2*D
70 R=.667:GOSUB 130:L=L+D
80 IF L<1 OR L>4 THEN L=L-2*D
90 _PHRASE(1, "L=L;" , "N=N;" )
100 NEXT X
110 _PLAY(1,1):_WAIT(1)
120 INPUT "AGAIN"; DD:GOTO 110
130 REM BROWNIAN ROUTINE
140 S=0:REM S is Sum
150 FOR I = 1 TO 12
160 S=S+RND(1)
170 NEXT I
180 D=INT(R*(S-6))
190 RETURN
    
```

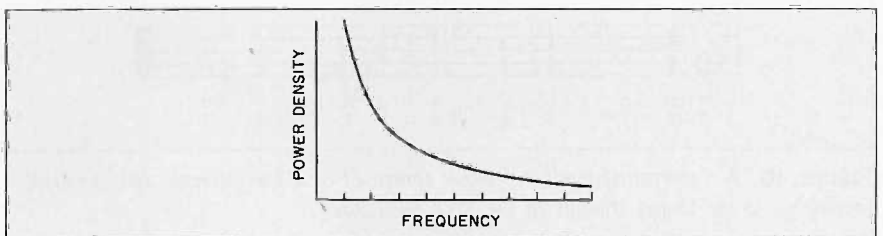

Figure 3a: The power-density spectrum of  $1/f$  noise.



Figure 3b: A line of  $1/f$  music generated from the pitches and rhythms in figures 1b and 2b but using the  $1/f$ -noise formula.



Listing 3: *IOVERF.BAS*, a program to generate 1/f noise.

```

10 _INIT:_INST(1):LL=8:LN=16:S=60:X=RND(-TIME)
20 FOR X = 1 TO 25
30 D=N:GOSUB 130
40 N=D:SN=N+S
50 D=L:GOSUB 130
60 L=D:SL=LL+1
70 _PHRASE(1,"L=SL;","N=SN;")
80 NEXT X
90 _PLAY(1,1)
100 _WAIT(1)
110 INPUT"AGAIN";DD
120 GOTO 90
130 REM 1/F ROUTINE
135 REM L is last value. K is 1/2 poss
136 REM values. PROBIT=1/K
140 L=D:D=0:K=16:PROBIT=.03125
150 J=INT(L/K)
160 IF J=1 THEN L=L-K
170 U=RND(1)
180 IF U < PROBIT THEN J=1-J
190 D=D+J*K
200 K=K/2
210 PROBIT=PROBIT*2
220 IF K>1 THEN GOTO 150
230 RETURN
    
```

to be an important part of musical coherence. Listing 3 provides the code to generate some 1/f music. Even musical lines made from the first two types of fractional noise have their possible applications. You can use them in simple musical contexts and together with other lines in more complicated ones.

Although 1/f noise may have the same power-density spectrum as a recording of a symphony by Mozart, the raw application of 1/f noise to compositional choices leaves out an important aspect of composition: musical structure. The application of fractals can be significantly useful in this area and provides an excellent point of departure for helping to mold the overall form of a piece of music.

**FRACTALS AND MUSICAL STRUCTURE**

Scaling, the space-filling curve, and self-similarity are three important concepts in fractals. Figure 4a shows a very regular fractal, the Koch snowflake. It is made from an equilateral triangle in the following way: Add another equilateral triangle of smaller scale to each side of the original, then add still smaller and smaller equilateral triangles recursively down to the resolution of the display. The Koch snowflake is a *scaling* fractal because it is made from the same shape reapplied at different scales. It is a *space-filling* curve because the edge of the snowflake—when you add an infinite number of triangles recursively—becomes infinitely long. (The edge assumes a form in between a one-dimensional line and a two-dimensional plane. This defines the snowflake as having a fractional dimension—thus, it is a fractal.) The Koch snowflake also exhibits *self-similarity*; that is, the small detail is

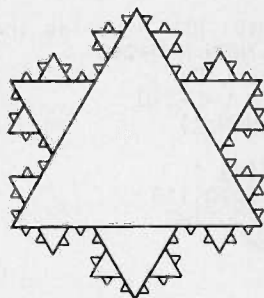

Figure 4a: The Koch snowflake, a scaling fractal.

MOTIF

PITCH	3	5	9	-3	0
TIME	1	2	2	1	1

Figure 4b: A "generating motif" of music composed of a few intervals and durations (analogous to the largest triangle in the Koch snowflake).

Figure 4c: The first and second layers of a polyphonic musical composition. The first layer is the original motif, while the second layer is merely a faster repetition of that motif added to each of its notes.



similar to the large detail. Self-similarity, although not a mathematical requirement of a fractal, is characteristic of all the fractals that we have found to be musically interesting.

The awareness of self-similarity abounds in studies of musical structure. In the early twentieth century, Viennese music theorist Heinrich Schenker developed a way of analyzing classical music that reflects the parts of a musical form as self-similar structures. Schenker's analytical techniques have had a growing influence in recent decades on a variety of musical ideas. Certain long-standing compositional procedures, such as those of canon, fugue, and motivic development, depend entirely on making new musical material by systematically transforming previous musical material. In many instances, these procedures result in clearly self-similar musical structures.

You can make an analogy in polyphonic music to the space-filling curve. If you choose a "generating motif" of a few intervals and durations (see figure 4b), it will serve as the slowest moving line in your musical fractal. (Its purpose is analogous to that of the largest triangle in the Koch snowflake.) Then, using the program in listing 4, you add a faster repetition of the motif to each of the notes in the original motif (see figure 4c). Then you add still faster motivic repetitions to each of the notes generated in the previous step as well. The result is a time-filling musical structure analogous to the space-filling curve of the Koch snowflake.

The program in listing 4 generates a three-line polyphonic composition. You can create an entire piece of music out of essentially one motif. The program places that motif in a self-similar structure by displaying it simultaneously in three different time spans.

You can change the nature of the resulting music radically by altering the motif. Changing only one pitch or time relationship can result in very different music because the change is perpetuated through every occurrence of the motif in all three layers

(continued)

Listing 4: *VARIATN.BAS*, a program for determinate fractal and Brownian variation.

```

5 REM*****
6 REM Copyright 1986 Curtis Bahn, Creative Associates Inc.
7 REM*****
10 CLS
20 DIM P(6):DIM AP(6):DIM BP(36):DIM CP(216)
30 DIM D(6):DIM AD(6):DIM BD(36):DIM CD(216)
40 DT=0:CC=0:BC=0:AC=0:GP=0:R=0:HP=100
50 _INIT:_INST(1):_INST(2):_INST(3)
100 INPUT"HOW MANY NOTES IN SET?"; PN:
    IF PN>6 OR PN<1 THEN GOTO 100
110 PRINT"INPUT";PN;"PITCH RELATIONSHIPS"
120 FOR LOOP=1 TO PN
130 INPUT P(LOOP):IF ABS(P(LOOP))>12 THEN PRINT"TOO BIG":
    GOTO 130
135 IF GP<P(LOOP)THEN GP=P(LOOP):
    IF BP>P(LOOP)THEN BP=P(LOOP)
140 NEXT LOOP
150 PRINT "INPUT";PN;"TIME RELATIONSHIPS"
160 FOR LOOP=1 TO PN
170 INPUT D(LOOP)
180 NEXT
185 INPUT"BROWNIAN RANDOMIZER APPLIED TO PITCH (1 OR 0)";
    R:IF R>2 GOTO 185
190 PP=ABS(BP)+ABS(GP)
195 LP=HP-(3*GP):SK=100/(3*PP)
200 REM FRACTAL ROUTINE
205 PRINT"COMPUTING FRACTAL"
210 FOR A=1 TO PN
220 AP(A)=P(A)+RC:AD(A)=D(A)
230 FOR B=1 TO PN
240 BC=BC+1:IF R = 1 THEN GOSUB 700
245 BP(BC)=AP(A)+P(B)+RC:BD(BC)=D(B)*D(A)
250 FOR C=1 TO PN
260 CC=CC+1:IF R=1 THEN GOSUB 700
270 CP(CC)=BP(BC)+P(C)+RC:CD(CC)=D(C)*BD(BC):DT=DT+CD(CC)
280 NEXT C: NEXT B: NEXT A
290 TS=255/DT
300 REM PLAYING ROUTINE
310 BC=0:CC=0
320 FOR A=1 TO PN
330 _SOUND(1,1,AP(A)+LP):CIRCLE(TC,90-(AP(A)*SK)),6
340 FOR B= 1 TO PN
345 BC=BC+1
350 _SOUND(2,1,BP(BC)+LP):CIRCLE(TC,90-(BP(BC)*SK)),3
360 FOR C= 1 TO PN
370 _SOUND(3,1,CP(CC)+LP):CIRCLE(TC,90-(CP(CC)*SK)),1
380 FOR LOOP=1 TO CD(CC):TC=TC+TS
385 REM all play statements for mono playback
390 _SOUND(3,0,CP(CC)+LP)
400 NEXT LOOP
410 NEXT C: NEXT B: NEXT A
420 _STOP(1):_STOP(2):_STOP(3)
430 INKEY$=DD$:IF DD$="" THEN GOTO 430
440 GOTO 300
500 REM BROWNIAN ROUTINE
510 S=0
520 FOR I= 1 TO 12
530 S=S+RND(1)
540 NEXT I
550 RC=INT(2*(S-6))
560 RETURN
    
```



of the musical structure.

In listing 4, we have limited the number of layers to three, but given the hardware, you could add layers to the musical structure until you achieve a point of aural saturation. You reach saturation when the input exceeds your aural resolution (when an additional layer makes the music move so fast that its tones become blurs) or surpasses the limitations of the synthesis system (when the tones in a new layer are too high for the synthesizer to play).

You can make a musical fractal that sounds less mechanical by incorporating a certain degree of randomness into the previous, non-random example. The idea is to produce random offsets of the original, nonrandom values. The program shown in listing 4 gives you the op-

tion of calling for Brownian random offsets in the selection of pitch intervals on the second and third layers. For the second layer the program will impart a change in the range of 0 to 6 semitones above or below the pitch value specified. The same range and distribution are applied for the third layer to those tones produced for the second layer.

The technique for creating this musical fractal is quite closely related to the technique in computer graphics for making fractal, Brownian mountain ranges (see reference 7). This complex computer graphic is made by nesting triangles, where the sides of the triangles are offset by some random amount proportional to the length of that side. In the musical fractals produced by the Brownian variation that is given in listing 4, an analogous

technique is applied.

The final musical fractal uses a technique similar to the one described above: You generate an original layer and then add faster layers to it. You generate all layers through a 1/f-noise algorithm producing self-similar patterns. Because it is a random process, its similarity is statistically, rather than literally, the same. This fact lends a varied yet consistent surface to the resulting music. (The code is provided in listing 5.)

**A LAYERED STRUCTURE**

To understand how the layers are made, you need to understand the concept of *pitch class*. A pitch class is a C or an F#, for example, without regard for its register. In other words, the highest and lowest Cs on the piano keyboard share the same pitch class, C; they differ only in octave.

You don't specify the number of notes in the first layer directly. Instead, you begin by specifying the number of different pitch classes you want to generate in the first layer. You may have noticed that the 1/f algorithm commonly produces repeated notes. Therefore, the contents of the layer are related to pitch-class diversity, not simply to the number of pitches in the layer. The number of pitches in the layer does determine the perceived

*(continued)*

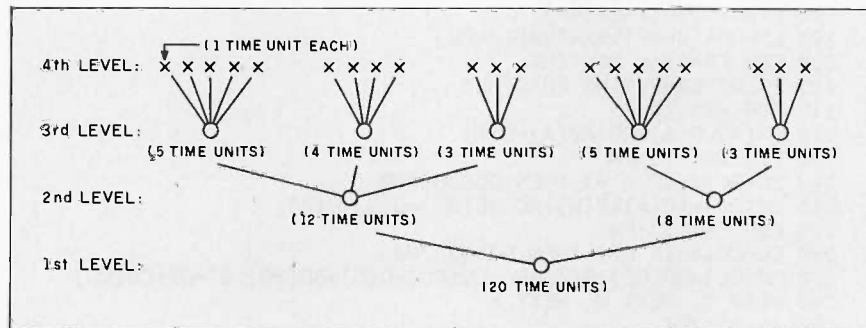

Figure 5a: The relationship in time of four levels of generated notes.

Figure 5b: A four-layer musical structure generated using the 1/f-noise algorithm.



## MUSICAL FRACTALS

Listing 5: *RANDOM.BAS*, a program to generate 1/f random fractals.

```

5 REM*****
6 REM Copyright 1986 Charles Dodge, North Cape Music
7 REM*****
10 CLS
20 DIM AP(10):DIM BP(100):DIM CP(255):DIM DP(2,255):TC=20
30 DIM BD(10):DIM CD(100):DIM DD(255)
40 DT=0:DC=0:CC=0:BC=0:AC=0:DIM CT(4)
50 DIM CF(4,12):DIM LAST(4):KN=50
60 X=RND(-TIME):LAST(1)=INT(RND(1)*32)
70 _INIT:_INST(1):_INST(2):_INST(3):_INST(4)
80 _MODI(1,5):_MODI(2,40):_MODI(3,15):_MODI(4,16)
100 FOR LOOP = 1 TO 4
110 PRINT"ENTER PITCH CLASS LIMIT OF LEVEL #";LOOP
120 INPUT PL(LOOP)
130 IF PL(LOOP)>6 THEN PRINT"TOO BIG":GOTO 120
140 IF PL(LOOP)<1 THEN PRINT"TOO SMALL":GOTO 120
150 NEXT LOOP
160 L=1
170 FOR A = 1 TO 10
180 GOSUB 820
190 IF CT(L)>PL(L) THEN GOTO 230
200 AC=AC+1
210 AP(A)=LAST(L)
220 NEXT
230 REM FRACTAL ROUTINE
240 SCREEN 2
250 FOR A = 1 TO AC
260 CIRCLE(DI/2,197-(AP(A)*5+20)),9
270 LAST(2)=AP(A)
280 FOR B = 1 TO 10
290 L=2
300 GOSUB 820
310 IF CT(L)>PL(L) THEN GOTO 570
320 BI=BI+1:BP(BI)=LAST(L)
330 CIRCLE(DI/2,197-(BP(BI)*5+20)),6
340 LAST(3)=BP(BI)
350 FOR C = 1 TO 10
360 L=3
370 GOSUB 820
380 IF CT(L)>PL(L) THEN GOTO 550
390 CI=CI+1:CP(CI)=LAST(L):IF CI=255 THEN AC=A:GOTO 590
400 CIRCLE(DI/2,197-(CP(CI)*5+20)),3
410 LAST(4)=CP(CI)
420 FOR D = 1 TO 10
430 L=4
440 GOSUB 820
450 IF CT(L)>PL(L) THEN GOTO 530
460 DI=DI+1
470 CIRCLE(DI/2,197-(LAST(L)*5+20)),.5
480 IF DI>255 THEN GOTO 500
490 DP(1,DI)=LAST(L):GOTO 520
500 DP(2,DI-255)=LAST(L)
510 IF DI=510 THEN AC = A: GOTO 590
520 DC=DC+1:NEXT D
530 DD(CI)=DC:DC=0:CT(L)=0:GOSUB 1020
540 CC=CC+1:NEXT C
550 CD(BI)=CC:CC=0:CT(L)=0:GOSUB 1020
560 BC=BC+1:NEXT B
570 BD(A)=BC:BC=0:CT(L)=0:GOSUB 1020
580 NEXT A
590 LINE (0,0)-(255,0):LINE (255,0)-(255,197):
LINE(255,197)-(0,197):LINE(0,197)-(0,0)
600 DD$=INKEY$:IF DD$="" GOTO 600
610 REM PLAY LOOPS
640 FOR A = 1 TO AC
650 _SOUND(1,1,AP(A)+KN)

```

(continued)

## Switches to make your PCs powerful.

Reliable and affordable port expansion without memorizing complicated software commands. Switch your PC between peripherals with the push of a button. Is MFJ good? Joe Campbell in his book, *The RS-232 Solution* said, "Switch boxes are sold by many suppliers, but by far the two best values are from MFJ Enterprises." Below are just some of those values.

When you need to switch between two peripherals ... or you need to have two computers share the same peripheral ...



MFJ-1240/\$79.95

The 1240 has a built-in transmit/receive switch that allows 2-way information flow. LEDs monitor data lines while built-in surge protectors guard them. Can be used as a null modem. MFJ's No. 1 seller!

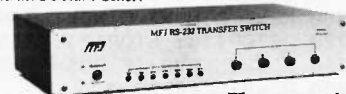

When you need 1-to-4 computers to share one peripheral or 1-to-4 peripherals to share a common computer ...

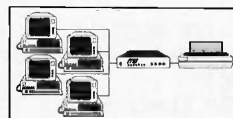

MFJ-1243/\$119.95

The perfect office switch. Save money. Don't buy extra printers or modems. Connect 1-to-4 computers to a single printer or let a PC share up to four peripherals. LEDs monitor data lines; surge protectors guard them. Two way communication is allowed.



When you need to interconnect four computers and four peripherals at one time! The MFJ-1294 gives you a computer system ...

MFJ-1294/\$299.95

With the MFJ-1294 you can create a mini-network of computers and peripherals. All eight devices can be working simultaneously! Think of the production you'll get with the MFJ-1294's 16 possible combinations.

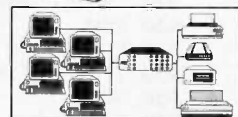

Seven additional models to choose from including MFJ's IBM and Centronics Parallel Switches. All RS-232 switches have RS-232 connectors, LEDs to monitor data lines, MOV surge protectors and transmit/receive buttons that allow 2-way communication.

## And Power Strips to make them safe.

Your fine computer and peripheral equipment can be damaged by electrical surges much smaller than you've been led to believe. Save them and your valuable data with an MFJ Power Center. Multi-filters isolate equipment, eliminating noise/hash/inter-action; MOVs suppress spikes and surges. These are heavy-duty, commercial quality Power Strips.

MFJ-1107 - 8 sockets; 2 unswitched; \$79.95  
MFJ-1108 - 7 sockets; 1 unswitched. Drop-out relay prevents disk drive head from bouncing; \$99.95

MFJ-1109 - like 1107 but intelligent (switch on the device that's plugged into the control socket and everything else comes on); \$129.95

There are other Switches, Power Centers and Computer Peripheral Products available from MFJ. Call and talk with us about all your computing needs. When you do, ask for our latest catalog. Both the call and catalog are free.

1-800-647-1800

For technical/repair information, or in Mississippi, or outside the Continental United States, please telephone...

1-(601) 323-5869 or  
telex 53-4590 MFJSTKV

All MFJ products come with a double guarantee we think is unmatched. Order from MFJ and try any product for 30 days. If it doesn't satisfy your needs, just return it for a full refund less shipping. If you keep it you can be assured of continued service and our One Year Unconditional Guarantee.

Call toll-free 1-800-647-1800 and charge the products you need to your VISA or MasterCard, or send a check or money order, plus \$5.00 shipping, and our shipping department will promptly have your computer peripheral on its way to you.

# MFJ

MFJ Enterprises, Inc.  
921 Louisville Road  
Starkville, MS 39759



```

660 FOR B = 1 TO BD(A):BC=BC+1
670 _SOUND(2,1,BD(BC)+KN)
680 FOR C = 1 TO CD(B):CC=CC+1
690 IF CC>255 GOTO 770
700 _SOUND(3,1,(CP(CC)+KN)
710 FOR D = 1 TO DD(C):DC=DC+1
720 IF DC>255 GOTO 740
730 _SOUND(4,1,DP(1,DC)+KN):GOTO 760
740 _SOUND(4,1,DP(2,DC-255)+KN)
750 IF DC=510 THEN GOTO 770
760 NEXT D:NEXT C:NEXT B:NEXT A
770 _STOP(1):_STOP(2):_STOP(3):_STOP(4)
780 DD$=INKEY$:IF DD$="" GOTO 780
790 BC=0:CC=0:DC=0
800 GOTO 610
820 REM      1/F ROUTINE
830 LL=LAST(L):NP=0:K=16:PROBIT=.03125
840 J=INT(LL/K)
850 IF J=1 THEN LL=LL-K
860 U=RND(1)
870 IF U<PROBIT THEN J=1-J
880 NP=NP+J*K
890 K=K/2
900 PROBIT = PROBIT*2
910 IF K>=1 GOTO 840
920 LAST(L)=NP:TEST=NP
930 REM      PITCH CLASS TEST
940 FOR I = 0 TO 11
950 IF INT((TEST+I)/12)=(TEST+I)/12 THEN CF(L,I)=1:GOTO 920
960 NEXT I
970 CT(L)=0
980 FOR I = 0 TO 11
990 CT(L)=CF(L,I)+CT(L)
1000 NEXT I
1010 RETURN
    
```

form of the resulting composition, however, because each note of the first layer, when elaborated with the notes of the subsequent layers, is heard as a section of the composition.

You choose the notes of the second layer by the same method as the first—indirectly—by specifying the number of new pitch classes to generate before going on to the next note. Thus, each first-layer note will be elaborated, on the average, by a different number of second-layer notes. Therefore, the whole composition will sound less geometrical and more natural. The number of pitch classes you specify for each second-layer elaboration of first-layer notes is important. Too few (one or two) may sound too uniform, and too many (more than five or six) may make the first-layer notes too long. You use a similar method to indicate the pitch-class diversity of the third layer. Here again, you specify the number of new pitch classes for the third-layer notes to be played in the same time span as a second-layer note. The fourth layer is also created in exactly the same way as the earlier ones.

The means for calculating rhythm in this example is quite simple. The program assigns a short duration to each fourth-layer note. The duration of a third-layer note equals the total time

*(continued)*

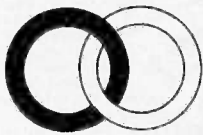

# FULL LINE ADD ON CARD FOR IBM

We are the reliable manufacturer of ADD-ON card and peripheral:

All our products are superior than our competitors in multi-wise and function-wise.

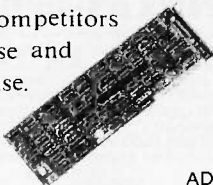

Good quality, Reasonable price.

\* WHOLESALE, DEALER, RETAIL, STORE AND OEM ENQUIRES WELCOME \*

**NIC TECHNOLOGY INC.**

ADDRESS: 3020, SCOTT BLVD, SANTA CLARA, CA 95054, U.S.A.

TELEX: 1561096 PECO UT TEL: (408) 980-9511 (2 LINES) ATTN STANLEY FAX: (408) 980-1530

The products:

1. ADD-ON card
    - a. Video card
    - b. I/O card
    - c. Memroy expansion card
    - d. Hard disk controller card
  2. Peripheral:
    - Monitor, Keyboard, Driver, Modem, Cable, Power supply, P/C case.
- "STOCKS AVAILABLE"

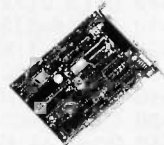



# PERFORMANCE PACKAGE

Blaise Computing Inc. introduces the PERFORMANCE PACKAGE™ for Turbo Pascal programmers.

# TURBO PASCAL

**NEW!**

**Turbo ASYNCH™** With Turbo ASYNCH, you can be in constant touch with the world without ever leaving the console. Rapid transit at its best. Turbo ASYNCH is designed to let you incorporate asynchronous communication capabilities into your Turbo Pascal application programs, and it will drive any asynchronous device via the RS232 ports, like printers, plotters, modems or even other computers. Turbo ASYNCH is fast, accurate and lives up to its specs. Features include...

- ◆ Initialization of the COM ports allowing you to set all transmission options.
- ◆ Interrupt processing.
- ◆ Data transfer between circular queues and communications ports.
- ◆ Simultaneous buffered input and output to both COM ports.
- ◆ Transmission speeds up to 9600 Baud.
- ◆ Input and output queues as large as you wish.
- ◆ XON/XOFF protocol.

The underlying functions of Turbo ASYNCH are carefully crafted in assembler for efficiency, and drive the UART and programmable interrupt controller chips directly. These functions, installed as a runtime resident system, require just 3.2K bytes. The interface to the assembler routines is written in Turbo Pascal.

The Turbo Pascal PERFORMANCE PACKAGE™ is for the serious Turbo Pascal programmer who wants quality tools to develop applications. Every system comes with a comprehensive User Reference Manual, all source code and useful sample programs. They require an IBM PC or compatible, utilizing MS-DOS version 2.0 or later. There are no royalties for incorporating PERFORMANCE PACKAGE functions into your applications.

Turbo POWER TOOLS and Turbo ASYNCH sell for \$99.95 each, and they may be ordered directly from Blaise Computing, Inc. **TO ORDER, call (415) 540-5441**

**Turbo POWER TOOLS™** Turbo POWER TOOLS is a sleek new series of procedures designed specifically to complement Turbo Pascal on IBM and compatible computers. Every component in Turbo POWER TOOLS is precision engineered to give you fluid and responsive handling, with all the options you need packed into its clean lines. High performance and full instrumentation, including...

- ◆ Extensive string handling to complement the powerful Turbo Pascal functions.
- ◆ Screen support and window management, giving you fast direct access to the screen without using BIOS calls.
- ◆ Access to BIOS and DOS services, including DOS 3.0 and the IBM AT.
- ◆ Full program control by allowing you to execute any other program from within your Turbo Pascal application.
- ◆ Interrupt service routines written entirely in Turbo Pascal. Assembly code is not required even to service hardware interrupts like the keyboard or clock.

Using Turbo POWER TOOLS, you can now "filter" the keyboard or even DOS, and create your own "sidekickable" applications.

YES, send me the Best for the Best! Enclosed is \_\_\_\_\_ for  
 Turbo ASYNCH     Turbo POWER TOOLS. (CA residents add 6½% Sales Tax. All orders add \$6.00 for shipping.)

Name: \_\_\_\_\_ Phone: \_\_\_\_\_  
 Shipping Address: \_\_\_\_\_ State: \_\_\_\_\_ Zip: \_\_\_\_\_

City: \_\_\_\_\_ Exp. Date: \_\_\_\_\_  
 VISA or MC #: \_\_\_\_\_

Turbo Pascal is a trademark of Borland International. Turbo POWER TOOLS, Turbo ASYNCH and PERFORMANCE PACKAGE are trademarks of Blaise Computing Inc. IBM is a registered trademark of International Business Machines Corporation. MS-DOS is a trademark of Microsoft Corporation.

**BLAISE COMPUTING INC.**

# BLAISE

*Watch us!*

- ◆ 2034 BLAKE STREET
- ◆ BERKELEY, CA 94704
- ◆ (415) 540-5441



## ABOUT THE PROGRAMS

The programs in listings 1 through 5 are written in MSX BASIC extended with the MUSIC MACRO commands for the Yamaha CX5-M music computer. We chose this particular machine because it is the most accessible computer that allows polyphonic (multivoice) sound production. Since most BASIC dialects contain commands to generate only monophonic (single-line) music, we wrote these programs so they could be modified easily for monophonic performance.

The programs in listings 1 through 3 produce short, monophonic musical segments by applying random processes to the parameters of musical pitch and time. In MUSIC MACRO, you prepare a short PHRASE that you then PLAY. Depending on the requirements of the system you use, you can fill an array or character string and send it later to your sound generator.

In listings 4 and 5, the longer fractal algorithms, the 64 rhythmic values of MUSIC MACRO were not enough for the exponential character of the relationships of the scaled time. Therefore, we introduced another scheme to produce many more time relationships. It uses a series of four nested loops, the indexes of which are either a result of the generating motif, as in figure 4b, or the result of a random process, as in figure 5b.

If your machine allows only mono-

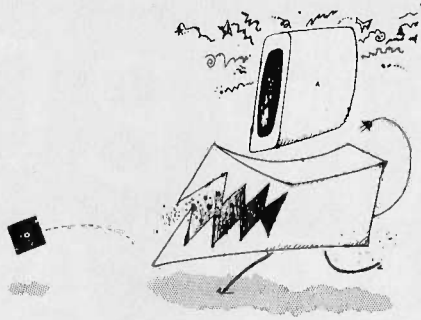

phonic sound generation, you can still realize the polyphonic music. Just place all your sound generation statements at the center of the nested loops, separated by small time factors. This will arpeggiate the example. By listening closely you will hear the differing rates of change of the layers articulated in this single line.

The program in listing 4, for making the first fractal, scales a given motif to three layers. The theme is entered as a series of relationships to an abstract reference pitch. This is like entering the x-axis values in relationship to zero for a linear graph in either a positive or negative direction. For example, the values 0, 3, and -2 will create a string of pitches starting on the reference pitch, moving to a pitch three semitones above it, and ending on the pitch two semitones below it. The program in listing 4 provides a "switch" to pro-

duce a Brownian random displacement of pitch on layers two and three. Using this feature will result in a less strictly patterned musical segment.

The program handles time as a ratio of values greater than 1, such as 1:1:2:3:1:1. Because of the exponential character of the relationships between the layers of the fractal, small numbers seem to provide the best results. Relationships of pitch and time are scaled to a range of values appropriate to the system. The notes of the score are displayed graphically during the performance. Hitting any key will repeat the performance.

The program in listing 5, to produce the second fractal, asks for the limit of pitch classes allowed for each layer of the fractal. A call to the *1/f* subroutine chooses a note based on the previous note of that layer or the last note of the previous layer. As the various arrays of durations and pitches are filled, they are graphically displayed on the screen. When the segment is completely generated, a border appears around the screen. Hitting any key initiates a performance. If the number of notes in the fastest layer exceeds 510, the program stops filling arrays. The performance is truncated at the last note of the first layer reached before the array of fastest notes was filled. You can alter the program for larger arrays, according to your machine's capabilities.

span of all the fourth-layer notes generated to play with it. Then, the total duration of all the third-layer notes for a given second-layer note determines its duration. Similarly, the total of all the second-layer notes for a given first-layer note determines its duration, and so on until all notes in the piece have an assigned duration. The relations in time of the various layers is illustrated in figure 5a.

We chose *1/f* noise to select the elements in figure 5b because of its unique memory. However, you can obtain interesting results if you mix the fractional noises used to generate

the various layers. For example, using white noise to calculate the fourth layer would lead to a greater diversity of timing.

### CONCLUSION

The exploration of fractal geometry's musical applications is in its infancy. The musical fractals offered above are relatively simple. There remains a large universe of fractal geometry yet to be broached by musicians. ■

### REFERENCES

1. Mandelbrot, Benoit B. *The Fractal Geometry of Nature*. New York: W. H. Freeman, 1982.

2. Hiller, Lejaren, and Loren Isaacson. *Experimental Music*. New York: McGraw-Hill, 1959.

3. Mathews, Max V. *The Technology of Computer Music*. Cambridge, MA: MIT Press, 1969.

4. Sørensen, Peter R. "Fractals." *BYTE*, September 1984, page 157.

5. Dodge, Charles, and Thomas A. Jerse. *Computer Music: Synthesis, Composition, and Performance*. New York: Schirmer Books, 1985.

6. Voss, Richard F., and John Clarke. "1/f Noise in Music: Music from 1/f Noise." *Journal of the Acoustical Society of America*, 63(1), 1978, page 258.

7. DeVries, Peter. "Computer Graphics." *Scientific American*, September 1984.



# dPOWER without dPRICE.

"We rate the documentation as excellent; for novice dBase II users, the manual alone might be worth the price of the full package." *InfoWorld*

"The PractiBase report writer is a decided improvement over dBase II." *PC Week*

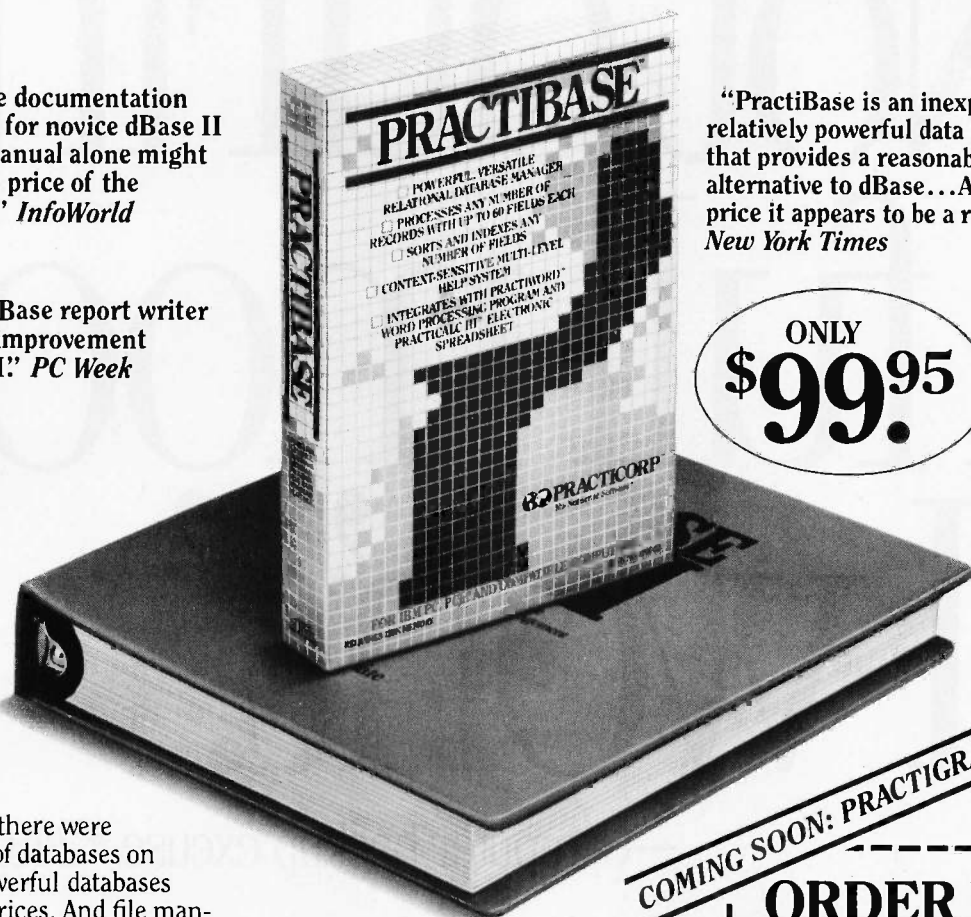

"PractiBase is an inexpensive but relatively powerful data base manager that provides a reasonably attractive alternative to dBase... And at the \$99 price it appears to be a real bargain!" *New York Times*

ONLY  
**\$99.95**

Until now, there were only two kinds of databases on the market. Powerful databases with powerful prices. And file managers that cost very little—and gave you very little in return.

Now you can get the power you want at the price you want to pay. With PractiBase®. The first inexpensive database that truly compares with *any* base at *any* price—especially at its low price of \$99.95.

Skeptical? We don't blame you. But consider some of PractiBase's features:

- A powerful relational database management system, including memo writer, forms generator, entry forms and page report generator
- Advanced dBase II\*-compatible programming language—including JOIN, UPDATE and TOTAL commands
- Reads and writes dBase II files
- Runs dBase II programs! (.PRG and .FMT files)
- Sorts on multiple keys in a single operation
- Handles up to three data files at one time
- Menu- or command-driven (you never have to stare at a dot!)
- Includes time-saving abbreviation macros

- Context-sensitive, multi-level HELP
- Includes 200-page manual, case study and command summary card
- NOT copy-protected
- For the IBM PC, XT, AT\* and compatibles
- Requires 256K minimum (hard disk optional)

Whether you're a first-time user or a power user, we believe you'll find PractiBase the equal of databases costing up to *ten times* its price.

You can buy PractiBase alone. Or save even more by buying it with PractiWord®—our full-featured word processor that gives you all the power of WordStar\*—for a combined price of only \$149.95.

Either way, you'll get dPower you need. Without dStroying your budget.

**PRACTICORP™**  
No-Nonsense Software™

The Silk Mill, 44 Oak Street, Newton  
Upper Falls, MA 02164 (617) 965-9870

\*The following are registered trademarks of the respective companies indicated: dBase and dBase II, Ashton-Tate; WordStar, Micro-Pro International; IBM, PC, XT and AT, International Business Machines Corp. PractiCorp, PractiBase and PractiWord are registered trademarks of PractiCorp International Inc.

COMING SOON: PRACTIGRAPH!™

## ORDER NOW!

**To order by mail:** Complete this coupon and return to PractiCorp International, The Silk Mill, 44 Oak Street, Newton Upper Falls, MA 02164

**To order by phone:** Call TOLL FREE 1-800-858-2727 or call 617-965-9870

**Yes!** Rush PractiBase to me:

Quantity	Price
_____ PractiBase @ \$99.95 each	\$ _____
_____ PractiWord @ \$99.95 each	_____
_____ PractiBase/PractiWord bundle @ \$149.95 each	_____
Subtotal _____	
MA residents add 5% sales tax _____	
Shipping and handling \$5.00	
TOTAL \$ _____	

Payment:  Check  Visa  MasterCard

Card No. \_\_\_\_\_

Expiration Date \_\_\_\_\_

Signature \_\_\_\_\_

Name \_\_\_\_\_

Shipping address \_\_\_\_\_

City \_\_\_\_\_ State \_\_\_\_\_ Zip \_\_\_\_\_

Phone no. (\_\_\_\_) \_\_\_\_\_

Allow four weeks for delivery. Outside U.S.A., add \$10 and make payment by bank draft in U.S. dollars only.

B686



# “Not during a full moon I won’t.”

—Computer backup excuse #243

People can get very superstitious about when they do their computer backup. Especially if it gives them an excuse for not doing it at all.

Because, after all, backing up is about as exciting as watching paint dry.

One way to take the curse off is to do it first thing in the morning. If you're one of those slow starters who has to have coffee and push some papers around for awhile when you get to work, that dead time could be perfect for backup.

As for how to do it, the floppy disk is fine if you have a limited amount of memory, and the data cartridge for 5 to 10 Mbytes or over.

To learn more about backup and other applications of the data cartridge, a 3M developed technology

whose time has come, contact your local computer products dealer.

And maybe you won't be one of those people who does his backup only once in a blue moon.

When you run out of excuses.™

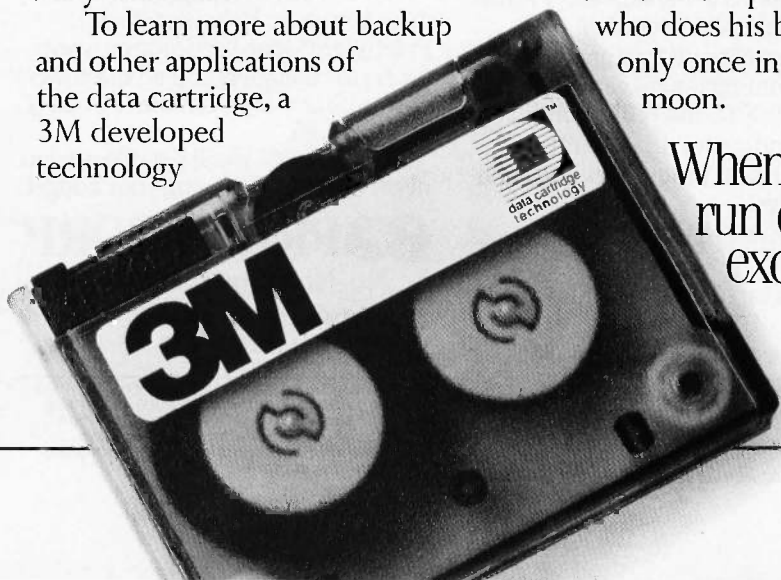



# A MIDI PROJECT

BY JAY KUBICKY

## *A MIDI interface with software for the IBM PC*

BEFORE I DESCRIBE my project, I'd like to discuss the MIDI specification. This standard defines a hardware interconnection scheme with a software specification for the purpose of connecting electronic musical instruments to a computer.

As the name implies, an electronic musical instrument is any instrument that produces sound electronically. The most common electronic musical instrument is the synthesizer. The first synthesizers looked like part of a piano keyboard attached to a long, flat box covered with dials and switches. But today there are many other forms; a modern synthesizer might well have no keyboard but might have a MIDI-in jack.

All synthesizers produce sound through a system of oscillators, filters, and other wave-shaping devices. One way to classify synthesizers is by the number of voices they have. At any given instant, each voice can produce one individual note. For example, an eight-voice synthesizer can produce eight simultaneous notes. In synthesizers with multitimbral capability each of these voices can produce a different sound.

On a modern synthesizer, the con-

trol values of the voices are stored within the synthesizer in what are known as "patches" or "programs." These programs hold all of the values for each sound the synthesizer can produce. Different sounds can be loaded into the synthesizer's sound-generating circuitry by changing the program. Most synthesizers can store from 32 to 128 programs.

Sequencers are a particularly interesting class of devices associated with MIDI interfaces. These allow you to store sequences of notes played from a MIDI-compatible keyboard or other MIDI device. Since only the codes for the notes are stored and not the actual notes, the sequencers can later play back this music at any speed without altering the pitch.

Besides synthesizers, MIDI also ties together drum machines, guitar synthesizers, and other MIDI-compatible devices.

### **THE MIDI PROTOCOL**

The MIDI protocol is a complex set of messages pertaining, in general, to various functions of the MIDI system, and, in particular, to functions of synthesizers.

Two types of bytes can be sent over

the MIDI interface bus—status and data. Status bytes are 8-bit bytes with their most significant bit being bit 7, always set to 1. Data bytes may never have their MSBs set.

Messages are made up of a combination of these two types of bytes. The status byte is sent first, and usually it is followed by one or more data bytes. Real-time messages have no accompanying data bytes and may be sent at any time, even inside of other messages.

MIDI messages are generally divided into two types—channel messages and system messages. The channel voice messages are an important subset of the channel messages. They are used to alter the status of the synthesizer's voices.

The *note-on* channel voice message is sent whenever a key is pressed. The data bytes in this message specify the number of the note and its velocity, which is determined by how hard the key was struck (this only applies to velocity-sensitive keyboards). The *note-*

*(continued)*

Jay Kubicky (934 North Orange St., Media, PA 19063) is a high school sophomore. He has studied music since age five and has been interested in computers for five years.



# Fast Forward.

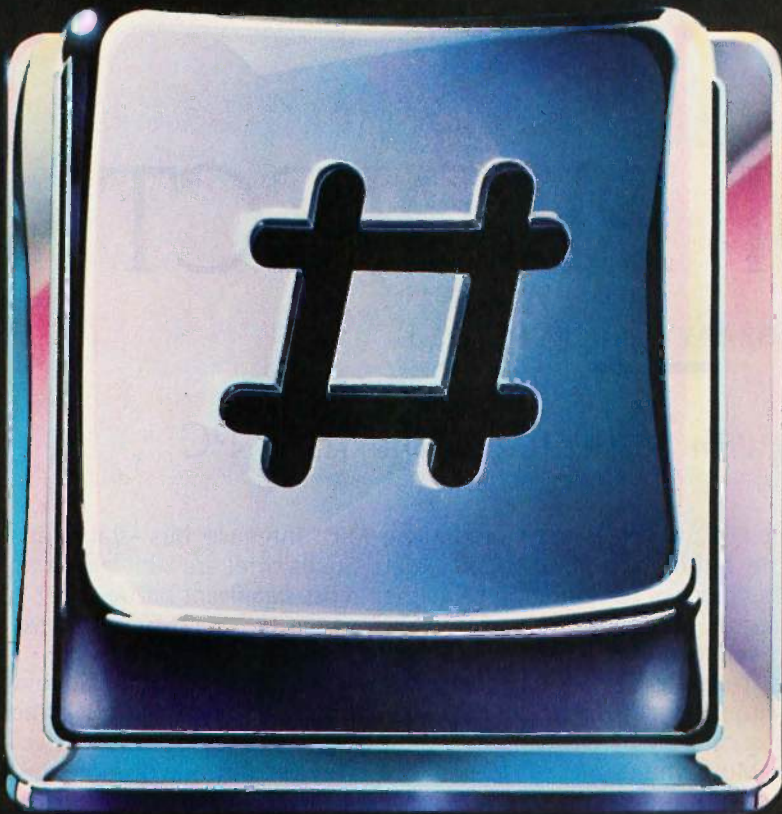

When you use your AT&T Card at a public phone, you don't have to hang up after each call. Just hit this button after your first conversation, and dial the number of your next long distance call. The phone automatically remembers your AT&T Card number. So you have more time to take care of business.

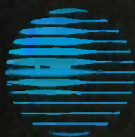

**AT&T**  
The right choice.

*off* message is sent whenever a note is released. As with note-on, there is an accompanying note byte and velocity byte (again, only pertinent on velocity-sensitive keyboards). The *program change* message is sent whenever a program is changed. The data byte is the new program number.

The *polyphonic key pressure/after-touch* message is sent after a key is pressed if the key pressure is reduced. Accompanying the status byte is the note number and pressure. The *channel pressure* message designates the volume for a given channel.

Most synthesizers have at least some sort of note-bender or pitch wheel built into them. In terms of MIDI, this is known as a continuous controller. A special MIDI code known as a control change pertains to all continuous controllers in the MIDI system. The *control change* message is meant for any type of controller in the MIDI system other than the keyboard or pitch wheel (such as pedals, modulation controllers, etc.). After the status byte, the controller number and value is sent. Controller numbers 122 through 127 are reserved (these codes are explained in the section on channel mode messages).

Since the pitch-bender is the most commonly used controller, it is assigned a *pitch wheel change* message of its own. This message is sent when the value of the pitch-bending device (wheel, joystick, etc.) is changed. Two accompanying data bytes are sent, giving a 14-bit resolution.

## CHANNEL CONTROL

Since the MIDI system can support many synthesizers at once, message arbitration must be accomplished through the use of "channels."

A channel is designated by the lower four bits of the first byte of any of the channel voice messages. These four bits direct the MIDI message to one of 16 devices that may be attached to the MIDI interface bus. Each device is responsible for recognizing its channel number and responding to its assigned messages. This allows up to 16 separate parts (voices) to be simultaneously played over a single MIDI interface bus.

There are four channel modes gov-



erning how devices will respond to channel-oriented messages.

### CHANNEL MODES

The following four channel modes apply to transmitter/receiver voice messages:

- *Omni-on poly*: Voice messages are received from all channels and are assigned to the voices polyphonically.
- *Omni-on mono*: Voice messages are received from all channels and control only one voice, monophonically.
- *Omni-off poly*: Voice messages are received from only one channel and are assigned to voices polyphonically.
- *Omni-off mono*: Voice messages are received in voice channels  $N$  through  $N+M-1$  and are assigned monophonically to voices 1 through  $M$ , respectively, where  $M$  is the number of voices and  $N$  is the start channel (usually 0).

Channel modes are set by sending a control change message to controllers 122 through 127.

The channel-oriented scheme lets you play up to 16 separate parts at once. There are many ways this can be accomplished. For instance, you could have 16 synthesizers hooked up to a single MIDI system bus (a rather expensive setup), or you could connect a few multitimbred synthesizers to a single MIDI interface bus.

On a multitimbred synthesizer, voice one could be strings, voice two could be brass, etc. A typical multitimbred synthesizer allows you to assign each of its six voices to a separate channel and to give each voice a different sound. Then you simply play different parts over different channels.

The only disadvantage with this type of setup is that you can assign only one voice per channel. This allows only one note to be played in each channel at any given instant.

[Editor's note: Be sure to check your synthesizer channel numbers. Channel 0 in Jay Kubicky's program corresponds to channel 1 on most synthesizers.]

### SYSTEM REAL-TIME MESSAGES

System real-time messages apply to all devices in the system and can be sent

(continued)

# Friendly Face.



When you're traveling on business, look for this friendly face—the AT&T Card Caller. It'll give you simple instructions on any call, including AT&T Long Distance Service calls. And you can use it with or without your AT&T Card. The AT&T Card Caller—a face you should get to know.



**AT&T**

The right choice.



any time, even between the bytes of another message. These messages control timing and synchronization of the system and are especially important when dealing with sequencers and drum machines.

The *timing clock* message synchronizes all time-relevant devices in the system such as sequencers, drum machines, etc. This message is sent at the rate of 24 beats per quarter note.

The *start* message tells all real-time devices in the system, such as sequencers and drum machines, to start. The *continue* message tells all stopped devices in the system to continue at the time of the next clock. The *stop* message tells all real-time devices to stop.

The *active sensing* message is optional. It is a dummy status byte sent at least every 300 milliseconds, regardless of other activity on the bus. Once the first active sensing message is received, all other devices on the bus that are capable will respond. If 300 milliseconds passes without the occurrence of a data transfer, the receiver will turn off all voices and return to normal operation.

The *system reset* message initializes all receivers to the condition of just having turned on system power. It is to be used sparingly, preferably under

manual control only. It should not be sent automatically on power-up.

### SYSTEM-COMMON MESSAGES

*System-common* messages are not channel-oriented and apply to all devices in the system. They implement the following functions:

The *song position pointer* message sets the internal beat-counter of sequencers, drum machines, etc., to a specific value. The two data bytes (with their MSB set to 0) contain the new beat-counter information and are sent with this code.

The *song position pointer* is really an internal register that contains the number of MIDI beats since the beginning of the song. It is normally set to 0 when the start message is sent.

The *song select* message defines the song to be played in sequencers, drum machines, etc. The one data byte used allows one of 128 possible songs to be selected.

The *tune request* message requests that all analog synthesizers in the system tune their oscillators.

### SYSTEM-EXCLUSIVE MESSAGES

The *system-exclusive* message makes up for all of MIDI's deficiencies. After a system-exclusive message and appro-

priate manufacturer identification is sent, any amount of any type of data can be sent over the bus (just as long as the MSBs of all data bytes are set to 0).

Upon receiving any sort of status byte other than a real-time message, the receiver automatically terminates system-exclusive mode.

The main purpose of the system-exclusive mode is to send actual program and sequencer data to be stored, analyzed, or changed in another synthesizer or computer.

An *EOX* (end of exclusive) message terminates the system-exclusive mode (manufacturer ID numbers are supplied by the MIDI committee).

## THE MIDI PROJECT

My MIDI project consists of two phases. In phase one I will show you how to build the hardware interface board and explain its inner workings. In phase two I will describe the software, how it works, and how to use it.

### PHASE I: BUILDING THE HARDWARE

At the hardware level, MIDI is an asynchronous serial interface (see photo 1). Typically, a MIDI-compatible device will have a MIDI-in port that receives MIDI data, a MIDI-out port that transmits MIDI data, and optionally a MIDI-thru port that echoes data received at the MIDI-in port back out again.

The operating speed of the serial interface is 31,250 bits per second (plus or minus 1 percent), with one start bit, eight data bits, and one stop bit. This speed is a convenient breakdown of 2 megahertz.

The interface circuit is a 5-milliampere current loop (see figure 1). The receiver is optoisolated and should require no more than 5 mA to drive. The MIDI interface cables use 5-pin DIN male plugs and the total bus length should be no more than 50 feet.

Since the MIDI interface transmits in a serial data format, a UART is needed to transfer data to and from it. The Zilog DART (dual asynchronous receiver/transmitter) serves this purpose nicely. The DART provides two

(continued)

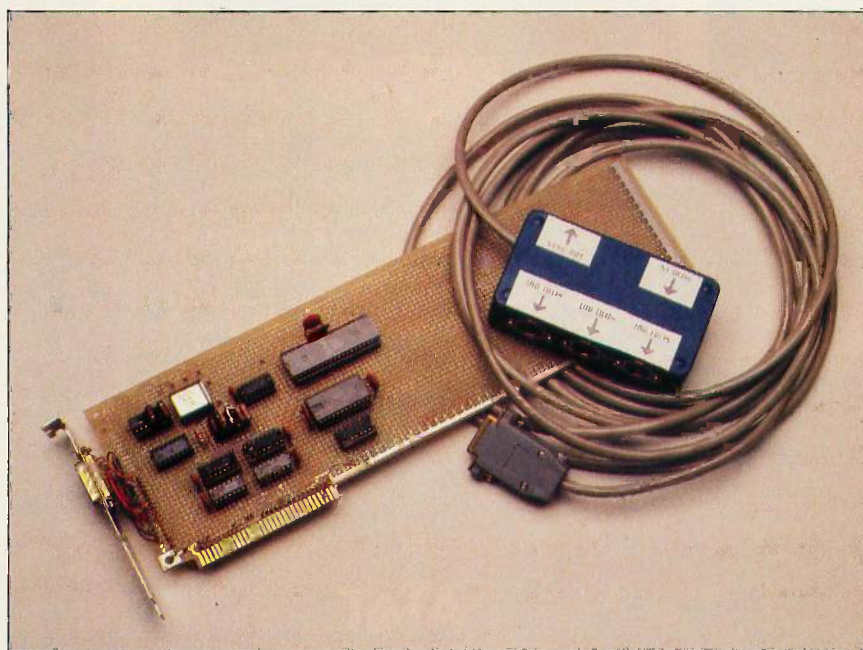

Photo 1: Jay Kubicky's MIDI interface board.



# MIDI PROJECT

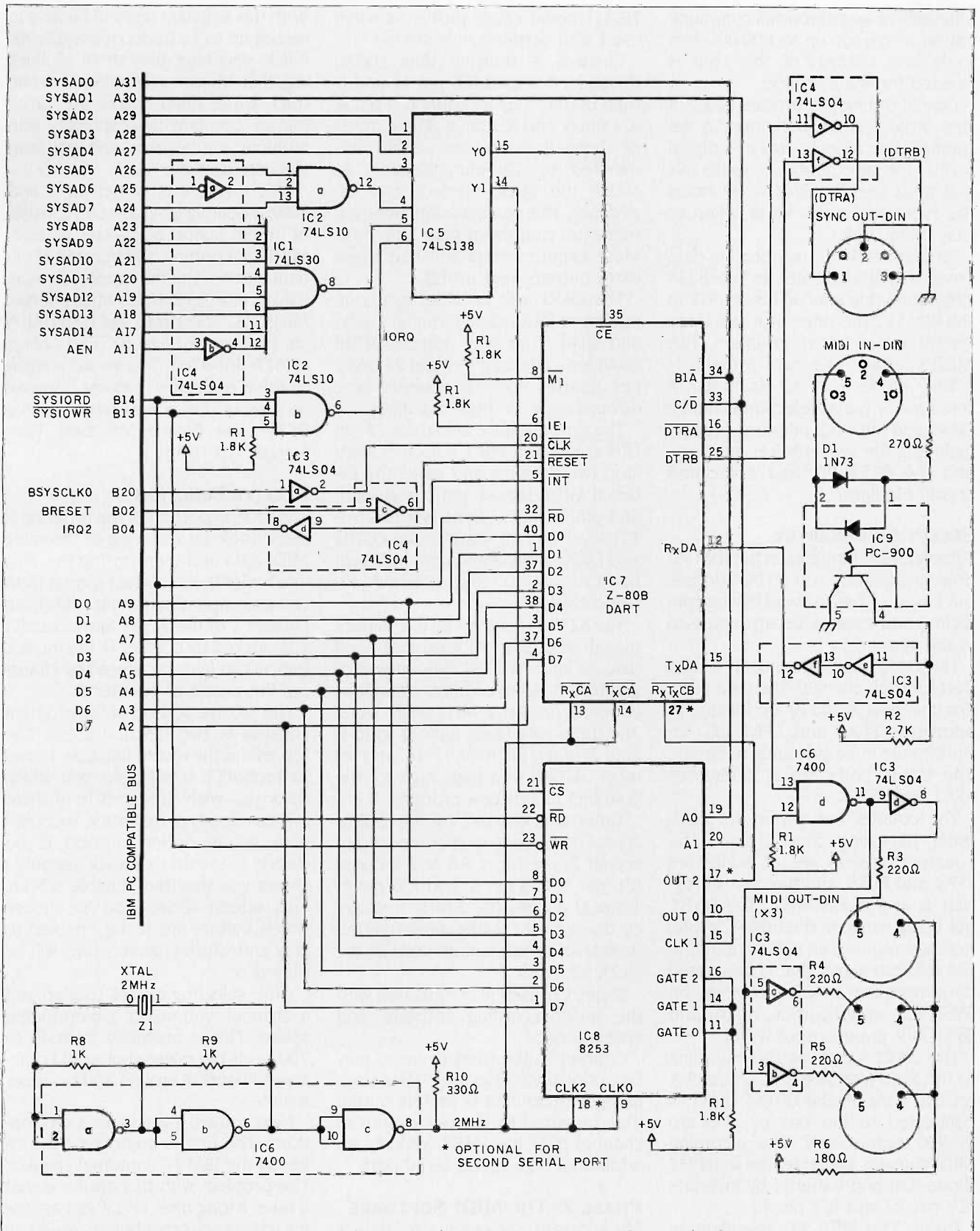

Figure 1: The MIDI 1.0 IBM Board.



channels of asynchronous communication at speeds up to 800,000 bps (only one channel of this chip is needed for the interface).

One of the major software goals of this project is to implement a sequencer that stores notes in a digital format for later playback. To do this you must keep track of when notes are received so you know when to play them back.

To keep track of the incoming data I used a dedicated timer, an Intel 8253 programmable interval timer (PIT), in the IBM PC. This timer provides three programmable down counters. This MIDI interface uses two of them.

The interface circuit consists of three major parts: selection circuitry, DART and MIDI bus interface circuitry including the synchronizer interface, and the 8253 PIT and associated crystal oscillator.

### SELECTION CIRCUITRY

Almost everything else in the IBM PC uses nine bits to select an I/O address, but I used 15 bits to avoid having conflicting addresses with anything else in the system.

The DART has a status and a data port for each channel. The data ports (for channels A and B) are located at addresses FFA0 and FFA1 (all addresses are in hexadecimal notation). The status ports are at addresses FFA2 and FFA3.

The counter has a port for each timer plus one control port. The counter registers are at addresses FFA4 and FFA6, and the control register is at address FFA7. The DART, not being native to the IBM PC's Intel heritage, requires an IORQ (input/output request) signal that is generated by performing an OR operation on  $\overline{\text{SYSIOR}}\overline{\text{D}}$  (input/output read) and  $\overline{\text{SYSIOR}}\overline{\text{W}}$  (input/output write).

The DART serves as the main link to the MIDI interface bus. Channel A receive data (RxDa) of the DART is connected to the bus by a Sharp PC-900 optoisolator. The incoming MIDI signal is protected by a 1N751 diode (D1) and buffered by inverters IC3 pin 10 and IC3 pin 12.

(Note: The MIDI 1.0 specification calls for an interface circuit using the Sharp PC-900 optoisolator. The

TIL-111 could cause problems when used with certain synthesizers.)

Channel A transmit data (TxDa) drives NAND gate IC6 pin 11 and is then buffered by inverters IC3 pin 4, IC3 pin 6, and IC3 pin 8. The outputs of these inverters are serially terminated by 220-ohm resistors to match the MIDI interface bus impedance. This configuration gives you two extra outputs at very little cost. Most experimenters will find these extra outputs very useful.

The DART also provides sync outputs from  $\overline{\text{DTR}}\overline{\text{A}}$  (data terminal ready) and  $\overline{\text{DTR}}\overline{\text{B}}$ . The sync output ( $\overline{\text{DTR}}\overline{\text{B}}$ ) provides a constant pulse of 24 beats per quarter note to external sync devices such as drum machines.

The sync interface also uses a 5-pin DIN connector. Pin 1 (DTRa) is start/stop (which starts and stops the external MIDI device), pin 2 is ground, and pin 3 is sync. Sync is a positive TTL-level square wave pulse. DTRa and DTRb are inverted (and buffered) by IC4 pin 10, and IC4 pin 12, respectively.

The 8253 PIT is used by the 16-track digital recording software that I will discuss later. The PIT has three programmable down counters capable of counting at over 2 MHz each. Note: The three gate leads (gate 0, gate 1, gate 2) of the PIT (pins 11, 14, and 16) must be tied to a logic high for the counters to function properly.

Timer 0 is clocked by the 2-MHz crystal oscillator circuit composed of crystal Z1, resistors R8 and R9, and IC6 pin 3, IC6 pin 6, and IC6 pin 8. Timer 0 divides the 2-MHz frequency down to the 24-beat-per-quarter-note level, which is then used as the clock for timer 1.

Timer 1 is used in conjunction with the music-recording software and sync interface.

Counter 2 (the third counter) may be optionally tied to the 2-MHz clock along with counter 0, and its output may be wired to the clock input of channel B of the DART, yielding an additional high-speed serial port.

### PHASE 2: THE MIDI SOFTWARE

My software implements a 16-track polyphonic recording system (I will sometimes refer to tracks as buffers).

With this software you will be able to record up to 16 tracks of polyphonic music and later play them all back together. Music can be entered to one track while other tracks are being played. Combine this capability with multiple synthesizers and you can simulate a whole band.

This software is written in C and 8088 assembly language and consists of three major parts—the receive-MIDI-data portion, the transmit-MIDI-data portion, and the support portion. [Editor's note: Jay Kubicky's MIDI programs MIDI111.C (source code) and RXINT11.A can be downloaded from BYTEnet Listings at (617) 861-9764. They are also available on disk as explained in *Disks and Downloads* on page 445, or in hard copy by writing BYTE, One Phoenix Mill Lane, Peterborough, NH 03458.]

### RECEIVE FUNCTION

The receive portion of the program is responsible for receiving all incoming MIDI data and then storing the data in a buffer in the correct format (with two accompanying timing bytes from counter 1 of the 8253). Since counter 1 is clocked by counter 0, the music's tempo can later be altered by changing the preset of counter 0.

The receive portion of the program consists of two function levels. The top level is the record function, known as `recbuff()`, which asks you which track you wish to record to. If there is data already in that track, `recbuff()` gives you an option to abort. If you decide to record to a track, `recbuff()` shows you the Track Enable screen. This screen allows you to choose which buffers are to be enabled to play and which channels they will be played on.

After selecting a track (buffer) and a channel, you select a metronome speed. This is presently from 40 to 200 beats per minute but would probably still work at around 300 beats per minute.

Next you are given various sync options. The first is audio sync, which beeps the IBM PC's internal speaker. The problem with this option is that it takes a long time, and if you are trying to play any other buffers while you record, it sounds choppy.

(continued)



# Why your next generation of products should use our 5th generation tools.

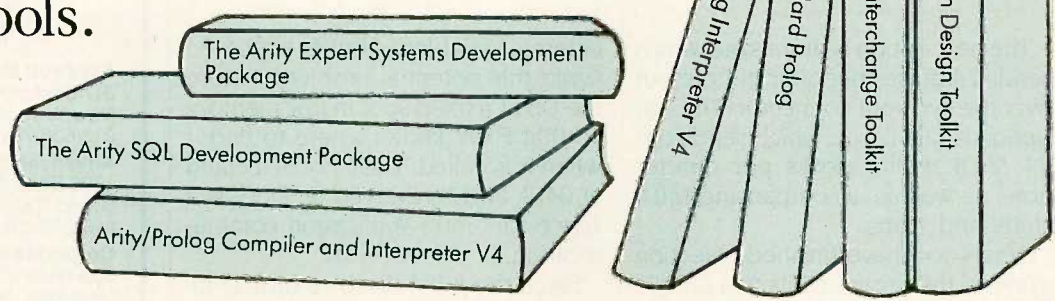

Arity's integrated family of programming tools allows you to combine software written in Arity/Prolog, the best of the fifth generation languages, with Arity SQL, the best of the fourth generation languages, and with conventional third generation languages such as C or assembly language to build your smarter application.

You can use Arity/Prolog to build expert systems using the Arity Expert Systems Development Package. Or to build natural language frontends. Or to build intelligent information management systems. Arity/Prolog lets you build advanced technology into your vertical applications package.

## And more...

That's not the whole story. Arity's products are all designed to be fast, powerful, serious. Each of our products contains unexpected bonuses. Such as a one gigabyte virtual database integrated into Arity/Prolog. The most powerful of its kind on a PC.

## Quality first. Then price.

In order to be the best, we had to prove it to our customers. Our tradition of quality software design is reflected in every product we sell. Quality first. Then price. And we always provide the best in customer support.

Our products are not copy protected. We do not charge royalties. We offer generous educational and quantity discounts. And we have a 30 day money back guarantee.

Try us to know that we keep our promise on commitment to quality and reliability. Try us by using our electronic bulletin board at 617-369-5622 or call us by telephone—you can reach us at 617-371-2422.

Or fill in this coupon. Whether you order today or not, let us send you full descriptions of our integrated family of Arity products.

Inquiry 27



We design and distribute high quality, serious application software for the IBM PC, XT, AT and all MS-DOS compatibles.

Please complete this form to place your order and/or request detailed information.

	Quantity	Info only
Arity/Prolog Compiler and Interpreter V4 .....	\$795.00	_____
Arity/Prolog Interpreter V4 .....	\$350.00	_____
Arity Standard Prolog .....	\$ 95.00	_____
Arity SQL Development Package .....	\$295.00	_____
Arity Expert System Development Package .....	\$295.00	_____
Arity Screen Design Toolkit .....	\$ 49.95	_____
Arity File Interchange Toolkit .....	\$ 49.95	_____
TOTAL AMOUNT (MA-residents add 5% sales tax) (These prices include shipping to all U.S. cities)	\$	_____

NAME \_\_\_\_\_

SHIPPING ADDRESS \_\_\_\_\_

CITY/STATE/ZIP \_\_\_\_\_

TELEPHONE \_\_\_\_\_

Payment:  Check  PO  AMEX  VISA  MC

Card # \_\_\_\_\_ Exp. date \_\_\_\_\_

Signature \_\_\_\_\_

ARITY CORPORATION • 358 BAKER AVENUE • CONCORD, MA 01742





## MIDI PROJECT

The next option is drum sync, which sends 24 pulses per quarter note out over the sync-out connector. The last option is MIDI sync, which sends out 24 MIDI timing clocks per quarter note, as well as accompanying MIDI starts and stops.

When you have finished selecting options, the program lets you enable the interrupt and start the play() routine. The receive function is interrupt-driven so that data may be played and recorded at the same time. The DART is programmed to interrupt on all RxDs (receive data) and then Rxint (receive interrupt) is enabled.

The receive-interrupt function is ideal for this, since it operates independently of, and concurrently with, the rest of the program, and it takes up little time. The function setint() sets up Rxint as interrupt 0A. The functions inton() and intoff() turn the interrupt on and off by enabling it or disabling it in the DART. This is important because any extraneous playing at the keyboard might otherwise prove disastrous.

The use of multiple segments in the program presents a problem to the interrupt operation. For instance, when Rxint is called, there is no telling what the processor was doing prior to the MIDI interrupt. Thus, the DS (data segment) could be set at anything, and the program would have no access to

external variables of buffer space. To avoid this potential problem, I store the DS at a fixed spot in low memory so that Rxint knows where to find it when it is called. This spot is located at 04FA and is reserved by DOS as a space for "intra-application communication."

Since the 8088 disables further interrupts when it executes any interrupt, you must be careful to turn the interrupts back on when entering Rxint so that system tasks such as supporting a timer can still be supported. The program must also issue an EOI (end of interrupt) to the 8259 PIC (programmable interrupt controller) just before returning. The Rxint function records the following types of MIDI data: note-on, note-off, program change, control change (all types), channel velocity, and note-bender. Figure 2 shows the format used to store MIDI data in memory.

As you can see from figure 2, four bytes are required for both note-on and note-off bytes. This stores a high resolution 16-bit timing byte and the note velocity. I chose to implement the sequencer this way because it is the easiest and most straightforward way possible. It is also possible to simply store a note and a duration byte (and perhaps one or two velocity bytes), but this would require much more complicated software.

To save memory, I chose to store

(continued)

Message Type:	First	Second	Third	Fourth	Fifth
note-on	00vvvvvv	LLLLLLLL	MMMMMMMM	Innnnnnn	-----
note-off	00vvvvvv	LLLLLLLL	MMMMMMMM	Onnnnnnn	-----
control change	11000000	LLLLLLLL	MMMMMMMM	ONNNNNNN	Occccccc
program change	01000000	LLLLLLLL	MMMMMMMM	Oppppppp	-----
channel velocity	01000001	LLLLLLLL	MMMMMMMM	Oaaaaaaa	-----
note bender	10wwwwww	LLLLLLLL	MMMMMMMM	-----	-----

vvvvv - top 6 bits of velocity byte  
 LLLLLLLL - low-order byte of time  
 MMMMMMMM - high-order byte of time  
 nnnnnnn - note number  
 NNNNNNN - controller number  
 ccccccc - controller value  
 ppppppp - new program  
 aaaaaaa - channel pressure  
 wwwwww - top 6 bits of high-order byte of pitch-bender

Figure 2: Memory format for MIDI program data.

## Advanced Authorized Dealers

(Eastern U.S.)

**Aardwolf Microsystems**  
 217 East 85th, Suite 102  
 New York, NY 10028  
 212/538-7840

**Advanced Information Systems, Inc.**  
 1336 Edna S.E.  
 Grand Rapids, MI 49507  
 616/243-1312

**Corporate Micros, Inc.**  
 333 West 52nd St., Suite 1204  
 New York, NY 10019  
 212/315-2853

**Crest Systems, Inc.**  
 2101 Magnolia Ave., Suite 208  
 Birmingham, AL 35205  
 205/328-4882

**Fast Forward, Inc.**  
 129 Adams Street  
 Louisville, KY 40206  
 502/589-0301

**ICS Software**  
 P.O.C. 359015  
 Brooklyn, NY 11235  
 718/743-4050

**INACOMP Computer Centers**  
 700 Remington Road  
 Schaumburg, IL 60195  
 312/519-1900

**Micro City Computers**  
 110 West 31st Street  
 New York, NY 10001  
 212/563-6110

**Mitech Corporation**  
 #1 Perimeter Park South, Suite 335-S  
 Birmingham, AL 35243  
 205/967-0605

**Modular Management Systems, Inc.**  
 451 Bloomfield Ave.  
 Caldwell, NJ 07006  
 201/228-3838

**National AI Lab, Inc.**  
 1800 Century Blvd., Suite 770  
 Atlanta, GA 30345  
 404/633-3900

**Network Data Systems, Inc.**  
 3419 Pierson Place  
 Flushing, MI 48433  
 313/732-6340

**PRISM Computer & Consulting Services, Inc.**  
 2100 Riverchase Center, Suite 420  
 Birmingham, AL 35244  
 205/988-5111

**Southeastern Systems, Inc.**  
 619 East Price Ave., Suite #12  
 Gastonia, NC 28054  
 704/866-8048

**TRIMARC Systems, Inc.**  
 11716 Parklawn Drive  
 Rockville, MD 20852  
 301/231-4991

**Upen Computer Systems**  
 4701 N.W. 72nd Avenue  
 Miami, FL 33166  
 305/594-2980



**THE  
 SOFTWARE  
 LINK, INC.**



# To Over 30,000 Installations, MultiLink® MEANS Multi-User.

At over 30,000 sites, as many as one-quarter of a million users tap into the power of MultiLink® Advanced everyday.

Since 1981, they've come to rely on our multi-tasking, multi-user system for compatibility with their favorite software, and the ability to share disks, files, printers, and programs in a *true* PC-DOS environment.

From the largest of the Fortune 500 to the smallest in small business, MultiLink® has provided a cost-effective multi-user solution that's available from no one else.

**MultiLink® Means Cost-Effective Timesharing on a PC.** MultiLink® Advanced utilizes the principle of timesharing by sharing a central PC's peripherals, files, and processor time among nine users. Up to eight inexpensive terminals can be connected to a single non-dedicated IBM PC, XT, AT or 100% compatible using standard RS-232 ports. Each terminal effectively emulates a PC having up to 512K RAM.

PC-Shadow™ Workstations, shown below, even have an AT look-alike, as well as work-alike, keyboard, display, and serial port. In addition, password-protected remote access via modem can be made with either dumb terminals or PCs running our terminal emulation software.

**MultiLink® Means PC-DOS Compatibility with a Software-Driven System.** Lotus 1-2-3, Symphony, WordStar, dBASE III, & Multimate are just a sampling of the wide variety of PC-DOS software that's fully compatible.

Our software-driven system is also IBM NETBIOS compatible, so programs that are written for IBM's Token Ring will run on our multi-user system, as well.

**MultiLink® Means Multi-User to Leading Computer Publications.** Whether you read *PC Magazine*, "MultiLink® Advanced delivers on...convenience, speed, and flexibility," or *InfoWorld*, "If you want a low-cost multiuser system with up to eight terminals, MultiLink® Advanced is worth a serious look," it becomes clear that MultiLink® Advanced is a formidable contender in the multi-user marketplace.

**See What MultiLink® Can Mean to You.** Learn, firsthand, how our multi-user system can benefit your company. Call The Software Link TODAY for complete information and the authorized dealer nearest you. MultiLink® Advanced is \$495 and comes with a money-back guarantee.

## MultiLink® ADVANCED



THE SOFTWARE LINK, INC.

8601 Dunwoody Place, Suite 632, Atlanta, GA 30338 Telex 4996147 SWLINK

CALL: 404/998-0700

Dealer Inquiries Invited

THE SOFTWARE LINK, INC./CANADA  
250 Cochrane Drive, Suite 12 Markham, Ontario L3R 6B7  
CALL: 416/477-5480  
Inquiry 316



MultiLink® is a registered trademark of The Software Link, Inc. MultiLink® Advanced & PC-Shadow™ are trademarks of The Software Link, Inc. IBM PC, XT, AT, PC-DOS, Token Ring, & NETBIOS are trademarks of IBM Corp. WordStar, dBASE III, Multimate, Lotus 1-2-3 & Symphony are trademarks of MicroPro, Ashton-Tate, Multimate International, & Lotus Development Corp., respectively.





# WALTZ LISP

The universal, superefficient  
LISP for MS-DOS and CP/M.

**Waltz Lisp** is a very powerful and complete implementation of Lisp. It is substantially compatible with established mainframe Lisps such as *Franz* (the Lisp running under *Unix*), *Common Lisp*, and *MacLisp*.

**Ultra fast.** In independent tests, **Waltz Lisp** was up to twenty(!) times faster than competing microcomputer Lisps.

**Easy to use.** Built-in WS-compatible full-screen file editor. Full debugging and error handling facilities are available at all times. No debuggers to link or load.

**Practical.** Random file access, binary file support, and extensive string operations make **Waltz Lisp** suitable for general programming. Several utilities are included in the package.

**Full Lisp.** Functions of type *lambda (expr), nlambda (fexpr), lexpr, macro*. Splicing and non-splicing character macros. Full suite of mappers, iterators, etc. Long integers (up to 611 digits). Fast list sorting using user defined comparison predicates. Built-in prettyprinting and formatting facilities. Nearly 300 functions in all.

**Flexible.** Transparent (yet programmable) handling of undefined function references allows large programs to reside partially on disk at run time. Automatic loading of initialization file. Assembly language interface.

**Superbly documented.** Each aspect of the interpreter is described in detail. The 300+ page manual includes an exhaustive index. Hundreds of illustrative examples.

Order **Waltz Lisp** now and receive *free* our  
**PROLOG Interpreter**

**Clog PROLOG** is a tiny (but very complete) PROLOG implementation written entirely in **Waltz Lisp**. In addition to the full source code, the package includes a 50 page **Clog manual**.

16-bit versions require DOS 2.x or CP/M-86 and 128K RAM (more recommended). Z-80 version requires CP/M 2.x or 3.x and 48K RAM minimum. **Waltz Lisp** runs on hundreds of different computer models and is available in all disk formats.



**\$169**

\*Manual only: \$30 (refundable with order). Foreign orders: add \$5 for surface mail, \$20 for airmail. COD add \$3. Apple CP/M, hard sector, and 3" formats add \$15. MC/Visa accepted.

For further information or to order call

**1-800-LIP-4000 Dept. 31**

In Oregon and outside USA call 1-503-684-3000.

**PRO**  
**CODE**  
INTERNATIONAL

15930 SW Colony Pl.  
Portland, OR 97224

## MIDI PROJECT

only the top 6 bits of the 14-bit pitch-bender code. To store all 14 bits would have required 5 bytes, and since pitch-bends don't usually take up a lot of space, 6 bits is enough. Control changes, however, do take up a lot of space (5 bytes). So I recommend that anything that outputs a control change be used sparingly.

Channel pressure (or velocity) is simply a way to transmit overall volume control over MIDI and is generally implemented on remote keyboards only.

### PLAY FUNCTION

The play portion of the program compares the timing bytes of the data stored in each track against the value of the 8253's counter 1 and sends out the appropriate codes when it finds a match.

The playnote function consists of four levels. The first level (pbufs()) is used for setup. This function asks you to select buffer assignments, metronome speed, and sync options, just like the recbuff() function. When the selection process is completed, the program starts the play() routine.

This function loops through all the active tracks (up to 16 tracks). (A track doesn't have to be active, even if it has music in it.) If the program finds an active track, the program then calls playfrom(). If all active tracks, or just track 0 (the conductor track), have run out of data, the playfrom() function returns. Otherwise, it loops through each track and checks timing information after each loop. Then after all 16 loops, it polls the keyboard and checks for a critical-error return from Rxint.

Playfrom() compares the next message stored in the buffer with the current timing value of the 8253. Then it decides if the counter value is equal to or less than the value in memory (remember, the 8253 is a down counter). If it is time for a given message to be sent out, the playfrom() function switches the top two bits of the first byte of the message to create the necessary MIDI function required.

The final layer of the play loop contains three functions that are written in machine language for the speed advantage. The rest of the program is

devoted to support and added features.

### RUNNING THE PROGRAM

When executed, the program seizes all contiguous RAM until it runs out of either buffers or memory. A minimum of two and a maximum of sixteen 24K-byte (3200-note) buffers are available for recording and playback.

After the memory allocation, a main menu displays all available options: Erase a Track, Record to a Track, Play from a Track, Track Information, Save a Track, Load a Track, Set MIDI Modes, Modify Input Filter, and Quit.

Only one option requires explanation. Track Information displays the transmit channel number, the memory used, memory remaining, and total memory in a given track. This is important information because Rxint has no memory-size checking and will let you play over track boundaries, "bleeding" onto the next track(s). This means you must be careful not to record onto tracks that have been "bled on." The input filter is associated with the Rxint routine and filters out certain commands (such as pitch-bend, etc.) before they are saved in the buffer.

My MIDI interface program provides no editing capabilities, but these could easily be added. It also does not provide auto-correction, which is the process of rounding notes off to the nearest eighth note, sixteenth note, etc., to make up for sloppy playing.

The entire MIDI interface program was written with the DeSmet C compiler, and certain elements of it may be compiler-dependent.

Other MIDI interfaces are available for the IBM PC, and the software associated with them provides added features, but they are often expensive. Typical MIDI interface hardware for the IBM PC costs \$200. The software needed for the interface can cost from \$50 to \$500. This entire interface can be built for under \$75 including the software.

*Editor's note: Copies of the MIDI specification can be obtained by sending \$35 to the International MIDI Association, 11857 Hartsbrook St., North Hollywood, CA 91607, (818) 505-8964. ■*



# When a PC's Limited Turbo PC is on your desk, you'll think it's a headliner too.

"... a good machine. And a heck of a buy... a fine box. One I'd happily choose over Big Blue's original... no status... beyond the status that attaches to getting twice as much for your money."

—Jim Seymour,  
*PC Week,*  
August 13, 1985

"It almost sounds unbelievable."

—*MIS Week,*  
August 21, 1985

"We tested a wide variety of software on the machine and everything ran well... The bottom line for anyone considering buying one of these computers would seem to be this: PC's Limited sells quality systems for extraordinarily low prices."

—*PC Week,*  
October 29, 1985

#### TOTAL SATISFACTION GUARANTEE WARRANTY

For Warranty Service: One year Limited Warranty on PC's Limited products. Contact Technical Support for a Return Authorization Number (RMA). Returns must be accompanied by your RMA, the invoice, and a brief explanation. During the Warranty Period, PC's Limited will repair or replace items at our option.

#### 30-DAY TOTAL SATISFACTION GUARANTEE

Any item bought from PC's Limited may be returned within 30 days from the date it was shipped for a full refund of your purchase price. Returned items must be as new, not modified or damaged, with all warranty cards, manuals, and packaging intact. Returned items must be shipped prepaid and insured, and must bear a PC's Limited Credit Return Authorization (CRA) on the shipping label. Call PC's Limited's Customer Support Department for CRA. No credits issued after 10 days from date of shipment.

#### CONSUMER TIP

When shopping for PC products, ask our competitors about their refund policies.

- 16-bit 8088-2 System Unit (runs at 4.77 or 6.66MHZ)
- 640K on Mother Board
- 360K Floppy Drive
- AT Keyboard
- 130W Power Supply
- Operations Manual
- One Year Limited Warranty

# \$795

Microsoft GW Basic™ \$95 • IBM DOS 3.1 \$85 • 8087-2 \$149



Our Turbo PC™ has sold in large quantities since the first week we introduced it. Of course, that's not surprising, since we were the first company to break the \$800 barrier with a machine that outruns the "Big" name by a 40% speed factor. Now, we're going to extend the margin even further by offering a 30-day money back guarantee. If that sounds good, it'll look even better when one of our Turbo PC's is on your desk. So call us today. We're guaranteeing you'll like what you get.

Some quantities may be limited. PC's Limited sells equipment certified to be compliant with FCC Class B standards. Where equipment manufactured by PC's Limited has not yet received certification, PC's Limited will substitute equivalent certified equipment. All prices are subject to change without notice. We are an independent sales organization.

## PC'S LIMITED™

SALES CALLS OUTSIDE TEXAS, 1-800-426-5150

SALES CALLS INSIDE TEXAS, 1-800-252-8336

1611 Headway Circle, Building 3, Austin, Texas 78754

Sales Calls from anywhere in the country, (512) 339-6962

Technical Support Calls, (512) 339-6963 Customer Service Calls, (512) 339-6964

\*Limited Warranty

Telex No 9103808386 PC LTD FAX (512) 339-6721





# Read what the experts say about the PC's Limited AT.

"I have no qualms recommending this system to experienced users who need the added speed."

—Sol Libes,  
*Micro/Systems Journal*,  
January/February 1986



"The PC's Limited AT™ proved to be the functional equivalent to the IBM® product, only faster. Priced at roughly one-third less, it rates as one of the best bargains available."

—Winn L. Rosch,  
*PC Magazine*,  
February 25, 1986

"If price is your primary consideration, skip both AT&T® and TI® and choose this issue's best buy, the PC's Limited AT™. Check its benchmark results—you won't be sacrificing performance to save money."

—PC Magazine,  
*Editor's Choice*,  
February 25, 1986

## And if that's not enough to convince you, now we've got a 30-day money-back guarantee.



- One Year Limited Warranty
- 80286-based System Unit (Runs at 6MHZ. 8MHZ option included at no extra charge.)
- 1024K on Mother Board
- 1.2 Meg Floppy Drive
- Combined Floppy/Hard Drive Controller Card
- AT Keyboard
- 192W Power Supply
- 2 Serials and 1 Parallel Port
- Clock/Calendar with Battery Backup
- Operations Manual

# \$1995

Microsoft GW Basic™ \$95 • IBM DOS 3.1 \$85 • 80287 \$195

I'm Michael Dell, President of PC's Limited. And I want you to know about your latest industry-leading step. We're so sure that you'll like everything about our PC's Limited AT that we're willing to offer you a 30-day money back guarantee on it. This machine, with 1024K on the Mother Board and an 8MHZ option included at no extra cost, has been a standout since we introduced it. So give us a chance to show you what it can do for your operation. With a deal like this, there's no way you can lose. (And see the opposite side of this page for information about our Turbo PC™, plus details on our guarantee.)

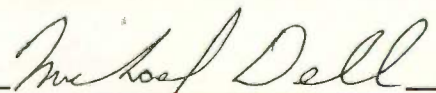



Call for latest prices.

# FREE SHIPPING

in the Continental United States via UPS Ground.

# NO SURCHARGE FOR



# OR



## Floppy Disk Drive

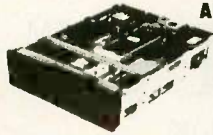

Also available for AT™ in Gray Color.

### \$109

## MITSUBISHI ELECTRONICS

Half-Height, DS/DD

## PANASONIC

Half-Height, DS/DD

## TEAC

3.5-B, Half-Height, DS/DD

## PC's Limited AT Multifunction Card

- Expandable To 3 Meg
- (1.5 on Board/1.5 on Piggy Back Board)
- Supports 64 or 256K Rams
- Parallel Port
- Serial Port (2nd Serial Optional)

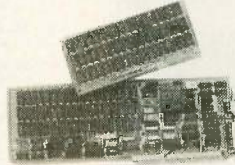

### \$199

Piggy Back Board \$59 w/OK

## PC's Limited Mini I/O

- Serial Port
- Parallel Port
- Clock
- Software
- Fits In Short Slot

### \$99

## 300/1200 Baud Hayes Compatible Modem Fits in Short Slot



### \$159

## 64K RAM

Set of 9 chips, 200 or 150 Nanoseconds

### \$10

per set

### 256K RAM \$29

Set of 9 chips 150 Nanoseconds

## PC's Limited Monochrome Graphics Fully Hercules Compatible

### \$159

- Text Mode 80 X 25
- Graphics Mode 720 X 348 Pixels
- One Parallel Printer Port

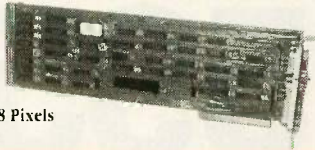

## Seagate 20, 30 and 40 MEG High Speed 40 MS Access Time Hard Drives for AT™

Uses Linear Voice Coil Activator.



Heads park automatically at power down.

20 MEG \$579

30 MEG \$699

40 MEG \$819

Includes Seagate Full Height Hard Disk Cable, and Mounting Rails. Boots from Hard Disk. One Year Warranty.

## PC's Limited PC-576 RAM Board

- Expandable to 576K
- Supports 64K or 256K RAMS
- Fits in Short Slot

### \$69 w/OK

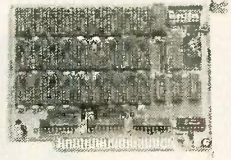

## PC'S LIMITED Six Function Card

- Upgradable to 384K
- Clock/Calendar
- Includes Software
- Parallel Port
- Serial Port
- Game Port

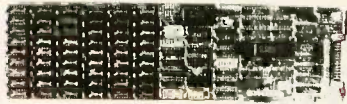

Two Year Warranty

### w/OK \$99 w/384K \$149

## SOLVE YOUR POWER PROBLEM.

## XT™ POWER 130W

### \$99

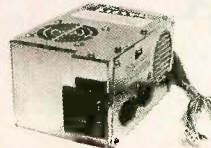

Directly replaces power supply in PC.™ Fully XT™ compatible. One Year Warranty

## PC'S LIMITED MONO-1 MONITOR \$169



- 12-inch screen
- Compatible with monochrome or color graphics cards

## PC'S LIMITED RGB-1 MONITOR \$459



- 11MM dot pitch
- RGB input
- 12-inch screen
- 600X240 resolution
- 16 colors

## TOTAL SATISFACTION GUARANTEE WARRANTY

For Warranty Service: One year Limited Warranty on PC's Limited products. Contact Technical Support for a Return Authorization Number (RMA). Returns must be accompanied by your RMA, the invoice, and a brief explanation. During the Warranty Period, PC's Limited will repair or replace items at our option.

### 30-DAY TOTAL SATISFACTION GUARANTEE

Any item bought from PC's Limited may be returned within 30 days from the date it was shipped for a full refund of your purchase price. Returned items must be as-new, not modified or damaged, with all warranty cards, manuals, and packaging intact. Returned items must be shipped prepaid and insured, and must bear a PC's Limited Credit Return Authorization (CRA) on the shipping label. Call PC's Limited's Customer Support Department for CRA. No credits issued after 30 days from date of shipment.

### CONSUMER TIP

When shopping for PC products, ask our competitors about their refund policies.

## Seagate HD & Western Digital Controller 20 MEG Hard Disk System for PC™



### Internal \$449

For Xebec 1220 Combined Floppy/Hard Disk Controller add \$75.

Includes Seagate Hard Disk, Western Digital Controller, Cables, Manual, Software, and Mounting Hardware.

Boots From Hard Disk 65 MS Access Time One Year Warranty

Our Hard Disk Systems are compatible with the latest versions of the following Computers: IBM PC, IBM XT, AT&T 6300, Compaq Deskpro, Tandy 1000, Tandy 1200, PC's Limited Turbo PC, Zenith 150, Zenith 151, Leading Edge PC (Both Models), Sperry PC, Wyse PC, Televideo PC, Faraday, Corona, Corona PC, Eagle PC, ITT PC, and most other Computers.

PLEASE SPECIFY YOUR COMPUTER TYPE WHEN ORDERING.

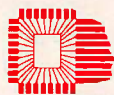

# PC'S LIMITED™

SALES CALLS OUTSIDE TEXAS, 1-800-426-5150

SALES CALLS INSIDE TEXAS, 1-800-252-8336

1611 Headway Circle, Building 3, Austin, Texas 78754

Sales Calls from anywhere in the country, (512) 339-6962

Technical Support Calls, (512) 339-6963 Customer Service Calls, (512) 339-6964

Telex No 9103808386 PC LTD FAX (512) 339-6721

Panasonic, TEAC, Mitsubishi, Intel, IBM, Hercules, Plantronics, Xebec, Seagate, Western Digital, AT&T, Compaq, Tandy, Leading Edge, Sperry, Wyse, Televideo, Faraday, Corona, Eagle, ITT, and Zenith are registered trademarks of their respective companies. IBM PC, IBM XT, IBM AT, are trademarks of IBM Corporation. Leading Edge PC, Sperry PC, Wyse PC, Compaq Deskpro, Zenith 150, Zenith 151, Televideo PC, Corona PC, Eagle PC, AT&T 6300, Tandy 1000 and Tandy 1200 are trademarks of their respective companies. Xebec 1220 is a trademark of Microware.

Ad Number 406/86

Some quantities may be limited. PC's Limited sells equipment certified to be compliant with FCC Class B standards. Where equipment manufactured by PC's Limited has not yet received certification, PC's Limited will substitute equivalent certified equipment. All prices are subject to change without notice. We are an independent sales organization.



\*Limited Warranty



Unitex AT™

Unitex PC™

\$1,695

\$595

FREE SHIPPING



# UNITEX PC™

- \* System Board Expandable to 640K
- \* 256k Random Access Memory
- \* 8 Expansion Slots
- \* 360k Floppy Disk Drive
- \* 135 Watt Power Supply
- \* 5150 Type Keyboard
- \* Runs IBM PC Software
- \* One Year Warranty\*

Same System Plus 10 MB Hard Disk

\$995

\$595

UNITEX AT™ \$1,695

UNITEX TURBO™ \$695

- \* System Board Expandable to 1024K
- \* 512k Random Access Memory
- \* 1.2 MB High Capacity Floppy Disk Drive
- \* Combined Floppy and Hard Disk Controller
- \* 230 Watt Power Supply
- \* Battery Backup Clock/Calendar
- \* AT Keyboard

- \* System Board Expandable to 640K
- \* Keyboard Selectable 4.77Mhz and 8 Mhz Speeds
- \* 256K Random Access Memory
- \* 360K Floppy Disk Drive
- \* 135 Watt Power Supply
- \* 5150 Type Keyboard

# UNITEX CO.

4962 El Camino Real Los Altos, CA 94022

1-800-426-5916

Inside California: 1-415-967-6465

IBM PC, XT, AT are trademarks of IBM Corp.



\* Limited Warranty

Free shipping via UPS Ground in Continental United States. Unitex reserves all rights to substitute equivalent items.

All prices subject to change without notice.

Unauthorized returns subject to a 15% restocking charge.



# MIDI PROGRAMMING

BY DONALD SWEARINGEN

## *Processing the MPU-401 track data stream*

IN A PREVIOUS BYTE article ("A MIDI Recorder," *Inside the IBM PCs*, Fall 1985), I described a software system, written in FORTH, for recording and playing back keyboard music using a MIDI-equipped synthesizer and Roland Corporation's MPU-401 MIDI interface for the IBM PC. The program in that article, MPU401.PCF, handles the communication requirements of the MPU-401 device and the MIDI protocol to store and play back MIDI data. MPU401.PCF stores the MIDI data received from the MPU-401 for each of eight "tracks" (which make up the track data stream) in the memory of the IBM PC as an array of 4096 contiguous bytes.

In this article, I will present a number of software algorithms, written in Turbo Pascal for the IBM PC, for processing such a track data stream. Among these are procedures for transposing MIDI pitches, scaling MIDI velocity values, modifying MIDI channel information, and quantizing timing values.

### **MIDI PROCESSING CONSTANTS**

The MPU-401 track data stream consists of a succession of track events (see figure 1). To simplify the process-

ing of the track data stream, I have defined a number of constants and data structures that are useful in manipulating the basic track events and MIDI information in the track data stream.

The program constants (listing 1) establish certain values that are used throughout the track data stream processing procedures. (Good programming dictates that you isolate such values in a single section of the program rather than scatter "magic numbers" throughout your code. This way, you only need to make modifications to any quantities in question in one place.)

The MPU-401 constants are values expected in track events received from the MPU-401. They represent either a special timing overflow byte or one of several MPU "marks" that the MPU-401 transmits in the track data stream. The MPU-401 default timebase and tempo constants will be used to calculate actual track event times as a function of the relative event timing bytes contained in each track event.

The MIDI command constants represent the eight basic MIDI commands that are contained within MIDI

status bytes (figure 2). Listing 1 also defines a text string for each MIDI command, to be used in translating the track events within a track data stream into a readable format.

Following the MIDI text, listing 1 defines a number of general-purpose constants that the MIDI processing functions require: error flags for function results, the size of data files containing track data, some MS-DOS file system constants, and text for hexadecimal conversions.

### **MIDI PROCESSING DATA TYPES**

The MIDI data types (listing 2) define the basic structures around which the MIDI processing functions will be designed.

The hex\_\_str type is used for conversion of a single byte to its hexadecimal equivalent in ASCII.

The track\_\_event\_\_type summarizes the various types of track events the program may expect to receive from the MPU-401. The track\_\_event structure is designed to store a single

(continued)

Donald Swearingen (100 Valencia #261, San Francisco, CA 94103) is a freelance software developer, consultant, musician, and composer.



Track Events						
	Timing byte	Event message bytes			Event type	Description
1-byte event	F8				OVFL	Timing overflow
2-byte events	00-EF	F8			MARK	MPU Marks NOP (F8), Measure end (F9) Data end (FC)
	00-EF	F9				
	00-EF	FC				
3-byte events	00-EF	00-7F			MIDI	MIDI messages using current running status
	00-EF	00-7F	00-7F			
	00-EF	C0-DF	00-7F			
4-byte events	00-EF	80-BF	00-7F	00-7F	MIDI_RS	MIDI messages establishing new running status
	00-EF	E0-EF	00-7F	00-7F		

Figure 1: The MPU-401 track data stream consists of track events, which may be one of four types and may be from 1 to 4 bytes long.

Listing 1: Constants used in processing the MPU-401 track data stream.

```

const
    TIMING_OVERFLOW = 248;      { MPU-401 Constants }
    NOP = 248;
    MEASURE_END = 249;
    DATA_END = 252;
    MAX_TIMING_COUNT = 240;

    TIMEBASE = 120.0;          { MPU-401 Default Timebase }
    TEMPO = 100.0;             { MPU-401 Default Tempo }

    MIN_MIDI_DATA = 0;         { Minimum MIDI Data Value }
    MAX_MIDI_DATA = 127;       { Maximum MIDI Data Value }

    NOTE_OFF = 0;              { MIDI Commands }
    NOTE_ON = 1;
    AFTER_TOUCH_K = 2;
    CONTROL_CHANGE = 3;
    PROGRAM_CHANGE = 4;
    AFTER_TOUCH_P = 5;
    PITCH_WHEEL = 6;
    SYSTEM_EXCLUSIVE = 7;

    MIDI_MESS_TEXT :           { MIDI Command Text Strings }
    array[0..7] of string[20] =
    ('Note Off',
     'Note On',
     'After Touch (key)',
     'Control Change',
     'Program Change',
     'After Touch (poly)',
     'Pitch Wheel',
     'System Exclusive');

    ERR = -1;                   { Function error flags }
    NOERR = 0;

    TRACK_DATAFILE_SIZE = 4096; { MPU-401 track data file }

    FILENAME_LEN = 14;          { MSDOS filename length }
    RECORD_LEN = 128;           { MSDOS record length }

    DIGITS :                    { Hex conversion digits }
    array[0..15] of char =
    '0123456789ABCDEF';
    
```

track event. The track\_event\_block structure (figure 3) contains a single track event and the "environment" in which the event occurs, including the running status for the track from which the event was extracted, the event length, and the event type.

The track\_data\_stream structure simply provides storage for a single track data stream. The track\_data\_block structure (figure 4) contains a complete track data stream (tds) and several other items useful in stepping through the track events contained in the track data stream: a pointer to the next byte to be accessed in the track data stream (tds\_ptr), an end-of-data indicator (edat), and the track event currently being processed in the track data stream (curr).

A final track event block constant (OVFL\_EVENT) is defined for use as a timing spacer in a track data stream.

### SIMPLE MIDI UTILITIES

You can use the basic MIDI utility functions (listing 3) apart from the MPU-401 processing environment. They operate strictly on MIDI data, independent of track data stream considerations.

The Boolean function midi\_status determines whether a prospective MIDI data byte is a MIDI status byte. Function midi\_chan returns the MIDI channel (0-15) from a MIDI status byte. Function midi\_cmd returns the MIDI command portion from a MIDI status byte. Function nmdat

(continued)



BIT	7	6	5	4	3	2	1	0
VALUE	1	COMMAND			CHANNEL			

Figure 2: A MIDI status byte contains a 3-bit figure that represents one of the eight basic MIDI commands and a 4-bit figure that directs the MIDI message to one of up to 16 MIDI devices connected to the system.

Listing 2: Data types used in processing the MPU-401 track data stream.

```

type
  hex_str = string[2];    { Result of byte-->hex conversion }
  track_event_type =     { MPU-401 Track event type }
  (
    OVFL,                { Timing Overflow }
    MARK,                { MPU mark }
    MIDI,                { MIDI using curr. running status }
    MIDI_RS,            { MIDI setting new running status }
    UNKNOWN              { Undefined track event }
  );
  track_event =         { Single track event }
  record
    time : byte;        { Event relative time }
    mess : array[1..3] of byte; { Event directive }
  end;
  track_event_block =  { Track event access environment }
  record
    running_status : byte; { Current track running status }
    event_len : 1..4; { Event length, including timing byte }
    event_type : track_event_type;
    event : track_event;
  end;
  track_data_stream = { In memory track data stream file }
  array[1..TRACK_DATAFILE_SIZE] of byte;
  track_data_block = { track data stream access environment }
  record
    tds : track_data_stream; { track data }
    tds_ptr : 1..TRACK_DATAFILE_SIZE; { track data read pointer }
    edat : boolean; { indicates end of track data }
    curr : track_event_block; { current track event }
  end;

const
  OVFL_EVENT : track_event_block = { Track overflow event constant }
  (
    running_status:0; { used to insert timing spacers }
    event_len:1; { into Track Data Stream }
    event_type:OVFL;
    event:
    (
      time:MAX_TIMING_COUNT;
      mess:(0,0,0)
    )
  );

```

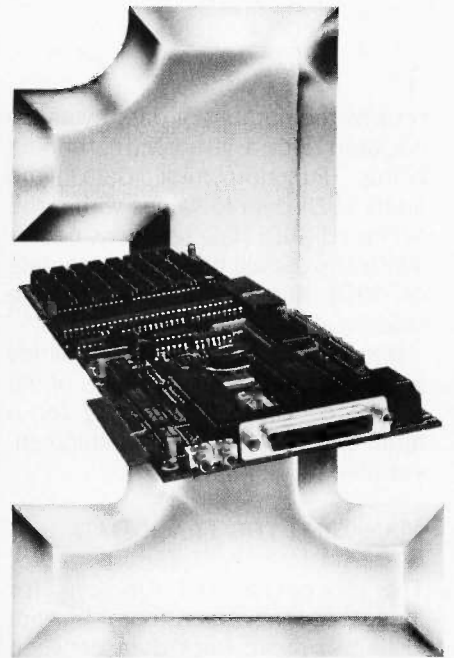

**Number One  
in Performance**  
**68010/68000**  
**Coprocessor for**  
**IBM/AT/XT/PC-**  
**8/10/12.5mz No Wait States**  
**\$1295<sup>00</sup> Qty. 1**

#### FEATURES

- 1-2 MB RAM (1MB Standard)
- 16K-64K EPROM
- 2-8 Serial Ports  
  Async/Sync/Bisync Communications
- Battery-backed Real Time Clock
- Battery-backed 2K-8K RAM
- 2 Parallel Ports
- 68881 Math Coprocessor
- Memory-mapped Dual-port BUS
- 3-9 Users Per Board (3 Standard)
- Up To 16 Boards Per AT/XT/PC
- Can Operate As Standalone Processor

#### SOFTWARE

- OS9 (Powerful UNIX-like Multi-user OS)
- CPM/68K
- Software selectable OS including concurrent PC DOS/OS-9 or CPM/68K operation
- Support Module for IBM Graphics
- High-speed Local/Global Disk Caching
- Basic, Pascal, Fortran, C, and COBOL

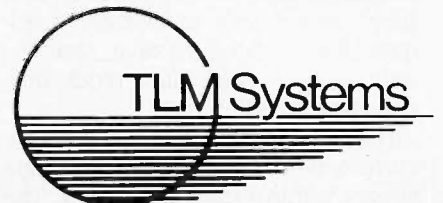
IBM is a registered trademark of International Business Machines Corporation. OS/9 is a registered trademark of Microchannel Systems Corp. CPM/68K is a registered trademark of Digital Research Corp. Microsoft, MS-DOS are registered trademarks of Microsoft. UNIX is a registered trademark of AT&T.

West: 4704 W. Jennifer, Suite 105, Fresno, CA 93711, 209/276-2345  
 East: 67 Grandview, Pleasantville, NY 10570, 914/747-1450  
 Distributor: Telemarketing Services, Inc.  
 1697 Garden Ave., Eugene, OR 97403, 503/345-7395

returns the number of data bytes associated with a given MIDI running status. Function `midi_data_limit` limits MIDI data to values within the accepted MIDI data range, as necessitated by certain types of processing of MIDI data values (e.g., scaling velocity data).

Use of these basic MIDI utilities enhances the understandability of the source code while providing for a more efficient MIDI programming environment.

### MANAGING THE TRACK DATA STREAM

The procedures and functions for managing the track data stream (listing 4) move track data between MS-DOS files and track data blocks. They also provide access to data bytes within the track data stream and allow you to display (dump) a track data stream in hexadecimal format.

The Turbo Pascal routines described in this article can process the unaltered track data stored by the FORTH program `MPU401.PCF`. However, the data arrays used by `MPU401.PCF` for storage of track data must somehow be made available in the Turbo Pascal environment. To accomplish this, you can store a track data stream array (all 4096 bytes) from the FORTH environment into an MS-DOS block file. Then you can easily read the file into a track data block structure for processing in Turbo Pascal. You can then load the output files created by the Turbo Pascal routines back into the FORTH environment for playback.

The procedure `reset_track_data` resets the "environment" variables in a track data block so that the track data block can be accessed from the beginning. Procedure `load_track_data` prompts the user for the name of the MS-DOS file to be loaded and then loads the file into a target track data block. Procedure `save_track_data` saves a track data block in a specified MS-DOS file.

The function `this_byte` returns the current data byte in the track data stream within a track data block. The procedure `advance` moves the track data stream pointer in a track data

(continued)

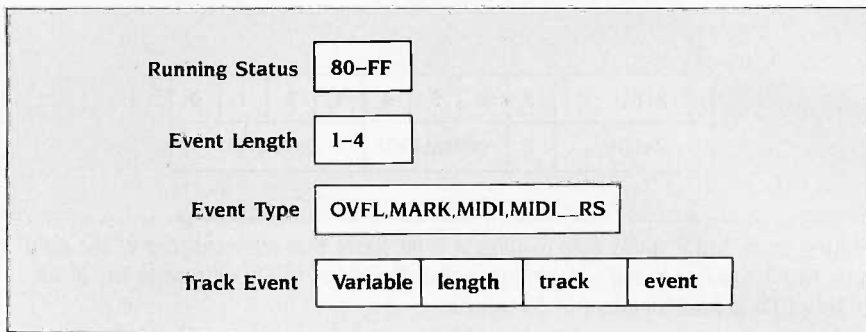

Figure 3: The track event block contains the running status for the track from which the event was extracted, the event length (from 1 to 4 bytes long), the type of event, and the actual track event.

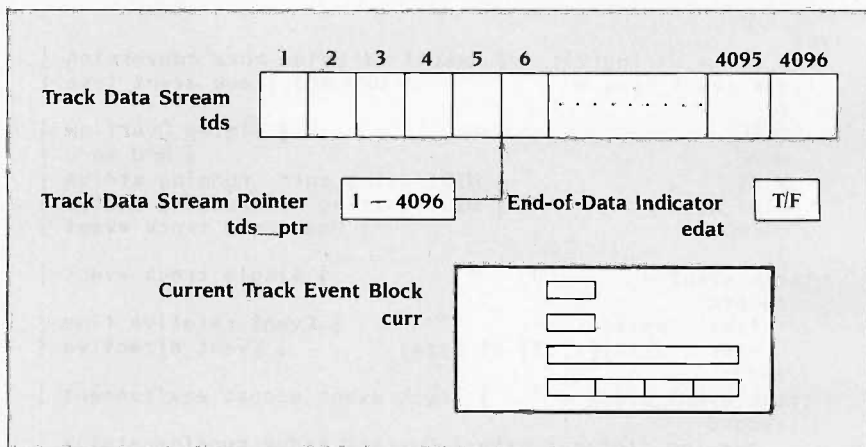

Figure 4: The track data block structure (as defined by listing 2) contains a complete track data stream (up to 4096 bytes long) made up of variable-length track events, a pointer to the next byte to be accessed, an end-of-data indicator, and the track event currently being processed.

Listing 3: Basic MIDI utility functions.

```

{ Return true if input is a MIDI status byte
}
function midi_status(midi_data_byte:byte):boolean;
begin
if (midi_data_byte > MAX_MIDI_DATA) then
    midi_status:=true
else
    midi_status:=false;
end;

{ Return the channel # from a MIDI status byte
}
function midi_chan(running_status:byte):byte;
begin
midi_chan:=running_status and 15;
end;

{ Return the command portion of a MIDI status byte
}
function midi_cmd(running_status:byte):byte;
begin

```



```

midi_cmnd:=(running_status shr 4) and 7;
end;

{ Return # of data bytes associated
  with a given MIDI status byte
}
function nmdat(running_status:byte):byte;
begin
  if (midi_cmnd(running_status) in
    [PROGRAM_CHANGE, AFTER_TOUCH_P]) then
    nmdat:=1
  else
    nmdat:=2;
  end;

  { Limit input to valid MIDI data range
  }
  function midi_data_limit(midi_data_byte:integer):byte;
  begin
    if midi_data_byte < MIN_MIDI_DATA then
      midi_data_limit:=MIN_MIDI_DATA
    else if midi_data_byte > MAX_MIDI_DATA then
      midi_data_limit:=MAX_MIDI_DATA
    else
      midi_data_limit:=midi_data_byte;
    end;
  end;
end;

```



**Number One  
In Performance**

## **Hard Disk Intelligent VCR Backup for AT/XT/PC**

### **FEATURES**

- High speed microprocessor controlled backup (68000)
- Two channel interface
- Built in LAN channel
- Software control of most VCR functions including Fast Forward, Rewind, and auto backup using VCR timer capabilities
- Economical VHS or Beta formats

Listing 4: Basic track data stream procedures and functions.

```

{ Reset status and pointer variables in track data block
}
procedure reset_track_data(var tdt:track_data_block);
begin
  with tdt do
    begin
      tds_ptr:=1;
      edat:=false;
      curr.running_status:=0;
      curr.event_type:=UNKNOWN;
    end;
  end;

  { Load track data stream from user
    specified file into track data block
  }
  procedure load_track_data(var tdt:track_data_block);
  var
    tdf : File;
    tdfn : string[FILENAME_LEN];
  begin
    reset_track_data(tdt);
    write('Track data filename: ');
    readln(tdfn);
    assign(tdf, tdfn);
    reset(tdf);
    blockread(tdf, tdt.tds, TRACK_DATAFILE_SIZE div RECORD_LEN);
    close(tdf);
  end;

  { Save track data stream from track
    data block to user specified file
  }
  procedure save_track_data(tdt:track_data_block);
  var
    tdf : File;

```

(continued)



West: 4704 W. Jennifer, Suite 105, Fresno, CA 93711, 209/276-2345  
 East: 67 Grandview, Pleasantville, NY 10570, 914/747-1450  
 Distributor: Telemarketing Services, Inc.  
 1897 Garden Ave., Eugene, OR 97403, 503/345-7395

## The track event management functions constitute the core of the MIDI data processing routines.

block forward to point to the next data value.

The function `itox` and the procedure `dump__track__data` work together to provide a hexadecimal dump of a track data block on the console device.

### TRACK EVENT MANAGEMENT

The track event management functions (listing 5) constitute the core of the MIDI processing routines. These functions and procedures serve to simplify the actual processing of the track events in the MPU-401 track data stream.

The procedures `track__event__message` and `next__track__event` work together to copy the next track event in the track data stream within a track data block into its current track event block. The action of these procedures is built entirely around the structure of the MPU-401 track event (recall figure 1), which can be from 1 to 4 bytes in length.

Procedure `next__track__event` scans the next byte of the track data stream (assumed to be a timing byte) to determine the appropriate action to take. If the byte represents a timing overflow event, the procedure places the single-byte event in the current event block and the procedure takes an exit. If the track event is a multibyte event, the procedure passes control to `track__event__message` so that the message bytes of the track event can be placed in the current event block.

Procedure `track__event__message` handles MARK, MIDI, and MIDI\_RS track event types. In the case of MARK events, the procedure stores the single message byte in the current

(continued)

```

    tdfn := string[FILENAME_LEN];
begin
write('Track data filename: ');
readln(tdfn);
assign(tdf, tdfn);
rewrite(tdf);
blockwrite(tdf, tdt.tds, TRACK_DATAFILE_SIZE div RECORD_LEN);
close(tdf);
end;

{ Return current track data byte from track data block
}
function this_byte(tdt:track_data_block):byte;
begin
this_byte:=tdt.tds[tdt.tds_ptr];
end;

{ Advance pointer to next track data byte
  in track data block
}
procedure advance(var tdt:track_data_block);
begin
tdt.tds_ptr:=tdt.tds_ptr+1;
end;

{ Convert byte to hexadecimal ASCII string
}
function itox(i:byte): hex_str;
begin
itox[0]:=chr(2);
itox[1]:=DIGITS[i div 16];
itox[2]:=DIGITS[i mod 16];
end;

{ Dump track data stream in hexadecimal format
}
procedure dump_track_data(var tdt:track_data_block);
label
return;
var
n, st, off : integer;
begin
writeln('Track Data Stream Dump...');
writeln;
write(' ');
for n:=0 to 15 do
write(itox(n):4);
writeln;
n:=0;
while (n < TRACK_DATAFILE_SIZE div 16) do
begin
st:=n*16;
write(itox(st div 256):2, itox(st mod 256):2, ' ');
for off:=0 to 15 do
begin
write(itox(ord(tdt.tds[st+off+1])):4);
if (tdt.tds[st+off+1] = DATA_END) then
goto return;
end;
writeln;
n:=n+1;
end;
return;
writeln;
end;

```



Listing 5: Procedures and functions for processing track events.

```

{ Fill in the message bytes of the current
  Track Event in a Track Data Block
}
procedure track_event_message(var tdt:track_data_block);
var
  i : byte; { index counter }
label
  return;
begin
with tdt.curr do
  begin
  case this_byte(tdt) of
    NOP, MEASURE_END, DATA_END:
      begin
        event_type:=MARK;
        if (this_byte(tdt) = DATA_END) then
          tdt.edat:=true;
        event.mess[event_len]:=this_byte(tdt);
        event_len:=event_len+1;
        advance(tdt);
        goto return;
      end;
    128..239: { MIDI status byte }
      begin
        running_status:=this_byte(tdt);
        event_type:=MIDI_RS;
        event.mess[event_len]:=this_byte(tdt);
        event_len:=event_len+1;
        advance(tdt);
      end;
    else
      event_type:=MIDI;
    end; { case }

    { fill in MIDI data bytes }
    for i:=1 to nmdat(tdt.curr.running_status) do
      begin
        event.mess[event_len]:=this_byte(tdt);
        event_len:=event_len+1;
        advance(tdt);
      end;
    end; { with tdt.curr }
  return;
end;

{ Advance to the next Track Event in a Track Data Block
}
procedure next_track_event(var tdt:track_data_block);
label
  return;
begin
if (tdt.edat) then { end of data }
  goto return;
with tdt.curr do
  begin
  event_len:=1; { count event time }
  case this_byte(tdt) of
    TIMING_OVERFLOW:
      begin
        event_type:=OVFL;
        event.time:=MAX_TIMING_COUNT;
        advance(tdt);
        goto return;
      end;
    0..239: { timing byte }
      begin

```

(continued)

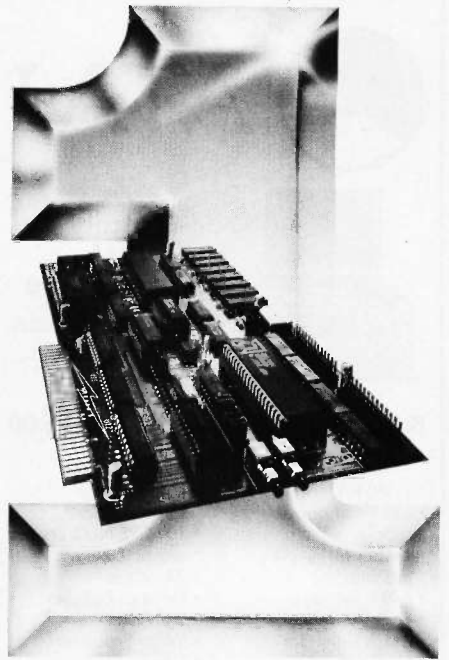

**Number One  
in Performance**

**Z80H  
BLUESTREAK™**

**IBM/AT/XT/PC- 8mz  
No Wait States**

#### FEATURES

- 64K-256K RAM
- 2K-8K EPROM/Static Ram
- 2 Serial Ports
- Async/Sync/Bisync Communications
- Real Time Clock
- Memory-mapped Dual-port BUS
- On-board/Remote Reset NMI capability
- Up To 32 Boards Per AT/XT/PC
- Can Operate As Standalone Processor
- Less Than Full Size Board  
(will fit other compatibles.)

#### SOFTWARE

- ZP/M™ CP/M Emulation Software  
(Supports Most CP/M Software)
- Multiuser Capability if Used As A  
Slave Processor

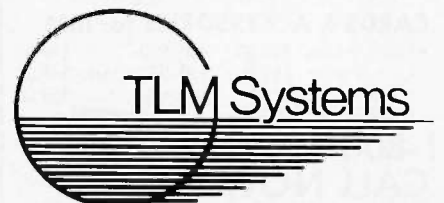
IBM is a registered trademark of International Business Machines  
CP/M/80 is a registered trademark of Digital Research Corp.

West: 4704 W. Jennifer, Suite 105, Fresno, CA 93711, 209/276-2345  
 East: 67 Grandview, Pleasantville, NY 10570, 914/747-1450  
 Distributor: Telemarketing Services, Inc.  
 1897 Garden Ave., Eugene, OR 97403, 503/345-7395

1-800-222-8324



ATAI

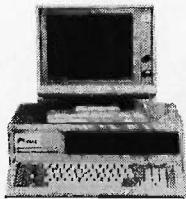

**Totally  
IBM  
Compatible  
A Full 1 Year  
Warranty**

**Basic Atai W/2 Drives .... \$695.00  
Atai Super Unit**

- 2-360 K Floppy
- 135 Watt power supply
- Amber tilt swivel monitor
- 640 K memory
- Serial/Parallel Port
- Clock Calendar
- MS/DOS 2.11
- 1200/300 Internal Modem
- Monochrome Graphics Card
- 100 CPS NLQ Printer w/tractor
- All cables
- General Ledger Software
- Word Processor
- Database
- Communications Software

**A Truly Complete System, only \$1495.**

Compare Against IBM, Att, Leading Edge!!!

**brother.**

**BROTHER M-1509**  
180 CPS Wide Column  
Beats Epson FX-286  
For Price/Performance.  
Standard NLQ mode w/tractor  
Call For Lowest Price.

**Brother Printers**

- M-1109 ..... \$195
- HR-15XL ..... \$360
- HR-25 ..... \$499
- HR-35 ..... \$680
- Twinriter-5 Dual Head ..... \$ Call

**EPSON**

- LQ-800 ..... \$545
  - LQ-1000 ..... \$765
  - LQ-1500 ..... \$999
- Accessories Available

**Panasonic**

- KXP 1080 ..... \$199
- KXP 1091 ..... \$239

**Epson Products**

- LX-80 ..... \$220
- LX-90 ..... \$240
- FX-80+ ..... \$259

**Okidata**

- 182 ..... \$299
- 192 ..... \$399
- 193 ..... \$599
- 84 ..... \$699
- 2410 ..... \$1499

**HARD DRIVE & BACKUPS**

- 10 Meg ..... \$385
- 20 Meg ..... \$475
- 30 Meg ..... \$690
- 40 Meg ..... \$795
- 10 Meg external Hard Drive ..... \$545
- 20 Meg External Hard Drive ..... \$635
- 20 Meg Tape ..... \$595
- 60 Meg Tape ..... \$795
- All Drives Seagates w/ Controller

**CARDS & ACCESSORIES for IBM**

- Mono/Printer \$95.00
- Color/Printer \$99.00
- Mono/Graphics/Printer ..... \$99.00
- RS-232 ..... \$59.00
- RS-232/Clock ..... \$69.00
- Parallel ..... \$59.00

**1-800-222-8324  
CALL NOW!!!!**



**COMPUTERS  
INTERNATIONAL  
6619 U.S.1 Miami, Fl 33143**

**MIDI PROGRAMMING**

```

event.time:=this_byte(tdt);
advance(tdt);
track_event_message(tdt);
end;
end; { case }
end; { with tdt.curr }
return;
end;

{ Store a Track Event in a designated Track Data Block
procedure store_track_event(var tdo:track_data_block;
                             eblk:track_event_block);

var
  i : byte; { index counter }
begin
case eblk.event.time of
MAX_TIMING_COUNT:
  begin
  tdo.tds[tdo.tds_ptr]:=TIMING_OVERFLOW;
  advance(tdo);
  end;
0..239:
  begin
  tdo.tds[tdo.tds_ptr]:=eblk.event.time;
  advance(tdo);
  for i:=1 to eblk.event_len - 1 do
  begin
  tdo.tds[tdo.tds_ptr]:=eblk.event.mess[i];
  advance(tdo);
  end;
  end; { case }
end;

{ Display a track event on the user console
procedure disp_event(eblk:track_event_block);
var
  i : byte; { index counter }
label return;
begin
with eblk do
begin
write(event.time:4);
if (event_len = 1) then
begin
write(' Timing Overflow':16);
goto return;
end;
if (event.mess[1] in [NOP,MEASURE_END,DATA_END]) then
begin
case event.mess[1] of
NOP :
begin
write('NOP':16);
goto return;
end;
MEASURE_END:
begin
write('Measure End':16);
goto return;
end;
DATA_END:
begin
write('Data End':16);
goto return;
end;
end; {case}
end; {if}

```



## MIDI PROGRAMMING

```

i:=1;
if (midi_status(event.mess[1])) then
  begin
    write(MIDI_MESS_TEXT[midi_cmnd(event.mess[1]):16];
    i:=i+1;
  end
else
  write(' ':16);
while (i <= (event_len - 1)) do
  begin
    write(event.mess[i]:4);
    i:=i+1;
  end;
end; { with eblk }
return;
writeln;
end;

{ Display all of the Track Events in a Track Data Block }
procedure disp_track_data(var tdt:track_data_block);
var
  time : real; { Actual time of current track event }
begin
  time:=0.0;
  reset_track_data(tdt);
  while not(tdt.edat) do
    begin
      next_track_event(tdt);
      time:=time+tdt.curr.event.time;
      write( ((time*60)/(TIMEBASE*TEMPO)):8:3 );
      disp_event(tdt.curr);
    end;
  end;
end;

```

Listing 6: Procedures and functions for processing MIDI key (pitch) data.

```

{ Return offset of MIDI key data in
  Track Event message, if present
}
function midi_key_offset(var eblk:track_event_block;
  chan:byte):integer;
begin
  midi_key_offset:=ERR; { default return value }
  with eblk do
    begin
      if ((event_type in [MIDI, MIDI_RS])
        and (midi_cmnd(running_status)
          in [NOTE_OFF, NOTE_ON, AFTER_TOUCH_K])
        and (midi_chan(running_status) = chan)) then
        begin
          midi_key_offset:=1;
          if (event_type = MIDI_RS) then
            midi_key_offset:=2;
          end;
        end;
    end; { with eblk }
  end;

{ Return MIDI key data from Track Event, if present
}
function get_midi_key(var eblk:track_event_block;
  chan:byte):integer;
var
  key_offset : integer;
begin

```

## Instant-C™ The Fastest Interpreter for C

**Runs your programs 50  
to 500 times faster than  
any other C language  
interpreter.**

**A**ny C interpreter can save you compile and link time when developing your programs. But only *Instant-C* saves your time by running your program at compiled-code speed.

**Fastest Development.** A program that runs in one second when compiled with an optimizing compiler runs in two or three seconds with *Instant-C*. Other interpreters will run the same program in two minutes. Or even ten minutes. Don't trade slow compiling and linking for slow testing and debugging. *Only Instant-C will let you edit, test, and debug at the fastest possible speeds.*

**Fastest Testing.** *Instant-C* immediately executes any C expression, statement, or function call, and display the results. Learn C, or test your programs faster than ever before.

**Fastest Debugging.** *Instant-C* gives you the best source-level debugger for C. Single-step by source statement, or set any number of conditional breakpoints throughout your program. Errors always show the source statements involved. Once you find the problem, test the correction in seconds.

**Fastest Programming.** *Instant-C* can directly generate executable files, supports full K & R standard C, comes with complete library source, and works under PC-DOS, MS-DOS, or CP/M-86. *Instant-C gives you working, well-tested programs faster than any other programming tool.* Satisfaction guaranteed, or your money back in first 31 days. *Instant-C* is \$495.

**Rational  
Systems, Inc.**

P.O. Box 480  
Natick, MA 01760  
(617) 653-6194

*The range of actions  
you might want to  
perform on the track  
events is limited only  
by your imagination.*

event block (edat is set to true if the mark is a DATA\_\_END mark) and the procedure takes an exit. For MIDI event types, the procedure copies the proper number of MIDI data bytes for the track data block's current running status into the current event block's message field. In the case of MIDI\_\_RS event types, the procedure updates the track data block's current running status.

Procedure `store__track__event` stores a single track event from a track event block into a target track data block. This procedure completes the set of functions for accessing and storing track events contained within track data blocks. You can now manipulate the track events between the time they are accessed and the time they are stored without considering the access and storage mechanisms.

I have included two additional utility procedures for displaying a translated track data stream: `disp__event` displays a single track event on the console device, and `disp__track__data` displays all the track events in a track data block. Note that `disp__track__data` makes use of the MPU-401 TIMEBASE and TEMPO constants to display the actual time offset (in seconds) of each event from the beginning of the track data stream.

#### MIDI INFORMATION PROCESSING

Given the constants, data structures, procedures, and functions discussed above, you now have the resources to begin processing the track events in the MPU-401's track data stream. While the range of possible actions you might want to perform on the track events is limited only by your imagination, the following examples may

```

get_midi_key:=ERR; { default return value }
key_offset:=midi_key_offset(eblk,chan);
if (key_offset <> ERR) then
  get_midi_key:=ebk.event.mess[key_offset];
end;

{ Set MIDI key value in a Track Event,
  if Track Event is of appropriate type
}
procedure set_midi_key(var eblk:track_event_block;
                      chan:key:byte);
var
  key_offset : integer;
begin
  key_offset:=midi_key_offset(eblk,chan);
  if (key_offset <> ERR) then
    eblk.event.mess[key_offset]:=key;
  end;

{ Transpose all MIDI pitch (key) data
  for a channel in a Track Data block
}
procedure transpose_pitch(var tdi,tdo:track_data_block;
                          chan,trans:integer);
var
  curr_key : integer; { MIDI key value from
                       current track event }
begin
  reset_track_data(tdi);
  reset_track_data(tdo);
  while not(tdi.edat) do
    begin
      next_track_event(tdi);
      curr_key:=get_midi_key(tdi.curr,chan);
      if (curr_key <> ERR) then
        set_midi_key(tdi.curr,chan,
                    midi_data_limit(curr_key+trans));
      store_track_event(tdo,tdi.curr);
    end;
  end;
end;

```

Listing 7: Procedures and functions for processing MIDI velocity data.

```

{ Return offset of MIDI velocity data in
  Track Event message, if present
}
function midi_vel_offset(eblk:track_event_block;
                        chan:byte):integer;
var
  offset : integer;
begin
  midi_vel_offset:=ERR; { default return value }
  { only MIDI key events have velocity }
  offset:=midi_key_offset(eblk,chan);
  if (offset <> ERR) then
    midi_vel_offset:=offset+1;
  end;

{ Return MIDI velocity data from Track Event, if present
}
function get_midi_vel(eblk:track_event_block;
                     chan:byte):integer;
var
  vel_offset : integer;
begin
  get_midi_vel:=ERR; { default return value }

```



## MIDI PROGRAMMING

```

vel_offset:=midi_vel_offset(eblk,chan);
if (vel_offset <> ERR) then
  get_midi_vel:=ebk.event.mess[vel_offset];
end;

{ Set MIDI velocity value in Track Event
  if Track Event is of appropriate type
}
procedure set_midi_vel(var eblk:track_event_block;
                      chan,vel:integer);

var
  vel_offset : integer;
begin
  vel_offset:=midi_vel_offset(eblk,chan);
  if (vel_offset <> ERR) then
    eblk.event.mess[vel_offset]:=vel;
  end;

{ Scale all MIDI velocity data for
  a channel in a Track Data block
}
procedure scale_vel(var tdi,tdo:track_data_block;
                   chan:integer; vel_fact:real);

var
  curr_vel : integer;
begin
  reset_track_data(tdi);
  reset_track_data(tdo);
  while not(tdi.edat) do
    begin
      next_track_event(tdi);
      curr_vel:=get_midi_vel(tdi.curr,chan);
      if (curr_vel <> ERR) then
        set_midi_vel(tdi.curr,chan,trunc(curr_vel*vel_fact));
        store_track_event(tdo,tdi.curr);
      end;
    end;
end;

```

serve as an introduction to the subject.

One of the most common actions you might want to apply to MIDI data is to change the pitches in a track data stream by a constant factor (transposition). The procedures and functions for processing MIDI key data (listing 6) provide the necessary tools. The functions `get_midi_key` and `midi_key_offset` work together to return the key (pitch) value from a track event's message portion. These functions check to determine whether the track event is of the proper type (i.e., whether it represents a MIDI command where a key value is present) and return an error flag if no key data is present so that the track event can be skipped in any MIDI key processing. Procedure `set_midi_key` sets the MIDI key value of a track event (if the event is of the appropriate type). Finally, the procedure `trans-`

`pose_pitch` transposes the key (pitch) values in all of a track data block's (tdi) track events, creating a new track data block (tdo) containing the pitch-altered track events. Note that all the key processing routines accept a MIDI channel input (chan) as the targeted MIDI channel for the transposition action. Also note that the `transpose_pitch` uses the function `midi_data_limit` to ensure that the transposed key data does not fall outside the range of valid MIDI data.

Another useful MIDI processing action is to scale or change (multiplying by a constant) all MIDI velocity (loudness) values in a track data stream. The MIDI velocity data procedures and functions (listing 7) provide this capability. These routines are written and function analogously to the MIDI key processing routines discussed above.

(continued)

ACCOUNT-EZE



"We mean Business"

by **DOBERMAN  
SOFTWARE**

**\$89.50**

A completely integrated accounting package for MS-DOS computers.

**EASY TO USE!**

This is the accounting system for people who are not accountants! No debits, credits, difficult lingo, difficult reports to wade through and become confused and frustrated.

**Free VCR training tape.**

**GENERAL INFORMATION**

• Menu driven • Single or Multi-user (DOS 3.1) • Complete Manual • Phone support available • Not copy protected • Password protection

**GENERAL LEDGER**

• Complete chart of accounts • Out of Balance entries not permitted • Income Statement, Balance Sheet, Activity Reports • Entries can be corrected after posting • Cash or Accrual basis • Any fiscal period

**ACCOUNTS RECEIVABLE**

• Aging Schedule • Single & multiple invoice statements • Monthly Billing • Partial Payments • Customer List

**ACCOUNTS PAYABLE**

• Check printing • Vendor List • Multiple or single invoices

**PAYROLL**

• All federal and state deductions • Customized deductions • Quarterly reports • W-2, Payroll Liability Report

**INVENTORY**

• Point of Sale • Invoicing • Purchase orders • Activity reports • Number of inventory items limited only by disk space

**SYSTEM REQUIREMENTS**

IBM or compatible with 256K RAM, DOS 2.1 or higher.

**ACCOUNT-EZE**

To Order Call Toll Free 24 hrs.

**1-800-824-7888**

Ask For Operator 137

M/C, Visa, Am. Exp., C.O.D. or send check or money order to:

**Doberman Software**

3025 Alhambra Dr.,  
Cameron Park, CA 95682

Add \$7.50 for shipping and handling.  
CA residents add 6% sales tax.

**Satisfaction Guaranteed!**

If for ANY reason you are unhappy with **ACCOUNT-EZE**, we will gladly refund the purchase price within 30 days.

IBM and MS-DOS are registered trademarks of IBM and Microsoft respectively.

Listing 8: Procedures and functions for processing MIDI channel data.

```

{ Redirect MIDI channel data in a
  Track Data Block to a new channel
}
procedure change_chan(var tdi,tdo:track_data_block;
                     old_chan,new_chan:byte);
begin
  reset_track_data(tdi);
  reset_track_data(tdo);
  while not(tdi.edat) do
    begin
      next_track_event(tdi);
      with tdi.curr do
        begin
          if (event_type = MIDI_RS) and
             (midi_chan(running_status) = old_chan) then
            event.mess[1]:=((event.mess[1] and $F0) or new_chan);
            store_track_event(tdo,tdi.curr);
          end;
        end;
      end;
    end;
end;

{ Extract a single MIDI channel from a Track Data Block
}
procedure extract_chan(var tdi,tdo:track_data_block;
                     chan:byte);
begin
  reset_track_data(tdi);
  reset_track_data(tdo);
  while not(tdi.edat) do
    begin
      next_track_event(tdi);
      with tdi.curr do
        begin
          if (event_type in [MIDI_RS,MIDI])
             and (midi_chan(running_status) <> chan) then
            begin { convert to NOP }
              event_type:=MARK;
              event_len:=2;
              event.mess[1]:=NOP;
            end;
          end;
          store_track_event(tdo,tdi.curr);
        end;
      end;
    end;
end;

{ Filter a MIDI channel from a Track Data Block
}
procedure filter_chan(var tdi,tdo:track_data_block;
                    chan:byte);
begin
  reset_track_data(tdi);
  reset_track_data(tdo);
  while not(tdi.edat) do
    begin
      next_track_event(tdi);
      with tdi.curr do
        begin
          if (event_type in [MIDI_RS, MIDI])
             and (midi_chan(running_status) = chan) then
            begin { convert to NOP }
              event_type:=MARK;
              event_len:=2;
              event.mess[1]:=NOP;
            end;
          end;
          store_track_event(tdo,tdi.curr);
        end;
      end;
    end;
end;
end;

```

## *The channel processing routines modify the portion of a status byte that sends a MIDI message to one of 16 possible MIDI devices.*

The MIDI channel portion of the MIDI status byte directs a MIDI message to one of 16 possible destinations (synthesizers or other MIDI devices). Often, you need to modify the channel information in one way or another. The MIDI channel processing routines (listing 8) provide a number of useful routines of this nature. Procedure `change_chan` redirects all of a track data block's (tdi) track events for a given MIDI channel (old\_chan) to another channel (new\_chan), creating a new track data block (tdo). Procedure `extract_chan` extracts a single MIDI channel's track events from a track data block. The procedure passes that channel's track events unaltered to the output track data block while turning track events for all other MIDI channels into NOP (no operations) events. Procedure `filter_chan` performs the inverse of the operation performed by `extract_chan`, passing track events for all channels except the channel designated for filtering.

### **EVENT TIME QUANTIZATION**

A final example of MIDI processing involves the "quantization" of the relative timing bytes in track events received from the MPU-401. This process consists of synchronizing the track event to the nearest multiple of a fixed timing constant quantum. While there are many possible ways to approach this problem, I have selected an algorithm that seeks to minimize the difference in the total elapsed time between the input track data stream and the output track data stream.

(continued)



# Osborne/McGraw-Hill Computer Books Your Link to Future Technology

## The Practical Guide to Local Area Networks

by Rowland Archer

Learn how to evaluate and select a LAN so you can avoid unexpected surprises after you make a purchase. Archer discusses five of the most popular LANs available for the IBM® PC and compatible computers: 3Com Ethernet, Corvus Omnet, Orchid PCnet, Novell Netware, IBM® PC Network and IBM® Token Ring.

\$21.95, Order #0-07-881190-2, 283 pp.  
6½ x 9¼

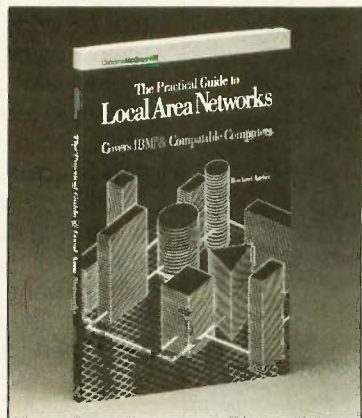

## Desktop Publishing From A to Z

by Bill Grout, Irene Athanasopoulos,  
and Rebecca Kutlin

Create newsletters, catalogs, conference brochures, news releases, and more! This book helps you choose the software, equipment, and procedures you need to achieve professional-looking results.

\$17.95, Order #0-07-881212-7, 225 pp.  
7¾ x 9¼

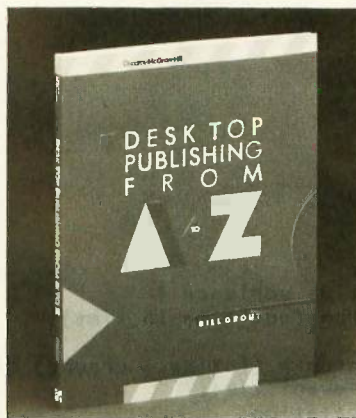

## Micro-to-Mainframe Links

by Ronald F. Kopeck

Sort out all the complex issues involved in linking microcomputers to mainframes for sophisticated, high-powered applications. Thoroughly explains the planning and evaluation process, the real and hidden costs of linking, maintenance, service, and monitoring.

\$18.95, Order #0-07-881228-3, 300 pp.  
7¾ x 9¼

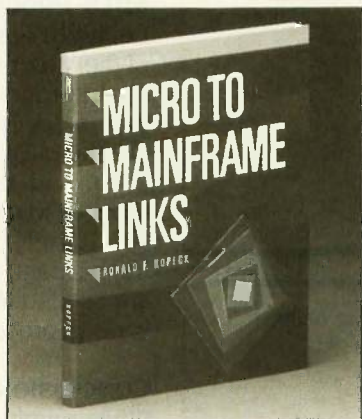

## Project Management Using Microcomputers

by Harvey A. Levine

Describes state-of-the-art project management techniques that can be applied to every business and to almost every computer system. Includes many application examples.

\$18.95, Order #0-07-881221-6, 350 pp.  
7¾ x 9¼

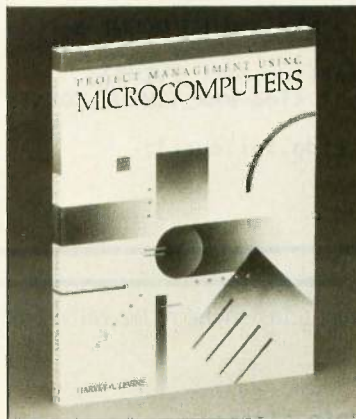

◆ Osborne/McGraw-Hill books are available at bookstores and computer stores everywhere.

◆ To order by mail, complete the coupon and send it to: Osborne/McGraw-Hill  
P. O. Box 400  
Hightstown, NJ 08520

◆ All orders must be prepaid and should include local tax.

◆ Checks, money orders, VISA and MasterCard are acceptable for payment. No postage or handling charges are required.

◆ Books will be shipped via UPS. Allow 4-6 weeks for delivery. Books will not be delivered to post office boxes.

This order is subject to acceptance by McGraw-Hill. Offer is good only in the U. S. A.

**Osborne McGraw-Hill**

NAME \_\_\_\_\_  
 ADDRESS (No PO Box) \_\_\_\_\_  
 CITY \_\_\_\_\_  
 STATE \_\_\_\_\_ ZIP \_\_\_\_\_  
 INDICATE METHOD OF PAYMENT  CHECK/MONEY ORDER  
 VISA/EXP. DATE \_\_\_\_\_  MASTERCARD/EXP. DATE \_\_\_\_\_  
 CARD # \_\_\_\_\_  
 SIGNATURE \_\_\_\_\_  
 QTY \_\_\_\_\_ ORDER # \_\_\_\_\_ PRICE \_\_\_\_\_

Osborne/McGraw-Hill  
 PO Box 400, Hightstown, NJ 08520  
 Clip and send.  
 42-Q-005-7000-1

SUBTOTAL \_\_\_\_\_  
 TAX \_\_\_\_\_  
 TOTAL \_\_\_\_\_

Listing 9: A procedure for quantizing timing values for track events.

```

procedure quantize(var tdi,tdo:track_data_block;
                  quantum:integer);
var
  in_time : real;           { Actual elapsed time,
                             input track data block }
  out_time : real;         { Actual elapsed time,
                             output track data block }
  etime : integer;         { Temporary storage for
                             adjustment of event time }
  ground : integer;        { Rounding term }
begin
  reset_track_data(tdi);
  reset_track_data(tdo);
  ground:=quantum div 2;
  in_time:=0.0;
  out_time:=0.0;
  while not(tdi.edat) do
  begin
    next_track_event(tdi);
    with tdi.curr do
    begin
      etime:=event.time;
      { Adjust in/out time variance }
      etime:=etime - trunc(out_time-in_time);
      { quantize }
      etime:=trunc(quantum * ((etime + ground) div quantum));
      in_time:=in_time+event.time;
      out_time:=out_time+etime;
      event.time:=etime;
      while event.time > MAX_TIMING_COUNT do
      begin
        store_track_event(tdo,OVFL_EVENT);
        event.time:=event.time-MAX_TIMING_COUNT;
      end;
      store_track_event(tdo,tdi.curr);
    end;
  end;
end;

```

Listing 10: A sample program using several of the MIDI processing routines discussed.

```

var
  tdt1,tdt2 : track_data_block;

begin { main }
load_track_data(tdt1);
disp_track_data(tdt1);
readln;

writeln('Transposing pitch for channel 0');
transpose_pitch(tdt1,tdt2,0,6);
dump_track_data(tdt2);
save_track_data(tdt2);

writeln('extracting channel 0');
extract_chan(tdt1,tdt2,0);
disp_track_data(tdt2);
save_track_data(tdt2);

writeln('filtering channel 0');
filter_chan(tdt1,tdt2,0);
disp_track_data(tdt2);
save_track_data(tdt2);

end. { main }

```

Procedure `quantize` (listing 9) maintains running totals (`in_time`, `out_time`) of the elapsed time in the input track data stream and the output track data stream, respectively. The procedure uses these totals to adjust the relative time of an output event before actually quantizing the event to the nearest multiple of the quantum value. If the quantization results in a relative time for the new event that exceeds the maximum possible timing count, timing overflow (null) events are placed in the output stream to represent the excess timing value before the track event in question is actually stored.

While the most accurate means of quantizing timing values would be to convert all the relative event times to actual event times before the quantization is applied, the algorithm presented here yields acceptable results.

### MIDI PROCESSING EXAMPLE

Listing 10 illustrates the use of several of the MIDI processing functions in an actual program. In each case, a track data block is read from an MS-DOS file, the MIDI processing action is applied, and the resulting track data block is written to a new file for further usage. The routines `dump_track_data` and `disp_track_data` are used to display the results of the various processing actions.

### CONCLUSION

While ambitious readers will surely find room for improvement and expansion on the ideas I have presented here, these Pascal routines provide a solid basis for understanding the requirements of MIDI data processing in the MPU-401 environment. I hope this introduction will serve as a useful stimulus to further MIDI programming activities. [Editor's note: The programs described in this article are available for downloading from BYTeNet Listings at (617) 861-9764 or from BIX (BYTE Information Exchange). The programs are LIST1.PAS, LIST2.PAS (etc.), through LIST10.PAS, written in Turbo Pascal for the IBM PC, and MPU401.PCF, written in PC/FORTH. You will need Turbo Pascal and PC/FORTH to run them. The listings in this article are also available on disk. See page 445 for details.] ■



# There's a Familiar Face Behind the New Name



**NANAO MONITORS.** The name is new to the American market. That's because for the first time in history, a huge new line of computer monitors is available to the U.S.—factory direct. 26 different models offered in three series, bringing you a range of features broader than any other. Color resolution from 480 dots x 200 lines up to 720 dots x 480 lines. And Ph scanning from 15.75 to 24.75 KHz. But the truth is that Nanao has been around for a long time. For over a decade we've supplied OEM's worldwide, designing and manufacturing monitors recognized for their outstanding performance and reliability. Now that same quality, selection and value is yours—right from the source. Nanao. The old standby with a new name.

## NANAO

**NANAO CORPORATION**  
153 Shimokashiwano-Cho  
Matto-City, Ishikawa, Japan

**NANAO USA CORPORATION**  
373 G. Vintage Park Drive  
Foster City, California 94404  
Phone (415) 341-7055

Distributor Inquiries Welcomed

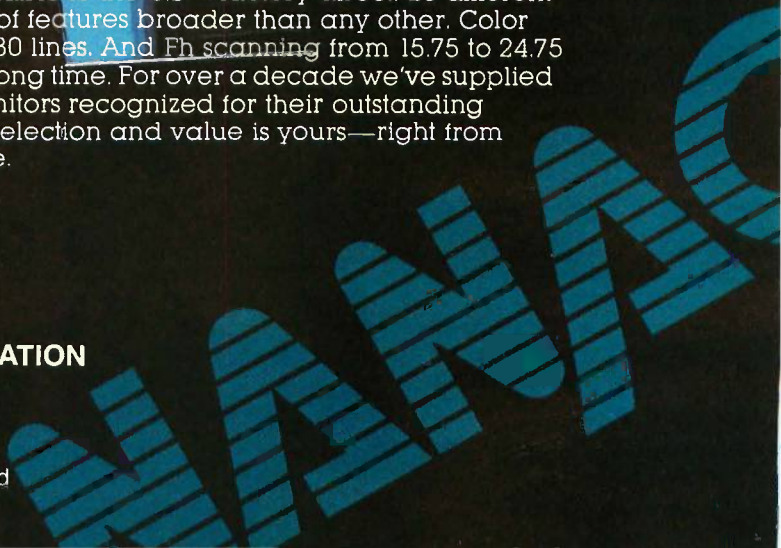



# Princeton Gra

## In a class ab

When you put Princeton Graphic Systems Monitors to work with IBM's new graphics cards, you step up to a new class of performance. Exciting RGB color, sharp, crisp graphics and text and Princeton's quality and dependability...all at a great price!

Our full line of monitors clearly demonstrates why Princeton is an industry leader in high-resolution technology.

### Princeton SR-12P Color Monitor

The first IBM compatible monitor available for the IBM Professional Graphics Controller.\*

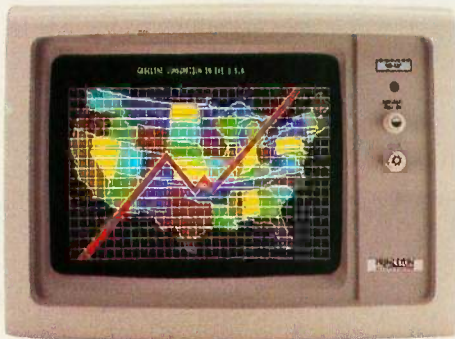

### Princeton HX-12E Color Monitor

The superior choice for use with IBM's Enhanced Graphics Adapter.\*



<b>COMPARE:</b>	Princeton SR-12P	IBM 5175
Dot Pitch (The lower, the better.)	.26 mm	.31 mm
Sugg. Retail Price (The lower, the better too!)	\$999	\$1295
Warranty	1 Year	90 Days

Designed for demanding professionals who won't settle for anything less than the finest color graphic capabilities. Displays more than 4,000 brilliant colors... features an anti-reflective coated black matrix tube for less fatigue and eye strain. You get the sharpest graphics and text... at a substantial savings!

<b>COMPARE:</b>	Princeton HX-12E	IBM 5154
Dot Pitch	.28 mm	.31 mm
Sugg. Retail Price	\$785	\$849
Tinted Black Matrix Tube	Yes	No
Warranty	1 Year	90 Days

Ideal for most computing applications, the HX-12E offers 64 high-resolution colors and easy-to-read text. It gives you sharp colors, crisp characters... for less eye strain and easier viewing, hour after hour. Built-in versatility also allows you to display 16 colors with the IBM Color Graphics Adapter\* automatically.





# phic Systems ove the rest

## Princeton HX-9 Series

For more performance in less space, the Princeton HX-9 series is in a class by itself.

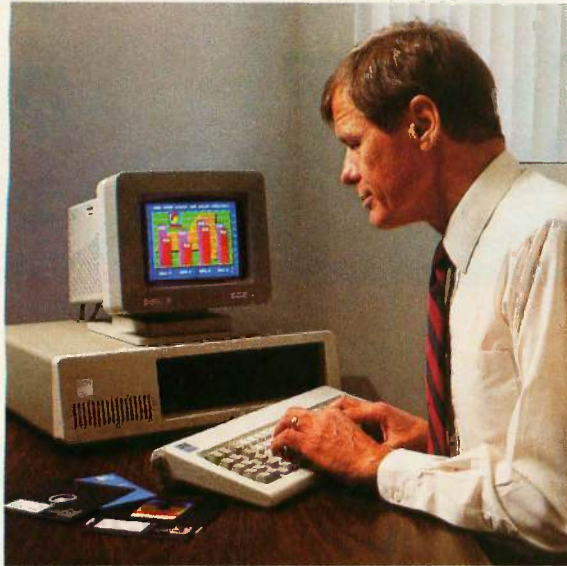

Nobody else—not even IBM—offers a 9", high-resolution RGB color display. The HX-9 and HX-9E feature a super-sharp .28mm dot pitch tube for crisp, clear text and graphics. Nonglare screens for less eye strain. The built-in tilt-and-swivel base allows you to adjust the screen to a comfortable viewing angle. Select green or amber display modes with built-in green/amber switch.

Full IBM compatibility enables you to use the HX-9 or HX-9E with the IBM Color Graphics Adapter.\* The HX-9E gives you added flexibility of full compatibility with the IBM Enhanced Graphics Adapter.\*

### Our other monitors also give you full IBM compatibility:

**Princeton SR-12 Color Monitor**—boasts twice the vertical resolution of the IBM Color Display... when used with graphics adapter cards such as the Sigma Designs Color 400.

**Princeton MAX-12 Amber Monochrome Monitor**—ergonomically designed to give you up to 15\*\* shades of high-resolution amber... plus high-resolution text and graphics when used with a monochrome card.



1984 and 1985 winner of the PC World "World Class PC Competition"!

**Princeton HX-12 Color Monitor**—16 sharp, clear colors and superb character definition make the HX-12 the winning choice among monitor users...



Princeton HX-12



IBM 5153

<b>COMPARE:</b>	<b>Princeton HX-12</b>	<b>IBM 5153</b>
Dot Pitch	.31 mm	.43 mm
Nonglare Screen	<b>Yes</b>	<b>No</b>
Warranty	<b>1 Year</b>	<b>90 Days</b>

See the clearly superior Princeton Monitors at your Authorized Princeton Graphic Systems Dealer. For the dealer nearest you, please call: **800-221-1490 (Extension 1604)**, 609-683-1660 (NJ only), Telex: 821402 PGS PRIN.

Princeton Graphic Systems, 601 Ewing Street, Bldg. A, Princeton, NJ 08540.

\* Or equivalents.

\*\* When used with IBM Color Graphics Adapter or equivalent.

IBM is a registered trademark of International Business Machines Corporation. Sigma Designs Color 400 is a registered trademark of Sigma Designs, Inc.

## PRINCETON™

GRAPHIC SYSTEMS  
AN INTELLIGENT SYSTEMS COMPANY



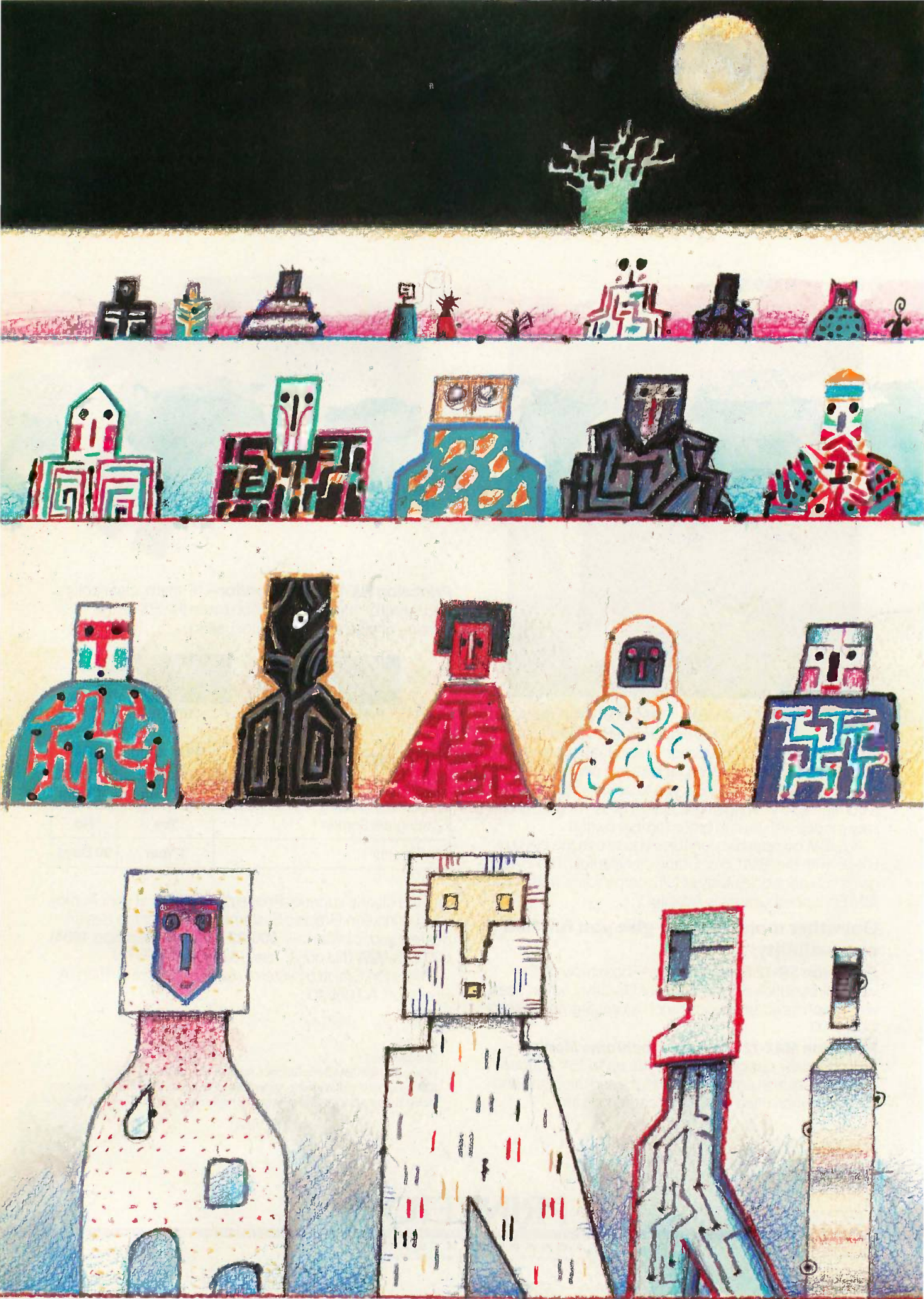



# Reviews

---

<b>REVIEWER'S NOTEBOOK</b>	
<i>by Jon Edwards</i> . . . . .	231
<b>THE ATARI 520ST</b>	
<i>by Eric Jensen</i> . . . . .	233
<b>COMPAQ DESKPRO 286</b>	
<i>by Stan Miastkowski</i> . . . . .	243
<b>TELE-286</b>	
<i>by Wayne Rash Jr.</i> . . . . .	251
<b>MIX C</b>	
<i>by Richard Grehan</i> . . . . .	257
<b>FOUR MIDI INTERFACES</b>	
<i>by Roger Powell and Richard Grehan</i> . . . . .	265
<b>CONCERTWARE+ AND SONGPainter</b>	
<i>by Mario Sergio Bernardo</i> . . . . .	273
<b>THE KURZWEIL 250 DIGITAL SYNTHESIZER</b>	
<i>by Christopher Morgan</i> . . . . .	279
<b>REVIEW FEEDBACK</b> . . . . .	289

---

ACCORDING TO ERIC JENSEN, the Atari 520ST is a very appealing machine and may well become popular. His praises and concerns are similar to those voiced in BYTE's product preview (January, page 84), but Eric also adds some special insight. And while he concludes that he would not be comfortable with the 520ST as his primary machine, the newly released Atari 1040ST does address many of his concerns.

The Compaq Deskpro 286 resembles the IBM PC-compatible Deskpro but has many more options. Stan Miastkowski reviewed the Model 1, whose basic configuration includes 256K bytes of RAM, a 1.2-megabyte floppy disk drive, and five expansion slots.

Wayne Rash reviews the TeleVideo Tele-286, an IBM PC AT compatible that runs at 8 MHz and comes with a standard 44-megabyte hard disk drive. He enjoyed working with the clone, although he found the documentation wanting.

The price of the Mix C compiler seemed too good to be true, so Richard Grehan, a BYTE technical editor, took a long hard look. He discovered that the product was full-featured and that the documentation alone was worth much of the cost. We should note also that Mix now provides a utility that clears up one of Richard's main reservations. Using their \$10 MASM utility, you can now link object files created by Microsoft's MASM or M80 assemblers into your Mix C programs.

We have three reviews in support of the music theme. Roger Powell and Richard Grehan have investigated four MIDI interfaces that will allow you to use powerful MIDI-equipped keyboards and hardware with your Commodore 64, IBM PC, Apple II, or Macintosh.

Mario Bernardo examines two music software packages for the Macintosh. As a musician, he recommends Concertware+ as a fine tool for music composition but has serious reservations about SongPainter.

Finally, Christopher Morgan presents the Kurzweil 250 Digital Synthesizer, an impressive, sophisticated machine with 3.6 to 6 megabytes of ROM, 68000-based hardware, and a grand-piano sound. The price is high, but the technology providing the state-of-the-art music-development environment has lasting implications.



# A FRIEND INDEED.

Face it. Everybody needs somebody some-time. And even the best PC occasionally needs help with faulty power.

So give your hard disc or critical-use system LINE 2® power conditioning. And eliminate those nagging problems that your PC can't prevent. Like voltage sags and surges. Brownouts. Spikes.

LINE 2 Power Conditioners are designed

specifically with your PC in mind. High inrush currents don't affect them. Neither do power problems. And they're amazingly economical.

A LINE 2 Power Conditioner can be your PC's best friend. And a friend in need is a friend indeed. Call us today at (619) 279-0831, or contact your local Square D distributor.

## TOPAZ®

A Subsidiary of Square D Company



# R·E·V·I·E·W·E·R'S N·O·T·E·B·O·O·K

---

There were many interesting products at the West Coast Computer Faire in San Francisco. Without a doubt, the most intriguing was David Small's MacCartridge, a cartridge-disk combination that allows 1-megabyte Atari STs to run Macintosh software faster, without modification, and using Atari's excellent and larger monochrome monitor. The product is real, but it may never be marketed, because Apple must approve its use of the Macintosh ROM. Still, I had to suppress a chuckle at the thought of using MacCartridge to run Meacom's Apple II emulator.

Speaking of which, I was also impressed with Mimic Inc.'s Spartan, an Apple II+ emulator for the Commodore 64. The \$299 unit includes eight standard Apple-compatible peripheral slots, and it runs DOS 3.3, Applesoft, Integer BASIC, Apple Pascal, and CP/M (with a Z80 card). A DOS card allows your 1541 drive to read both Apple and Commodore disks and, because the emulators have their own CPU and two video outlets, you can run both Commodore and Apple software at the same time (to different monitors, of course).

There are yet more peripherals for both the Amiga and the ST. Micro Forge showed a seven-slot expansion box for the Amiga. The system can hold two 10- to 40-megabyte hard disk drives and comes with a 130-watt power supply. Developers in need of RAM disks and workspaces for use with audio and video digitizers may also appreciate Comspec's \$1079 2-megabyte memory board, which comes with a pre-installed RAM test.

For the ST, Supra is now supplying 10- and 20-megabyte hard drives, the latter at the Faire for \$799. The display unit at the Faire impressively flashed 32K-byte Neochrome images on a color monitor. Finally, LogiKhron

has perhaps the first cartridge utility for the ST, a \$50 clock card with an internal battery that automatically loads the date and time into the ST when you boot.

Two applications stand out. For the Amiga, there is Aegis's Animator, which is bundled with their Images. The Animator, a color animation tool, allows you to create 32-color objects, animate them, and create storyboards with backdrops from Images. You can alter the position, shape, size, and color of objects and rotate them or plot their path around the screen.

For the ST, there is Migraph's Easy Draw, a "professional drawing program" that requires TOS in ROM. The list of features is very impressive. In addition to conventional capabilities, you can adjust the size of the drawing surface, add shadows, and use wedges and arcs. The software can support many professional needs, from the creation of floor plans to the presentation of intricate three-dimensional shapes.

There were yet more IBM PC AT clones and at ever-decreasing prices. The Ceptre PC-galaxy is a \$1995 AT compatible with eight slots (three of which are PC-compatible), a 6-MHz clock upgradable to 8 MHz, a 1.2-megabyte drive, and a 195-watt power supply. The Cranium 286/10 AT clone costs \$3050, which includes a 235-watt power supply, 12 slots, 6-MHz or 10-MHz clock speed, and a 31-megabyte hard disk drive.

For IBM users, there is Software Carousel from SoftLogic Solutions, a \$50 utility that accesses extended memory, allowing you to run up to 10 programs, each at the touch of a key. Every program can use all available system RAM because the software employs a virtual memory manager that can use lower RAM, AT extended RAM, "above board" RAM, or even

disk space as a reservoir. And by establishing the amount of RAM each program will use, you can switch immediately among applications, pausing one while running the next.

And, for the PC, there is Finally!, a subroutine library for compiled BASIC from Komputerwerk that contains over 100 utilities that you can include in your source code or link to your object code at run time. The utilities include a variety of general and geometrical mathematical functions, file and directory control, medium- and high-resolution graphics, hardware interfacing, number conversions, keyboard, printer and screen control, string handling, and sorting routines.

Lest Macintosh users feel slighted, I have enjoyed Affinity's Tempo, version 1.1, a macro facility that allows you to record and later replay keystrokes and mouse clicks. There are some special features. For example, you can make the playback of a macro conditional upon text in a document or the value of a spreadsheet cell. Macros are indispensable for carrying out repetitive tasks, but you will also enjoy automatically opening applications from the Finder and including dialog boxes within your macros. Unlike many macro facilities on the IBM PC, macros will only play back within the application in which you created them. You can suspend them by simply holding down the mouse button and even edit them during the pause.

And the reviews business goes on. We are organizing a joint review of new Modula-2 compilers for the Atari ST, Macintosh, and IBM PC. A Laser 128 is en route to a reviewer, and we are preparing in-house the formal review of the Amiga.

—Jon Edwards  
Technical Editor, Reviews



## Amdek challenges you to read between the lines.

Not all monitors are created equal. And no monitor in this price range can equal the new Amdek Color 722.

What makes the 722 RGB monitor so distinctive? For one, a dual frequency output that is capable of supporting IBM's Enhanced Graphics Adaptor. The result is 350 lines of resolution, assuring you of a sharper, crisper image that makes your graphs and charts look more like a work of art, and less like a rough sketch. For another, the fact that the 722 is made by Amdek — where monitors are our only line, not just a sideline.

The high performance 722 features an etched glass, non-glare screen that's easy on the eyes, plus front-mounted controls that are easy on the operator. This means less eye fatigue and greater productivity.

### All 350 of 'em.

What's more, the 3-position text switch enables you to choose green, amber or full-color type — up to 80 characters in width x 25 lines of text. There's even an optional tilt/swivel stand that allows you to select a viewing angle that's most comfortable for you.

It all adds up to more monitor for the money, and is backed by more warranty for your peace of mind. Amdek's warranty protects your investment for three full years on the CRT, and two years on all other parts and labor. No other monitor warranty offers you more.

For high resolution performance, see the new Amdek Color 722. We know you'll be impressed. After all, everytime an Amdek monitor is sold, we know that we are putting our image on the line.

# AMDEK

Inquiry 19

*Clearly the finest in monitors.*





# THE ATARI 520ST

BY ERIC JENSEN

## *A good engine for bit-mapped graphics at an attractive price*

The Atari 520ST is a very appealing machine. It is a good engine for bit-mapped graphics, with a good user interface and an attractive price. Still, the review machine had too many rough edges to serve as my primary machine. It is far from portable. A two-drive system put seven boxes on my tabletop and required four wall outlets.

The processor and each disk drive have separate power supplies and the four power switches are inconvenient. I don't like leaving the power supply plugged in while its output is turned off. It draws some power, and I worry that the system will be susceptible to power-line glitches even while turned off. The practical solution seems to be to use a switched outlet box.

### HARDWARE

The hardware appears clean. The 8-MHz clock rate (a bit faster than either Macintosh's or Amiga's) probably translates to about half a million typical instructions per second. There is no other special display support hardware, and none is needed for windowing applications. The display appears to be properly interleaved with the processor so that they do not have to wait for each other. The display generator is an interesting compromise. For the monochrome display, it fetches a word of data and shifts it out a bit at a time to determine the color for 16 successive pixels. For the color displays, it fetches either two or four words in sequence and shifts out a bit of each to develop a color lookup-table index. Again, there are 16 shift cycles before the

next words must be fetched. Thus you have neither the situation in which all the bits describing one pixel are in one word, nor that in which the most significant bits for all pixels are contiguous in memory.

As long as this arrangement is hidden under GEM—as it should be for almost all users—this is fine, but there are a couple of cases in which it could be inconvenient. If you were to use multiple planes of memory (with a degenerate color map) to represent multiple overlaid images, then the images would be inconveniently intertwined. If you have to mask out an irregular region in a picture, then you have to know not only the number of words in a scan line but also the spacing between words, which may not be the same in the image and the mask.

The 512K bytes of RAM is enough for most programming, although the operating system for the reviewed machine used more than 200K. [Editor's note: The latest production units for the 520ST and 1040ST have TOS in ROM.] In addition, the screen uses at least 32K more.

The displays are very crisp and clean, with enough resolution to draw pictures of good quality. The 12-inch screens provide almost twice the area of the 9-inch Macintosh screen. The SM124 monochrome monitor provides a 640-by-400-pixel display. This allows 22 lines of 110 characters in the directory font, or 20 lines of 77 in the standard font used in BASIC windows (allowing window borders), which is enough to do a fair job of emulating a dumb terminal. There are about 77 dots to

the inch horizontally by 65 vertically, which is fine enough resolution to make the jagged edges of diagonal lines fairly unobtrusive.

You can run the SC1224 color monitor in two modes (640 by 200 pixels with 4 colors or 320 by 200 pixels with 16 colors). The lower resolution mode is the operating system's initial choice. This keeps the aspect ratio of icons the same as on the monochrome monitor and simply doubles their sizes. The jagged edges are noticeable here but not particularly offensive. I was very impressed by the lack of colored "shadow" edges on

(continued)

Eric Jensen (50 Carriage Lane, Bedford, NH 03102) is a programmer for Hastech Inc. His interests include artificial intelligence, math and logic, and displays.



*Windows are not erased  
as neatly as they  
might be—you often see  
that every underlying  
window gets a "please  
clean up" signal.*

window borders and characters. Another plus is that you can work in black and white on this color monitor without eyestrain.

The disk drives use 356K-byte 3½-inch floppy disks. They seem reliable, but I had several problems. First, the cables are so short that most users will choose to put the drives to the left of the keyboard. If you try to put them on the right, they will block the mouse connector or sit at an uncomfortable angle. Second, you can press the eject button to remove disks, but the manuals do not explain whether it is safe to reset the machine or power down without first ejecting the disk. The eject button was also a bit inconsistent—crisp one time and mushy the next. Finally, the documentation does not explain that, in a two-drive system, the drive closer to the processor automatically becomes drive A. There are no switches to set or jumpers to connect. There is also no comment indicating that you cannot daisy-chain a third drive.

The two-button mouse has a good feel. You can remove the ball for cleaning, which is a nice feature not present on some professional workstations. However, I had one problem: I found double-clicking the buttons to be very difficult, even after adjusting the delay with the control panel. Perhaps Atari should be measuring up-to-down transition time rather than down-to-down. Perhaps button debouncing logic gets in the way.

Finally, the keyboard has about the same key feel (and exactly the same key spacing) as the Digital keyboard I use every day, so I like it. The oddest feature of the keyboard is the rhom-

boid shape of the function keys, which are almost impossible to hit without hitting their neighbors.

#### **GEM**

GEM appears to be a solid product, with a few excesses and inconveniences, but pretty well on target for anything short of animation. It includes calls equivalent to most of the Graphics Kernel System (GKS) used in many standard graphics programs, but it may be weak in the area of partially redrawn pictures.

Windows are not erased as neatly as they might be—you can often see that every underlying window gets a "please clean up" signal. And after clicking the mouse on any of the window-change bars, the cursor was not redisplayed until the mouse was moved. One of the few bugs I encountered here was a requirement that a window be retitled after it is moved. It seemed to acquire a new name on its first movement but not thereafter.

Atari's TOS, on the other hand, has a number of holes. I haven't documented any crashes. (It appears that memory may not completely recover when you change disks, leading to eventually running out of storage, but I haven't proved it. If so, it takes quite a few disk changes to run out of space.) I have, however, stumbled over a fairly steady stream of minor nuisances and cosmetic inconveniences. Exiting from a program back to the operating system, for example, does not reinitialize the color map; if, therefore, a program changes the colors to black and white, you might get back to the desktop and not see anything. Selecting textual instead of icon directory displays and then changing from low resolution to medium resolution leaves both icon and textual formats selected for the next directory display (and picks icon).

As a whole, though, TOS is a reasonable operating system. It provides a file system that looks almost identical to that in MS-DOS, with directories and subdirectories (called "folders" in the desktop idiom) and files with date and time stamp. (This latter feature is less useful than it should be because the clock resets with the processor,

and it is easy to forget about it.)

The desktop command interface does a pretty good job of providing most of the commands possible with MS-DOS. My MS-DOS manual lists 31 commands. Fourteen translate directly, eight are simply calls to standard utility programs (two of which are provided here), six make no sense in translation (such as setting the prompt on the command line), and the last three are more difficult. Renaming a file requires selecting the file, getting a menu of "File Info;" and overtyping the filename in the menu. Defining environment variables and creating batch jobs seem impossible, and commands that take arguments are a bit inconvenient. (The developer's package includes most of the missing utilities and a textual command interface that looks a lot like MS-DOS.)

The desktop is clearly much simpler than that provided with the Macintosh. Most of the basics are there, but, for example, there is no choice of font or type size from the main menu bar.

#### **ATARI BASIC**

The only languages that come bundled with the machine are Logo and BASIC. The BASIC on the review machine is modern, flashy, and huge. It will be more usable with the operating system in ROM, but with TOS in RAM, I had to disable graphics buffering and dimension the array as an integer array in order to use an array of 7000 elements. Still, Atari BASIC was considerably more than the minimal textbook language. It performed the BYTE computational benchmarks about twice as fast as an IBM PC, while apparently accumulating fewer floating-point errors, and it moved files about a third as fast.

The most obvious feature of the BASIC is its use of four windows—a command window at the bottom, a listing window at the upper left, an output window at the upper right, and an edit window pushed behind all of the above. Atari BASIC is smart enough to fill the screen on either the monochrome or the color monitor—a feature missing on the TOS desktop. There is an inconvenience here,

*(continued)*



## AT A GLANCE

### Name

Atari 520ST

### Company

Atari Corp.  
1196 Borregas Ave.  
Sunnyvale, CA 94086  
(408) 745-2000

### Components

**Processor:** Motorola 68000

**Memory:** 512K bytes of dynamic RAM

**Display:** 12-inch monochrome or color

**Graphics:** Three modes, 640-by 400-pixel monochrome, 320 by 200 with 16 colors, and 640 by 200 with 4 colors  
**Keyboard:** 94-key Selectric-style QWERTY keyboard with numeric keypad, cursor controls, and rhomboid function keys

**Sound:** Three independent sound channels from 30 Hz to 125 kHz

**Floppy disk drive:** Bundled, external 3½-inch single-sided double-density drive with capacity of 360K bytes; system supports maximum of two floppy disk drives

### Interfaces

MIDI-in and MIDI-out ports  
Monitor port (supports RGB analog, high-resolution monochrome)

Centronics parallel printer port (supports Epson-compatible printers)

RS-232C serial port

Floppy disk port

Hard disk port (10-megabit-per-second DMA transfer rate)

128K-byte ROM cartridge port

Ports for mouse or two joysticks

### Bundled Software

Atari Logo, Atari BASIC

### Optional Peripherals

SF354 single-sided drive \$199

SF314 double-sided drive \$299

### Price

Monochrome system \$799

Color system \$999



MEMORY SIZE (K BYTES)

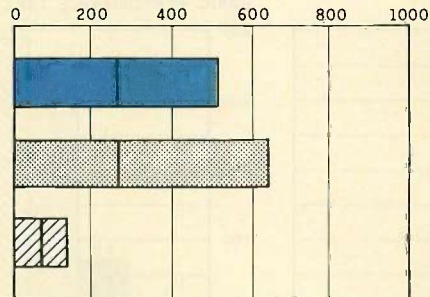

DISK STORAGE (K BYTES)

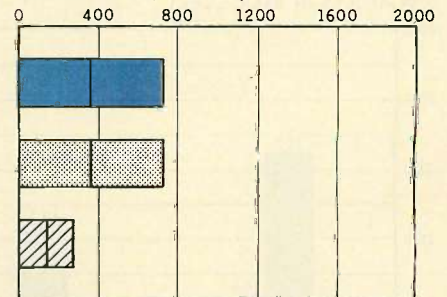

BUNDLED SOFTWARE PACKAGES

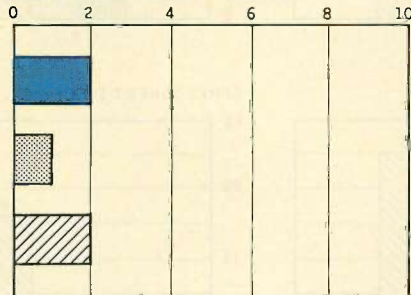

PRICE (\$ 1000)

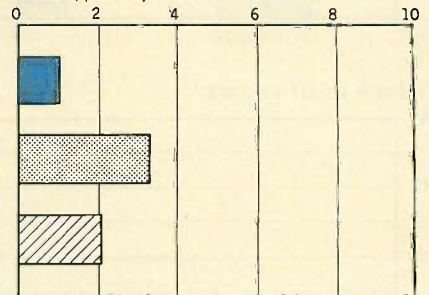

■ ATARI 520ST

■ IBM PC

■ APPLE IIe

The Memory Size graph shows the standard and optional memory available for the computers under comparison. The Disk Storage graph shows the highest capacity for a single floppy disk drive and the maximum standard capacity for each system. The Bundled Software Packages graph shows the number of software packages included with each system. The Price graph shows the list price of a system

configured with two disk drives, a monochrome monitor with connection apparatus, a printer port and serial port, 256K bytes of memory (64K bytes for 8-bit systems), the standard operating system for the computers under comparison, and the standard BASIC interpreter. Note that the price of the Atari 520ST includes 512K bytes of memory and a second single-sided drive.



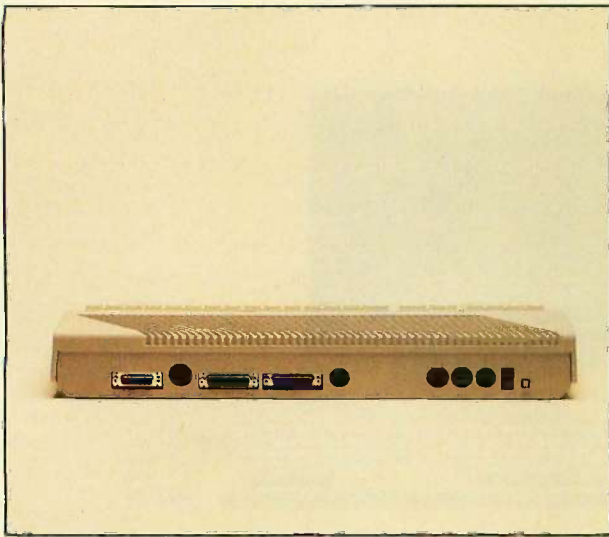

The ST ports include MIDI in and MIDI out, a Centronics parallel printer port, an RS-232C serial port, and a DMA port.

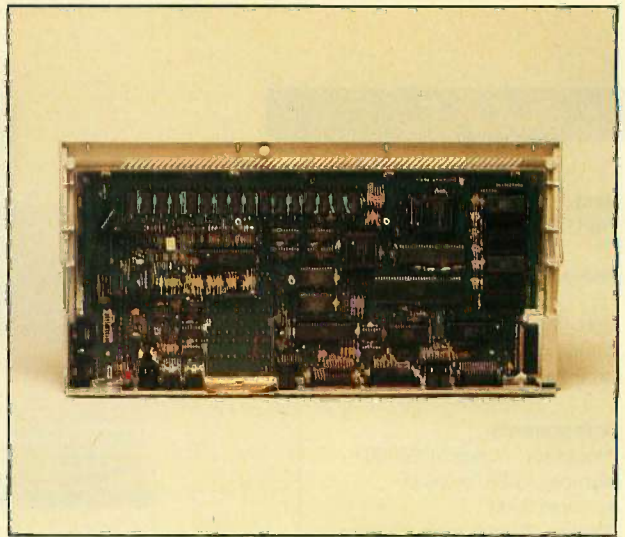

Inside the Atari 520ST.

DISK ACCESS IN BASIC (SEC)

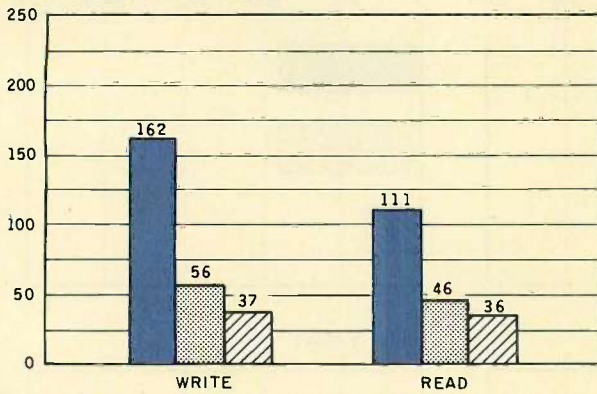

BASIC PERFORMANCE (SEC)

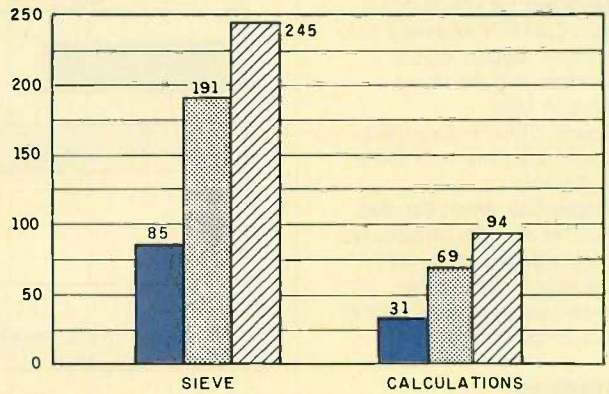

SYSTEM UTILITIES (SEC)

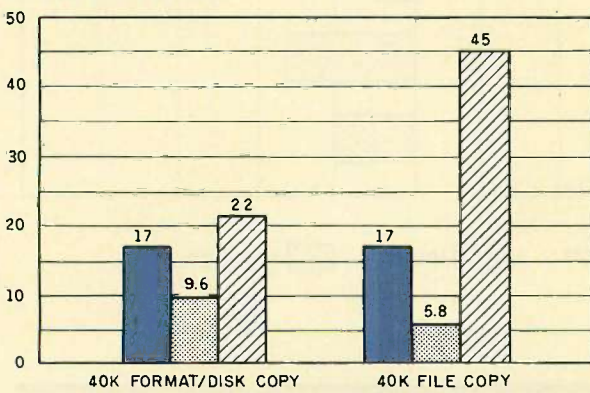

SPREADSHEET (SEC)

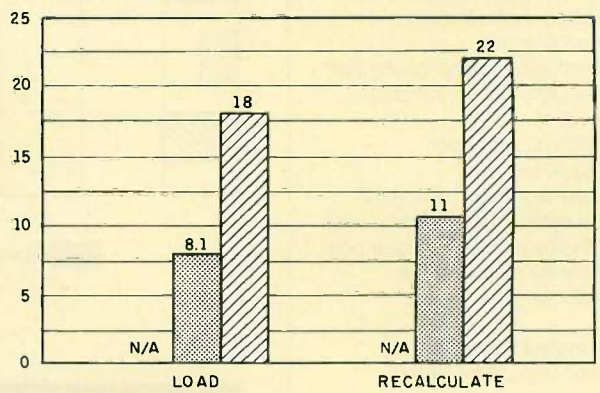

■ ATARI 520ST    ■ IBM PC    ▨ APPLE IIe

The graphs for Disk Access in BASIC show how long it takes to write and then read a 64K-byte sequential text file to a blank floppy disk. (For the program listings see *BYTE's Inside the IBM PCs*, Fall 1985, page 195.) The Sieve graph shows how long it takes to run one iteration of the Sieve of Eratosthenes prime-number benchmark. The Calculations graph shows how long it takes to do 10,000 multiplication and 10,000 division operations using single-precision numbers.

The System Utilities graphs show how long it takes to format and copy a 40K-byte file using the system utilities. The Spreadsheet graph shows how long it takes to load and recalculate a 25- by 25-cell spreadsheet in which each cell equals 1,001 times the cell to its left. Tests for the Atari 520ST were done using TOS and Atari BASIC. Running the Sieve on the Atari required that we dimension the array as an integer array.



# This is the Modula-2 compiler everybody's been waiting for...

**Especially Turbo Pascal users!**

## LOGITECH MODULA-2/86

**Now, you can cross the bridge to Modula-2 with ease.**

This is Modula-2 at its *absolute* best. It's a fully integrated development environment that takes into account what you need as a programmer. Without leaving the Editor, you can call the compiler, linker and utilities.

With Logitech's Modula-2, you'll have the ability to edit several files at once, comparing, window to window, various code modules. You can even move from window to window compiling, linking, debugging and running.

The compiler has the kind of power and room to breathe that you really need in today's complex applications. It is as *easy* to use as Turbo Pascal, without your programs being limited to 64K of code.

At your command will be the libraries of modules that make Modula-2 a programmer's dream. It has essentially the same structure as Pascal with the major addition of a library organization of code modules that allow you to put together programs on a solid, block-by-block, foundation of proven code.

Whether you're working with a module of your own making, or one of the many in our library, you'll find the system by which each module is identified, described and stored an organizational masterpiece. And that's at the heart of Modula-2.

Underneath the sophisticated system is a Modula-2 compiler that is the result of years of development and proven use in industry. We run on the Vax\*, and we run on the IBM PC. And the code is portable—from one to the other.

*Best of all... you can have it right now!*

**Logitech Modula-2/86** Complete with Editor, Run Time System, Linker, Cursor-positioning debugger, 8087 Software Emulation, BCD module, Logitech's extended library, Utility to generate standard .EXE files, Turbo Pascal (and standard Pascal, too) to Modula-2 translator (included without charge until 8/1/86), and much, much more!

**Logitech Modula-2/86 with 8087 support** Even if you haven't yet gotten an 8087 co-processor, you can still use this version.

**Logitech Modula-2/86 Plus** For machines with 512K or more. Takes advantage of the larger memory to increase compilation speed by 50%! Supports 80186 and 80286 as well as 8086 and 8088. Includes 8087 and 80287 support, too.

**Window Package** Now you can build true windowing into your Modula-2/86 code with ease, too. Very powerful and very full, yet only 15K in size. Features virtual screens, color support, overlapping windows and a variety of borders.

**Run Time Debugger** (source level) Much more powerful than just a symbolic RTD. Display source code, data, procedure call chain and raw memory. Set break points, assign values to variables, pinpoint and identify bugs in your source. The ultimate professional's tool!

**Utilities Package** Features a post-mortem debugger for static debugging. If a program you've written crashes at run time, the situation is frozen, and you can pinpoint, in source, the cause of the error and the data at that moment. Also includes a disassembler, a cross reference utility and a "version" utility that allows conditional compilation.

**Make Utility** Automatically selects modules affected by code changes for quick and minimal re-compilation and relinking. Even figures out dependencies for you.

**Library Sources** Source code for our major library modules is now available—for customization or exemplification.

**ROM Package** If you need to produce rommable code, call our 800 number for further information on this package.

To place an order call our special toll free number\*

**800-231-7717**

in California

**800-552-8885**

Special offer until 8/1/86!

**Free!** \$49.95 value Turbo Pascal translator!  
*Now, you can take your library with you!*

**\$89**

**Yes,** I'd like to take the next logical step in programming. Please send my copy of Logitech Modula-2/86 to the following address:

VISA  MasterCard  Check Enclosed

Card Number \_\_\_\_\_ Expiration Date \_\_\_\_\_

Signature \_\_\_\_\_

Name \_\_\_\_\_

Address \_\_\_\_\_

City \_\_\_\_\_

State \_\_\_\_\_ Zip \_\_\_\_\_ Phone (\_\_\_\_) \_\_\_\_\_

Here's the configuration I'd like:  Logitech Modula-2/86 \$89  Window Package \$49

Logitech Modula-2/86 \$129 with 8087 support  Run Time Debugger \$69 (source level)

Logitech Modula-2/86 Plus \$189  Utilities Package \$49

Please add \$6.50 for shipping and handling.  Make Utility \$29  Library Sources \$99

Total enclosed \$ \_\_\_\_\_  
 (California residents, please add applicable sales tax)



LOGITECH, Inc.  
 805 Veterans Boulevard  
 Redwood City, California 94063  
 Telephone (415) 365-9852

For European pricing, please contact:

LOGITECH SA  
 Box 32, CH-1143 Apples, Switzerland  
 Telephone 41 (21) 774545

Please call our 800 line for:  Information on our \*VAX version  Site License and University Discounts  Dealer and Distributor information

\*Turbo Pascal is a registered trademark of Borland International



*The developer's package includes a C compiler, linker, and debugger, and the glue to hold them together.*

though. The BASIC automatically wraps text to the next line after 80 characters, but a color window line holds only 38, and monochrome 77, so you can never see all of a long line without panning. All the normal window controls are available, so each window can be repositioned, resized, or even closed. You will soon discover the convenience of being able to keep an old listing on the screen in one window while you type modifications into another.

The editing features are woefully short of general word processing. You can move the cursor (with the cursor keys but not the mouse) and overtype characters fairly easily, but inserting new characters requires cursor positioning with the cursor keys, menu selection with the mouse, and finally the insert from the keyboard.

Perhaps the most useful extension of this BASIC is its ability to call a large number of the standard GEM display functions. For example, you can draw graphs and pictures from BASIC without resorting to obscure hieroglyphics or pokes. Other modern constructs include named subroutines and WHILE.

The developer's package includes a C compiler, linker, and debugger, and the glue to hold them together. There is an adequate editor. It took me about 8 minutes to get around the edit-compile-link-run loop, with a surprisingly large portion of that time spent in the linker searching the ex-

tensive GEM libraries. The compiler used the standard three passes and passed its output to an assembler, resulting in at least four trips through files. The linker took almost as long. Note in the benchmark graphs that disk I/O is about three times as slow as on the IBM PC; a hard disk would help considerably.

**CONCLUSION**

The Atari 520ST is a very appealing system in need of some further software development. The user interface is easy to learn and use, and the system is powerful enough for serious work. The developer's package appears to offer enough tools and access to the system internals to suggest that software will get written. The computer brings the convenience and naturalness of the "desktop metaphor" down to a lower price bracket, and thus a larger audience. It has a good chance of becoming a very popular machine. ■

**FREE SHIPPING ON ORDERS OVER \$100**

**HEWLETT-PACKARD**

<b>PACKAGE</b>	HP110, Thinkjet, Disc Drive...	\$ 2295.00*
2225B	Thinkjet Printer	\$ 379.00
7440A	8-Pen Plotter	\$ 969.00
9114A	710K Disc Drive	\$ 625.00
82143A	Thermal Printer	\$ 295.00
82161A	Cassette Drive	\$ 423.50
82162A	IL Printer	\$ 346.50
82164A	IL/RS-232 Interface	\$ 227.15
92285A	Laser Jet Toner (Black)	\$ 79.20
92286A	Font Cartridge	\$ 173.25

*\*(Limited quantities)*

**HEWLETT PACKARD**

HP-11C	Scientific	\$ 41.95
HP-12C	Financial	\$ 73.95
HP-15C	Scientific	\$ 73.95
HP-16C	Computer Science	\$ 87.95
HP-41CV	Scientific	\$ 130.95
HP-41CX	Scientific	\$ 187.95
HP-71B	Handheld Computer	\$ 389.95
New	CMT 32K RAM for 71B	\$ 139.00

**Coming Soon!**  
New HP Calculator Line.  
Call us for details & the lowest price.

**AST**

SixPakPlus	w/64K RAM	\$ 215.00
RAMpage	w/256K RAM	\$ 295.00
Advantage	w/128K RAM	\$ 359.00
Preview		\$ 239.00
RAMvantage	w/128K	\$ 299.00

**TERMS:**

- Liberal Return Policy
- **Free Shipping** on orders over \$100 (Continental U.S.)
- **NO ADDITIONAL CHARGE** for credit cards
- MD residents add 5% sales tax
- Credit references required for open account
- Allow 2 weeks for personal checks
- C.O.D.'s - cash, money order, bank or certified check

**COMPUTERS**

**Sperry "IT"**

**AT compatible**

Monitor • 1MB RAM • 80286  
• 1.2MB Floppy • 44MB Fixed Drive

**\$3695**

**Sharp PC7000**

**XT Portable**

25 line LCD • Detachable Keyboard • 320K RAM • 8086 • 2-360K Floppy Drives

**\$1395**

**AT&T**

4000 Modem \$ 349.00  
Softcall \$ 59.95



**CAPITAL MICRO**

P.O. BOX 29639

WASHINGTON, D.C. 20017

**(800) 544-4442**

in Maryland, call  
**(301) 565-3595**

**PRINTERS**

**Xerox/Diablo**

D-25	25cps Daisywheel	\$ 449.00
635	55cps Daisywheel	\$ 895.00
4045CP	Laserprint/Photocopier	\$ CALL

\*Price After Rebate

**Okidata**

ML182	120cps Dot Matrix	\$ 219.00
ML192	160cps Dot Matrix	\$ 349.00
Ok 20	Color Dot Matrix	\$ 189.00
ML193	160cps Wide Carriage	\$ 499.00
ML292	200cps Dot Matrix	\$ CALL
ML293	200cps Wide Carriage	\$ CALL

**Brother**

M1109	100cps Friction/Tractor	\$ 209.00
M1509	180cps Wide Carriage	\$ 369.00
HR-10	10cps Daisywheel	\$ 249.00
HR-15XL	17cps Daisywheel	\$ 339.00
HR-25	25cps Daisywheel	\$ 489.00
HR-35	36cps Daisywheel	\$ 699.00
2024L	200cps & NLQ	\$ CALL
Twinriter 5	Daisywheel & Dot Matrix	\$ 15.00

**Panasonic**

KXP1091		\$ 249.00
---------	--	-----------

**Citizen**

120D	120cps Dot Matrix	\$ 179.00
MSP-10	160cps Dot Matrix	\$ 259.00
MSP-15	160cps Wide Carriage	\$ 365.00
MSP-20	200cps Dot Matrix	\$ 345.00
MSP-25	200cps Wide Carriage	\$ 499.00
Premier35	35cps Daisywheel	\$ 439.00

**Toshiba**

P321	24 Pin-head/216cps	\$ 479.00
------	--------------------	-----------

**EPSON**

LX-80	100cps & NLQ Dot Matrix	\$ 215.00
JX-80	Color Dot Matrix	\$ 369.00
New LQ-800, LQ-1000		CALL
FX-85, FX-286, HS-80, AP-80		CALL
DX-10, DX-20, DX-35		CALL



# Look at what we're plugging now.

## Plug-in Teacs.

We offer a full line of PC compatible components to increase your floppy storage, to add Winchester drives, or to include a streaming cassette back-up.

Our FD-55 Series, half-height, low power, 5¼-inch floppy disk drives are the world-wide standard of excellence with over 3 million in service to date. A quick and easy way to double your capacity.

Our MT-2st Kit is all you need to plug-in a streaming cassette back-up system. With 90 ips performance, you can store up to 20 megabytes of back-up incredibly quick.

Our PS-5250 subsystem is a completely self-contained, self-powered add-on that includes a 20 megabyte Winchester drive and a 20 megabyte streaming cassette back-up.

With Teac, adding on more storage capacity is an open and shut case.

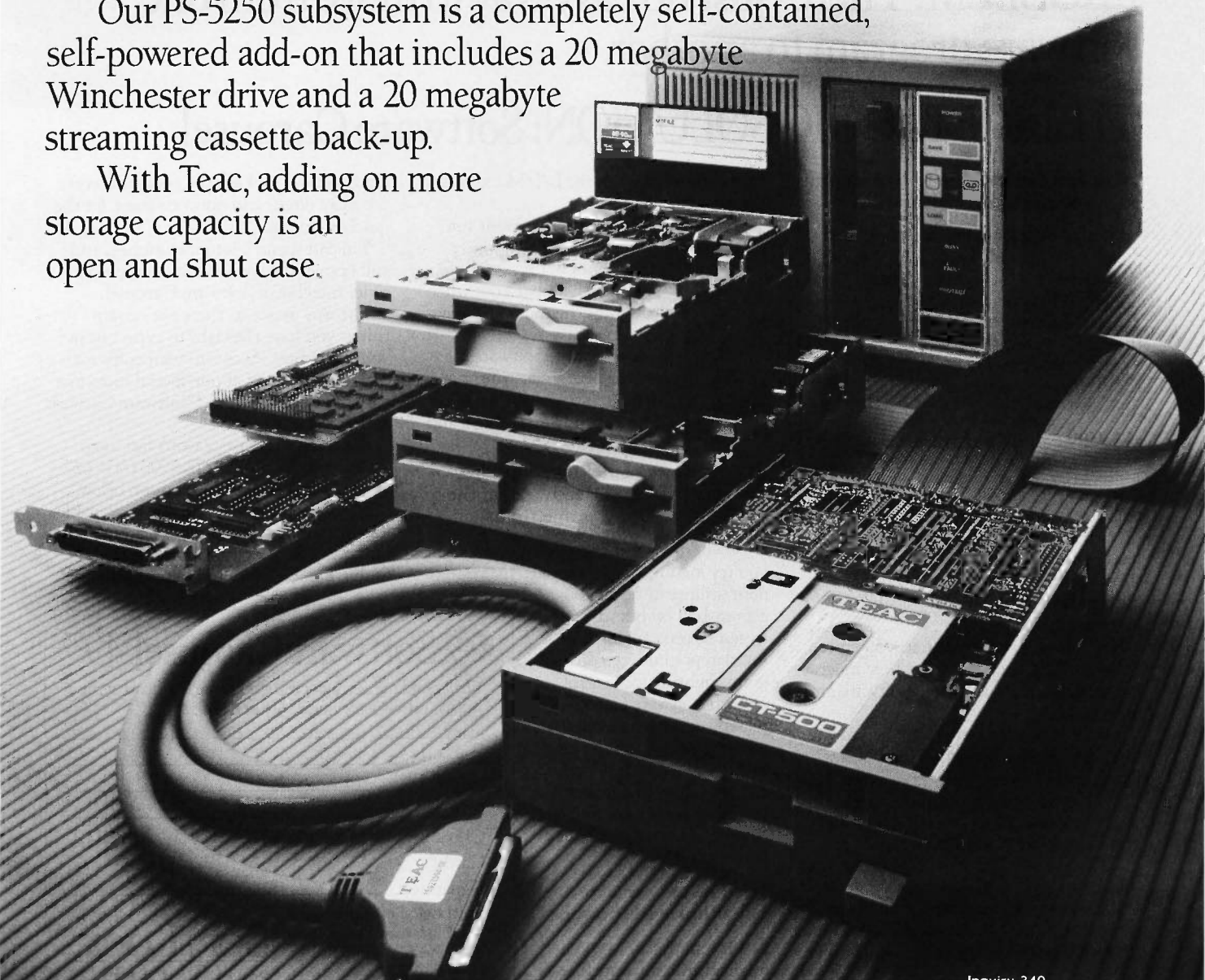

Inquiry 340

Built To Fanatical Standards. **TEAC**

INSTRUMENTATION AND COMPUTER PRODUCTS DIVISION, 7733 TELEGRAPH ROAD, MONTEBELLO, CA 90640

East (617) 475-7311

South/Midwest (312) 351-9124

Rocky Mountain (602) 242-4025 (303) 337-6329 (801) 532-2111

Northwest (408) 727-1427

Southern California (213) 726-0303

©1985



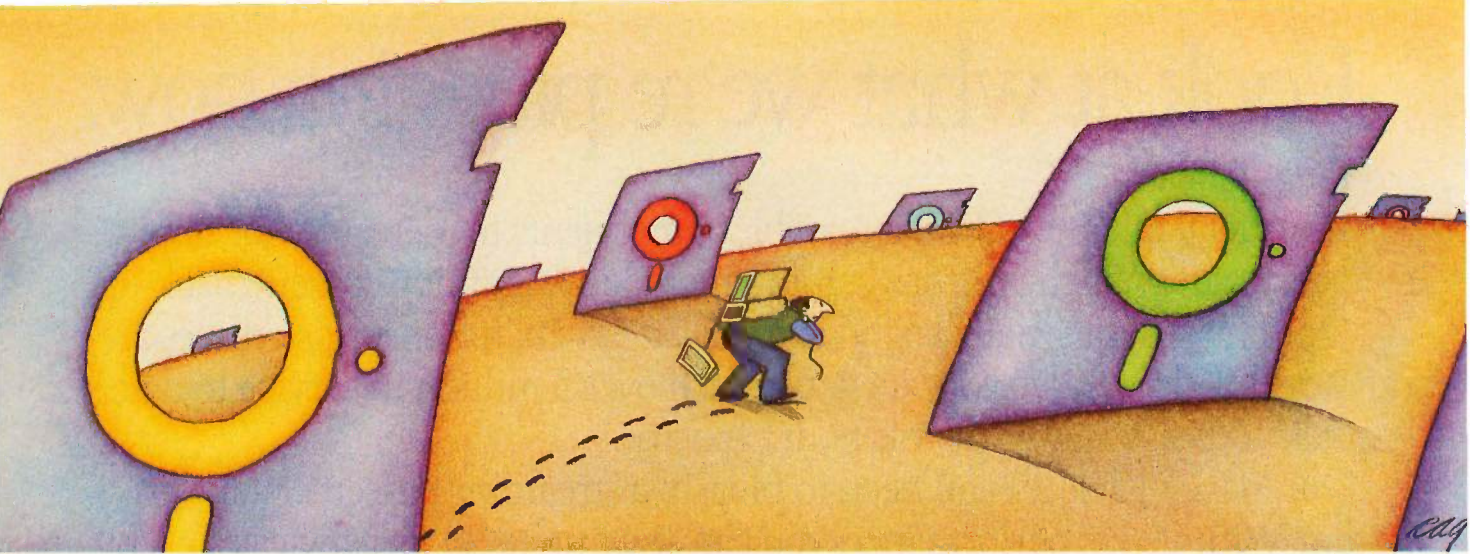

## PROBLEM: There's just no easy way to move from one software program to another.

## THE SOFTLOGIC SOLUTION: Software Carousel

Now you can keep up to 10 programs loaded and ready to run.

Hard to believe, but some people are happy with just one kind of PC software. Well, this is not a product for them.

But if you're someone who depends on many packages, all the time—someone who'd use several programs at once if you could, well now you can. With Software Carousel.

### Why call it "Software Carousel"?

In some ways, Software Carousel works like the slide projector you're used to. You load a handful of pictures, view one at a time, then quickly switch to another. A simple idea, with powerful possibilities for computing.

Here's how it works. When you start Software Carousel, just tell it how much memory you have, load your software and go to work.

Need to crunch numbers? Switch to your spreadsheet. Need your word processor? Don't bother saving your spreadsheet file. Just whip over to your document and do your work. Snap back to your spreadsheet, and it's just like you left it.

With up to ten different programs at your fingertips, you'll have instant access to your database, communications, spelling checker, spreadsheet, word processor, RAM resident utilities, languages, anything you like.

### Reach deep into expanded memory.

This could be the best reason ever for owning an expanded memory card, like the Intel Above Board, AST RAMpage, or any

card compatible with the L/1/M Extended Memory Standard.

Software Carousel puts programs into this "high-end" memory for temporary storage when they're not in use. And switches them back out when you want them. It's fast, efficient, and easy.

If you want, Software Carousel will even use your hard drive for swapping. Just allocate a portion for storage, and go to work.

### Sidekick, Superkey and Ready. All at the same time.

You know what happens if you try loading two or more RAM resi-

dent utilities at once. You get crashed keyboards, frozen screens, all kinds of interference between programs fighting for control.

With Software Carousel, you can have as many accessories and utilities on-tap as you want. Just load different ones in different Carousel partitions. Since they can't see each other, they can't fight.

### The easy way to maximize PC power.

With all this power, you might think Software Carousel is complicated and difficult to use. Not so. Set it up once, and it will remember forever. Better still,

Carousel will look for the programs you use most often, and optimize them for the quickest access.

You can spend a lot more money, and still not get the convenience and productivity increase of Software Carousel.

The way we see it, there are certain things you have the right to expect from your computer. Access to your software is one of them. And at our special introductory price of just \$49.95\*, Software Carousel is the best way to get it.

But hurry. This price won't last long.

Order today at 800-272-9900 (603-627-9900 in NH) or send the coupon below.

Special combination pricing is available for the purchase of Software Carousel and other SoftLogic products, including Cubit, DoubleDOS and Disk Optimizer.

	4X	8X	12X	16X
Word Star	Green	Green	White	White
1-2-3	Yellow	Yellow	Yellow	White
BPI	Red	Red	Red	Red

With Software Carousel running in RAM, you can load a program and retrieve a file up to 15 times faster. Test conducted on an IBM XT

## Software Carousel \$49.95\*

YES! Send me \_\_\_\_\_ copies of Software Carousel at the special introductory price of just \$49.95\*

Name \_\_\_\_\_

Company \_\_\_\_\_

Address \_\_\_\_\_

City \_\_\_\_\_ State/Zip \_\_\_\_\_

Check Enclosed  VISA  MC  AMEX

Card # \_\_\_\_\_ Exp. Date \_\_\_\_\_

Signature \_\_\_\_\_

SoftLogic Solutions, Inc.  
530 Chestnut Street  
Manchester, NH 03101  
800-272-9900  
(603-627-9900 in NH)

**SOFTLOGIC**  
**SOLUTIONS**

**Call today: 800-272-9900**

\*plus \$5.00 shipping and handling.



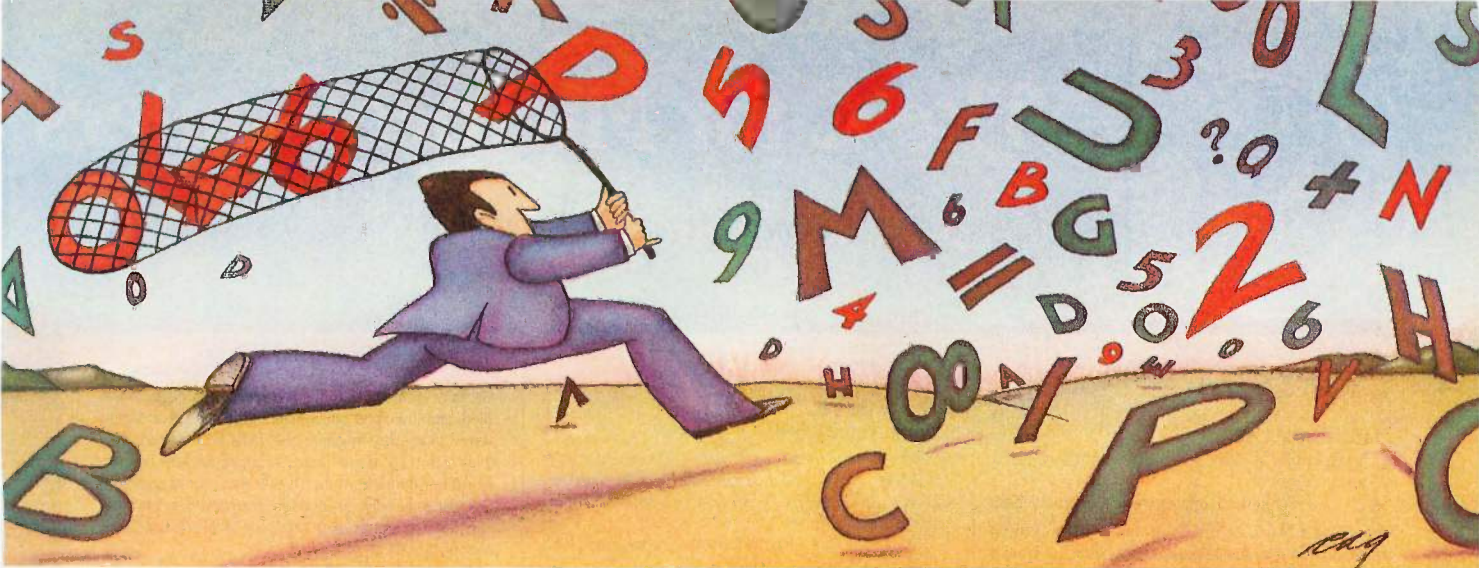

**PROBLEM:** The more experience your hard disk has, the harder it has to work,

**THE SOFTLOGIC SOLUTION:** Disk Optimizer™

**Your hard disk will run faster when it's not chasing around after files.**

Remember the old days when your hard drive was new? Remember that smooth, fast, slick performance? Those quick retrievals, rapid saves, lightning-like database sorts?

Well ever since, DOS has been doing its best to slow your hard drive down. Not by slowing down the motor, but by breaking your files up into pieces. Storing different chunks in different places. Data files, programs, overlays and batches that started out in one seamless piece are now scattered all over.

Loading is slower.

Sorting is slower.

Retrieving, backing-up.

Everything takes longer because your disk has to work harder.

Problem is, it's something that happens so gradually you may not notice the difference. At least, not until you see the dramatic improvement after using Disk Optimizer.

**File fragmentation—It's a problem you can see.**

Watch your hard drive the next time it reads or writes a file. Each "blip" of the LED means the drive-head is moving to another place on the disk—either to pick up or lay down another chunk of data.

And the truth is, head movement takes time. Far more time than actual reading and writing. What's worse, all this head movement causes extra wear and tear that can shorten the life of your drive.

**Disk Optimizer—Tunes up your disk by cleaning up your files.**

Disk Optimizer works by finding all the scattered pieces of your files and putting them

back together where they belong. Next time your drive reads it, there's just one place to look.

And the results are often dramatic. Reading and writing times may be cut by as much as two thirds. Database sorts that used to take hundreds of head moves now proceed quickly and efficiently. And since head movement is now at an absolute minimum, your disk drive will lead a longer, more productive life.

**Analyze, scrutinize, optimize.**

Before you optimize, you'll probably want to analyze. So Disk Optimizer shows you, in percentages, how much

fragmentation has taken place—on the entire disk, in individual directories, or for groups of files you specify using global or wildcard names.

Plus, there's built-in data security that lets you assign passwords to as many files or file groups as you want.

And the File Peeker gives you an inside look at the structure of files. It's a great way for non-programmers to learn more about computers, and a powerful tool for professionals who want to analyze the contents of their disks.

**Get your hard drive back in shape—at a special low price.**

When you think about it, it's simple. The longer you

own your hard drive, the more you come to depend on it. But the longer you wait to get Disk Optimizer, the less performance you'll have.

And the less chance you'll have to buy Disk Optimizer at the special introductory price of just \$49.95\*

That's a small price to pay to get back the speed you depend on. But it's a price that won't last long.

Ask for Disk Optimizer at your computer dealer.

Or order today by calling SoftLogic Solutions at 800-272-9900 (603-627-9900 in NH), or send the coupon below.

Special combination pricing is available when you buy Disk Optimizer along with other SoftLogic products like DoubleDOS, Software Carousel and Cubit.

Ask for details.

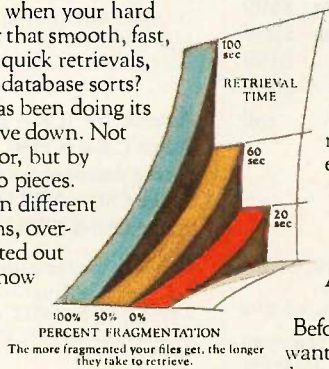

**Disk Optimizer \$49.95\***

YES! Please send me \_\_\_\_\_ copies of Disk Optimizer at this special introductory price.

Name \_\_\_\_\_

Company \_\_\_\_\_

Address \_\_\_\_\_

City \_\_\_\_\_ State/Zip \_\_\_\_\_

Check Enclosed  VISA  MC  AMEX

Card # \_\_\_\_\_ Exp. Date \_\_\_\_\_

Signature \_\_\_\_\_

SoftLogic Solutions, Inc.  
530 Chestnut Street  
Manchester, NH 03101  
800-272-9900  
(603-627-9900 in NH)

**SOFTLOGIC SOLUTIONS**

**Call today: 800-272-9900**

\* plus \$5.00 shipping and handling.





# The C for Microcomputers

PC-DOS, MS-DOS, CP/M-86, Macintosh, Amiga, Apple II, CP/M-80, Radio Shack, Commodore, XENIX, ROM, and Cross Development systems

## MS-DOS, PC-DOS, CP/M-86, XENIX, 8086/80x86 ROM

### Manx Aztec C86

*"A compiler that has many strengths ... quite valuable for serious work"*

Computer Language review, February 1985

**Great Code:** Manx Aztec C86 generates fast executing compact code. The benchmark results below are from a study conducted by Manx. The Dhystone benchmark (CACM 10/84 27:10 p1018) measures performance for a systems software instruction mix. The results are without register variables. With register variables, Manx, Microsoft, and Mark Williams run proportionately faster, Lattice and Computer Innovations show no improvement.

	Execution Time	Code Size	Compile/Link Time
<b>Dhystone Benchmark</b>			
Manx Aztec C86 3.3	34 secs	5,760	93 secs
Microsoft C 3.0	34 secs	7,146	119 secs
Optimized C86 2.20J	53 secs	11,009	172 secs
Mark Williams 2.0	56 secs	12,980	113 secs
Lattice 2.14	89 secs	20,404	117 secs

**Great Features:** Manx Aztec C86 is bundled with a powerful array of well documented productivity tools, library routines and features.

Optimized C compiler	Symbolic Debugger
AS86 Macro Assembler	LN86 Overlay Linker
80186/80286 Support	Librarian
8087/80287 Sensing Lib	Profiler
Extensive UNIX Library	DOS, Screen, & Graphics Lib
Large Memory Model	Intel Object Option
Z (vi) Source Editor -c	CP/M-86 Library -c
ROM Support Package -c	INTEL HEX Utility -c
Library Source Code -c	Mixed memory models -c
MAKE, DIFF, and GREP -c	Source Debugger -c
One year of updates -c	CP/M-86 Library -c

Manx offers two commercial development systems, Aztec C86-c and Aztec C86-d. Items marked -c are special features of the Aztec C86-c system.

<b>Aztec C86-c Commercial System</b>	<b>\$499</b>
<b>Aztec C86-d Developer's System</b>	<b>\$299</b>
<b>Aztec C86-p Personal System</b>	<b>\$199</b>
<b>Aztec C86-a Apprentice System</b>	<b>\$49</b>

All systems are upgradable by paying the difference in price plus \$10.

**Third Party Software:** There are a number of high quality support packages for Manx Aztec C86 for screen management, graphics, database management, and software development.

<b>C-tree \$395</b>	<b>Greenleaf \$185</b>
<b>PHACT \$250</b>	<b>PC-lint \$98</b>
<b>HALO \$250</b>	<b>Amber Windows \$59</b>
<b>PRE-C \$395</b>	<b>Windows for C \$195</b>
<b>WindScreen \$149</b>	<b>FirsTime \$295</b>
<b>SunScreen \$99</b>	<b>C Util Lib \$185</b>
<b>PANEL \$295</b>	<b>Plink-86 \$395</b>

## MACINTOSH, AMIGA, XENIX, CP/M-68K, 68k ROM

### Manx Aztec C68k

*"Library handling is very flexible ... documentation is excellent ... the shell a pleasure to work in ... blows away the competition for pure compile speed ... an excellent effort."*

Computer Language review, April 1985

Aztec C68k is the most widely used commercial C compiler for the Macintosh. Its quality, performance, and completeness place Manx Aztec C68k in a position beyond comparison. It is available in several upgradable versions.

Optimized C Macro Assembler	Creates Clickable Applications
Overlay Linker	Mouse Enhanced SHELL
Resource Compiler	Easy Access to Mac Toolbox
Debuggers	UNIX Library Functions
Librarian	Terminal Emulator (Source)
Source Editor	Clear Detailed Documentation
MacRam Disk -c	C-Stuff Library
Library Source -c	UniTools (vi,make,diff,grep) -c
	One Year of Updates -c

Items marked -c are available only in the Manx Aztec C86-c system. Other features are in both the Aztec C86-d and Aztec C86-c systems.

<b>Aztec C68k-c Commercial System</b>	<b>\$499</b>
<b>Aztec C68k-d Developer's System</b>	<b>\$299</b>
<b>Aztec C68k-p Personal System</b>	<b>\$199</b>
<b>C-tree database (source)</b>	<b>\$399</b>
<b>AMIGA, CP/M-68k, 68k UNIX</b>	<b>call</b>

## Apple II, Commodore, 65xx, 65C02 ROM

### Manx Aztec C65

*"The AZTEC C system is one of the finest software packages I have seen"*

NIBBLE review, July 1984

A vast amount of business, consumer, and educational software is implemented in Manx Aztec C65. The quality and comprehensiveness of this system is competitive with 16 bit C systems. The system includes a full optimized C compiler, 6502 assembler, linkage editor, UNIX library, screen and graphics libraries, shell, and much more. The Apple II version runs under DOS 3.3, and ProDOS, Cross versions are available.

The Aztec C65-c/128 Commodore system runs under the C128 CP/M environment and generates programs for the C64, C128, and CP/M environments. Call for prices and availability of Apprentice, Personal and Developer versions for the Commodore 64 and 128 machines.

<b>Aztec C65-c ProDOS &amp; DOS 3.3</b>	<b>\$399</b>
<b>Aztec C65-d Apple DOS 3.3</b>	<b>\$199</b>
<b>Aztec C65-p Apple Personal system</b>	<b>\$99</b>
<b>Aztec C65-a for learning C</b>	<b>\$49</b>
<b>Aztec C65-c/128 C64, C128, CP/M</b>	<b>\$399</b>

### Distribution of Manx Aztec C

In the USA, Manx Software Systems is the sole and exclusive distributor of Aztec C. Any telephone or mail order sales other than through Manx are unauthorized.

## Manx Cross Development Systems

Cross developed programs are edited, compiled, assembled, and linked on one machine (the HOST) and transferred to another machine (the TARGET) for execution. This method is useful where the target machine is slower or more limited than the HOST, Manx cross compilers are used heavily to develop software for business, consumer, scientific, industrial, research, and educational applications.

**HOSTS:** VAX UNIX (\$3000), PDP-11 UNIX (\$2000), MS-DOS (\$750), CP/M (\$750), MACINTOSH (\$750), CP/M-68k (\$750), XENIX (\$750).

**TARGETS:** MS-DOS, CP/M-86, Macintosh, CP/M-68k, CP/M-80, TRS-80 3 & 4, Apple II, Commodore C64, 8086/80x86 ROM, 68xxx ROM, 8080/8085/Z80 ROM, 65xx ROM.

The first TARGET is included in the price of the HOST system. Additional TARGETS are \$300 to \$500 (non VAX) or \$1000 (VAX).

Call Manx for information on cross development to the 68000, 65816, Amiga, C128, CP/M-68k, VRTX, and others.

## CP/M, Radio Shack, 8080/8085/Z80 ROM

### Manx Aztec CII

*"I've had a lot of experience with different C compilers, but the Aztec C80 Compiler and Professional Development System is the best I've seen."*

80-Micro, December, 1984, John B. Harrell III

<b>Aztec C II-c (CP/M &amp; ROM)</b>	<b>\$349</b>
<b>Aztec C II-d (CP/M)</b>	<b>\$199</b>
<b>C-tree database (source)</b>	<b>\$399</b>
<b>Aztec C80-c (TRS-80 3 &amp; 4)</b>	<b>\$299</b>
<b>Aztec C80-d (TRS-80 3 &amp; 4)</b>	<b>\$199</b>

### How To Become an Aztec C User

To become an Aztec C user call 1-800-221-0440 or call 1-800-832-9273 (800-TEC WARE). In NJ or outside the USA call 201-530-7997. Orders can also be telexed to 4995812.

Payment can be by check, COD, American Express, VISA, Master Card, or Net 30 to qualified customers.

Orders can also be mailed to Manx Software Systems, Box 55, Shrewsbury, NJ 07701.

### How To Get More Information

To get more information on Manx Aztec C and related products, call 1-800-221-0440, or 201-530-7997, or write to Manx Software Systems.

### 30 Day Guarantee

Any Manx Aztec C development system can be returned within 30 days for a refund if it fails to meet your needs. The only restrictions are that the original purchase must be directly from Manx, shipped within the USA, and the package must be in resalable condition. Returned items must be received by Manx within 30 days. A small restocking fee may be required.

### Discounts

There are special discounts available to professors, students, and consultants. A discount is also available on a "trade in" basis for users of competing systems. Call for information.

Inquiry 200

# MANX

To order or for information call:

## 800-221-0440





# COMPAQ DESKPRO 286

BY STAN MIASTKOWSKI

## *An IBM PC AT compatible with a switchable 6-MHz/8-MHz clock speed*

The Compaq Deskpro 286 comes in two standard configurations. The Model 1 comes with 256K bytes of RAM, a single 1.2-megabyte floppy disk drive, and five expansion slots. It retails for \$4499 with a dual-mode (green or amber) monochrome monitor that supports graphics. The Model 2 has 512K bytes of RAM, a single 1.2-megabyte floppy disk drive, a 30-megabyte hard disk drive, and four expansion slots. It retails for \$6254 with a monitor.

Externally, the Deskpro 286 bears a more-than-passing resemblance to the company's PC-compatible Deskpro. It has a large 19.8-by-16.5-inch footprint, and heavy-duty construction is evident throughout.

### THE KEYBOARD

The Deskpro 286 keyboard's 84-key layout is virtually identical to the Selectric-style keyboard on the IBM PC AT. Unlike the AT's keyboard, which has LED indicators for the Caps Lock, Num Lock, and Scroll Lock keys located on a panel above the main keyboard, the Deskpro 286 has LEDs for these functions physically located on the key caps. The keyboard weighs 3 pounds, 6 ounces and has a slightly spongy feel that I don't like. The sharp-edged "ears" used to tilt the keyboard upward left a series of marks on the furniture. Unlike the loud "clacks" that come from the IBM PC keyboard, the Deskpro 286 uses soft tones to let you know that you've successfully pressed a key. You can adjust the volume of the key tones by pressing a combination of three keys. The partially coiled keyboard cable

was a bother; it kept getting in the way and made it nearly impossible to push the keyboard flush to the system unit.

### BASIC OPTIONS

The unit I reviewed came with a single 1.2-megabyte floppy disk drive, a 30-megabyte full-height hard disk drive, and a tape backup unit for the hard disk. If you're interested in customizing your system peripherals, Compaq has a wide range of options (see the "At a Glance" box for details). There are three hard disk drives available (20, 30, and 70 megabytes), and all are full-height, which generally have faster access times and greater reliability than half-height hard disk drives. You can fill the remaining two spaces with any combination of half-

height 1.2-megabyte drives, 360K-byte drives, or the magnetic tape backup.

Like the IBM PC AT, the Deskpro 286 has a key lock on the front panel, which, when locked, disables the keyboard and prevents the system unit cover from being removed. For most users, it's probably more trouble than it's worth. It won't prevent the unit from being carted away; but since it's good standard operating procedure to keep a hard disk unit running full time to minimize disk damage on power-down, the key will enable you to leave the office at the end of the day and keep unauthorized (though not malicious) hands off your data. But woe be unto you if you lose the keys; they're not duplicatable and you'd need to order a new set from an address supplied in the manual. All these

precautions with the lock and keys are probably necessary so that Compaq dealers bidding for corporate or government business can match the specifications of the IBM PC AT.

### INSIDE THE SYSTEM UNIT

The cover of the system unit slides forward after you remove three screws on the rear of the Deskpro 286. The screws, which are a strange combination of slotted and Torx head, are also used to hold in the option cards. If you purchase the Deskpro 286 with a hard disk, you'll need to remove the

*(continued)*

Stan Miastkowski is a freelance writer, north-east bureau chief for Newsbytes, and editor in chief of the McGraw-Hill Microcomputer Handbook. He can be reached at POB 548, Peterborough, NH 03458.



*The system runs IBM PC software so fast, it's hard to imagine what the speed gain would be with the 80287 coprocessor.*

cover, unlatch the hard disk shipping lock, and then plug in the hard disk power connector. This is a sensible precaution for making sure that the drive isn't powered on before the lock is disengaged. It's a bit difficult for the large-fingered to connect the hard drive power, but it can be done.

The top of the massive power supply (165 watts) is sloped slightly to allow easier (though not easy) access to the rear connectors of the disk drives. The high-capacity fan is extremely quiet, and the Deskpro 286 never became warm to the touch even after extended periods of use.

The processor board has the 68-pin 80286 microprocessor and the peripheral circuitry. Sitting next to the processor is an empty slot for the optional 80287 numeric coprocessor. Since the system runs IBM PC software so fast, it's hard to imagine the speed gain using the coprocessor with software designed to work with it.

#### **CIRCUIT CARDS AND MEMORY**

There are eight slots in the system bus, six of which have the additional 36-pin connectors for AT-type cards that contain extended address lines for additional memory. One of the two 62-pin connectors is located behind the floppy disk drive and can only hold a half-length card. Compaq claims that most PC-type I/O boards will work in the Deskpro 286, although the high clock speed and different timing can cause problems with some. Memory-expansion cards designed for the IBM PC also won't work. The same goes for multifunction cards. These limitations shouldn't be a problem, however, since most of the functions those cards would han-

dle are already performed by cards included with the Deskpro 286.

The unit I reviewed came with four cards installed: an RGB/composite/monochrome video graphics board, floppy controller with parallel and serial interface, hard disk controller, and the basic system memory board. The Deskpro 286 will handle a maximum of 8.2 megabytes of RAM. The memory board must be fully populated with 2176K bytes before you can add more memory-expansion boards. You can have up to three memory-expansion boards, each holding a maximum of 2048K bytes in 512K-byte increments.

Since PC-DOS currently supports a maximum of 640K bytes of RAM, the VDISK utility is included with PC-DOS, which enables you to use the extra memory as a virtual disk. VDISK lets you specify the virtual disk size, sector size, and the number of entries. Memory size in excess of 1 megabyte must be accessed by using a /E option. The usual precautions about copying data from virtual disk to floppy or hard disk applies. If power is lost or you turn the machine off, the data on the virtual disk will be lost. With a system like this, a backup or uninterruptible power supply is an important accessory.

#### **THE DISPLAY**

The Deskpro 286 comes with a 12-inch green or amber monochrome monitor. Compaq calls it "dual mode"—when used in combination with the Deskpro 286's monochrome/color graphics board (which is standard in the 286), it will also display graphics as shades of amber (or green). You can change display modes by keyboard commands. Compaq eliminated a great deal of confusion about display boards by putting all the features on one board.

#### **SPEED**

The Deskpro 286 runs with a primary clock speed of 8 MHz. Toggling between the primary and the secondary speed of 6 MHz is a simple matter of pressing three keys simultaneously. You hear one beep when you're at 6 MHz, two beeps for 8 MHz. I ran a large variety of IBM PC software

(WordStar, MultiMate, R:base 5000, and Lotus 1-2-3) at the primary speed with no problems whatsoever.

IBM's recent decision to change the ROM BIOS on 30-megabyte versions of the PC AT to prevent the installation of "speedup" kits (the PC AT runs at 6 MHz) makes the Deskpro 286 an even more attractive alternative to the IBM AT. Though most users can get along fine with a 6-MHz machine, the extra speed afforded by the Deskpro 286's 8-MHz primary speed is something that you get used to quickly.

#### **DISK DRIVES**

The IBM PC AT-style 1.2-megabyte floppy disk drive is handy for storing large amounts of data, although with the Deskpro 286's optional hard disk drive, the floppy is not really needed. The 1.2-megabyte floppy disk drive is capable of reading and writing either 1.2-megabyte floppy disks or 360K-byte floppies. The disk-access light glows green when the drive is writing the high-density format and red when it's writing a 360K-byte floppy. The 1.2-megabyte drive has no problems reading 360K-byte format disks; but occasionally when it was writing data to a 360K-byte disk, the disk was unreadable by the 360K-byte drive on another machine. If you intend to swap data with another machine, you should purchase a Compaq 360K-byte drive.

My review unit came with a tape backup unit for the hard disk. This unit uses 3M DC 1000 tapes and each tape holds 10 megabytes of data. Compaq claims it takes about 16 minutes to fill the tape, and it takes 8 minutes to restore the data to the hard disk. The MS-DOS version 3.0 included with the unit has several tape commands for formatting and using backup tapes. For all the operations, the tape command prints a bar across the top of the screen to indicate how much longer the tape operation has to go. The most time-consuming part of the process is formatting a blank tape, which takes about 40 minutes. I was slightly annoyed the first time I formatted a tape because I had not noticed that the tape's write-protect switch was on and it was 20 minutes

*(continued)*



## AT A GLANCE

### Name

Compaq Deskpro 286,  
Models 1 and 2

### Company

Compaq Computer Corp.  
20555 FM 149  
Houston, TX 77070  
(713) 370-0670

### Size

6.4 by 19.8 by 16.5 inches

### Components

Processor: 80286, 6 MHz or  
8 MHz (switchable)

Memory: 256K or 512K bytes,  
maximum 2176K bytes on  
system board; up to 8.2  
megabytes available

Mass storage: Model 1: One  
half-height 1.2-megabyte  
5¼-inch floppy disk drive;  
Model 2: One 1.2-megabyte  
floppy disk drive and a  
30-megabyte full-height hard  
disk drive

Display: 12-inch amber or  
green monochrome display;  
dual-mode display adapter  
monochrome/color,  
text/graphics (switchable)

Keyboard: IBM PC  
AT-compatible

### Optional Hardware

360K-byte disk drive	\$350
1.2-megabyte disk drive	\$650
20-megabyte disk drive	\$2095
30-megabyte disk drive	\$2595
70-megabyte disk drive	\$5195
Tape backup system for hard disk	\$899
80287 numeric coprocessor	\$195
128K RAM upgrade	\$150
512K RAM upgrade	\$695
Monitor tilt-and-swivel adapter	\$50

### Optional Software

MS-DOS/BASIC version 3.0 or 3.1	\$65
------------------------------------	------

### Documentation

Operations guide

### Price

(standard configuration with  
monitor)

Model 1	\$4499
Model 2	\$6254

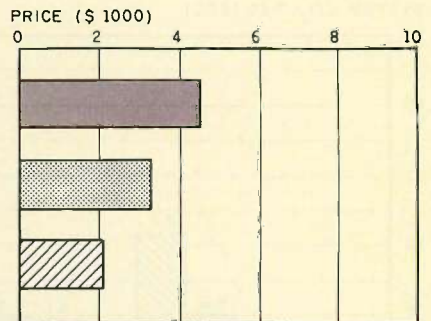
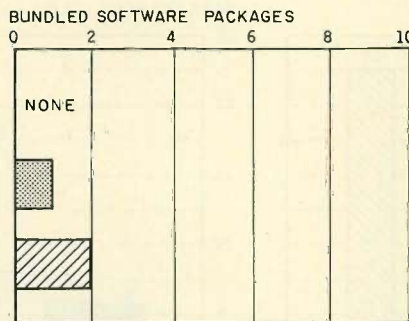
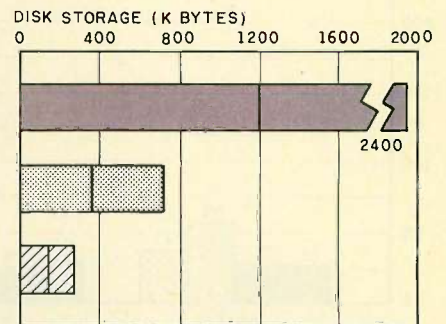
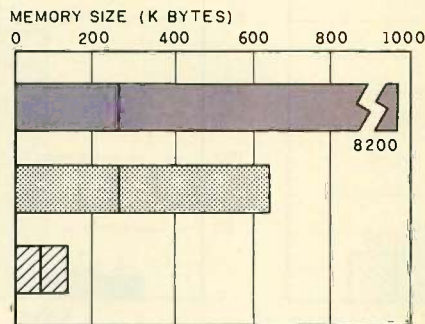

■ COMPAQ DESKPRO 286 (MODEL 1) ■ IBM PC ■ APPLE IIe

The Memory Size graph shows the standard and optional memory available. The Deskpro 286 Model 1 was used in this comparison. The Disk Storage graph shows the highest capacity for a single floppy disk drive and the maximum standard capacity for each system. The Bundled Software Packages graph shows the number of packages included with each sys-

tem. The Price graph shows the list price of a system configured with two drives (one 1.2-megabyte floppy disk drive for the Deskpro 286 Model 1), a monochrome monitor, graphics and color display capability, a printer port and a serial port, 256K bytes of memory (64K bytes for 8-bit systems), and the standard operating system for the computers under comparison.



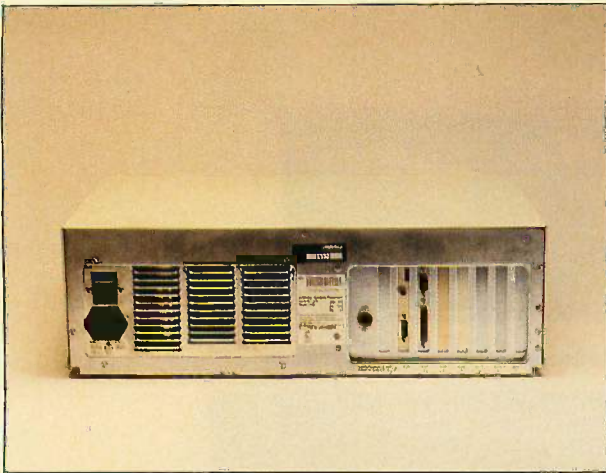

The back panel of the Compaq Deskpro 286. Note the 3-pin DIN power connector for the Compaq monitor.

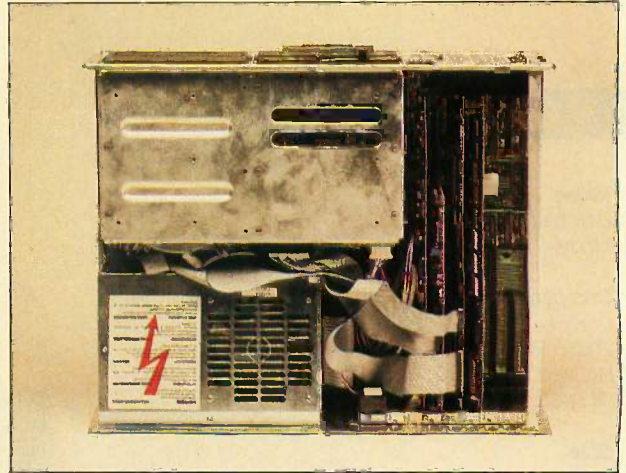

Inside the Compaq Deskpro 286.

DISK ACCESS IN BASIC (SEC)

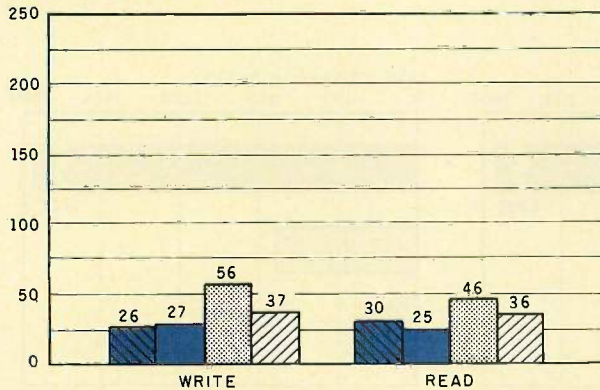

BASIC PERFORMANCE (SEC)

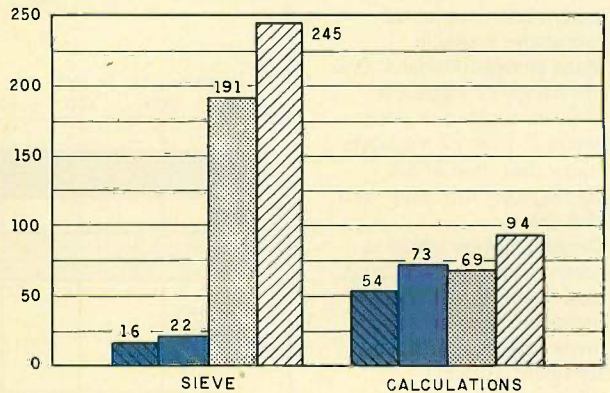

SYSTEM UTILITIES (SEC)

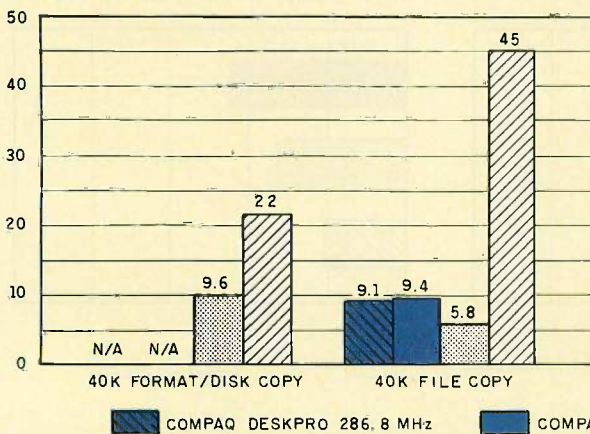

SPREADSHEET (SEC)

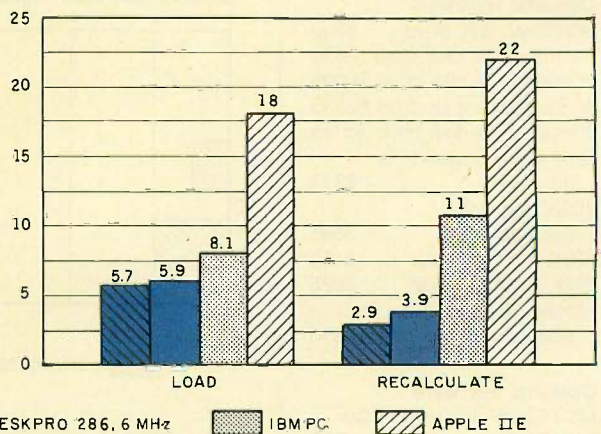

The graphs for Disk Access in BASIC show how long it takes to write and read a 64K-byte sequential text file to a blank floppy disk. (For the program listings, see "Benchmarking the Clones" by Jon R. Edwards and Glenn Hartwig, *BYTE's Inside the IBM PCs*, Fall 1985, page 195.) The Sieve graph shows how long it takes to run one iteration of the Sieve of Eratosthenes prime-number benchmark. The Calculations graph shows how long it takes to do 10,000 multiplication and 10,000 division operations using single-precision numbers. The

System Utilities graph shows how long it takes to format and copy a disk (adjusted time for 40K bytes of disk data) and to transfer a 40K-byte file using the system utilities. The Kaypro was tested using the drives in double-density mode. The Spreadsheet graph shows how long it takes to load and recalculate a 25- by 25-cell spreadsheet where each cell equals 1.001 times the cell to its left. The spreadsheet used was Microsoft's Multiplan. A 360K-byte disk was used in the Deskpro's 1.2-megabyte floppy disk drive.



REVIEW:  
COMPAQ DESKPRO 286

into the formatting before the operation failed. It would have been nice if the write-protect status of the tape could have been sensed earlier.

### SOFTWARE

The only software that comes standard with the Deskpro 286 is a self-booting User Programs disk that contains both demonstration and diagnostic programs. Included on the disk are graphics, word processing, and music demos, as well as an arcade-type game and biorhythm chart. All are impressive examples of how fast the Deskpro 286 runs. The diagnostic program is a complete system test, though the status messages leave more than a little to be desired. Instead of telling you which test is being performed, you're told to refer to a number, which you'll find in the operations guide. Tests that take a great deal of time (such as the memory test) display a cryptic message that says, "This test may take an extended period of time. Please stand by." There are no messages to indicate the status of the test.

Compaq sells their customized DOS version 3.0 for \$65. Version 3.1 is also available for the same price. Included are BASICA and the usual contingent of utilities and sample programs.

### DOCUMENTATION

Documentation is one area where the Deskpro 286 doesn't shine. The only manual that comes with the unit is an 80-page operations manual that is grossly inadequate. It contains a bare minimum of information designed for the naive. Numerous pages are involved with showing how to hook up the system. After that, you're pretty much left on your own. Gorgeous color photographs show you what wonderful add-ons you can spend your money on, but there's no additional information. The only useful part of the manual is a section on keystrokes needed to change processor speed, key-click volume, etc. It could have been better covered on a reference card, and one isn't included.

The MS-DOS manuals (included with the purchase of the operating system) are much better. Three

(continued)

# The Only EGA

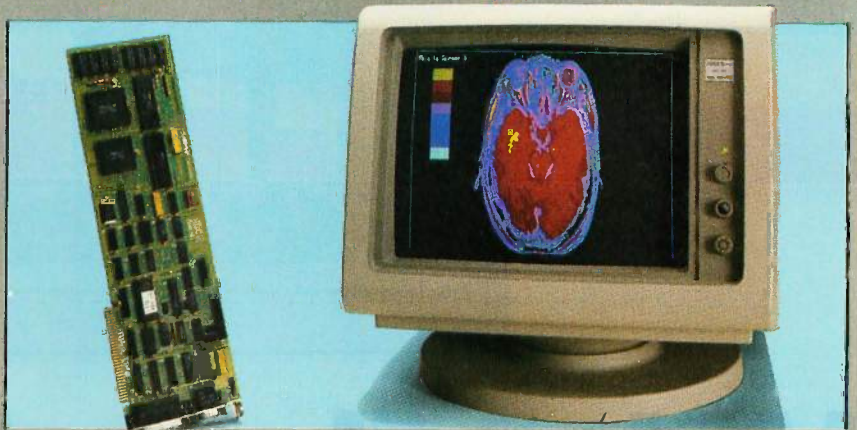

**A fully compatible 256k EGA card with a parallel port for only \$259. If you buy any display card: Color, Monochrome, Hercules, or EGA, without reading this ad, you're probably throwing away a lot of money.**

**BT/EGA Enhanced Graphics Adapter:** 256k of memory, and parallel printer port. Works with all standard IBM displays, and compatible displays.  
**5180 Monochrome Display:** Both text and 640x350 bit mapped graphics.

**5183 Color Display:** 640x200 and 320x200.  
**5184 Enhanced Display:** Color 640x350 16 simultaneous colors from a palette of 64.

### A Clear Upgrade Path

This really is the only display board you may ever need. Regardless of what monitor you buy today, this card is a clear upgrade path for the future, and the best choice today, even if you are only going to use a Monochrome Display. This means one board today does monochrome 640x350 bit mapped graphics and text, and provides a clear upgrade path to 640x350 Enhanced Color Display with no change of display board. It also runs with the 640x200, 320x200 Color Display.

### Killer Features

All boards come with a full 256k of memory, and a parallel printer port. That means no extras for later, and 16 simultaneous colors displayed from a palette of 64 colors, and crisp clear text on both Mono-

chrome and Enhanced Color Displays - features or options that are not available on other EGA boards. Since all your current software will run, you're set for today, and prepared for the standard of the future.

### The Display Deal

Of course many of you will want to take advantage of the EGA card right away, so we are offering a special deal when you buy the board together with a Basic Time<sup>®</sup> HR 31-350 monitor - you get both for just \$749, or the card only for \$259. This means that you can equip all your PC's now and in the future with displays and EGA cards and get the Qubie<sup>®</sup> "No Risk Guarantee", our one year warranty, and 48 hour turnaround on warranty repairs. The price is the whole price, there are no extras for freight, insurance, or credit cards.

### No Risk Guarantee

If you are not completely satisfied with your purchase, you may return it within 30 days of purchase for a complete refund, including the cost to send it back. If you can get any dealer or competitor to give you the same No Risk Guarantee, buy both and return the one you don't like.



For fastest delivery, send cashier's check, money order, or order by MasterCard/Visa. Personal Checks allow 18 days to clear. Company purchase orders accepted, call for prior authorization. California residents add 6% sales tax.

## QUBIE<sup>®</sup>

Department B  
507 Calle San Pablo  
Camarillo, California 93010

Inside California  
**805-987-9741**

Outside California  
**800-821-4479**

London (01) 223-4569 Sydney (02) 579-3322  
Paris (01) 321-5316 Canada (403) 434-9444

Hours: M-F 8am - 5pm PTZ  
Sat 8am - 12pm PTZ



Now with  
Freelance™

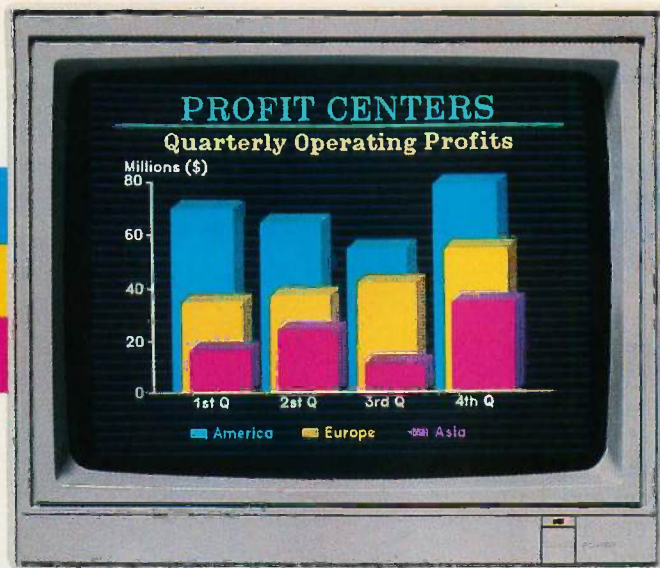

# VideoShow **MAKES** Presentations

With VideoShow you'll make the best presentations of your career.

VideoShow is the only complete hardware and software presentation system available today.

VideoShow:

## Makes Your Presentations Powerful

Use 1000 colors to brighten your images... hundreds more than with any other PC-based system. Plus 5 times better resolution. Add VideoShow's dynamic visual effects and you are guaranteed high impact and professional quality.

## Makes Presentations Easy

Select from a variety of software, and use your IBM® PC or compatible to create or update any chart, graph, diagram, or illustration in minutes. Even if you've never used a computer before and

can't draw a straight line. All you do is fill in the blanks.

## Makes Any Kind of Presentation

VideoShow lets you use any color monitor or video projector. Plus, you can get slides, overheads, or hardcopy. All in 1000 brilliant colors.

## VideoShow Makes Sense

At \$3150\* it pays for itself after just a few presentations. And you get the superior quality previously available only from expensive services.

## VideoShow Puts You in Control

No longer will your presentations be a terrific struggle. They'll just be terrific!

**Find out about it. Call 1-800-556-1234, Ext. 234. In Calif., call 1-800-441-2345, Ext. 234.**

**VideoShow™**  
from General Parametrics, Berkeley, CA



\*Suggested retail price for VideoShow 150.  
IBM is a registered trademark of International Business Machines Corporation.



*The Deskpro 286  
has nearly all the  
features that a  
serious user needs.*

manuals are included: a 527-page MS-DOS version 3.0 reference guide, a 182-page BASIC reference guide, and a 311-page BASIC guide to statements, functions, commands, and variables. All three are well written and organized so that information is easy to find. The examples used are a far cry from the head-scratching ones in early PC documentation.

All Compaq manuals are in a spiral-bound 7½-by-9-inch horizontal format, which is handy for use on a crowded desk. A technical reference manual is available for \$60.

#### SUMMARY

The Compaq Deskpro 286 is a high-powered professional-quality computer that has nearly all the features that a serious business or scientific user needs. In keeping with Compaq's reputation, it's extremely well thought out and built to withstand full-time heavy use. Its speed advantage alone recommends it over its closest competitor—the IBM PC AT. The price of the Deskpro 286 is slightly higher than a comparably equipped PC AT, and unlike the AT, the Deskpro 286 is unlikely to be available at anything other than list price.

If you buy a Deskpro 286, the usual caveat applies about choosing your dealer carefully. (Compaq has over 2500 in the United States alone.) Compaq has been very successful and has acquired some of the arrogance that often comes with success. They've continued to be secretive about technical matters, and getting information over the telephone is often difficult. A knowledgeable dealer can help Compaq Deskpro 286 users deal with any problems or questions. Despite its high price, the Deskpro 286 is an outstanding personal computer. It's a system whose technology will not quickly become obsolete. ■

# Hard Solutions

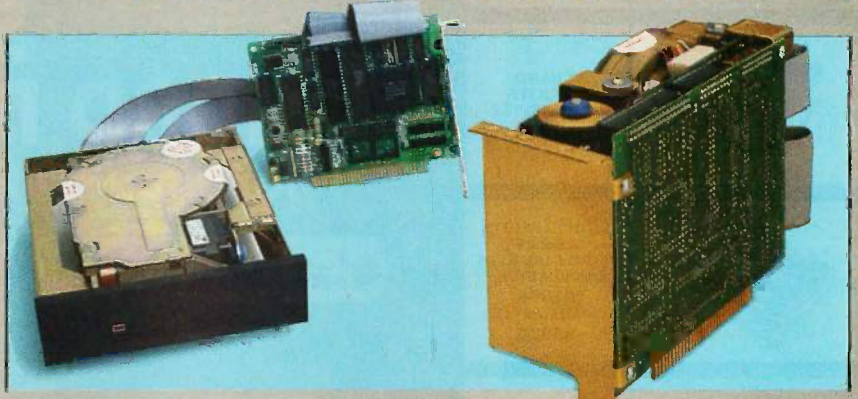

*Expanding your PC to include a 20 Megabyte hard drive has never been simpler with Qubie' internal or HardPack 20 slot mounted drives.*

**PC 20:** Standard, internal mounted 1/2 height unit for use in floppy disk area of a PC, PC XT or compatible.  
**HardPack:** Card Mount for slot mounting, 1/2 slot length to mount behind floppy drive, on a PC, PC XT or compatible.

**Data Transfer Rate:** 5 Megabyte/Sec  
**Access Time:** 65 Milliseconds  
**Power Requirements:** +5 VDC 2.0 A  
+12 VDC 9 A Max  
**Capacity:** 20 Megabytes  
**Reliability:** 14,000 Hours

#### The Pentagon Ashtray

The military is famous for paying \$450 for ashtrays. A lot of companies are asking the same kind of outlandish sums for a hard disk mounted on a card. You get a hard disk, a controller, and a bracket, and they charge you hundreds more than you pay for a Qubie' 20 Megabyte hard disk system. Unlike the others, our HardPack 20 fits into a single slot and nestles in behind your floppy drives. If you buy any other hard drive, you may simply pay more and get a whole lot less.

#### The Choice

We offer both types, an internal mounted like your floppy, or a card mount for the same \$499 price. Let's face it, the bracket doesn't cost us 450 bucks. While some people prefer the standard mounting, (like a floppy) so they can see the read/write light, others want a card mount so they can use both floppies they now have. Both drives boot directly from the hard disk, and require no software patches. They run all the popular software, and

#### No Risk Guarantee

If you are not completely satisfied with your purchase, you may return it within 30 days of purchase for a complete refund, including the cost to send it back. If you can get any dealer or competitor to give you the same No Risk Guarantee, buy both and return the one you don't like.



For fastest delivery, send cashier's check, money order, or order by MasterCard/Visa. Personal Checks allow 18 days to clear. Company purchase orders accepted, call for prior authorization. California residents add 6% sales tax.

are low power. Our format software allows changeable interleaving that gives you noticeable speed improvement over the standard XT drive. Both have the ability to run a second drive from the controller, (Part Number 2nd-20HP \$399), giving you 40 megabytes of storage for under \$900.

#### The Goodies

We give you some software that really enhances the use of a hard disk. 1dir is the hard disk organizer that really makes DOS a snap, and our special Qubie' version of ZylIndex, the super searcher is also included. Easy to read manuals make installation a snap. Of course the drives are backed by our "No Risk Guarantee", our one year warranty, and 48 hour turnaround on warranty repairs. The price is the whole price; there are no extras for freight, insurance, or credit cards. Order part numbers PC20-1000 for Tandy 1000, or HardPack 20. By popular demand we still offer the matching ashtray for just \$450, (Part No. PCKIDDING).

## QUBIE'

Department B  
507 Calle San Pablo  
Camarillo, California 93010

Inside California  
**805-987-9741**

Outside California  
**800-821-4479**

London (01) 223-4569 Sydney (02) 579-3322  
Paris (01) 321-5316 Canada (403) 434-9444

Hours: M-F 8am - 5pm PTZ  
Sat 8am - 12pm PTZ



# NEW!

## 21 MEGABYTE SCSI HARD DISK CARD

for your PC, AT or TANDY 1000

<p><b>5 MEGABYTES</b></p> <p>of </p> <p><b>FREE</b> software</p>	<p>PC HARD DISK KITS</p> <p>10 MEGABYTES \$475</p> <p>20 MEGABYTES \$495</p> <p>30 MEGABYTES \$675</p>
	<p>AT HARD DISK KITS</p> <p>33 MEGABYTES \$750</p>
	<p>HIGH CAPACITY AT &amp; XT HARD DISK KITS</p> <p>70 MEGABYTES \$1995</p> <p>120 MEGABYTES \$3995</p>
	<p>TAPE BACKUP</p> <p>40 MEG INTERNAL MT40 \$595</p> <p>40 MEG PORTABLE MT40P \$695</p>
	<p>TAPE BACKUP</p> <p>60 MEG INTERNAL MT60 \$795</p> <p>60 MEG EXTERNAL MT60E \$895</p>
	<p>TANDY 1000 MULTI-FUNCTION CARD</p> <p>SERIAL PORT/ DMA CONTR/ UP TO 512K RAM</p> <p>TMF-1 \$255</p>
	<p>PC/AT OR TANDY 1000 HARD DISK CARD</p> <p>21 MEG HARD DISK FREE SCSI PORT</p> <p>THC-21 \$675</p> <p>PCHC-21 \$675</p>
	<p>MASTER MEMORY SYSTEM</p> <p>HARD DISKS: 30 MEG FIXED 15 MEG REMOVABLE</p> <p>POWER DISTRIBUTION \$2295</p>
	<p>SCSI HOST ADAPTER CARD</p> <p>CONNECTS YOUR PC TO 7 OTHER DEVICES</p> <p>SCSI-1 \$190</p>
	<p>CALL FOR OUR FULL LINE OF HALF CARDS</p> <p>COLOR GRAPHICS MEMORY CARD FLOPPY CONTROLLER CALL</p>



only **\$675**

**IMAGINE!!!** MDI'S 21 MEGABYTE HARD DISK CARD simply plugs into your system and is ready to run!!! The hard disk card also contains a...

**"FREE SCSI PORT":**

A SCSI port which allows you to tie (daisy chain) up to seven external (peripheral) devices to your computer.

INCLUDED **FREE**

Direct/Assist	\$49 <sup>95</sup>
R/Assist	\$49 <sup>95</sup>
Light Speed	\$79 <sup>95</sup>
SCSI Board	\$190 <sup>00</sup>

**TANDY 1000 HARD DISK CARD**



21 MEG HARD DISK

**NOW IN OUR 8TH YEAR**

ORDER LINE 800-228-0891  
305-677-8333



1 YEAR WARRANTY, 30 DAY MONEY BACK GUARANTEE

**Micro Design International, Inc.**







# TELE-286

BY WAYNE RASH JR.

## *An IBM PC AT compatible with a standard 44-megabyte hard disk drive*

The TeleVideo Tele-286 is designed to be compatible with the IBM PC AT. Like the IBM, the Tele-286 is large and heavy, and its hard disk is hidden within the cabinet, with space for two floppy disk drives in the upper right of the front panel. Also like the IBM machine, the Tele-286 is based on the Intel 80286 microprocessor, and it accepts an 80287 math coprocessor. However, both processors in the Tele-286 run at a clock speed of 8 MHz—about one-third better than the IBM PC AT.

For this review I used the Tele-286 Model 2 (\$5395), which is roughly equivalent to the enhanced IBM PC AT. The Model 2 system includes one high-capacity floppy disk drive that holds 1.2 megabytes, a 44-megabyte hard disk, and 512K bytes of RAM, which can be expanded to 15

megabytes. The monitor I tested was TeleVideo's optional HRM-100, a high-resolution monochrome graphics monitor.

### EXAMINING THE HARDWARE

The system unit measures a whopping 21 by 16 by 6.5 inches, and it will dominate any regular-size desk. You can open the case by removing four screws at the rear of the machine and sliding the cover forward. Inside, you will find eight expansion slots, two of which accept standard IBM PC boards. The other six are designed to accept boards made for the 16-bit bus of the IBM PC AT. The disk drive controller board is already installed in a slot.

To the right of the expansion-card area is the power supply. In front of



the power supply are the disk drives. The primary hard disk is mounted in the front center and does not show when the cover is in place. To the right of the hard disk drive, the system can accommodate two half-height floppy disk drives placed one above the other. Below the floppy disk drive locations is room enough for a concealed half-height hard disk. The system provides sufficient cables to support two floppy and two hard disk drives.

The high-capacity floppy disk drive is similar to that of the IBM PC AT's—it can read from and write to a standard double-density (360K-byte) MS-DOS disk. Some other computers may have trouble reading data written by the Tele-286 to 360K-byte disks, however, since the tracks created by the high-

capacity disk drive are more narrow than those used by double-density disk drives. TeleVideo also warns that floppy disks formatted on the high-capacity drive will not work on other machines, although they worked fine on my Zenith Z-100. To ensure disk compatibility, TeleVideo offers a standard double-density disk drive.

The front of the machine is unremarkable except for the lack of the key-operated power switch that the IBM PC AT and most other compatibles have. With the Tele-286, you have to be content with a rocker switch on the rear of the machine.

On the rear, next to the power switch, is the power cord and an additional AC power outlet, which is the same kind used by the IBM monochrome monitor. Also on the back panel are connectors for the serial and parallel ports and the keyboard. Like the IBM PC AT, the Tele-286's RS-232C serial port uses a 9-pin connector, and the parallel port is Centronics-compatible.

The keyboard connects to the computer via a six-foot coiled cord and is much like that of the IBM PC AT. The only difference worth noting is that the LEDs indicating the position of the Caps Lock, Num Lock, and Scroll Lock keys are on the keys themselves rather than the keyboard bezel. Like the IBM PC AT, the Tele-286's keyboard is somewhat larger than that of

*(continued)*

Wayne Rash Jr. (10431 Collingham Dr., Fairfax, VA 22032) is a member of the professional staff of American Management Systems Inc., where he consults with the federal government on microcomputers.



SHIPPING NOW !!!

dMac III

The power of dBASE III for the Macintosh has arrived!!!

This new software product, named dMac III, is fully compatible with dBASE III and is three times faster.

dMac III features a powerful programming language that offers its owners the ability to develop professional business applications for the Macintosh.

In addition, you can transfer your dBASE III applications and databases to the Macintosh where dMac III will allow you to use them without modification.

Of course you can use dMac III along with the other popular Macintosh software products such as Microsoft WORD and Microsoft FILE.

As a dMac III owner you get the best of both worlds. All of the features of the most popular programmable database for the IBM PC plus the user friendliness of Apple's Macintosh.

SHIPPING NOW !!! SHIPPING NOW !!! SHIPPING NOW !!! SHIPPING NOW !!! SHIPPING NOW !!!

SHIPPING NOW !!! SHIPPING NOW !!! SHIPPING NOW !!! SHIPPING NOW !!! SHIPPING NOW !!!

To order dMac III contact:

**FORMAT SOFTWARE**  
11770 BERNARDO PLAZA CT.  
SAN DIEGO, CA 92128  
(619) 487-6946

Macintosh is a trademark of Apple Computer  
dBASE III is a trademark of Ashton-Tate  
IBM PC is a trademark of IBM  
Microsoft WORD and Microsoft FILE are trademarks of Microsoft  
dMac III is a trademark of FORMAT Software

the IBM PC—meaning, of course, that some keyboard templates designed for the PC may not fit.

TeleVideo's HRM-100 monitor sells for \$595 and comes with its own display adapter, which provides power and video signals to the monitor through one 9-pin connector, freeing your computer table of one more cable. You may want to check the pin assignments before you attach a monitor from another manufacturer. Another nice feature is its attached stand that allows the monitor to tilt and swivel. The display adapter allows the monitor to display color images as shades of green with a resolution of 640 by 400 pixels. Its character set is crisp and much easier to read than that of the IBM. In fact, the clear characters coupled with the 14-inch diagonal measurement of the screen make for one of the best monitors I have used.

#### SLOW STARTING

The hardest part about using the Tele-286 is setting up the system and formatting the hard disk—tasks that can be made simpler with clear instructions. Unfortunately, the instructions provided with the Tele-286 are no help.

The problem is letting the operating system know the system configuration—specifically, what kind of disk drives are installed in the unit. A special setup program stores that information in a section of memory that is kept alive by a lithium battery, which also powers the clock. Without the proper configuration data, the hard disk cannot be formatted or used.

First, I had to hook up the battery. The battery is attached to the side of the power supply with Velcro, and it has a connector that you attach to some pins on the motherboard—a job that requires a pair of long-nose pliers and a great deal of patience.

When you connect the battery, you have to be particularly careful to choose the correct set of pins. The directions in the manual are less than explicit, and you might accidentally connect the battery to what appears to be a set of jumper pins on the disk controller only an inch away. The battery connector will indeed fit onto the

disk controller, and it would be an easy mistake to make. While I didn't want to find out what happens when a battery is connected to the disk controller, I suspect it's not good.

Then I had to run the setup program. On the face of it, the process seems simple; you simply indicate to the setup program which disk drives are installed. But the setup program does not provide a menu of choices. And although the manual depicts a menu, the choices listed do not include a 44-megabyte hard disk, which is standard equipment on a Model 2.

To make matters worse, the drive selections are listed by the number of cylinders and the number of heads on the disk—information that's not readily available. It's not even clear whether the disk drive capacities that are listed are formatted or unformatted capacities. (The 44-megabyte hard disk in my review unit has an unformatted capacity of 53 megabytes.) After two weeks of frustration and telephone calls to TeleVideo, I managed to partition and format the hard disk, which took about an hour with the proper instructions.

#### SOFTWARE COMPATIBILITY

The Tele-286 comes with MS-DOS 3.1 and GW-BASIC 3.1. Both of these are versions of the software offered for the IBM PC AT. Unfortunately, the version of MS-DOS I received could not access all 44 megabytes on the hard disk—it was limited to only 32 megabytes, which makes disk partitions necessary. TeleVideo says it has a modified version of MS-DOS 3.1 that will support all 44 megabytes, but none was available for this review.

Like the IBM PC AT, the Tele-286 is not fully compatible with the IBM PC. For example, some versions of Microsoft's Flight Simulator will not run on the Tele-286, nor will some games and educational programs. However, the most serious compatibility problem is the Tele-286's failure to run Digital Research's Concurrent PC-DOS. However, every other IBM business program that I tried did run.

This deficiency suggests there might be compatibility problems with other

(continued)



## AT A GLANCE

### Name

Tele-286 Model 2

### Company

TeleVideo Systems Inc.  
550 East Brokaw Rd.  
San Jose, CA 95150-6602  
(800) 521-4897  
(800) 821-3774 (California)

### System Unit Size

21 by 16 by 6.5 inches  
45 pounds

### Components

Display: Text 80 columns by 25 lines; graphics resolution 640 by 400 pixels with shades of green using optional TeleVideo HRM-100  
Keyboard: Detached 84-key IBM PC AT-style QWERTY keyboard with 10 function keys; numeric/cursor-control keypad; LEDs in Caps Lock, Num Lock, and Scroll Lock keys  
Processor: 8-MHz Intel 80286  
Memory: 512K bytes expandable to 15 megabytes

### Mass Storage

44-megabyte hard disk drive  
1.2-megabyte floppy disk drive

### Expansion

Six IBM PC AT-compatible plug-in board slots, two IBM PC-compatible plug-in board

### Software

MS-DOS 3.1  
GW-BASIC 3.1

### Options

Memory expansion  
360K-byte floppy disk drive  
Additional hard disk  
Color monitor

### Documentation

Owner's manual  
MS-DOS 3.1 manual  
GW-BASIC manual

### Price

Model 2 \$5395  
HRM-100 \$595



MEMORY SIZE (K BYTES)

0 200 400 600 800 1000

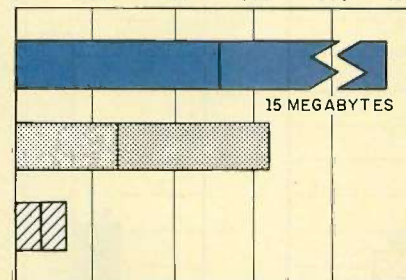

DISK STORAGE (K BYTES)

0 400 800 1200 1600 2000

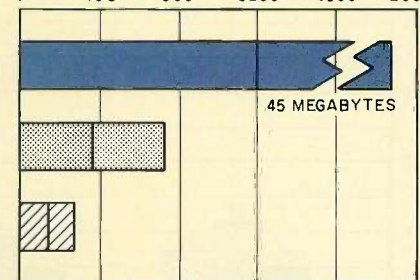

BUNDLED SOFTWARE PACKAGES

0 2 4 6 8 10

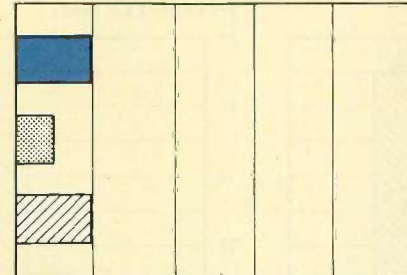

PRICE (\$'000)

0 2 4 6 8 10

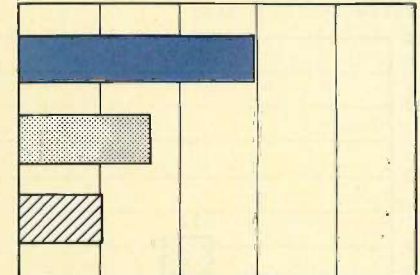

TELE-286

IBM PC

APPLE IIe

The Memory Size graph shows the standard and optional memory available for the computers under comparison. The Disk Storage graph shows the highest capacity for a single floppy disk drive and the maximum standard capacity for each system. The Bundled Software graph shows the number of software packages included with each system. The Price graph shows the list price of a system with two

disk drives, a monochrome monitor with connection apparatus and graphics capability, a printer port and serial port, 256K bytes of memory (64K bytes for 8-bit systems), the standard operating system for the computers under comparison, and the standard BASIC interpreter. Note that the Tele-286 Model 2 comes with 512K bytes of RAM and one of its two disks is a 44-megabyte hard disk drive.



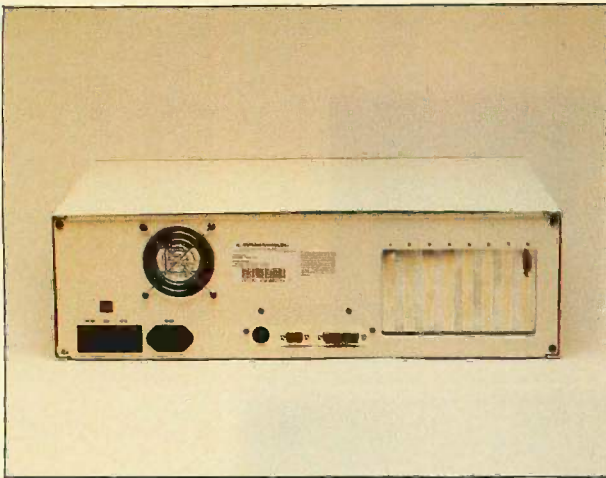

The rear of the Tele-286 showing the power cord receptacle, monitor power cord socket, serial and parallel ports, and access slots for expansion boards with the TeleVideo HRM-100 monitor adapter installed.

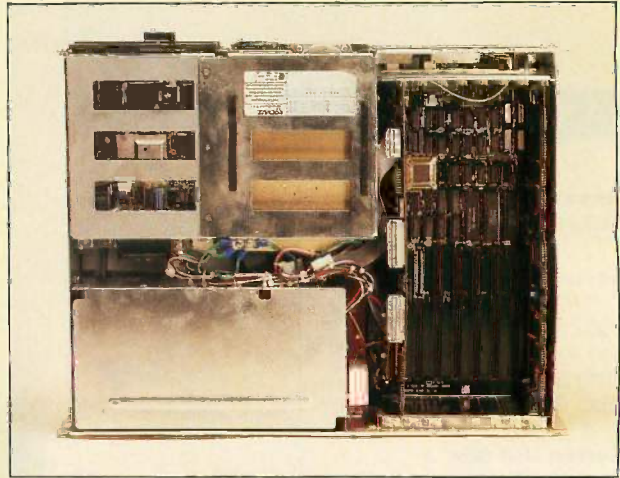

The inside of the Tele-286 showing the floppy and hard disk drives, power supply, and main circuit board with expansion slots.

DISK ACCESS IN BASIC (SEC)

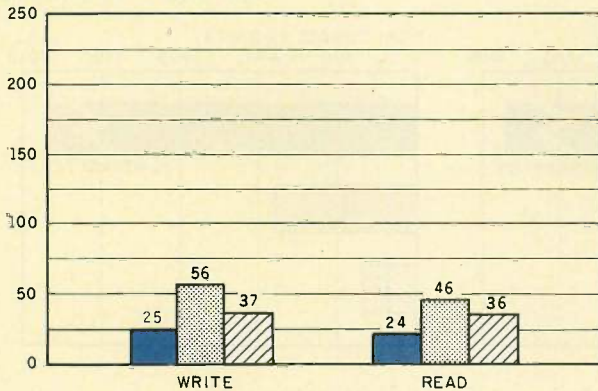

BASIC PERFORMANCE (SEC)

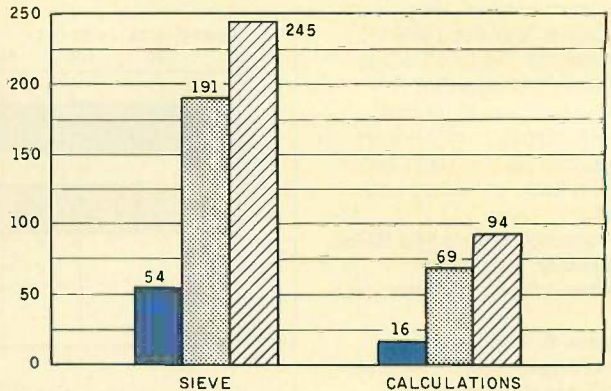

SYSTEM UTILITIES (SEC)

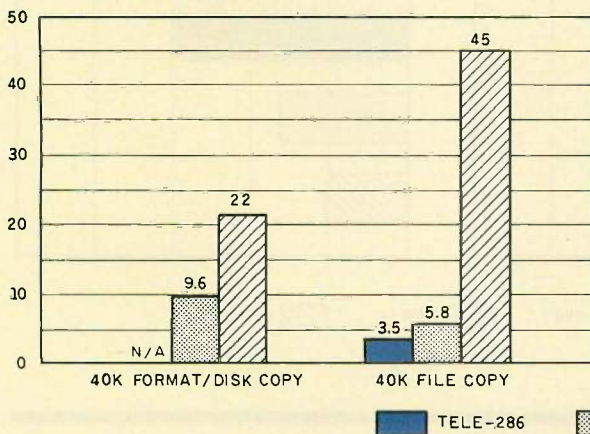

SPREADSHEET (SEC)

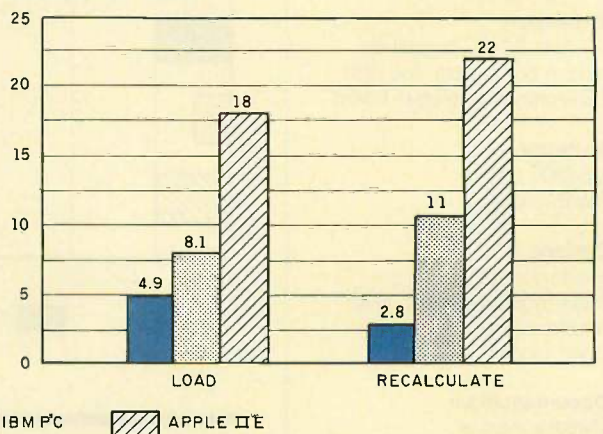

■ TELE-286    ▨ IBM PC    ▩ APPLE II E

The graphs for Disk Access in BASIC show how long it takes to write and then read a 64K-byte sequential text file to a blank floppy disk. (For the program listings see BYTE's *Inside the IBM PCs*, Fall 1985, page 195.) The Sieve graph shows how long it takes to run one iteration of the Sieve of Eratosthenes prime-number benchmark. The Calculations graph shows how long it takes to do 10,000 multiplication and 10,000 division operations using single-precision numbers. The System Utilities graphs show how long it takes to copy a 40K-byte

file using the system utilities. (The Disk Copy test was not run because our review unit had only one floppy disk drive.) The Spreadsheet graph shows how long it takes to load and recalculate a 25- by 25-cell spreadsheet in which each cell equals 1.001 times the cell to its left. The spreadsheet used was Microsoft's Multiplan. Tests on the Tele-286 were done using MS-DOS 3.1 and GW-BASIC 3.1. Our review system had 512K bytes of RAM, a 44-megabyte hard disk drive, and a 1.2-megabyte floppy disk drive.



programs. You should have your dealer demonstrate any software you are considering using on a Tele-286.

**THE BENCHMARKS**

The machine's speed is noticeably good with programs such as WordStar 2000, which is sluggish on the IBM PC. The benchmark tests support that feeling of speed. Memory-resident programs execute in one-third to one-fourth the time required on an IBM PC. Operations requiring floppy disk access execute in about half the time.

Some of the benchmark times depend heavily on the type or format of the disk drive being used. For example, the load time for Multiplan took only about one second from the hard disk. (Of course, timing accuracy is limited at such short intervals because of the time it takes to actually start and stop the stopwatch.)

Format and file-transfer times vary with the format in use. Naturally, formatting the 1.2-megabyte high-

capacity disk takes longer than the 360K-byte double-density disk. Also, file transfers took slightly less time with the high-capacity disk.

**CONCLUSIONS**

The Tele-286's most glaring weak point is its documentation. The problems I had in getting the machine running were entirely due to an inadequate owner's manual, and the same problems await any user who tries the do-it-yourself route. Once you get past the problems with setting up the system, the owner's manual improves some. The book is well illustrated and covers most routine activities adequately. There is also very complete coverage for such activities as adding additional disk drives and memory.

The manuals for MS-DOS and for GW-BASIC are also adequate. It appears that TeleVideo has simply reprinted the standard Microsoft manuals and has made no effort to expand or clarify them or to give ad-

ditional instructions. As a result, new users will find the manual tough to understand at first, but experienced users will be disappointed by the lack of advanced programming support.

Still, the Tele-286 performed most of the tasks I tried, endured frequent moves between my home and office, and persisted through days of constant disk-drive activity while I developed a diagnostics program that exercises the disk drives.

There are a number of good reasons to consider the Tele-286. The standard hard disk is considerably larger than that supplied with the IBM PC AT. The machine operates faster than the IBM, the monitor is easier to read, and it costs less. Cost may well be the major factor, since TeleVideo equipment is frequently sold at a considerable discount. While there are a number of IBM PC AT compatibles available, and more are on the way, it's difficult to find one much better than the Tele-286. ■



**ADD A NEW  
MERCEDES-BENZ  
TO YOUR EUROPEAN  
VACATION PLANS.  
AND SUBTRACT  
SOME OF THE COST.**

Plan to make European delivery of a new Mercedes-Benz part of your 1986 European vacation plans. Select any 1986 gasoline or diesel model\*, pick it up at the factory European Delivery Center—and embark on a deluxe driving vacation. Avoiding costly rentals while saving on the price of your new Mercedes-Benz. Send coupon for a free European Delivery brochure today.

\*Subject to availability.

Send coupon to: MHMA86-5  
Mercedes-Benz of North America, Inc.  
Marketing Communications Division  
One Mercedes Drive, Montvale, NJ 07645



Name \_\_\_\_\_  
Address \_\_\_\_\_  
City \_\_\_\_\_  
State \_\_\_\_\_ Zip \_\_\_\_\_

©1986 Mercedes-Benz of N.A., Inc., Montvale, NJ.





## MAKE THE CONNECTION . . .

Our **Connection** systems will solve your problem of trying to read and write diskettes or tapes from almost any computer system using your PC.

The **Diskette Connection** is a hardware system that enables the IBM PC or compatible to read and write most 8 inch, 5¼ inch, or 3½ inch diskettes.

With our **File Connection** software programs you can transfer data files between most computer systems, including CP/M, DEC, Honeywell, Univac, IBM 3740, S/1, S/3, S/23, S/32, S/34, S/36, and S/38.

Our **Word and Typesetting Connection** programs use IBM standard Document Content Architecture (DCA-RFT) to transfer document files between most word processing and typesetting systems, including Compugraphic MCS, CPT, Displaywriter, OS/6, Multiset, NBI, Quadex, Xerox, and Wang.

Our **Tape Connection** system will read and write IBM or ANSI standard ½ inch 1600 BPI magnetic tape. A full size 2400 foot tape can store a 45 MByte file and be written in 6 minutes.

Since 1982, we have supplied thousands of systems to customers around the world, including IBM, NASA, AT&T, Kodak, and General Motors.

Our specialty is conversion systems and we can provide a solution to your problem. Call us today to discuss your requirements.

*This ad is one of a series featuring NASA missions. For a free poster, send us your written request.*

**Box 1970 Flagstaff, AZ 86002  
(602) 774-5187 Telex 705609**



# MIX C

BY RICHARD GREHAN

## *A C compiler for the IBM PC that costs less than \$50*

Not long ago I was perusing BYTE and discovered an advertisement for a \$39.95 C compiler. I was struck by the potential value of a standard Kernighan and Ritchie C compiler for the IBM PC for less than \$50. Of course, it's wise to be wary about a software product that promises so much at such a value, so I ran both versions of Mix C down the gauntlet. (They also make a version for Z80 CP/M machines—I got the Kaypro version and ran the CP/M benchmarks on a Kaypro 10.)

### **WHAT YOU DO AND DON'T GET**

What arrived were two shrink-wrapped large blue-covered manuals of over 400 8½- by 11-inch pages. Stuck within the pages of one of the manuals were two Kaypro-readable floppies, and within the other was one IBM PC-compatible floppy. The disks are not copy-protected, so you can make backups or copy the contents onto a hard disk (which I did for the Kaypro 10). It isn't possible to get all the files plus boot information onto a single floppy disk, even for the MS-DOS version. Fortunately, the manual saved me from having to experiment with the distribution of files onto multiple disks; there is a section in chapter 1 that gives a file-by-file list of the recommended disk arrangement.

Many C compilers extend the compiler across several programs that are executed in succession. Mix C's compiler is an all-in-one file for the MS-DOS version and two for the CP/M version, a root file and an overlay. The disks also contain the Linker program and RUNTIME.OVY (both described below), as well as Mix C's library file, CLIB.MIX, and the standard I/O header and library files: STDIO and STDLIB.H, respectively.

Other files present on the MS-DOS disk (and on the second of the two CP/M floppies) consist of programs used for code optimization—both speed and size—and source files. STDLIB.C, PRINTF.C, and SCANF.C contain most of the source code for the standard C system; you can actually add or modify routines to these files and use them to create your own CLIB.MIX library file.

What you don't get with Mix C is any assembly source code output from the compiler that might aid you in debugging programs. Nor do you get the ability to link object files written in assembly language with Mix C functions. Additionally, as you may have guessed, you don't get a separate assembler program with Mix C, as you do with some of the other popular C compilers.

A peculiar program, CONVERT.COM, can be used, according to the manual, to convert object files to ASCII and back. I assumed that by this the manual meant CONVERT.COM could transform unreadable object code to text that was more or less understandable and from which I could glean the machine code generated by the compiler. However, what comes out of CONVERT.COM is a file consisting of streams of ASCII digits with function names sprinkled throughout. The only apparent use of an ASCII object file—as outlined in the manual—was that it provided a means for you to actually use a text editor to cut and paste functions from one object file to another. This seems to me to be at best

an abstruse exercise, and it certainly gets you no closer to the generation of machine code that would be useful for debugging.

### **COMPILING**

Producing an executable program from a source code file is typically an easy two-step process with Mix C; you simply execute the CC program to generate an object file, then execute Linker to create the final .COM file. There are, however, a variety of options available that enable you to optimize the resultant code for either space or speed.

Executable files created as described above do not contain low-level run-time routines (system I/O, for example) and as such they require the presence of a run-time support file called RUNTIME.OVY. The obvious advantage of this arrangement is that the resultant .COM files are smaller; a disk with numerous program files will show a real space savings due to the factoring out of common system routines. You can, however, request Linker to include run-time support in the resulting .COM file and so eliminate the necessity of moving RUNTIME.OVY about with all your C programs. Any gain in execution time is almost negligible, as demonstrated in the benchmarks, but the ability to create programs not requiring the presence of RUNTIME.OVY is certainly a necessity for anyone considering marketing products developed with Mix C.

If you are really cramped for space, you can optionally replace RUNTIME.OVY with SMALLCOM.OVY. This is a file identical to RUN-

*(continued)*

Richard Grehan is a BYTE technical editor. He can be reached at One Phoenix Mill Lane, Peterborough, NH 03458.

## AT A GLANCE

**Name**  
Mix C

**Type**  
Language

**Company**  
Mix Software  
2116 East Arapaho  
Suite 363  
Richardson, TX 75081  
(214) 783-6001

**Computer**  
PC-DOS and MS-DOS machines (DOS version 2.0 or later) and CP/M 80 (version 2.2 or later)

**Documentation**  
Mix C reference manual, bound, 400+ pages

**Price**  
\$39.95

TIME.OVY except that it is missing routines for long and floating-point data types.

Two programs provided with Mix C, Shrink and Speedup, allow you to optimize an object file for size or speed, respectively. The documentation is mysterious about the internal goings-on of Shrink, and I wasn't very impressed with its results. Speedup, however, improved execution times remarkably and at a small expense of space. The manual indicates that Speedup will have its most dramatic effects on integer arithmetic.

I ran the benchmarks with Speedup and Shrink files; you should note for these particular benchmarks I did include run-time support in the final executable files and that I did not speed up or shrink the system library code.

I was curious about the effects of speeding up *and* shrinking a file, so I tried running both programs on the Sieve object code on the IBM PC.

After shrinking and then speeding up, Sieve weighed in at 13,058 bytes and ran in 20 seconds; after speeding up and then shrinking, Sieve was 13,064 bytes and ran in 21 seconds. I won't even begin to try to explain the significance of the figures, but I would like to know what those 6 bytes are.

### LINKER

Not only does the Linker program operate similarly to other object code linking programs of its kind (Microsoft's Link, for example), but if you simply execute Linker with no file-names as arguments, it enters a special menu-driven mode. Commands from Linker's menu allow you to selectively load object files, specify libraries to search for unsatisfied references, and build executable files.

There is even a timesaving Find All command that will search and re-search a library file until all references have been satisfied. (The necessity for

(continued)

## Sourcecode Software for Computer-Aided-Design

File "BRACKET"

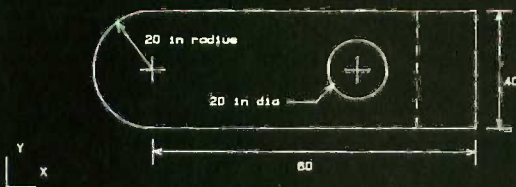

**CAD/BASIC** is a professional quality CAD program with source code supplied fully documented in BASIC. Create any 2-dimensional drawing using simple keyboard commands. Use real physical units - feet, millimeters, etc. Move a cursor around the screen with X,x Y and y keys. Coordinates are printed on the screen as it moves. Place node points, connect by solid or dashed lines, arrows or dimension lines, draw circles and arcs, add text, symbols and dimensions. Fit curves through node points with a unique B spline curve fitting routine. Create standard shapes and store on disk. Recall and place them anywhere on the screen. Scale drawings, rotate, store on disk, dump to a dot matrix printer or pen plotter. CAD/BASIC is the perfect low-cost solution for professionals and educators.

- IBMpc(64K) CAD/BASIC- \$120     Z-100 CAD/BASIC- \$120
- MAC(512K) CAD/BASIC- \$120
- IBMpc/Hewlett Packard 7470A Interface- \$50
- IBMpc/Houston Instruments 595 Interface- \$50

**Designer<sup>3D</sup>** is a 3-dimensional CAD program with source code supplied fully documented in BASIC. Interactively create 3D drawings with keyboard commands. Move cursor with X,x, Y,y and Z,z keys. Real physical coordinates (feet, millimeters, etc) printed on the screen as cursor moves. Place node points and connect by lines. Fit curves with automatic 3D B-spline routine. Move a point and all drawing elements move with it. Rotate, translate, scale, store drawings on disk. Recall and display up to 5 drawing simultaneously. Add physical data to drawing elements such as weight, inertia, resistance etc. to create a true graphics data base. *".. inexpensive, versatile, a very powerful design package..can do things Autocad can't."* - Boatbuilder Magazine.

- IBMpc(64K) Designer<sup>3D</sup>- \$120     Z-100 Designer<sup>3D</sup>- \$120
- MAC(512K) Designer<sup>3D</sup>- \$120     Apple Designer<sup>3D</sup>- \$120
- IBMpc/Hewlett Packard 7470A Interface- \$50
- IBMpc/Houston Instruments 595 Interface- \$50

Kern International, Inc, PO Box 1029, Duxbury, MA 02331 (617)826-0095



# This is all you'll ever need to use the System 488 Instrument Control Computer.

If you need to solve engineering problems you want System 488™. System 488 is faster than an IBM PC/AT® and more powerful and flexible than dedicated instrument controllers. System 488 is complete and ready to run when it arrives, yet there's plenty of room for future expansion.

## Ready To Use

Finally, an IBM PC/AT® compatible designed for engineering applications. System 488 is packed with all of the hardware and software you need to meet a tight schedule on a low budget.

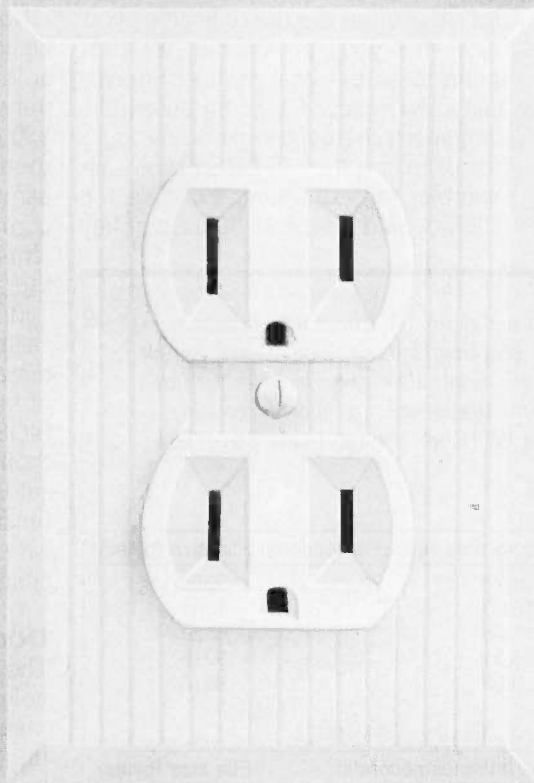

## Easy To Use

System 488 was designed for you. Our Co-Operator™ software and help windows are included to put problem solving information on your screen at the touch of a key.

## High Power, Low Price

System 488 has the power you need, backed by a technical staff that can give you straight answers to tough questions.

The complete system is just \$3980.

## Call today

Capital Equipment Corp.  
99 South Bedford St. #107  
Burlington, MA. 01803  
(617)-273-1818

## Hardware

8 MHz 80286 processor  
512K RAM  
Serial and parallel ports  
Floppy disk drive  
IEEE-488 interface  
Mono/color/EGA display interface  
Monochrome monitor

**Built-in...  
not  
added on.**

## Software

MS-DOS and BASIC  
Superkey®  
Full feature wordprocessor  
hp85 graphics emulation  
IEEE-488 applications library  
Co-Operator™

# cec



this is as follows: Suppose the Linker is searching a library file for routine A. It locates routine A and links it into the final run-time code. However, routine A calls routine B, which is defined in the same library, but appears before routine A. Linker will have to make another pass through the library to find routine B. The Find All command tells Linker to make multiple passes through the library file as required.)

Linker's Build command offers additional options: You can specify how much stack space the execution file will be allotted and whether or not it will include run-time support.

A special section in the manual describes the mechanics behind overlays and how you command Linker to

create overlay files. This is a tricky process and requires that you give some forethought to how your program will juggle overlay modules in memory, but the instructions are laid out in a step-by-step fashion and I had no trouble building several programs with overlays.

**MACHINE LANGUAGE INTERFACE**

Arising out of the fact that Mix C operates with its own peculiar format for object files are the difficulties you face when you try to interface a C program to an external routine. Specifically, the object file of an assembly language program processed through, for example, the MS-DOS MASM assembler (an equivalent example for CP/M would be the M-80 assembler)

cannot be linked to the object file of a C program created by the Mix C compiler. Also, the Mix C compiler provides no #asm directive found on many other C compilers for in-line assembly source code.

This means that if you have some module that requires coding in assembly language, you are faced with either hand-assembling your code into an array or explicitly poking it into memory from some external file.

However you manage to get a machine language routine into memory, at least Mix C provides functions for transferring control to your routine. You call your machine language subroutine using functions asm() and asmX(), and these functions accept arguments used to transfer the contents of the CPU registers to and from the routine.

Mix C also includes functions for calling the operating system's BDOS directly from C. The MS-DOS version of Mix C has functions for calling the BIOS (specifically, the IBM PC's BIOS, though most compatibles have identical BIOS entry points) in addition to functions for controlling system firmware such as the cursor and sound channels on the IBM PC.

**DOCUMENTATION**

The Mix C manual is a large bound volume that actually consists of five manuals in one. It begins with "Getting Started," a 19-page guide to the basics of using the Mix C package. This section touches on some of Mix C's optimization abilities and how to manipulate heap and stack space.

The "Tutorial" section follows, and it is an admirable 120 pages including an index. I was especially impressed by the range of topics covered; these include pointers, dynamic memory allocation, and structures. The level of presentation seems aimed for intermediate programmers.

Next is a 178-page reference manual that also contains an index. It is a robust guide to the use of C in general, dealing primarily with the standard function calls. "Functions," the 99-page section that follows, includes descriptions of the other functions that Mix C supports: UNIX functions,

(continued)

*Table 1: Benchmarks for Mix C run on a Kaypro 10. The benchmarks were run on the Kaypro's hard disk. Also, the benchmarks using Speedup and Shrink did include run-time support. Note that no compile times were given in the last three sections, as these compilations required considerable operator intervention. The benchmark programs are available on BYTenet Listings, (617) 861-9764.*

**Mix C Benchmarks — Kaypro 10**

**Without Run Time Support Included**

Benchmark	Compile time (seconds)	Execute time (minutes:seconds)	File size (bytes)
Sieve	:39	3:22	13056
Fib	:41	16:09	4864
Intmath	:51	2:28	5120
Sort	:56	5:31	9216
Fileio	:58	9:02	6016

**With Run Time Support Included**

Benchmark	Execute time (minutes:seconds)	File size (bytes)
Sieve	3:22	31232
Fib	16:09	23040
Intmath	2:28	23296
Sort	5:31	27392
Fileio	9:02	24192

**Using Speedup**

Benchmark	Execute time (minutes:seconds)	File size (bytes)
Sieve	:41	31488
Fib	13:23	23168
Intmath	1:14	24320
Sort	3:42	28160
Fileio	8:46	24960

**Using Shrink**

Benchmark	Execute time (minutes:seconds)	File size (bytes)
Sieve	3:31	31232
Fib	15:57	22912
Intmath	2:33	23168
Sort	5:34	27392
Fileio	9:04	24192



# Multiuser & LAN Solutions

## For IBM PC/XT/AT



### MULTIUSER

KT-7/PC<sup>2</sup> PC Work-a-like Terminal  
 Compatibility: Multilink Advanced<sup>3</sup>,  
 PC-Slave/16<sup>4</sup>  
 Display: 80 x 25, IBM PC character  
 set, PC look-a-like attributes, 14"  
 green or amber  
 Keyboard: AT style std. IBM  
 scan/ASCII codes. 5161/AT and  
 RT style opt.  
 Pages of memory: 1 std. 2 or 4 opt.  
 Communications: 2 bi-directional  
 RS-232C serial (data & printer)  
 ports  
 Operating systems: works with  
 PC-DOS<sup>1</sup>, MS-DOS<sup>5</sup>, QNX<sup>6</sup>,  
 UNIX<sup>7</sup>, XENIX<sup>5</sup>, THEOS<sup>8</sup>, PICK<sup>9</sup>,  
 and Concurrent DOS<sup>10</sup>.  
 Retail price: \$695.00  
 QUARTET<sup>2</sup> 4-port I/O card,  
 RS-232C  
 Retail price: \$299.00

### LAN

K-Net<sup>2</sup> Local Area Network  
 Compatibility: **NETBIOS**, Token-  
 Ring<sup>1</sup> software, (Advanced  
 Netware<sup>11</sup> 8/86)  
 Data Rate: 1 million bps  
 Cable: Twisted-pair/phone wire  
 Distance: Up to 4000 ft.  
 Addressable users: Up to 255  
 Physical: Half-sized card  
 Operating systems:  
 PC-DOS<sup>1</sup>/MS-DOS<sup>5</sup> 2.0 or later  
 Dedicated file server: Not needed  
 Message communication:  
 Interactive  
 Multiuser solutions supported:  
 Multilink Advanced<sup>3</sup>  
 PC-Slave/16<sup>4</sup>  
 Other features: electronic mail, net-  
 work data management, and  
 print spooling  
 Retail price: \$395.00

### WORKSTATIONS

KW-1 8088, 4.77 MHz, 512 Kbytes  
 Retail price: \$995.00  
 KW-2 8088-2, 8 MHz, 512 Kbytes  
 Retail price \$1,195.00  
 KW-3 80286, 6 or 8 MHz,  
 640 Kbytes  
 Retail price \$1,995.00  
 All the above include: monochrome  
 monitor with video board, AT style  
 keyboard, 8 slots, built-in K-Net<sup>2</sup>  
 with remote boot, upgradeable to  
 "complete" PC.  
 (800) 828-8899  
 (408) 436-6550 (In CA)  
 1705 Junction Ct., Bldg. #160  
 San Jose, California 95112

**Kimtron**

Trademarks: <sup>1</sup>IBM <sup>2</sup>Kimtron <sup>3</sup>Software Link <sup>4</sup>Alloy <sup>5</sup>Microsoft <sup>6</sup>Quantum <sup>7</sup>Bell Labs <sup>8</sup>THEOS Software <sup>9</sup>PICK Technologies <sup>10</sup>Digital Research <sup>11</sup>Novell © Copyright 1986 by Kimtron Corp.

Inquiry 181 for End-Users. Inquiry 182 for DEALERS ONLY.

JUNE 1986 • BYTE 261

Table 2: The same benchmarks run on a dual-floppy IBM PC using PC-DOS version 2.0.

Mix C Benchmarks — IBM PC Version  
Without Run Time Support Included

Benchmark	Compile time (seconds)	Execute time (minutes:seconds)	File size (bytes)
Sieve	:38	3:20	12921
Fib	:40	12:14	4682
Intmath	:51	1:46	5017
Sort	:55	4:56	9122
Fileio	:58	8:54	5922

With Run Time Support Included

Benchmark	Execute time (minutes:seconds)	File size (bytes)
Sieve	3:23	31628
Fib	12:12	23389
Intmath	1:45	23724
Sort	4:55	27829
Fileio	8:48	24629

Speedup

Benchmark	Execute time (minutes:seconds)	File size (bytes)
Sieve	:20	31771
Fib	3:51	23675
Intmath	:11	24002
Sort	1:07	28489
Fileio	7:55	25406

Shrink

Benchmark	Execute time (minutes:seconds)	File size (bytes)
Sieve	3:28	31571
Fib	12:00	23355
Intmath	1:47	23581
Sort	4:58	27770
Fileio	8:49	24569

functions specific to the operating system (MS-DOS or CP/M-80), and a special chapter on functions for direct communication to the IBM PC BIOS.

Finally, the 17-page "Tools" section is a close look at the Mix C's software components. It is really an extension of the first section, with the addition of a description of the overlay mechanisms provided with Mix C.

CONCLUSION

I ran the benchmarks on a Kaypro (see table 1) and an IBM PC dual-floppy system with 512K bytes of memory (see table 2). For the Kaypro, I ran all the benchmarks on the computer's internal 10-megabyte hard disk. There was no 8087 math coprocessor in the IBM PC; in fact, if Mix C provides 8087 support, it isn't mentioned anywhere in the documentation.

Compared with other C compilers I have seen, Mix C doesn't break any speed records. Devoted programmers will be unhappy with its inability to generate machine source code, the lack of a compiler directive for in-line assembly code, and the fact that object files created by other compilers or assemblers cannot be linked with Mix C object files.

Still, the compiler supports the K & R standard, it works, and it is certainly affordable. Therefore, I am willing to overlook its inadequacies. ■



GRAPHICS FOR WYSE

- ▶ I-300 Graphics field upgrade for Wyse Technology's WY-50, WY-75 terminals
- ▶ True Tektronix 4010/4014 graphics emulation
- ▶ 1024 by 800 pixel display, 1,000,000 pixels per second vector drawing rate
- ▶ Zoom, pan, rich native command set, hardcopy capability



**CODONICS**

*We Bring the Future into Focus*

**CLEVELAND CODONICS, INC.**  
18001 Englewood Dr. • Cleveland, Ohio 44130  
(216) 243-1198

Tektronix, Wyse Technology, Codonics are registered tradenames



HIGH-RESOLUTION, ALL-POINTS-ADDRESSABLE GRAPHICS FOR SHARP DETAIL.

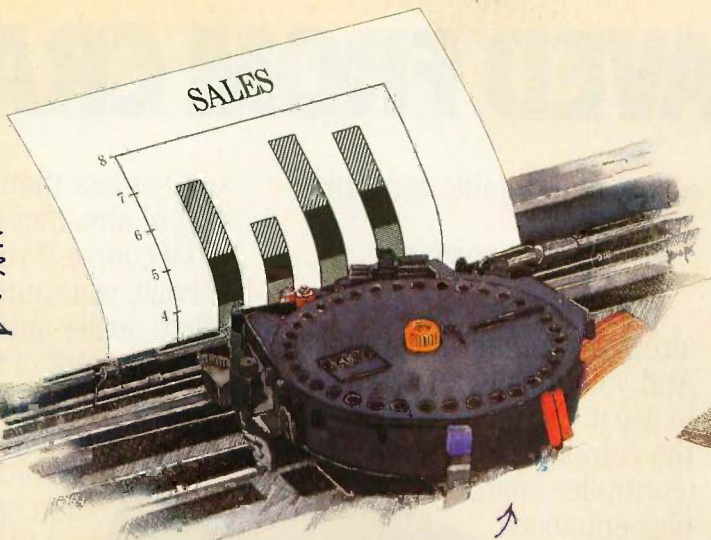

ADVANCED TECHNOLOGY RIBBON PRODUCES DARK, RICH PRINTING.

THE "QUIETWRITER" PRINTER'S ELECTRONIC PRINTHEAD THAT MAKES FOR WHISPER-QUIET PRINTING.

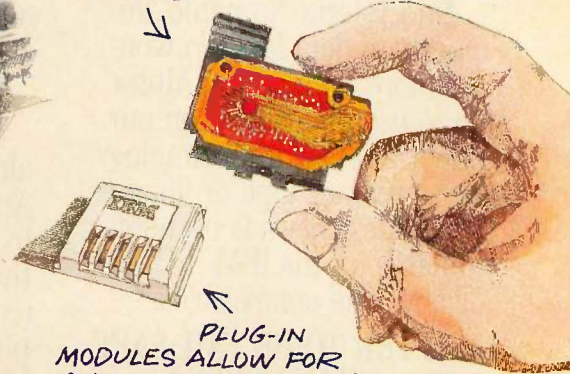

PLUG-IN MODULES ALLOW FOR QUICK CHANGES OF TYPE FACES

WORKS WITH ALL IBM PC'S AS WELL AS MANY OTHER MICROCOMPUTERS.

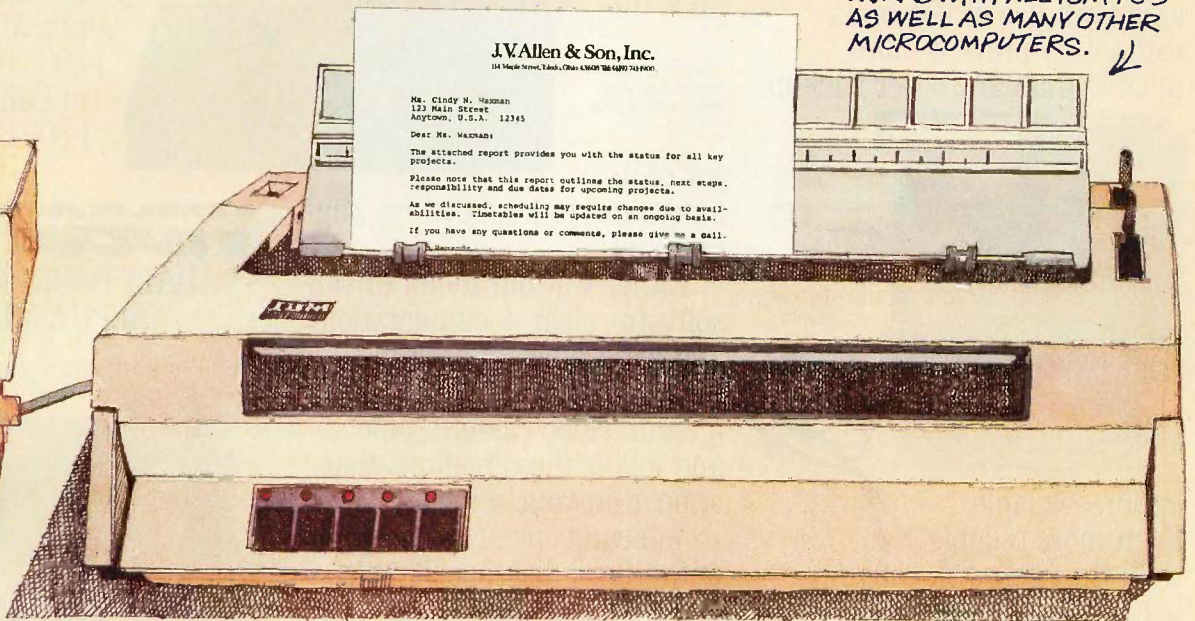
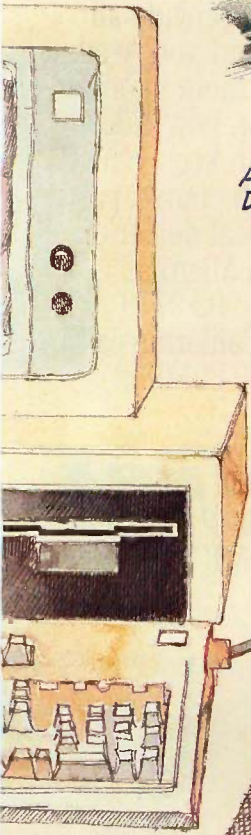

## The IBM Quietwriter® Printer Model 2 for whisper-quiet quality graphics and text.

Quality. That's the word that springs to mind when describing the "Quietwriter" Printer Model 2.

Its letter-quality printing, for example, gives you all the crispness and deep, rich gloss of IBM Selectric® Typewriter printing. The quality of its high-resolution graphics makes for full curves and sharp detail. And, of course, its whisper-quiet operation improves the quality of your work environment.

The "Quietwriter" Printer's other qualities? Speeds of up to 60 characters per second, depending on pitch and application. And interchangeable plug-in fonts that support the full 252-character set of the IBM Personal Computer. (Perfect if you need output in more than one type style.)

The IBM "Quietwriter" Printer attaches to IBM PCs and to many other personal computers. And it's part of our growing

family of personal printers. All designed to serve a single purpose: To give everything you do the finishing touch.

For the authorized IBM dealer or the IBM Product Center nearest you—or for free literature—call 1 800 IBM-2468, Ext. LC/104. Or contact your IBM marketing representative.

Inquiry 157

IBM Personal Printers...The Finishing Touch



# 15,000 SAVED FROM CRASH.

No hysteria. No panic. No reports of data loss. No wonder more than 15,000 Alpha Micro users have chosen our Videotrax™ backup technology over streamer tape or floppies.

The best news is it's now available for the IBM® PC-AT, XT and true compatibles.

## BETTER TO BE FAIL-SAFE THAN SORRY.

Exhaustive testing and long term use of Videotrax technology prove it more reliable than any other backup



*High-tech. Open your PC and slide the controller board into any expansion slot. Low-tech. Hook up VCR to computer with standard connector cables.*



option available. Even more reliable than the hard disk you're backing up.

At the heart of the system is a patented video tape controller board that employs a standard video cassette recorder for copying data. Which means Videotrax offers the sophisticated technology of today's VCRs. And the depend-

ability of a durable consumer good.

## EASY DOES IT.

If you own a VCR, you already own half the system. And you already know how to use it. Or you might opt for the complete subsystem (controller board plus enhanced VCR) and experience the

*Your basic video cassettes. Reliable, cheap, easy to find.*



joy of its automatic, unattended backup capabilities.

Either way, our menu driven software, clear documentation and wide range of backup modes keep it simple: Insert a blank video cassette tape and follow the directions that appear on your screen.

You can copy or restore your entire hard disk, specific files, or only files modified since the last backup, while the system busily self-monitors for proper functioning.

And for the price of taping your favorite TV shows, you can record your most valued computer data. Up to 80MB can be stored on a single cas-

sette at less than a third of the cost of streamer tape.

Of course, if you ever require service, your authorized Alpha Micro dealer and our world-wide network of factory service centers will provide all the support you need.

For more information on how Videotrax can keep you off the crash course, call your local dealer or Alpha Micro at 1-800-992-9779 (in California call 1-800-821-0612).

## VIDEOTRAX™ DATA BACKUP FROM ALPHA MICRO.

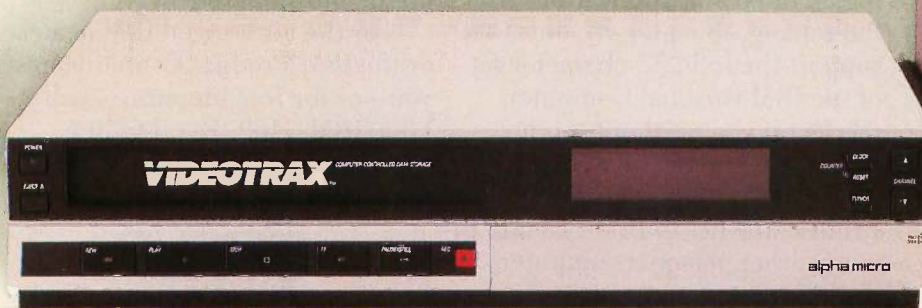





# FOUR MIDI INTERFACES

BY ROGER POWELL AND RICHARD GREHAN

Let's assume you have a personal computer and you want to connect it to a MIDI-equipped keyboard or other instrument. One of the first things you will need is interface hardware to send your MIDI signals through your computer. The MIDI specification requires a current-loop serial interface operating at 31,250 bits per second, so it is going to take something more than just retrofitting an RS-232C port.

In this article, we will look at four MIDI interfaces currently available for some of the most popular microcomputers. The TDS-AP for the Apple II+/IIe and the TDSC-64 for the Commodore 64 are from Syntech Corporation. The MPU-401 for either the IBM PC or the Apple II machines is from RolandCorp. The MIDIMAC for the Macintosh or Mac Plus is from Opcode Systems. The interfaces all include at least a high-speed UART with some sort of clock-generation circuitry, a buffered output stage, and an optoisolated input stage. (The MIDIMAC is an exception; it requires no special UART, since the Macintosh's serial ports can operate well above the speed required by MIDI.) However, most of the interfaces we'll look at in this article add extra features such as drum machine trigger signal outputs and tape synchronization inputs and outputs.

Of course, if you are an Atari ST owner, you are probably reading this with a bit of smugness, because the Atari ST has built-in MIDI ports.

## TDS-AP

Syntech Corporation's TDS-AP is a MIDI interface on a board that plugs into the Apple II+/IIe. It includes a pair of DIN jacks—one for MIDI in and one for MIDI out—as well as five mini phone jacks: tape in, tape out, foot-

## MIDI interfaces for the Commodore 64, IBM PC, Macintosh, and Apple II family

switch, clock out, and start/stop.

The tape-in and tape-out jacks allow for synchronization with a tape deck. If you have a multitrack tape recorder, you connect the tape-out signal to a line-in signal on a track of your tape machine; this track will become the *click track*. You then program whatever MIDI software you're running to output a sync tone and record this on the click track. Now connect the line-out signal from the click track to the tape-in port on the MIDI interface, and the sync tone that you have just recorded becomes the master clock for the system when you begin to record onto the other tracks of your tape recorder.

You can opt for some *hands-off* event control by attaching a footswitch to the TDS-AP's footswitch jack. For example, we tested the interface with multitrack recording and sequencer software that enabled us to halt the recording process by pressing the space bar or footswitch. If you have both hands busy on a synthesizer's keyboard, it's much easier to operate a footswitch than an Apple II's space bar.

The clock-out and start/stop lines of the interface can be used to drive a drum machine. The clock-out line connects to the clock-in line of the drum machine, and pulses on this line control the machine's tempo. The start/stop line—just as its name implies—provides trigger signals to begin and halt whatever sequence you have programmed into your drum machine. Of course, you could also use the clock-out and start/stop lines to con-

trol a sequencer.

The clock-out and start/stop lines add features that may not be immediately apparent. Not only do they permit you to control drum machines that are not equipped with a MIDI interface, but

they provide a direct control path to a drum machine that might otherwise be at the end of a line of daisy-chained MIDI devices (and would therefore suffer from signal-transmission delays). They also alleviate the problem that arises if you don't have enough MIDI-thru connectors available and are unable to hook the drum machine into the MIDI circuit at all.

The TDS-AP's documentation is a small 10-page pamphlet filled mainly with simplistic diagrams showing how to connect the interface to a tape deck, a drum machine, and a sequencer (they presume you already know how to connect the MIDI ports to whatever musical instrument you're using). We were happy to find an elaborate description of the procedure you must go through to create a click track. We rate the documentation as adequate: It provides you with

(continued)

Roger Powell (Magnetic Music, POB 328, Rhinebeck, NY 12572) is a professional musician and computer programmer. He has been involved with music synthesis as a consultant for the Moog Synthesizer Company and Bell Laboratories, where he was introduced to computer music. A long-standing member of Todd Rundgren's band Utopia, Roger has also played keyboards for David Bowie and Meat Loaf and has released two solo synthesizer albums. Roger has been producing his own line of MIDI-related software tools for music, including *Texture*, a 24-track MIDI sequencer for the IBM PC. Richard Grehan (One Phoenix Mill Lane, Peterborough, NH 03458) is a technical editor at BYTE.



## AT A GLANCE

<b>Name</b>	TDS-AP DS-AP TDSC-64 DSC-64	MPU-401	MIDIMAC
<b>Type</b>	TDS-AP: for Apple II +/Ile, with tape and drum sync DS-AP: for Apple II +/Ile, with drum sync only TDSC-64: for Commodore 64, with tape and drum sync DSC-64: for Commodore 64, with drum sync only	MPU-401: External processing unit, requires interface card for attachment to host computer MIF-IPC: Interface card for the IBM PC MIF-APL: Interface card for the Apple II	MIDIMAC: one in, three out MIDI interface for Macintosh
<b>Company</b>	Syntech Corporation 23958 Craftsman Rd. Calabasas, CA 91302 (818) 704-8509	RolandCorp U.S. 7200 Dominion Circle Los Angeles, CA 90040 (213) 685-5141	Opcode Systems 707 Urban Lane Palo Alto, CA 94301 (415) 321-8977
<b>Documentation</b>	10-page pamphlet included Technical documentation for any of Syntech's interfaces \$5		
<b>Prices</b>	TDS-AP \$199.95 DS-AP \$129.95 TDSC-64 \$199.95 DSC-64 \$129.95	MPU-401 \$200 MIF-IPC \$110 MIF-APL \$110	MIDIMAC \$125 MIDIMAC version for Mac Plus \$175 MIDIMAC upgrade for Mac Plus \$50

just enough to get going. If you are a programmer anxious to do some MIDI application software of your own, Syntech will send you the TDS-AP's technical documentation for an additional \$5.

### TDSC-64

The TDSC-64 MIDI interface for the Commodore 64, also from Syntech Corporation, is functionally almost equivalent to the TDS-AP interface (in fact, the same manual is packaged with both devices); the only major difference is that the Commodore version does not have a footswitch jack.

The TDSC-64 is about the size of a deck of playing cards and plugs into the Commodore 64's cartridge expansion slot. It has three DIN jacks and two mini jacks. One DIN jack is MIDI in, another is MIDI out, and the third carries the clock-out and start/stop signals. The phone jacks provide connections for tape in and tape out.

The third DIN connector mentioned above is compatible with Roland drum machines, but with some minor cable building you should be able to adapt the TDSC-64 for use with other brands of drum machines. You have

to bring out the clock-out and start/stop signals to a pair of phone plugs. Fortunately, the pin assignments for the DIN connector, along with a brief construction guide, are provided in the manual.

### MPU-401

Roland has been manufacturing the MPU-401 MIDI interface in versions for both the Apple and IBM PC for about three years. The package consists of an internal interface card that is specific to the host computer bus (called the MIF card), a multiwire cable with DB-25 connectors, and an external box (the MPU or MIDI processing unit) containing the actual MIDI serial hardware and custom support circuitry. [Editor's note: For more information on the MPU-401, see "A MIDI Recorder" by Donald Swearingen in *BYTE's Inside the IBM PCs, Fall 1985*.] The MPU-401 was designed to offload timing and synchronizing operations from the computer and is, therefore, known as an intelligent interface as contrasted with other passive, UART-only devices used for MIDI communication between synthesizers and computers. However, the MPU-401

may also be used in UART mode for applications that do not require the additional intelligence that the custom ROM and timers provide. Straightforward jobs like sending and receiving bulk voice data to and from synthesizers can easily be accomplished using only the basic UART.

For applications such as recording and playing MIDI data sequences back, the MPU-401 provides eight programmable timers and circuitry for interrupting the host computer to initiate data transfers. Normally, each timer is associated with a single track of MIDI data to be sent from the host to the MIDI receiving channel of an external synthesizer. As data is consumed by the receiver, the timer for that track will interrupt the host computer and request new information. This information packet starts with a timing byte to indicate an entry delay for the MIDI event that follows. The timer is armed with a countdown and will not send the MIDI packet until the count reaches zero. Thus, the MPU-401 acts as an event scheduler and allows the host computer to do other tasks in the foreground, such as dis-

(continued)



# State of the Smart.

## SmarTEAM 2400

- \* Bell 103/212A, CCITT V.22, V.22 bis (V.21 optional)
- \* Auto speed selection (300, 1200 or 2400)
- \* Auto answer, auto dial (tone or pulse)
- \* Hayes compatible
- \* Call progress detection (dial tone, ringing, busy)
- \* Speaker with volume control
- \* 8 LED status indicators
- \* 6 self test modes
- \* 2 YEAR WARRANTY



## SmarTEAM 2400B

Short card version of SmarTEAM 2400 for IBM PC, XT, AT and compatibles. Communication software included.

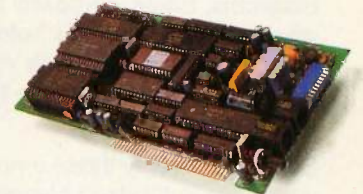

## SmarTEAM 1200AT (BELL)

100% compatible with Hayes 1200 plus full call progress detection (dial tone, ringing, busy). 300, 1200 full duplex.



## SmarTEAM 1200BH (BELL)

Half card for IBM PC, XT, AT and compatibles. Communication software included. 300, 1200 full duplex.



## SmarTEAM V.21/22 (CCITT)

300, 1200bps full duplex Hayes commands compatible.



### HEAD OFFICE: TEAM TECHNOLOGY INC.

10F, 270, NANKING E. RD., SEC. 3, TAIPEI, TAIWAN, R. O. C.  
TLX: 19725 PETRCHEN ATTN TEAM  
TEL: (02) 7414270, FAX: (02) 771-2985

Inquiry 341

### U.S. SALES & SERVICE

### MORRISON & DEMPSEY COMMUNICATIONS

19209 Parthenia St Ste D  
Northridge, CA 91324  
TEL: (818) 993-0195  
FAX: (818) 993-7209  
TLX: 325524 MODEM NTGE

### SINGAPORE:

**PET Computers Service (S) Pte Ltd.**  
Tel: 5331313

### HONG KONG:

**RAINBOW COMPUTER PERIPHERALS**  
Tel: 3-7281819

### SOUTH AFRICA:

**SPARTAN MICRO MANAGEMENT**  
Tel: (011) 788-5177

### CANADA

### BUDGETRON INC.

1320 Shawson Drive, Unit 1  
Mississauga, Ontario  
Canada L4W 1C3  
TEL: (416) 673-7800  
TLX: 06-968080

- \* Hayes is a registered trademark of Hayes Microcomputer Products, Inc.
- \* IBM PC XT, AT are registered trademarks of International Business Machines Corp.
- \* MITE is a registered trademark of MYCROFT LABS INC.



# Get the Picture with COLORPHOTOBASE



**PHOTOBASE** is a software package that works with data base management systems such as: *dbase II\**, *R:Base 4000\** and the *IBM Filing Assistant\**.



**PC-EYE** is a high speed, high resolution video digitizer board that lets you capture anything you can see.

Now you can open up a whole new dimension in data base applications by merging real-life color pictures with popular data base management systems. Pictures of people, products, diagrams, maps, company logos — whatever you want to photograph — can be integrated with your data base. Consider these typical applications:

**Security** — verify those employees who have authorized clearance to limited access areas. A data base containing employee pictures and personnel records can be searched and displayed for visual verification.

**Real Estate** — add pictures of houses to on-line real estate listings for faster property identification and improved sales presentations.

**Electronic Cataloging** — pictures of products can be combined with a data base system containing product specifications, pricing, availability and much more.

**Medical Files** — Existing data base systems containing patient histories can incorporate pictures of x-rays, cell slides and external body disorders. The ability to visually inspect previous medical problems of patients can greatly enhance the speed and accuracy of future diagnosis.

Customers, distributors and sales personnel can quickly search data and view the resulting product/picture information on one screen. Files can be updated easily, quickly.

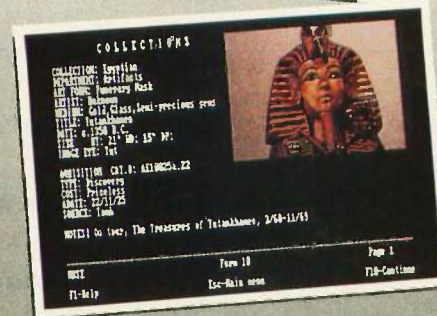
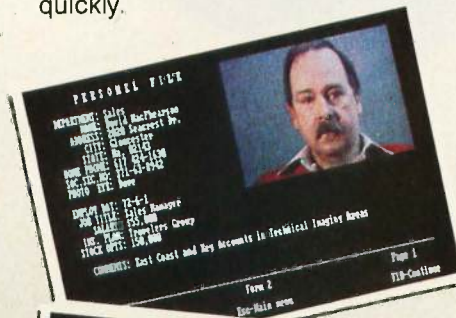

## It's Easy

With a simple keystroke, pop-out of your data base system and into the PHOTOBASE menu. Capture images of text, photos, artwork and 3-dimensional objects with an ordinary video camera and our high resolution PC-EYE™ video digitizer. Pop back into your data base system and add the picture name to your data base like you would any other piece of information. The full functionality of the data base system is preserved, but the resulting display is text and picture information on one screen.

Pictures are displayed in the upper right quadrant of the screen or at a full screen resolution of 320 x 200 with 256 optimized colors. Screen display can alternate with text, images, or both simultaneously viewed.

Call or write and we will send you information on PHOTOBASE, PC-EYE, compatible cameras and other imaging equipment in the Chorus Family of products.

**(603) 424-2900 or  
1-800-OCHORUS.**

TM PHOTOBASE and PC-EYE are trademarks of CHORUS Data Systems.

\*dBase II is a trademark of Ashton-Tate; R:Base 4000 is a trademark of Microrim, Inc.; IBM Filing Assistant is a trademark of International Business Machines Corporation.

# CHORUS



playing a musical score or loading disk files, while the playback progresses in the background via interrupts.

In actuality, a ninth timer exists for what Roland calls a conductor track. This counter operates similarly to the other timer tracks, but it is suggested in the MPU-401 reference manual that tempo changes or other events outside the data streams of the individual music tracks be scheduled using this timer.

The MPU external box is outfitted with one MIDI-in jack, two MIDI-out jacks, tape-sync-in and -out connectors, Roland DIN-sync output jack, and a metronome audio-out connector. The functions of the MPU-401 may be controlled by sending one of a number of specific commands to it. These commands break down into several categories, which are described below.

**Start/Stop, Record, and Playback:** After the host has initialized MIDI event data pointers for each track, sending a START command will commence playback of the MIDI data streams. You restart playback after a STOP command by sending CONTINUE, which does not reset any timers or status registers before beginning to play again. By sending a RECORD command, the MPU-401 will interrupt the host whenever data has been received from the MPU-401's MIDI-in port, typically coming from a MIDI keyboard device. The host must save the incoming event data in a buffer in order to have it available for further processing.

**Enable/Disable MIDI Thru:** Since the MPU-401 is connected between the host computer and MIDI-equipped synthesizers, there is a choice of whether or not data received from MIDI in is to be echoed to MIDI out. If, for example, a remote keyboard controller is being used—one which contains no sound-generating circuitry of its own—then you want the data sent from the keyboard to be passed on to the synthesizer receiving on the proper channel. On the other hand, if the control keyboard is also a sound synthesizer, you do not

want the data sent from the keyboard to be returned, which would create double-triggering of notes.

MIDI-format system-exclusive messages dealing with synthesizer voice-parameter data may also be echoed through to instruments that are connected to the MPU-401 MIDI-out port.

**Timebase:** The internal counting functions of MPU-401 must be based on

a standard timing interval, and there are seven selections ranging from 48 pulses per beat to 192, graduating by increments of 24. A whole beat is thus subdivided for rhythmic accuracy into timebase units. Roland recommends a setting of 120 pulses per beat in order to provide high enough resolution for real-time sequencing operations.

(continued)



**USRobotics' COURIER 2400™  
... The most dependable  
at 2400- or 1200-bps**

**Y**ou get 2400/1200/300-bps data communications and every first-class feature you'd expect in an auto-dial, auto-answer modem... at a surprisingly affordable price.

But a modem at any price is only as good as its performance... And that's where Courier 2400 really shines. Don't take our word for it. Ask any of the nearly 2,000 electronic bulletin board system operators who have chosen the Courier 2400 for one of the most demanding modem applications imaginable.

Listen to the unanimous chorus of praise for the Courier 2400 from tough reviewers at more than a dozen highly respected computer magazines.

Consider Courier 2400's performance record—less than one percent of all Courier 2400s sold have been returned for service, a record we challenge the industry to match. And we back up our confidence in Courier 2400

with a full two-year parts and service warranty.

Quality, performance, value—**your** modem should be this good. It is, if it's the **Courier 2400** from USRobotics.



The Intelligent Choice in Data Communications

8100 McCormick Blvd., Skokie, Illinois 60076  
Phone toll free 1 (800) DIAL USR  
In Illinois (312) 982-5001

To learn more, send for our FREE booklet: "24 Questions and Answers on 2400-BPS Modems!"

NAME \_\_\_\_\_

ADDRESS \_\_\_\_\_

CITY \_\_\_\_\_

STATE \_\_\_\_\_ ZIP \_\_\_\_\_

COMPANY \_\_\_\_\_

TITLE \_\_\_\_\_

PHONE ( ) \_\_\_\_\_

PERSONAL USE  BUSINESS USE

**Tempo and Metronome Functions:** One of the most significant features of the MPU-401 is its ability to control the speed of playback automatically by sending simple tempo-setting commands from the host. Not only can you set tempo from an absolute range of 8 to 240 beats per minute, but you can specify relative tempos using signed offsets. Additionally, you can control the rate of the new rela-

tive tempo, producing gradual speed-ups or slowdowns (*accelerando* or *decelerando*) in the music.

The MPU-401 has an internal, audible metronome with an external output jack for connecting to a mixing console. The metronome has several programmable modes for modifying the number of beeps per beat and placement of metric accents by alternating metronome pitches.

**Internal Parameters:** A variety of commands, such as read, set, and clear, are provided for altering the contents of the parameters internal to the MPU-401. Reference tables are kept for keeping track of notes-on for certain MIDI channels as well as buffers for the play timers. Note-on tables are necessary for producing notes-off in the event of stopping *play while* notes are locked on.

**Synchronizing Functions:** The MPU-401 may be used as the source of all timing signals in a multi-instrument MIDI system, or it may be slaved to the timing output of an external device. For using the unit as a master timing source, you may opt for MIDI timing clocks, which are transmitted over the standard MIDI-out port; FSK (frequency shift key) tape sync coming from the tape-out jack; or Roland DIN sync coming from the DIN-sync output jack. External sync signals may be derived from either MIDI timing clocks received at the MIDI-in port, or FSK tape sync coming into the tape-sync input jack from an audiotape track. (DIN sync refers to a voltage-pulse output signal at a rate of 24 pulses per quarter note [beat] and conforms to the standard that is used in many drum machines.)

By using tape sync, you may drive the computer sequencing software to play back along with the tape-recorded tracks, which has been synchronized via the click track. Likewise, MIDI timing-clock sync may be employed to lock the computer sequencer to the clock of another sequencing device. SMPTE time code, which is used throughout the film industry, can be translated to MIDI timing clocks through an additional piece of hardware (such as a Roland SBX-80) and sent to the MPU-401, thus linking the computer sequencer to any other SMPTE-oriented device.

**MIDI Data Filtering:** The MPU-401 can be set so that the generous amounts of data created by continuous controller devices (including pitch-bend wheels, modulation

(continued)

## Are you a victim of the RS-232 CABLE FABLE?



Which one have you heard? For example: "It has a 'standard' RS232 interface," or "All you need is a standard printer cable," or "If you have the manuals, I can probably figure it out with my breakout box."

The truth is that RS232C is one big non-standard. There are literally hundreds of possible configurations. Which one's for you?

**THE SMART CABLE 817** — Here's the one cable to connect virtually any computer to nearly any serial peripheral. No more "standard" cables. It's easy! It's the **SMART CABLE SC817** from IQ

Technologies. Just plug it in, flip a switch, and its ingenious electronics do the rest. Instantly. Automatically.

**SMART CABLE 817** is lightweight and compact and has a built-in male or female connector (you specify). The cable end has both a male and a female connector. Smart Cable does not require batteries or its own power source.

Smart Cable is the first truly universal connector for RS232 interfaces. Use it to connect any computer to any RS232 device. Don't let "cable fables" confound you any longer. Start making intelligent connections with Smart Cable.

"Another heaven-sent accessory." —*PC Week*

"A marvel of ingenuity." —*Microcomputing Magazine*

"4 excellents, 1 good." —*InfoWorld Report Card Rating*

"The answer to a costly problem." —*PC Magazine*

Just **\$49.95** plus shipping

Call **1-800-227-2817**

Dealer inquiries invited

MASTERCARD/VISA ACCEPTED

IQ TECHNOLOGIES, INC. BELLEVUE, WA

OTHER SMART PRODUCTS: SC 807 (IBM PCjr), SC 809 (Apple IIc), SC 821 PLUS (Smart CableMaker), SC 880 (IBM PC-AT), SMART SWITCH BOX 1000, SMART SWITCH BOX 1300, SMART DATA METER 931.

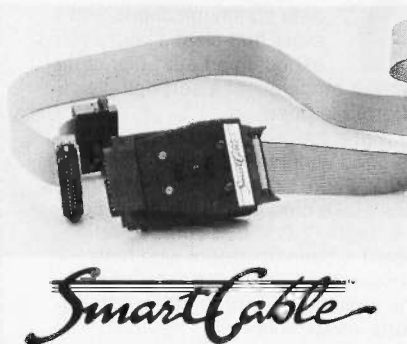



# AMERICA'S NEXT FAVORITE MOUSE.

The best price: \$99

## THE BEST HARDWARE:

LOGITECH has been the leading OEM mouse company for years, quietly providing mice to companies like AT&T, DEC, and H-P. We've designed LOGIMOUSE C7 just for the retail marketplace. And poured all our years of hardware engineering into it. You simply can't find a better mouse.

- IBM PC/XT/AT compatible through any serial port
- NO pad, NO external power supply
- HIGH (200 dpi) resolution
- Tactile feedback switches

## THE BEST SOFTWARE:

LOGIMOUSE is now available with all new software that sets new performance standards for the mouse:

**LOGIMOUSE Base Package** **\$99**  
 ■ LOGIMOUSE Driver Version 3.0: Faster and smaller. Makes LOGIMOUSE compatible with all Microsoft applications.

**LOGIMOUSE Plus Package** **\$119**

- LOGIMENU—Programmable Pop-Up Menu System: Customizable for all your favorite keyboard-based applications. Fully compatible with Microsoft Menu, only better.
- CLICK: A new concept in mouse software! It resides in memory, detects which application you are running and sets the mouse to your predefined setting. You define macros for the mouse buttons, set the mouse baud rate and protocol, define the pop-up menus to be used by LOGIMENU. Just add CLICK to your autoexec file and LOGIMOUSE will be ready to go with each of your favorite applications. So you can get down to work.
- POINT-AND-CLICK SHELL for Lotus 1-2-3: No more jerky cursor movement, no more delays, no more beeping. To select a cell, execute a command, scroll your spreadsheet, or call up context sensitive pop-up menus, just point with the mouse and click!
- POINT EDITOR—Mouse Based Program Editor: If you think a mouse was not meant for editing, POINT will change your mind.

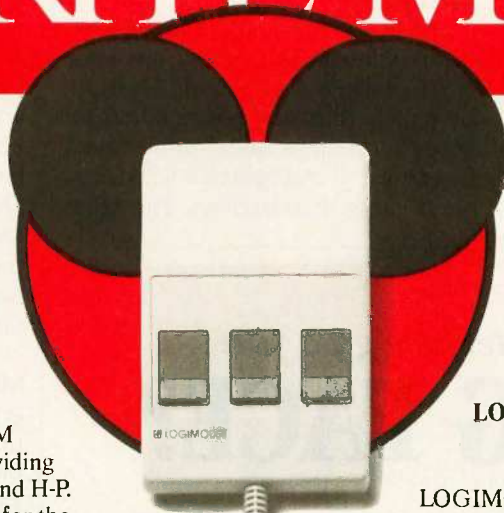

# LOGIMOUSE® C7

## LOGIPAINT SET

**With Base Package** **\$149**  
**With Plus Package** **\$169**

LOGIMOUSE C7 plus PC Paintbrush 3.0 is the most advanced paint set available for the PC. Use LOGIPAINT to design a logo, paint, or draw

a picture of a product you're developing. You won't believe its power with either free hand drawing or graphics.

To place a credit card order call our special toll-free number:

**800-231-7717**

Call toll-free in California:

**800-552-8885**

**YES!** I want America's next favorite mouse!

Please send me:

- |   |                                     |  |
|---|-------------------------------------|--|
| <input type="checkbox"/> LOGIMOUSE Base Package | <b>\$ 99</b>                        | Add \$6.50 for shipping & handling. Calif. residents add applicable sales tax. |
| <input type="checkbox"/> LOGIMOUSE Plus Package | <b>\$119</b>                        |  |
| <input type="checkbox"/> Plus Package Software  | <b>\$ 29</b>                        |  |
| <input type="checkbox"/> Base LOGIPAINT SET     | <b>\$149</b>                        |  |
| <input type="checkbox"/> Plus LOGIPAINT SET     | <b>\$169</b>                        | <b>MONEY BACK GUARANTEE</b>  |
| <input type="checkbox"/> VISA                   | <input type="checkbox"/> MASTERCARD | <input type="checkbox"/> CHECK ENCLOSED  |

Card Number \_\_\_\_\_ Expiration Date \_\_\_\_\_

SIGNATURE \_\_\_\_\_

NAME \_\_\_\_\_

ADDRESS \_\_\_\_\_

CITY, STATE \_\_\_\_\_

ZIP \_\_\_\_\_ PHONE \_\_\_\_\_

DEALER INQUIRIES WELCOME



# LOGITECH

LOGITECH, Inc.

805 Veterans Blvd., Redwood City, CA 94063, USA

Telephone: (415) 365-9852

LOGIMOUSE is a registered trademark of LOGITECH, Inc. Lotus and 1-2-3 are trademarks of Lotus Development Corp. Microsoft is a trademark of Microsoft Corp. PC Paintbrush is a registered trademark of ZSoft Corp.

wheels, keyboard pressure sensors) will not be transmitted to the host. In certain cases, the sequencing software does not want to receive all this data in order to conserve memory for higher-priority note data.

Another type of filtering, called channelizing, may also be enabled. By telling the MPU-401 which channels are acceptable to receive from, it's possible to reject or reassign signals

emanating from particular source channels.

### MIDIMAC

Opcode System's MIDIMAC interface is the ultimate in simplicity. It is a narrow metallic box measuring 1½ by 6½ by 1 inch that attaches to either the Mac's modem or serial printer port. Just plug it in and tighten it with a couple of large thumbscrews. The MIDI-

MAC box houses four MIDI jacks— one MIDI in and three MIDI out.

There isn't much we can say about this device: You plug it in and it works. Since the Macintosh is equipped with serial ports that can operate well beyond MIDI's 31.25 kHz, the only hardware required for a MIDI interface will be clock circuitry and optoisolators, hence MIDIMAC's compact design. There are no extra features on the MIDIMAC beyond the two extra MIDI-out ports; we were particularly unhappy to find no drum machine and tape-sync signal jacks available.

Also, if you have purchased the MIDIMAC interface and decide to upgrade to a Mac Plus, you will discover that not only has Apple made the Plus's new serial ports' mini DIN-8 jacks incompatible with MIDIMAC's connector, but even if you could make an adapter cable, the Mac Plus does not provide 5 volts on any of the new ports' pins. (The Macintosh does, and this is where the MIDIMAC gets its power.) Opcode Systems will upgrade a MIDIMAC to function with the Mac Plus for \$50, and since this requires modifications to the MIDIMAC's circuit board, you have to mail it in to have it "fixed." (You can purchase the MIDIMAC in a Mac Plus-compatible form to begin with for \$50 more than the Macintosh version.)

## Does your interface give you A LONG FACE?



It's sad! The hours that people spend trying to get two pieces of hardware interfaced through the serial ports. They buy "standard" cables that don't work! They call the "Tech Assistance" line and that's busy. They fiddle for hours with a breakout box and still don't get the correct pin configuration.

Well, now they can smile and use those hours for something productive! The **SMART CABLEMAKER SC821** has arrived.

Unlike other cable devices claiming to resolve RS232 connections, SC821PLUS's LED display gives a complete graphic display of the interface. And you know the interface is correct because your system is already up and running.

Total time to interface 2 pieces of equipment and figure the correct interface? About 30 seconds! Try that with a breakout box.

#### Features:

- Instantly interfaces all RS232 serial asynchronous equipment.
- Displays the correct cable configuration of the equipment being interfaced.
- Reconfigures for each RS232 application needed.
- Comes with 2 cables with male and female DB25 connectors on each end.
- Does not require batteries or power supply, derives power from attached devices.
- Tri-state LED's. Smart Cable logic.

Just **\$149.95**  
plus shipping

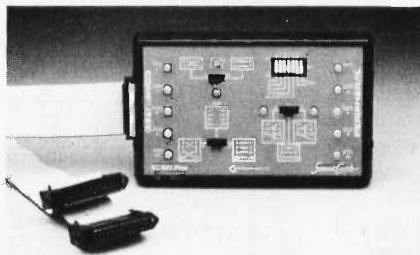

*Smart Cable*

Call **1-800-227-2817**

Dealer inquiries invited

MASTERCARD/VISA ACCEPTED

IQ TECHNOLOGIES, INC. BELLEVUE, WA

OTHER SMART PRODUCTS: SC 807 (IBM PCjr), SC 809 (Apple IIc), SC 817 (Universal RS-232 Interface), SC 880 (IBM PC-AT), SMART SWITCH BOX 1000, SMART SWITCH BOX 1300, SMART DATA METER 931.

### CONCLUSION

Since we purposefully selected devices for different machines, it would not be fair to perform head-to-head comparisons; an interface's capabilities depend largely on the machine for which it is designed. For example, although we mentioned our displeasure with MIDIMAC's lack of anything beyond MIDI ports, it's obvious that MIDIMAC's limitation is due to the fact that the only kind of ports Macintosh provides are serial ports. (If you're going to have a foot-switch connector, a clock out, and a start/stop trigger as on the TDS-AP, you're either going to have to use a parallel port or a very high-speed serial port with some serial-to-parallel conversion hardware.)

Still, we hope that we have given you an idea of some of the interfaces available for your computer. ■



# FREE OVERNIGHT DELIVERY & GUARANTEED LOWEST PRICES ON IBM-PC & COMPATIBLE HARDWARE AND SOFTWARE.

## FREE OVERNIGHT DELIVERY

Buy it today . . . use it tomorrow! Only Logisoft ships your order the same day via overnight courier\* . . . at no additional cost to you.

## OUR LOWEST PRICE GUARANTEE.

We're so confident about our low prices that if you can find a lower price, we'll beat it by \$10<sup>†</sup>. This includes any bonafide advertised price or quote on any of the hundreds of products we stock. Our Corporate Accounts Program also offers attractive volume discounts.  
Credit cards and PO's accepted.

## TOLL-FREE CUSTOMER SERVICE.

Customer service and technical support are only a toll-free call away. It's another reason why Logisoft has become the major supplier of hardware and software to more than 50,000 companies worldwide, including over 90% of the Fortune 1000.

# LOGISOFT®

To order or receive technical assistance, call our National Hotline:

**1-800-645-3491**

NY STATE: 1-800-235-6442 (516) 249-8440

Customer Service: 1-800-431-9037

FAX # 516-249-5289

Circle #400 on reader service card.

110 Bi-County Blvd., Dept. 543  
Farmingdale, NY 11735  
CANADA: 416-283-2354  
Domestic/Int'l Telex  
286905 SoftUR

EUROPE: 020-83 48 64  
Telex: 10759 Logic NL  
Mail orders to:  
LOGISOFT EUROPE BV  
p/b 9460, 1006 AL Amsterdam, Holland

\*Applies to order totaling over \$100. Shipped UPS—free if under \$100 (within Cont. U.S.). Due to weight restrictions, printers and monitors are shipped UPS—free.

<sup>†</sup>This offer does not apply to items under \$100, American Express or Terms orders. In these instances, we will meet any lower price. (We reserve the right to request a current written price quote.)

# NOW LEASE OR PURCHASE SYSTEMS FROM LOGICSOFT.

## THE ECONOMY AND FLEXIBILITY OF A LOGICSOFT LEASE.

High tech without high cost. Outstanding flexibility. Plus substantial tax benefits. Logicsoft's new leasing program gives you them all and much more. Lease the computer system you need now for 36 months (customized lease programs also available) at one of our low, low rates. At the end of the term, you can purchase the system for only 10% of the original purchase price. Or negotiate a lease extension. Give Logicsoft a call. We'll begin processing your lease agreement right over the phone. And deliver your system within three days. First and last lease payments required in advance. Lease proposals subject to credit approval. Rates based on current cost of funds.

## FREE 90-DAY, ON-SITE SERVICE ON ALL SYSTEMS.

Whether you lease or purchase a system from Logicsoft, you get a unique bonus: *a free 90-day, on-site system hardware service contract.* We've contracted with one of the nation's largest and most respected independent computer maintenance firms to provide you free service in most metropolitan areas. If a problem arises, it'll be corrected quickly and efficiently. *At your facility. And at no additional cost to you.* There's no inconvenience of transporting your system to and from a service center. Wherever you are. Whatever the problem. Expert assistance is only a phone call away.

# LOGICSOFT®

To order or receive technical assistance, call our National Hotline:

110 Bi-County Blvd., Dept. 543  
Farmingdale, NY 11735  
CANADA: 416-283-2354  
Domestic/Int'l Telex  
286905 SoftUR

**1-800-645-3491**

NY STATE: 1-800-235-6442 (516) 249-8440  
Customer Service: 1-800-431-9037  
FAX # 516-249-5289

Circle #400 on reader service card.

EUROPE: 020-83 48 64  
Telex: 10759 Logic NL  
Mail orders to:  
LOGICSOFT EUROPE BV  
pb 9460, 1006 AL Amsterdam, Holland

No surcharge for MasterCard, VISA, American Express, C.O.D., money order, check or PO's (please call for price verification) • No sales tax on orders shipped outside N.Y. State • Please add 2% for insurance and handling (Int'l orders add'l) • We do not bill until we ship. All products covered by mfg's warranty. Defective merchandise may be returned for repair or exchange only. We do not guarantee compatibility. Any goods returned for credit are subject to a 15% restocking charge.



# CONCERTWARE+ AND SONGPAINTER

BY MARIO SERGIO BERNARDO

## *Two software packages for making music on the Macintosh*

The ConcertWare+ and SongPainter software packages for the Apple Macintosh allow you to experiment with sound and learn more about composing music. ConcertWare+, which includes a complete sound-manipulation toolkit for experimentation, can be educational for both experienced and novice users. The SongPainter software package, on the other hand, has serious limitations.

### **CONCERTWARE+**

ConcertWare+ includes three integrated music utilities, Music Player, Music Writer, and InstrumentMaker, as well as 22 demonstration selections and 40 preset instrument sounds.

### **MUSIC PLAYER**

Music Player is a separate song-playing file with over one hour of demonstration musical selections. Short sentences identify each selection and its composer. Also, the sound quality is very good. You cannot edit the music from the player mode, but you can select demonstration songs, repeat them, and combine the songs in any order. You can change the tempo and choose any four instruments for playback. Unfortunately, the Music Player's "scrolling display" does not display real music notation; it displays only dots and dashes.

One other annoyance with Music Player is the lack of a volume control on the play-mode screen; you have to exit to the Apple control panel in order to modify volume. If you connect the audio output in the back of the Macintosh to your stereo unit, you can control the volume from the

stereo as well as produce better sound quality.

### **MUSIC WRITER**

With the Music Writer utility, you can input traditional music notation using the complete 88-key piano range. You can use all note and rest values from sixteenth to whole notes (including dotted notes and triplets), dynamic (volume) markings, all major and minor key signatures, as well as any individual pitch or accidental (sharp, flat, or natural). There is also a mode for quick vertical chord entry. You can play every possible combination of four-voice parts for any of the demonstration or user-created musical selections.

Music Writer's display supports real music notation with a large staff format appropriate for those unfamiliar with music notation. An additional, smaller split-screen format above the score displays the voice part currently being edited. Unfortunately, the display does not scroll the music as it's being played. You hear the entire selection, but you are left looking at the first few measures of the written score.

The creators of Music Writer took care to use terms and procedures that let you edit music without great difficulty. There are shortcuts for experienced users, including keyboard entry for note and rest durations, accidentals, and octave shifts, and a

very useful sound-with-entry mode that uses the bottom two rows of the Macintosh keyboard as piano keys. You can use this feature to review changes you make to an instrument's vibrato, to a waveform, or to an attack-decay-

sustain-release (ADSR) envelope. Another welcome feature for experienced users is a basic form of real-time input of note values using the keyboard or mouse. However, you must insert rest values manually, and you can only input one voice at a time.

In entry mode, a rhythmic auto-correction feature will correct notes to valid values. The program supports time signatures from 1 to 16 beats per measure and the choice of half, quarter, eighth, or sixteenth notes as the beat unit. Tempo control in ConcertWare+ could be improved. The program has 14 stepped values with gaps between values. Since there are 34 traditional metronome markings, many of these fall between ConcertWare+'s values and are not available.

The editing features in ConcertWare+ are easy to use and include cut and paste, transpose, delete, slurred and tied notes, and a quick way to change multiple note durations simultaneously. You can change instrument sounds and dynamic markings anywhere in the score. You can also edit and manipulate Music Writer scores with MacPaint, perhaps to in-

*(continued)*

Mario Sergio Bernardo (35 Hill St., Naugatuck, CT 06770) is a concert saxophonist and instructor of music at Keene State College in Keene, NH. He is currently performing and doing music research on a Fulbright Grant in Portugal.

sert lyrics, note beams, and so on. [Editor's note: Beaming is a new feature in the latest release of Music Writer.]

ConcertWare+ has excellent printing options. It allows full use of margins and varied paper and type sizes (see figure 1). It also lets you print individual voices or any combination of voice parts, providing a basic version of instrumental-part extraction. This is useful for chamber ensembles, quartets, or four-part vocal scores. You can print entire scores or just specific pages.

#### INSTRUMENTMAKER

InstrumentMaker lets you manipulate the sound parameters of the Macin-

tosh sound chip. You can create new or edit existing instrument waveforms, ADSR envelopes, harmonic-overtone envelopes, and vibrato, all by drawing the desired contour on the screen. You can combine different parameters of existing preset instruments into a new sound and get instant sound feedback on your changes by using the keyboard.

You can draw waveforms with the mouse on screen or create them from their individual harmonic content, starting with the fundamental tone and adding the next 19 harmonic overtones in any mix you desire. Similarly, you can draw the ADSR envelope directly on screen, without

getting directly involved with numeric values or parameters as on professional music synthesizers.

The vibrato controls are equally flexible. You can change width, modulation midpoint, length, and sustain.

Concertware+'s documentation is generally excellent, although it would be helpful to first-time users to include more detailed backup procedures and directions for the organization of working disks. This information is found in an appendix, not at the beginning of the manual.

#### SONGPAINTER

SongPainter has very attractive screen graphics, packaging, and an impressive manual, but it is a disappointing program. The SongPainter manual cover claims that you will be able to write from "simple songs to software symphonies." The maximum composition length, however, is 48 measures in 4/4 time. At the slowest of tempos, 48 measures generally accounts for only a few minutes of music. Traditional symphonic form ranges from 20 minutes on up in duration and includes hundreds or thousands of measures and complexities in harmony, rhythm, and orchestration, beyond the very rudimentary capabilities of SongPainter.

SongPainter is an icon-driven music package that represents instrument sounds and note lengths on the screen with icons rather than traditional music notation. The instrument icons are placed in "frames" along four horizontal "tracks," each representing an available voice part. You select notes by their names (C, C#, D, etc.). When selected, each note sounds so that you can determine its appropriateness. There are also help menus with descriptions of the various options available. The many demonstration selections are grouped by category.

#### DEFAULT VALUE

A control window lets you select note volume levels and durations. However, SongPainter's default duration value of one frame equaling a sixteenth note can be rather awkward, since

(continued)

**Concerto in D minor (for two violins)**  
**Johann Sebastian Bach (1685-1750)**

Now known as a composer, Bach was renowned by his contemporaries as a violinist and organist. This "Bach Double" concerto is a favorite among violinists.

Figure 1: An example of a printout using ConcertWare+'s printing options, which allow full use of margins and varied paper and type sizes.





# YOUR PC WANTS YOU TO GIVE IT THE SAME ADVANTAGE YOU GIVE YOUR TAPE DECK AND VCR.

It's only fair. Not to mention logical. PC's want to perform as well as all your other sophisticated electronic equipment. If you're like millions of informed people throughout the world, you rely on the ultimate in audio and video recording performance. You rely on TDK.

Well, you should also rely on TDK when it comes to your computer. TDK's Floppy Disks provide the same consistently high performance. The same level of absolute quality. Which is understandable since all TDK products share an unparalleled level of technical superiority that spans over 50 years.

In fact, TDK is the world's largest manufacturer of magnetic media.

What's more, they're also a major producer of electronic component parts, including the most sophisticated heads for disk drives. What a strategic advantage! With vital "inside" information like that, it's no wonder their disks provide error-free performance.

So, if you want to put a smile on your computer's face, choose from TDK's family of 5.25-inch standard, 5.25-inch High Density and 3.5-inch No-Risk™ Disks. It's to you and your PC's advantage.

 **TDK**  
THE NO-RISK™ DISK.

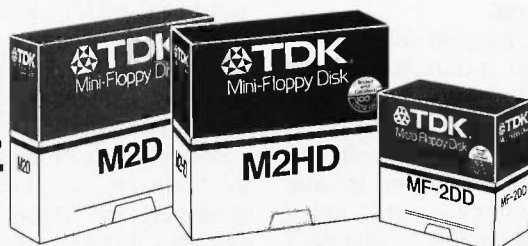

## AT A GLANCE

<b>Name</b>	ConcertWare+	SongPainter
<b>Type</b>	Music processor	Music processor
<b>Company</b>	Great Wave Software POB 5847 Stanford, CA 94305 (415) 325-2202	Rubicon Publishing 6300 La Calma, Suite 123 Austin, TX 78752 (512) 454-5004
<b>Disk Format</b>	one 3½-inch disk	one 3½-inch disk
<b>Computer</b>	128K Apple Macintosh	128K Apple Macintosh
<b>Features</b>	40 preset instrument sounds, custom instrument sounds, 23 demonstration songs, keypad play and real-time input, playback of individual parts, visual metronome, 64 meters, 14 tempos, all major and minor keys available, output as MacPaint document, and traditional music notation including ornaments and special markings	32 preset instrument sounds, 37 demonstration songs, playback of individual parts, 3 meters, 7 tempos, all minor keys available, and miniature dictionary definitions
<b>Documentation</b>	Manual	Manual, help function
<b>Price</b>	\$69.95	\$39.95

music usually uses both longer and shorter note values than a composition's basic beat. It would have been more practical for the default value to equal a quarter note (four SongPainter frames), a more usual beat in popular music. As it stands, if you decide toward the end of a composition that you need a faster note value than the present one-frame value, you have to first convert the entire song by doubling all the note durations and the tempo, followed by your new quicker note values. If the quarter note were the default value, you would have two faster values to fall back on.

**WRITING A SONG**

To write a song, you first select an instrument (perhaps a clarinet) from the voice window. To enter a sixteenth-note D for the first voice, you would choose the note name D from the tone window and the desired volume and duration (in this case one frame) from the control window. Finally, click

the mouse over frame 1, track 1 of the song window (the grid of four horizontal tracks upon which you place the instrument-, duration-, and pitch-icon information). For an eighth note, you would select a duration of two (frames) from the control window. A playback window allows you listen to, pause during, or repeat your song.

The height of each instrument icon corresponds to the individual note volume; a blank frame indicates silence or rest. SongPainter remembers the last combination of selected values, allowing you to enter repeated note characteristics very quickly. In addition, you edit on the same song window used for writing. You can see the names of the notes you have chosen, but this does not, in my view, serve as a satisfactory substitute for real music notation.

Some basic elements of music, such as measure and beat, have been stretched to accommodate SongPainter's bizarre method of music

notation. The frames used in SongPainter's notation do not correspond to beats. They are subdivisions of the beat, usually one real musical beat equal to four of SongPainter's frames. In addition, the completed song, often with dozens of different icon blocks on the screen, makes it impossible to detect music elements such as pitch, duration, and rhythm. The tapestry of icon shapes is a nice effect but has little or no value musically.

There are many other problems. There are only seven tempos available, with wide gaps between them. The only time signatures available are 4/4, 3/4, and 2/4. Therefore, you cannot set such important and often used time signatures as 6/8 and 2/2. Similarly, there are only nine preset changes available to modify the timbre envelope. Also, the only four-part harmonies allowed are major, minor, augmented, diminished, and seventh chords. More disturbing still, the chords labeled as major seventh sound like dominant seventh chords and vice versa, a very serious mistake since both serve different musical functions.

Unlike ConcertWare+'s musical dynamic markings (pp, p, mp, mf, etc.), SongPainter's volume markings are labeled quiet, medium, and loud. With accenting on, you can emphasize any sixteenth division of a measure, one of SongPainter's nicer features.

**CONCLUSION**

In conclusion, I would highly recommend ConcertWare+ for educational and musical exploration. Its strengths are the InstrumentMaker section and MusicWriter's ease of editing and entry of music. In addition, ConcertWare+ is also compatible with professional music synthesizers that have MIDI-to-Macintosh interface capability.

I find SongPainter restrictive and confusing, and I cannot recommend it, especially not for educational purposes. Those with the slightest musical knowledge will find themselves bored and frustrated by this music package, and novices will erroneously believe they are learning correct musical concepts. ■



# THIRD GENERATION PROGRAMMERS FROM GTEK

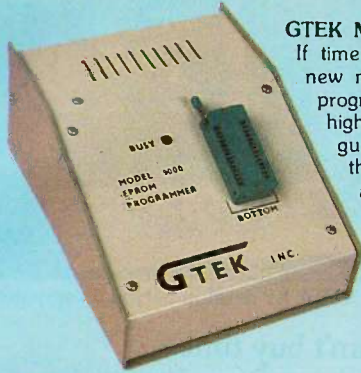

**GTEK MODEL 9000 (E)EPROM/MPU PROGRAMMER**  
 If time is money, then let us save some for you. The new model 9000, using its quick pulse algorithms, can program a 2764 in 10 seconds. The 9000 offers higher performance than the competition has even begun to think about. Baud rates to 57,600. Supports thru 512K standard, 8 meg worldwide parts with adapter, Cypress proms, mpu's. NO personality modules. As with our other programmers, RS-232, ASCII data formats, and flexible handshaking make the model 9000 compatible with virtually any computer. Introductory price \$749.

**MODEL 7228 (E)EPROM/MPU PROGRAMMER** The standard by which other programmers are judged. With thousands in the field, the time proven 7228 has become our most popular programmer. Intelligent algorithms standard. Programs a 2764 in one minute. Supports devices thru 512K, mpu's, eeproms, cmos. NO personality modules. Price \$599



**MODEL 7956 GANG (E)EPROM/MPU PROGRAMMER**

The 7956 can program eight 2764's in one minute using intelligent algorithms. Standard support thru 512K, eeproms, cmos, mpu's. A must for production environments. Available in stand alone only configuration for \$979 or with RS-232 interface for \$1099



**MODEL 7128 (E)EPROM/MPU PROGRAMMER** The programmer that won't die. Thousands manufactured since 1982. Supports thru 256K. **PRICE REDUCED** to \$389 including free PGX communications software, a \$95 value.

**MODEL 705** Motorola 68705 family programmer. Transfers object code to 28 and 40 pin mpu's. Single key stroke operation. \$299

**MODEL 7324 PAL PROGRAMMER** The 7324 has a built-in compiler. It supports 20 and 24 pin pals by MMI, NATIONAL, and TI, including the new shared product parts 20S10, 20RS10, 20RS8, 20RS4. It operates stand alone or via RS-232 with PALX communications package. Functionally tests parts after programming and securing. External compilers are supported thru JEDEC and AHS object formats. \$1499

**MODEL 7322** Same as 7324 but no stand alone capability. \$1249

**UTILITY PACKAGES**

**PGMX High Speed Communications Package.** For IBM PC, AT and compatibles. Bi-directional data rates to a scorching 57600 bps. Provides flexible manipulation of Intel Hex files, both 8 and 16 bit formats, and binary files. Use with model 9000. \$149

**PGX Utility Package.** For PC DOS, CPM, TRSDOS, ISIS, MSDOS. Use with 9000, 7956, 7228, 7128. \$95

**PALX Utility Package.** Provides communication, download of Palasm source. JEDEC and AHS object files to models 7324, 7322, 7316 pal programmers. \$95

**CROSS ASSEMBLERS and SIMULATORS**

You name the cpu, we've got the assembler. Simulators allow target software development and testing on your computer. Versions available for PC DOS, MSDOS, CPM. Start at \$200

**ERASERS**—We stock both Ultra Violet Products and Spectronics for your selection.

MODEL	CHIPS	TIMER	LAMP	PRICE
DE4	8	N	Tube	\$80
PE14T	9	Y	Tube	\$129
C25	25	Y	Grid	\$349
C50	50	Y	Grid	\$599

**ACCESSORIES**

- CABLES**—serial \$30, parallel \$30, custom Call For Quote
- MODEL 481/482/483 8048 family adapters \$98
- MODEL 511/512 8051 family adapter \$174
- MODEL 755/756 8755 adapter \$135

**SPECIAL REQUIREMENTS?** Call Us For A Quote On Custom OEM Programmers.

Run CPM Software on Your IBM or IBM Compatible

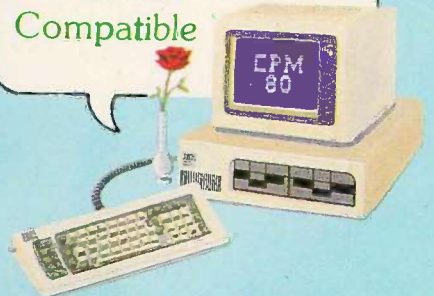

If you are a CPM user who wants to convert to MSDOS or PC DOS or a PC user who would like access to the thousands of CPM programs in existence, here is the perfect solution to the problem: CPEmulator from GTEK.

CPEmulator is the only field proven emulator which emulates the complete Z-80 instruction set. Terminal attribute emulation is Televideo, Lear Siegler, or the AMSI standard. CPM programs reside under PC DOS and are executable under PC DOS as well as 8086 programs.

Comes complete with COPYCPM, a disk conversion utility which allows transferring data and programs to and from 54 different CPM disk formats. Free CPM utility programs are also included.

Need speed? CPEmulators Speed Kit includes NEC V20 processor. (8080 opcodes only)

- CPEmulator Z80 emulator \$199
- CPEmulator 8080 emulator w/V20 \$199
- Both versions \$298

Call GTEK's CPM Hotline 1-601-467-9019

**The Printing Solution: Model 8014 Programmable Printer Switch**



Finally a way to have as many parallel printers as you need even when you only have one parallel port. With GTEK's programmable parallel switch, you can expand as you require. Perfect for networks.

With the spooling version, you can allocate available memory to fit your requirements, get multiple copies and more.

Both use ordinary IBM type parallel printer cables, expand one port to four, and may be cascaded in Star or Daisy Chain configurations for as many ports as desired. The desired port is selected with a simple escape sequence. For networks, previous selected port is saved on Port Stack and returned to with Return Escape Sequence. Complete with power supply.

- Model 8014 Four port programmable switch **PRICE REDUCED \$199**
- Model 8014-128K with 128K spool memory \$399



Development Hardware/Software  
 P.O. Box 289, Waveland, MS 39576 U.S.A.  
 601/467-8048; telex 315-814 (GTEK UD), INC.

GTEK, PALASM, CPM, MS-DOS, PC-DOS, ISIS, TRSDOS, & CPEmulator are registered trademarks.



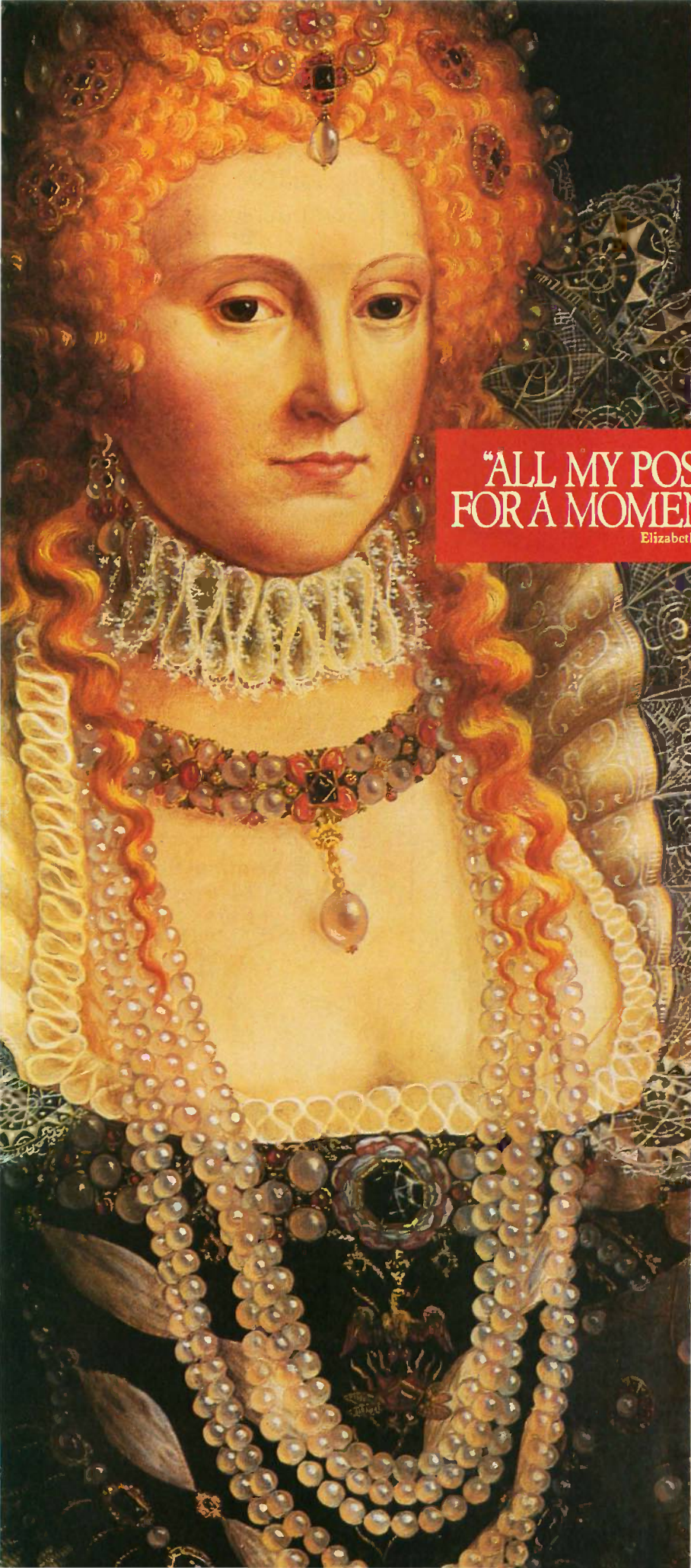

**"ALL MY POSSESSIONS  
FOR A MOMENT OF TIME."**

Elizabeth I



The ITT XTRA XP desktop personal computer

**You can't buy time.**

Long before Queen Elizabeth I, man began his quest to hoard that most precious and elusive of commodities. Time.

He can only make better use of the few hours he already has.

Hence, the development of today's business computer.

**The ITT XTRA™ XP. Our crowning achievement.**

By matching memory to the muscle of the Intel 80286 microprocessor, we're able to achieve "no wait states."

Processing never pauses for slower memory.

Making the ITT XTRA XP thirty percent faster than the IBM AT. And fully XT-compatible.

Giving you speed and flexibility.

Because, being a corporation of many businesses, we're in a unique position to better understand what you need to grow.

Today, as well as tomorrow.

	ITT XTRA XP	COMPAQ 286	IBM PC/AT
Lotus 1-2-3	11sec	13sec	15sec
dBase	36sec	52sec	56sec
FormSort	52sec	1min 5sec	1min 10sec

All comparisons are for purposes of illustration only. User's application performance is dependent on application.

**A moment's investment today can pay off royally tomorrow.**

Call (800) 321-7661. In California, (800) 368-7300.

And call quickly. Every moment wasted is a potentially profitable moment you'll never possess again.



**BECAUSE TIME IS THE  
ULTIMATE BOTTOM LINE.**

© 1986, ITT Information Systems. IBM, PC/AT and PC/XT are registered trademarks of International Business Machines, Intel 80286 is a registered trademark of Intel Corporation. Compaq 286 is a registered trademark of Compaq Computer Corporation. Lotus and 1-2-3 are registered trademarks of Lotus Development Corporation. dBase is a registered trademark of Ashton-Tate.

Inquiry 166 for End-Users. Inquiry 167 for DEALERS ONLY





# THE KURZWEIL 250 DIGITAL SYNTHESIZER

BY CHRISTOPHER MORGAN

The Kurzweil 250 Digital Synthesizer means many different things to different people.

- For the performing musician, the 250 is a fully equipped real-time performance instrument that lets you switch instantly from one voicing to another. No disk calls are involved, since the machine has no disk drives; digital samples come directly from RAM and 3.6 to 6 megabytes of ROM. The 250 also lets you store custom voicings on disk using an optional Macintosh interface.
- For hardware and digital-sound aficionados, the 250's state-of-the-art software and 68000-based hardware produce a fine imitation of a nine-foot concert grand—to say nothing of other instruments and effects. (It does not imitate all of these sounds consistently well, but who's quibbling when the results are this spectacular!)
- For sound engineers and musicians, the 250 has an excellent sequencer program for digital recording and mixing of tracks. You can easily record your own sounds and add them to the synthesizer.
- The Kurzweil 250 gives would-be musicians the chance to sound like virtuosos by using tricks like speeding up the music without raising its pitch, quantizing sequences of notes to clean up the rhythm, and so on.
- The 250 is a first-class MIDI machine that can drive or be driven by dozens of other MIDI devices, including

*A system that  
offers users sampling,  
sequencing, transposition,  
MIDI, and a grand-piano sound*



scores of MIDI software programs for the Mac and other computers.

- For programmers, composers, and students, the 250 offers a complete music development language.

## DESIGN METHODOLOGY

Designer Raymond Kurzweil wanted to develop a machine capable of reproducing the subtle tonal complexity of a piano or other instrument and also allowing you to create, edit, and perform new sounds with complete artistic freedom and control. The Kurzweil design team has succeeded on virtually every count.

The main problem with digitally sampling and reproducing a complex

sound like the piano is that the tone changes dramatically when the notes get louder and louder. The ratios of the overtones and the quality of the attack change, so that a loud piano-tone waveform is not a linear extension of the same note struck softly. If you have access to a piano, try hitting one key progressively harder and harder. Note that even the hammer hitting the string becomes a factor in the overall sound as volume changes, particularly in the treble notes.

Such complexity poses a dilemma to the digital designer: How do you capture the sound of the piano without digitizing the entire range of dynamics for each note—a process that would require huge amounts of ROM storage (30 billion bits according to Kurzweil)? The 250 solves this problem with novel data-compression techniques that use proprietary algorithms.

The technique is briefly described in "The Kurzweil 250 Digital Synthesizer" by Donald Byrd and Christopher Yavelow (*Computer Music Journal*, September 1985). "The K250 stores samples in a modified floating-point format with 18-bit words. In effect, the fractions contain the waveform with its dynamic range compressed as much as possible; most of the

*(continued)*

*Christopher Morgan is a part-time professional musician and a former editor-in-chief of BYTE. He is currently the editorial director of Lotus Publishing. He can be reached at POB 829, Brookline, MA 02146.*

## AT A GLANCE

### Name

Kurzweil 250 Digital Synthesizer

### Company

Kurzweil Music Systems Inc.  
411 Waverly Oaks Rd.  
Waltham, MA 02154  
(617) 893-5900

### Size

Keyboard, 57 by 27 by 9 inches; pedal pod, 17 $\frac{3}{4}$  by 11 $\frac{1}{8}$  by 4 $\frac{1}{8}$  inches

### Components

Keyboard: 88 notes, velocity-sensitive

Channels: 12

Power: AC 110 volts, 50/60 Hz, 380 watts (220-volt option available)

MIDI (in, out, thru): 16 channels, user-assignable; each sequencer track can be assigned to a separate MIDI channel; special MIDI mode slaves one Kurzweil 250 to another

### Price

Basic Kurzweil 250, \$12,970; sound-modeling program, \$1995; Sound Block Module A, \$1995; MacAttach software and interface, \$195; stand, \$195; plexiglass music rack, \$75

An expander system is also available and comprises a Kurzweil 250 without the keyboard unit. Three versions can be supplied: a basic system (\$9980); base system plus enhanced instrument voices (\$11,975); and a base system plus voices, sampling, sound modeling, and Macintosh software (\$13,970)

dynamic information is in the exponents. For typical musical sounds, the K250's separation of the original sound into compressed waveform and exponent uses the sample bits much more efficiently than would be possible through uniform compression systems such as those of dbx or similar companders."

Besides its data-compression capability, the 250 offers new levels of performance in sound quality, user sampling, sequencing, transposition, and MIDI utilization.

### OVERALL DESIGN

The Kurzweil 250 is a true digital instrument. That is, it contains millions of digital samples of musical-instrument sounds (called "soundfiles" in Kurzweil nomenclature) stored in ROM. Pressing a musical key on the 250 causes the processor to extract digital samples from ROM. The samples are converted to analog signals in the channel board.

The basic instrument contains 40 soundfiles in ROM—including the grand piano. Also built into ROM is a series of factory-generated "instruments," Kurzweil's term for the effects (envelope, tremolo, vibrato, etc.) used to alter a soundfile that affects its sound.

To hear sound on the Kurzweil, you assign a keyboard setup to the physical keyboard. The keyboard setup contains one or more instruments, each of which is a modified soundfile. A keyboard setup can be simple (the grand-piano soundfile by itself, for instance), moderately complex (piano on the right side of the keyboard, string bass on the left), or quite complex (clarinet, oboe, stereo vibes, and bass on one layer, and organ on the other, with the restriction that the organ will sound only if you press the velocity-sensitive keys with sufficient force). It's easy to edit keyboard setups with the keyboard editor.

### HARDWARE

The Kurzweil 250 Digital Synthesizer comes in a compact case that looks like an electric piano or an organ at first glance. It is quite a handful to transport and requires two people to lift it. Beneath the main unit is a

separate module, or pod, containing the power supply and two footpedals that normally control sustain and mute. The functions of these two pedals, like virtually every other knob and slider on the 250, are user-assignable. By isolating the power supply in the pod, the designers have helped to reduce possible hum in the system.

The action of the 88-note, velocity-sensitive wooden keyboard is strikingly similar to that of a grand piano. Directly above the keyboard is the control panel containing 38 buttons and sliders and, in the center, a 24-character-per-line, two-line LCD that serves as the main user interface. (A close-up of the 250's keyboard and control panel is shown in photo 4 of "Digital Music Synthesis" by Robert Moog on page 165 of this issue.) A standard calculator-style keypad is used to maneuver through command menus.

At the far left of the control panel are four sliders used to tune the instrument, to pan sounds between the two stereo output channels, and to adjust overall volume. To the right of these sliders is a group of six buttons and three more sliders used to control chorusing (a whole set of pseudo-reverberation and echo effects to enrich the sound of the synthesizer), to assign alphanumeric names to files and keyboards, and to adjust brightness, detuning, etc. Buttons in the center of the panel control transposition, the footpedals, and so on.

To the right are the controls for the sequencer, the sound-modeling program (digitizer), the various editors, the MIDI interface, and the interface to the optional Macintosh computer (via Kurzweil's MacAttach software). The interface is used to store custom soundfiles, keyboards, and keyboard setups on Macintosh disks, enabling you to build up a library of custom sounds and to trade sounds with other users via disk or modem.

There are three main microcomputer boards inside the Kurzweil 250: the central processor, the channel-group processor, and the channel board (see figure 1). The central processor is a Motorola 68000 running at 10 MHz. It has 128K bytes of ROM

(continued)





## Remember the first time you upgraded your color graphics hardware? The thrill is still the same.

The discovery of color graphics. As a child, it was a significant event. As a business person, it will change the way you use your personal computer.

Genoa Systems proudly introduces a new and colorful technology for the PC called Spectra EGA. The Enhanced Graphics Adapter that lets you rediscover the benefits, and the thrill, of color graphics on your PC.

### **An EGA with a better vision.**

EGA compatibility is an art that only Spectra has mastered. And, while other EGA hardware is incompatible with current industry standards, Spectra EGA fully supports hardware and software designed for the IBM Enhanced Graphics Adapter, Color Graphics Adapter and Monochrome Graphics Adapter. *And* the Hercules Board.

This means that you don't have to wait around for new

software updates in order to begin enjoying your EGA today.

### **A lot more than just pretty pictures.**

The first thing you'll rediscover with your Spectra EGA is color. There is a whole lot more than ever before. Sixty-four separate colors, in fact, from which any sixteen can be displayed at once.

Next, you'll notice a higher resolution in both text and graphics modes.

The real fun comes in putting the board to work. You'll see soft scrolling, panning and windowing that was never before possible on a PC. And the flicker-free display will allow you to regulate these movements at any speed, or in any direction.

There are 512 characters carried in Spectra's memory that can all

be displayed at once. Which is twice as many as previously possible on a PC.

And if you wish to use other characters, or even create your own alternate character set, Spectra will support those, too.

### **More colorful features.**

Each Spectra EGA comes fully equipped with a parallel printer port, light pen interface and 256K RAM on the single board. This is especially good news because a full 256K RAM is needed to run most popular graphics software effectively.

### **One thrilling price.**

Perhaps the best news is Spectra's price.

Upon first glance you may find that the Spectra EGA and the IBM EGA seem to be very closely priced. But look again. Because the standard IBM EGA only comes with 64K RAM, whereas Spectra EGA comes with a full 256K.

Now, you may purchase the extra memory board you'll need from IBM at an additional cost of about 70-80 percent. Or you can buy Spectra EGA from Genoa...and rediscover the thrill of a bargain.

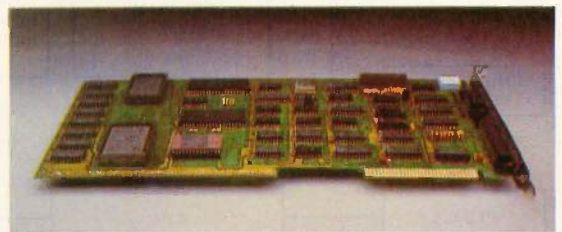

**Spectra Enhanced Graphics Adapter**

To find out more about Spectra, or a qualified Genoa distributor near you, call 408-945-9720. Or write to Genoa Systems Corporation, 73 E. Trimble Road, San Jose, CA 95131.

Spectra EGA from Genoa. Evolution in color graphics.

**Genoa**  
We make PCs better.

Inquiry 141

*Pitches can be changed on each channel independent of the other channels.*

and 128K bytes of battery-backed RAM for sequences, keyboard setups, instrument definitions, and general use. The system is extremely fast: Switching from one instrument sound to another is virtually instantaneous. By comparison, the MacAttach program plods along, taking from 2 to 4 minutes to load a custom soundfile.

The conversion to analog sound takes place in the channel board, which contains 12 channels, each with its own digital-to-analog converter, low-pass filter, and voltage-controlled amplifier. A mixer combines the 12 tracks down to 2 stereo outputs. For studio sound work, the Kurzweil offers balanced XLR inputs and outputs as well as unbalanced high- and low-level

connections. The Kurzweil 250 samples at a variable rate, meaning that pitches can be changed on each channel independent of the other channels.

The entire main chassis slides out of the unit at the rear for easy access. The engineers obviously put a lot of thought into the design of the boards and connectors. They are particularly easy to remove for servicing or upgrading.

To augment the sounds described for the basic 250, you can add the optional Sound Block A or B modules, which contain a set of 15 additional voices and 84 new factory-defined keyboard setups. The new keyboard setups also combine several of the new and old sounds. Further sound blocks are planned for the 250, including the recently introduced Sound Block C, which features several new pipe-organ sounds.

**SOFTWARE**

The possibilities for sound control on the Kurzweil 250 are virtually limitless. You control it by selecting commands from a large menu tree. The commands appear in the two-line LCD.

The simplest way to move around the menu is to use the four cursor-control arrows. Pressing the left and right arrows moves you back and forth within a given level of the tree; pressing the up and down arrows shifts you up and down the various levels of the tree.

You can also access any function directly by punching its code number into the numeric keypad or by using "shortcut" keys, a technique similar to that used in the Apple Macintosh when you want to avoid using the mouse to click on menu items. You can then access commands without having to step through the menus. However, you need to remember that certain Kurzweil keys get reassigned when you're using the various software editors.

**KEYBOARD-SETUP AND INSTRUMENT EDITORS**

The keyboard-setup editor lets you create your own keyboard setups out of combinations of instruments and soundfiles. Up to 40 such keyboards can be stored in the keyboard library, which is in battery-backed RAM, or on

*(continued)*

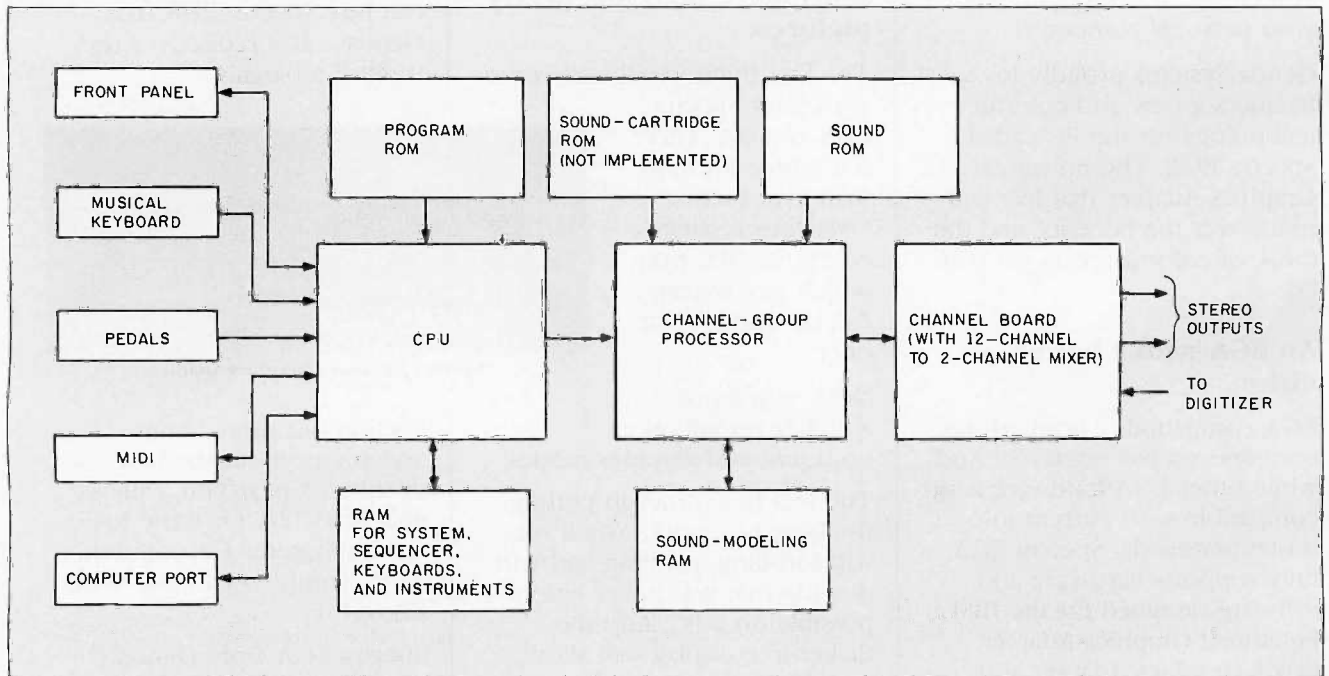

Figure 1. Block diagram of the Kurzweil 250 Digital Synthesizer, showing the three main microcomputer boards: the central processor, with its on-board Motorola 68000 microprocessor; the channel-group processor, used to extract and combine soundfiles; and the channel output board, which mixes as many as 12 channels of information into 2 and also serves as the input section for the digitizer.



# AT ONLY 80K... IT'S A WHOLE NEW BALLGAME!

Now, you can have it all... *all the software you need resident in RAM and plenty of memory to spare!* Because if you've got a hard disk, RAM disk or extended memory, Homebase now sets up a data space to swap data out when you call up one of Homebase's features. It's simple, very powerful and very sophisticated. And it allows us to give you the kind of Homebase you've been asking for... one that needs less than 80K!

In February, PC Magazine said, "Homebase is so elegant that it has one up on SideKick. One way to look at it is to say that Borland's product is a first generation organizer, while Amber's is second or third generation. This is one of those rare software offerings you have to see to believe. Each of Homebase's services could make it in the marketplace as a full featured stand alone product." And that was before we reduced the impact on RAM from 176K to 80K (and added a voice autodialer and an online editor)!

Imagine all these features, with so little overhead:

### Type-Ahead Keyboard Buffer

... User definable size, accepts control characters.

**Online Editor** ... Open a notepad, or edit a text file.

**Autodialers** ... (voice and data)

**ASCII Table** ... and Homebase allows you to add any other table you'd like, easily.

**Quickterm Terminal** ... Now, you'll have the ability to set up your computer to answer the modem and receive Electronic mail in the background while you're working in another application. You'll even be able to bring up Lotus while you're online!

Hit Alt Shift Q and jump right into the terminal no matter what other software you're running or plan to run while you're online. Includes Autodialer that saves and implements entire configurations. Scroll-back, X Modem file transfer and more.

### On-Line Context-Sensitive Help Calculator

... handles formulas, simple and complex math. Onscreen tape keeps track for you, converts between hex and dec, adding machine mode ... and much more. Variable window displays up to 26 variable values at once.

**Multiple Calendars** ... a system so powerful that it can keep track of a whole office, or a busy individual. Daily, weekly and monthly ... you can track appointments and business expenses ... even set alarms that show text from appointment slots. (alarm now automatically re-sets at re-boot.) Includes full search facility and coupled, daily to-do list.

**Online Databases** ... both free-form and structured databases available at the touch of a hotkey. The template maker allows you to create structured entry forms for your Homebase databases in minutes and the full search facilities let you manipulate the data easily.

**Phone Message Pads** ... just like the paper ones, but searchable, sortable and printable.

**On-Screen Clock  
Cut and Paste  
Screen Saver**

**Mobile Homebase** ... Homebase's Report Generator sorts, composes and prints information from your Homebase databases and calendars to clip into your appointment book when you're on the road. In addition, it can print out mailing labels, continuous form Rolodex™ cards ... it can even do mail merge.

**DOS Services** ... View up to four directories onscreen at once, copy or erase groups of related or unrelated files, view and even edit ASCII files ... and lots more. Create, delete and move between subdirectories visually.

**Phone Directory** ... you can search, sort, Autodial from and even print your phone directory.

Available at better dealers... worldwide.

PC Magazine  
Top Software  
Product of the Year!

**\$69.95**

\$29.95 Homebase Updates

Send in your original Homebase masters.



### SAFE!!!

Homebase Version 2.0 is compatible with most popular software, including Lotus, Word, dBase III+, WordStar 2000, and peripherals such as the Hercules monographic card, and EGA.

### Call Toll Free

800-538-8157 ext. 824

### SPECIAL OFFER Trade in your SideKick!

Get Homebase 2.0 for \$49.95  
(until July 15, 1986)

Just Send Us Your SideKick Disk!

in California

800-672-3470 ext. 824

Please enclose cheque or money order or ...

Visa  MasterCard  American Express

Card # \_\_\_\_\_

Exp. date \_\_\_\_\_

Homebase \$69.95\* per copy (Not copy-protected)

SideKick Trade In \$49.95

Homebase Update \$29.95

Please add \$5 shipping and handling  CA residents add 6½% sales tax.

30 day money-back guarantee.

Amount enclosed \$ \_\_\_\_\_

For the IBM PC, XT, AT and compatibles.

Name \_\_\_\_\_

Address \_\_\_\_\_

City \_\_\_\_\_ State \_\_\_\_\_ Zip \_\_\_\_\_

Phone: (Home) \_\_\_\_\_ Phone: (Office) \_\_\_\_\_ Ext: \_\_\_\_\_

Dealer, distributor and corporate quantity discounts phone: 408-996-1883

\*Orders outside the U.S., please add \$20 shipping and handling. (U.S. funds, please)



# More terminals without more computer



The advantages are clear. A BayTech port contender adds more users to your computer and does it at a price that's far less than expensive hardware or software modifications. A Model 5218B, for example, doubles your users by allowing 12 terminals to contend for 6 ports. Simple to set up and use, with easy-to-understand messages, the port contenders feature protocol conversion; user queue; disconnect by operator, computer or time-out; hardware or X-ON/X-OFF handshaking; and more. **(800) 523-2702**  
Seven models, \$629 to \$1,750.



Bay Technical Associates, Hwy. 603, P.O. Box 387, Bay Saint Louis, Mississippi 39520  
(601) 467-8231 Telex: 9103331618 (BAY TECH)

## REVIEW: KURZWEIL 250

a Macintosh disk using the MacAttach interface program.

The degree of freedom you have in creating keyboard setups is almost frightening. You can create your own sounds, musical or otherwise, and assign them to keyboards.

The instrument editor lets you control the chorusing, vibrato, tremolo, voicing, global parameters, and, via the envelope editor, the shape of the envelope waveform. The latter can consist of up to 255 separate segments, each of which can be a logarithmic-attack, exponential-growth, exponential-decay, or delay segment. Throughout, you have precise control of how quickly segments change in amplitude, what their absolute limits are, and so on.

### GLOBAL PARAMETERS

There are 10 user-controllable functions that affect the Kurzweil 250 globally. They are sustain, brightness, keyboard dynamics, tremolo, vibrato, pitch-bend, channel stealing, maintenance, chorus, and transposition. Some are straightforward, such as tremolo and vibrato. Others, such as chorus, are complex and can have a profound effect on the 250's sound.

Chorusing, as defined on the 250, involves combining a sound with altered versions of itself that are delayed in time or changed in pitch or volume. Chorusing can create the impressive illusion that an entire group of instruments is being played instead of just one.

Chorusing should always be applied judiciously, since certain keyboard setups used in the chorus mode quickly use up the available 12 channels. At that point the software must "steal" channels by selectively silencing some of the notes currently being played in order to play the newly struck keys. You have control over what algorithm the software uses to choose the notes to be "abandoned." Channel stealing is helpful in some situations but cannot get around the absolute hardware limitations of the basic system. (Still, compared to the monophonic, or one-note-at-a-time, synthesizers of the 1960s, today's polyphonic synthesizers are a plea-

(continued)

## DO YOU KNOW WHERE YOUR PROGRAM HAS BEEN?

If you know where your program is spending its time, you can improve its performance.

**The Watcher makes it easy.**

The Watcher collects data from one or more runs of your program. You can then instruct it to display as a histogram the percentage of time spent in different parts of your program and in DOS functions.

The Watcher uses symbolic information from the link map, including line numbers, or information you provide to relate the data to your source program.

## THE WATCHER KNOWS!

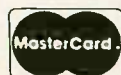

**\$39<sup>95</sup>**

*Stony Brook*  
INC.  
SOFTWARE

Forest Road, P.O. Box 107  
Wilton, New Hampshire 03086  
MC or Visa orders: (603) 654-2525

For any .COM or .EXE on PC, XT, AT or compatibles DOS 2.X or 3.X. Not for use with Basic or other interpreters.



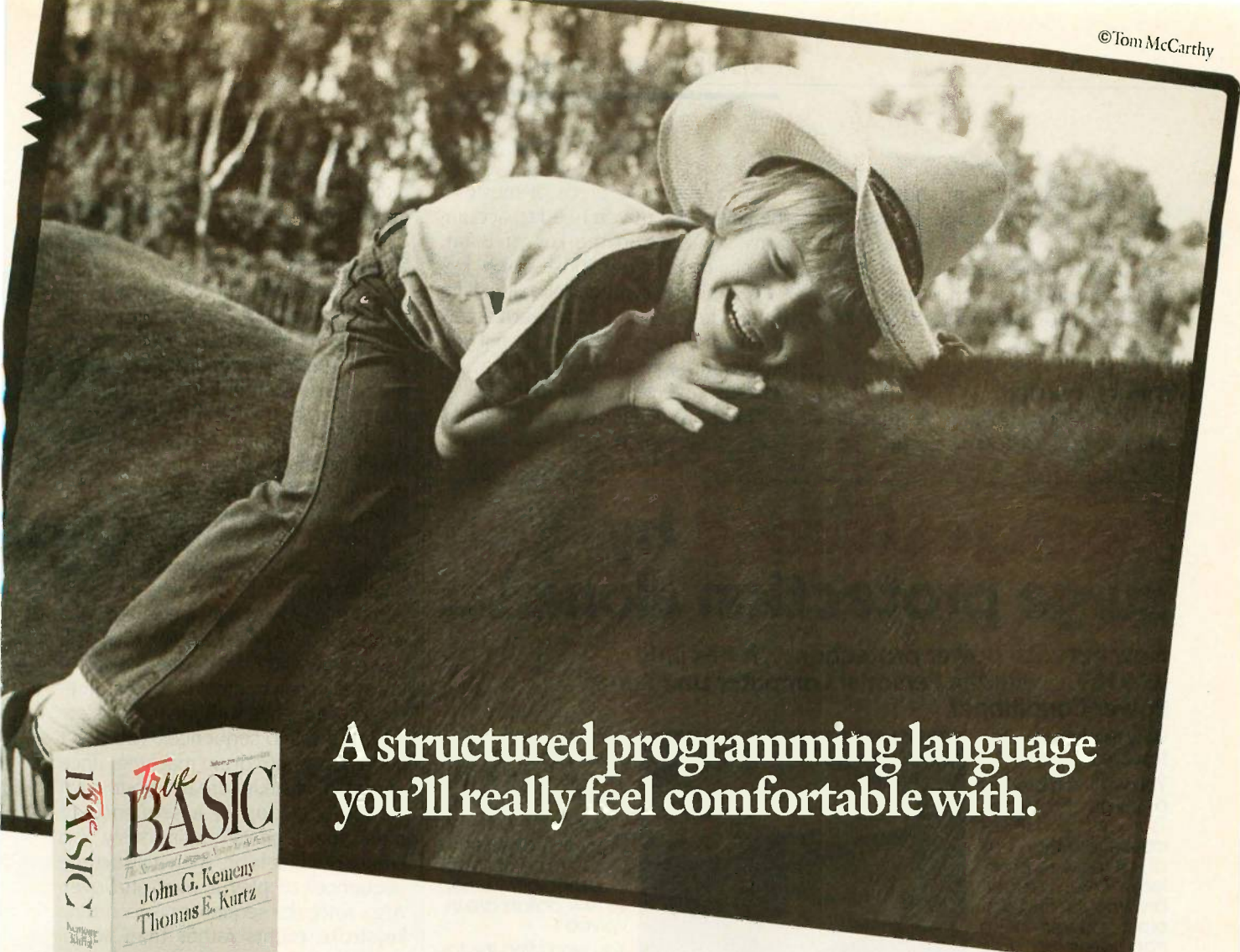

## A structured programming language you'll really feel comfortable with.

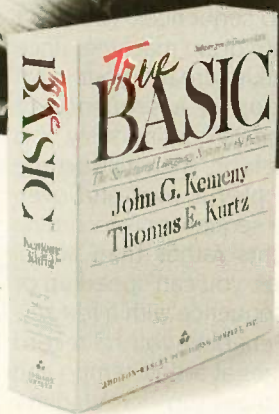

You know John Kemeny and Tom Kurtz. They developed the original BASIC. Now they're back with an even better version: a flexible, easy-to-use structured programming language they call True BASIC.<sup>™</sup>

True BASIC offers a full selection of control structures. External procedures can be compiled into libraries, making True BASIC faster and more powerful than any other programming language.

True BASIC has a complete matrix algebra package and the best graphics ever in a higher level language. And there are optional libraries for things like sorting and searching and 3-D graphics.

True BASIC programs run on any computer which runs True BASIC, good news for users with more than one kind of PC.

You'll love True BASIC. Whether you're programming for your own applications, teaching others, or developing products to go to market, send in the coupon below to receive a free demo disk.

Available for the IBM-PC<sup>™</sup> and compatibles, Apple Macintosh,<sup>™</sup> and Commodore Amiga.<sup>™</sup>

To order, talk to your local dealer or call (603) 643-3882 TODAY!



**True BASIC** inc.

39 South Main Street,  
Hanover, NH 03755 (603) 643-3882

My computer is:  IBM-PC/compatible  
 Apple Macintosh  
 Commodore Amiga

- I'D LIKE TO GET MY FREE DEMO DISK.
- I'd like more information on the True BASIC language products.
- I'm ready to buy. Call me and tell me how.
- I'd like information on True BASIC Mathematics Series and other products.

Name \_\_\_\_\_  
 Title \_\_\_\_\_  
 Company/University \_\_\_\_\_  
 Address \_\_\_\_\_  
 City, State, ZIP \_\_\_\_\_  
 Telephone \_\_\_\_\_

Suggested retail price \$149.90

Educational site licenses available from Addison-Wesley Publishing.

True BASIC Language System is a trademark of True Basic, Inc.  
Macintosh is a trademark of Apple Computer Corp.  
Amiga is a trademark of Commodore Business Machines.  
IBM is a trademark of International Business Machines Corp.



sure.) One way to get around the limitation of 12 channels is to use the 250's MIDI capability to drive external slave synthesizers such as Kurzweil's expander (which is essentially another 250, but without the keyboard).

**TRANSPPOSITION**

The 250's transposition feature is a particularly successful design. Let's

say you learned a piece of music in the key of C, but you need to accompany someone in the key of B-flat. Simply hit the transpose-down key twice, and the synthesizer will play in B-flat. There's no need to learn a new arrangement of the piece. Then if you hit two more keystrokes on the transpose-up key, you're back in the key of C. There are five modes of transposition: octave-pitch shift, chromatic-

pitch shift, octave transpose, chromatic transpose, and timbre shift.

**SEQUENCER**

The 250 comes with a sequencing program that lets you store note sequences in much the same way as you would with a tape recorder, although the process is entirely digital. The sequencer does not record actual tones. Instead, it records which keys are struck on the keyboard and how hard they are struck. It also preserves the effects associated with each voice being played. You can play a piece of music, then replay it to edit mistakes or change effects. The sequencer is extremely easy to use; it even lets you store a sequence on a Macintosh disk using the MacAttach interface program. You can control every parameter of a sequence with great precision.

With the 250 sequencer, you don't need a separate drum machine, since you can quickly create your own "loops." A loop is a sequence of music that repeats continuously. You create the first loop, then instruct the sequencer to play it over and over. Also, since the sequencer is recording keystroke events rather than actual musical pitches, you can speed up or slow down a sequence with a few keystrokes. This enables you to record difficult passages at a slow tempo and then speed them up to Vladimir Horowitz specifications. Another practical application is the so-called "time-compression/expansion" technique used to create commercials that are exactly one minute long. The sequencer lets you lengthen a piece of music that is, for example, 58 seconds long to exactly 60 seconds.

**Don't get burned by surge protection alone.**

Now get **total** power protection... for as little as \$139... with the Personal Computer Line Tamer™ Power Conditioner.

Why risk any power trouble?

You will if you buy just a surge protector. Transients and spikes cause less than half of all power problems. Overvoltages, brownouts and just plain power noise can mess up your system just as badly—and they're much more frequent. Only Line Tamer's ferro-resonant technology protects you from any conceivable power problem, short of a blackout

Line Tamers have protected the big boys for years, on all the big mainframes and minis. Those guys would laugh at surge suppression alone.

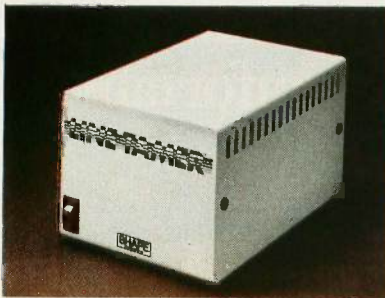

Choose from 150, 300, 450, or 600 VA models for the Line Tamer that's right for you.

Does it make sense to you to be half safe... especially when so few dollars are involved?

You won't find this total power protection from anyone else at anywhere near the price, so contact us for complete specifications and the dealer nearest you.

**SHAPE** THE CLEAN  
MAGNETRONICS, INC. POWER SOURCE

901 DuPage Avenue, Lombard, IL 60148  
Phone 1 312 620-8394 • TWX 910-991-2352



**THE SOUND-MODELING PROGRAM**

The sound-modeling program, or digitizer, lets you create your own soundfiles from tape recordings, records, or even a live microphone plugged into the 250. The user interface for the digitizer is cleverly designed and particularly easy to use. I found I could create an entirely new keyboard of sounds in just a few minutes. You can have someone speak or sing into a microphone, then digitize that voice into the 250 to



create an Uncle Harry voice, or whatever. The 250 automatically calculates the pitches of adjacent notes. The process is the culmination of the venerable practice of composing with "musique concrete," or modified sounds taken from nature.

You can store user-created soundfiles on disk (through MacAttach) and modify them just like you can the factory-installed files, and you can combine them with the factory-installed files to create striking effects.

Several features are worth pointing out in the digitizer. One is the high fidelity that is possible with the highest sampling rate of 50 kHz. The other is the ease with which you can edit the sampled sound. Once sampled, a sound can be "trimmed" to remove unwanted material at the beginning or end of the sample.

You can trade soundfiles, instruments, and keyboard setups with other Kurzweil users via disk or modem. I belong to PAN (the Performing Artists' Network), a database bulletin board for electronic musicians and audio engineers. The Synthesizer and MIDI Development Network keeps several soundfiles in the library, which members can download. I recommend PAN to anyone seriously interested in computer music synthesis. For more information, call (215) 489-4640.

#### MIDI INTERFACE

MIDI is the ubiquitous communications scheme for digital music devices that has become a de facto standard in the music industry.

The Kurzweil 250 offers a particularly full implementation of the MIDI specification and allows the synthesizer to control or be controlled by a variety of other synthesizers, hardware devices, or computers. The 250 has MIDI-in, MIDI-out, and MIDI-thru jacks on the back panel.

#### DOCUMENTATION

Considering the complexity of the machine, the 250's documentation is surprisingly good, although there were gaps in the earlier versions—no comprehensive diagrams of the software command trees, for instance.

(continued)

## Need Research That Utilizes Computer-Assisted Telephone Data Gathering?

Want to gather information rapidly using state-of-the-art computer-assisted telephone interviewing? Need fast access to tabulated results? Require integrated graphics with sophisticated analysis? Are you seeking real-time information?

### Call *RESEARCHNET* at McGraw-Hill Research

ResearchNet is the leading edge approach to research that integrates study design, computer-assisted telephone interviewing, on-line tabulation, and report analysis capabilities as well as real-time data gathering. ResearchNet links together McGraw-Hill Research project teams, interviewers' terminals, respondent input, and *you*—to produce timely, accurate and meaningful study results.

For a quote or proposal call Sheryl R. Fox (609) 426-5946 (Information Data Gathering) or Joseph T. Collins (212) 512-3264 (Full-Service Research) or write David P. Forsyth at McGraw-Hill Research, 1221 Avenue of the Americas, NY, NY 10020



If it's a marketing research problem, we probably pioneered the solution.

Save \$5.00 with this ad

## ISN'T IT TIME TO TRADE IN YOUR NORTON UTILITIES™ \*

or any other favorite utility, for the next generation disk and file management system?

### DMS/The Disk Management System is THE ANSWER!!

DMS is an Easy to Use, Menu-Driven, Full Screen software package that will help you:



- INCREASE SYSTEM SPEED AND RELIABILITY using the Align and Pack Commands
- EFFICIENTLY LOCATE AND REORGANIZE INFORMATION with Search and Sort commands.
- QUICKLY EXECUTE applications using function keys.
- GET A FULL PICTURE of information on your disk with Tree, Dump, and Map commands.
- RECOVER WITH EASE, erased files using the Recover command.
- CUSTOMIZE attributes of files and directories.
- INCREASE YOUR EXPERTISE with these and many more functions.

Over 40 Disk and File Management Functions at your finger tips.

#### WARNING: YOU MAY NEVER HAVE TO BUY ANOTHER DISK/FILE UTILITY AGAIN!!

\*In fact, you can save an additional \$10 by mailing in the distribution diskette of your obsolete utility. Norton Utilities is a trademark of Peter Norton.

All these features normally priced at \$99.00 now only \$94.00 with this ad

Demo diskette available for only \$5

Maryland Residents please add 5% sales tax.

To order direct call: (301) 384-1425 or Toll Free: 1-800-524-1081

Send order and payment to  
12904 Olivine Way  
Silver Spring, MD 20904

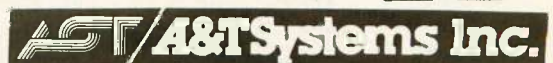

DMS runs on IBM PC, PC/XT, PC/AT and most compatible systems, running DOS 2.0 and above.

on  
the  
printer

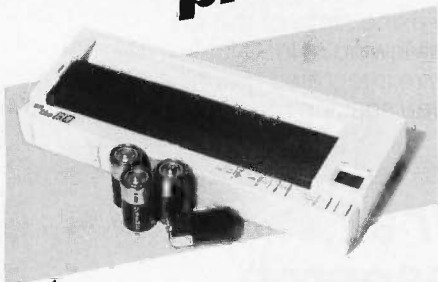

just  
**\$149.95**

Drop this battery powered printer into your briefcase and you have an office on the road. On-The-Go is loaded with features that give your printed output an extra touch of professionalism.

- It's small, just 11"x4½"x2"
- It's light, less than 2½" pounds
- 40 cps for two hours on 4 "C" batteries
- Normal, enlarged, double width, double strike, condensed, and shadow printing
- Quiet, reliable thermal printing
- 8½" wide roll or single sheet paper
- Epson MX-80 graphics compatible
- Industry standard parallel interface
- 5x7 character matrix with lowercase descenders & underlining
- 90-day limited warranty
- 30-day money back guarantee

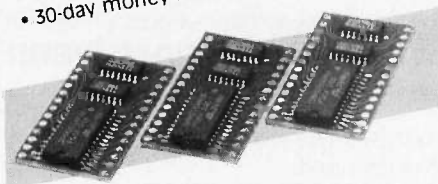

**LAPTOP MEMORY**

96k for Tandy 600	\$249
24K for Tandy 200	\$ 89
8K Tandy 100, NEC 8201	\$ 29

Visa & Mastercard accepted.  
Include 4% for UPS shipping and insurance.  
California residents add 6% sales tax.  
DEALER & OEM INQUIRIES INVITED

California (805) 482-9699  
Toll Free (800) LAP-TOPP

**LAPTOPP**  
Laptop Systems - 515 Calle San Pablo  
Dept. 4, Camarillo, CA 93010

REVIEW: KURZWEIL 250

*The biggest bottleneck to using the 250 is the MacAttach program.*

This situation has since been alleviated by the excellent diagrams in the Byrd and Yelow paper, copies of which have been sent to all Kurzweil owners.

One drawback to the documentation is that it's hard to find things when you need them. However, those sections describing the sequencer and the sound-modeling programs are particularly well written.

**NEW DEVELOPMENTS AND MISCELLANEOUS NOTES**

The biggest bottleneck I found to using the 250 is the MacAttach program. At 56,700 bps, MacAttach version 2.0 (which I used for this review) is far too slow, taking from 2 to 4 minutes to load one custom sound-file. This would be prohibitively slow for the live performer. To compound things, MacAttach makes no use of the Macintosh's graphics, and its functions are restricted to loading files to and from the synthesizer's memory and making disk copies. However, this past winter the Kurzweil people told me that they plan to announce Fast-link, an interface card for the Kurzweil that will increase MacAttach data transmission tenfold, making it possible to load a file in 5 to 10 seconds instead of 2 to 4 minutes.

They are also optimizing the Kurzweil 250 for use with a Macintosh equipped with a hard disk drive, and in particular, to work more efficiently with sophisticated MIDI-based music software such as Mark of the Unicorn's Performer and Southworth's Total Music.

In response to criticism that the piano voice has some weaknesses (slight pitch aberrations, certain tubiness in the midrange, and slight discontinuities from one keyboard region to the next), the company has remasked the ROMs containing the piano voice (and several others). It is now much smoother and more ac-

curate. The new harpsichord voice is also excellent, as are several other new voices in the upgraded software. The approximate charge for retrofitting to the new voicings is \$2500.

Redoing the ROMs gave the designers the chance to convert from 256K-byte chips to 1-megabyte chips, freeing up several slots on the motherboard for more sound blocks. Announcements of new sound blocks should be forthcoming.

The currently available Sound Block B features 10 new rock-drum sounds, all recorded in New York with the help of such musicians as Phil Collins and the Thomson Twins. It also includes an electric piano, electric guitar, and other voices.

I have a library of about 20 custom sounds for the 250 that I obtained from the company and from users groups. Most of them are adequate; a few are standouts. It's great fun to create your own.

**CONCLUSIONS**

For a variety of reasons, I feel the Kurzweil 250 Digital Synthesizer is the most important advance in the art of computer music synthesis in the past 10 years. Other approaches may have their particular advantages, but nowhere else have I found a machine that can do all the things the 250 can do for the price.

The 250 is not cheap, but combined with a good analog or digital multi-track tape recorder, it's just about all you need to create a high-powered electronic music studio. The design innovations contained in the 250 will undoubtedly be copied by others, and it's only a matter of time before the Japanese begin to upgrade their designs. (Kurzweil is in fact working with a Japanese company to create a new, lower-priced design.) When the next wave of machines arrives, the state of the art will really take off. ■

**BIBLIOGRAPHY**

- Kurzweil, Raymond, "The Goals of the Kurzweil 250," August 1984, unpublished.
- Loy, Gareth, "Musicians Make a Standard: The Phenomenon of MIDI," *Computer Music Journal*, Winter 1986. (This article is the best treatment of MIDI I have seen to date.)



IBM® PC-AT™  
COMPATIBLE  
COMPUTING  
AT AN  
AFFORDABLE  
PRICE...

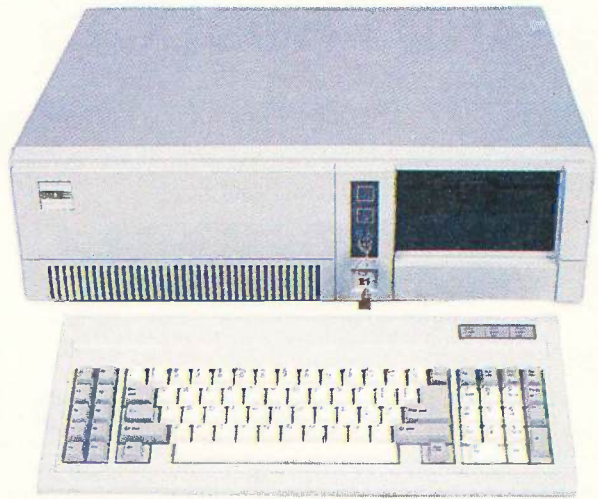

- Intel 80286 Processor
- MS DOS 3.1 Included
- 640K RAM On Mother Board
- 1.2 MB Floppy Drive
- Dual Floppy & Hard Drive Controller
- Clock/Calendar With Battery Back-Up
- Optional 80287 Math Co-Processor Available

**\$1699**

- ✓ Compatible
- ✓ Full Documentation
- ✓ Reliable
- ✓ Extended Burn-In Testing

**STANDARD** PC/XT™

**STANDARD** Turbo-XT™

- Intel 8088-3 (4.77 MHz)
- STD-5150 Keyboard
- 1-Half-Height Floppy Drive
- 640K Ram
- 135 Watt Power Supply
- 8 Expansion Slots



- Intel 8088-2 (4.77 or 6.66 Mhz)
- Keyboard Selectable Clock Speed
- Up To 40% Faster Processing Speed
- STD-5160 AT Style Keyboard
- 640K Ram
- One Half-Height Floppy Drive
- 8 Expansion Slots

**\$629**

*"Runs Major Software Written For The IBM PC & XT"*

**\$729**

All Standard Brand  
Products Carry A  
1 Year Warranty!

**PC  
SOURCE**

CALL TOLL FREE:  
800-626-4027  
Outside Texas  
512-331-6700  
Inside Texas



# Setting The Import Standard!!

**STANDARD BRAND PRODUCTS**

Enhancement Products For  
The IBM® PC Market...

**STANDARD MFC w/384K**

Multifunction Card



- 384K Ram
- Clock/Calendar
- Serial Port
- Parallel Port
- Game Port
- Software

**\$129**

**STANDARD MonoGraphic Card**

Hercules® Compatible Monochrome Graphics Card



- Text Mode 80X85 Characters
- Graphics Mode 720X348 Pixels
- Parallel Port

**\$119**

**FDC**

Floppy Disk Controller

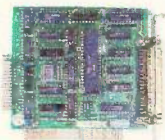

Controls Up to  
4 Floppy Disk.  
Includes Internal Cables... **\$49**

**5151 Keyboard**

For The IBM® PC or XT



With Separate  
Numeric And  
Cursor Keypad... **\$99**

**AT-MFC**

Multifunction Card for IBM AT



Up To 1.5 MB  
Memory Expansion,  
Serial & Parallel  
Port for IBM AT... w/OK **\$189**

**Power Supply**

150 Watt



Replacement  
Power Supply... **\$85**

**Monitor**

Monochrome Monitor



12" Amber Screen  
80X25 Lines  
720X350 Pixels... **\$99**

**I/O**

I/O Board



Serial Port,  
Parallel Port &  
Clock/Calendar... **\$99**

**ColorCard**

Color Display Card



ColorCard  
w/Parallel Port... **\$99**

**MonoCard**

Monochrome Display Card



MonoCard  
w/Parallel Port... **\$89**

**PowerMaster  
AC Center**

Three Important Functions  
In One Unit!

**\$89**



Front Panel

Rear Panel

- 4 Separate Power Outlets With On/Off Switch On Front Panel
- Surge Suppressor
- Swivel Base Monitor Stand

No Charge For UPS Ground Shipping. No Surcharge For MasterCard or VISA. Fortune 1000 Purchase Order Welcome. Warranty Work Requires Proof-Of-Purchase And Return Authorization Number.

Our "Standard Brand Products" are not sponsored or endorsed by IBM. IBM, PC, PC-XT & PC-AT are registered trademarks of International Business Machines Corporation.

**PG SOURCE**

12303-G Technology Blvd. Austin, TX 78727

CALL TOLL FREE:  
800-626-4027  
Outside Texas  
512-331-6700  
Inside Texas



# R·E·V·I·E·W F·E·E·D·B·A·C·K

## POCKET APL

In response to the review of STSC Inc.'s Pocket APL (March, page 237), I think Eric Johnson should have made the following two points: One, the program does take advantage of the 8087, if installed. There is a section in the supplied manual that shows the user how to change the program to software floating-point math if the 8087 default is not installed.

Two, APL's strength is in array processing, and the Calculations benchmark, as written, is not the best test of the calculating power of the program. For example:

```
▽CALC2
[1] A←1000p*1
[2] B←1000p01
[3] C←1000p1
[4] N←5
[5] I←1
[6] C←C×A
[7] C←C×B
[8] C←C÷A
[9] C←C÷B
[10] I←I+1
[11] →6×I I<N
[12] 'DONE'▽
```

This function performs 10,000 multiplication and 10,000 division operations in 64-bit double-precision numbers in 12 seconds. Compare this with the 7:18 time (see table 1, page 238) in the review. Also, with an 8087 installed, the correct figure for the Calculations benchmark as written in the review is 6:16, which illustrates how much time is spent calculating.

KEVIN DOWNING  
Evanston, IL

*The review gives examples of APL's use of arrays. The benchmark was structured to compare APL's mathematical abilities with BASIC's.*

JON EDWARDS  
Technical Editor, Reviews

## COLOR FOX

We would like to correct one minor misconception and point out one major

(and almost universally overlooked) virtue in John D. Unger's review of the Color Fox (January, page 301).

He states that the machine without the video board is slower for screen operations because it uses BIOS scrolling routines. It is definitely slower, but that's not the reason. The unaugmented Sanyo actually has to draw the dot configuration for each character on the screen using the main CPU.

A unique capability is buried in the Sanyo equipped with a video board, however. If you have two monitors available you can configure it as a two-screen system (e.g., text in monochrome using the video board and high-resolution color graphics using the Sanyo video circuitry; that's 640 by 200 pixels by 8 colors). We have recently sent some notes and software to SanPic Users Group (1967 Defiance Avenue, Las Cruces, NM 88001) showing how to use this capability for 320 by 200 pixels by 27 colors. We are not aware of other available software that exploits this capability.

KURT RUDAHL  
SALLY GOLDIN  
Bangkok, Thailand

## ECO-C88 C COMPILER

In the review of the Eco-C88 C compiler (January, page 307), David D. Clark uses a popular factoring algorithm—the Pollard rho method—as a benchmark (listing 3) to test the implementation of long integers. While the program may have dubious usefulness as a benchmark, it is not a correct implementation of this algorithm. The problem arises in the line

```
x = (x*x + 2) %p;
```

and in the two subsequent similar lines. The variable  $x$  may take any value less than  $p$ ; therefore, the multiplication  $x*x$  will eventually cause an overflow if  $p^2$  is much greater than  $2^{31} - 1$ , the greatest positive number that can be represented in 32 bits. This is true for the number given, and indeed for most larger numbers of interest. Most C compilers do not incorporate the code necessary for overflow checking, so no error is reported.

For the number used, 1394761, and using the program given, the factor 1181

is found after 871 iterations. A correct implementation takes only 38 iterations. It is a credit to the robust nature of this algorithm that it still works at all! A correct implementation can be obtained by declaring a double variable  $d$ , and by replacing the above line (and the two subsequent lines analogously) by

```
d = (double) x*x + 2;
x = d/p;
x = d - (double) x*p;
```

This is awkward and will not work for the largest values of  $p$ , but it works correctly for the given number.

Since the way in which a program reacts to an overflow situation may vary from compiler to compiler (and certainly will for different sizes of long int), I think it is dangerous to use this program as a benchmark.

MICHAEL SCOTT  
Dublin, Ireland

*The changes you suggest do correct the overflow problem and cause the program to operate as it should. Of course, they also destroy the utility of the program as a long integer benchmark. Also, if an argument in the range appropriate to the program is used, the program runs too fast to be useful as a benchmark. After experimenting with several other arguments, I am also amazed that the program works when overflow occurs. The value in the program is not unique in that respect. Factors of other large numbers can be found even when intermediate calculations overflow. The only difference is the unusually large number of iterations required to find a factor (the number of iterations required should have been a clue that the original program was not functioning as expected). I am not mathematically astute enough to explain why the algorithm still works with a pathological argument.*

DAVID D. CLARK ■

REVIEW FEEDBACK is a column of readers' letters. We welcome responses that support or challenge BYTE reviews. Send letters to Review Feedback, BYTE Publications, One Phoenix Mill Lane, Peterborough, NH 03458. Name and address must be on all letters.

# The database used now be used

Introducing dBASE III PLUS.™

The PLUS stands for all the improvements we've made to the world's number one selling database management software.

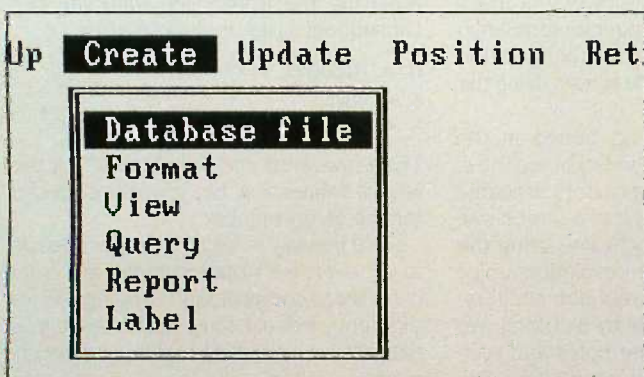

*The Assistant helps beginning users accomplish day-to-day data management tasks without programming.*

Mind you, dBASE III PLUS still has the powerful dBASE programming language, dot prompt, and all the features that have made dBASE III the standard of the industry.

We've simply raised the standard.

And just as dBASE III introduced more power to the people, our new dBASE III PLUS introduces more people to the power.

People who aren't all that crazy about programming, for example.

The Assistant feature in dBASE III PLUS now provides them with new easy-to-use pull-down menus for creating, using and modifying multiple databases.

So now anyone who can manage a simple cursor can manage day-to-day data management tasks. Without programming.

And by using our new Screen Painter,

anyone can create custom screens. Without programming.

Or using View, access related information in several databases at one time. Without programming.

With Advanced Query System, another new non-programming feature, any user can build complex queries just by selecting from the dBASE III PLUS pull-down menus.

For rapidly creating entire programs, there's even a new Applications Generator.

And for all those who wish to learn to program, the Assistant can be of further assistance. By teaching you programming commands as you go along. Without disrupting your work flow.

These are only a few of the dBASE III PLUS features that can help new users quickly get up to speed. And experienced users quickly increase their speed. (Sorting, for example, is up to two times faster and indexing up to ten times faster than dBASE III.)

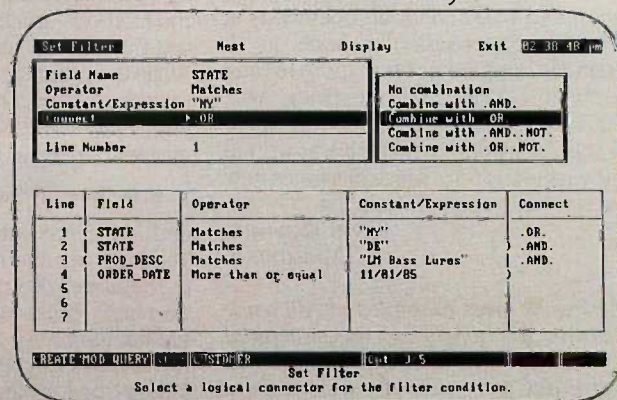

*Advanced Query System lets you set up and answer complex queries without programming.*



# by more people can by more people.

And it's the fastest way to network those users, too. Because now, true multi-user capabilities for local area networking are built right in.

dBASE III PLUS can also help put developers in the fast lane. With a new Data Catalog and more than 50 new commands and functions. Plus code encryption and linking, improved debugging aids, assembly language calls and much more.

For the name of the Ashton-Tate® dealer nearest you,\* call 800-437-4329, Extension 0282.\*\*

And get your hands on dBASE III PLUS. It's the software more people can look forward to using. Inquiry 30

\*Upgrades are available to all dBASE III owners. \*\*In Colorado call (303) 799-4900, Extension 0282. Requires IBM® PC or 100% compatible. Trademarks/owners: Ashton-Tate, dBASE III PLUS/Ashton-Tate; IBM/International Business Machines Corp. © Ashton-Tate. All rights reserved. 1986.

ASHTON-TATE

## dBASE III PLUS

*The data management standard.*

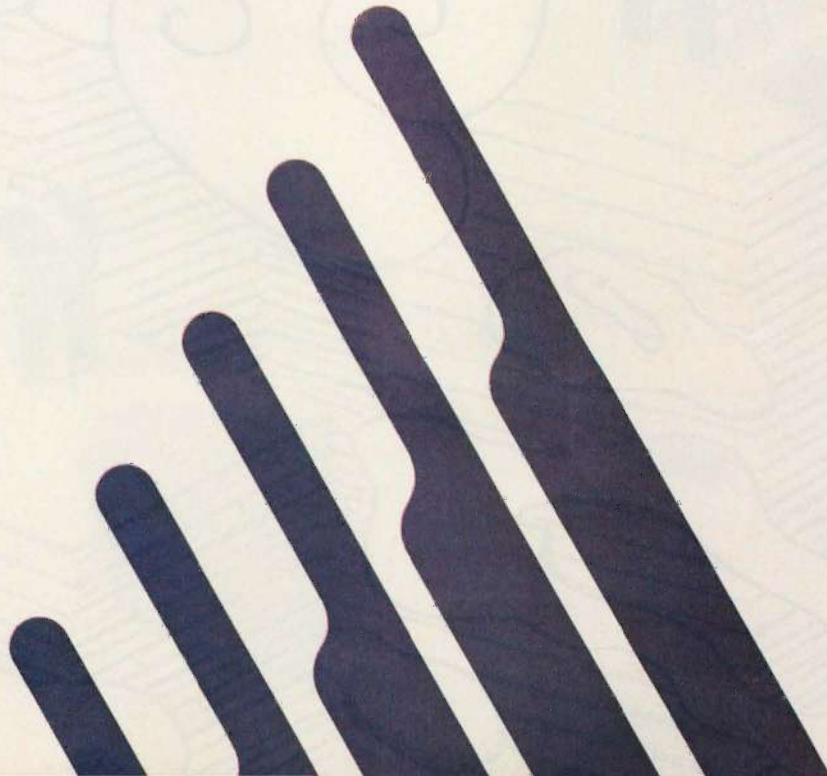







# Kernel

---

<b>COMPUTING AT CHAOS MANOR: COLOR AND CP/M</b> <i>by Jerry Pournelle</i> .....	<b>295</b>
<b>BYTE U.K.:</b>	
<b>MODEM MYSTERIES REVEALED</b> <i>by Dick Pountain</i> .....	<b>319</b>
<b>APPLICATIONS ONLY: UPGRADE FEVER</b> <i>by Ezra Shapiro</i> .....	<b>329</b>
<b>BYTE JAPAN:</b>	
<b>NEW TOOLS, NEW CHALLENGES</b> <i>by William M. Raike</i> .....	<b>339</b>
<b>ACCORDING TO WEBSTER: STORAGE FOR THE MASSES</b> <i>by Bruce Webster</i> .....	<b>347</b>

---

COLOR AND CP/M ARE the major themes of Computing at Chaos Manor this month. Looking at a new color monitor from NEC, the MultiSync, leads Jerry to the conclusion that the era of color text is here. And wondering whether he should finally retire Zeke, he comes to the conclusion that CP/M isn't dead. There are a lot of CP/M machines out there, they're good at what they do, and there's plenty of CP/M software. Jerry also looks for a macro editor and has the BDS 630/8 laser printer fixed.

In BYTE U.K., Dick tells us what happened when he added a WS3000 multi-standard modem to his computer system. Miracle Technology Ltd.'s new family of WS3000 modems are just about the state of the art in personal computer modems.

In Applications Only, Ezra tells us about four new versions of old, familiar programs: WordStar 2000 Release 2, dBASE III Plus, Volkswriter 3, and Keep-track Plus.

Our correspondent in Japan also added a modem to his system this month. Bill describes his experiences with his new Hayes Smartmodem and also with the DeSmet C development package, a C compiler.

Bruce Webster takes another pause from the 68000 wars. He begins the article with an industry update, in which he looks at what some of the major computer companies are up to. Bruce then looks at a couple of storage devices: MacBottom and the DASCH external RAM disk. MacBottom proves to be his product of the month. Bruce concludes by making some comparisons of mass storage devices, including a correlation between speed and fragility.

# A LASER PRINTER SHARING UNIT WITH 256K BUFFER AND 8 USER INPUTS FOR UNDER \$800?

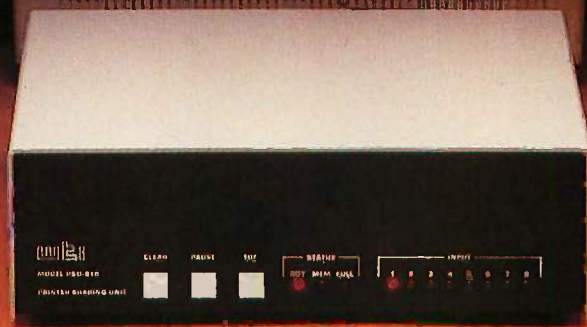

That's right! Now up to eight PCs, word processors, CAD systems, or whatever can share two printers automatically.

In addition to eight serial input ports, the PSU-81B gives you two output ports — one serial, one parallel — that can operate simultaneously.

You also get lots of other convenient features, including a pause button, clear button, memory test, TOF, and of course, a 256K dynamically allocated buffer.

So for under \$800, make your laser printer eight times more cost effective.

Check into our new PSU-81B, and other low-cost automatic printer sharing units, from the leaders in data communications technology.

Call or write WTI today for a complete catalog. In California, call (714) 979-0363. Telex 467741.

**800-854-7226**

**wti** western  
telematic inc.

2435 South Anne St., Santa Ana, California 92704





# COLOR AND CP/M

BY JERRY POURNELLE

## *Jerry looks at the prospects for color and shows that CP/M isn't dead*

I've started this four times. There's no easy way. I ended last month's column just before going out to Caltech's Jet Propulsion Laboratories for the *Voyager* encounter with Uranus. It was an absolutely wonderful weekend. Many friends and colleagues came down for the encounter. We had a wild party here at Chaos Manor, and then all got together out at JPL to watch *Voyager* do its stuff. Charley Kohlhasse, whose programs control *Voyager's* flight, joined us—*Voyager* arrived one minute early after more than five years and billions of miles in transit! Marvin Minsky showed up at JPL, found out where the science fiction writers were, and spent the rest of the day with us. We ended up at Burger Continental for dinner. Sunday was similar. A wonderful weekend.

Then came Tuesday morning and *Challenger*, and it wasn't so much fun anymore.

Since then I've received a lot of mail from readers saying the same thing: we've always thought we ought to support the space program, but we never got around to it. What should we do?

I've no room for the long answer. The short answer is, send \$30 to join the L-5 Society Promoting Space Development, 1060 East Elm St., Tucson, AZ 85719. Tell 'em Pournelle sent you. They'll tell you the rest.

Meanwhile, I've been busy. The space movement has known for a long time that we'd lose a shuttle one day; but we weren't really prepared when it happened. There's so much to do: press releases; news interviews, some sane and some absurd; and organizing the policies we ought to advocate. You can see what's coming. I didn't do anywhere near as much puttering around with small computers as I would have liked. On the

other hand, by making use of BIX, BYTE's electronic conferencing system, I was able to put together a national conference bringing together people from the White House staff, the National Commission on Space, the aerospace industry, major universities, and the space advocacy groups. I expect something will come of all that.

### **MULTISYNC**

The official name is the NEC JC-1401P3A MultiSync Monitor. With a name like that, it's got to be good? In any event, it certainly is. NEC calls the MultiSync "the intelligent monitor;" and it pretty well lives up to the billing.

The MultiSync isn't very large: I measure 12 inches diagonal of useful area. It comes with a neat swivel stand; when you set it up, it's about 14 inches high by 14 inches wide by some 18 inches deep (if you leave room for the cables). The stand swivels and tilts so that you can partially pack a keyboard under it for storage.

The MultiSync's resolution is 800 horizontal dots by 560 lines. Eighty-column text could have 10 dots horizontal width per column by as many vertical dots as you like. I've no real feel for those numbers. Subjectively, it looks good; more on that later.

The distinguishing feature of the MultiSync is that you can use it with a wide range of color boards. I took mine out of the box and plugged it into Big Kat, the Kaypro 286i IBM PC

AT clone that normally drives a 19-inch high-resolution Zenith monitor. No adjustments needed: MultiSync worked fine.

Not only did it *work* fine, but I was tempted to leave it in place. The MultiSync display is crisp and sharp. Text looks good on this monitor. The only problem, for me, is that the text is a little small. I'm farsighted, sufficiently so that I'm most comfortable sitting 30 to 35 inches from an eye-level monitor. The MultiSync is sharp enough that I *can* see and read text at those distances, but it's not really large enough for comfort; and due to the layout of my office, the screen for Big Kat is most conveniently placed 36 inches from my schnozz. I left the MultiSync connected to Big Kat for a day or so, but eventually I went back to my enormous Zenith, which doesn't look as sharp but is certainly large enough.

Next I connected MultiSync to the Golem, our monster CompuPro S-100 286/Z80 SPUZ system. The Golem can drive up to four physical consoles. One of those consoles is Old Reliable, the TeleVideo 950 I bought the first year I did this column. (Incidentally: anyone out there know where I can get some key caps for a 950? The only problem with my Telewidget is that the housekeeper dropped the keyboard last month and lost two key caps.) The other physical console for the Golem isn't exactly a console. It's the CompuPro S-100 PC Video board, which apes the IBM PC color system. With the PC Video board, a properly equipped CompuPro running Concurrent CP/M will also run about 85 per-

(continued)

*Jerry Pournelle holds a doctorate in psychology and is a science fiction writer who also earns a comfortable living writing about computers present and future.*

cent of the software developed for the IBM PC, including Lotus 1-2-3 and Flight Simulator.

The MultiSync works splendidly with the PC Video board. Text looks nice—once again, a bit small for people who like to sit as far away as I do; but it's readable, and everything is as steady as if it were painted on.

MultiSync will, without modification, work with the Enhanced Graphics Adapter PC board that is rapidly becoming the business standard; and also, I'm told, with the Professional Graphics Controller. I'm getting a Professional Graphics Controller, and I already have a Princeton Graphic PGC monitor; I'll provide a comparison when the Princeton board comes.

Meanwhile, the MultiSync is trouble-free. The instructions are clear. It works fine with the Perma Power Color Commander gadget (which lets you reprogram the color outputs; see last month's column). MultiSync has a text mode that lets you add color to text or background; not as flexible as the Color Commander, but likely to be all you'd need. Finally, MultiSync runs cool compared to some color monitors I've had here. I do wish it were about two inches larger.

### COLOR TEXT?

I'm convinced that the era of color text is here. On the other hand, I've been convinced before. Maybe it's the atmosphere at computer shows—I go to them, see text in color on screens, and come away convinced that it's something I could work with. Then I get it home, and it isn't.

It's likely I'm not trying the right stuff. It has taken me a long time to realize that the problem isn't the monitor, it's the computer hardware that drives the monitor. The standard PC color boards, including CompuPro's PC Video board, just are not good enough; not for me at any rate. Examining them closely shows why. My ancient Processor Technology VDM board—probably one of the last in the world still in operation—has about 11 vertical by 9 horizontal dots in the matrix that forms each letter. (I don't know exactly; I've mislaid the documents, and it's nearly impossible to count them on screen because they

run together, which, of course, is what you *want* them to do.)

While the MultiSync monitor could handle that, the IBM PC color and PC Video boards don't have that many dots forming each letter. The edges of the letters are therefore fuzzier. The better the monitor, the less fuzzy it is, but even with the best monitors there's still too much fuzziness. That's something I should have known (and heaven knows enough people tried to tell me); I can only plead that with the construction and other distractions, I wasn't paying attention. Worse: last spring during construction a Hercules color board came in here, but it got separated from its documents, and both got lost in the swim. I've started a search, but it hasn't turned up, and it's deadline time; so I can't even report on how that board looks with MultiSync.

I've more to confess. For months we have had a Princeton Graphic SR-12 color monitor sitting in the storage room. It arrived during hectic construction, when I was hounded from room to room by carpenters tearing down walls faster than I could move computers. At a show, I thought that the Princeton monitor had some of the best color text I'd ever seen; it arrived and wouldn't work with the standard color board in Big Kat. It isn't supposed to, of course. It needs a special color-video board. Somehow that board never arrived, and due to alternate waves of sloth and frantic activity here we forgot to remind anyone. Consequently, the SR-12, which friends assure me is one of the world's great monitors, has blushed unseen like the flower in the crannied wall. That too will be remedied, but not before I turn in this column.

So: it's probably my fault I don't have good color text for a PC AT. On the other hand, when I check with knowledgeable friends, they say they haven't really solved the problem either. On the gripping hand, as the Moties say, I know it *can* be done. By "good" color text I mean letters large enough for me to see and as well formed as those I have on my 1978 VDM board and my even older 14-inch Hitachi monitor; in other words, text that I could stand to look

at hour after hour; text that won't distract me when I'm trying to write books. I know it's possible, for two reasons.

First, the standard color output from the Kaypro 286i is *almost* good enough now. It would be good enough for most people, I think. I use Big Kat for my on-line communications, particularly BIX. I spend at least an hour a day at that. It doesn't take the concentration that creative writing demands, but I'd much rather write books on Big Kat than on, say, the original Kaypro II with built-in screen, and I *did* manage a novel on the Kaypro. Not only that, but a number of good writers, including Norman Spinrad and Roland Green, have done the same, and indeed continue to work with the older Kaypro machines to this day.

Second, the color outputs of both the Atari 520ST and the Amiga are *already* good enough to write books on. So far I haven't found a good enough (for me) text editor for either machine, but that's only a matter of time. Not only are there some really good programmers writing editors for both machines, but some of those programmers are in communication with me through BIX. They may not follow all my prejudices, but they're at least aware of them.

### LOOKING AHEAD

"I'm getting old, boss."

"Eh?" I woke from dozing. Zeke was nattering.

"Old. You just said it yourself. My VDM board was part of Zeke I. That's nine years old! I've got 8-inch disk drives. Noisy. And I'm big, huge, take up a whole corner of your new office. Big Kat there is no bigger than my disk drives! Time to retire. The boys would like to have me. Or Mrs. Pournelle. Or Notre Dame. It's silly. All those columns about the future of computers written on an obsolete CP/M wreck like me."

"You're no wreck, and you're not obsolete," I shouted, and woke up; but it gave me pause to think. Not that Zeke II can't do everything he was bought for. He can. Visitors are generally startled at just how fast he is at handling text and at saving it, if they're used to 5¼-inch floppies;

(continued)



# THE PROGRAMMER'S SHOP

helps save time, money and cuts frustrations. Compare, evaluate, and find products.

## RECENT DISCOVERY

dBASE Tools for C - incorporate C functions as extensions to dBASE III Plus. Also functions for business graphics, arrays, math, stats.  
MS C, Lattice, Aztec. PC Graphics \$ 79  
Tools \$ 79

## AI-Expert System Dev't

Arity System - incorporate w/C. PC \$295  
Experteach - Improved, samples PC \$399  
EXSYS - Improved, Debug, file & external program access. PC \$339  
1st Class - by example, interfaces \$250  
Insight 1 - Probabilities, fast MS \$ 79  
Insight 2 - dB2, language MS \$399  
Others: APES (\$359), Advisor (\$949), ES Construction (\$100), ESP (\$845), Expert Choice (\$449)

## AI-LISP

List Our  
GC LISP Interpreter - "Common", rich. Interactive tutorial \$495 Call  
GC LISP 286 Developer - 2 to 15 meg RAM, compiler & interp. \$1195 Call  
Microsoft MuLisp 85 \$199  
TLC LISP - "LISP-Machine" - like, all RAM, classes, compiler. MS \$225  
TransLISP - Good for learning MS \$ 75  
WALTZ LISP - "FRANZ LISP" - like, big nums, debug, CPM-80 MS \$149  
Others: IQ LISP (\$155), BYSO (\$125), UNX LISP (\$59), IQC LISP (\$269)

## AI-PROLOG

ARITY Standard - full, 4 Mcg Interpreter - debug, C, ASM PC \$ 350  
COMPILER/Interpreter-EXE PC \$ 795  
With Exp Sys, Screen - KIT PC \$1250  
MicroProlog - enhanced MS \$ 229  
MProlog - Improved, Faster PC \$ 475  
Professional MicroProlog MS \$ 359  
Turbo-86 - Learn Fast MS \$ 95  
TURBO PROLOG by Borland PC \$ 85  
Others: Prolog-1 (\$365), Prolog-2 (\$1795)

## Editors for Programming

BRIEF Programmer's Editor - undo, windows, reconfigure PC Call  
C Screen with source 80/86 \$ 75  
EMACS by UniPress - powerful, multifile, MLISP. Source: \$949 \$299  
Epsilon - like EMACS PC \$169  
FirsTime by Spruce - Improve productivity. Syntax directed for Turbo (\$69), Pascal (\$229), or C (\$239)  
Kedit - like XEDIT PC \$115  
Lattice Screen Editor-multiwindow multi-tasking Amiga \$100 MS \$125  
PMATE - power, multitask 80/86 \$159  
VEDIT - well liked, macros, buffers. CPM-80-86 MS \$119  
XTC - multitasking PC \$ 85

## FEATURE

Dan Bricklin's Demo Program. Prototype quickly. User feedback without programming. All 250 ASC characters plus attributes. Subsetting, macros. PC \$ 75

## Free Literature Compare Products

Evaluate products. Compare competitors. Learn about new alternatives. One free call brings information on just about any programming need. Ask for any "Packet" or Addon Packet □ AI □ ADA, Modula □ BASIC □ C □ COBOL □ Editors □ FORTH □ FORTRAN □ PASCAL □ UNIX/PC or □ Debuggers, Linkers.

### Our Services:

- Programmer's Referral List
- Compare Products
- Help find a Publisher
- Evaluation Literature FREE
- BBS - 7 PM to 7 AM 617-826-4086
- Dealers Inquire
- Newsletter
- Rush Order
- Over 700 products
- National Accounts

## C Support-Systems

Basic-C Library by C Source MS \$139  
C Sharp - well supported, Source, realtime, tasks PC \$600  
C ToolSet - DIFF, xref, source MS \$135  
Lattice Text Utilities PC \$ 99  
The HAMMER by OES Systems PC \$179  
PC LINT - checker MS \$125  
SECURITY LIB - add encrypt to MSC. C86 programs. Source \$250 PC \$125

## Fortran & Supporting

ASC Time Series \$469  
Forlib+ by Alpha - graph, comm. \$ 59  
MACFortran by Microsoft - full '77 \$229  
MS Fortran \$219  
No Limit - Fortran Scientific \$129  
PolyFortran - xref, pp, screen \$149  
Prospero - '66, reentrant \$349  
RM Fortran - enhanced "IBM Ftn" \$399  
Scientific Subroutines - Matrix \$149  
Strings and Things - registers, shell \$ 59

## MultiLanguage Support

BTRIEVE ISAM MS \$199  
BTRIEVE/N - multiuser MS \$469  
CODESIFTER - Execution PRO-FILER. Spot bottlenecks. MS \$109  
HALO Graphics- Multiple video boards, printer, rich. Animation. Any MS language, Lattice, C86 PC \$249  
Pfinish Performance Analyzer MS \$279  
PLINK-86 - a program-independent overlay linker to 32 levels. MS \$279  
PLINK-86 PLUS - incremental MS \$369  
PolyLibrarian MS \$ 85  
PVCS Version Control MS \$359  
Screen Sculptor - slick, thorough PC \$ 99  
ZAP Communications - VT 100, TEK 4010 emulation, full xref. PC \$ 85

## ATARI & AMIGA

We carry full lines of Manx, Lattice, Metacompo and Prospero.

Call for a catalog, literature and solid value

# 800-421-8006

THE PROGRAMMER'S SHOP™

128-B Rockland Street, Hanover, MA 02339

Mass: 800-442-8070 or 617-826-7531 4/86

## RECENT DISCOVERY

dBrief, the dBASE Assistant - optional syntax directed editing, screen gen, graphics, speed coding.  
dBASE II, III, Clipper. PC \$ 95

## C Language-Compilers

AZTEC C86 - Commercial PC \$399  
AZTEC C65 - Personal Apple II \$199  
C86 by C1 - 8087, reliable MS \$299  
Consular Mac C w/toolkit MAC \$299  
Lattice C - from Lifeboat MS \$289  
Lattice C - from Lattice MS \$339  
Mark Williams - w/debugger MS \$399  
Megamax - tight full ATARI/ST \$179  
Microsoft C 3.0 - new MS \$259  
Q/C 88 by Code Works - Compiler source, decent code, native MS \$125  
Wizard C - Lattice C compatible, full sys. III, lint, fast. MS \$389

## C Language-Interpreters

C-terp by Gimpel - full K & R, .OBJ and ASM, large progs. MS \$249  
INSTANT C - Source debug, Edit to Run-3 seconds MS \$399  
Interactive C by IMPACC Associates. Interpreter, editor, source, debug. PC \$225  
Introducing C - learn C fast, self paced tutorial PC \$109  
Professional Run/C - Run/C plus create add-in libraries, load/unload them. MS \$199  
Run/C - improved MS \$109

## C Libraries-General

Application Programmer's Toolkit MS \$349  
Blaise C Tools 1 (\$109), C Tools 2 \$ 89  
C Essentials by Essential PC \$ 85  
C Food by Lattice-ask for source MS \$109  
C Power Windows by Entelekon PC \$119  
C Utilities by Essential - Comprehensive screen graphics, strings. Source. PC \$139  
Entelekon C Function Library PC \$119  
Entelekon Superfonts for C PC \$ 45  
Greenleaf Functions - portable, ASM \$139  
Polytron - for Lattice, ASM source \$ 85  
Software Horizons - Pack 1 PC \$129

## C Libraries-Communications

Asynch by Blaise \$149  
Greenleaf - full, fast \$139  
Software Horizons - pack 3 \$119

## C Libraries-Files

FILES: C Index by Trio - full B + Tree, vary length field, multi compiler  
/File is object only MS \$ 89  
/Pro is partial source MS \$179  
/Plus is full source MS \$349  
CBTREE - multiuser record locking, sequential, source, no royalties MS \$ 99  
C'Tree by Faircom - no royalties MS \$339  
dbVISTA - full indexing, plus optional record types, pointers, Network.  
Object only - MS C, LAT, C86 \$179  
Source - Single user MS \$429  
Source - Multiuser MS \$829

**“BRIEF has improved my productivity tenfold. It paid for itself in 2 weeks!”**

**David Norwood, Microsystems Manager**

**Tailor Editing to Your Style**

- A high-level, readable *Macro Programming Language* - allows customization for programming languages . . . Complete, unlimited variables, etc.
- Edit *multiple files of unlimited size* (2 Meg is OK)
- Multiple *Windows* on screen with different or same file, fragments, etc.
- A bona-fide *UNDO* stack (up to 300) of all operations: deletions, reading files, search, translate, more.
- Full “*regular expression search*” - wild cards, complex patterns
- Reconfigurable keyboard
- Adjustable line length - up to 512.
- *Keystroke macros* - for common typing sequences
- Suspend BRIEF to execute, *exit to DOS* - run another program (like a compiler, dir, XREF, DIFF, or DEBUG) then resume BRIEF session
- *Compiler-specific* support like auto indent, syntax check, compile with-in BRIEF

For PC, AT, compatibles and Tandy 2000.

Only \$195



335-B Washington St., Norwell, MA 02061  
617-659-1571

**CALL 800-821-2492.**

Full Refund if not satisfied in 30 days.

**LEARN LISP**  
Interactively and Write Real Programs  
with TransLISP for Only \$75

A “COMMON LISP” compatible Tutorial, Interpreter, Debugging, and Pretty Printer plus a Fast, Full Screen Editor, Samples and Help

- Start Easily and Quickly:**  
A complete, modular tutorial helps you learn LISP at your own pace. An integrated, interactive environment provides all of the elements needed to enter, modify, analyze and debug programs.
- Natural Language, Expert Systems and Symbolic Manipulation:**  
Natural Language concepts are illustrated by a phone number retrieval program. Choose the best word processing program for you with the Expert System. Arithmetic expressions are translated to Assembler using a code generation program.
- Write Realistic Programs:**  
Short examples and substantial programs of about 10 pages in length help you learn by modifying, studying and using the key concepts needed to write programs of 1000 lines or more.
- The “COMMON LISP” Standard:**  
TransLISP includes a 300+ function subset of the “COMMON LISP” Standard. Use extras like the MSDOS interface and graphics. Or use “strict compatibility” to make programs written in TransLISP, upwardly compatible with other COMMON LISP systems like VAX LISP, GC/LISP or LISP Machine LISP.

**Recent Improvements:** 640K Memory use supports 12000 line programs. Full 8087 and 8086 floating point included.

Runs on any MS/PCDOS System with 256K. It is not copy protected.

“The best LISP I’ve ever used. Three times before, I tried to learn LISP, but until now I could never break through the surface.” *W.L. Whipple, User*

**ONLY \$75**



335-B Washington St.  
Norwell, Mass. 02061  
617-659-1571  
800-821-2492

Full refund if not satisfied during first 30 days.

Zeke’s 1.2-megabyte 8-inch drives are just about twice as fast as Big Kat’s floppies. I’m used to him.

On the other hand, Zeke has become a dedicated word processor. Not that he *can’t* do anything but write. I still have lots of CP/M Z80 programs for accounting, making calendars and keeping my schedule, and all the other things I expect small computers to do for me; but both PC-DOS and Concurrent DOS are so much faster, and it’s so much more convenient to have those programs memory-resident and readily available, that I haven’t fired up Zeke for anything but writing since we moved upstairs.

In fact, when I finish this column, I’ll save it on Zeke’s 8-inch disk, then turn around and put that disk in the Golem to check the spelling. I check spelling with The Word Plus, and, frankly, I don’t even remember if I have a Z80 version or if it was upgraded to run on the 8086 family. The Golem has both, and they operate invisibly; and he’s terribly fast, especially when I run the spelling program from the CompuPro M-Drive/H memory drives. I can then save the corrected column on the Golem’s 5¼-inch drive in PC-DOS format, insert the PC floppy into Big Kat, and send it all off to Peterborough through BIX.

That’s absurd. *Three* computers to get the column out? Surely one can go—but which?

Probably Zeke. What I should do is start a quest for a really good terminal I can run off the Golem at 38.4 kilobaud (or kilobits per second, as they want you to say now, although I can’t guess why). Last time I looked, there weren’t any that would scroll text fast enough for me: when I flip a screen page, I want that to happen right *now*. But surely there are new terminals that will do the job. Once I’ve found one, I’ll have to look at the keyboard. Of course, the screen has to be large enough, and bright enough, and the letters properly formed, and—

And if we’re going to do that, it can’t be long before we have good color boards and monitors and editors for the AT, and—

And at that point I say to heck with

*(continued)*



# DON'T LOOK FOR PRODUCTIVITY IN A PRODUCT.

The purchase of a data base system should be the beginning of a relationship.

That relationship should include planned product upgrades, experienced technical support, vertical application templates, informational seminars, training programs, user groups, newsletters, special marketing programs... and much, much more.

## Demand a Relationship

At Software Solutions, the relationship begins as soon as you contact us. We'll help you find answers to your questions about DataEase™—or about any information management issue.

The product evaluator at

Manufacturer's Hanover Trust summed up the experience of tens of thousands of users by calling DataEase "the most impressive productivity tool I have seen."

When you talk to us, ask for our sample diskette. See for yourself why *Data Based Advisor* points to DataEase as "the easiest to understand and use full-featured data base program," calling it "a program which could easily set the industry standard."

Discover us. Find out how important the company behind the product can be.

Send information and a free DATAEASE BYT 6/86 sample diskette for my PC (check one):

IBM  WANG  DEC  TI

Include materials relating to:

Corporate Client  Retailer  
 MIS/DP/IC Professional  VAD  
 Other \_\_\_\_\_

Name: \_\_\_\_\_

Title: \_\_\_\_\_ Phone: \_\_\_\_\_

Company: \_\_\_\_\_

Street: \_\_\_\_\_

City: \_\_\_\_\_ State: \_\_\_\_\_ Zip: \_\_\_\_\_

Mail to: Software Solutions, Inc. Telex: 703972  
12 Cambridge Drive 800-243-5123  
Trumbull, CT 06611

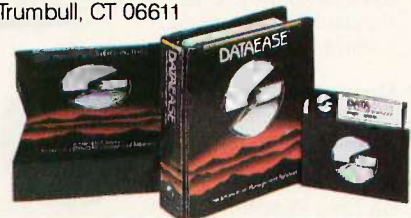

Software Solutions. Get into a relationship that works for you.

Canada  
Computertlinks, Toronto, Ontario; (416) 231-1270

United Kingdom  
Sapphire Systems, Essex; 01-554-0582

West Germany, Austria  
M&T Software Verlag, Munich, 089-4613-0

Scandinavia  
West Soft A/S, Alesund, Norway; (47) 71-46166

Switzerland, France  
Softsource, S.A. 1209 Geneva, Switzerland; 985152&985-153

it and do nothing. Which brings me to the point: CP/M isn't dead.

**VERY MUCH ALIVE**

Mrs. Pournelle has finished the outline and several chapters of a new book. She's using an Ampex terminal and a CP/M system built out of Ampro Little Boards by Don Castella of Disks Plus in Chicago. For some time, she's had her pick of computers and sys-

tems to use as word processors. She has used a Z-150; a Z-160; Adeline the Otrona (about whom more later); a Z-100; Lucy Van Pelt, the IBM PC; and a Macintosh. The system she likes best is the one she has now: CP/M, hard disk, Ampex terminal, and the WRITE text editor. Of course, all she does with that machine is write and edit, so it's hardly a fair test; but it does confirm my impression: given a

number of systems to choose from, a good CP/M system with WRITE is still about the best creative writer's word processor around.

Incidentally, her Ampex terminal does run at 38.4 kilobaud. It won't scroll as fast as Zeke does with his memory-mapped video, but then no terminal does. The amber screen is nice, the letter set is pleasing, and the letters are large enough. I could certainly live with it as my major system for writing books. I'm not too happy with where the arrow keys were put on the keyboard, but I'm not too happy with anybody's keyboard arrangement. She likes the terminal a lot, and I'm sure I would once I got used to it. Maybe I ought to get one and hang it on the Golem. But that's for another time. The point is that for writers a CP/M machine is not only good enough, there are ways in which it's superior to more "advanced" equipment; and built up from Little Boards the way Castella built Roberta's machine, a CP/M system certainly costs less than most comparably equipped "advanced" systems.

Don Castella periodically shows me the new stuff they're doing with Ampro Little Boards. There's a Little Board using the Intel 80186 chip; Don built up a system with a hard disk and a Link PC-emulation PC-Term terminal and brought it around. It seems quite nice. Castella and the Ampro people claim they can put together fast multi-user PC-DOS and Concurrent DOS systems at a lower cost per user than anyone else in the business, and I expect that's right. Of course, the Little Board systems are no more than 85 percent compatible with an IBM PC; about like a CompuPro, although the incompatibilities aren't the same.

Some of the incompatibilities may be due to the terminal. The Link PC-Term is supposed to emulate the IBM PC monochrome system, and perhaps it does; I haven't done any extensive tests. In fact, I have a confession: I've done almost nothing with the Little Board/186 system.

It isn't the Little Board's fault. If I don't sound enormously enthusiastic about partial clone systems, it's not because I don't think they have their

(continued)

**NEW!**  
For Your IBM PC or Compatible  
**RightWriter® Version 2.0**

**THE Intelligent Grammar and Style Checker**

RightWriter is a new tool to help you produce lean, powerful BUSINESS WRITING. RightWriter uses advanced artificial intelligence technology to flag errors in GRAMMAR, STYLE, USAGE, and PUNCTUATION. RightWriter is the first office automation package aimed at producing better writing, not more writing.

- **Messages are Inserted** directly into text to point out possible errors and problem areas.
- **Easy to Use** — only one command to learn, your word processor does the rest.
- **Works with Leading Word Processors** — including WordStar®, Volkswriter®, PFS:write®, MultiMate®, and others.
- **Readability Index** — measures the reading grade level of the document using the D.O.D. standard Flesch-Kincaid formula.
- **Uncommon Word List** — lists misspelled, slang, and uncommon words.
- **Recommends** — never decides. RightWriter is a writing aid. The final decision is always left to you,

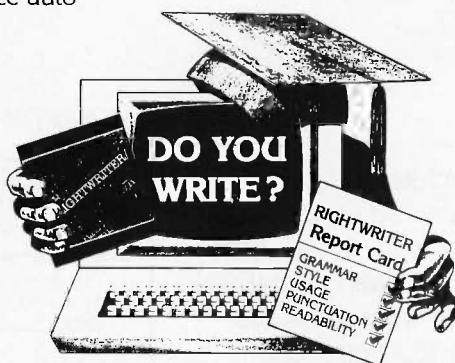

"...RightWriter is an idea whose time is long overdue."  
**Phil Wiswell — PC Magazine**

"RightWriter is an excellent, low-cost, eye-opening software package..."  
**Inside Word Management**

"The documentation is among the best I have seen."  
**Jim Pile, Soft Sector**

**Price \$95.00**

Available from your local dealer or:  
DECISIONWARE, INC./RightSoft Division  
2033 Wood St. • Suite 218  
Sarasota, FL 33577  
Phone Orders Call: (813) 952-9211  
Add \$4 for shipping and handling.  
VISA & MASTERCARD accepted  
**30 Day Money Back Guarantee**

RightWriter is a trademark of DecisionWare, Inc., WordStar is a trademark of MicroPro International Corporation. MultiMate is a trademark of MultiMate International. PFS:write is a trademark of Software Publishing Corporation. Volkswriter is a trademark of Lifetree Software, Inc.



# Your first color monitor should be good enough to be your last.

**NEC** introduces the only color monitor you need. Superb resolution plus MultiSync for across-the-board compatibility with all three PC graphics boards made by IBM® for business graphics, CAD/CAM, computer art, and text.

Now there's one high resolution color monitor that does things your way. The MultiSync™ monitor from NEC.

It gives you the best color resolution available at the price.

- Compatibility with the IBM Professional Graphics Adapter, the IBM Enhanced Graphics Adapter, and the IBM Color Graphics Adapter.



*Compatibility with the IBM® Enhanced Graphics Adapter Board*



- MultiSync, the NEC feature that automatically adjusts to color adapter board scanning frequencies from 15.75 KHz to 35 KHz — suggesting the possibility that the MultiSync monitor might be compatible with *all* color graphics boards that are fully compatible with the IBM PC, PC/XT, and PC/AT, now and in the future.

- Full implementation of high resolution graphics software for business and other applications, now and in the future.

- And color capability limited only by the board being used.

## See Things Our Way

Until now, you had to choose different color monitors for

compatibility with all three PC color graphics boards made by IBM. With so many board and monitor configurations, folks didn't know which way to look.

The new MultiSync color monitor gives you unique compatibility. As well as TTL and analog color. With 7 switchable text colors. And resolution up to maximum 800 horizontal dots and maximum 560 vertical lines, on a large, 13" diagonal viewing area.

All that, priced at just \$799. All from NEC, a name respected around the world for advanced, reliable products backed by nationwide service.



*Compatibility with the IBM® Professional Graphics Adapter Board*



It's the one color monitor that does everything your way.

*Compatibility with the IBM® Color Graphics Adapter Board*



But why talk more about it? Visit your nearest dealer and see a graphic demonstration of the new NEC MultiSync monitor's capabilities. Then draw your own conclusions.

For information dial  
**1-800-447-4700**

NEC HOME ELECTRONICS (U.S.A.) Inc.  
Personal Computer Division  
1401 Estes Avenue  
Elk Grove Village, IL 60007

# NEC

# The only breaks printers are the

**Xerox**

**Xerox Rebate Check**  
2080 Telegraph Road, Suite 200  
Bloomfield Hills, MI 48303

001877 8:20 7:30

ACCOUNT NUMBER	DATE
11470001	04/1/86

CONTROL NUMBER	AMOUNT
681	**500.00 **500.00

PAY TO THE ORDER OF: Malcolm Karlin  
8 Tanglewood Road  
Stamford, CT 21860

FIRST INTERNATIONAL BANK  
MAIN STREET, ROCHESTER, NY 14186

NOT VALID OVER 90 DAYS  
AUTHORIZED SIGNATURES  
*James Jones*

001877 1:07 200080 5:0 0007, 70Lm3

Rebate for the D80IF

**Xerox**

**Xerox Rebate Check**  
2080 Telegraph Road, Suite 200  
Bloomfield Hills, MI 48303

001879 8:20 7:30

ACCOUNT NUMBER	DATE
11470001	04/1/86

CONTROL NUMBER	AMOUNT
681	**400.00 **400.00

PAY TO THE ORDER OF: Paul Levett  
23 Sunset Avenue  
Bay Shore, NY 11706

FIRST INTERNATIONAL BANK  
MAIN STREET, ROCHESTER, NY 14186

NOT VALID OVER 90 DAYS  
AUTHORIZED SIGNATURES  
*James Jones*

001879 1:07 200080 5:0 0007, 70Lm3

Rebate for the D80

**Xerox**

**Xerox Rebate Check**  
2080 Telegraph Road, Suite 200  
Bloomfield Hills, MI 48303

001885 8:20 7:30

ACCOUNT NUMBER	DATE
11470001	04/1/86

CONTROL NUMBER	AMOUNT
681	**100.00 **100.00

PAY TO THE ORDER OF: Charles Eaton  
18 Allen Street  
Richmond, VA 20138

FIRST INTERNATIONAL BANK  
MAIN STREET, ROCHESTER, NY 14186

NOT VALID OVER 90 DAYS  
AUTHORIZED SIGNATURES  
*James Jones*

001885 1:07 200080 5:0 0007, 70Lm3

Rebate for the 635

**Xerox**

**Xerox Rebate Check**  
2080 Telegraph Road, Suite 200  
Bloomfield Hills, MI 48303

001880 8:20 7:30

ACCOUNT NUMBER	DATE
11470001	04/1/86

CONTROL NUMBER	AMOUNT
681	**75.00 **75.00

PAY TO THE ORDER OF: Diana Lynn  
2607 Thomas Drive  
Los Angeles, CA 16412

FIRST INTERNATIONAL BANK  
MAIN STREET, ROCHESTER, NY 14186

NOT VALID OVER 90 DAYS  
AUTHORIZED SIGNATURES  
*James Jones*

001880 1:07 200080 5:0 0007, 70Lm3

Rebate for the P32CQI

**Xerox**

**Xerox Rebate Check**  
2080 Telegraph Road, Suite 200  
Bloomfield Hills, MI 48303

001884 8:20 7:30

ACCOUNT NUMBER	DATE
11470001	04/1/86

CONTROL NUMBER	AMOUNT
681	**100.00 **100.00

PAY TO THE ORDER OF: Cameron McNaughton  
72 Berger Lane  
Rochester, NY 10177

FIRST INTERNATIONAL BANK  
MAIN STREET, ROCHESTER, NY 14186

NOT VALID OVER 90 DAYS  
AUTHORIZED SIGNATURES  
*James Jones*

001884 1:07 200080 5:0 0007, 70Lm3

Rebate for the 630ECS

When you buy a Xerox printer, what you get are breakthroughs. Not breakdowns.

You see, Xerox has been a leader in developing hard-working, reliable printers from the very beginning. We even invented daisywheel printing.

One of our latest printer innovations, however, doesn't stress higher tech, but rather lower prices.

Because from now until July 31 we're offering substantial rebates on our entire line of Xerox Diablo dot matrix and daisy-wheel printers.

So you'll be able to save from \$25 up to \$500, depending on the model you choose.

And choosing is easy since all of these Xerox printers are compatible with a wide range of personal computers, including Xerox, Apple and IBM.

Our Xerox Diablo dot matrix printers let you print in near-letter quality, or high-speed draft quality. And graphics can be merged right in with the text.

\*Average mean time between failure is 4000 hours.  
Xerox® Diablo® and the identifying numbers herein are trademarks of the XEROX CORPORATION.  
IBM® is a trademark of International Business Machines Corporation.  
Apple® is a trademark of Apple Computers, Inc.



# XEROX

# you'll get on Xerox ones you want.

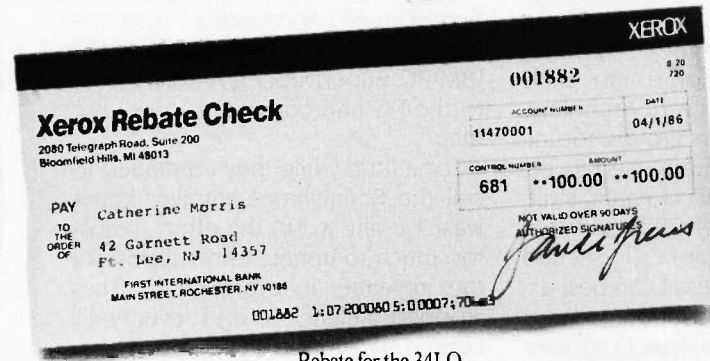

Rebate for the 34LQ

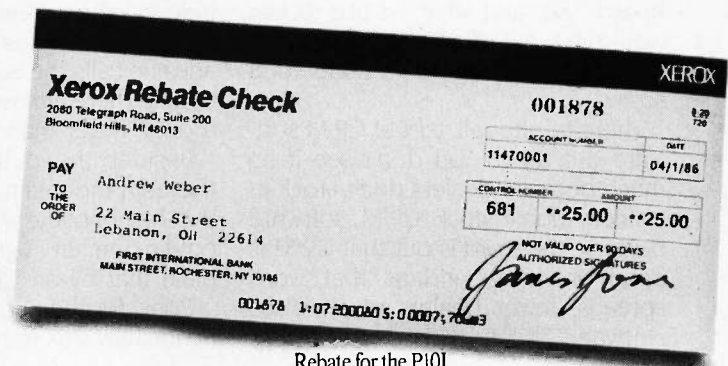

Rebate for the P101

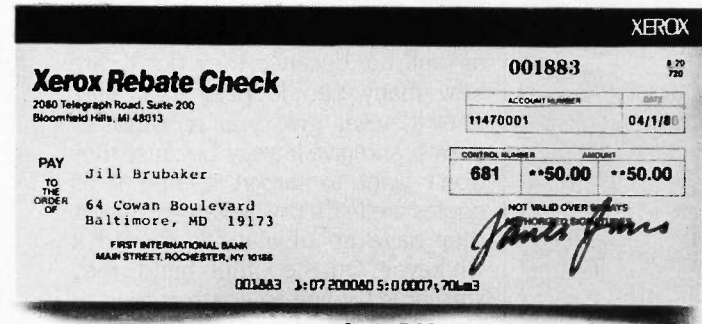

Rebate for the D25

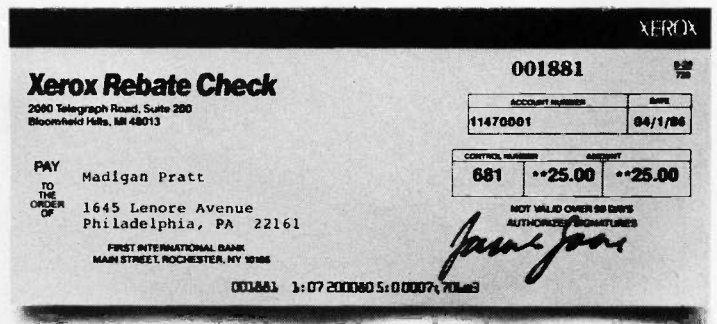

Rebate for the P12CQI

The Xerox Diablo daisywheel printers offer letter quality printing that can easily meet all your word processing needs.

You'll also have your choice of today's most advanced features. Like extended character sets, varied printing styles, and flexible paper handling capabilities.

And every Xerox Diablo printer is backed by a one-year limited warranty on parts and service.

So why not get a big break on the printers that don't break?\*

Call your local participating Xerox dealer or sales office for details today. Or call **1-800-TEAM XRX ext. 158A**. Or just fill out the coupon and send it in. We'll take care of the rest.

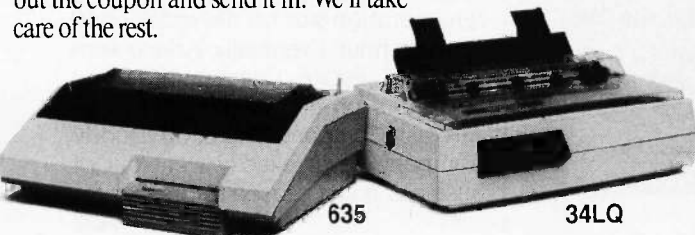

635

34LQ

FOR MORE INFORMATION ON XEROX DIABLO PRINTERS. CIRCLE CODE 398 ON THE READER SERVICE CARD.

**XEROX**

## Xerox, give me a break.

Have a dealer or Xerox Sales Representative contact me.  
 Send me more information on Xerox printers and the Xerox Rebate Program.

Name \_\_\_\_\_ Title \_\_\_\_\_  
 Company \_\_\_\_\_  
 Address \_\_\_\_\_ City \_\_\_\_\_ State \_\_\_\_\_  
 Zip \_\_\_\_\_ Phone \_\_\_\_\_

Send to: Xerox Corporation, P.O. Box 24, Rochester, NY 14692  
**call 1-800-TEAM XRX ext. 158A**  
or call 1-800-832-6979 ext. 158A 192/0601

place. They do: it's just not here. I don't much like multiuser systems (One user, at least one CPU!), but then I don't have to. I operate a small business, but it's not like most: I have a small number of products, not many customers (i.e., publishers), and a very small staff. I don't have inventories to maintain or shared databases to update, nor must I find the lowest-cost computer system to do the job. If I did, I'd look at the situation a lot differently. As it is, though, I'm much more excited about Roberta Pournelle's Little Board Z80, and what I'd like to see would be a Little Board 8/16 that would run both Z80 and 8086/8088 software.

There is, after all, a lot of CP/M software out there. You don't see it so much because dealers don't stock it. Dealers don't stock CP/M software because the word is out that CP/M is dead or dying; and as that word spreads, fewer dealers stock CP/M software. The spiral is deadly.

I don't know if the trend can be halted. I do know it's wrong. There are a lot of CP/M machines; they're very good at what they do; and you can get an awful lot of bang for the buck from them.

**NOT EXACTLY FREE . . .**

There's plenty of CP/M software, too. Much of it is in the public domain: free if you can find it. The trouble with free software is that it's not generally in anyone's interest to tell you about it. Dealers like Don Castella try to provide it with systems they sell. Barry Workman bundles some into packages he calls the Software Anthology Series. There are users groups, too, although fewer than there used to be.

Besides the public domain stuff, there's a mountain of CP/M software that has become what I call "pseudo public domain." I guess I can best explain that by an illustration.

Consider the Scrimshaw Company. Scrimshaw was started in a garage by

four guys. One had a CompuPro "boat anchor" S-100 system; they used it to develop a Pascal compiler. The compiler worked and was out there early: if you wanted to do Pascal on your 8080 system, you bought Scrimshaw or you went without. They sold a lot of them.

Eventually competition came along. But by the time better compilers had appeared, the Scrimshaw people had got into another kind of programming entirely. Their new stuff—call it the SuperDuper Accounting System—took off like a rocket. Then came the IBM PC. SuperDuper got ported over to the PC and continued to sell like fury.

For a little while they continued to sell the Scrimshaw compiler, but it wasn't really worth the effort. It cost too much to update and support for the revenue it brought in. They stopped selling it and eventually ceased to support it.

The Scrimshaw compiler is now pseudo public domain. It isn't *really* public domain, because Scrimshaw never officially put it there; but it may as well be, because they don't care how many people pass it around. They'll never give you *permission* to copy it and give it away, because they don't want to *support* it; and if all copies are in theory illegally obtained, they have no obligations toward it whatever. On the other hand, they sure aren't going to waste resources tracking down and suing pirates.

That's one case. Less complex is the case of the FuddyDuddy calendar program. The FuddyDuddy Company consisted of Duane and Arlene Goodhacker working off their kitchen table. They sold 71 copies of FuddyDuddy at \$87.50 each (thus doing better than a lot of start-up companies). Nobody was unhappy with the program, but it never took off. Expenses, including advertising, came to 93 percent of what they took in, so their effective remuneration was on the order of 40 cents an hour. Eventually, Arlene went into real estate sales, and Duane became a programmer at the Huge Aircrash Company. The FuddyDuddy Company never exactly went out of business, it just ceased to operate for

(continued)

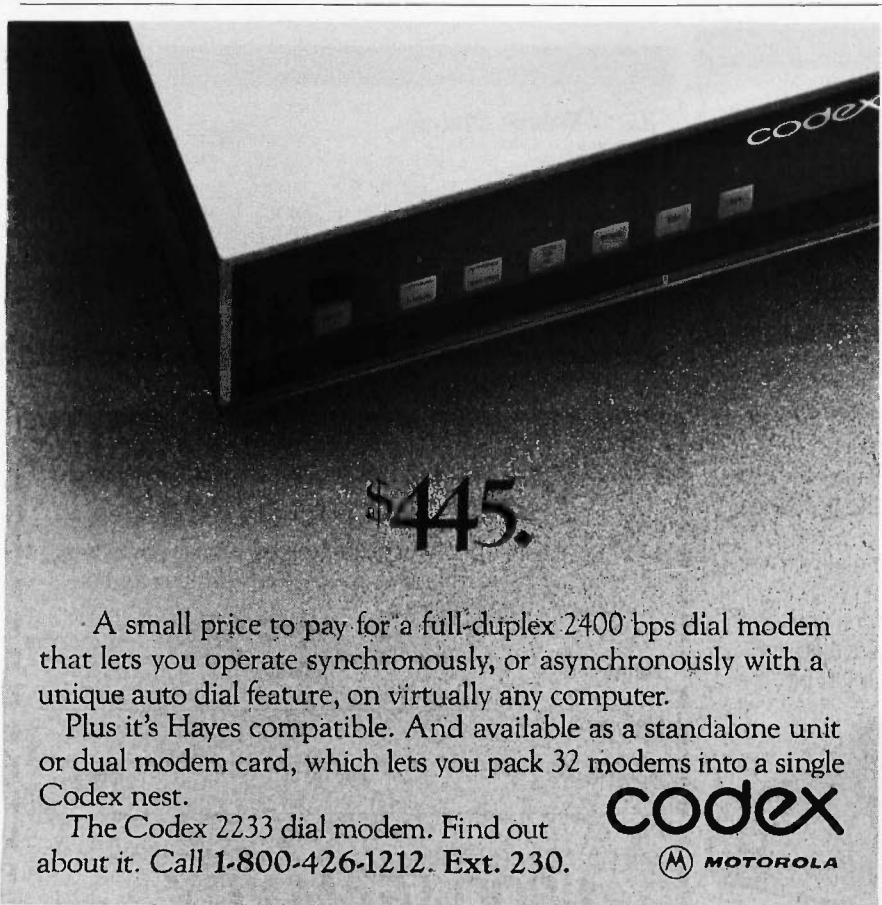

A small price to pay for a full-duplex 2400 bps dial modem that lets you operate synchronously, or asynchronously with a unique auto dial feature, on virtually any computer.

Plus it's Hayes compatible. And available as a standalone unit or dual modem card, which lets you pack 32 modems into a single Codex nest.

The Codex 2233 dial modem. Find out about it. Call 1-800-426-1212. Ext. 230.

**codex**  
 **MOTOROLA**

Motorola and @ are trademarks of Motorola, Inc. Codex is a registered trademark of Codex Corporation.  
 © 1986 Codex Corporation.



# jc lips

The Word is Out...

*It's going to break your heart if you already own a PC.*

JC LIPS provides a new experience in personal computing. Our third generation personal computer brings you technological advancement and features which have not been possible in the past. It runs all popular IBM PC software 2 to 4 times faster than other compatibles. It will impress you with unsurpassed performance and cool reliability. Best of all, it is available to you at an affordable price.

JC LIPS features the advanced-technology CMOS NEC V40 processor running at 8 MHz with an equivalent throughput of at least 9.5 MHz. The systemboard has 256K of RAM, expandable to 640K, a built-in floppy disk controller, a socket for a high speed floating point processor, and 8 I/O expansion slots. Also included as standard on systems are 360K floppy disk(s), a serial interface, a parallel printer interface, a battery backed-up clock, a keyboard, and a 135 Watt power supply, capable of handling all of this plus any accessories you may add later.

JC LIPS' display system includes a quality 14" high resolution monochrome monitor with a dark

background non-glare screen and a tilt and swivel base for easy viewing. The multi-function display card provides an IBM PC compatible interface for a monochrome display with Hercules compatible graphics or a RGB color graphics display.

JC LIPS is also available with high speed 20 MB hard disk with 2K cache buffer memory controller, Enhanced Color Graphics display adapter, high resolution RGB color monitor, local area networking controller, and more. These options can be added at any time, and with the features we supply as standard, it will be a difficult system to outgrow.

**NOW** the word is out. Another superb product is available from the high-performance, multi-user systems company, JC Information Systems.



## JC INFORMATION SYSTEMS

161 Whitney Place  
Fremont, CA 94539  
(415) 659-8440 TWX 910-381-7041



*There are a lot of orphan programs out there in the CP/M world.*

lack of interest; and FuddyDuddy became an orphan program.

There are a lot of orphan programs out there in the CP/M world. Some are really excellent. The real problem is finding them.

One solution would be for people like Duane and Arlene to turn their programs into shareware and let people who sell CP/M systems know they've done it. The word can be put out on bulletin boards, too. Shareware works this way: you can get a copy of the program from anyone who has it. You can pass it on to anyone you like. If you do like it and use it, send some money to the authors of the program.

Of course, the Scrimshaw people aren't about to make *their* programs shareware. On that one, you just have to let your conscience be your guide. The important thing is that there's a lot of CP/M software. Some is not bad, some is very good, and nearly all of it is cheap.

**V WEAPONS**

Into that complex situation comes the NEC company with its V20 and V30 chips. These chips replace the CPU chip in PClones and do two things: they make the PClone run a bit faster, and they emulate an 8080 so that you can run very nearly all the old CP/M software. The V20 replaces an 8088, and the V30 replaces the 8086. V20 chips work fine in PClones, including the Zenith Z-100, Z-150, and Z-160. They don't work in partial clones, including the DEC Rainbow, TI Professional, and Victor 9000.

Accelerate 8/16, which is CP/M software for using NEC V-series chips, is

available from Walt Bilofsky's Software Toolworks. Intersecting Concepts of Moorpark, California, has a cooperative arrangement with Software Toolworks to copublish; the Media Master program lets a V20-equipped PClone handle a wide variety of 5¼- and 8-inch disk formats, including, of course, PC-DOS. About the only major format it can't handle is Osborne single-density. Double-density works fine.

The result is wonderful for owners of CP/M machines: if you want to upgrade to a PClone, send \$99.95 to Software Toolworks and you get Accelerate 8/16, which includes the V20 chip, instructions, and Media Master. With that, you can not only transfer all your old CP/M files onto your new Zenith or Compaq or whatever, you can also run all your old CP/M programs. You don't need to go buy all new software.

Now for the bad news: we don't know *precisely* what CP/M software will run on the PClones. We do know that *most* will. If a program doesn't make really tricky BIOS calls, or subroutines embedded in specific locations in CP/M, it should work fine. Barry Workman reports that he has sold a number of copies of FTL Modula-2, his low-cost CP/M Modula-2 compiler with integral editor, to people with V20 PClones. I haven't tried that myself, but so far Barry has heard no complaints.

It's a bit hard to estimate the effect of the V-series chips. They don't cost a lot, and they definitely improve the performance of PClone machines. Reports of 20 to 25 percent speed improvements are probably exaggerated, but certainly WordStar and other I/O-bound programs go 10 to 15 percent faster; a significant upgrade for 20 bucks or so. Walt Bilofsky has done a lot more testing than I have; he reports that nothing runs slower, and most things run somewhat faster.

Thus, it makes sense to upgrade your PClone just for the speed improvement; and it also gives you access to a vast array of CP/M software.

If you have a PClone, you could do a lot worse than to get Accelerate 8/16. Then send for Workman's cata-

*(continued)*

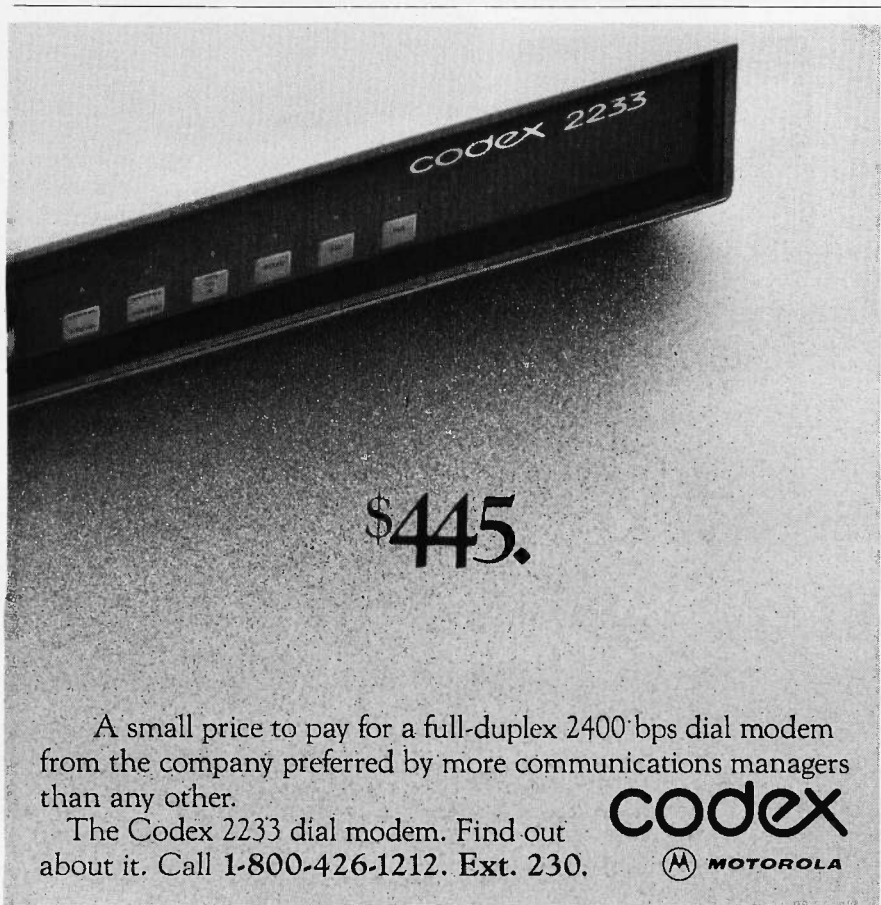

**\$445.**

A small price to pay for a full-duplex 2400 bps dial modem from the company preferred by more communications managers than any other.

The Codex 2233 dial modem. Find out about it. Call 1-800-426-1212. Ext. 230.

**codex**  
 **MOTOROLA**

Motorola and  are trademarks of Motorola, Inc. Codex is a registered trademark of Codex Corporation. © 1986 Codex Corporation.



# MORE PERFORMANCE

In a multi-user system, performance is the most important ingredient.

Introducing the top-of-the-line in our 286 series, the **CompuPro 286/80™** with more performance built in than ever. For starters, our new 8 MHz 80286 processor gets data from memory in only two clock cycles, compared with the three or four required by other systems. In addition to the 768K of high speed memory, the system's high performance 80 Megabyte hard disk has a dedicated 512K byte cache buffer that boosts its performance even more. Tape back-up and floppy drives are included along with nine serial ports, Concurrent DOS 816™ multi-user multi-tasking operating system and NewWord™ word processing software. The system includes a 16 slot S-100R motherboard, which means there's plenty of room for adding options such as memory expansion to a megabyte, more cache memory, additional I/O ports, slave processors, graphics, networking and more.



All this tech-talk translates simply to this: The CompuPro 286/80 has the power to solve your business computing needs today and tomorrow as your business grows. The price? A lot lower than you'd expect to pay for all this performance. Just \$12,500 suggested list. To find out how the CompuPro 286/80 (or any of our other multi-user systems) can give your business more performance, call today for the name of your nearest CompuPro dealer.

**10 MHz** available with AMD 80286! Dealers have details.

# MORE NET PERFORMANCE

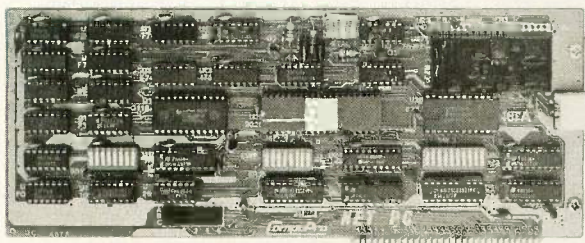

CompuPro has been providing networking solutions for years with our NET 100™ and NET 10™ products, and we're proud to introduce the latest member of our network family—The NET PC™. Simply plug the NET PC into your IBM® PC, XT, AT or 100% compatible and your personal computer now becomes an integrated part of high performance multi-user network. The NET PC includes the CPLINK™ requestor program that lets your PC become a part of the network while still running DOS.

CompuPro multi-user systems (like the 286/80) make ideal file-servers for networked PCs, and they're still fully functional as multi-user

computers. Your problem of how to move up to a true multi-user system and keep your existing PCs is now solved.

TECH-TALK: All our network products use the high speed (2.5 MBPS) ARCNET® token passing hardware protocol and DR NET™ software protocols (except a PC with CPLINK, which emulates DOS 3.1 conventions). The network may contain up to 255 nodes. The NET PC is a fully compatible super-set of the SMC ARCNET card and therefore may be used with other network software systems.

NET PC with CPLINK: \$550. NET 100 (for S-100 systems and the 286 series): \$495. NET 10 (for the CompuPro 10 Plus™): \$495. All prices are suggested list.

**AT COMPUPRO, PERFORMANCE IS NOT JUST ANOTHER BUZZWORD.**

**SUMMER HOT FLASH!** Get a super summer deal on a CompuPro 10 Plus four user system with a 40 megabyte hard disk. For a limited time we're slashing the price to just \$5995! See your nearest dealer for more details.

**CompuPro™**

Viasyn Corporation, 26538 Danti Court  
Hayward, CA 94545-3999 (415) 786-0909

log of CP/M software: there's an amazing amount of it, much of it packed 20 programs to a disk, and all cheap (Workman and Associates, 112 Marion Ave., Pasadena, CA 91106). Software Toolworks also has a ton of CP/M stuff.

NEC sent me a pile of V20 chips, which we're busily installing in every PC clone we have. The *Challenger* disaster interrupted our tests. Full reports another time, but we're very excited.

### INTEGRATION?

When IBM brought out the PC with PC-DOS rather than CP/M-86, it splintered the micro community. Nowadays, it's no big deal to transform files from CP/M to PC-DOS (although not everyone can do it), but for a while it was. PC-DOS, warts and all, became the mainstream. CP/M didn't vanish, but it sure got a lot less attention.

The V-series chips can bring those streams back together. There may even be a sort of renaissance through

hybrid vigor. More: I'm told that NEC is working on a chip that can run everything from Z80 through 80386 software. And someone will bring out a chip that has 68000 capabilities.

Integration of the micro community means larger customer bases for software. A larger market base means lower prices. Lower-priced, powerful software interests more people in small computers.

The only real question is, why did it take the Japanese to bring us together?

### THE GREAT EDITOR HUNT

It all started when I was talking with Don Castella about what I might do with the Little Board/186 machine.

"I do have an idea," I said. "I've collected some enormous files of stuff off BIX. I'd like to go through and edit them down. Delete blocks of nonsense. What I really need is a good macro editor, like WordMaster. What do we have?"

It turns out that I don't have anything. I might be able to tailor Borland's Turbo Editor Toolbox; although it won't hold files larger than memory, that's not such a severe limitation for PC-DOS as it was for CP/M. Alas, I haven't time to do the tailoring. I want something I can use *now*. WordStar in nondocument mode doesn't have proper macros. VEDIT would probably work—I recall I was pretty happy with it under CP/M-86—but I don't have a PC version.

Don suggested Pmate, which apparently is quite popular with programmers; but, alas, that's one of the few editors I don't have, and I'm not convinced it has the command processing I want.

Connie Kageyama brought over an editor called KEDIT, which looks all right; but in reading the manual I can't find out how the macro system works and whether search-and-replace mode lets you match control characters and delimiters and suchlike. I'm told that you can, but the documents don't explain it very well. I'll try again.

One problem is that I've been spoiled by WordMaster. (My mad friend MacLean dubbed it Word Masher long ago, and to this day I invoke it under the command MASH file.ext.) WordMaster not only lets you search and replace for carriage returns and linefeeds and other control characters, but it also has a way to insert any character you like into the text stream. (Well, there is one exception: if you try to insert a Control-Z, which is the CP/M "end-of-file" mark, WordMaster not only won't do it, but the screen flashes "Turkey!") There is a small buffer in which you can set up quite complicated commands, including conditionals. Finally, WordMaster lets you edit as long a file as your disk can hold. It was an early CP/M version of TECO and is, in a word, one of the best programming editors ever written.

There's only one problem. WordMaster was the first CP/M program published by MicroPro. When WordStar took off, MicroPro abandoned WordMaster. Not only is there no PC-DOS WordMaster, you can't get anyone at MicroPro to admit they ever

(continued)

\$445.

A small price to pay for a full-duplex 2400 bps dial modem that gives you better performance, better features, and better support than anything else available.

The Codex 2233 dial modem. Find out about it. Call 1-800-426-1212. Ext. 230.

**codex**  
M MOTOROLA

Motorola and M are trademarks of Motorola, Inc. Codex is a registered trademark of Codex Corporation.  
© 1986 Codex Corporation.



# MICROWAY'S 8087 RUNS 1-2-3™!

MicroWay is the world's leading retailer of 8087s and high performance PC upgrades. We stock a complete selection of 8087s that run at 5 and 8mhz. All of our coprocessors are shipped with a diagnostic disk and the best warranty in the business - one year! We also offer daughterboards for socketless computers (NEC PC) and 287Turbo which increases the clock speed of the 80287 from 4 to 8 mhz. Our NUMBER SMASHER™ includes 640K ram. It will run the IBM PC at clock speeds up to 10mhz and achieves a throughput of .1 megaflops with 87BASIC/INLINE, Intel

Fortran, or Microsoft Fortran. Software reviewers consistently cite MicroWay software and 8087 expertise as the best in the industry! Our customers frequently write to thank us for recommending the correct software and hardware to meet their specific needs. They also thank us for our same day shipping! In addition to our own products which support the 8087 and 80287, we stock the largest supply of specialized software available. For information call us at

**617-746-7341**

**FASTBREAK™** employs the 8087 to increase the speed of Lotus 1-2-3™ Version 1A or 1A\* by up to 36 to 1 **\$79**  
**FASTPAK™** includes FASTBREAK software and a 5mhz 8087 ..... **\$179**  
**87SFL™** MicroWay's Scientific Function Library contains 170 scientific and engineering functions. Callable from most 8087 compatible compilers. First Language **\$250**; Additional **\$100**.  
**A2D-160™** MicroWay's Data Acquisition Board performs 160,000 12 bit Analog to Digital conversions per second! Includes software drivers. The fastest 12 bit A to D board available. For the IBM PC or XT. .... **\$1295**

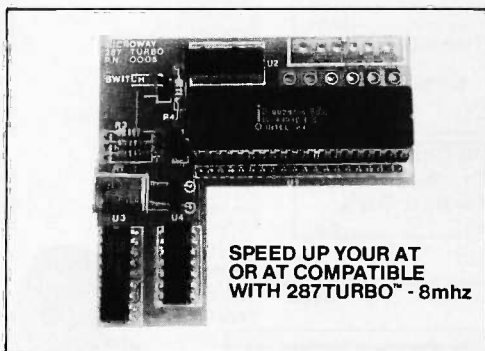

## MicroWay® 8087 Support

For the IBM PC, PC XT, PC AT and Compatibles.

**NUMBER SMASHER™** The World's Fastest Accelerator Card for the IBM PC, XT, and Compatibles! Includes an 8086 and 8087 pair tested to 10mhz, and 640K bytes of high speed ram. Compatible with all software, operating systems and hardware! Your program speed is increased by a factor of 2.5 to 4.0. Floating point programs run up to 2.8 times faster on the PC than on an 80287 equipped PC AT. One of the few accelerators on the market which is compatible with all EMS cards. Includes FASTBREAK. .... **\$1099**

**87/88Turbo™** is a stubby card which includes a clock calendar and a speed controller which changes the speed of your motherboard from 4.77 to 7.4mhz. Its use requires your PC to have a socketed 8224. Typical speed increase is 1.6. Some programs run up to 2.5 times faster. The card overcomes the problem of slow hardware by slowing up only when slow devices are accessed and running at full speed otherwise. It includes an 8087-2 ..... **\$350**

**286TurboCache™** This new MicroWay accelerator uses 8K of cache memory and 80286/80287 processors to provide an average speed increase of 3 to 1 for most programs. Call for specifications, benchmarks and price.

**MATRIXPAK™** manages a **MEGABYTE!** Written in assembly language, our runtime package accurately manipulates large matrices at very fast speeds. Includes matrix inversion and the solution of simultaneous linear equations. Callable from RM or MS Fortran, MS Assembler, or 87BASIC/INLINE ..... each **\$99**

**87FFT™** Written in assembly language, performs Forward and Inverse FFTs on real and complex arrays which occupy up to 512K bytes of RAM. Also does convolutions, auto correlations, hamming, complex vector multiplication, and complex to radial conversions. Callable from most 8087 compatible compilers. .... **\$200**

**87FFT-2™** performs two-dimensional FFTs. Ideal for image processing. Requires 87FFT **\$100**

**MegaPage™** Our Intel-Lotus specification memory card. The only EMS board which comes with two megabytes of cool-running, low power drain CMOS ram installed. Includes ram disk, print spooler, disk cache, and EMS drivers. For the IBM PC, XT, AT and compatibles ..... **\$549**

**DFixer™** Our disk utility which thoroughly checks PC or AT hard disks for bad sectors and updates the MS DOS file allocation table accordingly. Solves the AT hard disk problem! ... **\$149**

**DOptimizer™** Optimizes the way your hard disk or floppy stores its files. Speeds up accesses by recombining fragmented files. .... **\$49**

**DCache™** Our disk caching software speeds up your I/O by storing repetitively used tracks in memory. The amount of memory used can be selected in 64K byte banks ..... **\$49**

**87Verify™** For users who have to be absolutely sure of their results! This background task periodically performs an 8087 accuracy and stress test. **\$49**

**87MACRO/DEBUG™** Contains all the pieces needed for writing 8087/80287 assembly code including 8087 macros, object libraries for commonly used functions, including transcendental, trigonometric, conversions and MicroWay's debugger - 87DEBUG ..... **\$199**

**OBJ→ASM™** A multipass object module translator and disassembler. Produces assembly language listings which include public symbols, external symbols and labels commented with cross references. Ideal for patching object modules for which source is not available. .... **\$200**

**87BASIC™** includes patches to the IBM Basic or MS Quick Basic Compiler for USER TRANS-PARENT 8087 support. Provides super fast performance for all numeric operations including trigonometrics, transcendental, addition, subtraction, multiplication, and division. .... each **\$150**

**87BASIC/INLINE™** converts the output of the IBM Basic Compiler into optimized 8087 inline code which executes up to seven times faster than 87BASIC. Supports separately compiled inline subroutines which are located in their own segments and can contain up to 64K bytes of code. This allows programs greater than 128K! Requires the IBM Basic Compiler Version 1 and Macro Assembler. Includes 87BASIC ..... **\$200**

**MICROWAY UDI** runs RTOS or RMX compilers under DOS ..... **\$300**

### 8087 UPGRADES

All MicroWay 8087s include a one year warranty, complete MicroWay Test Program and accurate Installation Instructions.

**8087 5mhz..... \$109**  
For the IBM PC, XT and compatibles.

**8087-2 8mhz ..... \$149**  
For Wang, AT&T, DeskPro, NEC, Leading Edge.

**80287-3 5mhz..... \$179**  
For the IBM PC, AT and 286 compatibles.

**80287-8 8mhz..... \$295**  
For the Tandy 3000 and ITT-XP.

**287Turbo™ 8mhz** If you own an AT, Deskpro 286 or AT compatible, this is the card you need to get reasonable numeric performance. It plugs into your 80287 socket and includes a specially driven 8mhz 80287. The card comes in three configurations. The IBM AT version includes a hardware RESET button ..... **\$395**

**NEC V20, V30 ..... CALL**

**64K RAM Set 150ns..... \$10**

**256K RAM Set 150ns..... \$34**

**128K RAM Set PC AT..... \$49**

**JRAM, AST, INTEL ..... CALL**

**DCache plus 64K ABOVE BOARD PS..... 375**

**DCache plus 128K AT ABOVE BOARD..... 475**

**Microsoft Fortran Version 3.31 ..... 209**

**IBM Professional Fortran..... 565**

**Ryan-McFarland Fortran Version 2.0 ..... 399**

**FORLIB+ or STRINGS and THINGS..... 65**

**Grafmatic for Fortran or Pascal..... 125**

**Plotmatic..... 125**

**NAG Fortran Library..... 300**

**Lattice C..... 269**

**Microsoft C or QuickBasic..... CALL**

**IBM Basic Compiler Version 2.0..... 465**

**Summit BetterBASIC™..... CALL**

**IBM Assembler w/Librarian Version 2.0..... 155**

**Microsoft Assembler Version 3.01 ..... 99**

**Microsoft Pascal Version 3.31 ..... 199**

**STSC APL★PLUS/PC..... 450**

**Phoenix Plink86 or Cosmos Revelation... CALL**

**SPSS/PC+..... 595**

**EPSILON Text Editor..... 195**

**LABTECH NOTEBOOK..... 745**

**MultiHalo (one language)..... 189**

**Fifth Generation FASTBACK..... 150**

**MicroWay**

P.O. Box 79  
Kingston, Mass.  
02364 USA  
(617) 746-7341

# COMPUTER WAREHOUSE

CALL TOLL FREE **1-800-528-1054**

**FREE FEDERAL EXPRESS**  
**Air Express Shipping**  
 See Details Below

**HARDWARE**  
**NOW** **BEST PRICES**  
**No Charge for Bank Cards**

## PRINTERS

Anadex All Models	Call
Brother All Models	Call
Cannon Laser Printer	\$1949
Citizen MSP-10	\$250
MSP-15	\$349
MSP-20	\$315
MSP-25	\$485
Premier 35	\$409
Datasouth All Printer Models	Call
Diablo D-25	\$519
635	\$1079
Other Printer Models	Call

## EPSON

All Printer Models	Call
Fujitsu	Call
Juki	Call
6100	\$349
6300	\$669
NEC	Call
3510, 3550, 3515, 3530	\$729
8810, 8830, 8850	\$1039
PS, P6, P7	Call
EII 360	\$379
EII 370	\$379

## OKIDATA

All Printer Models	Call
Panasonic 1080	\$199
1091	\$239
1092	\$309
1592	\$425
KXP3151	\$399

## STAR MICRONICS

All Printer Models	Call
Toshiba 321	\$449
341	\$769
P351 Parallel & Serial	\$969

## MONITORS

Amdex All Monitors	Call
NEC All Monitors	Call
Princeton Graphics	Call
Zenith All Models	Call

## VIDEO TERMINALS

Qume QVT Green 101	\$299
QVT Amber 101	\$314
Wyse 30	\$299
50	\$419
75	\$559
Wyse 85	\$439
Wyse 350	\$859
Zenith Z-22	\$455
Z-29A	\$559
Z-49	Call

## MODEMS

AT&T	Call
4000 External	\$309
Anchor Automation	Call
Anchor Express	\$235

## HAYES

All Modems	Call
Prometheus All Models	Call
US Robotics Courier 2400	\$379
Password 1200	\$175
Microlink 2400	\$379

## DISK DRIVES

Alpha Omega Turbo 10	\$465
Turbo 20	\$509
Turbo 30	\$659
lomega	Call
Bernoulli 10 meg	\$1659
Bernoulli 20 meg	\$2289
Bernoulli 40 meg	\$3039
Paradise Macintosh Hard Disk	\$609

## COMPUTERS

<b>PANASONIC</b>	
Sr Partner Dual Drive	\$1599
Exec. Partner Dual Drive	\$2129
<b>TOSHIBA</b>	
T-1100	\$1389
<b>WYSE</b>	
Wyse pc 1100-1	\$979
Wyse pc 1100-20	\$1539

**Zenith Computer Products**  
**SAVE Up to 50%**  
 Z-All Models Call

## DISKETTES

Maxell MD-2 Plastic Box (Qty 100)	\$125
Sony MD/2 (Qty 100)	\$120

## COPIERS

### Canon «PC»

Canon PC-10	\$509
Canon PC-14	\$649
Canon PC-20	\$719
Canon PC-25	\$939

## XEROX

1020 w/Toner	\$1099
--------------	--------

## SANYO

SFT 600	Call
---------	------

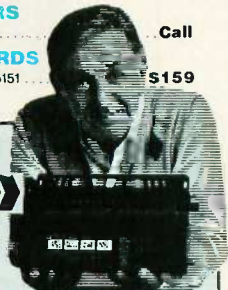

## SOFTWARE

### IBM PC and 100% Compatibles

## TRAINING

Flight Simulator	\$29
PC Logo	\$75
Typing Instructor	\$28
Typing Tutor III	\$28

## LANGUAGES

C Compiler (Microsoft)	\$227
Fortran Compiler (Microsoft)	\$203
Lattice C Compiler	\$242
Macro Assembler (Microsoft)	\$87
Pascal Compiler (Microsoft)	\$174
Quick Basic	\$57
Run C Interpreter	\$82
Turbo Pascal 3.0	\$38
Turbo Database Tool Box	\$30

## PROJECT MANAGEMENT

Harvard Total Project Manager	\$262
Microsoft Project	\$229
Super Project Plus	\$237
Timeline 2.0	\$219

## COMMUNICATIONS

CompuServe Starter Kit	Best Price
Crosstalk XVI	\$92
MS Access	\$145
PFS Access	\$76
Remote	\$92
Smartcom II	\$83

## INTEGRATIVE SOFTWARE

Enable 1.1	Call
Framework II	Call
Smart Software System	Best Price
Symphony	Call

## GRAPHICS

Chartmaster	\$205
Diagram Master	\$189
Energraphics	\$159
Energraphics w/Plotter Option	\$205
In-A-Vision	\$249
Microsoft Buss Mouse	Call
w/PC Paintbrush 3.0	\$107
Microsoft Chart	\$169
Microsoft Serial Mouse	\$119
Newsroom	\$32
PC Draw	\$199
PC Draw Light Pen	\$102
PC Mouse w/Dr. Halo II	\$104
PC Paint w/Mouse	\$119
PFS Graph	\$76
Printmaster	\$30
Signmaster	\$134
Turbo Graphix Tool Box	\$30

## WORD PROCESSORS

Leading Edge Word Processor	\$48
Leading Edge W/P w/Spell & Mail	\$95
Lightening	\$55
Microsoft Word 2.01	\$228
Multimate 3.3	\$203
PFS: Write w/Spell Checker	\$162
Wordstar w/Tutor	\$76
Wordstar Pro Pack	\$233

**Word Perfect (Ver.4.1) \$196**  
**Wordstar 2000 2.0 . \$233**  
**Wordstar 2000 + 2.0 \$278**

## UTILITIES

Copy II PC	\$19
1 DIR	\$47
Fastback	\$87
Norton Utilities 3.1	\$48
Printworks	\$36
Sidekick	\$30
Sidekick (Unprotected)	\$47
Sidekick—Superkey (Bundle)	\$85
Sideways 3.1	\$34
Superkey	\$39

## SPREADSHEETS

Lotus 1-2-3	Call
Multiplan	\$112
Spreadsheet Auditor 2.0	\$82
VP Planner	\$49

**Supercalc 3(Ver. 2.1) \$179**

## MONEY MANAGEMENT

Dollars & Sense w/Forecast	\$94
Tobias Managing Your Money	Call

## DATA BASE MANAGEMENT

Clipper	\$339
Cornerstone	\$75
dBase II	Call
dBase III Plus	Call
Extended Report Writer	\$79
KnowledgeMan II	\$279
KnowledgeMan Upgrade Kit	\$145
Nutshell 2.0	\$95
PFS: File	\$76
PFS: Report	\$67
Quickcode	\$138
QuickReport	\$138
Reflex	\$55
Think Tank	\$92

**R:Base 5000 . . . . \$319**

Many other titles available.

Inquiry 83 for MS DOS Products. Inquiry 84 for all others.

# COMPUTER WAREHOUSE

Order Line: 1-800-528-1054  
 Order Processing: 602-224-9345  
 2222 E. Indian School Rd.  
 Phoenix, Arizona 85016  
 602-954-6109

Store Hours: Mon-Fri 10-5:30  
 Saturday 9-1  
 Order Line Hours: Mon-Fri 7-5:30  
 Saturday 9-1  
 Order Processing Hours: Mon-Fri 10-3

Product shipped in factory cartons with manufacturer's warranty. Please add \$6.00 per order for UPS ground shipping on orders up to 10 lbs. Orders 10 lbs. and under you pay for ground service, receive air service at no extra charge. Available on orders 11-30 lbs. \$17 for air service. Prices & availability subject to change without notice. Send cashier's check or money order...all other checks will delay shipping two weeks.

We do not guarantee computer compatibility.



published Word Masher in the first place. It has become pseudo public domain.

The Golem lets me edit PC-DOS files: which is what I finally ended up doing. I capture the file on Big Kat's hard disk; write to a PC-DOS floppy; take the floppy out of Big Kat and insert into the Golem; copy the file into RAM disk (because I sure don't want to scroll back and forth through long files on 5¼-inch floppies!); use WordMaster to do the edit; copy back to floppy; put floppy in Big Kat; copy back to hard disk. . .

It all works, but I keep thinking there has *got* to be a good macro programming editor for a PC AT. I do wish MicroPro had ported WordMaster to PC-DOS. I wonder—what editor do they use for programming? I'm *sure* it's not WordStar. Oh well.

#### GET IT FIXED!

We dearly love the BDS Model 630/8 laser printer. Some of you may recall that we temporarily connected it to my wife's system. The idea was that we'd later set her up with a good dot-matrix printer and move the 630/8 in for the staff. I suppose you can guess what happened next. Just as jewelry is never really an investment—you can't ever sell it ("You want to sell *my* diamonds?")—there is no such thing as "temporarily" connecting a really first-class bit of machinery to your wife's computer.

However, compromise is possible. The BDS 630/8 has both serial and parallel input ports, and both can be active. Given a long enough shielded cable, we can connect the staff's PC up to Roberta's BDS machine when she isn't using it. A better solution is to network the printer using Applied Creative Technology's Systemizers. These are wonderful little boxes that let you connect up to 15 computers to a number of different printers so that you can choose whether to get fast, low-quality dot-matrix listings or high-quality stuff from the laser printer. The Systemizers have their own memory, too. You'll hear a lot more about the Systemizers in a future report; meanwhile, if you've got printer network problems, you could

(continued)

# C—the Advantage.



## Introducing the Lattice® MS-DOS C Compiler, Version 3.

There's never been a better time to buy Lattice C. Professional programmers the world over have made Lattice C the standard compiler for serious MS-DOS programming. Now Version 3 offers even more of the features that have made our previous versions so popular. Our new compiler features include:

ANSI language constructs including, *unsigned* as a modifier, *void* data type, *enum* data type, structure assignments, structure arguments, structure returns, and argument type checking.

The compiler also contains better aliasing algorithms, more efficient code generation, and more flexible segmentation, in-line 8087 code generation, and 80186/80286 code generation.

The library contains more than 200 new functions, including: ANSI/UNIX/XENIX compatibility; extended support for MS-DOS; extended support for networking including file sharing, file locking, and I/O redirection; and flexible error handling via user traps and exits. Plus the library has also been re-engineered to produce much smaller executables.

Try the new Version 3 C Compiler from Lattice. Because C-ing is believing.



## Lattice

Lattice, Incorporated  
P.O. Box 3702  
Glen Ellyn, IL 60138  
312/858-7950 TWX 910-291-2190

#### INTERNATIONAL SALES OFFICES:

Benelux: Ines Datacom (32) 2-720-51-61

Japan: Lifeboat Inc. (03)293-4711

England: Roundhill (0672)54675

France: SFL (1)46-66-11-55

Germany: (49)7841/4500 (49)8946/13290



do a lot worse than call Tim Wylde's people at Applied Creative Technology.

All very well; but the bottom line is that Roberta has become dependent on the laser printer. The other night she was using it to do the final submission copy for her book outline when it unaccountably stopped working. It would print a couple of pages of text, then rapidly go through a series of error messages and shut itself down in the middle of the third page. Turning it off and back on naturally got a "paper jam" error. When we cleared that it would work again, but only if we sent it fewer than two pages of text.

Roberta thought something was wrong with her file and tried fixing

that, but the problem persisted, so she called me. It took me about five minutes to deduce that the problem had to be the printer: it simply wasn't doing the hardware handshaking with her computer. The result was her computer kept pumping text out; the BDS printer's buffer would overflow; something within the BDS would detect that; and wham, it would shut itself off.

We solved the immediate problem by taking her text upstairs and printing it on my Hewlett-Packard LaserJet. (I've offered to swap with her: I get the BDS and she gets the HP. She isn't interested.) The next morning I called BDS. I described my problem to the telephone receptionist; a minute later, I had someone from technical sup-

port. Two minutes after that, they not only understood the problem but knew what to do about it. So far, no one at BDS had the remotest idea of who I was.

I had two choices. They'd send me a kit I could use to fix the machine myself, or they'd send a local technician out. I was ready to choose the do-it-myself route, but when they found out who I was they insisted on sending the technician.

They needn't have bothered. All, or nearly all, the electronics in the BDS laser printer is contained in the "lid." This two-inch-thick lid sits on top of the machine and is connected with eight screws. Remove the screws and the lid lifts off. There are some cables, well marked, that you must disconnect. You then put the new lid on, connect the cables, and replace the eight screws. It took the technician nine minutes. It would have taken either me or Roberta no more than double that.

The BDS 630/8 is built around the Canon laser-printer engine. Most of that is in a cartridge. With 85 percent of the electronics in the lid, fixing the BDS is a breeze. Their normal policy is to send you a new lid; you replace yours and send them the old one in their box. They fix the lid at their shop and recycle it. Fascinating. I wish more computer companies had a system like that.

Except for that incident—which was covered by warranty—the BDS 630/8 has been in heavy use for five months with nary a glitch. We've even discovered the secret of making it feed envelopes, which it does very well.

The BDS laser printer is terrific. It's quiet and fast, and it turns out good-quality work. As I noted in a previous column, the computer thinks it's a Diablo 630, meaning that almost everyone has software that can drive it; it took us about five minutes to hook it up. I can now testify that it's both reliable and easy to fix. If you need a good printer, be sure to consider the BDS.

**ADA**

It was a Sunday morning. I was watering my lawn. Up pulls a rented Buick.

*(continued)*

**ITEMS DISCUSSED**

**ACCELERATE 8/16** . . . . . \$99.95  
Software Toolworks  
15233 Ventura Blvd., Suite 1118  
Sherman Oaks, CA 91403  
(818) 986-4885

**AMPRO LITTLE BOARDS** . start at \$289  
Ampro Computers Inc.  
67 East Evelyn Ave.  
Mountain View, CA 94041  
(415) 962-0230

**BDS 630/8 LASER PRINTER** . . . \$2995  
BDS Corporation  
800 Maude Ave.  
Mountain View, CA 94043  
(415) 964-2115

**DREAMER** . . . . . \$259  
T. S. Microtech Inc.  
12565 Crenshaw Blvd.  
Hawthorne, CA 90250  
(213) 644-0859

**JANUS/ADA COMPILER C-PAK** . . \$99.95  
RR Software  
POB 1512  
Madison, WI 53701  
(608) 244-6436

**MEDIA MASTER**  
for most PCompatibles . . . \$39.95  
for DEC Rainbow . . . . . \$99.95  
Intersecting Concepts  
4573 Heatherglen Court  
Moorpark, CA 93021  
(805) 529-5073

**NEC MULTISYNC MONITOR** . . . . \$799  
NEC Home Electronics Inc.  
1401 Estes Ave.  
Elk Grove Village, IL 60007  
(800) 323-1728

**SR-12 COLOR MONITOR** . . . . . \$799  
Princeton Graphic Systems  
601 Ewing St., Bldg. A9  
Princeton, NJ 08540  
(800) 221-1490

**SYSTEMIZER** . . . . . \$300  
Applied Creative Technology Inc.  
2156 West Northwest Highway  
Suite 303  
Dallas, TX 75220  
(214) 556-2916

**UNIFORM** . . . . . \$69.95  
**UNIDOS** . . . . . \$69.95  
with V20 microprocessor . . . \$95  
Micro Solutions  
125 South Fourth St.  
DeKalb, IL 60115  
(815) 756-3411

**V20 AND V30 CHIPS** . . . Prices vary;  
call for nearest distributor  
NEC Electronics  
401 Ellis St.  
Mountain View, CA 94039  
(415) 960-6000



# NOW YOU CAN EXTEND THE BLESSINGS OF HYPERDRIVE TO LESS PRIVILEGED MACINTOSHES.



This is good news for anyone who owns a Macintosh. Or a HyperDriven Macintosh. And an act of unprecedented generosity for those who own both.

General Computer introduces HyperNet, software that gives other Macs access to HyperDrive's vast 10 or 20 megabytes of hard disk storage.

It means that, using the AppleTalk network, you can link a HyperDriven Mac with other Macs in your office. Creating a network you can easily expand, adding Macintoshes and/or HyperDrives as your needs change.

It means that you can use any Mac in your network to call up files from your HyperDrive. Editing, transmitting and other-

wise managing the data they contain. (It also supports multi-user database software.)

And it means that you can not only multiply the amount of information your Macs can manage, but divide the cost of HyperDrive accordingly.

Which could leave you with no economically viable alternative but to visit your authorized General Computer dealer. Or call (800) 634-9737. (In Illinois, call (800) 854-9737)\*



**GENERAL  
COMPUTER**

The leading edge starts here.

\*In Canada, call our distributor at (800) 565-1267 ©1986 General Computer Corp. HyperDrive, HyperNet, The leading edge starts here, and the General Computer Corp. logo are trademarks of General Computer Corp. Apple and AppleTalk are trademarks of Apple Computer, Inc. Macintosh is a trademark licensed to Apple Computer, Inc.

It was Randy Brukaradt, one of the R's of RR Software, the company that produces the best—darned near the only—Ada compiler for PCompatibles. Randy lives in the land of ice and snow, which is probably why he spends nearly all his time writing compilers. He was in town for the Ada Faire.

Randy had a bone to pick: when I mention low-cost Modula-2 compilers, I generally haven't mentioned RR's Janus/Ada Compiler C-Pak. It's also low-cost. Randy says, "The real war isn't between Ada and Modula-2, it's between modular languages and everything else. Ada and Modula-2 have much more in common than they have differences."

Niklaus Wirth, inventor of both Pascal and Modula-2, would disagree. To him, Ada is a language designed by a committee and, horror of horrors, includes exception handling. Wirth's opinion of exception handling is somewhat lower than my opinion of Boy Scouts who put live frogs in my sleeping bag.

On reflection, though, I think Randy is right. There really is more in common than in contention between Modula-2 and Ada. They have many of the same strengths and weaknesses. In both cases, the weaknesses are generally solved with faster machines and more memory—modular

programs sacrifice both speed and memory to ease of comprehension and maintenance. Both languages are worth knowing, and if you have to write a very large program and coordinate the work of many programmers, either is better than any other language that I know of.

If you want to know more about Ada, you could do a lot worse than to buy the RR Janus starter package. (They no longer sell the CP/M version, but you can get it through Workman and Associates.) The Janus package has good introductory materials and is more than enough to let you learn quite a bit about the language. Since the Department of Defense has mandated Ada for many of its programs, and the Janus/Ada package is now used as the teaching program in many military programming schools, it might be a good investment in job security as well.

#### SPIN AND POP?

The Otrona Attache was one of the nicest small computers ever made. When it first came out I called it the "BMW of the portables," and I've had no real reason to change that view. It really was the best small CP/M machine ever made. If Otrona had just stuck to developing portables, they'd have come up with a laptop machine compatible with the Attache and

gone on from there, and they'd have owned the portable market. Alas, the company abandoned its safe niche and tried to swim out in the big ocean with the other IBM PC compatibles—and is no more.

Unlike those who bought other orphans, Otrona owners are in luck. Jim Pope and his partners have acquired the manuals, spare parts, and partially completed machines dumped when Otrona's assets were liquidated. Jim tells me it was a real horror story: mounds of unsorted manuals, circuit diagrams, component boards, all in a heap in a warehouse, all sold by the pound. The result was good, though: they founded Spin and Pop Enterprises (POB 6458, Denver, CO 80206). I have mixed emotions about the name.

Spin and Pop can service, refurbish, and upgrade your Otrona. They even have a few Attaches to sell. Do understand: buying an Otrona Attache nowadays is a little like buying an old Duesenberg. It looks great and it will work fine, but it won't have a stereo tape player or fuel injection. I wouldn't give up my Attache for anything, and, indeed, we often carry her along on trips.

If you have or want an Otrona, you simply must make contact with Spin and Pop. Get your Otrona upgraded and use it! That machine is far too

## DEVICE PROGRAMMING WORKSTATION: \$2900.



14 DAY FREE TRIAL OFFER

ALLPRO—a total PROM/PLD/PAL\* software driven device programming workstation when integrated with an IBM PC.

\*Each socket pin is individually programmable for voltage, current, and slew rate to eliminate the need for active modules/adaptors

\*New devices require only software updates via floppy disc and/or modem

Compare features, compare price; then make the Logical choice

#### IT'S LOGICAL

For details, write or call:  
1321 NW 65th Place,  
Fort Lauderdale, FL 33309;  
(305) 974-0975;  
toll free 800-EE1-PROM  
TELEX 383142

\*PAL is a registered trademark of Monolithic Memories, Inc.

## LOGICAL DEVICES, INC.



nice to be left languishing in a closet.

**BEAUTIFUL DREAMER**

Are you tired of trying to remember WordStar commands? Are you weary of asking Lotus 1-2-3 for help? Does the IBM PC keyboard drive you nuts? Are you often in Num Lock when you shouldn't be, and vice versa? Is that your trouble, Bucky?

If so, help is at hand.

T. S. Microtech's Dreamer for the IBM PC is a neat little 7- by 10-inch box that plugs between your PC keyboard and the PC. It has a numeric keypad, plus arrow keys and 30 more keys. These do about 70 WordStar and Lotus 1-2-3 functions.

There are things about the Dreamer that I'd have done differently, but if I were running a data-entry shop, I'd certainly look into this gadget. It takes up room, and you'd want to think about the design of workstation furniture; but properly used, it could save a lot of time. TSM keeps upgrading to make other business programs easy to learn and easy to use. Definitely worth looking into. You'll hear more about this in the future.

**WINDING DOWN**

As usual, there's a huge mess of stuff I ought to look at and won't be able to get to. Real Soon Now.

The book of the month is John McPhee's *La Place de la Concorde Suisse*, which isn't in French; it's about the Swiss military defense system. With a population no larger than New Jersey's, the Swiss can put a fully equipped army of 650,000 in the field in less than 48 hours.

Addison-Wesley has a bunch of new computer books, all excellent. There's a new edition of *Programming in Ada* by J. G. P. Barnes (\$21.95), the book for experienced programmers who want to learn what Ada is all about; and a new release of Peter Grogono's *Programming in Pascal* (\$24.95), one of the best introductions to that language you'll ever find, and certainly the best explanation of pointers and event rings I've seen. Finally, Grogono, with Sharon Nelson, has written *Problem Solving and Computer Programming* (\$18.95). Carefully read that as well as Niklaus Wirth's *Algorithms + Data Structures = Programs* (from Prentice-Hall), and you'll have a better computer science education than many university graduates.

Today's mail disclosed another V20 chip and CP/M program from Micro Solutions, another outfit that I know produces good stuff. Their UniForm program enables Kaypros (and other machines) to read and write foreign disk formats, and it was nearly unique when it first came out; I thought it a

real boon at the time, and I would probably still use it if the Golem didn't have the ability to read a variety of disk formats. Now they have UniDOS, which they claim will run unchanged CP/M programs on an IBM PC. You don't even have to copy the data to PC format; Micro Solutions' new UniForm can run CP/M programs from about 200 different disk formats as if they were native to the PC. The Micro Solutions package can also run Z80 CP/M programs on an AT (no V20 there, but the program checks for the presence of a V20 or an 80286, as well as whether or not your program expects a Z80). It does this in software, of course, and slows things down, but actually, a fast PC AT can emulate a 3-megahertz Z80 pretty well. More on that next month, and now I'm really out of time.

Do write the L-5 Society. What if we lose another shuttle? The nation must always have access to the frontier. I don't expect I have to explain that to micro people. ■

*Jerry Pournelle welcomes readers' comments and opinions. Send a self-addressed, stamped envelope to Jerry Pournelle, c/o BYTE Publications, One Phoenix Mill Lane, Peterborough, NH 03458. Please put your address on the letter as well as on the envelope. Due to the high volume of letters, Jerry cannot guarantee a personal reply.*

**The Advanced Programmer: \$895**



**14 DAY FREE TRIAL OFFER**

PROMPRO-8X—an advanced EPROM, EEPROM and Single Chip Micro programmer with a 512K-bit RAM buffer

\*Supports MOS, HMOS, and CMOS 2716 thru 27512 and most other available EE/EPROMs

\*RAM image editing via keypad/display in 8 or 16 bit word formats.

\*Mini-gang, set program two EPROMs simultaneously.

\*Complete Stand-Alone and RS-232 interface capability. Compare Features, compare price; then make the Logical choice

**IT'S LOGICAL**

For details, write or call: 1321 NW 65th Place, Fort Lauderdale, FL 33309; (305) 974-0975; toll free 800-EE1-PROM TELEX 383142

**LOGICAL DEVICES, INC.**



# COMPUTER MAIL ORDER

## THE CMO ADVANTAGE

**TO ORDER**  
**CALL TOLL FREE**  
**1-800-233-8950**  
 DEPARTMENT A206

OR MAIL YOUR ORDER TO:

**COMPUTER MAIL ORDER**  
 Department A206  
 477 E. Third Street  
 Williamsport, PA 17701



**POLICY Inquiry 80**  
 Add 3% (Minimum \$7.00) shipping and handling. Larger shipments may require additional charges. Personal and company checks require 3 weeks to clear. For faster delivery use your credit card or send cashier's check or bank money order. Pennsylvania residents add 6% sales tax. All prices are subject to change and all items are subject to availability. Defective software will be replaced with the same item only. Hardware will be repaired or replaced at our discretion within the terms and limits of the manufacturer's warranty. We cannot guarantee compatibility. All sales are final and returned shipments are subject to a restocking fee.

**EDUCATIONAL INSTITUTIONS**  
**CALL TOLL FREE**  
**1-800-221-4283**

**CUSTOMER SERVICE**  
**& TECHNICAL SUPPORT**  
 1-717-327-1450

### CANADIAN ORDERS

1-800-268-3974  
 Ontario/Quebec

1-416-828-0866  
 In Toronto

1-800-268-4559  
 Other Provinces

TELEX: 06-218960

2505 Dunwin Drive,  
 Mississauga, Ontario  
 Canada L5L1T1

All prices shown are for U.S.A. orders. Call the Canadian Office for Canadian prices.

## THE CMO ADVANTAGE

- Next day shipping on all in-stock items.
- Free easy access order inquiry.
- Orders from outside Pennsylvania save state sales tax.
- Free technical support from our factory trained technicians.
- There is no limit and no deposit on C.O.D. orders.
- There is no extra charge for using your Visa or MasterCard and your card is not charged until we ship
- No waiting period for cashier's checks.
- We accept purchase orders from qualified corporations. Subject to approval.
- Educational discounts available to qualified institutions. (See the toll free educational phone number above.)
- **FREE CATALOG MEMBERSHIP**

## HOME COMPUTERS

### ATARI

65XE (64K).....\$89.99  
 130XE (128K).....\$139.00  
 520ST (512K).....\$369.00

#### 520ST Monochrome System

- 520ST with modulator
  - disk drive
  - mouse
  - logo
  - Basic
  - 1st Word
  - monochrome monitor
- LOW, LOW  
SYSTEM PRICE  
**\$64900**

#### 520ST Color System

- 520ST with modulator
  - disk drive
  - mouse
  - logo
  - Basic
  - 1st Word
  - color monitor
- LOW, LOW  
SYSTEM PRICE  
**\$79900**

800XL 64K.....CALL  
 1010 Recorder.....\$49.99  
 1050 Disk Drive.....\$149.00  
 1020 Printer.....\$29.99  
 1027 Letter Quality Printer.....\$129.00  
 1030 Direct Connect Modem.....\$59.99  
 Comrex 220 Atari.....\$89.99

### APPLE

APPLE IIe.....CALL  
 APPLE IIc.....CALL  
 IIC LCD Display.....\$329.00

### COMMODORE

**Amiga Package**  
 • 512K • 2 Drive  
 • RGB Monitor.....\$1599.00

**C64 Package**  
 • C64 • C1541  
 • Taxan 220.....\$499.00

**C128 Package**  
 • C128 • C1571  
 • NAP8562 Monitor.....\$779.00

**C128 Computer.....\$269.00**  
**C1571 (Disk Drive for C128).....\$249.00**

**C1902 (RGB 13" Monitor for C128).....CALL**  
**C1670 (Modem for C128)\$179.00**

C1530 Datasette.....\$39.99  
 C1660 Auto Modem.....\$59.99  
 DPS 1101 Daisy Printer.....\$339.00  
 Comrex 220 (C64 Interface).....\$89.99  
 Xetec SuperGraphix 8K.....\$69.99

## PORTABLE COMPUTERS

### NEC

PC-8401 LS.....\$699.00  
 PC-8201 Portable Computer.....\$339.00  
 PC-8231 Disk Drive.....\$599.00  
 PC-8221A Thermal Printers.....\$149.00  
 PC-8281A Data Recorder.....\$99.99  
 PC-8201-06 8K RAM.....\$79.99

### SHARP

PC-1350.....\$149.00  
 PC-1261.....\$149.00  
 PC-1500A.....\$169.00  
 PC-1250A.....\$89.99  
 CE-125 Printer/Cassette.....\$129.00  
 CE-150 Color Printer Cassette.....\$149.00  
 CE-161 16K RAM.....\$129.00

### hp HEWLETT PACKARD

41CV.....\$139.00  
 41CX.....\$199.00  
 HP 11C.....\$49.99  
 HP 12C.....\$75.99  
 HP 15C.....\$75.99  
 HP 16C.....\$89.99  
 HPIL Module.....\$98.99  
 HPIL Cassette or Printer.....\$359.99  
 Card Reader.....\$143.99  
 Extended Function Module.....\$63.99  
 Time Module.....\$63.99

We stock the full line of  
**HP calculator products**

## ACCESSORIES

### AMARAY

80 Column Printer Stand.....\$14.99

### CURTIS

Side Mount SS-1.....\$19.99  
 Side Mount AT SS-2.....\$34.99  
 Universal Stand SS-3.....\$19.99  
 Diamond SP-1.....\$29.99  
 Emerald SP-2.....\$39.99  
 Sapphire SPF-1.....\$49.99  
 Ruby SPF-2.....\$59.99

### DATA SHIELD

300 Watt Backup.....\$379.00  
 500 Watt Backup.....\$589.00  
 Turbo 350 Watt Backup.....\$449.00  
 P125 Power Director.....\$99.99  
 P150 Power Director w/Modem\$119.00

### KENSINGTON

Master Piece.....\$99.99  
 Master Piece +.....\$119.00

### KEYTRONICS

KB5150/KB5151/KB5151Jr.....CALL  
 KB5152B/KB5153/KB5149Jr.....CALL

### MEMORY CHIPS

4164 RAM Chips.....(ea.) \$1.99  
 128 RAM Chips.....(ea.) \$12.99  
 256 RAM Chips.....(ea.) \$10.99

### Polaroid

Palette.....\$1399.00  
 Power Processor.....\$229.00  
 Illuminated Slide Mounter.....\$39.99  
 Polacolor 2 Pack film.....\$18.99

## DISKETTES

### Dennison

Elephant 5 1/4" SS/SD.....\$9.99  
 Elephant 5 1/4" SS/DD.....\$11.99  
 Elephant 5 1/4" DS/DD.....\$14.99  
 Elephant Premium DS/DD(50).....\$69.99  
 Elephant 3 1/2" SS/DD.....\$24.99

### IBM

5 1/4" DS/DD floppy disks  
 (Box of 10).....\$26.99

### GENERIC

DS/DD w/Flip'n'File 10.....\$11.99

### maxell

3 1/2" SS/DD (10).....\$18.99  
 3 1/2" 5 pack SS/DD/Case.....\$9.99  
 3 1/2" DS/DD (10).....\$29.99  
 5 1/4" MD-1 SS/SD (10).....\$11.99  
 5 1/4" MD-2 DS/DD (10).....\$16.99  
 5 1/4" MD-2-HD for AT (10).....\$29.99

### Verbatim.

5 1/4" SS/DD.....\$12.99  
 5 1/4" DS/DD.....\$24.99  
 Disk Analyzer.....\$24.99

### DISK HOLDERS

#### AMARAY

50 Disk Tub 5 1/4".....\$9.99  
 30 Disk Tub 3 1/2".....\$9.99

### INNOVATIVE CONCEPTS

Flip'n File 10.....\$2.49  
 Flip'n File 50.....\$14.99  
 Flip'n File 50 w/lock.....\$19.99  
 Flip'n File Data Case.....\$9.99

## MODEMS

### ANCHOR

Volkmodem.....\$59.99  
 Volkmodem 300/1200.....\$189.00  
 Signalman Express.....\$259.00  
 Lightning 2400 Baud.....\$399.00  
 Expressi (PC Halfcard).....\$189.00  
 6470 (64/128) 300/1200 Baud..\$139.00

### AST

Reach 1200 Baud Half Card...\$399.00

### DIGITAL DEVICES

AT300 - 300 Baud (Atari).....\$99.99

### EVEREX

1200 Baud Internal (IBM/PC)...\$179.00

### Hayes

Smartmodem 300.....\$139.00  
 Smartmodem 1200.....\$389.00  
 Smartmodem 1200B.....\$359.00  
 Smartmodem 2400.....\$599.00  
 Micromodem IIe.....\$149.00  
 Smart Com II.....\$89.99  
 Chronograph.....\$199.00  
 Transet 1000.....\$309.00

### Novation

Smart Cat Plus.....\$299.00  
 J-Cat.....\$99.99  
 Novation 2400.....\$499.00  
 Apple Cat II.....\$219.00  
 212 Apple Cat II.....\$379.00  
 Apple Cat 212 Upgrade.....\$229.00

### QUADRAM

Quadmodem II  
 300/1200.....\$339.00  
 300/1200/2400.....\$499.00

### SUPRA

MPP-1064 ADIAA (C-64).....\$69.99

## DRIVES

### HARD

#### CORE

AT20-AT72MB.....CALL

#### EVEREX

60 Meg Internal Backup System\$799.00

#### OMEGA

A110H Single 10.....CALL  
 A210H 10 + 10.....CALL  
 A120H Single 20.....CALL  
 A220H 20 + 20.....CALL  
 Save on 10 & 20 Carts.....CALL

#### IRWIN

Tape Backup.....CALL

#### KITS

10 Meg with controller.....\$399.00  
 20 Meg with controller.....\$499.00

#### PRIAM

40, 60 MB Inner Space.....CALL  
 Shared Data.....CALL  
 Shared Space.....CALL

#### TALLGRASS

25, 35, 50, 80 meg (PC).....CALL  
 from \$1299.00

### FLOPPY

#### ALLIED TECHNOLOGY

Apple II,II+ ,Ile 1/2 height.....\$109.00

#### INDUS

Atari GT.....\$199.00  
 C-64 /128 GT.....\$199.00

#### MSD

SD1 C-64 Single.....\$219.00  
 SD2 C-64 Dual.....\$469.00

#### TANDON

320K 5 1/4" (PC).....\$119.00

#### TEAC

320K 5 1/4".....\$119.00

DEPT. A206

# CALL TOLL-FREE



<b>ANSA SOFTWARE</b>	
Paradox	\$499.00
<b>ASHTON-TATE</b>	
Framework II	\$389.00
dBase III Plus	\$389.00
<b>BATTERIES INCLUDED</b>	
Isgur Portfolio	\$159.00
<b>BORLAND</b>	
Lightening	\$59.99
Sidekick (unprotected)	\$57.99
Reflex	\$59.99
Travelling Sidekick	\$44.99
<b>CENTRAL POINT</b>	
Copy II PC-Backup	\$29.99
PC Option Board	\$84.99
<b>DECISION RESOURCES</b>	
Chartmaster	\$229.00
Signmaster	\$159.00
Diagram Master	\$209.00
<b>FIFTH GENERATION</b>	
Fasi Back	99.99
<b>FUNK SOFTWARE</b>	
Sideways	\$44.99
<b>HARVARD SOFTWARE INC.</b>	
Total Project Manager	\$269.00
Presentation Graphics	\$239.00
<b>LIFETREE</b>	
Volkswriter III	\$159.00
<b>LIVING VIDEOTEXT</b>	
Think Tank	\$109.00
Ready	\$64.99
<b>LOTUS</b>	
Symphony	CALL
1-2-3 Version 2	CALL
<b>MECA SOFTWARE</b>	
Managing Your Money 2.0	\$99.99
Manage Your Market	\$89.99
<b>MICROPRO</b>	
Easy	\$94.99
WordStar 2000	\$239.00
WordStar 2000+	\$289.00
WordStar Professional	\$189.00
<b>MICRORIM SOFTWARE</b>	
R:Base 4000	\$249.00
R:Base 5000	\$359.00
Clout 2.0	\$129.00
<b>MICROSOFT</b>	
Flight Simulator	\$34.99
MultiPlan	\$129.00
Word	\$249.00
Mouse	\$139.00
<b>MICROSTUF</b>	
Crosstalk XVI	\$89.99
Crosstalk Mark IV	\$149.00
Remote	\$89.99
<b>MULTIMATE</b>	
Multi Mate Word Proc	\$219.00
Advantage	\$289.00
On File	\$89.99
Just Write	\$89.99
<b>NOUNEMON</b>	
Intuit	\$69.99
<b>NORTON</b>	
Norton Utilities 3.1	\$57.99
<b>ONE STEP</b>	
Golf's Best	\$34.99
<b>PFS: IBM</b>	
Proof	\$59.99
File/Graph	(ea.)\$84.99
Report	\$74.99
Write/Proof Combo	\$84.99
<b>PROFESSIONAL SOFTWARE</b>	
Write-N-Spell	\$89.99
<b>THE SOFTWARE GROUP</b>	
Enable	\$329.00
<b>SATELLITE SYSTEMS</b>	
Word Perfect 4.1	\$219.00
<b>SORCIMI/UIS</b>	
Accounting	
API/AR/GL/INV/OE	(ea.) \$299.00
SuperCalc III	\$199.00
EasyWriter II System	\$239.00
Super Project	\$199.00
<b>SUBLOGIC</b>	
Jet	\$37.99

<b>Canon</b>	
A40, A50, A55	CALL
LBP-8A1 Laser	CALL
<b>CITIZEN</b>	
MSP-10 (80 col.)	\$279.00
MSP-15 (132 col.)	\$389.00
MSP-20 (80 col.)	\$349.00
MSP-25 (132 col.)	\$509.00
<b>CITIZEN</b>	
Prowriter 7500	\$169.00
Prowriter 1550P	\$349.00
Starwriter 10-30	\$399.00
3500 Tri Printer	\$1499.00
<b>Corona</b>	
Lazer LP-300	\$2799.00
<b>DIABLO</b>	
620 Daisywheel	\$299.00
D25 Daisywheel	\$549.00
635 Daisywheel	\$1099.00
D80IF Daisywheel	CALL
<b>daisywriter</b>	
2000	\$699.00
<b>EPSON</b>	
Homewriter 10, LX-80	CALL
FX-85, FX-286, RX-100	CALL
DX-10, DX-20, DX-35	CALL
SQ-2000, HI-80, HS-80, AP-80	CALL
LQ-800, LQ-1000	CALL
<b>JUKI</b>	
6000 Letter Quality	CALL
6100 Letter Quality	CALL
6200 Letter Quality	CALL
6300 Letter Quality	CALL
6500 Letter Quality	CALL
5510 Dot Matrix Color	CALL
<b>LEGEND</b>	
808 Dot Matrix 100 cps	\$179.00
1080 Dot Matrix 100 cps	\$259.00
1380 Dot Matrix 130 cps	\$289.00
1385 Dot Matrix 165 cps	\$339.00
<b>NEC</b>	
3000 Series	\$779.00
8000 Series	\$1099.00
ELF 360	\$399.00
Pinwriter 560	\$999.00
<b>OKIDATA</b>	
182, 183, 192, 193, 2410, 84	CALL
Okimate 10 (Specify C64/Atari)	\$189.00
Okimate 20 (IBM)	CALL
<b>Panasonic</b>	
KX1080	NEW
KX1091	\$259.00
KX1092	\$389.00
KX1592	\$469.00
KX1595	\$659.00
<b>QUADRAM</b>	
Quadjet	\$399.00
Quad Laser	CALL
<b>SILVER-REED</b>	
500 Letter Quality	\$219.00
550 Letter Quality	\$419.00
800 Letter Quality	\$699.00
<b>Star</b>	
SG-10C (C64 Interface)	CALL
SB/SD/SG/SR Series	CALL
Powertype Letter Quality	CALL
<b>Texas Instruments</b>	
T1850	\$529.00
T1855	\$639.00
T1865	\$799.00
<b>TOSHIBA</b>	
P321 (80 column)	\$499.00
P341 (132 column)	\$799.00
P351 (132 column)	\$1049.00

<b>AST</b>	
Ram Vantage	\$349.00
Rampage-PC	\$379.00
Rampage-AT	CALL
Six Pack Plus	\$229.00
I/O Plus II	\$139.00
Advantage-AT	\$399.00
Preview Mono	\$299.00
PC Net Cards	\$379.00
5251/11 On-line	\$669.00
5251/12 Remote	\$579.00
<b>dea</b>	
IRMA 3270	\$879.00
IRMA Print	\$999.00
IRMA Smart Alec	\$779.00
<b>EVEREX</b>	
Edge Card	\$259.00
Graphics Edge	\$219.00
Magic Card II	\$159.00
Magic Card I	\$99.99
<b>HERCULES</b>	
Graphics	\$299.00
Color	\$159.00
<b>IBEA Associates</b>	
IDEA 5251	\$549.00
<b>INTEL</b>	
PCNC8087 5MHz	
PCNC8087-2 8 MHz	CALL
PCNC80287 6 MHz	FOR
1010 PC-Above Board	YOUR
1110 PS-Above Board	PC
2010 AT-Above Board	
<b>MYLEX</b>	
The Chairman	\$439.00
<b>PARADISE</b>	
Color/Mono Card	\$149.00
Modular Graphics Card	CALL
Multi Display Card	\$199.00
Five Pack C, S, 0-384K	\$99.99
High Res Mono	CALL
<b>PERSYST</b>	
Bob Board	\$359.00
<b>QUADRAM</b>	
Quadport-AT	\$119.00
Liberty-AT (128K)	\$349.00
The Gold Quadboard	\$449.00
The Silver Quadboard	\$239.00
Expanded Quadboard	\$199.00
Liberty	\$309.00
QuadSprint	\$499.00
QuadLink	\$399.00
QuadColor	\$199.00
Quadboard-AT	\$399.00
8600 E.G.A. card	\$399.00
<b>STB</b>	
EGA Plus	\$379.00
<b>TECMAR</b>	
Captain - 64	\$199.00
Graphics Master	\$469.00
<b>VIDEO-7</b>	
EGA	\$429.00
<b>INTERFACES</b>	
<b>AST</b>	
Multi I/O (Apple II)	\$149.00
<b>DIGITAL DEVICES</b>	
Ape Face (Atari)	\$49.99
U-Print A (Atari)	\$54.99
U-A16/Buffer (Atari)	\$74.99
U-Call Interface (Atari)	\$39.99
U-Print C (C64)	\$49.99
P-16 Print Buffer	\$74.99
U-Print 16 apple IIc	\$89.99
<b>MICRO R &amp; D</b>	
Apple IIc Parallel	\$49.99
Kaypro 2000 Parallel	\$49.99
C64/128	\$59.99
<b>Orange Micro</b>	
Grappier CD (C64)	\$89.99
Grappier Plus (IIe, IIc)	\$89.99
Grappier C (IIc)	\$89.99
Grappier 16K (IIe, II+)	\$139.00
<b>PRACTICAL PERIPHERALS</b>	
Graphicard	\$69.99
Serial Card	\$99.99
Microbuffer II+ 64K	\$169.00
<b>QUADRAM</b>	
Microfazer	from \$139.00
Etazer (Epson)	from \$79.99

<b>IBM PC SYSTEMS</b>	
Configured to your specifications.	
Call for Best Price!	
<b>IBM-PC, IBM-XT, IBM-AT</b>	
<b>AT</b>	
Safari (7300)	CALL
6300	CALL
<b>Corona</b>	
PPC400 Dual Portable	\$1289.00
PPCXT 10 meg Portable	\$1989.00
PC40022 Dual Desktop	\$1389.00
PC400-HD2 10 meg	\$1989.00
<b>ITT</b>	
ITT X-TRA	
256K, 2 Drive System	CALL
256K, 10 meg Hard Drive System	CALL
XP5, 20 meg	CALL
<b>KAYPRO</b>	
KP-2000 Portable	CALL
Kaypro PC	CALL
<b>SANYO</b>	
MBC 550-2, MBC 555-2, MBC 675 Portable, MBC775, MBC 880 Desktop/Call	
<b>SPERRY</b>	
Sperry-AT	as low as \$1749.00
Sperry-IT	as low as \$2699.00
Call for Specific Configuration!	
All Models	CALL
<b>ZENITH</b>	
PC-138 Series, PC-148 Series, PC-158 Series, PC-160 Series, PC-171 Series, AT-200 Series	CALL

<b>MONITORS</b>	
<b>AMDEK</b>	
Video 300 Green	\$119.00
Video 300A Amber	\$129.00
Video 310A Amber TTL	\$159.00
Color 600 Hi-Res. RGB	\$399.00
Color 722 Dual Mode	\$529.00
Color 725	CALL
Color 730	CALL
<b>MAGNAVOX</b>	
8562 RGB/Composite	\$279.00
613 TTL Green	\$99.99
623 TTL Amber	\$99.99
<b>NEC</b>	
JB1205A	\$79.99
JB1270G/1275A	(ea.) \$99.99
JB1280G TTL Green	\$129.00
JB1285A TTL Amber	\$129.00
JC1401 Multi Sync RGB	CALL
<b>PRINCETON</b>	
MAX-12 Amber	\$179.00
HX-9 9" RGB	\$469.00
HX-9E Enhanced	\$519.00
HX-12 12" RGB	\$469.00
HX-12E Enhanced	\$559.00
SR-12 Hi-Res	\$599.00
SR-12P Professional	\$699.00
<b>QUADRAM</b>	
8400 Quadchrome I	\$499.00
8410 Quadchrome II	\$339.00
8420 Amberchrome	\$179.00
8500 Quad Screen	\$1449.00
<b>TAXAN</b>	
115 12" Green	\$119.00
116 12" Amber	\$129.00
121 TTL Green	\$139.00
122 TTL Amber	\$149.00
220 14" Color Composite	\$179.00
620 640x200 RGB	\$439.00
630 640x200 RGB	\$489.00
640 720x400 RGB	\$539.00
<b>ZENITH</b>	
ZVM 1220 Amber	\$99.99
ZVM 1230 Green	\$99.99
ZVM 1240 IBM Amber	\$149.00
ZVM 135 RGB	\$459.00
ZVM 1330 RGB	\$459.00
ZVM 1360 RGB	CALL
ZVM 1380 E G Comp	CALL

COMPUTER MAIL ORDER



# NEW RELEASE

## Ecosoft's Eco-C88 Rel. 3.0 C Compiler



\$5995

Release 3.0 has new features at an unbelievably low price. ECO-C88 now has:

- Prototyping (the new type-checking enhancement)
- enum and void data types
- structure passing and assignment
- All operators and data types (except bit fields)
- A standard library with more than 200 functions (many of which are System V compatible for greater code portability)
- cc and mini-make that all but automates the compile process
- 8087 support (we sense the 8087 at runtime - no dual libraries)
- ASM or OBJ output for use with MSDOS linker
- Tiered error messages - enable-disable lint-like error checking
- Fast compiles and executing code
- Expanded user's manual
- Enhanced CED program editor (limited time offer)

We also offer the following support products for Eco-C88.

### CED Program Editor

\$2995

CED now supports on-line function help.

If you've forgotten how to use a standard library function, just type in the name of the function and CED gives you a brief summary, including function arguments. CED is a full screen editor with auto-flagging of source code errors, multiple windows, macros, and is fully configurable to suit your needs. You can edit, compile, link, and execute DOS commands from within the editor. Perfect for use with Eco-C88. For IBM PC, AT and look alikes.

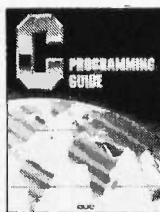

### C Programming Guide \$20

After reading the 1st edition, Jerry Pournelle (BYTE Magazine) said: "I recommend this book... Read it *before* trying to tackle Kernighan and Ritchie." The second edition expands this best seller and walks you through the C language in an easy-to-understand manner. Many of the error messages include references to this book making it a perfect companion to Eco-C88 for those just starting out with C.

### C Source for Standard Library \$10

Contains all of the source code for the library functions that are distributed with Eco-C88, excluding the transcendentals and functions written in assembler.

(\$20 if not with order)

### Developer's Library

Contains the source code for all library functions, including the transcendentals and those written in assembler. Perfect for the developer that wish to write their own custom functions or learn how we implemented the Eco-C88 library.

\$25

(\$50 if not with order)

### ISAM Library

Contains the code from the C Programmer's Library in relocatable format (i.e., .OBJ) including the delete code for the ISAM file handler.

\$15

(\$30 if not with order)



### C Self-Study Guide \$17

(Purdum, Que Corp.). Designed for those learning C on their own. The book is filled with questions-answers designed to illustrate many of the tips, traps, and techniques of the C language. Although written to complement the Guide, it may be used with any introductory text on C.



### C Programmer's Library \$22

(Purdum, Leslie, Stegemoller, Que Corp.). This best seller is an intermediate text designed to teach you how to write library functions in a generalized fashion. The book covers many advanced C topics and contains many useful additions to your library including a complete ISAM file handler.

Eco-C88 C compiler requires an IBM PC, XT, or AT (or compatible) with 256K of memory, 2 disk drives and MSDOS 2.1 or later. Call today:

1-800-952-0472 (for orders)

or

1-317-255-6476 (tech. info.)



Ecosoft, Inc.

6413 N. College Ave. • Indianapolis, IN 46220



TRADEMARKS: ECO-C88, ECOSOFT





# MODEM MYSTERIES REVEALED

BY DICK POUNTAIN

BYTE U.K. has finally been dragged kicking and screaming into the electronic age. This is the second column to be wholly transmitted to the U.S. over the telephone, using a 1200-bits-per-second modem, British Telecom's International Packet Switching Service, and a BIX (BYTE Information Exchange) mailbox. The changeover was relatively painless despite a certain initial apprehension on my part. Nevertheless, it did uncover one of those wonderfully obscure hitches that seem to accompany serial communications the way that black cats used to accompany witches.

I have owned a 300-bps acoustic coupler for several years now, but I've never really used it much. One reason is that until recently there has been little worthwhile to access in the U.K. The bulletin boards that do exist seem to be filled either with information relevant only to various computers that I do not own, or with trivia and a puerile form of humor that might have escaped from the pages of a school magazine.

But another reason is that the U.K. has a lot of catching up to do in communications. Until two years ago the state-owned telephone authorities forbade private citizens to connect any apparatus directly to the telephone network. As a result, the 300-bps acoustic coupler represented the state of the art in hardware for quite a while, unless you were a corporate user with a leased line. In addition, the low-cost home computers that have dominated the market here are seldom equipped with serial ports as standard features, and this also hindered the growth of communications.

Since the privatization and subsequent liberalization of the telephone network, some progress has been

## *Our U.K. correspondent struggles into the electronic age with the WS3000 modem*

made. Direct-connect modems are now becoming available at reasonable prices, and we are even starting to see speeds of 1200 and 2400 bps full duplex in the latest models. British modem manufacturers still complain that the approval procedure required by British Telecom takes too long and hinders their competitive efforts, but movement is visible nevertheless.

Also complicating the matter is the fact that the U.K. has a wider variety of communications standards to support than the U.S. does. Moreover, even when our standards appear to use the same speed as yours, ours are in fact based on different carrier frequencies than yours. Ours are based on CCITT standards rather than Bell; for example, our 300-bps standard is CCITT V21, whereas yours is Bell 103.

Although our bulletin board systems are mainly 300 bps, we have a major public teletext network called Prestel that uses the CCITT V23 standard, which operates at the split rate of 1200/75 (that is, 1200 bps receive and 75 bps transmit). This curious standard was chosen because Prestel was not designed to be a fully interactive system. It is mainly an information source for business data, weather reports, and the like. The 1200-bps receive speed gives reasonably quick screen updating, while the 75-bps transmit rate is adequate for sending short command sequences to turn to the required page.

With the advent of home computers, several vendors rented space on Prestel for electronic computer

magazines and encouraged home computer owners to use the service. So for several years one was faced with a choice of buying either a 300-bps or a 1200/75-bps modem. The split tended to be 1200/75-bps modems for

home computers such as the Sinclair Spectrum and Commodore 64, and 300-bps modems for CP/M users who were probably using U.S. telecommunications software.

In 1984 the British firm Miracle Technology Ltd. produced a multistandard (i.e., 300 and 1200/75 bps) modem called the Minor Miracle at what was then a very competitive price of just over £100. In 1985 the firm followed up on the success of this model with a new family of WS3000 modems that, in their various configurations, are just about state of the art in personal computer modems.

### **STRANGE INTERACTIONS**

The basic model in the WS3000 series operates with the V21 (300 bps full duplex) and V23 (1200/75 bps) standards as well as the equivalent Bell standards, at a price of £250. It comes with auto-dial and auto-answer facilities, uses the widely accepted Hayes protocols, and is highly intelligent. It also has internal storage for 60 telephone numbers.

The two more expensive models are identical to this model, except that they add 1200 full duplex (the V22 model) and 2400 full duplex (the V22bis model). Both lower-priced models can be upgraded to higher specifications after purchase.

I decided to purchase the V22

*(continued)*

Dick Pountain is a technical author and software consultant living in London, England. He can be contacted c/o BYTE, One Phoenix Mill Lane, Peterborough, NH 03458.

model, at a cost of £495, because I anticipate using BIX a lot, and uploading large text files at 1200 bps rather than 300 bps will save money in the long run. And to be honest, using BIX at 300 bps with my old acoustic coupler is a real pain. Most of the system's interactivity evaporates when you have to sit drumming your fingers waiting for the text to unfold on the screen.

My purchase decision was slightly complicated by the fact that Hayes launched a U.K. version of their best-selling Smartmodem 1200 just about the time I decided to buy, priced almost exactly the same as Miracle Technology's V22 model. However, a couple of factors (patriotism apart) made up my mind. The U.K. version of the Hayes operates only at 1200 bps full duplex, whereas the WS3000 operates at every standard you can think of, including Prestel's split rate. At a more trivial level, the WS3000 comes with a built-in phone jack to

connect the telephone handset, whereas the Hayes doesn't and so forces you to buy a doubling adapter.

I received my WS3000 V22 in the last week of 1985, after a lengthy wait due to production delays with the plastic cases. It's a smart-looking unit and, like the Hayes, slim enough to sit under the telephone. It has no mechanical controls, just a set of red lights that reveal the current status of the lines and operation modes.

I quickly got the unit set up and working faultlessly at 300 bps and spent a couple of days playing around on BIX and various U.K. bulletin boards. But try as I may, I simply could not make it work at 1200 bps. It took a while to discover this fact because a lot of commands and various registers can be altered on the device, and I had to play around for several days to be convinced that I was using the modem correctly. It is, in fact, very easy to use, and most of the stuff I was doing was quite irrele-

vant, but I discovered that only later.

The symptoms were simply that at any speed involving 1200 bps (including 1200/75 and 1200 full and half duplex) only garbage appeared on the screen, even though it was clear that the modem was dialing correctly and logging on successfully to the various services (including BIX). The obvious conclusion to draw was that the 1200-bps chip in the modem was faulty, but some hunch told me that this wasn't so. If that were the case, how could the modem dial and log on correctly? A painful process of detective work began, which involved several phone calls to Miracle Technology's patient and helpful customer service department.

The first two things to suspect when faced with an RS-232C-related problem are always communications parameters and cabling. It was easy enough to try all the possible combinations of parameters, and the

(continued)

# X-VIEW 86™

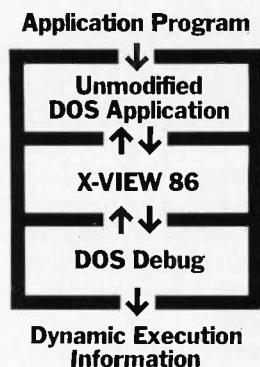

*X-VIEW 86 profiles the execution of DOS software, and displays information needed to improve program performance, identify compatibility issues, and pinpoint conversion problems.*

## Profiles DOS application software and solves problems Debug can't touch.

### X-VIEW 86 is a DOS software X-ray machine.

X-VIEW 86 monitors internal software operations during execution to help you debug, test, port, or convert programs. X-VIEW 86 adds new features to Debug to profile either your own applications software or top-sellers like 1-2-3®. You get fast, reliable results.

### Real solutions to technical challenges.

Save hours of time-consuming, tedious work using data from X-VIEW 86's built-in reports that identify:

- Execution hotspots
- Segment usage
- Memory map references
- I/O port references
- Interrupt calls
- Instruction set usage
- Report information is displayed on screen. And new breakpoint commands added to Debug stop a program on:
- I/O port references
- Interrupt calls
- Memory data references

### Hardware and software requirements.

X-VIEW 86 runs on the IBM PC and compatibles with DOS Debug 2.0 or 2.1. Even if you use a different debugger, X-VIEW 86 turns Debug into your program profiler. And it's not copy protected.

### Priced at an affordable \$59.95.

Get a whole new outlook on your work with X-VIEW 86. We've made it easy. Order today by calling 1-800-221-VIEW (in Texas, or outside the U.S., call 1-214-437-7411). We accept Visa, MC, DC, and AmEx cards. Or order by writing to: McGraw-Hill CCI Software, 8111 LBJ Freeway, Dallas, Texas 75251. X-VIEW 86 is just \$59.95 plus sales tax and \$3.00 shipping (\$9.00 outside the U.S.). Be sure to include credit card number and expiration date with mail orders. Orders paid by check are subject to delay. To order call

**1-800-221-VIEW**

**McGraw-Hill CCI Software**

8111 LBJ Freeway, Dallas, Texas 75251

X-VIEW 86 is a trademark of McGraw-Hill, Inc.; IBM is a registered trademark of International Business Machines; 1-2-3 is a registered trademark of Lotus Development Corporation.



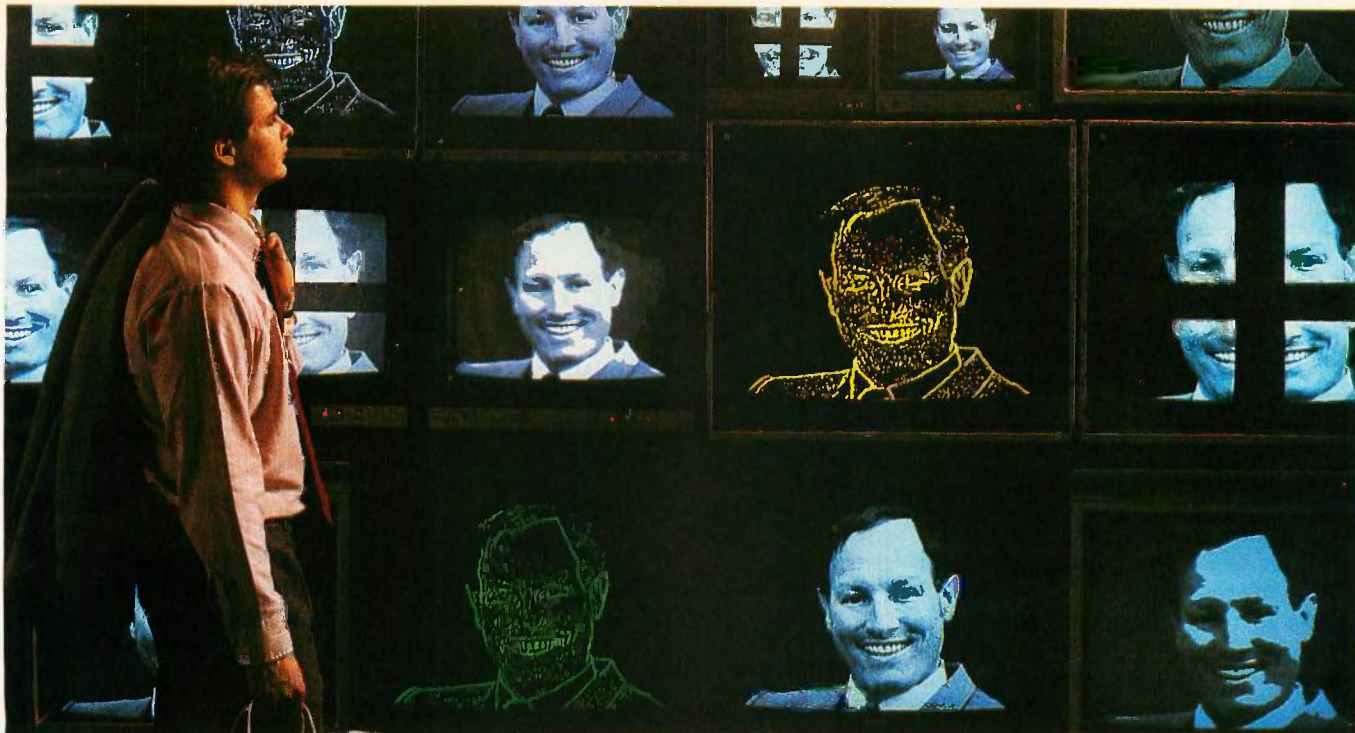

## “Attention shoppers. Our image processing dept. has been expanded again. Repeat...”

Welcome to Data Translation, home of the image processing board. Here you'll find the industry's most complete line of products for the IBM PC, IBM PC AT and the MicroVAX II.

Data Translation can furnish high and low resolution products for

real-time applications requiring user-defined convolutions, histograms, frame averaging, windowing, arithmetic and logic operations, graphic overlays, and even video animation. And all at prices that are often assumed to be misprints at first glance.

Naturally, you can depend on our standard five-day delivery and extensive software support. Have a productive day and thank you for shopping Data Translation.

**Call (617) 481-3700**

Image Processing Board	Computer	Resolution	Gray Levels	RS-170, VHS, RS-330, CCIR, PAL Compatible	VCH Compatible	Slow-Scan Compatible	Number of Video Inputs	Real-Time Frame Grab Input and Output LUT's	Memory-Mapped Frame-Store Memory	Real-Time Processing**	Hardware MM Convolutions**	Hardware Histograms**	Hardware Zoom, Pan, Scroll**	Software Support	Price
DT2803 Low Cost Frame Grabber	IBM PC, PC XT, PC AT	256x256	64	Yes	Yes	8*	Yes	Yes	1 buffer 256x256x8 (64 Kbytes)					VIDEOLAB PC SEMPER	\$1495
DT2851 + DT2858 High Resolution Frame Grabber and Auxiliary Frame Processor	IBM PC AT	512x512	256		Yes	8*			2 buffers, 512x512x8 each (512 Kbytes), and 1 buffer, 512x512x16 (512 Kbytes)	Yes	Yes	Yes	Yes	DT-IRIS	DT2851 \$2995 DT2858 \$1495
DT2603 Low Cost Frame Grabber	MicroVAX II	256x256	64	↓	↓	4	↓	↓	1 buffer 256x256x8 (64 Kbytes)					Coming Soon	\$1895

\*With DT2859 Eight Channel Video Multiplexer (\$395)

\*\*All frame processor boards operate in near-real-time with 16-bit internal accuracy; all 512x512 frame grabber boards process in real-time with 4-bit and 8-bit internal accuracy.



See our new 646 pg. catalog/handbook or see us in Gold Book 1986. Or call for your personal copy today.



# DATA TRANSLATION

World Headquarters: Data Translation, Inc., 100 Locke Dr., Marlboro, MA 01752 (617) 481-3700 Tlx 951 646. European Headquarters: Data Translation, Ltd., 13 The Business Centre, Molly Millars Lane, Wokingham Berks, RG112QZ, England Tlx: 851849862 (#D) In Canada (416) 625-1907. IBM PC and IBM PC AT are registered trademarks of IBM. MicroVAX II is a registered trademark of Digital Equipment Corporation. Data Translation is a registered trademark of Data Translation, Inc.



cable had been specially made to fit my serial port. Both checked out OK.

Next I presumed that my communications software was at fault. Trying several different packages, including the communications module of Symphony, convinced me that this was not the case.

Then a clue appeared. After a benchmarking session one evening, while the stopwatch was still in my hand, it occurred to me to time the rate at which the garbage emerged from the modem. A convenient standard text source was at hand in the shape of the modem's internal telephone directory. This can be listed by sending the command ATN? to the WS3000, and it worked fine at 300 bps but produced garbage at 1200 bps. The stopwatch revealed that the garbage was indeed being transmitted at 1200 bps, and a character count of the directory revealed that only one character in four was getting through properly, hence the garbage. This suggested that my serial port might not be receiving properly at 1200 bps. Discussions with Miracle Technology further encouraged this theory.

My workhorse computer is an IBM PC with a serial port provided by a Microsoft Systemcard multifunction board. A friend lent me a brand-new serial card, and I replaced mine with it. It displayed exactly the same symptoms. At this point, having put my own board back in place, I gave up rational thought and howled at the moon for a while.

Eventually, my courage returning, I decided that since the top of my computer was still off, I would take the whole darned thing apart bit by bit until I made it work. One by one, I removed boards from slots and tested the modem by logging on to BIX. When I removed the Microsoft Mouse card, the modem worked like a charm.

Those of you who have the bus version of the Microsoft Mouse know that the interface card has a jumper on it with four positions that let you choose which hardware interrupt the mouse will operate with. My mouse is an early version, and the jumper is not documented in the manual (it was mentioned on a piece of loose paper

## ITEMS DISCUSSED

WS3000 V22 PROFESSIONAL  
MODEM ..... £495

Miracle Technology (U.K.) Ltd.  
St. Peters St.  
Ipswich IP1 1XB  
England  
Tel: (0473) 216141

BRITISH TELECOM PACKET  
SWITCHSTREAM

British Telecom  
Customer Service Group  
G07 Lutyens House  
1-6 Finsbury Circus  
London EC2M 7LY  
England  
Tel: (01) 920 0661

in the box, which I lost within a week). The jumper had actually been moved once, when I tried out Digital Research's GEM, because the GEM manual clearly tells you to set the mouse on interrupt 3. I had, though, subsequently moved it back to 4. Moving it onto interrupt 3 again solved my problem, and both mouse and modem now work just fine.

There must be a moral to this story, but I don't know what it is. Perhaps you could say it's a warning that these open-architecture machines, of which we are all so much in favor nowadays, are not an altogether unmixed blessing. Maybe the ideal would be a closed machine that got everything right the first time.

### THE WS3000

The phantom bug having been defeated, I am now very happy with my choice of modem. The WS3000 is a very smart modem indeed, and the days of wrestling with an acoustic coupler (the handset popping out of the cup halfway through a call) seem like the dark ages.

The modem responds to commands that for the most part are the same as those of the Hayes Smartmodem. All such commands are prefixed by the letters AT (for attention), and the modem squeaks through its loudspeaker to acknowledge that its

attention has been gained. A set of 32 nonvolatile internal registers holds all the modem's parameters, and most of them can be read and written by the user. After you've messed them up so badly that the modem no longer works, the command ATZ will restore the original factory settings from ROM, for which I have been truly grateful several times.

The WS3000 differs from the Hayes Smartmodem in that it supports many more communications modes. There are 21 in all, when CCITT and Bell, half and full duplex, originate and answer, equalized and unequalized are taken into account. The six registers S25-30 hold codes that determine what settings will be used for each of the speeds: 75, 150, 300, 600, 1200, and 2400 bps. When the modem receives its first AT command during a session, it senses the speed being used and copies the appropriate code from one of these registers into S18, the current-mode register. So the user can fill registers S25-30 with the codes to be used as default settings. If visiting America, for example, I would load the appropriate Bell standard set.

In auto-answer mode the WS3000 is speed-sensing; in other words it tries to determine what speed the caller is using by comparing the carrier tone with all the ones it knows about, starting with the fastest. I haven't yet been able to test this facility as I don't get many calls from other modems.

One very powerful feature is the provision of a parallel control port. This port is brought out on the back panel of the case as a 26-pin connector and can be configured by software to emulate a Centronics printer port or a variety of other 8-bit ports. By writing suitable software (which can be put in ROM and added to the command set), you can use the port for remote control of machinery and instruments. It's possible for an instrument hooked up to the port to auto-dial a number and send its readings, or for a machine to auto-dial engineers and make a fault report. Those who are enthusiastic about the home of the future could use it to alter the central heating, for example, or reset

(continued)



Actually, we give you two things free.  
Our source code. And your freedom.

Just buy part or all of our excellent integrated  
business accounting system, the SBT Database  
Accounting Library.

We'll give you our source code absolutely free.

Which, in turn, gives you the freedom to  
customize our software to fit your business needs.

Say, for instance, you want to change the  
way a management report is formatted. Our free  
source code enables you to change it.

What's more, the change will be quick and  
simple because our software is written in easy-to-  
use dBASE.

In fact, the entire SBT Database Accounting  
Library runs with dBASE III or dBASE II, \* so you  
get the power and flexibility of those best-selling  
programs. Plus the freedom to use any computer  
that runs dBASE.

The SBT Database Accounting Library.  
Great software and freedom. All in the same box.

Call today for our demo disk and brochure.  
(415) 331-9900.

**THE SBT DATABASE ACCOUNTING LIBRARY.**

dProfessional	Time & Billing	\$395
dOrder	Sales Order processing	\$195
dInvoice	Billing/Inventory Control	\$195
dStatement	Accounts Receivable	\$ 95
dPurchase	Purchase Order	\$195
dPayable	Accounts Payable	\$295
dPayroll	Payroll/Labor	\$395
dLedger	General Ledger/Finance	\$395
dAssets	Asset/Depreciation	\$295
dProject	Project/Job Accounting	\$395
dBackup	Menu/Backup	\$ 65



Three Harbor Drive  
Sausalito, CA 94965  
(415) 331-9900

Call today for the name of the SBT consultant  
in your area.

# Free source code in every box.



the burglar alarm while on vacation.

I have found the WS3000 to be as transparent as a modem can be. I use a simple dumb-terminal program, configured to 1200 bps full duplex; the WS3000 then sets itself to this speed automatically. My keyboard enhancer program, Software Research Technologies' SmartKey, assigns modem command strings (e.g., ATDN1 for "dial stored phone number 1") and log-on strings to single keys, so I can get onto BIX with just two keystrokes, one to get a PSS (Packet SwitchStream) line and the other to do all the logging on. Borland's SideKick serves as an editor and, with its Paste facility, a means of transferring documents.

A nice bonus is that SideKick lets me use the WS3000 as an auto-dialer for both voice and data calls. By keeping all my phone numbers in SideKick's PHONE.DIR file, I can search the directory for a number and dial it by hitting a carriage return. This is a pretty good test of the WS3000's Hayes compatibility, since SideKick is designed to work with the latter.

This string-and-sealing-wax setup works just as well as any of the expensive blockbusting communications programs I've seen. The only feature I miss is the ability to call the terminal program, SideKick-style, from inside another application, and I understand that there are now products in the U.S. that will do this.

**COMMUNICATING IN THE U.K.**

Before I finish, a little elaboration on British Telecom's Packet SwitchStream

network would be useful, especially for British readers who are contemplating joining BIX.

The British Telecom services are called Packet SwitchStream (PSS) and International Packet SwitchStream (IPSS), and both can be obtained merely by opening an account, just like a regular telephone account. The cost of opening such an account is very reasonable indeed—a one-time connection charge of £25 and a quarterly rental charge of £6.25. For this you receive a password called your NUI, or network user identity, which will be recognized at one of the Packet Switching Exchanges that are situated in all the U.K.'s major cities. You also get an NUA, or network user address, by which other modem users can reach you.

By dialing the number of your Packet Switching Exchange (a local phone call) and giving your NUI, you will be connected to a computer called the PAD (packet assembler/disassembler). Once connected to the PAD you can gain access to other users or networks in the U.K., or abroad by entering their NUA just like a telephone number. For example, BIX can be accessed via the U.S. Tymnet network, whose NUA is 31069.

With packet switching, your message is chopped up into small packets (usually 128 bytes), and these packets are then mixed in with packets from other users and sent over a high-speed data link. Each packet contains an address that enables your whole message to be reassembled again at

the other end. By this means the data rate of the system can be kept very high, and so the cost to you is low.

For example, if you dial the U.S. directly by public telephone it costs about £45 per hour; most of the time is wasted, too, since the gaps between words (or typed characters in a data call) are much longer than the actual information. With packet switching there is no such waste, and the cost is much less. Tymnet, for example, costs £4.80 per hour and £3 per kilosegment (1000 packets) transmitted. To that you add the cost of the local phone call to your PAD, which goes on your ordinary phone bill. Inland calls on PSS and European calls are much cheaper still.

Assuming you have an IPSS account, the complete sequence to access BIX from the U.K. is as follows:

```
< your own NUI >
A9 31069   to get onto Tymnet
BYTENET1  at the Tymnet prompt
MGH       password
BIX       to log onto BIX
```

To go through the registration procedure, type new when BIX asks for your user name. You'll need a MasterCard or Visa (Barclaycard) credit-card number to pay the registration fee, so have it on hand before you start. Any BIX users who want to reach me can send mail to dickp.

[Editor's note: Starting with last month's column, BYTE U.K. is available on BIX in the Byte.uk conference. Dick encourages readers to add comments and queries about his columns to the conference.] ■

**mainframe powered CROSS ASSEMBLERS now under MS-DOS**

The **UniWare™** family of cross assemblers. Fully relocatable, of course, but absolute listings are no problem, even in loads with many source files. With a linker so capable that even multiple overlays are a breeze. Lots of macro power. And all tools have unlimited symbol capacity.

\$295 COMPLETE

Includes One Assembler

<b>Intel</b>	8086, 80186, 80286, 8051, 8048, 8080/5, 8041
<b>Motorola</b>	68000, 68010, 68020, 68HC11, 6809, 6805, 6801, 6800
<b>Hitachi</b>	HD64180, 6305, 6301
<b>Zilog</b>	Z80, Z8
<b>Others</b>	6502, 1802, TMS7000, 3870/F8

Software Development  
Systems, Inc.

(312) 971-8170

Visa & Master Charge Accepted (U.S.A.)  
England: Unit-C, Ltd., (0903) 205233

---

Minimum 320K memory recommended; discounts available on purchases of multiple assemblers; prices subject to change without notice. MS-DOS is a trademark of Microsoft.



# HOW TO GET A FREE COPY OF R:BASE 5000.

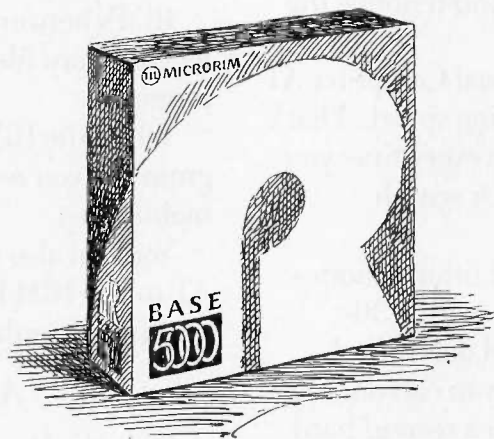

## LEGALLY.

It's simple. Buy one copy of R:base™ 5000 through any of the regular retail channels, from April 15th until June 30th. Then, send us your proof of purchase, and bingo! We'll send you another copy, free. Documentation and all. Just like that.

Here's your chance to double your productivity with the database management program that Datapro calls the best in the business. Use both copies at the office. Or bring one home. Give one to a

friend (or split the cost!). There are lots of ways you'll come out ahead.

Just send us your warranty card and a copy of the sales invoice (showing your name and date of purchase) to Microrim, P.O. Box 2606, Redmond, WA 98073. And start enjoying twice the benefits of the best DBMS around.

Oh sure, there are probably other ways you could get free copies of R:base 5000.

But none lets you sleep so well at night.

## R:BASE 5000 FROM MICRORIM

# The personal computer that continues to raise high performance to new heights.

If you work with high volumes of information, you need answers fast.

Which is why IBM created the Personal Computer AT.<sup>®</sup> The PC designed to push high performance even higher.

## The power of Advanced Technology.

Turn on the power, and you'll notice the advances right away.

To begin with, the Personal Computer AT can compute with astonishing speed. That's something you'll appreciate every time you recalculate a spreadsheet. Or search through a data base.

It can store mountains of information—up to 15,000 pages' worth—with a 30-megabyte "hard file" (fixed disk). And when business gets bigger, you can double your capacity to 60MB with a *second* hard file.

## Advanced Technology advances again.

Fast as it is, new models of the Personal Computer AT run up to 33% faster.

Plus, you can now select an enhanced keyboard. It has separate cursor keys, a separate numeric keypad (for easier data entry) and twelve function keys. It also has a main typing section patterned after the classic IBM Selectric<sup>®</sup> keyboard, which makes word processing easier than ever.

In addition, you can also choose a new option that lets you use 3.5-inch diskettes with your Personal Computer AT.

## Family ties.

The Personal Computer AT is compatible with the IBM PC and PC/XT. So it can run many of the thousands of programs written for the IBM PC family.

And with new IBM products, the Personal Computer AT can more easily communicate with other PCs.

IBM's networking options, for example, let you share files from a variety of popular programs.

While the IBM PC 3270 Emulation programs let you retrieve information from a mainframe.

You can also use the Personal Computer AT to run IBM PC XENIX<sup>™</sup>—an enhanced multi-user, multi-tasking operating system.

## A powerful value.

Only the Personal computer AT offers these capabilities *and* IBM's commitment to quality, service and support. A combination that can't be cloned.

Better still, you'll find that the new models offer higher performance without a higher price. And if you qualify, you can conveniently charge your Personal Computer AT on IBM's Credit Card. Or lease one with the IBM Commercial Lease Agreement.

See the Personal Computer AT at an Authorized IBM PC Dealer or IBM Product Center. Or call your IBM representative.

For the name of a store near you, call 1-800-447-4700. In Alaska, call 1-800-447-0890.

# The IBM Personal Computer AT, for Advanced Technology.

Little Tramp, character licensed by Bubbles Inc., s.a.

IBM, PC/XT and Personal Computer AT are trademarks of International Business Machines Corporation. XENIX<sup>™</sup> is a trademark of Microsoft Corporation. Based on SYSTEM V.





**IBM**<sup>®</sup>

©Copyright IBM Corporation 1986

JUNE 1986 • BYTE 327



# Kiss Your Daisywheel Goodbye Forever.



It's had a good life, but it's time to bury your old printer. Because now you can have a KISS™ instead. It can take the place of your dot matrix and daisywheel printers—and you'll never miss them.

KISS is the first intelligent laser printer that's both smart and simple. And at the unbelievably low price of \$1,995\*, it won't put you in the hole.

KISS is sophisticated. It's ten times faster than your old daisywheel and dot matrix printers. And it's very quiet. It produces crisp, near typeset-quality output at up to 400 characters per second. And it has its own cut-sheet feeder.

KISS has nine resident fonts. You can mix them on a single page, and even on one line for a lively style of your own.

Plus, it's smarter than your old printer. It works with WordStar®, Lotus® and any other software that will print to a Diablo 630® Epson FX 80® and QUME Sprint®. And at up to 6ppm, KISS is unmatched in efficiency and versatility.

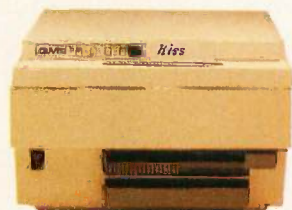

Aren't you dying to have a printer that can perform like that?

KISS is just one way QMS is meeting today's needs with proven technology.

Call us toll free at 1-800-245-KISS. Or write: QMS INC., P.O. Box 81250, Mobile, Alabama 36689. One Magnum Pass, Mobile, Alabama 36608.

**QMS**<sup>®</sup>  
Print Systems With Imagination™

Inquiry 282

\* This price good in the domestic United States only. WordStar is a registered trademark of Micropro International. Lotus is a registered trademark of Lotus Development Corporation. Diablo is a registered trademark of Xerox Corporation. Epson is a registered trademark of Epson America, Inc. QUME Sprint is a registered trademark of QUME Corporation. © 1986 QMS® Inc.





# UPGRADE FEVER

BY EZRA SHAPIRO

Writing this month's column has not been fun. None of the products is new; you and I have seen them all before. So I've been faced with a tough question: Should I base my evaluations on how the products have changed, or should I treat them as if they were brand new? Well, I've taken the dumb way out and tried to do both.

## IN THE CENTER RING

Imagine you're at the circus. It's time for the moment you've been waiting for—the elephant act. The elephants come marching out. They dance. They wave their trunks in the air. They roll giant colored balls across the ring. And then—the grand finale! The overhead lights dim. A spotlight shines on a curtain at the far side of the ring, which opens to reveal *an elephant on roller skates!* Fantastic! The crowd cheers! The elephant raises his trunk and slowly, majestically, skates around the ring. He's not very steady, but he manages to maintain his balance. You notice the expression on his face; he looks sad. Everyone applauds; you go home thinking about that poor, sad elephant.

A year later the circus comes to town again. You've been reading reports in the local paper about how the elephant act has been improved (or "enhanced," as we say in the computer biz). You go to the performance. You watch the elephants; strangely, nothing seems very different from last year. On schedule, the lights dim, the curtain opens, and out comes that same forlorn elephant on roller skates, *only this year the roller skates are motorized!* The sad elephant buzzes around the ring (steadier than last year because he doesn't have to pump his legs). The crowd cheers. You feel cheated. You shake your head in

## WordStar 2000 Release 2, dBASE III Plus, Volkswriter 3, and KeepTrack Plus

disbelief, and . . .

. . .and you put WordStar 2000 Release 2 back on the shelf, that's what.

Yes, friends, WordStar 2000 Release 2 (MicroPro, \$495) is with us at last, with all the charm of an elephant on motorized skates. It's faster than last year, to be sure, although it's still so ungainly and hungry for disk space that I wouldn't recommend running it on anything less than an IBM PC AT with a fast hard disk. The fact that MicroPro is so concerned about speed that it's offering a RAM version for users with 512K bytes or more (sent as a premium when you mail in your registration card) is a signal to me that the program still has problems.

After several weeks with the product, I find it clumsy, overdesigned, and uninviting, although the list of features looks terrific on paper. The program isn't absolutely ghastly, but I can't come up with a reason why I'd want to use it.

In all fairness, the program *does* give you everything you need for professional word processing, plus a number of bonuses. The documentation is clean, and the tutorials on disk are helpful. CorrectStar is still an excellent—and possibly the best—integrated spelling checker. The database-like mail-merge feature is very nice, as is the ability to store layout formats. You get great macro/abbreviation facilities. Two new features, arithmetic functions and multicolumn layouts, are welcome additions. And MicroPro supports just about every

printer ever made.

Yet I remain unsatisfied. Part of the problem is the interface, loosely (very loosely) based on original WordStar's use of Control-character prefixes. The prefixes have been changed to be more

mnemonic; block operations are triggered with Ctrl-B, exit options with Ctrl-Q. This makes more sense than the original, which used Ctrl-K for both. As a result, a veteran WordStar user like myself finds the landscape of WordStar 2000 familiar but unsettling. MicroPro contends that the transition is easy; I argue that if I'm going to have to learn a new system, I might as well learn something entirely new.

Menus or submenus fill nine lines at the top of the screen. Add the status and ruler lines, and nearly half the display is gone. This was ugly when WordStar did it; why not change with the times? I'd vastly prefer almost any other system—pull-down menus, pop-up menus, a command line, or anything that doesn't cause as much visual clutter.

I suspect that what I'm encountering is part of a master plan to make the program easily grasped by the computer-uninitiated in the business environment. After they become adept, the theory goes, they can turn off all the visual noise and get on with life. Well, I'm what is known as a "power user"—I don't need all the help—but I'm learning, too, and every time I have to ask a question I'm forced to confront all this stuff. There's no way around it.

Drawing another analogy, I expect a top-of-the-line word processor to

(continued)

Ezra Shapiro is BYTE's West Coast bureau chief. He can be contacted c/o BYTE, McGraw-Hill, 425 Battery St., San Francisco, CA 94111.



behave like a luxury sports sedan. I want good handling, quick response, fast acceleration to cruising speed, a sense of security and comfort, and I don't want convenience features to distract me from driving. The parallels to word processing are obvious. If WordStar 2000 were a car, it would be a limousine with tail fins.

With Release 2, WordStar 2000 has become an acceptable word processor at last, but there are at least half a dozen word processors on the market I rank as outstanding, including WordPerfect, XyWrite, MultiMate, Framework, Volkswriter, and even lowly, original WordStar (which you can get with CorrectStar). If you want to settle for "acceptable," be my guest. But think about that elephant.

**AN IMPORTANT PRODUCT**

Make no mistake, when you buy dBASE III Plus (Ashton-Tate, \$695), you're not just purchasing a database management program—you're joining

an institution. Over the years, the dBASE phenomenon has grown from a small cult happening to a massive superstructure. Although Ashton-Tate has built strong customer loyalty by providing excellent support for the product, you don't need it. Just look at the number of dBASE books, dBASE users groups, dBASE bulletin boards, dBASE consultants, dBASE utilities, dBASE program generators, dBASE compilers, dBASE . . . you get the idea. I often find myself recommending the program not because it's particularly suited to a given use, but because of all the support. There's a snowball effect, too. As dBASE becomes increasingly dominant, fewer competitors have the guts (or the budget) to challenge it head on, so they attempt to chip away at the edges of Ashton-Tate's market. As a result, I could probably pick out products that beat dBASE in any specific category (this one has a better query language, that one is more portable

to minicomputers and mainframes, the other one is easier for a novice, and so forth), but nobody beats dBASE overall.

Each upgrade to the original dBASE product has broadened its scope. The current move, from dBASE III to dBASE III Plus, adds the regular performance improvements (has a database manager ever been enhanced *without* an announcement of faster sorting and indexing?), networking capabilities, a few new programming commands, rewritten documentation, and a mild sprucing up of the user interface.

The networking will further solidify the product's position in the business community. You have file and record locking, eight levels of password protection, and encryption/decryption on any network that runs with PC-DOS 3.1, including networks from 3Com, Novell, AT&T, and IBM. Since I didn't have access to anything but a few single-user computers, I have no idea whether any of this works, but it sure sounds impressive.

As to the other stuff, I have mixed reactions. I've never found dBASE all that difficult to use in its rawest form, the infamous "dot prompt" interface. At that level, the program works like a language, and you can accomplish a lot with a limited number of commands. It's a bit confusing at first, but you can build a pretty straightforward card file without too much effort. Things get trickier as your needs become more complex, but if you can take the time to learn gradually it's no big deal.

However, software companies seem to feel that they have to prove that their products can be operated by the subaverage dunderhead, so Ashton-Tate has bolted on a "Framework-like" menu system, a query aid, a view mode, a Screen Painter, and an Applications Generator. It's here that dBASE III Plus lacks punch.

The menu system is okay, but database manipulations are rather arcane, and the menus will not save you from yourself if you don't have a clear idea of what you're trying to accomplish and how the program works. They do save a little time when you're building

(continued)

**DataSaver<sup>400</sup><sup>®</sup>**  
Standby UPS

Power protection for the most powerful micro-computer systems with peripherals is here, now, with the 400 Watt DataSaver. Protect your investment in application software and hardware with reliable, continuous power. 90 and 200 Watt capacities and international models are also available.

**Cuesta Systems Corporation**  
3440 Roberto Court  
San Luis Obispo, CA 93401  
TLX: 4949381 CUESTA

©1985, Made in U.S.A.  
Write or call 805/541-4160  
Dealer, O.E.M. inquiries invited





# The Best C Book A Powerful C Compiler

## One Great C Value \$39.95

A good C book just isn't complete without a good C compiler to go with it. That's why we give you both. You get a comprehensive 450 page book and a standard, full feature C compiler. It's everything you need to take advantage of this powerful, portable language.

Our book is filled with sample programs. You'll learn how to use pointers to functions with a program that computes the time value of money. A simple data base program illustrates dynamic memory allocation and linked lists. Sample programs are included with the description of all functions.

Our compiler works fast because it makes only one pass through your program. Unlike other C compilers, it doesn't require a separate program to control the compile process. And it won't wear out your disk drives creating intermediate files. One fast pass and you've got an object file that's ready to be linked.

You also get our fast linker and an extensive library of standard C functions. In addition to the portable C functions you get a large number of computer specific functions so you won't have to write them yourself. The library includes an interface to the BDOS and BIOS routines so you can easily add your own special functions when the job demands it.

You can't learn to program in C without a good book and a good compiler. You can buy other C books but they don't include a compiler. You can buy other C compilers but they don't include a book. Either way you spend a lot of bucks and the compiler might not do what the book says it should. With MIX C you don't have to worry. You get both a good book and a good compiler for just a few bucks. And we guarantee that the compiler does what the book says it should.

### Language Features

- Data Types: char, short, int, unsigned, long, float, double, void
- Data Classes: auto, extern, static, register
- Typedef, Struct, Union, Bit Fields, Enumerations
- Structure Assignment, Passing/Returning Structures

abs  
asm  
asmx  
atan  
atoi  
atol  
atol  
bios  
bdos  
bdosx  
biosx  
calloc  
ceil  
cfree  
chain  
character  
chdir  
chmod  
clearerr  
close  
clrscrn  
cmpstr

conbuf  
conc  
cos  
cpyst  
creat  
cursblk  
curslin  
curscol  
cursrow  
cursoff  
curson  
delete  
drand  
exec  
execv  
execl  
execv  
exit  
exitmsg  
exp  
fabs  
fclose  
fdopen

feof  
ferror  
flush  
fgetc  
fgetl  
fgetw  
fopen  
fprint  
fputs  
fread  
free  
freopen  
fscanf  
fseek  
ftell  
fwrite  
getc  
getch  
putc  
getchar

### Functions

getcseg  
getdseg  
getd  
putd  
getdate  
gettime  
getl  
putl  
getkey  
getmode  
setmode  
getw  
heapsiz  
heaptrap  
hypot  
index  
inp  
insert  
iofilter  
isalnum  
isalpha

isascii  
isctrl  
isdlgit  
islower  
isprint  
ispunct  
isspace  
isupper  
itoa  
keypress  
left  
len  
log  
log10  
longjmp  
lseek  
malloc  
alloc  
mathtrap  
mid  
mkdir  
modf

movmem  
open  
outp  
peek  
perror  
poke  
poscurs  
pow  
printf  
putc  
putchar  
puts  
putw  
rand  
read  
readatr  
reach  
writech  
readdot  
realloc  
rename

replace  
repmem  
rewind  
right  
rindex  
rmdir  
scanf  
setbuf  
setbufsiz  
setcolor  
setdate  
settime  
setjmp  
setmem  
sin  
sound  
sprintf  
sqrt  
srand  
scanf  
stacksiz  
str

strcat  
strcmp  
strcpy  
strlen  
strcat  
strncmp  
strncpy  
strsave  
system  
tolower  
toupper  
ungetc  
ungetc  
unlink  
write  
writechs  
xmembeg  
xmend  
xmemget  
xmemput  
xmovmem  
\_exit

## MIX Editor \$29.95

When you're programming in a high level language you need a high powered editor. That's why we created the MIX Editor. It's a powerful split screen text processor that works great with any language. It has auto indent for structured languages like Pascal or C. It has automatic line numbering for BASIC. It even has fill and justify for English.

You can split the screen horizontally or vertically and edit two files at once. You can move text back and forth between the two windows. You can also create your own macro commands from an assortment of over 100 predefined commands. It

comes configured like WordStar but you can customize it to work like other editors or word processors.

The editor works terrific with our C compiler. The MSDOS/PCDOS version has a macro for compiling direct from memory. If your program has an error the editor positions the cursor to the error and displays an error message. You can also run other programs and execute DOS commands. Because the editor works so well with our C compiler we want to make sure you have both. For a limited time we're offering the editor for only \$15 when purchased with the C compiler.

## ASM Utility \$10

The ASM utility allows you to create your own assembly language function libraries. It works with Microsoft's MASM or M80 assemblers. It provides macros for function entry and exit so you don't have to worry about environment details. It also provides a macro for calling C functions from assembly language. Lots of useful assembly language functions are included as examples.

**ORDERS ONLY**  
**1-800-523-9520**  
IN TEXAS  
**1-800-622-4070**

Canadian Distributor  
Saraguay Software: 416-923-1500

30 Day Money Back Guarantee

NOT COPY PROTECTED

Editor	\$ _____ (29.95)	<input type="checkbox"/> PC DOS/MSDOS (2.0 or later)	Name _____
C	\$ _____ (39.95)	<input type="checkbox"/> IBM PC Single Side	Street _____
C & Editor	\$ _____ (54.95)	<input type="checkbox"/> IBM PC Double Side	City _____
ASM Utility	\$ _____ (10.00)	<input type="checkbox"/> Tandy 2000	State _____ Zip _____
TX Residents	\$ _____ (6.125% sales tax)	<input type="checkbox"/> 8 Inch	Country _____
Shipping	\$ _____ (see below)	<input type="checkbox"/> Other _____	Phone _____
<b>Total</b>	\$ _____	<input type="checkbox"/> CPM 80 (2.2 or later/Z80)	
<input type="checkbox"/> Check <input type="checkbox"/> Money Order <input type="checkbox"/> MC/Visa		<input type="checkbox"/> 8 Inch	
* _____ Exp _____		<input type="checkbox"/> Kaypro II	
<b>Shipping Charges:</b> (No charge for ASM Utility)		<input type="checkbox"/> Kaypro 4	
USA: \$5/Order Canada: \$10/Order		<input type="checkbox"/> Apple (Z80)	
Overseas: \$10/Editor • \$20/C • \$30/C & Editor		<input type="checkbox"/> Osborne I SD	
		<input type="checkbox"/> Osborne I DD	
		<input type="checkbox"/> Morrow MD II	
		<input type="checkbox"/> Other _____	



2116 E. Arapaho  
Suite 363  
Richardson, TX 75081

(214) 783-6001

Ask about our volume discounts.

CPM is a trademark of Digital Research. MSDOS is a trademark of Microsoft. PC DOS is a trademark of IBM. WORDSTAR is trademark of Micro Pro.

or editing a simple database, but if you want a full accounting system you have to read all the documentation anyhow.

The query thing (is "structurer" a real word?) is a good shortcut. You get to select fields and filter criteria, and you can get your results *much* faster using it than you could if you had to type out queries in the dBASE language.

The view mode is merely a euphemism for file-join capabilities. You can build new tables from as many as 10 open files. I do not see this as helping the dunderhead; again, you have to know what you're doing.

The Screen Painter is a full-screen report/entry form editor. It's useful and self-explanatory.

The Applications Generator is a development tool aimed at helping people who don't know what they're developing. That's a snide remark, but this add-on is not going to construct a project that requires any real sophistication with no assistance from the operator. It's helpful for quick and dirty development, and I suppose you can use it to generate some blocks of code that would be boring to write out, but I still see the heavy-duty stuff as requiring programming expertise.

So, conclusions.

One: Database management is not an arena for idiots. It takes planning and intelligence.

Two: dBASE III Plus is not a program for idiots either. It comes with tools that make it simpler to build a baby

accounting system or an automated address book, but if that's all you're up to, there are cheaper, friendlier products on the market.

Three: If you use the tools as shortcuts while developing something, you're pretty smart. I salute you.

Four: The main point (to me) of this upgrade is the network support. If you need those capabilities, or want to buy into the dBASE culture, check this one out.

### A SOLID PERFORMER

Volkswriter 3 (Lifetree, \$295) is one of the great forgotten programs. People don't seem to get excited about it, probably because it doesn't do anything flashy. But I don't know if you want fireworks in your everyday word processor; Volkswriter 3 gets the work done and lets you move on to the next job. It's a good product that shouldn't be neglected, particularly considering the price tag.

Basic features: Function-key command set. Uncluttered screen. Decent mail merge. Remapping of ASCII keys. Import and export. Support for a wide variety of printers. TopView-compatible.

New features in this version: Automatic paragraph reformatting. Quick spelling checker with large dictionary. Ability to store multiple layouts, either within individual documents or as templates. Columnar math functions that make it possible to create a small spreadsheet within a document.

Liabilities: There are three things

about the program that I don't like. First, I wish it were possible to remap the command keys. I have a tough time with more than a couple of levels of function keys; Volkswriter 3 uses all four levels. Even though punching F1 gives me a diagram of the layout across the top of the screen, I still have trouble remembering the difference between Alt-something and Ctrl-something. Second, if the spelling checker decides that what you've typed is a botched abbreviation, it will demand that you repunctuate it. If the mistake is just a typo, you can't ask Volkswriter 3 to suggest alternatives. Finally, it's another one of those programs that lets you put a character anywhere on the screen. You position the cursor, type a character, and Volkswriter 3 fills the intervening area with spaces or returns as necessary. I'm willing to accept this as a mode, but in general I prefer having to put in the spaces myself so I can use the right arrow key to get from one line to the next.

Overall reaction: Volkswriter 3 is a solid workhorse of a word processor. If you demand lots of zippy features like windows and outlining and such, look elsewhere. But if you're on a tight budget (and who isn't?) and you need a businesslike editor, Volkswriter 3 is worth a long look.

### CUTE AND HANDY

There are dozens of hard disk management utilities for MS-DOS machines. As a rule, these programs are designed to simplify file handling and directory organization, and they all look pretty much alike. You can usually show the tree structure of your directories in some sort of graphics representation (useful!) and move from one directory to another by cursoring around the branches of the tree. Individual directories can be displayed when sorted by any reasonable criterion (name, size, age, attributes, etc.). Specific files can be viewed on screen, sent to your printer, copied, moved, deleted, renamed, tagged for mass operations (copying a selected group of files to a floppy disk, for example), and so on, and so on, and so on. In practice, the novice

(continued)

## ITEMS DISCUSSED

WORDSTAR 2000 RELEASE 2 . . . . . \$495  
(MS-DOS)  
MicroPro International Corp.  
33 San Pablo Ave.  
San Rafael, CA 94903  
(415) 499-1200

VOLKSWRITER 3 . . . . . \$295  
(MS-DOS)  
Lifetree Software Inc.  
411 Pacific St.  
Monterey, CA 93940  
(408) 373-4718

DBASE III PLUS . . . . . \$695  
(MS-DOS)  
Ashton-Tate  
20101 Hamilton Ave.  
Torrance, CA 90502-1319  
(213) 329-8000

KEEPTRACK PLUS . . . . . \$79  
(MS-DOS)  
The Finot Group  
2390 El Camino Real, Suite 3  
Palo Alto, CA 94306  
(415) 322-6161  
Orders: (800) 628-2828, ext. 700



# SAVE BIG ON 1200 AND 2400 BAUD MODEMS

Now you can save big by purchasing a modem for your personal computer DIRECT.

Sunnyvale Communications Company has acquired a wide range of products that will enable your computer to communicate with the outside world. These products are of outstanding quality and value.

Check these features:

## 1200 LC \$199

- Hayes™ command compatible
- 1200/300/110 bps
- Auto dial, Auto answer
- Built-in speaker
- RS-232 to any computer

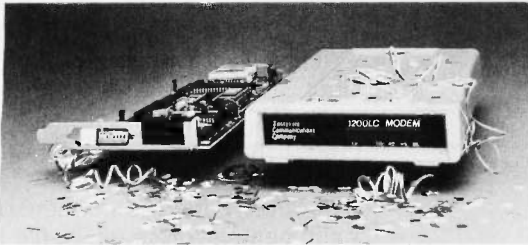

## 1200 TPC \$129

- Hayes™ command compatible
- 1200/300/110 bps
- Auto dial, Auto answer
- IBM™ internal
- Built-in speaker
- Software included

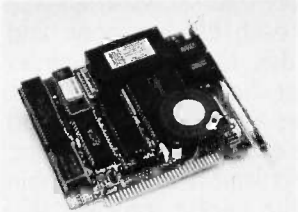

## 1200 SPC \$175

- Hayes™ command compatible
- 1200/300/110 bps
- Half-slot size
- Auto dial, Auto answer
- Built-in speaker
- Built-in diagnostics

Hayes is a registered trademark of Hayes Microcomputer Products, Inc. IBM is a registered trademark of International Business Machines Corp. Apple and Mac are registered trademarks of Apple Computer, Inc. Crosstalk is a trademark of Microstul, Inc.

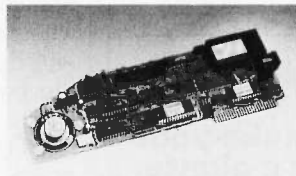

## AppleMate 1200 \$199

- Apple™ II, II+, IIe internal
- Hayes™ command compatible
- 1200/300/110 bps
- Auto dial, Auto answer
- Built-in speaker
- Super serial card equivalent
- Built-in diagnostics



## 2400 \$495

- Hayes™ command compatible
- 2400/1200/300 bps
- Auto dial, Auto answer
- Synch or Asynch operation
- Originate and Answer buttons
- Built-in speaker

## MacModem 1200LC \$229

- Mac™ compatible standalone
- Hayes™ command compatible
- 1200/300/110 bps
- Auto dial, Auto answer
- Built-in speaker
- Mac modem cable included

## MIRROR \$40

- Crosstalk™-like software
- Multi-tasking
- Menu-screen command structure



**Sunnyvale  
Communications  
Company**

1398 Borregas Avenue  
Sunnyvale, CA 94088-3565  
408/752-5095

**ORDER FORM**

**SC Sunnyvale Communications Company**

NAME \_\_\_\_\_

ADDRESS \_\_\_\_\_

DAY PHONE \_\_\_\_\_

CHECK ENCLOSED

VISA

MASTERCARD

SIGNATURE \_\_\_\_\_

ACCT. NO. \_\_\_\_\_

California residents add sales tax, all USA orders add \$4 per modem for shipping and handling (Canadian orders add \$10 per modem—international orders extra). No C.O.D.s or purchase orders accepted.

— TPC — LC — SPC

— MAC-LC — 2400

— AppleMate — MIRROR

Subtotal \$ \_\_\_\_\_

Subtotal \$ \_\_\_\_\_

Subtotal \$ \_\_\_\_\_

Handling \$ \_\_\_\_\_

TOTAL \$ \_\_\_\_\_

EXP. DATE \_\_\_\_\_

**800 835-9009 in CA  
558-5741 outside CA**

Attention all FX80, FX100, JX, & RX owners:  
**You already own half of  
 a great printer**

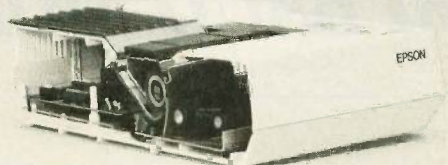

**Now  
 Only  
 \$79.95**

Now for \$79.95 you can own the rest. You see, today's new dot matrix printers offer a lot more.

Like an NLQ mode that makes their letters print almost as sharp as a daisy wheel. And font switching at the touch of a button —

in over 160 styles. But now, a Dots-Perfect upgrade kit can make your printer work like the new models in minutes. At a fraction of their cost.

Call now and use your Visa or Master Card. Don't replace your printer, upgrade it!

**1-800-368-7737**  
 In California: 1-800-831-9772

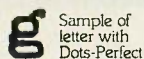

Sample of letter with Dots-Perfect

**Dots-Perfect**

**Dresselhaus**

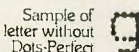

Sample of letter without Dots-Perfect



EPSON is a trademark of EPSON America, Inc.

837 E. Alostia Ave., Glendora, CA 91740 Tel: (818) 914-5831  
 An upgrade kit for EPSON FX, JX and RX printers

**KEYS CAN TALK TOO!**

**Function-Kease™ make your keyboard talk at a glance.**

**Function-Kease™ for:**

- |                            |            |
|----------------------------|------------|
| 1-2-3                      | Wordstar   |
| MS-DOS                     | Symphony   |
| Framework                  | dBase III  |
| Crosstalk                  | Pfs: Write |
| Microsoft Word             |            |
| IBM Filing/Reporting Asst. |            |

- IBM-PC, XT, AT**  
**Compaq**  
**Epson**  
**Apple IIe**  
**Sharp PC-7000**

Function-Kease™ are solid plastic keycovers molded to fit your computer.

**\$19.95**

When Ordering specify software and computer model. Check, Visa, Mastercard and approved POs are accepted. Custom and dealer inquiries welcome.

Pictured is example of Function-Kease™ for 1-2-3.

**Syntronics**

4901 Morena Boulevard, Suite 302  
 San Diego, California 92117  
 619 692-0695

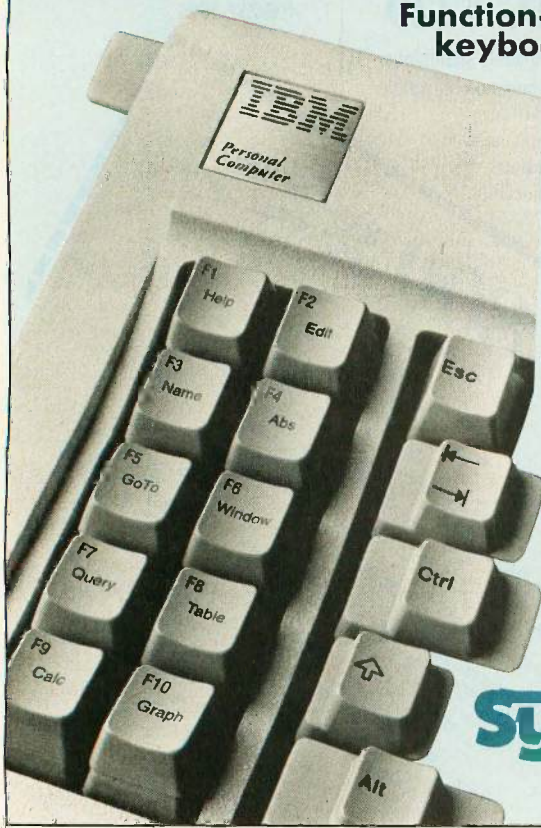

user is insulated from the cryptic world of the DOS command line, and the expert is given a shortcut through tedious disk-maintenance tasks.

I usually don't recommend paying money for any of these programs for two reasons. First, a lot of good public-domain and shareware utilities do exactly what the commercial ones do. Why pay for a commercial product when most of your money is going for packaging and promotional costs? You sure aren't buying originality or brilliant programming. The second reason is a matter of personal honor—I don't recommend products when I can't keep their names straight.

At first glance, KeepTrack Plus (The Finot Group, \$79) is yet another program of this type. It does all the expected things, and does them well, and who cares?

However, buried somewhere off on a submenu is a nice file-by-file backup-and-restore system that I haven't seen anywhere else yet. You select a branch of your directory tree (or your whole disk) for backup, and KeepTrack Plus duplicates your disk structure on the backup medium. That is, it will create the necessary directories so that the file C:\COMM\TALK\BIX.DOC will be copied to A:\COMM\TALK\BIX.DOC. KeepTrack Plus creates a master index in your root directory that shows where the backup of each file has gone and another index file on your target medium that shows what it contains. Both indexes are in plain ASCII, and they can be edited or viewed with no hassle. If you want to exempt certain files from the backup process, you create an ASCII file in your root directory that lists exceptions. The system is ideal for backing up on sequentially numbered floppies but will work with streaming tape, cartridge hard disks, and so on. I am far more comfortable with this file-by-file arrangement than with the standard DOS process that does not let you get at individual files.

The original KeepTrack is still available at \$39, but it lacks the backup system, and I won't recommend it for the reasons stated previously. For convenience software, KeepTrack Plus is pricey, but it makes life easier. ■



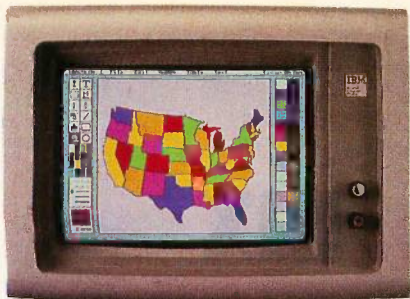

640 x 350 16 COLOR



EGA PAINT



GEM



FLIGHT SIMULATOR



PAINT BRUSH

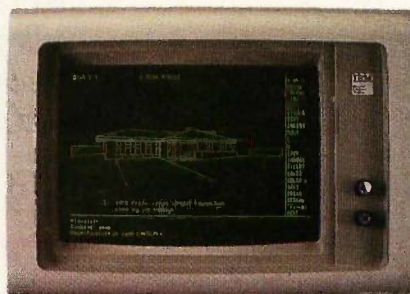

Auto CAD

# NO MORE Low-End Graphics Adapters.

## Why Settle for Less?

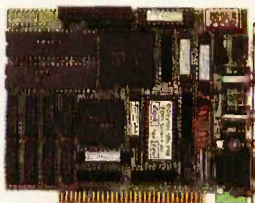

IBM sets the standards for Monochrome, Color/Graphics and the Enhanced Graphics Adapter. Hercules sets the Monochrome

Graphics standard. And the MegaGraph-Plus simply redefines the standard for what the Graphics Adapter is supposed to be: Monochrome text, Hercules graphics, color graphics, enhanced graphics. And most importantly . . . No software driver patches required.

## Fully Compatible

You can run almost all software from your early investment. Including Flight Simulator, Pin Ball, Jet and Lotus 1-2-3 Version 1A.

And it will still run all the business software packages written for IBM Enhanced Graphics Adapter (EGA). Examples include Auto CAD, IBM Drawing Assistant, Gem Draw, Microsoft Window, Word & Chart, Lotus 1-2-3 and Symphony, Dr. Halo, PC Paint Brush, EGA-Paint and many, many more.

ATronics is dedicated to the technical excellence of computing devices. To find out more about ATronics and our super-high performance ATI-1000 & ATI 2000 AT system compatible boards call or write:

Features	ATronics MegaGraph+	Quadram EGA+	IBM EGA	STB EGA+
Half size, fits in any slot of PC/XT/AT	X	X		
EGA compatible	X	X	X	X
CGA compatible	X	(1)	(2)	(2)
MDA compatible	X	X	X	X
Chip count	24	29	86	40
Hercules compatible 720 x 348 graphics	X	X		
No Software Patches required	X		X	X
Boot from:				
– Flight Simulator	X			
– Pin Ball	X			
– Jet	X			
Runs Lotus 1-2-3 version 1A:				
– Hercules mode	X	(1)		
– Color mode	X	(1)		
Two Video Jacks	X	X	X	
Display Memory	256K	256K	64K	256K
Light Pen connector	X	X	X	X
List Price	\$549	\$599	\$624	\$595

(1) Needs software driver patches.

(2) Compatible only to the BIOS level, but not the hardware level. Will not be compatible with most games software.



**ATronics International Inc.**  
491 Valley Way  
Milpitas, CA 95035  
(408) 943-6629 TLX: 510-600-6093

**MegaGraph PLUS**

Inquiry 34



# BYTE Invites You to Join **BIX**

BYTE is the world's leading high-tech microcomputer magazine. Its readers collectively possess more information about personal computers and related topics than any other group in the world. BIX is BYTE's brand-new electronic information exchange, a computer conferencing system that puts you in touch with BYTE readers and other computer enthusiasts on a daily basis.

---

## YOU AND BIX

BIX goes far beyond electronic bulletin boards to give you all the advanced features of true computer conferencing. It's the first major system dedicated to microcomputer information. Check these features:

- You can join ongoing discussions about your favorite computers, programming languages, operating systems, and applications programs, exchange information, ask questions, and offer opinions.
- You can read what others have already entered, add your own thoughts, and download information.
- You can participate when it's convenient for you, from home or office or while you're traveling.
- You also get electronic mail with BIX, putting you in direct, private contact with BYTE editors and BIX users everywhere.

## CUSTOMIZE BIX TO MEET YOUR NEEDS

As a BIX user, you select only the conferences and topics that are of real interest to you. You may join a new conference or leave an old one anytime you want. Each time you log on to BIX, you're immediately notified of any electronic mail messages waiting for you, and you see which of the conferences you've joined have had new activity since the last time you logged on. BIX keeps track of your interests.

With BIX, you're an active participant in a giant microcomputer information exchange.

## WHAT BIX COSTS... HOW YOU PAY

ONE-TIME REGISTRATION FEE:	
BYTE Subscriber .....	\$25
Nonsubscriber .....	\$39

BIX HOURLY USAGE FEES (All times are local):	
Off Peak (6 p.m.-7 a.m. plus weekends and holidays) .....	\$9
Peak (7 a.m.-6 p.m. weekdays) .....	\$12

## TELECOMMUNICATIONS CHARGES:

BIX is available via Tymnet from anywhere in the United States.

TYMNET (Continental U.S.):

Off Peak .....	\$2/hr.	Peak .....	\$6/hr.
----------------	---------	------------	---------

## PAYMENT:

BIX and Tymnet charges are billed through either VISA or MasterCard. No cash, checks, or money orders.

## START USING BIX NOW!

With our easy on-line registration, you can start using BIX in the next few minutes. No lengthy waiting for your registration to be processed by mail. (Step-by-step instructions on how to log on to BIX follow. Reading this material before you log on will speed you through the registration process.)

## LOG-ON INSTRUCTIONS AND REGISTRATION INFORMATION

### BEFORE YOU CALL BIX:

Having your credit card handy (VISA/MasterCard) before you log on will speed you through BIX registration. *You will not be billed for the time you spend on line registering for BIX. If at any time during the on-line process you decide not to register for BIX, just hang up.*

### HOW TO LOG ON TO BIX:

**Step 1:** Set your computer's telecommunications program for full duplex using 8-bit words, no parity,



and 1 stop bit, or 7-bit words, even parity, and 1 stop bit. You may call at either 300 or 1200 baud.

**Step 2:** To reach BIX via Tymnet.\*

- \* BIX is accessible from anywhere in the country through local Tymnet numbers. If you don't know the Tymnet numbers for your area, contact the BIX Customer Service Line (see below). At other times, numbers can be obtained by calling Tymnet at 800-336-0149.
- Call your local Tymnet number and log on.
- Depending on your baud rate, Tymnet will respond with "garble" or request a terminal identifier. Enter the letter "a". (Ignore quotation marks in this and succeeding entries.)
- Tymnet will ask you to log on. Enter "byteneti" and a carriage return (CR).
- Tymnet will ask you for a password. Enter "mgh" and (CR). You will then be at the door to the BIX computer.

**Step 3:** (If there is no prompt requesting a login at this point, hit a (CR) which should produce it.) When you see a phrase ending in "login:", enter "bix". (Echoing of this response is normal.)

You should now see the BIX logo scroll onto the screen and a prompt asking you to enter your name. Since this will be your first time on the system, enter "new" and a carriage return. This will

take you to a special section where you enter the information we need to register you as a BIX user. Follow the on-line prompts and supply the information requested. BIX lets you re-enter data if you make a mistake.

When you've completed your registration, BIX will automatically take you to a special "Learn" conference where you'll get a quick tutorial on how to use the system. (Typing "help" or "?" at any prompt while you are on BIX will give you an immediate review of available commands.)

### ACCESSING BIX FROM FOREIGN COUNTRIES

To reach BIX from other countries, you need an account with your local Postal Telephone & Telegraph (PTT) company. From your PTT, enter 310600157878. Then follow instructions starting at Step 3. A list of PTT addresses and contacts for most foreign countries is available by calling or writing BIX.

### CUSTOMER SERVICE

If you follow these instructions but still are unable to log on to BIX, call the BIX Customer Service Line for assistance at 800-227-2983, 8:30 a.m.-11 p.m. eastern time weekdays. In New Hampshire and outside the U.S., call (603) 924-7681.



*We'll Send You a BIX User's Manual and Subscriber Agreement As Soon As We've Processed Your Registration*

**BYTE INFORMATION EXCHANGE  
ONE PHOENIX MILL LANE  
PETERBOROUGH, NH 03458  
(603) 924-9281**



# OEM & OWN BRAND

## COMPOSITE & TTL COMPATIBLE

### COLOR & MONO MONITOR

# TERMINAL



TERMINAL; SD-M1201

SM-12SF 31A6; APPLE COMPATIBLE  
SM-12SF 39A7; IBM COMPATIBLE



OEM BRAND; SM-12CL 31A1



SM-CL401 SNS; 8 COLORS  
SM-C1402 SNS; 16 COLORS  
IBM COMPATIBLE



#### SEOUL OFFICE

6~8TH FL, THE JOONG-ANG DAILY NEWS BLDG., 7 SOONHWA-DONG, CHUNG-KU, SEOUL, KOREA  
TEL: 7516-955/7, 7516-959/961  
TLX: STARNEC K 22596  
CABLE: "STARNEC" SEOUL

#### LONDON OFFICE

6TH FLOOR, VICTORIA HOUSE SOUTHAMPTON ROW W.C. 1 LONDON, ENGLAND  
TEL: (01) 831-6951/5  
TLX: 264606 STARS LG  
FAX: (01) 430-0096

#### SANTA CLARA OFFICE

3003 BUNKER HILL LANE, SUITE 201 SANTA CLARA, CAL. 95050, U.S.A.  
TEL: (986)8473  
TLX: 171685 SAMSUNG SNTA

#### TOKYO OFFICE

KASUMIGASEKI BLDG., 2522 KASUMIGASEKI 3-2-5 CHIYOTA-KU, TOKYO, JAPAN  
TEL: (03) 581-5804, (03) 581-9521~4  
TLX: 228009 SANSEI



# NEW TOOLS, NEW CHALLENGES

BY WILLIAM M. RAIKE

Last month I went into detail about EM/3+, the "operating-system unification adapter" from Megasoft that lets me run both MS-DOS and CP/M-86 software and handles disks recorded under either operating system in more than two dozen formats. After living with it for another month, I'm even more enthusiastic than before; I've gained all the benefits of MS-DOS while retaining the use of much of my CP/M-86 software library. And I've had time to get used to two new acquisitions—a C compiler and a modem. But converting to a different operating system hasn't been all peaches and cream...

## THE DESMET C DEVELOPMENT PACKAGE

Almost all of my CP/M-86 software now runs under the combination of MS-DOS and EM/3+ on my computer (see May BYTE Japan, page 329) except for the Digital Research C compiler. It had been cumbersome to use, yielding bloated object code, so I welcomed the excuse to switch to a more suitable compiler. I finally decided to order the latest version (version 2.5) of the DeSmet C development package from CWare (POB C, Sunnyvale, CA 94087, (408) 720-9696). It includes a full C compiler, assembler, linker, and library files; I added the optional D88 symbolic debugger. Considering the compilation and linking speed, the small size of the compiled object programs, the exceptionally clear documentation, and especially the tremendously useful symbolic debugger, the whole package is a terrific bargain at \$159.

This column is definitely not intended as a full-scale product review, but I can't pass up the chance to give the DeSmet C compiler/debugger

## *Bill's conversion process continues as he adds a C compiler and a modem to his system*

combination a pat on the back. If you've ever gritted your teeth in exasperation because of your C compiler and linker while tracking down some elusive bug in a C program, you'll greet the D88 symbolic debugger with a huge sigh of relief. When you run your C program under the debugger, you can set breakpoints; list the C source code; display the contents of variables, registers, and memory; calculate the values of C expressions; and stop your program at crucial points to see what it's actually doing instead of what you think it's supposed to be doing.

Although the DeSmet C package is really designed for use with the IBM PC and compatibles, the compiler and linker ran with no modifications at all on my Fujitsu FM-16 $\beta$  computer, which makes no pretensions at all toward IBM PC compatibility. To use the D88 symbolic debugger, I had to make some minor modifications to the CONFIG.C file that's supplied on the distribution disk. Although the standard library has console functions that are specific to the IBM PC, the distribution disk includes easily understandable assembly language source code you can modify for any machine. And my Fujitsu, now running under the combination of MS-DOS and EM/3+, had no trouble reading CWare's IBM PC-formatted disks. The package even has a full-screen editor, but I prefer to stick with my usual editor.

I haven't run extensive benchmarks, but some statistics follow to give you

a rough idea of the DeSmet C compiler's performance. One of my small text post-processor utility programs, XPAG.C, contains 167 lines of C code. The DeSmet C compiler and linker took 5.36 and 2.95 seconds, respectively, or a total of 8.31 seconds, to produce an executable program file. The size of the executable file was 12,288 bytes, compared to 22,528 bytes under Digital Research C. (Digital Research C produces over 10K bytes of code even for the smallest possible C program: `main(){ }`). DeSmet C produces 1536 bytes for the same program, partly because the compiled program doesn't need to keep track of I/O redirection, which is handled automatically by MS-DOS.) I never did run Digital Research C on the well-known Sieve of Eratosthenes benchmark, but DeSmet C produced an executable program file only 7168 bytes long; it took 2.24 seconds to compile and 2.44 seconds to link. The `printf()` function accounts for over 5000 bytes of the final program size; it also represents about half of the compilation time. The execution time (to find 1899 primes 10 times) was 4.46 seconds. The times I've just quoted were measured on my Fujitsu FM-16 $\beta$ , which has an 80186 main processor running at 8 MHz, with all files residing in a RAM disk.

## A NEW MODEM AND ITS DOCUMENTATION

During a recent trip back to the U.S., I bought the Hayes Smartmodem 2400, and I'm already spoiled. After

*(continued)*

*William M. Raika, who has a Ph.D. in applied mathematics from Northwestern University, went to Japan in 1980 looking for 64K-bit RAMs. He has been there ever since as a technical translator and a software developer.*



using my old Epson 300-bits-per-second acoustic coupler, it's a real joy to be able to sit down at the computer, let the Smartmodem dial the number for me, and then communicate at 1200 bps, four times faster than before. I wonder how I ever put up with waiting for characters to plod across the screen at 300 bps.

Since the Smartmodem supports both the U.S. and international CCITT modem standards at 1200 bps and the CCITT standards at 2400 bps, I have no problem using it over here. Although there are still few chances to use the 2400-bps rate here in Japan, I now routinely use 1200 bps when communicating with BIX and other information utilities. It looks as if this modem will meet my communication needs for the foreseeable future.

Not only is the Smartmodem 2400 a well thought out, flexible, and powerful device, but it has the best

hardware documentation I've ever seen, bar none. In addition to the sections that provide clear descriptions of the operation of each of the common commands used for ordinary communication tasks, the manual contains detailed technical sections and appendixes that explain how to make the modem do practically anything imaginable. There's even a technical appendix that gives connection diagrams for modular telephone jacks (which I found essential to make the two-wire connection to my telephone junction box, since modular jacks aren't yet in widespread use in Japan). I also found specifications for pulse dialing, tables of touch-tone frequencies, and detailed descriptions of the RS-232C signals and how the modem uses them.

The descriptions of the RS-232C signals turned out to be indispensable for me. After rewriting my communications program in Turbo Pascal

under MS-DOS, I discovered that I could communicate readily with my laptop computer, but not with the Hayes modem. I eventually deduced that the RS-232C driver under Fujitsu's MS-DOS, unlike the CP/M-86 driver, won't output a character unless it senses that the DSR (data set ready) line (pin 6) is active. Since the Smartmodem holds pin 5 (the CTS, or clear to send line) active at all times but only activates the DSR line when a valid phone connection has been established, I surmised that everything would work just fine if I cut the DSR line (pin 6) in the cable and shorted pins 5 and 6 together at the computer side. This would fool the computer into thinking it had a valid DSR signal. It was a satisfying, if minor, bit of detective work. Sure enough, after minor surgery on the ribbon cable, I was able to communicate just as well under MS-DOS (and EM/3+) as I had before making the

## The Canon Bubble-Jet Printer is very compatible with all these units.

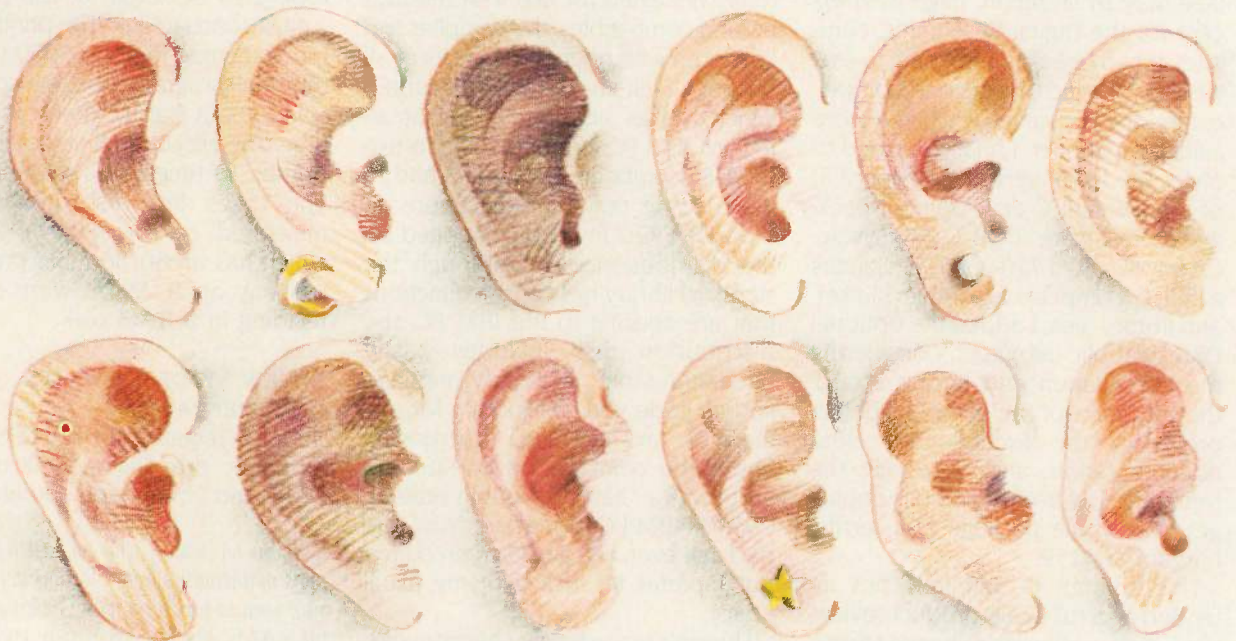



conversion from CP/M-86. I had a kludge that worked!

**SOME KLUDGES WORK BETTER THAN OTHERS**

But it turned out that I had congratulated myself just a wee bit early. The next problem that emerged was a direct result of what is, in my opinion, poor software design.

It seems obvious to me that device-driver routines ought to be "quiet" programs. That means that they shouldn't do anything that isn't absolutely necessary, and in particular they shouldn't produce any console output and shouldn't interfere with the execution of an application program, except in the event of an absolute catastrophe. The serial port driver under Fujitsu's version of MS-DOS displays a message on the console, in ever-so-polite Japanese, any time I turn the modem power on or off. Not content to foul up the screen,

any application program that happens to be running is interrupted and control returns to the operating system command processor. I was not amused one day when I flipped the modem power switch to "off" and my word processor immediately bombed out, returning me to the operating system minus the text I had created.

The solution seemed easy: Instead of using a modem signal line (pin 5) to pull up the DSR line, make a cable adapter that shorts pin 4 to pin 6 on the computer side. The computer always holds pin 4 (RTS, or request to send) high, so this second solution accomplishes the same thing, regardless of the state of the modem. But so much for theory; the problem persists, and I may just have to learn to live with it.

But I'm still annoyed by the software design process that allows such "error" handling in the first place. The same kind of problem crops up in

other places. For example, if I try to write a block of text to a disk file from within my word processor and make a typing mistake that indicates I'm trying to access a nonexistent disk drive, the operating system (again, politely) informs me of that fact and aborts the word processor without saying so much as "Excuse me." The sensible way to handle such errors would have been to have the operating system (or the BIOS) return from the I/O service request with an error indication and let the application program (word processor, communications program, or whatever) handle the error gracefully. There's no need for gratuitous messages on the screen, and certainly no excuse for aborting a program.

**FUNCTION KEYS DON'T**

It seems to me, for Japanese computer companies to compete successfully in the world software arena, they

*(continued)*

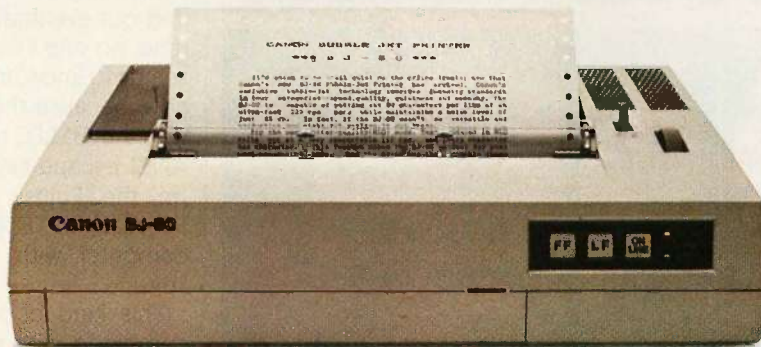

**Because high-speed, high-quality printing should be seen, not heard.**

The Canon Bubble-Jet Printer uses an exclusive system that combines thermal and ink-jet technology to print an ultra-fast 220 cps. While keeping the decibels down to a whisper.

For professional word processing, the Near Letter Quality mode (NLQ) churns out crisp, clear copy at a brisk 110 cps. And the BJ-80 has three graphic

image modes for high-resolution printouts of charts, graphs and diagrams.

Of course, the Bubble-Jet is fully compatible with Canon's fine line of Personal Computers and plug-compatible with the IBM PC. It's compact, lightweight and surprisingly affordable.

Ask your dealer about the full line of fast, efficient, economical Canon Printers. Find out what all the quiet excitement is about.

**Canon®**  
**PRINTERS**  
Printouts that stand out.

© 1986 Canon U.S.A., Inc. For more information: call 1-800-441-1313. (Or in Utah, call 800-922-3131.) Or write Canon U.S.A., Inc., Printer Division, P.O. Box 619865, Dallas/Fort Worth Airport, TX 75261.



**SUNDAY 10-5**

**PROMPT DELIVERY**

<b>COMPUTERS</b>	<b>APPLE IIC</b>	Call Hayes 300	<b>MODEMS</b>	124.99
IBM PC 256k 2 Floppies Mono Moni. w/ Card	Win Monitor	Call Hayes 1200B		322.00
\$1349.00	NEC PC 8401	Call Hayes 1200		347.00
<b>IBM PC</b>	<b>TOSHIBA LAP TOP</b>	Call Hayes 2400B		489.00
256k 10 Meg. Drive 1 Floppy w/Mono Monitor	\$1349.99	Micro Modern 2E		125.00
\$1749.00	\$624.99	Paradise Mon.-Col. Comb.		149.00
<b>IBM XT</b>	<b>SANYO MBC-555</b>	Hercules Mono		275.00
256k 2 Floppies Mono Moni w/ Card	\$1599.00	Hercules Color		199.99
\$1749.00	\$2699.00	Persyst Mono		188.00
<b>IBM XT</b>	<b>SPERRY PC IT</b>	AST-6 Pak 64K Sidekick		365.00
256k 10 Meg. Drive 1 Floppy w/Mono Monitor	289.99	Techar Captain		279.00
\$2099.00	419.99	STB EGA Plus		164.99
<b>AT&amp;T 6300</b>	<b>PRINTERS</b>	Video 7 EGA Plus		134.99
640k 20 Meg. Drive 1 Flop. w/Mono Monitor	Brother HR15-XL	Keytronic K100		159.99
Above w/Color Moni. add \$399.00	Brother HR-25	Amdek 310-A		359.99
<b>AT&amp;T 6300 Plus</b>	Brother HR-35	Amdek 300-Color		464.99
512k 1.2 Meg. D/D 360k w/Key Board Mono Monitor	Brother 1109	Amdek 722-Color		524.99
\$3399.99	Brother Twinwriter	NEC Multi-Sync		399.99
	Citizen MSP-10	PGS HX 12		149.99
	Epson HomeWriter 10	PGS MAX 12		409.95
	Epson FX-85	Taxan 630		
	Epson FX-286			
	Epson LG-1000			
	HP Think Jet			

**GUARANTEED LOWEST PRICES**

**COMPUTER: 1-800-874-1235**

**VIDEO: 1-800-223-6779**

**COMPUTER: (718) 237-2828**

**S'nW ELECTRONICS & APPLIANCES**

633 Bedford Ave, Bklyn, NY 11211

**TOLL FREE OUT OF N.Y.**

**IN N.Y. CALL (718) 237-2828**

**HOURS: Mon-Thurs. 9-6**  
**Fri. 9-2 Sun. 10-5 Sat. Closed**

C.O.D. Accepted

Credit Card Accounts charged at time of order

• Add Shipp. hand. Ins. • Prices subject to change without notice

• Qty Limited • Not responsible for typographical errors

should pay more attention to design criteria that avoid such problems. Another criticism I have concerns the keyboard driver for my machine under MS-DOS. My Fujitsu has 10 programmable function keys. Under CP/M-86, I used them frequently and effectively at both the level of the operating system and the level of applications programs. Fujitsu chose, under MS-DOS, to dedicate all 10 function keys for use with a "feature" that lets you edit the command lines you enter for the operating system. But Fujitsu's documentation doesn't mention any way to redefine them, either.

Under CP/M-86, it was possible to make BIOS system calls to have complete control over the console coprocessor (an MBL68B09) that manages the keyboard and the screen in the FM-16β. You'd load some registers, execute software interrupt 220, and the function keys get set to whatever you want. Obviously, Fujitsu must use some kind of BIOS interface to the coprocessor to accomplish the same functions under MS-DOS, but the documentation should say something about how it's done. I'll find out eventually, but in the meantime, no one I've been able to reach seems to know anything about it. And now, because the tricks you can use with the IBM PC to redefine keys using ANSI escape sequences don't work on the Fujitsu (see Best of BIX, February BYTE, page 386), I've got a computer with 10 useless function keys.

This kind of shortsighted design, combined with poor or nonexistent documentation and technical support from the factory, is a real problem. Hopefully, computer manufacturers will realize that foresight, good technical documentation, and support for software developers sells more computers.

**NEXT MONTH**

I'll discuss a couple of new computers from NEC that retain their compatibility with earlier models, and I'll tell you about a new laptop from Oki that has a built-in modem. I'll also share a quick overview of my reactions to the COMDEX show in Japan. ■

# What is a Best Western?



**The right place at the right price.**

Make reservations at any Best Western, see your travel agent, or call toll-free **1-800-528-1234**



"World's largest chain of independently owned and operated hotels, motor inns and resorts"



# Conquest: Two Cards for the Price of One



## One Card, One Slot, One Choice

Introducing Orchid's Conquest, the first PC multifunction card with 2 megabytes of the new Lotus EMS Expanded Memory. It's like having a multifunction card and an EMS card in one slot, but it costs less than you'd expect to pay for either.

### Multifunction Card

Conquest is a multifunction card with serial/parallel ports, clock/calendar, and DOS Memory. And Orchid's Switchless Installation gets you up and running in minutes.

### Expanded Memory Card

Conquest breaks the 640K DOS memory limit with 2 megabytes of Lotus EMS Expanded Memory. Orchid's Productivity Software lets you use this memory for RAM Disk and Caching, so you take advantage of it with your existing software.

Whether you're buying the first expansion card for your PC or an add-on for Lotus EMS Expanded Memory, Conquest is your choice:

- ▲ **First Card Buyers:** Conquest is a multifunction card with EMS.
- ▲ **Multifunction Card Owners:** Conquest is an EMS card with ports.

### Features:

up to 2 megabytes of RAM  
DOS & EMS Memory  
1 Serial, 1 Parallel Port  
Clock/Calendar

Productivity Software:  
RAM Disk  
Disk Caching  
Print Spooling  
Alarm & clock display

Optional PCnet connection



47790 Westinghouse Dr.  
Fremont, CA 94536  
415/490-8586  
Tlx: 709289

# HAVE YOU STRIPPED YET?

It's a question more and more PC owners are asking. And no wonder. What everyone is talking about is Softstrip™. The revolutionary technology that is changing the shape of computer software.

The Cauzin Softstrip System is more than just software or data on paper. Because when you invest in this system, you can do much more with your computer, and for far less than you are probably spending now. You can even create and print out your own data strips.

But that's only the beginning of an offer that's going to make you wonder why you haven't stripped yet...



## TAKE OUR ADS (SUCH AS THIS ONE)

It's part of our expanding StripWare™ Library containing programs, data, art, spreadsheet, macros and templates. The Library features a variety of software applications and you'll find new material appearing each month in such leading computer magazines as Lotus, PC, PC Tech Journal, and PC World.

## BUT THERE'S STILL MORE...

When you invest in the Softstrip System, you get the Softstrip reader, a special storage base, and a full one-year replacement warranty. Also included with your purchase is a complete Accessory Kit for your PC containing connector cables and communications software to link your computer to the reader.

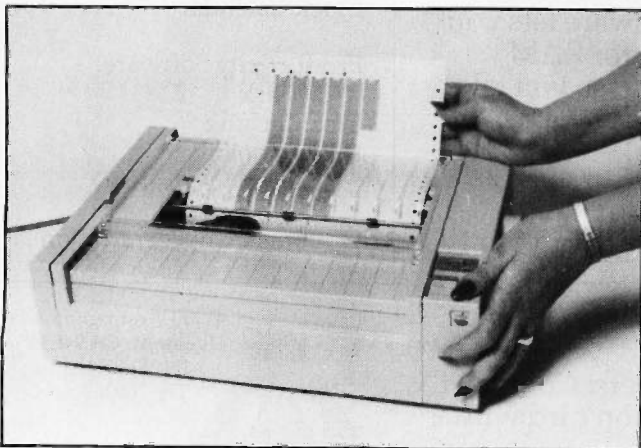

In addition, you'll find a StripWare Sampler with 48 programs from a line-up of popular authors and publishers that includes Addison-Wesley,

David Ahl, Family Computing, Tim Hartnell, Hayden Books, PC Tech Journal, Osborne/McGraw-Hill, The Waite Group, and John Wiley & Sons.

When you become a Softstrip reader owner, you also get a FREE one year StripWare Club membership with programs mailed to you monthly. You'll even receive a FREE Cauzin Effect Newsletter filled with the latest updates and news about Softstrip developments.

## AND IF THAT'S NOT ENOUGH TO START YOU STRIPPING...

You'll find StripWare brand software in authorized Softstrip dealers across the country. Our collection of titles include everything from

utilities, graphics and entertainment to business programs. All for only \$2.98 to \$19.98!

Do you want to create your own data strips? Well, now you can with a special StripWare package called "STRIPPER" that lets you print your disk files as strips using your own Epson dot matrix printer.

The printing software is only \$19.95,

but just think of the things you could be stripping. Store backup files on paper. Print, copy and mail your own programs to others easily and inexpensively....

The Cauzin Softstrip System is just that, a complete system that opens up a new world of computer programs and data on paper. And it's all yours for only \$199.95!

For the Softstrip System Dealer nearest you, (or if there isn't one in your area, to order), call toll free: 1-800-533-7323 (in Connecticut: 203-573-0150)



StripWare packages offer utilities, games, business programs, templates and much more.

**Softstrip**  
COMPUTER READABLE PRINT

Cauzin Systems, Inc.  
835 South Main St., Waterbury, CT 06706

Epson is a registered trademark of Epson America, Inc.

IBM and IBM PC are registered trademarks of International Business Machines, Inc., Softstrip® and the Softstrip® System Reader are trademarks of Cauzin Systems, Inc.



# BIORHYTHM CHART

What kind of day is it going to be for you today? Are you at your peak physically, emotionally or intellectually? Which day this week will be ideal for beginning that new project you've been putting off? Is next Tuesday the right night to take that certain someone out to dinner, and pop "the question"?

Let's face it, on given day of our life there are any number of important decisions or options to consider. The data strips on the right contain a Lotus template, from the public domain, called BIORYTHM CHART that could help.

Use the Cauzin communications program to read the strips to a data disk. The Lotus Retrieve command brings the model into Lotus 1-2-3™. Enter your birthdate and the current date into the appropriate cells and your personalized BIORYTHM CHART will appear on the screen. You are given data for 15 days prior, and after, the current date which is shown as zero.

Run your spouse's, friend's, or child's chart and figure out which days you should be doing things together, and which days to avoid one another. If you know your boss' birthday, you can figure out what mood he'll be in before he comes to work . . . and plan accordingly.  
GOOD LUCK!

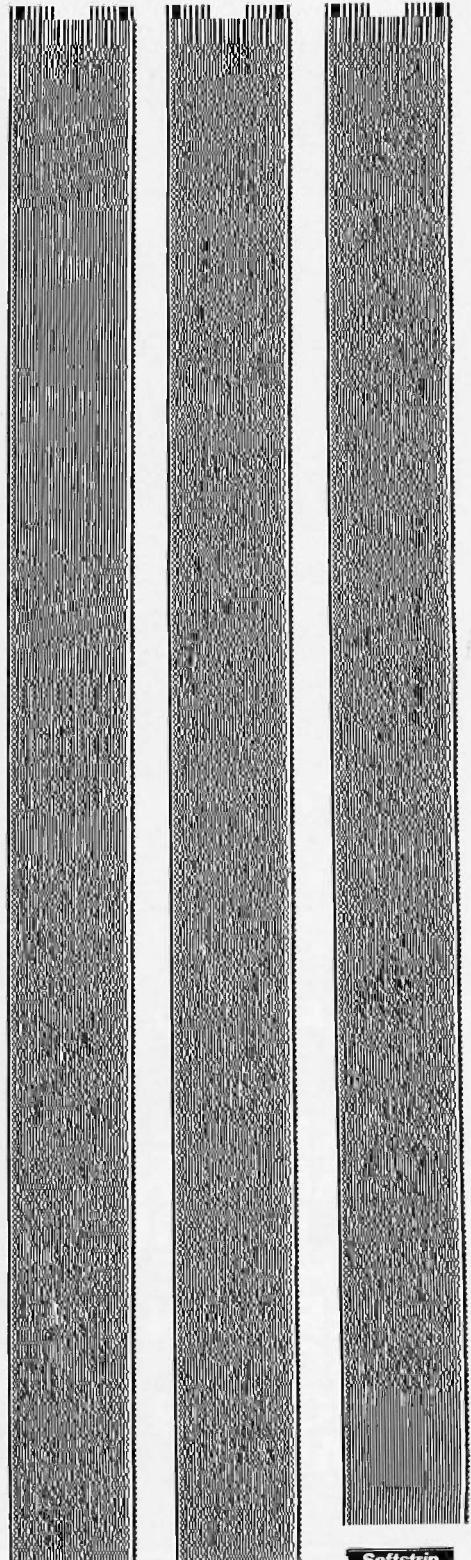

Softstrip

1

2

3

WORKSHEET OPTIONS VERSION 1.0  
© 1984 STELEE MANAGE  
IBM is a trademark of International Business Machines Corporation.  
1-2-3 is a trademark of Lotus Development Corp. All rights reserved.

StripWare Library No. 250

# American XTsr.

## THE IBM XT<sup>®</sup> COMPATIBLE WITH 60% MORE SPEED



### HIGHLIGHTS INCLUDE:

- 640K-bytes RAM on a four layer high reliability motherboard
- 2 Megabytes of expanded memory on the the American Above-Function Card™
- Turbo speed 4.77 to 7.37 MHz selectable without power down
- High Performance, high speed 8088-2 microprocessor
- Eight expansion slots; power-on auto self-test of system components
- Two 360K-byte DS/DD diskette drives
- 20M-byte hard disk drive
- 10M-byte formatted tape back-up included
- Serial, parallel, game ports, graphics card and real-time clock
- American Mouse™ with American Paintbrush™ for CGA and EGA graphics
- MS™ DOS 2.11 and Macro-Assembler software included
- 1 year limited warranty covering parts & labor

Salesman Incentive Program Available.  
FREE American Paintbrush Software.

## AMERICAN XTsr.™ PERFECT SYSTEM

### MAXIMIZE EXPANSION SLOT USAGE WITH THE AMERICAN ABOVE- FUNCTION CARD!

- Increase memory to 2 Megabytes RAM
- Based on Lotus®, Intel® and Microsoft® specifications
- Serial, parallel and game ports and real-time clock
- One year limited warranty

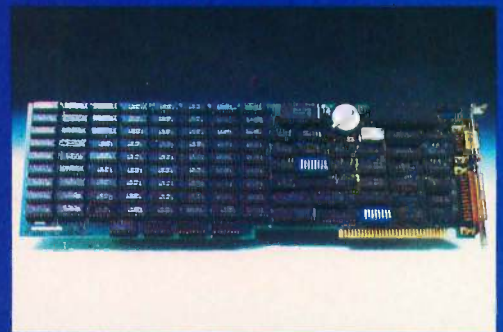

AMERICAN ABOVE-FUNCTION CARD™

#### Authorized Distributor and Service Center:

PC Land, Inc.  
Tustin, CA (714) 730-6723  
Micro Configuration East, Inc.  
Brooklyn, NY (718) 941-2512  
Computer Peripheral Warehouse, Inc.  
Deerfield Beach, FL (305) 481-2170  
PC Express  
Burnsville, MN (612) 894-9153  
Columbia Data Systems, Inc.  
Columbia, TN (615) 381-4650  
Imagine Computers  
Goleta, CA (800) 344-2964

D.L. MacNeil  
Elk Grove, IL (312) 952-8300  
The Super Source  
Norcross, GA (404) 441-3451  
Power House Sales  
Sioux Falls, SD (605) 335-7181  
Good Pasture Computer  
Dallas, TX (214) 986-1151  
Omega Data  
Hillsboro, OR (503) 640-3995  
Microsol  
Bethany, OK (405) 787-4354

Computer Wholesalers  
Lincoln, NE (402) 466-1692  
Computer Professionals  
Lakewood, CO (303) 232-4009  
Omega Data  
Kirkland, WA (206) 823-9769  
California Micro, Inc.  
Los Angeles, CA (213) 671-6075  
Mid America  
Carmel, IN (317) 846-3101  
Paris Sud Electronique Composants  
Paris, France (1) 69.20.66.99  
Inter-Micro Distributor, Inc.  
Alberta, Canada (403) 436-6393

Manufactured by:

## American

COMPUTER & PERIPHERAL, INC.

2720 Croddy Way, Santa Ana, CA 92704  
Tel: (714) 545-2004 • Fax: (714) 545-2146

Inquiry 384 for End-Users. Inquiry 385 for DEALERS ONLY.





# STORAGE FOR THE MASSES

BY BRUCE WEBSTER

## *An industry update, and Bruce also looks at some storage devices*

I'm writing this column in the last half of February, and the industry seems to be largely catching its breath after the Christmas season and the January trade shows. I'm doing a little breath-catching myself, after juggling different languages, compilers, and machines for last month's column. Once again, it's time to pause from the 68000 wars and look at a few of the products that have shown up over the past few months.

### INDUSTRY UPDATE

Apple, much to its dealers' surprise and delight, has wasted little time shipping the Macintosh Plus in significant numbers. No indication yet as to how the Mac Plus is selling with its hefty \$2600 price tag; I would suspect that dealers are having little trouble selling what they can get, though. In the meantime, some interesting rumors about the Apple IIx (next generation of the Apple II line) continue to surface. Over on BIX, one alleged description was posted that made the IIx appear to leapfrog the Amiga and the Atari ST machines: 4-megahertz 65C816 processor (which has a 16-megabyte address space and a 6502 emulation mode), Mac-equivalent ROMs, 4096 colors, high-resolution display, 32-voice sound synthesizer, 1 megabyte of RAM (expandable to multiple megabytes), Apple II and Macintosh emulation modes, and an affordable price tag (less than \$1500).

That rumor is wild enough to just possibly be true, especially if Steve Wozniak is indeed involved in the machine's design. Woz knows what hackers and developers want and—more important—knows that hackers and developers are the ones who write all the software that sells the machines. Rather than deliver a closed, crippled machine like the original 128K-byte Macintosh, which has gone through two generations in two years, Woz and Apple together just might have the brains and vision to put together a machine that can survive through the next ten years, just as the original Apple II has survived the last ten.

Atari, in the meantime, is having delays in shipping the 1040ST and the new 520ST. The word from Atari is "any minute now," and I suspect its people are working very hard to meet that, lest they fall victim to the famed Osborne syndrome. For those of you unfamiliar with microcomputer history, the Osborne 1 was a marketing innovation: a cheap, portable CP/M computer with lots of bundled software. Unfortunately, it had a number of limita-

tions, like a tiny screen (5 inches) that displayed only 52 characters on a line and disk drives that didn't hold a whole lot (90K bytes). Osborne, feeling the heat of competition from Kaypro (which had entered the mar-

ket with a similar but better system), announced the Osborne Executive, which corrected most of the problems of the Osborne 1. Unfortunately, production problems prevented Osborne from shipping the Executive for a few months, and sales of the Osborne 1 dropped to almost zero as dealers and customers waited for the new, improved version. Osborne was already on shaky financial ground, and that turned out to be the coup de grace, pushing Osborne into Chapter 11 financial reorganization (i.e., bankruptcy). Osborne emerged from bankruptcy a year or two ago but hasn't been able to make any significant market penetration.

So why would the people at Atari announce the 1040ST and the new 520ST before they could ship them? A combination of reasons, probably. Conflicting reports continue to come in on how the Amiga and the 520ST did during the Christmas season, but most sources indicate that the Amiga outsold the 520ST. Whatever the actual numbers, the 520ST was not the runaway success that many (including myself) thought it would be. That, combined with Apple's pending announcement of the Mac Plus and the lack of a good trade show forum during the spring, probably enticed Atari to make the announcement at the Winter Consumer Electronics Show in early January, even though they weren't ready to ship yet. At that time, they were saying "end of January," which was a reasonable and acceptable delay. Unfortunately, it's now late February, significant editorial coverage of the 1040ST has been appearing for a month now—with more to come—and the machines still haven't been shipped. I'll wager that 520ST sales have dropped off sharply, partly because of the announcements and partly because inventories of the "old" 520ST have been exhausted and Atari is (very understandably) unwilling or unable to produce more "old" units.

It would be a shame to see Atari hurt by this delay, especially since the 1040ST and the revised 520ST possibly represent the best price/performance deals in the history of microcomputers. Atari is probably better able to sur-

*(continued)*

Bruce Webster is a consulting editor for BYTE. He can be contacted c/o BYTE, POB 1910, Orem, UT 84057, or on BIX as bwebster.



# PROLOG APPLIED!

The **FIRST** Interactive Prolog for the IBM and Macintosh.

## PROLOG/i

A new enhanced Interactive Prolog for MS-DOS. Upwardly compatible with PROLOG V and V-plus. **\$69<sup>95</sup>**

## PROLOG/m

Prolog for the Macintosh! Edinburgh syntax. Floating point, math functions. **\$99<sup>95</sup>**

## THREE GREAT APPLICATIONS

READY TO RUN  
NO PROGRAMMING  
EXPERIENCE NECESSARY.

**NFL X-pert** **\$49<sup>95</sup>**  
Expert system for professional football handicapping.

**TOOLBOX** **\$29<sup>95</sup>**  
Including subroutines that speed and compress list handling, searches, sorts, reversal algorithms.

**TOYBOX** **\$29<sup>95</sup>**  
A collection of games and puzzles that make learning Prolog fun.

## MIX AND MATCH FOR ADDED SAVINGS

	PROLOG/i	PROLOG/m	*SAVE*
Interpreter plus...			
Toolbox or Toybox	\$ 79.95	\$109.95	\$20
Toolbox and Toybox	99.95	129.95	30
NFL X-pert	99.95	129.95	20
NFL X-pert and Toolbox and Toybox	119.95	149.95	30
BUY ALL 4 AND SAVE \$50	129.95	159.95	50
<b>Applications Only</b>			
Toolbox and Toybox	\$49.95		
NFL X-pert and Toolbox or Toybox	69.95		
BUY ALL 3 AND SAVE \$20	89.95		

**COMPATIBILITY**  
Applications fully compatible with Prolog compilers and interpreters with Edinburgh syntax.



**CHALCEDONY SOFTWARE, INC.**

**System Requirements**  
PC-DOS/MS-DOS Ver. 2.0 or later  
256K RAM  
512 Macintosh

5580 LA JOLLA BLVD.  
SUITE 126 D  
LA JOLLA, CA 92037  
(619) 483-8513

PHONE ORDERS: 1-800-621-0852 EXT 468

<input type="checkbox"/> PAYMENT ENCLOSED \$	PROLOG/i <b>\$69.95</b>
CA residents add 6% sales tax	PROLOG/m <b>99.95</b>
<input type="checkbox"/> CHARGE MY: <input type="checkbox"/> MasterCard <input type="checkbox"/> Visa	If you own PROLOG V or PROLOG V-plus, call for upgrade information.
Card No. _____ Exp. Date _____	<b>SHIPPING:</b>
Signature _____	\$ 5.00 U.S.
Mr./Mrs./Ms. _____	7.50 Canada
(please print full name)	10.00 Caribbean, Hawaii Air
Address _____	20.00 Overseas Air
City/State/Zip _____	COD Orders Not Accepted
	15 day check clearance

## ACCORDING TO WEBSTER

vive the sudden drop in sales than Osborne was, but they need to get those machines out the door soon; no company can survive dramatically reduced sales for long . . . except, possibly, IBM, which reputedly has a few billion dollars in the bank.

Commodore, in the meantime, seems to keep dodging the bullet that everyone thought would have been fatal by now. The bankers are apparently convinced that a live but ailing Commodore stands a better chance of paying off its debts than a dead one and that sales of the C-64, C-128, and Amiga are sufficient to keep Commodore alive for now. Smart folks, those bankers. The two big problems still appear to be lack of software and Commodore itself. Little new software has shown up in the past month, though a number of companies (like Aegis) claim to be on the verge of shipping several titles, and I still don't know if a decent word processor is available for the Amiga—especially critical because of Commodore's attempts to position the Amiga as a business machine.

Commodore seems to be hurting its own cause by throwing up roadblocks for developers. The latest obstacle: Commodore apparently wants software firms to pay \$500/product/year for the privilege of putting the Workbench (desktop interface) on their product disks. This strikes me as unnecessary and counterproductive, since every Amiga owner already has the Workbench. Developers can, of course, not put that stuff on their disks and just have the users make working copies, like most CP/M and MS-DOS software, but it is in both Commodore's and the developers' interest to make things as easy as possible.

IBM, as always, goes right along being IBM, comfortable in its view of the marketplace and its position therein. The question is how closely that view corresponds to reality, since the clone makers continue to eat away at IBM's market share. On the other hand, the real question might be whether or not it matters, since for large sections of the computer market, IBM has the apparent power to define just what reality is, with hordes of analysts and MIS managers following in its wake. Still, it was Zenith's portable, not the much-rumored (and still unannounced) IBM laptop computer, that won the key IRS contract. And the large inventories of unsold IBM PCs and XTs appear to be keeping IBM from introducing any new PC systems. Big Blue may just have painted itself into a corner.

## PRODUCT OF THE MONTH: MACBOTTOM

To be honest, I was hesitant about picking the MacBottom 20-megabyte hard disk as product of the month. I'm sure there are Macintosh hard disks that are newer, or cheaper, or faster, or have more sophisticated system software. And there isn't much about it that's flashy or exciting. In fact, in the few months I've had it, I've given very little thought to it. Ironically, that's exactly why I did pick it as product of the month: because, day after day, week after week, it has quietly, unobtrusively done its job and done it very well. No crashes. No bugs. No lost files. No lost desk space. No power switches to fiddle with. Easy boot-up. Nice utilities. Fast performance. In short, just

(continued)



# The FASTEST, EASIEST, MOST POWERFUL BASIC EVER!

## Amazing New Advancements for an Old Friend.

ZBasic is an incredibly advanced and powerful BASIC—but—it's still the old BASIC you're used to. Instead of spending 6 months of your life learning another complicated language, let ZBasic put your programs into light-speed, now! (If you know BASIC, you know ZBasic.)

## How Fast Is ZBasic?

Lightening fast. Four years of intense development have produced the ultimate BASIC. ZBasic is "Compiled BASIC," and generates stand-alone applications that make any other BASIC completely obsolete. Just look at these speed comparisons.

Sieve Benchmark on Different PC's			
Macintosh™		Apple IIe, IIc	
ZBasic™	7.4 sec.	ZBasic™	486 sec.
Mbasic™	684 sec.	Applesoft™	5,401 sec.
IBM® PC (8088)		Z-80 (CP/M™-80, TRS-80™)	
ZBasic™	13.7 sec.	ZBasic™	30 sec.
BASICA™	2,190 sec.	Mbasic™	2,520 sec.

10 iterations of the Sieve from Byte, January, 1983

## Compiler Speed/Interpreter Ease.

Like a BASIC interpreter, ZBasic allows you to write and execute your programs immediately! No messy "Linkers," "Loaders," or clumsy "Subroutine Packages" like most other compilers. To compile and edit, simply type "RUN." Debugging works the same as the interpreter, too. Just type "BREAK" or "CTRL C" to get back to the editor.

## Lightning-Fast Compilation.

Computer Language Magazine says, "Compilation is amazingly fast..." After typing "RUN," ZBasic compiles your program at blinding speed—40 lines per second.

## Works the Same on All Computers.

If you're tired of throwing away your old programs everytime you switch to a new computer, ZBasic is for you. Source code is portable from one computer to another, and since ZBasic uses Device Independent Graphics and Disk File commands, your programs automatically "Adapt" to any other computer. And the ZBASIC editor is the same on all versions—regardless of the computer.

## Einstein Math.

ZBasic offers programmers a math package that surpasses anything else in the industry! (Yes, ZBasic is even better than FORTRAN, PASCAL, MODULA-2 or any other language available!) You will have up to 54 digits of user-selectable accuracy at your power.

## "Superb Documentation!"

"The 387 page ZBasic manual is a model of clarity and organization. The documentation is superb, solidifying our impression that someone worked incredibly hard to make ZBasic a benchmark for all other BASIC Compilers." **PC WEEK**, Nov. 12, 1985

## Easy Structure—If You Want It.

ZBasic helps you "Structure" your programs in a way that's easy and simple...you may use GOSUB or GOTO with names or line numbers. Supports multi-line LONG IFs and LONG FNs. LIST programs with—or without—line numbers! ZBasic automatically indents loops and structures in LISTings, too.



## ZBasic Users Say:

"Awesome! It's about time! Great! Unbelievable!"

J.R. CPA  
Seymour, MO

"...fast, generates stand alone programs, requires only modest amounts of memory, has outstanding compilation speeds and...was bug free and felt solid. And the price is very attractive."

Bruce W. Tonkin  
COMPUTER LANGUAGE

"ZBasic is a powerful offering for BASIC programmers. It provides the flexibility of Turbo Pascal and the speed of compiled BASIC, all at a price that can't be matched. Kudos to Zedcor and to all users who make wise decisions to use ZBasic to the fullest."

Garry Ray  
PC WEEK

"The best I have ever seen. I love it! You should be proud of this product."

R. R. Manager  
Mesa, AZ

"Mind-blower! Easily the best BASIC I've ever seen!"

J. D.  
Baltimore, MD

## Versions shipping now!

- Macintosh, Apple IIe - IIc (128K & DOS 3.3)
- IBM PC and MSDOS 2.1 & Compatibles
- Kaypro Graphics version (CP/M-80)
- CP/M-80 2.0 or greater (Z80 only)
- TRS-80 Model 1/3, Model 4/4p

\$89<sup>95</sup>

Send me ZBasic right away! \$89.95 complete.

plus shipping

CREDIT CARD—MASTERCARD/VISA/AMEX/C.O.D.

\_\_\_\_\_  
\_\_\_\_\_  
\_\_\_\_\_  
\_\_\_\_\_  
\_\_\_\_\_

Card Expiration Date: \_\_\_\_\_  
My computer is a \_\_\_\_\_

Name \_\_\_\_\_

Address \_\_\_\_\_ APT. # \_\_\_\_\_

City \_\_\_\_\_ State \_\_\_\_\_ Zip \_\_\_\_\_

Day Phone \_\_\_\_\_

MAIL TO: ZEDCOR, INC.  
4500 E. Speedway, # 93  
Tucson, AZ 85712

# ZBasic™

ORDER TOLL-FREE:  
**1-800-482-4567**

30 day money-back guarantee.

Technical Support: (602) 795-3996

Arizona Residents add 5% Sales Tax. In U.S. add \$5.00 shipping. C.O.D. add \$5.00 per order. Outside U.S. and Canada, add \$20.00 per shipment for postage (U.S. currency only). C, Turbo Pascal, IBM PC, Fortran, Pascal, MODULA COBOL are trademarks of their respective companies—Macintosh is a trademark of Macintosh Laboratories, Inc.



# Compatibility without Compromise!!

— PC/AT, XT Compatible —

All included  
50% FASTER

# \$1995



Made in JAPAN

## TOMCAT 3200-AT MODEL III

- CPU INTEL 80286 6/8MHz
- RAM 512KB on Mother Board
- 2 X 1.2MB (360KB) Floppy Drives
- Floppy and Hard Disk Controller Card
- Turbo Display Color/Monochrome Card
- 1 Serial and 1 Parallel Card
- AT Keyboard
- Monochrome Display Monitor
- User's Manual & Technical Reference
- System Utility Disk (Setup, Diagnostic)

TOMCAT 3200-AT MODEL III (Hard Disk System 20MB) \$2,795



**OEM Acceptable**

Dealer Inquiry  
**"Welcome"**

### TOMCAT CORPORATION

Suite 304, 3820 Del Amo Blvd., Torrance, CA 90503  
TEL: (213) 542-6846 FAX: (213) 214-0276

### TOMCAT COMPUTER Inc.

Yaguchi Bldg., 3-6-4 Nishiwaseda Shinjuku-ku, TOKYO  
TEL: (03) 208-2511 TELEX: J28984 FAX: (03) 208-2662

## ACCORDING TO WEBSTER

about everything I want out of a hard disk, and all done so well that I take it for granted . . . or, at least, I will until I have to send it back and suddenly do without.

The MacBottom (built by Personal Computer Peripherals Corporation) sits underneath the Macintosh. It has the same "footprint" as the Mac; that is, it takes up the same amount of desk space. It's about two inches high, which—by adding that much height to the Mac—only serves to make the screen easier to see. It plugs into either the printer or modem port. If the printer port is used, the MacBottom will act as a printer buffer. You never have to turn the MacBottom on or off; instead, it senses (through the RS-422 port) whether or not the Mac is on and turns itself on or off accordingly. As most (all?) hard disks do, it makes some noise, but not an objectionable amount. It has a small, pleasantly green LED on the front that blinks during disk access (just so that you know it's doing something). The unit I have holds 20 megabytes; a 10-megabyte version has been available but is being phased out.

Since there is no way (at least none I know of) to boot off a hard disk connected to one of the serial ports, you do have to use a special boot disk to start things up. However, the boot-up program is smart enough to make a user-defined volume on the hard disk the default (start-up) volume and to eject the boot disk, leaving you with a hard disk-based system and no dreary floppy disks lying about.

MacBottom comes with MB Utilities. The boot-up program installs an important utility, the MacBottom Panel, as a desk accessory. You'll use this utility most often. As such, it is the easiest to access. It lets you "insert" (mount) or "eject" (dismount) volumes at will. It also shows any print buffering in progress and allows you to flush the buffer if desired. Three other MacBottom utilities let you create and delete volumes, change their size, change (without rebooting) the default volume, change the size of the printer buffer, and modify the boot sequence (which volumes are to be mounted, which one is the default, which port to use). Volumes do not automatically grow

(continued)

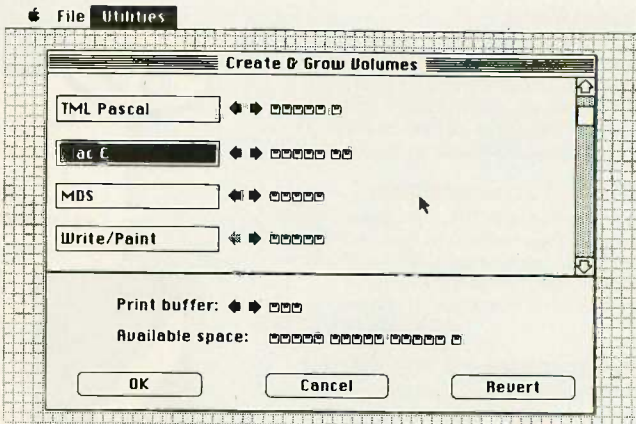
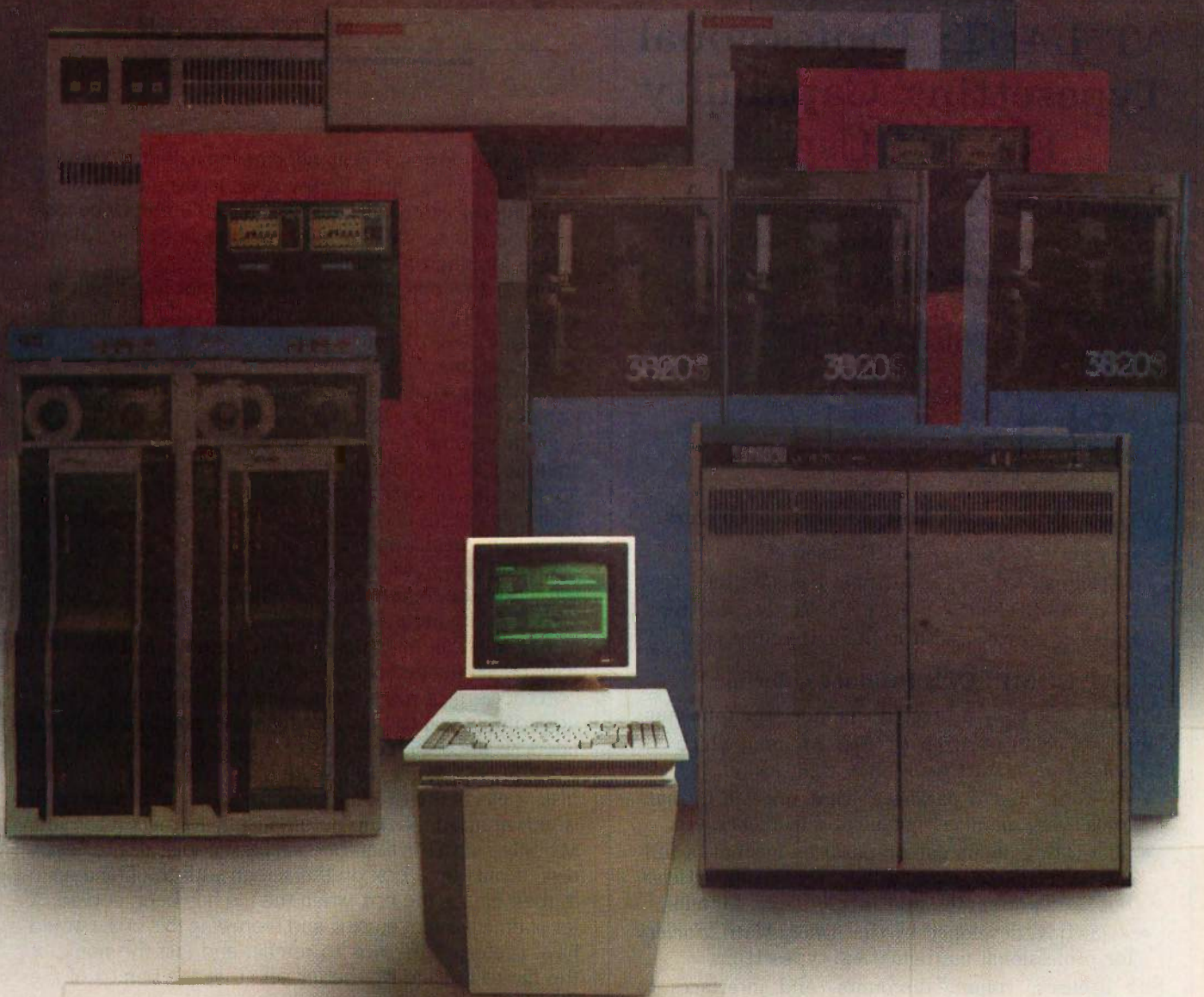

Figure 1: The Create & Grow Volumes Utility of MB Utilities. You can allocate and deallocate space for a volume 400K-byte chunks at a time. These chunks are shown as little floppy disks.





## UNIX™ SYSTEM POWER FOR PEOPLE WITH BIGGER THINGS IN MIND.

You know what UNIX™ System V can do.

But now you don't need a mini to do it. The AT&T UNIX PC puts room-size computing power right on a desktop.

Its Motorola 68010 chip, 10 MHz clock speed and up to 4MB RAM—with virtual memory support and internal hard disk options from 10 to 67MB—give you 75% of the power of a VAX\* 11/780.

For only 7% of the cost.

Development tools? The AT&T UNIX PC puts you in a UNIX System V environment complete with system utilities, the shell, C compiler and 68010 assembler. As for languages, you get the full range: C, Cobol, Fortran, Pascal, BASIC and the LPI\*\* high-performance suite. Not to mention C-ISAM†, INFORMIX† and sort/merge for database development.

All, with the convenience of built-in text editors, debuggers and graphics tools, including the GSS Virtual Device Interface.

Up- and downloading your work from minis or mainframes is easy. Thanks to the standard internal 300/1200 bps modem, RS-232 port, VT 100\* terminal emulation software and optional 3270 terminal emulation. You also get two jacks for phone lines and built-in communications software.

All of which make the AT&T UNIX PC ideal for ongoing voice/data communications and remote access to shared corporate databases.

---

### ONE OF THE COMPUTERS WITH THE FUTURE BUILT IN.

---

Even with all its available power and storage options, the AT&T UNIX PC still has room to grow. With three

expansion slots and the ability to connect up to seven serial devices.

Because when you have big ideas, accommodating them shouldn't be a big deal.

To find out about the AT&T UNIX PC and our **SPECIAL LIMITED TIME OFFER** call your AT&T Account Executive, authorized AT&T supplier or 1 800 247-1212.



**AT&T**

The right choice.

\*VAX and VT 100 are trademarks of Digital Equipment Corporation. \*\*LPI is a trademark of Language Processors, Inc. †C-ISAM and INFORMIX are trademarks of Relational Database Systems, Inc. © 1986 AT&T Information Systems.

# AT LAST: Professional Typesetting Capability For PC Users

With **PC T<sub>E</sub>X™** — the best-selling full implementation of Professor Don Knuth's revolutionary typesetting program T<sub>E</sub>X.

## **FINEST Typeset Quality Printing From:**

dot matrix          laser          phototypesetter

$$\sum_{i=1}^{\infty} \frac{1}{i} \begin{pmatrix} a_{11} & \dots & a_{1n} \\ a_{21} & \dots & a_{2n} \\ \vdots & \dots & \vdots \\ a_{m1} & \dots & a_{mn} \end{pmatrix} \int_{-\infty}^{\infty} e^{-x^2} dx$$

## **WIDEST Range Of Output Device Drivers:**

- Epson FX, LQ
- Toshiba
- Corona LP-300\*
- Screen preview, with EGA or Hercules card
- HP LaserJet\*
- Apple LaserWriter
- APS-5 phototypesetter

## **MOST COMPLETE Product Offering:**

PC T<sub>E</sub>X (not copy protected) includes the following:

- Our specially written *PC T<sub>E</sub>X Manual*, which enables you to start using T<sub>E</sub>X right away.
- Custom "macro packages" that provide formats for letters, manuals, technical documents, etc.
- The L<sub>A</sub>T<sub>E</sub>X document preparation system, a full-featured macro package for preparing articles, books, reports, etc., and L<sub>A</sub>T<sub>E</sub>X User's Manual.
- *A<sub>M</sub>S-T<sub>E</sub>X*, developed by the *Amer. Math. Society* for professional mathematical typesetting.

Site licenses, volume discounts, and interfaces to PC Paintbrush, PC Palette, FancyFont and Fontrix are also available.

**PRICED FROM ONLY \$249.00!**

(Printer drivers and interfaces additional.)



**Laser printer,  
fonts & software  
from \$2995.00**

For IBM PC/XT, AT or compatible, DOS 2.0 or higher, and 512K RAM. Hard disk required for printer drivers and fonts.

\*HP LaserJet and Corona require additional interface boards.

**For more information call or write:**

**Personal T<sub>E</sub>X, Inc.**

20 Sunnyside, Suite H, Mill Valley, CA 94941 (415) 388-8853

This ad, with space for the photograph, produced by PC T<sub>E</sub>X. Typeset on the Epson FX80, the Corona LP-300 laser printer, and the Autologic APS-5 phototypesetter.

T<sub>E</sub>X is a trademark of the American Mathematical Society. Manufacturers' product names are trademarks of individual manufacturers.

## ACCORDING TO WEBSTER

and shrink; instead, you allocate space in 400K-byte chunks, shown as little floppy disks (see figure 1). Also, shrinking a volume will cause the files thereon to be lost, since there is no clean way of "compacting" the volume before lopping off chunks of it.

This isn't as convenient as systems that handle all this automatically, but I've had no directory or file problems—nothing lost—so I can't complain. Besides, you can increase the size of a volume without affecting the files, and that's usually what you want to do anyway. One other function of the utilities: You can lock or unlock the Finder on a given volume. If you lock the Finder on the default volume, it will remain the default volume, even if you use applications on other volumes and those volumes have their own copies of system files. If you unlock the Finder, when you run an application on another volume, the Mac operating system will select that volume as the new default (provided the system files are there as well).

The backup program, MB Backup, is intelligent and easy to use. You can back up an entire volume, just files that have been changed since the last backup, or files of your own choosing. If you select the entire volume option, Backup prompts you to put in and label as many disks as are needed, since the contents of a given volume probably won't fit on a single 400K-byte disk. As Backup fills each disk, it ejects the disk and asks for a new one. If the disk is unformatted, Backup automatically formats it for you. My only quibble is that for each file it copies to the floppy disk, it puts up a box on the screen with the filename in it, then erases the box when the file has been copied. A lot of time is spent erasing and redrawing this box. I would have preferred the box to remain and just the name of the file to change or—better yet—that the names of the files being copied should form a scrolling list.

The changed files option lets you update the disks that form a complete volume backup by saving out (to the appropriate disk) just those files changed since the last backup. The selected files option, as you might guess, lets you scroll through a list of all the files on that volume and select which ones are to be saved onto the disk.

Backup has three restore options. If a file being restored already exists, a dialog box prompts for an overwrite/skip/cancel decision; if the file is in use, the options are just skip and cancel. This lets you restore to the volume in use, that is, the default volume. One important fact to be aware of: The files backed up on a floppy disk are special "MB Backup documents" and can be restored to normal format and use only by the restore options.

Another utility included with the MacBottom is Floppy Copy, which uses available disk space to speed duplication of floppy disks. This is intended primarily for single-drive systems and does a single-pass copy in around 1 minute 45 seconds. It does this by copying the source disk onto the hard disk itself, then writing the disk "image" onto the destination floppy disk, doing any initialization or formatting necessary. Having done that once, it asks if you want to make another copy of that same disk and will format and write a new copy of the disk in a little more than a minute.



## ACCORDING TO WEBSTER

I am pleased with the MacBottom hard disk. It does what I want it to, and it does it well and (to date) with no failures, problems, or glitches. The folks at PCPC assure me that it works fine on the Mac Plus and that they have a new system software release to support Apple's Hierarchical File System; I may have a follow-up on that in a month or so. At \$1595, MacBottom is a bit pricey, but if you're interested in worry-free, thought-free hard disk usage, it's worth it.

### DASCH RAM Disk

If, on the other hand, you're more interested in speed than in storage space, you might want to look at the DASCH (disk acceleration/storage control hardware) external RAM disk from Western Automation Laboratories Inc. Now, RAM disk software for the Macintosh is nothing new, but this is an actual external box that—like the MacBottom—connects to the printer or modem port and looks to the system like an extra disk drive. Also, like the MacBottom, it can double as a printer buffer. It has its own external power supply, so you can crash or turn off the Mac without affecting what's being stored on the DASCH. Unlike MacBottom, the DASCH is not made to fit under the Mac. Its dimensions are 7½ inches wide by 9 inches long by 2 inches high, and it must be placed either on top of or to the side of the Mac. It comes in three versions: 500K, 1000K, and 2000K bytes (the prices are \$495, \$795, and \$995); the smaller versions are upgradable to the larger versions for the difference in price plus 10 percent of that difference.

The start-up program, Start, will automatically copy files from the boot disk (or any other disk) to the DASCH, afterward selecting the DASCH as the default volume and ejecting whatever disk is in the drive. Again, like the MacBottom, this makes the start-up process relatively painless. Even more interesting is that the DASCH remembers what disks its files came from. If you then run the Backup utility that comes with the DASCH, you'll be prompted for each disk, and the appropriate files will be copied out. Another program, Configure, lets you modify Start in all sorts of ways: which port to use, whether or not disks other than the start-up disk are to be copied, whether or not existing files on the DASCH should be overwritten by their counterparts, and so on.

The DASCH is fast, easy to use, and can save lots of time. While my experience with it hasn't been quite as flawless as with the MacBottom, the few problems I've experienced have been minor and were easily dealt with. My only real criticism is the lack of a battery backup to protect against power drops and outages. Aside from that, I really like the DASCH.

One interesting problem I've had with both the DASCH and the MacBottom deals with restoring files previously backed up (or, in the case of the DASCH, copying files onto a "blank" RAM disk). If those files were originally in folders, they end up in folders on the destination volume. Unfortunately, those folders are unnamed (literally: "Unnamed #1," etc.), and they overlap with icons of

(continued)

C  
A  
L  
L

SUPER DISCOUNT WHOLESALER

**BTE COMPUTERS, INC.**

C  
A  
L  
L

IBM XT 512K Floppy.....	\$1988	ZENITH 148.....	\$1098
IBM XT 512K 20 Meg Hd.....	\$2488	ZENITH 158.....	\$1598
IBM AT 512K Floppy.....	\$3288	ZENITH 177.....	\$1988
IBM AT 512K Floppy 20 Meg Hd.....	\$3788	ZENITH 200 AT.....	\$2888
512K (OK) Memory Card.....	\$ 48	20 MEG Seagate Hd w/Cnt.....	\$ 448
384K (OK) XT Miltict. Card.....	\$ 98	10 MEG Irwin Tape Back-Up.....	\$ 448

### MONITORS

AMDEK Color 600.....	\$388
SONY IBM Hi Res Color.....	\$398
SONY w/V Tuner.....	\$498
TAXAN IBM Hi Res Color.....	\$395
ZENITH Amber ITL.....	\$159
RF MODULATOR IBM or Apple.....	\$9.99
Color Graphics Card RGB.....	\$ 78
APPLE Video 7.....	\$158

### PRINTERS

CITIZEN MSP10.....	\$ 248
EPSON FX85.....	\$ 368
OKIDATA 182.....	\$ 216
IBM Printer Cable (Hi Quality).....	\$ 15
DAISY Laser Printer (Cannon).....	\$2098
APPLE 2+ or 2e Cable.....	\$ 15
NP Laser Printer.....	\$2535
OTHER PRICES.....	CALL

### INTRODUCING THE NEW SUPER SPC-XT PORTABLE KIT

FITS ANY IBM, PC, XT or APPLE II+, IIE or (AT - CALL) COMPATIBLE MOTHER BOARDS

#### KIT INCLUDES:

- 3 DISK DRIVE SLOTS
- TTL or COMPOSITE (AMBER/GREEN)
- HARDWARE RESET
- POWER ON INDICATOR
- KEYPAD POWER SWITCH
- AUTOMATIC BRIGHTNESS CONTROL
- EASY TO ASSEMBLE

#### INCLUDES:

- 9" HIGH RES. MONITOR
- 135 W. SWITCHING POWER SUPPLY
- KEYBOARD
- ABS CASE, ACCESSORIES, MOUNTING HARDWARE, ASSEMBLY MANUAL, UP TO 6 EXPANSION SLOTS

**PRICE SLASH**

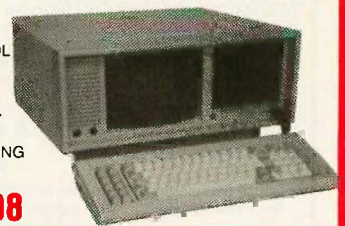

ONLY ..... **\$398**

### SUPER SPC-AT

#### TOTALLY IBM AT HARDWARE & SOFTWARE COMPATIBLE

MOTHER BOARD					
80286 MICROPROCESSOR					
80287 COPROCESSOR (OPTIONAL)					
512K STANDARD MEMORY					
8-1/10 EXPANSION SLOTS					
ONLY (OK).....	\$688.	DRIVE MFG	FORMATTED CAPACITY	ACCESS SPEED	PRICE
• SUPER AT KEYBOARD.....	\$ 89	SEAGATE	21	65	\$ 448
• SUPER AT CASE.....	\$ 89	SEA/CDC*	21	40	\$ 688
• SUPER AT 200 WATT		SEA/CDC*	30	40	\$ 845
POWER SUPPLY.....	\$149	CDC	40	28	\$1145
• 25M MULTI-FUNCTION		SEAGATE	40	40	\$ 988
CARD (OK).....	\$229	CDC	50	28	\$1399
		CDC	70	28	\$1598

### SUPER COMPATIBLE PC-XT MOTHERBOARD

TOTALLY IBM XT HARDWARE & SOFTWARE COMPATIBLE

• 256K MOTHER BOARD (OK).....	\$108	5150 KEYBOARD.....	\$54.00
• MONOCHROME GRAPHIC		5151 KEYBOARD.....	\$88.00
PRINTER CARD.....	\$ 98	XT CASE (Flip Top).....	\$48.00
• MULTI I/O CARD.....	\$108	135 WATT XT	
• PARALLEL PRINTER CARD.....	\$ 28	POWER SUPPLY.....	\$78.00
• SERIAL CARD.....	\$ 38		
• GAME PORT ADAPTER.....	\$ 19		
• EPROM WRITER CARD.....	\$108		

**SPECIAL THIS MONTH ONLY!**

### ★ APPLE COMPATIBLE PRODUCTS ★

• APL Iie+ Compatible Mother Board.....	\$228	• PRINTER CABLES.....	\$ 13
• APL Iie+ Compatible 80 Column Card w/64K Memory.....	\$ 48	• 80 COLUMN CARD FOR II+.....	\$ 42
• APL Iie+ Case, Keyboard w/Keypad.....	\$119	• Disk Controller Card II+ or Iie.....	\$ 39
• SS SERIAL CARD.....	\$ 68	• 16K Memory/Language Card.....	\$ 29
• APL Iie+ Replacement Keyboard.....	\$ 58	• Joystick II+ or Iie.....	\$ 15
• APL Iie Replacement Case.....	\$ 58	• Fancy Joystick II+ or Iie.....	\$ 19
• Power Supply (replacement II+ or Iie).....	\$ 39	• Half Height Disk Drives II+ or Iie.....	\$118
• APL Iie+ Detachable Keyboard w/Keypad.....	\$ 99	• Iie Drives.....	\$138
• APL II+ Compatible Mother Board.....	\$189	• Super Cooling Fans II+ or Iie.....	\$ 24
• APL II+ Replacement Case.....	\$ 38	• APL Video 7 RGB.....	\$158
• APL II+ Replacement Keyboard.....	\$ 38		
• APL II+ External Keyboard.....	\$ 79		
• APL II+ Functional, Numerical Keypad & Case.....	\$ 79		
• EPROM Writer Card.....	\$ 68		
• 2-80 CP/M CARD.....	\$ 38		
• GRAPPLER Compatible Printer Card.....	\$ 39		

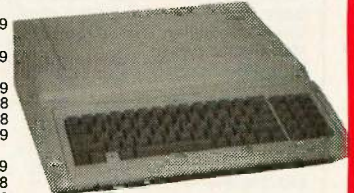

**2e CASE & KEYBOARD w/KEYPAD**

### MAIL TO BTE Computers, Inc.

14644 N. CAVE CREEK RD. #6 • PHOENIX, AZ. 85022

P.O. BOX 30705C • PHOENIX, AZ 85046-0705 • PHONE (602) 867-8962

MASTER CHARGE, VISA, AMEX, WELCOM, COD 3.9%, \$5.00 MINIMUM SHIPPING & HANDLING. NOT RESPONSIBLE FOR TYPOGRAPHICAL ERRORS. ALL PRODUCTS SUBJECT TO AVAILABILITY OR STOCK ON HAND. ALL PRICES ARE SUBJECT TO CHANGE WITHOUT NOTICE! ALL SALES ARE CASH DISCOUNT PRICES! REFUNDS ARE CREDITED ONLY.



# DARE TO COMPARE!

## IBM® PC/XT-COMPATIBLE COMPUTER SYSTEM

COMPARE OUR SYSTEM COMPONENTS TO OTHERS & SAVE!

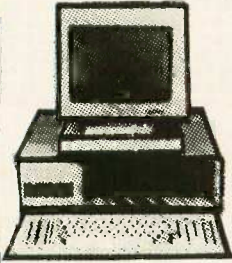

### OURS

- 25K Memory included
- 150-Watt Power Supply
- Monochrome Graphic Printer included
- Name-Brand Disk Drives such as TEAC & QUME
- MAGNAVOX High-Resolution TTL Monitor
- Full Warranty on all products: 1 yr. Warranty on boards, 2-yr. on MAGNAVOX monitors

### THEIRS

- Only 128K or OK
- 135-Watt unit
- w/o Graphics or Print capability
- Brand XYZ, "Mama-san," or worse
- Low resolution, no-name monitors
- 90-day Warranty (if you're lucky)

IBM PC-XT Type Case No. 90180.....	\$ 33.00
150-Watt Power Supply No. 90155.....	65.00
5150 IBM-Type Keyboard No. 90130.....	45.00
Mother Board expandable to 640K with 256K installed No. SPCL03.....	135.00
Monochrome Graphic Printer Board No. 99010.....	75.00
Floppy Controller Board No. 92260.....	29.00
2-Floppy Disc Drives at \$95 each No. 93140.....	190.00
12" TTL High Resolution Monitor by MAGNAVOX No. 96710.....	67.00
Complete with Instruction & Assembly Manuals.....	

### YOUR COST

**\$639<sup>00</sup>**

Any of these components may be purchased separately. All boards guaranteed for 1 year. IBM, PC/XT are trademarks of International Business Machines, Inc. Some assembly required.

### SmarTeam Modem

103/212A—Operates at 300 Baud & 1200 Baud  
 •Hayes Compatible  
 •Auto Answer, Dial & Redial  
 Uses RS 232-C Connector  
 No. 91990.....

**\$165.00**

### MAGNAVOX Color Monitor



- RGB High Resolution
- 14" diagonal
- 640 Dots/H-240 lines/80 column
- Built-in Tilt Stand

No. 97890.....

**\$318.00**

### Avatex 1200 Modem

- Auto Answer, Dial & Redial
- FCC Approved
- PC TALK III Software included
- Automatic Self Test on Power-Up

COMPARE AT \$199.00

No. 97070..... **\$87.00**

### Key Boards

- 5151 IBM Type Key Board Caps and Num Lock
- No. 51515..... **\$76.00**
- 5150M XT Key Board—looks like AT, has big return key & LED indicators
- No. 99020..... **\$59.00**

## ADD-ON BOARDS FOR IBM® COMPATIBLE SYSTEMS

### Monochrome Graphic Printer Board

- Built-in Parallel Printer Port •Text: 25 line x 80 column •Graphics: 720 x 348 resolution •TTL High Resolution Output

No. 92270..... **\$75.00**

### Multi I/O Card

- Built-in Floppy Controller that can drive 2 floppy drives •Two RS 232 Serial Adapters •Timer Port •Parallel Printer Port •Joystick Adapter

No. 96770..... **\$84.00**

### Multifunction Board

- Expandable to 384K RAM •Serial Port, Game Port •Parallel Printer Port •Clock Calendar w/Battery Backup •Software, Manuals and Cables

No. 92290..... **\$75.00**

### RS 232 Serial Board

- 1 Serial Port •2nd Port optional

No. 92310..... **\$27.00**

### Parallel Printer Card

- Also may be used as I/O Port

No. 92700..... **\$21.00**

### Color Graphics Board

- RGB and Composite Port •Light Pen Interface •Graphics: 320x200 (color); 640x200 (BW) •Text: 25x80

No. 92280..... **\$65.00**

### Floppy Disk Controller

- Drives 2 internal drives •Includes cable
- IBM PC compatible

No. 92260..... **\$29.00**

PLUS A HUGE SELECTION OF CABLES & ACCESSORIES!



### THE WHOLESALE OUTLET

DEPT. BY, 1 INTERSTATE AVENUE, ALBANY, NY 12205. To order call 1-800-344-4387 (Non-NYS Res.) or 518-459-7883 (NYS Res.) Personal and company checks accepted (on mail-in orders). Customer pays freight & handling FOB Albany, NY. Non-credit card orders shipped UPS, C.O.D. Minimum order \$25. Dealer and large quantity orders call 518-459-7883. Ask for Computer Dept. Some items not as pictured. Prices subject to change.

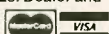

## ACCORDING TO WEBSTER

*Benchmarks that I ran on different mass storage devices showed an interesting correlation between speed and fragility.*

files already on the volume. Furthermore, when you open the folders on the DASCH, the icons inside are widely scattered, requiring (at least) a "Clean Up" command to get things straightened out. The clue seems to be in how the desktop file is created or restored. If you're doing a Restore command on the MacBottom, answer "yes" when it asks you if you want to update the desktop file. Of course, if you have folders already sitting on that volume, they'll end up being unnamed, and special icons may be lost. All in all, it points to some inadequacy in the utilities, the Mac operating system, or both.

### MASS STORAGE COMPARISONS

Just to compare the relative speeds of different mass storage devices, I ran a set of "benchmarks" consisting of performing typical user actions: copying a file, duplicating a file, opening an application, opening a document (by double-clicking it), and exiting back to the desktop. I used Microsoft Word (version 1.00), which fits the bill nicely because of its size and popularity. Note that all tests were run after having opened Word a few times, so that it no longer checked for the master disk.

The tests were run on a standard 512K-byte Mac, except for the internal RAM disk, which was run on a LeVco Monster Mac (2 megabytes) using Assimilation Process's Mac Memory Disk software. For that test, I sized the RAM disk so that only 512K bytes of application memory was left, so that there would not be an "unfair" advantage in copying files. All tests were run under Finder 4.1; both Macs had the old (64K-byte) ROMs and single-sided (400K-byte) drives. The hard disk was the 20-megabyte MacBottom, and the external RAM disk was the 1-megabyte DASCH.

Part of what made the timings so difficult was their variability. Generally, times tended to get better when they were repeated with few or no actions in between. For example, repeatedly opening a document, then exiting back to the desktop, tended to yield the best time for both actions. However, the times didn't always keep going down; they would occasionally jump back up by a second or two (or more).

A few interesting features of Word showed up as well. For example, the time to open Word on a two-drive floppy disk-based system is shown as 12.4 seconds. That was with disks in both drives. If I removed the disk from the

(continued)



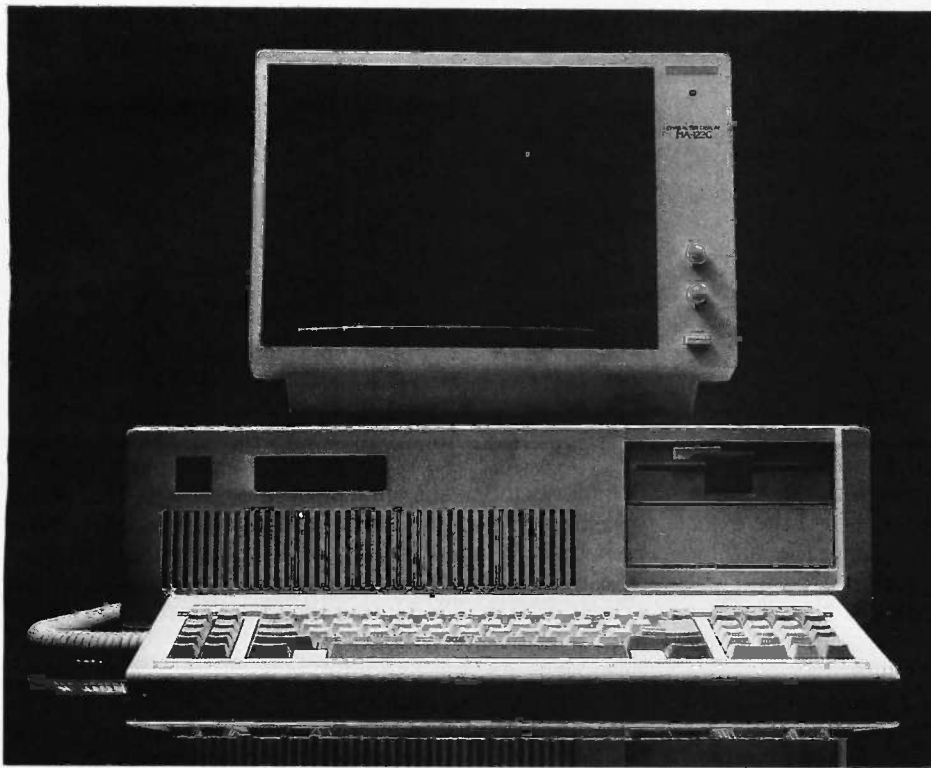

**THE  
MOST  
AFFORDABLE.**

**IBM AT<sup>®</sup>  
COMPATIBILITY  
40% FASTER  
QUANTUM<sup>™</sup>  
AT TURBO**

with

**20MB  
HARD DISK**

and

**FULL ONE  
YEAR  
WARRANTY**

**\$1995<sup>00</sup>**

call

**(714) 259-1127**

for

**QUANTITY  
DISCOUNTS**

**QUANTUM  
XT TURBO  
\$899<sup>00</sup>**

- 8088-2 Processor (CPU BOARD, MADE IN USA)
- 4.77-8 MHz speed switch selectable
- 256K expandable up to 1MB on board
- Two-360K Floppy Drives
- Mono or Color Graphics Card
- Hi-Res Mono Monitor
- Parallel Printer Port
- AT style keyboard
- Full (1) One Year Warranty

- 80286-8 Processor (CPU BOARD MADE IN USA)
- 6-8 MHz speed switch selectable
- 512K RAM expandable up to 2MB on board
- 1.2 MB Floppy
- 20 MB Hard Disk
- Parallel Printer Port on board
- 200 W. Power Supply
- AT style keyboard
- Fully assembled, tested and 48 hour burn-in.

**QUANTUM XT  
\$799<sup>00</sup>**

- 8088 Processor
- 256K expandable up to 640K on board
- Two 360K Floppy Drives
- Mono or Color Graphics Card
- Hi-Res Mono monitor
- Parallel Printer Port
- AT style keyboard
- Full (1) One Year Warranty

<input type="checkbox"/> 20 MB Hard Disk Sub System (Controller & Cable) . . . . .	\$ 465.00
<input type="checkbox"/> 20 MB Hard Disk (40MS) For AT . . . . .	\$ 650.00
<input type="checkbox"/> 33 MB Hard Disk Sub System (Controller & Cable) . . . . .	\$ 695.00
<input type="checkbox"/> 33 MB Hard Disk (40MS) For AT . . . . .	\$ 750.00
<input type="checkbox"/> 68 MB Hard Disk (25MB Voice Coil) . . . . .	\$1499.00
<input type="checkbox"/> 60 MB Tape Streamer Back Up . . . . .	\$ 899.00
<input type="checkbox"/> Mono or Color Graphics Card . . . . .	\$ 110.00
<input type="checkbox"/> 14" TTL Mono Monitor . . . . .	\$ 149.00
<input type="checkbox"/> 12" TTL Mono Monitor . . . . .	\$ 99.00

**AFTON COMPUTER INC.**

**24825 CALLE EL TORO GRANDE • EL TORO, CALIFORNIA 92630 • TELEPHONE (714) 259-1127**

Table 1: Some comparative times indicating relative performance of different types of mass storage on the Macintosh. The file used is Microsoft Word (version 1.00) and is 125K bytes. The document is the Memo file included on Word's master disk. The figures in parentheses are normalized times that tell you how much faster the internal RAM disk is than the other means of storage.

	Floppy Disk (single-sided)	Hard Disk (MacBottom)	External RAM Disk (DASCH)	Internal RAM Disk (Assimilation Process)
Copy File from Floppy	35.0	23.6	13.2	7.9
Duplicate File	16.9	9.2	4.3	0.7
Open File (application)	12.4	7.9	5.2	5.0
Open File (document)	23.6	10.6	6.8	6.4
Exit to Desktop	29.0	11.6	6.8	4.7
Combined Time (copy, open doc, exit)	87.6 (4.6)	45.8 (2.4)	26.8 (1.4)	19.0 (1.0)

external drive but left the drive connected, the time increased to 20.6 seconds. If I then disconnected the external drive, the time remained about the same (i.e., around 20.5 seconds). However, no such variation occurred with the other configurations, except that the time to open Word increased somewhat the first few times it was opened with disks in the drives. Strange.

The timings, found in table 1, confirm what you'd suspect: Internal RAM disks are faster than external RAM disks (though not by much), which are faster than hard disks, which are faster than regular floppies. The last row in the table—Combined Time—adds together the first, fourth, and fifth rows to give you a feeling for just how these time differences can accumulate.

The interesting correlation here is between speed and fragility. An internal RAM disk is the fastest form of mass storage, but it's also the most vulnerable. Files can be irreparably lost or damaged by power glitches, system crashes, or even programs that run amok. And, of course, if you turn the machine off without saving all your files to more permanent storage, they're gone for good. Some firms are developing software to preserve the contents of RAM in case of a system crash, allowing you to do a "warm" boot and still find the RAM disk and your files there, but that's no help against the other dangers.

External RAM disks shouldn't be affected by system crashes, rogue programs, or turning the computer off. Power glitches and outages can still cause a problem, though, unless the RAM disk has some sort of battery backup. As mentioned, the DASCH unit I have has no battery backup, though the folks at Western Automation claim to be working on one.

Hard disks shouldn't be affected by much of anything, but, unfortunately, they are. Power glitches at the wrong time (e.g., during a write operation) can cause problems, as can turning off the computer at the wrong moment. Physical shocks or movement can also affect them, causing the dreaded head crash, where the read/write head of the disk drive actually touches the surface of the disk itself. The MacBottom has some protection against both problems. The desktop Special menu has a Shut Down option

that moves the heads off the disk, then reboots the system; you should select this before turning the Mac off. I would be happier with a design that didn't require this shutdown step, but the MacBottom has survived power glitches and many power-downs without the Shut Down, so it doesn't appear to be overly sensitive in this area. As for shocks or movements, the under-the-Mac location does a great job of preventing accidental bumping or jostling.

Floppy disk drives are the heartiest form of mass storage (except, of course, for cassette tape, which we can safely ignore), least affected by crashes and other physical events. What few floppy disk problems I've had are related primarily to software (usually operating system) errors during reads and writes—and those will affect all forms of mass storage equally. Of course, the floppy disks themselves can be physically damaged, but the advent of the 3½-inch not-so-floppy disk has done much to eliminate those dangers. (A friend of mine, Matt Yuen, once put an address label and a stamp on a 3½-inch disk and dropped it in a mailbox. It arrived at its destination in working condition, with all data intact.)

So which is best for you? Well, that depends upon what you want and how much money you have to spend. These four options are not mutually exclusive; as I type this, the Mac at my left shows on its desktop three hard disk volumes, a floppy disk volume, and two RAM disk volumes, one internal and one external. My personal preference would be a 1- to 4-megabyte Mac with a 20-megabyte hard disk and running an internal RAM disk. On the other hand, if you have a lot of Macs in a network sharing a hard disk, giving each Mac an external RAM disk would improve performance of each workstation while reducing susceptibility to crashes and (with battery backup) power glitches or failures.

#### WRAP-UP

Next month, I will continue my attempt to catch up with the backlog of new products. I may also start a follow-up on last month's 68000 benchmarks, giving timings comparing different compilers on the same machine. But no promises. Until then, I'll see you on the bit stream. ■



(continued from page 24)

Let me describe some of the specific problems, such as the one with overlapping windows. This occurred specifically with small windows that had completely disappeared behind larger windows. There is an "under" menu selection to bring out hidden windows, but the mouse must be positioned over the hidden window, which is hard to do and rather frustrating. There are much better ways to do this. Overlapping windows represent sheets of paper lying on top of each other. The way one looks for hidden papers is to move the top papers. This suggests a simple solution: Move the top window to the bottom and thus uncover the hidden windows.

The window-frame moving algorithm follows the mouse while continuously flashing or painting the entire frame in white, which presents another problem. Since it takes a noticeable length of time to paint the frame, it is impossible for the system to follow the mouse with acceptable speed. The flashing effect is unpleasant, and in larger windows it deteriorates into nauseating waves of white. A simple rectangular outline is fast and adequate, as demonstrated by the Macintosh and

a number of other systems.

The Smalltalk-80 documentation is far from adequate. The system is not self-explanatory. Despite heavy use of the "explain" tools and the various books and manuals, figuring out what classes and their methods actually did was a frustrating experience.

On the other hand, the power and elegance of the documentation tools is quite impressive. Perhaps someone mistakenly thought that automatic documentation might make up for a lack of standard documentation. The fact is, Smalltalk requires documentation every bit as much as any other large system, and perhaps even more so because Smalltalk is dynamic. The Smalltalk books are excellent, but the nature of the system demands far more internal reference material.

I find it surprising that graphics are so little used for documentation. Smalltalk-80 suffers from a lack of graphics tools in general and is desperately in need of painting and drawing facilities along the lines of MacPaint and MacDraw. The existing paint facility is too slow and cumbersome for any significant work. With basic

graphics tools, it would be possible to add graphic documentation tools, which in turn would make high-quality internal documentation possible.

After years of work with various low- and high-level systems, I am quite used to working with poorly documented ones. There is no doubt that much of Smalltalk-80 is better documented than the average system. What is different, though, is the dramatic contrast in relative quality of various parts of the system. The text-oriented documentation tools are outstanding, but the documentation itself is poor. Smalltalk is a graphic system, but graphics are used only minimally for documentation. When a system has so many fine components, any flaws stand out. Smalltalk-80 did make me more productive; possibilities were opened that I would not have considered otherwise. Yet, I should have been even more productive. The flaws were so much in evidence that using Smalltalk was not the enjoyable experience it should have been. Such a system is unlikely to enjoy any significant success with a wider audience.

I. GANAPATHY

Vancouver, British Columbia, Canada ■

# Princeton Graphic Systems—the choice in PC monitors.

High resolution.  
Sharp, crisp text.  
Bright, vibrant colors.  
Full PC compatibility.  
Rugged dependability.  
We design our monitors to meet your most demanding computer needs.

From sophisticated business graphics to basic word processing, we make sure there's a Princeton monitor for you.



For the second year in a row, you've voted our high resolution HX-12 RGB color monitor the number one color monitor in the world.\* Thank you for your vote of confidence...

\* Results of PC World's "World Class PC Contest" for 1984 and 1985.





# This is all it takes to get IBM, Apple, Tandy, Macintosh and Compaq talking to each other.

And it's simple and inexpensive.

Now a powerful **GridNet™** Local Computer Communications Network is as close as your nearest electrical outlet.

Thanks to GridComm's Communicators, virtually any office can create its own high speed, error-free **GridNet™**... instantly! There's no need to purchase special system software. And there's none of the expense

and inconvenience of installing additional wiring. Because a **GridNet™** utilizes your existing electrical grid as a highly-effective data transmission medium.

And a **GridNet™** will support IBM PC, XT, AT, and all IBM compatibles, Apple and Macintosh, Hewlett-Packard, Tandy, AT&T, Epson, NEC... all the most popular micros and peripherals, in the

same network. Freely sharing data, with complete connectivity and effective compatibility.

The cost? As much as 60% below that of specially-wired systems.

Find out just how easy it is to increase your office's productivity. See your local dealer, or contact "The Great Communicator" for more information.



**THE GREAT COMMUNICATOR**

P.O. Box 2779, Danbury, Connecticut 06813-2779. For information call 203-790-9077

Trademarks: IBM, PC, XT, AT/International Business Machines Corp.—Apple, Macintosh/Apple Computer Inc.—Tandy/Tandy Corp.—Compaq/Compaq Computer Corp.—Hewlett-Packard/Hewlett-Packard Co.—Epson/Epson America Inc.—AT&T/American Telephone and Telegraph Co.—NEC/NEC Home Electronics (U.S.A.) Inc.

Inquiry 401



Conducted by Jerry Pournelle

## CREATIVITY OR STRUCTURE?

Dear Jerry,

I couldn't help writing after reading the letter to you in the March BYTE ("Language," page 293). As best I can tell, David Suits and you share the view that the balance between creativity and structure in programming leans more toward creativity than structure. Both of you seem to find that structure is at least as much of a burden as it is an aid. Truly, with no offense intended, this makes no sense to me—and I suspect at least a few others feel the same. After some thought, I think I have the real answer to the creativity/structure debate.

When I read the letter, I considered how I might make the light of reason dawn on both of you. Now I am sure that I cannot.

I am convinced that my best arguments in favor of structure (as embodied in my favorite language, Modula-2) would make only a little sense to you. It could not make sense because I claim that structured programming provides exactly those benefits Mr. Suits claims for his approach.

There must be at least two different kinds of programmers in the world. I don't mean good ones and bad ones. The difference is not one of skill, but of approach. Some prefer a structured approach, and some prefer a fluid approach. Since I find the structured approach the only reasonable way to program, I cannot imagine why anyone would willingly suffer under the anarchy of fluid programming. No doubt, I seem to Mr. Suits to be willing to go through my programming life wearing

the straitjacket of structure. (I refer to David Suits because I have his letter before me, although I also remember your article ("Come to the Faire," July 1985).

I think I see this difference between our two camps most strongly in Mr. Suits's use of the term *uncreative* to describe those of us who thrive on the structure of Pascal and Modula-2. I resented the use of such a pejorative term when I first read it, but I suddenly realized that I was thinking of equally pejorative terms to describe the approach to programming that Mr. Suits advocates. I think we're dealing with a relative issue here.

I'm not alone in thinking the only *real* way to program requires structure. I work with people who love Modula-2. To us, the

(continued)

# Princeton monitors set the pace.

To become a leader, you've got to keep ahead of the crowd. At Princeton, we set the pace. We delivered a color monitor for the IBM PC before IBM. And continue with a full line of state-of-the-art quality monitors. Monitors that deliver the features you demand.

## High resolution. Sharp, crisp characters. Bright, colorful graphics.

Take a close look at a Princeton monitor. You'll see the sharp, crisp characters and fully formed graphics that make our monitors stand out against the competition.

Add to it a fine dot pitch. A nonglare screen. Our flicker free technology. And you've got an image that makes you more productive, less fatigued.

**Easy to use.** Our monitors are compatible with the leading brands of personal computers. IBM™, Compaq™ and more. But we go one step further. By paying close attention to ergonomic detail, we make monitors compatible with you.



## Dependability.

You can count on Princeton monitors when you need them. They're rigorously engineered and manufactured under the highest quality control standards. Backed by a full one-year warranty. Supported by a nationwide service network. The result: monitors you can depend on.

Princeton's HX-12E gives you brilliant 64-color displays and extra sharp text.



## Bringing you the future.

Princeton continues to set the industry pace with products like our HX-12E, the first IBM-compatible high resolution RGB color monitor with a .28mm dot pitch to support IBM's Enhanced Graphics Adapter. And our SR-12P, the first IBM-compatible analog color monitor, with a .26mm dot pitch to support IBM's Professional Graphics Controller...



# Buy The New Toshiba P351C. Get Microsoft® Chart Free.



Introducing a P351 that will make you look great in black and white *and* in color—P351C.

It sells for only \$150 more than the industry's best selling full-function dot matrix printer, our own P351.

Toshiba 3-in-One printing means striking letter quality text, high speed drafts, and graphics that make your message *crisp and clear*.

Like the P351, the P351C is very compatible, gives you a 24-pin printhead, and our 200,000,000-character printhead life—the most reliable printer you can buy.

And if you buy before September 30, 1986, you get Microsoft Chart version 2.01, for free.

Microsoft Chart makes it easy to create a variety of commanding graphics. And Toshiba gives you the persuasive power of *color*. You'll be printing high-quality

presentations, business graphics and overhead transparencies in no time.

Microsoft Chart is just part of a terrific \$350 value Start Up Kit, which also includes ribbon, overhead transparency sheets, and handy starter guides. All *free* if you buy the P351C before September 30, 1986.

Act now. Call for the name of your nearest Toshiba printer dealer. See this great new printer. And take advantage of this great offer fast. Microsoft is a registered trademark of Microsoft Corporation.

## Call 1-800-457-7777.

In Touch with Tomorrow

# TOSHIBA

TOSHIBA AMERICA, INC., Information Systems Division





structure built into Modula-2 lets us express our creative ideas more quickly, make modifications more easily, and avoid details that detract from the problem at hand. David Suits (and the people who feel as he does) expresses exactly the opposite experience when working in a highly structured language.

I'm almost sure that this is a never-the-twin-shall-meet issue. The only remaining question is to decide whether it's a matter of nature or nurture. (This could take a few hundred years!)

I want to go on record as coming down on the nature side: I think preferences in approach to programming are due to temperament more than to whatever traditions are passed down to us or the long-term consequences of first experiences. I first learned BASIC and then dabbled in FORTRAN. My first experience with ALGOL was a great relief; I had found the language I'd been wanting all along without knowing it. Now, although I get along all right in Pascal, I like Modula-2 best.

It is possible that appreciating structure is an acquired taste and that enough experience with it might change the mind of some of Mr. Suits's camp. This is the

common assumption of people in the structure camp, but I suspect they may be dead wrong. Proponents of both camps may be speaking only to those who already agree with them.

For instance, in the March issue you say you still use BASIC for much of your work in spite of expressing an affinity for Modula-2. I have a friend who may be a more extreme case, he programs in BASIC and then converts to Pascal. BASIC is his working language, but he likes the speed of Pascal. My friend also finds Modula-2 attractive, but he plans to continue developing in BASIC and then translating into some other language.

I simply could not function that way. I would not dream of using BASIC for more than 25 or 30 lines of code (and would prefer to never be stuck with using it). I just can't follow BASIC. Unlike you, I would never choose BASIC over Modula-2. Although I am willing to allow that other factors are involved, part of that difference in the way you and I operate seems to be a matter of temperament. You and I both profess a liking for Modula-2, but that liking means quite different things to the two of us.

By the way, I think the analogy to the writing process that you presented in July 1985 ("How Do We Really Do It?" page 322) was quite apt. I didn't agree with the conclusions you drew with regard to programming; now that I think about it, I don't approach writing in the way you described either. (Writing is my profession, too.)

It seems clear to me that different approaches to programming can be attributed (at least in part) to temperament. This suggests that particular programming languages are best suited to particular programmers, not to programming per se.

JOHN M. CRAIG  
 Technical Support Specialist  
 Modula Corporation  
 Provo, UT

*You've misunderstood, which is probably my fault. First: I don't do much programming any longer. I'd very much like to, and now that I'm not fleeing carpenters every couple of days, I may have time to; but until then, any programs I do are very much in the quick-and-dirty category. Often they can be tacked onto a structure I've already written; and since*

(continued)

# Princeton outperforms the industry.



Only Princeton delivers the outstanding price/performance value you've come to expect from an international monitor company.

When we set out to design a Princeton Graphic Systems monitor we do it right. We

combine advanced technology (like a fine dot pitch) with

modern ergonomics (like a nonglare screen) for a superior performance monitor.

We build them with quality components to work day in and day out, even in the toughest conditions.

**We're looking better and better.**

Your support during 1985 enabled Princeton to grow three times faster than the personal computer industry as a whole. Our installed base of high resolution monitors in this segment alone grew beyond a quarter of a million...



those are mostly in CBASIC, I can either take time off to convert everything to Modula-2 or continue with CBASIC. I haven't time to make the conversions. I very much wish I did.

Second: it's only recently that there have been implementations of Modula-2 that provided an endurable programming environment. When I had the Lilith here—alas, your company has reclaimed it—it was a snap to do programming in Modula-2. Given that kind of environment where the machine manages all the gory details, you can be quite creative; but, alas, most people in the micro world find that structured programming requires that we keep track of some pretty onerous details by hand.

Lately I find myself more a moderator than a participant in language debates. Programming is fun, and I try to keep track of what's going on. But until I have more time, I'm likely to remain a moderator. Alas.—Jerry

### CAVEAT EMTOR

Dear Jerry,

The trouble with Pournelle's law (February Chaos Manor Mail, "Know Your Dealer," page 315) is the assumption that the average home computer buyer can find a vendor whose staff knows anything about computers, much less a vendor with more expertise than the purchaser. The industry may have been started by hobbyists who understood every solder joint, but it has long since been taken over by business types whose idea of "long term" is 90 days and whose idea of "technical" is the copious use of buzzwords (note that I said use, not understanding!). The industry is now dominated by mass merchandising operators, many of whom are snake oil salesmen. So even if you find a store with knowledgeable personnel, you may have serious problems.

My advice to a new buyer is to adopt an attitude of caveat emptor. More concretely, do all the following:

Learn about the hardware and software before you do anything rash.

If you somehow find an honest and competent dealer, stick with that dealer; it's cheaper than mail order in the long run.

Pay by credit card (*not* debit card); this will give you certain legal rights you will not have if you pay by check or cash. If you can arrange for the purchase to be legally considered a mail-order transaction, you can get the USPS to help you if you are sold a lemon.

If you don't have a trustworthy dealer, order from the cheapest source you can find: You probably won't get any meaningful support anyway. The well-known and high-priced manufacturer will swindle you on service as cold-bloodedly as anyone else. But forget the Brand X product that is not serviced by any independents.

Read the instructions. Follow them, even if you know "shortcuts." You can always burn out your motherboard later, if the need arises.

Order all available documentation. Yes, I know it's expensive; so is not having it when you need it!

If a dealer proposes a package, ask for a demonstration that will show if all the pieces work together. If the dealer starts to tell you that the "ABC 666" monitor is "just the same" as the "XYZ 456," that "I don't have this but do have that," that a certain printer is equivalent to another, or tries any other substitution, walk out. If you don't, you will learn more than you ever wanted to know about the Tower of Babel.

Ask somebody who owns one, especially if that person is dissatisfied. Get into a BBS and ask about skeletons in the closet.

Find out what the vendor means by "compatible"; it may not be what you mean.

Get it in writing. Make sure that you include all representations made by the dealer and that you specify both a full refund and a penalty for delay. But don't expect the dealer to stand behind claims made by the manufacturer: The dealer can't afford to and has no control over the manufacturer's flackery anyway.

Don't buy any copy-protected software. It will interfere with backup; it will cause you problems if you go to a faster machine, a faster disk, or a faster clock on the same machine. It may even give you grief just for installing a new version of your operating system.

Beware of terms like "high-res": They are just so much snake oil. In practice, "high-res" means "the resolution offered by what I am pitching." Metz's law states: "If it's really high-res, the manufacturer will tell you what the resolution is; if numbers aren't given, the manufacturer is ashamed of them." Practically, anything less than 640 by 200 in color or 720 by 350 in monochrome is suitable only for masochists.

Consider your intended use, then evaluate the trade-offs of resolution versus number of colors versus speed. Also consider the relative importance of horizontal and vertical resolution for your application.

Don't equate a requirement with a proposed solution. For instance, you do not require a mouse, but you may require the ability to point at data and to drag it around the screen. A mouse is a solution, but so are other methods. Identify all solutions, then select the one that best fits your needs and budget. The first solution proposed by a vendor will be the one that best achieves the vendor's objectives.

(continued)

## NEW! DEVELOPMENT SYSTEM

Value-rich, low-cost **UniLab II Universal Development Laboratory** turns your IBM PC or look-alike into a complete Development System. Supports more than 120 microprocessor types!



Up to 128K bytes of EMULATION ROM allows you to make program patches instantly. Since the target ROM socket connects data and address lines to both the analyzer and the emulator, no expensive adaptors or personality modules are needed.

The powerful BUS STATE ANALYZER features four-step sequential triggering, selective trace, and pass and delay counters. Symbolic trace disassemblers and debuggers are available for Z-80, 8048, 6500, 6800, 8031, 8085, Z-8, 1802, 8088/80188, 8086/80186, 68000 & more!

Bonus! Built-in PROM PROGRAMMER and STIMULUS GENERATOR. Call today, toll free 1-(800) 254-8500 or (415) 361-8883 (in CA)

**ORION** Instruments 702 Marshall Street Redwood City, CA 94063 USA



# Princeton is the best choice in PC monitors.

When you're looking for a personal computer monitor, look at Princeton Graphic Systems. Our growing family of high quality personal computer monitors delivers compatibility, brilliant colors, high resolution, and dependability. Whether you're designing sophisti-

cated business graphics or number-crunching a financial spreadsheet. That's why Princeton is number one in the minds of more

and more personal computer owners every year.

For the very best in PC monitors, the choice is clear: Pick the company that's at the top. Princeton Graphic Systems.



**HX-12E.** Our EGA-compatible monitor gives you 64 vivid colors. Extra sharp text and graphic displays. The finest dot pitch (.28mm) of any IBM-compatible enhanced monitor. Nonglare screen. Fully compatible with IBM's™ Enhanced Graphics Adapter (or equivalents).

**SR-12P.** Top-of-the-line analog color monitor features ultra high resolution (640 x 480), 4,096 colors for superb graphics. The finest dot pitch (.26mm) of any PGC-compatible monitor. Laminated nonglare panel.

**HX-12.** High resolution RGB color monitor with .31mm dot pitch gives you better graphics, better text than IBM's Color Monitor (5153). Nonglare screen. Voted "Best In the World" two years running in *PC World's* "World Class PC Contest".

**SR-12.** Super high resolution RGB monitor with a .31mm dot pitch. Compatible with Sigma Designs Color 400 board and others. Gives you 400 lines of resolution. Nonglare screen.

**MAX-12.** High resolution amber monitor. When used with an IBM-compatible monochrome adapter delivers 720 x 350 resolution. With an IBM-compatible color adapter, 640 x 200 resolution with 15 shades of amber. The monitor automatically adjusts to either card.

**HX-9/HX-9E.** Compact nine-inch high resolution RGB monitor. Perfect for workstations where space is at a premium. Both feature a .28 dot pitch and an etched dark glass screen. Ergonomic features like a built-in tilt/swivel base, nonglare screen, and a built-in green/amber switch. HX-9E is compatible with IBM's EGA (or equivalents).

All monitors come with free data and power cables.

Visit your local computer store today and ask about our full line of high resolution color and monochrome monitors. Monitors that live up to the Princeton Graphic Systems tradition of quality, performance, and value.

Princeton Graphic Systems, 601 Ewing Street, Bldg. A, Princeton, NJ 08540; (609) 683-1660; TLX 821402PGSPRIN; (800) 221-1490, ext. 104.

IBM is a trademark of International Business Machines, Inc. Color 400 is a trademark of Sigma Designs, Inc. QuadEGA+ is a trademark of Quadram Corp. Compaq is a trademark of Compaq Computer Corp.

**PRINCETON**<sup>®</sup>  
GRAPHIC SYSTEMS  
AN INTELLIGENT SYSTEMS COMPANY



# He who travels much appreciates daily service.

You don't need an ancient proverb to know daily service is important to business travelers.

That's why United offers daily service to Tokyo, Hong Kong, Osaka, and Sydney from more top business centers than any other airline.

And United offers daily nonstop service to Tokyo from five U.S. gateways.

You'll enjoy all the convenience of one-airline service from Tokyo to Seoul, Manila,

Singapore, Bangkok, Beijing and Shanghai.

And now, Mileage Plus offers a 50% bonus in First Class, a 25% bonus in Business Class and several other generous Royal Pacific mileage bonuses.

United's Royal Pacific Service. Call your Travel Agent. Or call United.

*You're not just flying,  
you're flying the friendly skies.*

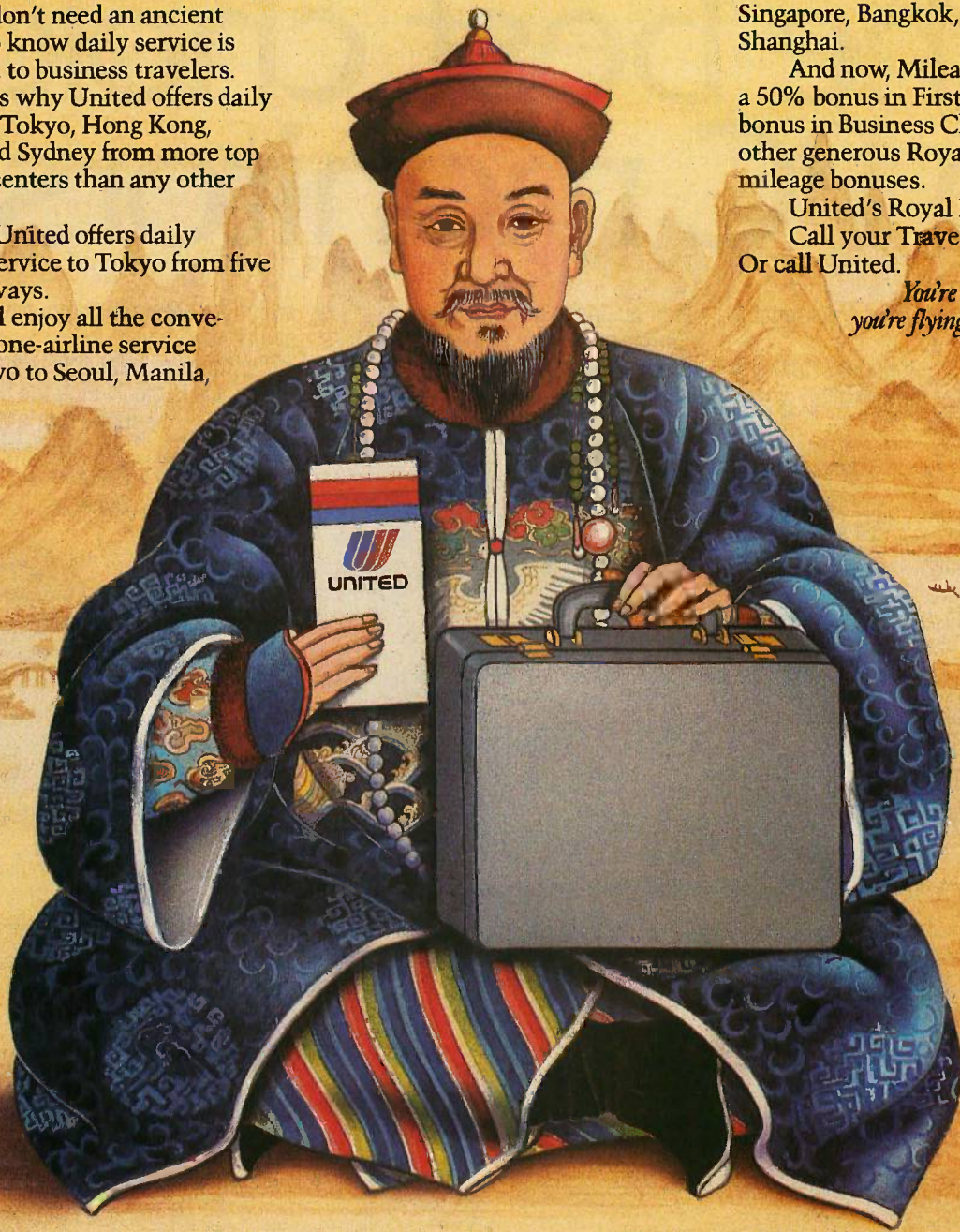

*fly  
the friendly  
skies.*



# United



CHAOS MANOR

which may not be compatible with yours. Once you have your system, get in the habit of backing up disks.

SEYMOUR J. METZ  
Annandale, VA

Well—there are still some dealers who understand what they're doing; as you say, if you find one, it's worth a lot to keep that dealer. But recall that Pournelle's law says: "If you don't know what you're doing, deal only with people who do." It doesn't condemn you to perpetual ignorance.

It's still a good idea to learn something about these little machines. It's fun, too. —Jerry

P-SYSTEM

Dear Jerry,

I've read BYTE for years and love it; I've read your column since it started and loved it. Yes, loved it, because today I read that the p-System is "the original user-hostile operating system." Never! It may be unconventional—after all, a prompt line that shows you all the possible options at any stage is not like CP/M's or MS-DOS's wonderfully user-friendly A> prompt. After all, the standard p-System screen editor isn't at all like those with 574 different keystrokes, and it does work well with both free text and programs, and it does leave the cursor at a syntax error (optionally, not compulsorily). Different—yes; user-hostile—never! You praise MOSYS, but its editor is reported to have many shortcomings.

Finally, at \$79.95 (available from Pecan), the UCSD p-System with compiler, editor, and native code generator (with 8087 and BCD support) should have been named product of the month.

STUART A. BELL  
Cambridge, United Kingdom

Surely you are not so fickle as to abandon me after all this time? I do agree: with the new price and, more important, the new support provided by Pecan, p-System is quite a bargain.

As to its hostility, I remain unrepentant. The problem with p-System is that it's thoroughly menu-driven; and while that does give you lots of on-screen prompts, it also makes you go around red robin's barn to get anything so simple as a directory. Indeed: it's the problems I have getting a directory (call the filer; specify devices by number, and the device number is never intuitive) that caused me to neglect p-System. You will note, though, that I always try to point out that a lot of people do love it, and they're not all masochists. —Jerry ■

## SONY

<p><b>3 1/2"</b> <b>SINGLE-SIDE</b> <b>14<sup>95</sup></b></p> <p><b>DOUBLE-SIDE</b> <b>22<sup>95</sup></b></p>	<p><b>5 1/4"</b> <b>HIGH DENSITY</b> <b>23<sup>95</sup></b></p> <p><b>VIDEO CASSETTES</b> <b>4<sup>69</sup></b></p>
---	---

Old Reliable **Delaware 1-800-451-1849**  
**Diskette Connection** **Oklahoma 1-800-654-4058**  
**Nevada 1-800-621-6221**

TERMS: Minimum 20 disks or \$35.00 — VISA or MasterCard accepted. COD orders add 2% for special handling. SHIPPING: 3 1/2" 5 1/4" Diskettes; Add 3% for every 100 Diskettes or any fraction thereof. 8" Diskettes; Add 4% for every 100 Diskettes or any fraction thereof. We ship UPS; orders requiring other delivery methods add shipping plus 2% of total order.

## DISKETTES

**FACTORY SEALED IN PACKS OF TEN, WITH TYVEK SLEEVE, ID LABEL & WRITE PROTECT TABS. "LIFETIME WARRANTY"**  
(No Manufacture Label or Pretty Box)

Single Side Double Density	Double Side Double Density
-------------------------------	-------------------------------

**.53 ea.** (MIN. 50) **.64 ea.**

Manufactured 100% by one of the BIG BOYS. IF you need a good Disk this is it. IF you need a name, we call them GOOD.

Old Reliable **Delaware 1-800-451-1849**  
**Diskette Connection** **Oklahoma 1-800-654-4058**  
**Nevada 1-800-621-6221**

TERMS: Minimum 50 Diskettes. — VISA or MasterCard accepted. COD orders add 2% for special handling. SHIPPING: 5 1/4" Diskettes; Add 3% for every 100 Diskettes or any fraction thereof. We ship UPS; orders requiring other delivery methods add shipping plus 2% of total order.

**Dysan**  
LIFETIME WARRANTY CORPORATION

<p><b>5 1/4" DISKS</b></p> <p>S-Side D-Den. <b>13<sup>95</sup></b></p> <p>D-Side D-Den. <b>17<sup>95</sup></b></p> <p>S-Side 96tpi <b>20<sup>95</sup></b></p> <p>D-Side 96tpi <b>25<sup>95</sup></b></p> <p>HIGH DEN. <b>30<sup>95</sup></b></p>	<p><b>3 1/2" DISKS</b></p> <p>S-Side D-Side <b>20<sup>95</sup>   25<sup>95</sup></b></p> <p><b>8" DISKS</b></p> <p>S-Side S-Den. <b>17<sup>95</sup></b></p> <p>S-Side D-Den. <b>19<sup>95</sup></b></p> <p>D-Side D-Den. <b>22<sup>95</sup></b></p>	<p><b>Dysan</b> <small>Interrogator</small></p> <p style="font-size: 2em;"><b>105<sup>00</sup></b></p> <p>Add 3% Shipping <b>PHONEIX</b> 16meg. CART.</p> <p><b>145<sup>00</sup></b> <small>error free</small> Add 6% Shipping</p>
--	---	--

Old Reliable **Delaware 1-800-451-1849**  
**Diskette Connection** **Oklahoma 1-800-654-4058**  
**Nevada 1-800-621-6221**

TERMS: Minimum 20 disks or \$35.00 — VISA or MasterCard accepted. COD orders add 2% for special handling. SHIPPING: 3 1/2" 5 1/4" Diskettes; Add 3% for every 100 Diskettes or any fraction thereof. 8" Diskettes; Add 4% for every 100 Diskettes or any fraction thereof. We ship UPS; orders requiring other delivery methods add shipping plus 2% of total order.

**3M**  
LIFETIME WARRANTY diskettes

<p><b>5 1/4" Disks</b></p> <p>S-Side D-Den. <b>7<sup>95</sup></b> <small>min 40</small></p> <p>D-Side D-Den. <b>11<sup>95</sup></b></p> <p>S-Side 96tpi <b>16<sup>45</sup></b></p> <p>D-Side 96tpi <b>19<sup>95</sup></b></p> <p>HIGH Den. <b>23<sup>95</sup></b></p>	<p><b>8" Disks</b></p> <p>S-Side S-Den. <b>15<sup>95</sup></b></p> <p>S-Side D-Den. <b>19<sup>45</sup></b></p> <p>D-Side D-Den. <b>20<sup>95</sup></b></p>	<p><b>3 1/2" Disks</b></p> <p>S-Side 135tpi <b>16<sup>55</sup></b></p> <p>D-Side 135tpi <b>22<sup>95</sup></b></p> <p>Data Cartridges DC100A DC300A DC300XL DC600A DC1000</p>
---	--	---

Old Reliable **Delaware 1-800-451-1849**  
**Diskette Connection** **Oklahoma 1-800-654-4058**  
**Nevada 1-800-621-6221**

TERMS: Minimum 20 disks or \$35.00 — VISA or MasterCard accepted. COD orders add 2% for special handling. SHIPPING: 3 1/2" 5 1/4" Diskettes; Add 3% for every 100 Diskettes or any fraction thereof. 8" Diskettes; Add 4% for every 100 Diskettes or any fraction thereof. We ship UPS; orders requiring other delivery methods add shipping plus 2% of total order.

**maxell**  
FLOPPY DISKS

**LIFETIME WARRANTY**

<p><b>5 1/4" Disks</b></p> <p>S-Side D-Den. <b>7<sup>95</sup></b> <small>min 40</small></p> <p>D-Side D-Den. <b>11<sup>95</sup></b></p> <p>S-Side 96tpi <b>16<sup>95</sup></b></p> <p>D-Side 96tpi <b>19<sup>95</sup></b></p> <p>HIGH Den. <b>23<sup>95</sup></b></p>	<p><b>3 1/2" Disks</b></p> <p>S-Side 135tpi <b>14<sup>95</sup></b></p> <p>D-Side 135tpi <b>22<sup>95</sup></b></p> <p><b>8" Disks</b></p> <p>S-Side D-Den. <b>19<sup>95</sup></b></p> <p>D-Side D-Den. <b>21<sup>95</sup></b></p>
---	---

Old Reliable **Delaware 1-800-451-1849**  
**Diskette Connection** **Oklahoma 1-800-654-4058**  
**Nevada 1-800-621-6221**

TERMS: Minimum 20 disks or \$35.00 — VISA or MasterCard accepted. COD orders add 2% for special handling. SHIPPING: 3 1/2" 5 1/4" Diskettes; Add 3% for every 100 Diskettes or any fraction thereof. 8" Diskettes; Add 4% for every 100 Diskettes or any fraction thereof. We ship UPS; orders requiring other delivery methods add shipping plus 2% of total order.

**Verbatim**  
LIFETIME WARRANTY DataLife

**SUPER QUALITY**

<p><b>5 1/4"</b></p> <p>S-Side D-Den. <b>7<sup>95</sup></b> <small>min 40</small></p> <p>D-Side D-Den. <b>11<sup>95</sup></b></p> <p>S-Side 96tpi <b>16<sup>95</sup></b></p> <p>D-Side 96tpi <b>19<sup>95</sup></b></p> <p>HIGH DEN <b>23<sup>95</sup></b></p>	<p><b>8"</b></p> <p>S-Side S-Den. <b>15<sup>95</sup></b></p> <p>S-Side D-Den. <b>18<sup>95</sup></b></p> <p>D-Side D-Den. <b>20<sup>95</sup></b></p>	<p><b>3 1/2"</b></p> <p>S-Side D-Side <b>15<sup>95</sup>   22<sup>95</sup></b></p> <p><b>HEAD CLEANERS</b></p> <p>5 1/4" Kit — <b>4<sup>75</sup></b></p> <p>5 1/4" Refills — <b>7<sup>00</sup></b></p> <p>8" Kits — <b>5<sup>05</sup></b></p> <p>8" Refills — <b>8<sup>00</sup></b></p>
--	--	---

Old Reliable **Delaware 1-800-451-1849**  
**Diskette Connection** **Oklahoma 1-800-654-4058**  
**Nevada 1-800-621-6221**

TERMS: Minimum 20 disks or \$35.00 — VISA or MasterCard accepted. COD orders add 2% for special handling. SHIPPING: 3 1/2" 5 1/4" Diskettes; Add 3% for every 100 Diskettes or any fraction thereof. 8" Diskettes; Add 4% for every 100 Diskettes or any fraction thereof. We ship UPS; orders requiring other delivery methods add shipping plus 2% of total order.

# McGraw-Hill introduces the affordable solution to the 640K limit.

New!

Why spend more than \$700 for an expanded memory board with 256K and new software versions that may be incompatible with your current software?

MAXIT™ is a 256K memory board, with software, that works above or below 640K to increase memory for 1-2-3® 1A and other popular memory-intensive programs, and allows RAM-resident and custom programs to run above 640K.

It's priced at an affordable \$195.

With MAXIT, you don't have to buy new software versions like 1-2-3 Release 2.

No matter how much memory your computer has now — even 512K or 640K — MAXIT can increase available memory.

It can work above 640K, using memory

that was reserved for the operating system but isn't being used.

MAXIT software adds memory above 640K to DOS, and enables 1-2-3 1A, memory-resident software, or custom programs to use it.

And if you already have software that works with expanded memory, you can use MAXIT's special driver software. It emulates costly expanded memory boards — giving you increased power at a fraction of the cost.

MAXIT works on the IBM PC, XT, the Portable PC, and many compatibles. It requires DOS 2.0 or above.

MAXIT works on the IBM PC AT, too. It fills out the AT's memory from 512K to 640K, and even goes beyond that.

MAXIT includes a 256K parity-checked memory card that uses the latest technology. It's a half-size card, too, so you can use it in a short XT slot.

Installation is a snap. Just follow the instructions in the illustrated Owner's Manual. The menu-driven setup software also gives you screen prompts. And if you have questions, our customer service department will answer them fast.

Once installed, MAXIT loads automatically. You don't have to learn a single new command to use it to its fullest.

Get the affordable solution to your PC's memory crisis. We've made it easy. Order MAXIT today by calling our toll-free number: 1-800-221-8439. (In Texas, call 1-214-437-7411.)

We accept VISA, MasterCard, American Express, and Diners Club cards.

Or order by writing to: McGraw-Hill CCIG Software, 8111 LBJ Freeway, Dallas, Texas 75251.

MAXIT is just \$195 plus \$4.00 shipping (\$12.00 outside the U.S.) and applicable state sales tax.

Be sure to include credit card number and expiration date with mail orders. Orders paid

by check are subject to delay.

MAXIT is covered by a 30-day money-back guarantee and a one-year warranty.

## 1-800-221-8439

(In Texas 1-214-437-7411)

**McGraw-Hill CCIG  
Software**

8111 LBJ Freeway, Dallas, Texas 75251

MAXIT is a trademark of McGraw-Hill CCIG Software. IBM is a registered trademark of International Business Machines Corporation. 1-2-3 is a registered trademark of Lotus Development Corporation.



**\$195**



THE BEST OF BIX is a selection of the most interesting messages from BIX, the BYTE Information Exchange conferencing system. The conferences covered for this month include those for the Commodore Amiga, Atari 520ST and 1040ST, the IBM PC family and compatibles, and the Macintosh computers. These pages represent only a small fraction of the material discussed in these conferences.

For information on joining BIX, see the instructions on page 336.

# AMIGA

The highlights of the Amiga conference this month include a benchmark comparison of two popular C compilers for the Amiga, 68020 upgrade VMEbus adapters, and GenLock and LIVE! digitizers.

Bugs and Fixes includes discussion of Amiga ABasiC speech functions, Alink linker improvements, disk "hashchain" tables, and more about the terminal program MaxiComm. Bugs and Fixes concludes with a short tutorial on Tymnet log-on procedures and file chopping, and the author of the Aegis Animator describes a minor glitch.

## COMPILER BENCHMARKS

amiga/product.dcsn #706, from ricks [Rick Schaeffer]

Benchmarks for Aztec C versus Lattice C Compilers  
Well, I finally got my Aztec C compiler! Of course, the first thing I did was run a whole series of benchmarks to compare it with my Lattice C compiler. Since there's been so much interest in Lattice vs. Aztec, I ran

all the benchmarks I could get my hands on and made up the table below for anyone else who is interested.

The rules under which the benchmarks were run were as follows: First, I used the default selections of both compilers as far as compile-time options go, since I wanted to compare "apples to apples" as much as possible. The Aztec compiler comes set up to take advantage of RAM disk during compiles, so I used the "cc2" program with Lattice (which I've modified to, likewise, take advantage of RAM disk for temporary files).

The Aztec C compiler automatically runs all passes of its compiler; cc2 does the same thing except it costs time to load cc2 itself, so I ran cc2 from RAM disk, again attempting to compare apples to apples. Compile times and link times were timed with a stopwatch, and time was measured from hitting Return after typing the command line to seeing the CLI prompt after the compile completed.

Run time was obtained by calls to the AmigaDos Current\_Time function. The source code for all the programs except the Dhrystone program was obtained from the November 1985 BYTE. The source code for the Dhrystone program was obtained from the CompuServe Amiga Forum database. A large comment header was removed from the Dhrystone program. Other than that, the programs were entered verbatim as published in BYTE except for the timing routines, which were for the Macintosh. I modified these to work with the Amiga.

The Aztec compiler, by default, generates code that uses 16-bit integers, and the Lattice compiler uses 32-bit integers. However, the Aztec compiler has a compile-time switch that causes it to use 32-bit integers, and there is a set of 32-bit libraries supplied with which to link such a program.

(continued)

Benchmark Results (seconds):								
	Frame	Intmath	Pointer	Qsort	Sieve	Float	Fib	Dhrystone
<b>Compile</b>								
Aztec(16)	21.44	26.58	23.29	27.07	24.70	26.07	23.67	36.26
Lattice	44.16	61.42	45.00	70.74	76.60	48.03	45.49	68.46
Aztec(32)	23.48	26.19	23.96	26.78	26.01	25.23	23.74	35.14
<b>Link</b>								
Aztec(16)	33.95	33.47	33.97	43.79	39.11	38.92	31.52	42.64
Lattice	112.34	109.79	111.73	112.00	116.49	114.34	115.35	112.64
Aztec(32)	35.52	30.64	33.64	41.86	40.49	38.42	32.99	39.47
<b>Executable Module Size (no register variables)</b>								
Aztec(16)	5012	5532	4996	9504	13432	5428	5124	6488
Lattice	13470	14108	13712	18224	22216	14336	13876	16040
Aztec(32)	5212	5772	5196	9684	13640	5628	5328	6812
<b>Executable Module Size (with register variables)</b>								
Aztec(16)	5012	5252	4988	9448	13380	N/A	N/A	6328
Lattice	13744	14088	13704	18204	22184	N/A	N/A	15996
Aztec(32)	5208	5488	5184	9628	13588	N/A	N/A	6644
<b>Run Time (no register variables)</b>						<b>(Dhrystone in Dhrystones/second)</b>		
Aztec(16)	0.00	4.34	19.77	55.23	4.80	15.90	19.55	1000
Lattice	0.10	21.77	16.85	56.40	5.96	118.32	22.70	454
Aztec(32)	0.10	9.82	19.88	61.55	5.87	15.90	22.59	704
<b>Run Time (with register variables)</b>						<b>(Dhrystone in Dhrystones/second)</b>		
Aztec(16)	0.00	2.70	10.54	42.00	2.68	N/A	N/A	1041
Lattice	0.00	21.40	10.53	44.60	3.98	N/A	N/A	462
Aztec(32)	0.00	7.38	10.51	42.95	3.28	N/A	N/A	769

Therefore, I ran the benchmarks twice for the Aztec compiler: once with the default of 16-bit integers and again with the 32-bit option and libraries selected. All timings are in seconds and hundredths except the run time for the Dhrystone benchmark, which is in Dhrystones per second. I did not include timings for compile and link of the register variables versions of the benchmarks. They were insignificantly different from the times shown, which are for the nonregister versions.

A couple of notes about these timings:

First, the run times are shown to the hundredth of a second, but I doubt the accuracy of the Amiga's clock at that resolution. I am confident, however, that the timings are accurate to the tenth of a second.

Second, the Aztec compiler supports and uses the Motorola Fast Floating Point (FFP) library, whereas the Lattice compiler uses Lattice's own IEEE-compatible floating-point library. The Lattice compiler can be linked with the FFP libraries, but it doesn't use them by default (you have to do the function calls yourself). That is the reason there is such a large difference in the floating-point benchmark for run time. It is my understanding that the FFP library will be supported by the Lattice compiler in a future release.

The Lattice compiler version I used for these benchmarks was 3.02. I understand that Lattice is now shipping version 3.03, but I have not, at the writing of this message, received my upgrade. The Aztec version used for the benchmarks was 3.20a.

amiga/product.dcsn #708, from duck [Dale Luck, Commodore-Amiga]  
a comment to 706

The Green Hills C compiler, running on a 14.4-MHz CSA board gives 2100 Dhrystones per second. I just found this out yesterday. For those who do not have the source code, a VAX-11/785 pumps them out at about 2050 per second.

amiga/product.dcsn #709, from ricks  
a comment to 708

You might be interested to know that a Convergent Technologies Mightyframe (12-MHz 68020) running their flavor of UNIX (called CTIX) checked in at 2931 Dhrystones per second.

### TENFOLD PERFORMANCE BOOST

amiga/tech.talk #407, from theo [Ted Inoue, Universal Imaging Corp.]

Anybody know of a Multibus adapter for the Amiga? Our company is looking into making the Amiga the front end to an image-processing system, but the boards come in Multibus format.

We'd like to use the Amiga to talk to our set of Multibus image-processing boards, and it would allow a really nice system for a reasonable price (reasonable being relative; in this market, \$25,000 to \$35,000 is very reasonable). So, if anybody knows of some way to adapt the output from the Amiga to talk to a Multibus system, I'd like to hear about it. Also, if there is any info on VMEbus capability, that would be nice. However, VME has a full 32-bit data and address path, so things might have to be hacked very hard to squeeze the Amiga to talk to VME boards.

amiga/tech.talk #410, from sassenth [Carl Sassenrath]  
a comment to 407

Commodore-Amiga in Los Gatos, California, makes boards that interface the Amiga to Multibus. This is how the Amiga talks to the Sun hosts. Send mail to "duck" for more info.

amiga/tech.talk #411, from jdow [Joanne Dow]  
a comment to 410

Better yet—please, Dale, post the info in Amiga/hardware if this can be

used as a special-purpose product. There are many, many here who'd like to do such a thing. I can see multiprocessing on the horizon.

amiga/tech.talk #413, from duck  
a comment to 407

Maybe this would be another application for our "BillBoards"; they are boards that we hacked together. One plugs into the Amiga and the other board plugs into our Sun-2's Multibus. We run "wack" remote on the Sun-2, peering into the Amiga's memory. Call Bill Kolb at Amiga, (408) 395-6616. Maybe he'd be willing to let out the design or schematics. The Amiga board does not run with anything else except our kludge-o RAM cards.

amiga/tech.talk #415, from sparta [Gary Bonham, Sparta Inc.]  
a comment to 407

You might try CSA (Computer System Associates) in San Diego, (619) 566-3911. They make the 14.4-MHz 68020/68881 board that I have in my Amiga. They have been working on coming off of their piggyback board with a full 32-bit VMEbus (they already have a 32-bit-wide RAM board up there). They may repackage the entire system in a larger box to accommodate it.

amiga/tech.talk #416, from sparta

68020

Yesterday I took my friend (Amiga) to CSA in San Diego for open heart surgery. It had already had a transplant a while ago resulting in a 68020/68881 running at the usual 7 MHz. Now, all operations up on the 68020 board occur at 14.4 MHz. At this rate there are not many computers out there that can keep up (in the price range). The Mandelbrot timing (in P3 mode) I have quoted before is now down to a shade over 3 minutes (versus about 37 minutes on a normal Amiga).

### GENLOCK AND AMIGA-LIVE!

amiga/product.dcsn #710, from duck

There seems to be a little confusion regarding these two separate peripherals. They are each complete peripherals in their own right. Neither depends on the other being on the Amiga. You can GenLock Amiga graphics to external video without doing frame-grabbing. Conversely, you can do video digitizing with Amiga-LIVE! without the GenLocker. They each have their own synchronizing circuitry. These two peripherals can also be coupled to achieve certain effects not possible when using either of them separately.

### BUGS AND FIXES

#### SOUND ADVICE

amiga/softw.devlpmt #1067, from duck

Audio Response, from a conversation with Sam Dicker, Commodore-Amiga

QUESTION: Why can't I SAY "JAH4"? When I TRANSLATE\$ "ja", it prints "JAH4"; but when I SAY "JAH4", I get an illegal function call message. ANSWER: You have found a bug in the SAY command which will be fixed in the next release. It looks like SAY can't handle strings ending in a number (the 4 in "JAH4"). I recommend, as a work-around, that you append a space to all strings that you SAY. The TRANSLATE\$( ) function does this for you, which is why the bug was never reported.

QUESTION: Can WAVE be used to get very different sounds?

ANSWER: All square, sawtooth, and random waves sound alike.

QUESTION: Please excuse the following waveform ignorance, but

(continued)



# Lycy Computer Marketing & Consultants



## SAVE ON THESE PRINTERS IN STOCK



1091 . . . . \$228

PANASONIC	
1091	228
3131 (NEW)	264
1092	325
3151	409
1080 (NEW)	209
1592 (NEW)	439

JUKI	
Juki 6100	344
RS232 Serial Board	55
6100 Tractor	119
6100 Sheet Feeder	209
Juki 6300	757

C. ITOH	
Prowriter 8510 sp+	Call
15505 sp+	Call
Printmaster	Call

LEGEND	
808	148
1080	197
1380	224
1385	268

EPSON	
LX80	209
FX85	333
JX80	Call
Homewriter 10	193
DX10	207
DX20	297
DX35	597
AP-80	244
HI-80	355
HS-80	298
FX-286 (NEW)	489
LQ-800 (NEW)	529
LQ-1000 (NEW)	659

BROTHER	
HR-15XL-P	359
HR-15XL-S	359

SEIKOSHA	
SP-1000 VC (C-64)	185
SP-1000 A Centronics	199
SP-1000 I IBM	199
SP-1000 AS RS-232	199
SP-1000 AP Apple IIc	199
BP-5200 I	649
BP sheet feeder	199
SP-1000 ribbon	8.50
BP-5200 ribbon	12.50

CORONA	
LP300	2495
200361 Toner Cartridge	.89

SILVER REED	
EXP400	249
EXP500	295
EXP550	399
EXP770	749

SG-10 . . . . \$205

OKIDATA	
Okimate 10	179
182	214
192	348
193	563

DIABLO	
D25	549
630 API	1599
630 ECS	1759
D 80 1F	2395
P 32 CO1	659
P 38	1749
C 150	999

STAR MICRONICS	
SG-10	205
SG-10c	219
SG-15	367
SD-10	319
SD-15	438
SR-10	469
SR-15	578
SB-10	589
Powertype	297
NX-10 (NEW)	CALL
NB-15 (NEW)	CALL

CITIZEN	
MSP-10	255
MSP-15	355
MSP-20	337
MSP-25	495
120D	188
Premier 35	429

**COLOR RIBBONS NOW AVAILABLE!!**

### MONITORS

PANASONIC	
DTH103 10" RGB Hi Res	395
TX12HP 12" Color	419
TR1201BPA 12" Amber	109
TR122M9P 12" Green IBM	148
TR122MYP 12" Amber IBM	148

PRINCETON GRAPHICS	
MAX-12 Amber	16-
1X-12 RGB	46-
SR-12 RGB	595

TEKNIKA	
MJ-10 Composite	179
MJ-22	255

AMDEK	
300 Green	118
300-Amber	128
310 Amber IBM	155
Color 300 Audio	234
Color 500 Composite	369
Color 600	397
Color 700	495
Color 710	569

SAKATA	
SG 1000 12" Green	99
SA 1000 12" Amber	109
SG 1500 12" Green TTL	119
SA 1500 12" Amber TTL	129
SC 100 13" Color Comp.	209
SC 200 13" RGB	389
STS1 Tilt Stand	29

COMMODORE	
1902 Color	CALL
1802 Color	CALL

THOMSON	
CM36512V1	269
CM36632	159

ZENITH	
ZVM 122A Amber	75
ZVM 123G Green	75
ZVM 124 Amber IBM	129
ZVM 131 Color	275
ZVM 133 RGB	389
ZVM 135 Composite	449
ZVM 136 Hi Res Color	589
ZVM 1220	95
ZVM 1230	95
ZVM 1240	149

### DRIVES

INDUS	
GT Atari	195
GT Commodore	195

TYMAC	
MDD-640 3 1/2"	
Apple Drive 640K	289

TANDON	
320K 9 1/2" Drive	115

### DISKETTES

DENNISON	
ELEPHANT 5 1/4" SSDD	11.99
ELEPHANT 5 1/4" SSDD	12.99
ELEPHANT 5 1/4" DSDD	14.99

SUNKYONG	
SKC 5 1/4" SSDD	11.99
SKC 5 1/4" DSDD	13.99

MAXELL	
5 1/4" MD1	13.99

### MODEMS

ANCHOR	
Volksmodem	55
Volksmodem 12	186

DIGITAL DEVICES	
Pocket Modem AT	Call
Compuserve	18.95

RACAL-VADIC	
2400PC	549
2400PA	799
2400V	559
1200PC	329

HAYES	
Smartmodem 300	133
Smartmodem 1200	377
Smartmodem 1200B	347
Smartmodem 2400	598

KYOCERA	
1200S	309

US ROBOTICS	
Password 1200	229
Password 300	139
Courier 2400	469

### IBM-PC COMPATIBLE

BRODERBUND (IBM)	
Bank St. Writer	48.95
The Print Shop	34.95
Graphics Library 1	22.95
Ancient Art of War	27.95
Champ Lode Runner	22.95
Karateka	22.95

LEADING EDGE	
Nutshell	69.95
Nutshell Filer	149.00

SUBLOGIC (IBM)	
Jet Simulator	34.95
Scenery Disks EA	14.95
Set 1-6	69.95

MICROPROSE (IBM)	
F-15 Strike Eagle	20.75
Solo Flight	20.75
Silent Service	20.75
Decision in Desert	24.95
Crusade Europe	24.95

**TOLL FREE 1-800-233-8760**



**TO ORDER**



**CALL TOLL FREE 1-800-233-8760**  
In PA 717-494-1030  
Customer Service 717-494-1670

or send order to  
**Lycy Computer**  
P.O. Box 5088  
Jersey Shore, PA  
17740

### RISK FREE POLICY

In-stock items shipped within 24 hours of order. No deposit on C.O.D. orders. Free shipping on prepaid cash orders within the continental U.S. Volume discounts available. PA residents add sales tax. APO, FPO, and International orders add \$5.00 plus 3% for priority mail service. Advertised prices show 4% discount for cash, add 4% for MasterCard or Visa. Personal checks require 4 weeks' clearance before shipping. Ask about UPS Blue and Red label shipping. All merchandise carried under manufacturer's warranty. Free catalog with order. All items subject to change without notice.

could I get a piano sound out of BASIC?

ANSWER: AmigaBASIC has very limited sound capabilities. It is designed to play fixed sine or custom waveforms at a fixed volume and fixed frequency. Fixed, that is, during the duration of the musical note. The sine or custom waveform represents one cycle of the "fundamental." This severely limits how interesting you can make your sounds.

The WAVE command defines the waveform before the SOUND command starts it playing. This makes it impossible to modify the waveform while the sound is playing. The SOUND command sets a constant volume for the entire duration of the sound. You cannot define an envelope (i.e., attack-decay-sustain-release). This gives all sounds an organlike quality.

The SOUND command also sets a constant frequency for the entire duration of the sound. You cannot add vibrato or bend the pitch of a note. AmigaBASIC is really designed to support only one synthesis technique: using the waveform to represent one cycle of the fundamental. This turns out to be the most serious restriction. A custom waveform (nonsinusoidal) can produce any set of harmonics. But they are fixed frequencies and exact harmonics, and not very interesting to the ear.

These are, by no means, limitations of the Amiga hardware and ROM kernel software. Dedicated music programs and even high-level languages can provide much better access to the hardware. For example, ABASIC, the BASIC that was shipped with the first machines had none of these limitations. Simply adding the ability to play a large waveform, either recorded digitally or synthesized, as the entire sound can produce just about any sound, including a piano sound.

Despite my criticisms of the design of AmigaBASIC's sound support, there are ways of "tricking it" into producing more interesting sounds. This may give you some ideas:

```
DIM waveform%(255)
FOR i%=0 TO 255
waveform%(i%) = 127
NEXT
FOR i%=0 TO 255
waveform%(i%) = 0
WAVE 0,waveform%
WAVE 1,waveform%
SOUND 60,5,255 - i%,0
SOUND 60,5,i%,1
```

NEXT

Good luck.

**ALINK PROBLEMS**

amiga/main #2371, from jriley  
a comment to 2367

FFP support is ready. Dropping Alink is in the works, but you gotta realize that you pay a price for playing by AmigaDOS's rules. No library format?

*Editor's note: Jriley is the log-on for the Lattice Support Group. Lattice Tech Support can be reached through the Lattice conference, the Lattice BBS [at (312) 858-8087 2400 bps, no parity, 8 data bits, 1 stop bit], and voice [(312) 858-0073]. Jriley is here to answer any questions you may have on Lattice products.*

amiga/main #2372, from jdow  
a comment to 2371

Even with no library format, Dale let slip that Alink can be sped up materially by allocation tricks. If the hacks that allocate OK but don't deallocate on exit are cleaned up, Alink might not be quite so objectionable.

amiga/main #2376, from jriley  
a comment to 2372

The price you pay for that hack can be more than it's worth. With a large link job going, Alink will effectively kill any multitasking due to lack of memory.

We don't need to complain about Alink, we need to fix it. After all, we are programmers (I hope).

amiga/main #2377, from jim\_kent [Jim Kent]  
a comment to 2376

I am not very familiar with linkers. However, I believe that they would not start freeing memory until they started resolving references, after the high point of memory allocation. If this is the case, then they really might as well hang onto everything until the end, in which case a

**AC/FORTRAN™**

**Mainframe** quality, full feature **ANSI FORTRAN 77** compiler includes: **Debugger**, Linker, Library Manager, Runtime Library, **IEEE** math, and **C** interface. Supports **Complex** numbers, **Virtual** arrays, **Overlays** and Dynamic Linking. Not copy protected. Available now. \$295. Turbo Amiga version also available.

---

**AC/BASIC™**
- Coming Soon

From the authors of **Microsoft BASIC** for Macintosh, comes AC/BASIC for the Amiga. Companion compiler to the **Amiga BASIC** interpreter: has more features and includes a **Debugger**, includes **BLOCK IF**, **CASE** statement, and **STATIC** keyword extensions and executes up to **50x** faster. AC/BASIC is the new BASIC, reference for MCG68000 based personal computers. Not copy protected. \$295.

Telephone orders welcome

Scientific/Engineering Software  
4268 N. Woodward, Royal Oak, MI 48072/(313) 549-7111  
Amiga trademark of Commodore Amiga.  
Microsoft trademark of Microsoft Corp.

Inquiry 399

Quelo®
**68000** Software Development Tools

- Motorola compatible macro assembler
- Industry standard
- Mature—first release January 1983
- Source code available

**Amiga and Atari 520/1040ST  
68000/68010/68020**

Native and Cross Assemblers

Host	Target	68000/68010 package	68020 package
Amiga	Amiga	\$ 99	\$149
Atari	Atari	\$ 99	\$149
MS-DOS/PC-DOS	Amiga/Atari	199*	249*
CP/M-80	Amiga/Atari	199*	—
CP/M-86	Amiga/Atari	199*	249*
CP/M-68K	Amiga/Atari	199*	249*

\*includes corresponding native assembler.

Additional hosts and targets available:  
UNIX 4.2, UNIX V, VAX VMS and external 68xxx boards

Contact Patrick Adams today  
**Quelo, Inc.**  
2464 33rd Ave. West, Suite 173  
Seattle, WA 98199  
phone 206/285-2528 telex 910-333-8171

Trademarks: Quelo, Quelo, Inc., MS, Microsoft Corp.; CP/M, Digital Research; UNIX, Bell Labs; Amiga, Commodore-Amiga, Inc.; Atari, Atari Corp.

Inquiry 290

**LIONHEART**

BUSINESS & STATISTICAL SOFTWARE

**PC/MS-DOS, AMIGA, MACINTOSH  
ATARI 520ST, CP/M, COMMODORE 128**

Explanatory books with professional compiled software; the new standard for statistical use. The influential Seybold Report on Professional Computing has this to say about Lionheart "... our sentimental favorite because of its pragmatic approach to the basic statistical concepts... The thinking is that the computer merely facilitates the calculations; the important thing is to be able to formulate a problem correctly and to determine what type of analysis will be most valuable." Let Lionheart help you get ahead of the competition!

- **BUSINESS STATISTICS** . . . . . \$145
- **EXPERIMENTAL STATISTICS** . . . . . 145
- **MULTIVARIATE ANALYSIS** . . . . . 150
- **QUALITY CONTROL & INDUSTRIAL EXPERIMENTS** . . . . . 145
- **FORECASTING AND TIME-SERIES** . . . . . 145
- **SALES AND MARKET FORECASTING** . . . . . 145
- **DECISION ANALYSIS TECHNIQUES** . . . . . 110
- **LINEAR & NON-LINEAR PROGRAMMING** . . . . . 95
- **PERT & CRITICAL PATH TECHNIQUES** . . . . . 95
- **OPTIMIZATION** . . . . . 110

PC/MS-DOS, Amiga, Macintosh, some CP/M  
VISA, MasterCard, AMEX, Check  
P.O. Box 379, ALBURY, VT 05440  
(514) 933-4918

Inquiry 188



slightly modified hack of the faster option would be OK. I wonder what Aztec's secret is.

amiga/main #2379, from jdown  
a comment to 2376

I said the hack had to be cleaned up properly so that things worked correctly. The ideal algorithm might be this: Allocate in 128K hunks until they don't have room, then try 64K on down until memory is gone.

Keep careful track of the allocations granted and deallocate on the way out. The way I understand things, Alink wastes an excessive amount of time allocating and deallocating small pieces of memory. Done slightly differently this could be made faster without significantly altering the operation of Alink.

Of course, an even faster linker has its advantages as well. The fix to Alink could proceed very quickly. The other, maybe and maybe not.

**REHASHING DISKS**

amiga/main #2351, from gspiko [Gord Sipko]

I am the not-so-proud owner of a "corrupt" sys: disk. I've been using DiskEd to repair the pointers and have been having great success. I almost have the disk usable again—only the :c directory to finish.

Now, here's the problem: When I recalculate the hash numbers for each of the commands in :c, I end up with 11 pairs of commands that hash to the same number and three other commands that have the same number. What gives?

Presumably the hash number must be unique! Does DiskEd have a problem? I'm stuck! Is there anyone out there that will own up to DiskEd?

amiga/main #2352, from mmorris [Martin Morris, Computer Toolsmith]  
a comment to 2351

The hash numbers are not unique; those files with the same hash code are chained together. The "hashed" entry points to the first file with that hash code. The "hashchain" field in the first file header points to the next, and so on. "Hashchain" is word 124/128 in the file header block, described on pages 1-4 and 1-5 of the Amiga technical reference manual.

**MORE ABOUT MAXI**

amiga/main #2375, from jdown  
a comment to 1435

Here's a reposting of 1434 and a couple of notes to help people doing Amiga downloads (thanks again to Willie):

amiga/main #1434, from langeveld [Willem Langeveld]

```
' this version is for MaxiComm format uploads
a$ = INPUT$(128,1) ' discard these 128
FOR I = 1 TO n ' n is determined by the file size
  a$ = INPUT$(10000,1) ' 10000 seems like a good number
  PRINT# 2,a$; ' Don't forget the ";"—it will insert a space
                ' otherwise
```

```
NEXT I
a$ = INPUT$( < nnn > ,1) ' < nnn > is the number of leftover bytes to be
                        ' copied
PRINT# 2,a$; ' Seems to work also without ";" , you get one
              ' byte extra
CLOSE etc.
```

this version is for normal XMODEM uploads with no MaxiComm header block  
FOR I = 1 TO n ' n is determined by the file size

```
a$ = INPUT$(10000,1) ' 10000 seems like a good number
PRINT# 2,a$; ' Don't forget the ";"—it will insert a space
              ' otherwise

NEXT I
a$ = INPUT$( < nnn > ,1) ' < nnn > is the number of leftover bytes to be
                        ' copied
PRINT# 2,a$; ' Seems to work also without ";" , you get one
              ' byte extra

CLOSE etc.
```

Hope this helps. The version of TxEd currently in Listings needs the second version (above) with the length mentioned in the txed.doc file.

**CHOPPING FILES**

amiga/main #2339, from efreedus [Eric Freedus]

Running TxEd  
I ran TxEd through the AmigaBASIC program listed to trim off the end. Apparently I had to allocate enough memory first. In any event, now I can't get it to run. I'm getting an "Unable to load TxEd: file is not an object module."

Second, when logging in through Tymnet, if I use the Backspace key to correct a typo, all console output is shut down thereafter. I'm sending, but I don't see my own keystrokes. Is there a key sequence to correct that during the Login procedure? The shutdown carries right through to when I'm on-line with BIX.

amiga/main #2340, from tom\_\_thompson [Tom Thompson, Technical Editor, BYTE]  
a comment to 2339

A backspace entered on the Tymnet log-on sequence kicks the system (for you) into half-duplex mode. Solution: Either abort the log-on if you make an error, or put your terminal program into half-duplex mode.

As for the chop problem, what was the file size of the output file versus the input file? The error message you're getting indicates that the chop failed (this is also the same error message you get with the unchopped file, that's why I suspect chop).

Also, TxEd may be one of those files where some of the code looks like an end-of-file character, so BASIC quits prematurely. Suspect this as the problem if your output file is a lot smaller than the input file.

amiga/main #2342, from jdown  
a comment to 2340

Make sure the chop number is the same as the chop number in Charlie Heath's message re TxEdDemo. He has uploaded two versions, and the BASIC program trimmed the "old" TED version to working size, not the new TxEd version.

amiga/main #2343, from jdown  
a comment to 2340

Also re Tymnet Log-on  
^H sets Tymnet into a mode where you must generate a local echo of characters you send. If your terminal program can do this, I highly recommend it for good typists (or even mediocre typists). A ^X and ^R enables XON/XOF (^Q/^S) flow control through the Tymnet node.  
The only way to abort the ^H mode is to hang up and redial Tymnet for a fresh start.

**ANIMATOR**

amiga/product.dcsn #685, from jim\_\_kent

My First Bug  
Actually, this is just my first documented bug. When running Animator

(continued)

## a message to our subscribers

From time to time we make the **BYTE** subscriber list available to other companies who wish to send our subscribers material about their products. We take great care to screen these companies, choosing only those who are reputable, and whose products, services, or information we feel would be of interest to you. Direct mail is an efficient medium for presenting the latest personal computer goods and services to our subscribers.

Many **BYTE** subscribers appreciate this controlled use of our mailing list, and look forward to finding information of interest to them in the mail. Used are our subscribers' names and addresses only (no other information we may have is ever given).

While we believe the distribution of this information is of benefit to our subscribers, we firmly respect the wishes of any subscriber who does not want to receive such promotional literature. Should you wish to restrict the use of your name, simply send your request to the following address.

BYTE Publications Inc.  
Attn: Circulation Department,  
70 Main St., Peterborough, NH 03458

or Images from the Workbench, if you change directory, you must change directory back to "sys:" or the Workbench will crash when you exit. CLI is fine. I'm not sure if I will be able to fix this bug as it appears to be in the Workbench. See topics "software" and "flames" for more discussion of this problem.

In the meantime I would really suggest for this and *many* other reasons that you get rid of the Workbench and run things from the not-as-pretty but *far* more reliable CLI. There is a batch file "noworkbench" included on the Animator disk that when run should keep Workbench from appearing when you reboot.

amiga/product.dcsn #686, from jdow  
a comment to 685

Rather than having the program automatically relog to "sys:" the more proper route is to note where it is when your program starts and relog to that. Somehow, I agree with you. A well-behaved program should not have any effect on the underlying system parameters after it exits unless it is something like CD, which must have that effect because of its function.

(CP/M is something like that—a program can log new "drives" and "users" all it wants. The only way it affects the CLI environment is to change the value at location 4. Well-behaved programs leave this alone unless appropriate.)

amiga/product.dcsn #687, from jim\_kent  
a comment to 686

Well, anyway, got my CD back to work. Bug fixed in 1.10 release of Animator.

## ATARI ST

This month's discussions include answers concerning Atari ST graphics and programming languages. Once again, the problem of resolution switching is addressed, and several conference members have made considerable progress in solving the problem. Also, a few helpful hints in graphics programming are offered. But the debate over which language to use rages on, as conference members discuss the pros and cons of Modula-2, C, and Pascal.

### GRAPHICS COPROCESSOR

atari.st/main #28, from dbetz [David Betz, Senior Editor, BIX]

Are the 1040STs being delivered with the sockets for the enhanced graphics chip?

atari.st/main #29, from neilharris [Neil Harris, Atari Corp.]  
a comment to 28

According to Sam Tramiel, the graphics chip is not intended for the 1040ST. It will go into a future product in the ST line, at a higher price point than the current model. However, the graphics coprocessor will be available as an upgrade board for the current models.

atari.st/main #30, from jruley [John Ruley, University of Dayton]  
a comment to 29

Whoa! That is directly opposed to what we've been hearing here and in the **BYTE** article [March 1986]—are you sure you mean that?

If it is a board-level operation, then is there going to be an upgrade for the 520ST as well? You could make a lot of friends that way!

## NOVAS

BEYOND IBM COMPATIBILITY  
MORE POWER PLUS RELIABILITY AT LESS COST

### NOVAS TURBO 286 MOTHERBOARD

- \* Fewer ICs For Greater Reliability—Only 36 Compared to IBM's 131
- \* Dual Speeds—6 & 8 MHz—Keyboard Selectable
- \* 4 Serial and 1 Parallel Ports On Board
- \* Expandable to 1 Megabyte RAM
- \* Fully Compatible BIOS
- \* Socket for 80287
- \* Complete with Installation Program
- \* One Year Warranty

\$595 OEM Quantities

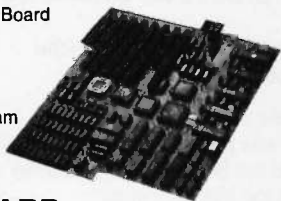

### NOVAS 1000 EGA BOARD

- \* Supports EGA, RGB, & Monochrome Monitors
- \* 640 x 350 Pixels EGA
- \* 640 x 200 Pixels Color
- \* 320 x 200 Pixels Color
- \* 720 x 350 Pixels Monochrome
- \* Parallel Port on Board
- \* 256K RAM on Board
- \* One Year Warranty

\$250 OEM Quantities



## NOVAS

COMPUTER SYSTEMS  
& COMPONENTS  
Since 1983

### COMPUTRADE COMPANY

780 Trimble Road, Suite 605  
San Jose, CA 95131 Tel: (408) 435-2662  
Fax: (408) 435-5458

CALL FOR OTHER COMPONENTS & SYSTEMS

\* IBM is a trademark of International Business Machines Corp.







# So you can't get Toshiba Printer Accessories, Bunkie?

Any time (24 hours) grab your VISA or MasterCard  
**JUST CALL 800/854-0561 EXT 837**  
 IN CALIFORNIA CALL 800/432-7257 EXT 837

### Type Font Cartridges for

#### Toshiba P351, P341 and P321 Printers

T/FC 011 \$69	T/FC 015 \$69
Bold Letter	ORATOR1 Orator2
T/FC 012 \$69	T/FC 016 \$69
Elite gothic	OutLine Script
T/FC 013 \$69	T/FC 017 \$69
Greek/Math/Apl	Theme Litabic

### Ribbon for 3-in-One Printers

T/R 001 \$12: Ribbon fits Toshiba dot matrix printers.

### Start-Up Kit

T/SK \$99: Accessory sample kit contains Type Font Cartridge (Bold Face, Letter Gothic), Type Font Disk (Extended Word Processing), Printer Ribbon, Data Disk, Enhancement Catalog, Type Font Catalog and much, much more.

### P351 Dual Emulation Kit

T/DE 351 \$99: Upgrade your early model P351 to add IBM Graphics Printer emulation. Complete instructions included.

### User's & Technical Reference Manuals

Complete line of manuals to support Toshiba Printers: P1340, P351, P341, P321. Write for complete catalog.

A minimum shipping and handling charge of \$4.75 will be added to each order. 6% sales tax will be added to California orders.

### Type Font Disks (Downloadable)

G/FD 051 \$50:	Designed especially for scientific applications; 4 fonts.
G/FD 053 \$30:	Maxiset (oversized characters for headlines); 1 font.
T/FD 016 \$69:	Extended word processing package. Ideal for desktop publishing; 5 fonts.
T/FD 011 \$49:	Standard word processing packaging; 3 fonts.
T/FD 014 \$49:	Presentation size type fonts; 2 Orators & 1 Outline.
T/FD 015 \$49:	Correspondence quality type fonts; 1 Roman, 1 Script & 1 Italic.
T/FD 013 \$69:	Math and Scientific fonts; 2 Math: 1 Application & 1 Scientific.
T/FD 021 \$49:	Quality Pack; 1 Regular and 1 Bold Italic & 1 Gothic.
F/FD 004 \$95:	2 Micro (10 & 20 cpi), Copper, Reg. Italic, Bold Italic, Zip & Science.
F/FD 002 \$95:	Demi Gothic, Gothic (15 cpi), Boss, Serif Italic, Gothic Italic, Fathead, Greek.
F/FD 004 \$95:	Roman, Elite Italic, OCR A & B, Pres. Pica, Greek, Micro (15 cpi).

**PRINTER ACCESSORIES** WRITE FOR A COMPLETE CATALOG  
 DIRECT INC. / P.O. BOX 19608-347, IRVINE, CA 92713

## FORTRAN PROGRAMMERS

Downloading from mainframes or developing on the PC the choice is F77L — Lahey Fortran.

**“Lahey’s F77L FORTRAN is the compiler of choice . . . F77L compiled the five files in a total of 12 minutes which was 4 times as fast as MS FORTRAN and an astounding 6 times as fast as Pro FORTRAN.”** PC Magazine

**“The manual that comes with this compiler is well put together. The messages are clearly explained, the compiler’s unique features are well documented. . . All in all, F77L is a fine, well supported product that we think will do very well in the marketplace.”**

Computer Language

**VERSION 2.0 NOW AVAILABLE — \$477**

Full ANSI FORTRAN-77  
 Source On-Line Debugger  
 Extensions for easy mainframe porting  
 Common/Array greater than 64K  
 Lattice C and other 3rd Party Compatibility

To order or for more information  
**(213) 541-1200**

**Lahey Computer Systems, Inc.**  
 31244 Palos Verdes Drive West, Suite #243  
 Rancho Palos Verdes, CA 90274

Requires MS-DOS and 8087

MS-DOS and MS FORTRAN are trademarks of Microsoft Corporation  
 Pro FORTRAN is a trademark of International Business Machines

as quick structure assignment in languages and operating system jobs such as garbage collection and memory reorganization. Oh joy!

### RESOLUTION SWITCHING

atari.st/tech #23, from swestrup [Stirling Westrup, Xuclid Research]

According to previous messages in the technical section of the old Atari conference (see April BYTE, page 367), you can change from low to medium resolution without rebooting if you poke the desired screen resolution into the hardware register ShiftMd. What is the address of this register? The only reference I could find to it was in the *Hitchhiker's Guide to the BIOS*, where they say that it is shadowed by SShiftMd at location \$44C.

atari.st/tech #25, from jtuermer [Joerg Tuermer]  
 a comment to 23

The address of ShiftMd is \$FF8260. I have no color monitor, so I can make no tests, but the XBIOS function 5 (`__SetScreen`) also mentioned in the *Hitchhikers Guide* should do the changing without booting. Changing by direct setting of ShiftMd may leave the machine with some problems concerning cursor, fonts, etc.

atari.st/tech #55, from swestrup  
 a comment to 25

Of course `__SetScreen` *should* change resolution without rebooting, but it doesn't! And here I am wanting to change resolution while booting. That's so programs in the Auto directory come up in the right resolution.

atari.st/main #39, from cheatn

We asked Digital Research Inc. if it was possible under software control to even switch from 320- by 200-pixel, 16-color resolution to 640 by 200 resolution so we could present 80-column text and then switch to a multicolor graphics display. The folks at DRI told us we'd have to reboot.

atari.st/main #44, from swestrup  
 a comment to 39

I have now successfully switched the Atari from low to medium resolution and back again without crashing the system or rebooting. My current problem is that GEM still thinks it's in the wrong mode and all of the fonts and windows are garbled. I tried poking the correct resolution into SShiftMd, but that didn't work.

atari.st/tech #70, from swestrup

I am uploading a listing of a 68000 assembler program that switches the Atari ST into medium-resolution mode without going through BIOS or XBIOS. It can be assembled and linked with the standard DRI assembler and linker that come with the developer's package. I have no idea what this program will do to a monochrome monitor. Are there any brave souls out there?

atari.st/listings #5, from swestrup

### FIXSCR.S

I wrote this test program to change the screen resolution from low to medium without having to reboot the system. This program has to operate in supervisor mode so that the hardware register ShiftMd (\$FF8260) can be set. The value \$F9 corresponds to Medium Res, while \$F8 is Low Res. Unfortunately, GEM does not recognize the change and behaves as if the old resolution is still in effect. In addition, this program will occasionally cause a few bombs to appear on the screen. I don't know why.



```
.TEXT
MOVE.L #0, -(A7) * PUSH A REQUEST FOR
MOVE.W #$20, -(A7) * SUPERVISOR STATUS
TRAP #1 * AND TRAP FOR IT
ADDQ.L #6,A7 * THEN FIX UP THE STACK

MOVE SR,D0 * READ THE STATUS REGISTER
MOVE.B #$F9,$FF8260 * GO TO MEDIUM RES MODE

AND #$DFFF,D0 * CLEAR THE SUPERVISOR BIT
MOVE D0,SR * AND SET US BACK IN USER
                * MODE

RTS
```

atari.st/tech #71, from jtuermer  
a comment to 70

My documentation says that a return from supervisor mode should be made with another call to Super (BDOS \$20). After the first trap you should save D0 and push it on the stack before the second one. This is the old value of the supervisor stack pointer (SSP). The present program leaves the SSP at the same value as the User SP before the RTS. Maybe this is producing the bombs.

I have looked carefully through a BIOS listing and cannot find where the \_\_SetScreen routine could possibly reboot. But if you try to set to a resolution not supported by your monitor, the next Vertical Blank Interrupt will branch through the routine pointed at by swv\_\_vec (\$46E), which is initially pointing to the system reset handler.

This is in fact what happens to the "brave souls." The system reboots and they are back in monochrome.

atari.st/tech #77, from sak [Sal Magnone, CIA Software]

I read the messages about changing screen resolution without rebooting or other troubles and thought I'd mention a new program. I just got a demo of a game called Pawn that's got some really great low-resolution pictures. The significance is that the game operates in medium resolution. It pulls the low-resolution 16-color picture down from almost the top of the screen, waits, then slides the picture back up, revealing the medium-resolution text that it covered coming down. My guess is raster interrupts. Can an ST do that? When you try and dump the pictures, they get scrambled as though the interrupt got turned off. The dump routine probably does kill video interrupts, because the picture looks like someone just switched modes on it. Then it goes back to normal after the dump stops.

atari.st/tech #78, from jtuermer  
a comment to 77

You can enable the HBLANK (autovector level 2) interrupt. This will give you an interrupt on every scan line. If you revector it to your own handler, you can decrement a counter set at VBL interrupt to the number of the scan line you want to change resolution, color, and so forth. If your counter reaches zero, make your changes. You may have to revector the other interrupts. This is described in the *Hitchhiker's Guide to the BIOS* (August 26, 1985, page 30).

atari.st/questions #22, from jriley

Do you still have to turn the machine off to switch between the high-resolution monitor and the modulator output? That is, can you have a black-and-white monitor and the RF modulator on at the same time? I know that would mean you'd have garbage on one or the other—but you'd be able to switch from the desktop.

(continued)

## Little Board™/186.... \$495

### High Performance, Low Cost PC-DOS Engine

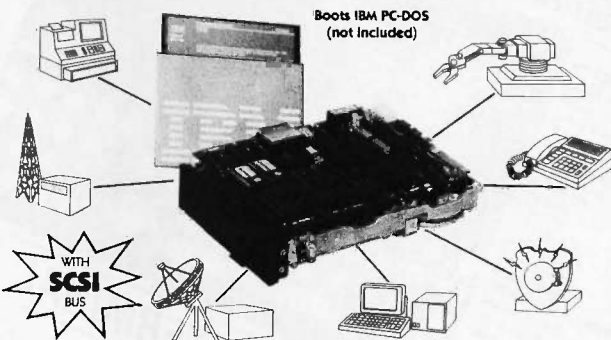

- Three times the COMPUTING POWER of a PC
- Data and File Compatible with IBM PC, runs "MS-DOS generic" programs
- 8 MHz 80186 CPU, DMA, Counter/Timers, 128/512K RAM, zero wait states, 16-198K EPROM
- Mini/Micro Floppy Controller (1-4 Drives, Single/Double Density, 1-2 sided, 40/80 track)
- 2 RS232C Serial Ports (50-38, 400 baud), 1 Centronics Printer Port
- Only 5.75 x 7.75 inches, mounts directly to a 5-1/4" disk drive
- Power Requirement: +5VDC at 1.25A; +12VDC at .05A; On board -12V converter
- SCSI/PLUS™ multi-master I/O expansion bus
- Software Included:
  - PC-DOS compatible ROM-BIOS boots DOS 2.x and 3.x
  - Hard Disk support
- OPTIONS:
  - Expansion board with:
    - 128 or 512K additional RAM
    - 2 Sync/Async RS232/422 serial ports
    - Battery backed Real Time Clock
    - 8087 Math Co-Processor
    - Buffered I/O Bus
    - STD Bus Adapter
    - Utilities source code
    - TurboDOS / Networking



IBM®, IBM Corp., 80186®, Intel, Corp., Turbo DOS®, Software 2000, Inc.

67 East Evelyn Ave. • Mountain View, CA 94041 • (415) 962-0230 • TELEX 4940302

## BUILD YOUR OWN IBM XT & AT COMPATIBLE SYSTEMS

<p><b>XT AT Case</b>                  \$59.00.....FLIP-TOP (XT look like)                  \$65.00.....FLIP-TOP (AT look like)                  (in cluding keyboard lock &amp; reset SW)                  \$65.00.....SLIDE-IN (XT look like)                  \$69.00.....SLIDE-IN (AT look like)                  (in cluding keyboard lock &amp; reset SW)                  \$109.00.....SLIDE-IN (AT)</p> <p><b>XT AT Power Supply</b>                  \$89.00.....XT 135W                  \$159.00.....AT 200W</p> <p><b>XT AT Keyboard</b>                  \$75.00.....5160 XT (AT look like)                  \$109.00.....5160 AT</p> <p><b>XT AT Mother Board</b>                  XT 640K (øK RAM)                  2 layers 4.77 MHZ.....\$159.00                  4 layers 4.77 MHZ.....\$195.00                  XT 640K (øK RAM) Turbo                  2 layers 4.77 MHZ/8MHZ...\$195.00                  4 layers 4.77MHZ/8MHZ....\$229.00                  AT (1MB/øK) 4 layers.....\$ CALL</p> <p><b>PC/XT AD-ON-CARD</b>                  Floppy Controller.....\$49.00</p>	   Disk I/O Card.....\$129.00 Color Graphics Card.....\$85.00 <b>Monitor</b> Color RGB (TVM) 14".....\$395.00 TTL Monitor (Mctek) 12" Amber..\$110.00
--	---

**U.S.A. OFFICE SKY HIGH CO., INC.**  
 WHOLESALE (415) 549-3479 RETAILER (415) 843-0714  
 IN EAST COAST & CANADA PLS CALL  
**3D MICRO WHOLESALE & DISTRIBUTION**  
 514 MCNICOLL AVENUE WILLOWDALE, ONTARIO M2H 2E1 CANADA TEL:(416)469-5250  
**MANUFACTURER EAST DIGITAL CO., LTD.**  
 2ND FL., NO. 432 KUANG-PU S. RD. TAIPEI, TAIWAN, R. O. C.  
 TEL:(02) 703-2243, 703-2471, 709-2515 TLX: 10531 GEMMING, 20830 ECLTD  
 IBM is a trademark of International Business Machines Corp.

**Special Purchase**  
**LAP COMPUTER**  
**FULL FACTORY WARRANTY**

**BUILT IN 300 BAUD MODEM**  
 Built in spread sheet, similar to Lotus Terminal Emulator to Communicate with Personal or Mainframe Computers.

**IT'S A HANDS FREE PHONE**  
 Comes with Rechargeable Batteries and Charger. Options Available Serial or Parallel Port Workstate Printer

**workState**  
 BY CONVERGENT TECHNOLOGIES

**THE MOST PORTABLE TERMINAL**

OUR BEST PRICE EVER **\$295.00** ORIGINALLY \$1195.00

Includes FREE SOFTWARE WORTH \$88.00  
 Information and Consultant Services Software

**OTHER SOFTWARE PACKAGES • WITH PURCHASE ONLY**

Case Management	\$15.00	Insurance Analyzer	\$15.00
Financial Statements	\$15.00	Real Estate	\$25.00
Inventory Analysis	\$15.00	Information Services	\$15.00
Marketing Management	\$15.00	Loan Analysis	\$15.00
Sales Receiver	\$15.00	Portfolio Analysis	\$15.00
Travel	\$15.00		

This state of the art computer comes with two instructional cassettes that talk you through the learning process. This means a human voice tells you which keys to press as you are learning to manipulate information on the screen. This computer also has built-in hardware that lets you hook in to services like Dow Jones/News Retrieval, The Source, MCI Mail, and many other services, including thousands of electronic bulletin boards. • Dimensions: 8 1/2" x 11 1/4" x 1 1/2" • 3 lbs. • Display: LCD, 46 characters per line, 16 lines. • Power: NiCad rechargeable battery, AC adaptor/recharger or 4AA alkaline batteries. • Typewriter-style keyboard and calculator pad. • Calendar and communications management. Internal Memory up to 128Kb x 11" pages. Microcassettes store up to 10 worksheets or 45 minutes of audio information.

**15 Day Money Back Guarantee**

**CEC** 1745 Adrian Road, No. 1  
 Burlingame, CA 94010  
 415 / 342-4058  
 800 / 228-3411

atari.st/questions #24, from neilharris  
 a comment to 22

Since the video shifter puts out a 60-Hz signal for color and a 71-Hz signal for monochrome, the two modes are not at all compatible. If you fed the wrong signal into a monitor, you would be likely not only to get garbage on the screen but also to damage the flyback transformer.

atari.st/questions #26, from al [Alastair J. W. Mayer, author of BIX's CoSy software]  
 a comment to 24

That's no worse than feeding a 50-Hz PAL signal into an NTSC monitor (or vice versa), something I've done more than once. Garbage, yes—like a severe case of out-of-adjustment horizontal and vertical hold—but my monitor still works fine. (Mind you, I don't make a habit of it and only did it for a few minutes at a time.)

atari.st/questions #27, from jim\_kent  
 a comment to 26

What sort of plans does Atari have for a standard video output? As it is, video-types are the only people left I can in good conscience recommend an Amiga to. (I'm a concerned animation programmer with a VCR.)

atari.st/questions #28, from neilharris  
 a comment to 27

The latest model of the 520ST has both RF and composite video outputs.

**LANGUAGES**

atari.st/main #52, from swestrup

Modula-2  
 Where can I get a good book on Modula-2? I'd like to decide whether I like the language before I go out and buy a copy of it.

atari.st/main #53, from jruley  
 a comment to 52

As to a book—it sounds corny, but I recommend *Modula-2: A Seafarer's Guide and Shipboard Manual* by Edward Joyce (Addison-Wesley, 1985). Not only is it a fairly complete reference on Modula-2 with a good index, it is actually fun to read!

atari.st/main #54, from neilharris  
 a comment to 53

Personally, I found the [Niklaus] Wirth book, *Programming in Modula-2*, 2nd edition, indispensable as a reference, and the Knepley and Pratt book, *Modula-2 Programming*, a good tutorial textbook. I will try to upload the sample program that comes with TDI's Modula-2/ST, which they have permitted to be passed around. It does use the GEM features.

atari.st/tech #33, from wbaker [Bill Baker]

Just started playing with Lattice C from Metacomco. My overall first impressions are that the language implementation is good, but I think the linker is a dog. A small hello-world program took five minutes to link. (I use double-sided drives.) There is a full AES and VDI library implementation with source in assembler but no real documentation other than function names and arguments.

Having tried Hippo C, Megamax C, and now Lattice, [I find] none of the C implementations anywhere near as good as TDI's Modula-2/ST. Looks like I may have to learn a new language if I want to have

**NEW PRODUCTS**

**SOFTWARE & PERIPHERALS**

**NEW CHIP RUNS CP/M ON IBM PC's**

Your IBM PC or compatible can run 1,000's of CP/M80 programs with NEC's new V-20/30 microprocessor and RUN/CPM software interface from Micro Interfaces Corporation. Features include ability to run CP/M or MS-DOS programs from same prompt, disk emulation allows PC to run CP/M programs from CP/M disks and directly READ, WRITE, and FORMAT approx. 100 of most popular formats, ability to run CP/M from Hard Disks or Ram Disks, run MS-DOS background programs on top of CP/M programs, 13 Logical or Physical drive assignments, approx. 100 CP/M terminals emulated. RUN/CPM sells for \$99.95 and includes NEC V-20/30, to order contact M.I.C. at 1-800-637-7226 or for Tech Info 1-305-823-8088.

**NEW Z-80 CO-PROCESSOR BOARD ONLY \$199.95**

Lowest priced Z-80 board currently available runs CP/M programs on IBM PC's and AT's. Comes complete with 5.0 Mhz clock, 64 K of memory, and includes all of the features of the RUN/CPM product listed above. Price is only \$199.95 and includes RUN/CPM software interface. Contact Micro Interface Corporation, 6824 N.W. 169th St. Miami, FL 33015, 1-800-637-7226 or 1-305-823-8088

Advertisement



development tools anywhere near as good as others I am used to (IBM PC family, Microsoft C, Brief editor, Make, and PLINK86).

atari.st/tech #34, from dmenconi [Dave Menconi]  
a comment to 33

Everyone is raving about Modula-2. My problem is that I will have to learn a new language. I will probably go for it because I really like developing in Ada, and I understand that Modula-2 is like Ada. Until I get around to it, I plan to develop in Personal Pascal by OSS. This Pascal is out for the ST and is coming out for the Mac RSN. They say that something that runs on the ST can be compiled and run with no modification on the Mac (of course it will need to be tweaked to be aesthetic and efficient). If true, OSS is really going to clean up!

atari.st/tech #49, from bwebster [Bruce Webster, Consulting Editor, BYTE]  
a comment to 34

No, no, no. Modula-2 is not like Ada, though both are derived from Pascal. In fact, Modula-2 and Ada represent diametrically opposed trends. Modula-2 is a very minimal language; just about everything beyond the basic language syntax is a user-defined library, though most Modula-2 implementations come with a set of standard libraries to save you the hassle of writing them yourself. Ada is a "kitchen sink" language, as in having everything but the kitchen sink. Modula-2 really resembles a hybrid of Pascal and C.

atari.st/tech #52, from wmiller [William Miller, Stratus Computer]  
a comment to 49

The similarity is in the concept of modules (Ada "packages") with separate definition and implementation sections. Other similarities exist due to the fact that both have Pascal as an immediate predecessor. But, as Bruce said, there is a major difference in the design philosophy.

atari.st/tech #54, from bwebster  
a comment to 52

Thanks. Couldn't have said it better myself. I haven't done any actual Ada programming, though I was almost on the industry review board (read: "enormous group") back in '79 when I was leaving General Dynamics and they were offering that as an incentive to stay. (Almost worked.) I have gone through a few books on Ada, though, and have carefully read Tony Hoare's talk, "The Emperor's Old Clothes," in which he describes his horror at the thought of ICBMs guided by programs written in Ada. There is a definite dichotomy of design, despite the resemblances.

atari.st/tech #61, from jerry [Jerry Pournelle, Consulting Editor, BYTE]  
a comment to 52

There are great similarities between Ada and Modula in that they are both highly structured and programs can conveniently be written in small independent packages or modules.

The difference is that Ada was designed by a committee of bright people, and Modula was designed by a single genius.

atari.st/tech #38, from jriley  
a comment to 33

Looks like it's Modula or nothing. That really gripes me—is there no decent C for the machine short of the \$300 Alcyon in the developer's kit?

I'd appreciate any comments—I am trying to replace Hippo C on my  
(continued)

## DESMET C COMPILER AFFORDABLE WORLDWIDE

- Australia** Micromart, N.S.W. Tel: (02) 568 2564 (PC&MAC)
- Botswana** Hi-Tech Services, Gaborone Tel: 4540 (PC)
- Britain** MLH Tech., Cheshire Tel: 0606-89 11 46 (PC&MAC)
- Denmark** Ravenholm Comp., Lyngby Tel: 02-88 72 49 (PC)
- Finland** Holosoft, Toivakka Tel: (9) 41 871 201 (PC)
- France** PG Soft, Paris Tel: (1) 205.39.47 (PC)
- France** R. P. M. I., Vincennes Tel: (1) 43654056 (MAC)
- Iceland** Hugbunadur, Kopavogur Tel: (354)-1-64 10 24 (PC)
- Japan** JSE International, Tokyo Tel: (03) 478-8271 (PC)
- Norway** Abacus Data, Oslo Tel: (472) 38 50 20 (PC)
- Sweden** Escort Data, Vallingby Tel: 08-87-33-55 (PC&MAC)
- U.S.A.** C Ware Corporation, California (408) 720-9696

Ask about distributors in Germany (PC), and New Zealand (PC&MAC)

### C Ware Corporation

505 W. Olive, Suite 767, Sunnyvale, CA 94086 U.S.A.  
(408) 720-9696 Telex: 358185  
We accept VISA, MasterCard & American Express

## Computers For The Blind

**Talking computers give blind and visually impaired people access to electronic information. The question is how and how much?**

**The answers can be found in "The Second Beginner's Guide to Personal Computers for the Blind and Visually Impaired" published by the National Braille Press. This comprehensive book contains a Buyer's Guide to talking microcomputers and large print display processors. More importantly it includes reviews, written by blind users, of software that works with speech.**

Send orders to:

**National Braille Press Inc.,  
88 St. Stephen Street, Boston, MA 02115  
(617) 266-6160**

*NBP is a nonprofit braille printing and publishing house.*

# Expansion Chassis/ Sub-System

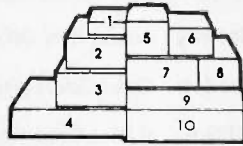
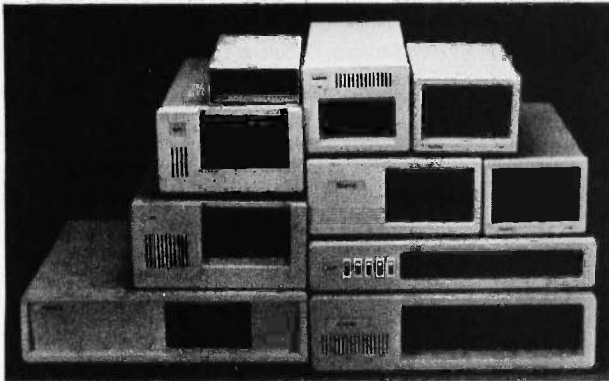

## Specification

Model No.	No. of Slot	Half Height Drive	Power Supply	Dimension D×W×H(cm)	Price
M-1*	0	1	A or B	30×15×6.5	\$149
M-2	3	3	C	42×25×16	\$299
M-3	5	3	C	39×30×15	\$259
M-4	12	2	D	40×39×14	\$299
M-5	0	2	E	39×18×15	\$149
M-6	0	1	A or B	26.5×18×13.5	\$169
M-7	5	2	C	38.5×30×13.5	\$299
M-8	0	2	E	39.5×18×13.5	\$149
M-9	0	2	F	38.5×49×9	\$249
M-10	8	4	G or H	43×49×14	\$259

\* Extra space for a stand alone controller

## EXT and RCV Adapters

- Connecting master expansion chassis to PC, XT or AT
- Fully buffered address, data and control signals.
- 3 feet shielded flat cable.

Price \$159

## Power Supply

	Watt	+5V	+12V	-12V	-5V
A	50	5.0	2.5		
B	50	1.8	3.5		
C	100	8.0	5.0	0.3	
D	100	10	3.5	0.5	0.5
E	45	4.0	2.0		
F	60	5.0	3.0		
G	135	15	4.2	0.3	0.3
H	150	15	6.0	0.3	0.3

**ORDER TOLL FREE: (800) 826-0267**  
**In California Call (415) 651-3355**

DEALER INQUIRIES INVITED

**SOURCE ELECTRONICS CORP.**

45277 Fremont Blvd., Unit 6  
Fremont, CA 94538

Telex: 279366

FAX: (415) 791-0935

520ST. If I don't get any kind of good news on a C by next weekend, I'm going to get Modula and chuck C for good.

atari.st/tech #46, from dmenconi  
a comment to 38

I am going to do my first project on the ST in Personal Pascal. I think it is a strong alternative to Modula-2 because it has a nice library for the ST and I understand it will soon be implemented on the Mac. As far as I know, Modula-2 isn't out on the Mac yet, and when it is, there will still be the question of portability.

The questions that remain are: How optimized is the code generated by these two languages? Personal Pascal has an optimizer, and from the manual it looks like they did some intelligent things. How soon will compilers for other machines be out?

So far I have rooted for this Pascal for a couple of reasons: coming soon on the Mac, nice ST interface, most people know Pascal better than Modula-2, and Pascal's been around longer, so its compilers are better understood. But Modula-2 has some nice features, too. First, it is likely to be more portable on future machines because there is one complete language definition instead of several (the original Pascal definitions had neither strings nor good I/O). Second, Modula is, I believe, more structured than Pascal. For instance, it has packages that allow a programmer to divide a program into modules and really keep track of which packages use which routines. This is a tremendous aid in avoiding spaghetti code.

A disadvantage that awaits the unsuspecting C programmer who would use either of these languages is that they're designed to protect the programmer from himself. For example, consider the strong typing; characters are type "char"—not integer or "char" depending on how the programmer feels that day, as in some languages.

So, there you have it, a long-winded dissertation on the other two choices. I highly recommend a careful examination of both languages before a choice is made.

atari.st/tech #48, from jruley  
a comment to 34

Well, I went with the Modula—maybe we should compare notes after we've both had some time to work with them. With respect to choosing between the two, I spent today reading a book on Modula-2, and it looks to me like it's possible to do anything in Modula-2 that you can do in C—although the implementations vary, they have all the same features. It's been awhile since I looked at Pascal, but unless yours has a lot of extensions (separate compilation, based variables, coroutines), there are quite a few things that will give you trouble if you try to do low-level stuff.

## RAM DISK AND C FUNCTIONS

atari.st/tech #40, from mmanlove [Mike Manlove]

Here are a couple of problems that have been bugging me for a week. I'd sure appreciate any insights that you might have.

First, is there a RAM disk that works with the TOS ROMs? I've got the Hippo RAM disk, which works fine with TOS.IMG but bombs when I boot ROM. Thinking about it, it seems like most RAM disks would perform brain surgery on the BIOS/XBIOS, which is most likely in ROM.

Second, has anybody had any luck with the C library functions Malloc() and Calloc() which come with the developer's kit? The application I'm working on really wants to play around in the heap, but right now it can't. Even a trivial program can get only a little memory allocated (504 bytes for my Malloc tester), and you don't get a null pointer if there's not enough memory—you get cherry bombs. Do I need to do something magical before using these functions?

Random comments: I'm running a 1-megabyte ST with the ROMs, two double-sided floppy disk drives, and both monitors (I couldn't



decide). I've been having a fine old time with the developer's kit, but the compile/link times off floppies are getting out of control, which is why I'm after all the RAM disk I can get. The TDI Modula-2 compiler may be the next step.

Thanks again for any help you can offer. I just got here, and BIX looks great!

atari.st/tech #42, from jim\_kent  
a comment to 40

I use the Michetron RAM disk with the same hardware configuration (except only a color monitor). Works like a charm. I'm also curious about Malloc problems.

atari.st/tech #56, from swestrup  
a comment to 40

As to the Malloc/Calloc problem: I am told that when your C program is loaded by TOS, it gives all of the memory to the program, which doesn't want it. In order to have Malloc have something to allocate, you have to do a Memfree call (I think that's what it's called) so that the memory is given back to TOS. The kicker is that the call requires the address of the last byte of memory that you want to keep. I have yet to figure out how to get this address from either the compiler or the linker.

atari.st/tech #57, from jim\_kent  
a comment to 56

I read in an addendum to my developer's kit (November 1985 or so) that in fact the start-up routine freed up almost all of memory and doing so was the cause of the problem. In any case I have since switched to the Lattice C compiler. Its start-up leaves your program with all but 4K bytes. Malloc calls seem to function well. I wrote a little C preprocessor (long story, it was a front end to a menu-maker package) just last week using lots of dynamically allocated memory with no problem.

Unfortunately, there was a file trashed in all versions of Lattice C that I could get my hands on—clib.bin. This is forcing me to use the "-t" option to produce .o output so I can use link68, the DRI linker. My general impression of Lattice C other than this has been a massive improvement in compile time, error reporting, and symbol size (31 characters) over Alcyon.

atari.st/tech #66, from mmanlove  
a comment to 56

This is just a hip-shot (I haven't read the remaining comments yet), but the standard C "sbrk()" function seems to be implemented. Would this give the end of the program itself or the end of all the memory that TOS handed over to it? I'll do some experiments.

atari.st/tech #67, from cheath  
a comment to 66

We had some problems with those memory management functions, too. I'll see if I can get my partner, the ST hack, to tell me what he figured out about them.

atari.st/tech #73, from jtuermer  
a comment to 56

If you have the developer's kit, you should look at a file called APSTARTS (if it is included in your version). Or look at the source of whatever module you mention first in your link run. It starts by adding up the length of text, data, and uninitialized data segments. This information comes from the base page. The address of the base page is handed over as 4(A7) to any program. The length of the base page

(continued)

# NEW 640K ON IBM/XT MOTHERBOARD for \$ 39.95 \*

Now you can have 640K Ram memory on your IBM XT motherboard without using any slots or taking any power. Easy to install two prom chip set lets you replace two banks of 64 chips with two banks of 256K chips, right on your motherboard!

- NO software or changes needed. NO soldering.
  - Works like a memory card but costs much less!
  - Requires two banks of 256K Ram memory.
  - Memory is checked and counted by IBM's built in P.O.S.T.
  - Satisfaction Guaranteed or your money back.
- MOTHER-MEM/XT Prom set with instructions ..... \$49.95
- \* \$10.00 rebate when you send in your old 64K chips
- Set of two banks (18 chips) 256K Ram memory tested and burned-in ..... \$64.95.
  - Add \$2.00 shipping. Check, COD, MASTERCARD, VISA
  - TOLL FREE ORDERS: (800) 541-2255 wait for tone, then dial 4314311 (touch tone only)

DEALERS INQUIRIES WELCOME.



12062 S.W. 117 Court  
Suite 121  
Miami, Florida 33186



Dept. B-01

**COMPETITIVE EDGE**  
631 S. MAIN ST. • PLYMOUTH, MI 48170 • (313) 451-0665  
**FEATURING S-100 COMPONENTS FROM:**

<b>COMPUPRO®</b>	RAM 22 <sup>cm</sup> \$446	CPU 286 <sup>cm</sup> \$671
	DISK 1A <sup>cm</sup> \$446	MDRIVE-H <sup>cm</sup> \$371
<b>EARTH</b>	TURBOMASTER 256K W/HDC	\$895
	TURBOSLAVE-1 8MHZ 128K	\$395
<b>LOMAS</b>	THUNDER 186 \$895	256K STATIC \$412
	COLOR MAGIC \$476	NVDISK 512K \$371
<b>TELETEK</b>	SYSTEMASTER®II 8MHZ 128K	\$795
	SBC-1 6MHZ 128K \$350	HDC \$375

**ALSO FEATURING OUR AT COMPATIBLE:**

**VELOCITY 286**

10 MHZ OPERATION  
1024 K ON  
MOTHERBOARD • 20MB  
FAST HARD DISK HI RES.  
MONOCARD STANDARD •  
1.2MB FLOPPY DRIVE  
WITH DOS 3.1 **\$3095**

**MONITOR EXTRA** OPTIONS:  
UP TO 16 MEGABYTES OF MEMORY •  
ENHANCED GRAPHIC ADAPTERS •  
HARD DISK SUPPORT TO 240MB SCO  
XENIX® SYSTEM FIVE • AUTOCAD  
READY SYSTEMS • 3278/79  
TERMINAL EMULATION

**ALSO**  
**CE 20MB XT W/512K**  
**\$1095**

*Includes floppy, hard disk, 512K memory, monocard w/parallel monitor.*

CompuPro, Ram 22, Mdrive-H are either trademarks or registered trademarks of Viasyn Corporation. Systemaster is a registered trademark of Teletek Enterprises. PC AT is a trademark of International Business Machines. Xenix is a registered trademark of Microsoft. uniPATH is a trademark of Pathway Design, Inc., SCO is a trademark of THE SANTA CRUZ OPERATION. Autocad is a trademark of Autodesk, Inc.

Now it costs even less  
to look good.



Wordstar 2000 is a trademark of MicroPro International Corp. Epson is a trademark of Epson America, Inc.



The Cordata Desktop Printshop™ has always been the best value in PC-compatible laser printers.

With speed and flexibility that the others can't match.

For example, we put 38 type fonts on diskette, not expensive cartridges. And let you mix up to 32 fonts in a single document. Automatically.

A high-speed graphics interface transfers data up to 30 times faster than Hewlett-Packard's LaserJet +, and because most Desktop Printshop features are implemented in software, they're easy to update.

And because Epson™ emulation is standard, the Desktop Printshop has a ready-to-run solution for many programs that other laser printers can't use.

But now the Desktop Printshop is an even better value.

A new forms design software program comes with the Desktop Printshop that lets you create documents quickly—and easily—using pull-down menus, not complicated commands.

We've also included the industry-acclaimed Wordstar 2000™ word processing program. So you can start producing near-typeset quality memos, reports, and correspondence right away.

Last, but not least, we've lowered the price of the Desktop Printshop to \$2995, including forms design software, Wordstar 2000 and 38 fonts on diskette.

So don't settle for just any laser printer. Demand the Desktop Printshop.

All it takes is a call to Cordata at: (800) 621-6746 (in CA: (805) 495-5800; in Canada: (604) 984-0641) for the name of your nearest Desktop Printshop dealer.

After all, how can you afford not to look your best?

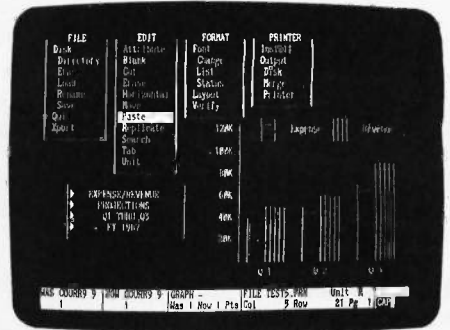

# Not to mention being easier.

## The Desktop Printshop™

CORDATA, 275 E. Hillcrest Drive, Thousand Oaks, CA 91360  
TELEX 650-2696270; in Europe: Holland 032-18111

 **cordata**  
formerly  **corona**  
data systems, inc.

Inquiry 95

(\$100) is also added to the total program length. A SetBlock (BDOS \$4A) then reduces the total space allocated for the program to this amount. You can change this start program or make a Malloc in your program to get more room. Someone told me that the DRI C compiler makes its Malloc allocations in the third segment (BSS). But the length of this segment is initially set to zero.

### NDC COORDINATES

atari.st/tech #74, from jruley

I've just finished a frustrating couple of hours with Hippo C, trying to make my graphics terminal program resolution-independent. The Abacus GEM book lists an option on the open virtual workstation function for NDC instead of RC screen coordinates, but this does not appear to work. Is this a problem with Hippo C or with the ST?

atari.st/tech #75, from neilharris

a comment to 74

NDC coordinates are not supported on the ST version of GEM.

atari.st/tech #83, from timoren [Tim Oren, KnowledgeSet Corp.]

a comment to 74

You can't use NDC with the ST's VDI, because it doesn't have a full GDOS implemented. That also prevents you from opening workstations on other physical devices (other than the screen) and prevents doing loads of new fonts. Atari is supposed to be testing a RAM-resident GDOS which will work by stealing the VDI trap. The MiGraph EasyDraw package uses an early version of the GDOS.

### GRAPHICS PROGRAMMING

atari.st/tech #79, from jruley

Help!

I am still, unfortunately, programming in good ol' Hippo C with the wonderful Abacus documentation. I need to do two things:

1. Read out the currently set color palette values. I can get the RGB representation of these values using one of GEM's inquiry functions, but how can I convert the RGB values to the color numbers (0-511)?
2. Save and restore the screen—specifically, I need a way to avoid the ugly gray blob that appears when the "fset\_input" function's dialog box disappears from the screen. I can do this by getting the screen address using "physbase" and treating the screen as an array, but the documentation led me to believe that I could use the "vro\_cpyfm" function to do this.

So far as I can tell, the blasted function does not do anything. Here's how I am trying to use it:

```
static short int handle, screen[8], *sMFDB, *dMFDB;
```

usual GEM set-up

```
screen[0] = 0;
```

```
screen[1] = 0;
```

```
screen[2] = 639;
```

```
screen[3] = 399;
```

```
screen[4] = 0;
```

```
screen[5] = 0;
```

```
screen[6] = 639;
```

```
screen[7] = 399;
```

```
vro_cpyfm(handle,3,screen,sMFDB,dMFDB);
```

all sorts of stuff, including fset\_input

```
vro_cpyfm(handle,5,screen,sMFDB,dMFDB);
```

My understanding from the documentation is that the first call to vro\_cpyfm should save the screen to a memory area and that the second call should restore it. This is not happening—in fact, I've tried

several variations, and so far as I can tell, the function simply does not work! Any suggestions?

atari.st/tech #80, from jim\_kent

a comment to 79

Well, I can maybe help you some with the first problem. Presumably, the 0-511 value is a 16-bit word divided into four 4-bit nibbles: 0 red green blue.

Personally I don't use GEM much, but try this:

```
atari_color_reg = gem_color_reg -> r*(1<<8) +
gem_color_reg -> g*(1<<4) +
gem_color_reg -> b;
```

Or maybe the same thing with the r, g, b reversed. You also might need to scale down (probably divide by 16) the GEM component values before you fold them into the register value.

atari.st/tech #84, from jtittsler [Jim Tittsler, Atari Corp.]

a comment to 79

I don't know how you get there from Hippo C, but if you can do an extended BIOS call, you can also get the value of each palette register. The extended BIOS call 7, setColor(colornum, color), sets the color register colornum to the given color. The old color is returned (and if "color" is negative, the hardware register is not changed, so there is a nondestructive way of inquiring the value of each of the palette registers).

From Hippo C, can you do something along the lines of: for(i=0; i<16; ++i) colorreg[i]=xbios(7, i, -1);?

atari.st/tech #85, from jruley

a comment to 84

No, you can't using Hippo. But as I'm writing my own XBIOS, that'll work just fine—thanks!

atari.st/tech #86, from jruley

a comment to 85

Well, I went off and tried it—looks like it'll work!

Anybody else out there still using Hippo? If so, I'll post my XBIOS routines in Listings.

### POWER PROBLEMS

atari.st/questions #2, from dbetz

I have a new Atari 520ST and have been having some problems that seem to be related to the power supply. Whenever the machine is running, the display jitters. I don't think it is related to the power in my house, since I have used many other computers without any similar problems. Also, my ST seems to be very sensitive to static electricity. I have it set up in my living room and whenever I walk across the carpet, I get a burst of "key clicks" from the ST, and if I am in an editor, I get a burst of garbage characters on the screen. I suspect that the problem is related to the power supply. Anybody have any idea what the problem is or what I can do about it?

atari.st/questions #9, from neilharris

a comment to 2

Are you running a monochrome monitor? If so, a color monitor in close proximity will cause some screen jitter due to 60-Hz vs. 71-Hz beating. Just turn off the other monitor.

atari.st/questions #10, from dbetz

a comment to 9

I was running the monochrome monitor and didn't have any other



monitors (color or otherwise) anywhere near the one I was using. I tried this in several locations in my house, so I don't think it was because I was too close to some sort of RF source. I have never had any trouble with any of the other computers I've used (including an Atari 520ST that I borrowed for a while). It really seems like this problem is related to the power supply or the main keyboard unit (I tried a different monochrome monitor also). Neil, thanks for your suggestion, but I don't think it's the source of my problem this time.

atari.st/questions #13, from mmanlove  
a comment to 10

I had a similar problem with the color monitor at first. Moving the CPU power supply away from the monitor (like, down on the floor) took care of it. Don't know if this could be the problem with the mono monitor, though.

atari.st/questions #14, from dbetz  
a comment to 13

Thanks for your suggestion. I didn't think of the possibility of interference from the power supplies. I had all three of them stacked right in back of the monochrome monitor! I don't have the machine anymore, so I can't check your theory, but I'll call the people that I sent it to tomorrow and suggest that they try it.

## IBM PC AND COMPATIBLES

The summary of events in the IBM conference this month includes a discussion on the V series of microprocessors, coping with hard disk problems, memory expansion for the PC XT, Trojan Horse programs, and programming the IBM 5550 Japanese PC.

### V20 HARD DISK PROBLEM

ibm.pc/pc.hardware #629, from lowellt [Lowell Tuttmann]

I thought that I would relate an interesting V20 experience I had in the last week. I got a "General Failure reading drive C:" on my 22-mega-byte hard disk (Micro Design) and decided it was time to reformat and reload the disk. At this time I had a V20 in place. I ran a good backup (32 floppies' worth) and then reformatted the disk. All was going well at this point. After restoring the files (many hours later) I found that I got "Parity check 2" at boot time on the hard disk. I was able to boot from a floppy and then go over to the hard disk without problems but definitely no boot. I replaced the 8088, reformatted the disk, reloaded it, and was able to boot OK with the 8088 in place. I then put the V20 back in and all is still fine. The boot process works fine, as does everything else. It is curious that I can format floppies with the V20 in place but not the hard disk.

ibm.pc/pc.hardware #631, from ucivms725 [John Leonard]  
a comment to 629

I had the same problem when I reformatted my hard disk. The problem was narrowed down to the RESTORE procedure. When I backed up my hard disk, I also backed up the hidden system files of DOS (a package deal when you back up the entire hard disk). When restored over the top of the newly formatted hard disk, these hidden files overwrite the already existing DOS files from the format. My disk would not boot from the hard drive, but the files were there A-OK if the system was booted from a floppy. I found two solutions: Back up each hard disk subdirec-

tory one at a time (if you can remember them) or unhide the two system files from the first backup disk and delete them.

My V20 is working perfectly, there appears to be no problem with any operation, and I found that when used in conjunction with an 8087 I cut the processing time of a large SPSS-PC (statistical program) run from 63 minutes to 13 minutes! (I would not have believed it had I not had a copy of the printout with the start and end times right in front of me!)

ibm.pc/pc.hardware #633, from naro [Richard Naro, NEC Electronics]  
a comment to 631

I would be interested in hearing the details of benchmarks with the V20. While it speeds up its internal operations, the only effect it can have on an 8087 is the time spent computing the effective address.

My guess is that much time is spent doing integer multiply/divide and string operations, which are highly optimized on the V20/V30 microprocessors.

ibm.pc/pc.hardware #634, from naro  
a comment to 629

Format routines are notorious for having CPU timing loops. My guess is that the format routine is the cause of the problem, but this is the first time I've heard of it on a hard disk. The 765 floppy disk controller chip is much more susceptible to this problem.

ibm.pc/pc.hardware #635, from conniek [Conrad Kageyama]  
a comment to 631

I don't know which DOS you are using, but in 3.x, there is a /P switch to the RESTORE function which will prompt you before replacing any existing files.

ibm.pc/pc.hardware #636, from lowellt  
a comment to 634

I think that the problem I had was what was described in message 631. The system files *were* restored over the newly formatted one, and I did get a DOS error message saying "target disk may not be bootable". I was curious about its being a timing loop because my floppies were fine after formats with the V20.

By the way, I ran all the benchmarks in the "V20.arc" files from NEC and I'll be glad to post the benchmark times that I got as soon as I can find the printout.

ibm.pc/pc.hardware #638, from dgookin [Dan Gookin]  
a comment to 635

Sometimes, depending on your flavor of MS-DOS, /P prompts *only* for hidden or system files. Very misleading and somewhat pointless.

ibm.pc/pc.hardware #639, from billn [Bill Nichols]  
a comment to 638

/P is supposed to prompt for two things: attempting to overwrite a read-only file or attempting to overwrite a file of the same name but a later date. Both cases work (for me) and are valuable. /P is necessary to avoid clobbering the hidden system files. If you skip /P but restore over them, you may not be able to reboot.

ibm.pc/pc.hardware #642, from lowellt

I think I'm a little confused about the V20 and the V20-8. I gather that these are the 4-MHz and 8-MHz versions, respectively. What happens if you put a V20-8 into a regular PC?

(continued)

ibm.pc/pc.hardware #643, from naro  
a comment to 642

Early versions of the V20/V30 that were marked with no speed info were 8-MHz devices. Currently, devices are marked as follows: 70108-5 = 5 MHz; 70108-8 = 8 MHz; 70108-10 = 10 MHz.

The latest mask level is M (it is found in the date code). This level is fully compatible with the 8086/8088 it can replace except for the -10 devices. This is because it is difficult for CMOS to use a 33% duty-cycle clock, so the 10-MHz devices still require a 50% duty-cycle clock (although below 9.5 MHz they are OK).

The device speed is only the clock at which the manufacturer will guarantee operation and does not affect the throughput of the micro-processor. The most noticeable impact will be on your wallet since there are price premiums for faster devices.

ibm.pc/pc.hardware #648, from billn  
a comment to 643

Do you have access to info on V60 and V70 chips? I'm interested in comparing them with the 80286 and 80386 on a performance basis. Thanks.

ibm.pc/pc.hardware #649, from naro  
a comment to 648

Yes, but the information is not in a form easily distributed yet. Send BIX mail with a request to be added to the mailing list, and I will send out information as it is published.

As for performance, the V60 can do 2 to 3 MIPS [million instructions per second]—but remember that a MIPS is not constant from machine to machine—and the V70 can do 4 to 6 MIPS. I prefer elapsed time as a better measure of performance. For example, the V60 floating point can do 32-bit reals in under 5  $\mu$ s (divide in under 8  $\mu$ s), and there is no penalty for the MMU [memory-management unit] since it is included in the internal pipeline.

### HARD DISK POWER FAILURE

ibm.pc/pc.hardware #667, from asantic [Alexander Asantic]

I have a Rodime 20-megabyte full-height drive in an expansion unit attached to a PC. I've been having a problem lately with the disk drive spontaneously losing power while in use. This has never happened in many months of use but appears to be occurring with greater frequency as time goes by. So far, no damage to the disk or the data on it.

It seems that a circuit breaker is tripping for some reason and probably needs to be replaced. The expansion unit has a very adequate 135-W power supply, and only one slot is filled. This slot contains a modem that has been there from the beginning. No other part of the computer besides the drive itself is affected when this problem occurs, and cycling the system power brings the disk back up.

The longer the system has been running, the more reliable the hard disk appears to be, so I am currently leaving the machine on 24 hours a day to insure that some important work gets done by Thursday. That's Murphy's Law for you! Anyway, any suggestions as to how to go about diagnosing/solving the malfunction would be appreciated.

ibm.pc/pc.hardware #668, from bbrown [Bob Brown]  
a comment to 667

Does your disk have a "power delay unit" between the power cable and the disk proper? This is a gizmo which is intended to "sequence" the hard disk on after the rest of the circuitry is stable, primarily to limit the amount of current drawn from the power supply at power-up.

Power sequencing is quite common on "real" computers, and a flaky sequencer can drop the attached device and anything that's "behind" it on the power circuit. I've never seen a power delay on a micro, so I

don't know what to tell you to look for to discover if you have one, but I know they exist because my MicroKit HD lists such a thing as an option in the documentation. If you've got one, I suspect it could cause the problems you are seeing, and I'm pretty sure you don't need it with your expansion box almost empty.

Anybody know what one of these jobbies looks like?

ibm.pc/pc.hardware #670, from billn  
a comment to 667

Circuit breakers also trip due to overheating and voltage spikes/surges. Are you using unfiltered power? If so, get a spike filter at least to protect your equipment. Breakers also get old and trip for no reason. It should be cheap to replace.

ibm.pc/pc.hardware #676, from asantic  
a comment to 668

Interesting suggestion! If there is a sequencer, it doesn't appear to delay power-up for very long, and it would have to be built into the innards of the drive chassis somewhere. I don't see anything likely-looking in plain sight. I still suspect a circuit breaker, but I haven't dismounted the unit yet to look around. I'm not really sure what to look for. There's something that looks like a relay in partial view (small case, clear plastic, metal inside), and I hope that's not the bugger causing the disk to crap out because he's soldered to a board. Thanks for the reply.

ibm.pc/pc.hardware #677, from asantic  
a comment to 670

The power is filtered, and there has never been a problem with power quality before. Overheating is unlikely since the drive becomes more reliable after the system has been powered up for a while. The expansion unit has a hefty power supply and lots of room and ventilation. (Sigma DynaFrame—ever meet one? Built like a tank.)

On the circuit-breaker assumption, how would you suggest I proceed?

Oh, by the way, there's a click when the power cuts out, and sometimes a click when the drive powers up.

ibm.pc/pc.hardware #678, from billn  
a comment to 677

That click could be most anything. One possibility is that the load in your expansion box is too small. The power supply puts out x watts, most of which has to be dissipated as heat. The regulators overheat and automatically cut out to prevent damage. Test: Move a peripheral board into the expansion box (not memory). Second possibility—flaky breaker. Breaker cuts out due to overheating because of high-resistance contacts. Test: Next time the system cuts out, *carefully* put your fingers on the breaker case. If it's more than warm, replace it. Third possibility: Check the grounding. But try the other two first.

ibm.pc/pc.hardware #682, from bbrown  
a comment to 676

Sequencers on real computers delay for several seconds, long enough for drive motors to reach 80% of full speed. I'd expect a "delay" on a PC disk to hold power for a second or so, long enough to notice. I'd also expect it to be separate from the drive proper.

ibm.pc/pc.hardware #683, from smack [Steve Mack]  
a comment to 677

I have just started using Rodime drives, and while I have not had the specific problem you mentioned, I have noticed a defect in these drives that might cause such a problem. The shock-mounted drive/printed-



circuit-board assembly is attached to the mounting frame in such a way that the pins on the underside of the PC board extend to or below the mounting frame at one point. They could easily short to the cabinet's mounting frame, possibly happening due to vibration/head movement or due to the gradual deterioration of the rubber shock mounts and consequent settling.

Who knows what shorting out random drive logic pins might cause? I always insert washers between the drive frame and cabinet frame to keep the PC board pins just enough farther from shorting that I can sleep well. Paranoid but plausible.

PS.: I should mention, I use 30-megabyte, not 20-megabyte, so the layout may differ.

### **HARD DISK SINGS THE BODY ELECTRIC**

ibm.pc.pc.hardware #672, from mhaas [Mark Haas]

My hard disk has recently started chirping. It's a high-pitched squeaky sound that comes, usually briefly, and then goes. If I press gently on the rear shock mounts (between the drive and its chassis), the chirp stops. The drive is a new Microscience 20-megabyte unit, and so far this seems to have no effect on the drive's performance or reliability.

Anyone have any suspicions about this? Should I be worried or just get out the screwdriver?

ibm.pc.pc.hardware #673, from dondumitru [Donald Dumitru]  
a comment to 672

My SysGen 30-megabyte (in an IBM PC) started chirping a couple of months ago. I set it out on a table with a power supply and fiddled until I found what piece was vibrating. Then I took a piece of tape and just taped the annoying part to the drive's frame with a bit of tension. (This assumes the chirper isn't a moving part.) Haven't heard it chirp since!

ibm.pc.pc.hardware #681, from conniek  
a comment to 672

I'd suggest checking all the screws first, naturally, but most likely the source of your squeak is the antistatic spring on the bottom of the drive, attached to the spindle. If you just tweak it a tad to change the tension on it, your noise should go away. At least that's the problem on most of the Microsci 20s.

ibm.pc.pc.hardware #688, from jshifrin [Jerry Shifrin]

One suggestion I've heard (but not tried) is to run the drive on its side for a while, presumably to move the lubricant around a bit.

ibm.pc.pc.hardware #689, from mhaas  
a comment to 681

I'll check that out as soon as possible. The chirping sound seems to be worst when the machine is dead cold, when it's first turned on. The noise essentially disappears after several minutes and then only occasionally reappears briefly. Is that consistent with the antistatic spring you mentioned?

ibm.pc.pc.hardware #690, from mhaas  
a comment to 688

This raises another question I have about hard disks. Are hard disk drives designed specifically to be mounted either horizontally or vertically? Thus, would you have to choose a specially designed drive to add into a Compaq Portable (vertical mount)? Can you have problems if you mount a PC with a hard disk vertically, as with one of those Curtis stands?

ibm.pc.pc.hardware #691, from barryn [Barry Nance]  
a comment to 690

I'm embarrassed to say this, but I installed my 20-megabyte disk upside down. Once I found out, I didn't bother to turn it around. It works just fine in that position, and I'm not going to tamper with success.

ibm.pc.pc.hardware #692, from conniek  
a comment to 689

I can't say for sure on that one. Now it's beginning to sound more like a bad bearing/bushing, though it could simply be a matter of the frequency of the vibration of the antistatic spring changing with the temperature.

ibm.pc.pc.hardware #695, from conniek  
a comment to 690

Well, the drives are supposed to be tested in all planes, but, really, you can do only so much to compensate for gravity. The word that I got was that you should do the low-level FDISK and FORMAT with the drive in its intended position, i.e., if you plan to set the machine on its side on the floor, then do all of the above with the machine in that position. I understand that this was very critical with the earlier CMI drives in the AT.

ibm.pc.pc.hardware #704, from petewhite [Pete White]  
a comment to 690

My Seagate has been running in a vertical configuration for over three months without being powered down for more than a few hours. Nary a problem, yet.

ibm.pc.pc.hardware #705, from petewhite  
a comment to 689

I have an external drive with a spring that exhibited the same noises, the same way. Drove me bananas! Turned out to be the antistatic spring. (Where were you when I needed you, Connie?)

ibm.pc.pc.hardware #706, from mhaas

Cure found for dreaded chirpies. Yes, a cure has been found for that dreaded disease inflicting thousands of hard disks, the chirpies. Connie was right. I removed the hard disk from the chassis, turned it over, and bent back the small brass spring that contacts the platter spindle. This relieved some of the springiness, just a tad, and cured the chirpies. Thanks, Connie.

For those with similar symptoms, don't bend the spring enough to actually deform it. You just want to reduce the spring's pressure on the spindle a slight amount.

### **MEMORY MODIFICATION**

ibm.pc.xt.hardware #102, from jkilgore [Jerry Kilgore]

I recently acquired a how-to note that had been extracted from a bulletin board somewhere. By adding an LS-158 chip, closing a jumper, and replacing the chips in banks 0 and 1 with 256K chips, I have 640K on the motherboard of my XT. Does any one know (1) why this works and (2) will it harm anything? The XT tech manual shows the empty LS-158 chip socket and the jumper but makes no other comment.

ibm.pc.xt.hardware #106, from dono [Donald Osgood]  
a comment to 102

Later-model XTs come with that capability built in. They don't mention it  
*(continued)*

because they want to sell you the memory, I suppose. It certainly is a normal capability of recent-vintage XT's.

ibm.pc/xt.hardware #111, from conniek  
a comment to 102

We have a number of members using that mod, and the file, I believe, was probably called MB640K or some such. That particular file, if I am correct, involved soldering an additional jumper, which is a little scary to me. There is a later mod that involves simply adding an additional chip to an empty socket, which negates the need for the soldering. Unfortunately, I don't recall the chip number.

ibm.pc/xt.hardware #112, from dondumitru  
a comment to 102

I have 640K on the motherboard—exactly as described in that mod. The modification involves (1) soldering a jumper between two solder pads (there just for the purpose of soldering a jumper to); (2) inserting a "decoder/multiplexer chip" into an empty socket (sorry, I don't remember the chip number); and (3) putting 256K chips into banks 0 and 1. Ta, dah! 640K for minibus. For an XT, this has to be the *best* way to upgrade your memory. For me, memory and the decoder/multiplexer cost around \$80. I had it installed in less than 45 minutes.

ibm.pc/xt.hardware #114, from rschnapp [Russell Schnapp]  
a comment to 112

I have the text of that mod in my SideKick Notes file. The mux chip is a 74LS158. If you'd like me to repost it (I don't know the original author's name or the message number), I will.

## AVOIDING TROJAN HORSES

ibm.pc/pc.software #632, from mwelch [Mark Welch]

I am uploading to the Listings conference a nifty little program called CHK4BOMB (in a file called CHK4BOMB.ARC). This program goes through a program and lists out all ASCII strings and *also* checks the program to see if it is doing any direct disk accesses through the ROM BIOS. In other words, it checks to see if a program that shouldn't be going to the disk drive actually does. I just ran it on a nifty-looking disk directory utility, and it came up with the following warning message (after listing out all the ASCII strings in the program):  
[clipped from output of CHK4BOMB.COM]

\*\*\*\*WARNING\*\*\*\*

This program uses the ROM BIOS routines for direct disk access. This program COULD format a disk or write to certain sectors without updating the directory or File Allocation Table. DO NOT RUN this program until checked by an expert, unless you are familiar with the author or company.

\*\*\*\*WARNING\*\*\*\*

This program writes to absolute sectors. The possibility exists to overwrite important data!

ibm.pc/pc.software #633, from petewhite  
a comment to 632

Sounds like a program that should be described in the Sysops conference. I'll have it as soon as it's listed; thanks for bringing it over. Right now I use the utility program ASCII to list and another utility to lock out disk access when testing. This one sounds a bit more simple to use.

ibm.pc/pc.software #635, from barryn  
a comment to 632

That does sound nifty. But I bet it would go nuts on Norton's Utilities.

ibm.pc/pc.software #639, from mwelch  
a comment to 633

Tell me about (and tell me where to get) the utility to lock out disk access when testing. I've heard that there is a program that tells the system that there is no hard disk; I would like to get that.

ibm.pc/pc.software #647, from conniek  
a comment to 632

We've been using it for some time now, and it is definitely handy. However, it's a tad slow, so what I usually do is to redirect its output to a file so that I can start it up and go away. Then a quick LIST of the output file does the trick if anything less than kosher is in there.

ibm.pc/pc.software #653, from petewhite  
a comment to 639

It's on the Cul-De-Sac, (617) 429-1784. File named DPROTECT.ARC. It tells you if anything wants to write to disk and locks it out so it can't. I'll have it in Listings as soon as a few problems are addressed. (In the Cul-De-Sac it's in Misc. Utilities #2, File #65—1 minute at 1200 bps.)

## IBM 5550 (JAPANESE PC) HELP!

ibm.pc/pc.software #748, from gperfect [George Perfect]

We are currently working on some windowing software for the IBM 5550 (Japanese PC) and have a small problem (apart from not understanding Japanese!).

We would like to display kanji—2-byte—characters on screen without using the BIOS. That is, we would like to place the character codes directly in the screen buffer and avoid the speed penalty incurred when using the BIOS calls.

To date, all attempts to do this have failed miserably. If anybody can assist with information or suggestions on speeding the display of kanji characters, I would be most grateful.

ibm.pc/pc.software #750, from barryn  
a comment to 748

George, there's some material in the Pascal conference that's related to direct-screen I/O. The assembler conference (topic cpu8088) has some as well, I believe. Neither set of material talks about kanji in particular, but you may be able to make use of the data anyway.

Two questions: What's the layout of the video memory (screen buffer) for kanji, especially in relation to the usual—English—layout of character/attribute byte pairs? And exactly what happens when you try writing to the screen—what symptoms do you get?

ibm.pc/pc.software #766, from gperfect  
a comment to 750

Thanks for the info. I think we understand how to write to a normal screen buffer (we do it all the time on other machines), but the problem with kanji is different. Kanji characters are stored in 16 bits—normally treated as 2 discrete bytes. The first byte (if within certain ranges of high-order ASCII, i.e., > 127 decimal) acts as a lead-in to tell the display software that the next byte will complete a 16-bit kanji code. With regard to the buffer format, it is basically the same as a standard PC (i.e., first byte for character code, second byte for attribute). The standard procedure for writing characters to an IBM screen buffer works for display of ASCII characters and single-byte Japanese (kana characters mainly), but the process fails with 2-byte codes.

The 5550 has a second display buffer which appears to work in APA graphics mode at all times. It appears that the BIOS fills this buffer with the FONT image of each character—read from disk if necessary (another small problem)—and, so far, we have only succeeded in making this happen by sending kanji characters via the BIOS calls.



Our problem is that we do not understand the operation of the 5550 BIOS (IBM does not publish it) and so cannot fathom the format of the character-display buffer or even if it is used by the BIOS in the display of kanji at all. There is a wealth of technical information available for the 5550 and several good books, but our Japanese partners have fought shy of translating it for us.

In terms of symptoms, our main problems are speed (using the 5550 BIOS is *extremely* slow) and clipping of characters on window boundaries, i.e., if a 2-byte character straddles a window border. The second problem is solved with a little searching (and a few curses at the JIS codes, which could make the process of identifying kanji mixed with single-byte characters much easier), but the first is a real problem to windowing software.

Right now, it would be a great help if someone who really knows the 5550 could tell us that what we want to do is impossible—at least we would save the effort of trying. Ideally, if somebody has worked the machine and knows the literature, we would appreciate a pointer to the answer. Thanks again for your help.

*ibm.pc.pc.software* #769, from *barryn*  
a comment to 766

I've never seen the Japanese PC, so I'm on thin ice here. All I can tell you is how I'd approach the problem if I were in your shoes.

I think you hit the nail on the head when you say the problem is the mystery of what the BIOS is doing—obviously it *works*, it's just too slow.

What do you think of this idea? Locate the Interrupt 10H vector in lower memory (assuming, as on a regular PC, that it's the one doing video-related functions) and use either DEBUG.COM or a product like ASMGGEN (available here on BIX in the IBM section of the Listings conference) to reverse-assemble the BIOS code that's pointed to by the Int 10 vector. Print out the result and go through it, analyzing the code for video-buffer updates and accesses. This process should eliminate the mystery of what the BIOS is doing.

Then you can proceed to use what you've found out to construct your own video-memory-buffer control routines and bypass the BIOS code for the too-slow functions.

## MACINTOSH

This month the Mac conference covers questions about hard disks, a debugger, a font, and some hints on using Word. There are also some questions concerning the Mac Plus.

### REQUEST FOR SCSI INFORMATION

*macintosh/hardware* #77, from *cfuller* [Clayton Fuller]

SCSI Info?

Where can I find more information on the SCSI standard? A source for the published standard would be nice, but if there are any articles describing its use, that would be better.

*macintosh/hardware* #79, from *tcantrell* [Tom Cantrell]  
a comment to 77

There are two SCSI info sources:

ADSI (Adaptive Data Systems Inc.)

2627 Pomona Blvd.

Pomona, CA 91768

(714) 594-5358

ADSI has a very complete *SCSI Guidebook*.

NCR Microelectronics Division  
Logic Products Marketing

1635 Aeroplaza Drive  
Colorado Springs, CO 80916  
(303) 596-5612

Ask for all info on the NCR 538x SCSI chips

[Editor's note: ADSI's SCSI Guidebook costs \$16.95 plus tax and/or shipping costs.]

### MACAPP, MUSIC DRIVERS, MAC PLUS COMPATIBILITY, AND TMON

*macintosh/softw.devlpmt* #145, from *smpuyol* [Robert Puyol]

About MacApp

I'm a certified developer in France, and I have two questions. What is the latest MacApp version? (Mine is 0.3, a Pascal Workshop alpha release.) Are Macintosh MacApp and Macintosh Smalltalk available?

*macintosh/softw.devlpmt* #146, from *mondrejko* [Michael Ondrejko]  
a comment to 145

There is a Smalltalk available for the Macintosh from Apple, mostly unsupported, but for \$50 definitely worth it. For an order form, contact: Smalltalk Request, c/o Eileen Crombie, Apple Computer Inc., 20525 Mariani Ave., Cupertino, CA 95014.

*macintosh/softw.devlpmt* #147, from *dsharp* [Doug Sharp]

Mac Music Driver?

Anyone know of a good way to output good multivoice music from a Mac program? I have heard Jazz Musician-Jam Session and got real excited until I heard what they wanted to license it for. I'd like a driver that could take a MusicWorks or Deluxe Music Construction Set type of file as input so I could use a decent editor to try out the sounds. It can't be purely digitized tunes because of memory-size and processor-use considerations. Any hints or pointers would be accepted.

*macintosh/softw.devlpmt* #148, from *petter* [Petter Gustad]

What is the latest version of Megamax C (any after v2.1)? Has anyone seen an updated version of Edit that runs on the Mac Plus?

*macintosh/softw.devlpmt* #150, from *tom\_thompson* [Tom Thompson, Technical Editor, BYTE]  
a comment to 148

I don't know about Megamax C. I *think* the MDS editor works on the Mac Plus, but I haven't used it sufficiently to be sure. Stuff that I've checked so far:

Application or Desk Accessory	Finder version #
MockWrite 3.0, 4.0	4.1
Macintosh Pascal 1.0	1.1g
Consulair Mac C 4.0	4.1

The MDS editor refused to print to the Imagewriter II on the Consulair disk, but that may be due to the super-stripped system file on the disk. MockWrite wrote to the Imagewriter II with no problems.

Oddly enough, TurboControl, with autostart set, didn't cause a crash on the Mac Plus. I can only conclude that it has something to do with the "old" Finder (4.1). It will be interesting to try it with the Mac Plus version to see what happens. I'm trying to do a compatibility study here to see what software will work without upgrades. Any info would be appreciated, as I want to see what impact it will have on the boxes of software I already have.

*macintosh/softw.devlpmt* #152, from *rkaapke* [Richard Kaapke]  
a comment to 150

I have used Bill Duvall's editor under Finder 5.1 with HFS. His editor  
(continued)

(MDS Edit) doesn't open files across HFS folders correctly. If you use the HFSOPEN patch program put into the public domain by Andy Hertzfeld, MDS Edit will open files correctly but save them to the "root directory" by using explicit filenames like "HD20:file".

macintosh/softw.devlpmt #153, from kschrucker [Kurt Schmucker]  
a comment to 145

I am also a MacApp tester/user. I think it is great. As a small test, I developed a program that uses multiple documents, the standard File and Edit menus, is compatible with multiple desk accessories, prints on the LaserWriter and the Imagewriter, and has all the standard window controls. Only 87 lines of (object) Pascal.

The first MacApp users meeting was held at the MacWorld Expo. About 50 people were there, and there was a high level of enthusiasm among many of the other MacApp users. Several serious applications were also shown: a shipboard navigation package, a re-implementation of MacPaint that supports multiple documents, auto-scrolling, and full-screen windows, and a crossword puzzle program.

Version 0.4 will be out soon. If you want an interim version (0.39) that lacks documentation and a couple of features, you can request it. Personally, I'd wait.

My guess is that after MacApp hits the street, it will be the *only* way to develop new end-user applications (end-user applications, not new device drivers or stuff like that) because it cuts your development time down so much (by a factor of 4 usually) and impacts your application (performance and space) so little.

macintosh/softw.devlpmt #155, from ccawfor [Chris Crawford]  
a comment to 153

I'm a little surprised at your assertion that MacApp impacts an application's performance and space so little. This certainly violates common experience with high-level languages. I attended a presentation on MacApp at a Software Entrepreneur's Forum meeting, and the lecturer seemed to acknowledge that MacApp did exact a considerable performance penalty.

macintosh/softw.devlpmt #156, from roberts [Guy Roberts]  
a comment to 148

I've been using Megamax C version 2.1b for about three weeks now on both a Mac 512 and a Mac Plus with no problems.

macintosh/softw.devlpmt #159, from ccawfor

TMON RAM Usage?

I am curious about using the TMON debugger. I have been using MacsBug for the last few months (before I got my Mac fattened I simply didn't debug—that's a tale of discipline). There seems to be a consensus that TMON is one of the best around, but I am curious about its consumption of RAM. How much disk space does it require? How much RAM does its resident portion require? Are there any constraints or gotchas in using it to debug production code?

macintosh/softw.devlpmt #160, from brecher [Steve Brecher]  
a comment to 159

TMON can take from 20K to 50K+ of RAM, depending on how you configure it and what "user area" (set of user-customizable routines) you use. Disk consumption is likewise variable depending on what you include/exclude (doesn't a guy like you have a hard disk?). I always have TMON loaded—it's my start-up application (I've altered it so that after loading the monitor it launches my "real" start-up application). Last time I used MacsBug was about 1947. Get TMON. Then get Darin Adler's public domain Extended User Area.

macintosh/softw.devlpmt #161, from kschrucker  
a comment to 155

Quantification of "little impact" = 10K to 20K in space and between 10% to -20% performance hit. (By that I mean the MacApp version can be from 10% slower than a non-MacApp-written application up to 20% *faster*.) Maybe I'm spoiled, but that seems like a good trade for a *big* reduction in development time.

macintosh/softw.devlpmt #163, from tom\_\_thompson  
a comment to 160

I've located the source for the Extended User Area and will upload it for you if you're interested.

macintosh/softw.devlpmt #164, from lloeb [Larry Loeb]  
a comment to 160

Darin's EUA fixes some minor TMON bugs as well. Gee, if it's not in Listings, I'll put it there.

macintosh/softw.devlpmt #167, from ccawfor  
a comment to 163

Yes, please do so; I just today ordered TMON from ICOM, so I will be very interested in the Extended User Area.

macintosh/softw.devlpmt #171, from hedges [Tom Hedges, Fractal Software]  
a comment to 147

Studio Session is supposed to sell for less than \$100, not a particularly high figure. It is due out by the end of April and would be your logical first step toward high-quality music output by the Mac.

macintosh/softw.devlpmt #175, from dsharph  
a comment to 171

I wasn't talking about a music program but a music driver to use from within a game I'm working on. If Studio Session is the same as the program I saw called Jam Session, then it is indeed a wonderful music machine, but the developers wanted mucho bucks to license a driver for developers. If they drop their prices considerably, I'd jump at it, but meanwhile I'm still looking for a good, reasonably priced Mac music driver.

macintosh/softw.devlpmt #176, from frankb [Frank Boosman]  
a comment to 175

I understand that MacroMind is now licensing code for developers to use in their programs. MacroMind produces VideoWorks and MusicWorks, and I seem to remember a sliding scale of royalty charges, up to a max of about 60 cents per unit. What they charge depends on what use you want to make of their code; it's handled on a case-by-case basis. Call the people at MacroMind for a MusicWorks driver.

macintosh/softw.devlpmt #177, from hedges  
a comment to 175

Oh, OK, I didn't think their retail price was that high. The music output code (which I have personally worked on) is sort of the "family jewels" of the Studio Session product, so it makes sense they don't want to license for cheap.

You can use a single digitized sound from SoundCap, a product from Fractal and MacNifty, but it would require lots more space if you wanted to output complex melodies. On the other hand, if you are content with sound effects and short bursts of music, the SoundCap digitized sounds might be the way to go. The SoundCap file unpack and output code is in the public domain and is posted in the Listings area.



macintosh/softw.devlpmt #178, from dsharp  
a comment to 176

I've talked to Mark Cantor of MacroMind, and they are licensing a VideoWorks driver with very minimal sound abilities for a reasonable sum. I am looking for a four-voice music driver. Sorry.

#### ANOTHER PROGRAM BUG

macintosh/softw.devlpmt #183, from ccrawfor

##### Odd Bug

I've got a pretty good programming problem here. I have a call to CautionAlert that causes the system to crash. It always crashes the system, with one exception: *if* I have installed MacsBug and *if* I crash the system once, get thrown into MacsBug, execute an Escape to Shell (ES) command, and then restart the program from that point, the CautionAlert will not subsequently crash. Moreover, I found that the crash occurs only when I set my program as the start-up program on the disk.

The ALRT definition in the resource file is fine and good, I checked it with the resource editor. So is the DITL for the ALRT. I thought that perhaps I wasn't initializing one of the many managers properly, but I am calling InitGraf, InitFonts, InitWindows, InitMenus, and InitDialogs, in that order, so it doesn't seem that I am leaving anything out.

This is not a make-or-break problem; I can leave the Minifinder as the start-up. I am curious, though, as to the cause of this odd little bug. Any ideas?

macintosh/softw.devlpmt #184, from brecher  
a comment to 183

You need to call TEInit.

macintosh/softw.devlpmt #185, from ccrawfor  
a comment to 184

Are you sure that I need to call TEInit? I am not using any part of the text edit package—at least, I didn't think that Alerts were part of the TE package. Am I wrong?

macintosh/softw.devlpmt #189, from ccrawfor  
a comment to 184

Oh, mortification! You were right! That's what I get for trying to save two lousy bytes that I thought were unnecessary because I wasn't directly using the text editor package. A great big OOPS!

#### INSTALLER TIP

macintosh/news #290, from lloeb

##### How to Fix the Installer

If you have read the errata to the latest Software Supplement (errata.wrt in Listings), you know the System Installer that Apple supplies wants to install 3.1 instead of 3.1.1. Here's how to rewrite the script to install the correct system file: Open System Installer with ResEd and find the INSC resources. In these resources there is a hex string that represents the date of the system to be installed. You paste here the date you got from the system you *wish* to be installed (by opening the destination system with FEdit and copying it from there). Save your changes (this *is* a backup disk, isn't it?). Open the Imagewriter (and LaserWriter if you have them) system files with ResEd again and paste the correct INSC resource (that hex date string) in those as well. Save your changes and you're done.

#### APL FOR THE MAC

macintosh/software #170, from jbaker [John Baker]

PortaAPL Version 3.0a

For the last two weeks I have enjoyed the immensely rewarding ex-

perience of working (day and night) with what may be the best "power user" problem-solving tool running on the Macintosh today.

I am speaking about version 3.0a of PortaAPL. The first two versions of this product, 2.0 and 2.1, were very satisfying pieces of software. The latest release pushes PortaAPL into the front line of top-quality APL systems. In my opinion PortaAPL is the best APL system buy on the market today. It compares very favorably in all respects to STSC's APL\*PLUS, the best MS-DOS APL.

At this point you may wonder who I am and what makes my opinion about APL systems worth anything. I run a small successful APL consulting firm in Edmonton, Alberta, Canada (home of the best hockey team in the NHL). My major clients are large mainframe APL shops in private industry, the Alberta government, and the University of Alberta. I have programmed in APL for over ten years.

Having worked on all of these systems, I can state without hesitation that PortaAPL is a very sound and thorough implementation of standard IBM VS/APL with many STSC extensions. It's the first complete APL system that costs less than \$300 and yet delivers the power and capacity required to run many mainframe-developed APL systems. I have ported hundreds of APL functions and one complete database system from VS/APL environments to PortaAPL with no difficulties or incompatibilities. Of course, the Mac cannot keep up with an Amdahl mainframe, but the amazing thing is this little interpreter is fast enough, running mainframe code, to still be useful.

If you want to experience *real power* on the Mac, do yourself a favor and get PortaAPL. You will not regret it. Take it from a very satisfied customer. PortaAPL is produced by Portable Software, 60 Aberdeen Ave., Cambridge, MA 02138, (617) 547-2918.

[Editor's note: PortaAPL costs \$275 plus \$10 handling charges.]

macintosh/software #175, from kerskine [Keith Erskine]  
a comment to 170

What kind of graphics does PortaAPL allow you to do?

macintosh/software #177, from jbaker  
a comment to 175

PortaAPL supplies a workspace of cover functions that allow you to access most of QuickDraw from APL. The system comes with a small plot demo that shows one how to set up a simple technical plotting system. I have modified this system to plot engineering graphs, log normal, splines, etc. The performance is quite adequate. It's not as fast as commercial plotting packages; however, the APL environment is more flexible and adaptable than some of the plot packages I have used. If you have a need for "nonstandard" plots, PortaAPL is a good tool to program them in.

#### BOSTON II FONT INFO

macintosh/software #179, from joeleben [Joe Leben]

For those that don't know about it, acquire the shareware package called the Boston II font. It's a collection of fonts that are *much* better than any I've seen, and I've got a lot of fonts. It's optimized for producing normal-sized text on an Imagewriter printer and has to be seen to be believed. The italics are even more legible than the normal characters. It comes with a well-formatted on-disk manual and other miscellaneous software, including a RAM disk package that can be used to speed up the printing of the heavily formatted manual. Best \$10.50 I've spent in a long time. It can probably be found on bulletin boards, but I got mine by mail by sending a blank disk and a check for \$10.50 (U.S.) to the following address: Charles E. Maurer, 31 Forsyth Ave. S, Hamilton, Ontario L8S 2A4, Canada.

P.S.: The manual is worth the \$10.50 for the typography tips and techniques that it presents.

(continued)

macintosh/software #182, from lloeb  
a comment to 179

I heartily concur. Best usable font I have for real correspondence.

macintosh/software #192, from bwebster [Bruce Webster, Consulting Editor, BYTE]  
a comment to 179

I'll second the comments about Boston II. I wrote nice things about it in a recent column (February BYTE), for which Charlie sent me a nice letter (as did Paul Rapoport, creator of the International font). Boston is now *the* font I use for word processing on the Mac. (Be sure to get Boston II; there's an older Boston running around.)

macintosh/software #233, from jamurphy [Joe Murphy]

Macintosh Pascal 2.0

Macintosh Pascal 2.0 has been finally released as an update for those of us who have Macintosh Pascal 1.0. The update should be available at any Apple dealer. It comes on two disks, one with the new version of MacPascal and the other with documentation about the update, some new sample programs, an installer to put the program on a hard disk (or to make backup copies), and a shell program. The shell program is a 75K run-time file that allows programs to be executed without running MacPascal.

The notorious copy protection is gone, but there are invisible files on the disks which make it necessary to use Copy II Mac, the utility included with the program or any copy program that copies invisible files to make backups.

They appear to have fixed all the bugs and have added some features. The program comes with Finder 5.2, but if you try to execute a file with the PSHELL (run-time file), it crashes unless you use Finder/System 4.1. I thought it was really amazing when I tried to run a file as an application, and my Mac did a very vicious crash. It was only when I tried the old Finder that I realized the problem. It seems incredible, but the PSHELL is not compatible with the version of the Finder it comes with! Overall, though, it is a free update (you need your master copies to get the update, although my dealer put the copies on two disks I brought because I didn't want to lose version 1.0), and Apple should be commended for that. It is a well worth getting and, aside from the one problem with the run-time file, is a great improvement over 1.0.

**SOME TIPS ON UNPRINTABLE CHARACTERS IN WORD**

macintosh/software #236, from lloeb

Word Tidbits

It is possible to find and change certain unprintable characters in the Find/Change dialogs. It requires the following special codes:

- ^w white space
- ^s fixed-size nonbreaking space
- ^t tab
- ^p paragraph (RETURN character)
- ^n new line (Linefeed?)
- ^- optional hyphen
- ^d Word document division

**MAC PLUS PIN-OUTS**

macintosh/tech.talk #144, from rkaapke

Mac Plus Peripheral-8 Pin-out

Since checking the connections between a Macintosh Plus and an Imagerwriter II, I have found that the pin-outs are identical. For those without an Imagerwriter II manual handy (see page 88, appendix C):

8 7 6  
5 4 3  
2 1

(You should recognize this pattern only in one orientation, which is looking at the pins in the male connector, holding it so that the flat part is pointing up.)

Pin 1: DTR	Data Terminal Ready Output
2: CTS	Clear To Send Input
3: TxD -	Transmit Data - Output
4: SG	Signal Ground
5: RxD -	Receive Data - Input
6: TxD +	Balanced Transmit + Output
7: NC	No Connection
8: RxD +	Balanced Receive + Input
Shield: PG	Protective Ground

I have no idea where to get these connectors other than on a Macintosh or Apple II peripheral-8 cable.

If you want to adapt a 9-pin to the peripheral-8, try using the Mac 512K to Imagerwriter II cable (which has a 9-pin on one side and a peripheral-8 on the other). Plug the 8-pin connector into the Macintosh Plus port, then get a "gender bender" 9-pin female to 9-pin female straight-through cable. Plug your 9-pin connector into one end of the gender bender and the Imagerwriter II cable's 9-pin connector into the other end. Note that the voltages found on the 9-pin connector are not supplied on the peripheral-8, so don't expect this to work with a ThunderScanner or Koala MacVision, or with any other device that requires power from the Macintosh and not from its own source.

This is theoretical—I have not tried it; as soon as my Plus arrives, I'll post any corrections that I needed to make.

Incidentally, I have a ThunderScanner and I will be thinking about the power problem.

All you brave souls who dare to try this out, please leave us a note telling of your success or corrected failures.

macintosh/tech.talk #150, from rkaapke

a comment to 144

When consulting this diagram, reverse the positions of the transmit and receive connections. When I used an Imagerwriter II to Macintosh 512K (DB-9 to peripheral-8) cable, I needed to exchange my transmit and receive lines for all the connectors I wanted to mate to the DB-9. The diagram in message 144 is for an Imagerwriter II; the Macintosh Plus has the transmit and receive lines (four in all) reversed. (Exchange TxD+ for RxD+, and so on.)

macintosh/tech.talk #151, from tom\_\_thompson

a comment to 150

Your pin-outs are correct. Possibly what's going on is the null modem (transmit-receive pair swap) in the cable. Can you confirm? To recap: pin 3 is TxD -, pin 5 is RxD -, as specified in message 144.

macintosh/tech.talk #152, from rkaapke

a comment to 151

Aha! Yes, of course—it's obvious now that I look at the connections! The Macintosh Plus peripheral-8 pin-out on message 144 is correct; an Imagerwriter II to Macintosh DB-9 is a "null modem" cable, and so if you use it with a Macintosh Plus to bring the peripheral-8 out to a male DB-9, the transmit and receive lines are reversed. You have to keep this in mind if your way of making an adapter from the Macintosh Plus peripheral-8 to a DB-9 is using the Imagerwriter II cable. Thanks for clearing that up for me. ■



# THE BUYER'S MART

## A Directory of Products and Services

THE BUYER'S MART is a monthly advertising section which enables readers to easily locate suppliers by product category. As a unique feature, each BUYER'S MART ad includes a Reader Service number to assist interested readers in requesting information from participating advertisers.

**RATES:** 1x—\$475 3x—\$450 6x—\$425 12x—\$375  
Prepayment must accompany each insertion.

**AD FORMAT:** Each ad will be designed and typeset by BYTE. Advertisers must

furnish typewritten copy. Ads can include headline (23 characters maximum), descriptive text (250 characters maximum), plus company name, address and telephone number. Do not send logos or camera-ready artwork.

**DEADLINE:** Ad copy is due 2 months prior to issue date. For example: June issue closes on April 1. Send your copy and payment to THE BUYER'S MART, BYTE magazine, 70 Main Street, Peterborough, NH 03458. For more information call Karen Burgess at BYTE 603-924-3754.

### ACCESSORIES

#### SOFTWARE PACKAGING, DISKS

Cloth binders & slips like IBM's. Vinyl binders, boxes, and folders—many sizes. Disk pages, envelopes, & labels. Low qty. imprinting. Bulk & branded disks. Much More! Low prices. Fast service. Call or write for FREE CATALOG.

**Anthropomorphic Systems Limited**  
376-B East St. Charles Road  
Lombard, IL 60148  
**1-800-DEAL-NOW (312) 629-5160**

Inquiry 657

### ACCESSORIES

#### SOFTWARE PUBLISHING

GDS offers a wide variety of services that will help get your software to the market. Address your needs with GDS.

- IBM style cloth/vinyl 3-ring binder/slips
- Labels, sleeves, disk pages, bulk diskettes...
- Disk duplication with 100% verification
- Shrink wrapping and product assembly
- Quick turn-around

A well packaged product can make the difference in making a sale. Call us now! VISA/MC

**GLENCO DEVELOPMENT SYSTEMS(312) 392-2492**  
3920 Ridge Ave., Arlington Hs., IL 60004

Inquiry 770.

### BOOKS / DISKS / VIDEOS

#### NOW THERE ARE TWO BOOKS!!

**Programmers' Handbook of Computer Printer Commands**

Vol. I — prts through 84 — \$37.95  
Vol. II — Set as new as 85 — \$26.95  
Set — I & II — \$58.95

\*50+ Manua. of DWP/DMP/Color \*450 pgs./Table Form  
MC/VISA/CK/PO + \$2 COD + \$2.50 S/H

**ORDERS CALL: 1-800-628-2828 ext. #534 OR WRITE:**  
**CARDINAL POINT INCORPORATED**  
P.O. Box 596, Ellettsville, IN 47429  
(812) 876-7811 (M-F 9-5)

Inquiry 671.

#### COMPUTER PROTECTION

- UPS • LINE CONDITIONERS • ISOLATORS
  - MODEM PROTECTORS
  - AC POWER INTERRUPTERS
- HUNDREDS OF HINTS & PRODUCTS —

FREE CATALOG 1-800-225-4876

**ELECTRONIC SPECIALISTS, INC.**  
171 So. Main St., POB 389, Natick, Mass 01760  
**(617) 655-1532**

Inquiry 691

#### FREE CATALOG OF ELECTRONIC PARTS!!

Thousands of parts and new surplus electronic parts at super low prices. FAST ORDER PROCESSING AND SHIPPING (95% of all orders shipped within 48 hours).

CALL OR WRITE FOR A FREE CATALOG...

**ALL ELECTRONICS CORPORATION**

POB 20406, Los Angeles, CA 90006-0406

**(213) 380-8000**

Inquiry 654.

### BUSINESS OPPORTUNITIES

#### VIDEO STORES

We need ambitious dealers in all U.S. states and Canada to market a powerful system to computerize video tape rental stores.

**WINCHESTER DATA PRODUCTS INC.**

3301-Executive Drive., #204, Raleigh, N.C. 27609

**(919) 872-0995**

Inquiry 763.

#### Self-Inking Printer Ribbon

For users of Okidata and other open spool ribbon printers. Controlled Printout Devices are a new kind of printing ribbon that re-ink themselves, and will last 15 times longer than the ribbon you are now using. For further information please call or write.

**CONTROLLED PRINTOUT DEVICES, INC.**  
POB 869, Baldwin Rd., Arden, NC 28704  
**(704) 684-9044**

Inquiry 678

#### LASER PRINTERS

I will pay you cash for your used toner cartridges!!  
(HP, Apple, Canon, etc.)

Recharging Service..... \$40

Call or write for free instant pickup service:

**PC Corporation, Laser Printer Products**

11 Freeman Street, Sloughton, MA 02072

**(617) 893-9000 (24 hours)**

**(617) 341-3005 (9-5 pm Eastern)**

Dealer inquiries welcome

Inquiry 731.

Do you know businesses or people that buy IBM hardware, software, accessories and supplies? If so, you could make commissions just for recommending our national firm. Full or part-time positions available. We discount most major brand name products 20-50%, which makes our prices most appealing. Plus you get \$ for the sale. Call or write for more info.

**WGGB**

316 North Owen Street Mount Prospect, IL 60056

**312-392-2621**

Inquiry 762

#### FREE CATALOG

Outstanding prices on computer accessories for your computer and workstation. Our catalog features a wide selection of quality products to meet all your accessory needs. Call or write today to receive your free catalog.

**LINTEK COMPUTER ACCESSORIES**  
POB 8056, Grand Rapids, MI 49508  
**(616) 241-4040**

Inquiry 712

#### DATA SWITCHES

Stop recabling forever, with our Serial or Parallel AB or X Data Switches. Two printers can share one computer or two computers can share one printer or plotter, or modem, or monitor, or etc. Prices start as low as \$42.00. Send for our catalog or see our ads in Jan./Mar./May issues. To increase your systems productivity today, call:

**602-623-5716**

**Via West, Inc.**

534 N. Stone Ave., Tucson, AZ 85705

Inquiry 759

### COMMUNICATIONS

#### TELETERM

Sophisticated Terminal Emulator of most popular terminals including DEC VT100, plus build your own up/download direct to disk/printer... error free file transfer protocols... full screen ASCII text editor... remote print... unattended file transfer mode...

**Telexpress, Inc.**

P.O. Box 217, Willingboro, NJ 08046

**(609) 877-4900**

Inquiry 755

### BAR CODE

#### BAR CODE READERS/PRINTING

Programs \$49-\$299. Readers \$325 up. PRINT Bar Codes on PC and Epson/Okidata or IBM Proprietary Code 39, I 2of5, UPC, MSI, DOD-LOGMARS, AIAG, Graphics chs up to 1". Labels, Catalogs from files. Subroutines for BASIC, Cobol, Clipper, Turbo Pascal, C, dBASE III Plus.

**Worthington Data Solutions**

130 Crespi Court, Santa Cruz, CA 95060

**(408) 458-9938**

Inquiry 764

#### LOWEST PRICES ON DISKETTES

5 1/4" SSDD \$45, DSDD \$55, High Density \$165  
3 1/2" SSHD \$145, DSHD \$185

- Lifetime warranty
- 100% error free
- Finest quality
- Includes tyvek sleeves
- Reinforced hub ring
- Labels & write protect tabs

Free UPS shipping. Minimum 100 diskettes.  
Send check or call. CA residents add 6 1/2% sales tax.

**Data Bureau Inc.**

1633 Westwood Blvd., Ste. 120

Los Angeles, CA 90024

**213-479-0345**

Inquiry 681

#### TURBO/COMMUNICATION

1. Asynchronous communications program written in Turbo Pascal™
2. Auto answer/Auto dial.
3. XModem protocol
4. Documented Source Code included.
5. For CPM/MMS-DOS/PCjr

Price \$30.00

**Larry Chryskos**

call: 6500 South Washenaw

Chicago, IL 60629

312-778-3146 after 6:00 pm.

Inquiry 711

# THE BUYER'S MART

## DISK CONVERSION

### CONVERSION SERVICES

Convert any 9 track magnetic tape to or from over 500 formats including 3 1/2", 5 1/4", 8" disk formats & word processors. Disk to disk conversions also available. Call for more info. (312) 459-6010

#### Pivar Computing Services, Inc.

165 Arlington Hgts. Rd., Dept. #B  
★ ★ Buffalo Grove, IL 60089 ★ ★

Inquiry 733

## DUPLICATING SERVICES

### WESTERN TRANSDATA, INC.

Why risk duplicating your important programs on your computer, when our equipment is designed solely to duplicate disks & verify their perfection 100%? Over 600 formats 3 1/2", 5 1/4" & 8". Plus serialization, copy protection, labeling, packaging, shrink-wrapping and fast, personalized service.

#### WESTERN TRANSDATA, INC.

1701 E. Edinger Ave. A-4  
Santa Ana, CA 92705  
714/547-3383 (collect)

Inquiry 761

## HARDWARE

### DON'T LET POWER PROBLEMS DESTROY YOUR FILES.

GET UNINTERRUPTIBLE POWER SUPPLIES FOR YOUR PC'S. CALL FOR BEST PRICINGS.

#### Everett/Charles® Marketing Services

6101 Cherry Avenue  
Fontana, CA 92335

800-443-1860 Calif. 800-821-0589

Inquiry 694

## DISK AND TAPE CONVERSIONS

High quality conversion services for Dedicated Word Processors, Mini and Microcomputers. Over 600 3 1/2", 5 1/4", and 8" formats. Also 800-1600BPI tape. Included: Wang, NBI, CPT, DEC, Vydec, Lanier, OS/6, Xerox, IBM Sys/34/36/38/5520, Mac, Victor, TRS, Apple, NSTAR, IBM PC/AT, HP, and most of the other microcomputers. We can convert directly into word processing software such as: DW3, WP, MS/WORD, WS, Samna, MM, PFS, and many others.

**DATA FORMATS, INC.** (408) 972-1830

Inquiry 683

## BLANKET SERVICES

Diskette duplication • Packaging • Stocking/Drop shipping • 48 hour delivery • SUPERLoK copy protection • No mastering fee • No charge for standard labels • Place a blanket order with releases as you need them for any quantity at a fixed price.

#### Star-Byte, Inc.

2564 Industry Lane, Norristown, PA 19403  
215-539-4300 800-243-1515

Inquiry 750

## SINGLE BOARD COMPUTER INDUSTRIAL STRENGTH

• FORTH O.S., Editor, Assembler, Target Compiler, RAM Disk • 8085 CPU • 16 A/D Channels • RS232 • Realtime Clock • Buffered Digital I/O • Battery Backed RAM • Single Supply • Watchdog Timer • Full Line of Support Hardware/Software • Counter/Timer • IBM/CPM Support • RS422 • FROM \$295.00 •

#### EMAC, INC.

1400 West Main, Carbondale, Illinois, 62901  
(618) 529-4525

Inquiry 692

## INCOMPATIBLE WORD PROCESSORS?

We convert to and from: XEROX, DEC, IBM, LANIER, WANG, PC-DOS, CONVERGENT TECHNOLOGY, WORDSTAR, MULTIMATE, SAMNA ASCII, MICOM, TAPE TO DISK. Also most CP/M systems.

LOWEST PRICES

#### DATA CONVERSION INC.

6310 Caballero Blvd. • Buena Park, CA 90620  
(714) 522-7762 (800) 824-4851 in CA.

Inquiry 682

## DUPLICATION SOLUTIONS

We have the answer to your duplication needs no matter what the volume. We supply auto-loaders, disks, and technical support. We provide copy protection, serialization, package assembly, and distributive shipping.

#### MegaSoft

P.O. Box 710, Freehold, NJ 07728  
1-800-222-0490 201-462-7628 (in NJ)

Inquiry 719

## EPROM/EEPROM PROG. \$250

Programs 2716-27512, 25xx and 68764/66 eproms via RS-232. Also 874x micros and 28xxA & 52Bxx EEPROMs. Automatic baud rate select, built in help menus, no personality modules!

#### 16 BIT I/O MODULE \$75

Low cost control via RS-232. Expands to 512!

#### INTELLITRONICS

P.O. Box 3263, Tustin, CA 92680  
(714) 669-0614

Inquiry 707

## HARDWARE

### Disk/Disk • Tape/Disk

Over 600 formats! 3 1/2", 5 1/4", or 8 inch disks; 9 track mag tape; 10 MB Bernoulli cartridge. Data base and word processor translation specialists.

#### Computer Conversions, Inc.

9580 Black Mountain Rd., Ste J  
San Diego, CA 92126  
(619) 693-1697

Inquiry 676

## USED APPLES & IBM's

Laser 128 (new) — call

PC Jr as low as \$325.00

Motherboards & accessories — call

We buy, sell, & horse-trade — Apple, IBM, & CBM.

#### SHREVE SYSTEMS

845 Lark Ave., Shreveport, LA 71105  
318-865-6743 4-9 p.m. C.S.T. VISA/MC

Inquiry 742

## The BG-Boards

and well-crafted books teach you how to construct circuits for interfacing external devices to IBM, Apple, TRS-80, Tandy, Commodore, Timex-Sinclair micros for monitoring and control. \$35 to \$350. Free catalog.

#### Group Technology, Ltd.

Route 1 Box 83, Check, VA 24072  
703-651-3153

Inquiry 701

## CONVERT CP/M <-> MS-DOS

Read, write and format CP/M diskettes on an IBM PC or compatible. Over 115 CP/M formats on the menu and you can add your own. Use Convert to copy text and data files (such as WordStar and Dbase II) between CP/M and MS-DOS. Or use it to manufacture CP/M diskettes.

#### Only \$69 from Selfware, Inc.

3545 Chain Bridge Rd., Suite 3  
Fairfax, VA 22030  
703-352-2977

Inquiry 739

## POWERLINE GREMLINS?? POWER FAILURES??

The MEIRICK STANDBY POWER SYSTEM is the TOTAL SOLUTION to your powerline problems.

240 watt system — \$365, 400 watt system — \$495;  
800 watt system — \$795

#### MEIRICK Inc., POWER SYSTEMS DIV.

Box 298, Frisco, CO 80443 303-668-3251

Inquiry 720

## WESTERN INFORMATION SYSTEMS Phoenix, Arizona

Distributors of Wyse, Televideo, Diablo, Case/Rixon Paradyne, Prentice. Also Canon laser and other printers.

#### LOWEST PRICES

Leasing Available

1-800 824-3086

Dealers Only

Inquiry 760

## DOCUMENTATION

### COMPUTER ASSEMBLY MANUALS

**BIG BLUE SEED for IBM® BUILDERS:** parts list, placement diagrams, instructions for assembling over 65 IBM-compatible bare cards — \$14.95.

**APPLE SEED II for APPLE™ BUILDERS:** instructions for assembling 77 Apple-compatible bare cards including the II+ and IIe motherboards — \$12.95.

**OVER 40 DIFFERENT BARE CARDS IN STOCK FOR THE HOBBYIST**

#### NuScope Associates

P.O. Box 790 • Lewiston NY • 14092

Inquiry 728

### Tandy 1000 Hardware

TanPak Multifunction Cards ..... \$329

Memory to 512K, RS232, Clock, DMA

TanPak Secondary ..... \$249

Memory to 256K, RS232, Clock

10 Meg Hard Drive with Controller ..... \$549

20 Meg Hard Drive with Controller ..... \$749

#### Hard Drive Specialist

1-800-231-6671 or 1-713-480-6000

16208 Hickory Knoll, Houston, Texas 77059

Inquiry 702

### 68000 COMPUTERS

Single board computers, 128K to 1M RAM, 4 serial, 2 parallel ports (expandable to 22 ports total), floppy controller for 2 to 4 drives, SASI interface for Winchester addition, timer/clock, real time multi-tasking multi-user operating system, assembler, line editor, 2 screen editors, spreadsheet. From \$995.00

#### AAA Chicago Computer Center

120 Chestnut Lane • Wheeling, IL 60090  
(312) 459-0450

Inquiry 650



# THE BUYER'S MART

## HARDWARE

### \$79 MONO/GRAPHIC/PRINTER BOARD

\* Hercules compatible \* 720 x 348 pixel  
 \* Lotus 1-2-3 compatible \* 80 x 25 text  
 \* Printer, Monitor port \* 1 year warranty  
 \* Light pen port \* In stock delivery  
 1 - \$99 2-9 \$89 10 - \$79

### SUGAR INTERNATIONAL

12015 NE 8th Ste. 3, Bellevue, WA 98005  
 (206) 462-9283, Mo-Sa, 9-6

Inquiry 752

## TANDY-EPSON

Our 10th year of DISCOUNTS  
 Ed or Joe McManus  
 Fgt. Prepaid. Save Tax  
 Toll Free 800-231-3680

### MARYMAC INDUSTRIES, INC.

22511 Katy Fwy., Katy (Houston), TX 77450  
 1-713-392-0747 Telex: 774132

Inquiry 715

## GBA

Full function IEEE-488 bus analyzer with 12,287 byte memory. Controlled from any RS-232 computer or terminal. Also provides full bus control and message sending capability. \$995.00

### Connecticut microComputer, Inc.

568 Danbury Rd., New Milford, CT 06776  
 Phone: 203-354-9395 Telex: 710-456-0052

Inquiry 679

## 1-800-826-0843 THE COMPUTER BARN

Wyse 50 \$409. Wyse PC — \$995.  
 Wyse 85 \$459. (Dual Floppy)  
 Televideo 905 — \$285.  
 Televideo At I — \$2095.  
 We Will Beat Any Published Price  
 Call for FREE Brochure

Inquiry 675

## HARDWARE ADD-ONS

### RS-232 RS-422

• Four Port RS-232 ..... \$349<sup>00</sup>  
 • RS-422/485 Serial ..... \$149<sup>00</sup>  
 • RS-232/422 with 24 Parallel I/O ..... \$199<sup>00</sup>  
 • RS-422 Synchronous ..... \$299<sup>00</sup>

Call About Custom Designed Boards

### ADAMS

P.O. Box 17525  
 Greenville, South Carolina 29606  
 (803) 297-9630

Inquiry 652

## FAST GRAPHICS COPROCESSOR

50,000 vector/second card for PC, XT or AT with CGA. Draws in hardware: zoom, pan, area fill, dithering, arcs etc. Turbo Pascal & MS-Fortran libraries. 14 day trial, 90 day warranty. 640x400 16 color: \$582. 640x200: \$378. Manual only: \$10, refundable.

### E-Heart Engineering

18103 Sky Park South #D, Irvine, CA 92714  
 (714) 261-1725

Inquiry 686

## HARDWARE ADD-ONS

### 640K for IBM XT and Portables

Expand your memory board with MAXRAM. Easy plug-in installation, does not violate IBM's warranty, 100% software compatible. MAXRAM-R includes two banks of 256K chips.

MAXRAM ..... \$49.00  
 MAXRAM-R ..... \$129.00

Shipping included, dealer pricing available.

Call (315) 478-0722 to order.

### LOGICAL SYSTEMS CORPORATION

6184 Teall Sta., Syracuse, NY 13217

Inquiry 713

## INFORMATION SERVICES

### TURBO S.I.X.

The Turbo Pascal Software Information eXchange offers its members megabytes of Turbo Pascal code for only \$6 per diskette. Also a monthly newsletter. Send \$1.95 for the TURBO S.I.X. catalog. Deductible from the \$19.95 membership fee when you join. MC/Visa.

### TURBO S.I.X.

P.O. Box 8373, Dept B2, Waco, Texas 76710  
 3101 Mitchell, Waco, TX (817) 753-2182

Inquiry 757

## MULTIUSERS

### MULTIUSER CLIPPER (OR C)!

With NOVELLIB and Nantucket's Clipper or Lifeboat's Lattice C Compiler.

- NOVELL or PC Networks
- Record & File Locking
- Dead-Lock Avoidance
- Print Spooling
- Login, Station ID, and More!
- Object code and examples

NOVELLIB only \$99. (Specify Clipper or C).

### Communication Horizons

701 7th Ave., Dept B, New York, NY 10036  
 Tel: (212) 724-0150 Source: NAN285

Inquiry 673

### DBASE III PLUS PLUS

NOVELLIB-2D gives you what Ashton-Tate left out: higher level Network functions:

- NOVELL or PC Networks
- Semaphore Locks
- Print Spooling & Banners
- Station & User ID, and More!
- Electronic Mail
- BIN code and examples

NOVELLIB-2D only \$99.

### Communication Horizons

701 7th Ave., Dept B, New York, NY 10036  
 Tel: (212) 724-0150 Source: NAN285

Inquiry 674

## PROGRAM/GENERATORS

### WINDOW.LIB

\$99.

An easy to use complete windowing system for programmers and writing in

- BASIC IBM, M.S. CB86
- C LATTICE, M.S.
- COBOL M.S. RMF
- PASCAL M.S. TURBO
- FORTRAN M.S. RMF

Window editor included. Create callable pop-up menus, help screens. The line selector features auto reverse highlighting and cursor control. No royalties. Ask about our BIOS/DOS LIB VISA/MC

GLESCO ENGINEERING (312) 392-2492  
 3920 Ridge Ave., Arlington Hts., IL 60004

Inquiry 677

## SOFTWARE BUSINESS

### dFELLER Inventory

A business inventory program written in modifiable dBASE source code. The menu-driven program lets you locate items by inventory name or number. It keeps track of reorder points, vendors, average cost, and other info. Requires dBASE II or III. PC-DOS/CPM \$150.

### Feller Associates

550 CR PPA, Route 3, Ishpeming, MI 49849  
 (906) 486-6024

Inquiry 696

## SOFTWARE/BUSINESS

### PC-Write™ Shareware

Fast, powerful word processor/text editor for IBM PC. New Version 2.6 with auto reformat, optional menus, on-screen help, laser printer support, new expanded manual. Mailmerge, split screen, ASCII files, macros. All software, tutorial/guide on diskette, \$10. OK to copy. Register for full manual, support \$75. 90-day money-back guarantee.

Quicksort (206) 282-0452 Visa/MC  
 219 First N. #224J, Seattle, WA 98109

Inquiry 737

### PC-File III™ Version 4

Search, sort, browse, global changes, macros, mailing labels, format reports with selection & calculations, sub-totals, totals, averages, encryption. Exchange data with 1-2-3 WORD, WordStar. Over 190,000 users. \$59.95 + \$5 s/h. For IBM PC.

### ButtonWare, Inc.

P.O. Box 5786, Bellevue, WA 98006  
 1-800-J-BUTTON

Inquiry 663

### PC-File/R™

All the power of PC-File III plus: Relational link to other databases, integrated letter writing & mail-merge, context sensitive pop-up help windows. New binary search retrieves data hundreds of times faster. \$149.95 + \$5 s/h.

### ButtonWare, Inc.

P.O. Box 5786, Bellevue, WA 98006  
 1-800-J-BUTTON

Inquiry 664

### SMITH'S INVOICE

Invoices, shipping labels, customer database. Customer & product mailing lists and labels. Menu driven—easy to use. For IBM PC with 128K and 2 DS/DD drives or hard disk. All software, manual on disk \$15. Same-day shipment on personal checks.

### Smith Consulting

Route 1, Box 213, Greensburg, IN 47240

Inquiry 743

### The Andsor Collection™

Unique concept: creates complete, self-contained, window-based data management environment, in one DOS file. Simplifies everything. Combine functions to create your own solutions in any application: calculations, database management, modeling, text processing, charts, data analysis, statistics, reports, labels, forms, presentations, mail-merge, etc. Simple enough for a PCjr, sophisticated enough for a PC AT.

SEE ALSO THE AD BELOW

Inquiry 656

### The Andsor Collection™

From simple calculations, files, inquiries, to complex models, data structures, reports. Superb 400 page hard-cover manual with many examples. US \$95 + \$5 s/h. 60-day money-back guarantee. Visa/MC/AmEx/Chk/MC/COD. Call or write now to order. IBM PC/XT/AT/PCjr. 128K, one drive or hard disk, monochrome and/or color. DOS 2.0+. Not copy-protected.

### ANDSOR RESEARCH INC.

181 University Avenue., Suite 1202,  
 Toronto, Ontario, Canada M5H 3M7  
 (416) 364-8423

# THE BUYER'S MART

## SOFTWARE/BUSINESS

### CUSTOM PAYROLL

All systems have multiple pay categories, calculation of all taxes, user defined deductions, 401(k) handling, many reports, paychecks, W-2 forms, and much more. Custom features are available. Prices start at \$695 for system, manual, and PC Basic source code.

#### Datasmith, Inc.

Box 8036, Shawnee Mission, KS 66208  
(913) 381-9118

Inquiry 684.

### Programmers:

We guarantee our products to be solid, bugfree.

\* CorrectForth - Very professional.

\* Correct\_Datamizer - 50:1 data compression guaranteed.

\* SafeModem - Hackerproof.

\$80.75 per program MC/VISA/MO/Check. Specify computer.

#### Correct Software, Inc.

RR1 Box 140, Black Hawk, SD 57718  
(605) 787-5904

Inquiry 680.

### LP88-LINEAR PROGRAMMING

A powerful menu-driven system for solving linear programs w/ up to 510 constraints & 2510 variables. Features include interactive & batch operation, spreadsheet-style input & editing, storage of problems & bases, Simplex Algorithm restart, report generator, sensitivity analysis. Req. IBM PC, 192K. \$99 w/8087 support, user's guide. VISA/MC.

#### EASTERN SOFTWARE PRODUCTS INC.

P.O. Box 15328, Alexandria, VA 22309  
(703) 549-5469

Inquiry 689.

### PC-Calc™ Version 3

64 columns x 256 rows, math and stat. functions, horizontal bar graphs, title locking, individually adjustable column widths, IF...THEN, link to other spreadsheets or PC-File databases, much more. Requires 256K IBM PC. \$59.95 + \$5 s/h.

#### ButtonWare, Inc.

P.O. Box 5786, Bellevue, WA 98006  
1-800-J-BUTTON

Inquiry 665

### PC-Type™

Fast, compact, capable & easy! Help panels, hands-on tutorial, macros, multiple-line headings & footings, DOS path support, print spooling, block operations, etc. ASCII files. Install program allows customization. \$59.95 + \$5 s/h. For 128K IBM PC.

#### ButtonWare, Inc.

P.O. Box 5786, Bellevue, WA 98006  
1-800-J-BUTTON

Inquiry 666

### BILINGUAL WORD PROCESSOR

DuangJan, a special word processor for English and; European, Greek, Lao, Portuguese, Russian, Spanish, Thai, Vietnamese, your own language, or more. For IBM PC/XT/AT/Clones with graphics & IBM/Epson/Clot printer. \$59 + \$4 S&H in US&Can (+ 10 others).

#### MEGACHOMP COMPANY

3524 Cottman Ave., Philadelphia, PA 19149, USA  
(215) 331-2748/8138

Inquiry 718

## SOFTWARE/BUSINESS

### MoneyCounts™ Version 3.0

Everything you need to take charge of your finances: Checking/Credit Card Mgt., Budgeting, Exp. Analysis, Financial Rpts., Graphics, Tutorial, much more. Great for home/business.

CPA designed, IBM PC/XT & Compatibles with DOS 2.0 or later and 192K - \$69.95

#### PARSONS TECHNOLOGY

6925 Surrey Dr. NE., Cedar Rapids, IA 52402  
(319) 373-0197 CHECK/VISA/MC

Inquiry 730

### DATA ENTRY SYSTEM

Heads-down data entry with two-pass verification for the PC/XT/AT & compatibles. Loaded with features like: Auto dup & skip, verify bypass, range checks, & table lookups. Fully menu driven only \$395. Call for free 30 day trial period.

#### COMPUTER KEYES

21929 Makah Rd., Woodway, WA 98020  
(206) 776-6443

Inquiry 677

### ★ FORECASTING ★ MODELING ★ PLANNING ★

Compatible with IBM PC & Apple II

#### MICRO-BJ™

• Box-Jenkins ARIMA • Econometrics package

• Identifi., estimate, forecast \$195.00

#### XTRAPOLATOR™

• Automatic forecasting \$195.00

#### PROFESSIONALS CHOICE

\* Link to Lotus, Visicalc

Multiple order discounts

50% off Apple II orders

#### STRATIX

P.O. Box 4413 • Burlingame, CA 94011

(415) 697-0573 MC/VISA

Inquiry 751

### TIME & BILLING \$99 JOB COST OPTION \$50

30 Day Money-back Trial  
Virtually unlimited number of jobs, direct cost, direct labor and overhead categories. Provision for job estimating is included in JOB COST OPTION. Very flexible and very easy to learn to use. Prints your statements, many reports including Job Summary and Job Detail, and more! For MS-DOS/IBM-PC & compatibles. VISA/MC/Prepaid/COD.

#### Accounting Systems

1148-5 Executive Circle, Cary, NC 27511  
(919) 467-3428

Inquiry 651.

### EC EDITOR — FOR IBM PC

Not enough room to describe this slick editor! EC regularly displaces editors and WPs 4 & 5 times its price. Mostly sold by word of mouth, w/companies coming back for more. Best value at \$49.50 + \$5 s/h! DEMO \$5: complete EC, but not sv files over 65 lns.

#### C SOURCE

12801 Frost Rd., Kansas City, MO 64138  
(816) 353-8808 VISA/MC/COD

Inquiry 669

### FIXED-ASSETS ACCOUNTING

Provides for multiple asset inventories. Supports all depreciation methods. 150 ACRS schedules supplied on disk. Several report formats including Tax Form 4562. CP/M-80 & DOS.

DEPRECIATION-MASTER II V4.0 \$349.00

(includes 1-year of support)

DEMO DISK \$35.00

MC, VISA, COD. Add \$4 for shipping/handling.

Generic Computer Products, Inc.

P.O. Box 790, Marquette, Michigan 49855  
(906) 249-9801

Inquiry 697.

## SOFTWARE/CHURCH

### Church Package

Parishioner Time, Talent and Treasure System program is written in modifiable dBASE source code.

• Contributions • Disbursements • Ledger

• Names with mailing labels

• Personal information database.

Requires dBASE II or III. PC-DOS/CPM-80 \$200.

#### Feller Associates

550 CR PPA, Route 3, Ishpeming, MI 49849  
(906) 486-6024

Inquiry 695

## SOFTWARE/EDUCATION

### "War or Peace? You Decide!"

Stimulates discussion on the role of nuclear weapons in national security. Players choose U.S. or Soviet side. Six crisis situations. High school or home use, both teacher and student manuals included. IBM or Apple. \$49.95 MC/VISA/AMEX. For info, call: 207-775-1330. For orders call: 1-800-628-2828 ext. 649.

#### Bright Ideas, Inc.

52 Exeter St., Portland, Maine 04102-2839

Inquiry 661.

## SOFTWARE/GENERAL

### Dr. T's MUSIC SOFTWARE

IF YOU CAN USE A WORD PROCESSOR YOU CAN MAKE MUSIC!

MIDI music-composition software for Commodore and Apple computers. Also, algorithmic composition programs for computer generation of sequences. Fully editable Bach songbook, Keyboard, Bass, and Drum disks. Patch libraries available for Yamaha and Casio synthesizers. Reviewed in Jan. '85 COMPUTE.

66 Louise Rd., Chestnut Hill, MA 02167

(617) 244-6954

Inquiry 687.

### MicroGANTT®

Control your project! You describe the work. MicroGANTT calculates the schedule and budget. Optimize the schedule interactively. Customize the reports. Sub-tasking, fixed and variable costs, multi-project resource allocation, unlimited size and scope. GANTT, PERT, CPM, DOD-7000. Call or write for free catalog.

#### Earth Data Corporation

P.O. Box 13168, Richmond, VA 23225  
(804) 231-0300

Inquiry 690

### AI for the IBM PC

TOPSI is a full version of OPS5 which runs under MS-DOS, Unix or CP/M. A fast, efficient expert system development tool.

Prototyping: \$125

Production: \$250

Professional: \$375

C version, add \$20 Shipping, add \$5

#### DYNAMIC MASTER SYSTEMS

POB 566456, Atlanta, GA 30356  
(404) 565-0771

Inquiry 686

### NAMEBRAND SOFTWARE. CHEAP!

\* At least 50% off! \*

IBM PC clone company goes out of business, and we at GIL ELECTRONICS buy their software inventory! Microsoft Basic Compilers, & Interpreters, Multiplan, Wordstar, Spellstar, & Mailmerge, dBASE II, CCP/M-86, RM Cobol, RealWorld General Ledger, Sales Analysis, Payroll, much more! All software is new, in original factory sealed packages. Send for FREE CATALOG today!

#### GIL ELECTRONICS

P.O. Box 1628-B, Soquel, CA 95073

Inquiry 698



# THE BUYER'S MART

## SOFTWARE/GENERAL

### ► SOFTWARE FOR PENNIES ◀

GET BEST AND LATEST PC-DOS, CP/M-80 AND CP/M-86 PUBLIC DOMAIN PROGRAMS FOR BUSINESS, PERSONAL, EDUCATION, SOFTWARE DEVELOPMENT, MODEMING, SCIENCE, AND MORE. AT LOW COST OF COPYING. 3-1/2, 5-1/4 AND 8" DISK FORMATS ARE SUPPORTED. SEND \$5.00 FOR CATALOG.

**MULTIPATH, INC.**  
Box 395, Montville, NJ 07045  
(201) 575-5880

Inquiry 725

### POWERFUL FILE MANAGEMENT

I.D.T. S FileManager® for people serious about their systems. No kid stuff—only powerful managing tools. File sort, copy, move, delete, search & change attributes. Undelete and clear files.

EDLIN enhancer & batch mode clean up and more. Menu driven. (about 1/3 Norton's) MCV/ISA

**\$34.95**  
**INTEGRATED DATA TECHNOLOGY, INC.**  
4775 Bunchberry Lane, Colorado Springs, CO 80917  
ORDERS: 303-488-2583

Inquiry 705

### THE BEST OF THE BEST!

Public Domain & User Supported Software for IBM PC or compatible. Word Processing, Database, Spreadsheets, Utilities, Games, Accounting, etc! 50 disk package **\$205.00**, or rent 2 wks. **\$75.00**. Info & Super Sampler Disk **\$6.50**, Deluxe Word Processor **\$6.50**, both **\$12.00**. MCV/ISA

**BLUE CIRCLE GROUP, INC.**  
Box 23502, Minneapolis, MN 55423  
(612) 823-4111

Inquiry 659

Does your hard disk seem like a vast and uncharted land?

### JOBS

Job \ Organization \ Backup \ System  
Clearly superior! Now with MACRO capability and user defined pop-up windows. \$49 M/C & VISA Welcome

### RCT Design

P.O. Box 179, Nipomo, CA 93444  
(805) 934-2905

Advanced disk management for IBM PC/XT/AT & compatibles.

Inquiry 766

## SOFTWARE/GRAPHICS

### SCIENTIFIC GRAPHS

SCI:GRAF produces high-res graphs (1680 x 1712 pixels) on Epson or IBM graphics printers. Supports log/linear scales, error bars, overlays, batch-mode operation. Very flexible data entry from disk or keyboard. User customizable. Requires DOS 2 or 3, 256K.

**\$99.95** (Sorry, no credit cards)

**Microcomputer Systems Consultants**  
27 Forest Ave., Port Jefferson Station, New York 11776-1820  
(516) 928-7493

Inquiry 722

### PLOTTER SOFTWARE

Save time and money by creating your own presentation quality text slides. THE DGI SIGNMAKER is an easy to use menu driven program for your IBM or APPLE computer and most plotters (Epson, HI, HP, HP-GL, IBM and others) for only **\$75**.

**DECISION GRAPHICS, INC.**  
P.O. Box 2776-B, Littleton, Colorado 80161  
Phone (303) 796-0341

Inquiry 685

## SOFTWARE/GRAPHICS

### Z-100 TURBO SOFTWARE

**-ZGL**- Color graphics library with windows.  
**-ZPORTS**- Directly control your I/O ports.  
Full source code! Risk-free 15 day trial.  
**-ZGL**- \$39.95, **-ZPORTS**- \$24.95

### Zimbazi Products

7405 BERKMAN DRIVE, AUSTIN, TEXAS 78752

Inquiry 765

### FORTRAN PROGRAMMER?

Now you can call 2-D and 3-D graphics routines within your FORTRAN program.

**GRAFMATIC**: 75 callable routines for screen output. **\$135**.  
**PLOTMATIC**: Pen plotter driver. **\$135**.  
For the IBM PC, XT, AT and compatibles. We support a variety of compilers, graphics boards and plotters.

### MICROCOMPATIBLES

301 Prelude Drive, Dept. B  
Silver Spring, MD 20901  
(301) 593-0683

Inquiry 721

### CREATE UNIQUE GRAPHICS

Go where no man has goes before. Explore the MANDELBROT set as described in Aug. 85 issue Sci. Am. Infinitely complex. Easy zoom. 8087 code and DRAGON CURVE included. COM file **\$25**. w/140K of 50% comment TURBO PASCAL source **\$50**. Liberal copyrite no protect. Shipping included. IBM color, TIPC 3 plane.

### Fractured Fractals

P.O. Box 1762, Lewisville, TX 75067

Inquiry 721

### MAPIT

#### Make your own MAPS!!

Simple to produce maps with your data. Includes most country and state outlines.

Any printer or HP plotter.  
Only **\$95** for MS-DOS or PC-DOS  
US Country Outlines available for **\$95**.

### QSC

Box 778, East Lansing, MI 48823  
(517) 641-4428

Inquiry 736

## SOFTWARE/LANGUAGES

### REFER SAVES HOURS

REF cross references program variable, values, keywords, linenumbers, and/or labels.

ENTER adds languages to supplied: asm, basic, c, cobol, pascal, ada, fortran, dbase, rbase.  
FINDREPL updates programs. **\$45**.

### James Halstead & Asc.

1551 Plainfield, Joliet, IL 60435  
(815) 725-0346

Inquiry 708

### Tools for CB80 & CB86

BDOS, DOS, and BIOS calls from CB80 and CB86! CBC Tools includes functions for directory access, string ops, a debugger, radix conversion, command line parsing, quicksorts, bit and byte ops, and more for CP/M-80, CP/M-86, and PC-DOS, \$180.00. Ask about our Pascal MT+ products.

### Minnow Bear Computers

POB 2233 Sta. A, Champaign, IL 61820-8233  
(217) 398-6883

Inquiry 724

## SOFTWARE/LANGUAGES

### BASIC PROGRAMMERS

Add SALT & PEPPER to your existing/new programs. Create dazzling Menus, intelligent Input Screens, Walking Strings, ASC/Desc Sort, PRT, SCR. Date processing & more. SALT & PEPPER has 28 modules. (in MS-DOS compatible interpreter BASIC). They merge with your program in minutes. S & P performs all the tricks. YOU get the applause. \$59.95. Demo disk. \$2.50. (\$2.50 s&h). MCV/ISA

### COMPUTER GURU

40 Wagner Ave., Piscataway, NJ 08854  
201-356-6477

Inquiry 769

### CROSS ASSEMBLERS

Develop microprocessor programs on your IBM PC or MS DOS computer.

\* Macros \* Conditional Assembly \* Editor \*

Complete support for most 8 bit microprocessors. Linker and EPROM Programmer Driver

### MicroComputer Tools Co.

1255C Kenwal Rd., Concord, CA 94521  
(415) 825-4200

Inquiry 716

### LISP for the MACINTOSH™

MacScheme™ implements the Scheme dialect of LISP. It features a fast byte code interpreter, debugger, editor that understands LISP syntax, multiple windows, and Quickdraw graphics. University site licenses available \$125. (+\$10 overseas). MCV/ISA. To order, call or write:

### Semantic Microsystems

4470 S.W. Hall St., Ste. 340, Beaverton, OR 97005 USA  
(503) 643-4339

Inquiry 740

### MAC BASIC COMPILER \$100

**+ McAssembly \$150**  
BASIC compiler generates asm, rel, or obj. Link, resource comp with assembler. ALL for **\$150!**

### PTERODACTYL SOFTWARE

Box 538, Fairfax, CA 94930  
est. 1982 415-485-0714

Inquiry 734

## SOFTWARE/GRAPHICS

### SCIENTIFIC GRAPHS

SCI:GRAF produces high-res graphs (1680 x 1712 pixels) on Epson or IBM graphics printers. Supports log/linear scales, error bars, overlays, batch-mode operation. Very flexible data entry from disk or keyboard. User customizable. Requires DOS 2 or 3, 256K.

**\$99.95** (Sorry, no credit cards)

**Microcomputer Systems Consultants**  
27 Forest Ave., Port Jefferson Station, New York 11776-1820  
(516) 928-7493

Inquiry 722

### PLOTTER SOFTWARE

Save time and money by creating your own presentation quality text slides. THE DGI SIGNMAKER is an easy to use menu driven program for your IBM or APPLE computer and most plotters (Epson, HI, HP, HP-GL, IBM and others) for only **\$75**.

**DECISION GRAPHICS, INC.**  
P.O. Box 2776-B, Littleton, Colorado 80161  
Phone (303) 796-0341

Inquiry 685

## SOFTWARE/LANGUAGES

### REFER SAVES HOURS

REF cross references program variable, values, keywords, linenumbers, and/or labels.

ENTER adds languages to supplied: asm, basic, c, cobol, pascal, ada, fortran, dbase, rbase.  
FINDREPL updates programs. **\$45**.

### James Halstead & Asc.

1551 Plainfield, Joliet, IL 60435  
(815) 725-0346

Inquiry 708

### Tools for CB80 & CB86

BDOS, DOS, and BIOS calls from CB80 and CB86! CBC Tools includes functions for directory access, string ops, a debugger, radix conversion, command line parsing, quicksorts, bit and byte ops, and more for CP/M-80, CP/M-86, and PC-DOS, \$180.00. Ask about our Pascal MT+ products.

### Minnow Bear Computers

POB 2233 Sta. A, Champaign, IL 61820-8233  
(217) 398-6883

Inquiry 724

### Minnesota SNOBOL4 Language

Powerful string & data handling facilities. Interpreter compatible with mainframe SNOBOL4. 32K strings, 32 bit integers, 8087 for float & large memory model. Sample poms include ELIZA. For >128K IBM PC & DOS or equivalent. Definitive "green" book by Griswold et al available. Guide + 5 1/4" SSD diskette **\$44.95**  
Guide + diskette + "green" book **\$59.95**  
"Green" book only **\$24.95**  
Postpaid in USA. In NY add tax. VISA/MC (914) 271-5855

### BERSTIS INTERNATIONAL

POB 441, Millwood, NY 10520

Inquiry 658

### BetterBASIC Programmers

BetterTOOLS™ SPEEDS BetterBASIC™ development. Includes: 150+ useful tools in 17 modules/manual/source code/no royalties. Quicksort/screen builder/extended math/directories/display and printer routines/powerful input/much much more. Only **\$89**. VISA/MC/COD

### SOFTWARE ASSOCIATES

6220 W. Airport Blvd., Houston, TX 77035  
(713) 726-0706

Inquiry 746

# THE BUYER'S MART

## SOFTWARE/LANGUAGES

### BASIC => PASCAL

- (1) converts BASIC to PASCAL.
- (2) transform spaghetti-code to structured statement (IF-THEN-ELSE, REPEAT, WHILE, CASE) automatically.
- (3) separate one big program into many procedures hierarchically.

BPCONV MS-DOS version \$199.00.  
(Sample conversion \$10.00)

**GOTOLESS CONVERSION**  
P.O. Box 50068, Denton, TX 76206  
PH (214) 221-0383

Inquiry 700

### CROSS ASSEMBLERS with "UNIVERSAL" LINKER and POWERFUL LIBRARIANS for IBM PC MS-DOS

Full featured for most microprocessors

#### ENERTEC, INC.

BOX 1312, Lansdale, PA 19446

215-362-0966 MC/VISA

Inquiry 693

### EXPERT SYSTEMS!

You can develop expert systems with KNOWOL, the Knowledge Oriented Language from IMCO. Includes a tutorial, unlimited development capability, and a smart rules editor. Not copy protected. An incredible introductory offer at \$39.95 plus \$2 s&h (\$4/COD).

#### Intelligent Machine Company

3813 N. 14th St., Arlington, VA 22201  
(703) 528-9136

Inquiry 706

## SOFTWARE/SCIENTIFIC

### \$10 SCI CALCULATOR

Power-packed, RAM resident, full-function infinitely programmable sci. calculator with matrix capability at \$10 (\$2 s&h).

Turbo Pascal source + utilities for sparse matrix handling \$10 w/calculator purchase.

#### SoftTech Inc.

18505 W. 8 Mile, Detroit, MI 48219

1-313-544-8544

Inquiry 744

### FORTRAN SOURCE CODE PROFESSIONAL SIGNAL PROCESSING & MATRIX ANALYSIS UTILITIES

35 PROGRAMS W/TUTORIAL & EXAMPLES  
FFT, AR Modeling, Digital Filters, Matrix: SVD, Conj. Gradient, Pseudo-Inverse, Root Finder, Cubic Spline Interp, Graphics, Random Numbers, More. Disk/Hard-copy. Documented. 130 pages. Bibliography. Send for Info Pkg. \$99.

#### CLAREN SOFTWARE

P.O. Box 5333 • MESA, AZ 85201  
(602) 820-3877

Inquiry 672

### forMath® text-formatter

- Equations, matrices, ratios, integrals, diagrams
- Macros, fonts, Greek/math symbols
- Hyphenation, secn/eqn/ref numbering
- indexes, table of contents, footnotes
- Dot-matrix, daisywheel, laser printers, all monitors

\$400. \$50 for demo

#### SHANTHA SOFTWARE INC.

50 West 97th St. Room 11N, New York City 10025

(212) 222-SNIP

Touchtone toll free: 950-1088-wait-FORMATH

Inquiry 741

## SOFTWARE/SCIENTIFIC

### BEAM ANALY. & SPRING DESIGN

Beam analysis program calculates shear, moments, reactions, slopes and deflections in beams. Price: \$50.00. Helical spring design program for compression, extension and torsion springs. Price: \$75.00. Both packages include disk and documentation. For Apple II series of computers or IBM PC, PCjr and compatibles.

#### SYLCA CORPORATION

33-47 14 Street, Dept B, Long Island City, NY 11106  
718-278-4604

Inquiry 753

### ► MATRIX 100 ◀

Powerful Matrix operations with single statements in IBM PC BASIC. Perform multiple regression, solve simultaneous equations, invert matrices, etc. MATRIX 100 commands are fast, reliable and easy to use. Price \$80, 8087 support \$125; compiler support \$250. (\$4 s&h. CA res. add sales tax).

#### STANFORD BUSINESS SOFTWARE, INC.

4151 Middlefield Rd., Suite 215, Palo Alto, CA 94303  
To Order Call (415) 424-9499

Inquiry 749

### ENGINEERING SOFTWARE WRITTEN BY ENGINEERS FOR ENGINEERS

Highest power per dollar. Highest power per K of memory. Satisfaction guaranteed.

Electronic Circuit Analysis . . . . . \$450.

#### TATUM LABS

33 Main St., Newtown, CT 06470

(203) 426-2184

Inquiry 754

### Affordable Engineering Software

CALL OR WRITE FOR FREE CATALOG  
Circuit Analysis • Root Locus • Thermal Analysis • Plotter Drivers • Graphics • Signal Processing • Filter Design • Report Pre-processor • Transfer Function Analysis.

#### BV Engineering

2200 Business Way Suite 207, Riverside, CA 92501  
(714) 781-0252 VISA/MC

Inquiry 667

### TIRED OF SEARCHING!!

Can't find that special conversion factor? You get thousands in the giant disk of units constants and conversion factors. No need for a calculator, conversions are calculated for you. Menu driven with color & printout features. Only \$19.95 including shipping.

#### R. D. ASSOCIATES

P.O. Box 820, Rogue River, OR 97537

503-479-1248

Inquiry 738

### UPGRADE YOUR IBM PC TO A STORAGE OSCILLOSCOPE!

Do Data Acquisition, Frequency Spectrum Analysis, Transfer Functions, Analysis with Lotus 1-2-3, and more—inexpensively and all without programming!

For info on SNAPSHOT Storage Scope:

#### HEM Data Corporation

17025 Crescent • Southfield, MI 48076

(313) 559-5607

Inquiry 703

## SOFTWARE/SCIENTIFIC

### PC TECHNICAL GRAPHICS

TEKMAR is a graphics library for the Tecmar Graphics Master. Similar to PLOT-10, includes WINDOW, VIEWPORT, AXIS. Support for HP, HI plotters. Curve fitting, complete plotting program. Log, semi-log, multi-axis, 3-D, contours. Demo disk, literature available.

#### Advanced Systems Consultants

21115 Devonshire St., Suite 329, Chatsworth, CA 91311

(818) 407-1059

Inquiry 653

### ► SCIENTIFIC CALCULATOR ◀

Memory resident emulation of the HP-11C plus direct insertion of results in foreground program, graphically presented, decimal, hex, binary, & octal operations, boolean functions and more. Mouse support. 8087 or Standard versions \$49.95 + 3.00 s&h.

#### K SOFTWARE HOUSE

Rt. 2, Box 83B1 Unionville, TN 37180

(615) 294-5090

Inquiry 710

### Digital Logic Design on the Macintosh™

The LogicWorks™ series allows you to create, test and document digital circuitry on your Macintosh. Full simulation capability lets you catch design errors before committing your circuit to hardware. From \$79.95 (US). Demo pkg. \$10. Visa/MC Accepted.

#### Capilano Computing Systems Ltd.

Box 86971, N. Vancouver, B.C., Canada, V7L 4P6

(604) 669-6343

Inquiry 670

## SOFTWARE/SYSTEMS

### CPM-80 LIVES on your PC

CP/Mulator puts a 4mbx 8 bit CP/M emulator in your IBM-PC for \$99. (\$3 s + h).

- A great 8 bit development system
- Saves expensive CPM-80 applications
- Increases PC speed 10% for 8088 programs
- Priced less than most software only products
- Uses no valuable board slots

#### Source Information

P.O. Box 2974, Warminster, PA 18974

VISA Phone (215) 628-4719 M/C

Inquiry 748

### LASER TYPOGRAPHY \$495.

Typographic composition software to drive the Cordata L300 Laser Printer as a typesetter. H & J 76 proportional space fonts, widths for 150 fonts available. Mix face & point size on any line, multicolumn capability.

#### Micro Print-X, Inc.

P.O. Box 581, Ballinger, TX 76821

(915) 365-2343 Dealer Inquiries Welcome

Inquiry 723

### Multi-Terminal

#### Disk Operating Systems

GASS-General Accounting Scientific Switching system. Multitasking. Can handle 12 terminals off IBM PC. Used in mini's since 1976. Dealers wanted. List Price \$95.

#### Maxe Systems, Inc.

5910 Youree Dr. Suite D, Shreveport, LA 71105

(318) 868-5422

Inquiry 714



# THE BUYER'S MART

## STATISTICS

### STATISTIX™

\$75 - Satisfaction guaranteed

A comprehensive, powerful, yet easy-to-use statistical analysis system for IBM PC/XT/AT's, Apple II's, and MS DOS machines. Clear 200p manual. Write for information.

#### NH ANALYTICAL SOFTWARE

801 West Iowa Ave., St. Paul, MN 55117

(612) 488-4436

Inquiry 727

## UTILITIES

### "USER-FRIENDLY" REDEFINED

Don't laugh. Now if your P.C.'s aren't friendly, it's your own fault. Meet TheEMCEE, your application manager. Replaces DOS prompt with custom menus. Runs programs, batch files and menus. 99 levels of password protection. Fast, friendly interface for users, powerful access and control for systems managers. Only \$49.95. What could be friendlier than that?

**COMMAND SOFTWARE SYSTEMS, INC.**  
1-800-423-9147 or 1-818-707-7100

Inquiry 767

## UTILITIES

### BTrees with C Source

These are powerful, portable, dependable file utility libraries. Thousands of programmers worldwide rely on our quality code. All source code included, no royalty fees, works with any K&R compatible C compiler.

• Btree only \$75.00 • ISAM only \$40.00 additional.

#### SOFTFOCUS

1343 Stanbury Dr., Oakville, Ontario, Canada L6L 2J5  
(416) 825-0903

Inquiry 745

## RATS!

RATS is a fast, accurate & complete regression package with unsurpassed POWER. Has both time-series & cross section analysis. Includes Box-Jenkins, logit & probit. Spectral analysis & graphics also available. Requires 256K RAM, IBM PC or compatible. \$200. MC/VISA.

### VAR Econometrics

P.O. Box 19334, Minneapolis, MN 55419

(612) 822-9690

Inquiry 758

## PADLOCK/PADLOCK II DISKS

PADLOCK furnishes the user with a method for providing protection against unauthorized duplication from DOS commands \$99. PADLOCK II disks come preformatted with finger-print and serialization. PADLOCK II disks offer superior protection. Ask about our HARD DISK protection with uninstall capability. MC/VISA.

### GLENCO ENGINEERING

3920 Ridge Ave., Arlington Hts., IL 60004

(312) 392-2492

Inquiry 699

## ZERODISK

ZeroDisk runs dozens of copyprotected business packages from your hard disk without floppies. Call for the latest list of software it handles. Needs IBM AT, XT, PC, or compatible, DOS 2.0 or higher. ZeroDisk is revised monthly and is not copy protected. \$75 US. Check or Credit Cards accepted.

### QUAD SOFTWARE LIMITED

45 Charles St. E. 3rd Fl.

Toronto, Ontario, Canada M4Y 1S2

(416) 961-8243

Inquiry 745

## The Statistician

includes: Multiple Regression (Stepwise, ridge, all subsets, backward elimination)

- Time series analysis • descriptive statistics
  - transformations • survey research • nonparametrics
  - XY plots • ANOVA • random samples • data base
  - data editor • search & sort • hypothesis tests
- For IBM, MS-DOS, XENIX, CPM, TRS-DOS.

### QUANT SYSTEMS

Box 628, Charleston, SC 29402  
803-571-2825

Please call  
TOLL FREE  
1-800-334-0854  
(Ext. 814)

Inquiry 735

## SOURCE CODE LIBRARIAN & REVISION CONTROL SYSTEM

TLIB™ keeps ALL versions of your program in ONE compact library file, even with hundreds of revisions.

- 5 times faster than SCCS • LAN compatible
- Free public domain MAKE (with source) by L. Dyer

### BURTON SYSTEMS SOFTWARE

POB 4156, Cary, NC 27511

(919) 469-3068

Inquiry 662

## MEDIA MASTER PLUS

READ, WRITE, and FORMAT over 60 CP/M disks and run most CP/M-80 programs on your IBM PC! Two program package includes ZP/EM, a CP/M-80 emulator program that transforms your IBM PC into a 1.2 MHz CP/M 2.2 computer. \$59.95 + \$3.00 S/H (CA 6%)

### INTERSECTING CONCEPTS, INC.

4573 Heathergreen Ct., Ste. 10

Moorpark, CA 93021

(805) 529-5073

Inquiry 708

## STATISTICS CATALOG!

If you need statistics for IBM PC or Apple II, call us and let our technical advisors help you find the statistics programs you need. Write or call now to get a FREE catalog of statistics and quality control software.

### HUMAN SYSTEMS DYNAMICS

9010 Reseda Blvd., Ste. 222  
Northridge, CA 91324

(800) 451-3030 (818) 993-8536 (CA)

Inquiry 704

## DOS USERS.

"Save time and frustration" — J.E. Pournelle

Still River Shell. Powerful full screen file / directory manager. Faster and easier than DOS. Full range of features. PC/MS-DOS 2.0+ . \$29 complete. \$9 shareware diskette. MC/VISA.

### Bob Howard

PO Box 57, Still River, MA 01467

617-456-3699

Inquiry 660

## GENSCREEN

For Microsoft Cobol/IBM Cobol  
Generates Cobol Source Code For Your Screen  
Section and Data Divisions Fast!!!

GenScreen is a powerful new programmer's productivity tool which utilizes a screen image text file produced from your own editor. This in turn is run through our interactive utility to produce 100% syntax free Cobol source code. GenScreen will produce "generic" or custom data names for your code automatically. GenScreen is available for only \$69.99 from

### Personal Computer Development Corp.

POB 8556, Warwick, RI 02888-8556

(401) 333-8704

Inquiry 732

## NUMBER CRUNCHER STAT SYS

Menu-driven. Multiple & stepwise regression, ANOVA, time series, Discriminant, cluster, and factor analysis. Principal components, scatter plots, histograms, t-tests, contingency tables, non-parametrics. Import/export data. Spreadsheet, sort, join, merge. \$79. IBM PC/Macintosh. Quantity discount.

### NCSS-B

865 East 400 North, Kaysville, UT 84037

801-546-0445

Inquiry 726

## RAMbak or WARP-TEN - 9.95

RAMbak automates the saving of new or changed RAM disk files to floppy disks and/or hard disk subdirectories. WARP-TEN is a programmable disk cache. PC, XT, AT, compatibles with 256K DOS 2.0+. Introductory price is only 9.95 each. (MN Res. + 6%).

### Software Brewing Company

P.O. Box 12094, St. Paul, MN 55112

612-636-2727

Inquiry 747

## PAL FOR SIDEKICK!

Personal Appointment Locator automatically shows coming appointments, searches your file, maintains to-do list, examines multiple files. Resident alarm too! Only \$45. Cheap at twice the price!

### PAL SOFTWARE

Ste. 12B 110 Green St., New York, NY 10012

212-925-1843

Inquiry 729

## TEXT SCANNING

ELIMINATE KEYBOARDING  
CONVERT TYPESET AND  
TYPEWRITTEN COPY  
TO DISK OR TAPE

CALL

### MEDIA CONVERSION CORPORATION

312-346-0102

Inquiry 717

## SUPERCOPY

The most EFFICIENT-INTELLIGENT-USER-FRIENDLY POWERFUL AUTOMATIC BACKUP UTILITY of protected diskettes, for IBM PC/XT/AT. EXCLUSIVE DISKETTE ANALYZER/DIAGNOSER FULL AUTOMATIC LOCKING CAPABILITY! Built-in HELP with full instructions in a disk file. \$50 VISA/MC/CHK

### YETIWARE CORP.

P.O. Box 21152, Mid Town Station

New York, NY 10129

DEALERS, CONTACT US

Inquiry 768

## XENIX/UNIX

### XENIX/UNIX SOFTWARE

TELETERM-X Multi-User Telecommunications  
XPD Print Manager/Spooler  
XTX File Transfer Utility  
X-MENU System Administration Utility  
and Menu Package

TELETERM-EM Terminal Emulator to turn your  
MSDOS/TRSDOS micro into a workstation

### Telepress, Inc.

P.O. Box 217, Willingboro, NJ 08046

(609) 877-4900

Inquiry 756

# QUALITY • SERVICE • PRICE!

## SUN-XT / PLUS COMPUTER

# \$795

(ASSEMBLED & TESTED)

Dealer & Computer Group  
CALL FOR SPECIAL PRICE



- One 360 KB 1/2 Height Disk Drive
- 256K RAM (Expandable to 640K)
- Enhanced Keyboard (AT Style)
- Hercules Compatible Mono Graphic Card (720x348)
- 12" High-Resolution TTL Mono Monitor
- 8 Expansion Slots □ Parallel Printer Port
- Uses MS & PC/DOS Operating System
- Meets FCC Class 'A' Regulations for Industry & Business Use

## SUN-XT Mono System

# \$895

2 Disk Drives • 640K RAM  
Mono G Card • 12" TTL Monitor  
Enhanced Keyboard • 135W P.S.  
Parallel Port

## SUN-XT Color System

# \$1193

2 Disk Drives • 640K RAM  
Color G Card  
13" RGB Color Monitor (640x240)  
Enhanced Keyboard • 135W P.S.

## SUN-ST Mono System (8MHz Turbo)

# \$995

2 Disk Drives • 640K RAM  
Mono G Card • 12" TTL Monitor  
Enhanced Keyboard • 135W P.S.  
Parallel Port (Switchable to 4.77 MHz)

## SUN-ST Color System (8MHz Turbo)

# \$1293

2 Disk Drives • 640K RAM  
Color G Card  
13" RGB Color Monitor (640x240)  
Enhanced Keyboard  
135W P.S. (Switchable to 4.77MHz)

## AT COMPATIBLE SYSTEM (8MHz)

# \$1725

One 1.2MB FDD • 640K RAM  
Keyboard • HDD/FDD Controller  
200W P.S. Case A&T  
(Call for other Configuration)

## SPECIAL SALE ITEMS

SUN-XT CPU (4.77MHz)	\$145
SUN-ST CPU (8MHz Turbo)	\$195
FDC w/Cable	\$49
CABINET	\$49
MULTI I/O PLUS (Serial, Par, Clock, Game)	\$95
POWER SUPPLY 135W	\$75
AT STYLE KEYBOARD	\$65
OTHER PARTS AVAILABLE	



## SUNTRONICS CO., INC.

12603 Crenshaw Blvd., Hawthorne, CA 90250

(Orders Only)

1-800-421-5775

(CA Orders & Tech Info.)

213-644-1140

### STORE HOURS

MON - FRI 9:00am - 6:00pm

SATURDAY 10:00am - 5:00pm

Dealer & OEM Inquiries Invited

TERMS: VISA, MasterCard (No Surcharges) COD, Cash or Certified Check (VISA or MC Ref. Required). School & Gov. Contractor P.O. accepted. Shipping & H/C \$4.00 for 3 lbs. plus \$6.00 for each additional lb. CA residents add CA Sales Tax, \$10.10 Min. Order. WARRANTY: 90 Days Warranty Labor. Parts Replacement Only.

# FUTURE MUSIC

MIDI  
HARDWARE  
SOFTWARE

- COMPUTER AND MUSIC SPECIALISTS!
- ALL MAJOR BRANDS AVAILABLE!
- THE BEST PRICES!
- TECHNICAL AND NOT-SO-TECHNICAL SUPPORT TOO!



**KEYBOARDS, SYNTHESIZERS, SAMPLERS, DRUM MACHINES, REVERBS, DELAYS, INTERFACES, SOFTWARE AND MORE.**

### IBM PC PRODUCTS

	List	Sale
MPU IBM Interface	\$ 310	\$223
TECMAR Music Card	CALL!	CALL!
Textures I	149	125
Textures II	349	295

Jim Miller		
Personal Composer	495	425
SDA Pro Midi System	599	449
Many More "New" Products	CALL!	CALL!

### APPLE MACINTOSH PRODUCTS

Deluxe Music Const. Set	49	32
Midi Conductor Interface	89	69
Opcode 128/512 Interface	125	95
Opcode Mac Plus Interface	200	160
Opcode Sequencer V2.0	200	175
Mark of the Unicorn		
Performer	295	260
Concertware Plus Midi	CALL!	CALL!
Digital Sampler Editors	CALL!	CALL!

**ATARI, AMIGA, CALL FOR LATEST INFO!**

### APPLE II SERIES PRODUCTS

	List	Sale
Passport Midi 8+ Software	169	129
Passport Master Tracks	249	199
Passport Leadsheet	149	109
Syntech Interface		
w/Drum Sync	129	99
Syntech Studio 2 Sequencer	225	175
Yamaha Editors	CALL!	CALL!
CZ Series Editors & Librarians	CALL!	CALL!
Digital Sampling on the IIE	CALL!	CALL!
Commodore 64/128 Products	CALL!	CALL!

### KEYBOARDS, SYNTHESIZERS, ETC.

DX7/TX7 Programs (1000s!)	\$1ea.
DX/RX 128 Ram Carts	125 95
CZ Series 64 Ram Carts	89 69
4 Track Recorders	CALL! CALL!
Studio Effects Devices	CALL! CALL!
Midi Keyboards	CALL! CALL!
Drum Machines	CALL! CALL!

## BYTE SPECIAL ISSUE \$ SALE \$

START YOUR COMPUTER MUSIC SYSTEM TODAY

**\$299 CASIO CZ101** SAVE \$200

PROFESSIONAL SYNTHESIZER SOUND, UP TO 4 UNIQUE SOUNDS AT ONCE, MIDI, PROGRAMABLE, PORTABLE. EASY TO USE — THE STANDARD —

**FREE AC ADAPTER & SHIPPING**

### BOOKS ON MIDI, MIDI PRODUCTS

- Understanding Midi - 82 Pages. . . . . 3.95 w/Product Guide
  - How to Understand & Program the DX7. . . . . 24.95
  - Synthesizer Technique . . . . . 8.95
- Send cost plus \$1.50 postage and handling to the address below or call toll free to order.

### SPECIAL PRICE ON ATARI SYSTEMS! CALL!

FUTURE MUSIC IS THE ONLY MUSIC STORE DEVOTED TO COMPUTER ENTHUSIASTS & HOME MUSICIANS. WE HAVE MANY MORE PRODUCTS AVAILABLE. IF YOU DON'T SEE WHAT YOU WANT HERE, CALL US.

MASTERCARD AND VISA ACCEPTED

**CALL 24 HRS. TOLL FREE!**

# 1-800-FOR-MIDI

FUTURE MUSIC, 1465 Terminal Way. Mail Orders and Correspondence to: Box 1090, Reno, NV 89504. Nevada Call 702-826-MIDI. Cust. Service 702-359-MIDI; 9-9 PDT



# BYTE

# LIMITED EDITION Classics

#A

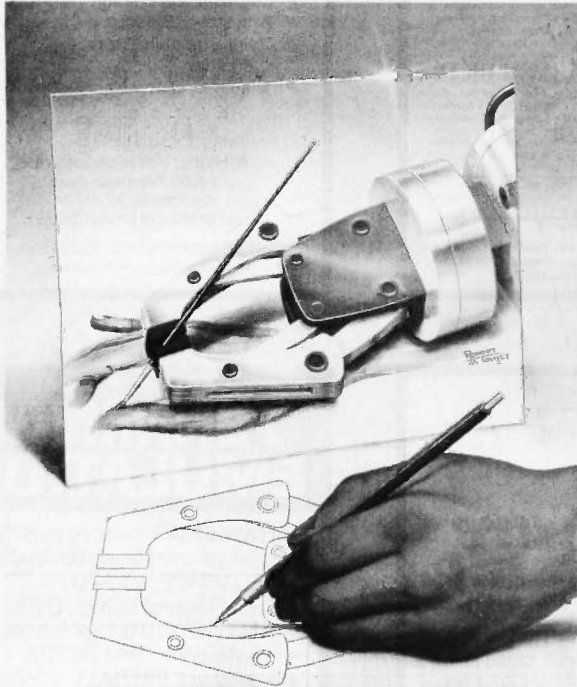

INTELLIGENT REFLECTIONS

ROBERT TINNEY

### Fascinating...And Unique!

The two 1985 Byte covers shown above are now available as 16" X 20" limited edition prints. Each edition is strictly limited to 1000 prints, which are individually inspected, signed and numbered by the artist, Robert Tinney. These excellent reproductions are made from the original paintings (not from transparencies or photos) to ensure accurate color fidelity.

Byte Limited Edition Classics are printed on select 100% cotton fiber stock. This is a museum grade acid free paper, highly resistant to yellowing and cracking; you will be assured of a print which will retain its color and beauty for generations. Accompanying each print is a handsome Certificate of Authenticity, which is also personally signed and numbered by the artist, and which certifies the quality and limited number of the edition.

### Price and Shipping

The price of each Byte Limited Edition Classic is \$55; if two or more prints are ordered, the price of each is only \$45.

Beautiful 16" X 20"  
Limited Edition Prints,  
each signed and numbered  
by the Artist.

#B

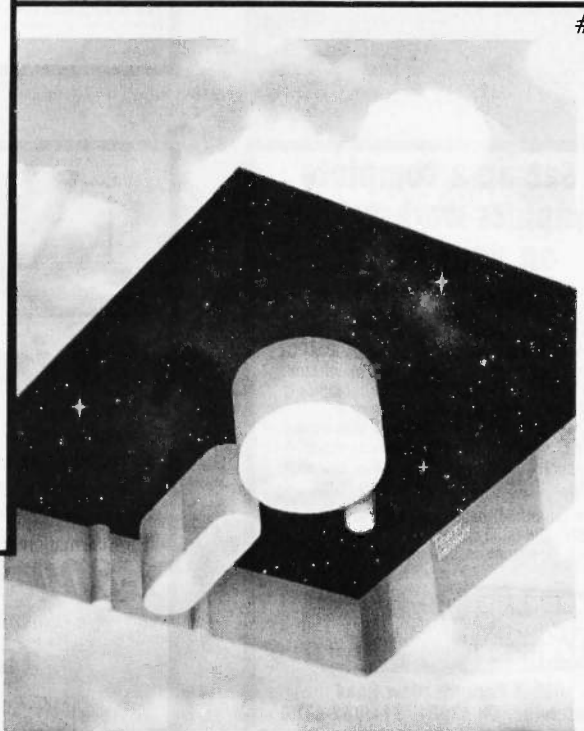

STORAGE SPACE

ROBERT TINNEY

Byte Limited Edition Classics are shipped flat, and are guaranteed to arrive undamaged or be immediately replaced. In fact, if for any reason you are not satisfied with your order, you may return it within 30 days for a no questions asked refund. Your prints will be shipped UPS Blue Label (two day delivery), and will usually be shipped within one week of receipt of order.

### Ordering

To order your Byte Limited Edition Classic(s), just clip out and mail the coupon below. If you prefer, you may call in a MasterCard or Visa order to Robert Tinney Graphics, 1-(504)272-7266.

Send me the following print for \$55 (\$45 each for two or more).

Qty.	#	Title	Amount
_____	_____	_____	\$ _____
_____	_____	_____	\$ _____
postage & handling \$4 (\$10 overseas)			\$ _____
<b>Total \$</b>			\$ _____

Bill my  Visa or  Mastercharge: Exp. Date: \_\_\_\_\_

Card No. \_\_\_\_\_

- I have enclosed check or money order to Robert Tinney Graphics  
 Please just send me your free color brochure.

### Ship To:

Name: \_\_\_\_\_  
 Address: \_\_\_\_\_  
 City: \_\_\_\_\_  
 State: \_\_\_\_\_ Zip: \_\_\_\_\_

Mail this coupon to:  
**Robert Tinney Graphics**  
 1864 N. Pamela Drive  
 Baton Rouge, Louisiana 70815

Visa or MasterCard orders  
**CALL 1-504-272-7266**

## GFK MEMORIES

**ADD-IN BOARDS  
PIN-FOR-PIN COMPATIBLE  
EASY INSTALLATION**

<b>HP 150</b>	(All Versions)	
	512K	\$660
<b>WANG PC</b>	256K	\$460
	384K	\$635
	512K	\$750

### GFK

Amandastr. 60, 2000 Hamburg 6  
West Germany

**Phone** (40) 4301051 **Telex** 2162272

Dealers are invited

**US Distributor:**  
HyPoint Technology (216) 526-0323

Inquiry 406

## TIME SAVING — MONEY SAVING PRINTER BUFFER



SPOOL-Z-Q PLUS

SPOOL-Z-Q PLUS is a parallel printer buffer which works with any parallel printer and frees up your computer for productive use while printing. Very high capacity (128K to 512K) and full time space and null character compression means that Spool-Z-Q Plus is really to take on the really big jobs. A special Paper-on-Held feature allows printing single sheets from the buffer. Spool-Z-Q Plus also has Copy, Clear, and Self-Test functions built in. Supplied complete with UL/CSA listed power supply, the Spool-Z-Q Plus is easy to install and use. All models are user adjustable to 512K at any time by just plugging in standard 256K RAM chips. Spool-Z-Q Plus is the professional's choice for size, features, and price.

(Without Cable) 128K-\$279 256K-\$309 512K-\$369  
(Including Cable) 128K-\$309 256K-\$339 512K-\$399

SPOOL-Z-Q BLUE PLUG IN PRINTER BUFFER FOR THE IBM PC and compatible computers IS A GENUINE HARDWARE PRINTER BUFFER, NOT A SPOOLER. Parallel only and Serial/Parallel models available. Works with any software and does not use any of the computer's memory. Sizes from 256K to 1024K are available. Spool-Z-Q Blue replaces the parallel printer card in the PC (May be EP1, 2, or 3). Many advanced features. Call or write for full details. Prices start at \$319 (Parallel only) and \$399 (Serial capable).

Available from dealers or direct from us. We accept A/C, VISA, AMEX or COD orders. No charge for shipping or COD. 15 day trial period (no-hassle refund policy) on all products. CA residents — 6% tax.

DEALER INQUIRIES INVITED.

O.E.M.s — We can modify our buffers to meet your special requirements.

1601 Fulton Ave., Suite 10A  
Sacramento, CA 95825  
(916) 483-0709

Inquiry 178

## PC/XT USERS!

- COGTREE Utilities by Cogitate ..... \$129.95
- LYNC by Norton-Lamber ..... \$199.95
- DATAFLEX by Data Access...Varies
- RMICOBOL by Ryan/McFarland .....Varies
- Universe by Omnitrend..... \$ 98.50
- Blue MacI by Cogitate..... \$599.00
- CadPower+ by Trilex..... \$995.00
- Softex Teaching Aids..... \$ 95.00
- PrintSet by Cogitate..... \$ 79.95
- CogiTAPE by Cogitate..... CALL!!
- Anti-Static Products.....Varies
- Uninterruptible Power Backups.....Varies
- TeleVideo Software.....CALL!!

COGITATE

"A Higher Form of Software"  
24000 Telegraph Road  
Southfield, MI 48034  
(313) 352-2345/Telex 386581

VISA/MASTERCARD ACCEPTED  
Dealer Inquiries Welcomed

Inquiry 71

## Set up a complete graphics workstation on your PC for under \$100!

MicroPlot's enhanced PC-PLOT-III graphics emulator software package enables IBM PC and compatibles to appear to a mainframe as a DEC VT-100/VT-52, a Retrographics VT-640, a Tektronix 4010/4014 or a partial Tektronix 4027. Over 12,000 copies are currently in use world-wide at major corporations, educational facilities, research labs and independent consulting firms.

For more information call toll free 1-800-338-0333, Ohio call 1-800-242-0333 Give operator this ID number: 766-8501.



659-H Park Meadow Road  
Westerville, Oh 43081 614/882-4786

Inquiry 226



## Sure it's insured?

SAFEWARE® Insurance provides full replacement of hardware, media and purchased software. As little as \$39/yr. covers:

- Fire • Theft • Power Surges
- Earthquake • Water Damage • Auto Accident

For information or immediate coverage call:

**1-800-848-3469**

In Ohio call 1-614-262-0559



SAFEWARE, The Insurance Agency Inc.

Inquiry 304

## TERMINAL EMULATION

Softerm PC emulates over 30 popular terminals including the:

- DEC VT102, VT220
- Data General D200, D410
- IBM 3101-20 (block mode)
- Hewlett-Packard 2622A
- Honeywell VIP7801, VIP7803

Guaranteed Compatibility

Call for free product brief \$195 MC-VISA-COD  
For the IBM PC/XT/AT, DG1, NEC, Wang PC, TI Pro, Gridcase, Tandy

**SETRONICS**

7899 Lexington Dr., Ste 210  
Colorado Springs, CO 80918  
(303) 593-9540

Inquiry 314

## Maxell Floppy Disks

The Mini-Disks with maximum quality.



Dealer inquiries invited. C.O.D.'s accepted. Call FREE (800) 235-4137.

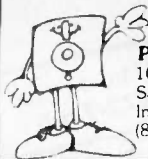

**PACIFIC EXCHANGES**  
100 Foothill Blvd., San Luis  
San Luis Obispo, CA 93401.  
In Cal. call (800) 592-5935 or  
(805)543-1037.

Inquiry 254

## TURBOLINK +

"TURBO Pascal hackers will like this program."

Jerry Pournelle  
Byte Magazine

- Add 512K of TURBO Pascal\* to your code
- Call up to 8 memory resident TURBO Pascal modules from programs written in:
  - BASIC, BASICA, Compiled BASIC
  - MS Pascal, C, MS FORTRAN
  - Standard, 8087 and BCD TURBO Pascal
- Add TURBO Pascal's 8087, BCD and graphic capabilities to other languages
- Automatically generate TURBO Pascal compatible inline machine code
- Use all TURBO Pascal variants in a single program
- For IBM PC and compatible

**\$6995**

S&H included Foreign orders add \$10.00

VISA/MC: 1-800-835-2246 x 123  
KANSAS CALL: 1-800-362-2421 x123  
Inquiries and Technical Information (303) 971-0729

**PATHFINDER SOFTWARE, INC.**  
P.O. Box 43, Littleton, CO 80160

\*TURBO Pascal is a registered trademark of Borland International

Inquiry 256

## M68000 SINGLE BOARD COMPUTER



On board 6-10 MHz CPU, 20K RAM, 32K EPROM, two RS-232, 16-bit port, 5-counter/timers expandable via Memory/FDC Board.

M68K CPU (bare board)	\$ 89.95
M68K CPU A&T (6MHz)	\$495.00
MD512K Memory/FDC (bare board)	\$ 89.95
MD512K Memory/FDC (128K)	\$495.00
FDC/Hard Disk Interface option	\$150.00
M68KE Enclosure w/power supply	\$249.00
M68K Monitor EPROM's	\$ 95.00
M68K Macro Cross Assembler	\$195.00
4XFORTH OS w/assembler, editor	\$295.00
CP/M 68K OS w/'C' compiler	\$395.00

**EMS** Educational Microcomputer Systems P.O. Box 16115 Irvine, CA 92713 (714) 854-8545

Inquiry 124



# Compu\$ave

Call Toll Free: 1-800-624-8949

A DIVISION OF ADLANKO CORPORATION

## MONITORS

Hitachi 1455S...	525	Amdek 310A.145
Mitsuba/TTL...	109	Amdek 722... 499
NEC Multisynch. 542		PGS MAX 12.162
Tatung 1370...	449	PGS HX12E.515
Tatung 1380...	519	Taxan 620...385
Tatung 1222A...	122	Taxan 640...495
Thom 36382St.	375	Wyse 620...399
Zenith 1240...	155	Zenith 1230.92
Roland/12"/RGB/640x240/37...	299	
Thomson/14"/Color Comp/Apple.	139	
Sakata/13"/RGB/800x400/31...	529	
Mitsubishi/Quadram/Tecmar...		CALL

## MODEMS

AST Reach Half-Card W/Soft...	325
Anchor Volksmodem...	49
Anchor Express Half-Card W/Soft...	185
Hayes Smartmodem 1200...	368
Incomm 2400 (Upgradable 4800+)	399
Novation 212 Apple Cat II...	375
Prac. Per. 1200 Half-Card W/Soft...	155
Prometheus Promodem 1200G...	195
Prometheus Promod 1200B W/Soft.	218
Racal-Vadic 1200V...	209
Racal-Vadic 2400 Half-Card W/Soft.	389
Zoom IIE Internal/Apple...	92
Codex/Rixon/UDS/Ven-Tel...	CALL

## COMPUTERS

Altos 986T-80 Multiuser System...	10695
Corona PPC400 Port./2 Drives...	1125
Sharp PC7000 Port./2 Drives...	1295
Sperry IT/1M/40M Hard Drive...	2995
Televideo AT/1.2M/20M/Monitor...	2385
Wyse PC1100/256K/1 Drive...	965
Zenith ZF138 Port./1 Drive...	1195
Zenith ZF148/256K/1 Drive...	899
Zenith ZF158/256K/1 Drive...	1399
Corvus/Molecular/Panasonic...	CALL

## PC-XT CLONE \$599

640K/4.77 MHz/1 Floppy Drive/135 W Power Supply/XT-Style Keyboard/ User Documentation/6 Months Warranty

## OLIVETTI M-24 \$1645

(FROM THE MAKERS OF AT&T 6300) 640K/8MHz/1 Floppy Drive/250 Watt Power Supply/Keyboard/Clock/Calendar 640x400 Mono & Color/7 Empty Slots Par & Serial Ports/Monochrome Monitor

## TERMINALS

Televideo 905...	299	Altos IV...	385
Televideo 955...	449	Ampex 210...	365
Wyse 30...	289	Ampex 219...	465
Wyse 50...	418	Qume 101G...	293
Wyse 85...	438	Visual 65...	425
Adds/CIE/IBM/Kimtron/Liberty...			CALL

## PRINTERS/PLOTTERS

Citizen 120D...	179	Canon A40...	235
Citizen MSP10...	248	Canon Lazer.	1975
Corona Lazer...	2265	Diablo D25...	519
Epson FX286...	549	Diablo 635...	1065
Epson LX90...	245	Juki 6100...	345
Epson LQ1000...	689	NEC P5...	975
Panasonic 1080.199		NEC P5XL...	1125
Panasonic 1091.235		NEC P7...	585
Toshiba 321...	495	Star NX10...	245
Toshiba 341...	795	Tally MT86...	425
Fujitsu Color Printer/220CPS...			495
Anadex/C. Itoh/Data Prod/Qume...			CALL
Genicom/Okidata/Televideo/TI...			CALL
Bufers/Cables/Sheet Feeders...			CALL
Stands/Switch Boxes/Tractors...			CALL
Houston/Ioline/Roland Plotters...			SAVE
Houston/Kurta/Summa Digitizers...			SAVE

## DISK DRIVES

Apple Compatible Floppy Drives...	121
IBM Compatible Floppy Drives...	89
IOMEGA Dual 20M Bernoulli Box...	2995
Tandon 20M Hard Card...	669
Seagate 20M Hard Drive Kit...	439
Seagate 30M AT Hard Drive...	695

## OTHER FLOPPY AND HARD DRIVES

Archive • CDC • Corvus • Gamma • Irwin Maynard • Micro Sci • Mitsubishi • Priam Panasonic • Shugart • Tallgrass • Teac Tecmar • Toshiba • Western Digital

## BOARDS

AST Rampage PC...	298
AST Six Pack Plus/64K...	212
Six Pack Clone/Game Port/OK...	99
ATI Graphics Solution...	199
Hercules Color Card...	143
Color Card Clone...	95
Intel Above Boards...	CALL
Orange Grappler + (Apple)...	69
Paradise Modular Graphics Card...	235
PC Monochrome Graph (Par Port)...	99
PC 576K RAM Board (OK)...	67
Quadram Vega EGA+...	389
Sigma 400 High Res Card...	455
Taxan 555 High Res Card...	189
Tecmar Captain/OK...	119
Microtek/Orchid/Persyst/STB...	CALL
Prac. Peripherals/Thesys/Vutek...	CALL

ALL TYPES OF BUSINESS, CAD AND RECREATIONAL SOFTWARE VERY LOW PRICES... CALL

## WE ALSO CARRY

Maynard Mouse W/Software... 122  
Intel 8087-2 Coprocessor Chip... 152  
Keytron 5153 Keyboard/Touch Pad. 265  
Disk Controllers/Joysticks/Labels  
Power Supplies/Surge Protectors  
Cables/Graphics Tablets/Light Pens  
VERY LOW PRICES FOR DS/DD DISKS

HOURS: MON - FRI 8AM - 6PM/SAT 9AM - 2PM  
IN ARIZONA CALL (602) 437-4855

CompuSave: 4207 S. 37th St., Phoenix, AZ 85040/For Customer Service Call (602) 437-4856/Prices Reflect Cash Discounts And Are Subject To Change Without Notice/Minimum Shipping Charge \$4 Purchase Orders & Major Credit Cards Welcome

# BYTE CONNECTION INC. (714) 778-6496

BOTTOM LINE PRICE BUSTERS! - "Who you gonna call?"

## PRINTERS

BROTHER M-1509	\$ 350	CITIZEN LQ24	\$ 895	D10-40	\$ 750
C-10	\$ 475	CITIZEN MSP 15	\$ 365	MSP 25	\$ 525
PREMIER 35	\$ 450	CORONA LASER	\$ 2350		
DIABLO 635	\$1250	INKJET	\$ 695	34LQ	\$1095
LAZER/COPIER 4045	\$4259	EPSON	CALL		
DATA PRODUCTS	CALL	FUJITSU MAX24	\$1175		
2400 PLUS	\$ 919	DL 2400	\$ 895	2100	\$495
HEWLETT-PACKARD LASER JET	\$2295	HP Plus	\$3250		
HP LASER 500 Plus	\$4145	NEC P560	\$ 895	P760	\$ 595
OKIDATA 192	\$ 369	193	\$ 479	PANASONIC P1592	\$1149
P1592	\$ 625	TOSHIBA P351	\$1095	P341	\$ 750

## PLOTTERS & DIGITIZERS

CALCOMP 1042 While Supplies Last	\$8395	1043	\$7359
1044	\$11,195	GOULD 6320 11 x 17	\$1550
IO LINE 3700	\$3895		
HI DMP 56	\$4596	DMP 40	\$ 775
DMP 51/52	\$4145		
HP 7475	\$1659	HP 7560	\$8415
NICOLET ZETA 824	\$8995	ZETA 836CS	\$13,295
GTCO 3648L	\$3095	1117A	\$1195
2436TL	\$5995		
KURTA 12 x 12	\$ 595	12 x 17	\$ 695
SUMMAGRAPHS 11 x 11	\$ 495	18 x 12	\$ 750
HITACHI 36 x 48	\$4195	TIGER 11 x 11	\$ 675
15 x 15	\$1295		

## GRAPHIC CONTROLLERS & MONITORS

HITACHI HM 3719 & BNW 15	\$3290
MICROVITEC 905CNO GRAPHPORT D	\$2795
TAXAN 840 & COLOR 400L	\$1199
PERSYST 808 16 & NEC 1401	\$1295
GALAXY 800 & MITSUBISHI 6489	\$2995
VERTICOM CD-1 & VERTICOM M-16	\$2395
BNW ADAPTER	\$1950
ARTIST-IT	\$2295
CONOGRAPHICS 400 & MITSUBISHI 3479 LP	\$2295
MITSUBISHI 1341 & SIGMA 400	\$1195

## HARD DRIVES & BACK UP SYSTEMS

UBM 10 MB HD, 10 MB Tape B/U & Cont.	\$ 899
UBM 20 MB HD, Controller	\$ 479
UBM 30 MB HD & Controller	\$ 695
UBM 70 MB HD, 28 MS for AT	\$1550
UBM(Archive) 60 MB Tape B/U	\$ 750
RHODIME 40 MB HD	\$ 875
PRIAM 60 MB HD	\$1595
FUJITSU 55 MB HD	\$2095
MOUNTAIN 60 MB	\$2250
MOUNTAIN 30 MB HD	\$1295

## PERSONAL COMPUTERS

UBM ★ I (IBM Compatible), 640K, AT or 5151 Look Alike Keyboard, Two 360 Floppies, PP, Graphics Board & Monitor	\$ 879
UBM ★ II Turbo, all the above with 360 Floppy, 20 MB HD	\$1359
UBM ★ IV, (IBM AT Compatible), with 8 MHz, 640 K, 1.2 MB Floppy, 20 MB HD Graphics Card, Monitor & Keyboard	\$2495
UBM Monographics	\$ 120
UBM AT Serial, Parallel	\$ 95
UBM Multi Function, S, P, C/C, Zero-384K	\$ 125
UBM 20 MB Subsystem	\$ 479
UBM Color Graphics	\$ 120
UBM EGA Compatible	\$ 350
DEALER'S INQUIRIES INVITED	
IBM PC, with 256K, K.B. Two 360 Floppies	\$1295
IBM PC XT, with 256K, 360 Floppy, 20 MB HD, K.B., Graphics Card, Monitor	\$2350
IBM PC AT, with 512K, K.B., 20 MB HD	\$3795
IBM PC Convertible 80 C 88 Processor, with 512K, Two 720KB Floppies	CALL
IBM Printer	\$ 475
IBM Quietwriter	CALL
IBM EGA, with 256K Memory	\$ 775
IBM EG Monitor	\$ 695

COMPAQ PORTABLE II with 512K, 80286 Processor, Two 360 Floppies	\$2875
COMPAQ DESK PRO, with 640K, Two 360 Floppies, Graphics Card & Monitor	\$1895
COMPAQ DESK PRO & PORTABLE 286, with 640K, 1.2 Floppy, 20 MB HD, Monitor	\$3895
For 86 MB, instead of 20 MB, add	\$ 995
AT & T 6300 PC, with 256K, K.B. Two 360 Floppies, AT & T Graphics Card & Monitor	\$1795
AT & T 6300 Plus, with 512 K, 1.2 Floppy, K.B., Graphics Card & Monitor	\$3495
SPERRY PC-IT, with 640K, 1.2 MB Floppy, 40 MB HD, K.B.	\$3095

## SOFTWARE

Accounting Package	\$ 495
AUTOCAD	\$1950
CALVANCE, VERSACAD, HITACHI & ANVIL	CALL
ARMOR SYSTEM'S Excalibur & Plus Series	CALL
COMPUTER ASSOCIATE (IUS) A/R, A/P, G/L	EACH \$ 350
UNIVAIR'S Dental Management & Medical Management-9000	CALL
CYMA Medical, Chiropractic, Orthodontic, Dental Package	\$1625
Physician Micro Systems Package	\$1850
Hotel Information Systems Package	\$2450
MICROCRAFT, BALCONE, UNIVAIR	CALL
IBM Doctor Officer Manager	\$2195

CALL FOR WHAT IS NOT LISTED, WE GUARANTEE THAT YOUR CALL WILL NOT BE A WASTE.

No charges for testing and configuring equipment. Prices and availability subject to change without notice.

(714) 778-6496

163 West Cerritos Ave., Anaheim, CA 92805

## FREE CATALOG



Outstanding prices on computer accessories for your computer and workstation. Our catalog features a wide selection of quality products to meet all your accessory needs. Call or write today to receive your free catalog.

**LINTEK COMPUTER ACCESSORIES**  
POB 8056, Grand Rapids, MI 49518  
(616) 241-4040

Inquiry 187

## PROFESSIONAL HANDICAPPING SYSTEMS

• PRESENTED BY PROFESSOR JONES •

**Thoroughbred "Gold" Edition™**  
A "Full" featured thoroughbred analysis designed for the professional and the serious novice.  
\$159.95 complete w/Master Bettor™ \$199.95  
Limited "Gold"™ Enables Professional Handicappers to assign specific values to racing variables they feel are important, create program weight based on particular track, and fine tune for maximum win percentage. Program designed for "ease of use." User needs no programming experience.  
(Contains Integrated Bettor™) \$299.95 complete

**Gold Dog Analysis™** \$149.95  
The ONLY professional greyhound analysis available that evaluates ALL variables.  
w/Integrated Bettor \$199.95  
Limited Version \$299.95

**Master Harness Handicapper™**  
Professional software designed to provide a thorough analysis of all trotter and pacer races in the United States and Canada.  
complete \$159.95  
w/Integrated Bettor \$199.95  
Limited \$299.95

**Lottery Analysis.** Statistical comparison program designed to detect subtle patterns in winning numbers and digits.  
Lottery (3-4 digit) \$79.95 w/Lotto (Max. 99 Digit) \$99.95

## FREE CATALOG

Professor Jones • 1940 W. State, Boise, ID 83702  
CALL 342-6939 • VISA/MasterCard/AMEX Welcome  
Terms: 48-Hour Free shipping of software. Add \$6 hardware/\$6 C.O.D. / \$6 UPS Blue / \$9 Out of Country. Idaho residents add 4%. 3 weeks personal checks. Cash price only. Add 2% VISA/MasterCard. AMEX Prices subject to change.

★ Your BEST BET in Handicapping Software Reviewed by Whole Earth Software Guide, and Corona Data Systems ★

Inquiry 276

Serial ◀■■■■■■▶ Parallel



## Convert What You Have To What You Want!

- RS232 Serial
- 8 Baud Rates
- Latched Outputs
- Centronics Parallel
- Handshake Signals
- Compact 3/4" x 4/4" x 1/4"

No longer will your peripheral choices be limited by the type of port you have available! Our new High Performance 700 Series Converters provide the missing link. Based on the latest in CMOS technology, these units feature full baud rate selection to 19.2K, with handshake signals to maximize transfer efficiency. Detailed documentation allows simplified installation. Order the Model 770 (Ser/Par) or Model 775 (Par/Ser) Today!

Buffer Products Coming Soon! **ligertronics** only \$89.95  
Connector Option \$10.00  
CA Residents 6% tax  
UPS Shipping \$3.00  
2734-C Johnson Dr.  
Post Office Box 3717  
Ventura, California 93006

CALL (805) 658-7466 or 658-7467  
For FAST Delivery

Inquiry 349

## Get the whole story on graphics terminal emulation.



To find out more about software that lets your PC emulate TEKTRONIX™ 4105/677/9 and DEC VT100™ terminals, call or write:

**GRAFFPOINT**

4340 Stevens Creeks Blvd., Suite 280,  
San Jose, CA 95129 (408) 249-7951

Inquiry 146

## ROSE ELECTRONICS DATA SWITCHES

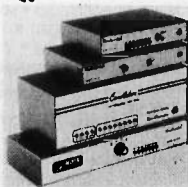

SHARE computers, printers, any parallel or serial device  
ELIMINATE cable swapping  
INEXPENSIVE way to network  
COMPATIBLE with all computers.

Businesses, Schools, Homes  
WE ALSO OFFER:  
Data Buffers, Line Drivers, Modems, Protocol Converters, Parallel - Serial Converters, Cables, Computers, Printers, Disk Drives, and more.

**AUTOMATIC - CARETAKER** is ideal for a business or school to share a printer or modem among many computers. Operation is fully automatic with no software required.  
Parallel or Serial 4 channels - \$295 8 channels - \$395

**MANUAL - HARD SWITCH** is operated with the flip of a switch. 2:2 and 2:4 models allow simultaneous communication.  
Serial 1:2 - \$59 1:4 - \$99 2:2 - \$109 2:4 - \$169  
Parallel 1:2 - \$79 1:4 - \$139 2:2 - \$119 2:4 - \$199  
LED and spike protection on serial models add \$20.

**CODE ACTIVATED - PORTER** connects one computer to multiple peripherals. A software code selects the peripheral.  
Parallel or Serial 4 channels - \$295 8 channels - \$395  
Buffer option 64K - \$100 256K - \$250

**REMOTE - TELEPATH** connects multiple computers to multiple peripherals. A selector at each computer or terminal chooses up to 4 peripherals and displays busy status.  
4:4 - \$495 4:8 - \$795 selector - \$39

Give a Rose to your computer

**ROSE ELECTRONICS** (713) 933-7673  
P.O. BOX 742571 MC & VISA Accepted  
HOUSTON, TX 77274 Dealer Inquiries Invited  
CALL US FOR ALL YOUR INTERFACE NEEDS

Inquiry 298

## 6800 Family Software



Software for 6800/01/05/09 microprocessors.

**SOFTWARE:** C compiler, Pascal, multitasking DOS, macro-assemblers, FORTRAN, 16K BASIC  
**FIRMWARE:** Fantom monitor/debugger, math library, 4K BASIC  
**CROSS-SOFTWARE:** Assemblers, PL/W Compilers, Linker, Simulators

**WINTERK**

Winterk, Corp  
1801 South Street  
Lafayette, IN 47904  
317-742-8428

Inquiry 377

## DATA ACQUISITION TO GO INTERFACE FOR ANY COMPUTER FREE IBM SOFTWARE



Connects via RS-232. Fully IBM compatible. Built-in BASIC. Stand alone capability. Expandable. Battery Option. Basic system: 16 ch. 12 bit A/D, 2 ch. D/A, 32 bit Digital I/O. Expansion boards available. Direct Bus units for many computers.

(201) 299-1615

P.O. Box 246, Morris Plains, NJ 07950

**ELEXOR**

Inquiry 127

## LOW COST UNIVERSAL PROGRAMMER KITS



- \* NO PERSONALITY MODULES REQUIRED
- \* ON LINE HELP AND MENU SELECTION
- \* ON BOARD 110/220V POWER SUPPLY
- \* FAST PROGRAMMING MODE AT 6V VCC
- \* BUILT IN MONITOR FOR I/O DEBUG
- \* CAD PCB, SILKSCREEN & SCHEMATIC
- \* SOFTWARE DRIVERS FOR MOST PCs
- \* SUPPORTS ALL 5V EPROMS, EEPROMS AND INTEL MICROCOMPUTERS

KITS FROM \$125 ASSEMBLED \$295  
DRIVERS \$35 SHIPPING \$4  
VISA & MASTER CARD ACCEPTED

**B&C MICROSYSTEMS**

6322 MOJAVE DR., SAN JOSE CA 95120  
PHONE (408) 997-7685 TELEX 4995363

## UNIVERSAL EPROM PROGRAMMER

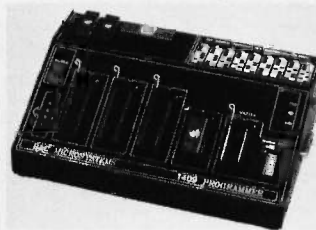

- \* NO PERSONALITY MODULES REQUIRED
- \* ON LINE HELP AND MENU SELECTION
- \* ON BOARD 110/220V POWER SUPPLY
- \* FAST PROGRAMMING MODE AT 6V VCC
- \* BUILT IN EPROM ERASER W/TIMER
- \* GANG PORT FOR FUTURE EXPANSION
- \* SOFTWARE DRIVERS FOR MOST PCs
- \* SUPPORTS ALL 5V EPROMS, EEPROMS AND INTEL MICROCOMPUTERS

1409C-33 \$545 1409C-34 \$695  
DRIVERS \$35 SHIPPING \$6  
VISA & MASTER CARD ACCEPTED

**B&C MICROSYSTEMS**

6322 MOJAVE DR., SAN JOSE CA 95120  
PHONE (408) 997-7685 TELEX 4995363



# Your System/Controller should fit you like a good suit.



## LET MICROMINT CUSTOM FIT YOU

Whether it's suits or system controllers, you can't buy off the rack when you need a custom fit.

That's why Micromint individualizes its system controllers to meet your particular needs and budget. What's most important to you? Software compatibility? Speed? Everything on one board? Economical computing power?

**#1:** "I want software compatibility."

**Solution:**

### THE SB180 COMPUTER/CONTROLLER

The SB180, only 4" by 7½", offers a Z80 compatible CPU running at 6MHz, 256K bytes of RAM, up to 32K bytes of ROM, two serial ports, a parallel port, Z80/6800 I/O expansion bus, and an industry standard 765A-compatible disk controller for up to four disk drives — any combinations of 3½", 5¼" or 8" drives. The SB180 is based on the Hitachi HD64180 CPU, a microcoded CMOS chip which provides high performance, reduced system cost, and low power operation while maintaining complete compatibility with the large base of standard CP/M software.

SB180-1 w/8K ROM monitor . . \$369.00  
SB180-1-10 w/8K ROM monitor,  
BIOS source and  
Z-system . . . . . \$418.00

**#2:** "I need speed."

**Solution:**

### THE Z8 FORTH SYSTEM/CONTROLLER

The Z8 FORTH System/Controller is only 4" by 4½" and includes a custom masked Z8 version of the FORTH

language with a full screen editor, cassette I/O driver primitives, EPROM programmer primitives, and other utility words. It also contains up to 4K bytes of RAM or EPROM, an RS-232 serial port with selectable baud rates, and two parallel ports. Additional Z8 peripheral boards include memory expansion, a smart terminal board, serial and parallel I/O, real time clock an A/D converter, and an EPROM programmer. It's perfect for data reduction and high speed control applications.

BCC21 w/utilities . . . \$225.00

**#3:** "Let me have an entire development system on one board."

**Solution:**

### THE BCC52 SYSTEM/CONTROLLER

The BCC52 is a new stand alone single board microcomputer which is bus compatible with the Micromint BCC11/BCC21 Z8 System/Controllers and expansion boards. The BCC52 features the Intel 8052AH-BASIC microprocessor which includes a ROM resident 8K byte floating point BASIC inter-



For a System Controller suited to your needs, give us a call.

preter with extensions for process control work. It contains sockets for up to 48K bytes of RAM/EPROM, an "intelligent" 2764/128 EPROM programmer, 3 parallel ports, a serial terminal port, and a serial printer port.

BCC52 . . . \$239.00

**#4:** "Give me lots of economical computing power."

**Solution:**

### THE BCC11 BASIC SYSTEM/CONTROLLER

The Z8 BASIC System/Controller is nearly identical to the FORTH System/Controller but contains a tiny BASIC interpreter, up to 6K bytes of RAM and EPROM, an RS-232 serial port with switch selectable baud rates, and two parallel ports. Add a power supply and terminal to start programming in BASIC or machine language. Programs can be transferred to 2732 EPROMS with the optional EPROM programmer for auto-start applications. It can also use any of the expansion boards mentioned under the Z8 FORTH System/Controller.

BCC11 . . . \$149.00

Additional information on peripheral boards and OEM pricing is available.

**Order Toll Free**  
**1-800-635-3355**  
In Connecticut call: 1-871-6170



MICROMINT, INC.  
25 Terrace Drive  
Vernon, CT 06066







## Bullet-286 8-MHz 80286 XT Motherboard

- Faster and more compatible than turbo expansion cards
- 9 times faster than XT, 65% faster than AT
- Completely XT hardware and software compatible\*
- Up to 1 MB onboard RAM with no wait states
- 10-minute, screwdriver-only installation
- One-year warranty

Marchand International  
1240 N. Van Buren, Unit 108, Anaheim, CA 92807  
(714) 630-3382

\*Except IBM ROM BASIC

Inquiry 203

## NEC PRINTERS

(1 Year Factory Warranty)

Pinwriter P5.....	\$ 925
Pinwriter P5XL.....	\$1100
Pinwriter P6.....	\$ 445
Pinwriter P7.....	\$ 575
Elf 350/360.....	\$ 380
3510/15/30/50.....	\$ 715
8810/15/30/50.....	\$1040

Optional Forms Handling  
Devices ..... CALL

QUALITY PRINTERS  
8415 Cement City Road  
Brooklyn, Michigan 49230  
Phone: 517-592-3749

Inquiry 287

## Computer Parts Mart

San Jose, CA 95112  
634 North 8th St. (408) 993-9011

### STEPPER ENSEMBLE

100 Step High Precision Motor

By Applied Motion. Stepper driver with bipolar windings, 26 ohms/15mh. 1/4" x 2.1" ground shaft with helical follower groove @ 0.182" pitch. This is an extremely high accuracy assembly good to better than 50 microns absolute. Ball bearings, 5.5gm/cm inertia, 10 oz. in. holding torque @ 400 ma. New, never used. Driver I.C.s: 3717 for P.W.M. Micro-stepping allow efficient use of any supply voltage up to 40v D.C. Motor and Two I.C.s including data sheets

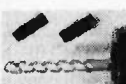

\$14.95

### STD-BUS

64K RAM Card expandable to 256K	\$ 99
256K Card	\$249
Votrax Card	\$149
SASI Interface Card	\$100
4-SIO Card	\$165
4-PIO Card	\$129
2-SIO & 2-PIO Card	\$125
280 CPU Card	\$ 79
6800 Proc. Card	\$300

Complete STD Systems available—Up to 10 slots, 10 MB Disk, etc.

Inquiry 81

## Nashua Diskettes

5 1/4" DS/DD with hub ring and sleeve, factory warranted, packaged in 50's. Shipping Extra. Quantity 50, 85¢ each.

The same low price our volume copying customers pay! **75¢** each Qty. 100

We sell 3 1/2" & 5 1/4" disks—all types, major brands. Call toll free:

**1-800-321-4668**

in Colorado, 303-234-0871

VISA, MASTERCARD, OR COD ACCEPTED

**ALF** 1315-F Nelson St.  
Denver, CO 80215

Inquiry 14



## PORTABLE ADDITIONS

PORTABLE DISK DRIVE \$229

3 1/2", ball. oper., TS-DOS, 100K storage

24K RAM CHIP for Tandy 200 \$89

8K RAM CHIP for Model-100 \$29

and NEC 8201... 3 for \$79, 6 for \$149

SIDESTAR for NEC Startlet \$399

128K Ram Disk Cartridge

SIDECAR for NEC PC-8201A \$259

4 banks of 32K in one cartridge

CALL TOLL FREE 1-800-732-5012

Calif: 805-987-1742

Canada: 604-856-8858, Australia: 02-449-8899

**PURPLE COMPUTING**

VISA/MC & AMER.EXP.

420 Constitution Ave., Camarillo, CA 93010

Inquiry 280

## FANSI- CONSOLE™

The Integrated Console Utility™ All the little things IBM forgot! for IBM—PC, XT, AT & clones.

- 1.2 to 3.0 times faster DOS & BIOS screen writing
- more escape sequences than ANSI.SYS
- usable in any language
- scroll recall facility
- compatibility w/PC & AT software
- full EGA support
- 255 character typeahead buffer
- increase key repeat rate
- no scroll blink for some adaptors
- VT 100/52 emulation
- auto dual screen disable
- keyboard induced breakpoints
- window support
- support for 50 line display
- many many more little features

400p Manual (w/slip case) & disk \$75, or just Shareware disk \$25. As described in *PC World* February 86, pg. 282 and in *Lotus* June 85, pg. 8.

HERSEY MICRO CONSULTING, INC.  
Box 82761, Ann Arbor, MI 48107  
(313) 994-3259 x525 VISA/MC

Inquiry 154

## IMPORT DIRECT SAVE 30%

MASTER PACKS	SAMPLE	IMPORT	IMPORT*
	1-4	5-49	50+
<b>PC-AT</b>	\$1595.00	\$1405.00	\$1299.00
512K RAM (Up to 1M on Board)			
1.2 M FLOPPY - FLOPPY & HARD DISK CONTROLLER			
AT KEYBOARD - CLOCK WITH BATTERY BACKUP			
195W POWER SUPPLY - DOS 3.10 & MANUAL			
	SAMPLE	5-49	50+
<b>PC-AT COLOR</b>	\$1899.00	\$1799.00	\$1550.00
SAME AS ABOVE WITH COLOR MONITOR AND COLOR/GRAPHICS CARD			
	SAMPLE	10-99	100+
<b>PC-XT TURBO</b>	\$999.00	\$899.00	\$595.00
640K RAM, 8088-2, (4.77 MHZ or 6.66 MHZ)			
360K FLOPPY - KEYBOARD - MONOCHROME/GRAPHICS PRINTER - 12" TTL HIGH RES MONITOR			
	SAMPLE	10-99	100+
<b>PC-XT</b>	\$899.00	\$595.00	\$495.00
256K RAM - 360K FLOPPY - KEYBOARD			
MONOCHROME/GRAPHICS/PRINTER CARD (Hercules Comp.) - 12" TTL HIGH RES MONITOR			

### DRIVES

	1-49	50+
<b>XT 360K FLOPPY</b>	\$89.00	\$85.00
<b>XT 10 MEG INTERNAL 1/2 HEIGHT</b>	\$395.00	\$355.00
<b>XT 20 MEG INTERNAL 1/2 HEIGHT</b>	\$479.00	\$425.00
<b>AT 1.2 MB FLOPPY</b>	\$149.00	\$129.00
<b>AT 20 MEG INTERNAL 40 MSEC</b>	\$579.00	\$505.00
<b>AT 30 MEG INTERNAL 40 MSEC</b>	\$879.00	\$895.00

### INDIVIDUAL PART PRICING FOB TAIWAN

	10-99	100+
<b>PC-XT-256K 6 SLOTS (super XT BIOS)</b>	\$74.75	\$85.00
<b>135W POWER SUPPLY</b>	\$51.75	\$45.00
<b>FLIP-TOP CLONE BOX</b>	\$26.45	\$23.00
<b>MONO/GRAPHIC/PRN (Herc comp)</b>	\$52.90	\$46.00
<b>KEYBOARD</b>	\$36.80	\$32.00
<b>FLOPPY DISK CONTROLLER</b>	\$23.00	\$20.00
<b>RAM KITS 256K</b>	\$25.30	\$22.00
<b>12" TTL HIGH RES MONITOR</b>	\$85.00	\$80.00
<b>SUBTOTAL BASIC PC NO DRIVES</b>	\$360.70	\$313.00
<b>DUTY</b>	\$14.79	\$13.00
<b>OCEAN FREIGHT</b>	\$24.00	\$20.00
<b>AIR FREIGHT</b>	\$100 extra	
<b>ACS IMPORT FEE</b>	\$350.00/ENTRY+10%	\$71.00
<b>TOTAL LANDED COST, L.A. HARBOR</b>	\$470.49	\$380.80

### MONITORS

	SAMPLE	10-49	50+
<b>CL-866 12" TTL MONO</b>	\$98.00	\$85.00	\$80.00
<b>MD-3 14" COLOR RGB</b>	\$361.00	\$276.00	\$235.00
<b>.39 DOT 640 x 200</b>			
<b>MD-7 14" COLOR RGB</b>	\$490.00	\$359.99	\$335.00
<b>.31 MM DOT 720 x 350</b>			

### ADD ON BOARDS - PARTIAL LIST

	10-99	100+
<b>PC-XT-640K MOTHER BOARD 6 SLOT</b>	\$76.00	\$73.00
<b>PC-XT-640K TURBO 4.77/6.66 MHZ</b>	\$69.00	\$65.00
<b>TRANS-NET (LAN) CARD 1.0 MHZ</b>	\$199.00	\$185.00
<b>384K MULTI-FUNCT (AST6 comp)</b>	\$66.70	\$58.00
<b>RAM KITS 384K</b>	\$36.80	\$32.00
<b>MOEM CARD 300/1200 (Hayes comp)</b>	\$115.00	\$105.00
<b>COLOR GRAPHICS CARD</b>	\$42.55	\$37.00
<b>AS SWITCH BOX (Centronics 2:1 or 1:2)</b>	\$27.80	\$24.00
<b>AS SWITCH BOX WITH 64K BUFFER</b>	\$65.55	\$67.00
<b>AT SERIAL/PARALLEL CARD</b>	\$81.00	\$85.00
<b>AT COLOR/GRAPHICS</b>	\$89.00	\$81.00
<b>64 INPUT ANALOG/DIGITAL CARD</b>	\$398.00	\$358.00
<b>128 LINE PARALLEL I/O CARD</b>	\$495.00	\$371.00

\* 100 UNIT ORDERS MAY BE SCHEDULED OVER 6 MONTHS

### ACS IMPORTERS

5311 DERRY AVE., UNIT A  
AGOURA HILLS, CA 91301  
HOURS 9 AM - 6 PM PST  
(818) 889-1092  
TELEX: 299353 POST UR





**ATTENTION MEGABYTERS**  
Beat The 33 Mbyte Limit!

Vfeature  
for **BIG** disks  
files  
User-Transparent  
Security Features Included.

**Golden Bow Systems**

S80 — \$120  
Add \$3 for shipping/  
handling  
California residents  
add 6% sales tax.

619/298-9349  
P.O. Box 3039  
San Diego, CA 92103



Inquiry 144

**CROSS-8**  
MAYBE THE ONLY DEVELOPMENT  
SOFTWARE YOU'LL EVER NEED

- Table based 8 bit cross-assembler
- Tables/Source files included for:  
1802 6502 8048 COP400  
3870 6801 8051 Z8  
8096 6805 8085 Z80
- Modify/Create tables for most 8 bit micros.  
Create your own instruction sets
- INTEL, MOTOROLA, TEKTRONIX output formats
- Use with any EPROM programmer
- 36 page manual, full instructions
- Available in the following disk formats:  
5" IBM-PC PC/MS-DOS 2.0 or greater, compatibles  
5" APPLE II+/IIE CP/M-80 (Softcard), compatibles  
8" SSSD CP/M-80 (Z80 only)

**\$99<sup>95</sup> US \$129<sup>95</sup> CDN**

Credit card orders: Include card no., name on card, expiry date, signature. Nova Scotia residents add 10% sales tax.

**UNIVERSAL CROSS-ASSEMBLERS**  
PO BOX 384 BEDFORD NOVA SCOTIA  
B4A 2X3 CANADA

Inquiry 359

**72 Digital I/O**

**PXB-721**  
**Parallel Expansion Board**

- For IBM-PC & Compatibles
- 72 Digital I/O Lines
- Simple Programming
- Uses One Expansion Slot
- Fast Delivery

**\$195**

**QUA TECH, INC.**  
478 E. Exchange St. Akron OH 44304  
(216) 434-3154 TLX: 5101012726

Inquiry 284

**RS-422**  
Communications Board

**NEW**

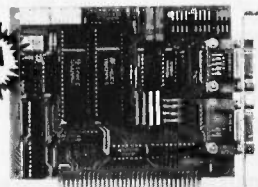

- For IBM-PC/AT/XT and compatibles
- Dual RS-422 serial interface
- Programmable to 56k baud
- Differential drivers to 4000 ft.

**\$345.00**

**QUA TECH, INC.**  
478 E. Exchange St. Akron OH 44304  
(216) 434-3154 TLX: 5101012726

Inquiry 283

**DATAFLEX™**

- Multi-user Database!
- Powerful!
- Multiple Operating System Compatibility!
- Attractive Dealer Pricing!
- Full Dealer Support!

Dataflex is a trademark of Data Access  
Dealer Inquiries Invited

**COGITATE**

24000 Telegraph Road  
Southfield, Michigan 48034 USA  
(313) 352-2345

Inquiry 72

64K ■ 128K ■ 256K  
**DRAMS**

80287-8 ■ 80287-3  
8087-3 ■ 8087-2  
8087-1

**BITTNER**  
**EE**  
ELECTRONICS

899 SOUTH COAST HIGHWAY  
LAGUNA BEACH, CA 92651  
(714) 497-6200  
CALL NOW FOR **FREE CATALOG**

Inquiry 42

**ORDER TOLL FREE  
24 HOURS EVERY DAY  
800-662-2686**

**HARDWARE  
COMPUTERS**

**IBM Compatible**  
256K Ram (Expands to 640K) 1 year warranty  
DUAL FLOPPY SYSTEM ..... 649  
20MB HARD DISK SYSTEM ..... 1049

**ATARI, PANASONIC, OLIVETTI COMPUTERS. .... CALL**

**MODEMS, BOARDS, DRIVES**

Evercom 1200 Internal... 175	AST Advantage..... 359
Smartmodem 1200B... 319	SixPakPlus 384K... 279
1200/2400... 389/579	Intel Above Board... 289
Racal Vadic 1200... 239	Paradise 5 Pak 384K... 199
Practical Modem 1200... 129	J-Ram 2/3... 149/199
Courier 2400... 439	J-Ram 3AT... 269
Genoa Spectrum... 279	Tecmar Captain 384K... 219
QuadEGA+... 399	6 Function Card 384K... 179
Paradise Modular... 269	384K Ram Card... 99
Taxan 555... 169	20MB Hard Disk Kit... 479
Sigma Color 400... 469	EasyCard 20MB... 749
Mono Graphics Card... 109	Sigma One Reel Tape... 659
Video 7 Vega... 409	Teac 55B... 109
AST Rampage... 309	DataShield XT 300... 369

**PRINTERS, PLOTTERS & MONITORS**

EPSON-AII Models, DOT MATRIX & DAISYWHEEL... CALL	
Canon Laser Beam... 2175	Roland DXY-101 Plotter... 509
Citizen 120D... 175	Houston Inst DMP-29... 1850
Citizen Premier 35... 425	Amdex 310A... 149
Panasonic 1080... 199	Amdex 600/722... 419/519
Panasonic 1091... 249	NEC 1280 TTL Mono... 119
Panasonic 1092... 319	NEC 1401 Multi-Sync... 549
Panasonic 1592... 449	Taxan 610/620... 355/399
Sweet P 600... 739	Taxan 630/640... 455/519

**SOFTWARE**

**ACCOUNTING & DATABASE**

BPI Accting/Mod... from 309	Managing Your Money... 110
Peachtree/Module... 269	dBase III Plus... 369
Back To Basics Accting... 209	Nutshell... 79
Open Systems/Module... 389	Reflex... 59
SBT GL, PR or Job Cost... 249	Revelation... 549
SBT AP or AR (source)... 189	PFS File & Report... 149
Accounting Partner 2... 559	Q & A/+256K... 205/239

**SPREADSHEETS & INTEGRATED SOFTWARE**

Lotus/Symphony... CALL	Smart SW System... 489
Framework II... 369	Multiplan 2.0... 119
Supercalc 3... 209	Mosaic Twin... 89

**WORD PROCESSING**

Volkswriter 3... 155	PFS Write & Proof... 82
Microsoft Word... 229	Multimate... 219
Word Perfect 4.1... 225	Multimate Advantage... 279

**GRAPHICS**

Chartmaster... 219	In'A' Vision... 289
Engraphics w/ Plot... 229	Microsoft Chart 2... 179
Freelance... 209	Dr. Halo II w/Mouse... 119

**UTILITIES & LANGUAGES**

Turbo Lightning... 57	Fontrix... 92
Microsoft Project 2... 239	Fastback... 115
Superproject... 209	Sideways... 37
Timeline 2... 259	Traveling Sidekick... 39
True Basic... 95	Windows... 59
Microsoft C Compiler... 239	Pop-Up Desktop... 55
Microsoft Fortran... 205	Deskview... 59
Macro Assembler... 90	Prokey... 77
Quick Basic... 63	Xtree... 31

Call Toll Free 24 hrs Every Day  
**800-662-2686** orders only  
for Ca. Orders, Tech Support, Price Quotes, Info  
**415-668-9350** 9-5 pacific time, m-f  
Call or Write for Free Catalog

PAYMENT: (No Fee For Credit Cards.) Visa, MasterCard, Cashier's Checks, Personal Checks with 2 wk. hold. Qualified P.O.'s. Ca. residents add sales tax.  
SHIPPING: UPS ground-2% per order, \$4 min. FREE for SW orders over \$1000. UPS Blue-3% per order, \$6 min. FREE for SW orders over \$1500. Printers, Monitors, Disk Drives, computers — Call for charges.  
All Products New with full warranties.  
Price & availability subject to change without notice.

**THE BAY**  
THE BEST PRICES THE BEST SERVICE

**Express**  
**COMPANY**

584 CASTRO ST., SUITE 487 SAN FRANCISCO, CA 94114  
a division of MCSS, Inc. Computer & Software specialists since 1981

JUNE 1986 • BYTE 407



Lowest Price Ever!  
on 3M Data Products  
LIFETIME WARRANTY

SS-DD	Qty - 5 Bx (lesser qty add 3%)	DS-DD
<b>75¢</b>	5.25"	<b>\$1.07</b>
\$1.52	5.25 96 TPI	\$1.92
\$1.52	3.50"/135TPI	\$2.15
		\$2.22

DS-HD 96 TPI (For the "AT")

\*Pre-packaged in 3M's Flip'n'File for \$4./box

\$1.50	8.00" SS-SD W/Wp	\$2.05
\$1.84	8.00" W/WP	\$2.99

3M Head Cleaning Kit	\$6.99
3M Data Cartridges - Qty 10/case (lesser qty add 5%)	
DC-100A	\$12.30
DC-1000	\$12.35
DC-300XLP	\$19.00
DC-600A	\$20.80

**SUPER SPECIAL!**  
3M Bulk Diskettes 5.25" DS-DD **50¢**



**An Apple A Day**

Win FREE Apple IIc Computer and CASH!

LIFETIME WARRANTY

SS-DD	Qty 5 Bx (lesser qty add 3%)	DS-DD
<b>75¢</b>	5.25" Qty 50 (10/Bx)	<b>85¢</b>
\$1.79	3.50" Qty 50 (5/plastic case)	\$2.29
	DS-HD for "AT" Qty 50 (10/Bx)	\$1.99

BASF diskettes are factory packed in boxes of 10 with Tyvek sleeves, user ID labels and write-protect tabs.



**Best Deal Ever**  
**Nashua**



SS-DD	(lesser Qty add 10%)	DS-DD
<b>68¢</b>	5.25" Qty 10 BX	<b>75¢</b>
\$1.69	(volume discounts available)	\$2.29
	3.50"/135 TPI	\$2.09

DS-HD for the "AT"

**Incredible Value!**  
No Logo **BULK** Diskettes  
Made by a leading magnetic media manufacturer  
LIFETIME WARRANTY

SS-DD		DS-DD
100 500 1000		100 500 10000
.53 .52 .50	5.25" w/hub ring	.62 .62 .59
1.52 1.50 1.48	3.50"/135 TPI	1.86 1.83 1.80
5.25" DS-HD for the "AT"		1.72 1.65 1.55

**COLOR DISKETTES**

SS-DD		DS-DD
<b>65¢</b>	5.25" W/hub ring	<b>85¢</b>

Ribbon Pack	Business Pack	
<b>RIBBONS</b>	<b>STORAGE</b>	
Epson MX 70/80	\$2.65 Amaray Media Mate	\$8.90
Epson MX 100	\$3.99 Disk Minder II-75	\$6.45
Okidata 80/32/83/92/93	\$1.35 Micro Disk Minders-36	\$6.45
Apple Image Writer	\$3.99 Plastic Library Case	\$1.50

TERMS: VISA, MasterCard, American Express. C.O.D. orders add \$4.00. Pre-paid orders deduct 2% discount. P.O.s accepted from corporations rated 3A2 or better, government, and schools on Net 30 basis. FPO, APO, AK, HI and PR orders add 5%. No sales tax outside Utah! Minimum order \$30.00. SHIPPING: Minimum \$4.00 for 100 or fewer diskettes or first 5 pounds.

TOLL FREE ORDER LINE:  
**1-800-523-9681**  
INFORMATION AND INQUIRIES  
**1-801-942-2273**

**DISKOCOTECH**

DISKOCOTECHNOLOGIES, INC.  
2034 East 7000 South Salt Lake City, Utah 84121  
Hours: 7 AM-6 PM (Mtn. Time)

**Quelo® 68000 Software Development Tools**

Quelo Assembler Packages are Motorola compatible. Each package includes a macro assembler, linker/locator, object librarian, utilities for producing ROMable code, extensive indexed typeset manuals and produces S-records, Intel hex, extended TEK hex, UNIX COFF and symbol cross references. Portable source written in "C" is available. It has been ported to a variety of mainframes and minis including VAX.

**68020 Assembler Package**  
For CP/M-86, -68K and MS/PC-DOS ..... \$ 750

**68000/68010 Assembler Package**  
For CP/M-80, -86, -68K and MS/PC-DOS ..... \$ 595

**68000 "C" Cross Compiler**  
For MS/PC-DOS by Lattice, Inc.  
With Quelo 68000/68010 Assembler Package \$1095  
With Quelo 68020 Assembler Package ..... \$1250

Call Patrick Adams today: Quelo, Inc.  
2464 33rd W. Suite #173  
Seattle, WA USA 98199  
Phone 206/285-2528  
Telex 910-333-8171

COD, Visa, MasterCard  
Trademarks: CP/M, Digital Research; MS, Microsoft Corporation; Quelo, Quelo, Inc.

Inquiry 291

**MODULAR DATA ACQUISITION**



- For IBM & Compatibles
- Flexible and Inexpensive
- Money Back Guarantee
- Free Technical Support

**Fast Delivery**  
**QUA TECH, INC.**

478 E. Exchange St. Akron OH 44304  
(216) 434-3154 TLX: 5101012726

Inquiry 285

**An RS-232 Break-Out-Box at a Fraction of the Cost.**

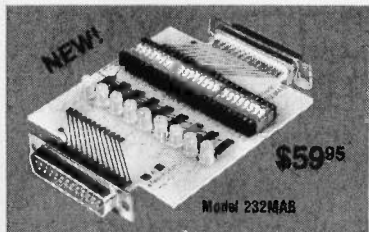

**RS-232 Multi-Adapter Board: 9 LED's for signal monitoring. 24 switches to open any line (except line 1). 20 jumper wires allow re-wiring to any configuration. 1 male and 1 female connector. Order direct! Only \$59.95.** All cash orders postpaid. (IL res. add 6% sales tax). We Accept MC, Visa. Free illustrated catalog of RS-232 interface and testing equipment. Phone: 815-434-0846. Make checks payable to:

**B & B electronics**  
MANUFACTURING COMPANY  
P.O. Box 1008B, OTTAWA, IL 61350

Inquiry 35

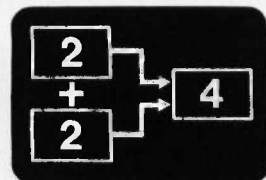

**PICTURES THAT THINK**

Boxes & Arrows™ is an IBM PC-based block diagram editor and computing system. If you are looking for something more than a spreadsheet, Boxes & Arrows will let you combine computation with pictorial representation.

- Automatic box & line drawing
- Labels and algebraic formulas
- Any printer, any display
- No limit to diagram size
- Call or write for full details



Inner Loop Software  
5456 McConnell Avenue  
Los Angeles, CA 90066  
(213) 822-2800

Inquiry 161

**OC8000**

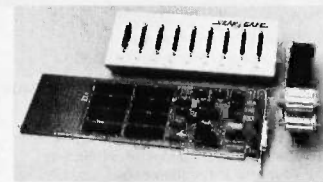

**EXPANDS PC PERFORMANCE AT A FRACTION OF NETWORKING COST**

- Adds four to eight serial communication ports to IBM PC, XT, AT or compatibles.
- Standard RS-232 or optional RS-422 ports for increased transmission speed and distance.
- Supported by Xenix, Multi-Link, RTCS, QNX, and other multi-user, multi-tasking operating systems.

**STAR GATE TECHNOLOGIES, INC.**  
Suite 109  
33800 Curtis Blvd. • Eastlake, OH 44094  
Call: (216) 951-5922

Inquiry 328

**WAVEFORM SYNTHESIZER**

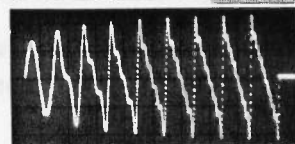

- For IBM-PC/XT/AT and compatibles
- Generates user-definable signal
- Up to 2000 points per envelope

**QUA TECH, INC.**  
**\$795.00**

478 E. Exchange St. Akron OH 44304  
(216) 434-3154 TLX: 5101012726

Inquiry 286



# ATTAK-286™

**HIGH SPEED 12 MHZ OPERATION** Software Selectable for **6,8,10, and 12 MHZ!**

- FULL IBM PC-AT\* COMPATIBILITY!
- FOUR MEGA-BYTE RAM CAPACITY ON MOTHERBOARD! USING 1 MEGA-BIT DRAMS.

**QUANTITY DISCOUNTS AVAILABLE FOR QUALIFIED DEALER, OEM, UNIVERSITY AND CORPORATE ACCOUNTS.**

**NEW!**

## HIGH SPEED INDUSTRIAL GRADE COMPUTER FOR:

- Scientific
- Engineering
- Industrial
- Medical
- University/Education
- Artificial Intelligence
- Etc., Etc., Etc.

Eight Compatible I/O Interface Connectors (Same as PC-AT)

Keyboard Interface (Same as PC-AT)

On Board Battery

CMOS Clock Calendar

Standard Power Connector (Same as PC-AT)

80287 Math Processor (Same as PC-AT)

Extended ROM Capability (Operates on all compatible BIOS ROMS)

Runs Intel 80286 at 6,8,10&12 MHZ! (Software selectable)

Extended Memory Capacity! Full Four Mega-Byte Capacity on Motherboard! (Uses 256k or NEW 1 Mega-Bit Drams)

Peripheral Support Circuits (Same as PC-AT)

**ORDER NOW!!**

**ONLY!**  
**\$199<sup>95</sup>**  
**EVALUATION BOARD KIT**

- ATTAK-286™ FULLY ASSEMBLED (LESS ICS) ..... \$499.95
- AT CASE 100% COMPATIBLE.....\$129.95
- AT POWER SUPPLY 192W.....\$129.95
- ATTAK-286™ TECHNICAL REFERENCE MANUAL ..... \$ 29.95
- TURBO-SCOPE™ A/D BOARD ..... \$ 99.95

Board Size: Standard IBM-AT\*  
Dimensions: 12 inch x 13.8 inch  
with 6 mounting holes to fit all  
AT compatible cases.

100% SATISFACTION GUARANTEED.  
10 DAY MONEY BACK GUARANTEE IF  
NOT COMPLETELY SATISFIED!



ATTAK-286™ evaluation board kit  
highest quality multi-layer PC  
board with full assembly  
instructions and parts lists!

**AiT CORPORATION**  
**ADVANCED INTELLIGENCE TECHNOLOGY**

4100 Spring Valley Road  
Suite 400  
Dallas, Texas 75244  
(214) 490-0344

TERMS: We accept cash, checks, money orders and credit cards. Prices and availability subject to change without notice. Shipping and handling charges via UPS ground 50¢/lb UPS air \$1.00/lb. Minimum charge \$3.00

\*IBM and IBM PC-AT are trademarks of International Business Machines

© 1986 AIT CORP.

P.C. Computer Brokers Inc.

## The Place To Buy Your Epson Printers

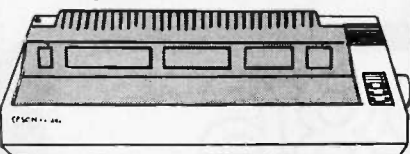

**EPSON**  
**1** **EPSON FX-286**  
List \$799<sup>00</sup> **\$529<sup>00</sup>**

Epson Printers	List	SALE
Homewriter Printer	\$249 <sup>00</sup>	\$199 <sup>00</sup>
AP-80 Printer	\$379 <sup>00</sup>	CALL
LX-90 Printer	\$329 <sup>95</sup>	\$229 <sup>00</sup>
RX-100 Printer	\$499 <sup>00</sup>	CALL
SQ-2000 Ink Jet Printer	\$2295 <sup>00</sup>	\$1579 <sup>00</sup>



**FX-85**  
list \$499<sup>00</sup> **\$349<sup>00</sup>**

Call Toll FREE 1-800-245-4122

Epson Printers	List	SALE
Spectrum LX-80	\$299 <sup>00</sup>	\$219 <sup>00</sup>
LQ-800 Printer	\$799 <sup>00</sup>	\$549 <sup>00</sup>
HS-80 Ink Jet Printer	\$449 <sup>00</sup>	\$339 <sup>00</sup>
DX-10 Daisywheel	\$299 <sup>00</sup>	CALL
DX-20 Daisywheel	\$459 <sup>00</sup>	CALL
DX-35 Daisywheel	\$899 <sup>00</sup>	CALL
Comrex High Speed CR-420 Printer	\$2195 <sup>00</sup>	\$1449 <sup>00</sup>
HI-80 Four Pen Plotter	\$599 <sup>00</sup>	CALL

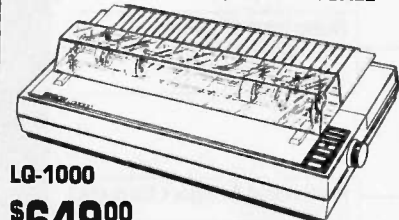

**LQ-1000**  
**\$649<sup>00</sup>** list \$995<sup>00</sup>

### THE MOST ESSENTIAL CARD FOR THE EQUITY I

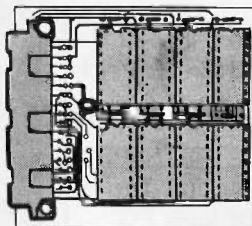

- Able to bring the mother board to 512K
- 1/2 the size of other cards
- Save up to \$70.00
- 3 year warranty Only **\$99<sup>00</sup>**



These Prices Are Good For Mail Order Dept. Only

**P.C. Computer Brokers Inc.**  
**3879 East 120th Ave.**  
**Thornton, CO 80233**  
**[303]450-6727**

Call Toll FREE 1-800-245-4122

## DOUBLE THE OPTION CAPACITY OF YOUR IBM PERSONAL COMPUTER

### PC-XTRA

- DIRECT EXTENSION OF IBM PC BUS
- NO SOFTWARE CHANGES
- NO HARDWARE MODIFICATION
- STYLING CONSISTENT WITH IBM

Add all those special options that you've been wanting without worrying about filling your plug-in and back panel space

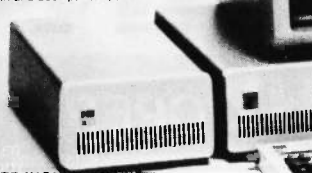

DEALER INQUIRIES INVITED.

**\$549<sup>00</sup>** F.O.B. SANTA ANA  
\*CALIFORNIA RESIDENTS ADD 6% SALES TAX

**P C HORIZONS, INC.**

1701 E. Edinger, Ste. A6, Santa Ana, CA 92705  
(714) 953-5396

Inquiry 252

## Heritage Systems Corp.



### HSC-9128 Video Terminal Card

- 80 by 24 Alpha-numeric video display
- ANSI X3.64 command set
- TTU/CMOS serial port (50 to 38.4K baud)
- Off card line drivers (RS-232, Fiber optic)
- IBM PC compatible keyboard input
- On Screen configuration utility
- 100 by 10mm, 5V only, 200mA

HSC-9128 video terminal card	\$129
HSC-9128 with RS-232, cables	\$159
HSC-9129 keyboard	\$119
Amdek 300G Video monitor (Green)	\$139
Amdek 300A Video monitor (Amber)	\$149

**PO Box 10588,**  
**Greensboro, NC 27404-0588**  
(919) 274-4818

Inquiry 153

## ATTENTION BERNOULLI BOOSTERS

Go Either Way!

**BOOT**  
from the Bernoulli Box!  
from the AT Hard Disk!

FORMAT WITH DOS  
PARTITION WITH FDISK  
NO SLOWING

We've been shipping Bernoulli Boots  
that work for over a year —  
still waiting?

### Golden Bow Systems

\$95-\$110

Add \$2 for shipping/  
handling  
California residents add  
6% sales tax



P.O. Box 3039  
San Diego, CA 92103  
(619) 298-9349

Inquiry 145

## NEW EPROM PROGRAMMER

**\$349**



The EP-1 is a great value, here's why:

- IBM PC Compatible, Communication Disk included.
- Also works with CP/M and Development Systems
- Supports over 100 types including 2716 through 27512, CMOS, and A-Suffix Parts
- Menu Driven Chip Selection by Manufacturer and Part Number
- No Personality Modules
- Fast Programming Algorithm
- Gold Textool ZIF IC Socket
- RS-232, 7 baud rates to 9600
- Full One Year Warranty
- U.V. Erasers from \$34.95

### BP Microsystems

5325 Glenmont, Suite E, Houston, TX 77081  
(713) 667-1636

Inquiry 52

## "CPYAT2PC"

IS LIKE HAVING A  
**FREE**  
360K FLOPPY DRIVE

Allows copying of IBM AT file for use on IBM PC's & compatibles with no modification of existing hardware or software. A 360K floppy drive is not required. CPYAT2PC may reside on your IBM PC/AT hard disk and copies 1 file or entire subdirectories in 1 step. Also runs on other AT compatibles such as COMPAQ 286, ZENITH Z-200, and KAYPRO 286i. Dealer inquiries welcome. ONLY \$79 + shipping.

### MICROBRIDGE COMPUTERS

Sky Way Building, Suite 125  
655 Sky Way, San Carlos, CA 94070  
(415) 593-8777 • (415) 595-2150



CHECK, COD WELCOME  
(Prepayment Required)



Inquiry 223

## You need a Printer Sharing Unit.

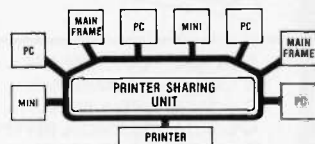

### Not another printer.

Save the cost of your next printer with our Printer Sharing Unit. Up to 8 computers can use one printer, automatically, without changing cables.

This rotating electronic switch scans the input ports. When it finds one ready to transmit, it locks-on and puts the printer to work. Printing completed, it starts scanning again.

For a demonstration or more information call us at (206) 355-0590, and we will give you the name of our dealer nearest you.



4-Channel \$395.00  
8-Channel \$595.00

### Datacom Northwest, Inc.

3303 112th St. SW, Everett, WA 98204

Inquiry 109



# WHEN IT ABSOLUTELY, POSITIVELY HAS TO BE THE BEST QUALITY AND PRICE . . . CALL D&D!

**2% DISCOUNT ON ALL ADVERTISED PRICES WITH PREPAYMENT (800) 662-7253**

## SPECIAL #1

### PC XT Compatible Turbo

- 640K • 8 MHz • Keyboard
- Flip Top Case • Two 360K Drives
- 135 Watt • 8 Slots • DOS 2.1

**\$659**

## SPECIAL #2

### IBM PC 256K

- Two 360K Drive

**\$1449**

## SPECIAL #3

### 10 MEG

### HARD DISK

- For IBM or Compatible
- Controller and Cables

Complete **\$359**

## SPECIAL #4

### NEW SPERRY IT

IBM AT compatibility for an affordable price!

- 1 Meg Ram included
- 1.2 MG floppy • 44 MG Hard Disk
- 8 MHz Operations • Monitor
- DOS 3.1 • Printer Port
- Two Serial Ports
- 100% AT Compatibility

**ONLY \$3799**

## SPECIAL #5

### XT COMPATIBLE

- 8 Slots • Two 360K Drives
- Keyboard • 135 Watts

640K 256K

**\$569 \$489**

## SPECIAL #6

### IBM AT COMPUTER SYSTEM

- 20 Meg hard Disk
- 1.2 Meg Floppy • DOS 3.1
- 512K Ram

D & D IBM

**\$3699 \$4299**

## SPECIAL #7

### CORONA PORTABLE

- IBM Compatible
- 256K • 2 Drives
- Monitor • Keyboard • DOS

**\$1179**

## SYSTEMS

### IBM

PC 256K, 2 Drives . . . . . **\$1395**  
 XT 256K, 1 Drive . . . . . 1699  
 XT 256K, 1 Drive 1-10 MG 2099

### COMPAQ

Portable, 2 Drives, 640K . . . **\$1875**  
 Call on Desk Pro's & 286 Systems

### CORONA

Portable . . . . . **\$1195**  
 Desk Top, 2 Drives, 256K  
 w/monitor . . . . . 1395

## MONITORS

### PRINCETON GRAPHICS

Max 12E . . . . . \$159  
 HX-9 . . . . . Call  
 HX-12 . . . . . 425  
 SR-12 . . . . . 749

### TAXAN

Call for best price

### AMDEK

310A . . . . . \$145  
 600 Color . . . . . 389  
 722 Color . . . . . 519

## MODEMS

### HAYES

Micromodem IIE Apple . . . \$149  
 300 External . . . . . 129  
 1200 External . . . . . 369  
 1200B IBM Internal . . . . . 339  
 2400 External . . . . . 639

### PROMETHEUS

Promodem 1200 External . . \$289  
 Promodem 1200A Apple . . . 269  
 Promodem 1200B IBM . . . . 269  
 Promodem 1200MAC . . . . . 339

## DISK DRIVES

### IBM COMPATIBLE

Teac 55B . . . . . \$99  
 Mitsubishi 4851 . . . . . 99  
 Tandon TM 100-2 . . . . . 99  
 Qume DT142 . . . . . 89  
 Okidata 1/3 HT . . . . . 84  
 10 MG Hard Card . . . . . New  
 20 MG Hard Card . . . . . Call

## PRINTERS

### EPSON

LQ 800 . . . . . \$569  
 LQ 1000 . . . . . 689

### OKIDATA

182, 120 cps . . . . . \$218  
 192, 160 cps, w/Roms . . . . 349  
 193, 160 cps, IBM . . . . . 499  
 84, 200 cps, IBM . . . . . 658  
 OKI-MATE 20, Color, IBM . . .  
 Apple & Amiga . . . . . **199**

### TOSHIBA

P321 . . . . . New  
 P341 . . . . . Call  
 P351 . . . . . \$1059  
 P351 Tractor . . . . . 159

### STARMICRONICS

SG10/15 . . . . . \$219/389  
 SD10/15 . . . . . 355/469  
 SR10/15 . . . . . 489/589

### CITIZEN

MSP-10 . . . . . \$249  
 MSP-15 . . . . . 359  
 MSP-20 . . . . . 389  
 MSP-25 . . . . . 539  
 Premier 35LQ New . . . . . **469**

## IBM EXTRAS

### AST RESEARCH

SixPak +, 64K w/Side Kick . \$209  
 Reach w/Crosstalk . . . . . 369

### HERCULES

Color Card w/Printer Port . \$149  
 Mono Graphics Card . . . . . 299

### GOODIES

IBM Printer Cable . . . . . \$15  
 64K Ram Set of Nine Chips . 15  
 256K Ram Set of Nine Chips . 39  
 Power Supply 135 Watts . . . 75  
 8087 CoProcessor . . . . . 129  
 DOS 2.1 . . . . . 65  
 DOS 3.1 . . . . . 69  
 Flip Top Case w/speaker . . . 49  
 Disk Controller w/cable . . . . 39  
 Color Card w/printer . . . . . 89  
 Monochrome Card w/printer . 100  
 Keyboard 0151 . . . . . 89  
 100 DS/DD 5 1/4 . . . . . 69  
 10 1.2MG for AT 5 1/4 . . . . . 259

## SPECIAL #8

### APPLE DISK DRIVE

### 100% APPLE

### COMPATIBLE 5 1/4"

525A for IIe and II+ . . . . . \$99  
 525C for IIc . . . . . \$2749  
 350M for Mac . . . . . Special

## SPECIAL #9

### NEW COMPAQ PORTABLE II

	LIST	D & D
MODEL 1	\$3599	\$2749
MODEL 2	\$4699	\$3649
MODEL 3		Call

**IN STOCK**

## SPECIAL #10

### MULTIFUNCTION CARD

- Serial and Parallel Ports
- Clock/Gameport • Ram disk/Printer spool Software
- 1 Year Warranty

w/384K only **\$154**

## SPECIAL #11

### PC XT COMPATIBLE

- 640K • 360K Drive • Keyboard
- 20 MG Hard Drive • Monochrome
- 8 Slots • Card w/printer port
- 135 Watt Power Supply
- Green Monochrome • Monitor
- DOS 2.1 • 120 Day Warranty

**ONLY \$1249**

## SPECIAL #12

### 20 MEG HARD DISK

### FOR IBM

- Seagate Drive
- Western Digital Controller

TESTED **\$469**

## SPECIAL #13

### COMPAQ 286 PORTABLE

- IBM AT Compatible • DOS
- 1.2 Meg Floppy • 640K
- 20 Meg Hard Disk • Monitor

**\$3989**

## MAKE THAT CALL!

Order Desk . . . . . (800) 662-7253  
 In California . . . . . (213) 970-0206  
 Customer Service . . . . . (213) 970-0215  
 Technical Support . . . . . (213) 970-0215  
 Retail Store . . . . . (213) 676-0815

Service Contracts Available

*All Sales Are Warranted for 90 Days, Parts & Labor*  
**WE SERVICE WHAT WE SELL!**  
**ALL SYSTEMS INCLUDE ASSEMBLY AND TESTING**

**VISIT OUR NEW RETAIL LOCATION:**  
**12824 INGLEWOOD AVE., HAWTHORNE, CA 90250**  
**PLEASE CALL: (213) 676-0815**

### MAIL ORDER:



13324 HAWTHORNE BLVD., SUITE 201  
 HAWTHORNE, CA 90250

### ORDER DESK:

Inside California **(213) 970-0206**  
 Outside California **(800) 662-7253**

**Hours: Monday—Friday 7 am to 6 pm**  
 Open Saturdays

**WE CARRY TOO MANY ITEMS TO LIST, PLEASE CALL FOR A QUOTE ON ANY ITEM.**

 No Surcharge for Credit Cards 

**Terms:** Prices reflect a cash prepaid discount. All merchandise new. We accept MC, Visa, Wire Transfer, Certified Check, P.O.'s from qualified firms. P.O. subject to approval & 3% surcharge. Terms: 2% 10 net 20. UPS Shipping: minimum \$4.00 first 5 pounds. We also ship U.S. Mail and Federal Express. Call for exact shipping cost. Tax: California residents only add 6 1/2% sales tax. All returns subject to 15% restock fee. Prices Subject to Change.

**d&d Discount Computers**  
 A CALIFORNIA CORPORATION



# COMPUTERBANC

**FREE SHIPPING ON ALL SOFTWARE \$200 MIN.**

### DRIVES

- 20 MB Seagate drive .....\$439
- 30 MB drive for AT .....\$699
- 360 K Floppy for AT .....\$110
- Teac 55B .....\$109

### IBM COMPATIBLE HARDWARE

- Multifunction card 384K, S, P, CLK .....\$139
- AT Multifunction card OK-3MB .....\$169
- MONOCROME graphics card .....\$99
- Color Graphics card .....\$89
- ComBo CARD ser, par, clock .....\$69
- EXPANSION CHASIS 7 slots .....\$569

### TAPE DRIVES

- 10 MB Irwin .....\$379
- 20 MB Irwin .....\$429
- Everex Stream 20 .....\$599
- Everex Stream 60 .....\$899

## SYSTEMS

**COMPAQ 286, 20MB**  
Portable, 512K, DOS  
**\$3999**

**COMPAQ Deskpro 20MB**  
640K, Monitor, DDS  
**\$2499**

**SPERRY IT 44MB**  
**LEADING EDGE**

**CALL CALL**

**IBM AT COMPATIBLE**  
8MHZ, 512K, 20meg  
Monitor, graphics, ser, par  
**\$2399**

**IBM XT COMPATIBLE**  
256K, 20 meg, Monitor  
graphics, ser, par  
**\$1195**

**IBM AT 30MB .....\$4259**  
512K, DOS, Monitor

**IBM XT 20MB .....\$2369**  
256K, DOS, Monitor

**EQUITY .....CALL**  
**ITT XTRA .....CALL**

### IBM SOFTWARE

- LOTUS 123 .....CALL
- Symphony .....CALL
- ENABLE .....359.00
- V P Planner .....59.00
- ASHTON TATE Framework .....369.00
- dBASE II .....279.00
- dBASE III Plus .....369.00
- POWERBASE .....CALL
- CLIPPER dBASE III Compiler .....355.00
- LATTICE C COMPILER .....249.00
- MULTIMATE .....225.00
- MULTIMATE ADVANTAGE .....269.00
- SORCIM SUPERCALC III .....199.00
- MICROSOFT Multiplan .....119.00
- Word .....225.00
- Windows .....55.00
- Project .....239.00
- FOX & GELLER Quickcode .....149.00
- BORLAND TURBO PASCAL .....39.00
- REFLEX .....55.00
- LIGHTENING .....55.00
- SUPERKEY .....39.00
- SIDEKICK (unprotected) .....46.00
- ASCH PRO Comm Software .....69.00
- CROSSTALK XVI .....99.00
- MIRROR Comm Software .....49.00
- PEACHTREE Back to Basics .....199.00
- BPI GENERAL ACCOUNTING .....299.00
- OPEN SYSTEMS .....CALL
- REALWORLD .....CALL
- ONE-WRITE PLUS .....149.00
- IN-HOUSE ACCOUNTANT .....89.00
- ACCOUNTING PARTNER .....199.00
- MONOGRAM DOLLARS & SENSE .....105.00
- TOBIAS MANAGING YOUR MONEY .....105.00
- SATELLITE WORD PERFECT .....225.00
- MICROPRO WordStar PRO .....249.00

- WordStar 2000 PLUS .....285.00
- SAMNA WORD III .....279.00
- RBASE 5000 .....359.00
- PRINTMASTER .....35.00
- BREAKTHROUGH TIMELINE .....255.00
- DECISION RESOURCES CHRTMSTR .....219.00
- ENERGRAPHICS w/plotter opt. ....207.00
- FUNK SIDEWAYS .....36.00
- LIFETREE VOLKSWRITER DELUXE .....149.00
- HARVARD TTL PROJECT MNGR .....285.00
- THINKTANK

### IBM HARDWARE

- AST 6 Pack Plus w/384k .....259.00
- Advantage W/128k .....399.00
- STB Rio Plus 384K 5 function .....239.00
- RIO Grande 3 function for AT .....289.00
- Companion PC 0-2 MB LIMS .....189.00
- Chaufeur monographs .....229.00
- EGA - Plus Color Board .....329.00
- JRAM 3 .....175.00
- JRAM AT3 .....225.00
- HERCULES Mono Graphics .....319.00
- Color Card .....159.00
- ORCHID Turbo 286E .....859.00
- QUADRAM Quadboard 0-K .....198.00
- EGA + .....379.00
- QuadPort for AT ser & par .....125.00
- TECHMAR Graphics Master .....CALL
- PARADISE Modular Graphics Card .....CALL
- SIGMA High Res Color 400 .....CALL
- 130 WAT Power Supply .....79.00
- TALLGRASS W/Tape .....CALL
- Graphics Edge Card .....249.00
- 1.2MB FLOPPY for AT .....189.00
- MOUSE SYSTEMS Mouse .....135.00
- FIELDMOUSE .....113.00
- MICROSOFT Mouse w/stfwr .....117.00
- KOALA KAT .....149.00

### MODEMS

- ANCHOR Express 300/1200 .....220.00
- Volkmodem 1200 (5 yr wrnty) .....169.95
- EXPRESS I 300/1200 .....179.00
- Lightning 2400 Baud .....CALL
- HAYES 1200 .....379.00
- 2400 .....349.00
- Micromodem //e .....CALL
- PROMETHEUS 1200 .....269.00
- Promodem 1200B .....219.00
- Promodem 1200A .....249.00
- Promodem 300 IIC .....115.00
- Promodem 2400 .....CALL

**SUMMER SPECIALS**

### MONITORS

- AMOEK 300A .....139.00
- 310A Hi-Res Amber .....155.00
- Color 722 RGB 720 X 350 .....CALL
- PRINCETON GRAPHICS HX-12 .....399.00
- HX-12E RGB 720X350 .....CALL
- SR-12 .....CALL
- MAX-12 .....149.00
- TAXAN: ALL MODELS .....CALL
- PANASONIC DT-S101 Color .....141.00
- DT-H103 10" High Res RGB .....369.00
- IBM COMPATIBLE Monochrome .....99.00
- Color RGB Monitor (640X200) .....349.00

### PRINTERS

- PANASONIC (2 yr warranty) .....199.00
- KX-P1080 .....229.99
- KX-P1091 .....229.99
- KX-P1092 .....315.00
- KX-P1592 .....439.00
- KX-P1595 240 CPS .....625.00
- KX-P3131 17cps Daisy .....269.00
- KX-P3151 22 cps Daisy .....395.00

- Citizen MSP-10 .....265.00
- MSP-15 .....355.00
- MSP-25 .....489.00
- STAR MICRONICS SG-10 .....219.00
- SG-15 .....399.00
- EPSON LX-80 .....CALL
- FX-286 .....for
- LQ-800 .....Best
- LQ-1000 .....Prices
- BROTHER .....We Will Beat
- Twinwriter 5 .....Any Advertised Price
- OKIOATA - All Models .....CALL
- TOSHIBA All Models .....CALL
- CANNON Laser Printer .....CALL
- HEWLETT PACKARD PRINTERS .....CALL
- HOUSTON INSTRUMENTS Plotters .....CALL
- Digitizers .....CALL

### APPLE PRODUCTS

- APPLE Compatible Drive IIe .....99.00
- IIC compatible drive .....99.00
- MAC Compatible 3 1/2 drive .....229.00
- BERNOULLI 5MB MAC drive .....CALL
- MICROSOFT Macenhancer .....CALL
- Softcard II .....259.00
- ASCII XPRESS (Communications) .....69.00
- APPLEWORKS .....215.00
- SPELLWORKS .....49.00
- PRINT SHOP .....35.00
- Mach III Joystick .....39.00
- SYSTEM SAVER Fan .....69.00
- VIDEO 7 IIC Enhancer .....CALL
- VIDEX Ultraterm .....165.00
- APRICORN (Lifetime Warranty) .....CALL
- Super Serial Imager .....75.00
- Graphics Interface .....65.00
- 80 Column/64K .....75.00
- EXTEND IT 64K .....55.00
- KOALA SpeedKey .....99.00
- DISKETTES APPLE/MAC .....12.00/24.00

Call for catalog. Thousands of products available. Volume discounts.



## COMPUTERBANC

16783 Beach Blvd., Huntington Beach, CA 92647  
TELEX #350757 ANSWER BACK—COMPUTER UD  
714/841-6160

For Customer Service Call 714-847-BANC

Cash prices indicated. All products are in factory sealed packages. We guarantee all items for 30 days. Within this period, defective merchandise returns must be accompanied by RMA number. All other returns will be subject to a 10% restocking fee. For prepaid orders, there will be a 3% shipping charge; 5% for UPS Blue Label; \$5.00 minimum; all orders outside U.S.A. at 15% shipping. California residents add 6% sales tax. Prices subject to change without notice.

©Copyright 1985 COMPUTERBANC. All Rights Reserved.



No Charge for Credit Cards

Orders Only

**800/332-BANC**

OUTSIDE CALIFORNIA



# A COMPUTER PROGRAM THAT SPEAKS YOUR LANGUAGE

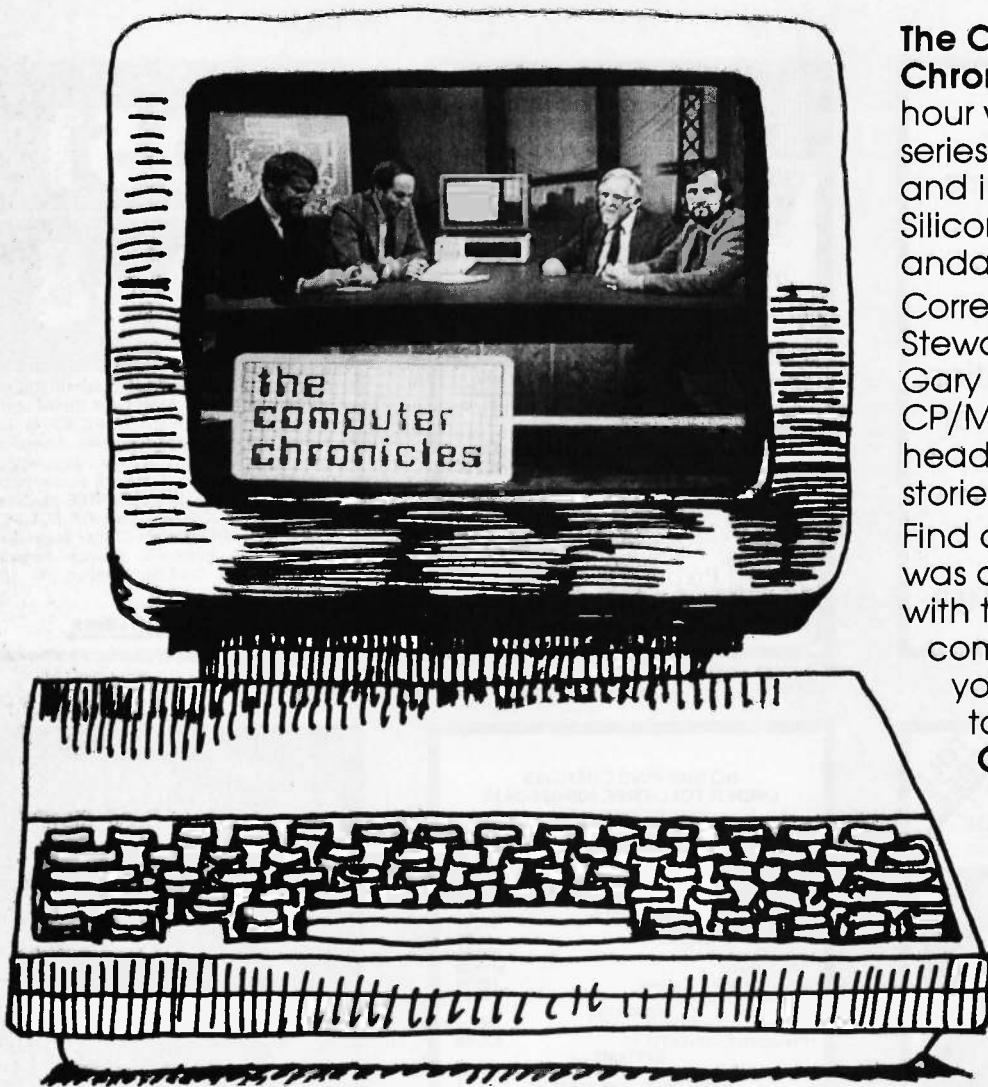

**The Computer Chronicles**, a half-hour weekly television series brings you news and information from Silicon Valley and around the world. Correspondent Stewart Cheifet and Gary Kildall, creator of CP/M cover today's headlines and the stories behind them. Find out what is, what was and what will be, with the only computer program you're ever going to need. **The Computer Chronicles**, every week on a public television station near you. (Check local listings for time and channel.)



Produced by KCSM, San Mateo, CA and WITF, Harrisburg, PA with funding from AFIPS and McGraw-Hill's **BYTE** magazine.

# \$99

## HARD DISK CONTROLLER

### New Shugart Model 1610 5 1/4" Hard Disk Controllers EMULATES

- XEBEC S1410 (1610-3) Full 90 day Guarantee
- DTC 510 (1610-1)
- SCSI (1610-4)

#### WORKS WITH

- Micromint COM 180, SB180
- Wavemat Bullet
- AMPRO All Boards
- Macintosh
- Apple IIe
- ACS 1000
- ISI 5160

**Manual and Schematic Only \$8**

#### COMPUTER SURPLUS STORE

226 Phelan Avenue  
San Jose, CA 95112  
408-280-1740

Inquiry 82

### 9-TRACK MAG. TAPE SUBSYSTEM FOR THE IBM PC/XT/AT

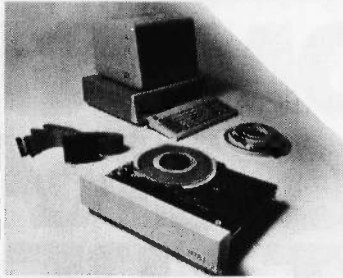

For information interchange, backup and archival storage, IBEX offers a 9-track, IBM format-compatible 1/2" magnetic tape subsystem for the IBM PC, featuring:

- 42 M-Bytes on a single reel.
- IBM format 1600 cpi.
- Software for PC-DOS, MS-DOS.

Write, phone or TWX for information

**IBEX**

IBEX COMPUTER CORP.  
20741 Manila St.  
Chatsworth, CA 91311  
(818) 708-6100  
TWX 910-493-2071

Inquiry 156

## MULTIFUNCTION CARD

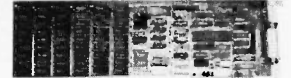

FOR IBM-PC & COMPATIBLES

# \$149

W/ 384K

INSTALLED

### 2 YEARS WARRANTY

- PARALLEL PORT • SERIAL PORT
- CLOCK/CALENDAR • GAME PORT
- RAM DISK/ PRINTER SPOOLER
- CABLES & MANUALS

COMPUTER AGE, INC.

55 Fishry St., Hartford, Ct. 06120  
203-724-5100

Terms: add \$3.00 for Handling Charges.  
Visa/MC accepted, no surcharges

Inquiry 85

Advertise your computer products through  
**BYTE BITS**  
(2" x 3" ads)

For more information call Dan Harper at  
603-924-6830

BYTE  
70 Main St.  
Peterborough, NH 03458

Inquiry 412

### STATE-OF-THE-ART MAGNETIC MEDIA

#### 5 1/4" DISKETTES

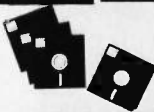

- With Hub Rings
- Write Protect Tabs
- Envelopes
- User ID Labels
- In Factory Sealed Poly Packs of 10

(YOU GET EVERYTHING BUT THE BOX)

Prices are per Disk

QTY.	50	100	500	1000
SSDD	.59	.53	.50	.47
DSDD	.62	.58	.55	.52

Library Case Holds 15 Diskettes..... Only \$1.00! plus 50¢ S&H

The 100 File ..... Only \$10.95 plus \$2.00 S&H  
100% ERROR FREE — LIFETIME WARRANTY  
Min. order \$25.00. Add 10% for less than 50 diskettes. Shipping and Handling: \$4.00 per 100 diskettes. Reduced shipping for larger quantities. C.O.D. add \$4.00. Cash or certified check.

Continental USA



Precision Data Products  
P.O. Box 8367, Grand Rapids, MI 49518  
(616) 452-3457 • Michigan 1-800-632-2468  
Outside Michigan 1-800-258-0028

Inquiry 265

# American Semiconductor

components • components • hardware • software

10 mb IBM Compatible Winchester HARD DRIVE **245.**

20 mb For AT, XT, Compaq, Tandy, Corona **345.**

TURBO XT **495**

8007	119
8007	176
8007	69
8007	270
V-20	18
FLOPPY	79
XT ADD ON CARDS	

Call us for your other needs.

## 1-800-237-5758

SALES EXT. 505

Vendor Line 813-961-9444 **VISA** Add 3% **MC** Add 3% **TECH. LINE** 813-961-5584

All new prime parts. All merchandise guaranteed.

NO SHIPPING CHARGES  
ORDER TOLL-FREE 800-824-3432

In California Call (818) 341-8833

#### DRIVES

1/2 Ht. IBM™ Compatible	89.99
Tandon 100-2	99.99
Tandon 100-4 (96 tpi)	129.99
Tandon 848-2	299.99

#### ADD ONS

Multi-Function w/OK	119.99
Monochrome Graphics	99.99
Color Graphics	109.99
64K D-Rams	9/10.99
640K Motherboard w/bios	189.99
Printer Card by IBM	49.99

#### MONITORS

Pfinceton Graphics MAX 12E	159.99
Princeton Graphics HX 12	439.99

#### SYSTEMS

PC/XT Compatible	599.99
------------------	--------

#### HARD DRIVE SUB-SYSTEMS

10 Meg.	399.99
20 Meg.	499.99

We carry a complete line of electronic components.  
Call or write for our free catalog!



**NICORN ELECTRONICS**

10010 Canoga Ave., Unit B-8, Chatsworth, CA 91311

Minimum order \$10.00 — No shipping charges on prepaid orders — C.O.D. add \$3.00 — UPS Blue add \$3.00 — Calif. residents add 6.1% sales tax. Personal checks need for clearance — VISA — MC

Inquiry 358

### IBM PC/XT VOICE SYNTHESIZER

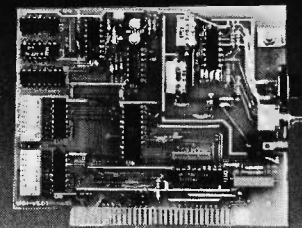

The MS1-VS01 card features

- Simple programming (BASIC, Assembly Language, etc.)
- 64 Unique Phonemes for Unlimited Vocabulary
- Switch Selectable I/O Address
- Interrupt Operation
- 4 Watt Onboard Audio Amplifier
- Low Cost (\$185)

MICROCOMPUTER SYSTEMS, INC.

1814 Ryder Drive  
Baton Rouge, LA. 70808  
(504) 769-2154

Inquiry 224



**NEW  
& IMPROVED**

The *Zipper*<sup>TM</sup> Modem

**Fully Hayes Compatible  
2 Year Warranty**

- Tone & Pulse dialing • Built-in speaker
- Auto dial/auto answer • 8 status lights
- Auto redial on busy

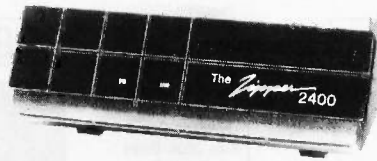

**1200 bps Standalone**  
Bell 103 and Bell 212A  
Compatible

**\$199**

**BFPRIZM12** (4 lbs.) Retail \$299.00

**2400 bps Standalone**  
CCITT V22, V22BIS, Bell 212A,  
and Bell 103 Compatible

**\$399**

**BFPRIZM24** (5 lbs.) Retail \$599.00

**1200 bps Half Card**  
for IBM PC & Compatibles  
w/Mirror Software

**\$199**

**BFPRIZM12H** (4 lbs.) Retail \$299.00

**NEW! ZipCard**  
**10 and 21**

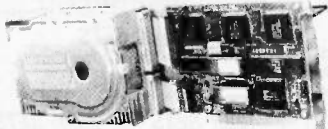

- Automatic head unloading
- 2K Sector Buffer

10 Mbyte **\$395** 21 Mbyte **\$595**  
BFPRIZC10 BFPRIZC21

**25 PIN "D" CONN's**

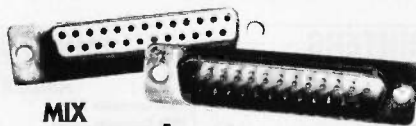

MIX  
N  
MATCH **\$1.00 each**  
25 pc. min.

BFCNDB25P Male D Connector  
BFCNDB25S Female D Connector  
BFCNDH252S 2 piece shielded hood

**CITIZEN**



**Call For Lowest Prices  
On All Models**

**ORCHID Tiny Turbo 286**



- Run your PC at AT speed
- Half slot size card
- 8 MHz 80286 processor

**BFORC286H** Retail \$695.00 **\$599**

**EPSON**

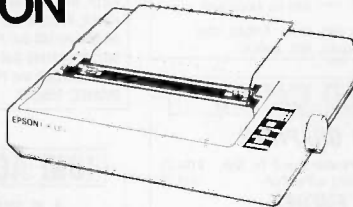

**Call for Lowest Prices  
On All Models**

**OKIDATA**

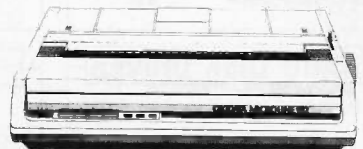

**Call For Lowest Prices  
On All Models**

**YOUR SATISFACTION GUARANTEED**

**CALL FOR DETAILS**

**IRVINE**

18241 Mc Dermott,  
Irvine, CA 92714  
**(714)660-1411**



**PRIORITY ONE ELECTRONICS®**

Inquiry 274

Mail Your Order To:

21622 Plummer St., Chatsworth, CA 91311-9970  
RETAIL: (818)709-5464 INDUSTRIAL: (818)709-5111



**SAN JOSE**

542 W. Trimble Rd.,  
San Jose, CA 95131  
**(408)435-7300**

MINIMUM PREPAID ORDER \$25.00. Terms U.S. VISA, MC, BAC, Check, Money Order, U.S. Funds ONLY. CA residents add 6%, 6½%, or 7% Sales Tax, depending on your local rates. Include MINIMUM SHIPPING & HANDLING of \$3.00 for the first 3 lbs., plus 50¢ for each additional pound (25¢ if within Calif.) Plus 25¢ per \$100.00 value of your order for PRIORITY ONE ELECTRONICS and PRIORITY 1 ELECTRONICS are registered service marks of the Heath Group, Ltd.

insurance. Orders over 70 lbs. sent freight collect. Just in case, include your phone number. Prices subject to change without notice. We will do our best to maintain prices through June 1986. Credit card orders will be charged appropriate freight. We are not responsible for typographical errors.

PRIORITY ONE ELECTRONICS and PRIORITY 1 ELECTRONICS are registered service marks of the Heath Group, Ltd. Zipper 212A, Zipper 2400, Zipper 1200B and Zipper Modem are trademarks of the Heath Group, Ltd.



**ORDER TOLL FREE (800)423-5922 (NOW IN CALIF. TOO!!)**

# THE DIVERSIFIED GROUP

4732 Rosecrans, Hawthorne, California 90250

## FREE SYSTEM PACKAGE WITH ALL DG-PC'S

<b>FREE</b> <b>RETAIL VALUE \$186</b> <b>FREE</b> <b>System Package Includes:</b> ★ 6 Ft Parallel Shielded Cable ★ Tilt and Swivel Monitor Stand ★ Twenty 5 1/4" Diskettes w/Lifetime Guarantee ★ Flip File Stores Seventy Diskettes ★ Parallel Port ★ Surge Protector Six Receptacles ★ <b>FREE FREE FREE FREE</b> ★ Offer Expires May 15, 1986	<b>DG-PC'S</b>  <b>The DG PC</b> Our computers offer the maximum alternatives in the PC XT compatible market. Alternatives which exceed current PC XT configurations. Standard features on all DG PC Series computers include: • Full compatibility with IBM PC XT machines • 640K bytes of parity checked memory, 8 slots • 150 watt power supply • keyboard • 1 Full Year Warranty on Parts and Labor. • 4 Layer Motherboard <b>BASE UNIT</b> System Unit 640K on Board One 360K Drive w/Controller 150 Watt Power Supply <b>\$699<sup>95</sup></b> <b>SYSTEM</b> System Unit 640K on Board Two 360K Drives 150 watt pwr sply Hi-Res Monitor w/Interface Card <b>\$847<sup>95</sup></b>	<b>IBM</b>  <b>IBM PC</b> Bare 256K <b>\$1099</b> One 360K Dr, 256K <b>\$1199</b> <b>IBM XT</b> One 360K Drive & 20 Meg Drive <b>\$2237<sup>95</sup></b> <b>IBM AT</b> Unenhanced <b>\$3391<sup>50</sup></b> Enhanced <b>\$3995<sup>95</sup></b> <b>IBM SYSTEM</b> PC-XT with 10 Meg One 360K Drive, Monochrome Monitor Monochrome Card <b>\$2421<sup>95</sup></b>
---	--	--

Service Contract Available on All Products

### DISK DRIVES

**MPI B-52**  
• Tandon Compatible • 360K  
Double Side/Double Density • Full Height  
2 for \$137.00

**5 1/4" DISK DRIVES**

	QTY. 1	QTY. 5
Toshiba 1/2 Height	\$ 99.95	\$ 99.95
IBM "Logo" Drives	119.95	109.95
Tandon TM100-2	99.95	99.95
MPI (Tandon Compatible)	79.95	79.95
AT 360K w/whiteface	119.95	—

**DISK DRIVE CONTROLLERS**

IBM (Original) Controller	\$ 99.95	—
IBM Compatible Controller	59.95	—

### PRINTERS

LETTER QUALITY — DOT MATRIX

**OKIDATA**

ML182P, 120 cps, Parallel	Call
ML192P, 160 cps, w/NLQ	Call
ML193P, 15" Carriage, 160 cps, w/NLQ	Call

**PANASONIC**

KX 1091	\$259.95
KX 1092	349.95

**TOSHIBA**

P341 24 pin 136 col.	\$869.00
P351 24 pin Par. & Ser.	1089.00
P1340 24 pin 80 col.	399.00

**EPSON** — Call for Availability  
We also carry Juki, Dynax, Toshiba, Star, Panasonic, NEC, Brother

### MONITORS

**AMDEK**

300G Composite Green	\$124.95
300A Composite Amber	134.95
310A Monochrome Amber	159.95

**TAXAN**

620 (640 x 200)	\$399.95
630 (640 x 400)	446.00
640 (720 x 400)	549.95

**PRINCETON GRAPHICS**

HX12, 640x200 Dot Pitch .31	\$421.95
HX12E, 640x350 Dot Pitch .28	517.95
SR12, 640x400 Dot Pitch .31	573.95
SR12P, 640x480 Dot Pitch .26	787.95
HX-9, 640x350 Dot Pitch .28	432.95
MAX12E, 720x350	169.95

### MEMORY

**64K SETS**  
All Upgrades Carry a 2 Year Warranty  
Nine 4164, 150ns \$10.95

<b>128K SETS</b> Nine, 4128 \$39.95 25 Sets \$32.95 ea.	<b>256K SETS</b> 9, 41256, 200ns \$34.95 25 Sets \$32.95 ea.
---	--

**80287**  
5MHz for AT & Deskpro \$189.95

**8087-3** \$142.95  
5MHz Math Co-Processor for IBMPC

**8087-2** \$154.95  
8MHz Math Co-Processor for AT&T, Compaq, Deskpro

### HARD DISK DRIVES

All Hard Disks Come With: 90 Day Warranty, Cables, and Controller

	QTY. 1	QTY. 5
10 Megabyte w/Controller	\$349.95	\$349.95
20 Megabyte w/Controller	489.95	469.95
30 Megabyte w/Controller	728.00	714.00

Most Hard Disks are  
Shugart, Microscel, CMI, Rodine, Segate  
Call for Others

**BERNOULLI BOX**

10 Meg	\$1779.95	—
20 Meg	2399.95	—

**TAPE BACK-UP BY IRWIN**

10 Meg Internal 1/2 Height, Low Power	\$446.00	\$436.00
10 Meg External Back-up	589.00	579.00

**DISK DRIVE CONTROLLERS**

Western Digital Hard Disk Cont.	\$179.95	—
Adaptic Hard Disk Cont.	199.95	—

### VIDEO CARDS

**DG GRAPHICS**

Color Graphics w/Parallel Port 2 Yr. War.	\$104.95
Monochrome Graphics w/Par Port	119.95

**EVEREX**

The Edge Color/Mono	\$269.95
The Graphics Edge	269.95

**IBM**

IBM Monochrome w/Parallel Port	\$226.95
IBM Color Card w/Parallel Port	214.95

**PARADISE**

Modular Graphics Card	\$259.95
Multi Display	159.95

**EGA**

DG EGA	\$292.95
STB EGA +	349.95
QUADRAM +	398.95
IBM EGA	498.95

**SIGMA**

Color 400 Board	\$458.95
-----------------	----------

**HERCULES**

Color Graphics	\$169.95
Monochrome Graphics	319.95

### IBM ACCESSORIES

**A-B SWITCH BOXES**

Parallel 2 pos.	\$49.95	Serial 2 pos.	\$64.95
-----------------	---------	---------------	---------

**DISKETTES**  
Xidex Dbl/Dbl 5 Year Warranty  
1 box of 10 \$9.95

**KEYTRONICS KEYBOARDS**

5153 Touch Pad	\$289.95
5150 Standard	\$169.95
5151 Deluxe	\$179.95

**BELKIN CABLES**

6 foot Shielded	\$14.95
IBMPC to Par.	\$14.95
IBMPC to Modem	\$16.95

### EXPANSION CARDS

AST SixPac+ w/384K 2 Yr War	\$261.95
MF-100 SixPac Compatible plus Gameport	\$89.95
AST Advantage w/1.5 Megabyte of Memory Parallel & Serial Ports	\$497.95
AST Rampage	\$362.95

### MODEMS

**Hayes**

1200 w/Smartcom II	\$362.95
1200 External	\$392.95
2400 External	\$595.95

**DG**

300/1200 Internal Hayes compatible,	\$156.95
-------------------------------------	----------



# THE DIVERSIFIED GROUP

**TERMS:**  
P.O.'s from Government Institutes, Universities, Fortune 1000 C.O.D.'s w/Guaranteee.  
Visa, MC, MD, Cashier's Check, Cash. Please Call for Shipping: Min. \$4.50  
We ship Fed. Express, USP, U.S. Mail

MAIL ORDERS: 8726 S. Sepulveda, Suite A132, Los Angeles, CA 90045  
WAREHOUSE: 4732 Rosecrans, Hawthorne, CA 90250

TOLL FREE ORDER LINE  
**(800) 523-1041**  
INSIDE CALIFORNIA  
**(213) 675-0717**



# HOW CAN YOU REFUSE THIS OFFER, IF YOU ARE SHOPPING FOR IBM CLONE!

Special Sale for IBM PC/XT Compatible Computer System

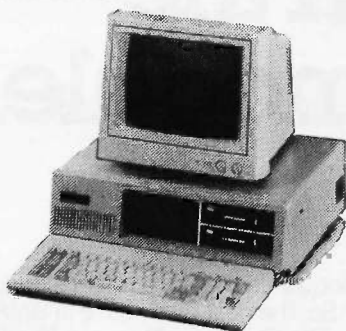

- Fully IBM PC/XT compatible
- 640K on board memories
- 8 IBM PC/XT standard I/O slots
- 8087 coprocessor ready socket
- Standard 4.77 MHz clock speed
- Flip-top type metal cabinet
- 83 key full function key board (enlarged return key and led indicators)
- Color graphic adapter with composut out (RES. 640 x 320)
- One parallel port for printer
- One RS-232 serial port
- One game port for joystick
- Real time clock with calendar (5 years battery back up on board)
- 135 watts hard disk ready power supply
- 2 halfheight 360K floppy drives
- 12" monochrome monitor included
- Fully assembled and tested
- 6 months parts and labor warranty

**OPTIONAL ADD ON :**

- A. For 5151 100 keys keyboard add \$40.00
- B. For 3way RGB color monitor 13" add \$285.00
- C. For 10 MGB internal hard disk with controller add \$499.00
- D. For 22 MGB internal hard disk with controller add \$599.00
- E. For Monochrome graphic adapter with printer port and TTL Monochrome 12" Hi-RES monitor add \$60.00

**SHIPPING CHARGES :** 5% for C.O.D., 2% for prepaid orders inside Continental U. S. No Personal Checks Accepted.  
**DEALERS INQUIRIES INVITED.** Inquiry 263  
 ● IBM is registered trade mark of IBM Corp.

**SPECIAL OFFER: \$949**

**PINE COMPUTER INC.**

1455 MONTEREY PASS RD., SUITE 103  
 MONTEREY PARK, CA 91754

**PHONE : (213) 269-1103**

**STORE HOURS : Mon. - Sat. 9 A.M. - 6 P.M.**

## IBM PERIPHERALS

- PC/XT 640K MOTHER BOARD, LOADED W/BIOS \$250.00
- COLOR GRAPHIC CARD W/RGB & COMPOSIT VIDEO OUT PUT (640x 400 RES) \$ 88.00
- MONOCHROME GRAPHIC CARD W/PRINTER PORT (720x348 RES) \$120.00
- FLOPPY/DISK CONTROLLER CARD W/CABLE \$ 49.00
- O/384K MULTIFUNCTION CARD W/PARALLEL PORT; SERIAL PORT; GAME PORT; CALANDER, CLOCK (BATTERY BACK UP) AND 384K RAM SLOTS \$119.00
- DISK I/O CARD W/PARALLEL PORT; SERIAL PORT; GAME PORT; CALANDER, CLOCK (BATTERY BACK UP) AND FLOPPY DISK CONTROL- LER W/CABLES \$135.00
- PARALLEL PRINTER CARD \$ 25.00
- SERIAL PRINTER CARD (RS-232) \$ 53.00
- DUAL SERIAL CARD (RS-232) (COM-1, COM-2) \$ 75.00
- O/512K RAM EXPANSION CARD \$ 52.00
- MOUSE SYSTEM (MICRO-SOFT COMPATIBLE) (3 BUTIONS) \$ 95.00
- EXTERNAL MODEM 300/1200 BULD (HAYS COMPATIBLE) \$250.00
- 135 WATT POWER SUPPLY 110/220V SIDE SWITCH \$ 95.00
- KEYBOARD : PC/XT LOOK ALIKE 84 KEY (5150) \$ 78.00
- KEYBOARD : SELECTIC-II LOOK ALIKE, LARGE RT KEY \$ 78.00
- KEYBOARD : ADVANCE 100 KEY MODEL : 5151 \$109.00
- KEYBOARD : AT LOOK ALIKE, LARGE RT KEY \$ 98.00
- PARALLEL PRINTER CABLE (6 FT.) \$ 14.00
- SERIAL PRINTER CABLE (6 FT.) \$ 14.00
- JOY STICK (SELF CENTERING W/2 FIRE BUTTON) \$ 25.00
- 360K HALF HEIGHT DISK DRIVE (PANASONIC OR TEAL) \$ 95.00
- SURGE SUPPRESSED POWER STRIP (6 OUTLETS) \$ 18.00

# BYTE back issues for sale

	1982	1983	1984	1985	1986
Jan.		\$3.70	\$4.25	\$4.25	\$4.25
Feb.	\$3.70	\$3.70	\$4.25	\$4.25	\$4.25
March	\$3.70	\$3.70	\$4.25	\$4.25	\$4.25
April	\$3.70	\$3.70	\$4.25	\$4.25	\$4.25
May	\$3.70	\$3.70	\$4.25	\$4.25	\$4.25
June	\$3.70	\$3.70	\$4.25	\$4.25	
July	\$3.70	\$4.25	\$4.25		
Aug.	\$3.70	\$4.25	\$4.25	\$4.25	
Sept.	\$3.70	\$4.25	\$4.25	\$4.25	
Oct.	\$3.70	\$4.25	\$4.25	\$4.25	
Nov.	\$3.70	\$4.25	\$4.25	\$4.25	
Dec.	\$3.70	\$4.25	\$4.25	\$4.25	

Circle and send requests with payments to:

**BYTE Back Issues**  
**P.O. Box 328**  
**Hancock, NH 03449**

Prices include postage in the US. Please add \$.50 per copy for Canada and Mexico; and \$2.00 per copy to foreign countries (surface delivery).

Payments from foreign countries must be made in US funds payable at a US bank.

Check enclosed  VISA  MasterCard

Card # \_\_\_\_\_

Exp. \_\_\_\_\_

Signature \_\_\_\_\_

Please allow 4 weeks for domestic delivery and 12 weeks for foreign delivery.

### SPECIAL ISSUES and INDEX

BYTE '83-'84 INDEX	\$1.75
1984 Special Guide to IBM PC's (Vol. 9, No. 9)	\$4.75
1985 INSIDE THE IBM PCs (Vol. 10, No. 11)	\$4.75

**NAME** \_\_\_\_\_

**ADDRESS** \_\_\_\_\_

**CITY** \_\_\_\_\_

**STATE** \_\_\_\_\_ **ZIP** \_\_\_\_\_

# How a software engineer got to captain the lunar landing module.

The Computer Museum is everything you'd expect, and a lot of things you wouldn't.

Of course, the museum contains a collection of the most significant accomplishments in the history of information processing. But it's not just a great place to see things, it's also a great place to do things.

There are over twenty interactive exhibits at The Computer Museum. You can design a car, create your own fractal landscape, or even captain the lunar landing



module on the Apollo flight simulator.

So, the next time you're in Boston, stop by The Computer Museum. You'll discover it's more than a lot of machines, it's also a lot of fun.

For more information, or to become a Museum Member, write The Computer Museum, or call (617) 423-6758.

**The Computer Museum**

B O S T O N  
There's something in it for everyone.

300 Congress Street, Boston, MA 02210

## Subscription Problems?

### We want to help!

*If you have a problem with your **BYTE** subscription, write us with the details. We'll do our best to set it right. But we **must** have the name, address, and zip of the subscription (new and old address, if it's a change of address). If the problem involves a payment, be sure to include copies of the credit card statement, or front and back of cancelled checks. Include a "business hours" phone number if possible.*



## BYTE

Subscriber Service  
P.O. Box 328  
Hancock, NH 03449







# FORTRON CORPORATION

3225 SELDON CT., FREMONT, CA 94538

IN CALIF: (415) 490-8171  
TLX: 559291 FORTRON  
FAX: (415) 490-9156

ORDER TOLL FREE: 821-9771

## U.L. Rated • High Reliability • Full Technical Support

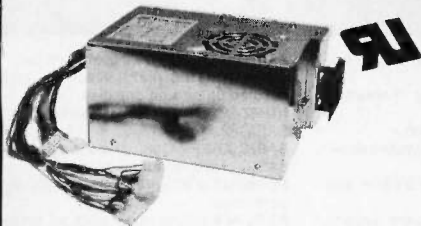

140W (Typ.) 150W(Max.)  
PC/XT \$129.00

- U.L. recognized, yellow card available File # E-101115(S)
- Meet FCC class B, European safety spec.
- 115/230V AC convertible
- Low noise DC fan
- OVP, OCP, short circuit protection
- IBM® standard pin out or Faraday type pin out selectable
- 100% 24 hrs. burn-in 100% pre-shipment test.
- One full year warranty





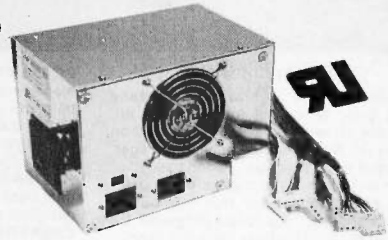





Your PC represents a substantial investment. It does not make sense to risk costly down time due to bargain power supply when for a few dollars more you can have the confidence of FORTRON QUALITY.

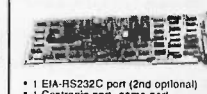



IBM is a registered trademark of International Business Machines.



FC 5192 200W (max)  
PC/AT \$189.00

## PROFITABLE DISCOUNT PRICES FOR SYSTEM INTEGRATORS & DEALERS - PLEASE CALL

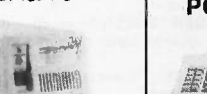
<b>FC 520</b> Color Graphic / Mono / Printer  <ul style="list-style-type: none"> <li>• TTL / composite level outputs</li> <li>• 320 x 200 (color) 640 x 200 (B&amp;W)</li> <li>• Centronics Printer Port</li> </ul> <b>\$99.00</b>	<b>FC 550 (CT-6040)</b> Monochrome / Graphic / Printer  <ul style="list-style-type: none"> <li>• 80 x 25 text mode</li> <li>• 720 x 348 graphic mode</li> <li>• Run Lotus 1-2-3- auto cad, etc.</li> <li>• IBM® compatible</li> </ul> <b>\$109.00</b>	<b>FC 730 (CT-6050C)</b> 384K Multifunctions  <ul style="list-style-type: none"> <li>• Memory expansion to 384K</li> <li>• Clock / calendar</li> <li>• Serial, parallel ports</li> <li>• Game port</li> </ul> <b>(OK) \$119.00</b>	<b>FC 740</b> Multi-I/O w/ Floppy Controller <b>\$109.00</b>  <ul style="list-style-type: none"> <li>• 1 EIA-RS232C port (2nd optional)</li> <li>• 1 Centronics port, game port</li> <li>• Clock / calendar</li> <li>• Control 2 floppy drives</li> <li>• (FC 770) w/ Floppy Controller</li> </ul> <b>\$99.00</b>	<b>FC 1730</b> Multifunction Card for PC AT  <ul style="list-style-type: none"> <li>• 1 EIA-RS232 port (2nd optional)</li> <li>• 128K to 1.5 MB memory</li> <li>• Expandable to 3 MB (optional) by piggy back board</li> <li>• Game port</li> </ul> <b>\$189.00</b>	<b>FC 1930</b> RS232 / Printer Port for PC AT  <ul style="list-style-type: none"> <li>• 1 EIA RS232 port (2nd optional)</li> <li>• Centronics parallel port</li> </ul> <b>\$99.00</b>
<b>FC 940</b> RS232 / Real Time Clock  <ul style="list-style-type: none"> <li>• RS232C port</li> <li>• To 5600 baud</li> <li>• Battery back-up</li> </ul> <b>\$59.00</b> (clock only) <b>\$49.00</b>	<b>Hard Disk Controller</b>  <p>Hard Disk Controller for XT</p> <ul style="list-style-type: none"> <li>• DTC 5150 BX ..... \$149.00</li> <li>• WD WX-2 (Western Digital) ..... \$145.00</li> <li>• Cable ..... \$ 9.50</li> <li>• F.D. &amp; H.D. Controller for AT</li> <li>• DTC 5290 ..... \$265.00</li> <li>• Western Digital WA-2 ..... \$280.00</li> <li>• Cable Set ..... \$ 18.00</li> </ul>	<b>FC 230</b> Floppy Disk Controller  <ul style="list-style-type: none"> <li>• Drives up to four 5 1/4" floppy drives</li> <li>• IBM compatible</li> <li>• With cables</li> </ul> <b>\$59.00</b>	<b>XT CPU Board</b>  <ul style="list-style-type: none"> <li>FC 150 (4.77 MHz) ..... \$148.00</li> <li>FC 180 (6.00 MHz) ..... \$159.00</li> <li>• Expandable to 640K on board memory</li> <li>• Optional 6087 co-processor</li> <li>• Optional IBM® comp. BIOS</li> </ul>	<b>Modems \$149.00</b>  <p>INTERNAL</p> <ul style="list-style-type: none"> <li>Hayes 1200 RS232 ..... \$389.95</li> <li>Everex 1200 bps ..... \$148.00</li> <li>Practical Peripheral ..... \$199.00</li> </ul> <p>EXTERNAL</p> <ul style="list-style-type: none"> <li>Hayes® compatible ..... \$179.00</li> </ul>	<b>SPECIAL</b> <b>*CMI #6640 40 MS 31 MB (formatted) Hard Disk Drive \$499.00 (listed \$899.00)</b> <ul style="list-style-type: none"> <li>• FC 830 512K memory exp. card ..... \$68.00</li> <li>• FC 835 576K memory exp. card ..... \$69.00</li> <li>• FC 930 serial / parallel adaptor for XT ..... \$49.00</li> <li>• FC 530 monochrome controller w/ printer port ..... 79.00</li> </ul>

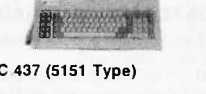
<b>Enhanced Graphic Adaptor</b> IBM® Compatible  <p>w/ o printer port</p> <ul style="list-style-type: none"> <li>• For PC/XT/AT and compatibles</li> <li>• 256K on board memory</li> <li>• Full 16 colors in 640 x 350 on IBM® enhanced color display</li> <li>• Support 640 x 350 IBM® compatible enhance color and monochrome monitors</li> <li>• Parallel port • Light pen interface</li> </ul>	 <p>w/ printer port</p> <p><b>EGA Monitor \$499.00</b></p>	<b>FORTRON 200</b> U.P.S. for PC  <ul style="list-style-type: none"> <li>• 115V / 230V AC Input convertible</li> <li>• Input current 2.5 amp</li> <li>• 200W continuous</li> <li>• 1/2 cycle (typical) transfer time</li> <li>• Hold-up time from 20 minutes (200W) up to 60 minutes (60W)</li> <li>• 5.12" x 7.7" x 13.18"</li> </ul> <b>\$259.00</b>	<b>FC 447</b> PC/AT Keyboard  <ul style="list-style-type: none"> <li>• IBM AT compatible keyboard</li> <li>• Enlarge return key</li> <li>• Light on num. lock key</li> </ul> <b>\$109.00</b>	<b>FC 427 (5150 Type) \$79.00</b> 	<b>FC 437 (5151 Type)</b>  <ul style="list-style-type: none"> <li>• For PC XT</li> <li>• Large return key</li> <li>• Light on num. lock keys</li> </ul> <b>\$99.00</b>
--	---	---	---	---	--

## CABINETS & EXPANSION CHASSIS

<b>FC 630 A-2</b>  <ul style="list-style-type: none"> <li>• For PC XT compatible side switch</li> <li>• To use FC 135-40 power supply</li> <li>• Complete mounting hardware</li> </ul> <b>\$79.00</b>	<b>FC 620</b>  <ul style="list-style-type: none"> <li>• For PC AT compatible</li> <li>• LED lamps, key, key lock, speaker and mounting hardware included</li> </ul> <b>\$139.00</b>	<b>FC 610</b> Drives Chassis  <ul style="list-style-type: none"> <li>• 18" x 8" x 6"</li> <li>• Capable of holding 2 half-height drives</li> <li>• Come w/ power supply, fan</li> <li>• LED power indicator</li> </ul> <b>\$149.00</b>	<b>FC 640 / 5 Slots</b> PC Expansion Chassis <b>\$239.00</b>  <ul style="list-style-type: none"> <li>• W/ 5 slot mother board</li> <li>• 100W power supply, fan</li> <li>• Capable of holding 3 half-height drives</li> <li>• Dia. 15 1/2" x 12" x 6 1/4"</li> <li>• Option of system interface adaptor ..... \$149.00</li> </ul>	<b>FC 650 / 8 Slots</b> PC Expansion Chassis <b>\$249.00</b>  <ul style="list-style-type: none"> <li>• PC XT identical size</li> <li>• W/ 8 slot mother board</li> <li>• 140W power supply</li> <li>• 4 half-height drives</li> <li>• System interface adaptor ..... \$149.00</li> </ul>	<b>FCC 660 / 12 Slots</b> PC Expansion Chassis <b>\$289.00</b>  <ul style="list-style-type: none"> <li>• Dia. 15 1/2" x 15 1/4" x 5 1/4"</li> <li>• W/ 12 slot mother board power supply, fan</li> <li>• Capable of holding 2 half-height drives</li> <li>• System interface adaptor ..... \$149.00</li> </ul>
--	---	---	--	--	---

<b>MONITORS</b> <ul style="list-style-type: none"> <li>• <b>Monochrome</b></li> <li>Tatung MM 1222 A / G ..... \$129.00</li> <li>Golden Star Green ..... \$109.00</li> <li>• <b>Color Hi-Res (640 x 200)</b></li> <li>Tatung CM-1360 ..... \$359.00</li> <li>• <b>Enhanced Graphic (640 x 350)</b></li> <li>Tatung CM-1380 ..... \$499.00</li> <li>Princeton HK-12E ..... \$529.00</li> <li>Mitsubishi EGA ..... \$529.00</li> <li>Quimax PX-22 ..... \$499.00</li> </ul>	<b>DISK DRIVES</b> <ul style="list-style-type: none"> <li>• Floppy</li> <li>Teac 555V ..... \$119.00</li> <li>1.2 MB 55GFV ..... \$149.00</li> <li>• Hard (w/ controller &amp; cable)</li> <li>10 MB ..... \$419.00</li> <li>20 MB ST-225 ..... \$449.00</li> <li>• 20 MB ST-4026 (40 MS) drive only ..... \$578.00</li> <li>• 30 MB ST-4038 (40 MS) drive only ..... \$699.00</li> <li>• 31 MB CMI-6640 (40 MS) drive only ..... \$499.00</li> </ul>	<b>Tape Back-Up</b> (w/ controller, cable & tape)  <p>INTERNAL</p> <ul style="list-style-type: none"> <li>Sygen 20 MB ..... \$645.00</li> <li>Everex 20 MB ..... \$699.00</li> <li>Sygen 60 MB ..... \$850.00</li> <li>Everex 60 MB ..... \$895.00</li> </ul> <p>EXTERNAL</p> <ul style="list-style-type: none"> <li>Sygen 20 MB ..... \$749.00</li> <li>Sygen 60 MB ..... \$895.00</li> <li>Everex 20 MB ..... \$789.00</li> <li>Everex 60 MB ..... \$995.00</li> </ul>	<b>Printers \$89.00</b>  <p>Admate DP-130 ..... \$219.00</p> <ul style="list-style-type: none"> <li>• 130 C.P.S.</li> <li>• 80 columns</li> <li>• 9 x 9 dot matrix field</li> <li>• Parallel standard interface</li> <li>TTX-80 ..... \$ 89.00</li> <li>• 50 C.P.S.</li> <li>• 80 columns</li> <li>• Parallel standard interface</li> <li>• Thermo printer</li> </ul>	<b>RAM CHIPS</b> <ul style="list-style-type: none"> <li>• 64K RAM ..... \$11.50 / 9 pc.</li> <li>• 256K ..... \$33.00 / 9 pc.</li> <li>• 128K ..... \$44.00 / 9 pc.</li> </ul> <p>(for PC AT)</p> <p><b>Terms:</b></p> <ul style="list-style-type: none"> <li>• Min. shipping &amp; handling \$6.00</li> <li>• CA res. add 6.5% tax</li> <li>• Restocking charge 15%</li> <li>• No rtn. goods w/o a RMA no.</li> <li>• Prices subject to change w/o notice</li> </ul>
--	--	---	--	--

# WHY PAY MORE?

## IBM Compatible Software only \$6 per disk

OVER 500 DISKS FULL OF PUBLIC DOMAIN AND USER SUPPORTED PROGRAMS



### Summary of Disks

People often ask "...how can you sell any really good programs for \$6? After all, everyone knows you have to spend \$300 on a good word processor, database manager, or spread sheet program... don't you?"

The truth is many of our satisfied customers have discovered that our public domain and user supported programs are actually some of the best and most sophisticated software you can buy, at any price! The commercial retailers don't want you to know about us or our programs, but why pay hundreds of dollars more for software that won't do any more than our \$6.00 package. Here is a sample of our library by category.

### WORD PROCESSORS

**PC-Write 2.5 (#78)** A full featured word processor that is faster than Wordstar.  
**TSCRIPT (#422)** word processor for PC-JR only. Pascal source code included.  
**DICTIONARY (#378)** Dictionary type spelling checker.  
**IV-ED (#415)** Word processor - editor.  
**LETTERWRITER (#415)** controls letter processing.

### SCREEN EDITORS

**FRED (#83)** Screen editor similar to IBM's Personal Editor.  
**RV-EDIT (#190)** Full screen editor from Bob Vollmer.  
**FOIL EDIT (#347)** Full screen editor. Top to bottom and left to right.

### TEXT PROCESSING TOOLS

**PC-READ (#194)** Program to determine clarity of text.  
**FOGIND (#378)** reverses writing complexity using the "Fog Index".  
**ROFFA 1.61 (#416)** make beautiful text formats with this processing tool.  
**PARSER (#419)** Public Domain version of this famous system.  
**WORDSTAR AIDS (#379)** collection of the most useful utilities for the Wordstar user.

### DATABASE PROGRAMS

**PC FILE III (#5)** most popular database program from Jim Button.  
**U-MIND (#133)** Fast hashing makes this a dandy database. (Intelligent database)  
**DATABASE OF STEEL 3.1 (#214, 215, 267, 268)** Database spreadsheet and expert system from Potomic Engineering.  
**NEWBASE (#233)** Menu driven database for the beginner.

**PC-DBMS (#383)** A relational database management system that provides on-line help and screen editing functions.  
**ELSIE EXPERT SYSTEM (#398)** Artificial intelligence shell to build a custom knowledge-base.  
**PDS\*BASE (#396)** Complete hierarchical data base system master/detail or mother/daughter type.  
**CREATOR (#339)** create, report, and sort makes this a super database management system.  
**INFOBASE (#340)** Forms driven database management system similar to INFOSTAR.

### DATABASES

**BOBCAT (#247)** Small business database. Excellent!  
**MFIND (#311)** Database of over 2000 movies that can be searched in any category, or you can add your own.

### SPREADSHEETS

**PC-CALC (#199)** Fabulous 123 work-a-like from the author of PC-File.  
**PC-PAD (#406)** Spreadsheet and address book program written in basic.

### SPREADSHEET TEMPLATES

**LOTUS 1-2-3 TEMPLATES AND MACROS (#140, 141, 165, 257, 289, 301-304, 406, 414)** Why spend hours of writing your macros when these are ready made? Modify them yourself.  
**SYMPHONY WORKSHEETS (#305, 306)**

### FINANCIAL PROGRAMS

**PC-CHECK MANAGER (#275)** Keeps multiple checkbooks in balance.  
**TAX FILE DBS (#295)** Tax record keeping system that saves you money on April 15.  
**SAGE TRADER (#242)** Analyzes commodity trades. Don't "short" this one!  
**PORTSWORTH PACKAGE (#101)** Evaluates your ever changing stock portfolios.  
**FINANCE (#164, 227)** Determine present and compound values, interest rates, etc.  
**HOME FINANCE (#406)** Lotus 1-2-3 Macro for real life applications.  
**PC-GENERAL LEDGER 1.2 (#237)** An exceptional accounting system. Used by some CPAs.  
**TIME AND MONEY (#251)** Financial record keeping and analyst system.  
**LOAN AMORTIZATION (#399)** For output to screen or printer. Lots of on-line help.

### COMMUNICATIONS

**QMODEM (#310)** The best and fastest com-

munications programs you can buy at any price, bar none!  
**PC-TALK (#391)** The classic "Freeware" communication program.  
**PC-VT (#286)** VT-100 Emulation.  
**SYSCOMM (#338)** Menu driven system allowing unattended file transfer.  
**RBBS 12.2 (#212)** Become a SYSOP and start a bulletin board.  
**FIDO NET (#333)** Bulletin Board System. Perhaps the easiest to run.

### MATH AND STATISTICS

**EPISAT 3.1 (#88)** Statistical analysis of small to medium-sized data samples.  
**KLP 1.9 (#332)** Kinetics linear programming system.  
**MATH PAK (#394)** Programs to teach and accelerate some math functions. BASICA

### LANGUAGES

**CHASM 2.13 (#10)** Cheap assembler with tutorial.  
**LADYBUG 1.0 (#94)** Logo like program.  
**XLISP 1.4 (#148)** Lisp language interpreter.  
**LAXON & PERRY FORTH (#263, 264)**  
**MVP-FORTH (#31, 32)** Two disk set of Mountain Valley Press Forth.  
**3FORTHs (#352)** To modify or expand your own forth language. MVPFORTH, FORTH-H and SEATTLE Computer's Forth.  
**PROLOG & UNIFORTH (#417)** Complete with editor and documentation.  
**SNOCREST BASIC (#409, 410)** two disk set. Real basic interpreter with manual. Can be used with a multi-user system.  
**TBASIC (#381)** Tiny basic. A limited subset of BASIC. Could be placed on a chip.

### PASCAL SETS

**PASCAL TOOLS (#130, 133)** Volume 1, 2 and 3 with source code from the famous book.  
**TURBO PASCAL-TOOLS (#248, 279, 292, 298, 324, 351, 353, 364, 365, 366, 375, 392)** 12 volumes of tools and utilities written especially for turbo Pascal. The most extensive collection around!

### UTILITIES

**DISKCAT 4.0 (#106)** Catalog all your disk files in a hurry.  
**GINACO (#66)** 54 polished routines written in basic for any beginner or experts. We love it!  
**ULTRA-UTILITIES 4.0 (#133, 245)** Recover lost files, modify sectors, etc. Like Nortons.  
**SYSTEMU (#250)** Build a menu driven menu system. Excellent for hard disks.  
**LOAD-US (#284)** Allows Lotus and Symphony to be used on a hard disk.

**ALIGN 1.6 (#217)** Disk alignment tool.  
**TOP UTILITIES (#273)** All of the most requested utilities on one disk.  
**NUMZAP (#284)** Removes line numbers from BASIC programs.  
**BASIC XREF (#358)** Chose bags with this BASIC cross-22 reference utility.  
**PC-INPUT (#363)** Program for BASIC screen generation.  
**PATCHES (#376)** make back up copies of some of the most popular commercial programs with this collection.

### PRINTER UTILITIES

**SP 3.4 (#186, 275)** Printer buffer that partitions your data so you can use your computer and print at the same time.  
**SIDEWAYS (#265, 411)** Prints text sideways on an Epson printer.  
**SETPRTR (#79)** Sets up Epson printer from a menu.  
**SLIDE (#244)** produce medium resolution slides and overhead transparencies.  
**PRINTER UTILITIES (#411)** Sorgasboard of utilities and tools.  
**EPSON PRINTER UTILITIES (#326)** Spool, set up routines all designed for Epson codes.  
**BANNER (#386)** make long banners with large letters. Includes MS-FORTRAN source codes.

### EDUCATION

**PC-TOUCH (#249)** A typing tutor.  
**EQUATOR (#249)** A teaching tool for math, science and finance.  
**PC-TUTORIAL (#403)** A first course in computer usage covering various aspects of MS-DOS. Good!  
**PC-PROFESSOR (#105)** Learn Basic the easy way. One of the best tutorials on BASIC.  
**PC-DOS HELP (#254)** type "help" for the DOS command you forgot.  
**FLASH CAROS (#367-370)** 4-disk set. Vocabulary builder, spelling teacher.

### GAMES

**TOP GAMES (#274)** The most requested arcade type games.  
**ARCADE GAMES (#293)** Another goodie bag of top Arcade games.  
**EMON (#296, 297)** Adventure game compiler.  
**TRIVIA GAMES (#327-329)** Lots of files and documentation for hours of fun. Will not work on PC JR.  
**PC JR GAMES (#354)** Games that will work only on PC JR. Combat, dungeons and dragons. Global Thermonuclear War.  
**MISC. GAMES (#390)** Good selection of educational, adventure, and arcade games.

### MUSIC

**PC-MUSICIAN (#127)** Compose music on your PC, save and play again.  
**PIANO MAN (#279)** Play your PC keyboard like a piano.

### APPLICATIONS

**GENEALOGY ON DISPLAY 3.0 (#90)**  
**GENEALOGY - FT 1.25 (#240)** from Pine Cone software.  
**LABELMAKER (#146)** Our favorite label file and maker Menu driven.  
**PC-FLY "Fliteplan" 2.1 (#261)** Pilots prepare and file your flight plans.  
**RECIPES 83 (#281)** Recipe index for use with PC File III (#5)  
**FAMILY HISTORY (#361)** Family history, ancestor and descendant charts. Sample programs.  
**FORM LETTERS (#388)** LOTS of samples of the most commonly used business letters. Modify!

### GRAPHICS

**PC-KEY DRAW (#344-345)** A small CAD system. Lots of demonstration files.  
**PC-PICTURE GRAPHICS (#136)** Drawing package allows you to zoom, color, and store pictures.  
**PC-GRAPH (#418)** Allows user to create graphics from PC-File report files.

## ORDER FORM

### LONE STAR SOFTWARE, INC.

2100 Hwy. 360, Suite 1204  
 Grand Prairie, Texas 75050  
 214/647-1010

SHIP TO: \_\_\_\_\_

TOTAL # \_\_\_\_\_ x \$6 = \_\_\_\_\_

DISK DIRECTORY (Explanation of all files & programs) x \$6 = \_\_\_\_\_

OTHER \_\_\_\_\_ = \_\_\_\_\_

SUBTOTAL \_\_\_\_\_

TEXAS RESIDENTS ADD 6% TAX \_\_\_\_\_

SHIPPING & HANDLING \_\_\_\_\_

(1 @ \$1.00 and .50 for each additional disk)

TOTAL \_\_\_\_\_

MASTERCARD  VISA

CARD NO. \_\_\_\_\_

EXPIRATION DATE \_\_\_\_\_

SIGNATURE \_\_\_\_\_

PLEASE ENCLOSE CHECK WITH ORDER

### CIRCLE DISK NUMBER DESIRED:

1	2	3	4	5	6	7	8	9	10	11	12	13	14	15	16	17	18	19	20
21	22	23	24	25	26	27	28	29	30	31	32	33	34	35	36	37	38	39	40
41	42	43	44	45	46	47	48	49	50	51	52	53	54	55	56	57	58	59	60
61	62	63	64	65	66	67	68	69	70	71	72	73	74	75	76	77	78	79	80
81	82	83	84	85	86	87	88	89	90	91	92	93	94	95	96	97	98	99	100
101	102	103	104	105	106	107	108	109	110	111	112	113	114	115	116	117	118	119	120
121	122	123	124	125	126	127	128	129	130	131	132	133	134	135	136	137	138	139	140
141	142	143	144	145	146	147	148	149	150	151	152	153	154	155	156	157	158	159	160
161	162	163	164	165	166	167	168	169	170	171	172	173	174	175	176	177	178	179	180
181	182	183	184	185	186	187	188	189	190	191	192	193	194	195	196	197	198	199	200
201	202	203	204	205	206	207	208	209	210	211	212	213	214	215	216	217	218	219	220
221	222	223	224	225	226	227	228	229	230	231	232	233	234	235	236	237	238	239	240
241	242	243	244	245	246	247	248	249	250	251	252	253	254	255	256	257	258	259	260
261	262	263	264	265	266	267	268	269	270	271	272	273	274	275	276	277	278	279	280
281	282	283	284	285	286	287	288	289	290	291	292	293	294	295	296	297	298	299	300
301	302	303	304	305	306	307	308	309	310	311	312	313	314	315	316	317	318	319	320
321	322	323	324	325	326	327	328	329	330	331	332	333	334	335	336	337	338	339	340
341	342	343	344	345	346	347	348	349	350	351	352	353	354	355	356	357	358	359	360
361	362	363	364	365	366	367	368	369	370	371	372	373	374	375	376	377	378	379	380
381	382	383	384	385	386	387	388	389	390	391	392	393	394	395	396	397	398	399	400
401	402	403	404	405	406	407	408	409	410	411	412	413	414	415	416	417	418	419	420
421	422	423	424	425	426	427	428	429	430	431	432	433	434	435	436	437	438	439	440
441	442	443	444	445	446	447	448	449	450	451	452	453	454	455	456	457	458	459	460
461	462	463	464	465	466	467	468	469	470	471	472	473	474	475	476	477	478	479	480
481	482	483	484	485	486	487	488	489	490	491	492	493	494	495	496	497	498	499	500



# Computer Connection

"THE COMPANY THAT DELIVERS"



## CALPAK

**BASE SYSTEM**  
 \*CPU w/256K  
 \*One 360K DS/DD Dr  
 \*Hi-Res Grn Monitor  
 \*Int. Card w/Par. Port

**\$1099**

## BUSINESS SYS.

\*CPU w/640K  
 \*1 Para. & 1 Ser. Port  
 \*Clk Cal w/Bat Bk up  
 \*Hi-Res Clr Grph Crd  
 \*Taxan #620 Clr Mon  
 \*2-360K DS/DD Drive  
 \*One 20 Meg Hd Disk

**\$2150**

## IBM

### PC BASE SYS.

\*CPU w/256K  
 \*1-360K DS/DD Drive  
 \*Hi-Res Grn Monitor  
 \*Int. Card w/Para Port

**\$1399** add \$145

### PC XT BUS SYS

\*CPU w/640 K  
 \*2 Para. & 1 Ser. Port  
 \*Clk Cal. w/Bat Bk up  
 \*Hi-Res Clr Grph Crd  
 \*Taxan #620 Clr Mon  
 \*1-360K DS/DD Drive  
 \*One 20 Meg Hd Disk

**\$2949**



## PRINTERS

### STAR MICRONICS

NX-10, 136 cps, Trac. & Sheet Feed \$ 299  
 SG-10, 120 cps, 2K buffer, 1 yr war 219  
 SG-15, 120 cps, 2K buffer 385  
 SD-10, 160 cps, 10" carriage 365  
 SD-15, 160 cps, Corr. Qual. 479  
 SR-10, 200 cps, 10" carriage 520  
 SR-15, 200 cps, w/Tractor 640

### OKIDATA

ML182P, 120 cps We  
 ML182 IBM, Graphics Comp Will  
 ML182S, 10" Carriage Beat  
 ML192P, 160 cps all  
 ML192 IBM, Graphics Comp Pricing  
 ML192S, 160 cps on  
 ML193P, 160 cps Oki  
 ML193 IBM, Graphics Comp Printers  
 ML193S, 160 cps with  
 ML84P, 200 cps or  
 ML84 IBM without  
 ML84S, 200 cps IBM  
 Okimate 20, 80/40 color Rom

### EPSON

LX80, 120 cps 10" carriage Call  
 FX85, 160 cps 10" carriage Us  
 JX80, 160 cps Color First  
 RX100, 100 cps 15" carriage For  
 FX286, 200 cps 15" carriage Lowest  
 LQ800, 180/60 P&S 7K 10" Authorized  
 LQ1000, 180/60 P&S 7K 15" Epson  
 LQ1500, 200/64 15" Dealer  
 DX10, LQ Printer Pricing

### BROTHER

HR-15XL, LQ 20 cps P or S \$ 355  
 HR-25, LQ 23 cps P or S 499  
 HR-35, LQ 36 cps P or S 699  
 2024L, 160 cps 24 wire 794  
 DH-45, LQ & Dot matrix 36/160 821

### JUKI

6100, LQ 18 cps w/proportional spc \$ 355  
 6300, LQ 40 cps 675

### TOSHIBA

P341P, 180/72, 132 col. \$ 779  
 P341P/S, 180/72, 24 wire 799  
 P351P/S, 240/100, 132 col. 1099

### PANASONIC

1080, 100 cps 2 yr. war. Prop. Sp. \$ 219  
 1091 w/Tractor, 120 cps, 2 yr. war. 239  
 1092, 10" carriage, 180 cps 375

### DATA PRODUCTS

8012, 180 cps 10" IBM comp. \$ 299  
 8022, 180 cps 15" IBM comp. 472  
 8050C, 200 cps w/color 1172  
 8070C, 400 cps w/color 1547

## PRINTER ACCESSORIES

### ORANGE MICRO

Grappler + \$ 75  
 Buffered Grappler +, 16K exp. 64K 149

### TOSHIBA

Bi-Directional Trac. 1351/351 \$ 149/155

### MICROTEK

Dumpling GX (same as Grappler +) \$ 69  
 Dumpling GX w/16K buffer 125  
 Dumpling GX w/32 buffer 135  
 Additional Buffering 16K 7

### SMT

Par. Card & Cable  
 w/Free word processing software \$ 69

### OKIDATA

Plug n Print for OKI Mate 20 \$ 79  
 Tractor for 182 & 192 39

### JUKI

Bi-Direc. Tractor for 6100/6300 \$ 115/125  
 Serial Interface for 6100 65

### CABLES

IBM PC to Parallel Printer \$ 16  
 Serial Cable 14  
 Centronics M/M or M/F 18

## IBM PC ACCESSORIES

IBM Dos 3.1 \$ 69

### PARADISE

Modular Graphics Card \$ 249  
 Module A 75  
 Module B 256K w/C & C 120  
 5-Pak same as 6-Pak-Ser. Port 175  
 Color/Mono Card New 220

### 64K MEMORY UPGRADE

64K (9 chips) 200ns & 150ns \$ 13

### HEXACE TECHNOLOGIES

Hi-Res Color Card for PC, XT, AT. \$ 89

### QUADRAM

Quad Color 1 Board \$ 179  
 Exp. Quadboard w/64K & Game Port 199

### TECHMAR

Graphics Master \$ 449

## APPLE & FRANKLIN ACCESSORIES

**ACCESSORIES**  
 Kensington System Saver \$ 69  
 Masterpiece Control Unit 119

### MICROTEK

Serial Interface \$ 85  
 80 col. for II & II+ 99

### MICROMAX

Viewmax 128K extended 80 col. card for  
 Apple IIE w/64K \$ 99  
 80 col. card for Apple II & II+ 139

## DISPLAY MONITORS

### QUADRAM

Amber chrome IBM compatible \$ 169

### AMDEK

V300G \$ 119  
 V300A 129  
 V310A for IBM PC 149  
 Color 300 199  
 Color 600 RGB Hi-Res 389  
 Color 710 Super Hi-Res 485  
 Color 722 Super Hi-Res 545

### TAXAN

IBM Green Monochrome#121 \$ 129  
 IBM Amber Monochrome#122 139  
 RGB IBM w/Cable#620 399  
 RGB Super Hi-Res. #640 Best Buy. 499  
 RGB/#630 450

### PRINCETON GRAPHICS

HX-12 for use with IBM PC \$ 445  
 Max 12E Amber for IBM 159  
 SR 12 Super Hi-Res 555  
 Scan Doubler 185

### QUIMAX

PX-4, RGB Hi-Res w/Gr. Text Mode \$ 410  
 DM-14 Monochrome for IBM 150

### VUTEK (2 yr. war.)

CPS Board, RGB & Comp. w/Par&Ser  
 Ports 2 yr war. \$ 189  
 Color Card (Herc. comp.) w/Para. 150

### AST RESEARCH

SixPak + w/64K & Sidekick \$ 215  
 SixPak + w/384K & Sidekick 255  
 Game Port 49  
 Preview MonoGraphics. 225

### KEYTRONICS

KB5151 \$ 175

### MICROTEK

Monochrome Text Par. & Ser. \$ 145  
 Color Graphics Card 2 yr. warr 125

### SIGMA DESIGNS

Color 400 L or H \$ 399

## ADVANCED LOGIC SYSTEMS

Z Engine 2.2 \$ 120  
 80 Col./64K 69

### APPLE

Super Serial Card \$ 139

### SMT

64K, 80 col. Card \$ 65

### MICRO-SCI

64K, 80 Col. Card \$ 49

## HARD DISK DRIVES

### CMS

10 Meg w/cont. formatted for IBM \$ 445  
 20 Meg w/cont. formatted for IBM 529

### ALPHA OMEGA

10 Meg w/Controller Card \$ 475  
 20 Meg w/Controller Card 565  
 30 Meg w/Controller Card 699  
 20 Meg for AT 445  
 33 Meg for AT 599  
 Shock Mounted 20 meg for Compaq 699

### SEAGATE

ST212, 1/2 HT 10 meg \$ 445  
 ST225, 1/2 HT 20 meg 545

## DISK DRIVES

### TANDON

TM100-2 for IBM PC \$ 110

### TEAC

55B Double Sided 360K \$ 99

### Drives For Apple & Franklin

CALL for current prices

## PERSONAL SYSTEMS

### APPLE

Professional Sys. incl: Apple IIE w/128K &  
 80 col., tilt mon., duo disk w/cont't kit \$1299  
 Pro System w/Color 1545  
 Apple IIc Lightweight Portable 789  
 Apple IIc w/Color 1399

### IBM

IBM PC Bare \$1095\*  
 IBMPC 64K, 1 Drive 1250\*  
 IBM PC, 2 Drives w/256K 1299\*  
 IBM XT, 10 Meg, 360K Dr. w/256K 2150\*  
 IBM XT Bare w/256K & IBM Floppy 1750\*  
**Call About All "AT" Systems**  
 \*Call for current IBM prices

### SANYO

MBC 555-2 w/2, 320K Drives &  
 more software \$ 899  
 775 Portable 1795  
 Serial Port for Sanyo 65

### COMPAQ

256K, w/2-320K Drives \$ 1699  
 Desk Top Model 1 1599  
 Desk Top Model 2 1925  
 Desk Top Model 3 Call  
 Desk Top Model 4 Call  
 We have "286" Ports. & D.P. in stock

### WYSE

1100-1 incl. 256K w/two 360K Drives 1 par  
 & 2 ser. ports \$ 1399  
 1100-2 Incl. 10 meg, 1 floppy, 256K, 1 Par.  
 & 2 ser. ports. 2599  
 \*Wyse Monitors & Exp. Chasis Available

## SOFTWARE

### LOTUS DEVELOPMENT CORP.

Lotus 1-2-3 New Version \$ 315  
 Symphony 420

### ASHTON TATE

D Base II \$ 299  
 D Base III+ 389

### PRINTER SWITCH BOX

**EXPONENT**  
 Centronics Two Switch \$ 58  
 Centronics Four Switch 83  
 Serial Two Switch 45  
 Serial Four Switch 69

## MODEMS

### ANCHOR

Volksmodem XII, 5 yr war \$ 185  
 Express 1200 250

### HAYES MICRO

300 Baud Smart Modem \$ 149  
 1200 Baud Smart Modem 379  
 1200 B for IBM PC w/S/M II 375  
 2400 Baud Modem 645

## DISKETTES

**PC DISKETTES**  
 Sgl./Dbl. (Box of 10) \$ 13  
 Dbl./Dbl. (Box of 10) 15

### COMPUTER CONNECTION

Dbl./Dbl. (Box of 10) \$ 16  
 Sgl./Dbl. w/Disk Container(10) 15  
 Dbl./Dbl. w/Disk Container 17  
 Bulk 50 & Up — Dbl./Dbl. 1.35 each

### SMA

PC Document for: Dos 3.1, 1-2-3, Symphony,  
 D Base III and much more \$11.95

## We Stock What We Sell!!

IF YOU SEE IT ADVERTISED FOR LESS, CALL  
 COMPUTER CONNECTION FIRST FOR LOWEST QUOTE

### MAIL ORDER:

17121 S. Central Avenue, Unit L  
 Carson, California 90746



NO SURCHARGE FOR CREDIT CARDS

We accept VISA, MasterCard, COO  
 (w/Deposit), Certified Checks or  
 Wire Transfers. Minimum Shipping  
 Charge \$4.00. Some items subject  
 to back order. California Res. add  
 8 1/2% Sales Tax. All returns are  
 subject to a 15% restocking charge  
 and must be authorized by store  
 manager within 10 days. Prices  
 subject to change without notice.  
 This Ad supersedes all others.

## ORDER LINE (800) 732-0304

(Outside California)

(213) 635-2809

(Inside California)

Mon. Fri. 7 a.m. to 6 p.m.

Saturday 11 a.m. to 3 p.m.

### CUSTOMER SERVICE:

(213) 635-5065

Mon.-Fri. 9 a.m. to 3 p.m.



## The Greatest buy on BASF Qualimetric Diskettes!

**.79** Ea. Qty. 50 **.90** Ea. Qty. 50  
5.25"SSDD 5.25"DSDD

Packaged in boxes of 10 with Tyvec sleeves, user ID labels and write-protect tabs.

### LIFETIME WARRANTY!

	Qty. 20-40:	Qty. 50+:
5.25"SSDD(P/N3406)	.81	.79
5.25"DSDD(P/N3407)	.92	.90
5.25"SSDD-96TPI(P/N3404)	.92	.90
5.25"DSDD-96TPI(P/N3405)	1.03	1.01
5.25"DSDD-HD(P/N3403)	2.07	2.04
3.50"SSDD-135TPI(P/N3402)	1.85	1.82
3.50"DSDD-135TPI(P/N3412)	2.41	2.37

FOR ORDERS ONLY: 1-800-621-6827  
(In Illinois: 1-312-256-7140)

INFORMATION & INQUIRIES: 1-312-256-7140

HOURS: 8AM - 6PM Central Time, Monday-Friday  
WE WILL MEET OR BEAT ANY NATIONALLY ADVERTISED PRICE ON THE SAME PRODUCTS AND QUANTITIES SUBJECT TO THE SAME TERMS AND CONDITIONS AS THE COMPETITIVE AD.

**DISK WORLD!, Inc.**

629 Green Bay Rd. • Wilmette, Illinois 60091

**DISK WORLD!**

## BASF Qualimetric Diskettes in Bulk.

**.72** Ea. Qty. 150 **.83** Ea. Qty. 150  
5.25"SSDD 5.25"DSDD

Save a lot of money by buying BASF QUALIMETRIC diskettes in bulk. Packed in cartons of 150 diskettes with Tyvec sleeves, User ID labels and write-protect tabs. **LIFETIME WARRANTY!**

	Qty. 150+:
5.25"SSDD(P/N3408)	.72
5.25"DSDD(P/N3409)	.83
5.25"SSDD-96TPI	N/A
5.25"DSDD-96TPI	N/A
5.25"DSDD-HD(P/N3410)	N/A
3.50"SSDD-135TPI(P/N3411)	1.51**
3.50"DSDD-135TPI(P/N3412)	2.05**

\* Available in 250 piece cartons only.

\*\* Available in 200 piece cartons only.

FOR ORDERS ONLY: 1-800-621-6827  
(In Illinois: 1-312-256-7140)

INFORMATION & INQUIRIES: 1-312-256-7140

HOURS: 8AM - 6PM Central Time, Monday-Friday  
WE WILL MEET OR BEAT ANY NATIONALLY ADVERTISED PRICE ON THE SAME PRODUCTS AND QUANTITIES SUBJECT TO THE SAME TERMS AND CONDITIONS AS THE COMPETITIVE AD.

**DISK WORLD!, Inc.**

629 Green Bay Rd. • Wilmette, Illinois 60091

**DISK WORLD!**

## 3M Bulk Diskettes Incredible Value!

**.54 ea.** DSDD  
Multiples of 50 only!

These are genuine 3M diskettes as supplied to software duplicator accounts. **LIFETIME WARRANTY.** Tyvec sleeves included! Limited supplies, so act now!(P/N10041)

FOR ORDERS ONLY: 1-800-621-6827  
(In Illinois: 1-312-256-7140)

INFORMATION & INQUIRIES: 1-312-256-7140

HOURS: 8AM - 6PM Central Time, Monday-Friday  
WE WILL MEET OR BEAT ANY NATIONALLY ADVERTISED PRICE ON THE SAME PRODUCTS AND QUANTITIES SUBJECT TO THE SAME TERMS AND CONDITIONS AS THE COMPETITIVE AD.

**DISK WORLD!, Inc.**

629 Green Bay Rd. • Wilmette, Illinois 60091

**DISK WORLD!**

## KODAK DISKETTES: Discover the future today!

**.92** Ea. Qty. 100 **1.13** Ea. Qty. 100  
5.25"SSDD 5.25"DSDD

### LIFETIME WARRANTY!

	Qty. 20-40:	Qty. 50+:
5.25"SSDD(P/N4200)	1.03	1.00
5.25"DSDD(P/N4201)	1.23	1.21
5.25"SSDD-96TPI	N/A	N/A
5.25"DSDD-96TPI	N/A	N/A
5.25"DSDD-HD(P/N4202)	2.35	2.31
3.50"SSDD-135TPI(P/N4206)	1.87	1.84
3.50"DSDD-135TPI(P/N4207)	2.46	2.42

### BULK 5.25" DISKETTES!

(Packaged in boxes of 100 with Tyvec sleeves, user ID labels and write-protect tabs.)

5.25"SSDD(P/N4203)	.92
5.25DSDD(P/N4204)	1.13

FOR ORDERS ONLY: 1-800-621-6827  
(In Illinois: 1-312-256-7140)

INFORMATION & INQUIRIES: 1-312-256-7140

HOURS: 8AM - 6PM Central Time, Monday-Friday  
WE WILL MEET OR BEAT ANY NATIONALLY ADVERTISED PRICE ON THE SAME PRODUCTS AND QUANTITIES SUBJECT TO THE SAME TERMS AND CONDITIONS AS THE COMPETITIVE AD.

**DISK WORLD!, Inc.**

629 Green Bay Rd. • Wilmette, Illinois 60091

**DISK WORLD!**

## DISK WORLD! Ordering & Shipping Instructions

FOR FASTEST SERVICE, USE NO-COST MCI MAIL. Our address is DISKORDER. It's a FREE MCI MAIL letter. No charge to you. (Situation permitting, we'll ship these orders in 24 hours or less.)

SHIPPING: 5.25" & 3.50" DISKETTES-Add \$ 3.00 per each 100 or fewer diskettes. OTHER ITEMS: Add shipping charges as shown in addition to other shipping charges. PAYMENT: VISA, MASTERCARD and Prepaid orders accepted. COD ORDERS: Add \$ 5.00 special handling charge. APO, FPO, AK, HI & PR ORDERS: Include shipping charges as shown and additional 5% of total order amount to cover PAL and insurance. We ship only to United States addresses, except as shown above. TAXES: Illinois residents add 7% sales tax.

MINIMUM ORDER: \$ 35.00

FOR ORDERS ONLY: 1-800-621-6827  
(In Illinois: 1-312-256-7140)

INFORMATION & INQUIRIES: 1-312-256-7140

HOURS: 8AM - 6PM Central Time, Monday-Friday  
WE WILL MEET OR BEAT ANY NATIONALLY ADVERTISED PRICE ON THE SAME PRODUCTS AND QUANTITIES SUBJECT TO THE SAME TERMS AND CONDITIONS AS THE COMPETITIVE AD.

**DISK WORLD!, Inc.**

629 Green Bay Rd. • Wilmette, Illinois 60091

**DISK WORLD!**

## ATHANA DISKETTES The great unknown!

**.60** Ea. Qty. 50 **.69** Ea. Qty. 50  
5.25"SSDD 5.25"DSDD

### LIFETIME WARRANTY!

	Qty. 50+:
5.25"SSDD(P/N3700)	.60
5.25"DSDD(P/N3701)	.69
5.25"SSDD-96TPI(P/N3702)	.88
5.25"DSDD-96TPI(P/N3703)	.92
5.25"DSDD-HD(P/N3704)	1.79
3.50"SSDD-135TPI(P/N3705)	2.00
3.50"DSDD-135TPI(P/N3706)	2.73

You've used these diskettes hundreds of times as copy-protected originals on some of the most popular software packages. They're packed in polybags of 25 with Polymer-impregnated sleeves user-ID labels and reinforced hubs, write-protect tabs.

FOR ORDERS ONLY: 1-800-621-6827  
(In Illinois: 1-312-256-7140)

INFORMATION & INQUIRIES: 1-312-256-7140

HOURS: 8AM - 6PM Central Time, Monday-Friday  
WE WILL MEET OR BEAT ANY NATIONALLY ADVERTISED PRICE ON THE SAME PRODUCTS AND QUANTITIES SUBJECT TO THE SAME TERMS AND CONDITIONS AS THE COMPETITIVE AD.

**DISK WORLD!, Inc.**

629 Green Bay Rd. • Wilmette, Illinois 60091

**DISK WORLD!**

## 3M Diskettes at the lowest prices ever!

**.78** EA. Qty. 50+ **1.10** EA. Qty. 50+  
5.25"SSDD(P/N1000) 5.25"DSDD(P/N1004)->

LIFETIME WARRANTY!  
Packed in boxes of 10 with User ID labels and write-protect labels.

	Qty. 20-40:	Qty. 50+:
5.25"SSDD(P/N1000)	.81	.78
5.25"DSDD(P/N1004)	1.13	1.10
5.25"SSDD-96TPI(P/N1008)	1.58	1.53
5.25"DSDD-96TPI(P/N1011)	1.98	1.93
5.25"DSDD-HD(P/N1040)	2.30	2.24
3.50"SSDD-135TPI(P/N1039)	1.58	1.53
3.50"DSDD-135TPI(P/N1046)	2.23	2.17
8.00"SSDD w/WP(P/N1020)	1.54	1.52
8.00"SSDD w/WP(P/N1025)	1.89	1.86
8.00"DSDD w/WP(P/N1030)	2.12	2.06

### DATA CARTRIDGES:

(Sold 10 to a carton only.)

	12.62	12.40	19.04	20.89
(Add \$ 5.00 shipping charges for cartridges.)				
DC100(P/N1041)	12.62	12.40	19.04	20.89
DC300XLP(P/N1042)	19.38	19.04		
DC600A(P/N1043)	21.45	20.89		

**DISK WORLD!**

## Printer Ribbons at extraordinary prices!

Brand new ribbons, manufactured to Original Equipment Manufacturer's specifications, in housings. (Not re-inked or spools only.)

### LIFETIME WARRANTY!

EPSON MX-70/80(P/N2500)

\$ 2.70 ea. + .25 Shpng.

EPSON MX-100(P/N2501)

\$ 4.08 ea. + .25 Shpng.

Okidata Micro83(P/N2505)

\$ 1.37 ea. + .25 Shpng.

Okidata Micro84(P/N2502)

\$ 2.98 ea. + .25 Shpng.

FOR ORDERS ONLY: 1-800-621-6827  
(In Illinois: 1-312-256-7140)

INFORMATION & INQUIRIES: 1-312-256-7140

HOURS: 8AM - 6PM Central Time, Monday-Friday  
WE WILL MEET OR BEAT ANY NATIONALLY ADVERTISED PRICE ON THE SAME PRODUCTS AND QUANTITIES SUBJECT TO THE SAME TERMS AND CONDITIONS AS THE COMPETITIVE AD.

**DISK WORLD!, Inc.**

629 Green Bay Rd. • Wilmette, Illinois 60091

**DISK WORLD!**

## Diskette Storage Cases

### AMARAY MEDIA-MATE 50:

A revolution in disk storage. Every once in a while someone takes the simple and makes it elegant. This unit holds 50 5.25" diskettes, has grooves for stacking, inside nipples to keep diskettes from slipping and several other features. We like it. (P/N3013)

\$ 9.69 ea. + \$ 2.00 Shpng.

### DISK MINDER II:

Low-priced, but effective storage for 75 5.25" diskettes. Smoked plastic top, beige bottom with inside dividers. (P/N2800)

\$ 6.49 ea. + \$ 2.00 Shpng.

### DISK MINDER 36:

As above, but holds 36 3.50" diskettes. (P/N2950)

\$ 6.49 ea. + \$ 2.00 Shpng.

### DISK CADDIES:

The original flip-up holder for 10 5.25" diskettes. Beige (P/N2200) or Grey (P/N2201)

\$ 1.65 ea. + \$ 2.00 Shpng.

FOR ORDERS ONLY: 1-800-621-6827  
(In Illinois: 1-312-256-7140)

INFORMATION & INQUIRIES: 1-312-256-7140

HOURS: 8AM - 6PM Central Time, Monday-Friday  
WE WILL MEET OR BEAT ANY NATIONALLY ADVERTISED PRICE ON THE SAME PRODUCTS AND QUANTITIES SUBJECT TO THE SAME TERMS AND CONDITIONS AS THE COMPETITIVE AD.

**DISK WORLD!, Inc.**

629 Green Bay Rd. • Wilmette, Illinois 60091

**DISK WORLD!**



# SUPER STAR® DISKETTES: The ultimate value in magnetic media.

No one told us how phenomenally successful Super Star® diskettes would become.

The idea was simple. Very simple.

We would do the same thing that big companies like IBM® do in regard to creating a "brand name" diskette. That is we would go to major manufacturers, buy top-quality diskettes in massive quantities, give them our own name and sell them inexpensively.

## A very simple idea ...that worked!

Now, tens of thousands of businesses, government agencies, schools and individuals have learned that you don't have to pay inflated "brand name" prices to get "brand name" quality.

Just buy Super Star® diskettes.

## Quality ...without high price.

We ship almost a million Super Star® diskettes a month and get very few of them back.

Unlike others who offer a "house brand" or "generic" diskettes, Super Star® diskettes are top-of-the-line quality, exceeding ANSI and IBM standards by 50% or more.

They are not cosmetically flawed, duplicator product (where a failure rate of 20% or more is expected) or what we in the diskette industry refer to as "floor sweepings", a term which speaks for itself.

## A lifetime warranty.

If you sense pride in our description of Super Star® diskettes, you've got it right.

After all, wouldn't you be proud if you found a way to deliver top-quality diskettes at about half the price of "brand names"?

## When every bit counts, it's Super Star®!

Nearly a million Super Star® diskettes a month are being sold to some of the largest and most recognizable names in the nation. They love 'em, because they save money...and they are dependable.

So now is the time for you to re-discover Super Star® diskettes.

And we say "re-discover" for a reason.

## You've already used Super Star!

Super Star® diskettes, as noted, are made by some of America's leading diskette manufacturers...and the odds are that you've already used them more than once as the copy-protected masters on some of the best known software programs around.

So, when you want the best...and the least expensive best...order Super Star®!

### SUPER STAR SPECIAL!

Your choice of storage at \$ 4.95!

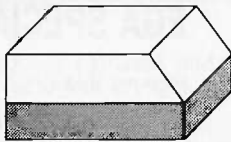

Buy 50 Super Star® diskettes and get a storage case for only \$ 4.95 (shipping included)!

These are durable plastic cases with dividers and are very nice units.

The 5.25" unit holds 50 diskettes and the 3.50" unit holds 40 diskettes.

5.25" Storage Case (P/N3100)...\$ 4.95 ea.  
3.50" Storage Case (P/N 3102)...\$ 4.95 ea.

# What the world needs now is a complete line of high quality, inexpensive diskettes with a LIFETIME WARRANTY!

## And DISK WORLD! has them!

### Super Star 5.25" Diskettes

5.25" SSDD (P/N 3800)	.55 ea.
5.25" DSDD (P/N 3801)	.64 ea.
5.25" SSDD-96TPI (P/N 3802)	.80 ea.
5.25" DSDD-96TPI (P/N 3803)	.84 ea.
5.25" DSDD-HD (P/N 3804)	\$ 1.72 ea.

ORDER IN MULTIPLES OF 50 ONLY!

All Super Star 5.25" Diskettes are poly-bagged in lots of 25 with sleeves, write-protect tabs and user ID labels.

QUANTITY DISCOUNTS: 350-500 diskettes, deduct 3%. 500-700 diskettes, deduct 6%. 750-1,000 diskettes, deduct 9%. 1,000+ diskettes, deduct 12%.

### Super Star 3.50" Diskettes

3.50" SSDD (P/N 3805)	\$ 1.52 ea.
3.50" DSDD (P/N 3806)	\$ 1.86 ea.

ORDER IN MULTIPLES OF 50 ONLY!

Super Star 3.50" diskettes are packaged in boxes of 50 with user ID labels.

QUANTITY DISCOUNTS: 350-500 diskettes, deduct 1.5%. 500-700 diskettes, deduct 3%. 750-1,000 diskettes, deduct 4.5%. 1,000+ diskettes, deduct 6%.

### The Super Star LIFETIME WARRANTY!

Super Star Diskettes are unconditionally warranted against defects in original material so long as owned by the original purchaser. Returns are simple: just send the defective diskettes with proof of purchase, postage-paid by you, with a short explanation of the problem and we'll send you replacements. (Incidentally, coffee stained diskettes or diskettes with staples driven through them or otherwise damaged don't qualify as defective.)

#### HOURS:

8AM-6PM Central Time

Monday - Friday

**WE WILL MEET OR BEAT ANY  
NATIONALLY ADVERTISED PRICE  
ON THE SAME PRODUCTS AND  
QUANTITIES SUBJECT TO THE  
SAME TERMS AND CONDITIONS.**

### HOW TO ORDER:

#### ORDERS ONLY:

1-800-621-6827

(In Illinois: 1-312-256-7140)

#### INQUIRIES:

1-312-256-7140

FOR FASTEST SERVICE, USE NO-COST MCI MAIL. Our address is DISKORDER. It's a FREE MCI MAIL letter. No charge to you. (Situation permitting, we'll ship these orders in 24 hours or less.)

SHIPPING: 5.25" & 3.50" DISKETTES-Add \$ 3.00 per each 100 or fewer diskettes. OTHER ITEMS: Add shipping charges as shown in addition to other shipping charges. PAYMENT: VISA, MASTERCARD and Prepaid orders accepted. COD ORDERS: Add \$ 5.00 special handling charge. APO, FPO, AK, HI & PR ORDERS: Include shipping charges as shown and additional 5% of total order amount to cover PAL and insurance. We ship only to United States addresses, except as shown above. TAXES: Illinois residents add 7% sales tax.

MINIMUM ORDER: \$ 35.00

# DISK WORLD!, Inc.

629 Green Bay Road  
Wilmette, Illinois 60091

TOLL FREE

800-854-8230

CA Residents 714-558-8813

OUR POLICY

- Surcharge for VISA or Mastercard.
- Volume purchasing agreements available.
- Orders subject to availability. • Supply limited on certain items.
- Pricing subject to change without notice.
- ACP Retail Store pricing may vary. Not responsible for typos.

Inquiry 9

CORPORATE BUYERS CALL BARRY

# IBM Compatible w/20Mb DRIVECARD



Don't miss out on this unbeatable system manufactured by Toshiba for ACP. ACP has sold over 3,000 **ADVANCED XT's** to satisfied customers including "true blue" users like Rockwell, Hughes, and Kodak. Not only is the price affordable but the features and compatibility are unbeatable. For more details call one of our expert consultants. Don't hesitate this will be a sellout!

ACP  
BASE  
PRICE **\$699<sup>00</sup>**

Call for complete Monochrome or Color RGB system prices with 10 or 20 Mb hard disk drives or the **NEW 20Mb Drivecard**.

**20 Mb Upgrade \$449**    **20 Mb Drivecard \$699**  
Package (1 Yr War)    Plug-In 1 Yr War

**SEAGATE FOR AT**  
(Linear Voice Coil Activator)

20 Mb for AT ..... \$575.00  
30Mb for AT ..... \$695.00  
40Mb for AT ..... \$815.00  
(Inc. Cable & Mounting Rails)

**PC UPGRADE SPECIAL**

**\$14<sup>95</sup>** SET OF (9) 64K RAMS  
**\$36<sup>95</sup>** SET OF (9) 256K RAMS  
**\$7.95** 4128 PIGGYBACK RAM  
**\$120.00** 8087-2 Coprocessor

**1200 Baud Hayes™ Comp. Modem**  
Short Card by U.S. Robotics with Telpac I Software.  
List \$499    ACP **\$149.95**  
Buy (6) ..... **\$139.95**

<b>AST</b>	
Sixpak Plus w/64K .....	\$235.00
Advantage 128K, AT .....	399.00
AST 525-11 .....	575.00
AST 3780 .....	575.00
RAMpage up to 2 Mb .....	Call
<b>DCA</b>	
Irma .....	\$785.00
Irmaline .....	895.00
<b>DIABLO/XEROX</b>	
620 Serial LQP .....	was 1495 now \$349.00
620 API LQP .....	399.00
620 D36 (36cps) .....	449.00
Tractor .....	was 395 now \$99.00
F-21 Sheet Feeder .....	was 896 now 249.00
Cable for 620 (to IBM) .....	29.00
Diablo P-11 100cps .....	129.95
Diablo S-11 100cps Serial .....	139.95
Diablo P-31 Wide .....	249.95
Diablo S-31 Wide .....	269.95
Other Diablo Dot Matrix's available .....	Call
<b>EPSON</b>	
FX85 160cps NLO .....	\$375.00
FX185 160cps Wide .....	499.00
All Epson Models .....	Lowest Price
<b>EVEREX</b>	
Graphics Edge or Edge .....	\$259.00
<b>HAYES</b>	
Smartmodem 1200 .....	\$385.00
Smartmodem 1200B .....	349.00
Smartmodem 2400 .....	575.00
Smartcom II 2.1 Software .....	88.00
Hayes Comp. 1200 (Int) w/SW .....	169.95
Hayes Comp. 1200 (Ext) .....	199.95
<b>HERCULES</b>	
Color Card .....	\$166.00
Graphics Card w/Software .....	295.00
<b>INTEL</b>	
Above Board PC or AT .....	Lowest Price
<b>IRWIN</b>	
310A 10 Mb Tape (Ext) .....	\$849.00
110D 10 Mb (Int) .....	495.00
<b>KEYTRONICS</b>	
5151 Deluxe Keyboard .....	\$169.95
5153 w/Touchpad .....	285.00
PC Jr. Numeric Keypad .....	39.95
<b>MICROSOFT</b>	
Mouse .....	\$125.00
Mouse (Serial) .....	145.00
<b>MOUNTAIN COMPUTER</b>	
20Mb Harocard .....	\$699.95
<b>MOUSE SYSTEMS</b>	
PC Mouse w/Painbrush .....	\$138.00
ACP Mouse w/Keyboard .....	149.00

**★ NEW ★ Advanced AT!**  
INTRODUCTORY PRICE

- 80286 CPU-8MHz
- 1.2 Mb Floppy Disk Drive
- Hard Disk Controller w/Floppy
- AT Style Keyboard
- 192W Pwr Sup. • 8 Expan. Slots
- MS-DOS 3.1, BIOS

**\$1495.00**

**ADVANCED AT CARDS**

ADV-320 Hard Disk Controller with Floppy for AT .....	\$229.00
ADV-6020AN Color/Graphics/Printer .....	89.95
ADV-8050 2Mb Multifunction with RS-232, Game & Cable .....	169.95
ADV-8080 3Mb Memory Expansion .....	129.95
ADV-8120 Printer/RS-232 and RS-232 (Opt.) .....	99.95

**ADVANCED PC/XT CARDS**

ADV-6040 Monochrome/Graphics/Printer .....	\$99.95
ADV-6040-3 As Above for 132 Col. .....	139.95
ADV-6050A Monochrome/Printer Adapter .....	85.95
ADV-6050C 384K Multifunction Card RS-232, Printer, Game, Clock 1/2 Card .....	119.95
ADV-7060 Floppy Controller, 2 Floppys .....	39.95
ADV-EGA EGA Short Card .....	329.95
ADV-6120E Printer, RS-232 x 2 .....	79.95
ADV-6250A Multifunction, RS-232, Printer, Game, 1/2 Card .....	95.95
6260A Multifunction, Floppy Cont., RS-232, Printer, Game, 1/2 Card .....	149.95
ADV-6280 640K Memory Card, OK .....	55.95
ADV-6090 Mono/Color/Graphics, Printer 80/132 Columns .....	179.95

<b>ORCHID</b>	
PC Turbo 186 w/256K .....	\$585.00
<b>PARADISE</b>	
Color/Monocard .....	\$185.00
Modular Graphics Card .....	274.00
<b>PERSYST</b>	
Mono Board w/Parallel .....	\$159.00
Color Board .....	139.00
Time Spectrum .....	Sale Call
<b>PRINCETON GRAPHICS</b>	
HX-12 RGB (640x240) .....	\$445.00
MAX-12E Amber TTL .....	175.00
SR-12 .....	575.00
HX-12E (690x350) .....	545.00
<b>PROMETHEUS</b>	
ProModem 1200 w/Mite (Int) .....	\$239.00
ProModem 1200B (Hayes Comp.) .....	289.00
Alpha/Num or Options Proc .....	79.95
<b>QUADRAM</b>	
Expanded Quadboard (OK) .....	\$185.00
Gold Quadboard (OK) .....	385.00
Silver Quadboard (OK) .....	215.00
Quadlink .....	399.00

<b>SIGMA</b>	
Color 400 Card .....	\$485.00
<b>SHARP</b>	
12" Med-res RGB Monitor .....	\$269.95
Color Plotter w/Software .....	199.00
<b>STAR MICRONICS</b>	
Gemini 10X .....	reduced TO LOW TO PRINT
Gemini 15X .....	sale TO LOW TO PRINT
SG10, SR10, Radix etc. ....	Lowest Price Yell
<b>TAXAN</b>	
415 (640x260) RGB .....	was 699 now \$279.95
Mod. 640 (Ultra Hi-res) .....	595.00
<b>TEMPLATES</b>	
Lolus, dBase III, etc. ....	Lowest Price
<b>TITAN</b>	
Accelerator PC w/256K .....	sale Call
<b>TOSHIBA</b>	
P321 "3 in 1" LQ Printer .....	sale \$599.00
P341 24 Pin 136 Col .....	869.00
P351 24 Pin w/Serial & Parallel .....	1099.00
T-1100 MS-DOS Lap Top .....	Call
<b>WESTERN DIGITAL</b>	
Filecard 10 Mb Plug-in .....	Call
Cobra Hard Disk Controller .....	\$179.95
<b>ZENITH</b>	
ZVM-1220/30 12" Grn/Amb TTL .....	\$109.00
ZVM-1240 & ZVM-135 RGB .....	Call

**SYSGEN 20/20**

- 20Mb Hard Disk
- 20Mb Tape Back-up
- New/Factory Box
- PC/XT/AT Comp.
- External Complete

Reg. Retail \$3300  
ACP Only **\$999**

**Grid Compass MS-DOS Lap Computer Demo Sale** Call for Details. 100's in Stock as Low as **\$849<sup>00</sup>**

**EGA SPECIAL**  
New Advanced EGA Card for High-res IBM Graphics.  
SPECIAL PRICE! Only **\$288<sup>88</sup>**

**UNBELIEVABLE!**

**Micropro INFOSTAR SYSTEM!** includes

Datatar, Reportstar (PC DOS) .....	\$99.95
IBM brand Pascal Compiler .....	99.95
IBM Pascal Reference .....	49.95
IBM DOS 2.0 .....	24.95
Visicalc IV IBM .....	39.95
Compaq MS DOS/BASIC ver.2 .....	49.95

# Advanced Computer



**WE WILL MEET ANY PRICE FOR CURRENT PRODUCT ADVERTISED IN POPULAR MAGAZINES. POLICY APPLIES FOR BOTH SOFTWARE AND HARDWARE!**

**GET OUR FLEET? IF NOT CALL & GET ON OUR MAIL LIST.**

**JUNE SPECIALS (SUPPLY LIMITED)**

**SYS GEN 20 Mb w/20Mb Backup \$999.00**

**For PC Jr. SUPER NUMERIC KEYPAD**

Manufactured by Keytronics. We have sold 1000's of these. **ACP \$39.95** Reg Retail \$99 or 6 for 239.95 ea

PC Jr. Color Adapter... \$29.95  
PC Jr. TV Adapter... 29.95  
PC Jr. Operation Manual... 19.95  
PC Jr. Compact Printer... 69.95  
PC Jr. 64K Adapter... 39.95  
Lotus 1-2-3 PC Jr... 179.95

**★ TI DEMO SALE ★**  
TI Professional CPU... \$750.00  
TI Professional w/10Mb... 1050.00  
TI Monochrome... 119.00  
Lotus 1-2-3 TI Pro... 229.00  
Home Accountant... 69.95  
64K Upgrades... 99.95  
3-Plane Graphics Adapter... 169.95  
Plus Sale On More TI Software!

**UPS POWER SUPPLY**

Back Up Power for your IBM, Apple or Compaq  
UPS-PC 200 Watts \$277.00  
UPS-AT 300 Watts 419.00  
UPS-AT 800 Watts 739.00

**A-B PRINTER SWITCH**

An AB Switch allows use of two printers with your computer system. We stock over 15 different configurations.  
AB Switch (Centronics) \$59.00  
AB Switch (DB25) 59.00

**NEW NEC V20**

P/N upd 70108  
Replace Your 8088 to increase Speed up to 40%

**\$18.95**

**DEC RAINBOW UPGRADE**

192K UPGRADE TO \$49.95 Base Plus Many DEC Software/Hardware Items!

**Build Your Own XT Compatible**

- 8 Slot XT MB... \$156.00
- XT-BIOS... 27.95
- 130 Watt Power Supply... 85.00
- Flip-Top Cass... 49.00
- XT Keyboard... 75.00
- 1/2 Hit 360K Floppy... 99.00
- Floppy Controller... 49.95
- Monochrome Adapter... 49.95
- TTL Mono Monitor... 97.77
- 256K RAM... 36.95

**CAPACITORS**

- 01uF DISC BYPASS CAPACITOR 10005.50
- 1 uF DISC BYPASS CAPACITOR 10010.50
- 01uF MONOLITHIC CAPACITOR 10011.25
- 01uF MONOLITHIC CAPACITOR 10014.25

**CORCOM EMI FILTER**

- STD CORCOM 3 Conductor Filter \$4.50
- Line Cord for above - 8 foot 14.50
- Line Cord 2 Conductor - 8 foot 25
- Line Cord 3 Conductor - 8 foot 95

**MUFFIN FANS**

- Torin 3" TA-300 Fan NEW! \$9.85
- Torin 4 1/2" Muffin Fan NEW! 12.85
- 12VDC Fan NEW! 14.85
- Flower Guards add 1.49
- Power Cords add 1.49

**IC SOCKETS**

- BOLDERTAIL 1-99 100
- 8 Pin STPLP \$13 110
- 14 Pin STPLP 15 111
- 18 Pin STPLP 17 112
- 18 Pin STPLP 20 114
- 20 Pin STPLP 28 226
- 22 Pin STPLP 29 227
- 24 Pin STPLP 29 227
- 28 Pin STPLP 39 332
- 38 Pin STPLP 48 336
- 40 Pin STPLP 48 342
- 64 Pin STPLP 3.95 325

**WIREWRAP (GOLD)**

- 8 Pin WW/3L \$9 540
- 14 Pin WW/3L 82 449
- 18 Pin WW/3L 85 555
- 18 Pin WW/3L 88 577
- 20 Pin WW/3L 98 606
- 22 Pin WW/3L 119 617
- 24 Pin WW/3L 125 617
- 28 Pin WW/3L 149 620
- 40 Pin WW/3L 1.85 718

**TEXTOLIZ/ ZERO INSERTION**

- 18 Pin \$6.75 24 Pin \$7.85 28 Pin \$8.95
- (We Stock All Types of Sockets)

**IDC CONNECTORS**

IDC TYPE	ACP NO	NUMBER OF CONTACTS	10	20	26	34	40	50
Solder Header	IDHxS	.79	1.20	1.65	2.10	2.40	3.00	
Rt Angle Solder Header	IDHxSR	.79	1.20	1.65	2.10	2.40	3.00	
Ribbon Header Socket	IDXsX	.75	.95	1.35	1.50	1.85	2.10	
Ribbon Header	IDMx	.40	2.25	5.95	6.75	7.25	8.25	
Ribbon Edgecard	IDExX	1.70	2.15	2.50	2.60	3.70	3.95	
Wirewrap Header	IDHxW	1.80	2.90	3.75	4.25	4.95	6.50	
Rt Angia W/W Header	IDHxWR	1.99	3.10	4.10	4.20	4.60	7.15	

NOTE: To order insert number of contacts in place of xx in ACP part number.  
ORDER QUANTITY OF 50pcs (mixed) AND TAKE AN ADDITIONAL 10% OFF.

**UV EPROM ERASER**

We Stock Full Line of UV Products  
**ALSO PROM PROGRAMMERS**

**DRIVE CABINETS**

IBM Style Hard Disk with power supply and fan  
Dual Hard Disk w/power sup & fan \$179.00  
Dual 5 1/4" Full Height vertical mount 285.00  
Dual 5 1/4" Full Height horizontal mount 65.00  
Dual 5 1/4" Thinline w/power sup & fan 99.00  
Single 5 1/4" Full Height w/power sup & fan 50.00  
Single 5 1/4" Thinline w/power sup & fan 80.00

**TANDON FLOPPYS**

**PULL OUTS**  
TANDON TM100-2... 69.95  
TM100-1... 39.95  
TM848-1... 99.95  
TM848-2... 169.95

**INTERISL STD BUS BOARDS**

ALMOST SOLD OUT  
Send or Call for List

**TRANSISTORS/DIODES**

PN2222A	751.00	1N2904	1181.00
PN2369A	51.00	2N3906	11.00
PN218A	31.00	1N914	21.00
2N218A	45	1N4148	21.00
2N219A	45	1N4148	21.00
2N2905	45	1N4148	21.00
2N2907	45	1N4148	21.00
2N3055	45	1N4148	21.00
2N3638	45	1N4148	21.00
2N3772	45	1N4148	21.00

**OPTO ISOLATORS**

MCT-2	5.99	4N33	5.99
MCT-6 <td>1.59</td> <td>4N35</td> <td>1.25</td>	1.59	4N35	1.25
MCT-69	45	4N37	1.25
MCA-255	1.69	4N38	.98
4N268	.85	TL1117	.79
4N27	1.09	4N253	1.09
4N28	.89	4N255	51.00

**LED LAMPS**

- Jumbo Red 1-99 100
- Jumbo Green 1-17 15
- Jumbo Yellow 1-17 15
- Mini Size Red 1-19 19
- Mini Size Green 1-19 19
- Mini Size Yellow 1-19 19

**AC/DC 24V POWER SUPPLY SPECIAL**

24V@1A Open Frame OEM Model Reg 34.95. ACP ONLY \$11.95

**CALL ACP FOR ALL YOUR VOLUME IC REQUIREMENTS**

**EDGE CONNECTORS**

8-100 ST	33.95	83.25	100
50-100 WW <td>4.75</td> <td>4.75</td> <td>21</td>	4.75	4.75	21
44 Pin ST <td>2.75</td> <td>2.60</td> <td></td>	2.75	2.60	
44 Pin WW <td>4.75</td> <td>4.25</td> <td></td>	4.75	4.25	
72 Pin ST <td>6.50</td> <td>6.10</td> <td></td>	6.50	6.10	
72 Pin WW <td>7.25</td> <td>6.95</td> <td></td>	7.25	6.95	

**D-SUBMINUTER**

DB25S (Female)	1.24	25
DB25P (Male) <td>\$3.10</td> <td>\$2.90</td>	\$3.10	\$2.90
DB25P (Male) <td>2.40</td> <td>2.29</td>	2.40	2.29
HDSP #1.25	Mtg H/W \$ 99	
DE37S (Female)	\$5.95	\$5.75
DE37P (Male)	5.25	5.10
DD37L #1.75	Mtg H/W \$ 99	
DD37S (Female)	\$8.95	\$8.65
DD37P (Male)	\$8.25	\$8.00
HDSP #3.25	Mtg H/W \$ 99	

**(OTHER STYLES IN CATALOG)**

**CENTRONICS**

IDC 38 Pin Male	\$8.95
IDC 38 Pin Female <td>8.95</td>	8.95
Solder 38 Pin Male <td>7.49</td>	7.49
Solder 38 Pin Female <td>8.49</td>	8.49

**(CALL TOLL FREE FOR IDC'S)**

**8600**

68000	118.95	68010	5.28	68502	5.25
68000L10	39.20	6820	3.90	68702	3.90
68000	2.90	6820	2.90	6860	7.90
68002	7.75	6828	14.50	6875	6.75
68003	18.25	6840	12.75	6880	2.50
6800E	9.50	6845	11.95	6890	22.95

**6500**

6502	\$4.50	6554	\$8.75	6522	\$5.25
6502A	8.90	6507	9.75	6532	9.50
6502B	8.90	6520	4.25	8551	11.50

**8000**

9005	\$ 5.75	8214	\$ 3.75	8259	\$ 6.76
9039	5.75	8218	1.95	8271	69.95
9080A	2.60	8224	2.20	8275	26.95
9080B	4.90	8226	1.95	8279	8.75
9082	4.95	8228	3.40	8283	24.95
9088	24.50	8237	13.75	8293	6.25
9087-2	129.95	8243-5	15.95	8294	5.50
9088	17.50	8238	4.25	8296	8.45
9089	88.95	8237-5	9.95	8297	6.45
8155	6.75	8250	10.50	8298	11.95
8156	6.75	8251	4.25	8299	48.95
8185	26.95	8251A	1.95	8302	19.95
8202	23.95	8253	6.75	8741	29.95
8203	37.95	8255	4.25	8746	24.50
8255	1.95	8256	3.50	8750	19.95
8212	1.95	8257	5.75	8753A	34.95

**Z-80**

2.5MHz	"A" 4.0MHz	"B" 6.0MHz
Z80-CPU	2.25	2.75
Z80-CTC	2.25	2.75
Z80-DART	7.50	5.50
Z80-DMA	8.00	8.95
Z80-DMA	8.00	8.95
Z80-SIO/1	8.50	9.50
Z80-SIO/2	8.50	9.50
Z80-SIO/9	8.50	9.50

**DISK CONTROLLERS**

UPD765	\$9.95	1787	\$21.95	6843	\$28.95
6847	17.50	1791	22.75	6845	14.95
6845	14.75	1792	32.95	1891	8.95
6847	19.50	1793	21.50	2143	6.95
		1795	21.50	2797	32.95

**CR2 CONTROLLERS**

8845	\$11.95	8275	\$28.50	TM5991B	\$39.50
6848	14.75	7220	34.95	8550	39.95
6847	17.50	7221	17.95	8552	39.95
46505	14.75	5037	21.95	8002	19.95
6847	19.50	NC7220	Graphics		34.95

**UARTS/USARTS**

1602B	\$3.95	2350	\$ 8.95	IM6403	\$ 8.75
1013A	3.95	8250	10.50 <td>TM55501</td> <td>14.95</td>	TM55501	14.95
1015A	6.75	IM6402	7.75	2551	8.95

**EPROMS**

1702 (1M5)	\$ 3.90	2732A-4 (450nS)	\$ 4.50
2708 (40nS)	3.85	2732A (250nS)	6.95
2708 (80nS)	5.50	2732-2 (200nS)	8.95
2714 (450nS)	3.85	2784 (450nS)	3.95
2714 (350nS)	3.85	2784 (250nS)	3.95
2516 (5V)	2.95	2784 (200nS)	4.95
TM5271	7.50	MC68254 (450nS)	19.95
TM5232	5.60	MC686784 (450nS)	19.95
2732 (450nS)	4.95	MC686784 (350nS)	21.95
2732 (200nS)	2.95	MC686784 (300nS)	35.95
2732 (200nS)	2.95	2712 (200nS)	15.95

**CMOS EPROMS**

27C16	\$7.95	27C64	10.95
-------	--------	-------	-------

**STATIC RAMS**

2101 (450nS)	\$2.29	MK4118	\$4.95
2102 (450nS) <td>\$2.29</td> <td>TM20016-2 (200nS)</td> <td>4.10</td>	\$2.29	TM20016-2 (200nS)	4.10
2102-1 (450nS) <td>.78</td> <td>TM20016-1 (150nS)</td> <td>4.95</td>	.78	TM20016-1 (150nS)	4.95
2102-2 (450nS) <td>1.39</td> <td>TM20016-1 (100nS)</td> <td>8.10</td>	1.39	TM20016-1 (100nS)	8.10
2111 (450nS)	2.75	HM6116P4 (200nS)	4.95
2114 (450nS)	1.45	HM6116P2 (120nS)	8.85
2114L (450nS)	1.89	HM6116L-4 (LP)	5.90
2114L (200nS)	2.98	HM6116L-2 (LP)	9.95
2147 (50nS)	5.00	28132 (300nS)	32.95
4044 (450nS)	3.75	HM6284P-4 (150nS)	35.95
4044-3 (300nS)	3.75	HM6284L-4 (LP)	36.95
4044-2 (200nS)	4.35	74S189 (36nS)	1.85
UPD410 (100nS)	3.75	83415 (50nS)	3.95
5101 (CMOS)	3.50	93A22P426 (50nS)	3.95

**DYNAMIC RAMS**

4027 (200nS
-------------

# California Digital

17700 Figueroa Street • Carson, California 90248

## IBM Compatible Computer

# \$495



**Eclipse**  
DATA PRODUCTS

- 256K Expandable to 640K on Motherboard
- Double Sided Double Density Disk Drive
- IBM Type Keyboard (with LED indicators)
- Floppy Controller Card
- Eight Expansion Slots
- 135 Watt Power Supply

The Eclipse 16 is an outstanding value in IBM Compatible Computers. After careful research and evaluation we found it to be the most reliable unit.

Our computer includes some of the newest features available, such as the 4.7MHz, multi-layer motherboard with 256K of RAM upgradable on board to 640K. A generous eight expansion slots and 135 Watt power supply give you ample room and power for add-on boards. The enclosure has an easy-access flip top lid making upgrades a breeze. And our floppy controller supports up to four drives, so as many as three additional drives can be used. Finally, each computer is configured and fully tested before sending it to you.

**Satisfaction Guaranteed!** We're really excited about this new unit, and so sure you will be too... that you may return the Eclipse 16 for a full credit towards an IBM PC if you are not completely satisfied.

### OPTIONS

20MB Hard Drive w/Controller .....	\$495	RGB Color Monitor.....	199
Additional Drive-Installed.....	99	TTL Monochrome Monitor.....	139
Irwin 10 Meg. Tape Back up.....	489	Microsoft Mouse .....	79
Upgrade from 256K to 640K RAM .....	79	Upgrade from Floppy Controller to Disk I/O	
8087 Math Co Processor.....	119	2 drive controller, clock/cal., software	
Color Graphics Card .....	79	parallel, serial, and game ports.....	79
Monochrome Graphics Card.....	99	1200 Baud Internal Modem w/Software	179

**NOW  
YOUR COMPUTER  
CAN READ!!**

Omni Reader... the first optical character reader designed and priced for small computers.

# \$179

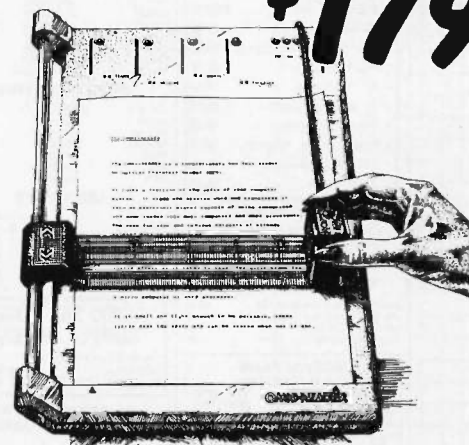

- Copy**
- Manuscripts
  - Contracts
  - Articles
  - Forms
  - Invoices
  - Purchase Orders

- Applications**
- Mailing Lists
  - Editing
  - Data Base Management
  - Transferring information between incompatible systems.

Uses a standard RS-232 serial port hookup to interface easily with your computer.

## 1200 BAUD MODEMS



**AVATEX 1200**  
**\$99**

This 300/1200 baud modem matches the design specs of the Bell 212A, feature by feature, bringing you reliability, impeccable transmission and easy operation. Hayes Compatible, except for "S" register. Communication software included.

The AVATEX 1200, at \$99, is a steal!

### SMARTTEAM 1200



**\$189**

The Team 212A offers all the features of the Hayes Smart Modem 1200 for a fraction of the price. Now is your opportunity to purchase a 1200 baud modem at the price of a 300 baud modem.

### SIGNALMAN 300 BAUD MARK VI



**\$49**

The Anchor Automation Mark VI is a 300 baud direct connect modem that plugs into any slot of your IBM/PC. This modem supports auto answer and auto dial capabilities. Other features include telephone number storage, send / receive text files, single key-stroke dialing along with many other functions provided on disk. The Mark VI was originally priced at over \$300.

## UltraLink 1200



The UltraLink is a 1200 baud HALF DUPLEX bell 202 compatible internal modem card for the IBM/PC. This unit operates full duplex at 300 baud.

The UltraLink adds a voice/data demension to your PC. Manufacturers original suggested price on this modem is \$795. California Digital's price is only \$99.

**\$99**

## MODEMS

Eclipse 1200 100% Hayes, with status lamps.	ECP-1200	179.00
Eclipse 1200B internal with software	ECP-1200B	179.00
Hayes Smartmodem 2400 baud modem	HYS-2400	599.00
Falitsu 2400/1200 baud auto everything.	FUJ-1935D	459.00
Team 1200 Hayes Compatible, 300/1200 baud.	TEM-SM1200	189.00
UltraLink 1200 data and voice on same line.	UTL-1200A	99.00
CTS 212AH 1200 baud, auto dial	CTS-212AH	219.00
Terminal software for CTS 212AH	CTS-212SFT	35.00
Prometheus 1200 super features	PRM-P1200	289.00
Signalman Mark VI, 300 baud internal PC	PRM-P1200B	279.00
Hayes Smart Modem 1200 baud, auto dial	SGL-MK6	49.00
Hayes 1200B for use with the IBM/PC, 1200 baud.	HYS-212AD	369.00
Hayes Smartmodem, 300 baud only, auto dial	HYS-1200B	299.00
Hayes Chronograph, time & date	HYS-103AD	199.00
	HYS-CHR232	199.00

## Seagate \$359

20 MEGABYTE WINCHESTER HARD DISK DRIVE

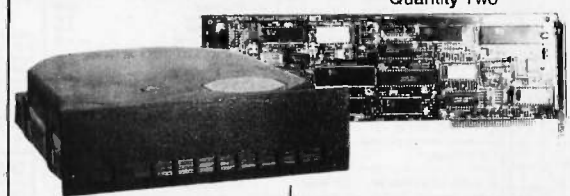

Five Inch Winchester Disk Drives

	each	two+	
SEAGATE 225 20 Meg. 1/2 H.	399	359	● Winchester Controllers for IBM/PC ●
SEAGATE 4026 26 M. 35ms.	859	829	FALCON FT-HDC half card
SEAGATE 4051 51 M. 35ms.	1095	1059	XEBEC 1220 with floppy controller
FUJITSU 2242 55 M. 35ms.	1799	1729	NATIONAL COMPUTER 5004
FUJITSU 2243 86 M. 35ms.	2295	2219	OTC 5150BX
RODIME RO-202E 27 Meg.	759	729	OMTI 6510 half card
RODIME RO-203E 40 Meg.	995	959	ADAPTEC 2010A software install
RODIME RO-204E 53 Meg.	1259	1195	WESTERN DIGITAL WD/1002
CONTROL DATA 94155-86 M.1829	1779		● SCSI/SASI Winchester Controllers ●
MAXTOR XT1140 140 Meg.	3379	3295	XEBEC 1410A 5 1/4" foot print
HONEYWELL 85M. 27 mS.	1795	1695	OMTI 20L
TOSHIBA MK56 70 M. 30ms.	1789	1729	● Winchester Accessories ●
TANDON 502 10 Meg.	419	379	Installation Kit with manual
			Winchester enclosure and supply
			Qual 20/34 cable set
			Switching power supply

TOLL FREE ORDER LINE  
**(800) 421-5041**

TECHNICAL & CALIFORNIA  
**(213) 217-0500**



# California Digital

17700 Figueroa Street • Carson, California 90248

## Letter Quality Printer F-10 DAISY WHEEL

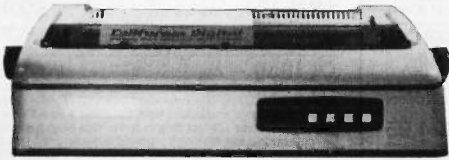

**\$429**

Quantity  
Two

Single unit price is \$499. But if you have already purchased an F-10 printer from California Digital, we will honor the \$429 price on the second printer.

## FREE

**Accessory Pak**  
Includes 6 Daisy Wheels  
& 2 ribbon cartridges  
With F-10 Purchase



## SONY 53W Floppy Disk Drive

3 1/2" New IBM portable compatible

**\$139**



## 5 1/4" DISK DRIVE SALE \$89

Quantity Two

Your Choice 48 or 96 TPI drive.  
QUME MODEL 142 • 48 TPI  
MITSUBISHI 4853 • 96 TPI



	One	Two	Ten
TEAC FD55BV half height	119	109	99
TEAC FD55FV 96 TPI, half ht.	119	109	105
TEAC FD55GF for IBM AT	189	179	175
SHUGART SA455 Half Height	119	109	105
SHUGART SA465 1/2 Ht. 96TPI	125	119	109
TANDON 100-2 full height	129	125	119
MITSUBISHI 4851 half height	119	109	105
MITSUBISHI 4853 96/TPI 1/2 Ht.	99	89	89
MITSUBISHI 4854 8" elec.	295	285	275
QUME 142 half height	99	89	89
Switching power supply			49
Installation Kit with manual			10
Dual enclosure for 5 1/4" drives			59
34 pin edge connectors			5
Scotch head cleaning kit			19
Flip & File Storage tubs			15

## CP/M 2.2 Operating System

**14<sup>95</sup>**

Complete with manual  
by Digital Research

Originally \$185.00  
Now only \$14.95

(10+ = 9.95 -- 100+ Call)

## TEKTRONIX MOUSE

**\$79**

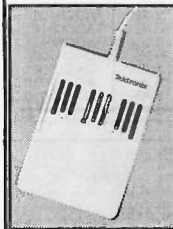

- 200 dots-per-inch resolution
- Programmable baud rate
- Multiple protocols
- Programmable buttons
- Serial interfaces
- Runs on any surface
- Free of pads or grids
- Microsoft TM compatible driver

Moving your cursor has never been so easy! This mouse combines the best features of optical and mechanical technology into one high performance mouse. The Tektronix mouse was private labeled by LogiTech for Tektronix. The 200 dots-per-inch resolution requires less desk space and gives you precision control. This mouse is fast and precise in the most demanding environments. And it has a programmable baud rate so you can use it with almost any of your favorite software.

## BAR CODE READER

For IBM/PC

**\$529**

The DataLogic bar code reader plugs directly between the keyboard and the mainframe of your IBM/PC.

Bar code is suitable for inventory control, freight and invoice records, personal records and other applications limited only by your imagination.

Also available for the Apple II and RS-232 serial.

## PLOTTER

**\$179**



The Comtex Comscriber is the ideal solution to make short work of translating financial and numeric data into a graphic presentation. Many ready to run programs such as Lotus 1-2-3, Visi-on and Apple business graphics already support this plotter.

The Comscriber I features programmable paper sizes up to 8 1/2 by 120 inches, 6 inch per second plot speed and 0.004" step size. Easy to implement Centronics interface allows the Comscriber I immediate use with the printer port of most personal computers. The Comscriber I is manufactured for Comtex by the Enter Computer Corporation. The plotter is marketed by Heath Kit and also sold under Enter's own "Sweet P" Label. This is your opportunity to purchase a plotter which was originally priced at \$795 for only \$219. Also available is a support package which includes demonstration software, interface cable, a multicolor pen assortment and a variety of paper and transparency material.

## Quick-Link 300

**\$59**



The Quick-Link 300 gives you an instant link to any dial up data base. Such as Dow Jones, Western Union or the Source. The Quick-Link has four user programmable log-on keys, allowing the operator, with only one key stroke, to dial the data base, log-in and give the password. All this information is permanently stored in non-volatile RAM.

Features include video output to television or monitor, auto dial, auto-log, full sized keyboard, 300 baud modem and 1200 baud auxiliary printer port. All this is available for only \$59.

## NEC RGB COLOR MONITOR

**\$219**

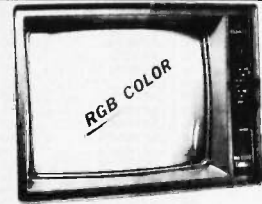

The NEC JC-1401D is a 13" medium/high resolution RGB monitor suitable for use with the Sanyo MBC-550/555 or the IBM/PC. The monitor features a resolution of 400 dots by 240 lines. Colors available are Red, Green, Blue, Yellow, Cyan, Magenta, Black and White. The NEC monitor carries the Litton-Monroe label and was originally scheduled for use in their "Office of the Future" equipment. A change in Monroe's marketing strategy has made these units excess inventory which were sold to California Digital. We are offering these "new" RGB monitors at a fraction of their original cost. Sanyo compatible NEC-1401/S; IBM/PC Computer compatible NEC-1401/PC

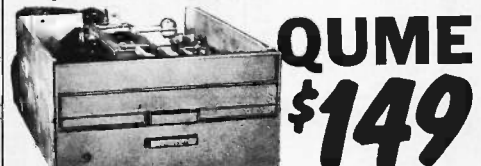

**QUME  
\$149**

### Eight Inch Single Sided Drives

QUME 841 single side	159	149	call
SHUGART 801R	359	359	354
SIEMENS FDD 100-8	119	115	109

### Eight Inch Double Sided Drives

QUME 842 "QUME TRACK 8"	189	179	call
SHUGART SA851R	495	485	475
OLIVETTI double sided	189	179	159
REMEX RFD-4000	179	169	159
MITSUBISHI M2896-63 1/2 Ht.	459	449	409
Dual 8" enclosure with power and fan			259
Switching power supply			89
Installation kit with manual			10

## MEMORY

4164 DYNAMIC MEMORY 150ns  
**\$ .99**  
Quantity 100

### DYNAMIC MEMORY

	1-100	100+	1000+
4164 150ns. 128 refresh	1.39	1.19	.99
41256 150ns. 256K	4.59	3.95	3.29

Shipping: First five pounds \$3.00, each additional pound \$.50.  
Foreign orders: 10% shipping, excess will be refunded.  
California residents add 6 1/2% sales tax. • COD's discouraged.  
Open accounts extended to state supported educational institutions and companies with a strong "Dun & Bradstreet" rating.







# Worldwide • Since 1974

• QUALITY COMPONENTS • COMPETITIVE PRICING • PROMPT DELIVERY

Mail Order Electronics • Worldwide  
**Jameco**  
ELECTRONICS

## COMMODORE® COMPATIBLE ACCESSORIES

**Now Compatible With C-128!**  
**RS232 Adapter for VIC-20, C-64 and C-128**

The JE232CM allows connection of standard serial RS232 printers, modems, etc. to your VIC-20, C-64 (excluding the SX-64 Portable), and C-128. A 4-pole switch allows the inversion of the 4 control lines. Complete installation and operation instructions included.

Plugs into User Port • Provides Standard RS232 signal levels • Uses 5 signals (Transmit, Receive, Clear to Send, Request to Send, Data Terminal Ready, Data Set Ready).

**JE232CM . . . . . \$39.95**

**Voice Synthesizer VIC-20 & C-64**  
Plug-In - Talking in Minutes!

**JE520CM . . . . . \$99.95**

**300 Baud Auto Modem**

**Mitey-Mo (For C-64) . . . . . \$69.95**

**Parallel Printer Interface**  
FREE 10K Buffer Included!

**MW350 (For VIC-20, C-64 & C-128) . . . . . \$69.95**

## TRS-80® COMPATIBLE ACCESSORIES

**E-X-P-A-N-D TRS-80 MEMORY**  
All kits come complete with documentation

**TRS-80 MODEL I, III**

TRS-16K3 200ns (Model III) . . . . . \$5.95

TRS-16K4 250ns (Model I) . . . . . \$5.49

**TRS-80 COLOR AND COLOR II**

TRS-64K-2 . . . . . \$11.95

New models only

TRS-CoCo-Incl. 2-50464's (41464's) . . . . . \$19.95

**TRS-80 MODEL 4, 4P**

TRS-64K-2 . . . . . \$11.95

Expands Model 4 from 16K-64K or Model 4P from 64K-128K

TRS-64K-2PAL . . . . . \$29.95

Expands Model 4 from 64K to 128K

**TRS-80 Model 100 • NEC • Olivetti**

M1008K . . . . . \$29.95 ea. or 3 for \$79.95

TRS-80 Model 100 Expansion

NEC8KR . . . . . \$29.95 ea. or 3 for \$79.95

NEC Model PC-8201A Expansion

OM108K . . . . . \$29.95 ea. or 3 for \$79.95

Olivetti Model M10 Expansion

**TANDY 200**

M200R . . . . . \$89.95 ea. or 2 for \$169.95

Tandy Model 200 Expansion

## UV-EPROM ERASER

Erases all EPROMs. Erases up to 8 chips within 21 minutes (1 chip in 15 minutes). Maintains constant exposure distance of 1". Special conductive foam liner eliminates static build-up. Built-in safety lock to prevent UV exposure. Compact. 9.00" L x 3.70" W x 2.60" H. Complete with holding tray for 8 chips.

**DE-4 UV-EPROM Eraser . . . . . \$74.95**

**UVS-11EL Replacement Bulb . . . . . \$17.95**

## DATA BOOKS

30003 National Linear Data Book (82) . . . . . \$14.95

30009 Intersil Data Book (85) . . . . . \$ 9.95

30013 Zilog Data Book (85) . . . . . \$14.95

30022 Nat'l. Logic Data Book Set (84) . . . . . \$24.95

210830 Intel Memory Handbook (83/84) . . . . . \$19.95

230843 Intel Microsystem Hndbk. (83/84) . . . . . \$19.95

## MUFFIN/Sprite-STYLE FANS

MUF60 (SPN3-15-2462) . . . . . \$9.95

Howard Industries (4.68" sq., 60 cfm)

SU2CT . . . . . \$9.95

EG&G Rotron (3.125" square, 20 cfm)

## APPLE® COMPATIBLE ACCESSORIES

All Apple Cards come complete with instructions. MADE IN THE USA!

**16K RAM CARD (Language Card)**  
For Apple II and II+

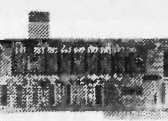

Expand from 48K-64K. Runs AppleSoft, DOS, CP/M and Pascal. (ARC-16K/MEM-1)  
**JE860\*\* . . . \$39.95**

**CONTROLLER CARD**  
For Apple II, II+ and IIe\*



Capable of handling up to two drives. Recommended drives: ADD-514 or ADD-12. (ACC-1)  
**JE875 . . . . \$49.95**

**EXTENDED 80-COLUMN CARD**  
For Apple IIe\*



JE864 is an extended 80-column/64K RAM Card. Ultra-high resolution capability.  
**JE864 . . . . \$69.95**



**128K RAM CARD**  
For Apple II, II+ and IIe\*

Four key software programs are included: Utilities, Diagnostics, Demos, and RAM Disk Emulators for DOS 3.3, CP/M and Apple Pascal. Expand-A-RAM.  
**JE868\*\* . . . \$119.95**



**APPLESURANCE DIAGNOSTIC DISK CONTROLLER CARD**  
For Apple II, II+ and IIe\*

PREVENTS CRASHES!

Test your RAM, ROM, CPU and Disk Drives. DRV-1/Applesurance II:  
**JE877 . . . . . \$69.95**



**PARALLEL PRINTER CARD**  
For Apple II, II+ and IIe\*

Fully compatible with Apple CP/M, Apple Pascal (or FORTRAN), and most other operating systems and software packages. Available for Apple II, II+ and IIe\*. PRT-1:  
**JE880 . . . . . \$59.95**



**PARALLEL/SERIAL 64K BUFFER CARD**  
For Apple II, II+ and IIe\*

Using the parallel jumper cable supplied, the JE883 will attach to the JE880 (above). Parallel Card needed for operation. The JE883 includes a standard parallel input with both parallel and serial (RS232) buffered outputs. P/S Buffer:  
**JE883 . . . . . \$79.95**

\*APPLE, APPLE II, II+ and IIe are registered trademarks of Apple Computers. \*\*When using CP/M, the JE860 and JE868 will only function with Version 2.20 or earlier; PASCAL (JE868) Version 1.1 or earlier.

## ADDITIONAL APPLE® COMPATIBLE PRODUCTS

Key: a=Apple II or II+ b=Apple IIe

APF-1 Cooling Fan with Surge Protection	Key: (a,b)	\$ 39.95
KHP4007 Switching Power Supply	Key: (a,b)	\$ 39.95
JE614 Numeric/Aux. Keypad - 11 accessible functions	Key: (b)	\$ 49.95
AMON 12" Green Monitor with Swivel Stand	Key: (a, b and I/c)	\$ 99.95
KB-EA1 Apple Keyboard and Case	Key: (a)	\$ 99.95
JE520AP Voice Synthesizer - Plug-In, User Ready	Key: (a,b)	\$119.95
ADD-12 5 1/4" Half-Height Disk Drive	Key: (a,b)	\$119.95
ADD-11c 5 1/4" Half-Height Disk Drive	Key: (I/c)	\$129.95
ADD-514 5 1/4" Full Height Disk Drive	Key: (a,b)	\$129.95
PM1200A Prometheus Internal Modem - 2 Cards	Key: (a,b)	\$299.95
PM1200M Prometheus Macintosh Ext. Modem	Key: (Macintosh)	\$349.95

## GENERAL APPLICATION POWER SUPPLIES

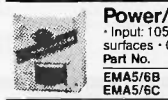

**Power/Mate Corp. REGULATED POWER SUPPLY**

Input: 105-125/210-250VAC @ 47-83Hz - Line regulation: ±0.05% - 3 mounting surfaces - Overvoltage protection - UL recognized - CSA certified  
Part No. Output Voltage (inches) Weight PRICE

EMA5/6B 5V@3A / 6V@2.5A 4 1/2" x 4W x 2 1/2"H 2 lbs. \$29.95

EMA5/6C 5V@6A / 6V@5A 5 1/2" x 4 1/2"W x 2 1/2"H 4 lbs. \$39.95



**4-CHANNEL SWITCHING POWER SUPPLY**

Microprocessor, mini-computer, terminal, medical equipment and process control applications - Input: 90-130VAC, 47-60Hz - Output: ±5VDC @ 5A - 5VDC @ 1A, ±12VDC @ 1A, -12VDC @ 1A - Line regulation: ±0.2% - Ripple: 30mV p-p - Load regulation: ±1% - Overcurrent protection - Adjustment: 5V main output - 10% - Size: 6 3/8" L x 1 1/2" W x 4-15/16" H - Weight: 1 1/2 lbs.

**FCS-604A . . . . . \$59.95**

## IBM® COMPATIBLE ACCESSORIES

**83-KEY KEYBOARD**

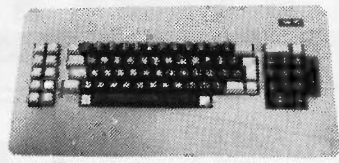

Identical layout as original IBM PC Keyboard - Highly desirable case with palm rest - Complete with cable and data - JUST PLUG IN!

**KB83 . . . . . \$49.95**

**Build an IBM PC/XT™ Compatible!**

IBM-64K 64K RAM Chips (18)	\$ 24.98
KB-83 83-Key Keyboard	\$ 49.95
IBM-FCC Floppy Controller Card	\$ 54.95
IBM-Case Case	\$ 49.95
IBM-MCC Monochrome Card	\$ 89.95
IBM-PS Power Supply	\$ 89.95
FD55B Disk Drive	\$119.95
IBM-MON Monochrome Monitor	\$109.95
IBM-MB Motherboard	\$199.95

Regular List \$789.58

**IBM™-Special (Incl. 9 items above) . . . \$699.95**

**Additional Add-Ons Available!**

IBM-KB 83-Key Keyboard	\$ 79.95
IBM-ENH Enhanced Keyboard	\$ 99.95
IBM-ICB Integrated Color Board	\$109.95
IBM-E384K Multifunction Card	\$169.95
IBM-20MBK 20MB Hard Disk Drive	\$499.95

IBM is a registered trademark of IBM Computers

## NEW! Universal NEW! 64K/256K Printer Buffer

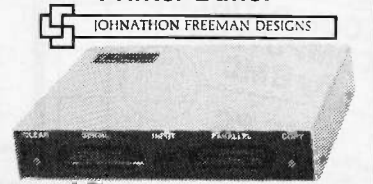

The UBUFFER Universal Printer Buffer is a hi-speed data buffer that accepts data at a high rate, and then outputs this data to your printer. You save valuable computer time. The UBUFFER can be connected to practically any computer or printer. There are four possible combinations: 1) Serial to Serial, 2) Serial to Parallel, 3) Parallel to Parallel, 4) Parallel to Serial. Manual included. Size: 9-1/3" L x 4 1/2" W x 1 1/2" H

**UBUFFER-64K . . . \$199.95**

**UBUFFER-256K . . . \$229.95**



**FD55B Teac 5 1/4" DS 1/2-Height . . . . . \$119.95**

**SA455 Shugart 5 1/4" DS 1/2-Height . . . . . \$139.95**

**TM100-2 Tandon 5 1/4" DS Full-Height . . . . . \$139.95**

**JMR 5 1/4" DISK DRIVE ENCLOSURES**

Complete with power supply, switch, power cord, fuseholder and connectors.

**DDE-1FH . . . . . \$69.95**

Houses 1 Full-Height 5 1/4" Floppy Drive.

**DDE-2HH . . . . . \$79.95**

Houses 2 Half-Height 5 1/4" Floppy Drives - Vertical

**HDDE-1FH . . . . . \$199.95**

Houses 1 Hard Disk Drive

\$20 Minimum Order - U.S. Funds Only  
Shipping: Add 5% plus \$1.50 Insurance

California Residents: Add 6% or 6 1/2% Sales Tax

Spec. Sheets - 30c each  
Prices Subject to Change

Send stamped, self-addressed envelope to receive a Quarterly Sales Flyer - FREE!

6/86



Send \$1.00 Postage for a FREE 1986 JAMECO CATALOG

©1986 Jameco Electronics

1355 SHOREWAY ROAD, BELMONT, CA 94002 • PHONE ORDERS WELCOME 415-592-8097 Telex: 176043

# WORLDWIDE IS HARD DRIVE HEADQUARTERS

Dealers: Call for quantity prices!

**ZOOM 1200**  
1200/300 baud, auto answer/auto dial, Hayes (AT) compatible internal modem, Denon dialer, monitor speaker, tone/pulse dialing, dual phone jacks, call progress tone detection, 2 Year Warranty. Made in USA.  
**\$199**  
INCLUDING SOFTWARE!

### XT DRIVES

<b>10MB DRIVE ONLY</b> Seagate, Miniscribe or Tokiko <b>\$249 ea.</b> Quantity 10 \$259 ea. qty 1-9	<b>10MB SYSTEM</b> With West Dig controller, drive, cables & inst. proc. <b>\$349 ea.</b> Quantity 10 \$359 qty 1-9	<b>20MB DRIVE ONLY</b> Seagate or Microscience <b>\$324 ea.</b> Quantity 10 \$334 ea. qty 1-9	<b>20MB SYSTEM</b> With West Dig controller, drive cables & inst. proc. <b>\$424 ea.</b> Quantity 10 \$434 ea. qty 1-9
---	---	---	--

**YOU LIKE IT, OR WE TAKE IT BACK!**  
If for any reason, you are not satisfied with any product you purchase you may return it within 10 days of receipt for replacement, credit or refund.\*

**WE'LL PAY YOU IF YOU FIND A LOWER PRICE!**  
If you buy any item from us at pricing in this ad and find a lower price from any source in this issue, that has the identical product in stock, we'll not only refund the difference you paid, but also pay you 20% of the difference for your trouble! If you find a lower price in this issue before you buy, from any source that has the identical product in stock, we'll beat it!\*

**GUARANTEED AVAILABILITY!**  
Any item you order will be shipped within Two working days or you will be given a firm ship days when you order! If for any reason we cannot ship by the date you are given, we will issue you a credit equal to 5% of the price of the products shipped late.

**SUPER VALUE!**

**30MB SYSTEM**  
Featuring Adeptec's 2070 with Seagate's new ST238  
**\$579 ea.**  
Quantity 10  
\$599 ea. qty 1-9  
Includes cables & inst. proc.

### AT DRIVES

Prices include cables, rails and inst. proc.

<b>20MB SEAGATE 4026</b> 40 ms access <b>\$539 ea.</b> Quantity 10 \$549 ea. qty 1-9	<b>40MB SEAGATE 4051</b> 40 ms access <b>\$729 ea.</b> Quantity 10 \$749 ea. qty 1-9	<b>44MB MINISCRIBE 6053</b> 28 ms access <b>\$995 ea.</b> Quantity 1
--	--	---

**XT COMPATIBLE COMPUTERS By BMC**  
CSA, UL and FCC Class B Approved

**BMC PC**  
640k motherboard (256k inst.), 1-360k floppy, 5150 keyboard, 8088 microprocessor (4.77MHz)  
**\$588**  
Including DOS 2.1!

**BMC TURBO PC**  
640k installed on motherboard, 1-360k floppy, 5150 keyboard, 8088-2 microprocessor (4.77MHz and 6.66MHz)  
**\$748**  
Including DOS 2.1!

### TAPE BACK-UPS

<b>40MB INTERNAL</b> <b>\$498 ea.</b> Quantity 10 With data cart and software \$519 ea. qty 1-9	<b>60MB INTERNAL</b> <b>\$775 ea.</b> Quantity 1 With data cart, software and controller	<b>60MB EXTERNAL</b> <b>\$795 ea.</b> Quantity 1 With data cart, software and controller
---	---	---

**LAZER PRINTERS**  
Name brand, fully IBM and EPSON graphics compatible, 8ppm, 16 type variations and serial/parallel interface built-in.  
**\$1888**

**BORLAND**  
Now in Stock  
**TRAVELING SIDEKICK**  
**\$38**

### COMPONENTS

- \*256K DRAMS set of 9-150ns . \$36
- \*64K DRAMS set of 9-150ns . \$9
- \*8087 . \$128
- \*8087-2 . \$159
- \*80287-3 . \$199
- \*V20 5MHz . \$11
- \*V20 8MHz . \$13
- \*V30 8MHz . \$16

**FUJI FREE FILM OFFER**  
Buy a box of 10 FUJI MD2D diskettes and get a roll of FUJI COLOR 400 film FREE!  
**\$13.50 per box**  
Quantity 100  
\$14.99 per box qty 1-99

### PC POWER SUPPLIES

\*150 Watt, Digital Switching . \$88

### KEYBOARDS (IBM XT Compatible)

\*5150 style . \$69  
\*5151 style . \$88

### BOARD PRODUCTS

\*AST Sipak - compat. mult board (ser. par. game, clk/act. exp to 384k, RAMDISK & PSPool) by MULTITECH (0k inst.) . \$96  
\*MULTITECH 576K short card (0k inst.) . \$56

### ACCESSORIES

\*WEST.DIG. 1002SWX2 XT hard disk cont. \$138  
\*2 DRIVE floppy controller . \$40  
\*Hercules compatible monochrome graphics card (720X348) w/gar port & light pen interface by MULTITECH . \$112  
\*MULTITECH color graphics card (1-2-3, IBM mono and CGA compatible) . \$98  
\*TAKAN 553 Ultra Hi Res color card . \$244  
\*MULTITECH E.G.A. card (IBM mono, CGA and EGA compatible) . \$288  
\*SIGMA E.G.A . \$369

### MODEMS

\*ZOOM Ite 300 baud Apple internal . \$92  
\*Smar TEAM 103/212A 1200/300 baud external, Hayes (AT) compatible . \$168  
\*ANCHOR EXPRESS: 1200 baud int. short . \$188  
\*ANCHOR LIGHTNING 2400 baud external, Hayes compatible . \$348

### MONITORS

\*TATUNG MM 1222A amber TTL . \$126  
\*TATUNG CM 1360 Hi Res RGB (640 X 200) . \$367  
\*PRINCETON HX-12E E.G.A. RGB (640 X 350) . \$519

ORDER LINES OPEN 7AM to 6 PM P.S.T.

**1-800-826-3736**

**1-800-358-8881**

### FLOPPY DRIVES

- \*PANASONIC 1/2 Ht. PC compatible . \$99
- \*SANYO 1/2 Ht. PC compatible . \$94
- \*APPLE II compatible, including cable . \$98

Outside California

Inside California

**THE FINE PRINT**  
No returns on software. Prior return authorization required; all items returned must be in original condition with carton, packing and all manuals etc... Some returns may involve a restocking charge. We accept Cashier and Certified checks, Money Orders, personal and company checks (product shipped when check clears), VISA and Mastercard with no surcharge. All products shipped UPS ground, unless specified otherwise (minimum shipping charge \$5.00, exact charges specified at time of order). All normal manufacturer's warranties apply. Membership clubs excluded. All items priced and in stock at time of ad placement and subject to vendor changes and prior sale at time of ad publication.

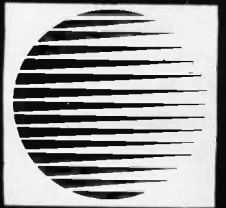

# WORLDWIDE ACCESS INC.

EVERYBODY HATES US, BUT OUR CUSTOMERS!

Inquiry 379

MON-FRI

6311-L DeSoto Avenue • Woodland Hills, California • 91367 • Phone: (818) 703-7996

OFFICE HOURS: 9AM to 5PM





**EPSON  
EQUITY II**

IBM-PC compatibility mated to the new NEC V30 microprocessor gives you 8086 CPU power at speeds of 4.77 and 7.16 MHz. On board you'll find 640K RAM, Hercules compatible mono graphics, clock/calendar and 5 full size option slots - all standard equipment! Add to this two 360K drives, an AT-type keyboard, TTL monitor and a one year warranty - well, you can see it makes sense to start building some EQUITY into your business.

The Epson EQUITY II... **CALL**

## Monitors and Terminals

TATUNG CM-1360 640x200 RGB, 13", G/A switch.	\$395
TATUNG MM-1222 HiRes 12" TTL (IBM)	109
ZENITH ZVM-1240 Amber (IBM)	155
ZENITH ZVM-1220G or 1220A Flat Screen	99
LIBERTY Freedom Terminals	CALL
LINK 125 Emulates WY-50 and others, HiRes 14" Grn/Amb 6 Scroll Rates, IBM Selectric K.B.	419
LINK PC-TERM Emulates WY-50, TVI 925 & More, 132 Col, IBM-AT KB, Ideal for Multi-user	449
LINK 220 DEC Compatible, Amber, 6 pgs Memory, RS-423, 26 Lines, To 38.4K Baud, 38 Funct. Keys, More	459

## Hard Disk and Tape Subsystems

PC-INSIDER/OUTSIDER, AT-INSIDER, Hard Disk Series for IBM. Boots from Hard Disk, Formatted w/ Ctrl. & Cbts., Hardware & P/S or PC Style Cabinet... **CALL NOW!**

### THIS MONTH'S SPECIAL

85MB Hard Disk w/25ms access 85MB Tape B/U, \$2795	
TECMAR QIC-60 External Tape	1449
TECMAR QIC-60 Host I/F Card	109
TECMAR 40200 - II Slot Expansion with 10MB	1395
SMS OMTI 5510-7 Controller	135
WANGTEK PC-36 60MB Int. Tape w/ Ctrl., Cable, S/W 919	
MICROPOLIS 1325 85MB Drive / 25ms Access	1498
QUANTUM Q-540 40MB Drive, 1 Year Warranty	1095
<b>DRIVE SUBSYSTEMS FOR COMPUPRO</b> with Disk 3, CABINET, FAN, P/S, CABLES, etc.	
-20MB Seagate	1115
-40MB Quantum Q-540	1715
-72MB 1325...\$2159 6085...2459 XT-1085	2359
10MB TAPE Int. (Requires Concurrent DOS)	439
10MB TAPE EXT. (Requires Concurrent DOS)	549
ALLOY IXCS-100T 17.7 Ext. Tape (CPM-80/86)	1729

## PC and AT Extended Memory, etc.

We carry the best selection of Multifunction & Memory Cards for IBM-PC, XT, AT, portables and compatibles!

INTEL Above Board PCMB 1010 - 64K to 2MB - Allows Lotus, Symphony, others to run above 640K, w/ FREE MicroSoft Windows!	\$229
INTEL Above Board-AT 128K to 4MB - Use all RAM	459
STB RIO GRANDE 128K to 5MB	269
TECMAR CLOSE OUT!! Save \$\$\$! 1-800-528-3138 CALL	

## PC Scientific and Industrial Cards

<b>INDUSTRIAL COMPUTER DESIGNS</b>	
1018-PC 96TTL I/O Lines	\$446
A/D 64-PC 64 Input...446 D/A 64-PC 64 Output	527
PC Prototyping Board	19

<b>SCIENTIFIC SOLUTIONS!</b>	
BASEBOARD (96 I/O Lines); DADIO (D to A Conv.)	
IEEE-488 Board; LABMASTER; MORE!	
Call Now for Lowest Price!	

## PC & AT Multi-user Cards

ALLOY PC-PLUS 512K to IBM	\$595
ALLOY PC-PLUS Package! 512K, Link PC-TERM Terminal, Cable	1150
RTNX SOFTWARE For PC/XT's (MSDOS 2.1)	119
ATNX SOFTWARE For AT's (MSDOS 3.1)	189

## Modems

PROMETHEUS PROMODEM 1200-Hayes Compatible with Power Supply and Software	\$275
<b>PROMODEM OPTIONS:</b>	
Communications Buffer	99
512K RAM for Buffer	59
Alpha Numeric Display	75
PROMETHEUS 1200G without Options	189
PROMETHEUS 2400	385
PROMETHEUS 1200A - Apple II, II+, IIe card w/ S/W265	
PROMETHEUS 300C - Apple IIc Piggy Back	129
PROMETHEUS 1200M - Stand Alone for Mac!	348
MULTITECH MT224EH MNP Error Correction	529
MULTITECH MT212AR Rack Mount	259
MULTITECH MT224AR Rack Mount	459
MULTITECH MT224ER Rack Mount with E.D.C.	495
U.S. ROBOTICS Auto Dial 212A	298
U.S. ROBOTICS PC/XT Modem with Telpac	199

CTS 212AHC Hayes 1200 Compatible	159
CTS 224ADH Hayes 2400 Compatible with pfs: Access	395

## Software

We sell all well known brands **ORDER CORRECTLY!** SOFTWARE IS NOT RETURNABLE!

WORDSTAR PRO-PAK Closeout!	\$289
NEW STAR NEWWORD 2 w/ MergePrint, WordPlus spell check, WordStar Compatible 8 bit...	\$99 16 bit 129
NEW STAR NEWWORD 3 for PC's, Spell checker, Indexing, Content Tables, Macro's, Shorthand keyboard, Run other programs while in NewWord	209
BD SOFTWARE C Compiler 8" SSSD 8 bit	95
pfs:FILE, REPORT,PLAN, etc.	43% OFF LIST!

## Power Solution

PC/XT Power Supply Up to 4 Drives	\$89
TRIPPLITE BC-425-FC 425 Watts, 15-20 Minutes	398
COMPUTER ACCESSORIES U-800 12-35 Minutes	699
SAFT SPS 400VA 400 Watt & Sine Wave	475
SAFT SPS 1000VA 1000 Watt & Sine Wave	999

## Floppy Disk Drives

MITSUBISHI 2894 8"	\$475
MITSUBISHI MF501 48TPI	95
TEAC FD55GFV / IBM-AT 96TPI	125
TEAC FD55FV 96TPI...\$115 FD55BV 48 TPI	95

## Printers and Buffers

BROTHER M-1509 180/45cps, P&S, Wide w/trac	CALL
BROTHER HR-35 36cps Daisey, Wide Carriage	\$729
BROTHER HR-15XL 17cps Daisey, S or P	359
BROTHER HR-10 12cps Daisey with Tractor	229
CALL 1-800-528-3138 Today for the BEST PRICE on EPSON - OKIDATA - CITIZEN	
HANZON Buffer 64K-256K S-S,S-P,P-S,P-P	265
HANZON Add-on 64K Module	45

**BUCK\$ BACK from XEROX!**  
Its Rebate time and XEROX is passing out the cash. Buy one of these printers and get up to \$500.00 back! Also the first month of your 1 Year Warranty includes On Site Service! You have to love adversity to ignore this deal.

**\$100 Break!**



**Xerox 635**

**BIG REBATES ON ALL XEROX PRINTERS!**

Xerox D25 Diablo	\$497 less \$50 Rebate = \$447
Diablo 635	1049 less \$100 Rebate = 949
Diablo D80-IF	2159 less \$500 Rebate = 1659
Diablo 341Q	989 less \$100 Rebate = 889
4045 Laser w/Copier	4995 less \$400 Rebate = 4595

Call 1-800-528-3138 Now and Put Your Money Back to Work for You.

## Networking

INTERCONTINENTAL MICRO SYS LANS-100	\$359
I.C.M. LAN-PC without RAM - Runs NOVELL	349



**cordata**  
formerly **corona**  
Data Systems, Inc.

## ATD/ATP

- 80286 CPU @ 8MHz
- 1.2 MB Floppy Drive
- HiRes Graphics (640x400)
- Serial/Parallel Ports
- 130 Watt P/S • 640K RAM

ROM BIOS Compatible to the IBM-AT. The CORDATA ATD/ATP runs virtually all software designed for today's business environment.

## Desktop Publishing



**LP-300  
DESKTOP  
PRINTSHOP**

Create professional looking newsletters, ad copy, documents, etc. with LASER accuracy.

- 8 pages/min
- Autofeed
- Cable & Toner Included
- 300x300 dots
- 38 fonts

Top your CORDATA systems off with the fastest CAD package on the market.

## FASTDRAFT 480

- 640x480 Color Card • 80287-3 Co-Processor
- NEC Multisync ROB Monitor

**BULLETIN! Cordata Announces  
HUGE PRICE DROP**

**Call 1-800-528-3138 for HOT DEALS!**

## Computer Systems

**IBM-PC COMPATIBLES**  
We carry a wide range of Desktop, Laptop & Portables designed to run the software that fuels today's business.

ZENITH 148, 158, 171, 200AT... **CALL**  
SPERRY IT... **CALL**  
XEROX 6064 ATT 6300 Compatible... **CALL**

**CompuPro™**

816/C2 w/80286, 512K RAM, SPUZ-256, 40MB HD, 10MB Tape, 5" 96TPI floppy, CDOS 816/286, NewWord & SuperCalc2... **CALL**

**SYSTEM 10 4 User, 8/16 bit, 40MB HD, 10MB Tape, CCP/M 816, 1MB M-Drive/H, NewWord, SuperCalc2, HyperTyper, Field Companion, Write, Friday!, etc.** \$5149

## Video / Graphics / CAD

<b>TATUNG SUPER RES PACKAGE!</b>	
CM-1380 RGB (EGA) Monitor (640x350) w/ Dual Scan Rate & EGA/Hercules compat. card w/ 256K!	\$845
STB EGA Plus - TTL mono & HiRes RGB	\$371
<b>HOUSTON INSTRUMENT PLOTTERS</b>	
DMP-41/42, 51/52	CALL
Call Now - We Will Not Be Undersold	

## S-100 Boards & Accessories

If you bought before calling S-100 you paid too much! We stock COMPUPRO, CROMEMCO, DUAL, ICM, KONAN, MULLEN, PICKLES & TROUT, INDUSTRIAL COMPUTER DESIGNS, TARBELL, VECTOR...

Just a few of THIS MONTH'S SPECIALS!

COMPUPRO RAM 16 64K Static	\$95
COMPUPRO RAM 22 256K Static	446
COMPUPRO PC-Video Board & CDOS 4.1	719
COMPUPRO CPU 286-8MHz & CDOS 4.1	1039
COMPUPRO Interfacer-3...372 Interfacer-4	263
COMPUPRO Disk-1A...372 Disk-3	447
COMPUPRO System Support 1	263
DUAL AIM-12 A/D Input 12 Bit/32 Channel	629
INTERCONTINENTAL MICROSYSTEMS Master & Slave Boards 8 & 16 bit. <b>IN STOCK.</b>	<b>CALL NOW</b>
MACROTECH MI-286 80286/280 Dual Proc	\$675
MACROTECH MSR-II 1MB DRAM	825
MACROTECH MSR-II 2MB DRAM	1059

## ROBOTICS — SCIENTIFIC BUS

For IBM PC/XT/AT/compatibles, Apple II...



The Local Applications Bus... LAB 40

- **Host Adaptor:** Modular approach to data acquisition and control. A 40 conductor ribbon cable bus is generated by a host adapter card. Up to 8 low cost Modules can be located anywhere on a cable up to 100 ft long. Bus features: DMA, interrupts, 16 data bits. Open & non-proprietary. Host adapter card, utility software & manual... \$150.
- **Fast A/D Module:** 650K samples/sec. 8 bit, four differential channels. Microprogrammable gain & offset. \$220. Complete package with Scope program, host adapter, Fast A/D Module & cable \$500. FFT available.
- **12 Bit A/D Module:** four channels, 10K samples/sec, inst. amp... \$235
- **Port/Relay Module:** fit standard relay rack. 24 bits I/O, interrupts.
- **Clock Module:** Real time & periods, battery, Interrupts, software.
- **Four Axis Stepper Motor Driver Module:** 15V @ 1.5A/phase/motor. Full step, half step, brake, free wheel. Software & motor included... \$92.
- **Smart Dual Axis Motor Control Module:** For DC, brushless or stepper motor drivers & encoders. Processors (from HP) allow changes & monitoring on the fly. Optically isolated. Call for low cost.
- **Unique to LAB 40** is its ability to efficiently interface directly to chips, such as co-processors & converters, with the lowest hardware & software overhead. Call for more info or order our Workbook.
- **LAB 40 Workbook:** 10 hardware and software projects with IBM PC... \$25.

### Computer Continuum

75 Southgate Ave., Suite 8 • Daly City, CA 94015  
(415) 755-1978

## ICs PROMPT DELIVERY!!!

SAME DAY SHIPPING (USUALLY)  
QUANTITY ONE PRICES SHOWN

OUTSIDE OKLAHOMA NO SALES TAX

DYNAMIC RAM		
256K	64Kx4	150 ns \$4.85
256K	256Kx1	100 ns 5.95
256K	256Kx1	120 ns 3.90
256K	256Kx1	150 ns 3.47
128K	128Kx1	150 ns 4.92
64K	64Kx1	150 ns 1.60
EPROM		
27512	64Kx8	250 ns \$29.00
27C256	32Kx8	250 ns 8.15
27256	32Kx8	250 ns 5.45
27128	16Kx8	250 ns 3.90
27C64	8Kx8	200 ns 5.30
2764	8Kx8	250 ns 3.80
2732	4Kx8	450 ns 3.85
STATIC RAM		
6264LP-15	8Kx8	150 ns \$3.45
6116LP-3	2Kx8	150 ns 2.10

640 Kbyte MOTHERBOARD KITS - Zentih 150 \$87.46  
IBM PC XT, Compat, Portable & Plus, Hp Vectra

Y20/V20 8 MHz \$17.50  
80287-9 8 MHz \$375.00

8087-2 \$185.00  
8087-3 \$135.00

OPEN 6 DAYS: WE CAN SHIP VIA FED-EX ON SAT.

MasterCard/VISA or UPS CASH COD

NO EXTRA CHARGE FOR FEDEX SAT DELIVERY ON ORDERS RECEIVED BY THE 5th A.M. \$2/4 Bk Fr. P-20th \$13/2 Bk

### Factory New, Prime Parts $\mu$ Proc

MICROPROCESSOR UNLIMITED, INC.  
24,000 S. Ponca Ave. (918) 267-4961  
BEGGS, OK, 74421

Prices shown above are for April 28, 1986

Please call for current prices. Prices subject to change. Please expect higher or lower prices on some parts due to supply & demand and our changing costs. Shipping & insurance extra. Cash discount prices shown. Orders received by 6 PM CST can usually be delivered to you by the next morning, via Federal Express Standard Air @ \$6.00, or Priority One @ \$13.00!

## PC EXPANSIONS

AST SixpackPlus (384K)	\$279
Advantage (128K)	\$369
Advantage (1.5M)	\$529
Advantage (3M)	\$809
Rampage (2M)	\$499
RampageAT (2M)	\$659
INTEL AboveAT (2M)	\$xall
Quadboard (384K)	\$249
Gold Quadboard (384K)	\$429
LibertyAT (2M)	\$xall
QuadportAT	\$135
Tecmar Maestro (2.5M)	\$629
HERCULES graphics board	\$299
Color Card	\$159
HAYES Smartmodem 1200B	\$349
Smartmodem 1200	\$389
Maynard Disk Controller	\$100
Sandstar Series	\$xall
MaynStream Tape backup from.	\$979
WDFile Card (10M)	\$769
Tandon Diskard (20M)	\$789
Set of 9 chips (64K)	\$12
Set of 9 chips (256K)	\$29
8087-3	\$119
Qume 142A \$99 Teac	\$109
Teac FD55BV (for AT)	\$109
CDC 9409: \$119 Tandon	\$109
Verbatim (Box of 10)	\$19
Maxell (Box of 10 for AT)	\$39

### VLM Computer Electronics

10 Park Place • Morristown, NJ 07960  
(201) 267-3268 • Visa, MC, Check or COD.

## 5 1/4" 3M FLEXYDISKS

Free headcleaner in each box. 5 1/4" only.

	10-90	100+
SS/DD Soft	\$ .86 ea	\$ .84 ea
DS/DD Soft	\$ 1.21 ea	\$ 1.18 ea
High Density (IBM-AT)	\$ 2.49 ea	\$ 2.47 ea
3.5/SS Micro	\$ 1.85 ea	\$ 1.80 ea

In Stock — Immediate Shipment.  
Mastercard, VISA, Check or Money Order.  
Add \$3.00 shipping charges per each 100 or part.  
Add \$2.50 additional for C.O.D. shipments.  
N.J. residents add 6% sales tax.

### Data Exchange

Dept. B, P.O. Box 993  
178 Route 206 South  
Somerville, N.J. 08876  
(201) 874-5050

Inquiry 227



### WEDGE-PC OEM PRODUCTS

PC-AT Compatible \$1695/one  
512k RAM, 1.2M disk drive, hard disk & floppy disk controller, monochrome card, 200W power, keyboard, enclosure.

PC-XT compatible \$595/one  
256k RAM, one 340 disk drive, monochrome card, keyboard, 130W power, enclosure.

1.2 MB Floppy disk controller card for XT \$99  
Fully tested. Six month warranty.  
Mono monitor \$109. Dealer call for qty price.

### WEDGE TECHNOLOGY INC.

1190 Mt. View-Alviso Rd., Suite R  
Sunnyvale, CA 94089 (408) 734-9866  
Telex 3719075 EDGE UB

## ONLY \$49



### POWER DIRECTORY

- ONE MASTER SWITCH AND FIVE POWER ILLUMINATING SWITCHES.
- CIRCUIT BREAKER.
- ADD \$16 FOR BUILT IN NOISE AND SPIKE FILTER.

\$110 retail value  
Postage Included  
Allow 4-6 weeks Delivery  
Washington residents add \$4.00

Send check or M/O to:  
9728 6th Ave. NW  
Suite 5  
SCENEA INCORPORATED Seattle, WA 98117  
(206) 789-7446 TLX 215015

Inquiry 105

## SAVE MONEY EPROM PROGRAMMER

APROTEK 1000 ONLY

### \$265.00

COMPLETE WITH PERSONALITY MODULE

117 AC POWER-RS-232 CONNECT  
-6 BAUD RATES - HANDSHAKE TO HOST  
ALLOWS READ, WRITE, VERIFY & COPY

Comes complete with IBM-PC, Apple, or CPM (Specify Computer) Driver Program on Disc.

Programs the following 5 Volt 24 or 28 pin devices: 2716 series through 27512, 25xx series, 68764 plus others. Please Specify Personality Module desired with order. Additional Personality Modules only \$15.00 ea. Full 1 year warranty.

TO ORDER: CALL 1 800/962-5800 OR WRITE APROTEK  
1071 A AVENIDA ACASO Add  
CAMARILLO CA 93010 \$4.00 Shipping USA  
Info: (805) 987-2154 VISA or MC Add 3%  
We Accept Govt School & Large Corp P.O.s

Inquiry 366

## 2 Mb EMS RAM / CLOCK FOR IBM PC/XT and COMPATIBLES WITH LIFETIME WARRANTY



FEATURES —

- Supports Lotus/Intel/Microsoft Expanded Memory Specifications (EMS).
- Uses either 64K or 256K DRAM chips.
- User upgradeable.
- Can fill system memory to 640K, allowing remaining memory to be used for EMS.
- Includes Clock/Calendar function.
- EMS memory manager software included.
- EMS compatible RAM Disk software included.
- EMS compatible Print Spooler software included.

\$1990 WITH 64K OF RAM

The Apparat 2 Mb Expanded Memory/Clock Board allows you the option of filling your system memory to the maximum 640K and/or using up to 2 MB RAM for expanded memory. The expanded memory manager software, which is provided, is compatible with the Lotus/Intel/Microsoft Expanded Memory Specification. The clock/calendar function allows you to automatically initialize the date and time on each system power-up.

### ADDITIONAL PRODUCTS —

- CLOCK/CALENDAR CARD
- PROM BLASTER (24 or 28 pin)
- COMBO II CARD
- 256K RAM CARD
- 512K RAM CARD
- EXTERNAL HARD DISK
- INTERNAL HARD DISK
- XT HARD DISK UPGRADE
- SHORT SLOT PAR/SERCARD FOR PPC, AT
- 384K RAM CARD FOR PPC
- AD-DISK DRIVES
- AT RAM CARD
- AT COMBO CARD
- CABLES

### Apparat, Inc.

4401 South Tamarac Parkway — Denver, Colorado 80237  
(303) 741-1778 — TOLL FREE 800/525-7674

Inquiry 306

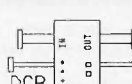

! not only a printer buffer!

THIS IS THE MOST SOPHISTICATED  
PRINTER BUFFER — MULTIPLEXOR — SWITCH

WITH TWO SEPARATE INPUTS (SERIAL AND PARALLEL) AND TWO SEPARATE OUTPUTS (SERIAL AND PARALLEL), CAN BE USED LIKE STANDARD BUFFER WITH ANY INPUT TO ANY OUTPUT BUT ALSO YOU CAN CONNECT 2 COMPUTERS TO 1 PRINTER, OR 1 COMPUTER TO 2 PRINTERS, OR 2 COMPUTERS AND 2 PRINTERS AND MORE = 1 COMPUTER TO 3 PRINTERS OR 3 COMPUTERS TO 1 PRINTER.

HIGH CAPACITY — 64 KB TO 256 KB AND — 256 KB TO 1 MB (MODELS A AND B) PAUSE, COPY AND RESET FUNCTIONS SERIAL PORTS WITH 7 OR 8 BITS WORD LENGTH, 1 OR 2 STOP BIT, PARITY, XON/XOFF, DTR, RTS

DCB-A-64K \$ 266 (\*) DCB-B-256K \$ 296 (\*)

(\*) Power supply and parallel cables are included

ALSO, WE HAVE THE MOST COMPLETE DATA CONVERTER UNIT CONVERTS RS232 SERIAL TO CENTRONICS PARALLEL OR VICE VERSA, JUST BY MOVING JUMPERS BAUD RATE AND PROTOCOL FULLY PROGRAMMABLE FROM 150 TO 19200 BAUDS INCLUDES DTR, RTS, XON/XOFF, PARITY, etc.

DCU \$ 60 (\*\*)

(\*\*) Power supply and cables NOT included

serial <math>\leftrightarrow</math> parallel  
bi-directional converter



INTECTRA, Inc. - Dept. 232  
2825 TERMINAL BLVD.  
MOUNTAIN VIEW - CA - 94043  
(415) 967-8818 TLX 345545

Inquiry 26





# the alternative.

## The SANYO complete word processing system

The alternative for WANG, Xerox or any dedicated word processing system.

At Micro Supply Organization we offer the lowest prices on Sanyo computers and software. With prices like these you can afford the convenience of owning and operating more than one computer. We also offer the User Support Hotline for questions concerning your computer or about software availability. Whether you need one or a dozen computers, Micro Supply Organization is the place to get them!

**The MBC 1160 Accounting Software**  
We carry a complete line of ADS accounting business software. Buy G/L, A/R, A/P, Inventory and receive the Payroll module **FREE**. The current retail price is \$398. per module. **Now from MSO you pay only \$99 per module. All five \$299.**

**20 meg internal hard drive sub-system for SANYO MBC 1150, 1160 & 1250. \$649**

**COMPAT** Disk Utility now available.

### USER SUPPORT HOT LINE

# 805/393-2247

All systems carry full 90 day warranty.

#### CASH PRICE ONLY

Check in advance. Add 3% for VISA/MC. Shipping & handling charges will be added to each order.

For our catalog with complete details and prices, send \$2.00 to:

Micro Supply Organization, Inc.  
4909 Stockdale Hwy. #180  
Bakersfield, CA 93309

15% Restocking on Returned Orders



## Get more for your money!

### SANYO MBC 1160

Including this **FREE** software:

- Wordstar • Spellstar
- Mailmerge • Calcstar
- Infostar • BASIC

#### 8-Bit Integrated Computer with 640KB Formatted Mini Floppy Disk Capacity

- Z-80A CPU with no-wait mode and large 64KB RAM/4KB ROM memory capacity for fast execution.
- CP/M operating system with editor, assembler and all standard utilities.
- No-glare amber monitor display screen for easy viewing.
- 80-character x 25-line display 256 characters in 8 x 12-dot matrix cells.
- Two internal double-sided, double-density, double-track 5 1/4" slim-type mini floppy disk drives with 640KB formatted capacity.
- Interfaces for one Centronics printer and one RS-232C port.
- Optional interface for hard disk drive and for external 8" floppy disk drive.

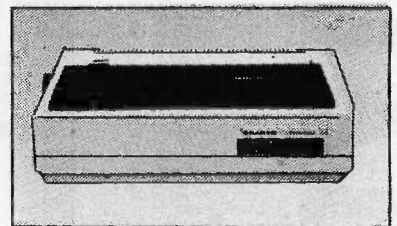

### LEGEND 880 OR SANYO PR 5000 Dot Matrix Printer

- 80 char/line or dot-image graphics
- Centronics parallel interface
- Tractors or Friction feed
- Pica, elite, condensed or proportional
- Epson compatible

Includes printer cable & full warranty

#### Letter quality Daisy Wheel Printer

- Letter-quality printer with 96-character daisy wheel printing element.
- Accepts paper up to 13 inches in width.
- 14 cps bidirectional printing.
- 10, 12 and 15 cpi printing pitches.
- Centronics parallel interface.
- Optional form tractor.

Includes printer cable & full warranty!

This complete package lists for \$3194.00

**Computer  
& Printer  
ONLY**

# \$699

# 1200 BAUD MODEM

Fully Hayes compatible, intelligent 1200 baud modems with features found on the expensive name brand modems. Also, a one year factory warranty from a reliable U.S. manufacturer. Choose either the internal Jade

1200 baud Smart-Card, including software for your IBM PC compatible; or our best selling Jade 1200 baud external modem for any computer with a serial RS-232C port. We guarantee your satisfaction.

INTERNAL  
OR  
EXTERNAL

# \$168

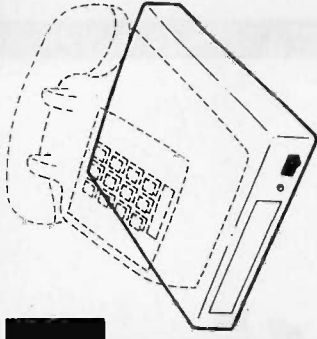

## JADE XPC or XPC-AT

- 640K of RAM
- 4.77 MHz 8088
- 7 MHz turbo mode
- 135 watt power supply
- 360K disk drive
- Floppy disk controller
- 5151-style keyboard
- 8 expansion slots
- PC-style case
- 90 day warranty

**\$788**

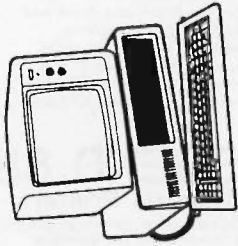

- 1 MB of RAM
- 6 MHz 80286
- 8 MHz turbo mode
- 200 watt power supply
- 1.2 MB disk drive
- Floppy/hard disk controller
- AT-style keyboard
- 8 expansion slots
- AT-style case
- 90 day warranty

**\$1988**

### OPTION #1

Two disk drives  
Mono graphics card  
Parallel printer port  
Amdek 310A monitor

XPC XPC-AT  
**\$1188 \$2488**

### OPTION #2

20 MB hard disk  
Mono graphics card  
Parallel printer port  
PGS MAX-12E monitor

XPC XPC-AT  
**\$1588 \$2888**

### OPTION #3

20 MB hard disk  
Color graphics card  
Parallel printer port  
Magnavox hi-res color monitor

XPC XPC-AT  
**\$1788 \$3088**

## MANNESMANN TALLY PIXY 3 3-PEN PLOTTER

**\$198** LIST PRICE \$799  
YOU SAVE OVER \$600!

Limited Quantity

We're probably making a mistake selling this high speed plotter for only \$198. They are easily worth at least \$500 more. Compare the features to plotters costing \$2000 or more.

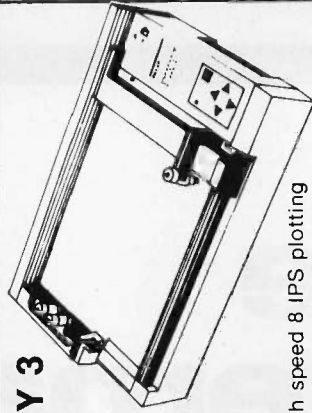

- High speed 8 IPS plotting
- 3-pen auto select
- 8 colors available
- Serial interface
- Full graphics + built-in fonts
- 8 1/2 x 11 paper or transparencies

	LIST	SALE
8 extra water base pens	\$30	\$1695
4 extra oil base pens	\$30	\$1695
100 sheets 8 1/2 x 11 paper	\$9	\$495
50 sheets 8 1/2 x 11 transparencies	\$9	\$495
Plotter software for IBM PC	\$195	\$595

## STAR GEMINI 10-X

120 cps, friction and adjustable tractor feed with graphics

**\$17995**

GEMINI 15X  
15" wide carriage

**\$28995**

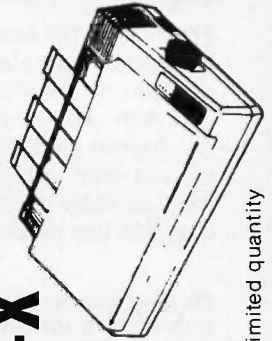

Limited quantity

Why pay \$1149 for a C. Itoh

## STARWRITER F-10

when our 40 cps letter quality daisywheel from the same manufacturer is only as low as

**\$39995**

Each for 5 or more

Each—\$499 2 to 5—\$429

Limited quantity

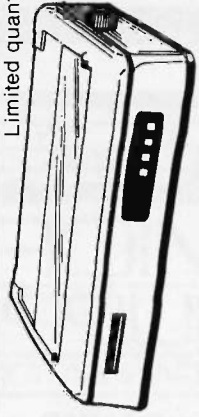

Bi-directional deluxe tractor \$249 \$14995  
Automatic cut sheet feeder \$449 \$19995

\*StarWriter is a Trademark of C. Itoh Digital Products, Inc.



## HARD DISK SYSTEM FOR YOUR IBM PC

# \$399.95

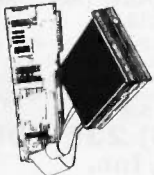

Complete with controller card, data cable, and mounting hardware, totally PC/XT compatible.

10 MB Internal Kit	_____	LIST	JADE
20 MB Internal 1/2 High	_____	_____	_____
			399.95
			489.95

## POWER/SURGE STRIPS

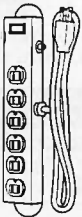

6 Socket, UL Listed, U.S. Made Power/Surge Strip  
List Price \$49 **\$1895**

6 Button, Under-Monitor, Swivel Power/Surge Control Center  
List Price \$129 **\$7995**

## 360K DISK DRIVE

# \$69.95

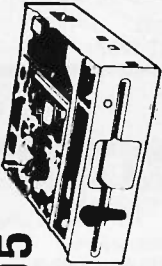

IBM PC, XT  
or  
Compatible

TANDON 100-2, DS, DD	_____	LIST	JADE
TEAC 55B, DS, DD	_____	_____	_____
			\$119.95
			\$119.95

## 20 MEGABYTE HARD- CARD

- Uses only one slot
- 21.3 MB formatted capacity
- Low power - only 11 watts
- Installs in just minutes
- Works w/standard power supply

## 80 COLUMN PC PRINTER

# \$98

CALL FOR DETAILS!

### FREE Software W/MOUSE

Microsoft Mouse w/Paintbrush	_____	LIST	JADE
PC Mouse w/PC Paint Plus	_____	_____	_____
			\$139.95
			\$139.95

### High Speed APU Chips

8087-3	_____	LIST	JADE
8087-2	_____	_____	_____
			\$249.95
			\$24.95

### AST Boards On Sale!

AST Six Pak Plus 64K	_____	LIST	JADE
AST Six Pak Plus 384K	_____	_____	_____
AST Rampage 256K	_____	_____	_____
AST Rampage 2 MB	_____	_____	_____
AST Advantage-AT 128K	_____	_____	_____
AST Advantage-AT 3 MB	_____	_____	_____
			\$395
			\$299.95
			\$379.95
			\$679.95
			\$399.95
			\$999.95

### ISO-BAR

These industrial quality ISO-BAR's contain surge suppression circuitry and built-in noise filters plus a 15 amp circuit breaker.

6 Socket, 1 Filter ISO-BAR	_____	\$44.95
8 Socket, 2 Filter ISO-BAR	_____	\$59.95
8 Socket, 4 Filter ISO-BAR	_____	\$69.95
200 Watt Standby Power Supply	_____	\$359
425 Watt Standby Power Supply	_____	\$539
		\$449.95

### MICROFAZER Buffers

Expandable to 64K (Parallel model to 512K)

8K Parallel in/Parallel out	_____	\$169
64K Parallel in/Parallel out	_____	\$164.95
128K Parallel in/Parallel out	_____	\$225
512K Parallel in/Parallel out	_____	\$445
Your choice: serial in/serial out; parallel in/serial out; serial in/parallel out.	_____	\$879
8K	_____	\$199
64K	_____	\$260
		\$199.95

### TALLTREE

JRAM-2	_____	LIST	JADE
0K	_____	_____	_____
2 MB	_____	_____	_____
JRAM-3	_____	_____	_____
0K	_____	_____	_____
2 MB	_____	_____	_____
			\$169.95
			\$599.95
			\$199.95
			\$629.95

### Printers

EPSON FX-85	_____	LIST	JADE
EPSON FX-286	_____	_____	_____
EPSON LQ-800	_____	_____	_____
EPSON LQ-1000	_____	_____	_____
EPSON LX-80	_____	_____	_____
			\$799
			\$899
			\$699
			\$539
			\$359.95

PRICED TOO LOW TO PUBLISH!  
Call us for our best price.

### New HAYES 2400B Internal

New 2400B Card w/S martcom	_____	LIST	JADE
HAYES Smartmodem 2400	_____	_____	_____
HAYES Smartmodem 1200	_____	_____	_____
HAYES 1200B w/o Smartcom II	_____	_____	_____
HAYES 1200B for IBM PC	_____	_____	_____
			\$579.95
			\$629.95
			\$389.95
			\$339.95
			\$359.95

### Multifunction Card

Up to 384K, parallel printer port, RS-232 serial port, game port, clock/calendar, RAM disk/printer buffer software package.

OK JADE 7 Pak Plus	_____	LIST	JADE
384K JADE 7 Pak Plus	_____	_____	_____
			\$299
			\$649

### 135/150 Watt Power Supply

135 Watt Power Supply	_____	LIST	JADE
150 Watt Power Supply	_____	_____	_____
			\$199
			\$249

### Apple Accessories

11c 1/2 High Disk Drive	_____	LIST	JADE
11e 1/2 High Disk Drive	_____	_____	_____
11e, 11+ Disk Drive Full Ht.	_____	_____	_____
11e 64K, 80 Column Card	_____	_____	_____
Grappler, Printer Card	_____	_____	_____
11+ 16K RAM Card	_____	_____	_____
11+, 11e Printer Card & Cable	_____	_____	_____
11+, 11e Cooling Fan	_____	_____	_____
			\$279
			\$239
			\$249
			\$159
			\$89.95
			\$99
			\$109
			\$49.95
			\$99

### INTEL Above Board

64K PC expands to 2MB	_____	LIST	JADE
2MB PC Above Board	_____	_____	_____
128K AT expands to 4MB	_____	_____	_____
4 MB AT Above Board	_____	_____	_____
			\$299.95
			\$599.95
			\$449.95
			\$1299.95

### IBM Video Boards

Hercules Color Graphics	_____	LIST	JADE
JADE Color Graphics	_____	_____	_____
Hercules Monochrome Graphics	_____	_____	_____
JADE Monochrome Graphics	_____	_____	_____
JADE EGA+ Card	_____	_____	_____
			\$245
			\$199
			\$499
			\$299.95
			\$495

# JADE COMPUTER

We accept cash, checks, credit cards or purchase orders from qualified firms and institutions. Minimum prepaid order \$15.00. California residents add 6 1/2% tax. Prices & availability subject to change without notice. Shipping & handling charges via UPS Ground 50c/lb. UPS Air \$1.00/lb. Minimum charge \$3.00.

4901 W. Rosecrans Ave. Box 5046  
Hawthorne, CA 90251-5046



Continental U.S.A.  
**(800)421-5500**  
Inside California  
**(800)262-1710**  
Los Angeles Area  
**(213)973-7707**

**PLACE  
ORDERS  
TOLL  
FREE!**

**Printer (Data) switch \$45.00**  
Distributors, Dealers welcome

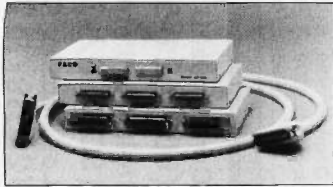

- Metal case, fully shielded
- Dimension: 1" x 4 1/4" x 8 1/4"
- Push button switch
- All pin switched
- 2 layer PC board
- Color: beige
- 1 year warranty

Switch box D type (RS232) Centronic	RS-232 Miniature Gender Changer MM, P/F Null Modem:	\$7
2 way switch (push button)	Jumper box, Surge protector	\$10
2 way cross (rotary)	Mini-toster, Mini-patch box	\$10
4 way switch (rotary)		\$15

**Cable**

Molded, shielded, UL cable \$12 and up

**30 Day Money Back Guarantee**

Terms: Shipping & handling \$3.00, C.O.D. add \$1.90 California residents add sales tax

**JACO ENTERPRISES**

1478 POPPY WAY, CUPERTINO, CA 95014  
(408) 996-0675

Inquiry 168

**NEW --- ZIPCALC**

FOR TURBO PASCAL™

**INSTANT TEXT DISPLAY** - the Pascal "write" procedure takes several seconds to fill the screen with text. ZIPCALC does it in less than 1/10 sec. Instant windowing capability is also included.

**ULTRA FAST NUMBER DISPLAY** - ZIPCALC removes the real number time barrier with a 32-bit Long Integer data type that converts to a string 7 times faster.

**HIGH SPEED COMPUTATION** - the Long Integer is ideal for many financial and other applications with its dramatic increase in computation speed. ZIPCALC provides a full set of procedures for Long Integer arithmetic, shifts, compares, conversions to other data types, and full string conversions. ZIPCALC has the power of a 32-bit processor in Pascal callable form.

**EASY TO LEARN - EASY TO USE** - ZIPCALC consists of 35 highly optimized routines, most assembler coded, a tutorial User's Guide, programmed demos, and many examples.

**IBM PC & TRUE COMPATIBLES**  
\$45 includes N.Y. sales tax & shipping

**DYNAMUS** 1045-B Gravel Road  
MICRO-DATA SYSTEMS, INC. Webster, N.Y. 14580  
(716) 671-5866  
Turbo Pascal is a trademark of Borland Int. Inc.

Inquiry 122

To be merely compatible isn't enough...

**Be the best!**

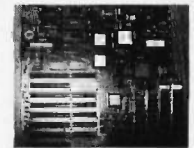

**Manufacturer directly offer : OEM, VAR, Dealer**

- \* 5 VLSI chips set
- \* more reliable than IBM PC/AT
- \* 6/8, 6/10 MHz software switch
- \* 7 DMA channel
- \* Expandable to 1MB memory on board
- \* System clock/calendar with CMOS RAM buffer and battery backup
- \* Fully AT compatible

**Wisetek International Co.**

469 Valley Way  
Milpitas, CA 95035  
Tel : (408) 263-1237

Inquiry 378

If you paid more for Chips,  
you didn't buy them at:

**MicroTech**

(206) 364-2209, 8 - 6 Mon.-Sat.  
P.O.Box 75673, Seattle, WA 98125

**RAMS**

256K	150 ns	2.75
256K	120 ns	3.25
64K	150 ns	1.20
64K	120 ns	1.35
6264LP-15	150 ns	3.15

**EPROMS**

2764	250 ns	3.25
2764	200 ns	3.75
27C64	250 ns	3.75
27128	250 ns	3.65
27256	250 ns	5.55

Shipping & handling: UPS ground \$2.00. Prices subject to change, Master Card/Visa add 3%, Wash. residents add 7.9% sales tax.

Satisfaction 100% guaranteed!

Inquiry 228

**TELECOMP**

A Complete System, PC/XT Compatible, 640K ..... \$685

**ADD-ON & ACCESSORY**

5151 Style Keyboard	..... \$75
AT Style Keyboard	..... \$75
384K Multifunction (OK)	..... \$95
Color/Graphic/Printer	..... \$63
135W PS	..... \$69
Floppy Drive Controller	..... \$39
Parallel Printer Cable	..... \$15
XT Type Case	..... \$39
AT Type Case	..... \$75
Seagate 225+WD	..... \$495
Taxan 620	..... \$395
PC/XT Turbo 4 Layers	..... \$155
Taxan 630	..... \$435
Turbo MB 640K/4 Layer	..... \$195
Samsung TTL	..... \$95
Special Price For Dealer	
System Turbo 4 Layers/xt	..... \$925

IBM is a registered trademark of International Business Machines Corporation

9282 Bolsa Ave.,  
Westminster, CA 92683  
(714) 894-8954 Telex. 3719632-CHTRADE

Inquiry 345

**NEW EPROM PROGRAMMER**  
EPROM-1 ..... \$495



- \* Programs all 28-Pin, 5-Volt EPROMs and EEPROMs.
- \* Perfect for engineering workstations, field service and small production runs.
- \* Simple keyboard and display for stand alone duplication.
- \* Interface to your computer via an RS232C port.
- \* PC control software included at no extra charge.

**TO ORDER PHONE:**

800-325-6028 Outside California

916-885-7262 Inside California

Visa and MasterCard accepted

INTERNATIONAL MICROSYSTEMS 11554 C Avenue  
INCORPORATED Auburn, CA 95603

Inquiry 164

**20 Meg Hard Disk Kit—\$435<sup>00</sup>**

Includes Half Height 20MB Hard Disk with controller and cables, 1 year warranty.

**Turbo Plus Motherboard w/0K—\$215<sup>00</sup>**

5 or 8 MHz switchable without powerdown, runs 3 times faster than PC/XT in 8 MHz

**PC/XT COMPATIBLE PARTS**

JUMBO-640 (4.77 MHz)	
Motherboard w/0K	\$125.00
AT-1 Meg Motherboard w/0K	\$745.00
Mono/Graphic Card w/ Printer Port	\$ 85.00
Color Card with Printer Port	\$ 85.00
EGA Color Card	\$275.00
RAMBANK Memory Expansion Card w/0K	\$215.00
Internal Modem (1200 baud)	\$165.00
Mitsubishi 360K Floppy Disk Drive	\$115.00
Irwin Tape Drive (10 Meg)	\$395.00

**LUCKY COMPUTERS**

(214) 690-6110

2011 Brandeis, Richardson, TX 75081

Inquiry 197

**I.C.s and Peripherals**

- \* **64K / 128K / 256K D-RAMs** at the **LOW PRICES**
- H-P Vectra 128K Upgrade** ..... \$39.85
- \* **V20-5** ..... \$14.00 / **V20-8** ..... \$18.00
- V30-8** ..... \$18.00 / **8087** ..... \$115.00
- 8087-2** ..... \$155.00 / **80287-3** ..... \$180.00
- \* **TEAC FD55-BV DS/DD Disk Drives** w/1 year factory warranty ..... \$95.00
- \* **MultiTech External Modem MultiModem** (100% Hayes compatible) 1200/300 bps ..... \$249.00
- 2400/1200/300 bps ..... \$449.00
- \* **Memory Boards**
- JRAM2-P / 2-S w/2MB ..... \$349.00
- JRAM3-P / 3-S w/2MB ..... \$399.00
- JRAM-AT3-P w/2MB ..... \$449.00
- Par/Ser/Clock Module ..... \$115.00
- \* **155W Power Supply** for IBM/PC & XT ..... \$125.00
- \* **2732, 2784, 27128, 27256, 4464, 6116, 6264**, etc. are available!

WARRANTY: All I.C.s are guaranteed for 180 days from the invoice date on defective items. We will replace them free of charge.

**Advanced Technology Products, Corp.**

P.O. Box 2205 / 1141 Georgia Ave., Silver Spring, MD 20902

**301-933-3523**

Prices are subject to change without notice.

Call us for the latest prices.

.... OEMS AND DEALERS ARE INVITED ....

Inquiry 11

**Ramjet 256K Print Buffer**



- FREES YOUR COMPUTER UP FAST
- FULL 256K BYTES OF BUFFER SPACE
- FAST DATA RATE - UP TO 7000 CPS
- WILL PAUSE FOR INDIVIDUAL PAGES
- MUCH LESS EXPENSIVE THAN OTHERS
- ALL FOR ONLY \$269.00

The RAMJET 256K Print Buffer is available in either parallel or serial versions. Dealer inquiries are very welcome. Custom programming for special applications is available. For more information or to order the RAMJET 256K Print Buffer:

**CALL (206) 236-2983**  
**Omnitronix, Inc.**

P.O. Box 43 - Mercer Island WA 98040

Inquiry 244



# Our 1986 Catalog is HOT off the press!

## Dealers! Check our Profitable Discount Pricing!

**LOOK** what's Inside!

### 5 Complete Systems

**Pricing!**



**XAT TURBO**

The **XAT** is our most versatile and powerful system. Using Intel's **80286** processor, the system runs at 6 and 8 MHz with a true 16-bit data bus. Comes standard with a 3 meg Add-On board, 2 parallel & one serial port, monitor, keyboard, DOS 3.1, two 5 1/4 height DS DD 1.2 meg floppies.



**XPC TURBO**

This standard system is as compatible with IBM as it can be. Featuring a 4-layer motherboard, 8-slot expansion, up to 640K memory on the motherboard, and the 6.67 MHz **TURBO** mode. Also included, DOS 3.1, Keyboard, 135 watt power supply, TTL 720 x 348 resolution video card, green or amber monitor, serial & parallel ports, Real Time Clock and software.



**XTC TURBO**

The perfect choice for the system integrator who needs the IBM compatibility, but not in the standard PC cabinet. This model features hinged and removable sides, up to 3 1/2 height peripherals out front, front mount AC switch and rear mount 135 watt power supply. Also makes an ideal Host or File Server unit in multi-user configurations!



**XTjr.**

The **XTjr.** is only junior in size! With up to 640K memory on the motherboard and four expansion slots, this stand-alone system is also great for workstations in a networking environment. It can be upgraded to the **TURBO** two speed motherboard and you can also add up to 2 serial & 2 parallel ports or any IBM compatible expansion card. A perfect word processing data entry system.



**XPC Compact**

This is truly the affordable portable, and will build it to your specifications. Need a 20 meg hard disk and 20 meg tape with 640K memory in your portable? No problem! The **XPC Compact** comes standard with a 9" amber TTL monitor, 135 watt P.S., 256K memory, two 360K drives, Real Time Clock/Calendar w/ battery Back-up, serial and parallel ports, and our **TURBO** Motherboard.

Amsterdam ■ 020-45-26-50

### 24 Add-On Cards

Germany ■

**2 MB Expansion Board**



This board satisfies the new approach suggested by Intel and Lotus 1-2-3. Also may be used on our **XT-SBC TURBO** board for memory based at 0K.

**Hard Disk Controller**



This Western Digital controller handles 1 or 2 drives, 5 to 140 megabytes with minimum software configuration. Features DOS 2.1 & 3.1 compatibility, and ST-506 Interface.

**384K Multi-Function**



A Multi-function board featuring Parallel Port, Serial Port, Game Port, Real Time Clock/Calendar with Battery Back-up. Expand to 384K, all Cables, PrintSpooler and RAM Disk Software, and Manuals.

**4 Meg Token Ring**



Connect your workstation to an existing 4 Megabyte IBM token ring system or build up your own IEEE 802.5 standard system. The lowest possible cost for 100% industry standard compatibility.

**AT H.D. & Floppy**



This new Western Digital combo board with its Hi-speed VLSI technology will give you a data transfer rate 50% faster than the existing combo board in the AT. Runs both 360K and 1.2 meg floppy disk drives.

**Mono & Color Graphics**



Supports two levels of graphics and text in composite monochrome or RGB color. Low resolution 320 x 200 pixel, high resolution 640 x 200 pixel.

**7 PAK Multi-Function**



Features Floppy Controller, Parallel Port, Serial Port (optional 2nd Serial), Game Port, Real Time Clock/Calendar with Battery Back-up, RAMdisk, Print-Spooler, all cables & manuals.

**PROM Laser**



Hi-speed algorithms will burn 2716, 2732, 2732A, 2764 (in 52 sec), 27128, 27256 EPROMs under software control right in your PC. Zero Force Insertion Sockets, Software, and Manual.

England ■

### 35 Components

Bombay ■ 357172

**Motherboards**

**XAT TURBO XT-SBC**

- RTC Calendar
- 6 & 8 MHz clock
- 8-slot expansion
- Intel 80286
- 4 77 & 8 MHz clock
- Serial & Parallel
- 4-layer PCB design
- RTC Calendar

**XPC TURBO XPC-XT**

- 4 77 & 6 67 MHz
- 4-layer PCB design
- 8-slot expansion
- up to 640K Memory
- 8088-2 processor
- Standard 4 77 MHz
- up to 640K memory
- 8-slot expansion
- standard 8088 CPU
- 8087 socket avail

**Power Supplies**

**XT 135 watt XT 150 watt**

- 135w switching
- Whisper Fan
- Side AC switch
- +5V-15A -5V-5A
- +12V-4.2A -12V-5A
- Whisper fan
- Hi-output 150 watt
- 4 DC connectors
- +5V-15A -5V-5A
- +12V-5.5A -12V-5A

**AT 200 watt XTC 135**

- 200 Watt power
- Exterior AC switch
- 4 DC power conn
- +5V-20A -5V-5A
- +12V-7.7A -12V-5A
- Rear Mount
- Rear On Off switch
- extra AC outlets
- +5V-15A -5V-5A
- +12V-4A -12V-5A

**Cabinets**

The **XTjr.** cabinet is only 3" x 16.5" x 15" yet it will hold a standard XT compatible motherboard includes a switching power supply. Front panel cut-out for a half-height floppy or hard disk.

Our **XPC-XT** cabinet has an 8-slot back panel with additional cut-outs for two RS-232-C ports. Features mounting for up to four half height peripherals.

The right choice for an external add-on cabinet! Add-on a floppy tape back-up or up to 33 meg of hard disk (half height). Switching power supply is included.

**Keyboards**

**AT**

This keyboard is standard equipment with all of our **XAT** systems, but the layout is so well liked, we're offering it here.

**XT**

Our volume purchases of these IBM style units allows us to lower the price once again.

**5051**

Now a fully electric unit at an affordable price! Features a 10-key numeric pad & a separate cursor pad.

**Drives**

**Archive**

**Irwin**

**Maxtor**

**Memtek**

**Miniscribe**

**Panasonic**

**Seagate**

**TEAC**

**Tulin**

### 3 Sub-Systems

### 3 Networks

### Cassette Training

### Int/Ext Modems

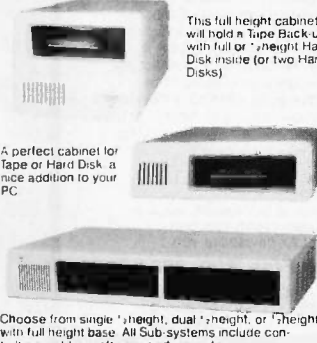

This full height cabinet will hold a Tape Back-up with full or 1/2 height Hard Disk inside (for two Hard Disks).

A perfect cabinet for Tape or Hard Disk, a nice addition to your PC.

Choose from single 1/2 height, dual 1/2 height, or 1/2 height with full height base. All Sub-systems include controllers, cables, software and manuals.

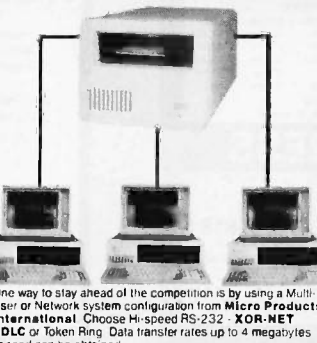

One way to stay ahead of the competition is by using a Multi-User or Network system configuration from **Micro Products International**. Choose Hi-speed RS-232-C **XOR-NET** SDLC or Token Ring. Data transfer rates up to 4 megabytes/second can be obtained.



What is the Cassette Training concept? Using Interactive Audio Training to combine the advantage of classroom and self-teaching methods. The Method One audio track delivers a lecture explaining the program, while the second track emulates the keyboard, actually running the Student's computer. At frequent intervals the tape pauses automatically to allow the student keyboard input, which is monitored for accuracy by the **KEYBOARD**.

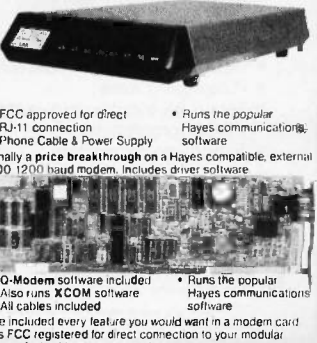

- FCC approved for direct RJ-11 connection
- Phone Cable & Power Supply
- Finally a price breakthrough on a Hayes compatible, external 300/1200 baud modem. Includes driver software.
- Runs the popular Hayes communications software
- O-Modem software included
- Also runs XCOM software
- All cables included
- Runs the popular Hayes communications software

We included every feature you would want in a modem card. It's FCC registered for direct connection to your modular phone jack with the cord included.

## PC Compatible CASH DRAWERS

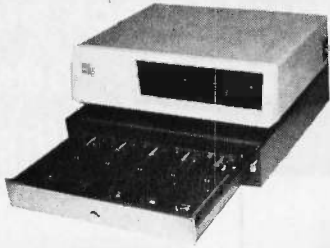

### M-S CASH DRAWER

10711 Flower St., Stanton, CA 90680

**(800) 544-1749**

In California call:

**(714) 821-1133**

Inquiry 232

## COMPUTERIZED CONCEPTS

4333 66th ST. N.  
ST. PETERSBURG  
FL 33709 USA

**NEW!**

### "INTER SOL"

Ever had a bad experience with Business software? Irritating isn't it? We thought so too, so we designed **INTER SOL!** Fully-Integrated, 12 modules, very easy to use, you can buy it and have it **CUSTOMIZED** for your needs! **FEATURES:** A/R-A/P-G/L-PURCHS-INVOICE-SALES-REPORTS-FIN STS-TAXES-PAYROLL-DAILY REPORTS.

AVAILABLE "WITH SOURCE CODES" I You customize it, or we will! **SAVE HUNDREDS OF DOLLARS!** Get it ALL with "INTER SOL", the fully-integrated solution.

INTER SOL . . . . (12 modules) . . . . \$97.00  
INTER SOL . . . (SOURCE CODES) \$122.00  
add \$3.00 S/H VISA-MC-CHECK  
**(813) 545-1996**

Inquiry 87

## CHANGING SYSTEMS? What Happens to Your Data? Does JUST Media Conversion Solve Incompatibilities?

### WHAT IF . . .

everything is changing, including your software, hardware, operating systems and media? What happens to your **spreadsheet** data and formulas, **database** structures and/or word processing documents and codes?

What do you do, and what is the cost?

### We Make Incompatible Data Compatible!

The source can be mainframes, minis, micros, dedicated word processors or typesetters. **ADAPSO** member.

**CompuData Translators, Inc.** 213-462-6222  
6565 Sunset Bl, #301 Hollywood, CA 90028

Inquiry 74

## 5 1/4" FLOPPY MOTORS

Now Buehler OEM replacement spindle motors for all major 5 1/4-inch, full-height floppy disk drives are available for fast delivery. Built to exact OEM size, performance and quality standards. Pulleys included.

For details and prices, contact:

Buehler Services, Inc.  
P.O. Box A, Hwy 70-E  
Kinston, NC 28501  
Phone: 919/522-4300





**5 1/4" SS/DD \$ .64**

OTHER BRANDS AS LOW AS \$ .54  
BULK DISKETTES- QUANTITIES  
OF 500 with TYVEK SLEEVES

**RIBBONS (All Brands)**  
EPSON MX 70/80 **\$4.20**  
Prices based on quantities of 48

C.O.D. **800-222-0490** C.O.D.  
201-462-7628 In N. J.

**MEGAsoft** P.O. Box 710,  
Freehold, NJ 07728

Inquiry 213

**NEW!**



**SafeSkin™**  
KEYBOARD PROTECTOR

Remains in place during keyboard use. Prevents damage from liquid spills, dust, ashes, etc. Fits like a second skin, excellent feel. Available for: IBM-PC, AT, Apple (all), Compaq, Model 100, NEC 8201, C64, Zenith 150, DEC, Kaypro, KB5151, AT&T 6300, WYSE 50 and many others. Send \$29.95, check, M.O., Visa & MC include exp. date. Specify computer type. Dealer inquiries invited. Free brochure avail.

**Merritt Computer Products, Inc.**  
2925 LBJ Fwy, #180 / Dallas, Texas 75234  
(214) 339-0753

Inquiry 215

## The ALL NEW SIBEC II



- 8052AH BASIC V1.1 CPU
- iSBX\* expansion connectors
- Prototyping area
- Five 8 bit input/output ports
- PROM programmer
- Expansion connectors

**CALL TODAY 603/469-3232**  
**\$295**



**Binary Technology, Inc.**

MAIN ST., P.O. BOX 67 • MERIDEN, NH 03770  
603/469-3232

\*iSBX is a trademark of the Intel Corporation

Inquiry 405

### DYNAMIC RAMS

41256	100ns	\$6.85
41256	120ns	\$3.35
✓41256	150ns	<del>\$2.75</del>
4164	120ns	\$1.40
✓4164	150ns	<del>\$1.30</del>
4464	150ns	\$5.50

PROCESSORS		E. PROMS	
8087-2	8MHz \$160.00	27C256	250ns \$8.50
8087-3	5MHz \$125.00	27256	250ns \$7.50
80287-3	6MHz \$195.00	27128	250ns \$3.95
80287-8	8MHz \$ CALL	27C64	200ns \$5.25
V-20	8MHz \$ CALL	2764	250ns \$3.50
V-30	8MHz \$ 20.00	2732A	250ns \$4.25
STATIC RAMS		8000's	
6264LP-15	150ns \$2.95	(Paris in stock)	

### I.C. EXPRESS

15358 Valley Blvd., City of Industry, CA 91746  
Phone: 818-369-2688 (Mon-Fri • 8-5)

ORDER TOLL FREE  
**(800) 892-8889 • (800) 882-8181**

Outside California Inside California

CALL FOR CURRENT PRICES & VOLUME DISCOUNTS.  
Price Shown for Cash • MasterCard/VISA add 3% more.  
Prices are subject to change. Minimum order \$10.00  
California residents must add 6.5% sales tax.  
Shipping & Handling: UPS Ground \$5.00, UPS Air \$7.00 (under 1 lb.)  
ALL MERCHANDISE IS 100% GUARANTEED.

Inquiry 160

### COLOR VT220 \$150\*

\*plus your

PC, jr, XT, AT or compatible

ZSTEMpc-VT220 Smart Terminal Emulator  
132 col. by windowing - no addit. hardware  
Double High Double Wide Characters  
Full VT100 line graphics. Smooth scrolling  
2-way file transfers incl. XMODEM and KERMIT

Full keyboard soltkeys/MACROS  
Data rates to 38.4KB. High Throughput  
Color/graphics, monochrome & EGA support  
International Font Support • DOS Access  
ISO and attribute mapped color

ZSTEMpc-VT220 \$150. 4010/4014 Option \$99  
ZSTEMpc-VT100 — Choice of the U.S. Airforce  
30 day money back guarantee. MC/VISA

**KEA SYSTEMS LTD.**  
#412 - 2150 W. Broadway  
Vancouver, B.C. CANADA V6K 4L9  
Support (604) 732-7411  
TELEX 04-352848 VCR

**Order Toll Free (800) 663-8702**

Zstem by KEA SYSTEMS

Inquiry 410



# THE LATEST IN PC ENHANCEMENT PRODUCTS

## ENHANCED GRAPHICS ADAPTOR \$295.00

100% IBM COMPATIBLE—PASSES IBM EGA DIAGNOSTICS

- COMPATIBLE WITH IBM EGA, COLOR GRAPHICS ADAPTOR AND MONOCHROME ADAPTOR
- DISPLAYS 16 COLORS OUT OF 64 COLORS
- COMES WITH 256K OF VIDEO RAM
- DUAL SCANNING FREQUENCIES—WORKS WITH STANDARD OR EGA TYPE RGB MONITORS
- LIGHT PEN INTERFACE

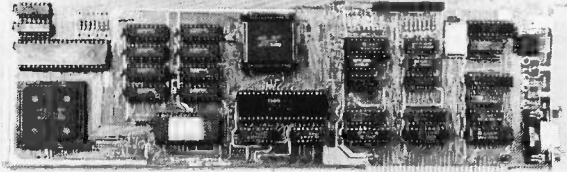

## EXTENDED MEMORY CARD \$199.95

UP TO 2 MEGABYTES OF LOTUS/INTEL COMPATIBLE MEMORY

- CONFORMS TO LOTUS/INTEL EXTENDED MEMORY SPECIFICATIONS (EMS)
- SHIPPED WITH ZERO K RAM, USER EXPANDABLE TO 2 MEGABYTES
- USES 64K OR 256K DYNAMIC RAMS
- USE AS EXTENDED (EMS) OR CONVENTIONAL MEMORY, RAMDISK OR SPOOLER
- SOFTWARE INCLUDES EMS DEVICE DRIVERS, PRINT SPOOLER AND RAMDISK

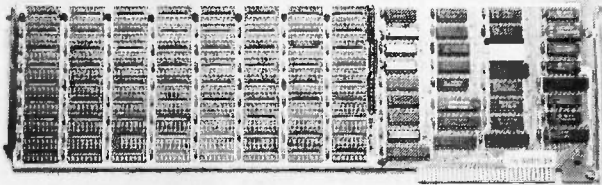

## AT MULTIFUNCTION CARD \$199.95

ADDS UP TO 3 MEGABYTES OF USER EXPANDABLE MEMORY

- SHIPPED WITH ZERO K RAM, USER EXPANDABLE TO 1.5 MEGABYTES RAM ON BOARD, UP TO 3 MEGABYTES WITH OPTIONAL PIGGYBACK CARD
- USES 64K OR 256K DYNAMIC RAMS
- PARALLEL PORT & GAME PORT
- SERIAL PORT
- OPTIONAL SECOND SERIAL PORT

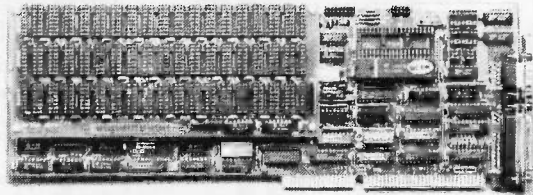

**PIGGYBACK MEMORY CARD (NO MEMORY INSTALLED) \$49.95**

## CLASSIC 286 SPEED PAK \$795.00

8 MHz 80286 ACCELERATOR BOARD FOR IBM PC/XT

- 8MHz 80286 RUNS 33% FASTER THAN A STANDARD AT
- RUNS AT PROGRAMS—COMPATIBLE WITH DOS 2.1, 3.0 & 3.1
- COMPATIBLE WITH ALL PC/XT HARDWARE & SOFTWARE WITH NO PATCHES OR MODIFICATIONS NEEDED
- 1 MEGABYTE MEMORY ON BOARD, EXPANDABLE TO 16MB
- HIGH SPEED 16-BIT BIOS AND RAM
- OPTIONS INCLUDE 80287 MATH CO-PROCESSOR, MULTITASKING SUPPORT AND MULTIUSER SUPPORT

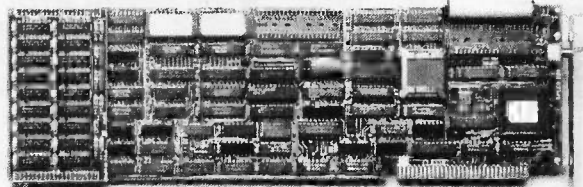

## EPROM PROGRAMMER \$129.95

FOR IBM PC/XT/AT AND COMPATIBLES

- PROGRAMS 27xxx SERIES EPROMS UP TO 27512
- MENU DRIVEN SOFTWARE PROVIDED ON DISKETTE
- AUTOMATICALLY SETS PROGRAMMING VOLTAGE
- LOADS AND SAVES EPROM BUFFER TO DISK
- READ, WRITE, COPY, VERIFY OR CHECK BLANK
- DEBUG STYLE EDITOR FOR EASY MODIFICATION OF PROGRAM
- SPLITS OR COMBINES EPROMS OF DIFFERING SIZES
- INTERNAL CARD WITH EXTERNAL ZIF SOCKET MODULE

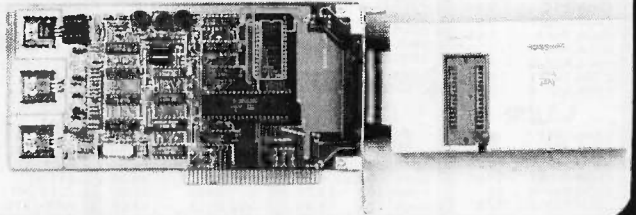

VISIT OUR RETAIL STORE LOCATED AT 1256 SOUTH BASCOM AVENUE IN SAN JOSE



**JDR Microdevices**

1224 S. Bascom Avenue, San Jose, CA 95128

Toll Free 800-538-5000 • (408) 995-5430

FAX (408) 275-8415 • Telex 171-110

© COPYRIGHT 1986 JDR MICRODEVICES

HOURS: M-W-F, 9-5

TU-TH, 9-9

SAT, 10-3

PLEASE USE YOUR CUSTOMER NUMBER WHEN ORDERING

TERMS: Minimum order \$10.00. For shipping and handling include \$2.50 for UPS Ground and \$3.50 for UPS Air. Orders over 1 lb. and foreign orders may require additional shipping charges - please contact our sales department for the amount. CA residents must include applicable sales tax. All merchandise is warranted for 90 days unless otherwise stated. Prices are subject to change without notice. We are not responsible for typographical errors. We reserve the right to limit quantities and to substitute manufacturer. All merchandise subject to prior sale.

THE JDR MICRODEVICES LOGO IS A REGISTERED TRADEMARK OF JDR MICRODEVICES. JDR INSTRUMENTS AND JDR MICRODEVICES ARE TRADEMARKS OF JDR MICRODEVICES. IBM IS A TRADEMARK OF INTERNATIONAL BUSINESS MACHINES. APPLE IS A TRADEMARK OF APPLE COMPUTER.

# BUILD A COMPLETE 256K XT SYSTEM—\$717

## STATIC RAMS

2101	256x4 (450ns)	1.95
5101	256x4 (450ns)(CMOS)	3.95
2102L-4	1024x1 (450ns)(LP)	.99
2112	256x4 (450ns)	2.99
2114	1024x4 (450ns)	.99
2114L-4	1024x4 (450ns)(LP)	1.09
2114L-2	1024x4 (200ns)(LP)	1.49
2114L-15	1024x4 (150ns)(LP)	1.95
TMS4044-4	4096x1 (450ns)	1.95
TMM2016-150	2048x8 (150ns)	1.49
TMM2016-100	2048x8 (100ns)	1.95
HM6116-4	2048x8 (200ns)(CMOS)	1.39
HM6116-3	2048x8 (150ns)(CMOS)	1.49
HM6116LP-4	2048x8 (200ns)(CMOS)(LP)	1.49
HM6116LP-3	2048x8 (150ns)(CMOS)(LP)	1.59
HM6116LP-2	2048x8 (120ns)(CMOS)(LP)	2.95
HM6264P-15	8192x8 (150ns)(CMOS)	3.89
HM6264LP-15	8192x8 (150ns)(CMOS)(LP)	3.95
HM6264LP-12	8192x8 (120ns)(CMOS)(LP)	4.49

LP=Low power

## DYNAMIC RAMS

4116-250	16384x1 (250ns)	.49
4116-200	16384x1 (200ns)	.69
4116-150	16384x1 (150ns)	.89
4116-120	16384x1 (120ns)	1.49
MK4332	32768x1 (200ns)	6.95
4164-200	65536x1 (200ns)(5v)	1.19
4164-150	65536x1 (150ns)(5v)	1.29
4164-120	65536x1 (120ns)(5v)	1.95
MCM6665	65536x1 (200ns)(5v)	1.95
TMS4164	65536x1 (150ns)(5v)(REFRESH)	1.95
4164-REFRESH	65536x1 (150ns)(5v)(REFRESH)	2.95
TMS4416	16384x4 (150ns)(5v)	4.95
41128-150	131072x1 (150ns)(5v)	5.95
TMS4464-15	65536x4 (150ns)(5v)	6.95
41256-200	262144x1 (200ns)(5v)	2.95
41256-150	262144x1 (150ns)(5v)	2.95

5v=Single 5 Volt Supply REFRESH=Pin 1 Refresh

## ★★★★HIGH-TECH★★★★

### NEC V20 UPD70108 \$14.95

REPLACES 8088 TO SPEED UP IBM PC 10-40%

- \* HIGH-SPEED ADDRESS CALCULATION IN HARDWARE
- \* PIN COMPATIBLE WITH 8088
- \* SUPERSET OF 8088 INSTRUCTION SET
- \* LOW POWER CMOS

8MHz V20 UPD70108-8 \$24.95  
8MHz V30 UPD70116-8 \$26.95

## ★★★★SPOTLIGHT★★★★

## EPROMS

2708	1024x8 (450ns)	3.95
2716	2048x8 (450ns)(5V)	3.49
2716-1	2048x8 (350ns)(5V)	3.95
TMS2532	4096x8 (450ns)(5V)	3.95
2732	4096x8 (450ns)(5V)	3.89
2732A	4096x8 (250ns)(5V)(21V PGM)	3.95
2732A-2	4096x8 (200ns)(5V)(21V PGM)	4.25
27C64	8192x8 (250ns)(5V)(CMOS)	5.95
2764	8192x8 (450ns)(5V)	3.49
2764-250	8192x8 (250ns)(5V)	3.95
2764-200	8192x8 (200ns)(5V)	4.25
MCM68766	8192x8 (350ns)(5V)(24 PIN)	17.95
27128	16384x8 (250ns)(5V)	4.25
27C256	32768x8 (250ns)(5V)(CMOS)	12.95
27256	32768x8 (250ns)(5V)	7.49

5V=Single 5 Volt Supply 21V PGM=Program at 21 Volts

## SPECTRONICS CORPORATION EPROM ERASERS

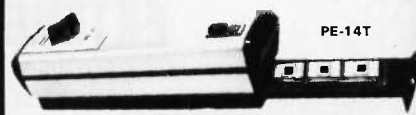

Model	Timer	Capacity Chip	Intensity (uW/Cm <sup>2</sup> )	Unit Price
PE-14	NO	9	8,000	\$83.00
PE-14T	YES	9	8,000	\$119.00
PE-24T	YES	12	9,600	\$175.00

# ORDER TOLL FREE 800-538-5000



### 8000

8035	1.49
8039	1.95
8080	2.95
8085	2.49
8087-2	169.95
8087	129.00
8088	6.95
8088-2	9.95
8155	2.49
8155-2	3.95
8748	7.95
8755	19.95
80286	129.95
80287	199.95

### 6500 1.0 MHz

6502	2.79
6502(CMOS)	9.95
6507	1.95
6520	4.95
6522	26.95
6532	6.95
6545	6.95
6551	5.95
6561	19.95
6581	34.95

### CRT CONTROLLERS

6845	4.95
6845	8.95
6847	11.95
HD46505SP	6.95
MC1372	2.95
8375	26.95
7220	19.95
CRT5027	12.95
CRT5037	9.95
TMS9918A	19.95

### CRYSTALS

32.768 KHz	.95
1.0 MHz	2.95
1.8432	2.95
2.0	1.95
2.097152	1.95
2.4576	1.95
3.2768	1.95
3.579454	1.95
4.0	1.95
4.032	1.95
5.0	1.95
5.0688	1.95
6.0	1.95
6.144	1.95
6.5536	1.95
8.0	1.95
10.0	1.95
10.738635	1.95
12.0	1.95
14.31818	1.95
15.0	1.95
15.0	1.95
17.430	1.95
18.0	1.95
18.432	1.95
20.0	1.95
22.1184	1.95
24.0	1.95
32.0	1.95

### 74LS00

74LS00	.16
74LS01	.18
74LS02	.17
74LS03	.18
74LS04	.16
74LS05	.18
74LS08	.18
74LS09	.18
74LS10	.16
74LS11	.22
74LS12	.22
74LS13	.26
74LS14	.39
74LS15	.26
74LS20	.17
74LS21	.22
74LS22	.22
74LS23	.22
74LS24	.26
74LS30	.17
74LS32	.18
74LS33	.28
74LS37	.26
74LS38	.26
74LS42	.39
74LS47	.59
74LS48	.69
74LS51	.17
74LS73	.29
74LS74	.24
74LS75	.29
74LS76	.29
74LS83	.49
74LS85	.49
74LS86	.22
74LS90	.39
74LS92	.49
74LS93	.49
74LS95	.49
74LS107	.34
74LS109	.39
74LS112	.29
74LS123	.49
74LS124	2.75
74LS125	.39
74LS126	.39
74LS132	.39
74LS139	.49
74LS136	.39
74LS138	.39
74LS147	.99
74LS148	.99
74LS151	.39
74LS153	.39
74LS154	1.49
74LS155	.59
74LS156	.36
74LS158	.29
74LS160	.29
74LS161	.39
74LS162	.49
74LS163	.39
74LS164	.49

### 74LS00

74LS165	.65
74LS166	.95
74LS169	.95
74LS173	.49
74LS174	.39
74LS175	.39
74LS191	.49
74LS192	.69
74LS193	.69
74LS194	.69
74LS195	.69
74LS196	.59
74LS197	.59
74LS221	.59
74LS240	.69
74LS241	.69
74LS243	.69
74LS244	.69
74LS245	.79
74LS251	.49
74LS256	1.79
74LS257	.39
74LS258	.49
74LS259	1.29
74LS260	.49
74LS266	.39
74LS273	.79
74LS279	.39
74LS280	.19
74LS283	.59
74LS290	.89
74LS293	.89
74LS299	1.49
74LS322	3.95
74LS323	2.49
74LS364	1.95
74LS365	.39
74LS367	.39
74LS373	.39
74LS374	.79
74LS375	.95
74LS377	.79
74LS378	1.18
74LS393	.79
74LS413	.49
74LS424	1.95
74LS464	.99
74LS465	.99
74LS469	1.29
74LS470	.89
74LS482	3.20
74LS483	3.20
74LS484	2.40
74LS485	1.49
74LS486	1.49
74LS487	1.49
74LS488	1.49
74LS489	1.49
74LS490	1.49
74LS491	1.49
74LS492	1.49
74LS493	1.49
74LS494	1.49
74LS495	1.49
74LS496	1.49
74LS497	1.49
74LS498	1.49
74LS499	1.49

## HIGH SPEED CMOS

A new family of high speed CMOS logic featuring the speed of low power Schottky (Bns typical gate propagation delay), combined with the advantages of CMOS: very low power consumption, superior noise immunity, and improved output drive.

### 74HC00

74HC: Operate at CMOS logic levels and are ideal for new, all-CMOS designs.

74HC00	.59	74HC148	1.19
74HC02	.59	74HC151	.89
74HC04	.59	74HC154	2.49
74HC08	.59	74HC157	.89
74HC10	.59	74HC158	.95
74HC14	.79	74HC163	1.15
74HC20	.59	74HC175	.99
74HC27	.59	74HC240	1.89
74HC30	.59	74HC244	1.89
74HC32	.69	74HC245	1.89
74HC51	.59	74HC257	.85
74HC74	.75	74HC259	1.39
74HC85	1.35	74HC273	1.89
74HC86	.69	74HC299	4.99
74HC93	1.19	74HC368	.99
74HC107	.79	74HC373	2.29
74HC109	.79	74HC374	2.29
74HC112	.79	74HC390	1.39
74HC125	1.19	74HC393	1.39
74HC132	1.19	74HC4017	1.99
74HC133	.69	74HC4020	1.39
74HC138	.99	74HC4049	.89
74HC139	.99	74HC4050	.89

### 74HC00

74HCCT: Direct, drop-in replacements for LS TTL and can be intermixed with 74LS in the same circuit.

74HC700	.69	74HC166	3.05
74HC702	.69	74HC174	1.09
74HC704	.69	74HC193	1.39
74HC708	.69	74HC194	1.19
74HC710	.69	74HC240	2.19
74HC711	.69	74HC244	2.19
74HC727	.69	74HC244	2.19
74HC730	.69	74HC259	2.19
74HC732	.79	74HC257	.99
74HC774	.85	74HC259	1.59
74HC775	.95	74HC273	2.09
74HC7138	1.15	74HC367	1.09
74HC7139	1.15	74HC373	2.49
74HC7154	2.39	74HC374	2.49
74HC7157	.99	74HC393	1.59
74HC7158	.99	74HC4017	2.19
74HC7161	1.29	74HC4040	1.59
74HC7164	1.39	74HC4060	1.49

### 74F00

74F00	.69	74F74	.79	74F251	1.69
74F02	.69	74F86	.99	74F253	1.69
74F04	.79	74F138	1.69	74F257	1.69
74F08	.69	74F139	1.69	74F280	1.79
74F10	.69	74F169	1.69	74F283	2.19
74F32	.69	74F240	3.29	74F374	4.29
74F64	.89	74F244	3.29	74F374	4.29

### 8200

8203	29.95
8205	3.29
8212	1.49
8216	1.49
8224	2.25
8237	4.95
8237-5	5.49
8250	6.95
8251	1.69
8251A	1.89
8253	1.89
8253-5	1.95
8255	1.69
8255-5	1.89
8259	1.95
8259-5	2.29
8272	4.95
8279	2.49
8279-5	2.95
8282	3.95
8284	2.95
8286	3.95
8288	4.95

### 2.0 MHz

6502A	2.95
6520A	2.95
6522A	5.95
6532A	11.95
6545A	7.95
6551A	6.95

### DISK CONTROLLERS

1771	4.95
1791	9.95
1793	9.95
1795	12.95
1797	12.95
2791	19.95
2793	19.95
2797	29.95
6843	19.95
8272	4.95
UPD765	4.95
MB8876	12.95
MB8877	12.95
1691	6.95
2143	6.95

## CRYSTAL OSCILLATORS

1.0MHz	5.95
1.8432	



# PARTIAL LISTING ONLY — CALL FOR A FREE CATALOG

## CMOS

4001	.19	14419	4.95
4011	.19	14433	14.95
4012	.25	4503	.49
4013	.35	4511	.69
4015	.29	4516	.79
4016	.29	4518	.85
4017	.49	4522	.79
4018	.69	4526	.79
4020	.59	4527	1.95
4021	.69	4528	.79
4024	.49	4529	2.95
4025	.25	4532	.95
4027	.39	4538	.95
4028	.65	4541	1.29
4035	.69	4553	5.79
4040	.69	4585	.75
4041	.75	4702	12.95
4042	.59	74C00	.29
4043	.85	74C14	.59
4044	.69	74C74	.59
4045	1.98	74C83	1.95
4046	.69	74C85	1.49
4047	.69	74C95	.99
4049	.29	74C150	5.75
4050	.29	74C151	2.25
4051	.69	74C161	.99
4052	.69	74C163	.99
4053	.69	74C164	1.39
4056	2.19	74C192	1.49
4060	.69	74C193	1.49
4066	.29	74C221	1.75
4069	.19	74C240	1.89
4076	.59	74C244	1.89
4077	.29	74C374	1.99
4081	.22	74C905	10.95
4085	.79	74C911	8.95
4086	.89	74C917	8.95
4093	.49	74C922	4.49
4094	2.49	74C923	4.95
14411	9.95	74C926	7.55
14412	6.95	80C97	.95

## 7400/9000

7400	.19	74147	2.49
7402	.19	74148	1.20
7404	.19	74150	1.35
7406	.29	74151	.55
7407	.29	74153	.55
7408	.29	74154	1.49
7410	.19	74155	.75
7411	.25	74157	.55
7414	.49	74159	1.65
7416	.25	74161	.69
7417	.25	74163	.69
7420	.19	74164	.85
7423	.29	74165	1.00
7430	.19	74166	.89
7432	.29	74167	.85
7438	.29	74177	.75
7442	.49	74178	1.15
7445	.69	74181	2.25
7447	.89	74182	.75
7470	.35	74184	2.00
7473	.34	74191	1.15
7474	.33	74192	.79
7475	.45	74194	.85
7476	.35	74196	.75
7483	.50	74197	.75
7485	.59	74199	1.35
7486	.35	74221	1.35
7489	2.15	74246	1.35
7490	.39	74247	1.25
7492	.50	74248	1.85
7493	.35	74249	1.95
7495	.55	74251	.75
7497	2.75	74265	1.35
74100	2.29	74273	1.95
74121	.29	74278	3.11
74123	.49	74367	.65
74125	.45	74368	.65
74141	.60	9368	3.95
74143	5.95	9602	1.50
74144	2.95	9637	2.95
74145	.60	96S02	1.95

## 74S00

74S00	.29	74S163	1.29
74S02	.29	74S168	3.95
74S03	.29	74S174	.79
74S04	.29	74S175	.79
74S05	.29	74S188	1.95
74S08	.35	74S189	1.95
74S10	.29	74S196	1.49
74S15	.35	74S206	1.49
74S30	.29	74S217	1.49
74S32	.35	74S226	3.99
74S37	.69	74S240	1.49
74S38	.69	74S241	1.49
74S74	.49	74S244	1.49
74S85	.95	74S257	.79
74S86	.35	74S253	.79
74S112	.50	74S258	1.95
74S124	2.75	74S280	1.95
74S138	.79	74S287	1.69
74S140	.55	74S288	1.69
74S151	.79	74S299	2.95
74S153	.79	74S373	1.69
74S157	.79	74S374	1.69
74S158	.95	74S471	4.95
74S161	1.29	74S571	2.95

## VOLTAGE REGULATORS

TO-220 CASE		
7805T	.49	7905T .59
7808T	.49	7908T .59
7812T	.49	7912T .59
7815T	.49	7915T .59
TO-3 CASE		
7805K	1.39	7905K 1.49
7812K	1.39	7912K 1.49
TO-93 CASE		
78L05	.49	79L05 .69
78L12	.49	79L12 1.49
OTHER VOLTAGE REGS		
LM323K	5V 3A	TO-3 4.79
LM328K	Adj. 5A	TO-3 3.95
78H05K	5V 5A	TO-3 7.95
78H12K	12V 5A	TO-3 8.95
78P05K	5V 10A	TO-3 14.95

## LINEAR

TL066	.99	LM733	.98
TL071	.69	LM741	.29
TL072	1.09	LM747	.69
TL074	1.95	LM748	.59
TL081	.59	MC1330	1.69
TL082	.99	MC1350	1.19
TL084	1.49	MC1372	6.95
LM301	.34	LM1414	1.59
LM309K	1.25	LM1458	.49
LM311	1.65	LM1488	.49
LM311H	.89	LM1489	.49
LM317K	3.49	LM1496	.85
LM317T	.95	LM1812	8.25
LM318	1.49	LM1889	1.95
LM319	1.25	ULN2003	.75
LM320	see 7900	KR2206	3.79
LM322	1.65	KR2211	2.95
LM323K	4.79	RP2240	1.95
LM324	.49	MP02907	1.95
LM331	3.95	LM2917	1.95
LM334	1.19	CA3046	.89
LM335	1.40	CA3081	.99
LM336	1.75	CA3082	.99
LM337K	3.95	CA3086	.85
LM338K	3.95	CA3089	1.95
LM339	1.65	CA3130E	.99
LM340	see 7800	CA3146	1.29
LM350T	4.60	CA3160	1.19
LF353	.59	MC3470	1.95
LF356	.99	MC3480	8.95
LF357	.99	MC3487	2.95
LM358	.59	LM3900	.49
LM359	.59	LM3909	.98
LM383	1.95	LM3911	2.25
LM386	.89	LM3914	2.39
LM393	.45	MC4024	3.49
LM394H	4.60	MC4044	3.99
TL494	4.20	RC4136	1.25
TL497	3.25	RC4558	.69
NE555	.29	LM13600	1.49
NE556	.45	75107	1.49
NE558	1.29	75110	1.25
NE564	1.95	75150	1.95
LM565	.95	75154	1.95
LM566	1.49	75188	1.25
LM567	.79	75189	1.25
NE570	2.95	75451	.39
NE580	2.50	75452	.39
NE592	.98	75453	.39
LM710	.75	75477	1.29
LM723	.49	75492	.79
H-TO-5 CAN, K-TO-3, T-TO-220			

## DATA ACQ INTERFACE

ADC0800	15.55	8T26	1.29
ADC0804	3.49	8T28	1.29
ADC0809	4.49	8T96	.89
ADC0816	14.95	8T96	.89
ADC0817	9.95	8T97	.59
ADC0831	8.95	8T98	.89
DAC0800	4.49	DM8131	2.95
DAC0806	1.95	DP8304	2.29
DAC0808	2.95	DS8833	2.25
DAC1020	8.25	DS8835	1.99
DAC1022	5.95	DS8836	.95
MC1408L8	2.95	DS8937	1.65

## INTERFIL

ICL7106	9.95
ICL7107	12.95
ICL7660	2.95
ICL8038	4.95
ICM7207A	5.95
ICM7208	15.95

## EDGECARD CONNECTORS

100 PIN ST	S-100	.125	3.95
100 PIN WW	S-100	.125	4.95
62 PIN ST	IBM PC	.100	1.95
50 PIN ST	APPLE	.100	2.95
44 PIN ST	STD	.156	1.95
44 PIN WW	STD	.156	4.95

## 36 PIN CENTRONICS

MALE			
IDCEN36	RIBBON CABLE	6.95	
CEN36	SOLDER CUP	4.95	
FEMALE			
IDCEN36/F	RIBBON CABLE	7.95	
CEN36PC	RT ANGLE PC MOUNT	4.95	

## DIP CONNECTORS

DESCRIPTION	ORDER BY	CONTACTS								
		8	14	16	18	20	22	24	28	40
HIGH RELIABILITY TOOLED ST IC SOCKETS	AUGATxxST	.62	.79	.89	1.09	1.29	1.39	1.49	1.69	2.49
HIGH RELIABILITY TOOLED WW IC SOCKETS	AUGATxxWW	1.30	1.80	2.10	2.40	2.50	2.90	3.15	3.70	5.40
COMPONENT CARRIES (DIP HEADERS)	ICCxx	.49	.59	.69	.99	.99	.99	.99	1.09	1.49
RIBBON CABLE DIP PLUGS (IDC)	IDPxx	---	.95	.95	---	---	---	1.75	---	2.95

FOR ORDERING INSTRUCTIONS SEE D-SUBMINIATURE BELOW

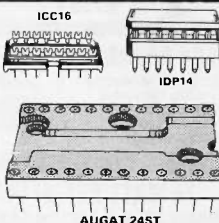

## DIODES/OPTO/TRANSISTORS

1N751	.25	4N26	.69
1N759	.25	4N27	.69
1N4148	25/1.00	4N28	.69
1N4004	10/1.00	4N33	.89
1N5402	.25	4N37	1.19
KBPO4	.55	MCT-2	.59
KBUBA	.95	MCT-6	1.29
MDA990-2	.35	TIL-111	.99
N2222	.25	2N3906	.10
PN2222	.10	2N4401	.25
2N2005	.50	2N4402	.25
2N2907	.25	2N4403	.25
2N3055	.79	2N6045	1.75
2N3904	.10	TIP31	.49

## D-SUBMINIATURE

DESCRIPTION	ORDER BY	CONTACTS						
		9	15	19	25	37	50	
SOLDER CUP	MALE	DBxxP	.82	.90	1.25	1.25	1.80	3.48
	FEMALE	DBxxS	.95	1.15	1.50	1.50	2.35	4.32
RIGHT ANGLE PC SOLDER	MALE	DBxxPR	1.20	1.49	---	1.95	2.65	---
	FEMALE	DBxxSR	1.25	1.55	---	2.00	2.79	---
WIRE WRAP	MALE	DBxxPWW	1.69	2.56	---	3.89	5.60	---
	FEMALE	DBxxSww	2.76	4.27	---	6.84	9.95	---
IDC RIBBON CABLE	MALE	IDBxxP	2.70	2.95	---	3.98	5.70	---
	FEMALE	IDBxxS	2.92	3.20	---	4.33	6.76	---
HOODS	METAL	MHOODxx	1.25	1.25	1.30	1.30	---	---
	GREY	HOODxx	.65	.65	---	.65	.75	.95

ORDERING INSTRUCTIONS: INSERT THE NUMBER OF CONTACTS IN THE POSITION MARKED "xx" OF THE "ORDER BY" PART NUMBER LISTED.

EXAMPLE: A 15 PIN RIGHT ANGLE MALE PC SOLDER WOULD BE DB15PR.

MOUNTING HARDWARE \$1.00

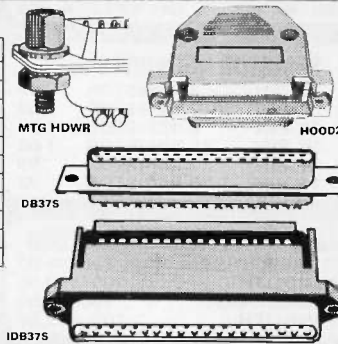

## IDC CONNECTORS

DESCRIPTION	ORDER BY	CONTACTS					
		10	20	26	34	40	50
SOLDER HEADER	IDHxxS	.82	1.29	1.68	2.20	2.58	3.24
RIGHT ANGLE SOLDER HEADER	IDHxxSR	.85	1.35	1.76	2.31	2.72	3.39
WW HEADER	IDHxxW	1.86	2.98	3.84	4.50	5.28	6.63
RIGHT ANGLE WW HEADER	IDHxxWR	2.05	3.28	4.22	4.45	4.80	7.30
RIBBON HEADER SOCKET	IDSxx	.79	.99	1.39	1.59	1.99	2.25
RIBBON HEADER	IDMxx	---	5.50	6.25	7.00	7.50	8.50
RIBBON EDGE CARD	IDExx	1.75	2.25	2.65	2.75	3.80	3.95

FOR ORDERING INSTRUCTIONS SEE D-SUBMINIATURE ABOVE

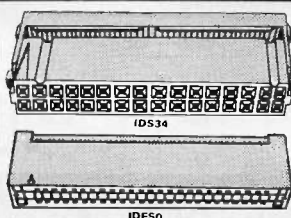

## HARD TO FIND "SNAPABLE" HEADERS

CAN BE SNAPPED APART TO MAKE ANY SIZE HEADER, ALL WITH .1" CENTERS

1x40	STRAIGHT LEAD	.99
1x40	RIGHT ANGLE	1.49
2x40	STRAIGHT LEAD	2.49
2x40	RIGHT ANGLE	2.99

## SHORTING BLOCKS

## BARGAIN HUNTERS CORNER

- DB25P** 100/\$45 10/\$6.90  
25 PIN MALE D-SUB CONNECTOR
- DB25S** 100/\$52 10/\$7.90  
25 PIN FEMALE D-SUB CONNECTOR
- HOOD-25** 100/\$31 10/\$6.90  
PLASTIC HOOD FOR DB25
- IDE34** 100/\$129 10/\$14.90  
34 PIN EDGE CONNECTOR
- AUGAT 16WW** 100/\$49 10/\$6.90  
16 PIN WIRE WRAP IC SOCKET MACHINE PIN
- .1uf DISC** 1000/\$29.50 100/\$3.95  
.1uf 16 VOLT CERAMIC DISC CAPACITORS

**SPECIALS END 6/30/86**

## PAGE WIRE WRAP WIRE PRECUT ASSORTMENT IN ASSORTED COLORS \$27.50

- 100ea: 5.5", 6.0", 6.5", 7.0"
  - 250ea: 2.5", 4.5", 5.0"
  - 500ea: 3.0", 3.5", 4.0"
- SPOOLS**
- 100 feet \$4.30 250 feet \$7.25
  - 500 feet \$13.25 1000 feet \$21.95
- Please specify color:  
Blue, Black, Yellow or Red

## WIRE WRAP PROTOTYPE CARDS FR-4 EPOXY GLASS LAMINATE WITH GOLD-PLATED EDGE-CARD FINGERS



IBM-PR2 **IBM**  
BOTH CARDS HAVE SILK SCREENED LEGENDS AND INCLUDES MOUNTING BRACKET

- IBM-PR1 WITH +5V AND GROUND PLANE . . . \$27.95
- IBM-PR2 AS ABOVE WITH DECODING LAYOUT . . . \$29.95

**S-100**

- P100-1 BARE - NO FOIL PADS . . . \$15.15
- P100-2 HORIZONTAL BUS . . . \$21.80
- P100-3 VERTICAL BUS . . . \$21.80
- P100-4 SINGLE FOIL PADS PER HOLE . . . \$22.75

**APPLE**

- P500-1 BARE - NO FOIL PADS . . . \$15.15
- P500-3 HORIZONTAL BUS . . . \$22.75
- P500-4 SINGLE FOIL PADS PER HOLE . . . \$21.80
- 7060-45 FOR APPLE IIe AUX SLOT . . . \$30.00

## EMI FILTER \$4.95

- MANUFACTURED BY CORCOM
  - LOW COST
  - FITS LC-HP BELOW
  - 6 AMP 120/240 VOLT
- 

**6 FOOT LINE CORDS**

- LC-2 2 CONDUCTOR .39
- LC-3 2 CONDUCTOR .99
- LC-HP 3 CONDUCTOR W/STD FEMALE SOCKET 1.49

## MUFFIN FANS

- 3.15" SQ ROTRON 14.95
- 3.63" SQ ETRI 14.95
- 3.18" SQ MASUSHITA 16.95

## SOCKET-WRAP I.D.™

- SLIPS OVER WIRE WRAP PINS
  - IDENTIFIES PIN NUMBERS ON WRAP SIDE OF BOARD
  - CAN WRITE ON PLASTIC, SUCH AS IC #
- | PINS | PART#     | PCK. OF | PRICE |
|------|-----------|---------|-------|
| 8    | IDWRAP 08 | 10      | 1.95  |
| 14   | IDWRAP 14 | 10      | 1.95  |
| 16   | IDWRAP 16 | 10      | 1.95  |
| 18   | IDWRAP 18 | 5       | 1.95  |
| 20   | IDWRAP 20 | 5       | 1.95  |
| 22   | IDWRAP 22 | 5       | 1.95  |
| 24   | IDWRAP 24 | 5       | 1.95  |
| 28   | IDWRAP 28 | 5       | 1.95  |
| 40   | IDWRAP 40 | 5       | 1.95  |
- PLEASE ORDER BY NUMBER OF PACKAGES (PCK. OF)

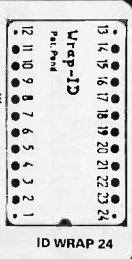

## FRAME STYLE TRANSFORMERS

- 12.6V AC CT 2 AMP 5.95
- 12.6V AC CT 4 AMP 7.95
- 12.6V AC CT 8 AMP 10.95
- 25.2V AC CT 2 AMP 7.95

**25 PIN D-SUB GENDER CHANGERS \$7.95**

## SWITCHING POWER SUPPLIES

**PS-IBM \$89.95**

- FOR IBM PC-XT COMPATIBLE
- 135 WATTS
- +5V @ 15A, +12V @ 4.2A
- -5V @ .5A, -12V @ .5A
- ONE YEAR WARRANTY

**PS-IBM-150 \$99.95**

- FOR IBM PC-XT COMPATIBLE
- 150 WATTS
- +12V @ 5.2A, +5V @ 16A
- -12V @ .5A, -5V @ .5A
- ONE YEAR WARRANTY

**PS-130 \$99.95**

- 130 WATTS
- SWITCH ON REAR
- FOR USE IN OTHER IBM TYPE MACHINES
- 90 DAY WARRANTY

**PS-A \$49.95**

- USE TO POWER APPLE TYPE SYSTEMS
- +5V @ 4A, -12V @ 2.5A
- -5V @ .5A, -12V @ .5A
- APPLE POWER CONNECTOR

**PS-SPL200 \$49.95**

- +5V @ 25A, +12V @ 3.5A
- -5V @ 1A, -12V @ 1A
- UL APPROVED
- ALUMINUM ENCLOSURE

## CAPACITORS

**TANTALUM**

Value	Voltage	Price
1.0µf	15V	.45
6.8	15V	.70
10	15V	.80
22	15V	1.35
.22	35V	.40

**DISC**

Value	Voltage	Price
10µf	50V	.05
22	50V	.05
33	50V	.05
47	50V	.05
68	50V	.05
100	50V	.05
220	50V	.05
560	50V	.05

**MONOLITHIC**

Value	Voltage	Price
.01µf	50V	.14
.047µf	50V	.15

**ELECTROLYTIC**

Value	Voltage	Price
1µf	25V	.14
2.2	35V	.15
4.7	50V	.15
10	50V	.15
47	35V	.18
100	16V	.18
220	35V	.20
470	25V	.30
2200	16V	.70
4700	25V	1.45

## DATARASE EPROM ERASER \$34.95

- ERASES 2 IN 10 MINUTES
  - COMPACT-NO DRAWER
  - THIN METAL SHUTTER PREVENTS UV LIGHT FROM ESCAPING
- 

## 1/4 WATT RESISTORS

- 5% CARBON FILM ALL STANDARD VALUES FROM 1 OHM TO 10 MEG. OHM
- 10 PCS same value .05 100 PCS same value .02
- 50 PCS same value .025 1000 PCS same value .015

## RESISTOR NETWORKS

- | Package | Pin Count | Resistor Count | Price |
|---------|-----------|----------------|-------|
| SIP     | 10 PIN    | 9 RESISTOR     | .69   |
| SIP     | 8 PIN     | 7 RESISTOR     | .59   |
| DIP     | 16 PIN    | 8 RESISTOR     | 1.09  |
| DIP     | 16 PIN    | 15 RESISTOR    | 1.09  |
| DIP     | 14 PIN    | 7 RESISTOR     | .99   |
| DIP     | 14 PIN    | 13 RESISTOR    | .99   |

## SPECIALS ON BYPASS CAPACITORS

- .01 µf CERAMIC DISC 100/\$5.00
- .01 µf MONOLITHIC 100/\$10.00
- .1 µf CERAMIC DISC 100/\$6.50
- .1 µf MONOLITHIC 100/\$12.50

## WISH SOLDERLESS BREADBOARDS

PART NUMBER	DIMENSIONS	DISTRIBUTION STRIP(S)	TIE POINTS	TERMINAL STRIP(S)	TIE POINTS	BINDING POSTS	PRICE
WBU-D	.38 x 6.50"	1	100	---	---	---	2.95
WBU-T	1.38 x 6.50"	---	---	1	630	---	6.95
WBU-204-3	3.94 x 8.45"	1	100	2	1260	2	17.95
WBU-204	5.13 x 8.45"	4	400	2	1260	3	24.95
WBU-206	6.88 x 9.06"	5	500	3	1890	4	29.95
WBU-208	8.25 x 9.45"	7	700	4	2520	4	39.95

## BOOKS BY STEVE GIARCIA

- BUILD YOUR OWN Z80 COMPUTER \$19.95
- CIRCUIT CELLAR VOL 1 \$17.95
- CIRCUIT CELLAR VOL 2 \$18.95
- CIRCUIT CELLAR VOL 3 \$18.95
- CIRCUIT CELLAR VOL 4 \$18.95
- CIRCUIT CELLAR VOL 5 \$19.95

## MICROCOMPUTER HARDWARE HANDBOOK FROM ELCOMP \$14.95

OVER 800 PAGES OF DATA SHEETS ON THE MOST COMMONLY USED ICs. INCLUDES TTL, CMOS, 74LS00, MEMORY, CPUs, MPU SUPPORT. AND MUCH MORE!

## NEW EDITION!

**1986 IC MASTER**  
THE INDUSTRY STANDARD  
**\$129.95**

VISIT OUR RETAIL STORE LOCATED AT 1256 SOUTH BASCOM AVENUE IN SAN JOSE

# JDR Microdevices

1224 S. Bascom Avenue, San Jose, CA 95128  
Toll Free 800-538-5000 • (408) 995-5430  
FAX (408) 275-8415 • Telex 171-110

**LITHIUM BATTERY**  
AS USED IN CLOCK CIRCUITS

3 VOLT BATTERY \$3.95  
BATTERY HOLDER \$1.49

HOURS: M-W-F, 9-5 TU-TH, 9-9 SAT, 10-3  
PLEASE USE YOUR CUSTOMER NUMBER WHEN ORDERING

TERMS: Minimum order \$10.00. For shipping and handling include \$2.50 for UPS Ground and \$3.50 for UPS Air. Orders over 1 lb. and foreign orders may require additional shipping charges - please contact our sales department for the amount. CA residents must include applicable sales tax. All merchandise is warranted for 90 days unless otherwise stated. Prices are subject to change without notice. We are not responsible for typographical errors. We reserve the right to limit quantities and to substitute manufacturer. All merchandise subject to prior sale.



# PARTIAL LISTING ONLY — CALL FOR A FREE CATALOG

## DISK DRIVES FOR APPLE COMPUTERS

**AP-150**  
**\$99.95**

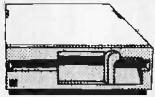

- 1/2 HT, DIRECT DRIVE
- 100% APPLE COMPATIBLE
- SIX MONTH WARRANTY

**BAL-500**  
**\$129.95**

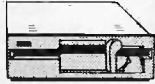

- TEAC MECHANISM-DIRECT DRIVE
- 100% APPLE COMPATIBLE
- FULL ONE YEAR WARRANTY

**AP-135**  
**\$129.95**

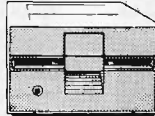

- FULL HT SHUGART MECHANISM
- DIRECT REPLACEMENT FOR APPLE DISK II
- SIX MONTH WARRANTY

**DOUBLE SIDED!**

**MAC535**  
**\$249.95**

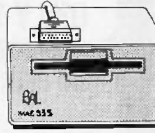

- 3.5" ADD-ON DISK DRIVE
- 100% MACINTOSH COMPATIBLE
- DOUBLE SIDED 800K BYTE STORAGE
- HIGH RELIABILITY DRIVE HAS AUTO-EJECT MECHANISM
- FULL ONE YEAR WARRANTY

**AD-3C**  
**\$139.95**

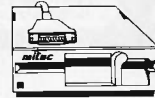

- 100% APPLE IIc COMPATIBLE, READY TO PLUG IN, W/ SHIELDED CABLE & MOLDED 19 PIN CONNECTOR
- FAST, RELIABLE SLIMLINE DIRECT DRIVE
- SIX MONTH WARRANTY

- DISK DRIVE ACCESSORIES**
- FDD CONTROLLER CARD \$49.95
  - IIc ADAPTOR CABLE \$19.95
  - ADAPTS STANDARD APPLE DRIVES FOR USE WITH APPLE IIc

**KB-1000**

**\$79.95**

- CASE WITH KEYBOARD FOR APPLE TYPE MOTHERBOARD
- USER DEFINED FUNCTION KEYS
  - NUMERIC KEYPAD WITH CURSOR CONTROL
  - CAPS LOCK
  - AUTO-REPEAT

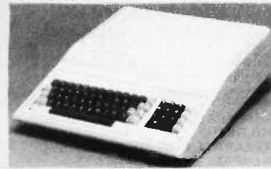

**KEYBOARD-AP**

**\$49.95**

- REPLACEMENT FOR APPLE II KEYBOARD
- CAPS LOCK KEY, AUTO-REPEAT
- ONE KEY ENTRY OF BASIC OR CP/M COMMANDS

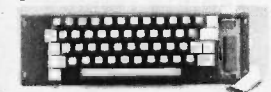

## EXTENDER CARDS

IBM-PC	\$45.00
IBM-AT	\$68.00
APPLE II	\$45.00
APPLE IIe	\$45.00
MULTIBUS	\$86.00

## APPLE COMPATIBLE INTERFACE CARDS

**EPROM PROGRAMMER \$59.95**

**MODEL RP525**

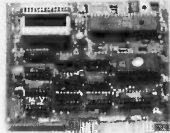

- DUPLICATE OR BURN ANY STANDARD 27xx SERIES EPROM
- EASY TO USE MENU-DRIVEN SOFTWARE IS INCLUDED
- MENU SELECTION FOR 2716, 2732, 2732A, 2764 AND 27128
- HIGH SPEED WRITE ALGORITHM
- LED INDICATORS FOR ACTIVITY
- NO EXTERNAL POWER SUPPLY NEEDED
- ONE YEAR WARRANTY

**16K RAMCARD \$39.95**



- FULL TWO YEAR WARRANTY
- EXPAND YOUR 48K APPLE TO 64K
- USE IN PLACE OF APPLE LANGUAGE CARD

BARE PC CARD W/INSTRUCTIONS \$9.95

**IC TEST CARD \$99.95**



- QUICKLY TESTS MANY COMMON ICs
- DISPLAYS PASS OR FAIL
- ONE YEAR WARRANTY
- TESTS: 4000 SERIES CMOS, 74HC SERIES CMOS, 7400, 74LS, 74L, 74H & 74S

**300B MODEM \$49.95**  
FOR APPLE OR IBM

INCLUDES ASCII PRO-EZ SOFTWARE



• FCC APPROVED

- BELL SYSTEMS 103 COMPATIBLE
- INCLUDES AC ADAPTOR
- AUTO-DIAL
- DIRECT CONNECT

CABLE FOR APPLE IIc \$14.95

**JOYSTICK CR-401 \$7.95**

FOR ATARI 400, 800, 2600, VIC 20/64 AND APPLE IIe

## DISKFILE

HOLDS 70 5 1/4" DISKETTES

**\$895**



3.5" DISKFILE HOLDS 40 \$995

## POWER STRIP

• UL APPROVED  
• 15A CIRCUIT BREAKER  
**\$12.95**

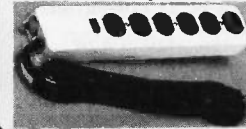

## BAL 3-WAY SWITCH BOXES

- SERIAL OR PARALLEL
- CONNECTS 3 PRINTERS TO ONE COMPUTER OR VICE VERSA
- ALL LINES SWITCHES
- HIGH QUALITY ROTARY SWITCH MOUNTED ON PCB
- GOLD CONTACTS
- STURDY METAL ENCLOSURE



**SWITCH-3P CENTRONICS PARALLEL \$99.95**

**SWITCH-3S RS232 SERIAL \$99.95**

## BAL PRINTER BUFFERS

- FREES COMPUTER FOR OTHER TASKS WHILE PRINTING LONG DOCUMENTS
- STAND-ALONE DESIGN; WORKS WITH ANY COMPUTER OR PRINTER
- ALL MODELS FEATURE PRINT PAUSE MEMORY CHECK, GRAPHICS CAPABILITY

**SP120P PARALLEL \$139.95**

- 64K UPGRADABLE TO 256K
- LED INDICATOR SHOWS VOLUME OF DATA IN BUFFER

**SP120S RS232 SERIAL \$159.95**

- 64K UPGRADABLE TO 256K
- 6 SELECTABLE BAUD RATES, FROM 600B-19,200B

**SP110P PARALLEL \$249.95**

- 64K UPGRADABLE TO 512K
- SPOOLS OUTPUT OF UP TO 3 COMPUTERS
- LED BARGRAPH DISPLAYS AMOUNT OF DATA IN BUFFER
- RESET FUNCTION CLEARS DATA IN BUFFER
- REPEAT FUNCTION CAN PRODUCE MULTIPLE COPIES OF A DOCUMENT



SP120



SP110

## NASHUA DISKETTES DEALS

5 1/4" SOFT SECTOR  
DS/DD WITH HUB RINGS

**\$990**  
BOX OF 10

**69¢ea**  
BULK QTY 50

**59¢ea**  
BULK QTY 250

NASHUA DISKETTES WERE JUDGED TO HAVE THE HIGHEST POLISH AND RECORDED AMPLITUDE OF ANY DISKETTES TESTED ACCORDING TO "COMPARING FLOPPY DISKS", BYTE 9/84

## DISKETTES

NASHUA 5 1/4"

N-MD2D	DS/DD SOFT	\$9.90
N-MD2F	DS/QUAD SOFT	\$34.95
N-MD2H	DS/HD FOR AT	\$49.95

NASHUA 8"

N-FD1	SS/DD SOFT	\$27.95
N-FD2D	DS/DD SOFT	\$34.95

NASHUA 3.5"

N-3.5SS	3.5" SS/DD FOR MAC	\$32.95
---------	--------------------	---------

VERBATIM 5 1/4"

V-MD1D	SS/OD SOFT	\$23.95
V-MD2D	DS/DD SOFT	\$29.95
V-MD110D	SS/DD 10 SECTOR HARD	\$23.95

## Sakata 120 CPS DOT MATRIX PRINTER

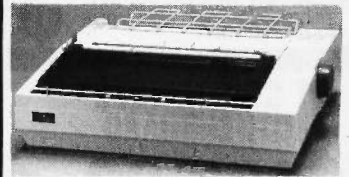

**MODEL SP-1200 \$169.95**

- EPSON/IBM COMPATIBLE
  - 9-WIRE PRINTHEAD
  - 120 CPS-BIDIRECTIONAL, 80 COL.
  - FRICTION AND TRACTOR FEED
  - PROPORTIONAL SPACING
  - CENTRONICS PARALLEL INTERFACE
  - 8 CHARACTER SETS AND GRAPHICS
- 6 FOOT IBM PRINTER CABLE \$9.95  
REPLACEMENT RIBBON CARTRIDGE \$11.95

## 5 1/4" FLOPPY DISK DRIVES

TEAC FD-55B 1/2 HT DS/DD (FOR IBM)	\$109.95
TEAC FD-55F 1/2 HT DS/QUAD (FOR IBM)	\$109.95
TEAC FD-55GFV 1/2 HT DS/HD (FOR IBM AT)	\$154.95
TANDON TM100-2 DS/DD (FOR IBM)	\$99.95
TANDON TM50-2 1/2 HT DS/DD (FOR IBM)	\$89.95
MPI-B52 DS/DD (FOR IBM)	\$89.95
QUME QT-142 1/2 HT DS/DD (FOR IBM)	\$79.95

## 8" FLOPPY DISK DRIVES

FD 100-8 SS/DD (ISA/801 EQUIV)	\$119.00
FD 200-8 DS/DD (ISA/851R EQUIV)	\$159.00

## DISK DRIVE ACCESSORIES

TEAC SPECIFICATION MANUAL	\$5.00
TEAC MAINTENANCE MANUAL	\$25.00
1/2 HT MOUNTING HARDWARE	\$2.95
MOUNTING RAILS FOR IBM AT	\$4.95
"Y" POWER CABLE FOR 5 1/4" FDDs	\$2.95
5 1/4" FDD POWER CONNECTORS	\$1.19

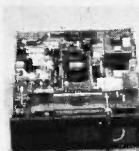

TEAC FD-55



TANDON TM100-2

## DISK DRIVE ENCLOSURES

<b>CAB-APPLE</b> APPLE TYPE CABINET W/OUT POWER SUPPLY	<b>\$24.95</b>
<b>CAB-1FH5</b> FULL HT 5 1/4" BEIGE CABINET W/POWER SUPPLY	<b>\$69.95</b>
<b>CAB-2SV5</b> DUAL SLIMLINE 5 1/4" CABINET W/POWER SUPPLY	<b>\$49.95</b>
<b>CAB-2SV8</b> DUAL SLIMLINE 8" CABINET W/POWER SUPPLY	<b>\$209.95</b>
<b>CAB-2FH8</b> DUAL FULL HT 8" CABINET W/POWER SUPPLY	<b>\$219.95</b>



CAB-2SV5



CAB-1FH5

## TEST EQUIPMENT FROM JDR INSTRUMENTS

**DIGITAL MULTIMETER PEN DPM-1000**  
AUTO RANGING, POLARITY AND DECIMAL!

**\$54.95**

- LARGE 3.5 DIGIT DISPLAY
- DATA HOLD SWITCH
- FREEZES READING
- FAST, AUDIBLE CONTINUITY TEST
- LOW BATTERY INDICATOR
- OVERLOAD PROTECTION



<b>20MHZ DUAL TRACE OSCILLOSCOPE</b>	<b>MODEL 2000</b>	<b>\$389.00</b>
<b>35MHZ DUAL TRACE OSCILLOSCOPE</b>	<b>MODEL 3500</b>	<b>\$549.00</b>

FOR MORE INFORMATION ON THE OSCILLOSCOPES, SEE OUR AD ON PAGE 41.

CALL FOR VOLUME QUOTES © COPYRIGHT 1986 JDR MICRODEVICES

# BUILD A COMPLETE 256K XT SYSTEM—\$717

## SEAGATE ST-225 20MB HARD DISK SYSTEM

INCLUDES HALF LENGTH HD CONTROLLER, CABLES, MOUNTING HARDWARE AND INSTRUCTIONS. ALL DRIVES ARE PRE-TESTED AND COME WITH A ONE YEAR WARRANTY.

# \$449.00

## XT COMPATIBLE MOTHERBOARD

# \$159.00

- 4.77 MHz 8088 CPU, OPTIONAL 8087 CO-PROCESSOR
  - 8 EXPANSION SLOTS
  - 0K RAM INSTALLED, EXPANDABLE TO 640K ON-BOARD MEMORY
  - ALL ICs SOCKETED, HIGHEST QUALITY PC BOARD
  - ACCEPTS 2764 OR 27128 ROMS
- PRO-BIOS \$29.95**

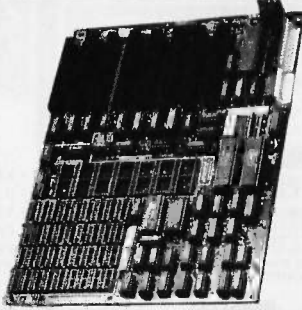

## GRT MONITORS FOR ALL APPLICATIONS

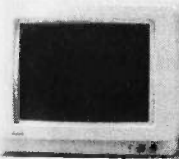

**LUXOR HI-RES RGB MONITOR**  
MODEL 190-9528

- DIGITAL RGB-IBM COMPATIBLE
- 14" SCREEN
- 16 TRUE COLORS
- 25 MHz BANDWIDTH
- RESOLUTION > 640 x 262
- 31mm DOT PITCH
- CABLE FOR IBM PC INCLUDED

**\$299.95**



**SAKATA COMPOSITE COLOR**  
MODEL SC-100

- TOP RATED FOR APPLE
- 13" COMPOSITE VIDEO
- RESOLUTION: 280H x 300V
- INTERNAL AUDIO AMP
- ONE YEAR WARRANTY

**\$169.95**



**CENTER SYSTEMS MONOCHROME**  
MODEL KLM-1211

- IBM COMPATIBLE TTL INPUT
- 12" NON-GLARE SCREEN
- P39 GREEN PHOSPHORUS
- VERY HIGH RESOLUTION: 25 MHz BANDWIDTH, 1100 LINES (CENTER)
- AMBER VERSION \$109.95

**\$99.95**

## IBM COMPATIBLE INTERFACE CARDS

ALL WITH A ONE YEAR WARRANTY

### MULTI I/O FLOPPY CARD

**\$129.95**

PERFECT FOR THE 640K MOTHERBOARD

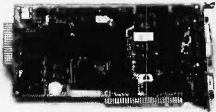

- 2 DRIVE FLOPPY DISK CONTROLLER
- 1 RS232 SERIAL PORT, OPTIONAL 2nd SERIAL PORT
- PARALLEL PRINTER PORT
- GAME PORT
- CLOCK/CALENDAR
- SOFTWARE: CLOCK UTILITIES, RAMDISK, SPOOLER
- OPTIONAL SERIAL PORT \$15.95

### MULTIFUNCTION CARD

**\$119.95**

ALL THE FEATURES OF AST'S 6 PACK PLUS AT HALF THE PRICE



- CLOCK/CALENDAR
- 0-384K RAM
- SERIAL PORT
- PARALLEL PORT
- GAME PORT
- SOFTWARE INCLUDED: PRINTER CABLE \$9.95, 64K RAM UPGRADE 9/\$10.71

### COLOR GRAPHICS ADAPTOR

**\$99.95**

FULLY COMPATIBLE WITH IBM COLOR CARD



- 4 VIDEO INTERFACES: RGB, COMPOSITE COLOR, HI-RES, COMPOSITE MONOCHROME, CONNECTOR FOR RF MODULATOR
- COLOR GRAPHICS MODE: 320 x 200
- MONO GRAPHICS MODE: 640 x 200
- LIGHT PEN INTERFACE

### MONOCHROME GRAPHICS CARD

**\$119.95**

FULLY COMPATIBLE WITH IBM MONOCHROME ADAPTOR & HERCULES GRAPHICS

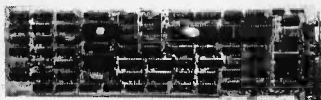

- LOTUS COMPATIBLE
- TEXT MODE: 80 x 25
- GRAPHICS MODE: 720 x 348
- PARALLEL PRINTER INTERFACE
- OPTIONAL SERIAL PORT \$19.95

### MONOCHROME ADAPTOR

**\$49.95**

ANOTHER FANTASTIC VALUE FROM JDR!

- IBM COMPATIBLE TTL OUTPUT
  - 720 x 350 PIXEL DISPLAY
- PLEASE NOTE: THIS CARD WILL NOT RUN LOTUS GRAPHICS AND DOES NOT INCLUDE A PARALLEL PORT

### FLOPPY DISK DRIVE ADAPTOR

**\$49.95**



- INTERFACES UP TO 4 STANDARD FDDs TO IBM PC OR COMPATIBLES
- INCLUDES CABLE FOR TWO INTERNAL DRIVES
- STANDARD DB37 FOR EXTERNAL DRIVES
- RUNS QUAD DENSITY DRIVES WHEN USED WITH JFORMAT

## EASYDATA 1200 BAUD MODEM FOR IBM

INCLUDES PC TALK III COMMUNICATIONS SOFTWARE



- NEW 10 INCH CARD
- HAYES COMPATIBLE
- AUTO DIAL/AUTO ANSWER
- AUTO RE-DIAL ON BUSY
- INCLUDES SERIAL PORT!
- ONE YEAR WARRANTY

# \$169.95

- BUILD YOUR OWN 256K XT COMPATIBLE SYSTEM**
- XT MOTHERBOARD \$159.95
  - PRO-BIOS \$29.95
  - 256K RAM \$26.55
  - 130 WATT POWER SUPPLY \$89.95
  - FLIP-TOP CASE \$49.95
  - DKM-2000 KEYBOARD \$79.95
  - 1/2 HEIGHT QUME DRIVE \$79.95
  - FLOPPY DISK CONTROLLER \$49.95
  - MONOCHROME ADAPTOR \$49.95
  - MONOCHROME MONITOR \$99.95
- TOTAL: \$716.10**

### MONITOR STAND



TILTS AND SWIVELS

**ONLY \$12.95**

### IBM PRINTER CABLE



- DB25 TO CENTRONICS
- SHIELDED CABLE \$9.95

## IBM STYLE COMPUTER CASE

AN ATTRACTIVE STEEL CASE WITH A HINGED LID FITS THE POPULAR PC/XT COMPATIBLE MOTHERBOARDS

- SWITCH CUT-OUT ON SIDE FOR PC/XT STYLE POWER SUPPLY
- CUT-OUT FOR 8 EXPANSION SLOTS
- ALL HARDWARE INCLUDED

# \$49.95

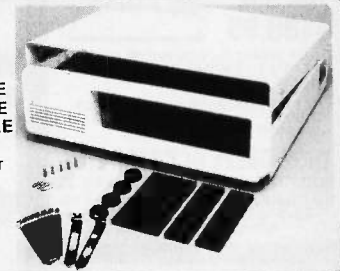

## IBM COMPATIBLE KEYBOARDS

DKM-2000 \$79.95

IBM-5151 \$99.95



- "5150" STYLE KEYBOARD
- FULLY IBM COMPATIBLE
- LED STATUS INDICATORS FOR CAPS & NUMBER LOCK
- 83 KEY - SAME LAYOUT AS IBM PC/XT KEYBOARD

- REPLACEMENT FOR KEYTRONICS KB-5151™
- SEPARATE CURSOR & NUMERIC KEYPAD
- CAPS LOCK & NUMBER LOCK INDICATORS
- IMPROVED KEYBOARD LAYOUT

## POWER SUPPLY



**NOW ONLY \$89.95**

- FOR IBM PC-XT COMPATIBLE
- 135 WATTS
- +5V @ 15A, +12V @ 4.2A
- -5V @ .5A, -12V @ .5A

**150 WATT MODEL \$99.95**

## DISK DRIVES TANDON TM50-2

# \$89.95

- 1/2 HT DS/DD
- IBM COMPATIBLE
- EXTREMELY QUIET!

TEAC FD-550	DS/DD	\$109.95
TEAC FD-55F	DS/QUAD	\$109.95
TEAC FD-55G	DS/HD	\$154.95
QUME QT-142	DS/DD	\$79.95
MOUNTING HARDWARE		\$2.95
AT/RAILS		\$4.95



# D·I·S·K·S · A·N·D · D·O·W·N·L·O·A·D·S

## ORDERING DISKS OF BYTE LISTINGS

Listings that accompany BYTE articles are available on disk in a variety of formats. For each BYTE issue, beginning with December 1985, all the listings mentioned in that issue are on that month's disk. There's no need to request individual listings or to send additional fees; the cost per disk covers an entire month's listings. To order a disk of these listings for noncommercial purposes, indicate the issue and the kind of disk on the form below. Enclose a check or money order in the correct amount made out to BYTE Listings. We cannot accept credit card orders at this time. All prices include postage. Send requests to BYTE Listings, One Phoenix Mill Lane, Peterborough, NH 03458. Program Listings may also be downloaded via BYTEnet Listings at (617) 861-9764.

BYTE issue: \_\_\_\_\_

### COMMON 5¼-INCH FORMATS

(All cost \$5 per disk in North America, \$6 in Europe and South America, \$7 in Asia, Africa, and Australia.)

- Apple II 5¼-inch DOS 3.3
- Apple II 5¼-inch ProDOS
- Hewlett-Packard 125
- IBM PC
- Kaypro 2 CP/M
- Texas Instruments Professional
- TRS-80 Model III
- TRS-80 Model 4
- Zenith Z-100

### COMMON 3½-INCH FORMATS

(All cost \$6 per disk in North America, \$7 in Europe and South America, \$8 in Asia, Africa, and Australia.)

- Apple Macintosh
- Atari 520ST
- Commodore Amiga
- Data General/One
- Hewlett-Packard 150

### CP/M STANDARD 8-INCH FORMAT

(\$6 per disk in North America, \$7 in Europe and South America, \$8 in Asia, Africa, and Australia.)

- Single-sided single-density

## OTHER FORMATS

Due to the diversity of requests and the custom work involved, there will be some delay in fulfilling these requests. (All cost \$6 per disk in North America, \$7 in Europe and South America, \$8 in Asia, Africa, and Australia.)

Size	Machine
<input type="checkbox"/> 8-inch	_____
<input type="checkbox"/> 5¼-inch	_____
<input type="checkbox"/> 3½-inch	_____

## SEND DISK TO:

Name \_\_\_\_\_

Street \_\_\_\_\_

City \_\_\_\_\_ State or Province \_\_\_\_\_

Postal Code \_\_\_\_\_ Country \_\_\_\_\_

Check or money order enclosed for \$ \_\_\_\_\_

## BULLETIN BOARDS IN CANADA

Listed below are some computer bulletin boards that carry program listings from BYTE. Programs are for noncommercial use in connection with BYTE articles only. Some BBSs may charge an annual maintenance fee, and you must pay your own telephone charges.

Western Canadian Distribution Center (3420 48th St., Edmonton, Alberta T6L 3R5) will be supplying listings to its member bulletin-board systems.

Edmonton, Alberta, (403) 454-6093

Meadowlark, Alberta, (403) 435-6579

Montreal, Quebec, PComm Systems,  
(514) 989-9450

Prince George, British Columbia, (604) 562-9519

Regina, Saskatchewan, (306) 586-5585

Toronto, Ontario, Epson Club of Toronto (EPCOT),  
(416) 635-9600

Winnipeg, Manitoba, (204) 452-5529

In addition, arrangements for BYTEnet Listings have been made with one or more system operators in the following nations: Australia, Denmark, France, Hong Kong, Italy, Japan, Malaysia, The Netherlands, Nigeria, Norway, Saudi Arabia, Singapore, Sweden, Switzerland, United Kingdom, and West Germany. Contact us at (603) 924-9281 for an up-to-date list. ■

## BYTE'S ONGOING MONITOR BOX

ARTICLE#	PAGE	ARTICLE	AUTHOR(S)	ARTICLE#	PAGE	ARTICLE	AUTHOR(S)
1	9	Microbytes	staff	14	185	Musical Fractals	Dodge, Bahn
2	29	What's New	staff	15	199	A MIDI Project	Kubicky
3	50	Ask BYTE/Circuit Cellar Feedback	Ciarcia	16	211	MIDI Programming	Swearingen
4	63	Book Reviews	Swearingen	17	233	The Atari 520ST	Jensen
			Graves	18	243	Compaq Deskpro 286	Miastkowski
			Czarnik	19	251	Tele-286	Rash
			Lent	20	257	Mix C	Grehan
5	85	Product Description: The Macintosh Plus	Robinson	21	265	Four MIDI Interfaces	Grehan
6	92	Programming Project: A Simple File-Indexing Scheme	Webster	22	273	ConcertWare+ and SongPainter	Bernardo
7	107	Ciarcia's Circuit Cellar: Adding SCSI to the SBI80 Computer. Part 2: Bus Phases	Ciarcia	23	279	The Kurzweil 250 Digital Synthesizer	Morgan
8	117	Sorting ProDOS Directories	Silvestri	24	295	Computing at Chaos Manor: Color and CP/M	Pournelle
9	131	Decoding MacPaint on the IBM PC	Anacker	25	319	BYTE U.K.: Modem Mysteries Revealed	Pountain
10	137	Programming Insight: Hilbert Curves Made Simple	Ackerman	26	329	Applications Only: Upgrade Fever	Shapiro
11	145	The Challenge of Music Software	Powell	27	339	BYTE Japan: New Tools, New Challenges	Raika
12	155	Digital Music Synthesis	Moog	28	347	According to Webster: Storage for the Masses	Webster
13	171	Digital Sampling on the Apple Macintosh	Yavelow	29	367	Best of BIX	BIXen

### QUANTITY AND QUALITY

This month we are revising the award system. Our present method, which is based on quantity of points earned by weighting each vote cast, will continue. Each excellent vote is weighted at 3 points, 2 for good, 1 for fair, and 0 for poor. In addition, we are instituting an award for highest average vote, which removes quantity as a factor in the voting. The author (not a staff member) with the highest average score will receive \$50.

The Product Preview of "The Atari 1040ST" by BYTE editors Phillip Robinson and Ion R. Edwards is the winner from the March BYTE. In second place. According to Webster. Bruce Webster discusses "68000

Wars: Round 1." "Finding the Titanic" wins third, netting for its authors, Marti Spalding and Ben Dawson, the \$100 bonus. In fourth is Bruce Webster's Programming Project, "A Simple Windowing System, Part 1: Basic Principles." Steve Ciarcia's Circuit Cellar on "Real-Time Clocks: A View Toward the Future" came in fifth place. And winners of \$50 are Steve A. Hersee and Dan Knopoff for "An ANSI Standard for the C Language."

This month, Marti Spalding and Ben Dawson are the first recipients of the new \$50 award for quality. Congratulations to all.

### BYTE ADVERTISING SALES STAFF:

**Dennis J. Riley, Advertising Sales Manager, One Phoenix Mill Lane, Peterborough, NH 03458, tel. (603) 924-9281**

#### NEW ENGLAND

ME, NH, VT, MA, RI,  
EASTERN CANADA  
Paul McPherson Jr. (617) 262-1160  
McGraw-Hill Publications  
575 Boylston Street  
Boston, MA 02116

#### ATLANTIC

NY, NYC, CT, NJ (NORTH)  
Leah G. Rabinowitz (212) 512-2096  
McGraw-Hill Publications  
1221 Avenue of the Americas—  
39th Floor  
New York, NY 10020

Dick McGurk (203) 968-7111  
McGraw-Hill Publications  
Building A—3rd Floor  
777 Long Ridge Road  
Stamford, CT 06902

#### EAST

PA (EAST), NJ (SOUTH),  
MD, VA, W.VA, DE, D.C.  
Daniel Ferro (215) 496-3833  
McGraw-Hill Publications  
Three Parkway  
Philadelphia, PA 19102

#### SOUTHEAST

NC, SC, GA, FL, AL, TN  
Maggie M. Dorvee (404) 252-0626  
McGraw-Hill Publications  
4170 Ashford-Dunwoody Road—  
Suite 420  
Atlanta, GA 30319

#### MIDWEST

IL, MO, KS, IA, ND, SD, MN, WI, NB, IN  
Bob Denmead (312) 751-3740  
McGraw-Hill Publications  
Blair Building  
645 North Michigan Ave.  
Chicago, IL 60611

#### GREAT LAKES, OHIO REGION

MI, OH, PA (ALLEGHENY), KY,  
ONTARIO, CANADA  
Renee Navarro (313) 352-9760  
McGraw-Hill Publications  
3000 Town Center—Suite 770  
Southfield, MI 48075

#### SOUTHWEST, ROCKY MOUNTAIN

UT, CO, WY, OK, TX, AR, MS, LA  
Kevin Harold (214) 458-2400  
McGraw-Hill Publications  
Prestonwood Tower—Suite 907  
5151 Beltline  
Dallas, TX 75240

#### SOUTH PACIFIC

SOUTHERN CA, AZ, NM, LAS VEGAS  
Jack Anderson (714) 557-6292  
McGraw-Hill Publications  
3001 Red Hill Ave.  
Building #1—Suite 222  
Costa Mesa, CA 92626

Karen Niles (213) 480-5243, 487-1160  
McGraw-Hill Publications  
3333 Wilshire Boulevard #407  
Los Angeles, CA 90010

#### NORTH PACIFIC

HI, WA, OR, ID, MT, NORTHERN CA,  
NV (except LAS VEGAS), W. CANADA  
Mike Kisseberth (415) 362-4600  
McGraw-Hill Publications  
425 Battery Street  
San Francisco, CA 94111

Bill McAtee (415) 349-4100  
McGraw-Hill Publications  
951 Mariner's Island Blvd.—3rd Floor  
San Mateo, CA 94404

#### WEST COAST SURPLUS

AND RETAIL ACCOUNTS  
Tom Harvey (805) 964-8577  
3463 State Street—Suite 256  
Santa Barbara, CA 93105

#### The Buyer's Mart

Karen Burgess (603) 924-3754  
BYTE Publications  
70 Main Street  
Peterborough, NH 03458

#### BYTE BITS (2x3)

Dan Harper (603) 924-6830  
BYTE Publications  
70 Main Street  
Peterborough, NH 03458

#### Post Card Mailings

**National**  
Bradley Browne (603) 924-6166  
BYTE Publications  
70 Main Street  
Peterborough, NH 03458

### International Advertising Sales Staff:

Mr. Hans Csokor  
Publimedia  
Reisnerstrasse 61  
A-1037 Vienna, Austria  
222 75 76 84

Mrs. Gurit Gepner  
McGraw-Hill Publishing Co.  
PO Box 2156  
Bat Yam, 59121 Israel  
3 866 561 321 39

Mr. Fritz Krusebecker  
McGraw-Hill Publishing Co.  
Liebigstrasse 19  
D-6000 Frankfurt/Main 1  
West Germany  
69 72 01 81

Mrs. Maria Sarmiento  
Pedro Teixeira 8, Off. 320  
Iberia Mart 1  
Madrid 4, Spain  
1 45 52 891

Mr. Andrew Karnig  
McGraw-Karnig & Associates  
Finnbodavagen  
S-131 31 Nacka, Sweden  
8-44 0005

Mr. Alain Faure  
McGraw-Hill Publishing Co.  
128 Faubourg Saint Honore  
75008 Paris  
France  
(1) 47-20-33-42

Mr. Arthur Scheffer  
McGraw-Hill Publishing Co.  
34 Dover St.  
London W1X 3RA  
England 01 493 1451

Manuela Capuano  
McGraw-Hill Publishing Co.  
Via Flavio Baracchini 1  
20123 Milan, Italy  
02 86 90 617

Seavex Ltd.  
400 Orchard Road, #1001  
Singapore 0923  
Republic of Singapore  
Tel: 734-9790  
Telex: RS35539 SEAVEX

Seavex Ltd.  
503 Wilson House  
19-27 Wyndham St.  
Central, Hong Kong  
Tel: 5-260149  
Telex: 60904 SEVEX HX

Hiro Morita  
McGraw-Hill Publishing Co.  
Overseas Corp.  
Room 1528  
Kasumigaseki Bldg.  
3-2-5 Kasumigaseki,  
Chiyoda-Ku  
Tokyo 100, Japan  
3 581 9811

Mr. Ernest McCrary  
Empresa Internacional de  
Comunicacoes Ltda.  
Rua da Consolacao, 222  
Conjunto 103  
01302 Sao Paulo, S.P., Brasil  
Tel: (11) 259-3811  
Telex: (100) 32122 EMBN



# R·E·A·D·E·R S·E·R·V·I·C·E

Inquiry No.	Page No.	Inquiry No.	Page No.	Inquiry No.	Page No.	Inquiry No.	Page No.
393 A&T SYSTEMS INC.	287	65 CLASSIC TECHNOLOGY	72, 73	137 FOX SOFTWARE INC.	20	211 MCGRAW-HILL TRAINING SYS.	163
2 A.S.T. RESEARCH	12, 13	66 CLASSIC TECHNOLOGY	72, 73	138 FUTURE MUSIC	398	212 MCGRAW-HILL TRAINING SYS.	163
3 A.S.T. RESEARCH	12, 13	67 CLEVELAND CODONICS INC.	262	140 GENERAL COMPUTER	313	213 MEGASOFT	438
399 ABSOFT	370	* CODEX CORPORATION	304	397 GENERAL PARAMETRICS	248	214 MEGATEL COMPUTER TECH.	373
* ACS IMPORTERS	405	* CODEX CORPORATION	306	141 GENOA SYSTEMS CORP.	281	* MERCEDES-BENZ OF NA	255
4 ADV. DIGITAL CORP.	28	* CODEX CORPORATION	308	406 GFK	400	215 MERRITT COMP. PRODUCTS	438
5 ADV. DIGITAL CORP.	28	71 COGITATE	400	142 GLENCO ENGINEERING	99	216 METACOMCO	4
6 ADV. INTELLIGENCE TECHN.	409	72 COGITATE	407	144 GOLDEN BOW SYSTEMS	407	217 MFI ENTERPRISES INC.	193
9 ADVANCED COMP. PROD.	424, 425	* COMPAQ COMPUTER CORP.	152, 153	145 GOLDEN BOW SYSTEMS	410	218 MICRO DATA BASE SYS.	75
10 ADVANCE DEVLPMNT. TECHN.	149	73 COMPETITIVE EDGE	379	146 GRAFPOINT	402	219 MICRO DESIGN INT'L.	250
11 ADVANCED TECHNOLOGY PROD.	436	74 COMPUTADA TRANSLATORS INC.	438	401 GRIDCOMM	358	220 MICRO INTERFACES CORP.	376
12 AFTON COMPUTER	355	* COMPUPRO	307	148 GTEK INC.	277	221 MICRO PRODUCTS INT'L.	437
13 AFTON COMPUTER	355	75 COMPUSAVE	401	* HARMONY COMPUTERS	373	222 MICRO SUPPLY	433
14 ALF PRODUCTS INC.	405	76 COMPUSERVE	95	151 HAYES MICROCOMP PROD.	87	223 MICROBRIDGE COMP. INT'L.	410
15 ALPHA MICRO	264	77 COMPUTER AFFAIRS INC.	97	303 HENHOUSE SOFTWARE	379	224 MICROCOMPUTER SYSTEMS	414
* ALPS AMERICA	125-129	85 COMPUTER AGE INC.	414	152 HERCULES COMPUTER TECH.	84	225 MICROGRAFX	17
16 ALSYS LTD.	140, 141	* COMPUTER CHRONICLES	413	153 HERITAGE SYSTEMS CORP.	410	* MICROMINT INC.	403
17 AMBER SYSTEMS	283	78 COMPUTER CONNECTION INC.	421	154 HERSEY MICRO CONSULTING	405	226 MICROPILOT	400
18 AMBER SYSTEMS	283	* COMPUTER CONTINUUM	432	155 HOUSTON INSTR./BAUSCH&LOMB	21	227 MICROPROCESSORS UNLTD.	432
19 AMDEK CORP.	232	80 COMPUTER MAIL ORDER	316, 317	156 IBEX COMP CORP.	414	* MICRORIM INC.	325
21 AMER. DESIGN COMPONENTS	406	* COMPUTER MUSEUM	418	157 IBM - (ISG) SERVICES	263	* MICROSOFT CORP.	59
384 AMERICAN COMP. & PERIPH.	346	81 COMPUTER PARTS MART	405	159 IBM CORP.	326, 327	* MICROSOFT CORP.	169
385 AMERICAN COMP. & PERIPH.	346	82 COMPUTER SURPLUS STORE	414	160 IC EXPRESS	438	* MICROSOFT CORP.	177
* AMERICAN SEMICONDUCTOR	414	83 COMPUTER WAREHOUSE	310	161 INNER LOOP SOFTWARE	408	228 MICROTECH	436
23 AMERICAN SMALL BUSN. COMP.	130	84 COMPUTER WAREHOUSE	310	* INTECTRA INC.	432	229 MICROWAY	139
25 AMPRO COMPUTERS INC.	375	86 COMPUTERBANC	412	163 INTEGRAND RESEARCH CORP.	70	230 MICROWAY	309
* ANTHRO CORP.	16	87 COMPUTERIZED CONCEPTS	438	164 INTERNATIONAL MICROSYS.	436	394 MIX SOFTWARE	331
26 APPARAT INC.	432	* COMPUTERS FOR THE BLIND	377	* IQ TECHNOLOGIES	270	402 MORE COMPUTER	76
* APPLIED COMPUTER INC.	48 A-D	89 COMPUTERS INTERNATIONAL	218	* IQ TECHNOLOGIES	272	232 M-S CORPORATION	438
8 APPLIED SOFTWARE KINETICS	52	90 COMPUTRADE	372	166 IIT INFORMATION SYSTEMS	278	233 NAAO USA CORP.	225
* APROTEK	432	91 CONCORD TECHNOLOGY CO.	52	167 IIT INFORMATION SYSTEMS	278	234 NAAO USA CORP.	225
27 ARITY CORPORATION	205	92 CONROY-LAPOINTE	62	168 IACO ENTERPRISES	436	235 NANTUCKET	39
28 ARTEK CORP.	35	93 CONROY-LAPOINTE	62	169 IADE COMP. PROD.	434, 435	236 NANTUCKET	39
30 ASHTON-TATE	290, 291	94 CONROY-LAPOINTE	62	170 IAMECO ELECTRONICS	428, 429	238 NATIONAL INSTRUMENTS	120
* AT&T COMMUNICATIONS	200, 201	95 CORDATA	380, 381	171 IC INFORMATION SYSTEMS	305	239 NATIONAL MEMORY SYSTEMS	68
* AT&T INFORMATION SYS.	351	96 COSMOS INC.	136	172 IDR INSTRUMENTS	41	* NCR	57
33 ATRON CORP.	182	99 CUESTA SYSTEMS	330	173 IDR MICRODEVICES	439	240 NEC HOME ELECTR.USA	301
34 ATRONICS INT'L. INC.	335	102 D AND D DISCOUNT	411	174 IDR MICRODEVICES	440, 441	241 NEC INFORMATION SYS.	CIII
35 B&B ELECTRONICS	408	104 DATA BLOCKS INC.	184	175 IDR MICRODEVICES	442, 443	242 NIC TECHNOLOGY INC.	194
* B&C MICROSYSTEMS	402	105 DATA EXCHANGE	432	176 IDR MICRODEVICES	444	243 OKIDATA	106
* B&C MICROSYSTEMS	402	106 DATA SPEC	172	177 IM SYSTEM INC.	188	244 OMNITRONIX INC.	436
36 BARRINGTON SYSTEMS	26, 27	107 DATA SPEC	172	178 IVB ELECTRONICS	400	245 ORCHID TECHNOLOGY	151
39 BASF SYSTEMS	134, 135	108 DATA TRANSLATION INC.	321	179 KADAK PRODUCTS LTD.	74	246 ORCHID TECHNOLOGY	151
40 BAY EXPRESS	407	109 DATACOM NORTHWEST INC.	410	410 KEA SYSTEMS	438	247 ORCHID TECHNOLOGY	343
41 BAY TECHNICAL ASSOC.	284	110 DECISIONWARE INC.	300	180 KERN PUBLICATIONS	258	248 ORCHID TECHNOLOGY	343
408 BELL & HOWELL QUINTAR DIV.	91	111 DECISIONWARE INC.	300	181 KIMTRON CORP.	261	249 ORION INSTRUMENTS	362
409 BELL & HOWELL QUINTAR DIV.	91	112 DIGITALK INC.	56	182 KIMTRON CORP.	261	250 OSBORNE/MCGRAW-HILL	223
* BEST WESTERN INT'L.	342	113 DISKO TECH	408	183 LAHEY COMPUTER SYSTEMS	374	251 PC COMPUTER BROKERS INC.	410
405 BINARY TECH. INC.	438	114 DISKETTE CONNECTION	365	184 LAPTOPP SYSTEMS	288	252 PC HORIZONS INC.	410
42 BITTNER ELECTRONICS	407	115 DISKS PLUS	76	185 LATTICE INC.	311	254 PACIFIC EXCHANGES	400
450 BIX	336, 337	116 DISK WORLD! INC.	422, 423	186 LIFEBOAT ASSOC.	181	255 PANASONIC COMPUTER DIV.	147
44 BLAISE COMPUTING INC.	195	117 DISPLAY TELECOMMUNCTS.	54	187 LINTEK COMP. ACCESSORIES	402	256 PATHFINDER SOFTWARE INC.	400
45 BLAISE COMPUTING INC.	195	118 DIVERSIFIED GROUP. THE	416	188 LIONHEART PRESS	370	257 PC MART	160
46 BORLAND INT'L.	CI, I	119 DOBERMAN SOFTWARE	221	189 LOGICAL DEVICES	314	258 PC NETWORK	80, 81
47 BORLAND INT'L.	CI, I	120 DOKAY COMP. PROD. INC.	404	190 LOGICAL DEVICES	315	* PC SOURCE	288 A-B
48 BORLAND INT'L.	31	121 DRESSSELHAUS COMP. PROD.	334	191 LOGICAL SYSTEMS INC.	414	* PC'S LIMITED	208 A-B
49 BORLAND INT'L.	31	122 DYNAMUS MICRO-DATA SYS.	436	400 LOGICSOFT	272 A-F	259 PC'S LIMITED	209
50 BORLAND INT'L.	33	147 EAST DIGITAL CO. LTD.	375	195 LOGITECH INC.	237	260 PECAN SOFTWARE SYS. INC.	121
51 BORLAND INT'L.	33	123 ECOSOFT	318	196 LOGITECH INC.	271	261 PERSOFT INC.	8
395 BORLAND INT'L.	133	124 EDUCATIONAL MICROCOMP SYS.	400	* LONE STAR SOFTWARE	420	262 PERSONAL TEX. INC.	352
396 BORLAND INT'L.	133	125 ELECTRONIC MUSICIAN	114	197 LUCKY COMPUTERS	436	263 PINE COMPUTER INC.	417
52 BP MICROSYSTEMS	410	126 ELEKTEK	24	198 LYCO COMPUTER	369	264 PRACTICORP	197
53 BROWN BAG SOFTWARE	45	127 ELEXOR INC.	402	199 MANX SOFTWARE SYS.	79	265 PRECISION DATA PRODUCTS	414
88 BTE COMPUTERS	353	129 EVEREX SYSTEMS	37	200 MANX SOFTWARE SYS.	242	266 PRIMAGES INC.	101
* BUEHLER SERVICES INC.	438	130 EVEREX SYSTEMS	37	201 MANZANA	48	272 PRINCETON GRAPHIC/SIGMA	55
54 BUSINESS TOOLS INC.	77	131 FLAGSTAFF ENGINEERING	256	203 MARCHAND INTERNATIONAL	405	267 PRINCETON GRAPHIC SYS.	226, 227
* BUYER'S MART SECTION	391-397	132 FLAGSTAFF ENGINEERING	256	204 MARK WILLIAMS CO.	51	* PRINCETON GRAPHIC SYS.	357
* BYTE BACK ISSUES	417	391 FORMAT SOFTWARE	252	205 MARK WILLIAMS CO.	53	* PRINCETON GRAPHIC SYS.	359
412 BYTE BITS MESSAGE	414	392 FORMAT SOFTWARE	252	* MAXELL DATA PRODUCTS	7	* PRINCETON GRAPHIC SYS.	361
* BYTE SUB MESSAGE	372	133 FORTRON CORPORATION	67	208 MAYNARD ELECTRONICS	15	271 PRINCETON GRAPHIC SYS.	363
* BYTE SUB SERVICE	418	134 FORTRON CORPORATION	67	* MCGRAW-HILL RESEARCH	287	273 PRINTER ACCESSORIES DIRECT	374
55 BYTE CONNECTION. THE	401	135 FORTRON CORPORATION	419	209 MCGRAW-HILL SOFTWARE	366	274 PRIORITY ONE	415
97 CEC	376	136 FORTRON CORPORATION	419	210 MCGRAW-HILL SOFTWARE	320	275 PRO CODE INTERNATIONAL	208
* C WARE/DESMET C.	377					276 PROFESSOR JONES INC.	402
* CALIFORNIA DIGITAL	426, 427					277 PROGRAMMER'S SHOP	297
56 CANON USA	340, 341					278 PROGRAMS IN MOTION	166
58 CAPITAL EQUIPMENT CORP.	259					279 PROSOFT	43
* CAPITAL MICRO	238					280 PURPLE COMPUTING	405
59 CALZIN SYSTEMS	344, 345					281 ODP COMPUTER SYSTEMS	170
61 CHALCEDONY SOFTWARE	348					282 OMS	328
62 CHALCEDONY SOFTWARE	348					283 OUA TECH INC.	407
63 CHORUS DATA SYSTEMS	268					284 OUA TECH INC.	407
64 CITIZEN AMERICA	115					285 OUA TECH INC.	408

.....  
 TO GET FURTHER information on the products advertised in BYTE, either pick up your touch-tone telephone and use TIPS (if you are a subscriber), or fill out the reader service card. Either way full instructions are provided following this reader service index which is provided as an additional service by the publisher, who assumes no liability for errors or omissions. \*Correspond directly with company.





# PRINTERS' PROGRESS.

For what you  
used to pay for  
a 9-pin printer

now, you can buy  
our fully-featured  
24-pin printer.

Our new Pinwriter™ P6, P7 series dot matrix printers are the first 24-pin printers that list for as little as \$699. Or about what you would have paid for an ordinary 9-pin printer a year ago.

Now, that's progress. Especially when you consider our new printers have an advanced 24-pin printhead. And print data at 216 characters per second and crisp, dense letter-quality at up to 65 cps.

Actually these new Pinwriter dot matrix printers surpass every other printer in their price range. In their combination of speed, graphics resolution, the number of built-in fonts and low noise level.

None of which will surprise you if you know NEC printers. Because nobody does more with 24-pin technology than NEC. In fact, we now have more 24-pin printer models than any other manufacturer.

So if you're looking for a printer that will do more and do it better, just progress to your NEC dealer and you'll get it for less than you imagined.

You can see the Pinwriter P6, P7 and our other 24-pin printers at your local dealer. For more information, call 1-800-343-4418 (in MA 617-264-8635). Or write: NEC Information Systems, Dept. 1610, 1414 Massachusetts Ave., Boxborough, MA 01719.



**NEC PRINTERS. THEY ONLY STOP  
WHEN YOU WANT THEM TO.**

**NEC**

NEC Information Systems, Inc.

Inquiry 241



# Radio Shack brings over 600 software programs within easy reach.

## 1986 Radio Shack Software Reference and Tandy Computer Guide

Over 600 programs listed by category and available off the shelf or through our Express Order service.

Plus, 24 pages devoted to the complete line of Tandy computers and peripherals.

**Radio Shack**  
COMPUTER CENTERS  
A DIVISION OF TANDY CORPORATION

ACCOUNTING  
BUSINESS GRAPHICS  
BUSINESS MANAGEMENT  
COMMUNICATIONS  
DATABASE  
EDUCATION/TRAINING  
ENTERTAINMENT  
GRAPHICS/DESIGN  
INDUSTRY SPECIFIC  
INTEGRATED PRODUCTS  
MATH/SCIENCE  
OPERATING SYSTEMS  
PERSONAL MANAGEMENT  
PROGRAMMING TOOLS  
SPREADSHEETS  
UTILITIES  
WORD PROCESSING  
COMPUTERS/PERIPHERALS

Now there's no more searching for the "right" program. The 1986 Radio Shack Software Reference and Tandy® Computer Guide is all you need for one-stop shopping. In it you'll find hundreds of programs for all types of computers—everything from XENIX® and MS-DOS® lines to portables.

This catalog features the most comprehensive software selection available. Essential business programs such as accounting, database management, and business graphics are readily available as well as a variety of industry-specific pro-

grams for you to choose from—programs for doctors, lawyers, farmers and other professionals.

And of course, there are dozens of programs and utilities specifically for programmers. We have advanced language development systems like *C Programming System* and *RM/COBOL*, plus powerful languages from Microsoft, like *Macro Assembler*, *XENIX Basic Interpreter* and *PASCAL Compiler*. You'll also find *GEM Desktop 1.2* and a multitude of operating systems. And you can add additional capability to your portable com-

puter with *Bar Code Driver* or *Bar Code Writer*.

We offer you the software you need most—from personal productivity to a wide variety of training packages. And if it's not available in the store, we'll order it through our Express Order System.

So visit a Radio Shack Computer Center today—it's your one-stop software store.

**Radio Shack**  
The Technology Store™  
A DIVISION OF TANDY CORPORATION

MS-DOS, XENIX, Macro Assembler, XENIX Basic Assembler and PASCAL Compiler/Registered TM Microsoft. C Programming System/TM Mark Williams Company. RM/COBOL/TM Ryan-McFarland. Bar Code Writer and Bar Code Driver/TM Prottable Computer Support Group. GEM Desktop 1.2/TM Digital Research Inc.