

# BYTE

THE SMALL SYSTEMS JOURNAL®

MAY 1986 VOL. 11, NO. 5

\$3.50 IN UNITED STATES  
\$4.25 IN CANADA / £2.10 IN U.K.  
A MCGRAW-HILL PUBLICATION  
0360-5280

## Storage Goes Optical



ROBERT  
86 MINNEY

# A single company has revolutionized the business of language, the language of business, and created the exciting new world of electronic reference works—Borland!

Which isn't bad for a 3-year-old. Turbo Pascal,® our first product, now has more than half a million users, and has become a world-wide standard. And that was just the beginning.

Since then, the Turbo Pascal family has grown to a family of 9, and today we're announcing our second language, Turbo Prolog,™ the natural language of Artificial Intelligence.

We've also introduced amazing business productivity tools like SideKick,® Traveling SideKick,™ Reflex, The Analyst,™ and SuperKey.®

We broke new ground in 1986 with Turbo Lightning.™ It includes the Random House® dictionary and thesaurus. Turbo Lightning is the forerunner of a complete electronic reference library, newly joined by the Word Wizard,™ which solves the unsolvable twists, and boggles and challenges your mind. Word Wizard



also includes Turbo Pascal source code so you can figure out how the Turbo Lightning access system works.

And here is a brief synopsis of current offerings from the Borland library of history-making software . . .

## Turbo Pascal® 3.0

The fastest Pascal compiler, plus an integrated programming environment. Includes a free MicroCalc™ spreadsheet, and 1,200 lines of annotated source code, ready to compile and run. Minimum memory: 128K.

## Turbo Tutor®

Takes you from basic right through advanced programming concepts and techniques. Includes 300-page tutorial and source code for every example used in the reference manual. Minimum memory: 128K.

## Turbo Graphix Toolbox™

Lets you create high-resolution graphics. Includes tools for complex business graphics, easy windowing, and storing screen images to memory. Complete with source code on disk, ready to compile. Minimum memory: 128K.

## Turbo Database Toolbox™

Perfect complement to Turbo Pascal. Contains complete library of Pascal procedures that allows you to search and sort data and build powerful database applications. Minimum memory: 128K.

## Turbo Editor Toolbox™ **NEW!**

It's all you need to build your own text editor or word processor. Provides all the routines—you decide which features you want. Source code included. Also includes the MicroStar™ text editor with pull-down menus and windowing. Interfaces directly with Turbo Lightning to let you spell-check your MicroStar files. Minimum memory: 192K.

## Turbo GameWorks™ **NEW!**

Reveals the secrets and strategies of game theory. Includes source code so you can write your own games. Gives you ready-to-play Chess, Bridge, and Go-Moku, an ancient Japanese game that will provide hours of fascinating diversion. Even if you don't want to write your own games, it's a terrific value. Minimum memory: 192K.

**NEW! NEW! NEW!**



## Turbo Prolog™

The natural language of Artificial Intelligence, Turbo Prolog is our second language and the latest product in the

Borland software library. Turbo Prolog is a fifth-generation language, and probably the most powerful programming language ever conceived. Includes a 200-page reference manual and free GeoBase,™ a natural query language database with commented source code on disk, ready to compile. It's all you need to know about Artificial Intelligence at a Humanity Intelligent price. Minimum memory: 384K.

**NEW!**



## Word Wizard™

Intriguing new addition to the Turbo Lightning Library.™ Solves unsolvable crosswords, and challenges your word skills and ability to break codes and ciphers. Scrambles, twists, turns, and boggles your mind. Includes Turbo Pascal source code and all the technical information you'll need to figure out the "nuts and bolts" of the Turbo Lightning access system. Minimum memory: 256K.



## SideKick®

Powerful desktop management program. #1 best-seller for the IBM® PC. Includes notepad, calculator, appointment scheduler, telephone directory and autodialer, and ASCII table. RAM-resident, it's always there to help, and stays in the background while you run other programs. One keystroke activates it. Minimum memory: 128K.



## Reflex, The Analyst™

Unique, easy-to-use database management and analysis. Shows your spreadsheet data from 1-2-3® dBase,® and others in five graphic forms—including bar charts, pie charts, scatter plots, line graphs, and stacked bar charts. Answers What if? questions. Minimum memory: 384K.



## Turbo Lightning™

An electronic reference library which includes the 80,000-word Random House Concise Dictionary and the 60,000-word Random House Thesaurus. Checks your spelling as you type. Gives you instant synonyms. Leads the revolutionary way in electronic publishing. Minimum memory: 256K.



## SuperKey®

Amazing keyboard enhancer for your IBM PC. With easy-to-write macros that can turn 1,000 keystrokes into 1.

Also includes powerful encryption technology that keeps confidential files confidential; locks your keyboard with secret password protection. (Because of encryption technology, SuperKey is under a US Government export ban.) Minimum memory: 128K.

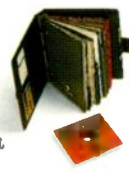

## Traveling SideKick™ **NEW!**

BinderWare® that includes an organizer, a binder, a software program, and a report generator that picks your SideKick's electronic brain, then prints out your appointments, daily/weekly/monthly/yearly calendar, phone lists, mailing labels, or whatever else you need when you're away from your desk. It's the smart new way to take your computer with you without taking your computer with you. Minimum memory: 256K.

## Special Prices!

You can save even more through September 1, 1986:

- Turbo Jumbo Pack—six Turbo products for only \$246.00: Turbo Pascal, Turbo Tutor, Turbo Graphix, Turbo Database Toolbox, Turbo Editor Toolbox, and Turbo GameWorks.
- SideKick and Traveling SideKick for only \$126.00.
- SideKick and Traveling SideKick and SuperKey, for only \$176.00.
- Turbo Lightning and Word Wizard for only \$149.96.

Step-by-step tutorial, demo programs with source code included!

# And now Borland introduces Turbo Prolog™, the natural language of Artificial Intelligence.

**P**rolog is probably the most powerful computer programming language ever conceived, which is why we've made it our *second* language—and "turbocharged" it to create Turbo Prolog.™

Our new Turbo Prolog brings supercomputer power to your IBM® PC and introduces you step-by-step to the fascinating new world of Artificial Intelligence. And does all this for an astounding \$99.95.

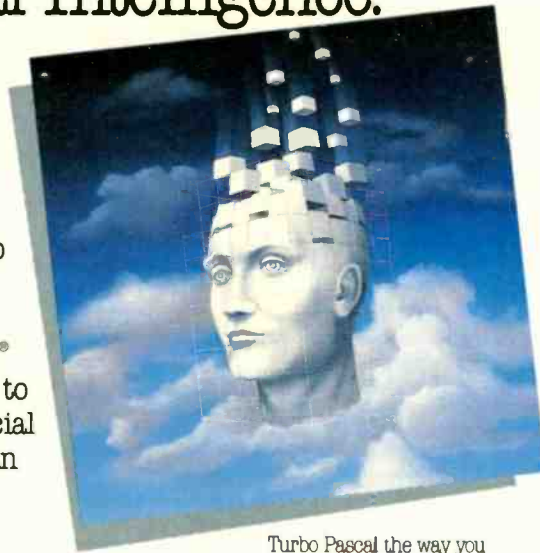

**Turbo Prolog is to Prolog what Turbo Pascal® is to Pascal!**

Our Turbo Pascal astonished everyone who thought of Pascal as "just another language." We changed all that—and now Turbo Pascal is the de facto worldwide standard, with hundreds of

thousands of enthusiasts and users in universities, research centers, schools, and with professional programmers, students, and hobbyists.

You can expect at least the same impact from Turbo Prolog, because while Turbo Prolog is the most revolutionary and natural programming language, it is also a complete development environment—just like Turbo Pascal.

Turbo Prolog radically alters and dramatically improves the brave new world of artificial intelligence—and invites you into that fascinating universe for a humanly intelligent \$99.95.

**Even if you've never programmed before, our free tutorial will get you started right away**

You'll get started right away because we have included a complete step-by-step tutorial as part of the 200-page Turbo Prolog Reference Manual. Our tutorial will take you by the hand and teach you everything you're likely to need to know about Turbo Prolog and artificial intelligence.

For example, once you've completed the tutorial, you'll be able to design your own expert systems utilizing Turbo Prolog's powerful problem-solving capabilities.

Think of Turbo Prolog as a high-speed electronic detective. First, you feed it information and teach it rules. Then Turbo Prolog "thinks" the problem through and comes up with all the reasonable answers—almost instantly.

If you think that this is amazing, you just need to remember that Turbo Prolog is a 5th-generation language—and the kind of language that 21st century computers will use routinely. In fact, you can compare Turbo Prolog to

Turbo Pascal the way you could compare Turbo Pascal to machine language.

**You get the complete Turbo Prolog programming system for only \$99.95**

You get a complete Turbo Prolog development system including:

- The lightning-fast Turbo Prolog incremental compiler and the interactive Turbo Prolog editor.
- The 200-page reference manual which includes the step-by-step Turbo Prolog tutorial.
- The free GeoBase™ natural query language database including commented source code on disk—ready to compile. GeoBase is a complete database designed and developed around U.S. geography. It includes cities, mountains, rivers, and highways, and comes complete with natural query language. Use GeoBase immediately "as is," or modify it to fit your own interests.

So don't delay—don't waste a second—get Turbo Prolog now. \$99.95 is an amazingly small price to pay to become an immediate authority—an instant expert on artificial intelligence! The 21st century is only one phone call away.

**YES!**

Rush me Turbo Prolog Today

**\$99.95**

To order by phone, or for a dealer nearest you, call (800) 255-8008; in CA call (800) 742-1133

Copies	Product	Price	Totals
___	Turbo Pascal 3.0	\$69.95	\$ ___
___	Turbo Pascal w/8087	\$109.90	\$ ___
___	Turbo Pascal w/BCD	\$109.90	\$ ___
___	Turbo Pascal w/8087, BCD	\$124.95	\$ ___
___	Turbo Database Toolbox	\$54.95	\$ ___
___	Turbo Graphics Toolbox	\$54.95	\$ ___
___	Turbo Tutor	\$34.95	\$ ___
___	Turbo Editor Toolbox	\$69.95	\$ ___
___	Turbo GameWorks	\$69.95	\$ ___
___	Turbo Lightning	\$99.95	\$ ___
___	Turbo Prolog	\$99.95	\$ ___
___	Word Wizard	\$69.95	\$ ___
___	Reflex, The Analyst	\$99.95	\$ ___
___	SideKick	\$84.95	\$ ___
___	Travelling SideKick	\$69.95	\$ ___
___	SuperKey	\$69.95	\$ ___
___	Turbo Lightning Word Wizard	\$149.95	\$ ___
___	SideKick		
___	Travelling SideKick	\$125.00	\$ ___
___	SideKick SuperKey		
___	Travelling SideKick	\$175.00	\$ ___
___	Turbo Jumbo Pack	\$245.00	\$ ___

Outside USA add \$10 per copy  
CA and MA res. add sales tax

Amount enclosed \$ \_\_\_

Prices include shipping to all US cities.

Carefully describe your computer system.

Mine is \_\_\_ 8-bit \_\_\_ 16-bit

I use \_\_\_ PC-DOS \_\_\_ MS-DOS

\_\_\_ CP/M-80 \_\_\_ CP/M-86

My computer's name and model is

The disk size I use is  3 1/2"  5 1/4"  8"

Payment  VISA  MC  Bank Draft  Check

Credit card expiration date \_\_\_/\_\_\_/\_\_\_

Card #

\_\_\_\_\_

\_\_\_\_\_

\_\_\_\_\_

\_\_\_\_\_

\_\_\_\_\_

\_\_\_\_\_

\_\_\_\_\_

\_\_\_\_\_

\_\_\_\_\_

\_\_\_\_\_

\_\_\_\_\_

\_\_\_\_\_

\_\_\_\_\_

\_\_\_\_\_

\_\_\_\_\_

\_\_\_\_\_

\_\_\_\_\_

\_\_\_\_\_

\_\_\_\_\_

\_\_\_\_\_

\_\_\_\_\_

\_\_\_\_\_

\_\_\_\_\_

\_\_\_\_\_

\_\_\_\_\_

\_\_\_\_\_

\_\_\_\_\_

\_\_\_\_\_

\_\_\_\_\_

\_\_\_\_\_

\_\_\_\_\_

\_\_\_\_\_

\_\_\_\_\_

\_\_\_\_\_

\_\_\_\_\_

\_\_\_\_\_

\_\_\_\_\_

\_\_\_\_\_

\_\_\_\_\_

\_\_\_\_\_

\_\_\_\_\_

\_\_\_\_\_

\_\_\_\_\_

\_\_\_\_\_

\_\_\_\_\_

\_\_\_\_\_

\_\_\_\_\_



4585 SCOTTS VALLEY DRIVE  
SCOTTS VALLEY, CA 95066  
(408) 438-8400 TELEX: 172373

Other Borland Products include Turbo Pascal, Turbo Tutor, Turbo Lightning, Turbo Database Toolbox, Turbo Graphics Toolbox, Turbo Editor Toolbox, Turbo GameWorks, SuperKey, SideKick, SideKick, The Macintosh Office Manager, Reflex, The Analyst, and Travelling SideKick—all of which are registered trademarks or trademarks of Borland International, Inc. or Borland/Analytics, Inc. Turbo Prolog and GeoBase are trademarks and Turbo Pascal is a registered trademark of Borland International, Inc. IBM and AT are registered trademarks of International Business Machines Corp. Copyright 1988 Borland International, Inc. 1046A Inquiry 40 for End-Users. Inquiry 41 for DEALERS ONLY.



# C·O·N·T·E·N·T·S

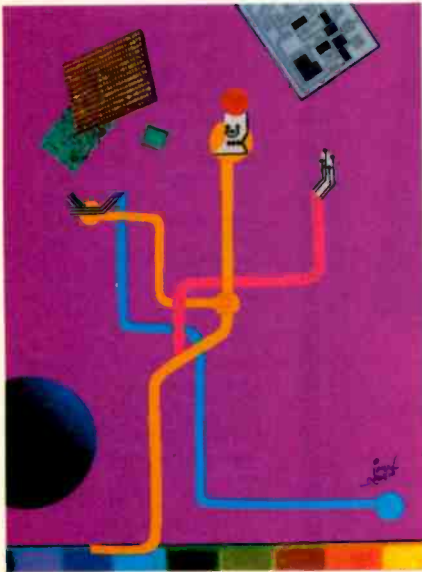

82



158

## FEATURES

<b>INTRODUCTION</b> .....	82
<b>CIARCIA'S CIRCUIT CELLAR: ADDING SCSI TO THE SB180 COMPUTER, PART I: INTRODUCTION</b> by Steve Ciarcia .....	85
This month's project takes few chips but much explanation.	
<b>PROGRAMMING PROJECT: DATA COMPRESSION WITH HUFFMAN CODING</b> by Jonathan Amsterdam .....	98
This may be the best all-around technique for data compression.	
<b>MODULA-2 AS A SYSTEMS PROGRAMMING LANGUAGE</b> by Ryn C. Corbeil and Anne H. Anderson .....	111
The authors describe how particular attributes of Modula-2 helped them develop a real-time multiprocessing operating system in a relatively short time.	
<b>LINKING DATA FLOW AND FUNCTIONAL LANGUAGES</b> by Chris Hankin, David Till, and Hugh Glaser .....	123
Combine the advantages of functional programming and parallel execution to increase execution speed.	
<b>EASY C</b> by Pete Orlin and John Heath .....	137
Some tips on using this preprocessor can help you write more understandable code.	
<b>PROGRAMMING INSIGHT: SUBROUTINE OVERLAYS IN GW-BASIC</b> by Mike Carmichael .....	151
With this technique you can store subroutines in a RAM disk and have your BASIC program call them one by one as they are needed.	

## THEME: MASS STORAGE

<b>INTRODUCTION</b> .....	158
<b>THE EVOLUTION OF MASS STORAGE</b> by Leonard Laub .....	161
Follow the development of mass storage media from the early days of magnetic tape to the latest microcomputer disk systems.	
<b>CD-ROM SOFTWARE DEVELOPMENT</b> by Bill Zoellick .....	177
To get the most out of CD-ROMs, you need to know how they differ from magnetic disks.	
<b>THE APPLICATION INTERFACE OF OPTICAL DRIVES</b> by Jeffrey R. Dulude .....	193
This article discusses the issues facing the applications programmer working with write-once disks.	
<b>OPTICAL DISK ERROR CORRECTION</b> by Solomon W. Golomb .....	203
Sophisticated codes allow media makers to use less disk space for error correction and more for storing data.	
<b>A ROUNDUP OF OPTICAL DISK DRIVES</b> by Rich Malloy .....	215
Rich describes a variety of recently announced optical storage systems.	
<b>TAPE BACKUP SYSTEMS</b> by Anthony Antonuccio .....	227
The "data insurance" these systems provide is more needed than ever with today's higher disk capacities.	
<b>LASER LIBRARIES</b> by Norman Desmarais .....	235
Several large databases are now available on optical disks.	

## REVIEWS

<b>INTRODUCTION</b> .....	250
<b>REVIEWER'S NOTEBOOK</b> by Ion Edwards .....	253
<b>THE AT&amp;T UNIX PC</b> by Alastair J. W. Mayer .....	254
The power of UNIX in a personal computer.	
<b>ZBASIC</b> by TJ Byers .....	265
An interactive BASIC compiler that lets you run the same code on several computers with little modification.	

BYTE (ISSN 0360-5280) is published monthly with one extra issue per year by McGraw-Hill Inc. Founder: James H. McGraw (1860-1948). Executive, editorial, circulation, and advertising offices, 70 Main St., Peterborough, NH 03458, phone (603) 924-9281. Office hours: Mon-Thur 8:30 AM - 4:30 PM, Friday 8:30 AM - 1:00 PM, Eastern Time. Address subscriptions to BYTE Subscriptions, POB 590, Martinsville, NJ 08836. Postmaster: send address changes. USPS Form 3579, undeliverable copies, and fulfillment questions to BYTE Subscriptions, POB 596, Martinsville, NJ 08836. Second-class postage paid at Peterborough, NH 03458 and additional mailing offices. Postage paid at Winnipeg, Manitoba, Registration number 9321. Subscriptions are \$21 for one year, \$38 for two years, and \$55 for three years in the USA and its possessions. In Canada and Mexico, \$23 for one year, \$42 for two years, \$61 for three years. \$69 for one year air delivery to Europe, 17,100 yen for one year surface delivery to Japan, \$37 surface delivery elsewhere. Air delivery to selected areas at additional rates upon request. Single copy price is \$3.50 in the USA and its possessions, \$4.25 in Canada and Mexico, \$4.50 in Europe, and \$5 elsewhere. Foreign subscriptions and sales should be remitted in United States funds drawn on a U.S. bank. Please allow six to eight weeks for delivery of first issue. Printed in the United States of America.

<b>GEM DRAW/MACDRAW</b> by Ricardo Birmele .....	269
Two second-generation paint programs	
<b>HARDCARD</b> by Eva White .....	273
A hard disk and controller on a card for the IBM PC	
<b>THE B&amp;C MICROSYSTEMS 1409 EPROM PROGRAMMER</b> by Robert Jacobs .....	279
An EPROM programmer that connects to one of your computer's RS-232C ports	
<b>NON-KEYBOARD INPUT DEVICES</b> by Chris Pappas .....	285
PC-Pedal, Footmouse, and Light Pen	
<b>RACTER</b> by Hugh Kenner .....	289
A software package that interviews and entertains	
<b>GENERAL ELECTRIC'S 3-8100 PRINTER</b> by Robert D. Swearingin .....	293
A low-end thermal printer	
<b>LETTRIX</b> by Alan R. Miller .....	299
A resident print processor for IBM PCs and compatibles	
<b>REVIEW FEEDBACK</b> .....	305
Readers respond to previous reviews	

## KERNEL

<b>INTRODUCTION</b> .....	308
<b>COMPUTING AT CHAOS MANOR: EXPANDED/EXTENDED MEMORY</b> by Jerry Pournelle .....	311
Jerry looks at a wide assortment of products	
<b>BYTE JAPAN: AN INNOVATIVE PROGRAM</b> by William M. Raike .....	329
EM/3+ is an operating-system unification adapter	
<b>APPLICATIONS ONLY: A MIXED LOT</b> by Ezra Shapiro .....	335
Ezra talks about Boxes & Arrows, Stella Boxcalc, Interlace, and PC-Outline	
<b>ACCORDING TO WEBSTER: 68000 WARS: ROUND 2</b> by Bruce Webster .....	343
The bout resumes, with comparisons and benchmarks	
<b>BYTE U.K.: INTUITIVE SOLUTION</b> by Dick Pountain .....	363
Dick describes an object-oriented programming system	
<b>MATHEMATICAL RECREATIONS: THE PELLIAN EQUATION</b> by Robert T. Kurosaka .....	379
This equation offers another method to solve word problems	

## BEST OF BIX

<b>AMIGA</b> .....	398	<b>IBM AND COMPATIBLES</b> .....	405
<b>ATARI ST</b> .....	402	<b>MACINTOSH</b> .....	414
<b>EDITORIAL:</b>			
LET OUR MODEMS GO .....	6	CIRCUIT CELLAR FEEDBACK .....	54
MICROBYTES .....	9	BOOK REVIEWS .....	63
LETTERS .....	14	EVENT QUEUE .....	78
WHAT'S NEW .....	29	CHAOS MANOR MAIL .....	392
CLUBS AND NEWSLETTERS .....	48	DISKS AND DOWNLOADS .....	469
FIXES AND UPDATES .....	49	BYTE'S ONGOING MONITOR BOX BOMB RESULTS .....	470
ASK BYTE .....	50	READER SERVICE .....	471



250



308

Address all editorial correspondence to the Editor, BYTE, POB 372, Hancock, NH 03449. Unacceptable manuscripts will be returned if accompanied by sufficient first-class postage. Not responsible for lost manuscripts or photos. Opinions expressed by the authors are not necessarily those of BYTE. Copyright © 1986 by McGraw-Hill Inc. All rights reserved. Trademark registered in the United States Patent and Trademark Office. Where necessary, permission is granted by the copyright owner for libraries and others registered with the Copyright Clearance Center (CCC) to photocopy any article herein for the flat fee of \$1.50 per copy of the article or any part thereof. Correspondence and payment should be sent directly to the CCC, 29 Congress St., Salem, MA 01970. Specify ISSN 0360-5280/83 \$1.50. Copying done for other than personal or internal reference use without the permission of McGraw-Hill Inc. is prohibited. Requests for special permission or bulk orders should be addressed to the publisher. BYTE is available in microform from University Microfilms International, 300 North Zeeb Rd., Dept. PR, Ann Arbor, MI 48106 or 18 Bedford Row, Dept. PR, London WC1R 4EJ England. Subscription questions or problems should be addressed to: BYTE Subscriber Service, POB 328, Hancock, NH 03449



# The Switchboard: EnGarde™

EnGarde™ is the surge suppressor with the added protection of a master switch that controls your computer and its peripherals. It quickens start-up time and reduces wear on your computer and peripheral ON/OFF switches.

An LED grounded outlet indicator and an anti-static touch pad are also built into EnGarde™

EnGarde™ also protects your computer from power surges caused by changes in electrical loads and other electrical disturbances. It includes a limited five-year warranty.

EnGarde™ is a product of Systems Control, manufacturer of power protection systems for the nation's utility companies.

Ask your dealer for the total protection of EnGarde™ Or call toll free 1-800-451-6866 to order (in Michigan call collect 906/774-0440). If unsatisfied, return EnGarde™ within 30 days for a full refund.



# EnGarde™

A product of Systems Control, a division of M.J. Electric, Inc.

# BYTE

**EDITOR IN CHIEF**

PHILIP LEMMONS

**MANAGING EDITOR, PRINT**

GENE SMARTE

**MANAGING EDITOR,**

**ELECTRONIC PUBLISHING AND COMMUNICATIONS**

GEORGE BOND

**CONSULTING EDITORS**

STEVE CIARCIA

JERRY POURNELLE

BRUCE WEBSTER

**SENIOR TECHNICAL EDITORS**

G. MICHAEL VOSE, *Themes*

GREGG WILLIAMS

**TECHNICAL EDITORS**

DENNIS ALLEN

ION R. EDWARDS, *Reviews*

RICHARD GREHAN

GLENN HARTWIG

KEN SHELDON

JANE MORRILL TAZELAAR

TOM THOMPSON

CHARLES D. WESTON

EVA WHITE

STANLEY WSZOLA

**ASSOCIATE TECHNICAL EDITORS**

MARGARET COOK GURNEY, *Book Reviews*

BRENDA McLAUGHLIN, *Applications Software Reviews, San Francisco*

DONNA OSGOOD, *San Francisco*

**NEWS AND TECHNOLOGY**

EZRA SHAPIRO, *Bureau Chief, San Francisco*

RICH MALLOY, *Senior Technical Editor, New York*

PHILLIP ROBINSON, *Senior Technical Editor, Palo Alto*

TONY LOCKWOOD, *Senior News Editor*

**ASSOCIATE NEWS EDITORS**

DENNIS BARKER

CATHRYN BASKIN

LYNNE M. NADEAU

**CONTRIBUTING EDITORS**

JONATHAN AMSTERDAM, *programming projects*

DAVID BETZ, *programming*

MARK HAAS, *at large*

RIK JADRNICEK, *CAD, graphics, spreadsheets*

ROBERT T. KUROSAKA, *mathematical recreations*

PHIL LOPICCOLO, *computers in medicine*

ALASTAIR J. W. MAYER, *software*

ALAN R. MILLER, *languages and engineering*

DICK POUNTAIN, *U.K.*

ROGER POWELL, *computers and music*

WILLIAM M. RAIKE, *Japan*

**COPY EDITORS**

BUD SADLER, *Chief*

ELIZABETH COOPER

FAITH HANSON

NANCY HAYES

CATHY KINGERY

ANNE FISCHER LENT

PAULA NOONAN

JOAN VIGNEAU ROY

WARREN WILLIAMSON

**ASSISTANTS**

PEGGY DUNHAM, *Office Manager*

MARTHA HICKS

JUNE N. SHELDON

JUDY WINKLER

**ART**

ROSSLYN A. FRICK, *Art Director*

NANCY RICE, *Associate Art Director*

JAN MÜLLER, *Art Assistant*

ALAN EASTON, *Drafting*

**PRODUCTION**

DAVID R. ANDERSON, *Production Director*

DENISE CHARTRAND

MICHAEL J. LONSKY

VIRGINIA REARDON

**TYPOGRAPHY**

SHERRY MCCARTHY, *Chief Typographer*

LEN LORETTE

DONNA SWEENEY

**SENIOR VICE PRESIDENT/PUBLISHER**

HARRY L. BROWN

**PUBLISHER'S ASSISTANT**

BEVERLY JACKSON

**CIRCULATION (800-258-5485)**

ANDREW JACKSON, *Subscriptions Manager*

LAURIE SEAMANS, *Assistant Manager*

SUSAN BOYD

MARY EMERSON

LOUISE MENEGUS

AGNES E. PERRY

JENNIFER PRICE

JAMES BINGHAM, *Single-Copy Sales Manager*

CATHY A. RUTHERFORD, *Assistant Manager*

CLAUDETTE CARSWELL

KAREN DESROCHES

**ADVERTISING SALES**

DENNIS J. RILEY, *Director of Sales and Marketing*

SANDRA FOSTER, *Administrative Assistant*

**ADVERTISING/PRODUCTION (603-924-6448)**

LISA WOZMAK, *Supervisor*

ROBERT D. HANNINGS, *Senior Account Coordinator*

MARION CARLSON

KAREN CILLEY

LYDA CLARK

MICHELE JACKSON

WAI CHIU LI, *Quality Control Manager*

JULIE MURPHREE, *Advertising/Production Coordinator*

**MARKETING COMMUNICATIONS**

HORACE T. HOWLAND, *Director (603-924-3424)*

VICKI REYNOLDS, *Marketing Production Manager*

LISA JO STEINER, *Marketing Assistant*

STEPHANIE WARNESEY, *Marketing Art Director*

SHARON PRICE, *Assistant Art Director*

DOUG WEBSTER, *Director of Public Relations (603-924-9027)*

WILBUR S. WATSON, *Operations Manager, Exhibits*

**RESEARCH**

PATRICIA AKERLEY, *Research Manager*

JULIE PERRON, *Market Research Analyst*

CYNTHIA DAMATO SANDS, *Reader Service Coordinator*

**FINANCIAL SERVICES**

PHILIP L. PENNY, *Director of Finance and Services*

KENNETH A. KING, *Business Manager*

CHRISTINE LEE, *Assistant*

VICKI WESTON, *Accounting Manager*

LINDA SHORT, *D/P Manager*

EDSON WARE, *Credit*

MARILYN HAIGH

DIANE HENRY

VERN ROCKWELL

JOANN WALTER

**PLANNING AND DEVELOPMENT**

MICHELE P. VERVILLE, *Manager*

FAITH KLUNTZ, *Copyrights Coordinator*

**PERSONNEL**

CHERYL HURD, *Office Manager*

PATRICIA BURKE, *Personnel Coordinator*

**BUILDING SERVICES/TRAFFIC**

ANTHONY BENNETT, *Building Services Manager*

BRIAN HIGGINS

MARK MONKTON

**RECEPTIONIST**

DENISE PROCTOR

**Officers of McGraw-Hill Information Systems Company, President:** Richard B. Miller, *Executive Vice Presidents:* Frederick P. Innot, *Construction Information Group:* Russell C. White, *Computers and Communications Information Group:* J. Thomas Ryan, *Marketing and International:* Senior Vice Presidents: Francis A. Shinal, *Controller:* Robert C. Violette, *Manufacturing and Technology:* Senior Vice Presidents and Publishers: Laurence Altman, *Electronics Week:* Harry L. Brown, *BYTE:* David L. McGrath, *Construction Publications:* Group Vice President: Peter B. McCuen, *Communications Information:* Vice President: Fred O. Iensen, *Planning and Development:*

*Officers of McGraw-Hill, Inc.:* Harold W. McGraw, Jr., *Chairman;* Joseph L. Donne, *President and Chief Executive Officer;* Robert N. Landes, *Executive Vice President and Secretary;* Walter D. Serwatka, *Executive Vice President and Chief Financial Officer;* Shel F. Asen, *Senior Vice President, Manufacturing;* Robert I. Bahash, *Senior Vice President, Finance and Manufacturing;* Ralph R. Schulz, *Senior Vice President, Editorial;* George R. Elsing, *Vice President, Circulation;* Ralph I. Webb, *Vice President and Treasurer.*

**Editorial and Business Office:** 70 Main Street, Peterborough, New Hampshire 03458, (603) 924-9281.

**West Coast Offices:** McGraw-Hill, 425 Battery St., San Francisco, CA 94111, (415) 362-4600.

McGraw-Hill, 1000 Elwell Court, Palo Alto, CA 94303, (415) 964-0624.

**New York Editorial Office:** 1221 Avenue of the Americas, New York, NY 10020, (212) 512-2000.

BYTE, BYTE, and The Small Systems Journal are registered trademarks of McGraw-Hill Inc.

# Circuit-Board-Artwork Software for the Design Engineer in a Hurry

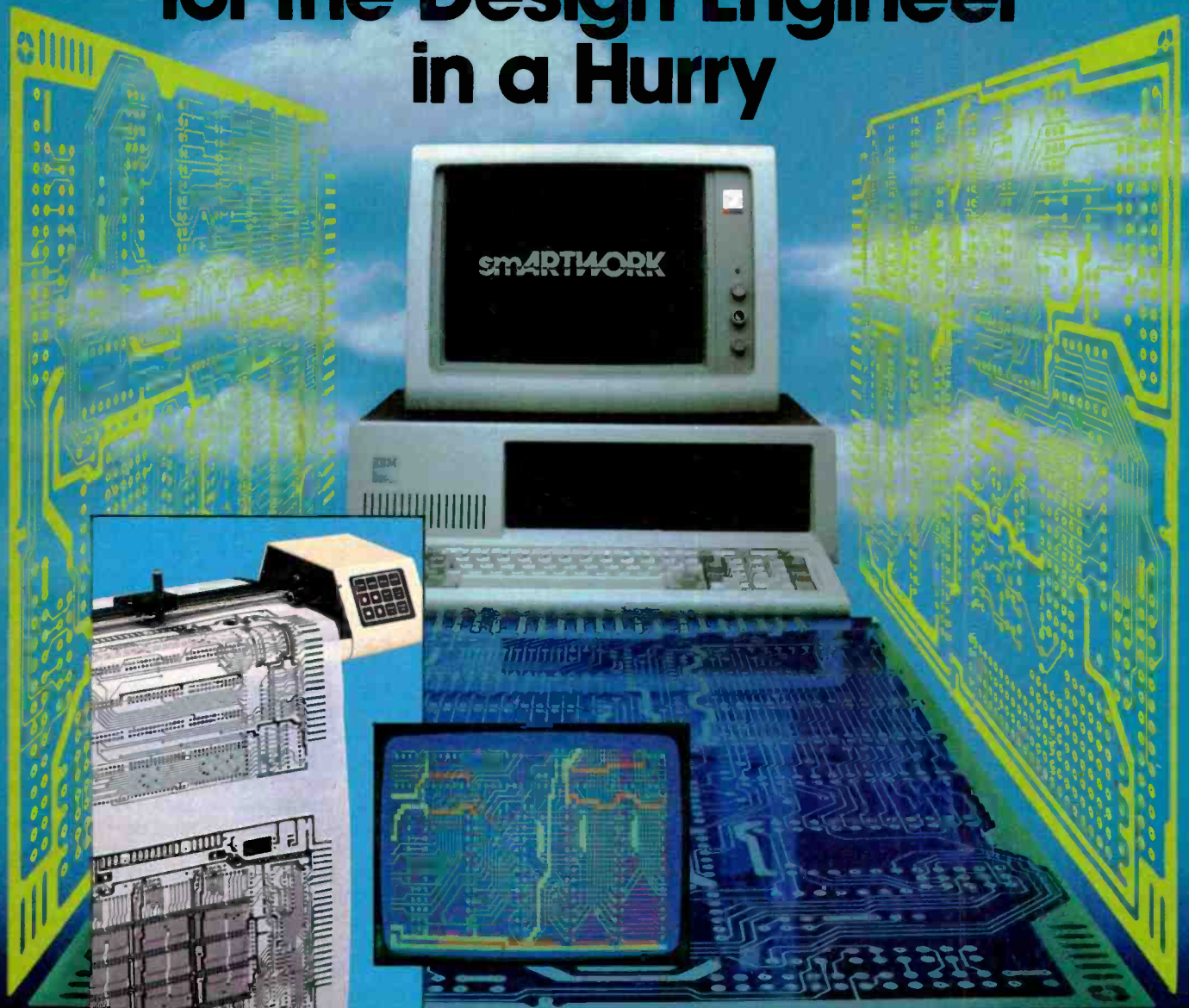

For only \$895, smARTWORK® lets the design engineer create and revise printed-circuit-board artwork on the IBM Personal Computer. You keep complete control over your circuit-board artwork — from start to finish.

Forget the tedium of taping it yourself or waiting for a technician, draftsman, or the CAD department to get to your project.

smARTWORK® is the only low-cost printed-circuit-board artwork editor with all these advantages:

- Complete interactive control over placement and routing
- Quick correction and revision
- Production-quality 2X artwork from a pen-and-ink plotter
- Prototype-quality 2X artwork from a dot-matrix printer

- Easy to learn and operate, yet capable of sophisticated layouts
- Single-sided and double-sided printed circuit boards up to 10 x 16 inches
- Multicolor or black-and-white display

#### System Requirements:

- IBM Personal Computer, XT, or AT with 256K RAM, 2 disk drives, and DOS Version 2.0 or later
- IBM Color/Graphics Adapter with RGB color or black-and-white monitor
- IBM Graphics Printer or Epson FX/MX/RX series dot-matrix printer
- Houston Instrument DMP-41 pen-and-ink plotter
- Optional Microsoft Mouse

#### The Smart Buy

At \$895, smARTWORK® is proven, convenient, fast, and a sound value. Call us today. And put it to work for yourself next week.

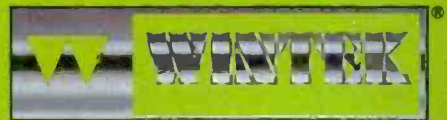

Wintek Corporation Inquiry 390  
1801 South Street  
Lafayette, IN 47904-2993  
Telephone: (317) 742-8428  
Telex: 70-9079 WINTEK CORP UD

In Europe contact: RT/A Terminals Limited,  
Woking, Surrey GU21 3JY ENGLAND,  
Telephone: 04662-71001, Telex: 859502

smARTWORK®, "Wintek" and the Wintek logo are registered trademarks of Wintek Corporation.

## LET OUR MODEMS GO

In many cases, social benefits must wait for technical advances. Until the development of the telegraph in the 1850s, for example, no one was well informed about world events. The telegraph made it possible to deploy correspondents widely and to publish their reports quickly. News services such as Reuters were born, and the public was soon much better informed than ever before.

Sometimes technology stands ready to bring about new social benefits, but social policy blocks the way. This is the situation with data communications in much of the world today. All the technological ingredients are present to move magazine publishing into a new era in which print and electronic media combined serve the reader far better than either can do alone. Satellite communications, large packet-switching networks, modems, personal computers, multiuser systems with computer conferencing software—all these can now link the subscribers of special-interest magazines such as *BYTE*. Subscribers can exchange information. What was an abstract community of interest becomes a functioning community unimpaired by geography and time zones. It is as if people can voluntarily form communities that live in electronic communications and record their lives in print. This adds a new dimension to publishing and gives new value to subscribers.

But social policy results in prohibitive costs for data communications in many parts of the world. Postal Telephone and Telegraph Agencies (abbreviated "PTTs") maintain monopolies on telecommunications. I will use one PTT as an example of these monopolies and their effects—not because this PTT is less progressive than any other but for the sake of clarity in discussing regulatory and pricing issues.

The West German PTT, for example, is the Deutsche Bundespost. To participate in telecommunications, our German readers must open an account with the Deutsche Bundespost and rent a modem from them at rates decided by regulatory agencies. During the Hannover Faire (CeBIT) in March 1986, many *BYTE* readers approached the *BYTE*/McGraw-Hill booth and expressed a strong desire to join the

*BYTE* Information Exchange (BIX). BIX is accessible through Tymnet, which can be reached from packet networks outside the United States by typing its Data Network Identifier Code 3106.

But the obstacles are great: Bundespost charges 120 deutsche marks (about \$50) per month for a 1200-baud full-duplex modem. An autodialer is an additional 30 DM per month. Users of the packet-switching network Datex-P must also pay telephone tolls for their calls to the 17 Datex-P nodes and 5 pfennigs (about 2 cents) per minute access charges at 1200 baud. On top of this, users face a charge of 23 pfennigs for every 2.964 seconds of connection with the U.S. There is a 20-pfennig-per-minute duration charge and a 1.6-pfennig-per-segment (kilocharacter?) volume charge. Bundespost offers no discount for any time of day or night.

## THE COST OF REGULATION

By contrast, within the United States, the BIX nighttime charge for telecommunications is a flat \$2 per hour. Users in the United States buy their own modems from many different vendors and can now get a full-duplex 1200-baud autodial modem for less than \$200. Since merely renting a modem for a year in Germany costs three times the purchase price in the United States, it is clear that regulation is costing German and other European consumers dearly. Put another way: For the modem rental in Germany, *BYTE* readers in the U.S. can buy a modem and use BIX for more than three hours per month for a year.

How is it possible for a nation as technologically advanced as Germany to have policies that retard the development of telecommunications? The Bundespost booklet on data communications, "Worldwide Connections: the Deutsche Bundespost, your partner for data transmission," provides the answer. The Bundespost points out that it has built up the necessary infrastructure for data communication and claims to offer reasonable prices. The booklet urges corporations to take advantage of the infrastructure through a "changeover from specialised data processing to integrated data communication. The necessary practical measure would be

the transition to data transmission and teleprocessing—within firms and in external business relations, on the domestic as well as on international markets." In other words, reorganize your data processing department to use telecommunications. This is a sound idea.

But what if you don't have a data processing department? What about exchange of information among individuals? In its only nod to the individual human being, the Bundespost booklet states, "The computer is on its way from business applications to private households. Before long these private computers will also be used for data communications." This booklet was published in March 1985. In fact, personal computers are already in many European homes and are being used for telecommunications to the limited extent that PTT regulations and charges permit.

The cost of regressive policies on data communications is high: Prohibitive charges prevent the natural development of international interactive communities. Once these charges are reduced, communities now separated by geography will be united by shared interests that transcend national and continental boundaries. This will greatly improve international understanding.

For this reason, we call upon the PTTs and the governments of the world to retreat from their monopolies on equipment and to reduce their data communications charges to individuals.

—Phil Lemmons  
Editor in Chief

## BYTE LISTINGS ON DISK

We apologize for the delays in getting *BYTE* Listings disks mailed to those of you who ordered them. We have had some difficulty making arrangements with a disk duplication service that can handle all of the formats requested and that can process the volume of orders we have received. We have been mailing disks as fast as we can, but some of the less common disk formats are taking much more time than we expected. Please bear with us.



Maxell Corp. of America, 60 Oxford Drive, Moonachie, NJ 07074



**maxell**<sup>®</sup>  
FLOPPY DISKS  
THE GOLD STANDARD

Inquiry 221

## Before you invest in a DEC\*VT240 terminal, consider the software alternative.

Stop and think about what you really need: A text terminal. Tektronix\* graphics. ReGIS\* graphics. File transfer capabilities. Communications.

Purchasing a state-of-the-art terminal may be one option, but Persoft has a smarter solution—**SmarTerm® 240**, the ultimate in terminal emulation software.

SmarTerm can do everything the state-of-the-art terminal can do—and more. That's why we call it **state-of-the-smart**.

With SmarTerm 240, the emulation is so exact you'll forget you're using a PC. It features superior text emulation, ReGIS graphics, Tektronix graphics, outstanding communications and file transfer capabilities.

You also get on-line help screens, remappable keyboard layouts and programmable softkeys which can simplify your most frequently performed tasks. You can even customize your own menus!

And because SmarTerm runs on your PC, you've always got a wealth of computing power right at your fingertips.

All SmarTerm products are backed by Persoft's strong technical support network. It's a service you expect from the industry leader in terminal emulation software.

No matter which terminal you're currently using—Data General Dasher\* D400, Tektronix 4010/4014, DEC VT100, VT125, VT220 or even the new VT240,



SmarTerm has a state-of-the-smart solution for you.

To find out more about the SmarTerm family of terminal emulation software, see your local dealer. Or contact: Persoft, Inc. 2740 Ski Lane Madison, WI 53713 (608) 273-6000 – Telex 759491

# STATE OF THE ART

# VS

# STATE OF THE SMART

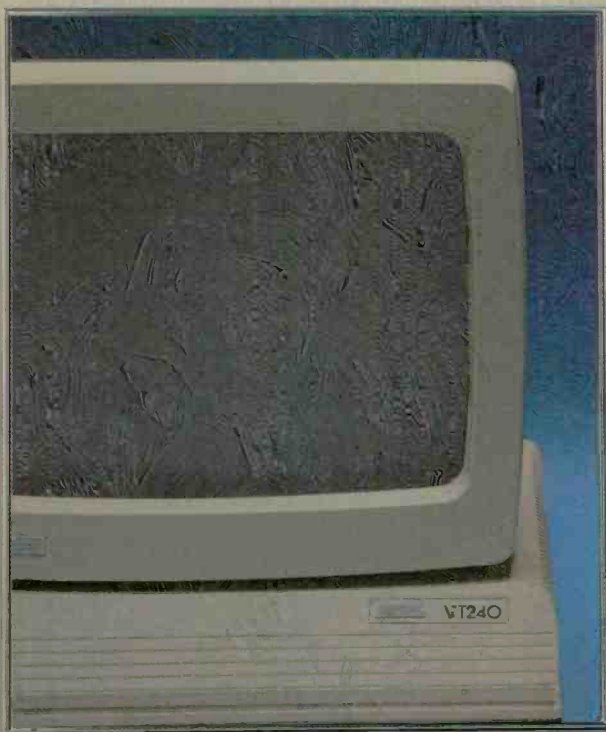

\*SmarTerm is a registered trademark of Persoft, Inc. \*DEC, VT and ReGIS, are trademarks of Digital Equipment Corp. \*DASHER is a registered trademark of Data General Corp. \*Tektronix is a registered trademark of Tektronix, Inc. © Persoft, Inc., 1986. All rights reserved.

# M·I·C·R·O·B·Y·T·E·S

---

Staff-written highlights of late developments in the microcomputer industry.

## Microsoft News

---

At the 1986 Personal Computer Forum in Phoenix, AZ, Bill Gates, chairman of Microsoft, argued that applications should not all have to work to the lowest common denominator—the 8088. "We must have a transition in which some benefits of new applications accrue only to the benefit of users of high-end systems," he declared.

Gates also said that a new type of software called "multimedia" software will soon emerge. It will use CD-ROMs and mix motion video, stills, music, voice, and so on. He predicted that CD-ROMs will attain large-scale use in part through the advent of an "information viewer" that lacks a disk and keyboard.

In other Microsoft news, Gates said that the Bellevue, WA, company is porting Excel from the Mac to run under Windows on the IBM PC. He wouldn't say when the program will appear under Windows but stated that it is easy to port to that environment.

At the CD-ROM conference in Seattle, WA, a few weeks later, Microsoft showed an encyclopedia demo that, while incomplete, has some parts that do exploit the audio, video, and text capabilities of CD-ROM. Bill Gates has noted that an encyclopedia should show pictures and play music when a user looks up Beethoven.

Finally, Gates announced that Microsoft has set up a new division just for CD-ROM. He believes that millions of these devices will be in use by 1990.

## New RAM Technology

---

Semiconductor firms are doing more with RAM chips than just increasing memory-access cycle speed and cell density. They are also offering new architectures that let more bits of data move in and out of a RAM chip in less time. Standard RAMs read or write a single bit at a time. The new nybble-mode RAMs available from many manufacturers allow high-speed serial access of up to 4 bits of data. The Am90C255 from Advanced Micro Devices of Sunnyvale, CA, is a nybble-mode CMOS 256K DRAM made with 1.4-micron, two-level metal, one-level polysilicon technology that has an effective 40-ns cycle time. NEC Electronics of Mountain View, CA, offers the  $\mu$ PD411001, a nybble-mode 1-megabit DRAM that is made with trench capacitor technology and 1-micron processing to give access times of 100, 120, or 150 ns.

But nybble mode isn't the only twist on the old familiar memories. AMD's enhanced-page-mode Am90C256, for instance, is a CMOS 256K DRAM that yields an entire row of 512 bits without interruption. That permits a continuous data rate of more than 18 MHz with cycle times as fast as 55 ns. Such chips cost more than regular RAMs, but their improved bandwidth is worth the money in many designs.

## Electronic Mail Service from AT&T

---

AT&T Information Systems of Lincroft, NJ, has instituted a new electronic mail service called AT&T Mail. Its metaphor is the "electronic office." You obtain an In Folder, which holds messages for 24 hours after you have read them; a Sent Folder; a Wastebasket; and a Desk, from which you can create and send messages. For an additional fee, you can get a File Cabinet to preserve messages for longer than 24 hours.

Delivery options include electronic mail, U.S. mail, urgent, overnight, COD, receipt requested, and memo. You can also create, send, and share data forms and mailing lists, as well as store signatures and logos on the system.

The current price schedule is \$0.80 for an electronic message, \$0.40 for a return receipt, \$2 for U.S. mail, \$27.50 for an urgent (same-day) message, \$0.40 for an electronic note, \$1.25 for COD, and \$7.50 for priority U.S. mail. On-line message create/edit is \$0.45 and on-line note create/edit is \$0.20 per session. Monthly fees include \$2 for the service, \$10 for the forms/file feature, and \$2 for a shared address list. Signature/logo registration is \$12 per year.

*(continued)*

## NEC V60 and V70 CMOS Microprocessors

---

NEC Electronics of Mountain View, CA, has completed development of its V60 and V70 32-bit CMOS microprocessors. Both chips are built on 1.5-micron technology and employ 375,000 transistors per chip.

The V60 has a full 32-bit internal architecture, a 16-bit external data bus, and a 24-bit external address bus. The V70 has 32-bit architecture inside and out. Both microprocessors have virtual-memory management, an arithmetic floating-point processor (IEEE 754), and a six-stage pipelined structure. At 16 MHz, either chip will run at 3.5 MIPS. Both also have an orthogonal instruction set of 273 instructions (of 119 types), 21 addressing modes, and thirty-two 32-bit general-purpose registers. A 4-gigabyte page-demand virtual-memory space is controlled by the on-chip memory manager and high-speed task switcher.

The V60 and the V70 have an emulation mode that can directly execute V20 to V50 object codes, which means that the chips can also execute 8088 or 8086 code.

## IBM, TI, ITT Join Communications Standards Group

---

IBM has announced that it will join a coalition of firms trying to establish standards for computer communications. The Corporation for Open Systems counts Digital Equipment Corporation, Hewlett-Packard, NCR, AT&T, Sperry, Convergent Technologies, and Xerox among the firms that already belong to the group. Other new members include Eastman Kodak, Du Pont, Boeing Computer Services, ITT, Texas Instruments, and Data General. COS reportedly will base its proposed networking standards on the Open Systems Interconnect, which has gained popularity among European vendors and is favored by IBM.

COS is based in Alexandria, VA. Its mission is "to provide a vehicle to accelerate the introduction of multivendor products and services based on adopted international standards."

## Graduate Credits Via Computer Conferencing

---

The New School for Social Research in New York City offers courses on Media Studies via computer conferencing. In association with an organization called Connected Education, the New School is offering four courses this semester that are run under the EIES conferencing system. The tuition of \$795 per course is the same as that of a traditional classroom course and includes unlimited access time on the conferencing system. School officials claim that the students' work is better than that in a traditional course and that the dropout rate is zero. Students can obtain half of the 36 credits necessary for a graduate degree through teleconferencing.

## Nanobytes

---

At the Personal Computer Forum in Phoenix, AZ, S. Jerrold Kaplan of **Lotus Development** laid out a development path for spreadsheets. Kaplan argues that spreadsheets are actually "object-oriented declarative programming languages." He said that future competition among spreadsheets will be in improving the programming environments that spreadsheets provide by adding type checking, debugging aids, and so on. . . . **Coral Software** of Cambridge, MA, is developing a new version of Logo for the Macintosh computer. A key feature of the new Logo is that it will be object-oriented. In addition, programs created with this Logo can be compiled, and Coral Software claims that they run at speeds comparable to programs written in C or Pascal. The new language will be available approximately in July for a price of about \$50. . . . Spokesmen for several companies made announcements at the Personal Computer Forum. Mitch Kapor, chairman of **Lotus Development**, said that Lotus products for Microsoft Windows will appear in 1987 and beyond. Dave Winer of **Living Videotext** talked about an unannounced Macintosh product code-named "Spanky" that will be ported to Windows on the IBM PC. Gary Kildall, chairman of **Digital Research Inc.** and CEO of **KnowledgeSet** (formerly Activenture), said that there will be some new very fast access CD-ROM mass storage systems that use tilting mirrors to speed operation. These will be expensive "professional" optical drives. . . . **Motorola** of Austin, TX, is pushing its manufacturing technology to make faster versions of the 68020. The state of the art is now the 20-MHz 68020, with samples available now and production scheduled for the second quarter of this year. The initial price is \$771 apiece in 100-piece quantities. . . . **Micro Industries** of Westerville, OH, now has the license to manufacture and market the Micromodule line of 8-bit microcomputer boards and accessories that was previously available from **Motorola's** Microsystems Operation. Micro Industries has contracted to provide service to boards built by Motorola for a minimum of five years. This contract ends Motorola's 10-year development and production of the 6800-based boards; the company will focus on VME products using the 68000 and its successors.

# Take off with a Tandy portable and get real computing power wherever you travel.



As a businessperson you can't afford idle time while traveling. That's why you need a Model 100 (\$499), a Tandy 200 (\$799), or our new Tandy 600 (\$1599) portable computer. Each is an important business tool that will keep you on top of business wherever you go.

## Traveling companions

The Model 100, a technological first, is perfect for writing letters, memos, reports and other correspondence anywhere, at any time. This lightweight computer was the first to feature five instant-on programs, an 40x8 display and a modem—all built in.

The Tandy 200 represents a true second generation in portable computers. You can do complete spreadsheet analysis and calculations with the popular Multiplan software that's built into the memory. Or use the Tandy 200 as your personal appointment calendar and address-and-phone directory.

## The most advanced laptop

Our new Tandy 600 features a 16-bit microprocessor, an 80-character by 16-line liquid-crystal

display, a built-in 3<sup>1</sup>/<sub>2</sub>" disk drive that stores 360K of data and 32K RAM (expandable to 224K).

The Tandy 600 also includes five resident applications—all designed by Microsoft® for the businessperson on the go. With the Tandy 600's larger display and expanded memory, Multiplan can hold more information. Using MS-Word, you'll also have quicker access to documents and more storage capacity with the built-in disk drive. File is an electronic database for names and addresses, expenses, client billing and more. And you can keep a large number of different files on the pocket-size diskettes. With Telecom and the Tandy 600's built-in modem, you're able to keep in touch with your office over phone lines.

## Tandy . . . Clearly Superior™

Tandy offers you a choice of three portable computers—one is sure to fit your needs. You can see these amazing portables at your local Radio Shack Computer Center. Come in today!

Available at over 1200  
Radio Shack Computer Centers and at  
participating Radio Shack stores and dealers.

**Radio Shack®**  
**COMPUTER CENTERS**  
A DIVISION OF TANDY CORPORATION

Send me a free  
Computer Catalog.

Radio Shack, Dept. 86-A-898  
300 One Tandy Center  
Fort Worth, TX 76102

Name \_\_\_\_\_  
Address \_\_\_\_\_  
Company \_\_\_\_\_  
City \_\_\_\_\_  
State \_\_\_\_\_ Zip \_\_\_\_\_  
Phone \_\_\_\_\_

Prices apply at Radio Shack Computer Centers and participating stores and dealers. Multiplan and MS-Word/TM Microsoft Corp.



# THE ST™ COMPUTER LINE FROM ATARI®

**IT'S LIKE GETTING THE POWER AND SPEED OF A FERRARI®  
FOR THE PRICE OF A FORD.®**

When Atari introduced the 520ST™, we set the personal computer industry on its ear.

Nobody had ever produced a machine so powerful and technically advanced for such an incredibly low price. Nobody but Atari has done it yet.

The competition was stunned.

The critics wrote rave reviews.

And consumers were ecstatic.

We could have rested on our laurels, but we didn't.

Instead, Atari extended the ST concept to a new computer called the 1040ST™.

The amazing new 1040ST is even more powerful than the 520ST and years ahead of all the competition at almost any price. The only question in

1986 isn't which company to buy a computer from, but which computer to buy from Atari.

At \$799, the 520ST gives you 512 Kbytes of RAM, a high-resolution monochrome monitor, 2-button mouse, and 3.5" disk drive.

At \$999, the 1040ST gives you 1024 Kbytes of RAM, an ultra high-resolution monochrome monitor, 2-button mouse, and a built-in double-sided 3.5" disk drive, plus built-in power supply. Both the 520ST and the 1040ST can be connected directly to your own color T.V. Or you can add an Atari RGB color monitor to get the sharpest, most colorful images possible. Add \$200 for color monitor.

It's simply a matter of choosing which model best fits your needs.

And whether you choose the 520ST or the 1040ST, you'll be getting the power and speed of a Ferrari for the price of a Ford.

In fact, you'll save hundreds and in some cases thousands of dollars over comparable computers. Which is why consumers are still ecstatic. Why the critics are still writing rave reviews. And why the competition is still stunned.



	ATARI® 1040ST*	COMMODORE® AMIGA™	IBM® PCAT™	APPLE® Macintosh™	APPLE IIc®
Price	\$999	\$1795	\$4675	\$1995	\$1295
CPU	68000	68000	80286	68000	65C02
Speed MHz	8.0	7.16	6.0	7.83	1.0
Standard RAM	1 MB	256K	256K	512K	128K
Standard ROM	192K	192K	64K	64K	16K
Number of Keys	95	89	95	59	63
Mouse	Yes	Yes	No	Yes	Optional
Screen Resolution (Non-Interlaced Mode)					
Color	640 x 200	640 x 200***	640 x 200	None	560 x 192
Monochrome	640 x 400	640 x 200***	720 x 350**	512 x 342	560 x 192
Color Output	Yes	Yes	Optional	None	Yes
Number of Colors	512	4096	16	None	16
Disk Drive	3.5"	3.5"	5.25"	3.5"	5.25"
Built-In Hard Disk (DMA) Port	Yes	No	Yes	No	No
Midi Interface	Yes	No	No	No	No
# of Sound Voices	3	4	1	4	1

Atari 520ST with 512K RAM, \$799.

\* Connects to standard color TV. For RGB color monitor add \$200.

\*\* With optional monochrome board (non bit-mapped).

\*\*\* Interface Mode - 640x400.

Ferrari is a registered trademark of Ferrari Italia SpA and Ferrari of America, Inc. Ford is a registered trademark of Ford Motor Company. IBM and PCAT are registered trademarks of International Business Machines Corp. Commodore and Amiga are trademarks of Commodore Electronics LTD. Apple, Apple IIc, and Macintosh are trademarks of Apple Computer, Inc. Atari, 520ST, 1040ST, and ST are trademarks of Atari Corp.

**ATARI®**

**POWER WITHOUT THE PRICE.™**

## CHOOSE YOUR LANGUAGE

I read with interest the letter from Mark Pickerill ("Speaking of Languages," February, page 356).

Like Mr. Pickerill, I am a "professional programmer." In fact, I have attained that most coveted of professional positions, compiler writing and programming-language design. My entire professional career has been spent designing and implementing various programming languages, from extended abstract assembly languages to standard Pascal to Ada derivatives. Currently, I am involved in the design and implementation of a high-level parallel language designed to run on a large, tightly coupled parallel processor.

Mr. Pickerill raises several language-design issues that merit a response.

Everyone has a favorite language. If Mr. Pickerill has chosen BASIC, that is his prerogative. I personally find BASIC distasteful, and I will use it only when no other language is available on a given machine. While I have not used some of the newer BASICs that offer traditional scoping, subroutines, and structured control mechanisms, my experiences have led me to believe that BASIC is inadequate for large programming projects and only suffices when a quick hack is required.

Mr. Pickerill is correct in his assessment that Pascal is not a complete language. It is, however, more than adequate for most programming projects. In fact, certain extended Pascal implementations (Turbo Pascal in particular) are an absolute joy to use. As a compiler writer, I can truly appreciate the speed of compilation that Turbo Pascal achieves. When I first used that package, I was absolutely amazed. I have since written several large systems programs in Turbo Pascal, including end-user interface software for a local-area network. I can assure you that some of the things I was able to accomplish in Turbo Pascal simply cannot be done effectively in the BASICs I had available to me.

Mr. Pickerill describes C as "a mess" and "a disaster." He claims the syntax is dirty, cryptic, and unreadable. In fact, the C syntax is quite clean; so clean, in fact, that mechanized parser generators have absolutely no problem generating compilers for it. I will grant that it is unreadable. As

most language designers quickly realize, languages are designed to be either easily readable or easily writable. Pascal, Ada, COBOL, and Modula are designed to be easily read, promoting self-documenting code. C is an easily writable language and was designed to effectively express algorithms in a minimum of space. It is rife with operators and has 11 levels of operator precedence. Once you have mastered those operators, however, it is a joy to dash off a few lines of C that can do what would require 30 lines of Pascal.

Frankly, C is not for everyone. If you want to become proficient at C, you must be prepared to spend some time learning to think in C. It is simply not possible to become fluent in C in a matter of hours. If you are not willing to invest the time, then do not use the language.

Remember, C was designed by systems programmers, not applications programmers. It meets their needs. It is a tool that can be used to achieve a goal. A fatal flaw among programmers is the desire to use one language for everything. Do you drive nails with a pair of pliers? Cut wood with a butter knife? Write numeric-intensive applications in C, screen editors in COBOL, or system code in APL? It is the programmer's responsibility to learn several languages to keep in a "toolbox." When a programming problem arises, the programmer can then make an intelligent choice as to which tool will best solve it.

Mr. Pickerill makes an attack upon the use of lowercase letters in programming languages. Agreed, a compiler that forces the user to use only lowercase letters is an atrocity, and the author of said compiler should be thrashed with a stack of listings. However, it is well known among psychologists that lowercase letters are, in fact, much easier to read than uppercase ones. Lowercase letters have a mixture of short and tall letters ("x" versus "l," for example). Such variations in height provide more pattern-matching information for your brain to quickly distinguish the letter at which it is looking. Since all uppercase letters are the same height, it takes longer for your brain to identify an uppercase letter. Further, words written in all uppercase TEND TO ATTRACT YOUR EYES AND SIGNIFY ALARM. There is a sublim-

inal message of urgency contained in a string of uppercase letters that your brain must overcome when reading them.

Finally, Mr. Pickerill makes some statements regarding the simplicity of compilers. He contends that the use of double-character delimiters and excessive "syntactic sugar" in some languages indicates an inherent simplicity within a compiler and, I suppose, some laziness on the part of the compiler writer. Nothing could be further from the truth. Double-character delimiters (such as /\* and \*/ which delimit comments in C) are used simply because there aren't enough single-character delimiters available. It is desirable that delimiter pairs have some symmetry so that they are aesthetically pleasing and understandable. In ASCII, the possible candidates are < and >, ( and ), | and |, and { and }. Currently, C uses all of these pairs for something other than comment delimiters: < and > are comparison operators, ( and ) denote nested expressions, | and | denote array indexing, and { and } delimit multiple statement blocks. Character-set limitations force the use of double-character delimiters to make lexical analysis context-free.

Mr. Pickerill also voices the traditional complaint about semicolons. In Pascal, the semicolon *separates* statements; it does not *terminate* them. In order for a parser to remain on track, it needs such syntactic sugar to verify that its impression of a program corresponds to the programmer's. It is possible to remove much of the extra tokens from the Pascal syntax, but a subsequent penalty of parser complexity is paid. Error recovery, which is already quite difficult, becomes even harder. It is far more desirable to give the compiler a little

(continued)

**LETTERS POLICY:** To be considered for publication, a letter must be typed double-spaced on one side of the paper and must include your name and address. Comments and ideas should be expressed as clearly and concisely as possible. Listings and tables may be printed along with a letter if they are short and legible.

Because BYTE receives hundreds of letters each month, not all of them can be published. Letters will not be returned to authors. Generally, it takes four months from the time BYTE receives a letter until it is published.



**ON BOARD 20**  
Hard Drive Card

**ON BOARD 10**  
Hard Drive Card

# A Hard Drive The Easy Way.

Turn your PC into an XT in seconds with OnBoard, Maynard's new hard drive card!

## So your PC needs a hard drive...

When you bought your PC, you never dreamed you'd need more than floppy drive performance. But now, both you and your PC are ready for more. In fact, there's just one reason you've been putting off getting a hard drive. Admit it. It's the installation. Cables and controller and all that.

Well, relax. OnBoard is here. The hard drive card that boosts your PC's storage capacity to rival any XT or AT\* on the block! OnBoard snaps easily into one of your IBM PC's expansion slots! Open your PC, plug in OnBoard, and close your PC. Just like that. Your PC will boot directly to OnBoard when you power up — no more floppy disk maneuvering.

## Powerful Self-Control.

If you already have a hard drive in your PC, OnBoard's controller card will double up and run both hard drives. Which helps keep your expansion slots open for other business.

## Lots of Head Room, Lots of Desk Room.

OnBoard puts up to 20MB of power into your PC, turning it into a hard drive heavyweight in seconds! If you need less storage but the same speed and fine performance, you can install OnBoard 10.



## Single-Slot Installation.

Simply snap OnBoard into expansion slot 1 of your IBM PC\* or XT, leaving all your other slots free for additional boards.

**OnBoard is designed to work in today's leading PCs and is available at the finest computer stores. Contact your local dealer or call us today for more information.**

\*IBM PC, XT, and AT are trademarks of International Business Machines.

 **Maynard Electronics**  
Shaping tomorrow's technology.

460 E. Semoran Blvd., Casselberry, FL 32707 305/331-6402



# Dot Matrix <sup>& Now Laser!</sup> Printing Made Beautiful

This entire ad, from top to bottom, was printed on an inexpensive dot matrix printer with Fancy Font,<sup>®</sup> a unique program that works with almost any word processor to produce high resolution, proportionally spaced, letter quality printing.

No special hardware or installation is required, so you'll be using Fancy Font as soon as you get it.

Fonts, including Roman, Sans Serif, Bold, *Italic*, *Script*, Old English and more, from 8 to 24 points come standard with Fancy Font.

**FLEXIBLE.** Fancy Font comes with a complete set of over 1500 mathematical, foreign language and other special symbols.

Hundreds of additional fonts in sizes from 6 to 72 points are available, at a nominal additional charge, from our growing font library.

You can edit any character and also create your own characters or logos, up to 1 inch by 1 inch.

Powerful formatting features let you center, justify, wordwrap and type flush left or right, with or without running headers and footers — even with different fonts and sizes on the same line.

**IMPACT YOUR LASER.** Combine the high quality of the HP LaserJet, LaserJet+ or Canon Laser printer with the font styles and sizes of Fancy Font for the ultimate in visual impact.

You can mix internal printer fonts, cartridge fonts and Fancy Font letters on the same line to create materials with typographic impact.

**COST EFFECTIVE.** You can buy Fancy Font from your local dealer or direct from SoftCraft for only \$180.

You'll get near typeset quality at a small fraction of the time and cost of using art or typesetting services.

You'll be turning out beautiful reports, newsletters, presentations, letters, mathematical texts, overheads, invitations and more after getting your copy of Fancy Font. The applications are limited only by your imagination.

Fancy Font runs on PC-DOS, MS-DOS and CP/M systems with Epson, Toshiba and compatible dot matrix printers and laser printers.

Call or write now to order Fancy Font or ask for complete information including actual samples and independent reviews.

**CALL TODAY 1-800-351-0500**

MasterCharge and Visa accepted

**SoftCraft, Inc.**

222 State Street, Madison, WI 53703 (608) 257-3300

help and simplify the language grammar, so that the compiler writer can concentrate on the important things, like effective optimized code generation.

Mr. Pickerill suggests that a CR-LF sequence is sufficient to terminate statements; he is showing his assembler roots. An important feature of modern languages is that they are lexically independent of the source-code format. That is, it doesn't matter how you indent your code or how you break it up across various lines, it still looks the same to the compiler. This is not true of BASIC or most assembly languages. While some languages force the programmer to indicate explicit line continuations, I abhor any dependency on the source-code format. Let's face it, how many people enjoy counting out to column 7 for their FORTRAN programs? How about all you COBOL programmers making sure that paragraph names begin in column 4 (or was it 8)? And let's not forget putting those FORTRAN continuation marks *exactly* in column 72!

In conclusion, I'd just like to say that Mr. Pickerill is entitled to his opinion. However, those who are interested should understand that most languages are not designed willy-nilly. A lot of thought goes into each and every trade-off made during the course of designing and implementing a language. A full understanding of those trade-offs is necessary before you start condemning a language.

As an aside, Mr. Pickerill concludes with the contention that assembly code still has a place in this world. I agree, when one is programming in a uniprocessor environment. Let me tell you, though, writing effective assembly code in a multiprocessor environment (with hundreds of processors) is so difficult that the only recourse is to use high-level languages that hide the scheduling problems from the programmer.

CHUCK MUSCIANO  
Palm Bay, FL

## ATARI 520ST VERSUS AMIGA

I am very glad that you did such a fantastic product description on the Atari 520ST (January, page 84). I have had mine since mid-November, and I think it's going to be around for quite some time. But there are a few things that I should mention concerning the ST and its future.

To start, I want to tell you a little about the ST-Amiga battle. For the moment, let's just imagine that the Mac was never created. Both machines are new, and both are quite good in their own right. But there is a large price difference, and what you

(continued)

New! Windows-Compatible In-a-Vision 1.1

FREE Microsoft Windows!  
Limited Offer

# Complex Drawing Made Easy

We created In-a-Vision just for you. The engineer who needs more productive drafting support. The designer who needs versatility for alternate ideas or quick revisions. The architect who needs to manage a variety of working drawings. And the businessman who needs first-class presentation materials as well as detailed flow charts and organization charts.

## Point. Click. Draw.

Now all you do to create complex technical drawings, systems designs, blueprints, diagrams, illustrations, and proposals is point, click and draw. With In-a-Vision's mouse support, windowing, icons,

and pull-down menus, you produce drawings more quickly, accurately and efficiently than ever before. In-a-Vision's advanced technology includes many features not found on comparable systems costing thousands more. For example, you can pan around in a user-definable drawing space up to 68" x 68" and zoom in on specific areas for

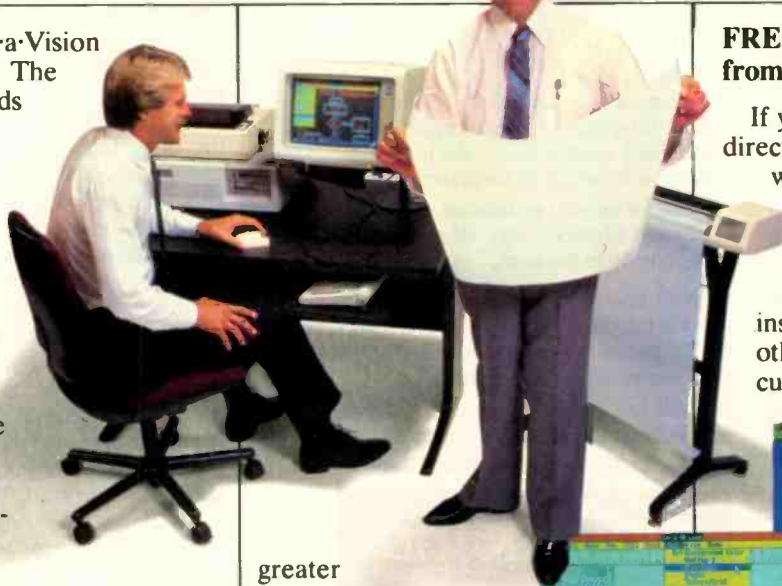

greater detail. Scale, rotate and dimension symbols, fill an area with your choices of pre-defined colors and patterns, as well as draw lines with multiple styles and widths. Other features include overlays, predefined and user-definable page sizes, rulers, grids, and templates to speed popular applications.

## Multi-tasking in a PC-based CAD system.

In-a-Vision uses multi-tasking to enable you to continue drawing while printing hard copies or edit multiple drawings simultaneously.

## FREE Microsoft Windows from MICROGRAFX!

If you purchase In-a-Vision directly from MICROGRAFX, we'll give you a free retail copy of Microsoft Windows so you can use In-a-Vision as part of a fully integrated working environment. Move instantly from In-a-Vision to other applications and back... cut and paste text and drawings

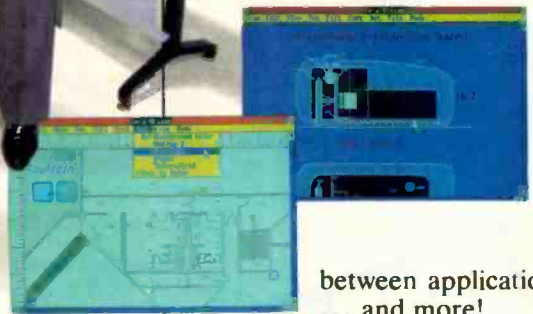

between applications... and more!

We're confident you'll agree — In-a-Vision will make your complex drawing tasks simple and make you more productive. Satisfaction guaranteed.

## TO ORDER CALL: 800-272-3729

Demo disk\* or brochure available to qualified customers. In Texas or for customer support, call (214) 234-1769.

MICROGRAFX, Inc., 1820 North Greenville Avenue, Richardson, Texas 75081.



**MICROGRAFX®**  
The Picture of Success.

(Most popular graphics cards, plotters, and printers supported.)  
Microsoft Windows-compatible. Call for specific operating environment requirements.

\* Demo requires MS Windows. Full demonstration system for users without Windows available for \$49.00.

Inquiry 237

In-a-Vision and MICROGRAFX are trademarks of MICROGRAFX, Inc.  
Microsoft is a trademark of Microsoft, Inc.

# Escape the Programmer's Prison

Do you feel imprisoned by your IBM PC? Do you spend too much time wrestling with a rigid, unyielding programming language? Are you tired of clumsy programming tools that straight-jacket your creativity instead of liberating it?

If so, you're ready for Methods—a Smalltalk, object-oriented programming system for the IBM-PC and compatibles that sets you free from the constraints of other languages. Until you program with Methods, you don't know just how quick and creative programming can be on the IBM PC.

Methods is . . .

. . . high-performance object-oriented programming. A powerful, language-compatible subset of Smalltalk-80™.

. . . a toolkit of over 100 classes—easily-customized software building-blocks for rapid, incremental development of real-world applications.

. . . an open-ended, window environment that encourages exploration while allowing recovery from any error.



. . . extensively documented in a four-part manual for everyone from beginners to experienced programmers—the perfect introduction to Smalltalk programming.

. . . ideal for software prototyping, simulation, databases, advanced user interfaces, and numerous AI applications.

Methods also offers easy access to DOS, a powerful directory/file browser system, remote UNIX™ access, an object-oriented shell for DOS programs, and much more.

Methods requires DOS and 512K RAM on IBM PC's (including AT) or "compatibles," and can be used with or without a mouse.

**digitalk inc.**

5200 West Century Boulevard  
Los Angeles, CA 90045 (213) 645-1082

Available from Digitalk for \$250. Outside U.S. add \$15.00 for shipping and handling.  
California residents add sales tax.  
Educational and dealer discounts available.



IBM is a trademark of International Business Machines Corporation.  
Smalltalk-80 is a trademark of Xerox Corporation.  
UNIX is a trademark of Bell Laboratories.

Inquiry 111

## LETTERS

get for your money may not be what you paid for. The Amiga's graphics ICs are very powerful, and the sound chip gives good synthesized music, but that is where the power stops dead in its tracks. However, since people respond emotionally to sight and sound, the demos are sure to catch someone's eye. Inside, there is very little true support for the unbound power of the 68000. In the low-resolution mode, those great graphics chips steal almost 75 percent (yes!) of the possible CPU time that could be used for other real-computer things. Since the complicated data for the screen must come from the same RAM on the same bus as the CPU, there are excessive wait cycles imposed on the 68000. This, together with an overall slower CPU time than the ST, causes the Amiga to appear timid when compared to the ST.

Inside the ST, you will find more custom ICs than the Amiga and more powerful off-the-shelf chips than the Amiga. This adds up to a suprafast computer. Further into the hardware side of things, the ST has three serial ports (RS-232C, MIDI in, and MIDI out) and a keyboard. All of these are handled separately, without the 68000, and all in hardware. The 520ST also has a 68901 interrupt controller that keeps track of 16 separate events in the system with very little intervention by the CPU (this chip is really a necessity with the 68000 and is missing from the Amiga). And this (drum roll, please) is where the DMA port comes in. It transfers data to RAM without using the CPU, and does it at a rate of 1.33 megabytes per second. The standard disk drives are also quite fast. The ST can bring in a 32K-byte file—including start-up, directory search, and loading—in less than 4 seconds. The Amiga takes almost 20 seconds. The Amiga also uses an awkward disk configuration, and much of the disk support is done in software (*slow*). The drives can store slightly more than the ST's double-sided drives, but time is sacrificed in exchange. The Amiga format is done much like a C-64. In fact, to get a directory, the Amiga goes out and finds a program called DIR, loads it, and then goes back searching—not a very speedy or effective way of doing things.

Now to talk about software. First of all, there is almost four times as much software out for the 520ST as for the Amiga. Second, intuition on the Amiga is graphically more colorwise than GEM on the 520ST but really isn't a good user interface. The windows are poorly configured and move with flicker. The Amiga operating system is very clumsy to use and full of bugs. And for the note of how every-

(continued)

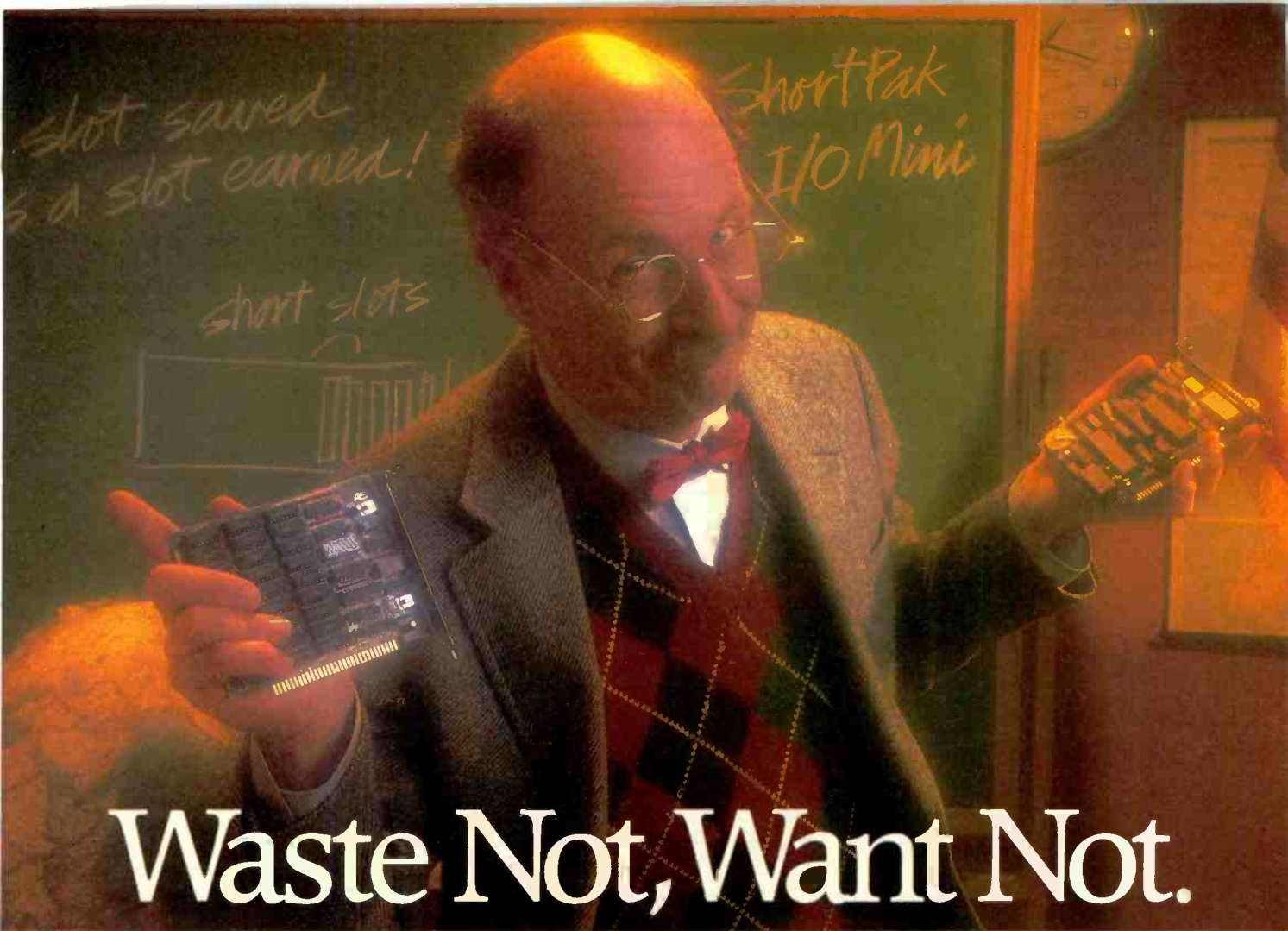

# Waste Not, Want Not.

AST's ShortPak™ and I/O Mini™ Offer the Powerful Memory and Input/Output Capabilities of Full-Size Boards on Convenient Half-Size Cards.

**Waste Not.** Don't waste valuable, full-size, system-expansion slots on memory or I/O cards. AST Research offers the space savers—short-board solutions for adding memory and input/output to your IBM® PC-XT, 3270 PC or Portable. And users of new, basic IBM PCs, check your system chassis. You may have short slots, too.

Of course, ShortPak and I/O Mini work just fine in long slots also.

**Small Size, Big Memory With AST's ShortPak.** Now you can boost your PC's memory with up to 576 Kilobytes (Kb) in a single, short slot. Using both 64Kb and 256Kb chips, this versatile short card rounds out virtually any system's memory to the DOS 640Kb limit.

And with every ShortPak board, you'll get SuperPak™ utility software including SuperDrive™, SuperSpool™ and, AST's new fASTdisk™ electronic hard disk. Both SuperDrive and fASTdisk let you create lightning-fast, electronic RAM disks and SuperSpool lets you spool files to the printer while you continue to enter and process data on your system.

**Powerful Connections With I/O Mini.** This short card offers all the

input/output ports you may ever require. With up to two serial ports, a parallel port and battery-backed clock/calendar, this five-inch board connects to printers, plotters, mice, modems and more. In addition, SuperPak software is included.

**Want Not.** When you install ShortPak and I/O Mini in your PC's short slots you get the added memory you need to run today's memory-intensive software and the vital serial and parallel ports needed to make peripheral connections.

Plus you save your long slots for other expansion products—like AST's RAMpage!® expanded memory board, offering up to 2.0 megabytes of memory; ColorGraphPlus™, our 16-color IBM compatible color graphics card; and, our complete line of networking and micro to mini/mainframe cards.

By the way, there'll be a test covering this material on Thursday morning. Please be prepared. For tutoring contact your local Authorized AST Dealer or call AST's Customer Information Center (714) 863-1333. Or write, AST Research, Inc., 2121 Alton Avenue, Irvine, California 92714. TWX: 753699 ASTR UR. Don't wait until Wednesday night.

#### ShortPak Features

- Offers up to 576Kb memory on a single board (no piggyback required)
- Rounds out system memory to 640Kb on single board
- Fits short and long slots\*
- Uses 64Kb and/or 256Kb DRAMs
- Includes SuperPak utility software
- Two-year warranty

#### I/O Mini Features

- Standard serial port
- Standard battery-backed clock/calendar
- Fits short and long slots
- Optional: second serial port and parallel port
- Includes SuperPak utility software
- Two-year warranty



**AST**  
RESEARCH INC.

Inquiry 2 for End-Users.  
Inquiry 3 for DEALERS ONLY

body compares them and rates them against the Mac, you must consider that Apple is not letting any operating systems look or act like theirs.

If you have a problem with your Amiga that your dealer doesn't know about, you are pretty much stuck. To talk to Commodore you either have to be God or Electronic Arts, a company that mainly focuses on games. If you want to talk to people at Atari, they are very free, open, and extremely nice.

The last thing I want to mention is that on page 99 of the article on the 520ST, the authors state that the only way to move a file out of a folder is to copy it to another disk and then copy it back to the original disk outside of the folder. There is a much simpler way of doing things. First, open the directory for disk A. Then double-click on the folder you want. It should open up and show you the file you want to copy. Then go back and double-click on the disk A icon again. It

will open up into another window, so that now you have the main directory and the folder directory. Simply drag the file you want copied from the folder's directory into the regular directory window, and it will copy out of the folder. True, you do have to go back and delete the original file, but this is really a quite sane precautionary procedure. Suppose you then decide you didn't want it moved, or maybe it gets lost, or the disk crashes. You still have the original.

MIKE M. FARNSWORTH  
Renton, WA

Why buy 3  
packages to get  
a complete  
multi-user  
dBASE\* System?



\$2385

After all, FoxBASE is a compiler, an interpreter and a multi-user dBASE system all in one. That means single vendor support and no problems with product incompatibility.

Not only that, FoxBASE actually outperforms dBASE and other dBASE compiler products: its program execution speed is far superior to the competition and its compiler runs up to 60 times faster than other compilers. And FoxBASE is available

FoxBASE™  
does it better.  
For less.



\$995

for the widest variety of machines and operating systems.

In addition, FoxBASE is interactive and 100% dBASE compatible (including full macro usage). The only thing you won't get is all those annoying dBASE bugs!

Best of all, FoxBASE costs less than half the other packages.

So call (419) 874-0162 now, and ask for a copy of our comparative analysis (including benchmarks). After all . . .

Nothing Runs Like a Fox.

**FOXBASE™** 

Fox Software, Inc.  
27475 Holiday Lane, Perrysburg, OH 43551  
(419) 874-0162

\*dBASE is a registered trademark of Ashton-Tate FoxBASE is a trademark of Fox Software, Inc. Clipper™ is a trademark of Nantucket

### HOW GOOD IS DVORAK?

The February BYTE contained an article on page 241 concerning the Dvorak keyboard arrangement ("Keyboard Efficiency"). Having used the Dvorak keyboard for many years, I eagerly read what Donald W. Olson and Laurie E. Jasinski had to say about it.

However, their results correspond neither with the many books and articles I have read on the subject nor with my own experience. I downloaded the BASIC program, but, not being a programmer, I couldn't figure out what was going on. So I tackled the problem with a pencil and paper.

My approach was more intuitive than scientific, I guess, but it seemed that if the Dvorak arrangement had all but 2 of the 12 most-used letters in the English language (ETOAINSHDRLLJ, as I have read) on the home row, then it must be more efficient than the QWERTY arrangement.

To simplify my task, I used units instead of actual measurements and set to zero all operations that both arrangements share. That is, the space bar, the shift key, and the actual key travel were all disregarded. Next, I assigned all home-row keys that lie under the typist's fingers a value of 0. All home-row keys that don't lie under the typist's fingers received a value of 1. Upper- and lower-row keys received a value of 2, with the exception of the keys the typist must stretch for. These received values of 3. For the QWERTY arrangement, the hyphen also was assigned a value of 3.

I used Lincoln's "Gettysburg Address" for my work text. After saving it to disk, I used the search-and-replace feature of Spellbinder to do a simple number-for-letter substitution both for the QWERTY arrangement and for the Dvorak arrangement. I added the resulting string of numbers on an adding machine.

Viewing the final printout, one immediately sees that virtually no word of any significant length can be typed with-

(continued)

# THE PC PENS

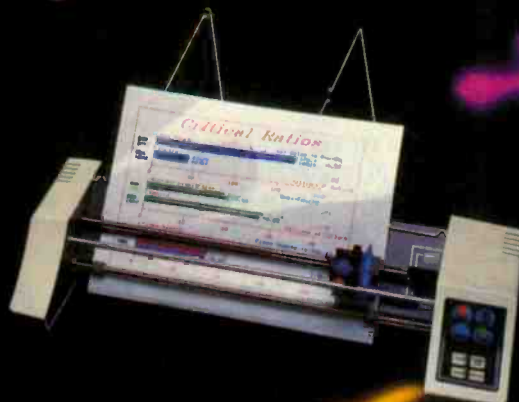

**D**iscover new dimensions in PC graphics with Houston Instrument's "PC Pens"—a family of desktop plotters that allow you to add brilliant color and clarity to your presentations.

Starting at \$699,\* these compact plotters produce professional graphics that dot-matrix printers simply can't match. With sharp resolution, HI's PC Pens give you countless graphic choices—a variety of pen types (felt tip, hard nib, and drafting), plotting media (paper, vellum, and transparencies), and special firmware.

Whether you're producing sales graphs, creating CAD drawings,

or charting household finances, these plotters complete the picture on 8½ × 11 or 11 × 17 inch formats.

Choose from Houston Instrument's single-pen DMP-40, the four-pen PC Plotter series, or the impressive eight-pen DMP-29. Each features a standard RS-232-C compatible interface and Houston Instrument's built-in DM/PL™ language, making each one immediately compatible with most microcomputers and hundreds of software packages. And each is remarkably reliable and simple to use.

For more information and the name of the distributor nearest you, call Houston Instrument at 1-800-531-5205

(512-835-0900 if in Texas) or write Houston Instrument, 8500 Cameron Road, Austin, Texas 78753. In Europe, contact Houston Instrument, Belgium NV., Rochesterlaan 6, 8240 Gistel, Belgium. Tel.: 32-(0)59-277445, Tlx.: 846-81339.

\*U.S. suggested retail price for PC595 model plotter. Pricing subject to change. DM/PL is a trademark of Houston Instrument.

## houston instrument

A Division of **AMETEK**

out constantly returning to the home row using the Dvorak arrangement. The QWERTY arrangement, on the other hand, has severe difficulties with many words, including "conceived," "remember," "devotion," and "government."

The final result of all this was that the QWERTY arrangement required 1716 units of movement, while the Dvorak arrangement required only 844 units of movement, or a little better than 50 percent less. This is still a far cry from a 10 to 1 improvement, but it also ignores several of the Dvorak arrangement's other virtues. For one, the Dvorak arrangement has far fewer "trouble" letter combinations (for which the same finger on the same hand must move sequentially from the upper row to the lower row, or vice versa). Then, too, the Dvorak arrangement has a better hand-to-hand workload division. The Dvorak arrangement also evens out the workload of the individual fingers, so the more powerful fingers do more of the work, and vice versa.

I do quite a bit of typing, and I notice most the reduction in fatigue and typos. Although it's true that it can be difficult to find Dvorak keyboards at different work

sites, nonetheless they are available, more now than ever before. I personally have an old Remington manual (which I converted myself), an IBM Selectric, a Victor 9000, and a Wyse WY-50, all with Dvorak keyboards. I simply wouldn't go back.

GREG RAVEN  
Los Angeles, CA

The Dvorak-Dealey Simplified Keyboard, or DSK, is certainly a vast improvement over the QWERTY, or Universal, keyboard. But before deciding to switch, I would suggest you also consider the English Keyboard Scheme shown in figure 1 (U.S. Patent #3,847,263).

While studying at the University of Washington, I had the opportunity to examine August Dvorak and W. L. Dealey's research in detail. I also found their final layout was not as efficient as it could be, and I was unable to obtain any reasonable explanation for the discrepancies from Dr. Dvorak, who was still alive at that time. My aim was to develop similar keyboards for languages other than English, but an improved arrangement for English using the Roman alphabet was the result. I also found the English arrangement better than



Figure 1: The English Keyboard Scheme.

the various foreign keyboards or the DSK in French, German, Spanish, Italian, and Portuguese. I have used Dvorak and Dealey's data for the most frequently used words in English as well as many other letter-frequency and digraph-frequency tables.

Although I found the American National Standards Institute reluctant to even consider Dvorak's work or mine, I have persisted in my own efforts. I have designed keyboards for English using the "initial teaching alphabet" (a phonemic alphabet) and the Shavian alphabet (a phonetic alphabet, after George Bernard Shaw). I have recently completed work on a Russian keyboard using the Cyrillic alphabet; and I am continuing work on another for Inuktitut, which uses a syllabic alphabet for the Inuit (Eskimo) language. Of interest

(continued)

# X-VIEW 86™

Application Program

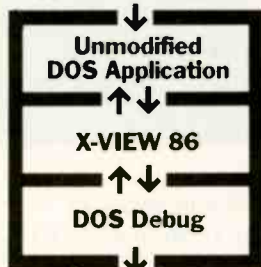

Dynamic Execution Information

X-VIEW 86 profiles the execution of DOS software, and displays information needed to improve program performance, identify compatibility issues, and pinpoint conversion problems.

## Profiles DOS application software and solves problems Debug can't touch.

### X-VIEW 86 is a DOS software X-ray machine.

X-VIEW 86 monitors internal software operations during execution to help you debug, test, port, or convert programs. X-VIEW 86 adds new features to Debug to profile either your own applications software or top-sellers like 1-2-3®. You get fast, reliable results.

### Real solutions to technical challenges.

Save hours of time-consuming, tedious work using data from X-VIEW 86's built-in reports that identify:

- Execution hotspots
- Segment usage
- Memory map references
- Report information is displayed on screen. And new breakpoint commands added to Debug stop a program on:
- I/O port references
- Interrupt calls
- I/O port references
- Interrupt calls
- Memory data references

### Hardware and software requirements.

X-VIEW 86 runs on the IBM PC and compatibles with DOS Debug 2.0 or 2.1. Even if you use a different debugger, X-VIEW 86 turns Debug into your program profiler. And it's not copy protected.

### Priced at an affordable \$59.95.

Get a whole new outlook on your work with X-VIEW 86. We've made it easy. Order today by calling 1-800-221-VIEW (in Texas, or outside the U.S., call 1-214-437-7411). We accept Visa, MC, DC, and AmEx cards. Or order by writing to: McGraw-Hill CCIG Software, 8111 LBJ Freeway, Dallas, Texas 75251. X-VIEW 86 is just \$59.95 plus sales tax and \$3.00 shipping (\$9.00 outside the U.S.). Be sure to include credit card number and expiration date with mail orders. Orders paid by check are subject to delay. To order call

**1-800-221-VIEW**

**McGraw-Hill CCIG Software**

8111 LBJ Freeway, Dallas, Texas 75251

X-VIEW 86 is a trademark of McGraw-Hill, Inc.; IBM is a registered trademark of International Business Machines; 1-2-3 is a registered trademark of Lotus Development Corporation.



# Ven-Tel's Half Card™ modem is in all the best computers. Here's why...

Ven-Tel gives you lots of reasons to buy our Half Card™ modem for your IBM PC or compatible. The Half Card™ is a complete system that lets you communicate with other PCs, mainframes, and databases effortlessly. It includes Crosstalk-XVI® software. It's reliable. It's got all of the features you want. And it's a good value.

## Do You Own One of These Computers?

Chances are you do. And if you're thinking of buying a modem, consider the Half Card™. Because of its small size, the Half Card™ fits in more computers, including all of the models we've listed here. The Half Card™ is small, so it fits in short slots or long. That means you can save your long slots for other expansion uses.

## Effortless Communication

Each Half Card™ comes with Crosstalk-XVI® communications software, by Microstuf. It's the easiest to use, whether you're a beginner or an old hand, and the most powerful. A full on-line help menu makes using Crosstalk® for the first time a snap. It can turn your PC into a terminal on a mainframe computer with its powerful terminal emulation feature. It will even operate your PC when you're not there. You can call into an information service such as The Source or Dow Jones News Retrieval, or transfer files and electronic mail, all at the touch of a button. The Half Card™ connects your computer to the world. Effortlessly.

## More Modem for Your Money

When you buy the Half Card™, you don't need anything else. The Half Card™ is a complete communications package that includes a full-featured modem and the best known software on the market. Complete easy-to-understand instructions with full technical support on installation and use. And a very competitive price. The Half Card™ with Crosstalk-XVI® software, retails for only \$549.

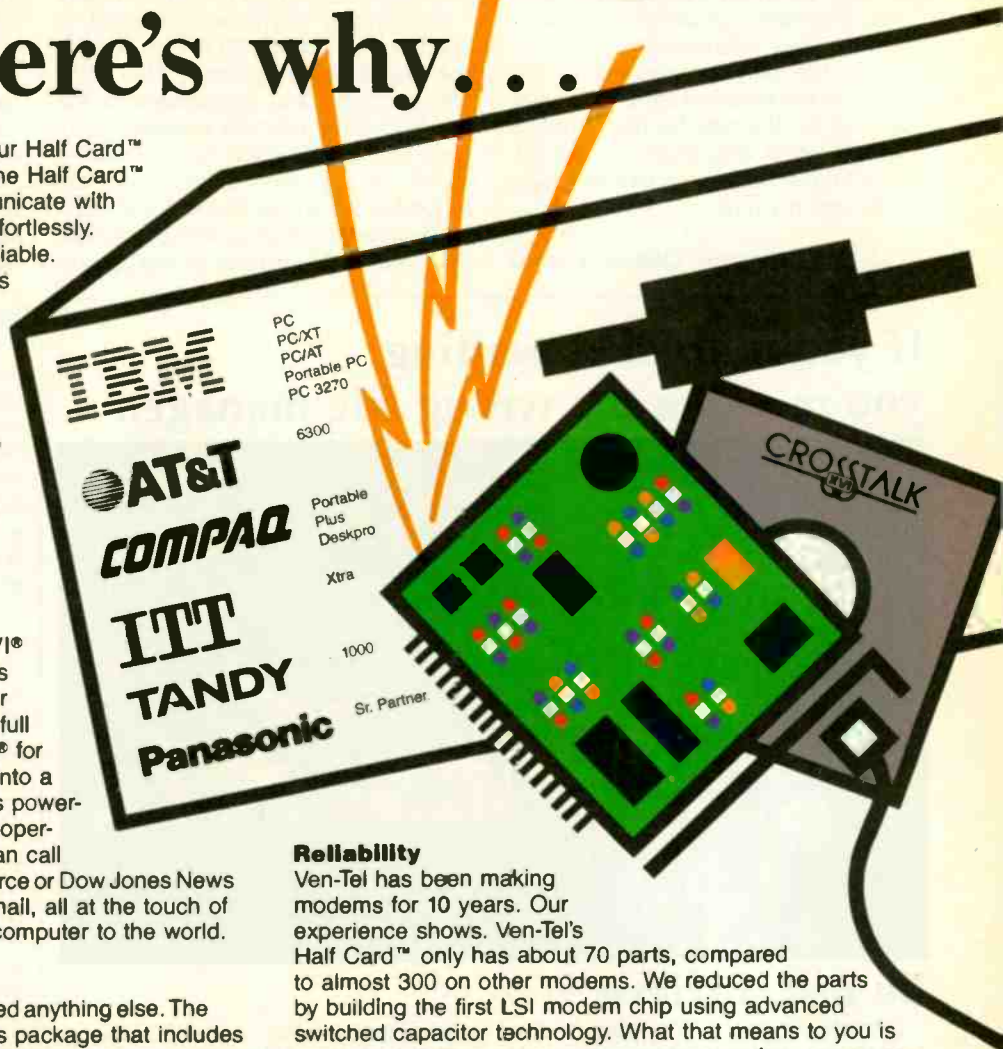

## Reliability

Ven-Tel has been making modems for 10 years. Our experience shows. Ven-Tel's Half Card™ only has about 70 parts, compared to almost 300 on other modems. We reduced the parts by building the first LSI modem chip using advanced switched capacitor technology. What that means to you is greater reliability and lower power consumption, so you can load up your PC with expansion boards and not worry about heat or power problems. And we back the Half Card™ with a full two-year warranty on parts and labor.

## You Can Buy the Half Card™ Anywhere

You can get the Half Card™ at ComputerLand, Businessland, the Genra Group, Entré Computer Centers, Macy's Computer Stores and other fine dealers nationwide. Also from Ven-Tel: the 1200 Plus™, an external modem and the PC Modem 1200™, an IBM internal with V.22 International capability.

## Features

- 1200/300 baud auto-dial, auto-answer.
- Uses the industry standard "AT" command set.
- Runs with virtually all communications software, including Smartcom II and PC Talk III and integrated packages such as Symphony and Framework.
- Includes Crosstalk-XVI® software.
- On-board speaker and extra phone jack for easy switching from voice to data mode.
- Selective tone or pulse dialing; full or half duplex.
- Automatic answer on any ring.
- True ring or busy signal detection.



## Effortless Communication

# Ven-Tel Inc.

2342 Walsh Avenue  
Santa Clara, CA 95051  
(408) 727-5721

Crosstalk is a registered trademark of Microstuf, Inc. Smartcom II is a trademark of Hayes Microcomputer Products. Symphony is a trademark of Lotus Development. Framework is a trademark of Ashton-Tate.

to Arnie Skurow, who sought interfaces for the disabled, an early project of mine included a keyboard for use in English which could be used with only one hand.

Lastly, the only arrangement of the Dvorak-Dealey keyboard shown in your article was for the right-handed typist. A reversed layout also exists for the left-handed typist both in the Dvorak-Dealey model and my own.

MR. X  
Kingston, Ontario, Canada

After reading Donald Olson and Laurie Jasinski's article on the Dvorak keyboard, I thought you might be interested in another experience with the keyboard. I rearranged the keytops on my Ohio Scientific computer and reprogrammed the ROMs to make a Dvorak keyboard. I noticed only a very slight improvement in speed, on the same order as that described in the article. The first few hours of use were terrible (even worse than I had expected). Once I became accustomed to

the new arrangement, however, I was thoroughly pleased. As I noted above, it did not improve speed as much as I had hoped. Ah, but fatigue was another story. My hands are much more relaxed and I type more smoothly than with QWERTY.

Since this was my home computer, the real test of the new arrangement came the following Monday when I had to switch back to the QWERTY arrangement at work. Surprise! No problem at all in reverting to the old arrangement—that is, until I hit the first A. If you compare the two keyboards, you will note that they share a common position for the two letters A and M, while all other keys have different positions. This continues to be the only major problem in switching between the two arrangements. After the first few words, I adapt easily to either keyboard. But every time I type an A or M, I have a tendency to revert to whichever keyboard I have used the most during the preceding few days.

STEVEN P. HENDRIX  
Sagamore Hills, OH

## If you're tired of waiting, you're using the wrong file manager.



### Be fast. Btrieve.®

If batch jobs and reports turn waiting time to nighttime, then wake up! You're using the wrong file manager.

Btrieve® file management hates waiting as much as you do. It's written in assembly language especially for the IBM PC. And based on b-tree file indexing, with automatic balancing for access speed that won't degrade as your database grows. With Btrieve, your applications always run fast. So you'll be out the door faster.

**The standard for networking.** Btrieve/N (network version) sets the standard for the industry's most popular LANs and multi-user systems. Btrieve/N offers safe network file management that coordinates simultaneous updates and prevents lost data.

**Automatic file recovery.** Btrieve provides automatic file recovery after a system crash. Your Btrieve data always

comes back intact.

**Fully-relational data management.** SoftCraft's entire family of products gives you a complete, fully-relational database management system. Rtrieve™ adds report writing capabilities. Xtrieve™ speeds users through database queries with interactive menus.

**For professional programmers.** Btrieve is the fast, reliable answer for all your application development in BASIC, Pascal, COBOL, C, FORTRAN and APL. With Btrieve, you can develop better applications faster. And know they'll run—fast.

**SC SoftCraft Inc.**

P.O. Box #917 Austin, Texas 78766  
(512) 346-8380 Telex 358 200

Suggested retail prices: Btrieve, \$245; Btrieve/N, \$595; Xtrieve, \$195; Xtrieve/N, \$395; Rtrieve, \$85; Rtrieve/N, \$175. Requires PC-DOS or MS-DOS 1.X, 2.X, or 3.X. NO ROYALTIES.

Authors Olson and Jasinski are not impressed with the Dvorak keyboard layout. Having tried it, I am inclined to agree with them. However, both they and Dvorak only addressed the typewriter keyboard.

Today's word processors and microcomputers have many more keys on their keyboards, with quite different usage than the typewriter of the thirties. Where would Dvorak have put Ctrl, Alt, Del, Ins? How would he have allowed for the more frequent usage of O and Y? Should special function keys be at the top or the side? When we have a numeric keypad, why do we need a second set of number keys, or if we do, why don't we make the numbers the uppercase and have the !, @, #, \$, etc., available for use without shifting?

We need a new Dvorak who will give us a total keyboard for today's needs and technology.

E. A. CLARKE  
Ponoka, Alberta, Canada

### CRTS ARE SAFE

If they haven't already, your readers will probably soon receive an ad for a radiation shield for their computer monitors. Carefully worded so as to remain legal (maybe) the ad will imply that cathode-ray tubes emit ionizing (X-ray like) radiation, that this is harmful to the operator, and that the way to save yourself is to purchase the advertised shield to put between you and the CRT. One ad I just received from a national distributor of computer products shows an operator dressed in a full

(continued on page 390)

# WHEN YOU NEED ACCESS TO FULL MEMORY, STRUCTURE, COMPATIBILITY WITH GW- & PC-BASICA, OR WHEN YOU NEED THE POWER AND FLEXIBILITY OF C OR PASCAL...

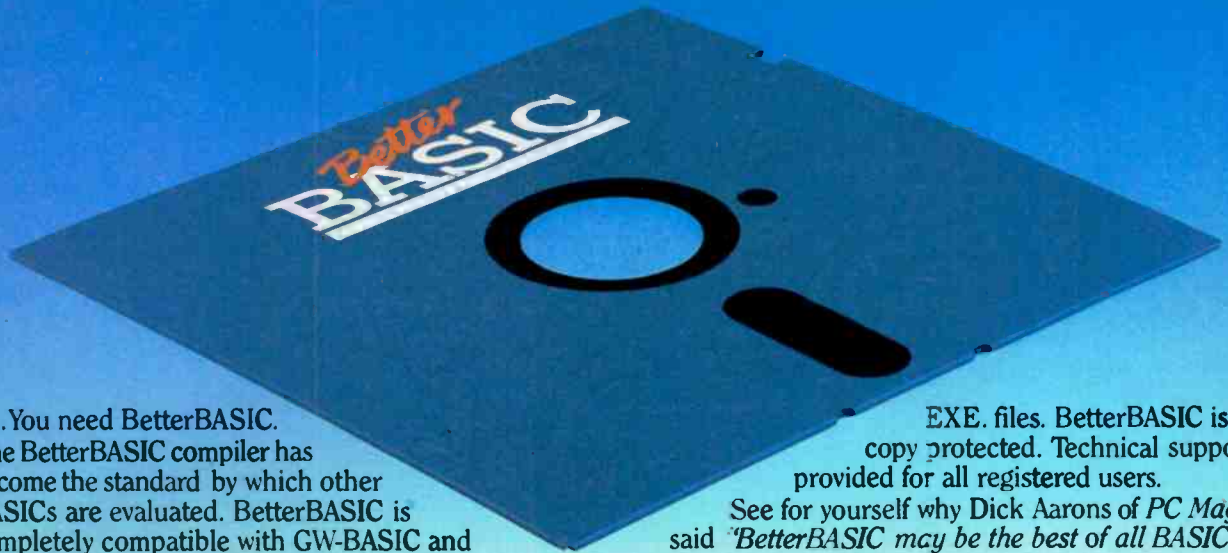

... You need BetterBASIC. The BetterBASIC compiler has become the standard by which other BASICs are evaluated. BetterBASIC is completely compatible with GW-BASIC and PC-BASICA when running on IBM PC's and true clones. You can load and run your existing BASIC programs in BetterBASIC. It uses standard MicroSoft syntax and gives you more than 150 additional statements such as XREF, DEFINE WINDOW, MAKE MODULE, and PROCEDURE. In benchmark comparisons, BetterBASIC is five times faster than interpreted BASIC. There is optional 8087/80287 math chip support, and an optional Runtime System to create stand-alone

EXE. files. BetterBASIC is not copy protected. Technical support is provided for all registered users.

See for yourself why Dick Aarons of *PC Magazine* said "BetterBASIC may be the best of all BASIC programming worlds" and selected BetterBASIC as "Editor's Choice" (Oct. 29, 1985).

BetterBASIC	\$199
8087/80287 Math Chip Support	\$99
Runtime System	\$250
Sample Disk with Tutorial	\$10

Ask your dealer or call to order: **1-800-225-5800**

*Better*  
**BASIC™**

BetterBASIC is a registered trademark of Summit Software Technology, Inc. IBM PC, XT, AT, and Microsoft are registered trademarks of International Business Machines Corp. Tandy is a registered trademark of Tandy Corp.

Inquiry 345

**Summit Software Technology, Inc.™**  
106 Access Rd. Norwood, MA 02062

MAY 1986 • BYTE 25

# For \$295 you

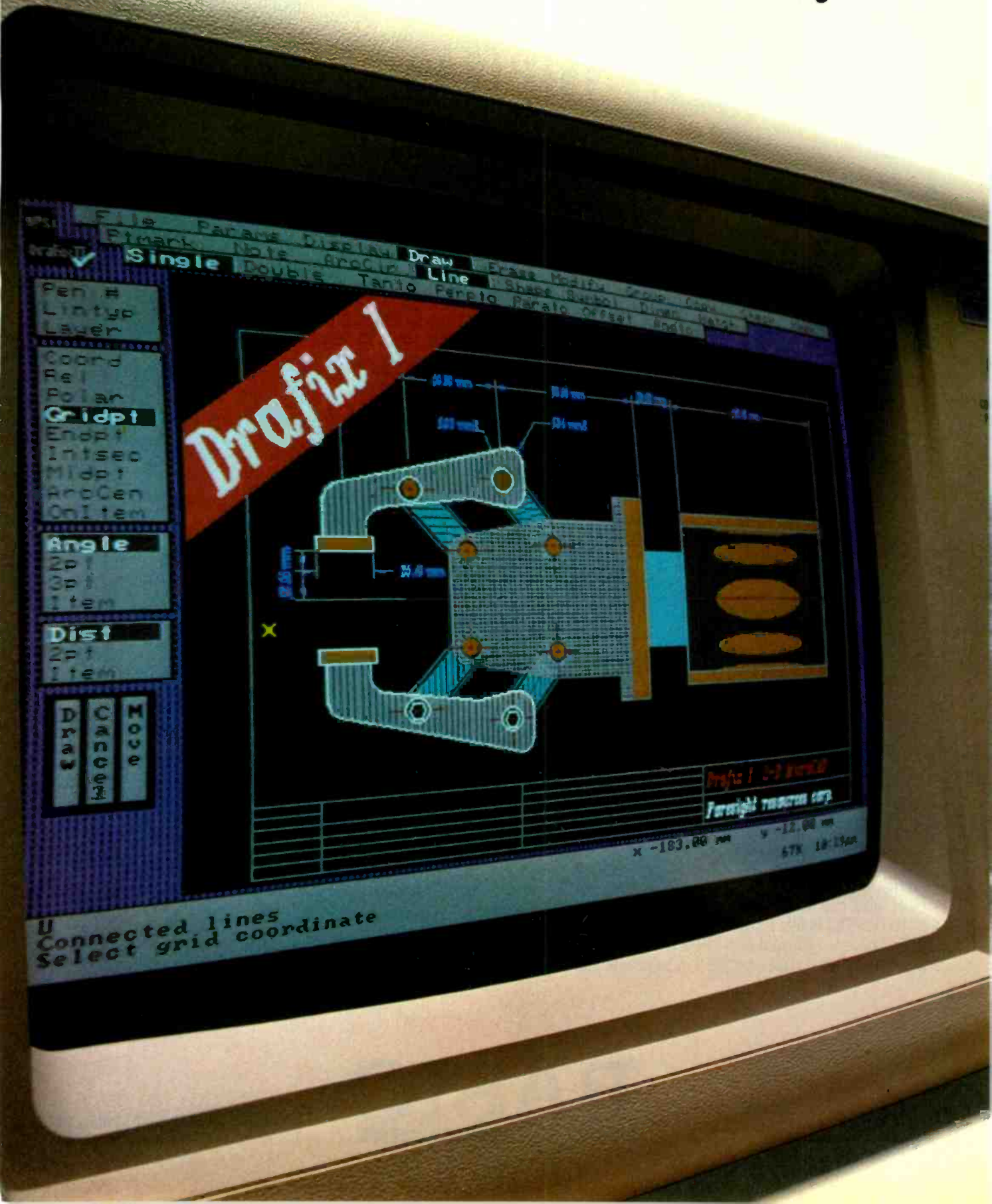

**Draft 1**

File Param Display Draw Erase Modify Snap Grid Layer Zoom View Print Quit

Point Note Arc Circle Line Shape Stretch Rotate Offset Undo

Single Double Tan to Parallel Parallel Offset Angle

Pen #  
Line up  
Layer

Coord  
Rel  
Pol  
Grid 1  
End  
1 item  
Mid  
Arc Cen  
On Item

Angle  
2pt  
3pt  
1 item

Dist  
2pt  
1 item

EARD  
ECCUR  
ECON

x -183.88 mm y -12.00 mm  
67K 18:13pm

Draft 1 - 2-D Drawing  
Paragraphics corp.

U Connected lines  
Select grid coordinate

# can draw your own conclusions.

**Drafix I. The first high performance CAD software everyone can afford.**

Low-cost, high performance computer-aided design & drafting (CAD) software is finally available for use on your PC.

There's never been a professional CAD package so complete at such a low cost.

Drafix I from Foresight Resources. Only \$295.

**Powerful, full-featured second generation CAD software.**

Drafix I offers all of the capabilities you expect to find in packages costing \$2,000 or more.

This is not simply a souped-up paint package. Drafix I is a breakthrough in design that organizes sophisticated CAD functions into smooth, fast operations. All of the drawing, designing and editing functions that designers demand from a serious CAD tool are included in Drafix I.

**A breakthrough in screen design and visual user interface.**

Drafix I features the best organized screen design ever devised. Very simply, it displays all the information you need, all of the time.

The entire menu hierarchy is displayed constantly. There's no need to memorize commands or search for menus.

Snap-mode options are continually shown on the left screen border and can be selected "on the fly" by either pointer device or a single keystroke. Roll-down screens provide quick access to the virtually unlimited drawing, display and editing options.

And it's all controlled by a versatile three-button mouse, or digitizer, with on-screen prompts so each button function is clearly defined.

**AutoCAD<sup>®</sup> compatible for easy expansion.**

If you or someone in your company already uses AutoCAD, Drafix I offers an inexpensive way to add to your capability.

The optional Drafix I/AutoCAD file exchange utility permits transfer of drawings between Drafix I and AutoCAD.



Entire menu hierarchy visible at all times.

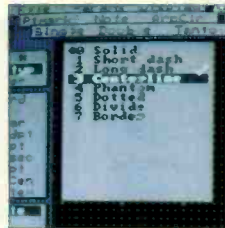

Extensive use of roll-down menus.



On-screen prompts define each mouse button function.

It's the perfect, low-cost alternative for increasing your drafting and design capacity.

**Low introductory bundle prices.**

Drafix I is designed to run on the IBM PC/XT/AT<sup>®</sup> and compatible personal computers. It supports all major graphics display cards, monitors, printers and plotters.

And to get you up and running we offer two special bundles—all the equipment you need at introductory prices you won't believe.

Get Drafix I with your choice of the Mouse Systems' PC Mouse<sup>®</sup> or Torrington's Manager Mouse<sup>®</sup> for just \$395.00. Or get Drafix I with SummaSketch 12"x12" digitizer tablet with stylus for just \$585.00.

**Order today. Take advantage of our 30-day, money back guarantee.**

We're so certain you'll like the performance and versatility of Drafix I you're welcome to try it risk free for 30 days. If you're not completely satisfied, return it to us for a full refund.

Find out just how good CAD software can be. For only \$295.00.

Use our toll-free number and any major credit card to order your copy of Drafix I today.

SPECIFICATIONS	
<b>Code specifications</b>	<b>Modify/Edit</b>
Latex "T" language	Attributes
Auto graphics	Break/Divide
Floating point database	File/Character
Coprocessor support	Trim
PC DOS/MS-DOS 2.1 or later	Stretch
<b>Drafix I Features</b>	Erase
<b>Items</b>	Explode symbols & polygons
Lines	Merge
PI markers	Replace
Arcs & circles	Region select
Note text	Workgroup
Polygons & ellipses	
Symbols/individual & nested	<b>Auto hatching, polygon fill</b>
<b>Item attributes</b>	
16 pen colors	<b>Auto Dimensions</b>
255 Layers	Linear: Hor/Ver/Aligned
6 Linetypes	Angular
12 text fonts	Dia/Radius
32 PI marker types	Leader/Notes
<b>Screen Display</b>	Ordinate
Zoom/Plan/Full	Cham & Baseline
8 Save Views	<b>Check calculations</b>
Slide save/view	Coordinates
Grids on/off	Distance & angle
<b>Metric &amp; English Standards</b>	Area & perimeter
Engineering (decimetric)	<b>Item Masking</b>
Architectural (ft in)	<b>Hardware</b>
<b>Project drawing info</b>	<b>Computers</b>
<b>Numeric input</b>	IBM PC XT AT and compatibles
Keyboard and cursor	AT&T 6300 Plus
Absolute, Relative, Polar	Zenith
<b>Snap Modes</b>	System Requirements
Gridpoint	— 512K RAM
Endpoint	— RS-232 Comm port
Midpoint	— Mouse or digitizer
Intersect	— Coprocessor recommended
On item	<b>Graphics Display boards</b>
Quadrant	IBM VGA/EGA and compatibles
Tangent	Hercules and a wide range of graphics boards
Arc center	<b>Digitizers &amp; Locators</b>
<b>Transform/Copy</b>	All popular locator devices supported
Move	<b>Plotters</b>
Rotate	All popular plotters ("C" size) supported
Scale	"E" size plotter option available
Mirror	<b>Printers</b>
Align	All popular laser and dot matrix printers supported

Order Now! Call Toll-Free! **1-800-231-8574**, Ext. 150

- Drafix I CAD Package \$295
- Drafix I with Mouse \$395
- Mouse Systems \_\_\_\_\_
- Torrington \_\_\_\_\_
- Drafix I with SummaSketch tablet \$585
- AutoCAD File Exchange Utility \$ 95

Check, money order, Visa and MasterCard accepted

Dealer Inquiries welcome

**FORESIGHT**  
RESOURCES CORP.™ 932 Massachusetts Lawrence, KS 66044 913/841-1121

AutoCAD is a trademark of Autodesk Inc.  
IBM PC/XT/AT are trademarks of the IBM Corp.  
PC Mouse is a trademark of Mouse Systems Inc.  
SummaSketch is a trademark of Summagraphics Inc.  
Manager Mouse is a trademark of Torrington Company

# 1 + 1 = 3



One IBM PC, XT/AT or compatible, plus one Advanced Digital PC-Slave II, now equals a complete 3-user (or more) system.

### *Do you need a true multi-user PC system?*

If so, read on. The Advanced Digital solution will simply add up in your favor.

To add two or more users to your IBM PC, XT/AT or compatible, just plug in our PC-SLAVE II and two low-cost monochrome monitors and keyboards. You can now run PC-DOS™ or MS-DOS™ on each user with PC-NET™ software to support your network. The end result is a true multi-processor system that allows each user to run independently on their own CPU and memory, yet sharing a common data base.

### *Do you need networking capabilities?*

The realm of IBM networks is only a step away with the

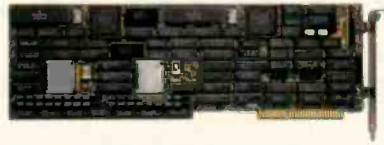

## PC Slave II™

The Ultimate Two-User IBM PC® Card

PC-Slave II and PC-NET software. An expanding network of multi-user PC's is truly cost-effective since you will be sharing data and communication between users and PCs. File and record locking are also provided so each user can run independently of others while still tied through the network.

### *Do you need additional users?*

Expand your existing supply of PC standalones into multi-user systems by simply adding more PC-Slave II's.

The PC-Slave II features two Intel 80188 CPU's @8Mhz, two 512Kb RAM per CPU and two monochrome/keyboard controllers all on a single board.

MS-DOS is a registered trademark of Microsoft  
PC-DOS, PC-NET are registered trademarks of IBM Corporation  
PC-Slave II is a registered trademark of Advanced Digital Corporation



To learn more about the multi-user solution contact:

**ADVANCED DIGITAL CORPORATION**  
5432 Production Drive  
Huntington Beach, CA 92649  
(714) 891-4004 (800) 251-1801  
Telex 183210 ADVANCED HTBH

**ADVANCED DIGITAL U.K. LTD.**  
27 Princes Street, Hanover Square  
London W1R8NQ-United Kingdom  
(01) 409-0777 (01) 409-3351  
TLX 265840 FINEST



Inquiry 6 for End-Users.  
Inquiry 7 for DEALERS ONLY.

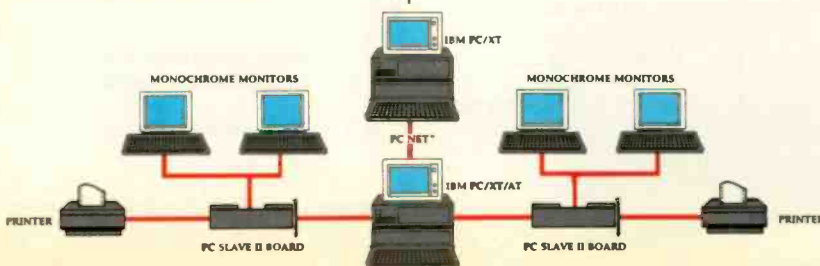

## Compaq Announces 80286-based Portable

Compaq Computer Corp. has introduced the Compaq Portable II, an IBM PC AT-compatible computer based on an Intel 80286 processor running at 6 or 8 MHz. Lighter and smaller than the original Compaq Portable, the new computer weighs 23.6 pounds and measures 7.5 by 13.9 by 17.7 inches. It has a modified IBM PC AT keyboard, a 9-inch monochrome monitor, a real-time clock, a socket for an 80287 coprocessor, parallel and serial interfaces, and interfaces for an RGB or composite monitor or standard TV set. The dual-mode monitor displays 80 characters by 25 lines and has a resolution of 640 by 200 pixels in graphics mode and 720 by 350 pixels in text mode.

The machine has room for up to two storage devices, either two 1/3-height 360K-byte floppy-disk drives or one floppy drive and a 1/2-height 10-megabyte hard-disk drive. Like the hard disk in the company's first portable, the new portable's hard-disk drive is shock-mounted, but it now includes a disk-controller board, eliminating the need for an expansion board.

One of the computer's expansion slots is 8-bit, and the other is 8-/16-bit. The main system board can hold 640K bytes of RAM. An optional memory board that attaches under the main system board enables you to



The Compaq Portable II runs on an 80286 processor.

expand memory to 2.1 megabytes without using an expansion slot. All configurations can hold up to 4.1 megabytes of RAM.

The new machine's 165-watt power supply, which is more powerful than that of the original portable, uses surface-mount technology to achieve greater power in a smaller unit. As an \$89 option, the Compaq Portable II features an automatic power-switching board that senses whether you have 110- or 220-volt operation and adjusts the machine to handle the correct voltage.

The Compaq Portable II sells for \$3499 with 256K bytes of RAM and one 360K-byte floppy drive; \$3599 with 256K bytes of RAM and two floppy drives; and \$4799 with 640K bytes of RAM, one floppy drive, and one 10-megabyte hard disk. Contact Compaq Computer Corp., 20555 FM 149, Houston, TX 77070. (713) 370-0670.

Inquiry 550.

## Atari ST Hard Disks

The SupraDrive Hard Disk series for the Atari 520ST and 1040ST computers is available with 10, 20, 30, or 60 megabytes of storage. The drives attach to the computer's high-speed DMA port and, according to the company, improve the speed of data transfer by three to ten times over that of floppy-disk-based systems. The company says the burst data-transfer rate is 155K bytes per second for the 10-megabyte drive, 625K bytes per second for the 20-megabyte drive, and 940K bytes per second for the 30- and 60-megabyte drives.

The 520ST and 1040ST can boot directly from the SupraDrives. All the drives come with software that includes formatting, partitioning, and backup utilities. Partitioning lets you create up

to four logical drives for file storage, each of which appears as an icon on the GEM desktop and can be used like a separate disk drive.

The drives are compatible with the TOS operating system and applications software and with other DMA-bus peripherals for the 520ST and 1040ST, such as CD-ROM players, coprocessors, and other devices. Prices are \$799 for a 10-megabyte drive; \$995 for 20 megabytes, \$1295 for 30 megabytes, and \$1995 for 60 megabytes. Contact Supra Corp., 1133 Commercial Way, Albany, OR 97321, (503) 967-9075. Inquiry 551.

## Borland's Prolog

Borland International released Turbo Prolog, designed as a software simulation of the Japanese fifth-generation computing engine. The compiler runs on any IBM PC with at least 384K bytes of RAM and one disk drive.

Turbo Prolog is an incremental, six-pass compiler that produces native-code, linkable object modules; its linking format is compatible with the PC-DOS linker. The programming interface, which employs its own pull-down menus and windows, lets you move back and forth between windows for purposes of editing, debugging, listing, and running a program. Type checking can be done across module boundaries. Borland says there are no limits to the

(continued)

size of compiled modules or source code. The language supports color, graphics, turtle graphics, sound, and windowing.

The \$99.95 package consists of the compiler, a full-screen text editor (with automatic identification of source-code errors), a reference manual, and a tutorial. The disk also holds commented source code for GeoBase, a natural-query-language database about U.S. geography. Contact Borland International, 4585 Scotts Valley Dr., Scotts Valley, CA 95066, (408) 438-8400.

**Inquiry 552.**

### Memory-Resident Lotus Utility

**D**esigned for use with Lotus's 1-2-3 and Symphony, SQZ! from Turner Hall Publishing is a memory-resident program that compresses, or squeezes, worksheet files automatically when you save them on disk. According to the company, the program reduces the size of worksheets by approximately 80 percent. It automatically restores the files to their original size when you retrieve them, with no loss of content. Worksheets remain their original size in RAM.

In addition to reducing the storage space that files require, the program cuts the time spent saving and loading files on floppy-based systems and reduces the cost of sending files electronically. A 150K-byte file that normally takes 20 minutes to transmit at 1200 bps takes 2 minutes after it's compressed, the company says. The program can also encrypt files and save them as ASCII text.

SQZ!'s compression capabilities are based on public-domain and proprietary algorithms and take advantage of redundancy in the

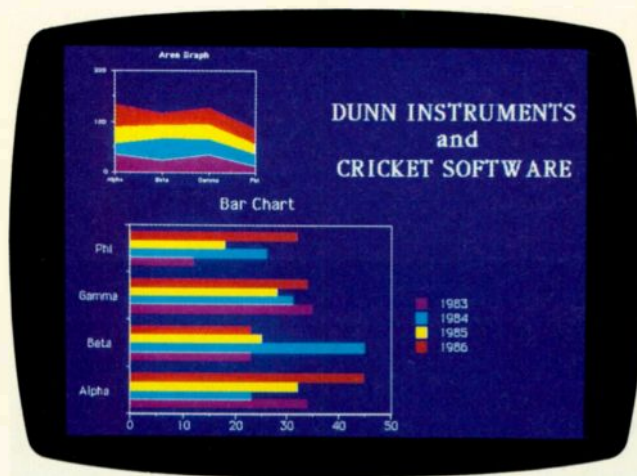

*Cricket Graph produces color graphics with the Mac.*

Lotus file formats. The program occupies less than 30K bytes of memory and supports the Lotus/Intel/Microsoft expanded memory specification. SQZ! runs on IBM PCs and compatibles and costs \$79.95. For more information, contact Turner Hall Publishing, 10201 Torre Ave., Cupertino, CA 95014, (408) 253-9607. **Inquiry 553.**

### Color Graphics, Page-Layout Software for Mac

**C**ricket Software's Cricket Graph offers users of the 512K-byte Macintosh the capability to design and print presentation graphics in color. And because it can handle multiple-graph page layouts, the program can be used for certain desktop-publishing applications.

Cricket Graph provides 12 types of graphs and charts: scatter, line, area, bar, column, stacked bar, stacked column, pie, polar, quality control, double Y, and text. It can plot more than 2000 data points per series and allows for regression-curve fits, three-dimensional depth, and error bars.

The software lets you enter data in a spreadsheet-

like form or import it from SYLK files, text files, or from other applications through the clipboard. You can sort data, group it by ranges of values, smooth it, and transform it by logarithmic, trigonometric, exponential, and statistical functions. A dialog box provides for changing axis tick marks and labels, plot symbols, and bar patterns. You can resize plot frames and explode pie chart segments.

You can assign any of eight printer ribbon or pen hues and 16 fill patterns. Cricket Graph prints color on the Apple Imagewriter II, Apple Color Plotter, and Hewlett-Packard 7470A and 7475A color plotters. (Versions of the program are available for other printers, and other versions let you put your work on 35mm color slides.)

With the package's layout capabilities, you can move, resize, and overlay as many as 10 graphs per page. Color graphs and charts can be imported to MacPublisher II and merged with text and images. Cricket Graph stores graphics internally in PICT, rather than bit-mapped, files and retains color data when passing files to black-and-white applications.

Cricket Graph has a suggested retail price of \$195;

versions for film recorders and color printers are \$495; a demo disk is \$6.95. Contact Cricket Software, 3508 Market St., Suite 206, Philadelphia, PA 19104, (800) 345-8112; in Pennsylvania, (215) 387-7955. **Inquiry 554.**

### Robotics Controller for Apples

**T**he VIP (Very Intelligent Peripheral) Card from Bukowski Robotics is an Apple-compatible robotics controller card that can be used as a stand-alone controller or as a coprocessor in an Apple II. You develop programs for robotics or control applications in BASIC or other languages, load the programs into the card from the computer's disk drive, and then place the card into the robot or other device to be controlled.

The card has a 65C02 microprocessor, 16 I/O lines, two timer/counters, and 8K bytes of nonvolatile RAM. It can be expanded to include 48 I/O lines, six timer/counters, and 24K bytes of EPROM or static RAM. Other options include a real-time clock/calendar, a 16-channel relay controller board, and an 8-channel 8-bit data-acquisition board. Memory modules with up to 128K bytes of RAM and battery backup are also available.

The card fits into any slot of an Apple II, II+, or IIe; software bundled with the card includes routines for a parallel port, serial port, stepper-motor driver, and a variety of home-control utilities.

The VIP Card costs \$129. For more information, contact Bukowski Robotics, 1555 West University, Suite 105, Tempe, AZ 85281, (602) 966-6230. **Inquiry 555.**

*(continued)*



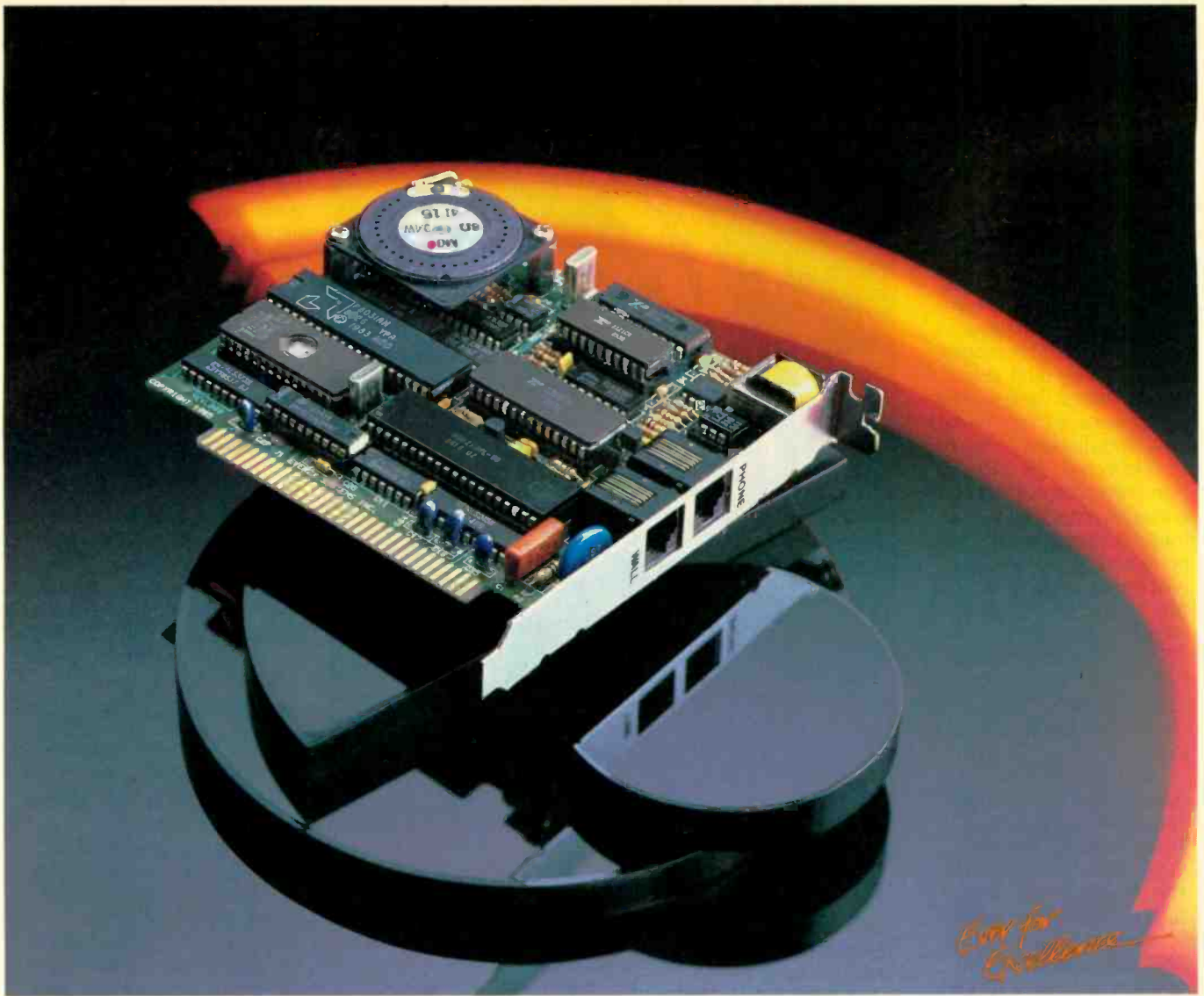

## Evercom™ ... 1200 baud, \$249

Now the EVEREX Evercom modem is available on a half-size card, perfect for the short slots in the IBM XT, Portable, and many compatibles. EVEREX has combined innovative engineering and technology to produce a quality

Hayes-compatible 1200 baud modem that out performs the competition at a lower price. EVEREX engineering is the key ingredient that delivers QUALITY and FEATURES without sacrificing PRICE.

### Demonstration -- FREE Brochure

Remember, before you buy a modem, check the features, check the price, and then call EVEREX to set up a demonstration at your local dealer.

When you call, we will also send you the total solution brochure describing EVEREX's complete line of IBM microcomputer peripherals.

**1-800-821-0806**

in California

**1-800-821-0807**

**EVEREX**  
EVER for EXcellence

48431 Milmont Dr. Fremont CA 94539  
(415) 498-1111

### Before you buy a modem, check these features:

	EVERCOM	HAYES 1200B
• 300/1200 bps Hayes-compatible	YES	YES
• Half-size card	YES	NO
• Automatic dialing, answering, and redialing	YES	YES
• Call Progress Monitoring	YES	NO
• Configurable from COM1 - COM4	YES	NO
• Internal Speaker with software adjustable volume control	YES	NO
• One and pulse dialing	YES	YES
• Automatic data-to-voice transition	YES	NO
• Detects receiver off-hook	YES	NO
• Reports speed mismatch	YES	NO
• Supports 132 columns	YES	NO
• Communications software included	YES	NO
• Extended Hayes command set	YES	-
• List price	\$249	\$489

Evercom is a trademark of Everex Systems, Inc. IBM PC and XT are registered trademarks of International Business Machines Corp.

Hayes 1200B is a trademark of Hayes Microcomputer Products Inc.

Inquiry 131 for End-Users. Inquiry 132 for DEALERS ONLY.

MAY 1986 • BYTE 31

## Image Processing on the PC AT

**D**ata Translation's image-processing system for the IBM PC AT consists of two plug-in boards. A high-resolution frame-grabber board (the DT2851) captures 512 by 512 by 8-bit video images, stores them in memory, processes them in real time, and displays them. A second board, the Auxiliary Frame Processor (DT2858) connects directly to the frame grabber through I/O ports and speeds image-processing calculations. The firm claims that the DT2858 executes convolutions on a 512 by 512 by 16-bit image frame in .85 seconds, as compared with 4 to 5 seconds on the PC AT alone.

The frame grabber can operate with standard and nonstandard video sources, including video cameras, VCRs, and slow-scan devices. The processor can merge, subtract, and offset frames by a constant and allows AND, OR, and XOR logic operations. It has multiple input and output lookup tables for creating thresholds and contours and producing pseudocolor.

Features of the board include an 8-bit video A/D converter and three 8-bit D/A converters. The board's two 256K-byte memory buffers can store two complete image frames on board, permitting parallel processing of multiple images.

The auxiliary board has a 16-bit pipelined processor and a RAM conversion table. It speeds the creation of histograms and convolutions and operations such as zoom, pan, and scroll.

Optional DT-IRIS Image Processing Software is also available. The package contains a subroutine library that can be called from BASIC, Pascal, C, FORTRAN, and macro assembler. Rou-

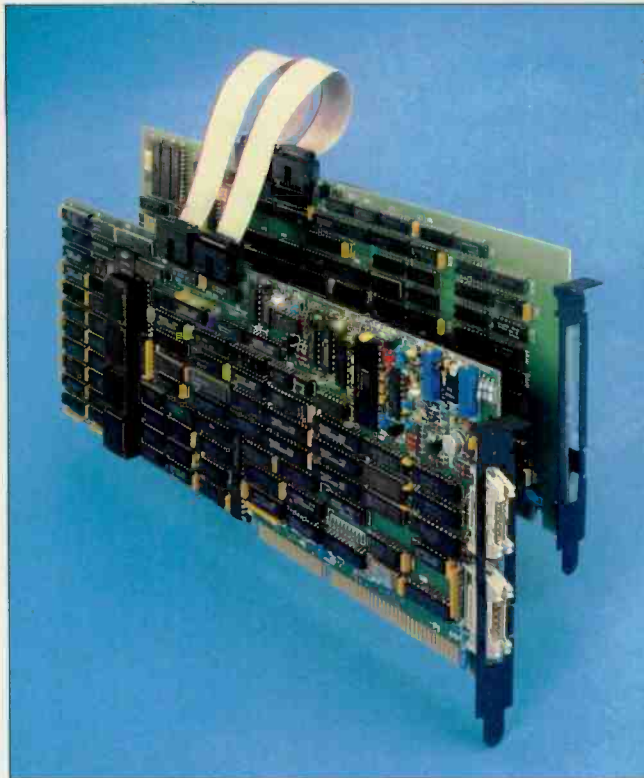

Data Translation's image-processing boards.

tines include windowing, frame averaging, and text, line, and circle overlays.

List price for the frame grabber is \$2995 and for the auxiliary processor, \$1495. The DT-IRIS software costs \$995. Contact Data Translation Inc., 100 Locke Dr., Marlboro, MA 01752, (617) 481-3700. Inquiry 556.

## Amiga CAD Tool

**P**CLO (printed circuit board layout) is a multiple-layer interactive autorouting CAD program for engineers and technicians using the Commodore Amiga. Full trace manipulation and editing, *n*-layer capability, and use of graphics are among this package's features.

PCL0 is priced at \$1000 for single sites; multiple-site licenses are available. For more information, contact SoftCircuits Inc., 401 South-

west 75th Terrace, North Lauderdale, FL 33068, (305) 721-2707.

Inquiry 557.

## Software Lets Mac Work Like Apple II

**C**omputer Applications has developed a program called II in a Mac that lets you run Apple DOS 3.3 and ProDOS programs on the 512K-byte Macintosh. With II in a Mac, you can transfer commercial and public-domain Apple II software to the Macintosh computer without modification.

Features of the emulator include four logical drives, RAM disks, joystick, language card, clock, keyboard buffer, high- and low-resolution graphics, 68000 system calls, and Apple II soft switches and hardware accesses. The program also provides access to Mac

peripheral hardware through the printer and modem ports and works with desk accessories and Switcher software.

II in a Mac comes with communications software for the Apple II and the Macintosh. You can choose a serial transfer (using the Imagewriter cable) or a modem transfer.

Computer Applications offers library disks containing public-domain Apple II programs for business, entertainment, and graphics uses.

Retail price of II in a Mac is \$69.95. For more information, contact Computer Applications Inc., 12813 Lindley Dr., Raleigh, NC 27614, (919) 846-1411.

Inquiry 558.

## Ada Compiler for MS-PC-DOS Machines

**A**rtek has developed an Ada compiler that runs under MS- and PC-DOS and comes with a full-screen editor, an interpreter/debugger, a linker/library manager, an A-code disassembler, and documentation for \$895. Artek says its system meets all the 1983 Department of Defense specifications except tasking.

The compiler package features generic subprograms and packages, as well as array and record aggregates, operator overloading, and dynamic arrays and exceptions. It takes a single pass over source code in order to produce executable pseudocode. You can invoke a second pass to translate this A-code into machine language for the Intel 8086.

The compiler system requires at least 384K bytes of memory. A hard disk is recommended for development of large applications. Contact Artek Corp, 100 Seaview Dr., Secaucus, NJ 07094, (800) 722-7835; in New Jersey, (201) 867-2900. Inquiry 559.

(continued)

SuperKey, PC Magazine's "Product of the Year"

# Without SideKick, SuperKey, and Traveling SideKick, your IBM PC is only half-awake

It's sleepwalking instead of sprinting. Dawdling instead of dashing, because it's not getting the supercharge of a high-speed productivity booster like SuperKey, PC Magazine's "Product of the Year." Or the real-time desktop management of SideKick, the #1 best seller for the IBM PC. Or the electronic clout and Computer Age organizational skills of Traveling SideKick.

### SuperKey "macros" are electronic shortcuts to success

You avoid repetition like getting out of bed 47 times every morning, or cooking dinner 83 times every night—when once is obviously enough. But if you haven't yet discovered the time-saving power of SuperKey, you'll find yourself typing the same set of keystrokes over and over again. Which makes no sense when a SuperKey macro cuts all that out. Macros are electronic shortcuts that can turn 1000 keystrokes into 1.

Aside from macros, SuperKey also gives you powerful encryption technology that scrambles your files and keeps confidential files confidential. It also lets you lock your keyboard, and foils would-be intruders with secret password protection.



Combine the electronic wizardry of SuperKey with the practical efficiency of SideKick

The best way to get the most done in the shortest time is to put both SuperKey and SideKick to work. They're designed to work hand-in-hand, and their complementary talents are astounding.

### Traveling SideKick gets personal organizers out of the Stone Age into the Computer Age

If you have SideKick, you need Traveling SideKick—and if you don't have SideKick, you need them both! Traveling SideKick is a revolutionary new combination of binder and software, making a completely new category in personal organizers: BinderWare.™ It prints out information that's already in your SideKick files, produces it in convenient familiar forms, then lets you

What SuperKey brings to the party includes time-saving macros, encryption, secret passwords, and programmable and re-programmable keys.

What SideKick brings includes a notepad with full-screen editing and wordwrap, a phone directory, autodialer, calculator, appointment scheduler, and ASCII table. (If you don't own a word-processing program, don't buy one, because with SuperKey and SideKick, you probably don't need one.)

Both SuperKey and SideKick work with your existing software, like Reflex,™ 1-2-3,™ MultiMate,™ Wordstar,™ Turbo Pascal,™ and dBase.™

gather it all together into your Traveling SideKick binder and hit the road.

Traveling SideKick includes report-generating software which produces up-to-the-minute telephone lists, address lists, meeting schedules, travel itineraries, calendars, and much much more. It also includes instant reference maps, airline and hotel reservation numbers, international telephone codes, and currency units. You get preprinted daily/weekly/monthly/yearly calendar forms, alpha-belted address book forms, and even a receipt envelope that clips inside your binder. You can order refills at any time.

### What's inside your Traveling Sidekick



- TABLET OF EXTRA FORMS IN POCKET ON BACK FLAP, FOR USE IN ANY OF THE ORGANIZER SECTIONS.
- ADDRESS BOOK SECTION PREPRINTED ADDRESS FORMS WITH TABBED DIVIDERS FOR EASY REFERENCE.
- MISCELLANEOUS SECTION TO STORE ALL EXTRA PREPRINTED FORMS AND COMMONLY USED RECORDS.
- ROLLER BALLPOINT PEN BLACK PEN THAT FITS IN FLAP FOR EASY ACCESS.
- REFERENCE SECTION CONTAINS MAPS THAT SHOW AREA CODES AND TIME ZONES, TOLL FREE NUMBERS FOR TRAVEL, ACCOMMODATIONS, METRIC CONVERSION CHARTS.
- FINANCE SECTION MULTIPLE LEADER FORMS, RECEIPT LOG AND STORAGE ENVELOPE, CREDIT CARD INFORMATION.
- CALENDAR SECTION YEARLY, MONTHLY, WEEKLY, AND DAILY ENGAGEMENT CALENDARS SUPPLEMENT THOSE YOU PRINT OUT WITH TRAVELING SIDEKICK.
- PENDING SECTION "A TO BE CONTINUED" SECTION FOR CURRENT PROJECTS, MEETING NOTES, ETC.
- CALCULATOR IN ONE OF TWO BUSINESS-CARD-SIZE STORAGE POCKETS.
- TRAVELING SIDEKICK SOFTWARE GENERATES, UPDATES AND PRINTS YOUR ADDRESS AND CALENDAR FILES.

Buy one, buy two, or all three at spectacular savings

Sold separately—SuperKey is \$69.95, SideKick is \$84.95, and Traveling SideKick is \$69.95 (until September 1, 1986). Incredible values, but you can save even more. Here's how: SideKick and Traveling SideKick for only \$125.00; you save \$29.90! SideKick and SuperKey, all three for only \$175.00; you save \$49.85!

Whichever combination you buy, you're boosting your productivity, joining the Computer Age, prodding your IBM PC awake, and getting it to do what it can do with the right kind of help—SuperKey, SideKick and Traveling SideKick!

**YES!** I want the best.

To order by phone, or for a dealer near you, call (800) 255-8008 in CA call (800) 742-1133

### Rush me:

Copies	Product	Price	Totals
___	Trio	\$175.00*	\$ _____
___	SideKick and Traveling SideKick	125.00*	\$ _____
___	SideKick	84.95	\$ _____
___	Traveling SideKick	69.95*	\$ _____
___	SuperKey	69.95	\$ _____
Subtotal		\$ _____	
Outside USA add \$10 per copy CA and MA res. add sales tax:		\$ _____	
Amount enclosed		\$ _____	
Prices include shipping to all US cities.			
Payment: VISA MC Bank Draft Check			
Credit card expiration date _____			

Card # \_\_\_\_\_

NOT COPY-PROTECTED  
\*\*60-DAY MONEY-BACK GUARANTEE

Name: \_\_\_\_\_

Shipping Address: \_\_\_\_\_

City: \_\_\_\_\_

State: \_\_\_\_\_ Zip: \_\_\_\_\_

Telephone: \_\_\_\_\_

CCDs and purchase orders WILL NOT be accepted by Borland. Outside USA make payment by bank draft, payable in US dollars drawn on a US bank.

\*Limited Time Offer until September 1, 1986

\*\*YES, within 60 days of purchase, should you find that this product does not perform in accordance with our claims please call our customer service department and we will gladly arrange a refund.

### Minimum system requirements:

IBM PC, XT, AT, or true compatible.  
Trio—384K, SideKick—128K, Traveling SideKick—256K, SuperKey—128K. TR15



4585 SCOTT'S VALLEY DRIVE  
SCOTT'S VALLEY, CA 95066  
(408) 438-8400 TELEX 172373

Inquiry 42 for End-Users.  
Inquiry 43 for DEALERS ONLY.

Borland products include Turbo Database Toolbox, Turbo Lightning, Turbo Tutor, Turbo GameWorks, and Turbo Editor Toolbox—all of which are registered trademarks or trademarks of Borland International or Borland/Analytics, Inc. SuperKey, Turbo Pascal, and SideKick are registered trademarks, and Traveling SideKick, Reflex, and BinderWare are trademarks of Borland International, Inc. IBM is a registered trademark of International Business Machines Corp. 1-2-3 is a registered trademark of Lotus Development Corp. MultiMate is a trademark of MultiMate International, Corp. Wordstar is a registered trademark of MicroPro International Corp. dBase is a registered trademark of Ashton-Tate. Copyright 1986 Borland International BI-1040A



## 32-bit Processor for IBM PC

Oasys announced a 32-bit coprocessor board that the company claims provides VAX-like performance on an IBM PC. Called the DS-32, the board uses the 10-MHz National Semiconductor 32032 processor with full 32-bit data paths and no wait states. The board can accommodate 2 megabytes of memory, and up to 4 megabytes of additional memory is available with an add-on board.

Other features of the DS-32 include the National Semiconductor NS32081 floating-point coprocessor, two serial ports, and a 16-bit interrupt-driven counter/timer. An NS32082 MMU is optional.

The DS-32 can run UNIX System V release 2 and Virtual MS-DOS simultaneously while the IBM PC's processor runs MS-DOS. According to the company, Virtual MS-DOS adds demand-paged virtual memory capabilities to MS-DOS, enabling the computer to run tasks as large as 15 megabytes. The board supports Green Hills' native and cross compilers for 68000 and 32000 systems, as well as development packages from Oasys.

The coprocessor board fits into one slot on an IBM PC or compatible. Prices for 10-MHz, 1-megabyte systems begin at \$2500. For more information, contact Oasys, 60 Aberdeen Ave., Cambridge, MA 02138, (617) 491-4180. Inquiry 560.

## Graphics Program Resides in RAM

New England Software introduced Graph-in-the-Box, a memory-resident program that lets you create business graphs from data in spreadsheets, databases, word processors, and other

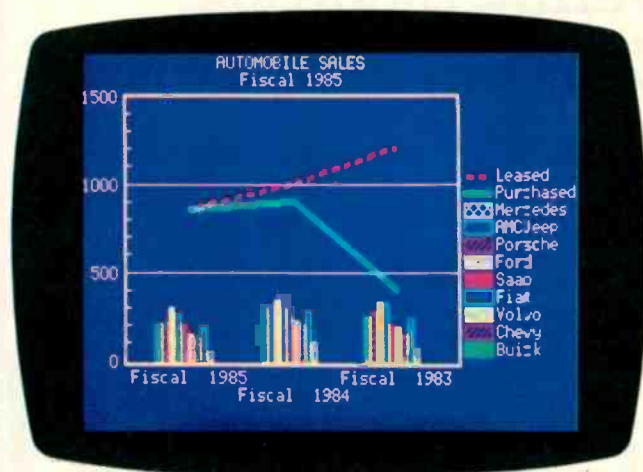

Graph-in-the-Box memory-resident software.

application programs. The program will create charts with data from programs that have no graphics capabilities and with computers that are not equipped for graphics.

Unlike most graphics programs, Graph-in-the-Box captures information that you highlight on screen with the cursor. It converts the captured data to a chart that you can analyze on screen, store, or print. You can choose from 11 types of charts, all of which are represented by icons on the program's menu. Choices include column, stacked column, bar, stacked bar, line, line with filled area, step, step with filled area, scatter, pie, and exploded pie charts. You can also capture titles and captions, add grid lines, fill patterns, and change scale.

The program works with other memory-resident programs and with IBM- and Hercules-compatible graphics boards, IBM- and Epson-compatible dot-matrix printers, and HP-compatible laser printers and plotters. It resides in 128K bytes of memory and runs on IBM PCs and compatibles with a minimum of 256K of memory.

Graph-in-the-Box sells for \$97.60. For more information, contact New England Software, Greenwich Office Park 3, Greenwich, CT 06830, (203) 625-0062. Inquiry 561.

## More Storage for the Mac Plus

Univation's SlimLine Hard Disk Subsystem combines a hard disk and a removable cartridge for the Macintosh Plus. The SlimLine unit connects to the SCSI port on the computer and transfers data at a rate of 5 megabytes per second. The removable cartridge is mounted vertically below the hard disk, and both are housed in an enclosure that serves as a base for the computer.

The drives come in configurations that combine a 20-, 30-, or 40-megabyte preformatted hard disk with a 10-megabyte removable cartridge. A unit with two removable cartridges is also available. A SlimLine drive with a 10-megabyte removable cartridge and a 20-megabyte hard disk costs \$2995; with a 30-megabyte hard disk, \$3295; and with a 40-megabyte hard disk, \$4495. A unit with two removable cartridges sells

for \$3495. The company plans to sell a drive with one removable cartridge only for less than \$2500.

Contact Univation Inc., 1231 California Circle, Milpitas, CA 95035, (408) 263-1200. Inquiry 562.

## GridNet LAN Uses Existing AC Wiring

GridComm's GCM GridNet is a local-area network that uses an office's existing electrical wiring as the network medium. The network uses an interface called the GC-1400 to connect any personal computer equipped with a serial or parallel port to an electrical outlet. The interface modulates the data from the computer's port, encrypts it, and sends it via an error-correcting communications channel to another interface.

The GC-1400 contains 8K bytes of memory that function as an electronic mail inbox. The data-transmission rate is 5760 bps, with a claimed error rate of zero. Up to eight connections can be made on the network at the same time. The geographical size of the network is limited to 50,000 square feet.

Also available are two other interfaces: the GC-1100, a receive-only interface designed for connecting a printer to the network, and the GC-Zero, a 300/1200-bps modem that allows users of the network to connect with remote systems and vice versa.

The GC-140 costs \$549, the GC-1100 sells for \$449, and the GC-Zero modem sells for \$799. For more information, contact GridComm Inc., 20 Old Ridgebury Rd., Danbury, CT 06810, (203) 790-9077. Inquiry 563.

(continued)

# This is the Modula-2 compiler everybody's been waiting for...

Especially Turbo Pascal users!

## LOGITECH MODULA-2/86

Now you can cross the bridge to Modula-2 with ease.

This is Modula-2 at its *absolute* best. It's a fully integrated development environment that takes into account what you need as a programmer. Without leaving the Editor, you can call the compiler, linker and utilities.

With Logitech's Modula-2, you'll have the ability to edit several files at once, comparing, window to window, various code modules. You can even move from window to window compiling, linking, debugging and running.

The compiler has the kind of power and room to breathe that you really need in today's complex applications. It is as easy to use as Turbo Pascal, without your programs being limited to 64K of code.

At your command will be the libraries of modules that make Modula-2 a programmer's dream. It has essentially the same structure as Pascal with the major addition of a library organization of code modules that allow you to put together programs on a solid, block-by-block, foundation of proven code.

Whether you're working with a module of your own making, or one of the many in our library, you'll find the system by which each module is identified, described and stored an organizational masterpiece. And that's at the heart of Modula-2.

Underneath the sophisticated system is a Modula-2 compiler that is the result of years of development and proven use in industry. We run on the Vax\*, and we run on the IBM PC. And the code is portable—from one to the other.

*Best of all . . . you can have it right now!*

**Logitech Modula-2/86** Complete with Editor, Run Time System, Linker, Cursor-positioning debugger, 8087 Software Emulation, BCD module, Logitech's extended library, Utility to generate standard .EXE files, Turbo Pascal (and standard Pascal, too) to Modula-2 translator (included without charge until 8/1/86), and much, much more!

**Logitech Modula-2/86 with 8087 support** Even if you haven't yet gotten an 8087 co-processor, you can still use this version.

**Logitech Modula-2/86 Plus** For machines with 512K or more. Takes advantage of the larger memory to increase compilation speed by 50%! Supports 80186 and 80286 as well as 8086 and 8088. Includes 8087 and 80287 support, too.

**Window Package** Now you can build true windowing into your Modula-2/86 code with ease, too. Very powerful and very full, yet only 15K in size. Features virtual screens, color support, overlapping windows and a variety of borders.

**Run Time Debugger** (source level) Much more powerful than just a symbolic RTD. Display source code, data, procedure call chain and raw memory. Set break points, assign values to variables, pinpoint and identify bugs in your source. The ultimate professional's tool!

**Utilities Package** Features a post-mortem debugger for static debugging. If a program you've written crashes at run time, the situation is frozen, and you can pinpoint, in source, the cause of the error and the data at that moment. Also includes a disassembler, a cross reference utility and a "version" utility that allows conditional compilation.

**Make Utility** Automatically selects modules affected by code changes for quick and minimal re-compilation and relinking. Even figures out dependencies for you.

**Library Sources** Source code for our major library modules is now available—for customization or exemplification.

**ROM Package** If you need to produce rommable code, call our 800 number for further information on this package.

To place an order call our special toll free number

**800-231-7717**

in California

**800-552-8885**

Special offer until 8/1/86!

includes

**Free! \$49.95 value Turbo Pascal translator!**

*Now, you can take your library with you!*

**\$89**

Yes, I'd like to take the next logical step in programming. Please send my copy of Logitech Modula-2/86 to the following address:

VISA  MasterCard  Check Enclosed

Card Number \_\_\_\_\_ Expiration Date \_\_\_\_\_

Signature \_\_\_\_\_

Name \_\_\_\_\_

Address \_\_\_\_\_

City \_\_\_\_\_

State \_\_\_\_\_ Zip \_\_\_\_\_ Phone (\_\_\_\_) \_\_\_\_\_

Here's the configuration I'd like:  And include the indicated items:

Logitech Modula-2/86 \$89  Window Package \$49  
 Logitech Modula-2/86 \$129  Run Time Debugger \$69  
with 8087 support (source level)

Logitech Modula-2/86 Plus \$189  Utilities Package \$49

Make Utility \$29

Library Sources \$99

Please add \$6.50 for shipping and handling.

Total enclosed \$ \_\_\_\_\_  
(California residents: please add applicable sales tax)



LOGITECH, Inc.  
805 Veterans Boulevard  
Redwood City, California 94063  
Telephone (415) 365-9852

For European pricing, please contact:

LOGITECH SA  
Box 32, CH-1143 Apples, Switzerland  
Telephone 41 (21) 774545

Please call our 800 line for:  Information on our \*VAX version  Site License and University Discounts  Dealer and Distributor information

\*Turbo Pascal is a registered trademark of Borland International

## NEW SYSTEMS

**AT-Compatible for Under \$2000**

The Gemini Advantage Processor (GAP) from Gemini Electronics is an IBM PC AT-compatible computer based on an 80286 microprocessor running at 6 or 8 MHz. The computer comes with 1 megabyte of RAM on the main board, which has two selectable memory maps and a socket for an 80287 coprocessor. A 10-MHz microprocessor is optional.

The GAP is equipped with 12 expansion slots, six of which have 16-bit buses. Two 8-bit slots accommodate long expansion cards, and the remaining four 8-bit slots hold short cards. The machine comes with one 1.2-megabyte floppy-disk drive. Five half-height drive positions are available, with four accessible through the front of the case.

An AT-style keyboard is standard. The computer has an external reset button and a 230-watt power supply with an external fuse and a 110-/220-volt switch.

Options for the GAP include serial and parallel ports, graphics cards, monochrome and high- and medium-resolution color monitors, plotters, and digitizers. Also optional is a 360K-byte floppy-disk drive and fast-access hard-disk drives with 10, 20, 30, and 40 megabytes of storage. Prices for the hard disks range from \$342 to \$882.

The computer is priced at \$1995. For more informa-



*Gemini Electronics' GAP, an IBM PC AT-compatible.*

tion, contact Gemini Electronics Inc., 130 Baywood Ave., Longwood, FL 32750, (305) 830-8886. Inquiry 564.

**68020 Single-Board Computers**

Microbar Systems introduced two 68020-based single-board computers for Multibus systems. The GPC68020 is intended for use with real-time and multiuser operating systems and enables users of 16-bit Multibus I systems to upgrade to a 32-bit processor. The MT68020 is designed to improve the performance of 32-bit Multibus II systems.

Both are available with a 12.5- or 16.67-MHz 68020

microprocessor. The GPC68020 comes with 1 or 2 megabytes of dual-ported dynamic RAM, while the MT68020 comes with 1 to 4 megabytes. Both have interfaces to an iSBX connector for add-on I/O modules, four 28-pin sockets for PROMs, two serial ports, a 16-bit parallel port, and five 8-bit counter/timers. A memory-management unit, four-channel DMA controller, and floating-point coprocessor are options on both systems.

The company says it will port UNIX System V and real-time operating systems to the MT68020.

The GPC68020 with 1 megabyte of RAM costs \$2785, and the MT68020 with 1 megabyte of RAM costs \$3490. For further

details, contact Microbar Systems Inc., 785 Lucerne Dr., Sunnyvale, CA 94086, (408) 720-9300. Inquiry 565.

**Motorola's 68000 Development System for IBM PCs**

Designed for software development, Motorola's PC/68000 converts an IBM PC into a multiprocessor host with a UNIX operating environment.

The plug-in module runs the System V/68 operating system, which the firm says is functionally equivalent to AT&T's UNIX System V. Buffering and cache memory in both the IBM PC and PC/68000 allow the 68000 to perform processing tasks while the 8088 or 80286 handles I/O required by the 68000. Switching between System V/68 and PC-DOS requires a two-keystroke combination, and files can be transferred both ways between the two operating systems.

The PC/68000 comes with a 10-MHz microprocessor, memory-management unit, 2 megabytes of dual-ported RAM, the System V/68 operating system, plus an I/O kernel and diagnostics. It sells for \$4500 and runs on an IBM PC with a 10-megabyte hard disk.

For more information, contact Motorola Semiconductor Products Inc., POB 20912, Phoenix, AZ 85036, (800) 521-6274. Inquiry 566.

## PERIPHERALS

**Everex Tape Drive for the IBM PC**

Everex Systems has released an external tape backup drive that provides 60 megabytes of storage capacity for the IBM PC and

compatibles. Priced at \$995, the Excel-Stream 60-8 contains a ¼-inch streaming tape drive, power supply, and circuitry. The unit can back up 10 megabytes of data in two minutes.

The tape drive features automatic formatting and read-after-write error checking. It has fully configurable DMA channels, port addresses, and interrupt lines and uses QIC standards.

The drive comes with soft-

ware for file-by-file or image backup. Contact Everex Systems Inc., 47777 Warm Springs Blvd., Fremont, CA 94539, (415) 498-1111. Inquiry 567.

(continued)

# THIRD GENERATION PROGRAMMERS FROM GTEK

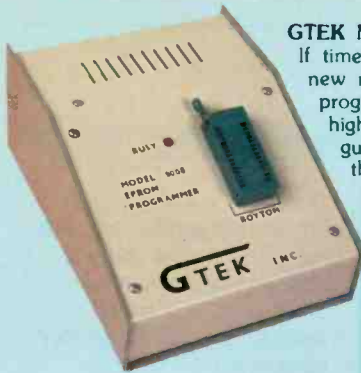

**GTEK MODEL 9000 (E)EPROM/MPU PROGRAMMER**  
If time is money, then let us save some for you. The new model 9000, using its quick pulse algorithms, can program a 2764 in 10 seconds. The 9000 offers higher performance than the competition has even begun to think about. Baud rates to 57,600. Supports thru 512K standard, 8 meg worldwide parts with adapter, Cypress proms, mpu's. NO personality modules. As with our other programmers, RS-232, ASCII data formats, and flexible hand-shaking make the model 9000 compatible with virtually any computer. Introductory price \$749.

**MODEL 7228 (E)EPROM/MPU PROGRAMMER** The standard by which other other programmers are judged. With thousands in the field, the time proven 7228 has become our most popular programmer. Intelligent algorithms standard. Programs a 2764 in one minute. Supports devices thru 512K, mpu's, eeproms, cmos. NO personality modules. Price \$599



### MODEL 7956 GANG (E)EPROM/MPU PROGRAMMER

The 7956 can program eight 2764's in one minute using intelligent algorithms. Standard support thru 512K, eeproms, cmos, mpu's. A must for production environments. Available in stand alone only configuration for \$979 or with RS-232 interface for \$1099

**MODEL 7128 (E)EPROM/MPU PROGRAMMER** The programmer that won't die. Thousands manufactured since 1982. Supports thru 256K. **PRICE REDUCED** to \$389 including free PGX communications software, a \$95 value.

**MODEL 705** Motorola 68705 family programmer. Transfers object code to 28 and 40 pin mpu's. Single key stroke operation. \$299

**MODEL 7324 PAL PROGRAMMER** The 7324 has a built-in compiler. It supports 20 and 24 pin pals by MMI, NATIONAL, and TI, including the new shared product parts 20S10, 20RS10, 20RS8, 20RS4. It operates stand alone or via RS-232 with PALX communications package. Functionally tests parts after programming and securing. External compilers are supported thru JEDEC and AHS object formats. \$1499

**MODEL 7322** Same as 7324 but no stand alone capability. \$1249

### UTILITY PACKAGES

**PGMX High Speed Communications Package.** For IBM PC, AT and compatibles. Bi-directional data rates to a scorching 57600 bps. Provides flexible manipulation of Intel Hex files, both 8 and 16 bit formats, and binary files. Use with model 9000. \$149

**PGX Utility Package.** For PCDOS, CPM, TRSDOS, ISIS, MSDOS. Use with 9000, 7956, 7228, 7128. \$95

**PALX Utility Package.** Provides communication, download of Palasm source, JEDEC and AHS object files to models 7324, 7322, 7316 pal programmers. \$95

### CROSS ASSEMBLERS and SIMULATORS

You name the cpu, we've got the assembler. Simulators allow target software development and testing on your computer. Versions available for PCDOS, MSDOS, CPM. Start at \$200

**ERASERS**—We stock both Ultra Violet Products and Spectronics for your selection.  
**MODEL CHIPS TIMER LAMP PRICE**

DE4	8	N	Tube	\$80
PE14T	9	Y	Tube	\$129
C25	25	Y	Grid	\$349
C50	50	Y	Grid	\$599

**ACCESSORIES**  
**CABLES**—serial \$30, parallel \$30, custom Call For Quote  
**MODEL 481/482/483** 8048 family adapters \$98  
**MODEL 511/5128051** family adapter \$174  
**MODEL 755/756** 8755 adapter \$135

**SPECIAL REQUIREMENTS? Call Us For A Quote On Custom OEM Programmers.**

Run CPM Software on Your IBM or IBM Compatible



If you are a CPM user who wants to convert to MSDOS or PCDOS or a PC user who would like access to the thousands of CPM programs in existence, here is the perfect solution to the problem: CPEmulator from GTEK.

CPEmulator is the only field proven emulator which emulates the complete Z-80 Instruction set. Terminal attribute emulation is Televideo, Lear Siegler, or the AMSI standard. CPM .COM programs reside under PCDOS and are executable under PCDOS as well as 8086 programs.

Comes complete with COPYCPM, a disk conversion utility which allows transferring data and programs to and from 54 different CPM disk formats. Free CPM utility programs are also included.

Need speed? CPEmulators Speed Kit includes NEC V20 processor. (8080 opcodes only)

CPEmulator Z80 emulator \$199  
CPEmulator 8080 emulator w/V20 \$299  
Both versions \$298

Call GTEK's CPM Hotline 1-601-467-9019

### The Printing Solution: Model 8014 Programmable Printer Switch



Finally a way to have as many parallel printers as you need even when you only have one parallel port. With GTEK's programmable parallel switch, you can expand as you require. Perfect for networks.

With the spooling version, you can allocate available memory to fit your requirements, get multiple copies and more.

Both use ordinary IBM type parallel printer cables, expand one port to four, and may be cascaded in Star or Daisy Chain configurations for as many ports as desired. The desired port is selected with a simple escape sequence. For networks, previous selected port is saved on Port Stack and returned to with Return Escape Sequence. Complete with power supply.

**Model 8014** Four port programmable switch **PRICE REDUCED** \$199  
**Model 8014-128K** with 128K spool memory \$399



Development Hardware/Software  
P.O. Box 289, Waveland, MS 39576 U.S.A.  
601/467-8048; telex 315-814 (GTEK UD), INC.

GTEK, PALASM, CPM, MS-DOS, PC-DOS, ISIS, TRSDOS, & CPEmulator are registered trademarks.

## PERIPHERALS

**PC-based Interface System**

**A**jida Technologies' Personal Protosystem is a complete interface system for the IBM PC. You can design and build a circuit on the Protosystem, connect it to the signal lines provided on the console, and test it using your PC. The Protosystem software lets you control the console signal levels and test your design.

The 7- by 8- by 3-inch console provides 32 bits of buffered digital I/O, two channels of 8-bit A/D, two channels of 8-bit D/A, three programmable 5-MHz counter/timers, a 4-MHz clock, 5-volt and 12-volt power supplies, and breadboard space for 24 14-pin DIPs. It connects to your IBM PC via the parallel port.

The Personal Protosystem comes with setup software and a BASIC driver for \$425; FORTH and C drivers are also available. Contact Ajida Technologies Inc., POB 40178, Berkeley, CA 94704, (415) 548-6434. **Inquiry 568.**

**Sound Recorder for the Amiga**

**T**he FutureSound digital sound recorder makes it possible to record, play back, and store sounds from instruments or other sources on the Commodore Amiga. Among the recorder's features is multitrack recording, which lets you record several sounds and play them back simultaneously. The recorder offers variable recording speeds, ranging from a few samples per second to 28,000 samples per second, as well as variable playback speeds.

The device connects directly to the computer's parallel port and is equipped with an additional

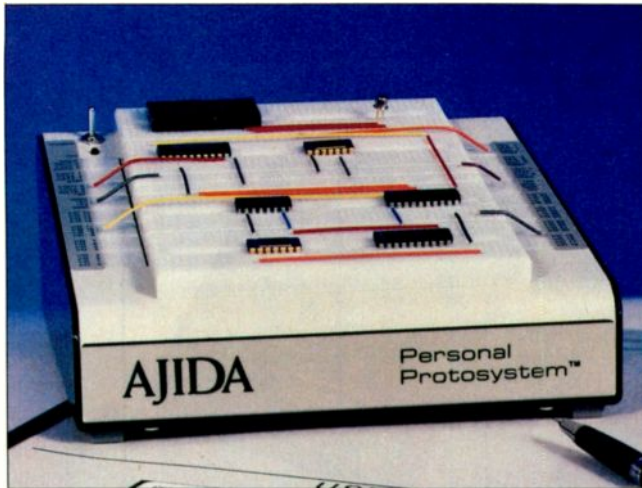

*Ajida Technologies' Personal Protosystem for IBM PCs.*

connector for a printer. It comes with a microphone, a jack for using other microphones, connecting cables, and recording software.

FutureSound sells for \$175. Contact Applied Visions, 15 Oak Ridge Rd., Medford, MA 02155, (617) 488-3602. **Inquiry 569.**

**Excalibur Adds Speed and Memory to Mac**

**A**ssimilation Process's Excalibur is an external 2-megabyte RAM drive for the Apple Macintosh that increases the speed at which the computer loads and executes programs. According to the company, a Mac equipped with the drive loads and executes MacWrite in 6 seconds, while a floppy-based 512K Mac requires 28 seconds, and a system with an Apple Hard Disk takes 11 seconds.

The RAM drive fits under the Macintosh and connects to the computer through the external disk-drive port. You can boot software directly from the drive, which requires no controlling soft-

ware. The drive's battery backup will store data for six to eight hours.

An external port on the back of the device lets you connect an external floppy disk, hard disk, or up to three additional Excalibur drives. The drive will also accommodate additional RAM, and the company says that upgrades will be available in 1-megabyte increments later this year.

The 2-megabyte Excalibur costs \$699 and runs on the Macintosh and Macintosh Plus. For more information, contact Assimilation Process Inc., 20833 Stevens Creek Blvd., Suite 101, Cupertino, CA 95014, (408) 446-0797. **Inquiry 570.**

**CAD Plotter**

**E**nter Computer, manufacturer of the Sweet-P plotter, announced the Model SP1200 plotter for computer-aided design and engineering. The plotter produces drawings from size A to size E, a large format suitable for engineering and architectural drawings.

The single-pen plotter emulates Houston Instruments' DM/PL plotter and is compatible with CAD/CAE software such as AutoCAD,

VersaCAD, CADKEY, and others. The plotter uses HP-compatible pens and will also accept a variety of other pens. Pen speed reaches 10 axial inches per second with .0025-inch resolution.

The plotter comes with 14K bytes of buffer space. It attaches to computers or CAD workstations through an RS-232C port that operates at rates between 300 and 9600 bits per second.

The Model SP1200 sells for \$4995. For more information, contact Enter Computer Inc., 6867 Nancy Ridge Dr., San Diego, CA 92121, (619) 450-0601. **Inquiry 571.**

**1200-bps Acoustic Coupler**

**A**nderson Jacobson has developed an acoustic coupler for use with portable computers. Called the AJ 1232-P, the device communicates at 1200 and 300 bps and is compatible with Bell 212A and 103 standards. It can be used in two modes, either as an acoustic coupler or as a direct-connect modem hooked to a telephone with a standard RJ-11 modular jack. You can power the coupler with an optional rechargeable 12-volt battery pack or plug it into a regular electrical outlet.

The AJ 1232-P weighs about 4½ pounds and measures 14 by 8½ by 4 inches, excluding the carrying case and battery pack. It costs \$795. For more information, contact Anderson Jacobson Inc., 521 Chaucet Ave., San Jose, CA 95131, (408) 435-8520. **Inquiry 572.**

*(continued)*



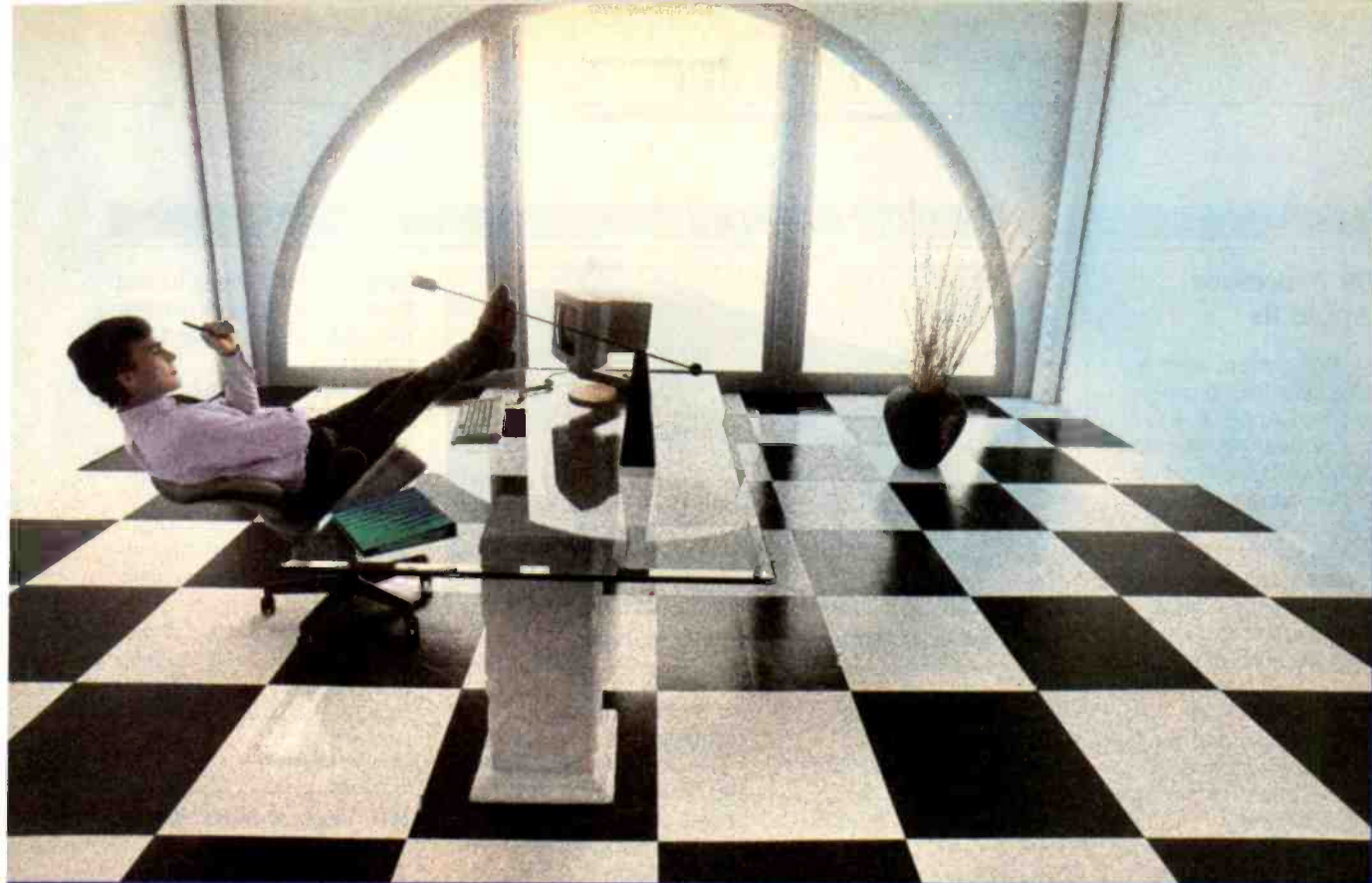

*Clipper gives dBASE III™ users more time to do more. Or less.*

Clipper™ allows you to run all dBASE III™ programs 2 to 20 times faster than they do with the standard dBASE interpreter.

That frees up extra time you're wasting if you're running dBASE III programs without Clipper.

Extra time to think.  
To create. To produce.  
To use as you choose.

You see, Clipper is the first true compiler for dBASE III. Clipper eliminates the time-consuming translation which the dBASE interpreter performs line after line whenever a program is run.

With Clipper, once you've debugged your source code, it's compiled into more efficient machine code.

And Clipper compiles all your dBASE III programs. The ones you have today. The ones you'll have tomorrow. But don't wait until tomorrow to order Clipper.

Today, Clipper has already been purchased to speed up dBASE run time at 3M and Touche Ross. At Exxon and NASA. In

the Harvard Physics Department. For the State of Arizona and TRW.

And that's just a few of the installations worldwide. From Greece to Venezuela to Canada to Europe.

So stop wasting time.

Call our toll-free 800 number and get Clipper.

You'll spend less time running dBASE III and more time running the rest of your life.

 **Nantucket**™

5995 S. Sepulveda Blvd., Culver City, CA 90230 (800)251-8438 In California (213)390-7923

dBASE III is a registered trademark of Ashton-Tate

## ADD-INS

**68000 Processor for Apple IIs**

The R68 System adds a Motorola 68000 processor to an Apple II, II+, or IIe. The board is intended for 68000 software development and coprocessing, for teaching 68000 software development, or for digital signal processing when used with the company's digital scope and spectrum analyzer. Because the board runs as a stand-alone system after start-up, you can reboot the Apple and run other programs without affecting the board or the program it is currently executing.

The R68 uses an 8-MHz processor; a 10- or 12-MHz processor is optional. Other features include 48K to 256K bytes of memory, eight levels of priority interrupt hardware, two levels of interrupt from the Apple to the 68000, four 8-bit interface ports between the Apple and 68000, two 8-bit I/O ports, two 16-bit programmable counter/timers, and a serial port.

Among the software's capabilities are routines for writing and testing applications programs. The software also includes an S-C macro assembler with an integral coresident program editor.

The R68 System with software and manuals sells for \$499. Contact Rapid Systems Inc., 659 North 34th St., Seattle, WA 98103, (206) 547-8311. Inquiry 573.

**Double the Amiga's Memory**

Starpoint Software released a 256K-byte RAM card for the Commodore Amiga that expands the computer's memory to 512K bytes. The card comes

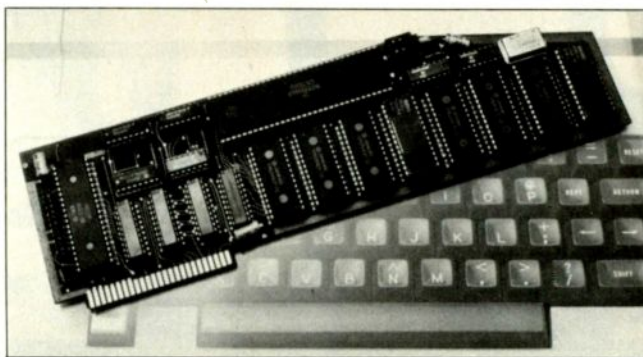

The R68 System, an Apple-compatible coprocessor board.

with a manual and schematics. Suggested retail price is \$120. Contact Starpoint Software, 122 South Broadway, Yreka, CA 96097, (916) 842-6183. Inquiry 574.

**Analog/Digital Interfaces for IBM PCs**

The DAISI series of interfaces, from Interactive Structures, is a modular system of analog and digital interfaces for the IBM PC. The system is based on a master interface, the DMI-110, which fits in a single slot in the computer and holds up to four snap-on modules.

Add-on modules include the DAI-120, which performs analog data acquisition and is suitable for such applications as reading temperatures, resistances, and sensor outputs. The DAI-120 sells for \$450. A second module is the DDI-160, which provides 24 lines of digital I/O and three timer/counters that can be used for controlling and monitoring equipment and measuring pulses and counting events. The DDI-160 sells for \$220. The company says that the system can be ex-

panded to hundreds of channels.

The DMI-110 costs \$220 and comes with a menu-driven demonstration disk. The firm also sells the DAISI/Notebook (\$895), an optional software package for data acquisition, control, and color graphics plotting.

For more information, contact Interactive Structures Inc., 218 Great Valley Parkway, Malvern, PA 19355, (215) 644-8877. Inquiry 575.

**Digital Signal Processor**

Based on the 16-/32-bit Texas Instruments TMS32010 processor, the Model 10 Digital Signal Processor is a coprocessor board for IBM PC, XT, AT, and compatible computers. The board is designed for applications in communications, instrumentation, and numeric processing. It also performs signal-processing functions such as filtering and FFTs.

The board is equipped with 8K bytes of dual-ported RAM, three 16-bit timers that provide sampling rates from .001 Hz to 200 KHz, a two-way 16-bit register for communications between the TMS32010 and the computer's processor, and interrupt capabilities between the two processors. An external I/O bus connector

handles data transfer to and from the board and permits the addition of A/D and D/A piggyback modules.

The signal processor is packaged with a debugger, in-line assembler, disassembler, signal-display software for the IBM Color Graphics Adapter, signal editor and waveform generator, and examples of applications such as spectrum analysis.

The price is \$750. Contact Dalanco Spry, 2900 Connecticut Ave. NW, Washington, DC, 20008, (202) 232-7999. Inquiry 576.

**HP Vectra Hard Disks**

Bering Industries introduced a series of internal hard-disk drives for the Hewlett-Packard Vectra. The series includes four models. The VKF-20 is a 20-megabyte hard-disk drive, and the VKR-10 is a 10-megabyte removable-cartridge drive. The VKF-20 provides 40 megabytes of storage by combining two 20-megabyte hard disks. The VKC-2010 combines a 20-megabyte hard disk and 10-megabyte removable cartridge.

All the drives have an average data-transfer rate of 145K bytes per second and an average seek time of 85 milliseconds. Each comes with a disk controller card, cables, and an installation manual. A 10-megabyte cartridge is included with all configurations that include removable-cartridge drives.

Prices are \$1150 for the VKF-20, \$1650 for the VKR-10, \$1850 for the VKF-2020, and \$2250 for the VKC-2010. Contact Bering Industries Inc., 1400 Fulton Place, Fremont, CA 94539, (415) 651-3300. Inquiry 577.

(continued)

# Choose your own colors with **COLOR COMMANDER™** pushbutton color control center

## The first peripheral of its kind



Suggested User Price \$359.00

## 16 color choices with your present color board and software

This exciting new peripheral expands the limited palette offered by your software or the IBM RGB color graphics system, to provide an *unrestricted choice* of the 16 IBM colors... and lets you see your changes as you go.

Just push two buttons, and COLOR COMMANDER changes any color your software has chosen to your choice of the 16 IBM colors. Relieve eye strain on monochrome programs; change white-on-black to a more legible black-on-white, or a soothing yellow-on-blue. On color programs, change dull to vibrant, repetition to variety. See your changes as you go, compare colors before-and-after, and re-do until you're satisfied.

The amazing new COLOR COMMANDER is easy to install and to use... and you'll use it constantly, to avoid eye-strain, and to make hard copies in the new colors. It simply hooks up between your IBM PC/XT/AT or compatible and the digital RGB color monitor, without requiring access into the computer. It electronically recodes the graphics adapter color information, pixel by pixel, and can change colors with *any* PC software, including PC Paint, Graphics Partner, Lotus 1-2-3, Wordstar, and even high-resolution CAE/CAD programs. You can use it with your screen shooter, plotter, color printer or film recorder.

Ask to try the revolutionary new COLOR COMMANDER wherever computer products are sold. Or write for free descriptive literature. But do it today and start getting the most from your color graphics system tomorrow.



1. Bring improvement, excitement and imagination to multi-color graphics

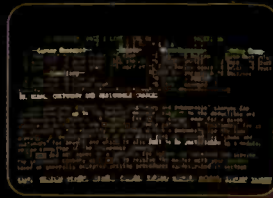

2. Add color to monochrome programs—even in high resolution—for improved legibility, less eye-strain

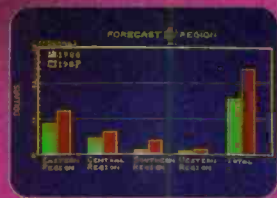
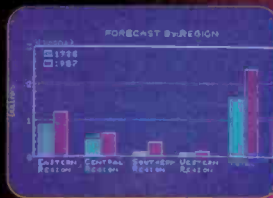

3. Add interest and variety to charts and graphs

## PERMA POWER Electronics Inc.

5601 West Howard Avenue • Chicago, Illinois 60648  
Telephone (312) 647-9414

\* PC Paint is a trademark of Mouse Systems Corporation; Graphics Partner is a trademark of Bright Bill Roberts and Company, Ltd; Lotus and 1-2-3 are trademarks of Lotus Development Corporation; Wordstar is a registered trademark of MicroPro Corporation; IBM is a registered trademark of International Business Machines Corporation.

## Pascal, C Tools for the Mac

**P**ascal Extender and C Extender are run-time libraries of routines aimed at simplifying Macintosh interface programming. They support most standard Toolbox commands and add new routines for making and manipulating windows, menus, scroll bars, and dialog and alert boxes.

Extender code uses Toolbox data structures, so all direct "in line" Toolbox calls remain supported and function normally. You can declare some windows as exceptions to be handled by your own routines, while others are handled by the Extender.

Pascal Extender for the Apple Macintosh Pascal interpreter (2.0) and the TML MacLanguage Pascal compiler costs \$69.95. C Extender for Megamax C and Manx Aztec C costs \$129.95. Contact Invention Software Corp., POB 3168, Ann Arbor, MI 48106, (313) 996-8108. Inquiry **578**.

## Symbolic Debugger

**S**oft Advances has recently announced DSD86, a full-screen symbolic debugging program for computers running MS- or PC-DOS. A windowing system lets you control the screen layout. Display types include instructions, registers, stack, memory, and source. You can also customize the keyboard interface; any command line can be bound to the Ctrl, Alt, and function keys. A recursive macro facility permits consistent extensions to the program's 45 commands.

Using source-level debugging, you can open one or more windows displaying current source files. All displays show addresses symbolically. If an address doesn't exactly match any symbols, the program finds the closest symbol and displays it with the offset from the target address. Among other features are single-keystroke stepping through source lines and procedures and the capability of having breakpoints set to a specific line number.

The list price of DSD86 is \$69.95. DSD87, a version for numerically intense applications, supports the 8087 coprocessor and has a window that shows all internal 8087 registers and flags; it sells for \$99.95. Contact Soft Advances, POB 49473, Austin, TX 78765, (512) 478-4763. Inquiry **579**.

## 8096 Simulator/Debugger

**C**ybernetic Micro Systems' Sim8096 enables you to debug 8096 code on an IBM PC, XT, or AT. The multiwindow display shows source code, registers, stacks, memory locations, timers, I/O ports, and pins, as well as documenting program flow. You can scroll through the source code without executing it, single-step through it, or run it until a breakpoint is hit.

Sim8096 has a feature that lets you embed I/O stimulus commands in the source code. I/O commands can also be input from the keyboard at any time. Internal structures such as the A/D converter, the UART, and various timers are accessible. The program also provides a summary display of the analog channels, HSIO registers, and interrupt count.

You can access all memory spaces using three modes: absolute, symbolic, and indirect. Another memory mode provides access to the special-function registers; a caption describes each register.

Commands use either single characters or control characters. (You use Ctrl-B to set a breakpoint, for example.) When parameters are required, the program issues a descriptive prompt.

Sim8096 sells for \$995 and is copy-protected. It runs under DOS 2.0 or later and needs 256K bytes of RAM. Contact Cybernetic Micro Systems Inc., POB 3000, San Gregorio, CA 94074, (415) 726-3000. Inquiry **580**.

## Tools and Routines for Turbo Pascal

**A** collection of analytical tools and library routines, Turbo Extender is designed to heighten the capabilities of Borland International's Turbo Pascal. The package's large code model lets you write modular programs using all 640K bytes of available PC-DOS address space without using overlays or chaining. All object code is loaded into memory at run time. Any procedure in any module can call any procedure in any other module, and procedures pass parameters using standard Pascal syntax.

Turbo Extender has utilities that automate use of the large code model. Shellgen converts existing overlaid programs into separate modules. Exporter checks calls made across module boundaries and

maintains structures needed for multimodule operation. Bigmake recompiles automatically only those modules that require it. And Buildexe can convert the object modules into a single standard EXE file.

Additional capabilities include a disk-cache toolbox, virtual data paging, and access to expanded memory for arrays of at least 2 megabytes or virtual arrays of as much as 32 megabytes.

Turbo Extender comes with complete source code and a 150-page manual. The price is \$85. You'll need Turbo Pascal version 3 and PC-DOS 2.0 or later. Contact TurboPower Software, 478 West Hamilton Ave., Suite 196, Campbell, CA 95008, (408) 378-3672. Inquiry **581**.

## COBOL Generator for CP/M Computers

**S**ourceView Software says its Interactive Cobol Generator for CP/M machines helps a programmer by reducing the time spent on the mechanical process of producing code. The software builds a prototype of the application being developed.

The generator runs under Ryan McFarland COBOL and can be used with a text editor. It has a full-screen editor for creating R/M COBOL screens and a data dictionary for maintaining definitions in documented form.

Interactive Cobol Generator sells for \$149.50. Contact SourceView Software International, 835 Castro St., Martinez, CA 94553, (415) 228-6220. Inquiry **582**.

(continued)

**NEW RELEASE**  
EVEN MORE FEATURES

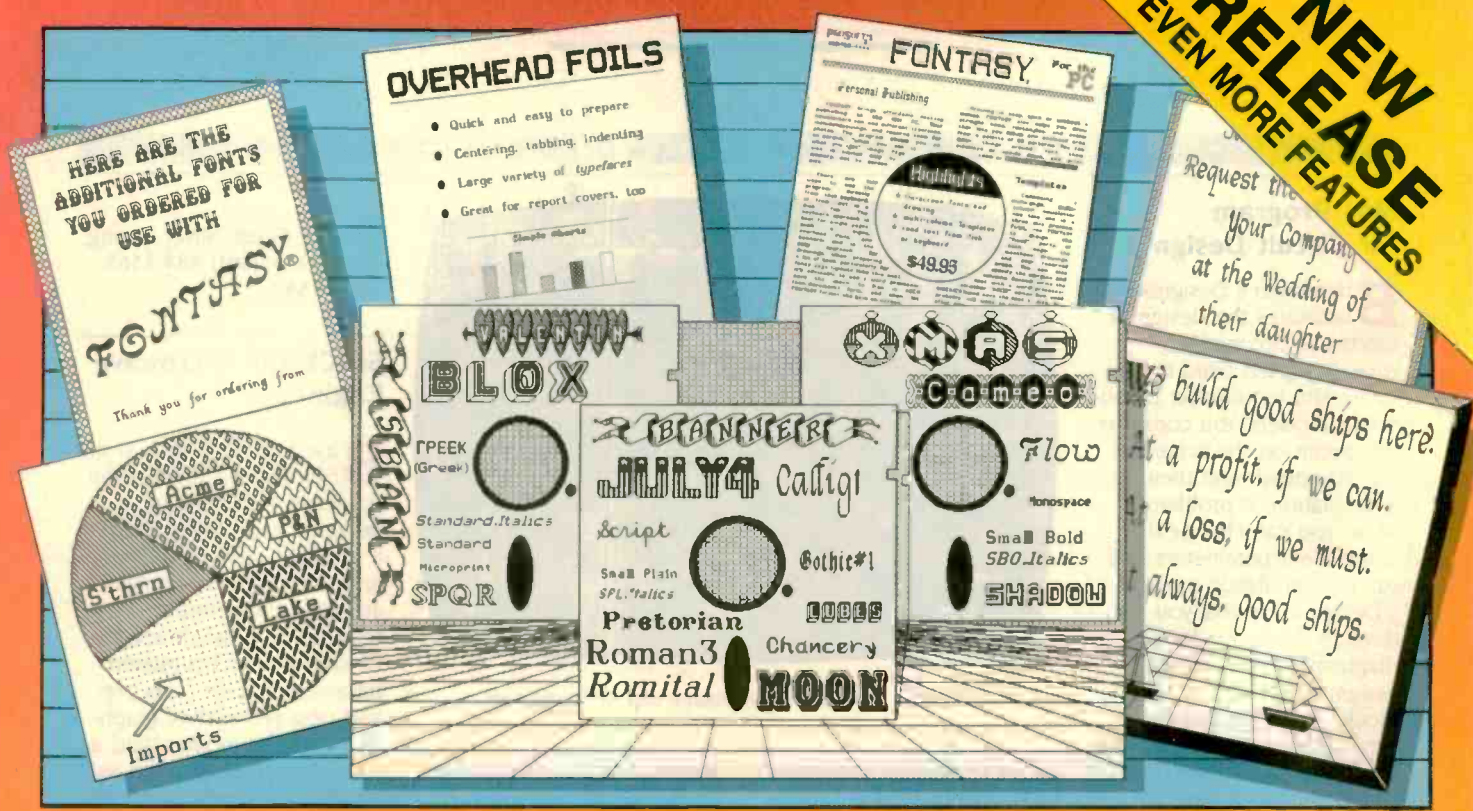

Fontasy printed all of these.

# See What You Can Do With

**P**resentations! Newsletters! Flyers! Signs! Overhead Foils! Invitations! Menus! Logos! Announcements! Banners! Layouts! When you need a goodlooking visual quickly you need FONTASY — superb typefaces and simple drawing in one easy-to-use package.

FONTASY gives you a "what-you-see-is-what-you-get" picture, as you type and draw on the graphics screen of your IBM-PC. You can create a page at a time, see a mini-picture of that page, print it, and save it on disk. Page size is limited only by memory, not by screen size.

## Features

Proportional space, justify, kern, bold-face, rearrange, magnify, black/white reversal, rotate, mirror image, lines, rectangles, ovals, draw, fill-in, undo (and un-undo), on-line help, 200-page book, and easy control from keyboard or mouse. Corporate licenses available.

FonTS, fonts, and more fonts! We have over 275 typefaces in our growing library, and will be happy to send you free print samples on request.

When you deal directly with the manufacturer (that's us), you pay rock-bottom distributor prices. If you order FONTASY now, we will give you 28 fonts (a \$50 value) at no extra charge. With so many features at such a low price, FONTASY belongs in your software library even if you already have a "font" program.



**\$69<sup>95</sup>**  
Includes 28 Fonts and free ClipArt.

## Equipment Needed

IBM-PC, XT, AT, or true compatible (Compaq, etc.) with IBM or Hercules graphics adapter and graphics monitor. 256K memory needed for partial pages, 448-640K recommended for full pages. Dot-matrix printer. Mouse optional. MS-DOS 2.00 or above.

FONTASY supports: IBM graphics printer, Proprinter, Epson FX, JX, LX, MX, RX, and LQ-1500; C. Itoh 8510, 1550, 1570, Pro-writer-Jr, H-P LaserJet, ThinkJet, Microline 92, 93; Gemini 10X, 15X; Radio Shack DMP 105-430, 2100; Toshiba 351, 1340-1351; Star; and most Epson-compatibles.

## Money-Back Guarantee

Fontasy is not copy-protected and has a 30-day money-back guarantee. So, take advantage of our breakthrough price and order now TOLL-FREE:

**1-800-824-7888, operator 669 (ORDERS ONLY)**

For further information and same day shipping, call: (818) 765-4444

**PROSOFT®**  
7248 Bellaire Ave., Box 560  
No. Hollywood, CA 91603-0560

Fontasy \$69.95

Tax \_\_\_\_\_  
Shipping \_\_\_\_\_  
Total \_\_\_\_\_

Name \_\_\_\_\_ Company \_\_\_\_\_  
Address \_\_\_\_\_ Telephone \_\_\_\_\_  
City, State, ZIP \_\_\_\_\_  
Visa/MC \_\_\_\_\_ Exp. Date \_\_\_\_\_  
Computer \_\_\_\_\_ Memory \_\_\_\_\_ Printer \_\_\_\_\_

Terms: M/C, Visa, checks. Please add \$3.00 shipping and handling in U.S. or Canada, \$20.00 overseas, \$2.00 for C.O.D., and sales tax in Calif.

## Mac Program for Circuit Design

**B**rainPower's DesignScope facilitates the design of electronic circuits by eliminating the need to construct and reconstruct bread-board models. You construct the circuit on the screen of the Macintosh and then run a simulation; if problems arise, you can change the component parameters and run the simulation again.

DesignScope lets you develop electronic block diagrams on the screen, assign parameters to the blocks, and then run the simulation of the system and watch the waveforms that result. You don't have to design component circuitry.

The program's available component blocks include phase-locked loops, analog switches, voltage-control oscillators, peak detectors, noise generators, flip-flops, multipliers, rectifiers, and log-exponential amplifiers.

DesignScope's suggested list price is \$249.95. Contact BrainPower Inc., 24009 Ventura Blvd., Suite 250, Calabasas, CA 91302, (818) 884-6911. Inquiry 583.

## Imaging Software

**T**he Imaging Toolkit, which runs on the IBM PC, XT, and AT, is a collection of tools for generating, processing, and displaying images. The library of functions, compatible with the Lattice C or Microsoft C version 3.0 compiler, includes image capture, contrast manipulation, convolutions, intensity transection, histograms, and others. Utilities are supplied for three-dimensional geometric transformations and ray-trace illumination models.

Functions supporting image-generation applications include three-dimen-

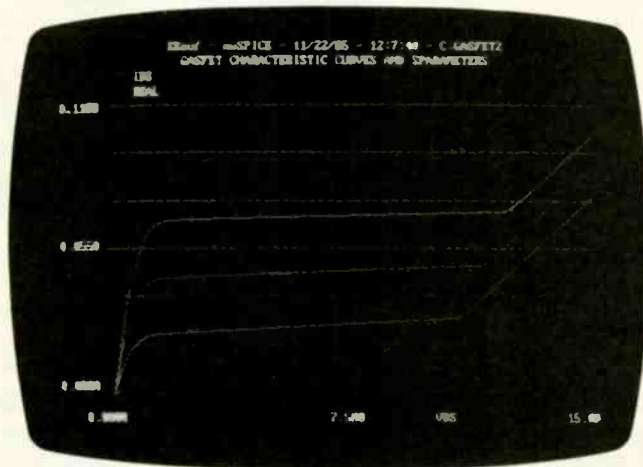

*Microwave SPICE, a package for microwave and RF applications.*

sional three-axis transformations and quadratic-surface intercept models. A utility called GENIMAG lets you project two-dimensional images in three-dimensional space from any viewpoint. Device-interface primitives are provided for pixel and raster setting, vector drawing, and so forth. The company claims that an FFT program called FFT87-2D can transform an array of 512 complex elements in 1.3 seconds.

Minimum requirements are 256K bytes of memory, one disk drive, an IBM-compatible graphics adapter, an 8087 coprocessor, and MS-DOS 2.0 or later. The Imaging Toolkit works with Tecmar's Graphics Master display adapter, Chorus Data Systems' PC-Eye, Microsoft's Mouse, and other hardware options. The price is \$799. Contact Rapid Imaging Software, POB 941, Tijeras, NM 87059, (505) 243-9454. Inquiry 584.

## Scientific Word Processor

**T**ech/Word is a word-processing program for scientists, mathematicians, and other people working

with technical text. Standard mathematical structures—sub- and superscripts, roots, matrices, fractions, etc.—are built into the package.

To input a built-up fraction, for example, you press a function key that sets up a one-character-wide fraction, with a blank denominator and numerator. You then insert the numbers; the program draws the fraction line, centers the numerator and denominator, and adds space if needed. If you edit the fraction, the software automatically adjusts the format. In a similar way, matrices, square roots, and parentheses expand to accommodate the figures within them. Because the program treats math expressions as units, you can insert and delete text in multi-level lines without fouling up the format.

The package runs under MS-DOS 2.0 or later and needs 256K bytes of RAM and two disk drives. It works with the IBM Color Graphics Adapter, the IBM Enhanced Graphics Adapter, and the Hercules display adapter; it also works with IBM's monochrome adapter but doesn't show custom fonts. Tech/Word retails for \$350. A demo is \$30. Contact Goldstein Software Inc., 2

Redgate Court, Silver Spring, MD 20904, (301) 384-5565. Inquiry 585.

## SPICE for Microwave Engineers

**B**ased on version 2G6 of SPICE developed at the University of California at Berkeley, Microwave SPICE is a program capable of dc, time, or frequency-domain analysis. The software relates active device characteristics to process-related parameters. It includes pre- and post-processors, graphics, electrical models, and a user interface described as suited to microwave and RF applications.

Microwave SPICE can read a Touchstone (EEsof's linear circuit-design program) circuit file as well as a regular 2G6 file. After you provide model parameters of the device and specify the analysis function desired, the program reads in the circuit descriptions and runs the analysis.

Models ranging from a transistor to complex networked elements are examined in terms of their S-parameters. Elements can be extracted for dc and temperature analysis, and Y-parameters can be isolated and extracted. If you specify physical and electrical characteristics, the program will predict the circuit's performance under different operating conditions.

Microwave SPICE can be used alone or with other EEsof packages. It runs on the IBM PC and compatibles and requires 640K bytes of RAM. Retail price is \$8400; volume discounts are offered. Contact EEsof Inc., 31194 La Baya Dr., Suite 205, Westlake Village, CA 91362, (818) 991-7530. Inquiry 586.

*(continued)*

# Dac-Easy Accounting "Best Software Value"

InfoWorld  
1985 "Product of the Year" Awards



Dac-Easy "Accounting Product of the Year"

PC World  
December, 1985

70,000 and more every day. That's how many smart buyers have already streamlined their accounting with the fastest-selling, most highly praised accounting package ever introduced.

Dac-Easy offers seven full feature accounting modules in a perfectly integrated package, with instant access to:

- General Ledger
- Accounts Receivable
- Accounts Payable
- Forecasting
- Inventory
- Purchase Order
- Billing

You can generate over 300 reports from 80 different routines. And best of all, Dac-Easy Accounting can be used to manage either service- or product-based businesses.

Dac-Easy Accounting is non copy-protected, and comes in a handsome package with easy-to-follow documentation.

Read what the experts have to say. Compare Dac-Easy with packages sold module by module for *thousands* more. Then join more than 70,000 people who have said "Yes!" to Dac-Easy Accounting.

### 30-day money back guarantee

Dac Software offers an unconditional guarantee on Dac-Easy Accounting (less postage and handling). There is a \$10 restocking fee if the disk envelope is opened.

**Minimum Hardware Requirements:**  
IBM (PCjr, PC, XT or AT) or other compatibles. (Also available for Apricot and Victor 9000.) 128K memory, one DSDD disk drive, 132 column printer in compressed mode, 80X24 CRT, MS-DOS<sup>2</sup>, PC DOS<sup>1</sup> 2.0 or later.

<sup>1</sup>Trademarks of International Business Machines Corp.  
<sup>2</sup>Trademark of Microsoft Corp.

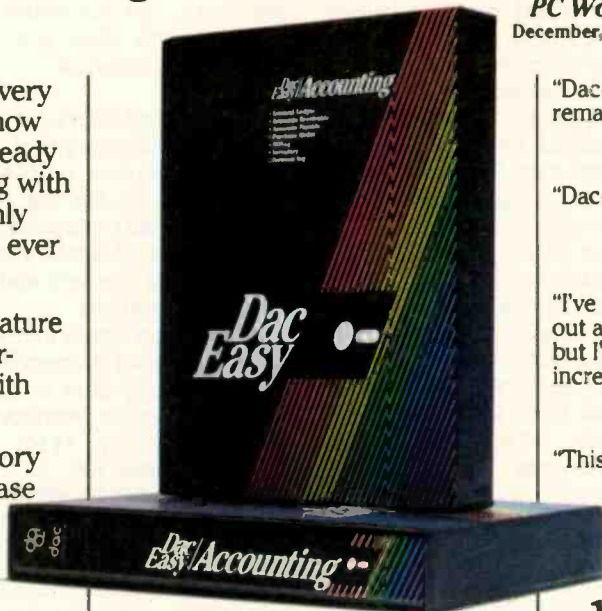

# \$69.95

**NEW!**

Dac Easy Payroll™

ONLY

# \$49.95

Dac-Easy Payroll was designed to solve all your personnel and payroll management problems, outperforming systems costing thousands more. And it can either stand alone or integrate perfectly with Dac-Easy Accounting to form a comprehensive business management program. Features include:

- Built-in 1986 federal and state tax tables (all 50 states)
- Automatic federal, state and city withholding calculations.
- FICA and user-defined deductions like union, insurance, etc.
- Prints continuous form checks and W-2s.
- Up to 99 departments, with earning and deduction codes per department.
- Manages hire dates, raises, reviews, terminations, vacations and sick time.
- Generates complete range of management reports.
- Supports hourly and salaried employees, four different payroll periods, tips, piece-rate and after-the-fact payroll, and much, much more!

All for only \$49.95...with the same money back guarantee!

\*Hardware requirements — same as Dac-Easy Accounting, except two DSDD floppy disks require.

"Dac-Easy has done something truly remarkable."

InfoWorld Editorial,  
December 2, 1985

"Dac-Easy is a genuinely amazing deal!"  
PC Magazine,  
October 15, 1985  
"Editor's Choice"

"I've never before in a review come right out and told readers to buy a product, but I'm doing it now. Dac-Easy is an incredible value."

PC Week,  
August 27, 1985

"This is an incredibly good value."  
InfoWorld,  
September 23, 1985

Call toll free or  
return coupon below today

# 1-800-992-7779

Ask for operator #827

In Texas or  
for more information call  
214-458-0038

☎ dac software, inc.  
4801 Spring Valley Rd., Building 110-B  
Dallas, TX 75244

Please rush me \_\_\_\_\_ copies of Dac-Easy Accounting at \$69.95 per copy and \_\_\_\_\_ copies of Dac-Easy Payroll at \$49.95 per copy. I've enclosed \$7.50 postage and handling. In Texas, add 6 1/2% sales tax (\$4.28 for each Accounting, \$3.06 for each Payroll). U.S. prices only. Please indicate computer brand \_\_\_\_\_

- Check     Money Order  
 AMEX     VISA     MASTERCARD

Expires \_\_\_\_\_

Account Number \_\_\_\_\_

Name \_\_\_\_\_

Company Name \_\_\_\_\_

Street Address \_\_\_\_\_

City \_\_\_\_\_

State \_\_\_\_\_ Zip \_\_\_\_\_

Phone \_\_\_\_\_

Signature \_\_\_\_\_

CALL 1-800-992-7779 FOR  
IMMEDIATE RESPONSE

Series™

#827

## Outliner for Apple IIe/IIc

**T**hinkWorks, designed to be used alone or with AppleWorks, is an outline processor for the Apple IIe and IIc. Besides letting you build, rearrange, and expand and collapse outlines, the package allows you to search and replace text, enter paragraphs for any entry, and merge one outline into another. With the AppleWorks word processor, you can insert an outline into another document.

To run the software on a IIe, you need an extended-memory 80-column card. The program works with Apple's Profile and UniDisk 3.5 and Quark's Catalyst. It retails for \$125. Contact Megahaus Corp., 5703 Oberlin Dr., San Diego, CA 92121, (619) 450-1230. Inquiry 587.

## XENIX Work-alikes of Lotus 1-2-3, dBASE

**T**he Santa Cruz Operation has developed UNIX-based versions of two popular DOS applications: SCO Professional, described as a Lotus 1-2-3 work-alike, and SCO FoxBASE, similar to Ashton-Tate's dBASE II.

SCO Professional integrates spreadsheet, database, and graphics capabilities. It can read 1-2-3 files, and it regenerates DOS-readable data. The company says enhancements to standard 1-2-3 include 256 query fields in the database, larger worksheet space, and character preview graphics on any terminal. UNIX utilities can be chosen from a menu. The program lists for \$795 and runs on IBM's PC AT and compatibles and AT&T's PC 6300 Plus.

SCO FoxBASE functions like dBASE II and is compatible with it in terms of

language and data files. It can run dBASE programs in multiuser mode without modification. FoxBASE permits as many as 48 fields per record, provides 14-digit precision in computations, and supports the 8087 and 80287 coprocessors. You can convert dBASE files to FoxBASE by rebuilding the index files. SCO says the resultant index files are typically 50 percent smaller than dBASE's. FoxBASE, written in C, lists for \$795 and runs on the same machines as SCO Professional.

Contact The Santa Cruz Operation, 500 Chestnut St., POB 1900, Santa Cruz, CA 95061, (408) 425-7222. Inquiry 588.

## Low-Cost Spreadsheet with Word Processor

**I**nterface Technologies has packaged a spreadsheet, described as similar to Lotus's 1-2-3, with a full-function word processor and priced it at \$99.95. Called Farsight, the program runs on the IBM PC line and true compatibles.

Farsight's window environment lets you have multiple documents or spreadsheets on the screen. ITC says there's no limit to the number of windows that may be open. Data can be copied between documents with as few as six key-strokes.

You can use 1-2-3 data files with Farsight Calc

without learning any new commands. The spreadsheet/data manager uses a sparse-matrix technology similar to that used in 1-2-3 release 2.0, lets you search for values and labels, and incorporates pop-down menus.

Farsight Word offers full editing capabilities, global search and replace, proportional and micro spacing, and page breaks indicated on the screen. It works with many spelling checkers and dictionary programs.

The software needs at least 256K bytes of memory and dual floppy disks or a hard disk. Contact Interface Technologies Corp., 3336 Richmond, Suite 200, Houston, TX 77098, (800) 922-9049 or (713) 523-8422. Inquiry 589.

## Accounting Package for the Macintosh

**B**PI Systems has tailored its General Accounting package from the BPI Entry Series for the Apple Macintosh. The software provides three subsidiary ledgers: accounts payable, accounts receivable, and payroll. It also offers a chart of accounts, six journals plus a general ledger for recording each transaction, default options, automatic check writing, and comprehensive financial reports.

General Accounting for the Macintosh is priced at \$425. Contact BPI Systems Inc.,

3001 Bee Cave Rd., Austin, TX 78746, (512) 328-5400. Inquiry 590.

## Program Lets Distant Users Work Together

**A**merican Video Teleconferencing's In-Synch lets two people separated by distance work with the same program as if they were in the same room. This package runs on IBM PCs or compatibles connected by modem over ordinary phone lines, and two users can collaborate as if looking at one screen and sharing a keyboard.

In-Synch, which resides in memory, lets both keyboards send commands or insert data into a program that's been loaded into each computer. Both displays show the same thing. If only one machine is running In-Synch, conferencing is still possible with a snapshot feature that lets you capture text or graphics and send it to your partner. (Snapshots can be saved to disk at any time.)

Users can also type comments anywhere on the shared screen. And the program automatically records any important conference transactions.

In-Synch, which also provides some conventional communications functions such as auto-dialing and file transferring, runs under DOS 2.0 or later and requires that each computer have at least 384K bytes of RAM (the company recommends 640K) and a Hayes-compatible modem. It works with Hercules graphics adapters and IBM Color, Monochrome, and Enhanced Graphics Adapters. The price is \$149.95. Contact American Video Teleconferencing Corp., 110 Bi-County Blvd., Suite 115, Farmingdale, NY 11735, (516) 420-8080. Inquiry 591.

## WHERE DO NEW PRODUCT ITEMS COME FROM?

*The new products listed in this section of BYTE are chosen from the thousands of press releases, letters, and telephone calls we receive each month from manufacturers, distributors, designers, and readers. The basic criteria for selection for publication are: (a) does a product match our readers' interests? and (b) is it new or is it simply a reintroduction of an old item? Because of the volume of submissions we must sort through every month, the items we publish are based on vendors' statements and are not individually verified. If you want your product to be considered for publication (at no charge), send full information about it, including its price and an address and telephone number where a reader can get further information, to New Products Editor, BYTE, 70 Main St., Peterborough, NH 03458.*



# PCturbo

ORCHID

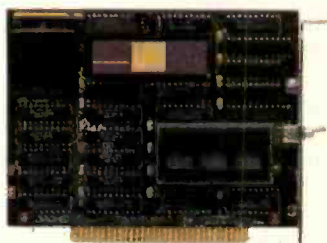

**TinyTurbo 286 — \$695**  
**AT Speed In a Half Slot**  
**The People's Choice**

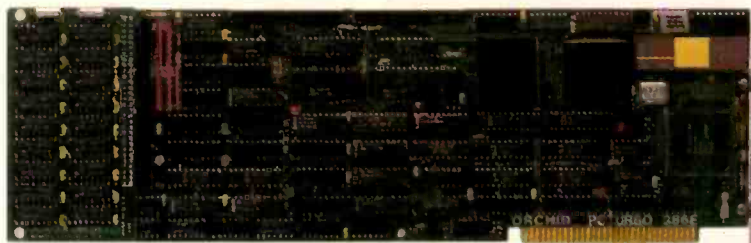

**PCturbo 286e — \$1195**  
**Double AT Speed In a Full Slot**  
**The Super-Achiever's Choice**

## BE #1 WITH THE LEADER

### Two Breakthroughs to TURBOCHARGE Your PC!

Orchid became the #1 Turbo company by delivering the performance, price, and compatibility you wanted. Now we have followed our critically-acclaimed PCturbo 186 with two powerful new 8MHz 80286 Turbos.

#### TinyTurbo 286

A half-slot PC/XT caching accelerator for AT speed at a tiny cost. It's 100% PC compatible, even with copy-protected software, because you can switch back to the 8088 — a feature our competitors wish they had.

#### PCturbo 286e

A full-slot PC/XT/AT coprocessor. Twice the speed of an AT; 5 times that of a PC for lightning calculations, dazzling screens, and unbelievable performance. A Megabyte of RAM, optional

EMS memory, and free RAM Disk, Caching, and Print Spooling. Now your PC can wait on you instead of the other way around.

#### Applications:

- ▲ Windows: No longer do you need an AT to make it fly.
- ▲ Math: Crunch through computations with 8MHz 80287 power.
- ▲ Spreadsheet: Load and recalculate with amazing speed.
- ▲ CAD: Redraw, zoom, and pan in a flash.
- ▲ Database: Run lengthy updates on Friday rather than all weekend.
- ▲ EMS: Supports Lotus specification.

Norton SI Program V3.0

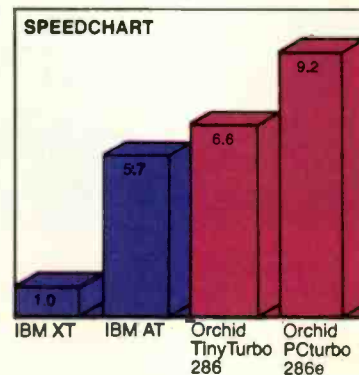

**Choose TinyTurbo 286**  
 If you would like AT speed.

**Choose PCturbo 286e**  
 If you demand the ultimate in performance.



47790 Westinghouse Dr.  
 Fremont, CA 94536  
 415/490-8586  
 Tlx: 709289

The Innovative Leaders

PCturbo 286e and TinyTurbo 286 are trademarks of Orchid Technology. All other products names are trademarks of their manufacturers.

## LOOKING FOR AT PERFORMANCE FROM YOUR PC?



### EARTH HAS IT FOR LESS THAN \$1,000!

**YOUR SEARCH IS OVER!! EARTH COMPUTERS'** exciting new high-speed, 80286 accelerator card, **TurboACCEL-286™**, is just what you've been looking for. The **TurboACCEL-286** will boost your PC performance up to **Five times...** its completely software transparent...and its only **\$995!** **TurboACCEL-286** will function with most operating systems and application programs (unlike other so-called accelerator boards).



The **TurboACCEL-286** features a high-speed, 8MHz, 80286 processor, 512Kbytes of RAM (expandable to 1Mbytes), a switch for 8088 operation, and facilities for an 80287 math coprocessor. It occupies one expansion slot, is completely compatible with most PCs and is software transparent. **End your search for AT performance. Order the TurboACCEL-286 today! Call or write:**



**EARTH COMPUTERS**

P.O. Box 8067, Fountain Valley, CA 92728  
TELEX: 910 997 6120 EARTH FV

**(714) 964-5784**

Ask about **EARTH COMPUTERS'** other fine PC and S-100 compatible products.

# C·L·U·B·S A·N·D N·E·W·S·L·E·T·T·E·R·S

**SOFTWARE MAINTENANCE NEWS**, Nicholas Zvegintzov, 141 St. Marks Place #5F, Staten Island, NY 10301, (718) 816-5522. Annual subscription: \$15.

**VENTURA PCjr USER'S GROUP**, c/o Entré Computer Center, 4738-1 Telephone Rd., Ventura, CA 93003. Monthly newsletter and meetings, hopes for a Fido BBS.

**APL MARKET NEWS**, POB 2485, Secaucus, NJ 07094. Published quarterly. Annual subscription: \$15.

**MILWAUKEE APPLE USERS SYMPOSIUM (MAUS)**, Dick Stevens, Rt. 6, S79-W30979 Romeo Court, Mukwanago, WI 53149, or call Jeanne Colburn at (414) 781-9640. Monthly newsletter and meetings, SIGs, public-domain library. Annual dues: \$12.

**MACINTOSH MEETING AND DRINKING SOCIETY (MACMAD)**, 514 North Wickham Rd. #150, Melbourne, FL 32935. BBS, monthly meetings and newsletter, public-domain software library. Annual dues: \$20.

**CONCURRENT USERS GROUP (CONUG)**, Garry Silvey, POB 734, Marina, CA 93933. Monthly newsletter, public-domain software library. Annual dues: \$25.

**UCLA MICROCOMPUTING**, University of California-Los Angeles, Office of Academic Computing Microcomputer Support Office, 5628 MSA, Los Angeles, CA 90024, (213) 825-8183.

**TI-WEST**, Fred Russo, 2021 Ocean Ave. #126, Santa Monica, CA 90405, (213) 392-3217. Public-domain software and information exchange for Texas Instruments users. Meetings and newsletters.

**DENVER AREA SANYO USERS GROUP**, Don Robertson, 1210 Saulsbury St., Lakewood, CO 80215, (303) 232-6955. Monthly meetings for 550/555 users only, \$15 annual fee includes monthly newsletter.

**WORD PROCESSING USERS' GROUP (W/PUG)**, Box 144, Malverne, NY 11565, (516) 746-0056. Bimonthly newsletter, public-domain software library, BBS. Annual membership: \$15.

**COMMODORE ASSOCIATION OF THE SOUTHEAST (CASE) Inc.**, Bill Freeman, POB 110386, Nashville, TN 37211, (205) 854-3496. Regional board organizes Commodore users groups. Annual meetings, quarterly news on disk, \$25 annual dues.

**QUAD CITY OSBORNE GROUP (QCOG)**, R. H. Lay, POB 2456, Davenport, IA 52809, (319) 386-3484. Meetings, newsletters, and 24-hour BBS. Annual dues: \$30.

**TIMEX SINCLAIR AMATEUR RADIO USERS GROUP (TSARUG)**, Alexander Burr, K5XY, 2025 O'Donnell Dr., Las Cruces, NM 88001. Fido network at (505) 646-5194, monthly journal, \$12 annual dues.

**HP SERIES 80 USERS GROUP**, Rainer Kroos, Hasenweg 14, D-4817 Leopoldshöhe, West Germany. Correspondence with American Hewlett-Packard users welcome.

**BALTIMORE USERS GROUP (BUG)**, POB 567, Owings Mills, MD 21117-0567. For users of IBM PC-compatibles. \$10 annual dues includes newsletter.

**EPSON INTERNATIONAL USERS GROUP**, 25, Sawyers Lawn, Drayton Bridge Rd., London W13 0JP, England. Public-domain software, BBS, and newsletter.

**C USERS GROUP**, Leon Heller, 8 Morris Walk, Newport Pagnell, Buckinghamshire MK16 8QD, England. Send self-addressed envelope for details.

**THE BOSTON CENTER FOR COMPUTER APPLICATIONS**, 334 Newbury St., Boston, MA 02115, (617) 247-0538. Newsletter, services for business users.

**DVORAK DEVELOPMENTS**, Freelance Communications, POB 717, Arcata, CA 95521, (707) 826-0102. News about the Dvorak keyboard. \$12 annually. ■

**CLUBS AND NEWSLETTERS** is an acknowledgment of new clubs and newsletters received at BYTE. Please allow at least four months for your club's mention to appear. Send information to BYTE, Clubs and Newsletters, POB 372, Hancock, NH 03449.

**STANDARD**  
BRAND PRODUCTS

**STD-AT**



IBM® PC-AT™  
COMPATIBLE  
COMPUTING  
AT AN  
AFFORDABLE  
PRICE...

- Intel 80286 Processor
- MS DOS 3.1 Included
- 640K RAM On Mother Board
- 1.2 MB Floppy Drive
- Dual Floppy & Hard Drive Controller
- Clock/Calendar With Battery Back-Up
- Optional 80287 Math Co-Processor Available

**\$1699**

- ✓ Compatible
- ✓ Full Documentation
- ✓ Reliable
- ✓ Extended Burn-In Testing

**STANDARD** PC/XT

**STANDARD** Turbo-XT

- Intel 8088-3 (4.77 MHz)
- STD-5150 Keyboard
- 1-Half-Height Floppy Drive
- 640K Ram
- 135 Watt Power Supply
- 8 Expansion Slots



- Intel 8088-2 (4.77 or 6.66 Mhz)
- Keyboard Selectable Clock Speed
- Up To 40% Faster Processing Speed
- STD-5160 AT Style Keyboard
- 640K Ram
- One Half-Height Floppy Drive
- 8 Expansion Slots

**\$629**

*"Runs Major Software Written For  
The IBM® PC & XT"*

**\$729**

All Standard Brand  
Products Carry A  
1 Year Warranty!

**PC  
SOURCE**



CALL TOLL FREE:  
800-626-4027  
Outside Texas  
512-331-6700  
Inside Texas

12303-G Technology Austin, TX. 78727

# Setting The Import Standard!!

**STANDARD**  
BRAND PRODUCTS

Enhancement Products For  
The IBM® PC Market...

**STANDARD MFC w/384K**

Multifunction Card



- 384K Ram
- Clock/Calendar
- Serial Port
- Parallel Port
- Game Port
- Software

**\$129**

**STANDARD MonoGraphic Card**

Hercules® Compatible Monochrome Graphics Card



- Text Mode 80X85 Characters
- Graphics Mode 720X348 Pixels
- Parallel Port

**\$119**

**FDC**

Floppy Disk Controller

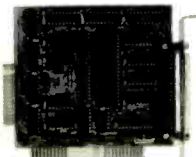

Controls Up to  
4 Floppy Disk.  
Includes Internal Cables. .... **\$49**

**5151 Keyboard**

For The IBM® PC or XT



With Separate  
Numeric And  
Cursor Keypad ..... **\$99**

**AT-MFC**

Multifunction Card for IBM AT



Up To 1.5 MB  
Memory Expansion.  
Serial & Parallel  
Port for IBM AT... w/OK **\$189**

**Power Supply**

150 Watt



Replacement  
Power Supply ..... **\$85**

**Monitor**

Monochrome Monitor



12" Amber Screen  
80X25 Lines  
720X350 Pixels. .... **\$99**

**I/O**

I/O Board



Serial Port,  
Parallel Port &  
Clock/Calendar ..... **\$99**

**ColorCard**

Color Display Card



ColorCard  
w/Parallel Port ..... **\$99**

**MonoCard**

Monochrome Display Card



MonoCard  
w/Parallel Port ..... **\$89**

**PowerMaster  
AC Center**

Three Important Functions  
In One Unit!

**\$89**



4 Separate Power Outlets With  
On/Off Switch On Front Panel

Surge Suppressor

Swivel Base Monitor Stand

No Charge For UPS Ground  
Shipping. No Surcharge For  
MasterCard or VISA. Fortune 1000  
Purchase Order Welcome.  
Warranty Work Requires Proof-  
of-Purchase And Return  
Authorization Number.

IBM and Hercules are trademarks  
of their respective companies.

**PG  
SOURCE**

12303-G Technology Austin, TX. 78727



CALL TOLL FREE:  
**800-626-4027**  
Outside Texas  
**512-331-6700**  
Inside Texas

# F·I·X·E·S A·N·D U·P·D·A·T·E·S

## BYTE'S BUGS

### Repairs to Robotics Articles

In editing "Autonomous Robot Navigation" by Charles Jorgensen, William Hamel, and Charles Weisbin (January BYTE, page 223), we inadvertently added a few errors and omitted a reference. These corrections relate to the text box "Sonar Sensors" on pages 230-231.

First, figure A4 represents an answer to the problem of sonar's low angular resolution rather than representing the problem itself. The figure shows the sonar analog of binocular vision.

Second, in the actual distance formula in table A, the  $D_r$  and the equal sign are

reversed. The proper formula is

$$\text{Actual Distance} = D_r \sqrt{A_r / S_r}$$

Third, figure A, table A, and the associated text are drawn from H. R. Everett's article "A Multielement Ultrasonic Ranging Array," which appeared in the July 1985 *Robotics Age* (page 13). Mr. Everett's article was cited in the references at the end of "Autonomous Robot Navigation," but the citation of the reference was not included in the article itself.

A slight typo appears in listing 1 of "AI in Computer Vision" by John L. Cuadrado

and Clara Y. Cuadrado (beginning on page 237). On page 245, in the line preceding the comment that PDPROLOG does not support floating-point math, cylinder should have an uppercase C.

And finally, in Kirk E. Pennywitt's "Robotic Tactile Sensing" (beginning on page 177), the definition on page 200 of a newton is slightly flawed. As Keith J. Lavalley of East Hampton, Connecticut, pointed out to us, the correct definition is: 1 newton equals 1 kilogram meter/second squared.

Our apologies to readers and writers.

### More on "Arithmetic"

Surry P. Everett, a reader in Bath, North Carolina, encountered a few problems while working with Peter Rice's "Arithmetic on Your PC" (March 1985, page 119). He points out that dividing a number by itself (25/25) results in an error (illegal function call) at line 11070 of listing 1 because N, used as a subscript, is less than zero. Mr. Everett suggests the following code change, which Mr. Rice agrees works:

```
11070 WHILE Z%(N)=0:IF N=0
      THEN GOTO 11080 ELSE
      N=N-1:WEND
```

Two similar errors appear at lines 13370 and 13630 if a single-digit divisor (25/5) is used. Mr. Everett suggests the following:

```
-Add a line: 13365 IF Y%(100)=0
              THEN GOTO 13400
```

```
-Delete line 13640
```

```
-Change a line: 13650 IF BX=0
                 THEN GOTO
                 13670 ELSE
                 BX=BX-1
```

According to reader Everett, these changes will work in all situations of non-negative integers, excluding a divisor of zero.

Mr. Rice says the only other problem he is aware of is in the assembler listing. People who downloaded LONGMATH.ASM can fix it by replacing JLE LABEL3 with JBE LABEL3 in the division procedure.

### Four Little Steps Move 520ST Files

Our product description of Atari's 520ST (January, page 84) made the process of moving a file out of a folder, explained on page 99, sound more complicated than it really is. To move a file, open the folder

(which indeed takes over the disk window). Open the same disk again (which gives you an additional window of the disk). Copy the file from the folder to the disk window. Delete the file in the folder. Ta da.

### SIMPL Name Already Claimed

Jonathan Amsterdam's three-part Programming Project that began in the December 1985 issue concerned a compiler that he named SIMPL. We've since received a letter from James E. Bernstein advising us that SIMPL is the copyrighted name of a high-level language and compiler developed and used by his company, General Health (in Washington, D.C.).

Mr. Amsterdam replies that he did a cur-

sory search of computer science literature before adopting the name. Some people at the University of Maryland had used it, but they did not object to him doing likewise. "My high-level language was constructed for purely pedagogical purposes," he writes. "It will probably never be mentioned again in print after the last installment of the project, and it certainly will not evolve into a product."

### How to Access and Use BYTENet Listings

To access BYTENet Listings, call (617) 861-9764. When you get the carrier tone, enter two or three carriage returns so that our software can determine your operating parameters.

Optimum modem settings are 8 bits, 1 stop bit, and no parity at full duplex, or 7 bits, 1 stop bit, and even parity at half duplex. Acceptable operating speeds are 300 or 1200 bps. At this time, BYTENet Listings does not sup-

port 2400-bps transmissions.

The BYTENet Listings software itself is menu-driven. Programs may be downloaded using ASCII, Kermit, Tele-Link, and XMODEM protocols.

BYTE listings are also available on BIX. After connecting with the system, type join listings at the main prompt. (For more information on BIX, phone (800) 227-2983 between 8:30 a.m. and 11:00 p.m. Eastern time, weekdays.)

Conducted by Steve Ciarcia

## COMMUNICATION PROBLEM

Dear Steve,

I have an old Apple parallel printer interface card (vintage 1978) that I wish to use with an Epson MX-80 printer. Handshaking is by two lines: an STR (strobe) to the printer and an ACK (acknowledge) from the printer. A jumper block is used on the card for the various polarity configurations of ACK and STR, and I have it set for a negative-going STR and ACK for the Centronics interface. But the printer and the Apple II refuse to talk to one another through this arrangement.

I note that the printer (and the current Centronics interface) has provision for three handshaking lines and uses them: STR, ACK, and a BUSY line from the printer. Is it possible to hook up the Epson MX-80 to the parallel card, which has no obvious provision for a BUSY input from the printer?

I am enclosing parts of the *Installation and Operating* manual, which you may find useful in helping me.

ALBERT WEINSELBAUM  
Martinez, CA

*The diagram on page 9 of the printer manual shows the correct configuration for the jumper block. A negative STR and an ACK signal are the only ones used for handshaking—BUSY isn't used. Your problem is undoubtedly in one of three areas: a bad interface card, a nonfunctioning printer, or a defective cable connecting the printer with the interface card.*

*The best method for solving the problem depends on the resources available to you. Nearby friends with compatible computer equipment can simplify the process considerably by providing equipment to substitute for existing peripherals. If that is impractical, your best course may be to contact your dealer.*

*You can isolate the problem by executing these three steps in any order:*

1. Exchange the connecting cable with a known good one. A functional system indicates that the original cable was defective.
2. Replace the printer card with a known good printer interface card, using the

*same cable you are currently using (if possible). If the setup works, the problem is in the Apple printer card.*

3. Substitute a known good printer for the current one. If it works, the problem is in your printer.—Steve

## APPLE DECODING

Dear Steve,

I want to use an EPROM-based card in slot 5 of my Apple II that requires approximately 1500 bytes of memory. Can you give me details of an addressing circuit that would accomplish this?

RAY RUSEL  
San Jose, CA

*Pin 20 on the Apple bus is active low for a 2K-byte address range: C800-CFFF hexadecimal. This is the common ROM space that is shared by all peripheral slots in the Apple. Pin 20 on slot 5 could be used to enable a 2K by 8 EPROM like a 2516 or 2716. No further address decoding is necessary.*

*A good source of information on the built-in decoding of the Apple IIe is Understanding the Apple IIe by James Sather (Brady Communications).—Steve*

## HARD DISK ON A TRS-80

Dear Steve,

I want to connect a 5-megabyte Seagate Technology ST506-type drive to my TRS-80 Model 4P. I would appreciate any information you have on interfacing a hard disk to a TRS-80 and prices for a SASI interface.

I have been programming in assembly language for two years, so I would be able to write custom software drivers for the unit. Since I understand only the rudiments of electronics, I would be able to make a hardware interface only if it is not overly complex.

ED GRIEBEL  
Rochester, NY

*Hard Drive Specialist sells a 5-megabyte hard-disk system for the TRS-80 Model I, III, 4, or 4P computers. The basic unit, called the HDS I, is a complete system that includes its own case and a power supply. A second drive can be added to the HDS I, giving a total capaci-*

*ty of 5, 10, 15, or 30 megabytes. All necessary device drivers are included with the unit, making the HDS I compatible with the DOSPLUS, LDOS, and TRSDOS 6.0 operating systems. For additional information and prices, contact Hard Drive Specialist, Compukit Division, 16206D Hickory Knoll, Houston, TX 77059. (713) 480-6001.*

*A SASI interface for the Radio Shack computers, including the 4P, is available from Micro Mainframe, 11285-E Sunrise Gold Circle, Rancho Cordova, CA 95670. If you decide to use a SASI interface, keep in mind that SASI-compatible drives tend to be more expensive than an ST506-type drive due to the added cost of the disk-controller hardware built into the drive.—Steve*

## SIEVE OF ERATOSTHENES

Dear Steve,

Perhaps the greatest service BYTE magazine has provided is its publishing of simple benchmark programs. I have run them many times to test hardware and software against published results before spending project and personal funds.

However, after years of personal bewilderment and after asking all my knowledgeable friends, I am finally writing to you and admitting my ignorance. Where did the Sieve of Eratosthenes come from? Is it some classic mathematical joke that I missed in my engineering education? It's a good benchmark program, but it's terri-

(continued)

IN ASK BYTE, Steve Ciarcia answers questions on any area of microcomputing. The most representative questions received each month will be answered and published. Do you have a nagging problem? Send your inquiry to

Ask BYTE  
c/o Steve Ciarcia  
POB 582  
Glastonbury, CT 06033

Due to the high volume of inquiries, personal replies cannot be given. All letters and photographs become the property of Steve Ciarcia and cannot be returned. Be sure to include "Ask BYTE" in the address.

The Ask BYTE staff includes manager Harv Weiner and researchers Larry Bregoli, Bill Curlew, Jeannette Dojan, Jon Elson, Roger James, Frank Kuechmann, Edward Nisley, Dick Sawyer, Andy Siska, and Robert Stek.

# MARK WILLIAMS' C SOURCE DEBUGGER

Those who insist on C compiler performance  
are very big on Mark Williams.

And the compiler is just part of our total C Programming System.

## NEW 3.0 ENHANCEMENTS

These and other powerful utilities now included in the C Programming System:

- make: compiles only what's necessary from multiple modules, a powerful programming discipline
- diff: identifies differences between two files
- m4: macroprocessor expression editing and substitution
- egrep: extended pattern search
- MicroEMACS: full screen editor with source

## COMPILER FEATURES

- Runs under MS-DOS
- Full Kernighan & Ritchie C with recent extensions including void and enum
- Register variables for fast, compact code
- Full UNIX™ compatibility and complete libraries
- Large and small memory models
- MS-DOS linker compatibility
- 8087 Support
- One-step compiling
- English error messages
- ROMable code
- Linker, assembler, archiver
- Extensive third party library support

## csd C SOURCE DEBUGGER

- Debugs at C source level without assembly language
- Separate evaluation, source, program and history windows
- Can execute any C expression
- Capabilities of a C interpreter, but runs in real time
- Set trace points on any statement or variable

Mark Williams' C compiler has earned a place in some very big companies for some very good reasons: it proves the benchmarks right with the speed, code density, consistent performance and expert support required in professional development environments.

But a total development tool shouldn't stop with compiling. Or go on and on with extras that add up and up.

Only Mark Williams' C Programming Systems *includes* the csd C Source Debugger with true source level debugging to speed your programming job.

And only Mark Williams' new 3.0 version *includes* utilities like "make" to make quick work of even the largest projects.

From source code to final product, only one takes you all the way: Mark Williams' C Programming System.

All for only \$495. Ask about our 60-day money back guarantee when you call

**1-800-692-1700 to order today.\***

You'll be big on the total C Programming system from Mark Williams, too.

 Mark Williams Company

1430 West Wrightwood  
Chicago, Illinois 60614

© 1985 Mark Williams Company  
UNIX is a registered trademark of Bell Labs.

\*In Illinois call 312-472-6659.

ble at counting prime numbers.

JAMES L. BARNETT  
APO NY

*The Sieve of Eratosthenes algorithm for generating prime numbers was developed by a Greek gentleman named Eratosthenes, who lived from about 275 B.C. to about 195 B.C. Around 240 B.C. he became head of the library at Alexandria (in Egypt), the most advanced center of learning that then existed in the world. Known for his talents in poetry, drama, literature, geography, philosophy, and astronomy, Eratosthenes created accurate maps of the known world, calculated the circumference of the earth and the tilt of its axis, and determined the size and distance from earth of the sun and the moon.*

*Far from being terrible at counting prime numbers, the Sieve of Eratosthenes is an extremely elegant, efficient method that is very accurate. I suggest that you consult the following sources for further information and explanations: "A High-Level Language Benchmark" by Jim Gilbreath (September 1981 BYTE, page 180), which explains how the algorithm*

*works, and The Art of Computer Programming, Volume 2: Semi-Numerical Algorithms by Donald E. Knuth (Addison-Wesley, 1969).—Steve*

**EAGLE DOCUMENTATION**

Dear Steve,

I have an Eagle IIE-4 computer with all its bundled software. I am at the point where I would like to expand my system and add items like a coprocessor card and a downloading device. Unfortunately, Eagle is not very big on documentation, and to install a coprocessor board, I need to know what's inside my computer. I'd like to know where everything is supposed to be before I start taking my baby apart. I've already contacted Eagle about this, so now I'll try you: Where can I find a technical guide or service manual for the Eagle IIE-4?

ART STANIEC  
Chicago, IL

*Eagle Computer Company has undergone a reorganization that reduced its number of individuals and services. All documentation and support services are being provided by a separate company*

*called Eagle Microsystems. You can obtain the documentation you mention by contacting this company at the following address:*

Eagle Microsystems  
5900 Washington Blvd.  
Culver City, CA 90230  
(213) 839-2263

—Steve

**APPLE SURGERY**

Dear Steve,

I am the owner of an Apple II+ that I've customized to be portable, and I am very happy with it. However, there are times when I regret having a II+ instead of a IIe. To solve this dilemma (without having to buy a new computer), I am contemplating a hardware upgrade and the necessary modifications to bring my II+ up to an equivalent IIe if possible.

Though I am capable of performing such surgery myself, the real problem is finding a suitable published reference that spells out the technical differences between these two models and supports the information with schematics and other details

(continued)

**FORTRAN PROGRAMMERS**

Downloading from mainframes or developing on the PC the choice is F77L.

*"Lahey's F77L FORTRAN is the compiler of choice... F77L compiled the five files in a total of 12 minutes which was 4 times as fast as MS FORTRAN and an astounding 6 times as fast as Pro FORTRAN."* PC Magazine

*"The manual that comes with this compiler is well put together. The messages are clearly explained, the compiler's unique features are well documented... All in all, F77L is a fine, well supported product that we think will do very well in the marketplace."*

Computer Language

**VERSION 2.0 NOW AVAILABLE — \$477**

SEE OUR AD  
MARCH BYTE

Full ANSI FORTRAN-77  
Source On-Line Debugger  
Common/Array greater than 64K  
Lattice C and other 3rd Party Compatibility

To order or for more information

**(213) 541-1200**

**Lahey Computer Systems, Inc.**

31244 Palos Verdes Drive West, Suite #243  
Rancho Palos Verdes, CA 90274

Requires MS-DOS and 8087

MS-DOS and MS FORTRAN are trademarks of Microsoft Corporation  
Pro FORTRAN is a trademark of International Business Machines

**New Quark®/PC** Single Board Computer



Base model 5.75" x 8"

Only \$**495.**

Quantity discounts available

- IBM PC® compatible single board computer mounts to 5 1/4" drive
- Includes Floppy Disk & Color Graphics CRT Controllers plus more

**Also includes:** Legal BIOS • Boots PC DOS® 2.1 • Printer Port • 2 Serial Ports • 256K RAM • Clock Speed at 4.77 MHz • Alphanumeric and Graphics Modes for Color Video Controller • Standard IBM® Keyboard Port.

**Options include:** 512K RAM • Piggyback I/O channel OEM Expansion Board • XT - Compatible Hard Disk SCSI Interface • Real Time Clock with battery-back-up • Clock speed of 9.5 MHz (Twice as fast as a PC)

The Megatel Quark/PC is for OEM and end user applications that require PC compatibility in a compact single board computer. The Quark/PC BIOS will run most IBM PC® software including Flight Simulator and Lotus®. To meet your specifications a set of options let you add memory, speed and an XT-compatible hard disk interface. Not only does it quickly mount to a 5 1/4" drive, it also comes with floppy disk and CRT color graphics controllers — all for just \$495.

To order or enquire call us today. Dealer enquiries welcome. Megatel Computer Technologies (416) 745-7214 150 Turbine Drive, Weston, Ontario M9L 2S2 Telex: 065-27453 U.S. Address: 1051 Clinton St., Buffalo N.Y. 14206 Distributors: NCS Electronics — Varese, Italy • SES Electronics — Nordlingen, Germany • Perdex Microtronics — Biggin Hill, U.K. • Microcomputing — Ghent, Belgium.

Quark is a registered trademark of F. and K. MFG. CO. LTD. IBM, IBM PC and PC DOS are registered trademarks of International Business Machines Corp. Lotus is a registered trademark of Lotus Development Corp. MS-DOS is a registered trademark of Microsoft Corp.

**megatel**



# Mark Williams

Now the biggest name  
in C compilers comes in a size  
everybody can afford.

Let's C™  
\$75

Introducing Mark Williams' \$75 C compiler. Want to explore C programming for the first time? Or just on your own time? Now you can do it in a big way without spending that way. With Let's C.

This is no little beginner's model. Let's C is a powerful programming tool, packed with all the essentials of the famous Mark Williams C Programming System. The one chosen by Intel, DEC, Wang and thousands of professional programmers. The one that wins the benchmarks and the reviewers' praise:

*"(This compiler) has the most professional feel of any package we tested..."—BYTE*  
*"Of all the compilers reviewed, (it) would be my first choice for product development."—David W. Smith, PC WORLD*

And now for more big news. Get our revolutionary csd C Source Debugger for just \$75, too. You can breeze through debugging at the C source level ignoring clunky assembler code.

Affordable, powerful, debuggable. Mark Williams Let's C is the big name C compiler at a price you can handle. Get your hands on it now.

#### Mark Williams Let's C

- For the IBM-PC and MS-DOS
- Fast compact code plus register variables
- Full Kernighan & Ritchie C and extensions
- Full UNIX™ compatibility and complete libraries
- Small memory model
- Many powerful utilities including linker, assembler, archiver, cc one-step compiling, egrep, pr, tail, wc
- MicroEMACS full screen editor with source
- Supported by dozens of third party libraries
- Upgradeable to C Programming System for large scale applications development

**Let's C Benchmark Done on an IBM-PC/XT, no 8087.**  
Program: Floating Point from BYTE, August, 1983.

Exec Time in Seconds

Let's C	134.20
MS 3.0	347.45

Use this coupon or charge by calling toll-free:  
1-800-MWC-1700. In Ill. call 312-472-6659.

**ORDER NOW! 60-DAY MONEY BACK GUARANTEE!**

#### Mark Williams Let's C

Please send me:

\_\_\_\_\_ copies of Let's C and \_\_\_\_\_ copies of csd (C Source Debugger) at \$75 each. (Ill. residents add 7% sales tax.)

Check    Money Order    Visa, MasterCard or American Express

Name \_\_\_\_\_

Address \_\_\_\_\_

City \_\_\_\_\_ State \_\_\_\_\_ Zip \_\_\_\_\_

Card # \_\_\_\_\_ Exp. Date \_\_\_\_\_

Signature \_\_\_\_\_



**Mark Williams Company**

1430 West Wrightwood  
Chicago, Illinois 60614

Inquiry 219

needed to plan and execute such an upgrade.

I'm particularly interested in knowing about the IIe auxiliary connector, the II+ slot 0, their conventions and differences, and the II+ lowercase/uppercase SHIFT KEY MOD.

If you are aware of any such published references, I would appreciate it if you'd let me know them.

BRUCE SCHAFFER  
Los Angeles, CA

*In a recent installment of his regular "Ask the Guru" feature in Computer Shopper, Don Lancaster suggested the way to make a II+ into a IIe is to unplug the cord from the II+, then discard everything but the cord. Next, you find a IIe that's missing a cord and plug yours into it.*

*It is, unfortunately, not very practical to upgrade an Apple II+ to a IIe. The technical reasons are too complex and involved to describe here. Some sources*

*of detailed information on the Apple hardware are*

*Gayler, Winston D. The Apple II Circuit Description (Howard W. Sams)*

*Sather, James. Understanding the Apple II (Quality Software)*

*Sather, James. Understanding the Apple IIe (Brady Communications)*

—Steve

### APPLE III

Dear Steve,

Where can I locate a directory of off-the-shelf programs for my Apple III? Apple apparently is not marketing that machine anymore. Vendors, as a result, are not marketing software. There are apparently thousands of these machines around. I suspect that a software developer might earn a good living offering popular programs for the Apple III.

Could CP/M offer a way out of my software dilemma? If I want to add CP/M capability to my Apple III, what card would provide the best reliability?

PATRICK J. FORRESTER  
Carson City, NV

*A complete listing of all Apple software is contained in Vanloves Apple Software Directory. It sells for \$24.95 and is available in many bookstores or from*

*PC Telemart/Vanloves  
11781 Lee Jackson Highway  
Fairfax, VA 22033  
(800) 368-4422*

*As far as a CP/M card for your Apple computer, look at the Microsoft and ALS cards. They seem to have a good track record with users.—Steve*

## CIRCUIT CELLAR FEEDBACK

### THE SP1000

Dear Steve,

I had begun putting together an S-100 board using the SP1000 speech-recognition chip, when I discovered your article in the November 1984 BYTE ("The Lis'ner 1000"). I wonder if you could help me with some questions I have about the SP1000.

I was unable to locate the recommended 7.15909-MHz crystal. Instead, I have found a 7.3728-MHz crystal; will this work? Also, I am interfacing the chip to a 6-MHz Z80 system. Will a program writ-

(continued)

# You already own a computer that can talk. Now let it.

Now you can upgrade almost any personal computer and make it more powerful than ever, by giving it the power of speech.

The Votrax Personal Speech System is the least expensive sophisticated voice synthesizer available today. The PSS's text-to-speech vocabulary is virtually unlimited, and you can define an exception word table and customize your translations. So the PSS can say just about anything!

#### It's a speech and sound specialist.

The PSS can also mix speech and sound effects or speech and music. It contains its own speaker, a programmable master clock, 256 programmable frequencies, a programmable speech rate for a more natural rhythm, and 16 programmable amplitude levels for incredible control of word emphasis. You can control the volume. Plus, it doesn't use any of your computer's valuable memory.

#### It's computer friendly.

The PSS is unbelievably easy to use. It doesn't need an interface card for most computers. It comes with standard serial and parallel ports. Speech, music, and sound effects are as simple as printing out a document.

#### What do you do with a talking computer?

There are countless practical applications. Businesses may want the PSS for spoken transmission of information, narration of displays, and product demonstrations. It makes verification of data input possible for the blind. It can be part of a burglar alarm system. Children can use the PSS as a study aid. And it helps games come alive, speaking while you play.

Whatever your computer can do, the PSS can help it do it better, at a cost that makes it all worthwhile: only \$395.\* Call (313) 583-9884 to hear an actual voice demonstration of the PSS.

\*Suggested retail price

#### There's also the Type 'N Talk.

If you want a less sophisticated unit and want to spend a little less, consider the Votrax Type 'N Talk (TNT). Its vocabulary is also limited only by what you can type. It doesn't use any computer memory, it's compatible with most computers, and it's only \$249.\* Just plug it in to your own speaker and go!

For more information about the Personal Speech System or the Type 'N Talk, see your local computer retailer, call toll-free or write:



1394 Rankin  
Troy, Michigan 48063  
1-800-521-1350  
(In Michigan, call collect  
313-588-0341)

GIVE YOUR  
COMPUTER  
THE POWER OF  
SPEECH.



The future... a little sooner than you expected.™



**ACHIEVE THE POWER  
AND SPEED OF TOMORROW'S  
TECHNOLOGY. TODAY.**

**INTRODUCING  
THE EXEC. PARTNER™ FROM  
PANASONIC®**

The Panasonic Exec. Partner. What makes it an executive? The 7.16 MHz 8086-2 microprocessor for high-speed processing. So you can do more in less time.

What makes it your partner? Like all ambitious achievers the Panasonic Exec. Partner gets along with others. Namely, IBM hardware and software.

You'll also accomplish more with the new high-resolution plasma display. It lasts four times longer, offers clearer definition and is easier to read than an ordinary screen.

The Exec. Partner's built-in dual mode printer will help

you make a good impression. From silent, draft-quality mode to correspondence quality.

The 256K internal memory has built-in expandability to 640K. So the Exec. Partner will run the most sophisticated data base management programs. And its expansion slot allows you to fulfill the needs of specific applications like telecommunications and Local Area Networks.

Tomorrow's technology for today's executives. The

new Panasonic Exec. Partner.

**Panasonic  
Industrial Company**

For the location of your nearest dealer, call 1-800-PIC-8086.

IBM is the registered trademark of International Business Machines, Inc.

# SECURE PROCESSING... AT LAST!

Protect Proprietary Software with HEI's System 180.



Connects directly to IBM PC or compatibles, and Apple II computers.

- Allows for protected local processing with proprietary programs
- Controls the number of access cycles to your program
- Program is erased if there is a physical or electronic attempt to compromise protected routines

The HEI System 180 Protected Processing System lets program publishers distribute proprietary software for customer processing without loss of security. Routines stored in HEI System 180 firmware are invulnerable to physical or electronic tampering, and protected from unauthorized use.

The software supplier sets the System 180 for a designated number of operating cycles. When these cycles have been completed by the lease or purchase customer, the system may be reactivated using a secret code.

The system is currently being used for remote customer processing of the Strong-Campbell Interest Inventory\*, Performax Pathfinder\*\*, and other sophisticated programs. May be used with the HEI Model 185 card scanner for fast, accurate data input.

Call or write to learn about secure distributed processing with your software.

 **HEI inc.**

**Scanning Systems Division**

2378 Wilshire Blvd.  
Mound, Minnesota 55364  
612-472-7914

Inquiry 152

## CIARCIA FEEDBACK

ten in C for my system be too slow for speech recognition and/or synthesis?

FRANK MEREWETHER  
Long Beach, NY

*A 7.3728-MHz crystal is less than 3 percent different from the one specified. It will cause the pitch of the speech to be almost imperceptibly higher. Timings will also be altered by less than 3 percent and should cause no problem.*

*The C language should be adequate for synthesis of speech, and, with your system running at 6 MHz, you probably will not find that your processor's speed is a bottleneck. Speech recognition is no easy matter, however.—Steve*

## RECALLING HALCYON TIMES

Dear Steve,

In June 1978 life was simple. I bought a North Star Horizon II kit with two serial ports: one for a terminal, one for a printer.

In November 1985 life got complicated. I bought an Apple IIe (no one sells kits anymore, except maybe you). I plan to get a board with a clock and two serial ports and an external modem. Someday, maybe, I'll be able to afford a letter-quality printer, a plotter, a digitizer pad...

The trick is to hook all these serial devices together in all the conceivable useful combinations: computer to modem, computer to printer, computer to computer, etc. Western Telematic Inc. makes a device with eight RS-232C ports that they say will "allow a user on any port to communicate with an RS-232C device on any other port. Up to four pairs..." It sounds great, but it costs \$895. Isn't there something between that and shuffling cables by hand?

PETER W. MEEK  
Ann Arbor, MI

*I know what you mean! But I think there are cheaper solutions than the one you mentioned. Maybe not much cheaper, but if you build from scratch, you could save quite a few bucks.*

*If you want off-the-shelf solutions, try looking at peripheral switchers from*

*Bay Technical Associates*

*POB 387*

*Bay Saint Louis, MS 39520*

*(800) 523-2702*

*Inmac*

*2465 Augustine Dr.*

*Santa Clara, CA 95054*

*(313) 961-6865*

*Both companies offer manual and "automatic" peripheral-switching devices from*

*(continued)*

# The

## WHO

Since 1978 we've been the leader in discount microcomputer sales, leading not only in price, but in product selection, innovative services and reputation. We're a solid organization that is here to stay.

## WHAT

Our objective is to give you the finest in micro-computer products, professional service and technical support at the lowest possible price. No gimmicks, no T-shirts, no coffee cups.

## WHERE

We're just a toll-free phone call from anywhere in the U.S. for Business Accounts and Mail Order customers. Standard Federal Express shipping will make us seem next door.

## WHEN

Call or visit us when you need quality products by Lotus, Microsoft, Ashton-Tate, Intel and others, low prices, professional service, quick delivery, and outstanding technical support.

## WHY

We do all of this because you deserve to deal with professionals. We're confident that once you try us you will become a repeat Conroy-LaPointe customer and never again resort to the "no service" discounters.

# Of Conroy-LaPointe.

## RETAIL STORES

Independently owned and operated by  
Conroy-LaPointe Computer Stores, Inc.

Three Conroy-LaPointe Computer Stores along the West Coast bring low prices, wide selection, and professional service to the retail and local business environment. Visit us in . . .

**San Francisco • Seattle • Portland**

415-982-6212

206-455-0206

503-620-5595

## MAIL ORDER

Our most visible service, the Mail Order department has long been the standard by which other microcomputer discounters are judged. We have been often imitated, but never equaled. In Oregon, call 1-800-451-5151 or nationally . . .

**1-800-547-1289**

## BUSINESS ACCOUNTS

We are pleased to announce a new and exciting service — our Business Accounts Program. We have designed this program as the total solution to the microcomputer needs of American business. We will be offering credit terms, as well as a Quantity Purchase Program, our standard Federal Express shipping, no cost technical support, and our everyday professional service. You will deal with Business Accounts Representatives who know microcomputers and how they are used in the corporate environment. For more information, in Oregon call 503-684-7261, or nationally . . .

**1-800-4-CONROY**

Inquiry 95 for Apple. Inquiry 96 for IBM Peripherals. Inquiry 97 for all others.

B1

# Conroy • LaPointe <sup>SM</sup>

## Try It. Then Buy It. PC-Write.™

A fast, full-featured word processing package for the unbelievable price of \$10. Complete. You get a manual on disk, mail merge, split screen, keyboard macros, on-screen formatting, full printer support, and more.

Try *PC-Write* for \$10. Then register for \$75 to get:

- latest diskette
- printed manual
- two updates
- phone support
- newsletter

Registration supports our "shareware" concept that keeps our prices low, and allows our development of *PC-Write* enhancements.

Shareware means you can get *PC-Write* from a friend or user group to try, and give away copies yourself. Then register if you like it. No risk!

Byte  
May 1986

# NEW

## Version 2.6

Automatic reformatting with proportional spacing, more on-screen help, optional menus, HP LaserJet+ support, and a wonderful new manual.



**Order PC-Write Today.**  
**Satisfaction Guaranteed.**

*Quicksort*™  
(206) 282-0452

219 First N. #224y  
Seattle, WA 98109



## CIARCIA FEEDBACK

about \$120 and up, depending on the number of serial lines you want to switch.

However, I sense that you are a kit builder, so let me try to convince you to build your own. I think you will find what you need to know in my article "Build an RS-232C Code-Activated Switch" (May 1983). While the unit described there is less flexible than what you need, it could be easily expanded to fit your setup. You could control which devices were connected together via one of your computers or even with a switch.

I hope this helps. If you build something, please let me know.—Steve

### LIVING SENSIBLY

Dear Steve,

I am interested in building the xenon strobe light described in "Living in a Sensible Environment" (July 1985). Before I start, I need a few questions answered.

What kind of circuit element is shown in figure 22 on page 155 (see figure 1), and what is its function? Can you give me more information on the trigger transformer, such as the turns ratio and voltage across the primary side? What is the purpose of the two diodes in the circuit? Finally, how would you connect the secondary of the transformer to the FT-1 xenon flash lamp?

STEPHEN J. MALEY  
Spencerport, NY

The answers are, in order:

1. The NE2 (see figure 1) is a neon bulb that is available from Radio Shack (catalog #272-1101). In the circuit shown on page 155, the neon bulb triggers the SCR (silicon-controlled rectifier) when the 1- $\mu$ F capacitor has charged to about 70–80 volts (sufficient to turn on the neon bulb), so it is the trigger mechanism for the flash. The 500-kilohm potentiometer varies the charging rate of the 1- $\mu$ F capacitor, thus varying the flash rate.

2. Suitable trigger transformers for the circuit can be obtained from

Mouser Electronics  
11433 Woodside Ave.  
Santee, CA 92071

Catalog numbers 42FM401 and 42FM403 would be suitable. The maximum permissible primary voltage is typically about 300 V; the secondary

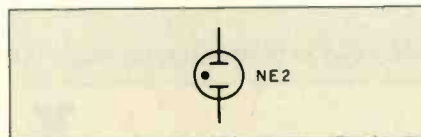

Figure 1: A neon bulb.

voltage is about 4000 V.

3. The two 1N4004 diodes rectify the incoming alternating current, changing it to direct current. The diodes are also arranged in a voltage-doubler configuration, boosting the DC voltage obtained to the levels required by the flash tube.

4. The xenon flash lamp has three terminals: anode, cathode, and trigger. The trigger terminal connects with the trigger transformer secondary.—Steve

### SBI80 AND MACINTOSH

Dear Steve,

Having read your SBI80 article, I decided that your single-board computer is just what I need. I already have two Shugart SA200 drives, a power supply, and a monitor. I also have a few questions about the SBI80.

Can I plug in my Macintosh keyboard as a terminal? Can I use the Mac external drive as a 3½-inch floppy on the SBI80? What about a 5-, 10-, or 20-megabyte hard disk? Are you planning such an interface in the future?

ANTHONY ORESTEEN  
Batavia, IL

Forget about using your Mac drives for the SBI80; they just wouldn't work since they are not the same type of 3½-inch drive. Nor can you use the keyboard itself from your Mac. You could use your Mac as a terminal into the SBI80, though. A good terminal-emulation program is all you need, preferably one that can emulate a terminal with direct cursor control (like a TeleVideo, Lear Siegler ADM 3A, etc.). I understand that a good program is Red Ryder, available from FreeSoft Company, 10828 Lacklink, St. Louis, MO 63114. You would run the terminal-emulation program on the Mac and have the Mac's serial output port connected via cable into the console input on the SBI80.

Check this month's Circuit Cellar for a combination 300/1200-bps modem and SCSI hard-disk expansion board for the SBI80.—Steve ■

Over the years I have presented many different projects in BYTE. I know many of you have built them and are making use of them in many ways.

I am interested in hearing from any of you telling me what you've done with these projects or how you may have been influenced by the basic ideas. Write me at Circuit Cellar Feedback, POB 582, Glastonbury, CT 06033, and fill me in on your applications. All letters and photographs become the property of Steve Ciarcia and cannot be returned.

# A \$1495 PC/AT?

**Is This a Joke?**

**A★Hoax?**

**A★Trick?**

**A★Put-On?**

**A★Spoof?**

**A★Flimflam?**

No, it's an **A★Star™**! And, unlike most of its would be competitors, it's none of the above. What it *is* will astonish you! At \$1495\*, **A★Star** is by far the lowest priced PC/AT compatible on the market. But, it's not just another clone, it's better!

**A★Star™** runs 30% faster than most AT's, has twice the memory and eight *available* expansion slots; theirs has only seven. Plus, **A★Star** is so "compatible" it's backed by an exclusive money back guarantee. Better yet, **A★Star** is the only "network ready" AT you can buy...at *any* price.

But that's not all. **A★Star™** is also the only PC/AT compatible made in America by an American Stock Exchange manufacturer. And that's real peace of mind when you consider the unknown origin and quality of many of the cheap, import imitations.

**A★Star™** It's about time! And...it's from Wells American.



**Wells American**

3243 Sunset Boulevard • West Columbia, South Carolina 29169 • (803) 796-7800 TWX 510-601-2645

\*Second unit price. Call us for first unit pricing and guarantee details. You'll be amazed!

Call for latest prices.

# FREE SHIPPING

in the Continental United States via UPS Ground.

# NO SURCHARGE FOR OR

## Seagate HD Western Digital Controller

### 20 MEG Hard Disk System for PC™



**Internal \$449**  
**External \$599**

For Xebec 1220 Combined Floppy/Hard Disk Controller add \$75.

Includes Seagate Hard Disk, Western Digital Controller, Cables, Manual, Software, and Mounting Hardware.

Boots From Hard Disk 65 MS Access Time One Year Warranty

Our Hard Disk Systems are compatible with the latest versions of the following Computers: IBM PC, IBM XT, AT&T 6300, Compaq Deskpro, Tandy 1000, Tandy 1200, PC's Limited Turbo PC, Zenith 150, Zenith 151, Leading Edge PC (Both Models), Sperry PC, Wyse PC, Televideo PC, Faraday Mother Boards, Corona PC, Eagle PC, ITT PC, and most other Compatibles.

**PLEASE SPECIFY YOUR COMPUTER TYPE WHEN ORDERING.**

## Seagate

### 20 and 30 MEG High Speed 40 MS Access Time Hard Drives for AT™

Uses Linear  
Voice Coil  
Activator.

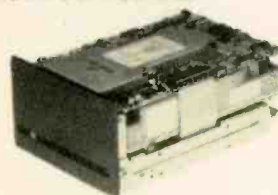

Heads park automatically  
at power down.

**20 MEG \$579**  
**30 MEG \$699**  
**40 MEG \$819**

Includes Seagate Full Height Hard Disk, Cable, and Mounting Rails.

Boots from Hard Disk. One Year Warranty.

## 64K RAM

Set of 9 chips, 200 or 150 Nanoseconds

# \$10

per set

### 300/1200 Baud Hayes Compatible Modem Fits in Short Slot



# \$159

## 256K RAM \$29

Set of 9 chips  
150 Nanoseconds

### PC'S LIMITED Six Function Card

- Upgradable to 384K
- Clock/Calendar
- Includes Software
- Parallel Port
- Serial Port
- Game Port



Two Year Warranty w/OK \$99 w/384K \$149

### PC's Limited AT Multifunction Card

- Expandable To 3 Meg (1.5 on Board/1.5 on Piggy Back Board)
- Supports 64 or 256K Rams
- Parallel Port
- Serial Port (2nd Serial Optional)

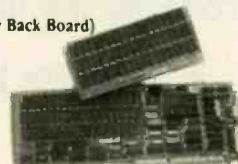

# \$199

w/OK

Piggy Back Board \$59 w/OK

### PC's Limited PC-576 RAM Board W/OK

- Expandable to 576K
- Supports 64K or 256K RAMS
- Fits in Short Slot

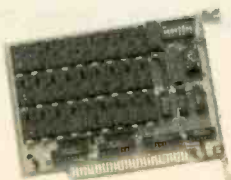

# \$69

### SOLVE YOUR POWER PROBLEM. XT™ POWER 130W



# \$99

Directly replaces power supply in PC.™  
Fully XT™ compatible. One Year Warranty



# PRICES AND MACHINES THAT OUTRUN THE COMPETITION.

**PC'S LIMITED TURBO  
PC™**

**High Performance  
Competitive Price**



**\$795**

One year warranty.\*

Includes: System Unit, 640K on Mother Board,  
360K Floppy Drive, AT Keyboard, 130W Power Supply.

Runs all Major Software written for the IBM PC™ and PC/XT™, 40% faster, without modifications.  
(Processor) 16-bit 8088-2, 4.77 or 6.66 MHz Clock Speed. (Expansion Slots) 8; 7 are available in above configuration.

GW Basic \$95 • IBM DOS 3.1 \$85 • 8087-2 \$149

**PC'S LIMITED AT™**  
High Performance Competitive Price



"Editor's Choice"  
—Feb. 25, 1986

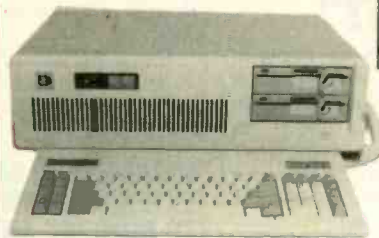

**\$1995**

One Year Warranty.\*

**8MHz Option included  
at no extra charge.**

Includes: 80286-based System Unit, 1024K on  
Mother Board, 1.2 Meg. Floppy Drive, Combined Floppy  
and Hard Disk Controller Card, AT Keyboard, 192W  
Power Supply, 2 Serials and 1 Parallel Port, and  
Clock/Calendar with Battery Backup.

Runs all Major Software written for the IBM PC™, PC XT™, and PC AT™. (Processor) Intel 80286 running at 6MHz.  
(Expansion Slots) 8. Same Bus Configuration as IBM PC AT™.

GW Basic \$95 • IBM DOS 3.1 \$85 • 80287 \$195

**PC's Limited Mini I/O**

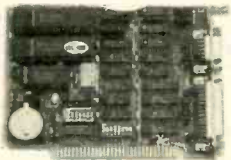

**\$99**

- Serial Port
- Parallel Port
- Clock
- Software
- Fits In Short Slot

**PC's Limited Monochrome Graphics  
Fully Hercules Compatible**

- Text Mode 80 X 25
- Graphics Mode 720 X 348 Pixels
- One Parallel Printer Port

**\$159**



**PC'S LIMITED  
MONO-1 MONITOR, RGB-1 MONITOR  
\$169**



- 12-inch screen
- Amber
- Compatible with monochrome or color graphics cards

**PC'S LIMITED  
RGB-1 MONITOR  
\$459**



- .31MM dot pitch
- RGB Input
- 12-inch screen
- 690X260 resolution
- 16 colors

**Floppy Disk Drive**



**\$109**

Also available for AT™  
in Gray Color.

**MITSUBISHI  
ELECTRONICS**  
Half-Height, DS/DD

**TEAC**

55-B, Half-Height, DS/DD

**PANASONIC**

Half-Height, DS/DD

**PC's Limited Universal  
Video Adapter**



**\$259**

- Replaces numerous cards, including IBM, Hercules, Plantronics.
- Provides 132 column text—color or mono
- Supports all parallel printers and plotters
- Emulates color software on monochrome monitor in 16 shades

**TERMS**

For Warranty Service: One year Limited Warranty on PC's Limited products. Contact Technical Support for a Return Authorization Number (RMA). Returns must be accompanied by your IBM invoice and a brief explanation. During the Warranty Period, PC's Limited will repair or replace items at our option.

For Credit: Contact our Customer Support Department within 30 days of date shipped from PC's Limited for Credit Return Authorization (CRA). Credit requests are subject to a 10% Restocking Fee. No credits are issued after 30 days from shipping date. In the unlikely event your order arrives defective, return it within 30 days of the original shipping date for a full refund of your purchase price.

IBM's and CRA's are valid 10 days only.



**PC'S LIMITED™**

**SALES CALLS OUTSIDE TEXAS, 1-800-426-5150**

**1611 Headway Circle, Building 3, Austin, Texas 78754**

**Sales Calls from anywhere in country, (512) 339-6962**

**Technical Support Calls, (512) 339-6963 Customer Service Calls, (512) 339-6964**

\*Limited Warranty

Telex No 9103808386 PC LTD FAX (512) 339-6721

We are an independent sales organization.

Panasonic, TEAC, Mitsubishi, Intel, IBM, Hercules, Plantronics, Xerox, Seagate, Western Digital, AT&T, Compaq, Tandy, Leading Edge, Sperry, Wyse, Televideo, Faraday, Corona, Eagle, ITT, and Zenith are registered trademarks of their respective companies. IBM, PC, IBM XT, IBM AT, are trademarks of IBM Corporation. Leading Edge PC, Sperry PC, Wyse PC, Compaq Deskpro, Zenith 150, Zenith 151, Televideo PC, Corona PC, Eagle PC, AT&T 6300, Tandy 1000 and Tandy 1100 are trademarks of their respective companies.

Some quantities may be limited. PC's Limited reserves the right to substitute equivalent items. All prices are subject to change without notice.

**Ad Number 405/86**

# THUNDERSTONE ARTIFICIAL INTELLIGENCE

Consolidated Diesel, CDC, Cullinet, Crown Zellerbach, David Sarnoff Research Center, RCA Labs, Dunn & Bradstreet Computing Services, Inc., EG&G Washington, Riverview Hospital, General Electric,

*PC MAGAZINE* said our first AI product, **LOGIC-LINE 1™**, "... comes closer to achieving its lofty aims than most other PC programs that claim to possess intelligence."\* We're pleased to announce our new company name, and two spectacular new products for your portfolio of data-manipulation assets.

## QUESTION: IS AI "STILL CRAZY AFTER ALL THESE YEARS?"

We used to be *Clarity Software*. In our first advertising ever, we asked, "Would you buy a pacemaker from *Mattel*?" We asserted that, compared to **LOGIC-LINE 1** artificial intelligence software, competitive products were toys by comparison. *PC MAGAZINE* agreed. So did satisfied customers around the world, a few of whom are around this ad.

Our success has effectively stomped the mortal spit out of the brain-damaged geeks whose rancid cells have been polluting the gene pool of legitimate AI professionals.

Our aggressive ad also got a rise out of another *Clarity Software*, a Texas firm. Relax, *Clarity*. You had the name first, so we cloned *Joshua*, of Jericho fame, long enough to give us a new corporate name: **Thunderstone** (he had his own hunch about artificial intelligence - *JOSHUA 24:27* - suggesting that an ordinary stone can be made to remember events).

It's not too big a leap of logic to name a company "Thunderstone," especially if that company is trying to turn a bucket of sand (which is all a computer really is) into something even *artificially* intelligent.

So, *now* we're **Thunderstone**. Still railing at those trendy marketing wizards who figure that *calling* their product "AI" is enough reality (since they're into science fiction so seriously, we suggest they do something really creative, like starting their own religion). And we respectfully submit three **Thunderstone** products for your review: Our meteoric success, **LOGIC-LINE 1**, and two new rock-solid products, **LOGIC-LINE 2™** and **COMPREHENSION™**.

### LOGIC-LINE 1: \$250 TRUE AI! CLONE THE WORLD'S GREAT MINDS ON YOUR PC.

**LOGIC-LINE 1**, a major breakthrough in sub-cognitive mathematics, distills the DNA/RNA-like analog to any writer's thought processes. It allows you to search any textbase for actual concepts and inference patterns unique to that writer.

**LOGIC-LINE 1** lets you take advantage of the best minds the world has produced. Not only can you learn from history, but you can perpetuate the intellectual *essence* of the great thinkers. You can apply their thought processes to today's problems.

In other words, even though Einstein may never have had a single thought about ecology,

you can apply his thinking patterns to solving ecological problems! Or you can clone your own best thinking, again and again.

**LOGIC-LINE 1** was produced by a couple of learning-cyberneticists and the physicist who developed one of the first DNA/RNA-tracking systems (Yes, boopie, the *RNA-of-thought* assertion is more than an advertising creation).

Can a PC simulate the thinking of great writers? We're sticking a money-back guarantee on our products, and to any so-called AI competition.

### LOGIC-LINE 2: \$400 EXTENDING LOGIC-LINE 1 TO NUMERIC AND MATHEMATICAL CONCEPTS

What **LOGIC-LINE 1** is to textual data, **LOGIC-LINE 2** is to numeric and symbolic data.

At its lowest level, you can do pattern recognition on financial data, algebraic and chemical formulae, tax laws, manpower-allocation statistics and all the other data that makes the financial world go around. (Too bad Malcolm Forbes is already using the slogan "Capitalist Tool.")

And at its highest level? You just might use **Thunderstone** tools to save the free world, again.

That's right: *Again!* **LOGIC-LINE 2** began with the mathematics of *possibilistic analysis* and *recursion* (developed by men like Alan Turing and Norbert Wiener) that directly led the Wellington College team to breaking the German naval codes in World War II (if you're involved with SDI, there's a special federal/DOD-phone number below).

*For customers who already own LOGIC-LINE 1, we will upgrade you to LOGIC-LINE 2 for the difference in price between the two packages: \$150.*

### COMPREHENSION: \$75 AN EXPERT SYSTEM THAT HELPS YOU DEBUG YOUR OWN THINKING/LEARNING PROCESS

Given our insights in analyzing the thinking process, it's only natural that we'd produce an *expert system* that helps you debug your own thinking and learning. **COMPREHENSION** is designed as a trouble-shooting companion for students or executives.

When it's 2:00 AM, and you have a 9:00AM exam or project deadline, your computer can now debug *you*. Through conditional branching structures, **COMPREHENSION** allows you to subjectively diagnose information-skill weaknesses and improves your overall intelligence/performance.

### WAKING UP FROM THE BOOLEAN DREAM

It's time to make a major departure from "if-then" thinking. Human thought processes are much more versatile. **Thunderstone** has taken a major departure from boolean AI approaches. Ours are *sub-cognitive* tools, as opposed to *cognitive* tools (such as those from expert-system builders like *Teknowledge* in Palo Alto, one of the few reputable AI companies anywhere).

**COMPREHENSION** and the **LOGIC-LINE** series are intended to amplify the man-machine loop. Does **LOGIC-LINE** make the computer *think* like a man? No. As Frank Herbert (*DUNE*) says: "The human intellect is cast in the crucible of survival, not in the play of symbols." Nevertheless, **Thunderstone** products explore the mathematics of the human thought process as described by Pulitzer Prize-winning author Douglas Hofstadter (*METAMAGICAL THEMAS*): "The brain itself does not 'manipulate symbols,' the brain is the medium in which the symbols are floating and in which they manipulate each other."

The genius, then, of a particular mind, is evidenced by the DNA/RNA-like patterns of what Hofstadter calls *neural firings*. The product of that process is words. Words which can be analyzed by **LOGIC-LINE** to simulate further inference from your own best thinking, or from the long-dead, but still-great minds.

### WHAT DO YOU THINK?

You may return any purchases, for any reason whatsoever, within 30 days for a full refund. We think you'll love **Thunderstone** software (We also think you're too smart to be fooled with \$249.95 or \$399.95 price tags): **COMPREHENSION** is \$75; **LOGIC-LINE 1** is \$250; **LOGIC-LINE 2** is \$400.

To find out more about **LOGIC-LINE 1**, **LOGIC-LINE 2** or **COMPREHENSION**, call 216/729-1132. To order by phone, call 800/621-5839 (or in Illinois, call 800/972-5855). If you are with the US government or one of the intelligence *spook shops*, **Thunderstone** software is available to federal/DOD buyers through IBIS Corporation, 131 Elden Street, Herndon, VA 22070 (call 800/532-3344 or 703/478-0300). Please add \$5 shipping per order, and Ohio residents add 5% sales tax.

## THUNDERSTONE CORPORATION

*AI from anyone else is like buying  
a pacemaker from *Mattel**

PO Box 839 • Chesterland, OH 44026 • USA  
216/729-1132

Sask Oil (Canada), SCIEX (Canada), St. Joseph's Hospital, Sperry, SUNSystems, Tektronix, Texas Instruments, TWA, The Pentagon, US Attorney General, U.S. Geological Survey, Woods Hole Oceanographic Institut

\*January 14, 1986, page 140. Copyright © 1986 by Thunderstone Corporation. **LOGIC-LINE 1™**, **LOGIC-LINE 2™** and **COMPREHENSION™** are trademarks of Thunderstone Corporation, a division of Expansion Programs International, and require a 128K IBM PC or compatible with at least one diskette drive and run under MS-DOS 2.1 and up. Advertising & PR by TRBA, 408/258-2708.

# B·O·O·K R·E·V·I·E·W·S

VARIATIONS IN C  
Steve Schustack  
Microsoft Press  
Bellevue, WA: 1985  
344 pages, \$19.95

MACINTOSH GRAPHICS  
IN MODULA-2  
Russell L. Schnapp  
Prentice-Hall  
Englewood Cliffs, NJ: 1986  
190 pages, \$19.95

ALGORITHMS  
AND DATA STRUCTURES  
Niklaus Wirth  
Prentice-Hall  
Englewood Cliffs, NJ: 1986  
288 pages, \$32.95

---

VARIATIONS IN C  
Reviewed by John D. Unger

As Steve Schustack states in his preface, *Variations in C* is written for experienced programmers who want to use this powerful language to write professional commercial software. Although this book requires no previous knowledge of C, it is not for beginners or for those who are not interested in using C to write sophisticated, efficient code. The book could also be useful to moderately skilled C programmers who want to become more proficient in the language and who want to learn some of the techniques and tricks of the professional C programmer.

## OVERVIEW

*Variations in C* is divided into two parts. The first part, which introduces the reader to the language in a fast-paced, progressive manner, is geared to the novice, but it is worthwhile reading for experienced C programmers, too. The latter part of the book covers the more powerful and difficult features of the C language, such as pointers, structures, and bit fields. These sections center on an exam-



ple of a business-oriented order-entry program for software vendors. This program contains more than 1500 lines of source code in 28 separate functions and header files. Schustack first presents the logic and structure behind the program and then lists all the program's functions, along with their complete source code. Certain functions are described in a simplified form as "stubs" and later presented in final form when the relevant advanced coding techniques are introduced. The succeeding sections draw on portions of this program to describe the more advanced features of C, and by the end virtually all the functions have been presented and their code unraveled for the reader.

**STYLE AND STRUCTURE**  
*Variations in C* is well written and easy to read. The author's extensive knowledge of C shows in his

smoothly and logically presented tutorial on the structure of the language. The chapters are divided into short, self-contained sections with large purple headings, which make it easy to follow topics as they are introduced and then elaborated upon. Scattered throughout the text are highlighted boxes, titled either COMMENT or CAUTION, that contain key sentences summarizing the section. The boxes provide an excellent visual focus on the crucial points.

I found the second part of the book slower reading than the first. This is partly due to the fact that the material is more advanced, but since these sections refer extensively to the language and structure of the order-entry program, it just takes more time to read and understand the

(continued)

# Compatibility without Compromise!!

—PC/AT Compatible—

All included  
50%FASTER

## \$1995



Made in JAPAN

## TOMCAT 3200-AT MODEL III

- CPU INTEL 80286 6/8MHz
- RAM 512KB on Mother Board
- 2 X 1.2MB Floppy Drives
- Floppy and Hard Disk Controller Card
- Turbo Display Color/Monochrome Card
- 1 Serial and 1 Parallel Card
- AT Keyboard
- Monochrome Display Monitor
- User's Manual & Technical Reference
- System Utility Disk (Setup, Diagnostic)



**OEM Acceptable**

### TOMCAT CORPORATION

Suite 304 3820 Del Amo Blvd., Torrance, CA 90503  
TEL:(213)542-6E4E

### TOMCAT COMPUTER Inc.

Yaguchi Bldg. 3-6-4 Nishiwaseda Shinjuku-ku, TOKYO  
TEL:(03)208-2511 TELEX:J28984 FAX:(03)208-2E62

## BOOK REVIEWS

source code as well as the descriptive text.

Unlike some other books on C, which have a distinct UNIX-style approach, *Variations in C* is oriented toward microcomputers, specifically MS-DOS machines. The software examples in the text and the order-entry program were written on an IBM PC using version 3.00 of the Microsoft C compiler.

### STRENGTHS

Schustack's fluid yet precise writing style and his confidence in his own abilities as a C programmer help the reader to progress through the first part of the book quickly and easily. He obviously has experience in teaching people the C language.

His discussion of the C preprocessor and its uses is one of the best I have read on this important subject, and I learned a lot from it. His knowledge of the efficient design of user interfaces shows in the software examples, where, for example, he demonstrates how to align titles and prompts along the same columns.

The order-entry program is certainly a bonus in a book like this. Schustack uses it effectively to show how to write large and complex programs for interactive, screen-oriented applications. If you are like me, you won't have direct use for a program designed to keep track of sales and orders. However, many of the functions that make up the software are programming gems that can be included in a variety of other applications programs.

### WEAKNESSES

The author's complete reliance on the Microsoft compiler is the book's only serious weakness. His descriptions of how to use that compiler, the Microsoft Link program, and their varieties of command-line switches are completely lost on someone who might be using another compiler. A programmer with Schustack's experience could have written more generically about how to compile and link source code.

Much of C's power and usefulness is due to its portability. The other books I have read on C, and the six MS-DOS C compilers and interpreters I have used, stick close to the standards for C described in Brian W. Kernighan and Dennis M. Ritchie's book *The C Programming Language* (Prentice-Hall, 1983). The Microsoft C compiler that Schustack uses for all the examples in *Variations in C* implements most of the recommendations for a proposed ANSI C standard rather than the more common K & R standard. This causes no problems if you're planning to use the Microsoft compiler, but it could confuse you if you try to compile some of the book's source-code examples with another compiler. Schustack clearly points out the use of the proposed ANSI standard by the Microsoft compiler but does not consistently indicate which of his examples use code that would go beyond the K & R standard, as they do when he uses enumeration data types and the void type for functions that return nothing. The book is limited by the use of a language standard that, as far as I know, is implemented by only one compiler.

(continued)

# THE PROFESSIONAL'S CHOICE

Lotus 1-2-3 <b>\$319</b>	Lotus Symphony <b>\$449</b>	dBase III Plus <b>\$369</b>	NEW FrameWork II <b>\$369</b>	MultiMate <b>\$219</b>	Word Perfect 4.1 <b>\$209</b>
--------------------------------	-----------------------------------	-----------------------------------	--	---------------------------	-------------------------------------

## Software

### Word-Processing Editors

FANCY FONT	\$139
FINAL WORD II	\$219
MICROSOFT WORD	\$239
MULTIMATE	\$219
MULTIMATE ADVANTAGE	\$269
OFFICE WRITER/ SPELLER	\$239
PFS: WRITE	\$ 89
SAMNA WORD III	\$259
THINK TANK	\$109
TURBO LIGHTNING	\$ 59
VOLKSWRITER 3	\$159
VOLKSWRITER SCIENTIFIC	\$269
WORD PERFECT 4.1	\$209
WORDSTAR 2000	\$249
WORDSTAR 2000+	\$289
WORDSTAR PRO	\$259
XYWRITE III	\$249

### Database Systems

ALPHA DATA BASE MANAGER II	\$179
CLIPPER	\$359
CONDOR III	\$339
CORNERSTONE	\$259
DBASE III PLUS	\$369
KMAN 2	\$319
PARADOX	\$549
PFS: FILE/PFS: REPORT	\$169
POWERBASE	\$219
Q & A	\$199
QUICKCODE III	\$159
QUICKREPORT	\$159
R BASE 5000	\$359
REFLEX	\$59
REVELATION	\$559

### Spreadsheets/Integrated Packages

ENABLE	\$349
FRAMEWORK II	\$369
JAVELIN	\$549
LOTUS 1-2-3	\$319
MULTIPLAN	\$135
OPEN ACCESS	\$259
SMART SYSTEM	\$529
SPREADSHEET AUDITOR	\$109
SUPERCALC 3	\$209
SYMPHONY	\$449

### Graphics

CHARTMASTER	\$219
DIAGRAM MASTER	\$215
EXECUVISION	\$249
ENERGRAPHICS	\$189
FREELANCE	\$219
GEM DRAW	\$159
GRAPHWRITER COMBO	\$329
IN-A-VISION	\$289
MS CHART NEW OVERHEAD	\$189
EXPRESS	\$139
PC DRAW	\$239
PC PAINTBRUSH	\$ 89
PFS: GRAPH	\$ 89
SIGNMASTER	\$159

### Project Management

HARVARD TOTAL PROJECT MANAGER	\$279
MICROSOFT PROJECT-NEW	\$249
PROJECT SCHEDULER NETWORK	\$339
SUPERPROJECT	\$209
TIMELINE 2.0	\$259

### Desktop Environments

DESK ORGANIZER	\$ 69
GEM DESKTOP	\$ 39
SIDEKICK	\$ 39

### Communications/Productivity Tools

CROSSTALK	\$ 99
PROKEY	\$ 89
KEYWORKS	\$ 59
RELAY GOLD	149
REMOTE	\$119
SMARTERM	\$Call
SMARTCOM II	\$ 99
SUPERKEY	\$ 55

### Statistics

SPSS/PC	\$575
STATPAK-NWA	\$329
STATPAC-WALONICK	\$349
SYSTAT	\$419

### Network Applications

DBASE III LAN PAK	\$569
KMAN 2	\$1195
OPEN SYSTEMS	\$459
R BASE 5000	\$839
REVELATION	\$939
WORD PERFECT	\$495

### Languages/Utilities

CONCURRENT DOS	\$189
C66 C COMPILER	\$299
DR FORTRAN 77	\$219
FASTBACK	\$113
LATTICE C COMPILER	\$289
MARK WILLIAMS C	\$319
MICROSOFT C COMPILER	\$249
MS BASIC COMPILER	\$249
MS FORTRAN	\$229
NORTON UTILITIES	\$ 59
QUICK BASIC	\$ 79
TURBO PASCAL	\$ 49
XENIX	\$Call

### Accounting

EPI	\$239
GREAT PLAINS	\$479
IJS EASYBUSINESS	\$319
ONE WRITE PLUS	\$179
OPEN SYSTEMS	\$369
PEACHTREE	\$299
REAL WORLD	\$399
STAR ACCOUNTING PARTNER II	\$529

## Hardware \*

### Multifunction Boards

AST ADVANTAGE (128K)	\$359
AST 6 PAK PLUS (64K)	\$329
AST 6 PAK PLUS (384K)	\$259
AST RAMPAGE PC	\$299
AST RAMPAGE AT	\$429
GOLD QUADBOARD (OK)	\$419
INTEL ABOVEBOARD PS (64K)	\$339
ORCHID CONQUEST (OK)	\$279
ORCHID BLOSSOM (384K)	\$249
ORCHID PC TURBO W/ DTRBOARD (256K)	\$669
PERSYST TIME SPECTRUM (384K)	\$246
QUADBOARD (384K)	\$219
SILVER QUADBOARD (OK)	\$219
TECMAR CAPTAIN (384K)	\$229
TECMAR WAVE (64K)	\$209
J RAM-3	\$Call

### Display Boards

EVEREX EDGE	\$299
EVEREX GRAPHICS	\$299
EDGE	\$299
HERCULES GRAPHICS CARD	\$299
HERCULES COLOR CARD	\$159
PARADISE COLOR/MONO	\$169
PARADISE MODULAR GRAPHICS	\$275
QUADRAM EGA+	\$379
SIGMA COLOR 400	\$489
STB EGA PLUS	\$399
TECMAR GRAPHICS MASTER	\$469
TSENG ULTRA PAK	\$429
TSENG ULTRA PAK-S	\$369

### Emulation Boards

AST 5251-11	\$569
AST 5251-12	\$499
AST BSC	\$489
AST SNA	\$599
CXI 3278/9 Plus	\$959
IRMA	\$799
IRMLINE	\$999

### Modems

AST REACH 1200	\$369
HAYES 1200	\$389
HAYES 1200B	\$349
HAYES 2400	\$579
TRANSNET 1000	\$279
VENTEL 1200	\$369
HALF CARD	\$319
WATSON	\$319

### Mass Storage/Backup

EXCEL STREAM 60 TAPE (INT)	\$899
IOMEGA BERNOULLI BOX-IOHO	\$2399
IRWIN 310A 10MB TAPE (EXT)	\$850
IRWIN 110D 10MB TAPE (INT)	\$479
MAYNSTREAM 60MB TAPE (INT)	\$1199
MOUNTAIN DRIVECARD 20MB	\$949
PRIAM 42MB AT	\$1295
SYSGEN SMART IMAGE 20 MB (INT)	\$625
TALLGRASS	\$Call
TECMAR QIC-60AT TAPE (INT)	\$1199

### Monitors

AMDEK 310A	\$169
AMDEK 600	\$379
AMDEK 710	\$439
AMDEK 722	\$499
PRINCETON HX-12	\$449
PRINCETON MAX-12E	\$179
PRINCETON SR-12	\$579
PRINCETON HX-42E	\$539
PRINCETON HX-3	\$529
TAXAN 122 AMBER	\$159
TAXAN 630/640	\$469/\$339

### Networks

AST PC NET	\$Call
ORCHID PC NET 3 COM	\$Call

### Printers/Plotters

BROTHER TWINWRITER	\$939
DIABLO	\$Call
EPSON FX-85	\$359
EPSON FX-286	\$539
EPSON LO-100C	\$799
EPSON HI-80	\$399
EPSON DX-10/20/35	\$Call
HP 7475A	\$Call
JUKI 6300	\$699
NEC 3550	\$869
OKIDATA 192	\$399
OKIDATA 193	\$519
TI 955	\$799
TOSHIBA P321	\$Call
TOSHIBA P341	\$Call
TOSHIBA P351	\$1069

### Input Devices

KEYTRONIC S 51	\$179
KOALA	\$105
MICROSOFT MOUSE	\$129
PC MOUSE W PAINTPLUS	\$139

### Accessories

CURTIS SURGE PROTECTORS	\$Call
DATASHIELD BACKUP POWER	\$Call
GILTRONIX SWITCHES	\$Call
MASTERPIECE PLUS MICROFAZE INL NE BUFFERS	\$Call
TRIPPLITE BACKL P POWER	\$Call
256K RAM SET	\$ 39
8087 MATH CHIP	\$135
80287 MATH CHIP	\$199

Hercules Graphics Card <b>\$299</b>	Mountain Drivecard 20 <b>\$949</b>	Quadram NEW EGA <b>\$379</b>	Princeton HX-12E <b>\$539</b>	Smartmodem NEW 2400B <b>\$549</b>	IRMA Board <b>\$799</b>
---	--	------------------------------------	-------------------------------------	---	-------------------------------

\*CALL FOR SHIPPING COSTS



## LOWEST PRICE GUARANTEE!!

We will match current nationally advertised prices on most products. Call and compare.

free!

Diskette Library Case with your order



# 1-800-221-1260

In New York State call (718) 438-6057

TERMS:  
Checks—allow 14 days to clear. Credit processing—add 3% COD orders—cash, M.O or certified check—add \$5.00. Shipping and handling UPS surface—add \$3.00 per item (UPS Blue \$8.00 per item). NY State Residents—add applicable sales tax. All prices subject to change.



MON.-THURS. 9:00 AM-8:00 PM  
SUN. & FRI. 9:00 AM-4:00 PM

# Softline

Softline Corporation  
P.O. Box 729, Brooklyn, N.Y. 11230  
TELEX: 421047 ATLN UI  
FAX: 718-972-8346

# PROLOG APPLIED!

The FIRST Interactive Prolog for the IBM and Macintosh.

## PROLOG/i

A new enhanced Interactive Prolog for MS-DOS. **\$69<sup>95</sup>**  
Upwardly compatible with PROLOG V and V-plus.

## PROLOG/m

Prolog for the Macintosh! Edinburgh syntax. **\$99<sup>95</sup>**  
Floating point, math functions.

## THREE GREAT APPLICATIONS

READY TO RUN  
NO PROGRAMMING  
EXPERIENCE NECESSARY.

**NFL X-pert** **\$49<sup>95</sup>**  
Expert system for professional football handicapping.

**TOOLBOX** **\$29<sup>95</sup>**  
Including subroutines that speed and compress list handling, searches, sorts, reversal algorithms.

**TOYBOX** **\$29<sup>95</sup>**  
A collection of games and puzzles that make learning Prolog fun.

### MIX AND MATCH FOR ADDED SAVINGS

	PROLOG/i	PROLOG/m	*SAVE*
Interpreter plus...			
Toolbox or Toybox	\$ 79.95	\$109.95	\$20
Toolbox and Toybox	99.95	129.95	30
NFL X-pert	99.95	129.95	20
NFL X-pert and Toolbox and Toybox	119.95	149.95	30
BUY ALL 4 AND SAVE \$50	129.95	159.95	50
<b>Applications Only</b>			
Toolbox and Toybox	\$49.95		
NFL X-pert and Toolbox or Toybox	69.95		
BUY ALL 3 AND SAVE \$20	89.95		

### COMPATIBILITY

Applications fully compatible with Prolog compilers and interpreters with Edinburgh syntax.



**CHALCEDONY SOFTWARE, INC.**

**System Requirements**  
PC-DOS/MS-DOS  
Ver. 2.0 or later  
256K RAM  
512 Macintosh

5580 LA JOLLA BLVD.  
SUITE 126 D  
LA JOLLA, CA  
92037  
(619) 483-8513

PHONE ORDERS: 1-800-621-0852 EXT 468

<input type="checkbox"/> PAYMENT ENCLOSED \$ _____	PROLOG/i \$69.95
CA residents add 6% sales tax	PROLOG/m \$99.95
<input type="checkbox"/> CHARGE MY _____	<i>If you own PROLOG V or PROLOG V-plus, call for upgrade information.</i>
<input type="checkbox"/> MasterCard <input type="checkbox"/> Visa	<b>SHIPPING:</b>
Card No. _____ Exp. Date _____	\$ 5.00 U.S.
Signature _____	7.50 Canada
Mr./Mrs./Ms. _____	10.00 Cambean, Hawaii Air
(please print full name)	20.00 Overseas Air
Address _____	COD Orders Not Accepted
City/State/Zip _____	15 day check clearance

## BOOK REVIEWS

Strictly speaking, library functions are not part of the C language and should not be an issue concerning portability of source code. However, certain library functions that have become de facto standards for the language are included, in the form described in K & R, with all the compilers I have used. Most of the problems with the Microsoft compiler's compatibility stem from the use of unique or uncommon library functions or from unique extensions to standardized functions.

Examples of function calls described in the book that either will not run or will produce errors are

- use of a \* in the width field as an argument in the printf I/O function

example: `printf("%*.*f",6,2,123.4567);`

to print the number as 123.45

- use of capital letters D, U, O, and X as alternative type descriptions for ld, lu, lo, and lx with the scanf() function to indicate long integers
- use of h in the context hd, for example, to indicate a short integer

I hesitate to list a matter of programming style as a weakness, but the author consistently detracts from the readability of his source code by depending heavily on the #define preprocessor command and the typedef statement to create synonyms for new storage classes and data types. He claims that this makes his code more readable, but unless you have read this book or carefully scrutinized the header files for his source code, it is unclear what kind of data type the programmer has defined for the array prices[] when he wrote `IMPORT money prices[]`; or what type of data a function defined as `stepcode id_cust()` returns. To be fair to Schustack, after going through the sections of the book that use the order-entry program's functions and header files as examples, I understood these and other synonym types and classes, but I still found their implementations somewhat awkward.

### CONCLUSION

*Variations in C* is a good book. The author set out to teach experienced programmers the C language and its effective use in writing professional applications programs, and the book accomplishes this task in a readable, thorough manner. However, if there is one thing I have learned from reading a variety of books on the C language, it is that no single text can effectively teach all the features of C. I would have liked the book better if the author had stayed closer to the C-language standard in Kernighan & Ritchie and if he had not been so single-minded about the Microsoft C compiler. In the final analysis, however, the book's strengths outweigh its weaknesses considerably.

John D. Unger (POB 95, Hamilton, VA 22068) began programming at MIT on an IBM 7094. He currently writes graphics and applications programs in C on microcomputers.

(continued)

**ORDER  
LINE  
800-354-7330**

**LOWEST PRICES**

**NO SURCHARGE  
ON BANK CARDS**

**SILICON SPECIALTIES**

**HARDWARE**

**ZENITH COMPUTERS**  
Always  
the lowest prices.  
Call us for a quote.

**PRINTERS**

Anadex All Models	Save
Brother All Models	Save
Cannon Laser Printer	\$2099
Citizen MSP-10	\$255
MSP-15	\$349
MSP-20	\$319
MSP-25	\$485
Premier 35	\$409
Datsouth All Printer Models	Save
Diablo D-25	\$529
635	\$1079
Other Printer Models	Save

**EPSON**

All Printer Models	Save
Juki 6100	\$349
6300	\$669
NEC	
3510, 3550, 3515, 3530	\$729
8810, 8830, 8850	\$1039
P5, P6, P7	Save
BH 360	\$379
BH 370	\$379

**OKIDATA**

All Printer Models	Save
Panasonic 1080	\$219
1091	\$235
1092	\$309
1592	\$429
KXP3151	\$399

**STAR MICRONICS**

All Printer Models	Save
Silver Reed	
EXP400 Parallel	\$179
EXP550 Parallel or Serial	\$409
EXP800 Parallel or Serial	\$619

**TOSHIBA  
PRINTERS  
SPECIAL**

321 Parallel	SAVE
321 Serial	SAVE
341 Parallel	\$829
341 Serial & Parallel	\$879
351 Serial & Parallel	\$985

**MONITORS**

Amdex All Monitors	Save
NEC All Monitors	Save
Princeton Graphics	Save
Zenith All Models	Save

**BOARDS**

AST Advantage	\$389
Rampage PC	\$299
Six Pack Plus	\$219
Hercules Color Card	\$149
Graphic Card	\$305
Intel	
Above Boards	Save
Maynard Hardcard	\$549
Paradise Modular Graphic 06-1	\$239
Five Pak	\$115
Quadram	
Gold & Silver Boards	Save
Quadlink	\$329
Quad EGA+	\$365
Tec. Mar Graphics Master	\$445
Captain No Memory	\$155

**COMPUTERS**

**PANASONIC**

Sr. Partner Dual Drive	\$1599
Exec. Partner Dual Drive	\$2129

**TOSHIBA**

T-1100	\$1389
--------	--------

**WYSE**

Wyse pc 1100-1	\$979
Wyse pc 1100-20	\$1539

**Zenith Computer  
Products  
SAVE up to 50%**

Z-158 All Models	Save
Z-138 All Models	Save
Z-148 All Models	Save
Z-171	Save
Z-200	Save

**DISK DRIVES**

Alpha Omega Turbo 10	\$515
Turbo 20	\$515
Turbo 30	\$675
Iomega	
Bernoulli Boxes for IBM	Save
Bernoulli Boxes for Macintosh	Save
Paradise Macintosh Hard Disk	Save

**VIDEO TERMINALS**

Quime QVT Green 101	\$299
QVT Amber 101	\$314
Wyse 30	\$299
50	\$419
75	\$559
Wyse 85	\$439
Wyse 350	\$859
Zenith Z-22	\$455
Z-29A	\$559
Z-49	Save

**MODEMS**

AT&T	
4000 External	\$309
Anchor Automation	
Anchor Express	\$235

**HAYES**

All Modems	Save
Prometheus All Models	Save
US Robotics Courier 2400	\$389
Password 1200	\$180
Microlink 2400	\$379

**KEYBOARDS**

Keytronics 5151	\$159
-----------------	-------

**DISKETTES**

Maxell MD-2 Plastic Box (Qty 100)	\$125
Sony MD/2 (Qty 100)	\$120

**PLOTTERS**

Epson Hi-80	Save
-------------	------

**SOFTWARE**

**IBM PC and 100% Compatibles**

**WORD PROCESSORS**

Leading Edge Word Processor	\$48
Leading Edge W/P w/Spell & Mail	\$97
Lightning	Save
Microsoft Word 2.0 I	\$228
Multimate 3.3	\$203
PFS: Write w/Spell Checker	\$76
Wordstar w/Tutor	\$162
Wordstar Pro Pack	\$233

Word Perfect (Ver. 4.1)	\$199
Wordstar 2000 2.0	\$233
Wordstar 2000 Plus 2.0	\$278

**GRAPHICS**

Chartmaster	\$205
Diagram Master	\$189
Energraphics	\$160
Energraphics w/Plotter Option	\$205
In-A-Vision	\$250
Microsoft Bus Mouse	\$107
w/PC Paintbrush 3.0	\$169
Microsoft Chart	\$120
Microsoft Serial Mouse	\$32
Newsroom	\$199
PC Draw	\$102
PC Draw Light Pen	\$104
PC Mouse w/Dr. Halo II	\$119
PC Paint w/Mouse	\$76
PFS Graph	\$30
Printmaster	\$134
Signmaster	Save
Turbo Graphix Tool Box	Save

**LANGUAGES**

C Compiler (Microsoft)	\$227
Fortran Compiler (Microsoft)	\$203
Lattice C Compiler	\$242
Macra Assembler (Microsoft)	\$87
Pascal Compiler (Microsoft)	\$174
Quick Basic	\$57
Run C Interpreter	\$82
Turbo Pascal 3.0	Save
Turbo Tool Box	Save

**UTILITIES**

Copy II PC	\$19
1 DR	\$47
Fastback	\$87
Norton Utilities 3.1	\$48
Primeworks	\$36
Sidelick	Save
Sidelick (Unprotected)	Save
Sidelick - Superkey (Bundle)	Save
Sideways 3.1	\$34
Superkey	Save

**TRAINING**

Flight Simulator	\$29
PC Logo	\$75
Typing Instructor	\$28
Typing Tutor III	\$28

**MONEY MANAGEMENT**

Dollars & Sense w/Farcast	\$94
Tabias Managing Your Money	\$94

**PROJECT MANAGEMENT**

Harvard Total Project Manager	\$262
Microsoft Project	Save
Super Project Plus	Save
Timeline 2.0	\$219

**COMMUNICATIONS**

CompuServe Starter Kit	Best Price
Crosstalk XVI	\$92
MS Access	\$145
PFS Access	\$77
Remote	\$92
Smartcom II	\$83

**INTEGRATIVE SOFTWARE**

Enable 1.1	Save
Framework II	Save
Smart Software System	Best Price
Symphony	Save

**SPREADSHEETS**

Lotus 1-2-3	Save
Multiphan	\$112
Spreadsheet Auditor 2.0	\$82
VP Planner	\$49

Supercalc 3(Ver.2.1) Save

**DATA BASE MANAGEMENT**

Clipper	\$339
Cornerstone	Save
dBase II	Save
dBase III Plus	Save
Extended Report Writer	\$79
Knowledgeman II	\$289
Knowledgeman Upgrade Kit	\$145
Nutshell 2.0	Save
PFS: File	\$76
PFS: Report	\$67
Quickcode	\$138
QuickReport	\$138
Reflex	Save
Think Tank	\$92

R:Base 5000 ... \$319

**SILICON SPECIALTIES**  
2034 WEST SOUTHERN  
MESA, ARIZONA 85202  
602-969-0909

Inquiry 319 for MS DOS Products. Inquiry 320 for all others.

Product shipped in factory cartons with manufacturer's warranty. Please add \$10.00 per order for UPS shipping. Prices & availability subject to change without notice. Send cashier's check or money order... all other checks will delay shipping two weeks.



Circle 388

CALL

SUPER DISCOUNT WHOLESALER

# BTE COMPUTERS, INC.

CALL

IBM XT 512K FLOPPY	\$1988	ZENITH 148	\$1098
IBM XT 512K, 20 MEG HD	\$2488	ZENITH 158	\$1598
IBM AT 512K FLOPPY	\$3288	ZENITH 177	\$1988
IBM AT 512K FLOPPY, 20 MEG HD	\$3788	ZENITH 200 AT	\$2888
512K [OK] MEMORY CARD	\$ 48	20 MEG SEAGATE HD w/CNT	\$ 488
384K [OK] XT MLTIFCT. CARD	\$ 98	10 MEG IRWIN TAPE BACK-UP	\$ 468

## MONITORS

AMDEK COLOR 600	\$388
SONY IBM HI RES. COLOR	\$398
SONY w/TV TUNER	\$498
TAXAN IBM HI RES. COLOR	\$395
ZENITH AMBER TTL	\$159
RF MODULATOR IBM OR APPLE	\$9.99
COLOR GRAPHICS CARD RGB	\$ 78
APPLE VIDEO 7	\$158

## PRINTERS

CITIZEN MSP10	\$248
EPSON FX85	\$368
OKIDATA 182	\$216
IBM PRINTER CABLE (HI QUALITY)	\$ 15
DAISY LASER PRINTER (CANNON)	\$2098
APPLE 2j or 2e CABLE	\$ 15
HP LASER PRINTER	2535
OTHER PRICES	CALL

NEW SHORT COLOR &amp; MONOCHROME TTL GRAPHICS CARD \$158

## INTRODUCING THE NEW SUPER SPC XT PORTABLE

FITS ANY IBM PC, XT or APPLE II+, IIe or (AT - CALL) COMPATIBLE MOTHER BOARDS  
KIT INCLUDES:

- 3 DISK DRIVE SLOTS (AMBER GREEN)
- TTL or COMPOSITE
- HARDWARE RESET
- POWER ON INDICATOR
- KEYED POWER SWITCH
- AUTOMATIC BRIGHTNESS CONTROL
- EASY TO ASSEMBLE

- INCLUDES:
- 9" HIGH RES. MONITOR
- 135 W. SWITCHING POWER SUPPLY
- KEYBOARD
- ABS CASE, ACCESSORIES, MOUNTING HARDWARE, ASSEMBLY MANUAL, UP TO 6 EXPANSION SLOTS

ONLY \$588



## SUPER SPC AT TOTALLY IBM AT HARDWARE

MOTHER BOARD & SOFTWARE COMPATIBLE

		DRIVE MFG	FORMATTED CAPACITY	ACCESS SPEED	PRICE
80286 MICROPROCESSOR		SEAGATE	21	65	\$465
80287 COPROCESSOR (OPTIONAL)		SEA/CDC*	21	40	\$699
512K STANDARD MEMORY		SEA/CDC*	30	40	\$845
8 1/0 EXPANSION SLOTS		CDC	40	28	\$1145
ONLY (OK)	\$888	SEAGATE	40	40	\$999
• SUPER AT KEYBOARD	\$ 89	CDC	56	28	\$1399
• SUPER AT CASE	\$ 89	CDC	70	28	\$1598
• SUPER AT 200 WATT POWER SUPPLY	\$149				
• 2.5M MULTI-FUNCTION CARD (OK)	\$229				

## SUPER COMPATIBLE PC/XT MOTHERBOARD

TOTALLY IBM XT HARDWARE &amp; SOFTWARE COMPATIBLE!

• 256K MOTHER BOARD (OK)	\$149	<b>SPECIAL THIS MONTH ONLY!</b>	
• MONOCHROME GRAPHIC PRINTER CARD	\$ 88	5150 KEYBOARD	\$48.00
• MULTI-I/O CARD	\$128	5151 KEYBOARD	\$88.00
• PARALLEL PRINTER CARD	\$ 28	XT CASE (FLIP TOP)	\$48.00
• SERIAL CARD	\$ 38	135 WATT XT POWER SUPPLY	\$78.00
• GAME PORT ADAPTER	\$ 28		
• EPROM WRITER CARD	\$109		

## \* APPLE COMPATIBLE PRODUCTS \*

• APL II+ COMPATIBLE MOTHER BOARD	\$230	• DISK CONTROLLER CARD II+ or IIe	\$39
• APL II+ COMPATIBLE 80 COLUMN CARD	\$230	• 16K MEMORY/LANGUAGE CARD	\$29
W/64K MEMORY	\$48	• JOYSTICK II+ or IIe	\$19
• APL II+ CASE, KEYBOARD w/KEYPAD	\$119	• FANCY JOYSTICK II+ or IIe	\$15
• SS SERIAL CARD	\$69	• HALF HEIGHT DISK DRIVES II+ or IIe	\$118
• APL II+ REPLACEMENT KEYBOARD	\$58	• HC DRIVES	\$138
• APL II+ REPLACEMENT CASE	\$58	• SUPER COOLING FANS II+ or IIe	\$24
• POWER SUPPLY (REPLACEMENT II+ or IIe)	\$39	• APPLE VIDEO 7 RGB	\$158
• APL II+ DETACHABLE KEYBOARD w/KEYPAD	\$99		
• APL II+ COMPATIBLE MOTHER BOARD	\$189		
• APL II+ REPLACEMENT CASE	\$38		
• APL II+ REPLACEMENT KEYBOARD	\$38		
• APL II+ EXTERNAL KEYBOARD	\$78		
• APL II+ FUNCTION, NUMERICAL KEYPAD & CASE	\$78		
• EPROM WRITER CARD	\$58		
• Z-80 CP/M CARD	\$38		
• GRAPPLER COMPATIBLE PRINTER CARD	\$39		
• PRINTER CABLES	\$13		
• 80 COLUMN CARD FOR II+	\$42		



2e CASE &amp; KEYBOARD w/KEYPAD

MAIL TO BTE Computers, Inc.

P.O. BOX 30705C • PHOENIX, AZ 85046-0705 • PHONE (602) 867-8962

MASTER CHARGE, VISA, ARE WELCOME. \$5.00 MINIMUM SHIPPING & HANDLING.  
NOT RESPONSIBLE FOR TYPOGRAPHICAL ERRORS. ALL PRODUCTS SUBJECT TO AVAILABILITY  
OR STOCK ON HAND. ALL PRICES ARE SUBJECT TO CHANGE WITHOUT NOTICE!  
ALL SALES ARE CASH DISCOUNT PRICES! REFUNDS ARE CREDITED ONLY.

## BOOK REVIEWS

### MACINTOSH GRAPHICS IN MODULA-2

Reviewed by Scott L. Norman

Macintosh owners interested in modern programming languages are probably aware that the Modula Corporation markets an implementation of Niklaus Wirth's Modula-2 for the Mac. MacModula-2, a nearly complete implementation of the language, can access several hundred Toolbox routines in the Mac's unique ROM.

This very richness of resources presents a problem. As hefty as the MacModula-2 documentation is (it runs to nearly 600 pages, not including a large supplement), it cannot provide detailed instructions for using all the Macintosh facilities. A need exists for additional information on specific topics, and Russell L. Schnapp's *Macintosh Graphics in Modula-2* is intended to address it.

### FIRST IMPRESSIONS

Schnapp assumes that his audience will use Wirth's own *Programming in Modula-2* (Springer-Verlag, 1982) or some other book as a general guide, so he devotes less than 10 pages to an overview of the language. Approximately the same amount of space is devoted to suggestions for organizing your working disks and to a run-through of the Modula-2 program-development cycle (compilation, linking, and debugging). The bulk of the book consists of listings of program modules that exercise the Mac's graphics capabilities, along with explanations of the theory behind the code.

The introductory material was clearly intended to help the inexperienced user get under way; unfortunately, it is already partially out of date. I obtained my review copy of the book at the same time as the MacModula-2 system itself, and I noted that the language package I received (version 4.0) is distributed among three disks instead of the two referred to in the book. Some of the files have been renamed as well. This is hardly a major flaw, but it does point up the difficulty of keeping Macintosh books synchronized with software updates.

There is another small stumbling block to bringing up Modula-2 under the guidance of this book. In an attempt to remember the users of 128K-byte Macs, the author frequently makes use of program modules that are to be found in disk files specifically intended for the small-memory machines. Users of 512K-byte machines (Fat Macs), who might want to save space by removing some of these files from their working disks, will have to change some details of Schnapp's program listings. For example, the QuickDrawTypes module required for most of the procedures in the book is found in a file intended for 128K-byte Macs; the equivalent resource for 512K-byte machines is called QuickDraw1. (The MacModula-2 supplement should be the final authority on what you need for various machine configurations.)

### ORGANIZATION

*Macintosh Graphics in Modula-2* proceeds through Macintosh graphics facilities, animation and simulation, interactive

(continued)



# Powerful MS-DOS<sup>TM</sup> Software.

For the IBM®-PC, XT, AT & others with generic MS-DOS/PC-DOS 2.0 or higher.

Not copy  
protected!

Only **\$39<sup>95</sup>** Each!

## UTAH COBOL<sup>TM</sup>

Whether student, teacher or professional programmer, this is the one you've heard so much about.

- It's easy to use. Compiles 5000 statements on a 128K machine.
- 170 clear error messages, i.e. DATA-NAME IS MISSING OR MISPELLED.
- Distribute your object code programs royalty free.
- Small object code programs conserve disk space.
- Fast compile times to increase programmer productivity. Over 25 times faster than one compiler costing \$995!
- You get a diskette and 213-page manual with lots of examples and 16 complete COBOL source code programs. **\$39.95.**

Also available: COBOL Application Packages, Book 1 **\$9.95.**

## UTAH PASCAL<sup>TM</sup>

- 14-digit precision, BCD math, no round-off errors with decimal arithmetic for business and floating point + 63 - 64 for scientific.
- A very nice TRACE style debugging.
- Arrays up to 8 dimensions and 64K strings.
- External procedures and functions with dynamic auto-loading.
- One-step compile, no assembly or link required.
- You get a 132-page manual and diskette. **\$39.95**

## UTAH PILOT<sup>TM</sup>

- Perfect for industrial training, office training, drill and testing, virtually all programmed instruction, word puzzle games, and data entry facilitated by prompts.
- John Starkweather, Ph.D., the inventor of the PILOT language, has added a built-in full-screen text editor, and much more.
- Meets all PILOT-73 standards for full compatibility with older versions.
- You get a diskette, 125-page manual and ten useful sample programs. **\$39.95.**

Also still available for 8-bit machines with CPM<sup>®</sup> is our world famous Nevada Software Series used by 50,000 customers in 40 countries. These include Nevada COBOL, Nevada FORTRAN, Nevada PASCAL, Nevada PILOT, Nevada BASIC and Nevada EDIT. **\$39.95** each.

Satisfaction guaranteed. If for any reason you're not completely satisfied, just return the package within 15 days in good condition, and we'll refund your money.

IBM is a registered trademark of International Business Machines Corp. CPM is a registered trademark of Digital Research. MS is a trademark of Microsoft Corp. © 1985 Ellis Computing, Inc.

## UTAH FORTRAN<sup>TM</sup>

- FORTRAN IV based upon ANSI-66 standards.
- Very fast compile times and easy to use.
- IF . . THEN . . ELSE constructs.
- Chaining with blank and named common.
- Copy statement.
- ENCODE and DECODE.
- Free-format input and output.
- A very nice TRACE style debugging.
- 150 English language error messages.
- You get a diskette, and 223-page manual. **\$39.95**

## UTAH EDIT<sup>TM</sup>

- A character-oriented full-screen video display text editor designed specifically to create COBOL, FORTRAN and PASCAL programs.
- Only requires 15K disk space so it can fit on the same disk as your compilers.
- Completely customizable tab stops, default file type, keyboard control key layout and CRT by menu selection.
- Diskette comes with easy to read 58-page manual. **\$39.95.**

## UTAH BASIC<sup>TM</sup>

- This interpreter has a built-in full-screen editor.
- Single- and Multi-line user definable functions.
- BCD Math- no round-off errors.
- Full Matrix operations.
- You get 220-page manual and diskette. **\$39.95.**



Handling/Shipping: No shipping charge within US. Overseas add \$10 for first package, \$5 each additional. Checks must be in US Dollars, drawn on a US bank.

Utah Software requires 128K RAM and PC-DOS or MS-DOS 2.0 or higher.

HOW TO ORDER. Send check or money order to Ellis Computing, Inc. with VISA or MASTERCARD order by phone. Sorry no COD's.



Ellis Computing, Inc.  
5655 Riggins Court, Suite 10  
Reno, Nevada 89502  
Phone (702) 827-3030

SINCE 1977  

**ELLIS COMPUTING<sup>TM</sup>**

# AT LAST: Professional Typesetting Capability For PC Users

With **PC<sub>T</sub>EX<sup>TM</sup>** — the best-selling full implementation of Professor Don Knuth's revolutionary typesetting program **TEX**.

**FINEST Typeset Quality Printing From:**  
dot matrix      laser      phototypesetter

$$\sum_{i=1}^{\infty} \frac{1}{i} \begin{pmatrix} a_{11} & \dots & a_{1n} \\ a_{21} & \dots & a_{2n} \\ \vdots & \ddots & \vdots \\ a_{m1} & \dots & a_{mn} \end{pmatrix} \int_{-\infty}^{\infty} e^{-x^2} dx$$

**WIDEST Range Of Output Device Drivers:**

- Epson FX, LQ
- Toshiba
- Corona LP-300\*
- Screen preview, with EGA or Hercules card
- HP LaserJet\*
- Apple LaserWriter
- APS-5 phototypesetter

**MOST COMPLETE Product Offering:**

PC<sub>T</sub>EX (not copy protected) includes the following:

- Our specially written *PC<sub>T</sub>EX Manual*, which enables you to start using **TEX** right away.
- Custom "macro packages" that provide formats for letters, manuals, technical documents, etc.
- The **L<sup>A</sup>T<sub>E</sub>X** document preparation system, a full-featured macro package for preparing articles, books, reports, etc., and **L<sup>A</sup>T<sub>E</sub>X User's Manual**.
- **A<sub>M</sub>S-TEX**, developed by the *Amer. Math. Society* for professional mathematical typesetting.

Site licenses, volume discounts, and interfaces to PC Paintbrush, PC Palette, FancyFont and Fontrix are also available.

**PRICED FROM ONLY \$249.00!**

(Printer drivers and interfaces additional.)



**Laser printer,  
fonts & software  
from \$2995.00**

For IBM PC/XT, AT or compatible, DOS 2.0 or higher, and 512K RAM. Hard disk required for printer drivers and fonts.  
\*HP LaserJet and Corona require additional interface boards.

**For more information call or write:**

**Personal TEX, Inc.**

20 Sunnyside, Suite H, Mill Valley, CA 94941 (415) 388-8853

This ad, with space for the photograph, produced by PC<sub>T</sub>EX. Typeset on the Epson FX80, the Corona LP-300 laser printer, and the Autologic APS-5 phototypesetter.

TEX is a trademark of the American Mathematical Society. Manufacturers' product names are trademarks of individual manufacturers.

## BOOK REVIEWS

graphics, and the third dimension. Each chapter includes exercises and a bibliography. There are two appendixes summarizing important QuickDraw and Toolbox procedures, as well as a glossary and an index.

The chapter on graphics facilities introduces a new library module. MiniOD, for the reader to copy onto a working disk. MiniOD provides access to a few of the most important QuickDraw routines, such as those for handling the graphics pen and drawing predefined shapes, and is called upon by most of the other routines in the book. The code listing is followed by brief descriptions of the data types that it imports from other prepackaged modules, along with descriptions of the procedures it exports in turn.

That's the basic pattern for the remainder of the book: Complete modules are used to introduce new concepts, and earlier modules are frequently drawn upon in the best spirit of Modula-2. Schnapp does a fairly good job of explaining the function of each procedure, though I suspect beginners might appreciate lengthier explanations.

It is unfortunate that some of the typography is unclear. The module listings are photoreduced from dot-matrix printouts, and it is sometimes difficult to distinguish vital punctuation marks: a few letters are sometimes blurred as well. You can avoid eyestrain by purchasing a disk from Schnapp's own company that contains source code for all the modules in the book.

The graphics facilities chapter goes on to develop modules for drawing nested shapes and filling them with predefined patterns. A drawing program constructs a map of the United States and introduces the idea of reading coordinates from a data file. The author does not make it clear, however, that the file has been created with a text editor, and there is some misinformation about the program's ability to supply the .DAT suffix to the filename.

The discussion of animation and simulation starts with simple shapes that can be drawn and erased so quickly that they produce a good illusion of motion. Schnapp moves on to the use of scrolling to handle more complex shapes. There is a useful treatment of a reliable timer module and a good summary on equations of motion as they apply to generalized moving objects. Bouncing-ball routines, with and without simulated frictional losses, illustrate this material.

The interactive graphics chapter helps the reader use Modula-2 to manage a mouse, menus, and windows. The book treats the use of the mouse for pointing, selecting, and manipulating objects and briefly describes the use of the computer's event queue. The manipulation of objects by pushing and dragging has its limits, so the chapter explains how to set up command menus with such professional-looking features as shaded lettering for unavailable options. There is a good discussion of windows (including resizing and updating them) but nothing on dialog boxes, push buttons, or edit fields.

A discussion of three-dimensional graphics opens with a quick review of orthographic projection and the mathematics of rotating an image about the coordinate

(continued)



## MAKE THE CONNECTION . . .

Our **Connection** systems will solve your problem of trying to read and write diskettes or tapes from almost any computer system using your PC.

The **Diskette Connection** is a hardware system that enables the IBM PC or compatible to read and write most 8 inch, 5¼ inch, or 3½ inch diskettes.

With our **File Connection** software programs you can transfer data files between most computer systems, including CP/M, DEC, Honeywell, Univac, IBM 3740, S/1, S/3, S/23, S/32, S/34, S/36, and S/38.

Our **Word and Typesetting Connection** programs use IBM standard Document Content Architecture (DCA-RFT) to transfer document files between most word processing and typesetting systems, including Compugraphic MCS, CPT, Displaywriter, OS/6, Multiset, NBI, Quadex, Xerox, and Wang.

Our **Tape Connection** system will read and write IBM or ANSI standard ½ inch 1600 BPI magnetic tape. A full size 2400 foot tape can store a 45 MByte file and be written in 6 minutes.

Since 1982, we have supplied thousands of systems to customers around the world, including IBM, NASA, AT&T, Kodak, and General Motors.

Our specialty is conversion systems and we can provide a solution to your problem. Call us today to discuss your requirements.

*This ad is one of a series featuring NASA missions. For a free poster, send us your written request.*

Box 1970 Flagstaff, AZ 86002  
(602) 774-5187 Telex 705609

Inquiry 136 for End-Users.  
Inquiry 137 for DEALERS ONLY.

## . . . FLAGSTAFF ENGINEERING

# VIP SERVICE

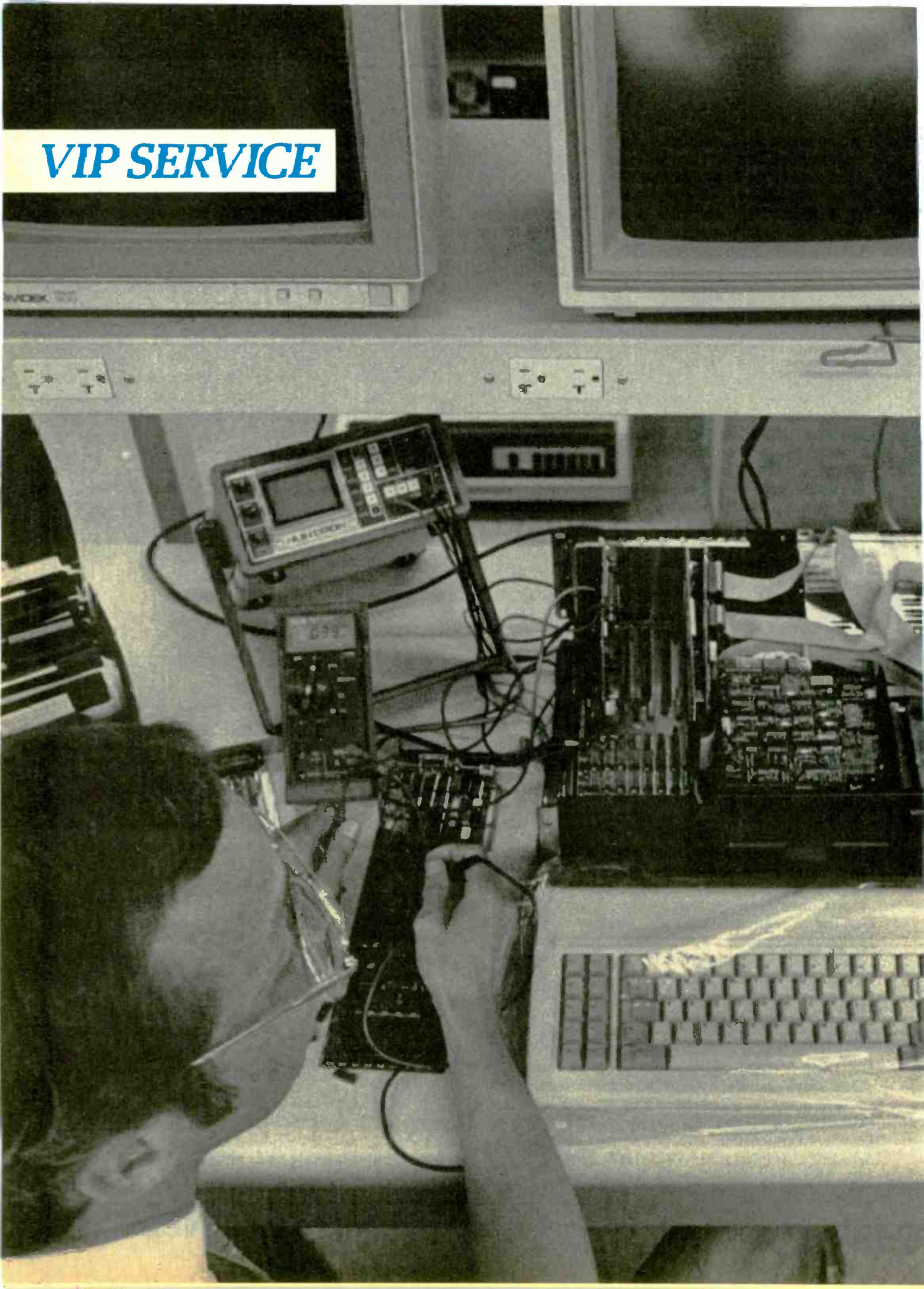

If you're a serious PC user, you know that even the finest personal computer products can develop problems. When that happens, Micro Mart customers know they can trust us to get them on-line again.

We have the largest in-house service department in the Southeast. Our experienced

technicians offer the fast, reliable service that business needs. Plus expert advice and information to help you select the right PC options from our \$15 million inventory.

Micro Mart service and support. For some very important people. Our customers. Call us today.

## COMPUTERS

### MULTIFUNCTION BOARDS

We have a complete line of Multifunction Boards compatible with the Portable, XT/AT.

SIX PAK 64-384K, multifunc. \_\_\_\_\_  
I/O MINNIE I/O shortboard for Portable & AT \_\_\_\_\_ **New Low Price!**

ADVANTAGE 128K-3Mb, expansion for AT \_\_\_\_\_  
RAMPAGE 64K-2Mb \_\_\_\_\_ **NEW!**

QUADRAM QUADBOARD Loaded, 384K \_\_\_\_\_ **CALL!**

QUADRAM GOLDBOARD, 384K \_\_\_\_\_ \$459

TECMAR CAPTAIN O-384K, multifunc \_\_\_\_\_ \$175

TALLTREE J-RAM II \_\_\_\_\_ **CALL!**

INTEL ABOVE BOARD, PC & AT \_\_\_\_\_ From \$280

THEYSIS FASTCARD \_\_\_\_\_ \$235

### GRAPHIC CARDS

HERCULES Mono & Color Graphics cards \_\_\_\_\_ **New Low Price!**

TECMAR Graphics Master, HiRes Color & Mono supports Lotus \_\_\_\_\_ \$449

QUADRAM Quadcolor I & II color cards \_\_\_\_\_

PARADISE Multi-display or modular graphics cards \_\_\_\_\_ From \$199

STB Chauffeur & EGA Plus \_\_\_\_\_ From \$289

SIGMA Color 400 for PGS SR-12 \_\_\_\_\_ **New Low Price!**

### FLOPPY DISK DRIVES

1/2 HEIGHT Disk Drives from Shugart, Mitsubishi, TEAC and Toshiba. PC, XT & AT Compatible. \_\_\_\_\_ From \$99

**BEST SUPPLY ON EAST COAST**

### HARD DISCS

IRWIN/TANDBERG Tape back-up systems \_\_\_\_\_ From \$495

SEAGATE Fast 10, 20, 30, and 75 Meg. for PC & AT \_\_\_\_\_ **CALL!**

RODIME Hard Discs in Stock \_\_\_\_\_ **CALL!**

SYSGEN Complete line \_\_\_\_\_  
\_\_\_\_\_ **Call for our special Sysgen pricing!**

BERNOULLI TECHNOLOGY Hard disc Subsystems \_\_\_\_\_ From \$2875

PRIAM Superfast 40 & 60 Meg. for AT \_\_\_\_\_ **Call!**

Best availability of voice coil and stepper motor hard drives with highest quality controllers \_\_\_\_\_ From \$495

## SOFTWARE

### ACCOUNTING, SPREADSHEETS & INTEGRATED PACKAGES

SORCIM/IUS Complete line including Windows \_\_\_\_\_ From \$295/each

SORCIM SuperCalc 3, vers. 2.0 \_\_\_\_\_ **New Low Price!**

### ENHANCEMENTS & UTILITIES

FOX & GELLER Complete line for dBase II/III, RBase 4000 \_\_\_\_\_

NORTON Utilities 3.0 \_\_\_\_\_ \$69

ROSESOFT ProKey 3.0 \_\_\_\_\_ \$89

CENTRAL POINT SOFTWARE Copy II PC \_\_\_\_\_ \$35

SOFTSTYLE Set FX+ and Printworks, printer control \_\_\_\_\_

SIDEWAYS Inverts printout \_\_\_\_\_ \$51

BORLAND SideKick and SuperKey \_\_\_\_\_ From \$40

BORLAND Lightning and Reflex \_\_\_\_\_ **New! Call!**

### COMPILERS & LANGUAGE TOOLS

LATTICE C-Compilers \_\_\_\_\_ \$279

MICROSOFT Complete line \_\_\_\_\_

MICROSOFT QuickBasic \_\_\_\_\_ **New Low price!**

BORLAND Turbo Pascal, Turbo Toolbox & more \_\_\_\_\_ From \$35/each

### GRAPHICS

Z-SOFT PC Paintbrush, mouse graphics \_\_\_\_\_ \$95

DECISION RESOURCES ChartMaster, Latest Version, **CALL!**

MICROSOFT Chart \_\_\_\_\_ **CALL!**

MICROSOFT Windows \_\_\_\_\_ **CALL!**

### COMMUNICATIONS

MICROSTUF Crosstalk XVI, Latest version \_\_\_\_\_ \$99

HAYES Smartcom II \_\_\_\_\_ \$85

### WORD PROCESSING

MULTIMATE w/spelling checker & tutorial \_\_\_\_\_ **New Low Price!**

MICROSOFT Word, New version \_\_\_\_\_ **New Low Price!**

LIFETREE Volkswriter Deluxe \_\_\_\_\_ \$169

SSI WordPerfect, version 4.1 \_\_\_\_\_ **New Low Price, CALL!**

MICROPRO WordStar Professional series \_\_\_\_\_ **New Low Price!**

### OFFICE & PROJECT PLANNING

HARVARD Total Project Manager \_\_\_\_\_ \$339

SORCIM/IUS Super Project \_\_\_\_\_ \$199

MICROSOFT Project \_\_\_\_\_ \$175

### DATA BASE MANAGERS

Call for unadvertised Data Base Managers \_\_\_\_\_

MICRORIM 5000, Report Writer & Clout \_\_\_\_\_ **New Low Price!**

WARNER SOFTWARE The Desk Organizer \_\_\_\_\_ \$145

MICROSTUF Infoscope \_\_\_\_\_ \$99

## NETWORKING/ PROTOCOL CONVERSION

SNA & BISYNC 3780, 5251, Mod 11 & 12, 3274, 3278 \_\_\_\_\_

PC TURBO 186/187 board, 128K, 8087 Serial Board attached \_\_\_\_\_ \$875

IRMA Complete line \_\_\_\_\_ From \$849

## PRINTERS

We have thousands in stock.

### DOT MATRIX

EPSON FX85/286 \_\_\_\_\_ **NEW!**

EPSON LQ1500/LQ800/LQ1000 \_\_\_\_\_ **New Prices!**

OKIDATA 192 & 193, ML84, Pacemark 2410 \_\_\_\_\_

TOSHIBA P-341, P-351 & NEW 321 \_\_\_\_\_ **New Low Prices!**

NEC New P-5, P-6 & P-7. **Low Price!**

### LETTER QUALITY

NEC Spinwriters 2050, 3550, 8850 \_\_\_\_\_ **New Low Prices!**

EPSON DX20 & DX35 \_\_\_\_\_

**New Letter Quality Printers!**

We carry a full range of form handling options.

## CHIPS

All our chips are tested and priced for quick sale. Call us!

INTEL 8087, 80287, high speed coproc. \_\_\_\_\_ **Call for Market Price.**

64K-256K RAMCHIPS \_\_\_\_\_ **Call for Market Price.**

128K Piggy-back chips for your AT \_\_\_\_\_ **Call for Market Price.**

## MODEMS

HAYES Smartmodem 300, 1200, 1200B & 2400. We have the best stock in the USA \_\_\_\_\_ **Call!**

VEN-TEL 1200 Baud Half Card w/Crosstalk \_\_\_\_\_ \$399

PEACHTREE TECHNOLOGIES P-1200 ext. \_\_\_\_\_ \$279

## MISCELLANEOUS

MAXELL Diskettes \_\_\_\_\_ \$25

DYSAN Diskettes at the lowest price in the USA \_\_\_\_\_ **Call!**

MOUSE SYSTEMS PC Mouse, optical w/software \_\_\_\_\_ \$139

MICROSOFT Mouse, bus or serial mechanical \_\_\_\_\_ **New model in stock!**

KEYTRONICS 5151 keyboards \_\_\_\_\_ **CALL!**

KEYTRONICS 5153 Keyboard with mouse \_\_\_\_\_ **NEW!**

KENINGTON MICROWARE MasterPiece \_\_\_\_\_ \$99

CURTIS Accessories, Pedestals, cables, etc. \_\_\_\_\_

GRAVIS Joysticks \_\_\_\_\_ \$45

QUADRAM Microfazer print buffer 8-128K \_\_\_\_\_ From \$129

TRIPPELITE ISOBAR surge protectors, 4 & 8 plug \_\_\_\_\_ From \$49

POLAROID Palette \_\_\_\_\_ \$1245

## MONITORS AND CRTS

PGS Max12 (E), HX12, HX12(E), & SR-12 \_\_\_\_\_ **New Low Prices!**

AMDEK Color 600 \_\_\_\_\_ **CALL!**

AMDEK 722, New alternative to IBM enhanced monitor \_\_\_\_\_ \$569

AMDEK 300A/300G/310A \_\_\_\_\_ \$129/\$119/\$165

© Copyright 1986, Micro Mart, Inc. Technology Corporate Campus 3159 Campus Drive Norcross, Georgia 30071

Prices are subject to change without notice and are similar, but may vary at over 20 Micro Mart Retail Stores.

Leasing and financing options are available. MasterCard/VISA or ask for Micro Mart Blue Chip Credit.



(404) 449-8089

Orders only

1-800-241-8149

BT 5/86



America's PC Specialist

## SAVE MONEY ON EPROM PROGRAMMER



TECHNICAL BREAKTHROUGH NOW ALLOWS A PRICE REDUCTION

only \$26500

### A SIMPLE, INEXPENSIVE SOLUTION TO PROGRAMMING EPROMS

Why spend hundreds more for a programmer when you can buy the APROTEK-1000 for only \$265.7

The APROTEK 1000 can program 5 volt, 25XX series, 27XX series and 68XXX series devices plus CMOS versions of the above types. Included with each programmer is a personality module of your choice. You may require future modules at only \$15.00. Please specify modules by EPROM Type.

APROTEK 1000 comes complete with a menu driven program which allows READ, WRITE, COPY and VERIFY with Checksum. Easy to use with IBM, Apple, Kaypro and CPM microcomputers with a RS-232 port. Interface is a simple 3-wire RS-232C with a female DB-25 connector. A handshake character is sent by the programmer after programming each byte. The interface is switch selectable at 6 baud rates & between 300 and 19.2k baud.

The APROTEK 1000 is truly universal. It comes standard at 117 VAC 50/60 HZ and may be Internally jumpered for 220-240 VAC 50/60 AZ. FCC verification (CLASS B) has been obtained.

APROTEK 1000 is covered by a 1 year parts and labor warranty

TECHNICAL INFO: 1-(805) 987-2454

CALL OUR TOLL FREE ORDER LINES TODAY:

1-(800) 962-5800 US or 1-(800) 962-3800 CA  
1071-A Avenida Acaso, Camarillo, CA 93010



## ENHANCED GRAPHICS ADAPTER

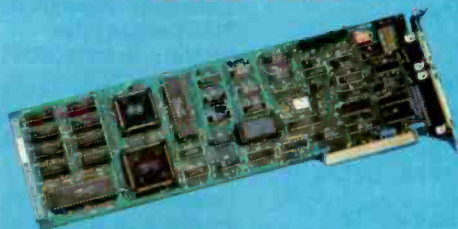

### SEGA Board

- On Board 256K Display Memory
- Compatible with the IBM EGA, CGA & MDA
- Works with Monochrome, RGB & Enhanced Color Monitors
- Runs the software supporting IBM EGA card

SEGA Board ..... \$395  
SEGA with EGA Monitor ..... \$895

Order Toll Free (800) 826-0267  
In California Call (415) 651-3355

**SOURCE ELECTRONICS CORP.**  
45277 Fremont Blvd., #6  
Fremont, CA 94538

IBM is a registered trademark of International Business Machines, Inc.

## BOOK REVIEWS

axes. Results are simply stated without proof, but the treatment should pose no particular problem to anyone who has a nodding acquaintance with sines and cosines. In any case, the demonstration routines (which feature rotating, tumbling images) are quite explicit when it comes to setting up the coordinate transformations needed to represent solid objects on the CRT.

The chapter starts with wire-frame images whose vertices are read from a data file; a wire-frame space shuttle is also used to demonstrate the construction of stereo pairs of images. Matters conclude with modules that employ the powerful concept of the QuickDraw region in a more general technique for handling hidden edges.

I found that the wire-frame demonstration module had problems. Elements often failed to join up properly as the image rotated, for example. Things improved with the SolidCube program and its derivatives. There is considerable flicker when the drawing routines are handling complex tasks, such as rotating the "illuminated" cube; I assume this happens because MacModula-2 compiles to an intermediate interpreted code and not to machine language.

### AN EVALUATION

In his preface, Russell Schnapp states that his objective was to write a book that would serve both as a tutorial on applying Modula-2 to specific tasks and as an introduction to Macintosh graphics with a Modula-2 orientation. On balance, the book is successful, although Schnapp has done better on the first count. The book is too terse to serve as a general-purpose guide to the Mac's storehouse of graphical tools. It is considerably more successful as a vehicle for helping Modula-2 users to write useful, polished-looking programs. Readers with some previous exposure to the ideas behind the Mac's user interface should be able to extend the book's program modules to handle other graphical chores quite handily.

Scott L. Norman (8 Doris Rd., Framingham, MA 01701) is on the technical staff of GTE Laboratories in Waltham, Massachusetts, and is a frequent contributor to computer magazines.

### ALGORITHMS AND DATA STRUCTURES

Reviewed by Michael O'Neill

The writing of books about data structures and algorithms is virtually a cottage industry these days. *Algorithms and Data Structures* immediately stands out from the crowd because of the stature of its author. Niklaus Wirth is well known as the designer of the languages Pascal and Modula-2 and as a high-profile advocate of what is loosely known as "structured programming." Unfortunately, this book's first notable feature is also its last; it has little else to recommend it.

The section developing the algorithm for building an optimal binary search tree is one example of the book's problems. Most of the derivation of this algorithm is straight-

(continued)

# MICROWAY'S 8087 RUNS 1-2-3™!

MicroWay is the world's leading retailer of 8087s and high performance PC upgrades. We stock a complete selection of 8087s that run at 5 and 8mhz. All of our coprocessors are shipped with a diagnostic disk and the best warranty in the business - one year! We also offer daughterboards for socketless computers (NEC PC) and 287Turbo which increases the clock speed of the 80287 from 4 to 8 mhz. Our NUMBER SMASHER™ includes 640K ram. It will run the IBM PC at clock speeds up to 10mhz and achieves a throughput of .1 megaflops with 87BASIC/INLINE, Intel

Fortran, or Microsoft Fortran. Software reviewers consistently cite MicroWay software and 8087 expertise as the best in the industry! Our customers frequently write to thank us for recommending the correct software and hardware to meet their specific needs. They also thank us for our same day shipping! In addition to our own products which support the 8087 and 80287, we stock the largest supply of specialized software available. For information call us at

617-746-7341

**FASTBREAK™** employs the 8087 to increase the speed of Lotus 1-2-3™ Version 1A or 1A\* by up to 36 to 1 **\$79**  
**FASTPAK™** includes FASTBREAK software and a 5mhz 8087 ..... **\$179**  
**87SFL™** MicroWay's Scientific Function Library contains 170 scientific and engineering functions. Callable from most 8087 compatible compilers. First Language **\$250**; Additional **\$100**  
**A2D-160™** MicroWay's Data Acquisition Board performs 160,000 12 bit Analog to Digital conversions per second! Includes software drivers. The fastest 12 bit A to D board available. For the IBM PC or XT..... **\$1295**

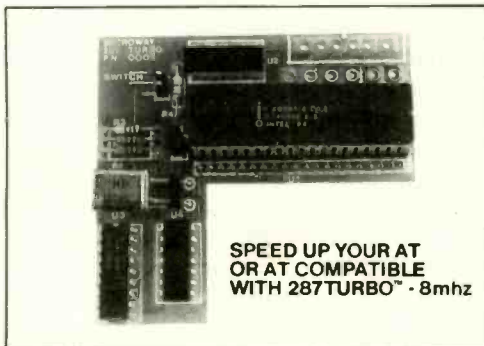

## MicroWay® 8087 Support

For the IBM PC, PC XT, PC AT and Compatibles.

**NUMBER SMASHER™** The World's Fastest Accelerator Card for the IBM PC, XT, and Compatibles! Includes an 8086 and 8087 pair tested to 10mhz, and 640K bytes of high speed ram. Compatible with all software, operating systems and hardware! Your program speed is increased by a factor of 2.5 to 4.0. Floating point programs run up to 2.8 times faster on the PC than on an 80287 equipped PC AT. One of the few accelerators on the market which is compatible with all EMS cards. Includes FASTBREAK..... **\$1099**

**87/88Turbo™** is a stubby card which includes a clock calendar and a speed controller which changes the speed of your motherboard from 4.77 to 7.4mhz. Its use requires your PC to have a socketed 8224. Typical speed increase is 1.6. Some programs run up to 2.5 times faster. The card overcomes the problem of slow hardware by slowing up only when slow devices are accessed and running at full speed otherwise. It includes an 8087-2 ..... **\$350**

**286TurboCache™** This new MicroWay accelerator uses 8K of cache memory and 80286/80287 processors to provide an average speed increase of 3 to 1 for most programs. Call for specifications, benchmarks and price.

**MATRIXPAK™** manages a **MEGABYTE!** Written in assembly language, our runtime package accurately manipulates large matrices at very fast speeds. Includes matrix inversion and the solution of simultaneous linear equations. Callable from RM or MS Fortran, MS Assembler, or 87BASIC/INLINE..... each **\$99**

**87FFT™** Written in assembly language, performs Forward and Inverse FFTs on real and complex arrays which occupy up to 512K bytes of RAM. Also does convolutions, auto correlations, hamming, complex vector multiplication, and complex to radial conversions. Callable from most 8087 compatible compilers..... **\$200**

**87FFT-2™** performs two-dimensional FFTs. Ideal for image processing. Requires 87FFT **\$100**

**MegaPage™** Our Intel-Lotus specification memory card. The only EMS board which comes with two megabytes of cool-running, low power drain CMOS ram installed. Includes ram disk, print spooler, disk cache, and EMS drivers. For the IBM PC, XT, AT and compatibles ..... **\$549**

**DFixer™** Our disk utility which thoroughly checks PC or AT hard disks for bad sectors and updates the MS DOS file allocation table accordingly. Solves the AT hard disk problem! ... **\$149**

**DOptimizer™** Optimizes the way your hard disk or floppy stores its files. Speeds up accesses by recombining fragmented files ..... **\$49**

**DCache™** Our disk caching software speeds up your I/O by storing repetitively used tracks in memory. The amount of memory used can be selected in 64K byte banks ..... **\$49**

**87Verify™** For users who have to be absolutely sure of their results! This background task periodically performs an 8087 accuracy and stress test **\$49**

**87MACRO/DEBUG™** Contains all the pieces needed for writing 8087/80287 assembly code including 8087 macros, object libraries for commonly used functions. Including transcendental, trigonometric, conversions and MicroWay's debugger - 87DEBUG ..... **\$199**

**OBJ-ASM™** A multipass object module translator and disassembler. Produces assembly language listings which include public symbols, external symbols and labels commented with cross references. Ideal for patching object modules for which source is not available. .... **\$200**

**87BASIC™** includes patches to the IBM Basic or MS Quick Basic Compiler for USER TRANS-PARENT 8087 support. Provides super fast performance for all numeric operations including trigonometrics, transcendental, addition, subtraction, multiplication, and division. .... each **\$150**

**87BASIC/INLINE™** converts the output of the IBM Basic Compiler into optimized 8087 inline code which executes up to seven times faster than 87BASIC. Supports separately compiled inline subroutines which are located in their own segments and can contain up to 64K bytes of code. This allows programs greater than 128K! Requires the IBM Basic Compiler Version 1 and Macro Assembler. Includes 87BASIC ..... **\$200**

**MICROWAY UDI** runs RTOS or RMX compilers under DOS ..... **\$300**

### 8087 UPGRADES

All MicroWay 8087s include a one year warranty, complete MicroWay Test Program and accurate Installation Instructions.

**8087 5mhz..... \$109**  
For the IBM PC, XT and compatibles.

**8087-2 8mhz ..... \$149**  
For Wang, AT&T, DeskPro, NEC, Leading Edge.

**80287-3 5mhz..... \$179**  
For the IBM PC, AT and 286 compatibles.

**80287-8 8mhz ..... \$295**  
For the Tandy 3000 and ITT-XP.

**287Turbo™ 8mhz** If you own an AT, Deskpro 286 or AT compatible, this is the card you need to get reasonable numeric performance. It plugs into your 80287 socket and includes a specially driven 8mhz 80287. The card comes in three configurations. The IBM AT version includes a hardware RESET button ..... **\$395**

**NEC V20, V30 ..... CALL**

**64K RAM Set 150ns ..... \$10**

**256K RAM Set 150ns ..... \$34**

**128K RAM Set PC AT ..... \$49**

**JRAM, AST, INTEL ..... CALL**

DCache plus 64K ABOVE BOARD PS. .... **375**

DCache plus 128K AT ABOVE BOARD. .... **475**

Microsoft Fortran Version 3.31 ..... **209**

IBM Professional Fortran ..... **565**

Ryan-McFarland Fortran Version 2.0 ..... **399**

FORLIB+ or STRINGS and THINGS. .... **65**

Grafmatic for Fortran or Pascal. .... **125**

Plotmatic. .... **125**

NAG Fortran Library. .... **300**

Lattice C ..... **289**

Microsoft C or QuickBasic. .... **CALL**

IBM Basic Compiler Version 2.0 ..... **465**

Summit BetterBASIC™ ..... **CALL**

IBM Assembler w/Library Version 2.0. .... **155**

Microsoft Assembler Version 3.01 ..... **99**

Microsoft Pascal Version 3.31 ..... **199**

STSC APL★PLUS/PC. .... **450**

Phoenix Plink86 or Cosmos Revelation. ... **CALL**

SPSS/PC+ ..... **595**

EPSILON Text Editor ..... **195**

LABTECH NOTEBOOK ..... **745**

MultiHalo (one language) ..... **189**

Fifth Generation FASTBACK ..... **150**

**MicroWay** P.O. Box 79  
Kingston, Mass.  
02364 USA  
(617) 746-7341

# DARE TO COMPARE!

## IBM® PC/XT-COMPATIBLE COMPUTER SYSTEM

COMPARE OUR SYSTEM COMPONENTS TO OTHERS & SAVE!

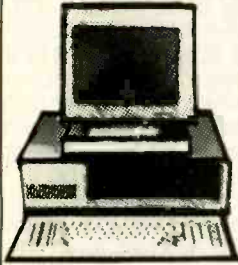

### OURS

- 25K Memory included
- 150-Watt Power Supply
- Monochrome Graphic Printer Included
- Name-Brand Disk Drives such as TEAC & QUME
- MAGNAVOX High-Resolution TTL Monitor
- Full Warranty on all products: 1 yr. Warranty on boards, 2-yr. on MAGNAVOX monitors

### THEIRS

- Only 128K or OK
- 135-Watt unit
- w/o Graphics or Print capability
- Brand XYZ, "Mama-san," or worse
- Low resolution, no-name monitors
- 90-day Warranty (If you're lucky)

IBM PC-XT Type Case No. 90180.....	\$ 33.00
150-Watt Power Supply No. 90155.....	65.00
5150 IBM-Type Keyboard No. 90130.....	45.00
Mother Board expandable to 640K with 256K installed No. SPCL03.....	135.00
Monochrome Graphic Printer Board No. 90010.....	75.00
Floppy Controller Board No. 92260.....	29.00
2-Floppy Disc Drives at \$85 each No. 93140.....	170.00
12" TTL High Resolution Monitor by MAGNAVOX No. 96710.....	87.00
Complete with Instruction & Assembly Manuals.	

### YOUR COST

**\$639<sup>00</sup>**

Any of these components may be purchased separately. All boards guaranteed for 1 year. IBM, PC/XT are trademarks of International Business Machines, Inc. Some assembly required.

### SmarTeam Modem

103/212A—Operates at 300 Baud & 1200 Baud  
• Hayes Compatible  
• Auto Answer, Dial & Redial  
Uses RS 232-C Connector  
No. 91990.....

**\$165.00**

### MAGNAVOX Color Monitor

• RGB High Resolution  
• 14" diagonal  
• 640 Dots/H-240 lines/80 column  
• Built-in Tilt Stand  
No. 97890.....

**\$318.00**

### Avatex 1200 Modem

• Auto Answer, Dial & Redial  
• FCC Approved  
• PC TALK III Software included  
• Automatic Self Test on Power-Up  
**COMPARE AT \$199.00**  
No. 97070.....

**\$99.00**

### Key Boards

5151 IBM Type Key Board Caps and Num Lock  
No. 51515..... **\$76.00**  
5150M XT Key Board—looks like AT, has big return key & LED indicators  
No. 99020..... **\$59.00**

## ADD-ON BOARDS FOR IBM® COMPATIBLE SYSTEMS

### Monochrome Graphic Printer Board

• Built in Parallel Printer Port • Text: 25 line x 80 column • Graphics: 720x348 resolution • TTL High Resolution Output  
No. 92270.....

**\$75.00**

### Multi I/O Card

• Built-in Floppy Controller that can drive 2 floppy drives • Two RS 232 Serial Adapters • Timer Port • Parallel Printer Port • Joystick Adapter  
No. 96770.....

**\$84.00**

### Multifunction Board

• Expandable to 384K RAM • Serial Port, Game Port • Parallel Printer Port • Clock Calendar w/Battery Backup • Software, Manuals and Cables  
No. 92290.....

**\$75.00**

### RS 232 Serial Board

• 1 Serial Port • 2nd Port optional  
No. 92310.....

**\$27.00**

### Parallel Printer Card

• Also may be used as I/O Port  
No. 92700.....

**\$21.00**

### Color Graphics Board

• RGB and Composite Port • Light Pen Interface • Graphics: 320x200 (color); 640x200 (BW) • Text: 25x80  
No. 92280.....

**\$65.00**

### Floppy Disk Controller

• Drives 2 Internal drives • Includes cable • IBM PC compatible  
No. 92260.....

**\$29.00**

PLUS A HUGE SELECTION OF CABLES & ACCESSORIES!



## THE WHOLESALE OUTLET

DEPT. BY 1 INTERSTATE AVENUE, ALBANY, NY 12205. To order call 1-800-344-4387 (Non-NYS Res.) or 518-459-7883 (NYS Res.) Personal and company checks accepted (on mail-in orders). Customer pays freight & handling FOB Albany, NY. Non-credit card orders shipped UPS, C.O.D. Minimum order \$25. Dealer and

large quantity orders call 518-459-7883. Ask for Computer Dept. Some items not as pictured. Prices subject to change.



## BOOK REVIEWS

forward, but Wirth presents it obscurely. A crucial fact (concerning expression 4.73) necessary for producing an efficient program is not so easy to derive; Wirth states it without a derivation. The development of the algorithm is further obscured by a nonstandard notation for summation, a consistently incorrect variable name in a summation limit (e.g., expression 4.68), and the use of the letter "k" to represent two different variables (in expressions 4.65 and 4.72). Finally, Wirth claims that the sample output, a search tree for keywords, was generated by applying the program to its own text; this is not so.

This probably sounds like nit-picking. It is. Most of the book is like the passage I just nit-picked. I find it difficult to learn anything from a text that contains obscure derivations, nonstandard notation, and incorrect formulas. I found no gross errors, but the little ones are legion.

Wirth does not appear to have made any firm decision concerning the degree of sophistication of this book's intended reader. The sections on data types and simple data structures, for example, are elementary, while the section on string searching is considerably more advanced.

This book is a substantially revised version of a work published 10 years ago (*Algorithms+Data Structures=Programs*, Prentice-Hall, 1976), which explains two more problems it has. One concerns Wirth's treatment of the technique of loop invariants. He uses this technique only in the sections that were added; the sections carried over from the original version do not have it. Loop invariants appear, are used for a few pages, vanish, and reappear 200 pages later. Wirth should have left this method out or used it throughout the text, and he should have explained it more clearly. The second problem concerns the choice of language for presenting programs. The earlier version of this book used Pascal; this edition uses Modula-2. I see no evidence that Modula-2 is superior to Pascal for the programs given in this book. Because of that, and because Pascal is more widely known and available than Modula-2, I think Wirth ought to have retained the former as his presentation language.

I have two complaints about the book's typography. First, the listings use indentation of about one character width; this does not provide a clear demarcation of different levels, particularly when a listing crosses to the next page. Second, the typeface is very light and difficult to read.

*Algorithms and Data Structures* does have some good points. Wirth presents a wide range of material of both theoretical and practical interest. The chapter on recursion and the section on string searching, for instance, provide good coverage of some subtle and useful algorithms without too much of the obscurity that mars the rest of the book.

The good points, however, do not outweigh the bad. For the most part, *Algorithms and Data Structures* is poorly structured and obscurely written, and I cannot recommend it. Both Robert L. Kruse's *Data Structures and Program Design* (Prentice-Hall, 1984) and R. Sedgwick's *Algorithms* (Addison-Wesley, 1983) are better books on this subject. ■

Michael O'Neill (2227 Dwight Way #4, Berkeley, CA 94704) has been programming computers for 20 years.



Unitex AT™

\$1,695

Unitex PC™

\$595

FREE SHIPPING



# UNITEX PC™

- \* System Board Expandable to 640K
- \* 256k Random Access Memory
- \* 8 Expansion Slots
- \* 360k Floppy Disk Drive
- \* 135 Watt Power Supply
- \* 5150 Type Keyboard
- \* Runs IBM PC Software
- \* One Year Warranty\*

Same System Plus 10 MB Hard Disk

\$995

\$595

UNITEX AT™ \$1,695

- \* System Board Expandable to 1024K
- \* 512k Random Access Memory
- \* 1.2 MB High Capacity Floppy Disk Drive
- \* Combined Floppy and Hard Disk Controller
- \* 230 Watt Power Supply
- \* Battery Backup Clock/Calendar
- \* AT Keyboard

UNITEX TURBO™ \$695

- \* System Board Expandable to 640K
- \* Keyboard Selectable 4.77Mhz and 8 Mhz Speeds
- \* 256K Random Access Memory
- \* 360K Floppy Disk Drive
- \* 135 Watt Power Supply
- \* 5150 Type Keyboard

# UNITEX CO.

4962 El Camino Real Los Altos, CA 94022

1-800-426-5916

Inside California: 1-415-967-6465

IBM PC, XT, AT are trademarks of IBM Corp.

\* Limited Warranty

Free shipping via UPS Ground in Continental United States. Unitex reserves all rights to substitute equivalent items.

All prices subject to change without notice.

Unauthorized returns subject to a 15% restocking charge.

# E·V·E·N·T Q·U·E·U·E

## May 1986

**SECOND ANNUAL INTERNATIONAL COMPUTER GRAPHICS IMAGE CONTEST.** For an entry form, contact Raster Technologies Inc., Two Robbins Rd., Westford, MA 01886, (617) 692-7900, ext. 226. Entries must be submitted by June 1.

**EXPO 86: THE 1986 WORLD EXPOSITION, Vancouver, British Columbia, Canada.** EXPO INFO, POB 1800, Station A, Vancouver, British Columbia V6C 3A2, Canada, (604) 660-3976.  
May 2-October 13

**VIDEOTEX '86: THE ELECTRONIC INFORMATION INDUSTRY SHOW INTERNATIONAL CONFERENCE & EXHIBITION, Infomart, Dallas, TX.** Cynthia Parsons, Online International Inc., 989 Avenue of the Americas, New York, NY 10018, (212) 279-8890. May 6-8

**AAMSI CONGRESS 1986: COMPUTER APPLICATIONS IN MEDICINE AND HEALTH CARE, Anaheim, CA.** AAMSI, 1101 Connecticut Ave. NW, Suite 700, Washington, DC 20036, (202) 857-1199.  
May 8-10

**ASSOCIATION FOR SYSTEMS MANAGEMENT ANNUAL CONFERENCE, New Orleans, LA.** Richard McCaffrey, Association for Systems Management, 24587 Bagley Rd., Cleveland, OH 44138, (216) 243-6900. May 11-14

**COMPUTER GRAPHICS '86, Anaheim, CA.** National Computer Graphics Association, 2722 Merrilee Dr., Suite 200, Fairfax, VA 22031, (800) 225-6242, or (703) 698-9600.  
May 11-15

**1986 ANNUAL INDUSTRIAL ENGINEERING CONFERENCE AND SHOW, Dallas, TX.** Institute of Industrial Engineers, Conference Department, 25 Technology Park/Atlanta, Norcross, GA 30092, (404) 449-0460. May 11-15

**FOURTH ANNUAL COMDEX/EUROPE, RAI Congress and Exhibition Centre, Amsterdam, The Netherlands.** The Interface Group Inc., 300 First Ave., Needham, MA 02194, (617) 449-6600; in Europe, World Trade Center, Tower C, 12th Floor, Strawinskyaan 1245, 1077 XX Amsterdam, The Netherlands; telephone: (31) 20-621941; Telex: 12358NL. May 12-14

**PRINTED CIRCUIT FABRICATION EXPO '86/MINNEAPOLIS: EXPLORE EMERGING TECHNOLOGY, Minneapolis, MN.** PC FAB Expo, Technical Seminars Trade Shows, 1790 Hembree Rd., Alpharetta, GA 30201, (404) 475-1818.  
May 12-14

**TROPICTRONICS/AMAZON TRADE FAIR II, São Paulo, and Manaus, Amazonas, Brazil.** Joseph Burke, International Trade Administration, U.S. Department of Commerce, Room 4044, Washington, DC 20230, (202) 377-5014. May 12-15 (São Paulo); May 19-22 (Manaus)

**ELECTRO/86 AND MINI/MICRO NORTHEAST, Boston, MA.** Electronic Conventions Management, 8110 Airport Blvd., Los Angeles, CA 90045, (213) 772-2965. May 13-15

**INFOBASE '86: INTERNATIONAL DATABASE EXHIBITION AND CONVENTION, Frankfurt, West Germany.** Michael Kip, Messe Frankfurt GmbH, Ludwig-Erhard-Anlage 1, POB 970126, D-6000 Frankfurt 97, West Germany; telephone: (0 69) 7575-477/520; Telex: 4 11 558 messe d.  
May 13-15

**THE L.A. PROFESSIONAL VIDEOSHOW AND VIDEO PRODUCTION CONFERENCE, Long Beach Convention Center, Long Beach, CA.** Lisa Welp, The Professional Videoshow, 51 Sugar Hollow Rd., Danbury, CT 06810, (203) 743-2120. May 13-16

**THE INFO SHOW: INFORMATION MANAGEMENT EXPOSITION & CONFERENCE, Los Angeles Convention Center, Los Angeles, CA.** Cahners Exposition Group, Client Services, 999 Summer St., POB 3833, Stamford, CT 06905, (203) 964-8287.  
May 14-16

**EURIT '86 (THE EUROPEAN CONFERENCE ON INFORMATION TECHNOLOGY IN EDUCATION): DEVELOPMENT OF EDUCATIONAL SOFTWARE AND COURSEWARE, Enschede, The Netherlands.** Pieter Sinnighe Damsté, c/o Twente University of Technology, COI, POB 217, NL-7500 AE Enschede, The Netherlands.  
May 20-23

**EUROCOMM 86: EUROPEAN COMMUNICATIONS WEEK AMSTERDAM 86, Amsterdam, The Netherlands.** EuroComm

86, c/o RAI Gebouw bv, Europaplein, 1078 GZ Amsterdam, The Netherlands; telephone: (020) 5 411 411. May 20-23

**SINO-EUROPEAN ARTIFICIAL INTELLIGENCE JOINT SEMINAR, Shenzhen, People's Republic of China.** Dr. Shao Zu-Ying, CCTS/ICOS, 5/F., Electronics Building, Shenzhen Special Economic Zone, People's Republic of China; in Europe, Dr. J. M. Richards, The Turing Institute, George House, 36 North Hanover St., Glasgow G1 2AD, Scotland.  
May 26-30

**AUTOMACH AUSTRALIA, Sydney, Australia.** Leslie Hossack, Society of Manufacturing Engineers, One SME Dr., POB 930, Dearborn, MI 48121, (313) 271-1500; in Australia, Adolph Greco, A. Greco & Associates Pty. Ltd., Integrated Project Management Services, POB 1399, Cherrybrook 2120, New South Wales, Australia; telephone: (02) 875-2377; Telex: SECCO AA25468. May 27-29

**USING COMPUTERS IN THE LAB: THE SECOND ANNUAL SYMPOSIUM FOR SCIENCE EDUCATORS, Tufts University, Medford, MA.** Symposium II, Technical Education Research Centers, 1696 Massachusetts Ave., Cambridge, MA 02138, (617) 547-3890. May 27-31

**WORKSPACE 86: PEOPLE, SPACE AND TECHNOLOGY, Moscone Center, San Francisco, CA.** Charles Yourd, Workspace, 665 Chestnut St., San Francisco, CA 94133, (415) 776-2111. May 28-30 ■

*IF YOU WANT your organization's public activities listed in BYTE's Event Queue, we need to know about them at least four months in advance. Send information about computer conferences, seminars, workshops, and courses to BYTE, Event Queue, POB 372, Hancock, NH 03449.*

# PC NETWORK GOES TO THE

# O R I E N T D I R E C T

How do you suppose most manufacturers of personal computer products get started?

They go to the Orient... taking either their designs or simply their ideas to one or more of the major electronics manufacturing concerns, getting bids for making these devices under contract to the creators. Multifunction Cards, Video Cards, Disk Controllers, Modems and I/O Boards all begin their life in this way.

This relationship between the manufacturing capabilities of the East and the design and marketing talents of the U.S. has resulted in the incredible selection of enhancement products for the IBM and Apple computer markets.

Well, with 100,000 members and growing strong, The Network sent its buyers east to visit some of these manufacturing

concerns to check out the feasibility of directly importing these products in the necessary volumes to *save our members money!* What they came back with was astounding.

Now, we always figured that there were some pretty substantial markups as these boards came into the country and got fancy boxes and marketing promotions under any one of a number of well known brand names in the peripheral add-on markets *but we had no idea they were so large!*

To prove our point, consider what they brought back. Each board is constructed to the same precise standards, on similar machinery to their name-brand duplicates. The difference? *As a Network member, you pay only 8% over our unusually low wholesale price...and you get our full 1 year warranty!*

## Hercules™ Smarter Brother

A Monochrome Graphics Card with Printer Port...100% compatible with Hercules™ product...



Wholesale price...  
**\$99.00\***

## Graphics Printer Interface

If all you want is a printer, this is the card for you. Supports all text and graphics printer features.

Wholesale price... **\$29.00\***



## The Multi-384 Board

A clone of the AST's SixPakPlus™, includes up to 384Kb of expansion memory, 1 serial, 1 parallel, 1 game port, a clock/calendar and software standard.

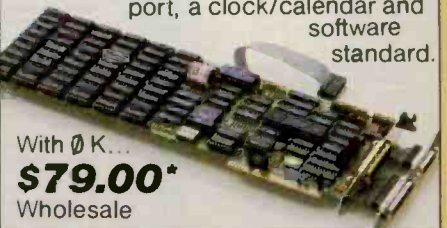

With 0 K...  
**\$79.00\***  
Wholesale

## IBM Color Card

100% compatible with the IBM offering. The wholesale price?



A mere **\$69.00\***

## I/O Multifunction Card

Identical I/O board to the AST's I/O+™ with 2 serial, (1 standard) 1 parallel, 1 game port and clock/calendar with software.



Wholesale price...  
**\$65.00\***

## 512 K Memory

The least expensive way to add memory to your current system. With 0 K installed.



Wholesale priced at only...  
**\$59.00\***

™Six Pack, I/O Plus and AST are all registered trademarks of AST Research Inc. Hercules is a registered trademark of Hercules Computer Technology Inc.

\*PC NETWORK Members pay just 8% above this wholesale price, plus shipping. All prices reflect a 3% cash discount. Minimum shipping \$2.50 per order. International orders call for shipping & handling charges. Personal checks: please allow 10 working days to clear.

**CALL TOLL-FREE 1-800-621-SAVE** In Illinois Call (312) 280-0002

**PC NETWORK**  
GET THE NETWORK ADVANTAGE!!!

# PC NETWORK

## BUY HARDWARE AND SOFTWARE AT WHOLESALE + 8%, AND GET 14-30 DAY SOFTWARE RENTALS†...

Listed below are just a few of the over 30,000 products available at our EVERYDAY LOW PRICES! The Network carries products for Apple, IBM, CP/M and most other popular computer families.

### GAMES & EDUCATIONAL SOFTWARE FOR YOUR APPLE II & MACINTOSH

Wholesale		Wholesale	
Arrays Home Accountant/Mac Only	\$65.00	Miles Computing Mac Attack-Mac Only	22.00
Axlon Art Portfolio & Card Shop	31.00	Palatit Mac Type-Mac Only	23.50
Bluechip Baron/Millonaire/Tycoon	19.75	Penguin Graphics Magician	28.97
Broderbund Logo Runner	17.25	Penguin Pensate or Xyphus	20.00
Broderbund Chopfiter	17.00	Penguin Transylvania-Mac Only	20.00
Broderbund Print Shop	21.75	Professional Software Trivia Fever	19.00
Broderbund Dazzle Draw	31.97	Priority Software Forbidden Quest	21.00
CBS Mastering the GRE	53.50	Scarborough Master Type	19.75
CBS Murder by the Dozen	20.97	Scarborough Run for the Money	26.00
CBS Goren Bridge Made Easy	45.00	Simon & Schuster Typing Tutor III	28.25
Counterpoint The News Room	26.97	Sir-Tech Wizardry	17.25
Davidson Speed Reader II	31.00	Sir-Tech Rescue Raiders	18.97
Davidson Math Blaster	21.50	Sublogic Night Mission Pinball	19.25
Davidson Word Attack!	44.00	Sublogic Flight Simulator II	27.25
1st Byte Smooth Talker-Mac Only	44.00	▶ Spinaker Alphabet Zoo, Face Maker, Kinder Comp, Hey Diddle, Diddle, Rhymes & Riddles, Story Machine	20.77*
Hayden DaVinci-House/Interiors/Landscape	24.75	▶ Spinaker The Most Amazing Thing	20.75*
Hayden Sargon III	24.75	▶ Spinaker Delta Drawing	20.75*
Infocom Deadline or Suspended	24.00	T/Maker Click Art-Mac Only	25.00
Infocom Enchanter, Planifall, Cutthroats, Witness or Zork I	19.75	Warner Desk Organizer	65.00
Infocom Hitchhiker's Guide or Seastalker	21.75	Videa Fun Pack-Mac Only	19.25
Infocom Suspect, Sorcerer or Infidel	21.75	Videa Mac Checkers & Reversi	25.17
Infocom Zork II or III	65.00	Virtual Combinatics Micro Cookbook	17.50*
Layered Front Desk-Mac Only	21.00		
Mirage Concepts Trivia	21.00		

### BUSINESS SOFTWARE FOR YOUR APPLE II & MACINTOSH

(Please add \$2.50 shipping and handling for each title ordered from below.)

▶ Apple Apple Works	\$160.00	▶ Microsoft Word for Macintosh	\$102.00
Borland International Turbo Pascal	30.00	▶ Microsoft File for Macintosh	102.00
BPI GL, AP, AR, PR or INV	190.00	▶ Microsoft Calc for Macintosh	102.00
Broderbund Bank Street Writer	37.25	▶ Microsoft Basic for Macintosh	66.00
Central Point Copy II Plus or Copy II Mac	16.25	▶ Microsoft Chart for Macintosh	66.00
Funk Software Sideways	26.50	▶ Monogram Dollars & Sense for Apple II	55.00
Funsoft Macasm	60.00	▶ Monogram Dollars & Sense for Macintosh	70.00
Haba Habades	40.00	▶ Odesta Helix for Macintosh Reg's 512K	200.00
Haba Quartet	87.00	▶ Provis Open-View-Mac Only	130.00
Harvard Mac Manager	29.95	▶ Sensible Software Sensible Speller IV	109.00
Human Edge Mind Prober	22.00	▶ Softcraft Fancy Fonts	37.00
▶ Human Edge Sales Edge	110.00	▶ Softtech Microsystems UCSD Pascal Software Arts TK Solver for Mac	134.00
▶ Human Edge Communication Edge	98.00	▶ Software Publishing PFS:File, Write, or Graph	63.50
▶ Living Wildest Think-Think-Mac Tool	65.00	▶ StoneWare DB Master-Mac Tool	95.00
▶ Main Street Filter-Mac Only	87.50	▶ Teios Television for Mac	85.00
▶ MECA Managing your Money	87.50		

### HARDWARE FOR YOUR APPLE II & MACINTOSH

(Please add shipping and handling charges found in italics next to price.)

#### DISK DRIVES

Alps AP-100A Dual Apple Drives in One Case	\$309.00* (7.00)	Hayes Micromedium IIe w/Smartcom	\$125.00* (2.50)
Apple MAC 400KB External Drive	349.95* (7.50)	Novation Apple Card II	174.45* (3.50)
Corvus 5.25MB Hard Drive	939.00* (20.20)	Prometheus 1200 A	276.00* (6.00)
Omega Microcull 5MG Removable Drive for Macintosh	1,250.00* (27.00)	Low Cost 1200 Baud Internal Modem for Apple II	299.00* (6.00)
Micro Sci A2 143KB Drive	120.00* (5.00)	Prometheus Promodem 1200 w/Mac Pack	95.00* (2.50)
Micro Sci Apple II Controller	55.00* (2.50)	Zoom Zoom/Modem IIe	95.00* (2.50)
▶ Paradise Mac 10MB Hard Drive Subsystem	750.00* (16.20)	Microcmodem Compatible-Free Dow Jones	
▶ Paradise Mac 20MB Hard Drive Subsystem	950.00* (20.52)		
▶ PC Network 140K External Drive for Apple IIc	95.00* (2.50)		
Rana Elite 163K Drive	225.00* (5.00)		
Tecmar 5.25MB Removable Drive for MAC	99.00* (21.58)		
Tecmar 10MB MAC Drive	99.00* (21.58)		
Tecmar 5MB MAC Drive Upgrade	1,235.00* (26.68)		

#### MODEMS

Wholesale		Wholesale	
IOmega Bernoulli Box	\$2,100.00* (45.36)	PC Network Internal 1200BPS Modem	119.00* (2.50)
Dual 10MB Drives		Low Cost Short Slot Hayes Compatible Modem	
▶ PC Network 10MB INTERNAL 1/2 Height Autoload Drive, New, lower price	340.00* (7.34)	Hayes Smartmodem 1200B w/Novation Smartcom III/VT100 Emulator	312.00* (2.50)
▶ PC Network 10MB Tape Backup Same unit used in Compaq's DeskPro	395.00* (8.94)	Hayes Smartmodem 1200B Alone	265.00* (2.50)
▶ PC Network AT42MB Internal Hard Disk	1,050.00* (24.95)	Prometheus Promodem 1200B Internal	225.00* (2.50)
▶ PC Network Access Time-Comes Complete	495.00* (10.69)		
▶ PC Network 20MB Tape Backup Half Height w/Int. w/Controler	495.00* (10.69)		
▶ PC Network 20MB Internal 1/2 Height Hard Drive-By Seagate or Microscience	395.00* (9.48)		
▶ PC Network Half Height DS/DC Drives	85.00* (11.27)		
▶ Tandem TM1002 Full Height DS/DC Drives	120.00* (2.20)		

### BOARDS AND BUFFERS

ALS Z-Engine	\$115.00* (2.50)	Kensington System Saver Fan	56.97* (1.50)
AST Multi/II-2 serial/Clock	155.00* (2.50)	Koala MacVision	150.00* (3.00)
Microtek Premium Softcard IIe	243.67* (2.50)	Koala Koolatap Touch Tablet	78.00* (1.50)
Microtek Dumping/GX	25.00* (2.50)	MAA Super-R-Mod RF Modulation	44.00* (1.50)
Orange Micro Grappler +	66.00* (2.50)	PC Network Cooling Fan with Surge Protector & Dual Outlets	25.00* (2.50)
Orange Micro Serial Grappler	66.00* (2.50)	PC Network SSD Diskettes (Box of 10)	9.95* (1.00)
PC Network 280 Card	35.00* (2.50)	PC Network Macintosh Diskettes	15.95* (1.50)
Quadram APC/II Graphics Interface	68.00* (2.50)	Includes Free Flip & File Case	
Quadram RAM-Mac II	82.00* (2.50)	These Diskettes are Guaranteed for Life! No Generals!	
Quadram MultiCore-1 Parallel/1 Serial	140.00* (2.50)	Sony Mac Diskettes (Box of 10)	19.00* (1.50)
Thunderware Thunderclock	104.00* (2.50)		

### ACCESSORIES

Apple Macintosh Carrying Case	\$69.00* (1.49)
Apple Macintosh Security Kit	29.00* (1.50)
Apple Macintosh Numeric Keypad	69.00* (2.50)
Hayes Mac III Joystick w/ Fire Button for IIe	26.50* (1.80)
Kensington Dust Cover for MAC or ImageWriter	7.50* (1.50)
Kensington Starter Pack	49.00* (3.00)
Kensington Surge Protector	29.50* (2.50)

### MEMORY CHIPS

(All Memory Chips Guaranteed for Life!)

▶ 64K Dynamic Upgrade Kits (3 Chips) Quantity Discounts Available!	\$9.00* (1.00)	Amdex Video 300G Composite Green	\$110.00* (3.00)
▶ 64K Dynamic Ram Chips (Each)	1.00* (1.00)	Amdex Video 300A Composite Amber	120.00* (3.00)
▶ 256K Dynamic Ram Chips (Each)	2.90* (1.00)	Amdex Video 310A IBM Type Amber	130.00* (3.00)
▶ 128K IBM AT Piggyback Chips (Each)	5.50* (1.00)	Amdex Color 300 NEW Composite	245.00* (4.64)
		Amdex Color 600 NEW High Res RGB	365.00* (7.98)
		Amdex Color 722 Graphics Monitor	440.00* (9.29)
		▶ Magnavox 12" TTL IBM Type Amber	79.00* (5.00)

### MONITORS

Princeton HX-12 RGB Monitor	399.00* (8.60)
Princeton MAX-12e	156.00* (5.00)
Works with Color or Mono Card	
Quadram Quadchrome II	289.00* (6.24)
640x200 RGB w/14" Screen	
Black, Phosphor Mask/IBM Case	
Taxan 630 High Res RGB Monitor	383.00* (8.27)
Taxan 640 Highest Res (740x400)	439.00* (10.69)
Currently Available—Works with Persyst BOB Card & the AT&T Computer	
Zenith ZVM 1230A Green High Res/Non Glare	81.00* (2.50)

### EXTERNAL MODEMS

Anchor Signalman Express	\$205.00* (5.00)
Hayes Smartmodem 300	120.00* (5.00)
Hayes Smartmodem 1200	340.00* (5.00)
Hayes Smartmodem 1200B with new Smartcom III VT100 Emulator	312.00* (2.50)
Hayes Smartmodem 1200B Alone	265.00* (2.50)
Hayes Smartmodem 2400	625.00* (5.00)
PC Network Internal 1200BPS Modem w/BitCom Software Short Slot Hayes Compatible	119.00* (2.50)
Prometheus Promodem 1200 External 100% Hayes Compatible	276.00* (6.00)
U.S. Robotics Courier 2400BPS Modem	395.00* (5.00)
U.S. Robotics Password 1200BPS Modem	195.00* (4.00)

### TERMS & CONDITIONS

▶ PC NETWORK—Members pay just 8% above the wholesale price, plus shipping. All prices reflect a 3% cash discount. Minimum shipping \$2.50 per order. International orders call for shipping & handling charges. Money orders, personal and company checks please allow 10 working days to clear. All prices subject to change without notice!

†RENT BEFORE YOU BUY—Members are eligible to join the NETWORK'S Business and Game software Rental Libraries and evaluate products for a full 14 (Regular) or 30 (VIP) days to see if it meets your needs. And the NETWORK'S rental charges are far less than other software rental services—just 20% OF THE MEMBER WHOLESALER PRICE. Rental titles available in IBM/Apple/MAC and CP/M Formats. Hardware prices highlighted by ▶ reflect recent major price reductions.

### GAMES & EDUCATIONAL SOFTWARE FOR YOUR IBM

(Please add \$1 shipping and handling for each title ordered from below.)

Wholesale		Wholesale	
ATI Intro to PC DOS Vol 1 & II	\$23.00	▶ Infocom Deadline or Suspended	\$24.00*
ATI Intro to BASIC	23.00	Microsoft Flight Simulator	27.00*
Bluechip 1Chess (Your Toughest Opponent)	34.00	Mouse Systems PC Paint—Turn your PC Into A Color Macintosh!	59.95*
Bluechip Millionaire/Oil Baros or Tycoon	19.75	Scarborough Master Type	19.75*
Broderbund Logo Runner	17.25	Sierra On-Line Crossing	18.00*
CBS Goren Bridge Made Easy	40.00	Sierra On-Line King's Quest II	24.75*
CBS Mastering the SAT	50.00	▶ Spinaker Alphabet Zoo, Kinder Comp, Story Machine, Face Maker, Hey Diddle, Diddle, Rhymes & Riddles	15.25*
CDEX Training for Wordstar	37.25	▶ Spinaker Delta Drawing	20.75*
Comprehensive Intro to Personal Computing	26.50	▶ Spinaker Most Amazing Thing	20.77*
Davidson Math Blaster, Word Attack!	21.50	Sublogic Night Mission Pinball	19.25*
Davidson Speed Reader II	31.00	Virtual Combinatics Micro Cookbook	21.00*
Hayden Sargon III	24.00		
Individual Professor DOS	29.75		
Individual The Instructor	24.50		
▶ Infocom Zork for Windows	19.75		

### BUSINESS SOFTWARE FOR YOUR IBM

(Please add \$2.50 shipping and handling for each title ordered from below.)

▶ Ashton-Tate dBase III	\$345.00*	MicroPro Wordstar 2000	2,09.00*
▶ Ashton-Tate Framework II	365.00*	MicroPro Wordstar 2000+	2,50.00*
Borland Turbo Pascal	30.00	MicroRim RBase 5000	285.00*
Borland Sidekick (Protected)	24.50	Microsoft C Compiler	205.00*
Borland SuperKey	29.75	Microsoft Word—Latest Version 2.0	202.00*
BPI GL, AP, AR, PR	262.00	Microsoft Multiplan	102.00*
BPI Aur	262.00	Microsoft Mouse	107.00*
BPI Personal Accounting	43.75	Monogram Dollars & Sense	85.00*
Breakthrough Timeline	230.00	▶ Multimate Multimate (Latest Version)	180.00
Central Point Copy II PC	20.00	Norton Norton Utilities 3.1	43.00*
Conceptual Instruments Desk Organizer	157.00	Osas The Word Plus	75.00*
Digital Research DR Logo	75.00	Open Systems P/D Sales	ea. 275.00*
Digital Research Gem Desktop	25.00	Power Base Power Base	155.00*
Digital Research Gem Draw	7.00	Real World GL AP, AR or OE/INV	ea. 35.00*
Enertronics Energraphics	143.00	Resolut ProKey Version 3	65.00*
Funk Software Sideways	32.00	Ryan MacFarland RM COBOL (Dev. System)	520.00*
LifeTree Volkswagen III	175.00	Sanna Sanna III Word Processor	207.75*
▶ Harvard Harvard Project Manager	225.00	Sanna Sanna III Word Processor	320.00*
Harvard Total Project Manager	285.00	▶ Satellite Software Word Perfect	125.00*
▶ Hayes Smartcom II—New, VT-100 Emulator	68.00	Softcraft Fancy Fonts	125.00*
▶ Human Edge The Management Edge	22.00	Software Publishing PFS:File, Write, Graph	68.00*
▶ Human Edge Mind Prober	22.00	Software Publishing PFS:Report	64.00*
Infocom Cornerstone	210.00	Sorcin Supercalc III	169.00*
Lifetree Volkswagen III	125.00	Starcom Ability	247.50*
▶ Lotus Development Lotus 1-2-3	285.00*		
MDBS KnowledgeMan/2	229.00		

### HARDWARE FOR YOUR IBM

(Please add shipping and handling charges found in italics next to price.)

#### DISK DRIVES

IOmega Bernoulli Box	\$2,100.00* (45.36)	PC Network Internal 1200BPS Modem	119.00* (2.50)
Dual 10MB Drives		Low Cost Short Slot Hayes Compatible Modem	
▶ PC Network 10MB INTERNAL 1/2 Height Autoload Drive, New, lower price	340.00* (7.34)	Hayes Smartmodem 1200B w/Novation Smartcom III/VT100 Emulator	312.00* (2.50)
▶ PC Network 10MB Tape Backup Same unit used in Compaq's DeskPro	395.00* (8.94)	Hayes Smartmodem 1200B Alone	265.00* (2.50)
▶ PC Network AT42MB Internal Hard Disk	1,050.00* (24.95)	Prometheus Promodem 1200B Internal	225.00* (2.50)
▶ PC Network Access Time-Comes Complete	495.00* (10.69)		
▶ PC Network 20MB Tape Backup Half Height w/Int. w/Controler	495.00* (10.69)		
▶ PC Network 20MB Internal 1/2 Height Hard Drive-By Seagate or Microscience	395.00* (9.48)		
▶ PC Network Half Height DS/DC Drives	85.00* (11.27)		
▶ Tandem TM1002 Full Height DS/DC Drives	120.00* (2.20)		

#### MODEMS

IOmega Bernoulli Box	\$2,100.00* (45.36)	PC Network Internal 1200BPS Modem	119.00* (2.50)
Dual 10MB Drives		Low Cost Short Slot Hayes Compatible Modem	
▶ PC Network 10MB INTERNAL 1/2 Height Autoload Drive, New, lower price	340.00* (7.34)	Hayes Smartmodem 1200B w/Novation Smartcom III/VT100 Emulator	312.00* (2.50)
▶ PC Network 10MB Tape Backup Same unit used in Compaq's DeskPro	395.00* (8.94)	Hayes Smartmodem 1200B Alone	265.00* (2.50)
▶ PC Network AT42MB Internal Hard Disk	1,050.00* (24.95)	Prometheus Promodem 1200B Internal	225.00* (2.50)
▶ PC Network Access Time-Comes Complete	495.00* (10.69)		
▶ PC Network 20MB Tape Backup Half Height w/Int. w/Controler	495.00* (10.69)		
▶ PC Network 20MB Internal 1/2 Height Hard Drive-By Seagate or Microscience	395.00* (9.48)		
▶ PC Network Half Height DS/DC Drives	85.00* (11.27)		
▶ Tandem TM1002 Full Height DS/DC Drives	120.00* (2.20)		

### MULTIFUNCTION CARDS

Apparat AT Ram Expansion Card	\$139.00* (2.50)	Hercules Color Card w/Parallel Port	\$142.00* (2.50)
▶ AST'S SixPakPlus™ With 64K	195.00* (2.50)	▶ Hercules Monochrome Graphics Card	263.00* (2.50)
AST' I/O Plus™	120.00* (2.50)	Paradise Modular Graphics Card	219.00* (2.50)
AST' Advantage Ix™ AT	355.00* (2.50)	▶ PC Network EGA Clone	260.00* (2.50)
Eversage Magic Card/64K	160.00* (2.50)	▶ PC Network Hercules Mono Card Clone	99.00* (2.50)
▶ PC Network 512K Memory Board w/DK	65.00* (2.50)	100% Hercules Compatible!	
PC Network The Multi-384 Board	79.00* (1.10)	▶ PC Network Color Card	69.00* (2.50)
A clone of the AST'S SixPakPlus™ includes up to 384KB of expansion memory 1 serial, 1 parallel, 1 game port, a clock/calendar and software standard.		Persyal BOB Card Ultra High Res Color Graphics Adapter	299.00* (2.50)
▶ PC Network I/O Plus II Clone	59.00* (2.50)	Quadram Quad EGA + Enhanced Graphics Adapter	340.00* (2.50)
SuperPak™ Game/Code standard		▶ STB Graphs Plus II	19

# COMPLETE SYSTEMS

(Optional local warranty service available in most major metro areas)

## IBM PC BASE SYSTEM

IBM PC w/256K  
Floppy Drive Controller  
2 Double Sided Double  
Density Disk Drives  
Mix and Match with  
your Favorite Monitor  
and Printer!

**\$1,250.00\***

CUSTOM  
CONFIGURATIONS  
WELCOME

CALL FOR  
LATEST IBM  
ANNOUNCEMENTS



## IBM PC HARD DISK SYSTEM

IBM PC w/256K  
Floppy Drive Controller  
1 Double Sided Double  
Density Disk Drive  
Half Height Hard Disk

w/10MB  
**\$1,620.00**

w/20MB  
**\$1,690.00**

## PORTABLE HARD DISK SYSTEM

256K/1 Floppy/Hard Disk



**\$1,999.00\*** w/20MB

call for 10MB

## DESKPRO SYSTEM

256K CPU/1 Floppy/Hard Disk



**\$1,940.00\*** w/10MB

**\$2,025.00\*** w/20MB

## APPLE IIc



## APPLE IIe



## MACINTOSH SYSTEMS



## 64K IBM PC MEMORY EXPANSION KITS

Quantity Discounts Available.  
Guaranteed for Life!



Set of 9 Chips **\$9.00\***

## DISKETTES

Guaranteed for Life!

Brand name diskettes  
available in boxes of 10  
or in bulk packs of 50

5 1/4" DS/DD  
**\$8.95\***  
Bx. 10 / Bx. 50  
ea. .59\*

5 1/4" SS/DD  
**\$7.95\***  
Bx. 10 / Bx. 50  
ea. .47\*

3 1/2" SS/DD  
Bx. 10  
**\$15.95\***  
Free Flip  
& File Case

## 1/2 HEIGHT DS/DD DISK DRIVES

The Network buys direct  
and makes fantastic deals  
with manufacturers like MPI/  
Tandon/CDC/Shugart/Queme/  
TEAC and others to bring you  
fantastic prices on Name  
Brand drives for your PC/AT/  
XT/rt/or Compatible.



**\$85.00\***

Quantity Discounts Available

## INTERNAL PC HARD DISK

Low Power/Automatic Boot. Works on standard PC's  
and Compatibles. Includes drive/controller/cables/  
mounting hardware and instructions



Full one year warranty!  
10MB  
**\$340.00\***

20MB  
**\$395.00\***

Quantity Discount Available



**\$280.00\***

WordPerfect  
**\$180.00\*** ea.  
MultiMate™

\*Members pay 8% above this wholesale price plus shipping.

CALL TOLL FREE 1-800-621-S-A-V-E (orders and memberships)

In Illinois call (312) 280-0002 Validation code: B356

Customer Service and Order Status (312) 280-1567

TM & R—Registered Trademarks of IBM/COMPAQ/APPLE/AST Research/LOTUS/Multimate Int./IOMEGA

# PC NETWORK

GET THE NETWORK ADVANTAGE!!!

SEE WHY OVER 100,000 HAVE JOINED  
MAKING US THE NATION'S #1 SOURCE  
FOR EVERYTHING IN COMPUTING...

- **Our 600 Page Wholesale Catalog**  
Over 30,000 products priced at Wholesale + 8%. Anything you will ever need at a Consistent low price...
- **Quarterly Catalog Updates**  
Your Catalog is never obsolete! Keep on top of the newest products and latest price changes.
- **The Printout**  
Our newsletter gives you fantastic specials along with unbiased analysis of new products and industry trends.
- **10 Day Returns on any Hardware!!**  
If you don't like any hardware product—for any reason—return it for a refund.
- **1000 + Title Rental Library**  
14 to 30 day rentals on over 1000 different titles. Try before you buy!!
- **Size-Strength and Stability**

The Network has over 150 employees, 45,000 square feet of office and warehouse space, inventory valued in excess of \$15,000,000 and is ranked the largest computer product supplier in the Nation! Our commitment is to serve our customers and our 90% repeat business rate is proof!!

Prices subject to change without notice.

## CALL TOLL FREE 1-800-621-S-A-V-E

(Orders—Membership and Advice!)

In Illinois call (312) 280-0002

Your Membership Validation Number **B356**

You can validate your membership number and, if you wish, place your first money-saving order over the phone by using your VISA, MASTERCARD or AMERICAN EXPRESS. Our knowledgeable sales consultants are on duty Mon.-Fri. 8:00 AM to 7:00 PM, SAT. 9:00 AM to 5:00 PM CST.

PERSONAL COMPUTER NETWORK  
320 West Ohio  
Chicago, Illinois 60610

Call now...Join the PC NETWORK and start saving today!  
Customer Service and Order Status (312) 280-1567  
8:30 AM to 4:30 PM, Mon.-Fri. CST



## FEATURED PRODUCTS!

20MB PC TAPE BACKUP **\$495.00\***

With controller cables and software.

## EPSON PRINTERS (Unbelievable Low Prices!!)

LX-80 80 COL/100CPS **199.00\***  
FX-85 80 COL/160CPS **299.00\***  
FX-286 132 COL/200CPS **459.00\***  
LQ-1000 132 COL/180CPS **CALL**

AMDEK V310A IBM TTL AMBER **130.00\***

AST™ SixPakPlus™ w/64K **195.00\***

PC NETWORK THE MULTI-384 BOARD **79.00\***

A functional clone of the AST's™ SixPakPlus.

Includes up to 384Kb of expansion memory, 1 serial, 1 parallel, 1 game port, clock/calendar and software standard.

HAYES 1200B **312.00\***

with new Smartcom III/VT100 Emulator

TALLGRASS TG-5025 **2,250.00\***

25MB Hard Disk with 60MB Tape Backup

IBM Logo Full Height Drive **125.00\***

Genuine IBM DS/DD—Not Equivalents!

IOMEGA 20MB Bernoulli **2,100.00\***

\*Members pay 8% above this wholesale price plus shipping.

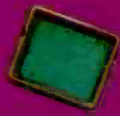
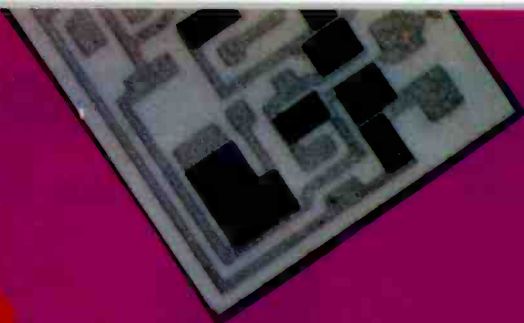
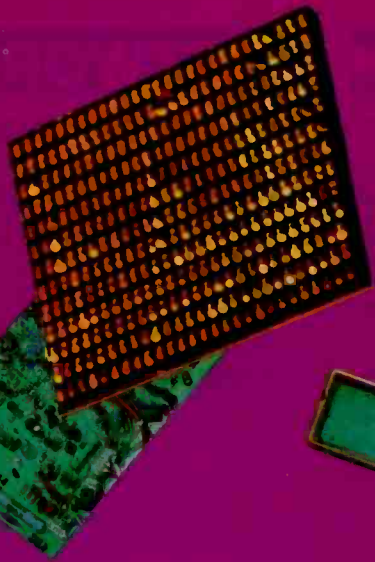

Paul  
DEVEN

# Features

---

**CIARCIA'S CIRCUIT CELLAR:**  
**ADDING SCSI TO THE SB180 COMPUTER,**  
**PART I: INTRODUCTION**  
*by Steve Ciarcia* ..... 85

**PROGRAMMING PROJECT: DATA**  
**COMPRESSION WITH HUFFMAN CODING**  
*by Jonathan Amsterdam* ..... 98

**MODULA-2 AS A SYSTEMS**  
**PROGRAMMING LANGUAGE**  
*by Ryn C. Corbeil and Anne H. Anderson* . 111

**LINKING DATA FLOW AND**  
**FUNCTIONAL LANGUAGES**  
*by Chris Hankin, David Till,*  
*and Hugh Glaser* ..... 123

**EASY C**  
*by Pete Orlin and John Heath* ..... 137

**PROGRAMMING INSIGHT:**  
**SUBROUTINE OVERLAYS IN GW-BASIC**  
*by Mike Carmichael* ..... 151

---

IN THE CIRCUIT CELLAR this month, Steve again turns his attention to the SB180 computer, which he introduced last fall. This single-board machine with its high price/performance ratio has proved to be quite popular, and Steve now begins a two-part tutorial article describing how to implement an SCSI bus on the SB180. This takes very few chips but much explanation.

Jonathan Amsterdam's Programming Project presents a method for shortening files by compressing the information they contain. This can save disk space and also cut down on the time needed to transmit large files between computers. The method under discussion is Huffman coding, an elegant data-compression algorithm that, in one sense, Jonathan considers to be the "best" way to compress data.

To illustrate the virtues of Modula-2 as a systems programming language, Ryn Corbeil and Anne Anderson describe how its particular attributes helped them develop a real-time multiprocessing operating system in a relatively short time.

In "Linking Data Flow and Functional Languages," Chris Hankin, David Till, and Hugh Glaser explain how this linkage combines the advantages of functional programming and parallel execution to achieve gains in execution speed.

Pete Orlin and John Heath, in "Easy C," offer numerous tips on using C's preprocessor to write more understandable code. Included is a set of definitions that change the operator notation from the mystical to the obvious.

In his Programming Insight "Subroutine Overlays in GW-BASIC," Mike Carmichael outlines a technique by which you can store subroutines in a RAM disk and have your BASIC program call them one by one as they are needed.

ONCE IN A LIFETIME A NEW PRODUCT APPEARS ON  
THE HORIZON THAT SHINE ABOVE ALL OTHERS

# THE CREATOR™

APPLICATION GENERATOR

by Advanced Development Technologies

- ★ FOURTH GENERATION PRODUCTIVITY
- ★ ELIMINATE DATABASE MANAGEMENT SYSTEMS
  - ★ A COMPLETE APPLICATION GENERATION ENVIRONMENT
  - ★ DEVELOP APPLICATIONS IN LESS TIME
    - ★ REDUCE CODE REQUIREMENTS BY 90 PERCENT
- ★ TRAPS ERRORS WITH DETAIL ANALYSIS
  - ★ MULTIPLE FILE ACCESS WITHOUT PROGRAMING
- ★ 99 INDEXES PER DATA FILE
- ★ AUTOMATIC RECORD LOCK
  - ★ UNLIMITED FILE AND RECORD SIZE
- ★ PRODUCES COMPLETE DOCUMENTATION

**\$99**

MASTERCARD/VISA

## INCLUDES:

Internal Expression Compile  
Relational File Structure  
ISAM File Access Method  
Screen and Report Generator  
Rich Library of Functions

● Data Dictionary

● System and User Defined Variables

For Only \$99 The **CREATOR™** Lets You Develop Applications Without Being Bugged Down By A Lot Of Code. Regardless Of How Simple Or Sophisticated The Applications, Save Hundreds Of Hours Of Programing By Using This Advanced Method Of Application Development. Manages All Phases Of Program Development:

● Program Generation ● Database Defination

● Screen And Report Formation ● Multiple Levels of Menus.

A Complete Development System Available For IBM, PC, XT, and AT Requires 256K RAM Includes Unlimited Run Time

**800-528-6060**

**EXT. 239**

CHECKS AND MONEY ORDERS ACCEPTED

© THE CREATOR™ IS A TRADEMARK OF  
**ADVANCE DEVELOPMENT TECHNOLOGIES**  
2720 N. 68th St., Suite 5379  
Scottsdale, Arizona 85257

**602-945-1375**

IBM PC, XT, AT Is a  
Copyright of International  
Business Machines, Inc.



## ADDING SCSI TO THE SB180 COMPUTER PART 1: INTRODUCTION

BY STEVE CIARCIA

*A tutorial on the  
small computer system interface*



In September and October 1985, I introduced the SB180 to BYTE readers. This 4- by 7-inch single-board computer has a higher price/performance ratio than many refrigerator-size S-100 systems, and I believe it has set new standards in the world of 8-bit computing. Thousands of SB180 systems are now in use.

In the months following the SB180's introduction, I described a 1200-bits-per-second modem expansion interface for the SB180 called the COMM180 and demonstrated a COMM180/SB180 turnkey bulletin-board system. Attentive readers were quick to note that, while I said nothing specific in the article, the COMM180 was a dual-purpose board containing both a 1200-bps modem and an SCSI hard-disk expansion interface.

I chose not to explain this extra COMM180 function at that time because it might not have been fully appreciated by an audience that hadn't been properly introduced to it. Implementing an SCSI bus on the SB180 takes very few chips but a great deal of explanation.

In the next two months, I'd like to pick up where I left off and describe the SCSI, which is a significant new standard, in more detail. Because of this, my presentation will be tutorial in nature, with specific emphasis on

the NCR 5380 SCSI bus-interface chip.

While this month's project is the SCSI portion of the COMM180 interface (the COMM180 schematic included in this article is of the complete dual-function COMM180 and is slightly different from the modem-only circuit presented in my December 1985 article), the simplicity of its design fits the tutorial format of this article. The lessons as well as the circuitry can easily be applied to other computers. I'll start with the whys before the hows.

### STANDARD INTERFACES

Standards exist at virtually every level of the electronics industry. Computer languages, operating systems, graphics interfaces, printer interfaces, backplane interfaces, electrical connectors, and component packages all have standards to which they conform. Even the color code used to determine resistor values is a dominant industry standard.

The SB180 and the COMM180 contain several industry standards. The SB180 runs ZRDOS and ZCPR3, which form an im-

*(continued)*

Steve Ciarcia (pronounced "see-ARE-see-ah") is an electronics engineer and computer consultant with experience in process control, digital design, nuclear instrumentation, and product development. He is the author of several books about electronics. You can write to him at POB 582, Glastonbury, CT 06033.

proved operating system based on CP/M for 8-bit microcomputers. To access the printer, it uses the Centronics parallel interface, another standard, and it also uses a standard floppy-disk interface. The SB180 board, in addition to the optional SCSI interface, uses an RS-232C serial interface, another industry standard.

Standards play an important role in the growth of an industry. They help to reduce product cost, reduce risk to the end user, expand the size of available markets, ease system modifications, and create multiple sources.

So that you can better understand SCSI, I want to discuss other standard interfaces and how they differ from SCSI. Figure 1 shows a breakdown of the various interfaces used in computer systems. They can be categorized as system buses, device-level interfaces, local-area networks (LANs), and I/O buses.

System buses (also known as back-

planes) are designed to support CPU-to-memory transfers. This type of access requires a high-speed, random-access interface capable of addressing a large amount of data. Due to these requirements, backplanes operate within defined hardware slot arrangements and can be relatively expensive to implement. Multibus, S-100, STD, and IBM PC are some popular system buses now in use. I cheerfully add the 40-pin SB180 bus to this list.

Device-level interfaces are designed to provide low-level control of peripheral devices, that is, items like disk drives and printers. For example, ST506, the most popular disk-drive interface, uses one of its interface signals to control a stepper motor located inside the disk drive. Pulses on this signal's line position the read/write head over the appropriate track before the data is read from or written to the disk drive.

LANs are used to transfer data between devices over long distances. Allowing devices to be separated by several thousand feet of cable provides a great deal of configuration flexibility. To support these requirements, data is transferred serially to minimize signal skewing and interconnection cost. Ethernet, Arcnet, AppleTalk, and Omnet are a few popular LANs.

I/O buses resemble system buses in many ways. They both allow multiple devices to be connected on the same bus, provide a parallel data path for transferring information, and use control signals to manage bus operation. However, I/O buses have other requirements that make them unique.

I/O buses operate over cables rather than backplane slots. Cabling provides flexibility in interconnecting system peripherals. While cables are inherently slower than backplane connections, they provide enough band-

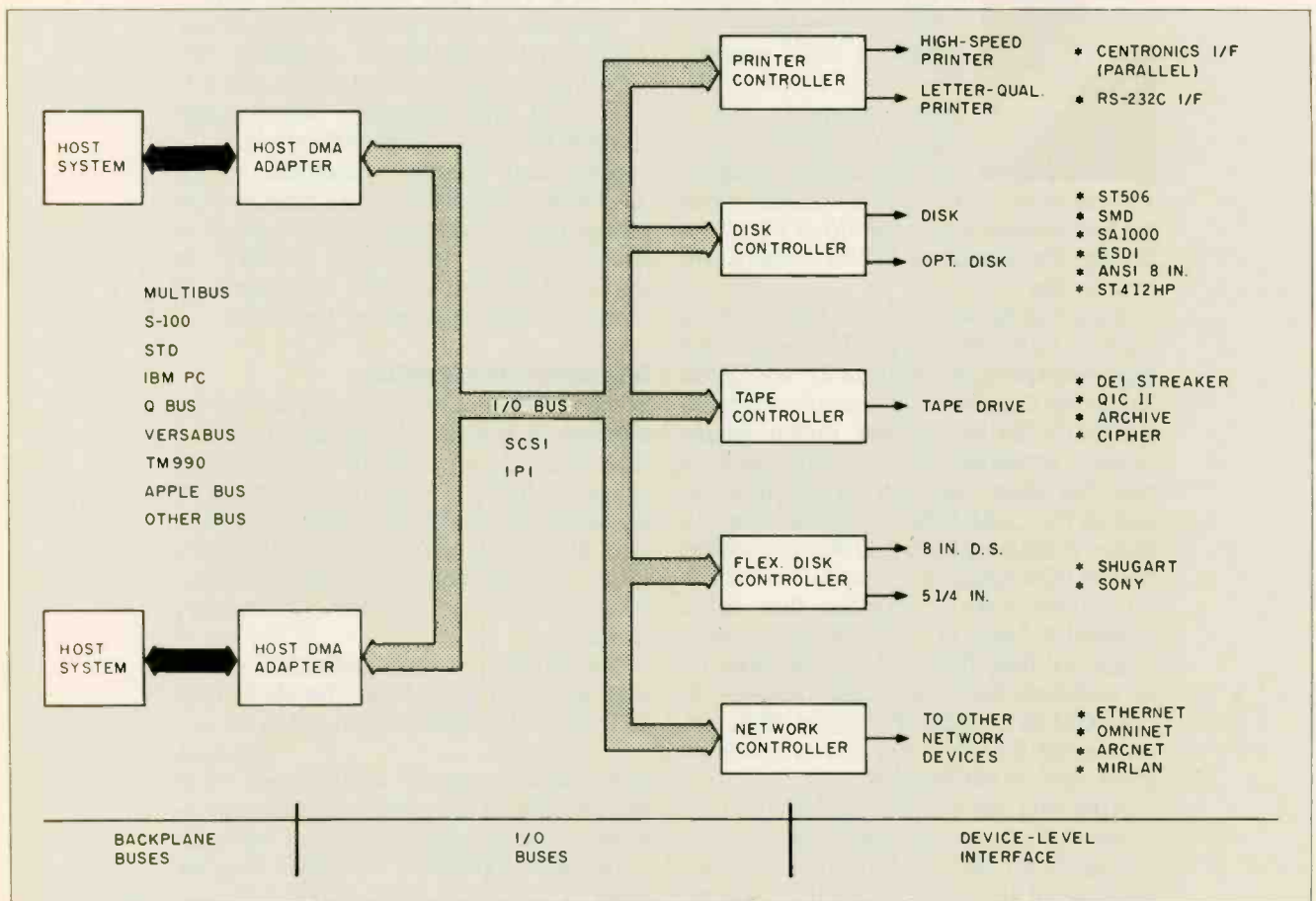

Figure 1: Computer-system interfaces.

width to accommodate even the fastest peripherals. Unlike system interfaces, I/O buses primarily use block-oriented transfers and are relatively inexpensive to implement.

LANs and I/O buses also share many characteristics: data is typically transferred in large sequential blocks; multiple devices can be connected to the bus; and cables are used to interconnect devices. Unlike LANs, I/O buses transfer data in a parallel form, provide faster transfer rates, and are designed to operate over much shorter distances. I/O buses are often referred to as "very local area networks."

## OVERVIEW

Before I begin a detailed description of the COMM180 and its specific hardware, a few words are in order about what SCSI is and why it is used. SCSI is a standard, intelligent I/O subsystem for small computers. In a technical sense, standard means that no matter what system it is implemented on, the interface will look the same. This is important because it means that, as new computers or peripherals are developed that contain an SCSI interface, they can be connected to existing peripherals and computers (that also contain an SCSI interface) without modifying the existing system or peripheral.

SCSI evolved from Shugart Associates systems interface (SASI), commonly pronounced "sassy." SASI was developed in the late 1970s for use primarily as a disk-controller interface. As so often happens in the computer industry, SASI was modeled after a de facto IBM standard, the IBM I/O channel.

In November of 1981, Shugart Associates and NCR jointly approached the American National Standards Institute committee on intelligent peripherals and proposed that SASI be used as a foundation for defining an intelligent peripheral interface standard. By April of 1982, the X3T9.2 ANSI subcommittee was established, and the name was formally changed to SCSI.

After more than three years of definition and participation by more than 120 companies, the ANSI sub-

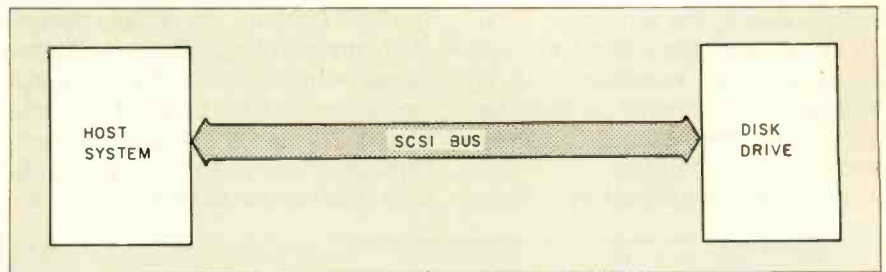

Figure 2: A simple SCSI configuration.

committee has forwarded Revision 17 of the proposed SCSI standard into its second public review period. Final acceptance of the standard is expected within a year. Interest in the standard has spread throughout the electronics industry. Currently, the European Computer Manufacturers Association is working to adopt SCSI as its standard.

The intent of the SCSI standard is to make computer peripherals as easy to interconnect as stereo equipment. This provides the host computer with device independence within a class of devices. Device independence is a powerful concept that lets peripherals be added or upgraded to an existing computer system without requiring lengthy product design and qualification cycles.

Much of the standard's success is a result of the flexibility that the interface offers. To demonstrate the versatility of SCSI, I will describe four unique system architectures: single-user/single-tasking, multitasking, multi-user, and multiprocessing systems. These examples represent actual product offerings that span a wide range of computing requirements.

## SINGLE-USER/SINGLE-TASKING SYSTEMS

Personal computers, which make up a majority of the computers sold, can be generally characterized as single-user/single-tasking systems. In these systems, I/O is performed in a sequential manner. If you want to store a file to disk and then read another file from disk, you wait for the first task to complete before you start the second. Figure 2 shows a block diagram of a single-user/single-tasking system.

Because the SCSI interface operates with generic device types, the system

can be designed to use a variety of intelligent mass storage systems. This gives the user a choice of configurations that meet performance and storage-capacity requirements.

Flexibility is important, but product cost is the primary concern for this class of computer. A hard-disk drive and a controller board may account for as much as 50 percent of the system cost. Disk-drive manufacturers have traditionally provided drive-level electronics that interface to the host bus through a disk controller. However, with the increasing integration of controller electronics, several manufacturers are now finding it less costly to provide an integrated SCSI controller directly on the disk drive.

Obviously, a single board is less expensive than two boards and interconnecting cables. Less obvious is the savings realized by achieving higher manufacturing yields on the disk drives themselves. Traditionally, a hard disk has had to be flawless. All tracks had to be error-free, or the flawed tracks had to be specifically noted to the host drive controller so that they would not be used. With SCSI, the host computer is no longer concerned with exact track location or flawed tracks, since the disk is addressed as a logical storage device. The disk drive/SCSI controller manages the surface defect mapping and merely presents the user with single mass storage quantity. By not having to produce completely flawless hardware, the manufacturer's assembly yields are increased, and overall product cost is reduced.

## MULTITASKING SYSTEMS

In single-tasking or single-threaded environments, system performance

(continued)

suffers due to the sequential nature of all I/O operations. Seek and rotational latencies associated with the disk drive may occupy up to 70 percent of the time required to access a sector of information.

In single-user/multitasking systems,

the SCSI standard lets devices not actively transferring data remove themselves from the bus, so that other I/O operations can be initiated or completed. This lets the system take advantage of the "dead" time (when no data is being transferred) on disk ac-

cesses. Therefore, multiple disk drives can be seeking data simultaneously, providing for higher bus utilization. The drive that locates its data first will reselect the host and complete the transfer. Figure 3 shows a block diagram of a single-user/multitasking system.

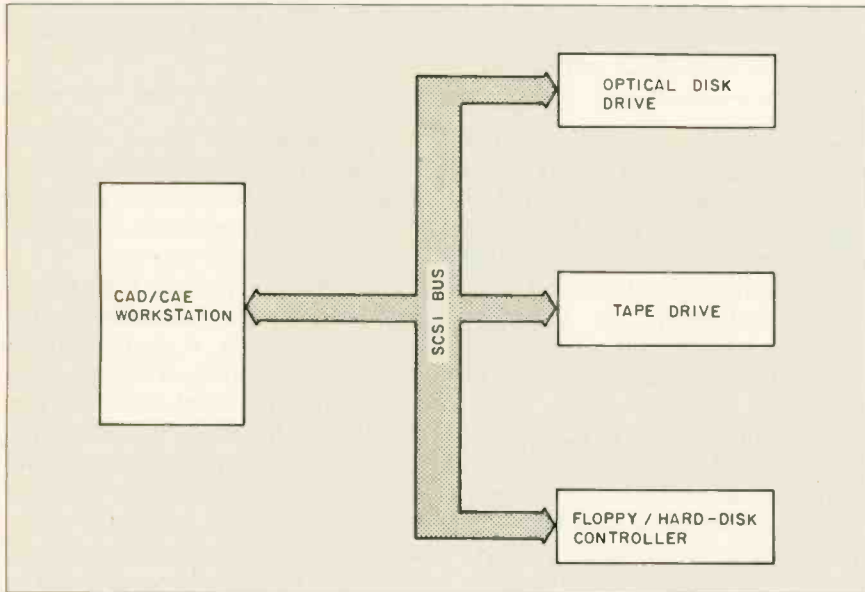

Figure 3: A single-user/multitasking SCSI system.

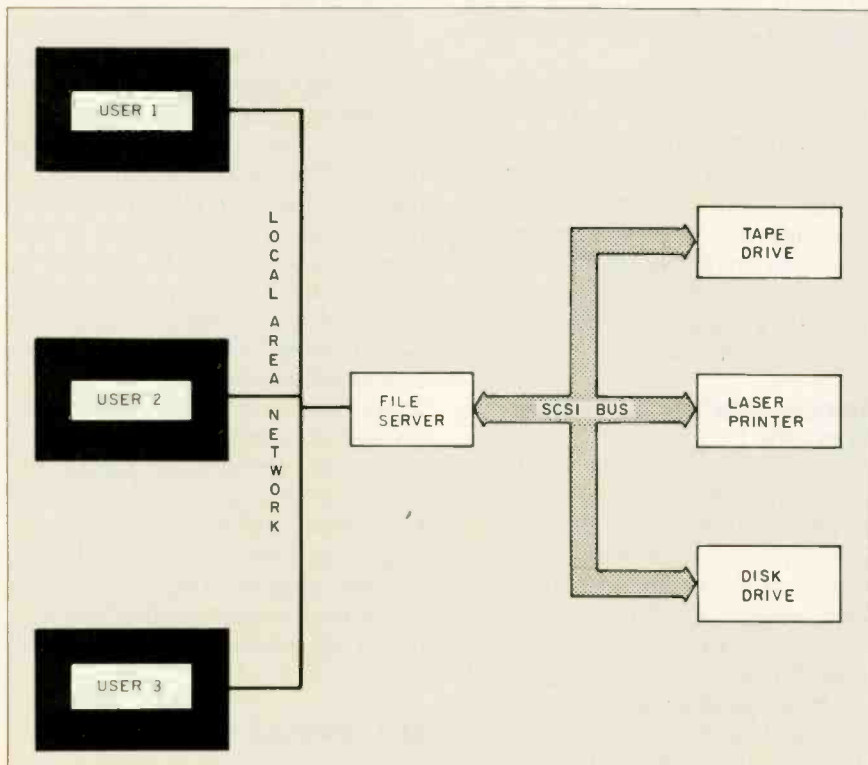

Figure 4: SCSI in a multiuser system.

### MULTIUSER SYSTEMS

In today's office environment, personal computers are stand-alone devices that support individual productivity requirements. However, if data needs to be shared among users, the system components will have to be networked. Local-area networks can be used to accomplish this. Since data is shared among various components, file servers are used as common storage elements. File servers, in many cases, are personal computers modified to support multiuser file management. Figure 4 shows a common file-server implementation.

In some cases, having multiple users dramatically increases system response time. However, since the SCSI bus supports data rates up to 1.5 megabytes per second in an asynchronous mode and up to 4 megabytes per second using a synchronous handshake, system performance need not suffer. This fast transfer rate coupled with the disconnect capability allows for high data throughput and efficient bus utilization. Additionally, these transfer rates match or exceed the performance of the commonly used LANs.

The SCSI interface supports several commands that increase system performance and provide shared file protection in multiuser systems. Search commands, implemented in the file server or the disk controller, allow keywords to be searched for locally rather than choking the LAN or the SCSI bus with large data transfers. These commands increase system performance while reducing bus bandwidth requirements. To keep shared files from being accessed simultaneously, the reserve and release commands can be used to manage file activity. Reserved files are not available to other users until the files have been released by the current users.

Aside from sharing data, file servers can be used to share expensive system resources like laser printers, large storage devices, color plotters, and even copiers. The SCSI interface eases the task of reconfiguring the file server for specific system requirements.

### MULTIPROCESSING SYSTEMS

Systems supporting multiple operating systems, real-time data acquisition, communication processors, or other dedicated processors have traditionally used backplane architectures to support their multiprocessing requirements. These systems require a local communications bus as well as an intelligent peripheral interface. The SCSI interface, with its multihost capability, provides the needed functionality at a fraction of the backplane cost. In addition to file transfers between individual processors and mass storage devices, interprocessor communications can be accomplished across the SCSI interface. Furthermore, freedom from requirements imposed by backplane buses provides increased design flexibility. Figure 5 shows a block diagram of a multiprocessing system.

The SCSI interface directly supports up to eight bus devices. This may preclude the use of the standard SCSI interface in complex multiprocessing configurations. However, a modified standard proposed by Ampro Inc. called SCSI/Plus provides a binary selection phase that supports up to 64 bus devices.

### BENEFIT SUMMARY

These systems are but a few of the many configurations that use SCSI as the backbone of their architectures. The standard offers the flexibility needed to satisfy a range of system requirements, from inexpensive personal computers to very expensive multiuser systems. Additionally, integrated circuits, board-level products, and fully integrated bus devices are readily available from a variety of manufacturers. In each product category, SCSI offers a cost-effective solution that provides the necessary performance, features, and vendor

(continued)

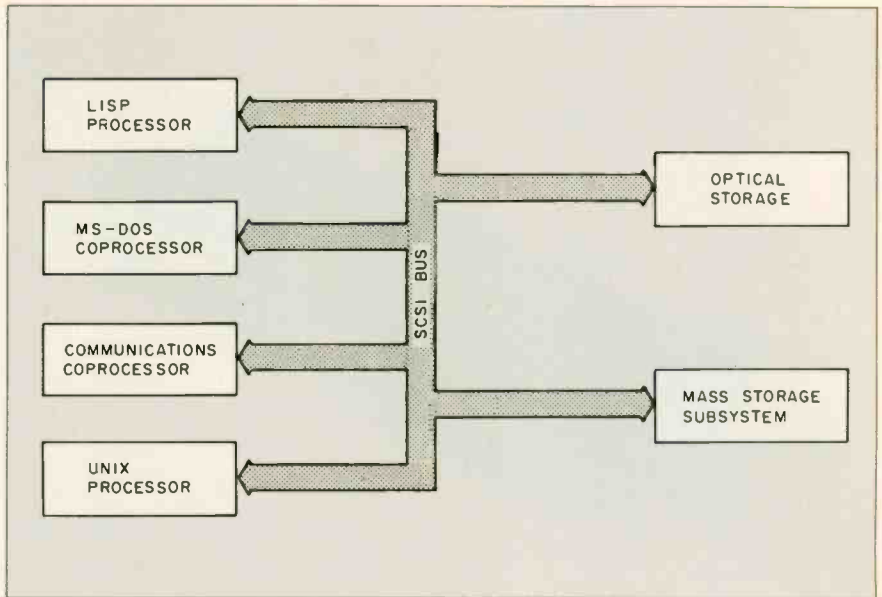

Figure 5: The SCSI bus in a multiprocessing system.

**SCSI Bus Signals.** There are a total of 18 signals. Nine are used for control, and nine are used for data. (Data signals include the parity signal option.) These signals are described as follows:

**BSY (BUSY).** An "OR-tied" signal that indicates that the bus is being used.

**SEL (SELECT).** A signal used by an initiator to select a target or by a target to reselect an initiator.

**C/D (CONTROL/DATA).** A signal driven by a target that indicates whether CONTROL or DATA information is on the DATA BUS. True indicates CONTROL.

**I/O (INPUT/OUTPUT).** A signal driven by a target that controls the direction of data movement on the DATA BUS with respect to an initiator. True indicates input to the initiator. This signal is also used to distinguish between SELECTION and RESELECTION phases.

**MSG (MESSAGE).** A signal driven by a target during the MESSAGE phase.

**REQ (REQUEST).** A signal driven by a target to indicate a request for a REQ/ACK data-transfer handshake.

**ACK (ACKNOWLEDGE).** A signal driven by an initiator to indicate an acknowledge for a REQ/ACK data-transfer handshake.

**ATN (ATTENTION).** A signal driven by an initiator to indicate the ATTENTION condition.

**RST (RESET).** An "OR-tied" signal that indicates the RESET condition.

**DB(7-0,P) (DATA BUS).** Eight data-bit signals, plus a parity-bit signal that form a DATA BUS. DB(7) is the most significant bit and has the highest priority during the ARBITRATION phase. Bit number, significance, and priority decrease downward to DB(0). A data bit is defined as 1 when the signal value is true and as 0 when the signal value is false.

**Data parity DB(P) is odd.** The use of parity is a system option (i.e., a system is configured so that all SCSI devices on a bus generate parity and have parity detection enabled, or all SCSI devices have parity detection disabled or not implemented). Parity is not valid during the ARBITRATION phase.

Figure 6: SCSI bus signals and their definitions.

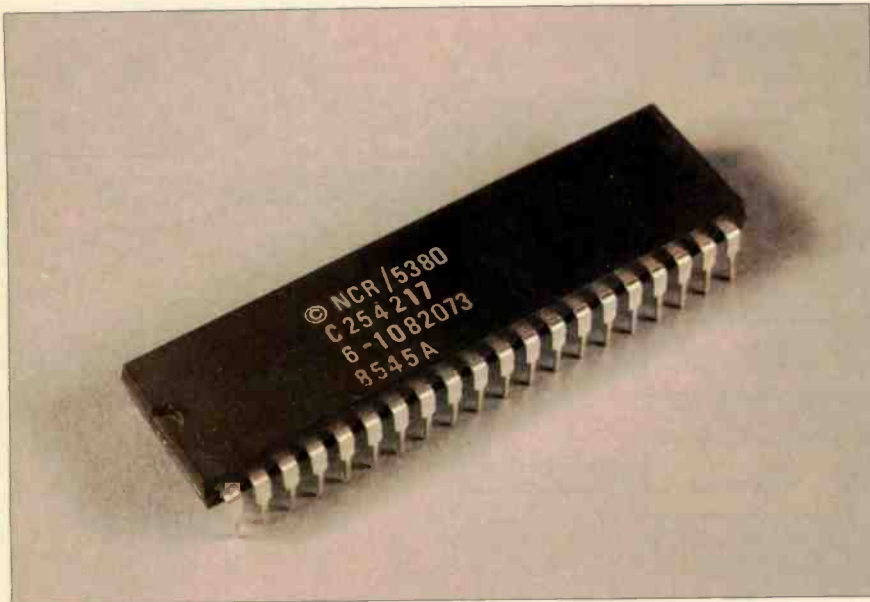

Photo 1: The NCR 5380 SCSI interface chip.

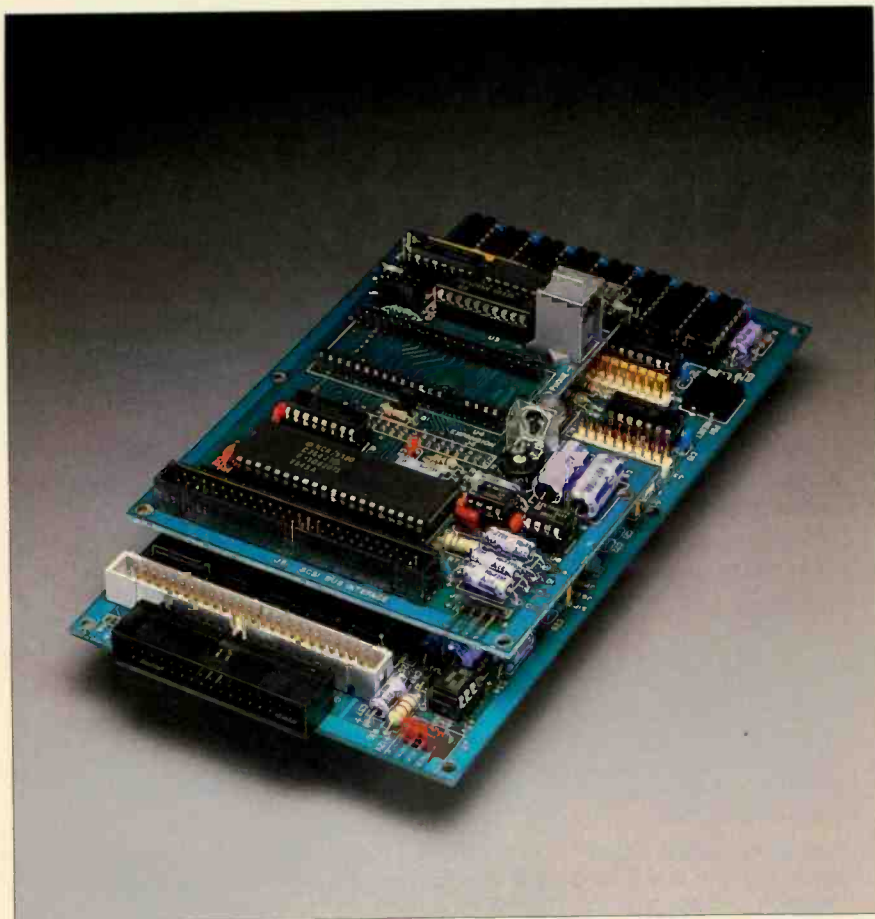

Photo 2: The COMM180 SCSI interface board rides piggyback on the SB180 single-board computer. The NCR 5380 is the large chip toward the front. Note the empty socket for the MOSART modem chip (see the November 1985 Circuit Cellar for a description of the MOSART).

uniqueness to make it a truly usable standard.

#### SCSI BUS PHYSICAL INTERFACE

The SCSI bus features a byte-wide data bus, an optional parity line, and nine control signals used to manage the flow of information between SCSI devices. (Actually, the parity line is mandatory; paying attention to it is optional.) Figure 6 describes the 18 lines on the SCSI bus.

The SCSI standard defines both asynchronous and synchronous data transfers. Asynchronous data transfer (the mode implemented on the COMM180) will support data-transfer rates up to 1.5 megabytes per second. The synchronous data-transfer mode will support data rates up to 4 megabytes per second. Synchronous data transfer is intended for high-performance systems and peripherals and requires a more complex hardware interface than is provided on the COMM180. These data rates are not arbitrary—they are determined by various delays built into the standard.

SCSI bus devices are interconnected using a daisy chain with termination required only on each end of the chain (see figure 7). Up to eight devices are allowed on the SCSI bus, with up to 2048 logical units supported per bus device. An arbitration scheme resolves bus conflicts. The bus is designed to operate up to a cable length of 6 meters using open-collector bus transceivers (used on the COMM180) or up to 25 meters using more expensive differential-pair driver/receivers. Differential-pair operation offers higher noise immunity in addition to longer cable lengths.

The SCSI standard also allows for host-to-host and peripheral-to-peripheral communications, for example, disk-to-tape backup without host intervention. This feature is not presently supported by the SB180 BIOS.

The SB180 BIOS is written to run a subset of SCSI called Single Tasking. This means that only one host computer can be on the SCSI bus, and it can talk to only one peripheral device at a time (but you can hook up to seven peripheral devices on the bus). The COMM180 board will, however, support the full SCSI implementation.

This means that you can write a driver to implement the full SCSI standard if needed.

**LOGICAL INTERFACE**

In order to provide device independence, the SCSI standard has included a logical as well as a physical interface definition. This logical interface is supported through a defined software command structure. Command structures have been defined for each SCSI device type. The device types supported by the interface can be characterized as direct-access devices (disk drives), sequential-access devices (tape drives), output-only devices (printers), write-once, read-mostly devices (write-once optical disks), read-only devices (optical disks), and other processor devices.

The intent of the logical interface is to remove any of the physical elements of a device interface from the SCSI protocol. A computer designed to support the SCSI interface need not know the number of heads, tracks, or sectors per track when communicating with an SCSI disk drive. The host issues commands that refer to logical sector numbers. The disk-drive

controller translates the logical sector number into the physical head, track, and sector locations. The host only needs to know the maximum number of sectors available, which can be acquired through a read capacity command.

**THE NCR 5380**

The NCR 5380 is a single-chip 40-pin NMOS device designed to provide a low-cost, low-parts-count implementation of the SCSI bus as defined by the ANSI X3T9.2 subcommittee (see photo 1). Capable of supporting both the initiator and target roles (which I will explain in detail next month), the NCR 5380 can be used in host adapter or peripheral controller designs. This device supports arbitration, including reselection, allowing it to be used in complex SCSI configurations (the SB180 BIOS does not support arbitration and reselection).

A significant feature of the NCR 5380 is the on-chip open-collector bus transceivers. These transceivers are capable of sinking 48 milliamperes of current at 0.5 volt and allow the chip to be directly interfaced to the SCSI bus through optional ex-

ternal bus terminators.

The NCR 5380 communicates with the Hitachi 64180 CMOS microprocessor as a peripheral device. The chip is controlled by reading and writing several internal registers that can be addressed as standard or memory-mapped I/O (it is addressed as standard I/O on the COMM180). The chip optionally supports DMA transfers and can be designed to operate in a polled or interrupt-driven environment. Since the NCR 5380 does not operate from a clock, no external clock circuitry is required, and all signals operate asynchronously.

The NCR 5380 allows every signal on the SCSI bus to be sampled or asserted via its internal registers. This provides the benefit of supporting only the level of the SCSI protocol required of your design. Since the SCSI protocol is determined by the controlling firmware, it is the responsibility of the programmer to operate the chip in accordance with the standard. Even though the SCSI protocol is a standard, early SASI implementations have subtle protocol violations. The Xebec S1410 disk con-

(continued)

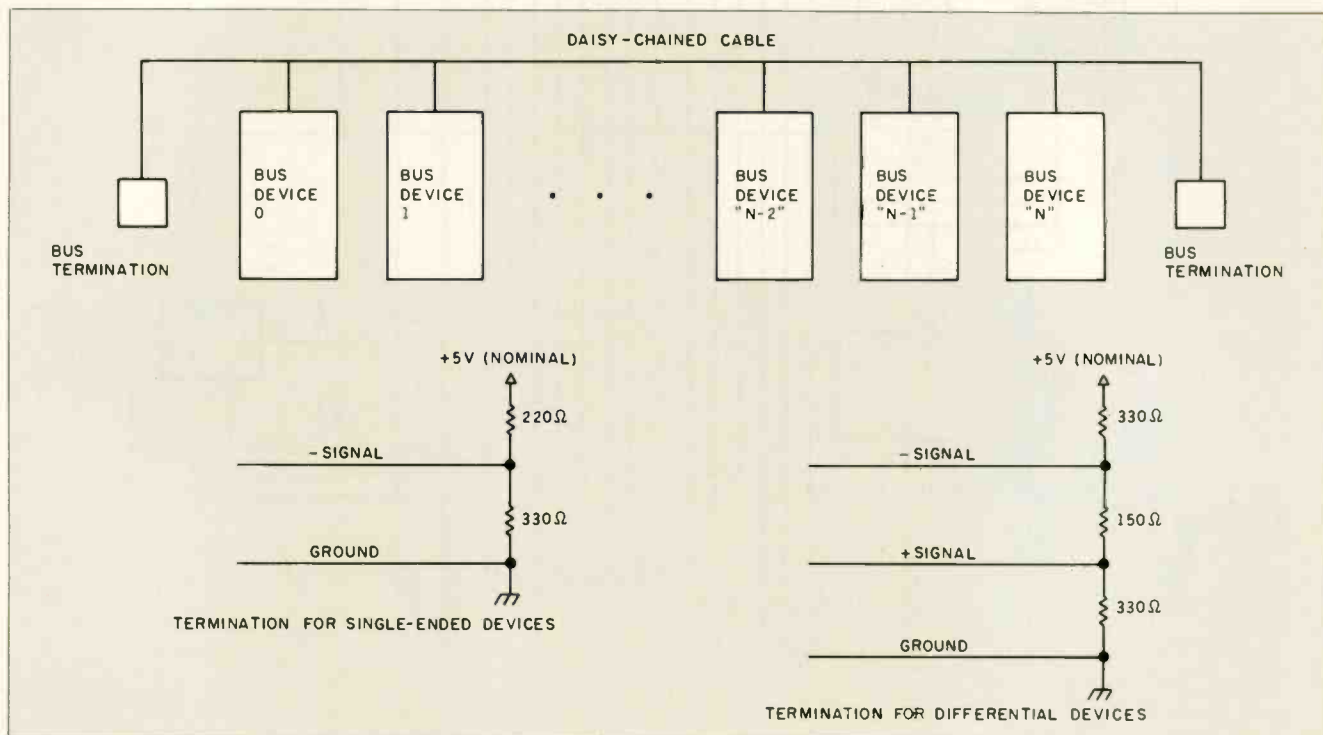
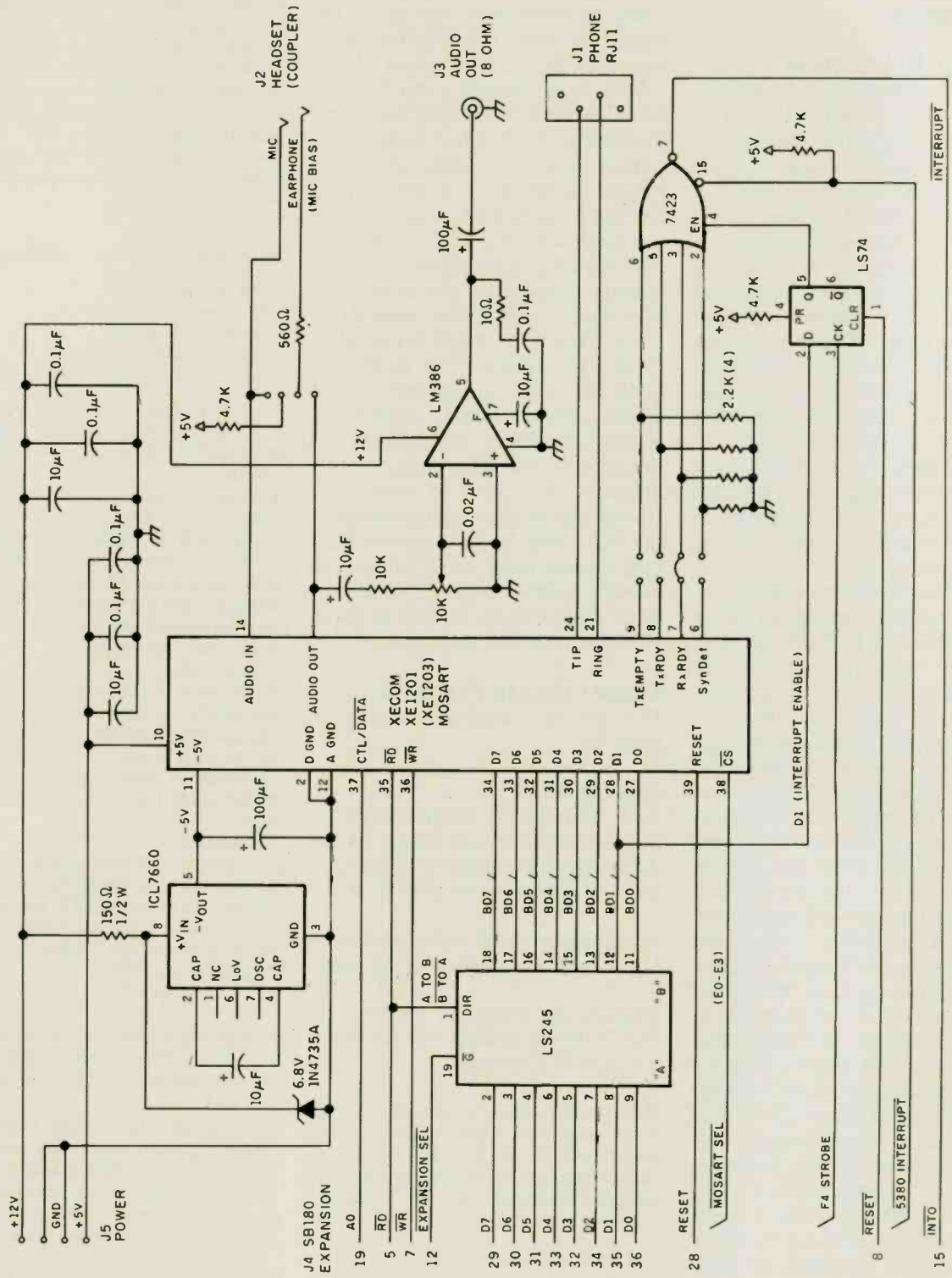

Figure 7: SCSI bus termination hardware characteristics.







troller, supported by the SB180 BIOS, is one of these products. The flexibility of the NCR 5380 accommodates these design variations.

**HARDWARE DESCRIPTION**

Little logic is required to interface the NCR 5380 to the 64180 on the SB180 (see figure 8). The signals required are available on the J4 expansion interface. The signal EXPANSION SEL, J4 pin 12, is decoded at address E0-FF hexadecimal. This signal and the address lines A4-A2 are connected to an LS156 that generates chip selects for the NCR 5380 register interface (F8-FF), the NCR 5380 DMA interface (F0), and the XE1201/1203 MOSART (E0-E3). Since the LS156 provides open-collector outputs, the chip-select signals are pulled up through 4.7-kilohm resistors. The address signals (A2-A0) from the expansion interface and the RD and WR signals can be directly interfaced to the 5380 for register addressing.

The data bus from the expansion interface is buffered through an LS245 that is enabled by EXPANSION SEL. Its direction is determined by the RD signal. The buffered data bus is connected to the 5380 data bus.

The COMM180 is designed to support DMA transfers with the NCR 5380 (see photo 2). When the 5380 requires a byte of information or wishes to transfer a byte of information, it asserts the DRQ signal. Since the Hitachi 64180 requires an active low DMA request, DRQ from the 5380 is inverted. In response to the DRQ output, the 5380 requires a DACK signal to select the internal data registers. DMA channel 0 of the 64180 is programmed to address I/O location F0 hexadecimal in response to DMA requests from the 5380. Addressing location F0 generates a DACK pulse to the 5380, which causes DRQ to be deasserted. Depending on the direction of the transfer, the DMA either generates an I/O READ or I/O WRITE strobe to clock clock the data into or out of the 5380. This process is repeated for each DMA request.

**THE SASI SUBSET**

The SCSI bus can accommodate a variety of systems. Simple systems

may use only a fraction of the available options, while high-end applications can use all the optional bus features. As mentioned previously, the SB180 is most cost-effective in a minimum SCSI configuration.

SCSI in its simplest form is just a SASI interface. SASI designs assume that one host will select a peripheral device, most likely a disk drive, and remain connected to it until the I/O transfer is completed. Because these products are used in low-cost, low-performance applications, single-ended configurations that do not support parity are the most popular.

The SB180/COMM180 is typical of most SASI designs. The BIOS supplied with this board accommodates single-user/single-tasking applications as supported by the Xebec SI410 and the Adaptec ADP4000 disk-controller products. You can use other controllers with similar capabilities. Since the NCR 5380 supports general SCSI use, software tasks can be written outside the realm of the BIOS to support other device types as well as more complex protocol versions.

**CIRCUIT CELLAR FEEDBACK**

This month's feedback begins on page 54.

**NEXT MONTH**

I will continue my discussion of the SCSI interface, concentrating on the communication details of the protocol and the different bus phases. ■

*Special thanks to Mike McBride and Harry Mason for their contributions to this project.*

*Diagrams and information specific to the NCR 5380 are reprinted with the permission of NCR Corporation.*

There is an on-line Circuit Cellar bulletin-board system that supports past and present projects. You are invited to call and exchange ideas and comments with other Circuit Cellar supporters. The 300/1200-bps BBS is on line 24 hours a day at (203) 871-1988.

Due to an overwhelming response and increased production rate for the SB180, as described in the September and October 1985 Circuit Cellars, the assembled and tested SB180-1-20 "BYTE Readers' Special" price of \$499 has been extended indefinitely by Micromint.

Editor's Note: Steve often refers to previous Circuit Cellar articles. Most of these past articles are available in book form from BYTE Books, McGraw-Hill Book Company, POB 400, Hightstown, NJ 08250.

*Ciarcia's Circuit Cellar, Volume I* covers articles in BYTE from September 1977 through November 1978. *Volume II* covers December 1978 through June 1980. *Volume III* covers July 1980 through December 1981. *Volume IV* covers January 1982 through June 1983. *Volume V* covers July 1983 through December 1984.

The following items are available from

The Micromint Inc.  
25 Terrace Dr.  
Vernon, CT 06066

(800) 635-3355 for orders  
(203) 871-6170 for information

1. SB180 computer board with 256K bytes of RAM. Complete with user's manual and ROM monitor. Assembled and tested.

SB180-1 . . . . . \$369

2. Complete SB180 computer board with 256K bytes of RAM, user's manual, ROM monitor, and the Z-System, including ZRDOS, ZCPR3, an editor and utilities, BIOS source, ROM monitor source, ZAS assembler, ZDM debugger, and user's manuals. Provided on four 5¼-inch SB180 format DS/DD disks. Assembled and tested.

SB180-1-20 . . . . . \$499

3. COMM180 SCSI-only expansion board for the SB180 computer with hard-disk BIOS upgrade (board can be upgraded to include the modem at any time). Complete with user's manual. Software supplied on 5¼-inch DS/DD SB180 format disk. Assembled and tested.

COMM180-S . . . . . \$150

4. COMM180 1200-bps modem and SCSI expansion board for the SB180 computer with TERM3 and hard-disk BIOS upgrade. Complete with user's manuals. Software supplied on two 5¼-inch DS/DD SB180 format disks. Assembled and tested.

COMM180-MOI-S . . . . . \$479

SCSI hard-disk drives, enclosures, cable sets, and various SB180 enhancement products are now available. Call for a price list.

Please include \$10 (on items 1 and 2) or \$6 (on items 3 and 4) for shipping and handling in the continental United States (\$4 additional for Canada), \$15 for surface or \$35 for air mail elsewhere. Connecticut residents please include 7.5 percent sales tax.

To be included on the Circuit Cellar mailing list and receive periodic project updates and support materials, please circle 100 on the Reader Service inquiry card at the back of the magazine.

# Avocet puts you in the chips!

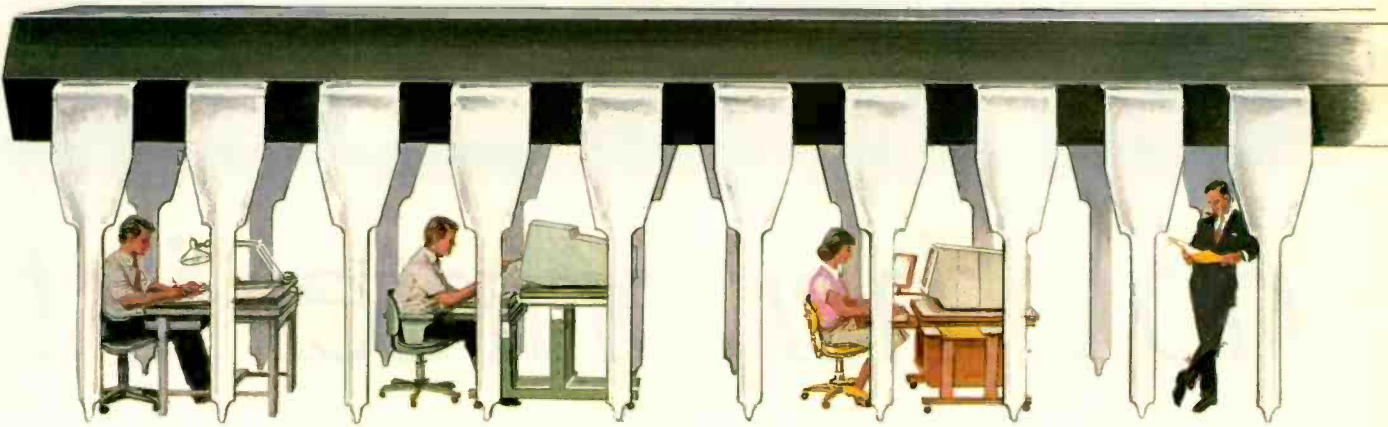

**Now you can use your PC to develop software for virtually any microprocessor. Quickly. Easily. Inexpensively.**

## THE AVOCET CROSS-ASSEMBLER FAMILY.

**AVMAC™ Macro Cross-Assembler**  
MSDOS™, PCDOS™ ..... \$349  
VAX™/UNIX™ ..... \$995

**XASM Cross-Assembler**  
CP/M™ -80, CP/M-86 ..... \$249

**Target Microprocessors Supported:**

6804	6502/65C02	Z8
6805	6800/01,6301	Z80
6809	NEC 7500	68HC11
1802/1805	8085	HD64180
8048/8041	COP400	68020
8051	F8/3870	68000/68010

**New AVMAC Macro Cross-assemblers** offer these important features: Powerful macro facility, relocatable code, linker and librarian, cross-reference by line and procedure, plain English error messages and much more.

™ Signifies manufacturer's trademark.

Avocet cross-assemblers, simulators, emulators and EPROM programmers will help put your design ideas into more chips than any other software development system on the market. You don't need a mainframe, or even a dedicated system. All you need is a PC, a good idea...and Avocet. It's as simple as that.

Avocet has been creating tools for software development since 1979 to help design engineers find easier and more productive ways to develop software for virtually any microprocessor—without

switching development systems.

Our customers turn ideas into real products. From data entry through assembly, debugging and final EPROMs, Avocet has everything you need to transform your personal computer into a fully integrated development system.

### Cross-assembler capabilities.

No matter what the application, our family of cross-assemblers runs on any computer with CP/M\* or DOS and processes assembly language for most microprocessors.

### Taking the bugs out.

Avocet's new debugging tools will eliminate "crash and burn" from your vocabulary in two ways.

First, AVSIM software simulator/debuggers allow you to test program modules on your PC. No special hardware is required for executing your target code interpretively in a crash-proof, interactive environment. AVSIM's full screen display lets you see at a glance what your program is doing.

When you're ready to test your program in a working model, Avocet's TRICE in-circuit emulators allow you to examine target memory and register, set breakpoints, single-step, trace and more. A standard serial interface lets you control emulation and download code from your PC.

And best of all, TRICE costs less than \$500.

### Progressive EPROM programming.

Avocet AVPROM programmers work with over 37 different devices including EPROMs through 27512, CMOS and E<sup>2</sup> PROMs, and MPU/EPROM combos using fast "adaptive" algorithms. These intelligent, self-contained units work with any personal computer using Avocet's GDX driver software.

### Made to order.

You don't have to come to Maine to get Avocet products (unless, of course, you want a really great lobster dinner). Just call, toll-free,

## 1-800-448-8500

(in the U.S. except Alaska and Hawaii)

and we'll rush out your order, send out more information, or, if you want, talk about some of your great ideas. Avocet Systems Inc., P.O. Box 490-BB, Rockport, Maine 04856. (207) 236-9055. Telex: 467210 AVOCET CI



**AVOCET SYSTEMS INC.™**



# *no other printer is th*

## **Add up everything that's up front:**

*No other letter-quality printer is this easy, this fast and this good—all three at once! If you thought that was impossible, you were right...up until Star created the new NB-15!*

*It makes everything so easy for you. Because everything's where you want it. Right at your fingertips. Up front. On the front panel.*

*And we mean everything: You can select from 3 font styles, 4 print pitches, 2 print modes, and 8 form lengths—19 functions in all. And you can choose additional font cartridges, too.*

*There's also an exclusive software override. Full software compatibility.*

*And IBM® PC compatibility, of course.*

*Both tractor and single sheet feeds are standard. And there are optional automatic sheet feeders, single and dual bin. With button-control paper alignment right up front, too.*

PROP  
136  
163  
222

PRINT  
PITCH

TOF

PAPER  
FEED

ON LINE

*is up front with you.*

*Best of all, the NB-15™ gives you all this with 24-wire quality printing. All at top speeds of 300 cps draft and a full 100 cps with true letter quality.*

*Plus a 16K buffer. That's all the memory you could hope for.*

*The all-new NB-15 business printer. The newest and brightest Star has just come out at a dealer near you. And it's already out in front!*

***In front with  
quality up front.***

***The new  
Star NB-15***



**star**  
MICRONICS



# DATA COMPRESSION WITH HUFFMAN CODING

BY JONATHAN AMSTERDAM

*A close look at an elegant way  
to compress information*

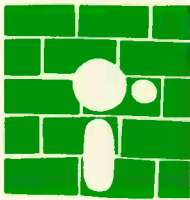

Am I the only one, or have you also noticed that there's never enough room on a disk? No matter how big a floppy is—200K, 400K, or even 800K bytes—it's almost too easy to stuff it to the gills. The same goes for hard disks. Sure, it takes a while to fill up 20 megabytes. But eventually, things get so tight you couldn't fit your own name into the space left.

Using data-compression techniques, you can shorten files by compressing the information they contain. But data compression can do more than just save disk space. It can also cut down on the time needed to transmit large files between computers, especially if the transmission is done over slow links like telephone lines. If you compress the file before sending it and uncompress it on the receiving end, you can reduce the total time for the transmission. The technique can work interactively, too. If you are using your computer as a terminal to communicate with a host computer via a modem, the host can send compressed commands and data that your computer uncompresses before displaying. The result can be apparent communication speeds that greatly exceed the actual transmission rate of the hookup. Such a system could make remote full-screen editing pleasant,

even over 1200-bps lines.

This month, I will discuss an elegant data-compression algorithm called Huffman coding. Invented by David Huffman in 1952, it's easy to implement and widely used. In a sense I'll make precise later, Huffman coding is the "best" way to compress data in general.

## THE PROBLEM DEFINED

For the sake of concreteness, I will discuss Huffman coding in the context of compressing ASCII text files. The program I will construct takes as input a text file, that is, a sequence of 1-byte characters. Hopefully, the output will be a shorter file. A separate uncompressing program will turn the compressed file back into the original one when you so desire.

How is it possible to reduce the size of a file without losing some of the information it contains? The answer involves constructing a code for each character of the file. Note that ASCII, as its full name—American Standard Code for Information Interchange—suggests, is itself a character code. ASCII assigns a unique 7-bit pattern to each character. Since all the codes have

*(continued)*

*Jonathan Amsterdam is a graduate student at the Massachusetts Institute of Technology Artificial Intelligence Laboratory. He can be reached at 1643 Cambridge St. #34, Cambridge, MA 02138.*

the same length, ASCII is a fixed-length encoding scheme.

The idea behind Huffman coding (and, by the way, Morse code as well) is that variable-length codes can achieve a higher data density than fixed-length codes if the characters differ in frequency of occurrence. For instance, in a file of English text, the space character will probably be by far the most common character, accounting for perhaps one-sixth of the file's contents. The letter "e" will likely finish second. Letters like "x" and "z," on the other hand, will be infrequent, if present at all. By using an English-letter frequency table, you can construct a coding scheme that assigns short codes to the frequent characters and long codes to the infrequent ones and use it to encode English files. The size of a file will be reduced if it conforms well to the frequency table. But you can do better by constructing a different code for each file, using the actual number of

occurrences of characters in that file as the frequency table.

For those of you who remain skeptical about the ability of this method to shorten files, let's take as an example the sentence you are now reading. The frequency counts for the characters in the sentence, along with the coding schemes produced by the Huffman algorithm, appear in table 1. The sentence contains 147 characters, including spaces and punctuation. If the sentence were stored as a text file, each character would occupy 1 byte, so the sentence would take up 147x8 or 1176 bits. Since 27 distinct characters are found in the sentence, the best fixed-length encoding you could hope for would use 5 bits per character; the sentence would thus occupy 735 bits. The Huffman-coded version occupies only 612 bits, a 17 percent improvement over the best fixed-length code and a 48 percent savings over the ASCII storage method. In practice, I have found Huffman coding

to reduce file sizes by about 30 percent.

Variable-length codes can compress information, but they have their drawbacks. For one thing, they are difficult to manipulate inside a computer, which prefers fixed-size objects; hence, a fixed-length code like ASCII is superior when space or transmission time isn't an issue. Variable-length codes are also sensitive to mangled bits. A single incorrect bit in a variable-length encoding can throw off the rest of the message. In a fixed-length code, an incorrect bit will affect only one character.

A third problem with variable-length codes crops up when you try to decode an encoded file. Say your coding scheme assigns the code 0 to the character "a," 1 to "b," and 01 to "c." The string "ab" is encoded as 01. But when decoding this string, you can't know whether the original string was "ab" or "c."

To avoid ambiguity, it is sufficient that the code possess the prefix property. In a code with this property, no character code occurs as a prefix—an initial sequence—of any other code. The code in the previous paragraph does not have the prefix property because the code for "a," 0, is a prefix of the code for "c," 01. The code in table 1 does have the prefix property, as do all codes generated by the Huffman algorithm. The prefix property makes decoding easy. The decoder can read one bit after another until the sequence of bits read so far corresponds to a character code. It then outputs the character and begins reading again.

### AN OVERVIEW

Let's now take a close look at the Huffman algorithm, which uses a frequency table to construct a variable-length code with the prefix property. The secret to the algorithm is that versatile and elegant data structure, the binary tree. It so happens that a correspondence exists between codes with the prefix property and binary trees where every node has either two children or none. The nodes with no children—the leaves of the tree—are labeled with characters. Each left branch of the tree is labeled with a 0,

Table 1: The frequency distribution and Huffman encoding for the sentence "For those of you who remain skeptical about the ability of this method to shorten files, let's take as an example the sentence you are now reading."

Character	Frequency	Code
space	26	101
e	17	010
t	13	1000
o	12	1001
a	10	1101
s	8	0111
i	7	0000
h	7	0001
n	7	0010
l	5	11001
r	5	11000
f	3	01101
y	3	00111
u	3	00110
m	3	111011
w	2	111111
k	2	111110
p	2	111100
b	2	111101
d	2	011001
c	2	011000
x	1	1110101
g	1	1110100
F	1	1110010
' (apostrophe)	1	1110011
, (comma)	1	1110001
. (period)	1	1110000



and each right branch with a 1. Let us call such a tree a code tree. Figure 1 shows a simple code tree.

To get the code for a particular character, just trace the path from the root of the tree to the leaf labeled with that character. Every time you turn left, add a 0 to the character's code; every time you turn right, add a 1. In the tree shown, the character code for "d" is 011. The form of the tree embodies the prefix property, because for one code to be a prefix of another, one character would have to be on a path between the root and some other character. But this is impossible, because the characters occur only at the leaves of the tree.

To construct such a tree from the frequency table, the Huffman algorithm begins by finding the two characters with the lowest nonzero frequencies. (If a character has a frequency of zero, it can be ignored. If more than one character has the minimum frequency, it doesn't matter which is chosen.) It combines these two characters into a tree by creating a new node and making the characters its children. The tree is assigned a frequency that is the sum of the frequencies of its children. The algorithm again picks the two lowest-frequency values that occur, this time including the newly constructed tree in its search. Again, it pairs the two lowest values into a tree. It continues this process until only one tree remains; that tree is the Huffman code tree for the frequency table, and the character codes can be read off it directly. Figure 2 shows how the algorithm constructs the tree in figure 1. Figure 3 provides a more formal description of the algorithm.

**HUFFMAN IS "THE BEST"**

It should be clear that the Huffman algorithm constructs a binary tree that can be used to encode characters, but it is far from obvious that it constructs the best such tree. It does, but before proving it, I should define what I mean by "best."

Since the goal of the algorithm is to minimize the space occupied by a file, it's clear that the best encoding of the file is the one that will take up the

(continued)

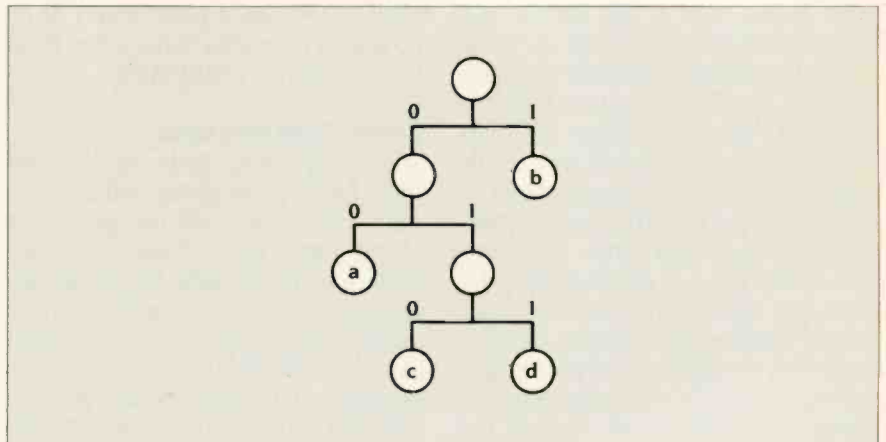

Figure 1: A simple code tree.

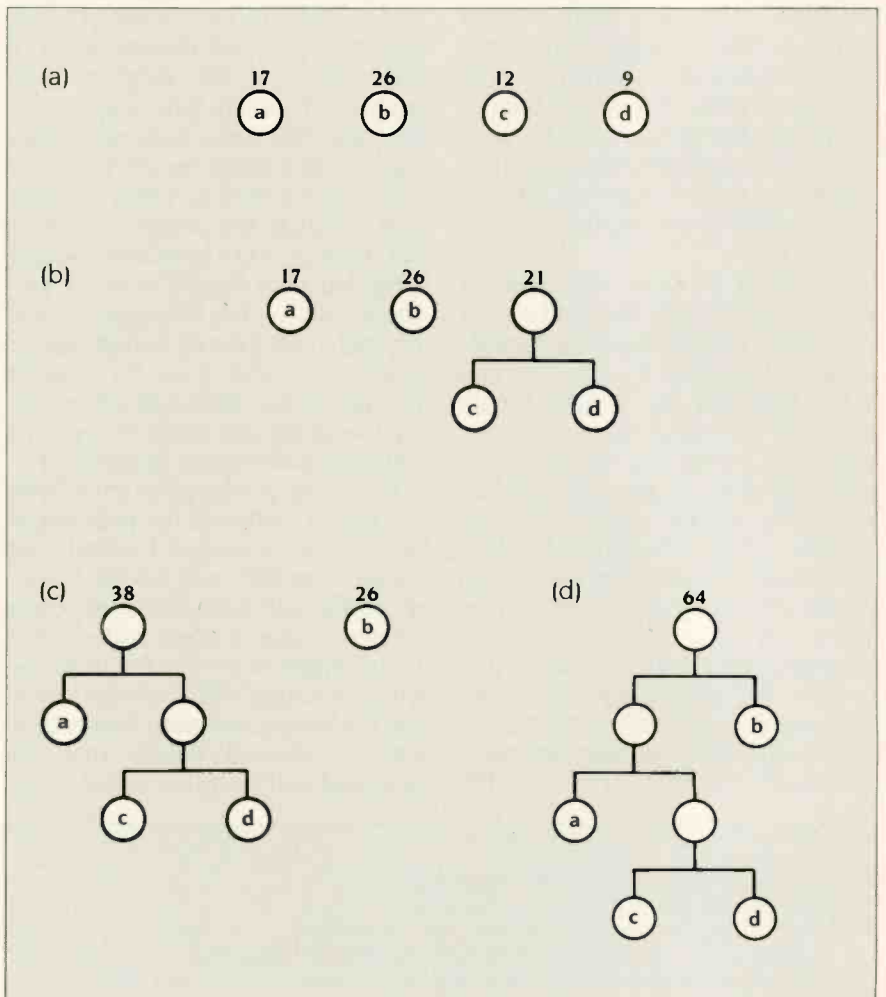

Figure 2: How the Huffman algorithm constructs the tree in figure 1: (a) It begins with a list of characters and their frequencies; (b) It combines the characters with the lowest frequencies, "c" and "d," into a subtree and puts the subtree in the list; (c) Now the character "a" and the newly constructed subtree have the lowest frequencies, so they are combined; (d) Finally, the remaining character is combined with the subtree to form the completed code tree.

least space, that is, the fewest bits. How does that translate to code trees? Let's assume that the frequency table used to construct the tree consisted of the number of times each character occurred in the file rather than, say, the percentages of the characters' occurrence in English. (The Huffman algorithm will work either way, but it is guaranteed to be best only with the former interpretation of the frequency table.) Given a code tree, it's easy to calculate exactly how many bits the corresponding file will occupy. Observe that the length of the path from the root to a character—the number of branches you have to traverse to get to the character—is the same as the number of bits in that character's code. Since the frequency of a character is the number of times it occurs in the file, multiplying the frequency of the character by the number of bits in its code yields the total number of bits the character will occupy in the encoded file.

Performing the same calculation for each character in the tree and adding the results together yields the number of bits in the entire encoded file. This value is called the weighted path length of the tree because it is computed by multiplying the length of each root-to-leaf path in the tree by the path's weight, which is the frequency of the character at the leaf. For instance, the weighted path length of the tree in figure 2d is  $17 \times 2 + 12 \times 3 + 9 \times 3 + 26 \times 1 = 123$ . The weighted path length of a code tree is what you should minimize. I am claiming that, for any distribution of frequencies, the Huffman algorithm constructs the tree that has the

smallest weighted path length of all possible code trees constructed from that frequency distribution.

### SOME OBSERVATIONS

Three interesting facts about code trees bear on the proof of the above claim. The first I call the generality observation: You can construct any code tree by repeatedly taking two subtrees and combining them into a larger tree. Therefore, the important aspect of the Huffman algorithm is not the way it builds up the tree from subtrees, but the fact that it always chooses the smallest subtrees to combine at each step.

The second observation is this: If you increase the path length of a subtree by 1, you add the frequency of the subtree to the weighted path length of the entire tree. I call this the lowering observation because increasing a subtree's path length is just like lowering the level at which the subtree occurs in the overall code tree. For instance, say I have a tree whose weighted path length is 30. A particular subtree has frequency 5, and the path from the root to that subtree is three branches long. If I increase the path to four branches while holding everything else constant, the tree's weighted path length becomes 35.

This is easy to see when the subtree is a leaf. If I increase the path length of a leaf by 1, it's as if I added 1 bit to the character code for the character at that leaf. If the character occurs  $n$  times, I have in effect added  $n$  bits to the length of the file. But that's the same as saying that I have increased the tree's weighted path length by  $n$ , since I showed before that the weighted path length is equal to the

number of bits in the file.

For the case of a nonleaf subtree, recall that the subtree's frequency is the sum of the frequencies of its children, which are in turn the sum of the frequencies of their children, and so on down until the leaves are reached. So the frequency of a subtree is just the sum of the frequencies of all the leaves under that subtree. Now, if I increase the path length of the subtree by 1, I have also increased the path length of each of its leaves by 1. By the argument in the previous paragraph, I have increased the weighted path length of the tree by the sum of the frequencies of the subtree's leaves. But this is just the frequency of the subtree itself.

The third and most important observation I call the swap observation. Consider any two subtrees of a code tree. If the higher subtree—the one with the shorter path length—has a smaller frequency than the lower subtree, you can swap the two subtrees and thereby decrease the weighted path length of the entire tree. Figure 4 provides an example. I think the easiest way to convince yourself of the truth of this observation is to imagine lowering the higher subtree one level at a time until it reaches the level of the lower subtree. By the lowering observation, each time the subtree descends a level, the entire tree's weighted path length increases by the frequency of the subtree. Now imagine raising the lower subtree up in the tree until it reaches the level of the higher subtree. By the same reasoning used for the lowering observation, you can see that each level this subtree ascends will decrease the tree's overall weighted path length. Now which is greater, the amount of increase or of decrease? Both subtrees move the same number of levels because they are being swapped, but the subtree responsible for the decrease is the ascending subtree, which has a higher frequency. So the net effect must be that the overall weighted path length is decreased.

### THE PROOF

I will now show that no code tree using a given frequency distribution

*(continued)*

For each character with a nonzero frequency,  
 add the character to the list of subtrees.  
 While the list of subtrees contains more than one subtree,  
 remove from the list the two subtrees with the smallest frequencies;  
 make them the children of a new subtree whose frequency is the sum of  
 their frequencies;  
 add the new subtree to the list.  
 The remaining subtree is the Huffman code tree.

**Figure 3:** The Huffman algorithm takes a table of characters and their frequency counts as input and produces a code tree as output.

# You need Borland's Traveling SideKick because wherever you go, there's work to be done

**T**raveling SideKick™ is the only personal organizer developed from and designed for the Computer Age.

An electronic leap ahead of traditional diaries, day-timers and organizers, Traveling SideKick is BinderWare™ that includes a software program, a report generator, reference materials, maps, addresses, appointments, telephone numbers, calendars, customer lists, travel itineraries, a calculator, and much much more.

You need Traveling SideKick because it is the new Computer Age way to take all your facts, files and figures with you wherever you go—whether you're taking work home or heading out across America and the world.

## Traveling SideKick is your SideKick's sidekick

More than half a million of you already know how indispensable SideKick, the RAM-resident desktop manager, is on your IBM® PC (So do many Macintosh™ owners who are now using our SideKick/Mac version). While SideKick enjoys the rank of #1 best seller for the IBM PC, it can

## What's inside your Traveling Sidekick



**TABLET OF EXTRA FORMS**  
A POCKET ON BACK FLAPS FOR USE IN ANY OF THE ORGANIZER SECTIONS.

**ADDRESS BOOK SECTION**  
PREPRINTED ADDRESS FORMS WITH TABBED COVERS FOR EASY REFERENCE.

**MISCELLANEOUS SECTION**  
TO STORE ALL EXTRA PREPRINTED FORMS AND COMMONLY USED RECORDS.

**ROLLER BALLPOINT PEN**  
BLACK PEN THAT FITS IN FLAP FOR EASY ACCESS.

**REFERENCE SECTION**  
CONTAINS MAPS THAT SHOW AREA CODES AND TIME ZONES, TOLL FREE NUMBERS FOR TRAVEL ACCOMMODATIONS, METRIC CONVERSION CHARTS.

**FINANCE SECTION**  
MULTI-USE LEDGER FORMS, RECEIPT LOG AND STORAGE ENVELOPE, CREDIT CARD INFORMATION.

**CALENDAR SECTION**  
YEARLY, MONTHLY, WEEKLY, AND DAILY ENGAGEMENT CALENDARS, SUPPLEMENT THOSE YOU PRINT OUT WITH TRAVELING SIDEKICK.

**PLANNING SECTION**  
A TO BE CONTINUED SECTION FOR CURRENT PROJECTS, MEETING NOTES, ETC.

**CALCULATOR**  
IN ONE OF TWO BUSINESS-SIZE STORAGE ROCKETTS.

**TRAVELING SIDEKICK SOFTWARE**  
GENERATES, UPDATES, AND PRINTS YOUR ADDRESS AND CALENDAR FILES.

only go where your computer goes—so if your computer stays in your office or den, so does SideKick. Traveling SideKick changes all that.

**For a limited time, Traveling SideKick is only \$69.95**

Until September 1, 1986, you can get Traveling SideKick for

## How it works for you:



Whatever's already in your SideKick—phone numbers, appointments, calendar, addresses, customer lists, airlines, restaurants, etc.—can be picked up and printed out by Traveling SideKick's Report Generator.



You simply clip the freshly printed information into your Traveling SideKick binder and hit the road. Instant access to information—no matter where you are.

Naturally, you can add new information/files/data to your SideKick as it occurs. Traveling SideKick instantly incorporates all changes and updates. Traveling SideKick will also sort your address files by name, zip code, or company name. It prints mailing labels and other information selectively, and will search your files for existing addresses and appointments.

just \$69.95—which is tremendous short-term and long-term value. Short-term because it solves immediate problems at a very low price, and long-term because Traveling SideKick works this year, next year, and all the "next years" after that. (Unlike old-fashioned daytime organizers, electronic organizers and calendars aren't obsolete at the end of the year.)

## Special Offer: Get both SideKick and Traveling SideKick for only \$125.00

You probably already have SideKick, but in case you don't, we're offering you both SideKick and Traveling SideKick for only \$125.00. (SideKick alone is usually \$34.95. Add that to Traveling SideKick's \$69.95, and you're looking at \$154.90—which you don't have to look at, because you get \$29.90 off when you buy both.) Whichever way you buy, you're getting our 60-day money-back guarantee\*\* and making a highly organized and productive step into modern business life.

Traveling SideKick is an organizer, a binder, a software program and a report generator that picks your SideKick's brain, then prints out your appointments, daily, weekly, monthly, or yearly calendar, your phone lists, and mailing labels, itinerary, or whatever else you need.

**YES!** I want the best

Rush me Traveling SideKick at:

**\$69.95\***

Or both Traveling SideKick & SideKick at \$125.00.\*\*

To order by phone, or for a dealer near you, call (800) 255-8008 in CA call (800) 742-1133

Send me \_\_\_\_\_ Traveling SideKick(s) at \$ \_\_\_\_\_  
Send me \_\_\_\_\_ of both SideKick(s) at \$ \_\_\_\_\_  
Outside USA add \$10 per copy  
CA and MA res. add sales tax \$ \_\_\_\_\_  
Amount enclosed \$ \_\_\_\_\_  
Prices include shipping to all U.S. cities  
Payment: VISA MC Bank Draft Check  
Credit card expiration date \_\_\_\_/\_\_\_\_/\_\_\_\_  
Card # \_\_\_\_\_

Carefully describe your computer system

Mine is:  8-bit  16-bit

I use:  PC-DOS  MS-DOS  CP/M-80  CP/M-86

My computer's name and model is: \_\_\_\_\_

The disk size I use is:  3 1/2"  5 1/4"  8"

**NOT COPY PROTECTED**  
**\*\*60-DAY MONEY-BACK GUARANTEE**

Name: \_\_\_\_\_  
Shipping Address: \_\_\_\_\_

City: \_\_\_\_\_  
State: \_\_\_\_\_ Zip: \_\_\_\_\_

Telephone: \_\_\_\_\_  
CODs and purchase orders WILL NOT be accepted by Borland. Outside USA make payment by credit card or International Postal Money Order.

\*Special Introductory Offer until September 1, 1986

\*\*YES, if within 60 days of purchase this product does not perform in accordance with our claims, please call our customer service department and we will gladly arrange a refund.

Minimum System Requirements:

256K IBM PC, PCjr., XT, AT, and true compatibles  
TS15



4585 SCOTTS VALLEY DRIVE  
SCOTTS VALLEY, CA 95066  
(408) 438-8400 TELEX 172373

Borland products include Turbo Pascal, Turbo Database Toolbox, Turbo Lightning!, Turbo Graphics Toolbox, Turbo Tutor, Turbo OmegaWorks, Turbo Editor Toolbox, Reflex, The Analyzer, SideKick, SideKick, The Macintosh Office Manager, Traveling SideKick, and SuperKey—all of which are trademarks or registered trademarks of Borland International, Inc. or Borland/Analytix, Inc. Copyright 1986 Borland International BI-1043B

Inquiry 406 for End-Users. Inquiry 407 for DEALERS ONLY.



can have a lower weighted path length than the tree produced by the Huffman algorithm using the same frequency distribution. Other trees may have the same weighted path length, but none can be better.

By the generality observation, any code tree can be constructed by building it up out of smaller subtrees. To be more concrete about this, say that you are building a code tree that diverges from the one that would be built by the Huffman algorithm. At the point of divergence, the frequencies of the remaining subtrees are 9, 12, 17, 26, and 32. The Huffman algorithm would combine the 9 subtree and the 12 subtree (see figure 5a), but to make the divergent subtree, you combine the subtrees 12 and 26 and then 9 with 17.

In this divergent tree, the lowest-frequency subtree and the one it is combined with (subtrees 9 and 17 in this example) must be at the same level. But where does the subtree of second-lowest frequency (subtree 12) turn up? There are three possibilities: at a lower level than 9 (figure 5b), a

higher level than 9 (figure 5c), or the same level (figure 5d).

If 12 is lower than 9, the swap observation says that we can swap the two subtrees to get a better tree. If 12 is higher than 9, it must also be higher than 17, so we can swap 12 and 17 to again get a better tree. Any tree that diverges from the Huffman tree in one of these two ways can't have the lowest weighted path length.

Now to the third case. If 12 is on the same level as 9, it is also on the same level as 17. Swapping 12 and 17 won't change the weighted path length of the tree. But it will make 9 and 12 children of the same node, which is just where the Huffman algorithm would have put them. So although the tree in figure 5d diverged from the Huffman algorithm at this point, there is another tree with the same weighted path length that doesn't diverge from it here.

Abandon the tree in figure 5d and begin the argument again with the tree in figure 5e. The subtrees to consider are 17, 21, 26, and 32 (9 and 12 subtrees make a subtree of fre-

quency 21). Since 21 is higher on the tree than both 17 and 26, it can be swapped with 26 to get a better code tree. Hence, the tree in figure 5e is worse than the Huffman tree. In general, one of two things will happen to a new tree. Either it will diverge from the Huffman tree as in case 1 or case 2 above, showing itself to be worse than the Huffman tree, or it won't diverge at all, in which case it just is the Huffman tree.

That concludes the proof. Let me sum up. The idea is that a tree can diverge from the tree constructed by the algorithm in only three ways. If it diverges in one of the first two ways, it can't be minimal. Only if it diverges in the third way can it be minimal—but then the Huffman algorithm will produce a different tree with the same weighted path length, hence also minimal. It follows that no code tree can be better than the Huffman tree.

**IS "BEST" ALWAYS BEST?**

I've only shown that, given a frequency distribution, the Huffman algorithm produces the shortest character code with the prefix property over that distribution. Huffman coding is optimal only in this narrow sense. In many cases, a Huffman code based on characters will fare worse than some other scheme. For instance, consider the sentence "John, where Bill had had 'had,' had had 'had had.'" An encoding in which "had" is 1, "Bill" is 01, "where" is 001, and "John" is 000 does much better than a Huffman code based on characters. In fact, that encoding is what you would get with the Huffman algorithm if you applied it to the words of the sentence. In many cases, the Huffman algorithm will do poorly no matter what. For example, pictures are often represented digitally as bit maps. Since many pictures consist of large regions that contain all 0s or 1s, a preferable compression technique is run-length encoding, in which long sequences of identical bits (or characters) are represented by a single character and a count indicating the number of consecutive occurrences of that character.

Despite its drawbacks, Huffman coding applied to the characters of a

(continued)

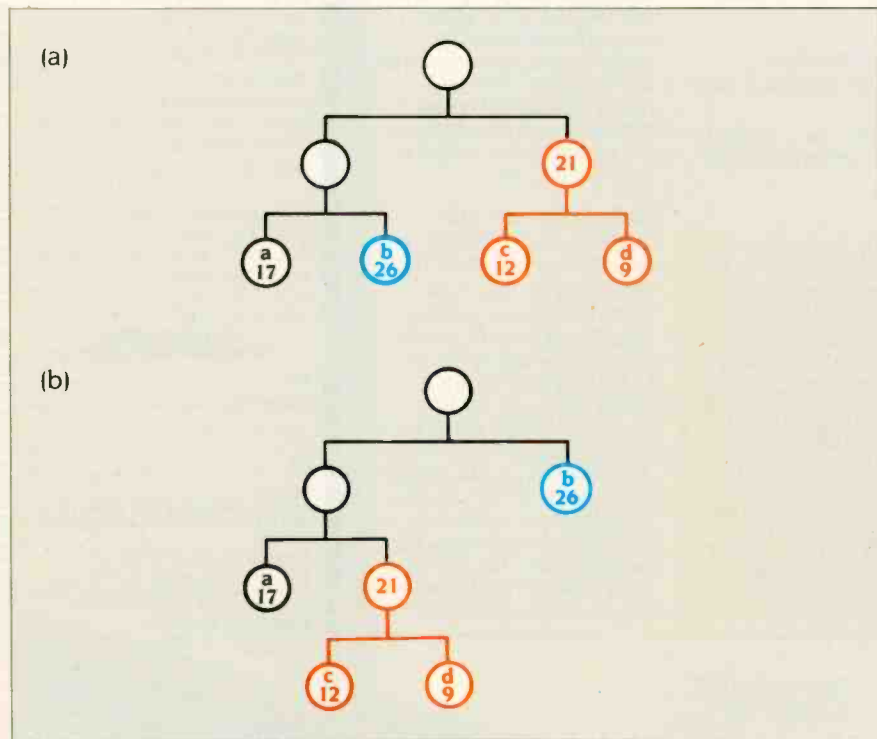
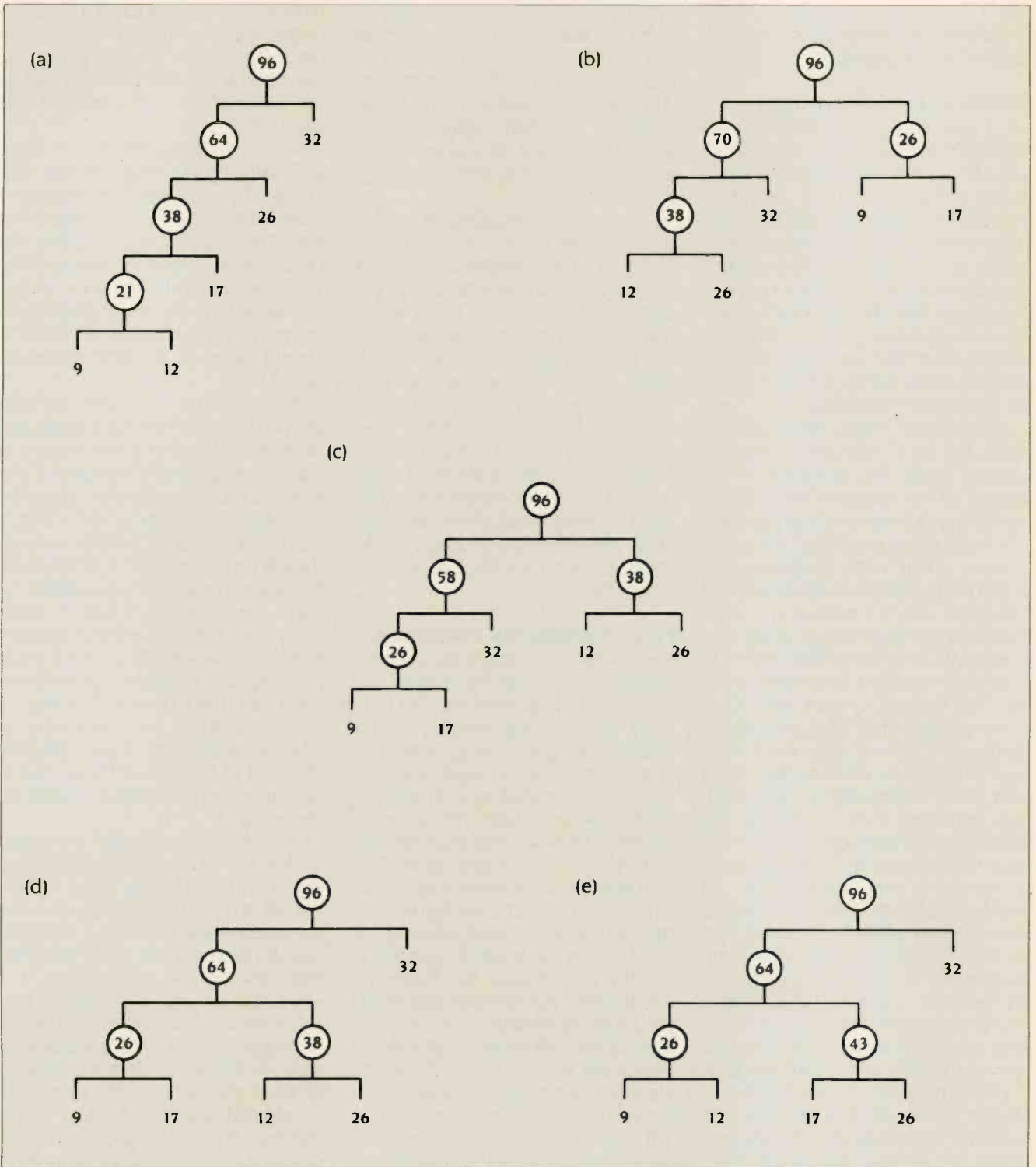

Figure 4: An illustration of the swap observation. Before the swap, the red subtree is higher in the code tree than the blue subtree. The weighted path length of the tree before the swap is 128; after the swap, it's 123.

# PROGRAMMING PROJECT



**Figure 5:** Given the subtrees 9, 12, 17, 26, and 32, examine some trees that diverge from the tree produced by the Huffman algorithm. For now, look at only the frequencies of these subtrees and ignore the characters these frequencies correspond to: (a) The tree the Huffman algorithm would build from these subtrees; (b) The subtree with the second-lowest frequency (12) is lower in the tree than the subtree with the lowest frequency; (c) The subtree with the second-lowest frequency is higher in the tree than the subtree with the lowest frequency; (d) The second-lowest frequency is at the same level as the lowest frequency; (e) Swapping 12 and 17 gives a tree that diverges from the tree that would be produced by the Huffman algorithm at a later point than that of figure 5d and yet still has the same weighted path length of the tree of figure 5d.

file is usually your best bet, especially for text files like program sources and written documents.

### HUFFMAN IMPLEMENTATION

My implementation of the Huffman algorithm uses a data structure I call a node to construct the code tree. A node is just a Modula-2 or Pascal record that contains five fields: a character; a frequency count; two children, which are pointers to other nodes; and a parent, which is also a pointer to a node. The children pointers are used to trace down the tree when decoding, and the parent pointers are used to trace paths from the leaves to the root for encoding.

My program begins by creating a node for each character in the frequency table. The character is assigned to the character field of the node, and its frequency is assigned to the node's frequency field. Since this node is a leaf, both its children are assigned the value NIL (in Pascal and Modula-2, NIL is a pointer value that points to nothing). The program also constructs an array of the leaves indexed by character to serve as an index into the tree for use in encoding.

The program then places all the leaf nodes in a list and does the following: When the list contains more than one node, it removes the two smallest, combines them, and puts the resulting node back in the list. To combine two nodes A and B, the program constructs a new node C, sets its children fields to point to A and B, sets the parent fields of A and B to point to C, and assigns the sum of the frequencies of A and B to C's frequency field. (C's character field is never used, so it need not be set.) When only one node is left in the list, that node is the root of the Huffman tree.

I haven't specified how the list of nodes is represented or how the smallest nodes are chosen. My program uses an array for the list, and I choose the smallest node by stepping through each node in the array and comparing it against the smallest found so far. The procedure is similar to Selection Sort and results in a Huffman algorithm with the same time complexity:  $O(n^2)$ , where  $n$  is the number of characters in the frequen-

cy table (see my "An Analysis of Sorts" on page 104 of the September 1985 BYTE for an explanation of Selection Sort and "Big O" notation). Although it's possible to do better ( $O(n \log n)$ , in fact) using a more sophisticated data structure, it's probably not worth the trouble, for two reasons.

First, if you are encoding characters, that is, bytes, there cannot be more than 256 distinct characters in the file since a byte can represent only 256 distinct values. Usually, there will be many fewer. For such small values of  $n$ , it is not clear that the theoretically faster but more complex algorithm will be quicker in practice. Another reason in favor of the simpler algorithm is that, when using Huffman coding to compress a file, most of the time taken by the compression program is spent reading from and writing to the disk. For large files, the time taken to construct the tree pales in comparison.

### FILE-COMPRESSION PROGRAMS

Some additional apparatus is needed before you can use the Huffman algorithm to compress files. You must write an encoding program and a decoding program. The encoding program takes a file as input and produces an encoded and (hopefully) shorter file as output. The decoding program takes an encoded file and restores it to its original state. Two problems must be solved before you write these programs: saving the code tree and performing bit-oriented I/O.

If the encoding program uses the input file to calculate the frequency distribution, the Huffman algorithm produces a minimal tree. But this method has a drawback that makes it unsuitable for short files. Since the algorithm generates a different code for each file, it is necessary to store the code tree along with the encoded file so the decoding program can do its job. If the file is too short, the number of bits saved in compression is less than the number of bits it takes to store the tree. You can solve this problem in a couple of ways. One way is to combine many short files into a longer one, which is then compressed. Another is to forgo the

minimal encoding by using a common frequency distribution to encode many files. If the frequency distributions of the files are close enough to the common one, this method will save bits.

Since I want my program to work well with a wide range of files, I've chosen to compute the frequency table from the file. But this leaves me with the problem of outputting the code tree along with the encoded file. The tree should be stored in a way that allows the decoding program to reconstruct it easily, and, of course, it should take up as little space as possible.

To output the code tree, my program starts with the root node and does the following: If the node is a leaf, it outputs a 0 followed by 8 bits that represent the character stored at that leaf. If the node is not a leaf, it outputs a 1 and recursively outputs the left and right children of the node. The algorithm and its counterpart for input are shown in figure 6. Since every code tree with  $n$  leaves has  $n-1$  nonleaf nodes (a fact I leave to you to verify), the space occupied by the code tree is  $(8+1)n + n-1 = 10n - 1$  bits. Note that it isn't necessary to save the frequencies of the nodes; the structure of the tree and the characters appearing at the leaves suffice for decoding.

The second hurdle to be overcome is that the Huffman algorithm produces an encoding in terms of bits, but all programming languages and file systems deal with data in byte-size chunks. Routines for doing bit-by-bit input and output are required.

My solution uses a single-byte buffer to accumulate bits to be output. A counter, call it  $n$ , is initialized to zero. Each time the bit output routine is called, the  $n$ th bit of the byte is set or cleared and the counter incremented. When the byte is full, it is output to the file and the counter is reset. Input works analogously: An entire byte is read in at once and its bits doled out one at a time. The algorithms for bit-oriented I/O are shown in figure 7.

A subtle but important complication arises in bit-oriented I/O: It is im-

(continued)

# IN STATISTICS, LESS IS MORE

SYSTAT™, the first company to port a mainframe statistics package to microcomputers, has now been joined by BMDP™, SAS™, and SPSS™. Now you have a choice. You can buy a lot of package to do a little statistics or a little package to do a lot of statistics. In statistics, as in art, less is more.

## What's less?

**Less to learn.** SYSTAT has less than half the commands.

**Less to wait.** SYSTAT is faster on big and small problems

**Less to spend.** SYSTAT's single user and site license prices are lower.

**Less memory.** SYSTAT uses less RAM. And *much* less disk space. It even works on floppy disk systems.

## What's more?

**More statistics.** SYSTAT Version 3.0 has more statistical capabilities than *any* microcomputer statistical package. It even has more than mainframe BMDP, SAS/STAT, or SPSS.

**More machines.** SYSTAT operates on IBM™ PC's and compatibles, generic MS-DOS™ machines like the HP-150™, Wang™ and DEC Rainbow™, on CP/M™ machines, on several UNIX™ minicomputers and mainframes, on the VAX 11/780™, and even on the Apple Macintosh™.

**More accuracy.** SYSTAT's regression routines have been proven more accurate than SAS PROC GLM, SAS PROC REG, BMDP1R, BMDP2R, and SPSS REGRESSION on micros or mainframes.

**More variables.** On a 512K microcomputer, SYSTAT can compute regressions and other statistical analyses on more variables than any other microcomputer statistical package.

To evaluate a statistical software package seriously, you should look beyond brand name or marketing hype to find a program that will give you the accurate results you need. Ask for the booklet "STATISTICS QUIZ" which contains simple problems you can run to reveal bugs and serious deficiencies in mainframe and microcomputer statistical packages. We want to help you get a package that gets the correct answer.

## SYSTAT capabilities include:

- Full screen spreadsheet data editor
- Missing data, arrays, character variables
- Unlimited cases
- Process hierarchical files and variable length records
- Rectangular and triangular files
- Relational database management and report generation
- Character, numeric, and nested sorts
- Merge and append large files
- Unlimited numeric and character transformations
- Optional programming language
- Interactive or batch
- Read and write text and external files
- Subgroup processing in statistical modules with SELECT and BY
- Value labels
- RECODE statements for quick multiple codes
- Scatterplots, contours, histograms, stem-and-leaf, boxplots, bar charts, quantile, probability plots
- Basic statistics, frequencies
- T-tests
- Multi-way crosstabs with log-linear modeling, association coefficients, PRE statistics, asymptotic standard errors
- Pairwise/listwise missing value correlation, SSCP, covariance, Spearman, Gamma, Kendall Tau, Euclidean distances

- Linear, polynomial, multiple, stepwise, weighted regression
- Extended regression diagnostics
- Multivariate general linear model
- Multi-way ANOVA, ANOCOVA, MANOVA, repeated measures
- Post-hoc tests
- Principal components with rotations and scores
- Multidimensional scaling
- Multiple and canonical discriminant analysis. Bayesian classification
- Cluster analysis (hierarchical, single, average, complete median, centroid linkage, k-means, cases, variables)
- Nonparametric statistics (sign, Runs, Wilcoxon, Kruskal-Wallis, Friedman two-way ANOVA, Mann-Whitney U, Kolmogorov-Smirnov, Lilliefors, Kendall coefficient of concordance)
- Time Series (smoothing, seasonal and nonseasonal ARIMA, ACF, PACF, Cross-correlation function, transformations, forecasting, Fourier analysis)
- Nonlinear estimation (non-linear regression, least absolute values regression, logit, probit, maximum likelihood estimation, iteratively reweighted least squares)
- Non-copy-protected version available
- Micro, mini, and mainframe versions

## Macintosh interface version available.

Single copy price:  
\$595 USA and Canada,  
\$695 Foreign  
Site licenses and quantity prices available.

## Call or write for additional information

SYSTAT, Inc.  
2902 Central Street  
Evanston, IL 60201

312 864.5670

**SYSTAT**™

## PROGRAMMING PROJECT

possible to determine exactly where the end of a file of bits occurs. Since file systems keep track only of bytes, a program reading a file does not know how many of the bits in the file's final byte were actually written when the file was created. To get around this problem, my encoding program

stores the number of characters of the file with the file's encoding. The decoding program then does not have to worry about where the end of the file is, because all it has to do is decode the indicated number of characters.

Now that all the pieces are in place,

I will describe the encoding and decoding programs. The encoding program begins by reading the input file and constructing the frequency table, which is just an array of integers indexed by character. It also notes the length of the file, in characters. It then passes the frequency table to the Huffman algorithm, which constructs the code tree. The program then opens the output file, outputs the number of characters in the input file (as a 16-bit number) and the Huffman code tree (whose output format I described above), and proceeds to re-read the input file and encode it. A character is encoded by looking it up in the index to the Huffman tree, which provides a pointer to the leaf containing the character. The parent links are then traced until the root of the tree is reached, then the path is retraced from top to bottom with the appropriate bits being output: 0 for left branches, 1 for right.

The decoding program begins by reading in the number of characters and the code tree from the file to be decoded. It then sets a pointer to point to the root of the code tree and reads a bit from the file. If the bit is a 1, it takes the right branch of the tree; if a 0, the left. The program reads bits and traverses the tree until a leaf is reached, then outputs the character at that leaf. It then starts again at the top of the tree to decode the next character. It decodes as many characters as indicated by the number stored at the beginning of the file.

The encoding and decoding programs consist of five modules: one encapsulates all the procedures directly related to the Huffman algorithm, two others provide CharStream and BitStream data types for performing character- and bit-oriented I/O, and the remaining two are the main modules for the two programs. Separating the Huffman algorithm and the I/O procedures into separate modules makes it possible to use them for other programs without having to copy, edit, or recompile code. [Editor's note: The Modula-2 source code for the encoding and decoding programs is available on BYTE.net Listings at (617) 861-9764. These programs are also available on disk. See page 469 for details.] ■

```
Algorithm writeTree takes a tree node as input. (To output a tree, call
  writeTree with the root of the tree.)
If the node is a leaf,
  output a 0 bit followed by the 8-bit code for the character at the leaf.
Otherwise,
  output a 1 bit;
  call outputTree with the node's left child;
  call outputTree with the node's right child.
```

```
Algorithm readTree returns a tree.
Read a bit from the file.
If it is a 1,
  call readTree to get the left child, L;
  call readTree to get the right child, R;
  construct a new node N with children L and R;
  set the parent of L and R to be N;
  return N.
If the bit is a 0,
  read the next 8 bits and convert them into a character, C;
  construct a new node, storing C in its character field;
  set both the node's children to NIL;
  return the node.
```

Figure 6: Algorithms for writing and reading the code tree to a file.

```
Algorithm readBit returns a bit (1 or 0). To initialize a file for reading,
  set curBit to 7. At end of file, readBit will keep returning the last bit of the file.
If curBit = 7,
  If not end of file,
    read a byte from the file and put it in curByte;
    set curBit to 0.
  Otherwise, increment curBit.
In both cases, return the value of the curBit'th bit of curByte.
```

```
Algorithm writeBit takes a bit as argument. To initialize a file for
  writing, set curBit to 0.
Set the curBit'th bit of curByte to the bit given as argument;
If curBit = 7,
  write curByte to the file;
  set curBit to 0.
Otherwise,
  increment curBit.
```

Figure 7: Algorithms for bit-oriented I/O. The routines assume bits numbered from 0 to 7. A file can be opened for reading or writing, but not both at once. Both routines use the global variables curBit and curByte. The expression "the curBit'th bit of curByte" means the bit of curByte whose number is the current value of curBit.



# CAD — \$299 !

Finally you can get a complete CAD package at a reasonable price! For only \$299, ProDesign II provides the advanced features you get on CAD systems costing thousands of dollars. But there is another, very important reason you should get ProDesign II. ProDesign II is very unique among CAD packages. It is easy to learn and use. When we call ProDesign II "The Easy to Use CAD System", we're not joking. You will be productive with ProDesign II in an hour or two instead of a week or two.

What else does ProDesign II offer? Compatibility. Compatibility with over 100 printers. Compatibility with over 50 plotters. Compatibility with most graphics adapters, digitizing tablets, and mice. Compatibility with most display adapters. Compatibility with any software that can produce HP plotter commands. Compatibility with mainframe CAD systems (IGES). All at no extra charge!

What additional hardware do you need? None! An IBM PC compatible and 512K RAM is all you

need. ProDesign II produces high resolution drawings on your dot matrix printer — better than .005" resolution on an IBM/Epson compatible printer. In fact, the drawings on this page were printed on a \$299 dot matrix printer! You don't have to get a mouse or digitizing tablet. ProDesign II is designed for easy and efficient keyboard use. You won't even need a math coprocessor, although it is supported. From a small drawing on a dot matrix printer to an E-Size drawing on a large plotter, ProDesign II is the one to use!

**ProDesign II**  
Affordable, Compatible, and Usable!

Where can you get ProDesign II?  
See your local computer dealer, or contact:

**American Small Business Computers**

118 South Mill  
Pryor, OK 74361  
(918) 825-4844

Inquiry 20

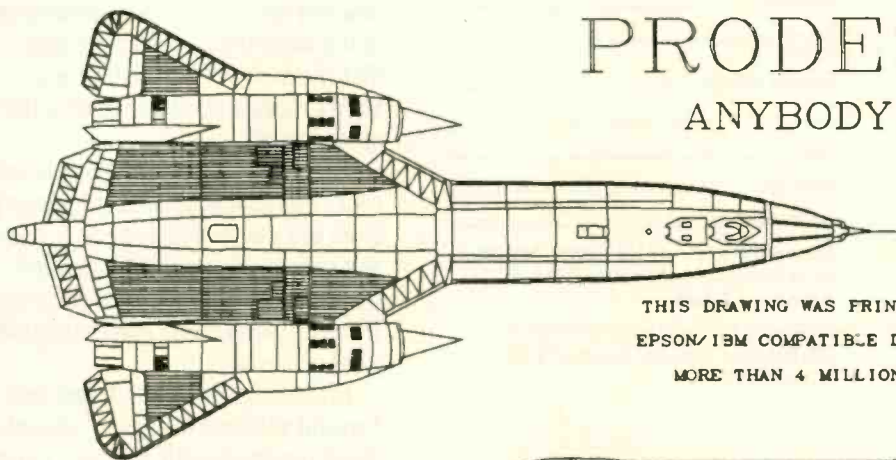

## PRODESIGN II ANYBODY CAN DO IT!

THIS DRAWING WAS PRINTED ON AN ORDINARY  
EPSON/IBM COMPATIBLE DOT MATRIX PRINTER.  
MORE THAN 4 MILLION DOTS PER PAGE!



DRAWN USING PRODESIGN II  
THE EASY TO USE CAD SYSTEM  
ONLY \$299!

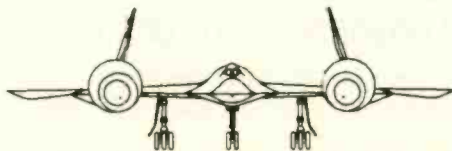

SR-71  
BLACKBIRD

WORLD'S FASTEST JET — 3500+ MILES PER HOUR

# LOTUS 1-2-3.<sup>®</sup>

# FARSIGHT.

## WHY THEY'RE ALIKE.

For starters, the Farsight Spreadsheet works like a clone copy of Lotus version 1A, the one over a million people already use. If you're among them, you already know Farsight: all the commands, formats, all the keyboard- and menu-driven macros.

You don't have to re-learn a thing. Your existing 1-2-3 files, macros and templates will never know the difference, either—so your investment in 1-2-3 data and procedures is secure. But Lotus itself wants you to surrender your copy of 1A and spend \$150 on a new release that requires a lot of re-training. Thanks, but no thanks.

Compare: the Farsight Spreadsheet is fully supported by the people who created it. And Farsight gives you some amazing high-voltage features to work with.

*IBM is a registered trademark of International Business Machines Corporation. 1-2-3 is a registered trademark of Lotus Development Corporation.*

*Hardware requirements: IBM PC family or 100% compatible, dual-floppy or hard disk, PC-DOS 2.0 or higher.*

YES, rush me \_\_\_\_\_ copies of Farsight, non-copy protected and money-back guaranteed for 30 days. Enclosed is \$99.95 plus \$7.00 shipping and handling per copy. In Texas, add \$6.13 sales tax. U.S. prices only.

Check    Money Order  
 AMEX    VISA    MASTERCARD

Credit Card # \_\_\_\_\_

Expiration Date \_\_\_\_\_

Signature \_\_\_\_\_

Name \_\_\_\_\_  
please print

Shipping Address \_\_\_\_\_

City \_\_\_\_\_

State/Zip \_\_\_\_\_

Day Phone \_\_\_\_\_

International orders add \$30 shipping/handling. If paying by check or draft, must be in U.S. dollars drawn on a U.S. bank

INTERFACE TECHNOLOGIES CORPORATION  
3336 Richmond, Suite 200, Houston, TX 77098  
(713) 523-8422

## WHY THEY'RE DIFFERENT.

Farsight frees you from the hassles of copy protection. It costs \$99.95, which isn't cheap: rather, at \$495 Lotus and others are almost criminally over-priced. \$99.95 is exactly what high quality, feature-loaded software *should* cost.

Features! Farsight gives you pop-down menus. And multiple windows: now you can work on two spreadsheets at the same time—and handle your disk file management chores and word processing without leaving the spreadsheet.

Farsight Word is included at no extra cost. This professional word processor gives you proportional spacing, search and replace, decimal tabs, multiple typestyles and lots of other convenience features found in the most expensive word processors.

Everything's integrated, too: use Farsight windows to "paste" spreadsheet results directly into your letters and reports.

One other thing: you get a 30-day money back guarantee. So you can't lose. Order Farsight; do it now. You'll get everything you love about Lotus. And that's just for starters.

**ONLY \$99.95**

 **FARSIGHT**

*A bright new look at Lotus.*

*from Interface Technologies Corp.  
3336 Richmond, Suite 200, Houston, TX 77098*

**1-800-922-9049**

*(In Texas, call 713/523-8422) Telex: 322127  
In Europe, call ITC in Switzerland at (01) 700-3037*

# MODULA-2 AS A SYSTEMS PROGRAMMING LANGUAGE

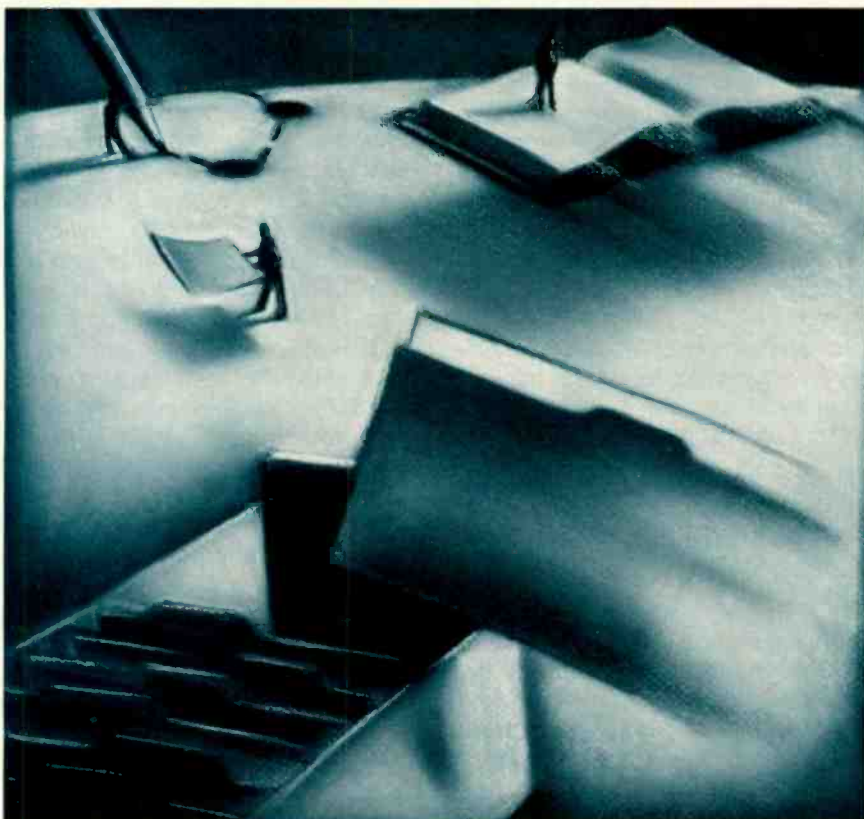

*The process is the key  
to synchronization*

**M**odula-2 is a powerful systems programming language used to develop operating systems. Although it is similar to its ancestor Pascal (both were developed

by Niklaus Wirth), the design goals for each were quite different. Niklaus Wirth designed Pascal as a teaching language that emphasized structured programming concepts and portability. In Modula-2 he has transformed and extended Pascal into a language designed for systems programming as well as for general use. For example, Modula-2 includes constructs for programming with machine-level bits and addresses and for creating processes and switching between them. And you can compile different parts of a program separately, thus making it easier to manage large-scale programming projects. These features are defined in Modula-2 itself, rather than in extensions, making program portability a realistic goal.

To illustrate the attributes of Modula-2, this article describes our experiences in implementing Hermes, a real-time multiprocessing operating system that was produced on the Lilith personal computer (see refer-

*(continued)*

Ryn C. Corbeil (Penultimate Systems Inc., 9968 Hibert St., Suite 200, San Diego, CA 92131) was a project systems programmer at Burroughs Corporation on the Hermes project. He has a B.S. in computer science from California Polytechnic State University at San Luis Obispo.

Anne H. Anderson (3015 8th St., Boulder, CO 80302) was also a project systems programmer on the Hermes project. She has a B.A. in sociology/anthropology from Swarthmore College and an M.S. in computer science from San Diego State University.

ence 1) in a relatively short period of time using very little assembly language. It is a successor to the Thoth operating system (see reference 2). Modula-2 aided in this development in several key areas: memory management, multiprocessing, message passing, device handling, and software engineering. Most of the resulting operating system is portable to other machines; those parts that aren't portable are largely isolated in separately compiled modules. Let's look at the main areas in which Modula-2 helped us in our development task.

**MEMORY MANAGEMENT**

The basic requirement for managing memory is the ability to manipulate machine addresses by referring to them and performing arithmetic operations on them. Unlike most high-level languages, Modula-2 defines address-manipulation operations as part of the language itself. It defines several abstract types and functions for this purpose and specifies the relationships between them. The actual implementation of these types and functions can vary from machine to machine as long as the basic definitions and relationships are preserved.

Modula-2 contains the following address-manipulation types:

- WORD an individually accessible unit of storage
- ADDRESS a pointer to a WORD
- POINTER TO *t* a pointer to a variable of type *t*

On a 16-bit machine, a WORD can be 16 bits long. Likewise, on a 32-bit machine, it can have a length of 32 bits.

The types ADDRESS and POINTER vary accordingly to maintain compatibility with the definition of a WORD.

Modula-2 also defines certain compatible address-manipulation functions.

- ADR(*v*) returns the ADDRESS of variable *v*
- SIZE(*v*) returns the size of variable *v* in WORDs
- TSIZE(*t*) returns the size of a variable of type *t* in WORDs

You can manipulate POINTERS with normal arithmetic operations. For example, if *p* is a variable of type ADDRESS, the following statement sets *p* to the machine address immediately following variable *v*:

```
p := ADR(v) + SIZE(v);
```

This statement has the same result on any machine regardless of WORD length, because it depends only on the basic relationship between ADDRESS and SIZE as defined by Modula-2.

For an example of Modula-2's memory management, let's keep track of memory blocks with a record called a MemoryDescriptor defined as:

```
TYPE
    MemoryDescriptor = RECORD
        link: ADDRESS;
        size: CARDINAL
    END;
```

The link field of a MemoryDescriptor contains the machine address of the next memory block. The size field provides the length of the current block. Figure 1 illustrates a chain of

such blocks. Each begins with its own MemoryDescriptor record.

If you want to get a memory block of size *n*, you programmatically follow the link fields until you find one that's big enough. An ADDRESS-type variable called *current* contains the address of the proper MemoryDescriptor. However, the address you want is that of the *n*-word block following the MemoryDescriptor, not the address of the MemoryDescriptor itself. The following Modula-2 statement gets it for you:

```
RETURN (current +
        TSIZE(MemoryDescriptor))
```

Since TSIZE(MemoryDescriptor) returns the length of a memory descriptor, you add that length to the value of *current* to get a pointer to the desired memory block. Figure 2 illustrates the results.

Another helpful memory-management feature is *type coercion*, which lets you look at one type of data area as if it were another type. For example, if *i* is an INTEGER variable and *a* is an ADDRESS variable, you can assign *a* to *i* with the statement *i* := INTEGER(*a*). Likewise, you can assign *i* to *a* with the statement *a* := ADDRESS(*i*). These function-like types allow you to map variables of different types onto the untyped storage of the machine.

Modula-2 lacks a minor feature that would be useful. It has no definition for the size of a WORD in standard units, such as bits or bytes. To convert the output of the SIZE and TSIZE functions to bytes, you must define a conversion constant, for example, BytesPerWord, that you can change

(continued)

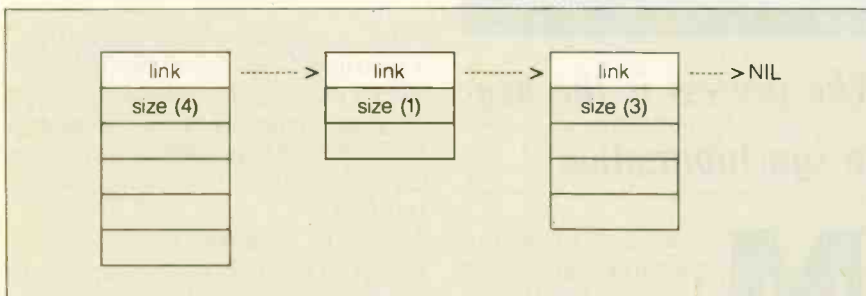

Figure 1: A chain of memory blocks. Each block begins with a MemoryDescriptor record that points to the next block.

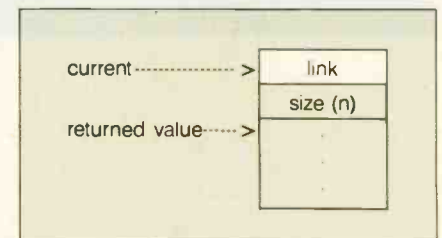

Figure 2: The returned value is a pointer equal to the current pointer value plus the size of the MemoryDescriptor record.



# BETTER SONY THAN SORRY.

The bomb's up. The system's down. You've lost all your data to disk error because you made a very basic human error. You didn't use Sony floppy disks.

Next time, go with the industry standard, the company who invented the 3.5" disk drive system, and a floppy disk that comes 100% certified error free. Sony.

Only Sony 3.5" micro floppy disks contain such error suppressing materials as patented Vivax™ magnetic particles and a high-molecular DDL™ binder system. This protects your micro floppy disk, and the information on it, for its lifetime; and assures data retrieval in the order you choose. Guaranteed.

So use Sony 3.5" or 5.25" floppy disks, and avoid disk error. If you use somebody else's, you could be sorry.

**SONY**  
THE ONE AND ONLY®



depending on the WORD length of your machine.

**MULTIPLE PROCESSES**

It is helpful to be able to create and destroy processes as you wish (see the text box "A Process for Each Concurrent Activity" below). With Modula-2 you can. Let's use a record called a ProcessDescriptor to describe a process; this record contains a complete description of its status. The ProcessDescriptor includes all the information needed to execute the process or to restart it if interrupted. This record also holds scheduling information, such as the process priority and process-management information, for example, a pointer to a list of descendant processes created by the original one.

The status information describing

the execution of the process is machine-dependent. Modula-2 derives this information from its NEWPROCESS procedure

```
NEWPROCESS(code, stack,
           stacksize, p);
```

where code is the name of the procedure to be executed, stack is the address of the memory block to be used for the process stack, and stacksize is the size of that stack block. When control is returned from the procedure NEWPROCESS, the variable *p* contains the initial machine-state description for the process. Modula-2 assigns this returned value *p* the type PROCESS.

If you want to create a new process, you can call NEWPROCESS to obtain the machine-dependent description of the initial state of the process. You

then add such information as process priority and pointers to various operating-system lists. See figure 3 for an illustration of the resulting process description.

To define a process, you have to specify the sequence of instructions that it will execute. To do this you can use the Modula-2 facility to pass a procedure name as a parameter. You pass a procedure name to NEWPROCESS, which sets up the PROCESS variable so that the first instruction the process executes is the first statement of this procedure.

During execution when one process is suspended, you want another one to begin processing. The process chosen depends on which ones are ready to execute and on their relative priorities. Another Modula-2 intrinsic

*(continued)*

## A PROCESS FOR EACH CONCURRENT ACTIVITY

What is a multiprocessing operating system? How is it different from a single-process operating system such as CP/M or MS-DOS?

A process is the execution of a sequence of instructions. In CP/M or MS-DOS only one sequence of instructions can be in execution at a time (with the exception of interrupt routines). This means that one program must complete execution before another program can begin.

A multiprocessing operating system allows more than one sequence of instructions to execute concurrently. Concurrently does not necessarily mean simultaneously; the execution of different sequences of instructions can be interleaved by switching the processor from one sequence to another. It is the job of the operating system to perform this switching. When more than one processor is available, different processes can even execute simultaneously. Even in a multiprocessor system, however, there are frequently more processes than processors, so the operating system must still make decisions about when to assign a processor to a particular process.

Different types of multiprocessing operating systems use different algorithms for deciding which process to execute and for how long. A time-shar-

ing operating system allows each process to execute in turn for a short, fixed period of time, possibly giving more or longer time slices to higher-priority processes. A real-time operating system typically assigns the processor to the highest-priority process that is ready to execute. A process retains control of the processor until the process runs out of work or a higher-priority process becomes ready.

Regardless of the type of operating system you have, when a process is suspended, the operating system saves its status. It makes a record of all the information required to restart the process, including the address of the next instruction that the process should execute and the address of the top of the stack it is using. When the processor switches back to a suspended process, all the information saved is restored and the process continues from the point where it was interrupted.

There are several advantages in using processes to build programs. First, each process can concentrate on a specific task. It can perform its task without being too concerned with what other processes might be doing at the same time. For example, consider a program made up of two processes, an input process that reads characters from the keyboard and stores them in

a queue, and a command-execution process that removes characters from the queue, interprets them as command names, and executes the requested command. The input process can store characters as they are typed regardless of whether the command-execution process is ready for a new command (at least until the queue is full). This allows you to type ahead, a feature that would be more complicated in a single-process program.

Another advantage occurs when dealing with peripheral devices, especially those that use interrupts. Device communication tends to be asynchronous with respect to the program executing; an interrupt does not conveniently occur only when the executing program is ready for one. In a multiprocess system, whenever a device interrupt occurs, the currently executing process can be suspended. Control can then be transferred to another process that is responsible for handling the device. The input process is a good example of such a device handler. It gets control of the processor whenever you type a key.

Finally, where multiple processors are available, a multiprocess program can take advantage of the additional processing power, usually making significant gains in execution speed.

function, TRANSFER, provides this ability. TRANSFER is called as follows:

```
TRANSFER(currentprocess,
          nextprocess);
```

where currentprocess and nextprocess are PROCESS variables originally initialized with NEWPROCESS. TRANSFER saves the current machine registers in the currentprocess variable. It then resets the machine registers using the values in nextprocess. TRANSFER causes the new process to begin executing at the point where it was last suspended.

When a process completes or its resources are needed elsewhere, you can destroy it by reclaiming the memory allocated for the process stack and removing the ProcessDescriptor from the descriptor list. You should also destroy any descendant processes that it may have created during its lifetime.

Another process-related feature of Modula-2 is the treatment of priorities. Modula-2 lets you associate a priority with a kind of module called a monitor. Whenever a process starts executing a procedure in a monitor module, the process's priority is made equal to the monitor's priority. It keeps this priority until it completes the procedure; then its original priority is restored.

**MESSAGE PASSING**

In addition to multiple processes, Modula-2 also enables processes to communicate with each other. We call this ability message passing. Message passing is used to transfer information between processes and to synchronize those communications so that each is at a specific known point before the dialog proceeds (see the text box "Processes Can Pass Messages to Synchronize at right).

Message-passing procedures such as Send, Receive, and Reply must accommodate messages of varying length and type. To illustrate why, let's discuss a particular kind of process called a proprietor. A proprietor owns a resource and manages it as directed by user-process requests that vary depending on the proprietor. For exam-

(continued)

## PROCESSES CAN PASS MESSAGES TO SYNCHRONIZE

Processes can synchronize and exchange data using Send, Receive, and Reply procedures as illustrated in figure A. The process shown is sending a message to a receiving process. The sending process calls the Send procedure and specifies the receiver's unique identifier and the message. The receiving process gets this message by calling the Receive procedure and specifying the sender's identifier. The receiving process later responds to the sender with a reply by calling the Reply procedure.

If the sending process calls Send before the receiving process calls Receive, the operating system

suspends the sending process. Likewise, if the receiving process calls Receive before a message has been sent, the receiving process is suspended. When both Send and Receive have been called, the operating system resumes execution of the receiving process. The sender remains blocked until a reply message is returned by the receiver, at which time both processes are again eligible for execution.

Typically, a process sends a message to another process requesting that some work be performed. The receiving process performs the work and returns a reply message when the job is finished.

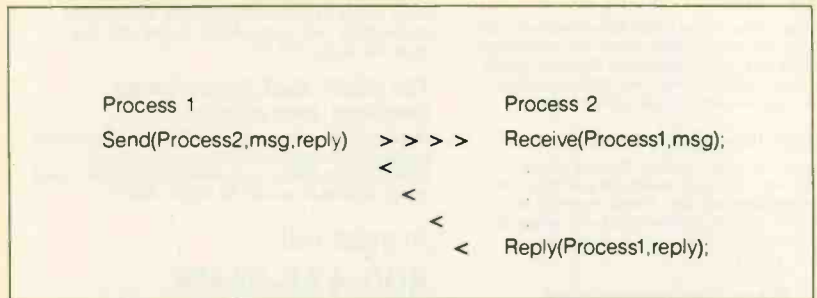

Figure A: The communications interaction between two processes showing the relationship between the Send, Receive, and Reply procedures.

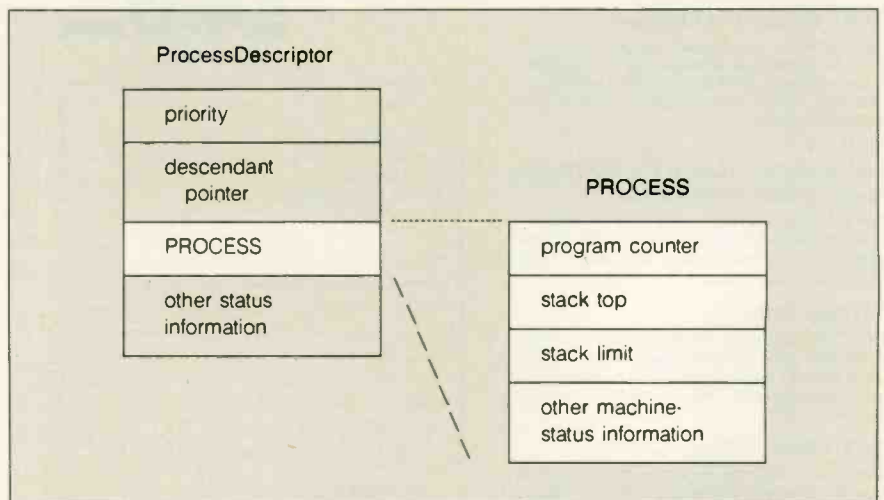

Figure 3: A ProcessDescriptor including the machine-dependent PROCESS variable provided by Modula-2.

ple, a keyboard proprietor would typically receive requests from user processes asking for a single character (a keystroke read from the keyboard device). However, a disk proprietor would receive messages made up of complex file records from very different user processes. Modula-2 makes it very easy for the message-passing procedures to accept messages of varying length and type.

As an example, let's discuss the Send procedure

```
PROCEDURE Send( Destination:
                ProcessId;
                MessageLength: CARDINAL;
                Message: ARRAY OF WORD;
                VAR ReplyLength: CARDINAL;
                VAR ReplyMessage: ARRAY OF
                WORD ); Status;
```

The parameter Message is an exam-

ple of a Modula-2 *open-array* parameter. Its upper and lower bounds are determined dynamically by the index range of the actual parameter. In addition, because its type is ARRAY OF WORD, its corresponding actual parameter may be of any type. For example, a message of type PrintMessage is sent by a process to request service from the printer proprietor, while a MouseMessage type is sent to obtain mouse coordinates from its proprietor. Both of these message types are compatible with ARRAY OF WORD.

This is an important concept. The strong typing provided by Modula-2 allows you to build data structures conveniently and correctly. But the language provides, in a controlled, well-defined way, the ability to convert from one type to another. You can manipulate complex structures and reduce them to simpler, more efficient forms.

Another powerful component of the Modula-2 language is its case-variant record. It can be very useful in, for example, a clock proprietor. A clock proprietor could receive any one of four types of request: a delay request from a process that wishes to wait for a certain amount of time; a wake-up request from another process to prematurely awaken a sleeping process; a request for the time of day; or a request to set the clock with the correct time. If you enumerate the different clock requests, a case-variant record becomes quite appropriate for handling the various messages.

Because message passing is such a flexible mechanism, it has a high potential for error. Modula-2 helps minimize this potential by means of consistency checks. For example, Send's parameter MessageLength specifies the size of the message in bytes. To verify that MessageLength is not larger than the actual maximum size of Message, you can use the Modula-2 standard function HIGH(x). This returns a number equal to the number of elements in the array x minus one. The Send procedure compares MessageLength to HIGH(Message) to ensure consistency.

(continued)

# The Key to Unlocking Your Operating System

## Discovering MS-DOS™

Kate O'Day. A comprehensive study of MS-DOS commands; how to use MS-DOS to produce letters and documents; create names and manipulate files; use the keyboard and function keys to perform jobs faster; and direct, sort, and find data quickly. No. 22407, \$15.95

## MS-DOS® Bible

Steven Simrin. The second in the Waite Group's MS-DOS series helps intermediate users create, edit and manage files, handle data, and customize the keyboard. Details the tree-structured directories, DOS filters, and DEBUG, LINK, and EDIT commands. No. 22048, \$18.95

## MS-DOS® Developer's Guide

Angermeyer and Jaeger. Explore this book's variety of topics, including assembly coding tips and higher-level language debuggers and aids. Written expressly for programmers who want to learn tricks for getting their software running in the MS-DOS environment. No. 22409, \$24.95

## CP/M® Bible: The Authoritative Reference Guide to CP/M

Waite and Angermeyer. This detailed reference manual puts CP/M's commands and syntax at your fingertips. Instant access to all CP/M keywords, commands, utilities, and conventions are found in this easy-to-use format. No. 22015, \$19.95

## CP/M® Primer (2nd Edition)

Waite and Murtha. This tutorial companion to the CP/M Bible is for novices and advanced programmers alike. Includes the details of CP/M terminology, operation, capabilities, internal structure, plus a tear-out reference card with commands. No. 22170, \$16.95

## Soul of CP/M®: How to Use the Hidden Power of Your CP/M System

Waite and Lafore. This companion volume to CP/M Primer teaches you to use and modify CP/M's internal features, including how to modify BIOS and use CP/M system calls in your programs. No. 22030, \$19.95

## C Primer Plus

Waite, Prata, and Martin. Provides a clear and complete introduction to the C programming language. Interfacing C with assembly language is included, as well as many sample programs usable with any standard C compiler. No. 22090, \$22.95

## UNIX™ Primer Plus

Waite, Martin, and Prata. For those who want to learn about the amazing UNIX operating system, this primer presents UNIX in a clear, simple, and easy-to-understand style. No. 22028, \$19.95

## UNIX™ SYSTEM V Primer

Waite, Martin, and Prata. Shell scripts and shell programming are covered in detail, as is the SED stream editor.

UNIX filters, text cut and paste, and text formatting utilities of NROFF and TROFF are explained. No. 22404, \$19.95

## Advanced UNIX™ — A Programmer's Guide Stephen Prata

This advanced guidebook details the system's key components and programming mechanisms. Shows how to use simple and complex commands, including the Bourne Shell, shell scripts, loops, system calls, and more. No. 22403, \$21.95

## The UNIX™ Shell Programming Language Manis and Meyer

Demonstrates how the powerful UNIX shell programming language is creating a revolution in programming. Emphasizes the Bourne shell, while including the C shell and the Korn shell as well. No. 22497, \$24.95

To order call  
**800-428-SAMS**

In Indiana  
call 317-298-5566  
Ask For Operator 818



A Division of Macmillan, Inc.

Book No.	Quantity	Price
Shipping & Handling		\$ 2.50
AR, CA, FL, IN, NC, NY, OH, TN, WV residents add local sales tax		\$
Total		\$
Name _____		
Company _____		
Address _____		
City _____		
State _____ Zip _____		
Daytime Telephone No. _____		
Bill me my credit card (VISA, MC, AE)		
<input type="checkbox"/> <input type="checkbox"/> <input type="checkbox"/> <input type="checkbox"/> <input type="checkbox"/> <input type="checkbox"/> <input type="checkbox"/> <input type="checkbox"/> <input type="checkbox"/> <input type="checkbox"/> <input type="checkbox"/> <input type="checkbox"/> <input type="checkbox"/> <input type="checkbox"/> <input type="checkbox"/> <input type="checkbox"/> <input type="checkbox"/> <input type="checkbox"/> <input type="checkbox"/> <input type="checkbox"/> <input type="checkbox"/>		Exp. Date _____
Signature (required) _____		
<small>Check or money order enclosed. Make checks payable to Howard W. Sams &amp; Co. Attach this form with payment to Howard W. Sams &amp; Co., Dept. 104 • 4500 West 62nd Street • Indianapolis, IN 46268</small>		

Prices subject to change without notice



We have over 1000 Software and hardware items in stock. Shipments on almost all items within 24 hours!



**FREE SOFTWARE!**  
With over \$100 purchase you will receive a free diskette for your IBM PC with label maker, checker game and banner programs.

Call for programs not listed

Technical & Other Info. (602) 246-2222

**TOLL-FREE ORDER LINE 1-800-421-3135**

**SOFTWARE**

**---DATA BASE MANAGERS---**

Clipper	\$345
Clout 2	129
Condor III	310
Fox and Geller Quickcode	145
Fox and Geller Quickreport	145
Knowledgeman	225
Knowledgeman II	299
K Paint	60
K Graph	135
K Text	105
K Report	135
Nutshell	Call
PFS: File	78
RBase 5000	Call
Think Tank	93
Tlm IV	169

**---WORD-PROCESSING---**

Easy (Micro Pro)	89
Leading Edge w/Merge/Spell	75
Microsoft Word 2.01	229
Multimate 3.31	205
Multimate Advantage	255
Oasis Word Plus	85
Peachtree 5000	145
PFS: Write	78
Random House Spell Checker	36
Samna III 3.0	265
Volkswriter 3	Call
Word Perfect 4.1	199
Wordstar	170
Wordstar Propac	238
Wordstar 2000	238
Wordstar 2000+	285

**---SPREADSHEETS---**

Microsoft Multiplan	115
PFS: Plan	78
Supercalc III 2.1	Call
Twin	79
VP Planner	69

**---ACCOUNTING---**

BPI Accounts Payable	299
BPI Account Receivable	299
BPI General Accounting	299
BPI Payroll	299
Cyma	Call
Dollars and Sense	95
Tobias Managing Your Money	94

**TCs. Big Four equivalent of Peachtree Series 4** - Specially augmented and customized for your IBM PC Terminal and Printer - GL, AR, PA, AP, CP/M-80, CP/M-86 for PC XT, DOS 1.1, 2.0.  
Each Module \$65 For All Four \$249

**---INTEGRATED---**

Enable	Call
Smart Software	Call

**---TRANSFER PROGRAMS---**

Crosstalk XVI	89
Hayes Smartcom II	88
Microsoft Access	149
Move-It	79
Remote	89

**---GRAPHICS---**

Chartmaster	206
Dr. Halo II	99
Energraphics w/o Plotter	170
Energraphics w/Plotter	220
Fancy Font	129
Fontrix	99
Freelance	199
Graphwriter/Combo	310
Microsoft Flight Simulator	30
PC Paint Brush	62

Printshop	\$36
PFS Graph	78
Signmaster	135

**INCREDIBLE VALUE!**

Nationally advertised boards for IBM PC and most compatibles at giveaway prices.

**1 year warranty**

Keyboards (similar to 5151)	\$89
Monochrome Board w/Printer Port	\$79

Hercules Graphic Board Equivalent with Parallel Port	\$95
--	------

Expansion Board 0 to 576K	\$42
---------------------------	------

AST Six Pack Equivalent plus game port	\$99
--	------

Four Drive Floppy Controller	\$45
------------------------------	------

Color Card without printer port	\$79
---------------------------------	------

Color Card with printer port	\$89
------------------------------	------

<b>IBM PC CLONE</b> 256K, 2 drives 7 expansion slots with Amber Monitor	\$850
--	-------

**---LANGUAGES---**

Lattice C Compiler 3.0	Call
Run C Professional	169
Microsoft C Compiler	235
Microsoft Fortran	209
Microsoft Macro Assembler	89
Microsoft Pascal Compiler	78
Microsoft Quick Basic	59
Multi Halo	140

**---UTILITIES---**

Copy II PC	19
Copy II PC Board	79
Copywright	45
Desqview	59
Fastback	95
Norton Utilities 3.1	52
PC Tools	19
Prokey 4.0	75
Superkey	35

**---PROJECT MANAGEMENT---**

Harvard Total Project Manager	269
Microsoft Project	235
Super Project Plus	Call

**HARDWARE**

**---HARD DRIVES---**

Bernoulli 20 MB 1/2 ht.	2439
Seagate 20 MB Internal w/Controller	499

**---MODEMS---**

Anchor Express	235
Hayes 1200	Call
Hayes 1200B w/Software	Call
Hayes 2400	599
U.S. Robotics Courier 2400	Call
U.S. Robotics Password 1200	Call

**---RAM---**

64K 150NS Chips (Japan - Set of 9)	9.50
256K Ram Chips (Set of 9)	27

**---BOARDS---**

AST Advantage	359
---------------	-----

**HARDWARE**

AST Sixpack (384K)	Call
Hercules Color Card	145
Hercules Graphics Card	299
J RAM III	Call
J RAM III AT	Call
Paradise Five Pak	119
Paradise Modular Graphics Card	249
Quadram Board with Par/Ser and Game Port	199
Quadcolor I	185
Sigma Maximizer Multifunction	149
STB Chauffeur Board	249
STB EGA Plus	320
STB Mono Board	155
AB Parallel Print Switch w/cables	75
Mini Micro Parallel Print Buffer	69
IBM 120 Watt Power Supply	83

**---COMPUTERS---**

Corona PC	Call
-----------	------

Sperry PC Mono 256K Dual Drive Serial Port, Clock, MS/DOS 2.11	\$1650
--	--------

ITT Computers PC Compatible 256K Dual Drive, Mono, MS/DOS	Call
---	------

ITT XP 80286 IBM/PC Compatible, 512K, 10 MB Winchester, 3 times faster than an XT, 30% faster than an AT	Call
--	------

Sharp Portable	Call
----------------	------

**---PRINTERS---**

**FAST! ALL NEW PRINT SELECT PROGRAM VERS. 2.0**  
Written in assembly language for most MS-DOS computers. With purchase of any printer you will receive at no charge this menu driven program to set print characteristics or to make your computer function as a correcting typewriter. Retail value \$35.

<b>CITIZEN</b>	
MSP-10	255
MSP-15	355
MSP-20	329
Citizen 120D	169
Premiere 35 Daisywheel	415

**EPSON** - Call on all models

<b>JUKI</b>	
Juki 6100	349
Juki 6300	685

<b>NEC</b>	
3550	785
8850	1135
P5 Parallel	995
Elf 360	398

**OKIDATA** - Call on all models

<b>PANASONIC</b>	
1091	239
1092	309
1592	435
KXP3151	410

**STAR MICRONICS** - Call for prices

<b>TOSHIBA</b>	
1340	460
P351	975
P341	799

**---MONITORS---**

<b>AMDEK</b>	Call for price
Taxan 121 Green	Call
Taxan 122 Amber	Call
Princeton Max 12	169

**TERMS:** Add 3% for C.O.D. orders. Shipping on most software is \$5.00. AZ orders +6 1/2% sales tax. Personal check - allow fourteen (14) days to clear. Prices are subject to change. We accept purchase orders from authorized companies.

No Charge for MasterCard or Visa



**TOLL-FREE ORDER LINE 1-800-421-3135**

**WAREHOUSE DATA PRODUCTS**

2701 West Glendale Ave. • Phoenix, AZ 85051

Hours 7 A.M. to 6:30 P.M. M.S.T. - Mon thru Fri.  
Saturday 9:00 A.M. to 4:00 P.M.

```
IF MessageLength >
    HIGH(Message)*BytesPerWord
THEN Error
END
```

Modula-2 allows for this flexibility in message passing.

**DEVICE HANDLING**

How do processes synchronize and communicate with peripheral devices such as touch screens, mice, voice recognition units (VRUs), and others? For example, if you give a computer a verbal command, the VRU goes to work independently and recognizes the command. The device must inform a process of this event and present it with the recognized information. The waiting process is called an event handler and has the following cyclic structure:

```
Initialize;
LOOP
    AwaitEvent( VRUevent,
                VRUmessage );
    Interpret( VRUmessage );
END;
```

The variable VRUmessage returns the recognized information, the confidence level of the recognition, and other useful status information from the VRU. Then this information must be interpreted. The tricky part of this sequence is detecting the external event—the interrupt from the VRU. In this case TRANSFER is evoked by an asynchronous interrupt. This particular mechanism is machine-dependent and is not considered part of Modula-2. However, the following description illustrates an accepted technique for activating a device. You associate a process with each device (interrupt level) using NEWPROCESS and memory locations reserved by the computer for interrupt handling. When the VRU presents an interrupt, a spontaneous TRANSFER is made to its associated event-handler process that reads characters from the VRU and composes and sends VRUmessage. When the interrupt-handling process completes, it TRANSFERS back to the interrupted process. Figure 4 illustrates the various pro-

cesses involved in our simple example.

Reading characters from a peripheral device (like the VRU) brings up an important question. How does Modula-2, supposedly a machine-independent language, provide access to machine-dependent characteristics like I/O? Strictly speaking, the language has no statements for input or output. However, it does allow the expression of machine-specific operations, such as the I/O for a particular device, and encourages us to collect such machine-specific operations in a separate module. This module makes available a machine-independent interface for device I/O and hides all the details. If you isolate these machine-specific details, it becomes easier to move the system to different computers. When you do move the system, you need to modify only the implementation part of the module, leaving the interface unchanged.

Obtaining data from a device is one thing; deciphering it is another. Modula-2 helps you deal with the often cryptic data that devices present. A typical device packs a variety of status information into one word; each bit represents some condition. To unpack this information, you can use a Modula-2 standard type called BITSET. Each bit in a BITSET variable can be singled out and tested. For example, if you want to examine the sixth bit of the status from the VRU, first you declare a BITSET variable VRUstatus, then

```
GET( VRUstatusAddress,
     VRUstatus );
IF 6 IN VRUstatus
THEN ... END
```

Additional set operations include set union, difference, intersection, and symmetric difference. For example, if you are concerned only that the third bit of the VRU status is on and that the fifth bit is off, you can compare the intersection of two BITSETs with a third BITSET:

```
IF VRUstatus * {3, 5} = {3}
THEN ... END
```

You can also include and exclude individual bits in sets as with the follow-

(continued)

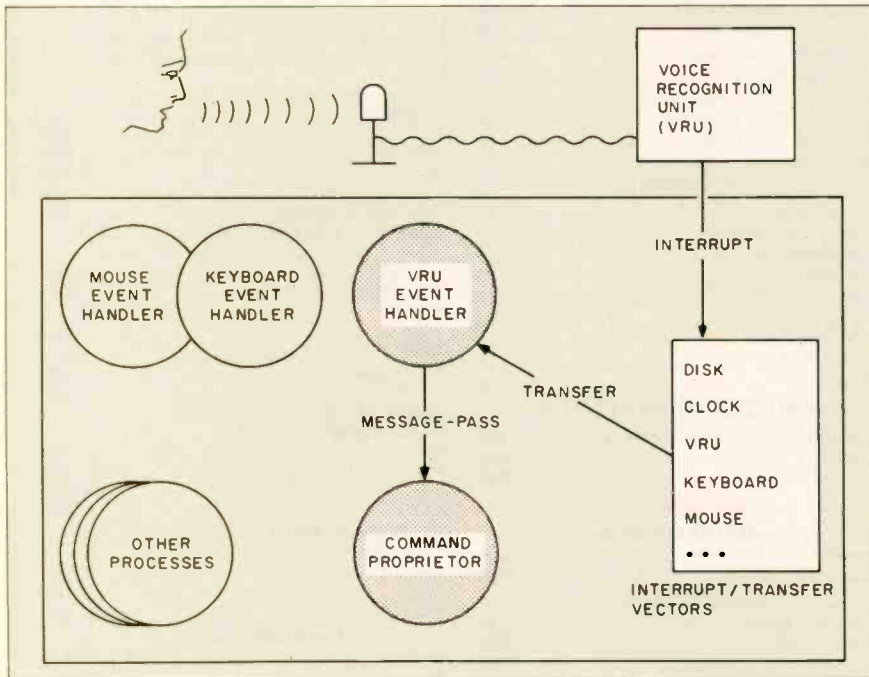

Figure 4: Event handling. When a spoken command is given, the VRU recognizes the utterance and generates an interrupt that prompts a spontaneous TRANSFER to the process dedicated to handling VRU interrupts. The event-handler process reads from the device and composes a message, which it sends to the command-proprietor process. After receiving a reply from the command proprietor, the event handler waits for the next event.

Color 400  
Now Supports  
AutoCAD<sup>®</sup> and VersaCAD<sup>®</sup>

# Princeton SR-12 and Sigma Designs Color 400 "The Ultimate in Graphics Resolution and Performance"...

PC Products June 1985

**SR-12 and Color 400. A brilliant combination for super-high resolution graphics and a crisp character display.**

For a brighter, sharper display with your IBM PC, XT, or AT, here's a team that can't be beat. The SR-12 super-high resolution RGB monitor from Princeton Graphic Systems and Color 400, the advanced color graphics adapter card from Sigma Designs.

**A Revolution in Resolution.** Begin by snapping the Color 400 into your PC. Without any software modification, text suddenly becomes readable. Graphics turn sharper and cleaner. Jagged edges smooth out, and annoying flicker fades away. Color 400 automatically *doubles* the number of lines on standard line software. It allows true high

resolution display of Lotus 1-2-3 and Symphony charts, graphics from Dr. Halo, CadPlan, Lumena 400, and others. Also, create dazzling business charts in 16 vibrant colors with Paintbrush 400, included with the card. Enjoy fully formed, monochrome quality characters in text mode. For word processing, spreadsheet, CAD/CAM, or pro-

fessional design applications, Color 400 is the answer to your graphic needs.

**Turn on SR-12 for the impressive**

**results.** The SR-12 displays your Color 400 image with unmatched clarity and brilliant color. Because the SR-12 combines a .31mm dot pitch tube and a non-glare screen with an incredible 640 x 400 non-interlaced resolution, you get a flickerless image that's as crisp and clean as a personal computer can produce.

See how impressive this state-of-the-art image can be on your own PC system. Visit your local retailer today and ask about this new color graphics team. Princeton Graphic Systems' SR-12 and Sigma Designs' Color 400. An unmatched, brilliant combination.



SR-12

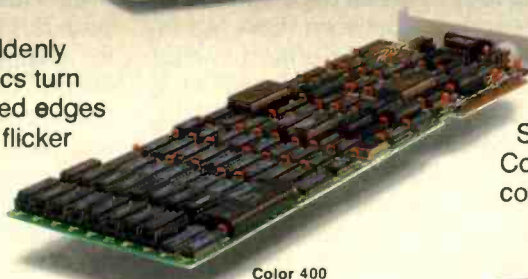

Color 400



SIGMA DESIGNS, INC., 2023 O'Toole Avenue, San Jose, CA 95131  
(408) 943-9480 Telex: 171240



Princeton Graphic Systems, 601 Ewing Street, Bldg. A, Princeton, N.J. 08540  
(609) 683-1660, Telex: 621402 PGS PRIN, (800) 221-1490 Ext. 2204

Graphic Screens courtesy Mouse Systems, Inc. and Forthright Systems, Inc.

IBM PC, PC XT, and PC AT are registered trademarks of International Business Machines, Inc.  
AutoCAD is a registered trademark of Autodesk Inc. VersaCAD is a registered trademark of T and W Systems, Inc.



**WE'LL MEET OR BEAT ANY PRICE!**

**HIGH PERFORMANCE IBM® COMPATIBLES**



Monitor Optional  
**TURBO-XT SYSTEM**  
**\$ 675**

**SYSTEM INCLUDES**

- 256K RAM expandable to 640K on board
- 360K floppy drive
- Serial port
- Parallel port

- Game port • 150W power supply • IBM style keyboard
- IBM style metal case • Clock/Calendar • Complete Manual

**FULLY ASSEMBLED, JUST PLUG IN, 1 YEAR WARRANTY!**

**OPTIONAL WITH 20MB HARD DISK \$1195**

**30 DAY TRIAL!**

With credit towards the purchase of IBM® PC at Wholesale Plus 7% if not completely satisfied!

**EXCEPTIONAL TECH SUPPORT!**

**MEGA-AT SYSTEM (60286 CPU)**

**\$ 1990**

**SYSTEM INCLUDES**

- 60286 CPU • 512K RAM expandable to 1.2MB on board
- 1.2 MB Floppy Drive • Combined Floppy Hard Disk Controller • AT Keyboard • 200W Power Supply
- Serial Port • Parallel Port • Clock/Calendar
- Battery backup on board • Complete Instruction Manual

**LARGEST SELECTION OF OEM/SELF-ASSEMBLY BOARDS, BUILD YOUR OWN XT**

- 256/640K on Board, 8088 CPU (same dimension as IBM®) **\$159**
- Graphics compatible Monochrome Card with printer port **\$115**
- Color Graphics Card, 640 x 200 **\$ 95**
- Multi Disk I/O Card, handles 4 dr serial, parallel, game ports, clock/calendar **\$115**
- 512K RAM card - ok **\$ 55**
- 384K Multifunction Card with serial, parallel, game aopt, ramdisk, spooler, clock/cal **\$115**
- IBM® Style Keyboard **\$ 70**
- 135W switching Power Supply **\$ 85**
- IBM® Style case, sliding with flip top **\$ 45**
- 360K TEAC Floppy Drives **\$ 98**

Price Quotes For Domestic Dealers by Written Request Only!

**10,000 IBM® PC SOFTWARE, WHOLESALE PRICE PLUS 7%**

**INTERNATIONAL DEALERS WELCOME WE ARE SINGLE SOURCE EXPORTERS!**

**LOW PRICES ON PRINTERS, NEC, EPSON, CITOH, OKIDATA**

**TELEX 510 601 0960**

**24 HOUR QUOTE RESPONSE, CORPORATE ACCOUNTS & OEM DEALERS WELCOME!**

**PHONE 201-288-8629**

• VISA • MASTERCARD • CHECK  
PRICES SUBJECT TO CHANGE WITHOUT NOTICE



377 Rt. 17, Hasbrouck Heights, N.J. 07604, USA

**MODULA-2**

ing statements:

INCL(VRUstatus, 1);  
EXCL(VRUstatus, 7);

where you set the first bit in VRU-status and reset the seventh bit.

**SOFTWARE ENGINEERING ISSUES**

Building an operating system is not a trivial effort. The module concept is very important in managing the complexity of development. First you define and categorize the various functions into separate modules. Then you build and test the modules, distributing the effort among several people. Modula-2's modular compilation facility is helpful in writing and compiling the individual modules. You can reduce the complexity of the task by breaking the programming down into smaller and smaller modules and by sharing modules that satisfy a common need. You can build modules in parallel once you define the interfaces between them. An interface can be defined using Modula-2's DEFINITION MODULE construct. A DEFINITION MODULE specifies data and procedures that are available for use by other modules. It provides the name and argument list for procedures, leaving the actual algorithmic details to be specified in a companion IMPLEMENTATION MODULE.

**OUR EXPERIENCES**

Our experiences using Modula-2 in memory management were quite favorable. We were able to write all the Hermes memory-management functions without having to resort to assembly language. Most of these functions are portable to any other machine having a Modula-2 compiler because the functions depend only on the basic characteristics of the language's address-manipulation features.

Modula-2 also provides standard functions that hide the machine-dependent aspects of a process. We were able to save development time by concentrating on high-level issues such as process scheduling, rather than on such details as saving machine status. And we are confident

that our implementation of processes is largely portable: Any Modula-2 compiler for another machine will provide an appropriate implementation of the PROCESS variable and the NEWPROCESS and TRANSFER functions.

The parameters of our message-passing procedures provide for variable-length, variable-format messages. The length and format are defined by the sender and checked for consistency by the operating system. This flexibility is made possible by Modula-2.

Modula-2 helped Hermes extend the concept of process synchronization to synchronization between internal processes and external devices. It allowed us to map the asynchronous behavior of devices onto the more general multiprocess model. It also helped in establishing consistent interfaces to a world of ever-changing peripherals.

We found Modula-2 to be a very powerful and appropriate language for writing Hermes. It provides the features that are essential for memory management, process manipulation, and message passing. The fact that three programmers were able to build Hermes in six months attests to Modula-2's expediency. In addition, it continues to aid in the system's maintenance. From our experience, we feel that Modula-2 has what it takes to build an operating system. ■

**REFERENCES**

1. Wirth, N. "The Personal Computer Lilit." Institut fur Informatik, Eidgenossische Technische Hochschule (ETH), Zurich, Switzerland, April 1981.
2. Cheriton, D., M. Malcolm, L. Melen, G. Sager. "Thoth: A Portable Real-Time Operating System." *Communications of the ACM*, vol. 22, no. 2, February 1979, page 105.

**BIBLIOGRAPHY**

- Anderson, A. *Hermes: A Message-Passing Operating System for Real-Time Applications*. San Diego Research Center, Burroughs Corp., San Diego, CA, August 1983.
- Hirschy, E. "Hermes: An Operating System for a Modula-2 Environment." *Proceedings of the ACM Conference on Personal and Small Computers*, vol. 6, no. 2, December 1983.

# QNX vs UNIX

## A QUESTION OF ARCHITECTURE

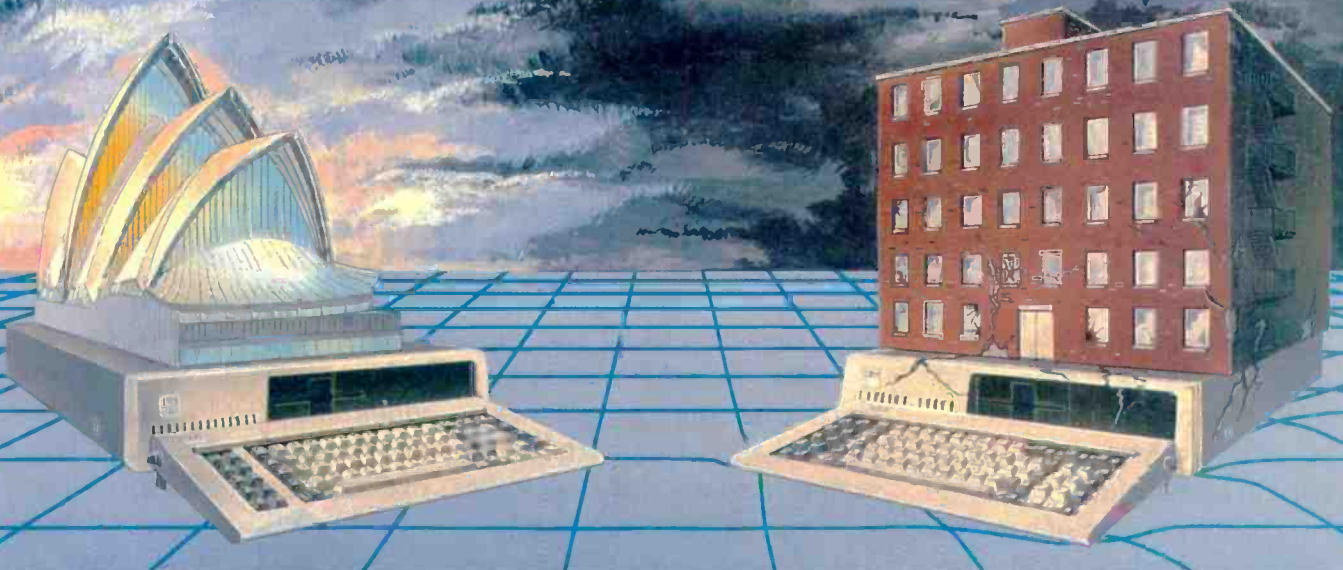

### What do QNX and UNIX have to do with architectural design?

The design determines the environment in which you and your applications must survive. If the sheer weight of the UNIX operating system brings the PC to its knees, all applications running under it will suffer. Unix was conceived more than a decade and a half ago and the product today is the result of modifications, additions and patches by hundreds of programmers. The result is a large and convoluted piece of software which needs the resources of an AT or more.

QNX's superb performance and compact size is the result of one dedicated design team with a common purpose, and complete understanding of both the software and the environment in which it must run. It runs quickly and efficiently on PC's and soars on an AT. Unlike Unix, QNX is capable of real time performance and is the undisputed choice for real time process control, and office systems. You can buy an OS that offers you a 1 to 3 user dead end on an AT, OR, you can consider QNX which allows you anywhere from 1 to 10 users on both PC's and AT's. And we don't stop there. Unlike other Unix-type systems for PC's, QNX is also a networked operating system. Not a patch-on network, but a fully integrated networking system for up to 255 micros. QNX allows you to start with a single machine and grow if and as required. There are no dedicated file servers and you can attach terminals (users) to any machine. To choose a solution which ignores networking, is closing the door on your future.

Everyone is talking about Unix like systems, but no one wants to abandon the tremendous amount of DOS software available. QNX does not force you to make that decision. You can run either PC DOS 2.1 or 3.1™ as one of QNX's many tasks. (DOS File compatibility and DOS development tools are also available). Don't misunderstand us. We at Quantum have a great deal of respect for Unix. It was a major force in moving operating systems out of the 1960's and into the 70's. QNX however, was designed in

the 80's and will be a driving force of the 1990's. Over 20,000 systems have been sold since 1982.

Quantum strongly believes that there are good reasons for buying QNX, DOS and Unix. If you want more than DOS and a working alternative to PC Unix, give us a call and we will discuss your needs.

End-Users, VAR's, OEM's and software developers are invited to take the QNX challenge.

- **MULTI-USER:** -10 serial terminals per PC, AT.
- **MULTI-TASKING:** -40 tasks per PC, AT.
- **NETWORKING:**
  - 255 machines.
  - up to 10,000 tasks and 2000 users/network.
  - 2.5 Megabit token ring.
- **REAL TIME:** -2800 task switches/sec (AT).
- **MESSAGE PASSING:** -Intertask communication between any of 1000's of tasks on any machine.
- **MEMORY:** -88K to 110K for QNX.
- **PC DOS:** -Executes as a task under QNX.
- **C Compiler:** -Standard Kernighan and Ritchie.
- **Flexibility:** -Single machine or networked. One to thousands of users. Full resource sharing of disks and devices on all machines.
- **Support:**
  - Online update system allows downloading of new releases over the phone.
  - Technical support hot line.
- **COST:**
  - From US \$450
  - Call for runtime prices.
- **HARDWARE SUPPORT:** -IBM PC, XT, AT™ (both real & protected) and compatibles.



Moodie Drive HiTech Park 215 Stafford Rd. Ottawa, Ontario, Canada. K2H 9C1 Phone (613) 726-1893

IBM PC, AT, XT AND PC-DOS ARE REG. TM OF INTERNATIONAL BUSINESS MACHINES CORP. UNIX IS A REG. TM OF AT&T BELL LABS

NOW  
COMES  
WITH FREE  
PRINTER CABLE!

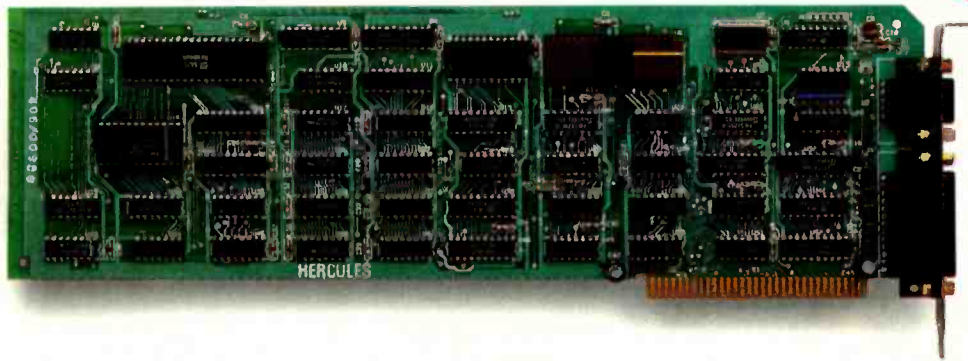

## The world's best selling monochrome graphics card for the IBM PC.

There are more Hercules™ Graphics Cards in more IBM® PCs, XT's and AT's than any other monochrome graphics card in the world.

Over a quarter of a million demanding users around the world use a Hercules Graphics Card to improve the performance of their software.

### The Lotus® 1-2-3® Booster.

Consider Lotus 1-2-3. Hercules gives an off-the-shelf copy of 1-2-3 the highest resolution possible on an IBM PC, XT or AT. More 1-2-3 users choose the Hercules Graphics Card to get crisper text and sharper graphics than any other monochrome graphics card.

And we bring the same performance to other integrated programs like Symphony™, Framework™, and SuperCalc®3.

But we don't stop there. The Hercules Graphics Card

improves all kinds of software.

Like Microsoft® Word, a word processor that enables you to display text with subscripts, superscripts and italics.

Or pfs:Graph, an easy-to-use business graphics program that converts your data into presentation quality graphs.

Or Microsoft® Flight Simulator, the high flying game for the overworked executive.

Or our own Graph X™, a library of graphics sub-routines that eases graphics programming.

Or AutoCAD™, a computer aided design program that offers features normally associated with expensive CAD systems.

And we supply free software with each card to do hi-res graphics using the PC's BASIC interpreter.

### State-Of-The-Art Hardware.

The Hercules Graphics Card gives you graphics resolution of 720h x 348v and a

parallel printer port. Our unique static RAM buffer provides sharp 9 x 14 characters and flicker-free scrolling. Our exclusive safety features help



prevent damage to your monitor.

State-of-the-art custom IC technology delivers unsurpassed reliability. Ordinary graphics cards use up to 30 ICs to do what one Hercules IC does. By using fewer parts, we reduce the possibility of component failure.

Which is one reason we warranty the Hercules Graphics Card for two years.

Unbeatable reliability. Advanced technology. Proven by over a quarter of a million users. Why settle for anything less than Hercules?

Call 1-800-532-0600 Ext 408 for the name of a Hercules dealer nearest you and we'll rush you our free info kit.

**Hercules.**  
We're strong on graphics.

Inquiry 157

# LINKING DATA FLOW AND FUNCTIONAL LANGUAGES

## *Exploiting the data-flow mechanism to gain execution speed*

*Editor's note: This article was adapted from Principles of Functional Programming (© 1984) by Chris Hankin, David Till, and Hugh Glaser (pages 104-115) and used by permission of Prentice-Hall Inc., Englewood Cliffs, NJ.*

In recent years, language designers have turned away from imperative languages to functional languages to avoid the problems connected with the control of access to global resources and the lack of referential transparency. In the field of computer architecture, data flow has emerged as a paradigm for multiprocessor machines providing a simple way of making a number of processors cooperate on a single task. Linking data flow and functional languages combines the advantages of functional programming and parallel execution.

The salient feature of data flow is that instead of a centralized control unit and a program counter, operations are selected for execution when their operands have been computed. Therefore, the flow of data between operations provides the sequencing control that would normally be provided by the program counter in a conventional "control flow" machine. When several operators have all their operands ready, any or all of them can be performed, in sequence or simultaneously, giving rise to parallelism within data-flow systems. Operators can have no "side effects": They

*(continued)*

Chris Hankin (Department of Computing, Imperial College of Science and Technology, 180 Queens Gate, London SW7 2BZ, England), David Till, and Hugh Glaser (Department of Computing, King's College, Strand, London WC2, England) are lecturers in computing at London University.

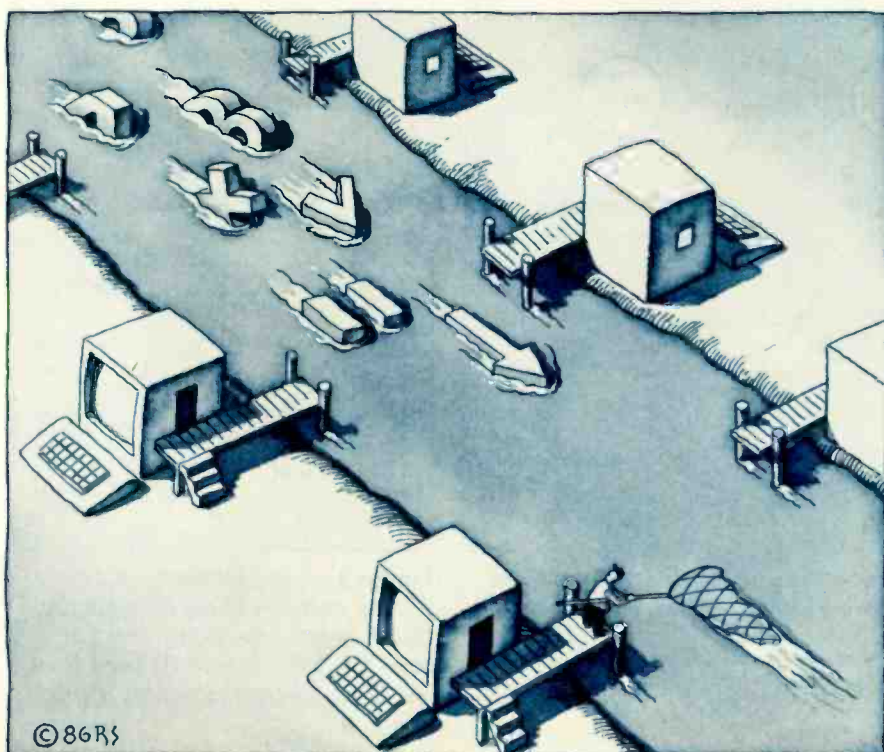

© 86RS

receive a number of inputs and produce a number of outputs. There are no concepts of instruction sequencing or global memory. [Editor's note: For further discussion of data flow, see "Applying Data Flow in the Real World" by William Gerhard Paseman, May 1985 BYTE, page 201, and "Using Data Flow for Application Development" by Wayne P. Stevens, June 1985, page 267.]

Two different data-flow models, pipeline data flow and token data flow, have been investigated. In both models directed graphs represent data-flow programs. The nodes of a pipeline data-flow graph represent processes; the arcs represent channels between processes. In this model, the arcs carry streams of data between processes. A substantial amount of work has been done on the formalization of pipeline data flow, and it has formed the semantic basis for some of the work on multiprocessing using functional languages.

All of the current data-flow architectures, however, are based on token data flow. In this model, the nodes are used to represent more primitive

operations, and the arcs are the channels that carry the operands and therefore represent the data dependencies between operators. Approaches to token data flow differ in the rules that are used in the construction of programs. In this article we restrict our attention to acyclic graphs, partly because this makes the treatment more straightforward, but also because we feel that this approach is more appropriate for the implementation of functional languages.

We can see some of the benefits of using data flow in the implementation of functional languages by considering the following simple example in Hope (for an introduction to Hope, see "A Hope Tutorial" by Roger Bailey, August 1985 BYTE, page 235):

```
dec sum_square : num # num ->
  num;
--- sum_square(a, b) <= a * a +
  b * b;
```

While this program does not specify any control information, it is clear that the plus operator requires the results

of the two multiplications and that these can be evaluated independently. We could, for example, redefine the function in a formalism that highlights the data dependencies between operators. This is precisely what the data-flow notation does.

In the next section, we describe a data-flow notation that can be used for the translation of functional programs. We then go on to describe two algorithms for the execution of data-flow programs. Both of these mechanisms support the full range of facilities found in functional languages.

**A DATA-FLOW NOTATION**

The notation we use consists of a set of five basic operator types, a function application operator, and a notation for function definition. Figure 1 shows the basic operators.

The graphs show all data dependencies explicitly. If two operators use the same value, they must both have an input arc that emanates from the same place. There is an explicit duplicate node that can be used to

(continued)

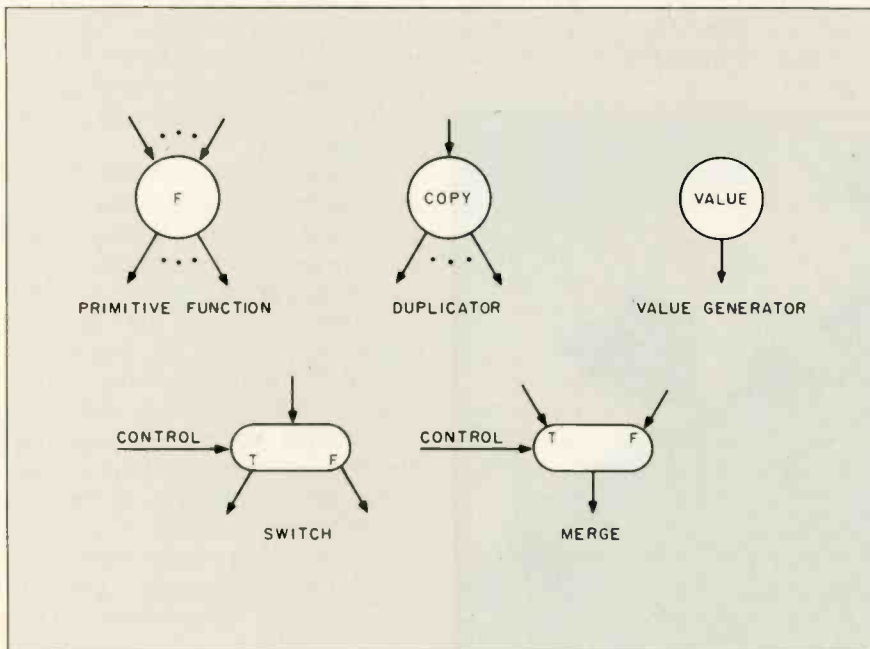

Figure 1: In these diagrams of the basic operators, the data flow is directed down the page. Inputs to and outputs from a graph are shown as arcs that are connected to the graph only at one end.

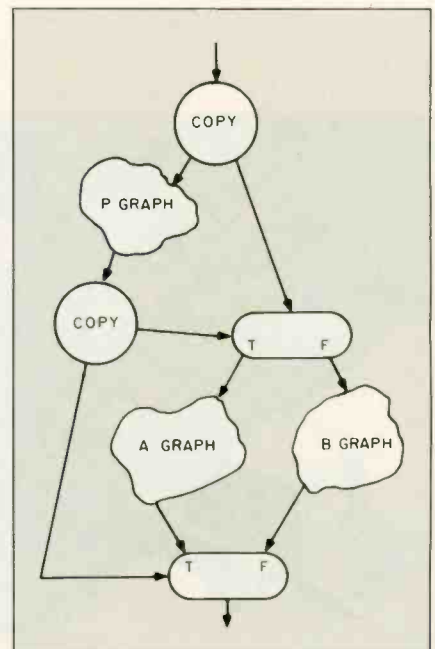
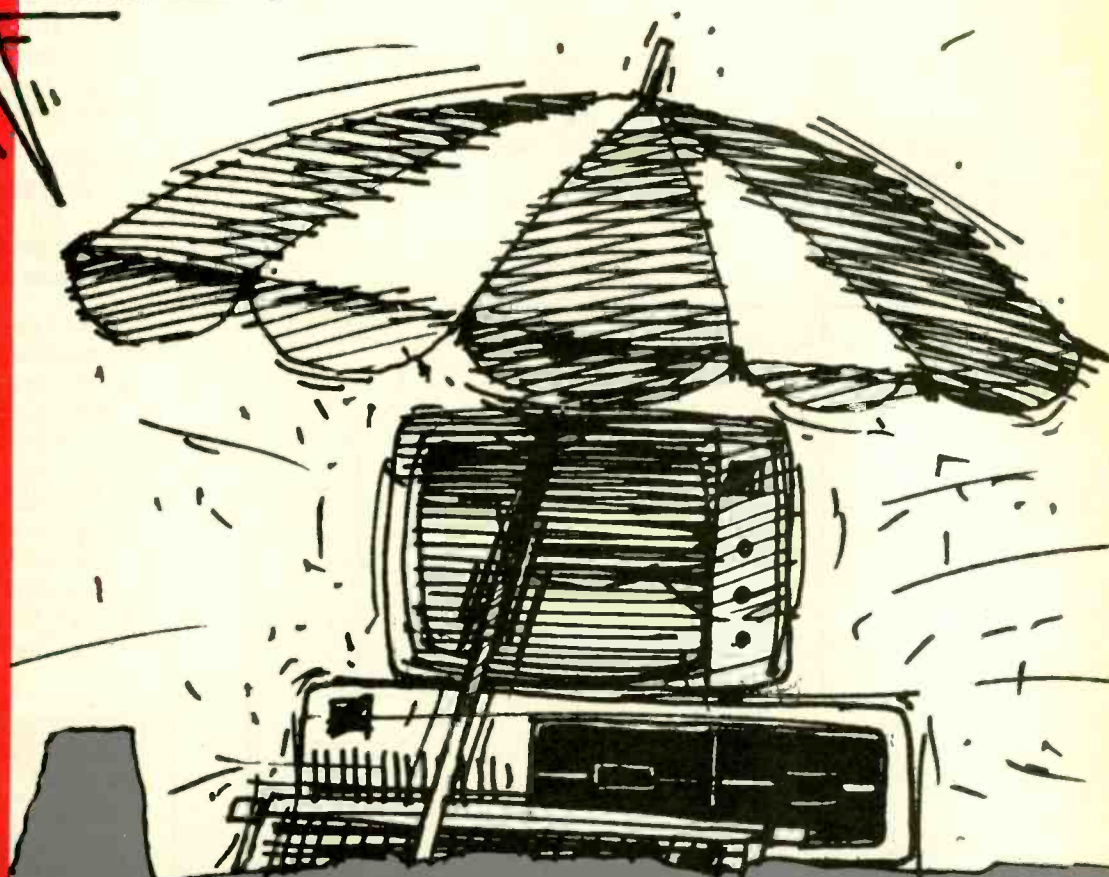

Figure 2: A possible graph for the defining expression of the Hope function: `dec f : num -> num; --- f(a) <= if P then A else B; where P, A, and B are arbitrary expressions referring only to a.`



HI, HONEY!



Honeywell synchronous  
VIP emulation and file  
transfer (FTF an option).  
Compatible with Topview.  
Honeywell VIP  
asynchronous emulation  
and file transfer.  
Compatible with Topview.

ASYNCHRONOUS     \$399  
SYNCHRONOUS     \$499

TO ORDER PHONE TOLL FREE  
1-800-826-7839

**TDT**

GROUP INC.

R vergate Plaza, 444 Brickell Ave  
Suite 902, Miami Florida 33131  
Telephone 305/372-9332, Telex 4947306

**Connections IBM PC—Honeywell mainframe.**

DPS 4, 6, 7, 8, LEVEL 6, 66, ETC.

provide the appropriate number of copies of a value. The value generator is the operator used to insert literal values onto the graph at run time; literal values include the integers, Booleans, and other primitive types, as well as function names. The switch and merge operators are used to construct conditional computations. For an example, see figure 2.

At run time the switch uses its control input, which is a Boolean value, to select one of its output arcs to receive the input value. Similarly, the merge uses its control input to select a value from one of its input arcs. If the expressions of the conditional had used other values from the environment (e.g., if there were other parameters to the function), then the

graph would require multiple switches and merges, all taking their control input from the P graph.

You can define a graph as a function by enclosing it in a "box." See figure 3 for an example of the graph of the product function

```
dec prod : num # num -> num;
--- prod(a, b) <=
    if a >= b
    then a
    else a * prod(a + 1, b);
```

The arcs entering the box represent the parameters of the function, and the arcs emanating from the box represent the results of the function. The name of the function is in the bottom left corner of the box. An explicit apply node (see figure 4a) represents an application of a user-defined function. Boxed graphs containing self-referential apply nodes represent recursive function definitions.

Assuming that you have a definition (continued)

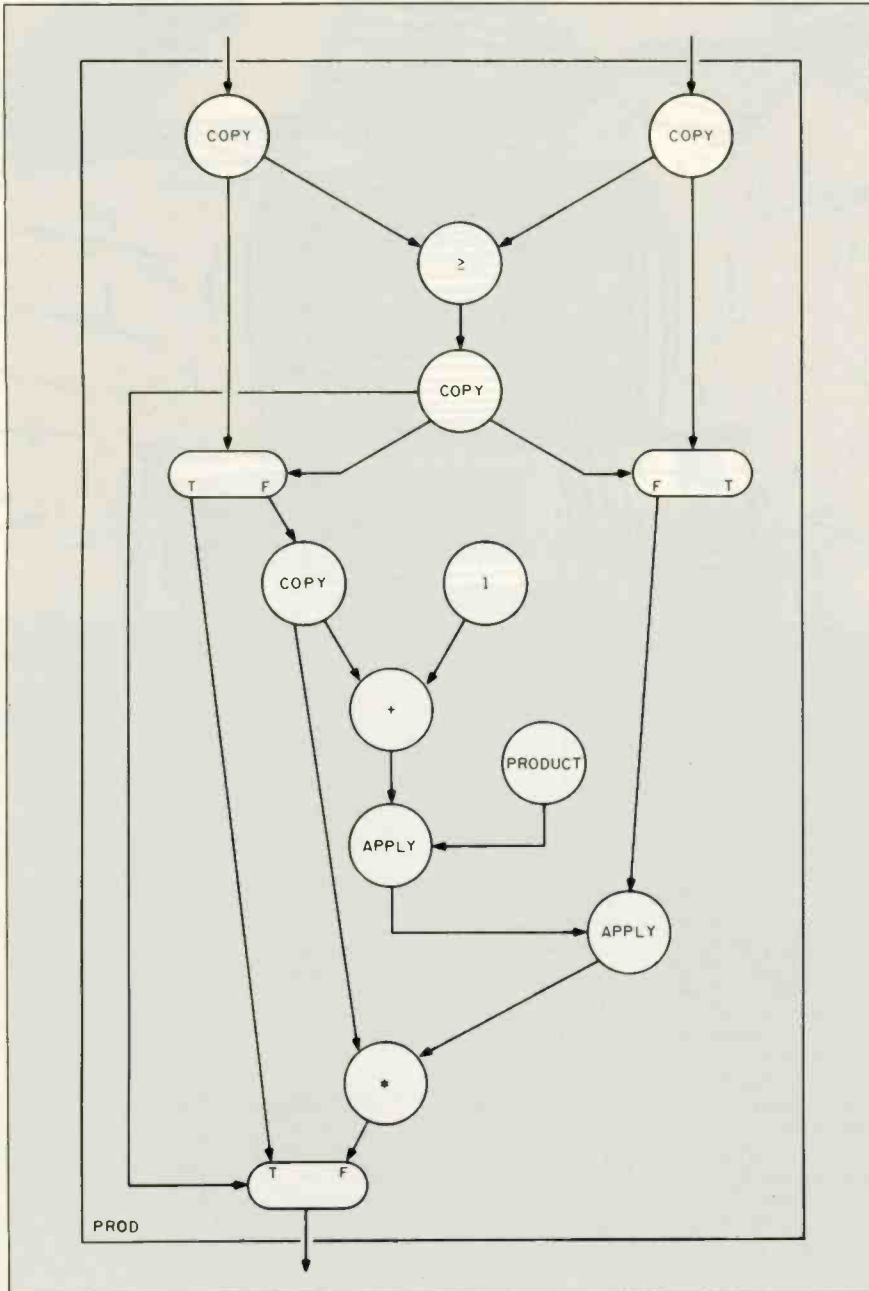

Figure 3: The box defines the graph as a function. Note that the T output from the right switch is omitted because the value of b is not required when the condition is satisfied. Any application of prod will require two apply nodes.

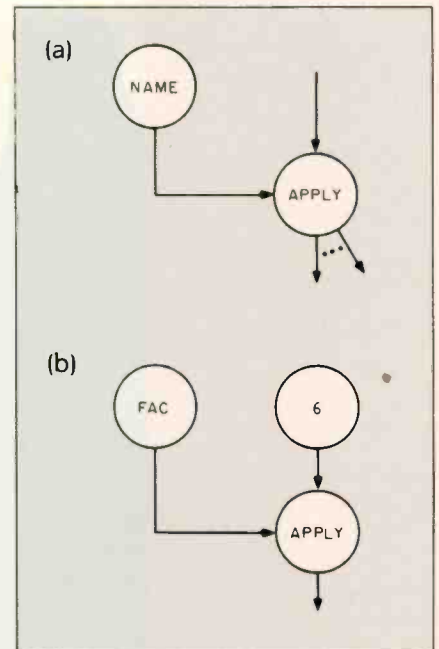

Figure 4: The apply node takes two inputs, a function name or closure and a parameter value. Function names can be written explicitly at the node or passed on an input arc as are function closures. As its result, the apply node produces a value or a function closure depending on whether the applied function was a first-order function or a higher-order function.



## Doesn't your IBM PC deserve IBM service?

You chose an IBM Personal Computer for lots of good reasons. And now that you depend on it to help keep your office running smoothly, doesn't it make sense to help protect your investment with blue chip service from IBM?

No matter what IBM PC you have, blue chip service is more than just expert repair.

Blue chip service offers the choice of service that's right for you at the price that's right for you. It means we'll exchange your monitor, for example, at your place or at any of our Service/Exchange Centers.

And blue chip service means a lot of things you don't see. Quality. Speed. Commitment. And IBM experience. Every year IBM invests many hours of training to keep its service representatives current on technologies that never stand still.

As an IBM customer you deserve blue chip service. It's the best thing you can do for your IBM Personal Computer.

For more information, use the coupon or call 1 800 IBM-2468, Ext. 104, and ask for the Service/Exchange Maintenance Department.

Blue chip service from **IBM**<sup>®</sup>

IBM Direct	104-5-86
Service/Exchange Maintenance Dept.	
One Culver Rd.	
Dayton, NJ 08810	
<input type="checkbox"/> Please send me more information on IBM PC service.	
Name _____	Title _____
Company _____	Phone _____
Address _____	
City _____	State _____ Zip _____

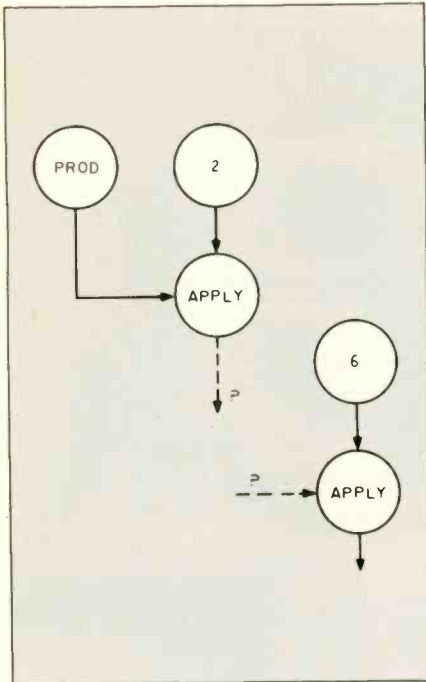

Figure 5: What value does the first apply node produce? What function is supplied to the second?

of "fac," the factorial function, you can use the apply node as in figure 4b. When a function has more than one parameter, as in figure 3, the situation is slightly more complex because the apply node has only one parameter input.

In figure 5, two questions arise. What value is produced by the first apply node, and what function name is supplied to the second apply node?

Both questions can be answered by a more careful consideration of function names. In our notation, a function name is not just an identifier; it also contains information about the number of parameters that the function requires and the values of any "fixed" parameters. Therefore, the first apply node in the diagram produces a new name with the same identifier as prod but with the additional information that the first parameter has been fixed at 2. We use the term *closure* to refer to such function names that contain fixed parameters. The answer to the second question is that we con-

nect the output of the first apply node to the name input of the second.

When the name input of an apply node carries a function that requires only one further input, the node is conceptually replaced by a copy of the function. The copy executes using the parameter from the replaced node and the values that were fixed by preceding apply nodes. The process is much more powerful than the example suggests. For example, the name produced from an apply node need not be passed directly to the next apply but could be copied or transformed in some way first (see figure 6).

As a final remark on our data-flow notation, we note that the apply node does allow multiple outputs. This allows us to translate Hope functions that produce more than one output. In this case, any "internal" apply node that produces a name will have a single output, and the final apply node will have the same number of outputs as are produced by the Hope function.

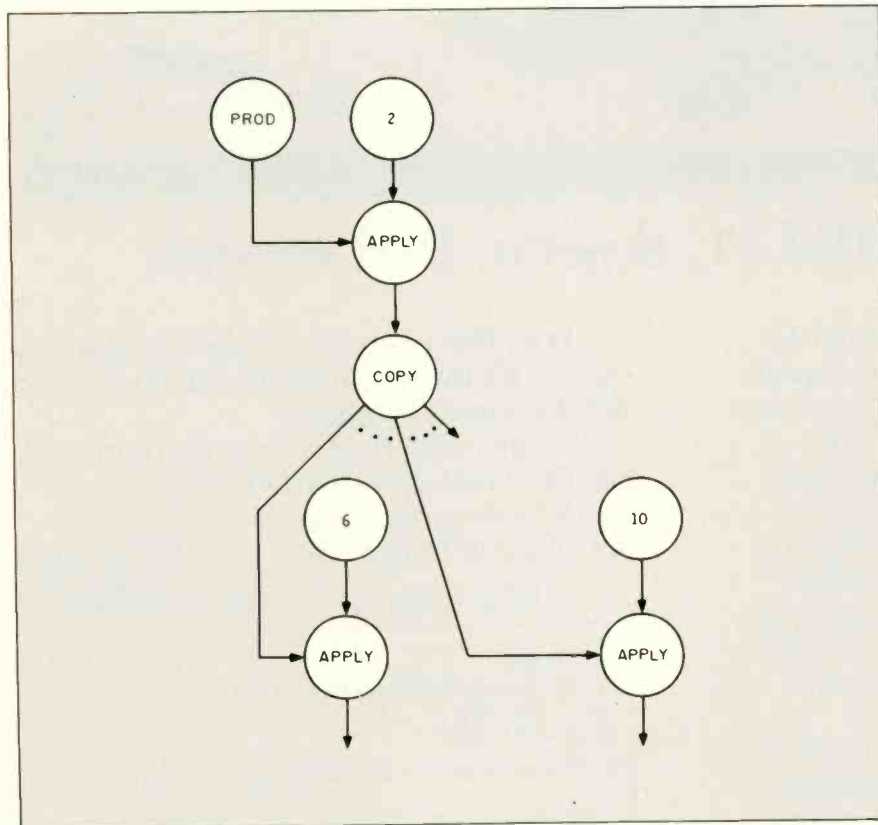

Figure 6: The name produced by the first apply corresponds to a single parameter function that produces the product of all values between 2 and the parameter value.

### DATA-FLOW EVALUATION MECHANISMS

There are two approaches to the evaluation of data-flow programs. One is the classical data-driven approach, a call-by-value mechanism in which arguments are evaluated before they are passed to a function. The second is the demand-driven approach that provides lazy evaluation. For our purposes, the important aspects of lazy evaluation are that arguments are not evaluated until they are required, and if required, they are evaluated only once. We describe each mechanism at an abstract level within the context of the data-flow notation that we have presented.

First, we define a data-driven mechanism in which each data-flow instruction consists of IDEN, an identifier; TYPE, a type that is one of the basic operators or apply; INPR, an input record that has a field for each input; and OUTL, an output list of instruction identifier/input field name pairs.

Each value produced from the execution of an instruction must be directed to a particular input arc

(continued)

# Get the Picture with COLORPHOTOBASE



**PHOTOBASE** is a software package that works with data base management systems such as: dBase II\*, R:Base 4000\* and the IBM Filing Assistant\*.



**PC-EYE** is a high speed, high resolution video digitizer board that lets you capture anything you can see.

Now you can open up a whole new dimension in data base applications by merging real-life color pictures with popular data base management systems. Pictures of people, products, diagrams, maps, company logos — whatever you want to photograph — can be integrated with your data base. Consider these typical applications:

**Security** — verify those employees who have authorized clearance to limited access areas. A data base containing employee pictures and personnel records can be searched and displayed for visual verification.

**Real Estate** — add pictures of houses to on-line real estate listings for faster property identification and improved sales presentations.

**Electronic Cataloging** — pictures of products can be combined with a data base system containing product specifications, pricing, availability and much more.

**Medical Files** — Existing data base systems containing patient histories can incorporate pictures of x-rays, cell slides and external body disorders. The ability to visually inspect previous medical problems of patients can greatly enhance the speed and accuracy of future diagnosis.

Customers, distributors and sales personnel can quickly search data and view the resulting product/picture information on one screen. Files can be updated easily, quickly.

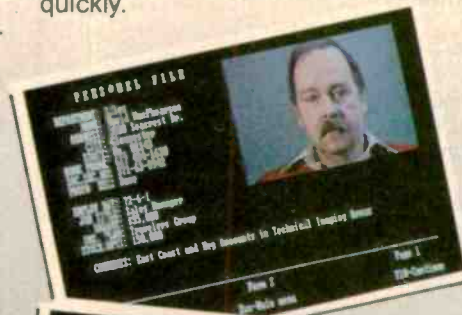

## It's Easy

With a simple keystroke, pop-out of your data base system and into the PHOTOBASE menu. Capture images of text, photos, artwork and 3-dimensional objects with an ordinary video camera and our high resolution PC-EYE™ video digitizer. Pop back into your data base system and add the picture name to your data base like you would any other piece of information. The full functionality of the data base system is preserved, but the resulting display is text and picture information on one screen.

Pictures are displayed in the upper right quadrant of the screen or at a full screen resolution of 320 x 200 with 256 optimized colors. Screen display can alternate with text, images, or both simultaneously viewed.

Call or write and we will send you information on PHOTOBASE, PC-EYE, compatible cameras and other imaging equipment in the Chorus Family of products.

**(603) 424-2900 or  
1-800-OCHORUS.**

TM PHOTOBASE and PC-EYE are trademarks of CHORUS Data Systems.

\*dBase II is a trademark of Ashton-Tate; R-Base 4000 is a trademark of Microrim, Inc.; IBM Filing Assistant is a trademark of International Business Machines Corporation.

# CHORUS

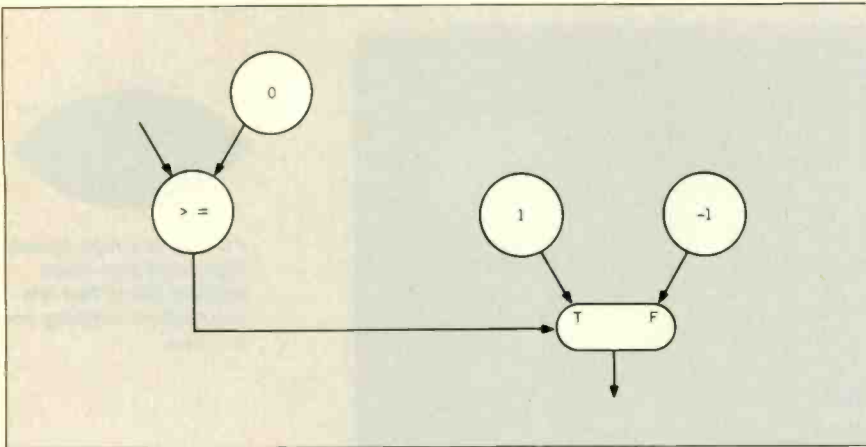

Figure 7: This is a program that returns the sign of its input, which arrives in the "left" input field of instruction 2. As we noted earlier, outputs emanate from a particular instruction but are not directed toward any instruction. This is represented in the code by an asterisk in the output list of an instruction.

some other instruction. Therefore, we need a way of uniquely identifying instructions and a way of distinguishing between input arcs. We have used a record with named fields to represent the set of input arcs, and each instruction has a unique identifier. Destinations for each of the results of an instruction are specified in the output list that contains one instruction per input field pair for each output arc. The instruction type identifies the operation to be performed, which in the case of value generators and primitive functions must include information about which specific instance of the class is required. Figure 7 shows an example of a data-flow program in this notation.

The major cycle of the execution mechanism is

```
FOR any instruction DO
  IF the instruction has all of its
    required inputs
  THEN execute the instruction
  ENDF
ENDD
```

Several different instances of this cycle may be active at any one time; each would operate asynchronously with the others.

The meaning of "the instruction has all of its required inputs" will vary according to the type of the instruction under consideration, but it can be represented by the following expression:

```
the type is value
OR the type is one of primitive, copy,
  switch, apply
  AND all fields in the input record
  contain values
OR the type is merge
  AND the control input field and
  the appropriate other input
  field contain values
```

A value operation always has its required inputs. All other operations require a complete set of inputs, with the exception of merge, which requires only its control input and the selected input.

The most complex part of the cycle is "execute the instruction," which may be represented as in listing 1. With the exception of apply, the execution

(continued)

Listing 1: A representation of the "execute the instruction" command within the major cycle of the data-driven execution mechanism.

```
CASE type of instruction OF
primitive : perform the operation using the inputs;
  FOR each instruction in the output list DO
    put the appropriate result in the specified input field
  ENDD.
copy : FOR each instruction in the output list DO
  put the value from the input record into the specified input field
ENDD.
value : put the value into the specified input field;
switch : IF the control input is TRUE
  THEN place the other input value in the specified input field of the first
    instruction in the output list
  ELSE place the other input value in the specified input field of the second
    instruction in the output list
  ENDF.
merge : IF the control input is TRUE
  THEN place the second (true) input value in the input field specified in
    the output list
  ELSE place the third (false) input value in the input field specified in the
    output list
  ENDF.
apply : IF the first input is a single parameter function
  THEN generate a copy of the function;
    place the second input value in the input record of the first instruction
    in the function
  ELSE IF the first input is a closure that requires a single parameter
  THEN generate a copy of the function;
    pass the second input and the closure values to the input
    records of the appropriate instructions;
  ELSE generate a new closure with the second input value
  ENDF
ENDF
ENDC;
delete the instruction;
```

# NOW CITIBANK DIRECT ACCESS MAKES IT THIS EASY TO MANAGE YOUR IRA.

**The only PC Banking Service to give you up-to-the-minute control of your IRA and brokerage investments.**

With Direct Access, managing your Citibank IRA and Citicorp Brokerage investments is as easy as the touch of a button on your PC. You'll know instantly how much money you have invested and where it is. With Direct Access, you can invest your IRAs in CDs, Money Market Accounts, even earn potentially higher returns with a Citibank Portfolio IRA: stock and bond funds managed by Citicorp financial specialists.

Direct Access gives you on-line control over your Citibank IRA and Citicorp Brokerage investments. Start funding your 1986 Citibank IRA through Direct Access now, and by moving your other IRA accounts to Citibank you'll have everything you need to know at your fingertips.

**Direct Access—the most versatile, complete PC banking service around.**

On-line control of your IRA and brokerage accounts is just the start of what Direct Access can do. With Direct Access and a Citibank checking account you can pay bills to anyone at the touch of a button. You can transfer money between accounts, open new accounts and access



the resources of Dow Jones News/Retrieval.<sup>®</sup> You'll also get a Citicard so you can get cash at hundreds of Citicard Banking Centers.

Direct Access is compatible with more than forty of the most popular personal computers. And best of all, you can even download your banking transactions into programs like Lotus and Dollars and Sense in order to manage your finances without hours of manual input.

**Save \$100 or \$50 on a Hayes<sup>®</sup> Modem**

Get a terrific rebate on your choice of six Hayes Modems right now by signing up for Direct Access. And you get Direct Access free for the first two months—no risk, no obligation. Just call 1-800-633-3386, Ext. 7004 for more information on all the features Direct Access offers you. And put control of your financial life at your fingertips.

IT'S YOUR CITI<sup>™</sup>  
**CITIBANK** 

A CITICORP COMPANY  
© Citibank N.A. 1986 Member FDIC

Modem rebate offer expires June 30, 1986. Direct Access is a Service mark of Citicorp. Dow Jones/News Retrieval is a registered Service mark of Dow Jones & Co. Hayes is a registered trademark of Hayes Microcomputer Products, Inc. To get Direct Access you must open a Citibank checking account. The Portfolio IRA is a fiduciary service offered under our Collective Investment Trust for Citibank IRAs. Citicorp Brokerage is a division of Citicorp Financial Services, Inc., members NASD/SIPC. All trades are cleared by arrangement with Newbridge Securities Inc., a subsidiary of Citicorp Financial Services, Inc. © Citibank N.A. 1986 Member FDIC.

mechanism is straightforward. In the case of apply, it is necessary to distinguish between an application that is providing the last parameter to a function (closure), in which case a copy of the function is generated ready for execution, and the other cases where a new closure is produced. The new copy of a function has to be "knitted into" the program by setting up the input records of initial instructions with parameter values and ensuring that the function output instructions send their results to the correct destinations. This mechanism to "generate a copy of the function" is shown below:

```

create a new copy of each instruction
  in the function, assigning unique
  identifiers and changing the
  output lists accordingly;
FOR each output instruction in the
  function
DO set the output list to the
  appropriate values from the
  output list of the apply operator
ENDDD;
    
```

The program is acyclic; instructions are thus executed only once. After execution, each instruction is deleted.

As an example of this process, we show how the sign program in figure 7 would be executed when the input is 5 (see table 1).

### DEMAND-DRIVEN SYSTEMS

In demand-driven systems, the presence of operands and a request for the result of an operation controls the computation. Effectively, a structure is imposed on the program that carries requests in the reverse direction to the flow of data. This requirement is reflected in an extended definition of a data-flow instruction:

A data-flow instruction consists of  
 IDEN: an identifier  
 TYPE: a type, which is one of the basic operators or apply  
 SOUL: a source list, which is a list of instruction identifiers  
 INPR: an input record, which has a field for each input  
 OUTL: an output list, which is a list

of instruction identifier/input field name pairs

The representation of the program is therefore slightly more complicated. The "sign" program is specified in table 2. The main execution cycle is also more complicated. Only instructions whose results have been requested are executed and then only if the required operands have been computed. Otherwise, the request is propagated.

Listing 2 defines the mechanism. Only the inputs that are needed by merge are requested. The control input is requested first, and then either the true input or the false input is requested, depending on the control value. The specifications for "the instruction has all of its required inputs" and "execute the instruction" are the same as the data-driven version, with the exception of the apply operator. The apply operator requires only its left input, the function or closure name, and is executed as follows:

```

apply : IF the first input is a single
        parameter function
        THEN generate a new
        copy of the function
        ELSE IF the first input is a
        closure that
        requires a single
        parameter
        THEN generate a
        new copy of the
        function
        ELSE generate a
        new closure
        remembering the
        identifier of the
        second instruction
        in the source list
        ENDF
    ENDF
    
```

Table 1: The execution of the sign program in figure 7 when the input is 5. Each snapshot in the trace results from executing all possible instructions.

IDEN	TYPE	INPR	OUTL
Step 1:			
1	value/0	( )	(2.right)
2	> =	(left:5,right)	(5.control)
3	value/1	( )	(5.true)
4	value/ - 1	( )	(5.false)
5	merge	(control,true,false)	(*)
Step 2:			
2	> =	(left:5,right:0)	(5.control)
5	merge	(control,true:1,false: - 1)	(*)
Step 3:			
5	merge	(control:TRUE,true:1,false: - 1)	(*)
Step 4:			
1	(The result to be output)		

Table 2: The demand-driven execution of the sign program in figure 7.

IDEN	TYPE	SOUL	INPR	OUTL
1	value/0	( )	( )	(2.right)
2	> =	(?,1)	(left,right)	(5.control)
3	value/1	( )	( )	(5.true)
4	value/ - 1	( )	( )	(5.false)
5	merge	(2,3,4)	(control,true,false)	(*)

In this mechanism, a closure consists of the function name and a list of instruction identifiers that are the sources of its parameters. The parameters may thus be requested, if required, when the function is evaluated. We define "generate a new copy of the function" as follows:

create a new copy of each instruc-

*(continued)*



# PC 3780 FILE TRANSFERS STAY ON THE TRACK

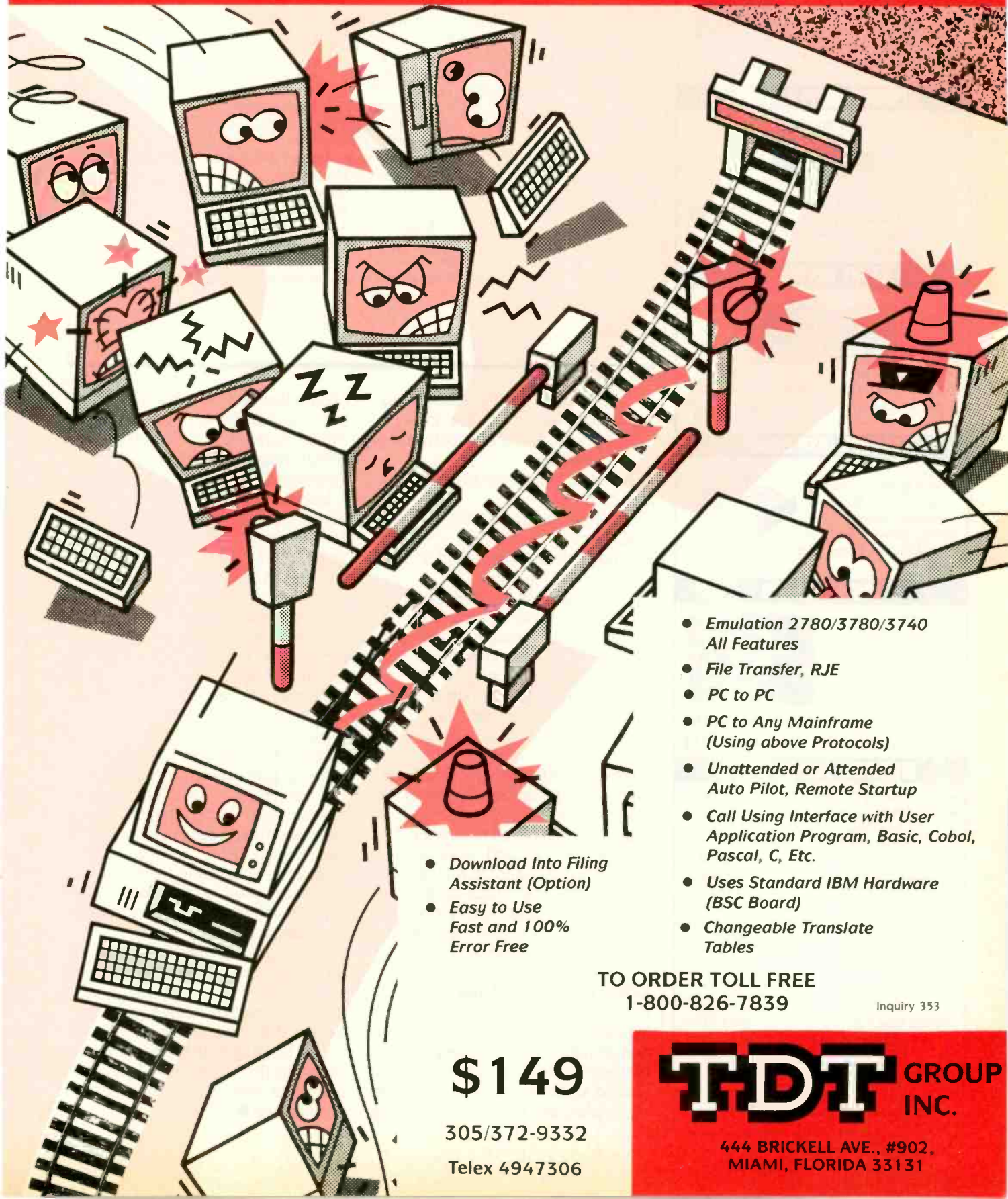

- Download Into Filing Assistant (Option)
- Easy to Use  
Fast and 100%  
Error Free

- Emulation 2780/3780/3740  
All Features
- File Transfer, RJE
- PC to PC
- PC to Any Mainframe  
(Using above Protocols)
- Unattended or Attended  
Auto Pilot, Remote Startup
- Call Using Interface with User  
Application Program, Basic, Cobol,  
Pascal, C, Etc.
- Uses Standard IBM Hardware  
(BSC Board)
- Changeable Translate  
Tables

TO ORDER TOLL FREE  
1-800-826-7839

Inquiry 353

**\$149**

305/372-9332

Telex 4947306

**TDT** GROUP  
INC.

444 BRICKELL AVE., #902,  
MIAMI, FLORIDA 33131

## DO IT YOURSELF IBM XT/AT COMPATIBLE SYSTEMS

Introducing XT64 Basic System

- 640K Motherboard
- 135 Watts Hard Disk Ready Power Supply
- Color Graphic Card
- One DS/DD Slim Drive
- Floppy Disk Controller
- Assembly Instruction



**\$699.00**

### POWER SUPPLY, CASE



- ★ 135 Watts Hard Disk Ready Heavy Duty Power Supply **\$75.00**
- ★ Flip Top Metal Cabinet With Built In Speaker **\$45.00**

### XT/AT KEYBOARD



- ★ Enlarge Return, Shift & Control Key & LED Indicators for Caps, Num Lock & Scroll Lock **\$65.00**

### FLOPPY DISK DRIVE

- Pop-Up Mechanism
- Direct Drive Brushless Spindle Motor
- High Speed Data Access
- All Japanese Name Brand



**\$85.00**

### MOTHERBOARD

- 640K Motherboard
- IBM XT Fully Compatible
- 8088 CPU W/8087 Optional
- 8 I/O Slots

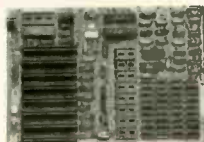

- ★ W/O Memory Chip **\$140.00**
- ★ W/Memory Chips **\$220.00**

### MONITOR, ADD-ON CARDS

- ★ High Res. TTL Green/Amber **\$95.00**
- ★ High Res. Color Monitor **\$310.00**
- ★ Disk I/O Card for 2 Disk Drives W/Serial, Parallel, Game Port & Clock **\$119.00**
- ★ Color Graphic Card **\$89.00**
- ★ Monochrome Graphic Card **\$119.00**
- ★ Floppy Disk Controllers **\$39.00**

## JM SYSTEM INC.

1580 Industrial St., Los Angeles, CA 90021

**\* IMMEDIATE DELIVERY \***

Please Call For Our Special Dealer Price  
Mail Orders Hot Line

**(213) 624-9986**

IBM XT/AT Are Registered Trademarks of International Business Machines Corp.

## LINKING DATA FLOW

Listing 2: *The demand-driven mechanism.*

```

FOR any instruction whose output has been requested DO
  IF the instruction has all of its required inputs
  THEN execute the instruction
  ELSE CASE type of instruction OF
    primitive,copy,switch :
      send the request to all instructions in the source list,
    merge : IF control input is present
      THEN IF control value is true
        THEN send the request to the second instruction
              in the source list
        ELSE send the request to the third instruction in
              the source list
      ENDF
    ELSE send request to first instruction in source list
      ENDF
    apply : send the request to the first instruction in the source list
  ENDC
ENDF
ENDD
    
```

tion in the function, assigning unique identifiers and changing the source and output lists accordingly;

FOR each input instruction in the function

DO set up the source list  
ENDD;

OR each output instruction in the function

DO set the output list to the appropriate values from the output list of the apply operator;

request the output if required

ENDD

This mechanism provides lazy evaluation (assuming a lazy constructor for lists) for two reasons. First, values are computed only when they are required; second, once a value has been computed, it will be available to any later requests because copy sends its result to all instructions in its output list, even if they have not all requested the value.

### CONCLUDING REMARKS

Currently a number of research projects are directed toward the construction of data-flow computers, but few of the projects that are now at an advanced stage were begun with functional languages in mind. (For a survey

of data-flow architectures, see "Data-Driven and Demand-Driven Computer Architecture" by P. C. Treleaven, D. R. Brownbridge, and R. P. Hopkins. *ACM Computing Surveys*, volume 14, number 1, March 1982, and "A Survey of Proposed Architectures for the Execution of Functional Languages" by S. R. Vegdahl, *IEEE Transactions on Computers*, volume C-33, number 12, December 1984.) With few exceptions, the link between data flow and functional languages has not played a major role in these projects, as evidenced by the fact that none of the architectures have provided efficient support for higher-order functions.

The aim was, and it often still is, to exploit the data-flow mechanism in order to gain execution speed either for conventional or data-flow languages. Thus, we find that the model here described, designed to bear a close relationship with functional languages, is different from many of the other notations, particularly in its support of higher-order functions in a natural way.

The traditional data-flow mechanism has begun to bear fruit in the field of high-speed computation, and the model we have described has potential for the implementation of functional languages. It remains to be seen whether functional languages and data flow will form a useful partnership. ■

Tokyo

Osaka

Seoul

Beijing

Shanghai

Taipei

Hong Kong

Manila

Bangkok

Singapore

Sydney

Melbourne

Auckland



# A fresh breeze across the Pacific.

Now, only one airline can take you from all fifty states to thirteen cities across the wide Pacific. Now one airline handles everything. Your ticketing and seat assignments, boarding passes and baggage.

And United offers you more nonstops to more business centers across the Pacific than any other airline.

You'll enjoy United's famous Royal Pacific Service, too. It's the best of the friendly skies in First Class, Business Class, and Economy. And, of course, you'll be flying with a friend, every step of the way. United Airlines to the Far East and South Pacific.

Call United or your Travel Agent.

*You're not just flying  
you're flying the friendly skies.*

# United

# THE CASE OF THE DISAPPEARING CABLES



Front view.

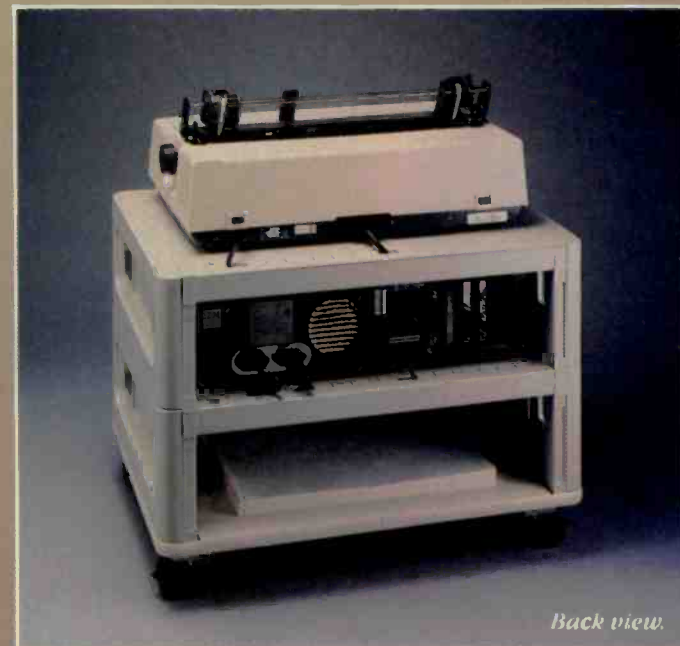

Back view.

Here's a puzzle for you, Watson! Look at this new MicroManager!

Can't say I see anything out of the ordinary, Holmes.

Think, Watson, not about what you see, but rather what you *don't* see.

But, Holmes, everything seems perfectly in order.

Precisely! When did you ever see a printer station that was perfectly in order, Watson?

Zounds, Holmes! Some rascal has stolen the cables!

So it seems, Watson, but observe carefully—there's more to this than meets the eye. The cables have been cleverly concealed right under our very noses! Notice how each cable disappears through a knock-out hole and enters a channel in the rear of the device. Remove these vertical panels and—voila!—we discover the cables passing from level to level through secret compartments.

T H E  
**MICROMANAGER**  
S Y S T E M

Holmes, you've solved the Case of the Disappearing Cables!

Elementary, my dear Watson. But the MicroManager has solved an even deeper mystery—*where to put the printer!* See how this Basic Floor Unit is actually composed of individual sections—"modules," Americans call them. Consider the possibilities, Watson—single modules used as desktop printer or monitor stands, for keyboard storage, or what-have-you. Combined, they can form any sort of work station we need! The base has locking casters for instant mobility. There's even an optional paper refolding attachment! Cunning, isn't it?

By Jove, Holmes, this new MicroManager is the most diabolically clever device we've ever encountered!

Indeed, Watson. Thank Heaven its creators are on our side!

**MicroComputer Accessories, Inc.** 

USA: P.O. Box 3725, Culver City, CA 90231. Telephone 213/641-1800. EUROPE: Rue de Florence 37, 1050 Bruxelles, Belgique. Telephone 02/538.61.73.

Inquiry 235 for End-Users. Inquiry 236 for DEALERS ONLY.

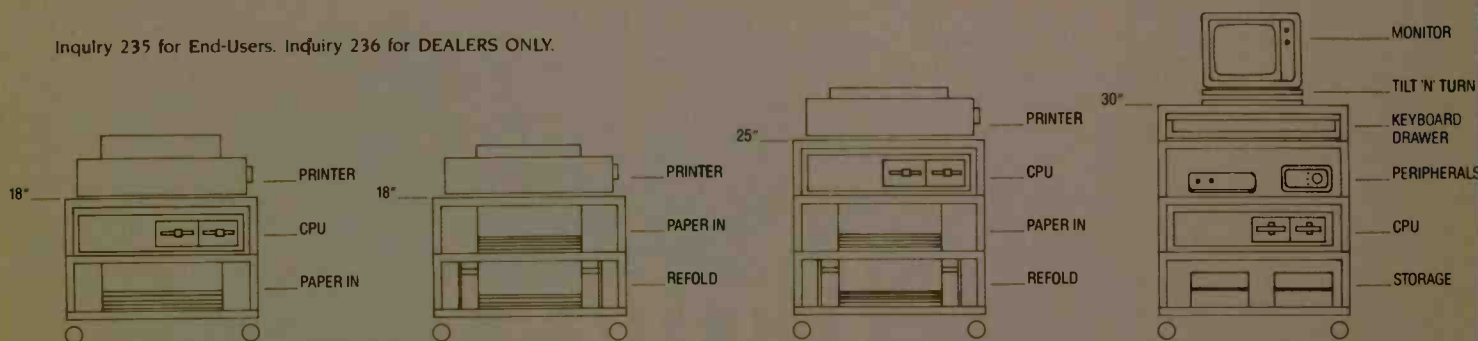

# EASY C

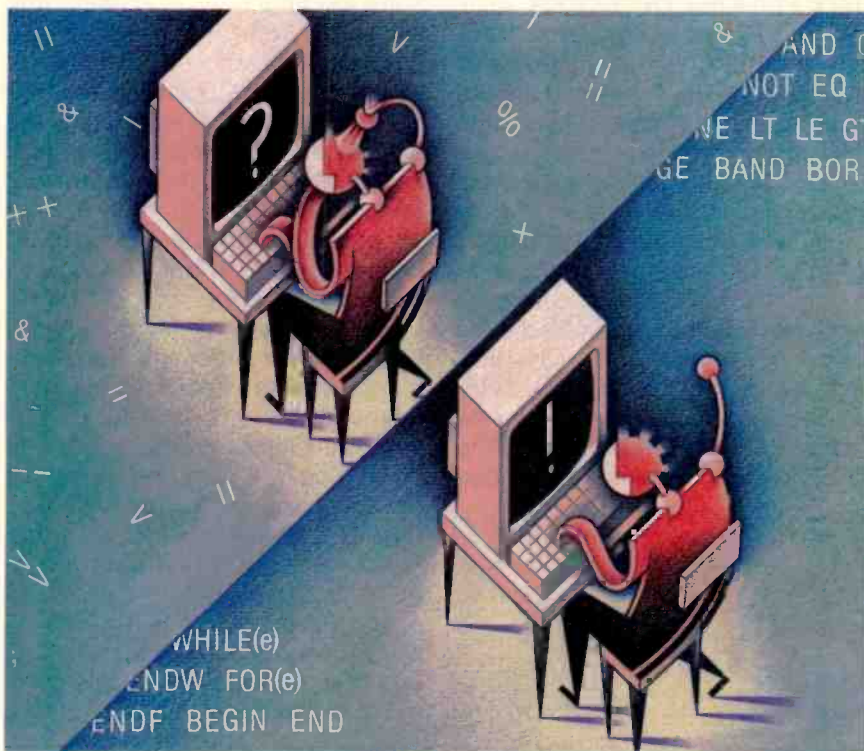

*Use C's preprocessor  
to write more  
understandable code*

**I**f you think you'd like to try C but are put off by the confusing notation and the unfriendly look of its code, take heart. It doesn't have to be that bad. If you're already using C and are tired of errors due to mistaken operators, improper nesting, or incorrect punctuation, you can eliminate these problems, improve your productivity, and get on with the never-ending battle of

dangling or NULL pointers.

Because we have had bad experiences with other powerful but "compact" languages (most notably APL), we were also less than thrilled by our first exposure to C. However, its efficient object code, powerful branching and looping, easily implemented recursion, and the availability of an optimizing compiler made it an attractive language to use on a new software project. One catch was that the project was to be staffed by programmers with a minimum of C experience who would probably find C difficult to learn.

**WHAT'S WRONG WITH C?**

What are the weak points of C in terms of quickly learning to write programs with a minimum number of errors? Our answer to this question is highly subjective and reflects the definite biases we developed while learning and applying other languages. However, in talking to other programmers using C, we found that many share the following objections:

- Difficult operator notation. The use of &, &&, ~, etc., to indicate operators is confusing to say the least. Memorizing them is one thing. Easily detecting their improper use in code is much more difficult. If you use this compact operator notation, you will have a small, efficient compiler. Unfortunately, it can drive you up a wall in debugging subtle, typographical programming errors.
- Context-dependent operators. This

*(continued)*

Pete Orlin and John Heath are software engineers. They can be reached at CAB Concepts, 125 Main St., Suite F, Bay Saint Louis, MS 39520.

feature of C (which has good and bad points) permits multiple operator definitions. The ampersand (&) can be the bitwise AND operator or the "address of" operator. It depends on where you use it and whether its use is unambiguous. Again, this feature results in a compiler that fits in a small computer but only at the cost of coding errors that can be difficult to track down. The fact that the majority of C operators are context-dependent makes learning to use them difficult and time-consuming.

- Poorly structured code-block definition. The standard C constructs (while, for, if, and switch) appear to be designed to be used on a single line, or at least over a small number of lines, and are terminated in the same manner as single-line C statements. If you want to expand the range of these statements, you can use braces ({ and }). The braces define the limits of blocks of code. Since a structured block usually extends over a large number of program statements, the problem is not in finding the beginning of a block but rather in unambiguously locating its branches and

the end of its span of control. With nested if statements in loops, the possibilities for confusing those statements that have closing braces are endless.

With these objections in mind, we developed a set of preprocessor statements (#define statements) to change the flavor of the language while retaining all its powerful features. We call our technique Easy C.

### USER-FRIENDLY OPERATORS

The first element of Easy C is a set of definitions that change the operator notation from the mystical to the obvious. They also help eliminate unintentional, context-dependent errors. Figure 1 lists the #define statements that implement this element of Easy C. Figure 2 gives three examples of their use. The arithmetic comparison operators (LE, GT, etc.) are consistent with many other languages, as are the logical operations (AND, OR, etc.). The bitwise operators (BAND, BOR, etc.) are not generally available, so the names were chosen arbitrarily. The INC and DEC operators are unique

to C and are used to increment and decrement a variable. The MOD operator is used to perform modulo division (remaindering). In keeping with the customary C preprocessor conventions, these names are capitalized. These names are replaced by the preprocessor with C keywords, symbols, and operators.

The Easy C operators follow exactly the same rules as the C operators they replace. So if you're having trouble using one of them, the explanations you find in your favorite C text still apply. The only restriction you may encounter is with the preprocessor that your C compiler uses. The rules for the preprocessor are not well defined in Brian W. Kernighan and Dennis M. Ritchie's *The C Programming Language* (Prentice-Hall, 1978). Hence, all preprocessors do not have to behave in exactly the same way when performing #define substitutions. To avoid possible difficulty in conjunction with other #define items, put blanks on both sides of the operator.

What do you gain by using Easy C? First, using it means no more chasing down bugs in compiled programs because you meant logical AND (&&), instead of bitwise AND (&) but either forgot to hit the & key twice or confused them. Second, if you now use &, you mean it to be the "address of" operator and not the bitwise AND. A significant advantage of this technique is that you can debug Easy C by inspection prior to compilation with a much greater chance of detecting typographical and usage errors. The compiler does not catch the majority of these errors. They must be tracked down and eliminated in a running (or almost running) program.

### BRANCHING AND LOOPING

Choosing Easy C's branching and looping formats was much more difficult than defining simple operator-substitution names because these constructs are closely linked to style in programming. As with any question of style, subjectivity is the rule. In presenting these constructs, we realize that what we find pleasing and consistent, you may find stilted and arbitrary. However, a clear and consistent style is probably the best way to

```

/* Logical operators */
#define AND  && /* logical AND */
#define OR   || /* logical OR */
#define NOT  !  /* logical NOT */
#define EQ   == /* equal value comparison */
#define NE   != /* not equal value comparison */
#define LT   <  /* less than value comparison */
#define LE   <= /* less than or equal to value comparison */
#define GT   >  /* greater than value comparison */
#define GE   >= /* greater than or equal to comparison */

/* Bitwise operators */
#define BAND & /* bitwise AND */
#define BOR  | /* bitwise OR */
#define BXOR ^ /* bitwise exclusive OR */
#define BNOT ~ /* bitwise NOT */
#define LSHF << /* left shift */
#define RSHF >> /* right shift */

/* Arithmetic operators */
#define INC  ++ /* increment */
#define DEC  -- /* decrement */
#define MOD  %  /* modulo division */

```

Figure 1: The #define statements for the Easy C operators. The preprocessor replaces the uppercase Easy C operator with the lowercase C operator in a program.

Example 1: Checking a character to see if it is a letter (see Kernighan and Ritchie, page 127). If the character contained in "c" is greater than or equal to a lowercase "a" and is less than or equal to a lowercase "z," or is greater than or equal to an uppercase "A" and is less than or equal to an uppercase "Z," then it is a letter.

```
In C:
if ((c >= 'a' && c <= 'z') || (c >= 'A' && c <= 'Z'))
    return(LETTER);
```

```
In Easy C:
if ((c GE 'a' AND c LE 'z') OR (c GE 'A' AND c LE 'Z'))
    return(LETTER);
```

Example 2: Extracting *n* bits from a word starting at offset "p" (see Kernighan and Ritchie, page 45). Right-shift the bits into position, create a bit mask, and mask off the undesired bits.

```
In C:
return((x >> (p + 1 - n)) & ~(~ 0 << n));
```

```
In Easy C:
return((x RSHF (p + 1 - n)) BAND BNOT(BNOT 0 LSHF n));
```

Example 3: Checking for a bit pattern in a word. If either bit 4 or 7 is set and bit 0 is set, return a value of true.

```
In C:
if (((x & 16) || (x & 128)) && (x & 1))
    return(TRUE);
```

```
In Easy C:
if (((x BAND 16) OR (x BAND 128)) AND (x BAND 1))
    return(TRUE);
```

Figure 2: Code fragment examples of the use of the Easy C operators. Note that the compactness of C is not lost and that even with a minimal knowledge of C, the expressions are easily readable.

lower your coding-error rate. It also improves your chances of quickly understanding the operation of code you haven't seen in several months. If you are working as part of a group, it becomes critical in sharing the maintenance of a program.

We chose the constructs presented here with three objectives in mind. First, they had to improve the readability of C by clearly marking conditional code blocks and the span of control of conditional constructs. Second, they had to simplify the syntax of C to the point that the only punctuation required when writing a program is the semicolon. Third, they had to be consistent with the structured design method we use that permits only two branching and two looping structures.

The #define statements listed in

figure 3 implement the Easy C structured constructs. Four basic constructs are defined, two for branching and two for looping. A fifth construct, BEGIN\_\_END, is defined to reduce the use of the braces to list markers in initialization expressions. Definitions of the use of each of the constructs are given in figure 4.

These constructs have certain common characteristics. First, each is contained within its own code block ( { } pair ). This eliminates the unexpected machine code that is occasionally produced when constructs are nested. It also solves the problem of what belongs to each individual brace. Second, each element of a construct is also contained within its own code block. This allows an arbitrary number of C statements (including

(continued)

# Run Protected Software from a Hard Disk.

## ZeroDisk ZeroDisk ZeroDisk ZeroDisk

ZeroDisk lets you run dozens of popular business software packages without floppies. Call us for the latest list of software it handles. ZeroDisk needs an IBM PC or XT or AT or compatible, running under DOS version 2.0 or higher. It occupies 15k bytes of memory. ZeroDisk is not copy-protected.

ZeroDisk is revised monthly. You may get revisions for an \$18 US trade-in fee.

To order ZeroDisk, send a check for \$75 US, or call us with your credit card. We will ship the software within a day.



**Quaid Software Limited**

45 Charles Street East  
Third Floor  
Toronto, Ontario M4Y 1S2  
(416) 961-8243

none) to be used within the element. Third, the line containing the substitution expression (represented by the letter *e* within the parentheses) must obey the preprocessor rules. The first of these rules is that a comma may appear only when it is protected by an open parenthesis. Thus, using a comma to separate multiple statements within a FOR statement is not allowed, but using a comma within an argument list is. The second rule involves the length of the expression. Many compilers require that the expression and its closing parenthesis be contained on one line. If the compiler you use has this restriction, you must follow this rule.

The no-comma and one-line rules may seem restrictive at first. In use, however, these two rules serve to keep looping expressions simple by forcing code into an initialization block or the loop body. The tendency to "load" a loop expression with code is hard to resist in C. Some programmers manage to write small programs within the parentheses of a for loop with a loss of clarity that is not made up for by the compactness of the source code. The executable code

that is produced from these compact loop statements is usually about the same size and speed as that produced from simpler expressions and more explicit coding. The net result is that the only thing accomplished is an increase in the potential for confusion. Hence, it is not worthwhile to try to be overly clever because of the limitation on looping expressions.

Another common feature of the constructs is the simplicity of punctuation. Other than the semicolon, which is used to terminate lines of C code and to separate subexpressions in the for loop expression, no other punctuation is required. The general punctuation rule for Easy C is this: If it's a C-code statement, terminate it with a semicolon; if not, don't.

The last common feature of the constructs is our attempt to create an uncommon end statement for each of the constructs. Note that in figure 3 each construct ends in some variation on double braces. While it was tempting to simplify things by using the same keyword for all of them, we made each end statement different for clarity. If you are nesting various types of constructs, the usual practice

is to take a listing of the code and draw nesting lines between the elements of each of the constructs. If an IF statement ends in anything other than an ENDIF or if the lines must cross to connect the correct elements, a nesting error has been made. Thus, the form of the end of the construct helps the programmer determine what was *intended*.

## BRANCHING

Easy C defines two branching constructs. Both support *n*-way (multiple) branching. However, our intention is to do it in two different ways. The IF construct computes each logical expression in the IF and ELSEIF statements and executes the code block associated with the first expression that evaluates to a nonzero result (the C value for true). If no match is made, the code block associated with the ELSE statement executes. If there is no ELSE block, no code executes. The CASE statement computes the value of the expression. This value is used to calculate the address of the start of the code block containing the value as a constant in its CASEOF statement. If the computed value does not correspond to one of the CASEOF constants, then the DEF-CASE code block executes.

It's important to note that the CASE statement does not have to work this way for all compilers. It may actually perform the comparisons. An unwritten convention has grown up over the years that a CASE-type statement results in some form of address computation to immediately execute the matching code block and avoid the sequential computation of logical conditions. If your compiler does not produce this type of machine code, then it will operate just like the IF, and there is little difference in which construct you use. We use the Lattice C compiler, which does address computations if the number of branches and the constants meet the right conditions. Otherwise, it performs the comparisons directly.

## THE IF CONSTRUCT

The general form of the IF statement is shown in figure 4. The expressions

(continued)

```

/* IF__THEN__ELSEIF__ELSE construct */
#define IF(e)      { if (e)      /* if statement */
#define THEN      {             /* then statement */
#define ELSEIF(e) } else if (e) /* elseif statement */
#define ELSE      } else {      /* else statement */
#define ENDIF     ; } }        /* end of if statement */

/* CASE construct */
#define CASE(e)    { switch (e) { /* head of case */
#define CASEOF(e) case e : {    /* case block */
#define DEFCASE   default : {   /* default case block */
#define ENDCOF    } break ;     /* end of case block */
#define ENDCASE  } }           /* end of case */

/* WHILE construct */
#define WHILE(e)  { while (e) {  /* while statement */
#define ENDW     ; } }          /* end of while statement */

/* FOR construct */
#define FOR(e)    { for (e) {    /* for statement */
#define ENDF     ; } }          /* end of for statement */

/* BEGIN__END construct */
#define BEGIN    {              /* beginning of block */
#define END      }              /* end of block */

```

Figure 3: The #define statements for the Easy C branching, looping, and code-block separator constructs. These constructs eliminate the punctuation required by C in nesting branches and loops.



# AMERICA'S NEXT FAVORITE MOUSE.

The best price: \$99



## THE BEST HARDWARE:

LOGITECH has been the leading OEM mouse company for years, quietly providing mice to companies like AT&T, DEC, and H-P. We've designed LOGIMOUSE C7 just for the retail marketplace. And poured all our years of hardware engineering into it. You simply can't find a better mouse.

- IBM PC/XT/AT compatible through any serial port
- NO pad, NO external power supply
- HIGH (200 dpi) resolution
- Tactile feedback switches

## THE BEST SOFTWARE:

LOGIMOUSE is now available with all new software that sets new performance standards for the mouse:

**LOGIMOUSE Base Package** **\$99**  
 ■ LOGIMOUSE Driver Version 3.0: Faster and smaller. Makes LOGIMOUSE compatible with all Microsoft applications.

**LOGIMOUSE Plus Package** **\$119**

- LOGIMENU—Programmable Pop-Up Menu System: Customizable for all your favorite keyboard-based applications. Fully compatible with Microsoft Menu, only better.
- CLICK: A new concept in mouse software! It resides in memory, detects which application you are running and sets the mouse to your predefined setting. You define macros for the mouse buttons, set the mouse baud rate and protocol, define the pop-up menus to be used by LOGIMENU. Just add CLICK to your autoexec file and LOGIMOUSE will be ready to go with each of your favorite applications. So you can get down to work.
- POINT-AND-CLICK SHELL for Lotus 1-2-3: No more jerky cursor movement, no more delays, no more beeping. To select a cell, execute a command, scroll your spreadsheet, or call up context sensitive pop-up menus, just point with the mouse and click!
- POINT EDITOR—Mouse Based Program Editor: If you think a mouse was not meant for editing, POINT will change your mind.

## LOGIPAINT SET

With Base Package

With Plus Package

**\$149**

**\$169**

LOGIMOUSE C7 plus PC Paintbrush 3.0 is the most advanced paint set available for the PC. Use LOGIPAINT to design a logo, paint, or draw

a picture of a product you're developing. You won't believe its power with either free hand drawing or graphics.

# LOGIMOUSE® C7

To place a credit card order call our special toll-free number:

**800-231-7717**

Call toll-free in California:

**800-552-8885**

**YES!** I want America's next favorite mouse!

Please send me:

- |   |                                     |  |
|---|-------------------------------------|--|
| <input type="checkbox"/> LOGIMOUSE Base Package | <b>\$ 99</b>                        | Add \$6.50 for shipping & handling. Calif. residents add applicable sales tax. |
| <input type="checkbox"/> LOGIMOUSE Plus Package | <b>\$119</b>                        |  |
| <input type="checkbox"/> Plus Package Software  | <b>\$ 29</b>                        |  |
| <input type="checkbox"/> Base LOGIPAINT SET     | <b>\$149</b>                        | <b>MONEY BACK GUARANTEE</b>  |
| <input type="checkbox"/> Plus LOGIPAINT SET     | <b>\$169</b>                        |  |
| <input type="checkbox"/> VISA                   | <input type="checkbox"/> MASTERCARD | <input type="checkbox"/> CHECK ENCLOSED  |

Card Number \_\_\_\_\_ Expiration Date \_\_\_\_\_

SIGNATURE \_\_\_\_\_

NAME \_\_\_\_\_

ADDRESS \_\_\_\_\_

CITY, STATE \_\_\_\_\_

ZIP \_\_\_\_\_ PHONE \_\_\_\_\_

DEALER INQUIRIES WELCOME



# LOGITECH

LOGITECH, Inc.

805 Veterans Blvd., Redwood City, CA 94063, USA  
 Telephone: (415) 365-9852

LOGIMOUSE is a registered trademark of LOGITECH, Inc. Lotus and 1-2-3 are trademarks of Lotus Development Corp. Microsoft is a trademark of Microsoft Corp. PC Paintbrush is a registered trademark of ZSoft Corp.

1-800-222-8324



ATAI



**Totally  
IBM  
Compatible  
A Full 1 Year  
Warranty**

**Basic Atai W/2 Drives . . . . \$695.00**

**Atai Super Unit**

- 2-360 K Floppy
- 135 Watt power supply
- Amber tilt swivel monitor
- 640 K memory
- Serial/Parallel Port
- Clock Calendar
- MS/DOS 2.11
- 1200/300 Internal Modem
- Monochrome Graphics Card
- 100 CPS NLQ Printer w/tractor
- All cables
- General Ledger Software
- Word Processor
- Database
- Communications Software

A Truly Complete Computer System, only . \$1495.

Compare Against IBM, Att, Leading Edge!!!



**BROTHER M-1509**

180 CPS Wide Column  
Beats Epson FX-286

For Price/Performance.

Standard NLQ mode w/tractor  
Call For Lowest Price.

**Brother Printers**

- M-1109 . . . . . \$195
- HR-15XL . . . . . \$360
- HR-25 . . . . . \$680
- HR-35 . . . . . \$680
- Twinriter-5 Dual Head . . . . . \$ Call

**EPSON**

- LQ-800 . . . . . \$545
  - LQ-1000 . . . . . \$765
  - LQ-1500 . . . . . \$999
- Accessories Available

**Panasonic**

- KXP 1080 . . . . . \$199
- KXP 1091 . . . . . \$239

**Epson Products**

- LX-80 . . . . . \$220
- LX-90 . . . . . \$240
- FX-80+ . . . . . \$259
- FX-85 . . . . . \$ Call
- JX-80 . . . . . \$40
- FX-286 . . . . . \$ Call

**Okidata**

- 182 . . . . . \$299
- 192 . . . . . \$399
- 193 . . . . . \$599
- 84 . . . . . \$699
- 2410 . . . . . \$1499

**HARD DRIVE & BACKUPS**

- 10 Meg . . . . . \$385
- 20 Meg . . . . . \$475
- 30 Meg . . . . . \$690
- 40 Meg . . . . . \$795
- 10 Meg external Hard . . . . . \$545
- 20 Meg External Hard . . . . . \$635
- 20 Meg Tape . . . . . \$595
- 60 Meg Tape . . . . . \$795
- All Drives Seagates w/ Controller

**CARDS & ACCESSORIES for IBM**

- Mono/Printer \$95.00
- Color/Printer \$99.00
- Mono/Graphics/Printer . . . . . \$99.00
- RS-232 . . . . . \$59.00
- RS-232/Clock . . . . . \$69.00
- Parallel . . . . . \$59.00

1-800-222-8324

CALL NOW!!!!

COMPUTERS INTERNATIONAL

6619 U.S. 1 Miami, Fl 33143



EASY C

within the IF and ELSEIF statements are evaluated in order of appearance. The code block for the first expression that evaluates to a nonzero value (true in C) executes. If none of the expressions is true, the ELSE code block executes. The #define statements for the IF are set up to require a C statement or at least the null operator (the ; again) in the THEN block. The other blocks can be empty and the ELSEIF and ELSE are optional. The C statements within the block must be terminated with a semicolon. Beyond this, no other punctuation should be used. The braces associated with isolating the various blocks are already included.

To see how the preprocessor works in converting Easy C to C, let's look at a simple IF statement:

```
IF( a EQ b )
  THEN
    test = 1;
  ELSE
    test = 0;
ENDIF
```

The preprocessor uses the #define statements to expand this to

```
{ if ( a == b )
  {
    test = 1;
  } else {
    test = 0;
  } }
```

Coding several nested ifs in C, with all of the braces needed to ensure that the compiler did not misunderstand your intentions, would probably result in more errors due to mismatches than would be worth the effort to correct. In Easy C brace matching is automatic and always correct. The code block in a particular THEN, ELSEIF, or ELSE is always unambiguously associated with the correct IF. This can be particularly helpful with the else, which always associates itself with the last if that did not have an else. This might not be the if you had in mind, so you won't get a compiler error, you will get a run-time bug.

**THE CASE CONSTRUCT**

The general form of the CASE statement is shown in figure 4. CASE operates as follows: First, the expression

in the CASE statement is evaluated. The CASEOF statement with this value as its constant is then selected for execution. If no CASEOF contains a constant equal to the value of the expression, then the code block associated with the DEFCASE statement executes. Each code block following a CASEOF is ended with an ENDCOF, as is the DEFCASE code block. As many CASEOF-ENDCOF blocks as desired can be included. They do not have to contain C statements. A DEFCASE-ENDCOF must always be included. It can also be empty. The CASE is ended with the ENDCASE statement.

CASE and CASEOF were chosen instead of some variation on switch and case because they appear in the structured design method we use. If you wish to follow C more closely, they can be replaced by SWITCH and CASE in the #define statements for them. Your preprocessor should distinguish between the uppercase and lowercase forms. The names of the end statements (ENDCOF and ENDCASE) might then be changed to something more consistent with this choice. The contents of the #defines for the statements must not be changed. They are used to balance the braces that isolate the code blocks.

**LOOPING**

Easy C defines two looping constructs. The FOR construct is used in counting loops and the WHILE statement is used in loops terminated by a logical condition. Because C permits logical termination conditions in FOR loops and has the ability to increment in WHILE loops, choosing which one to use is largely a matter of clarity and convenience. In both looping constructs, the code within the loop will not be executed if the logical condition is false (equal to zero) when an attempt is made to enter the loop.

The form of the WHILE loop construct is given in figure 4. It operates by first evaluating the expression. If it is true (nonzero), the optional statements within the loop execute. An expression that can be evaluated to an integer numeric or logical result is re-

(continued)

# NO OTHER HARD DISK BACKS YOU UP LIKE SYSGEN.™ HARD DISK AND *AUTOMATIC* TAPE BACK-UP: \$1395.



10 Mbyte disk/20 Mbyte cassette tape with automatic tape back-up and error correction for \$1395.



INDUSTRY STANDARD  
QIC-24  
DATA FORMAT

20 Mbyte disk/60 Mbyte cartridge tape with QIC-24 industry standard tape format, automatic tape back-up and error correction for \$2095.

## Why the Sysgen Flat-Pak™ is your *smartest* storage and back-up choice:

The Flat-Pak, like all Sysgen systems, is designed so you can sit down at your PC and use it. Period. A reliable Sysgen hard disk keeps your data on-line: You never have to juggle disks or cartridges. And only Sysgen backs your data up *automatically*. All in a slim half-height chassis that slips neatly under your monitor. So absolutely nothing stands between you—and your work.

## Only Sysgen gives you *unattended* back-up.

Set the Flat-Pak once, like a VCR, and it will back up your data up to twice daily, seven days a week. *That's* smart.

## Two ways to get unbeatably affordable disk and tape add-on:

Choose the 10 Mbyte Flat-Pak with 20 Mbyte cassette back-up; or the 20 Mbyte version with 60 Mbyte

cartridge back-up, using the industry standard QIC-24 tape data format.

Because both Flat-Pak systems utilize your IBM's hard disk controller, they are compatible with all software written for current versions of PC DOS® (Should your system require it, Sysgen offers an XT compatible controller for just \$350.)

## Get the smartest, most reliable storage and back-up solution—at the best price.

Sysgen's entire disk and smart tape family offers an unbeatable combination of capacity and value. You won't find a smarter solution—or a better price.

Compare for yourself: For a Sysgen dealer near you, call 1-800-821-2151, Dept. 41.



**SYSGEN**  
INCORPORATED

Trademarks: Sysgen, Flat-Pak—Sysgen, Inc. Registered Trademarks. IBM, PC DOS—International Business Machines Corporation.

47853 Warm Springs Blvd., Fremont, CA 94539  
(415) 490-6770, Telex 4990843

quired. Statements within the body of the loop are not required.

The FOR loop expression contains three optional subexpressions. They are used to set a loop counter, test for an end condition, and increment a loop counter. The statements within the body of the loop are optional. A convenient way to visualize the operation of the FOR loop is to think of it as a form of a WHILE loop. For example, the FOR loop

```
FOR(initial expression; end expres-
  sion; loop expression)
  C statement(s);
ENDF
```

is equivalent to the WHILE loop

```
initial expression;
WHILE(end expression)
  C statement(s);
  loop expression;
ENDW
```

The initial expression is evaluated

once prior to loop entry. The end expression is evaluated at each loop entry. If it is false, the loop terminates. The loop expression is evaluated each time the loop is entered, after executing the code in the body of the loop and before going back to the top of the loop. Note that these subexpressions need not be related to counting. The only restriction is on the end expression, which must be capable of being evaluated to an integer numeric or logical value.

Each of the subexpressions is optional. However, the semicolons must be included. Thus the FOR equivalent of a WHILE loop is

```
FOR(;end expression; )
  C statement(s);
ENDF
```

If no end expression is put in the FOR loop, an infinite loop forms. While this construct is not generally allowed in structured code, it is useful

in system programs when execution must be held in a particular location pending an interrupt.

### COMPLEX CODING EXAMPLES

Figures 5 (C) and 6 (Easy C) show a complex coding example taken from Kernighan and Ritchie (page 113). The program examines a set of strings (argc in number) pointed to by the array argv. The program will print selected strings based on the results of this examination. (We won't discuss the use of pointers, marked here by the asterisks in the loop expressions. Kernighan and Ritchie give a full explanation.) Understanding precisely what the program does is not as important in determining the structure of the program as comparing the two versions for readability and ease.

The most obvious difference between the two listings is the simplicity of the operators and punctuation used in the Easy C example. We replaced special characters (&&, ==, etc.) with English abbreviations (AND, EQ, etc.), which results in a more readable program. The elimination of all special punctuation except the semicolon also improves readability and helps avoid some of the more frustrating run-time errors. For example, let's examine the while-for-switch nested construct. It is used to search the array of string pointers. In C, the rules of punctuation permit nesting if you write the constructs sequentially. Thus, the while is followed (without punctuation) by the for, which is followed by the switch. Since the switch contains more than one statement, the braces mark the limits of the code within the switch. The errors that can occur with this type of punctuation are easy to make and difficult to find. For example, if you place a semicolon at the end of the line containing the for or the while, you won't get a compiler error and the program will run. However, the compiler will think you mean that the for or while loops contain no code blocks. Thus, placing a semicolon at the end of the while statement means that it is not the top of the nest but is a stand-alone statement to be executed until

(continued)

Branching Constructs	
<b>IF-THEN-ELSEIF-ELSE Construct</b>	
IF( expression )	
THEN	
C statement(s);	
ELSEIF	(optional)
C statement(s);	(optional)
ELSE	(optional)
C statement(s);	(optional)
ENDIF	
<b>CASE Construct</b>	
CASE( expression )	
CASEOF( constant )	
C statement(s);	(optional)
ENDCOF	
	(additional CASEOF-ENDCOF blocks)
DEFCASE	
C statement(s);	(optional)
ENDCOF	
ENDCASE	
Looping Constructs	
<b>FOR Construct</b>	
FOR( initial expression; end expression; loop expression )	
C statement(s);	(optional)
ENDF	
<b>WHILE Construct</b>	
WHILE( expression )	
C statement(s);	(optional)
ENDW	

Figure 4: The Easy C code-block formats.



## For thousands of years, man used personal computers without decent tape backup. Enough.

Personal computers have come a long way. Unfortunately, tape backup systems have not. Their functions are primitive, they're frightening to install and truculent to use.

Genoa's Galaxy™ Systems are more highly evolved. So not only do they outperform competitive systems, but using them is actually something that can be done by an ordinary human.

### The simpler. The better.

Our software is what makes the difference between our systems and everybody else's. And it's designed to help you use the system easily in either of two modes. Namely, menu-driven or batch file.

The menu mode operates true to its name, with menus showing all the commands you have to choose from. And there isn't a thing you can't do from the menu mode because it's comprehensive.

You'll want to use the batch mode for routine operations though, because it allows you to create a "file"

to contain those operations and run them automatically, just by hitting a few keys.

But probably the best example of just how downright civil the Galaxy systems can be is our auto backup. You just preset the time and the desired function, and the system does the rest. Automatically.

No other tape backup systems, by the way, operate this simply.

### The features all tape backups should have. But don't.

Before you make your first backup — which is the right time to do this — our installation software checks your disk configuration to make sure your tape drive will run at top speed. And it checks the entire system to guarantee it will perform as promised. No competitive system offers anything like it.

Another thing you can do is abort any command at any time. So you don't have to sit through a 20-minute

file-by-file restore just because you hit the wrong key.

You can also do a file-by-file restore from an image backup. So you can get back the one file you need rather than all the files you don't.

But whether it's a couple of files or a complete image, you'll be pleased to know you can restore to any storage device, thanks to Galaxy's interchangeability feature.

Multiple backups on the same tape — even from multiple sources like a floppy or another hard disk — aren't a problem either. The system simply starts recording where the last backup ended.

Or you can use multiple tapes to back up very large files. The system will just let you know when it needs a new tape.

We also perform crc error checking constantly. We can back up a 20 Mb disk in just over 4 minutes. And we're network compatible.

### What price progress?

Surprisingly, the Galaxies cost somewhat less than tape backup systems that offer less. Which includes all of them.

For the Genoa Galaxy dealer near you or complete specs, call 408-945-9720. Or write Genoa Systems Corporation, 73 E. Trimble Road, San Jose, CA 95131.

The Genoa Galaxy Systems. The most civilized tape backup in history.



*The IBM®-compatible Genoa Galaxies are available as internal or external versions of 1/4" streaming tape or cassette models. (External cassette not shown.)*

**Genoa**  
We make PCs better.

the logical condition is false. Since the semicolon is the usual terminator for a line of C code, it is easy to inadvertently place one at the end of a C looping construct. Finding the semicolon can be much more difficult.

In contrast, the lack of special punctuation in Easy C makes the nesting of this section of the code unambiguous. Instead of using a semicolon to indicate the range of a loop and a single brace to indicate the range of the nest, each of the nested items is terminated with its own end symbol. Each of the nested items contains the braces needed to tell the compiler what is included in it. Semicolons are used only on simple C statements. If you place one at the end of the WHILE or FOR statements, the compiler will interpret it as a null statement. However, because it is in a code block marked by braces, the rest of the statements within the block are processed normally. Thus, an un-

intended semicolon will be ignored.

The second group of nested statements (starting at if (argc != 1) in figure 5) illustrates the differences between C and Easy C in coding nested branches. The clarity resulting from the use of end statements and the explicit designation of THEN and ELSE paths makes the code more readable. The explicit endings solve the problem of finding out who belongs to all those braces at the end of the program. The more difficult problem of determining exactly how many braces are needed is also taken care of neatly.

#### SIZE, SPEED, PORTABILITY, AND OTHER QUESTIONS

What does Easy C do to the size and speed of a program? The answer to that depends on your compiler. If you have the Lattice C compiler, the answer is nothing. The two program versions listed in figures 5 and 6 com-

plied to the same object code. On other compilers, the code blocks defined by the braces included in the Easy C definitions may result in additional code.

The question of portability (the ease with which an Easy C program may be compiled using other compilers and other computers) is somewhat more complex. The portability of Easy C ultimately rests on the preprocessor. If the constructs and their usage are consistent with the definition of the preprocessor given in Kernighan and Ritchie (the de facto standard), then they should be as portable as C. The Easy C constructs follow that preprocessor definition. The only other question concerns the use of extensive code-block nesting resulting from the braces defined in the Easy C operators. If a compiler is not designed to accept high levels of code-block nesting, then Easy C cannot be used with it. This sort of restriction in a C compiler would be remarkable but not unheard of.

How does it work in practice? After compiling several thousand lines of code written in Easy C, we discovered no problems. In terms of productivity and ease of learning, the payoff was better than anticipated. Coding errors involving improper nesting were rare because of the ease with which nesting can be inspected and also because of the use of the braces. A branching or looping statement without an end, or an end without a branching or looping statement, results in mismatched braces, which produces a compiler error. Thus, nesting errors are caught at compile time where they are a lot easier to find and correct.

Our attempt to produce a version of C that is quicker to learn and apply turned out to be successful. Replacing special symbols with familiar letter symbols removed one of the big hurdles to confidence in writing programs. The simplification of punctuation involved in looping and branching constructs helped build confidence in the ability to write correct code. Aside from structures and unions (which take a while to appreciate) and pointers (which never

```
#define MAXLINE 1000
main(argc,argv) /* Find pattern from first argument */
int argc;
char *argv[];
{
  char line[MAXLINE], *s;
  long lineno = 0;
  int except = 0, number = 0;

  while (--argc > 0 && (*++argv)[0] == '-')
    for (s = argv[0]+1; *s != '\0'; s++)
      switch (*s) {
        case 'x':
          except = 1;
          break;
        case 'n':
          number = 1;
          break;
        default:
          printf("find: illegal option %c \n", *s);
          argc = 0;
          break;
      }
  if (argc != 1)
    printf("Usage: find -x -n pattern \n");
  else
    while (getline(line,MAXLINE) > 0) {
      lineno++;
      if ((index(line, *argv) >= 0) != except) {
        if (number)
          printf("%ld: ", lineno);
        printf("%s", line);
      }
    }
}
```

Figure 5: A complex C coding example.

(continued)

# PRINTER SHARING AND PRINT BUFFERING ALL IN ONE VERSATILE UNIT

Print Master from BayTech is an intelligent printer controller that connects between your computers and printers. It allows you to share one printer automatically, contend for multiple printers automatically, or switch between several printers by sending a simple code. Plus, Print Master's built-in buffer spools data until your printer can receive it.

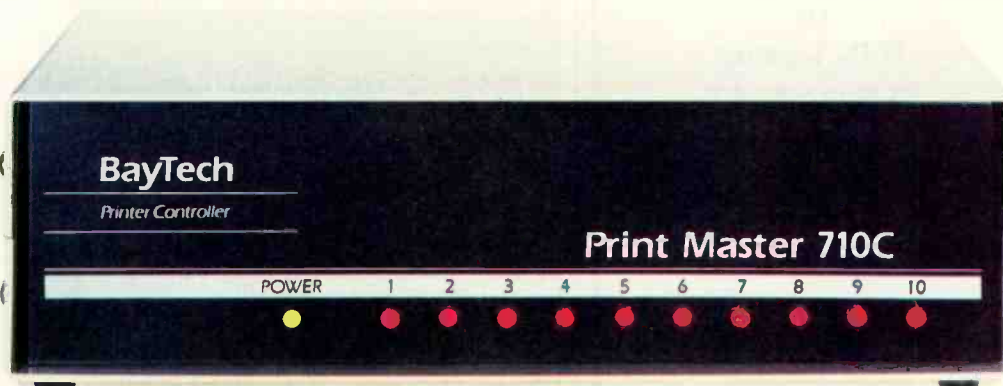

## A VERY FLEXIBLE PRINTER SHARER

You configure Print Master's ports for any combination of printers and computers by answering questions from the easy-to-follow menus. For example, with the ten-port Print Master, nine computers can share one printer, eight computers can share two printers, seven computers can share three printers, and so on, to one computer which can share nine printers. You can also menu-select these features: the baud rate, word size, stop bits, parity, and XON/OFF handshaking; the disconnect time-out; and form feeds. Ports may be configured individually to translate for printers and computers using different configurations. All changes you make are saved in non-volatile memory.

## PRINT MASTER'S BUFFER KEEPS YOU WORKING

Since Print Master can accept data faster than your printer, you can dump a print job into Print Master's 512K buffer and then go on to another project. All connected users can send data to this common pool buffer, and they can be doing it at the same time, even if no printer is available. Data is stored in the buffer until it can be sent on a first-in-first-out basis to

the selected printer. If you need more memory, Print Master is optionally available with one megabyte buffer.

## CONTROL PRINT OUTPUT FROM YOUR COMPUTER

If several users are sharing one printer, printer sharing is completely automatic. There are no codes to send. You simply perform your normal print operation. If you are sharing several identical printers, connection is also

automatic. Again, you perform your normal print operation and are connected to the next available printer on a first-come-first-serve basis. Print Master will send data to all printers simultaneously to keep your printers running at full capacity.

If you are sharing several different printers, such as a letter printer, a laser-jet and a plotter, you do your normal print routine but insert a short printer select code (which you can define yourself) as the first characters of your data. The data is then routed to the selected printer. It's that easy.

## CHOOSE SERIAL OR PARALLEL MODELS

Print Master comes in six, eight and ten port models that feature serial, parallel, or combination serial/parallel ports. And BayTech provides technical support and service on all models if you ever have a problem.

Want more details? Call or write BayTech at P.O. Box 387, Bay Saint Louis, MS 39520. Telex 910-333-1618. Phone 601-467-8231 or

**800-523-2702**

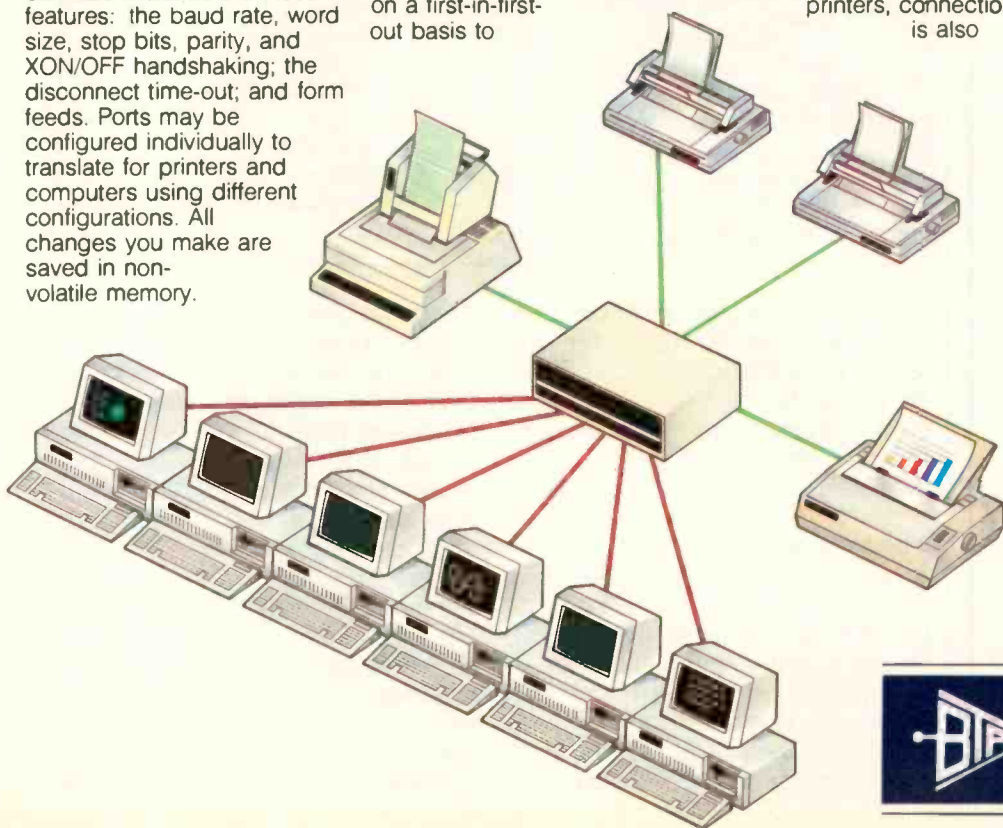

**BAY TECHNICAL ASSOCIATES, INC.**  
DATA COMMUNICATIONS PRODUCTS

Does **YOUR** disk Look Like **THIS?**



Let

**H.D. Tuneup  
cleanup your act!**

**H.D. Tuneup** tunes your disk file system, making it better than new. File loads speed along like new. Directory searches are faster than new.

**H.D. Tuneup** reallocates all of your files to be contiguous. Each file is placed in its proper location, adjacent to it's neighbors in the directory.

Disk operations run faster when your files have been Tuned.

**H.D. Tuneup** relocates your sub-directories into one area of your disk, as close to the root as possible. All deleted entries are actually removed.

Your drive head moves less from directory to directory than when your disk was new. TREE/F will fly when listing all of your files.

**H.D. Tuneup** requires IBM PC/XT/AT compatability, 196k, and DOS 2.x/3.x. Fixed disks up to 32mb may be tuned, along with any 5.25" diskette.

NOT COPY PROTECTED!

**ONLY \$39.95** plus \$3.00 S/H

**SofCap Inc.**  
P.O. Box 131  
Cedar Knolls, N.J. 07927

Visa (201) 386-5876 M/C

N.J. residents add 6% sales tax.

**For the best performance  
from your disk  
TUNE IT UP!!**

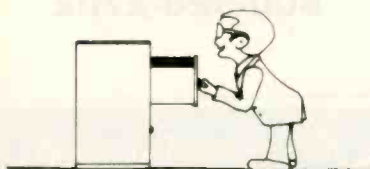

Visa, Master Card, Checks, Money Orders, or COD only.

**EASY C**

```
#include "EASYC.H" /* Easy C defines */
#define MAXLINE 1000
main(argc, argv) /* Find pattern from first argument */
int argc;
char *argv[];
BEGIN
char line[MAXLINE], *s;
long lineno = 0;
int except = 0, number = 0;

WHILE(DEC argc GT 0 AND (*INC argv[0] EQ '-'))
FOR(s = argv[0] + 1; *s NE '\0'; s INC)
CASE(*s)
CASEOF('x')
except = 1;
ENDCOF
CASEOF('n')
number = 1;
ENDCOF
DEFCASE
printf("find: illegal option %c \n," *s);
argc = 0;
ENDCOF
ENDCASE
ENDF
ENDW
IF(argc NE 1)
THEN
printf("usage: find -x -n pattern \n");
ELSE
WHILE(getline(line, MAXLINE) GT 0)
lineno INC;
IF((index(line, *argv) GE 0) NE except)
THEN
IF(number)
THEN
printf("%ld: ", lineno);
ENDIF
printf("%s", line);
ENDIF
ENDW
ENDIF
END
```

Figure 6: A complex Easy C coding example.

cease to be a source of wonder and confusion). a typical programmer with limited C experience could expect to be producing code in a matter of days. Experienced programmers become comfortable with it immediately.

**TRYING EASY C**

If you're using C or have access to a C compiler and want to try Easy C, put the #define statements appearing in figures 1 and 3 into a file (ours is called EASYC.H). Be sure to mention this file in a #include statement prior to the first line of code in your program (see the first line of figure 6).

After that, just follow the rules we have described. If you have questions about the use of the operators, use the #define statement as a reference to convert them to standard C and consult a C manual for help. Kernighan and Ritchie is the accepted standard for C, although it is difficult to study. *Programming in C* by S. G. Kochan (Hayden Book Company, 1984) is recommended if this is your first exposure to C. Kochan includes numerous specific examples and clear explanations of all of the details of C. He also uses structured coding and points out the nonstructured aspects of C that can lead to problem code. ■



# THE LEADER'S OFFER.

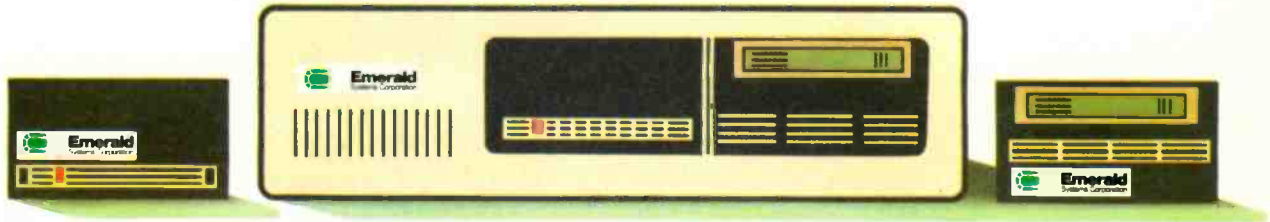

*Emerald is the leader in high performance hard disk and tape backup subsystem technology.*

## We Want You To See What We've Got

We want you to experience the innovative new technologies, products, and services you can get only from the Leader. Like DiskMeld™—Emerald's proprietary technology that allows two physical hard disks to meld into one logical file or volume. And what better way to try DiskMeld, than by getting the second disk at half price?

No one else can offer all the options we can. That's why we're making this special, limited offer (available now, direct from Emerald or from your dealer).

## Powerful Mass Storage

Emerald pioneered true mass storage for microcomputers. Our PC, XT, AT, and IBM compatible-based hard disk subsystems offer power, versatility, and performance you won't find elsewhere:

- DiskMeld™—Emerald technology that merges two physical hard disks into one logical file or volume.
- Larger volumes—Emerald was the first to shatter the PC-DOS 32 MegaByte barrier.
- Faster access through Disk Caching.
- Faster throughput with our user-selectable interleave.
- On-site self diagnostic functions.
- On-site preventative maintenance with Trackfix™.
- Internal or external hard disk subsystems.
- A wide range of capacities, from 30 to 236 MegaBytes.
- Xenix System III and System V compatibility.
- QNX Compatibility.

## Backup: Fast, Secure, Automatic

Our 1/4-inch tape backup subsystems provide the best combination of speed and automation available. With functions and features you won't see anywhere else.

- ASP™—our new backup/restore utility, with an easy to use. Lotus-like interface, digital and graphic displays.
- Real-time information on status of backup.
- Three types of file-by-file backup.
- Super-fast streaming.
- Password security.
- Multiple backup sessions on the same tape—lets

**Get 50% off a 30-MB disk & 60-MB tape drive when you buy a 72-MB disk.**

When you buy an Emerald™ 72-MegaByte hard disk subsystem at the regular price between April 8 and May 30, 1986, we'll give you a coupon good for 50% off the price of our high-performance 30 MegaByte drive and/or a 60 MegaByte 1/4 inch tape backup. (You can purchase the second disk or tape backup anytime before September 30, 1986. So there's plenty of time to work it into your budget.

But there's more—\$500 worth of free software when you buy all three (the 72-MegaByte hard disk at our regular retail price, and the 30-MegaByte drive and 1/4 inch tape backup at half price). You'll get Borland's Turbo Lightning™, Reflex: The Analyst™, and Superkey™; Microsoft Windows™, Ready!™ from Living Videotext, and Funk Software's Sideways™.

**Offer Ends May 30, 1986**

you save on tape media while physically organizing your data the way you want it.

- Programmable time-activator—a backup that runs itself.
- Advanced self-diagnostic and maintenance functions for tape subsystems.
- 60-MegaByte internal or external subsystems.
- Installable device drivers for custom applications.
- Xenix System III and System V compatibility.
- QNX Compatibility.

## Mainframe Connectivity

Our Micro-to-mainframe tape subsystems perform all these same functions—and they allow you to transfer data offline between mainframes and your PCs.

- Rapid translation between EBCDIC and ASCII—connects micros to mainframes and minis, through industry standard 1/2-inch tape. And does it 100 times faster than terminal emulation. (At 3.3 MegaBytes per minute, that's 3 times faster than any other 1/2-inch subsystem available.)
- EBCDIC to dBase III and Lotus 1-2-3, via CSV reformatting.
- Data transfer and hard disk backup on the same system.

## NetWorthy Subsystems™

All our subsystems are network-compatible, with special support for LANs. That means you won't have to sacrifice any of the performance features you paid for when you bought your subsystem—or your LAN.

- Novell LANs.
- IBM LANs.

- Most MS-Net compatible LANs.
- Online backup with network users logged on.
- Hidden files and other Novell special files.

## On-Site Service Available Now

Emerald now offers Green Light Service™—our next-day, on-site service option. It covers all Emerald components, as well as your IBM, Compaq, or Zenith PC, most popular modems, monitors, printers, add-in memory, and multi-function boards in your system. And of course, we still back our products with a limited one-year warranty, and with expanded customer support that's available for free consultation ten hours of every business day.

## Hurry

Try DiskMeld now—with the second disk at half price. Or, add 1/4-inch tape backup for half price. Better yet, add both, and get \$500 worth of free software. This offer ends May 30, 1986, so act now.

It's the perfect opportunity to discover what makes Emerald the Leader. And what keeps us ahead of the pack.

**Special limited offer. Call today!**  
(619) 270-1994.  
*Dealer inquiries invited.*

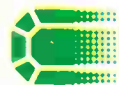

**Emerald**  
Systems Corporation

Mainframe Storage For Micros

4757 Morena Boulevard  
San Diego, CA 92117  
U.S.A.  
(619) 270-1994  
Telex: 323458 EMERSYS  
Easylink: 62853804

Emerald Systems Europe  
P.O. Box 310  
6236 Maastricht Airport  
The Netherlands  
4402-77979  
Telex: 56239

Turbo Lightning, Reflex, The Analyst, and Superkey are trademarks of Borland International. Microsoft Windows is a trademark of Microsoft, Inc. Ready! is a trademark of Living Videotext. Sideways is a trademark of Funk Software. dBase III™ Ashton-Tate—Lotus 123™ Lotus Development Corporation—IBM PC and AT™, International Business Machines Corporation—Novell NetWare™ Novell Inc.—Emerald, DiskMeld, Extended Mass Storage Architecture, Archival Storage Protector, ASP, Trackfix, NetWorthy Subsystems, and Mainframe Storage For Micros™ Emerald Systems Corporation.

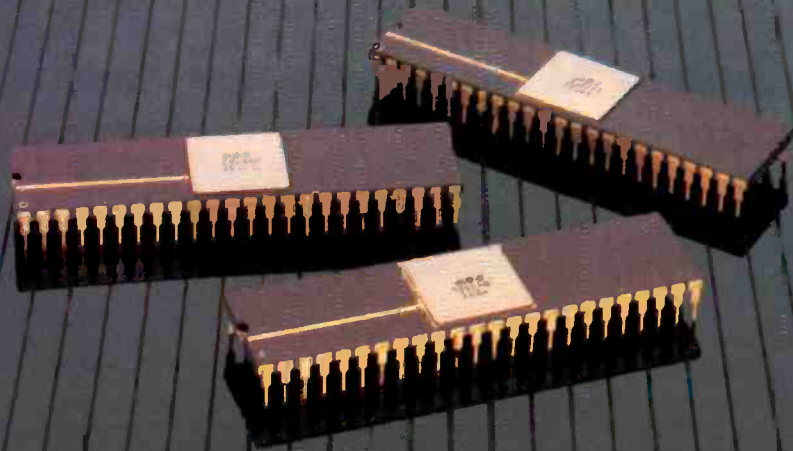

YOU'RE LOOKING AT  
4096 COLORS  
4-CHANNEL STEREO  
32 INSTRUMENTS  
8 SPRITES  
3-D ANIMATION  
25 DMA CHANNELS  
A BIT BLITTER  
AND  
A MALE AND FEMALE VOICE.

## ONLY AMIGA GIVES YOU ALL THIS AND A 68000 PROCESSOR, TOO.

Three custom VLSI chips working in combination with the main processor give Amiga™ graphic dazzle, incredible musical ability and animation skill.

And they make Amiga the only computer with a multi-tasking operating system built into hardware.

All these capabilities are easy to tap because Amiga's open architecture provides you with access to the 68000 main bus in addition to the serial, parallel and floppy disk connectors. Complete technical manuals enable you to take full



advantage of the custom chips and the software support routines in the writable control store on the Kickstart™ disk that comes with every Amiga computer.

You can access these resources in a number of development languages, including Amiga Macro Assembler™, Amiga C, Amiga Basic (Microsoft®—Basic for the Amiga), Amiga Pascal and even Amiga LISP.

So Amiga not only gives you more creativity, it gives you creative new ways to use it.

*Amiga by Commodore.*

GIVES YOU A CREATIVE EDGE.

# SUBROUTINE OVERLAYS IN GW-BASIC

BY MIKE CARMICHAEL

*Have your BASIC program  
call subroutines from disk*

IF YOU HAVE EVER run out of memory when developing a large BASIC program, you've probably wished you could store all those subroutines on a disk and have your program call them one by one when they are needed. Of course, you can use the COMMON and CHAIN statements to maintain global variables and forge a path between program modules, but Microsoft's GW-BASIC does not allow the programmer to link a main program with a series of subroutines.

Yet there is a way around GW-BASIC's limitation in which a program can call subroutines from a disk. And if the subroutines are stored in a RAM disk, the additional run time necessary to load a subroutine is hardly noticeable.

The idea is simple: Set aside a section of RAM and load individual subroutines, as needed, into that section where each subroutine can be executed. In GW-BASIC, however, when you try to load a subroutine into memory that's adjacent to the main program, you destroy the interpreter's work area, which always resides in the memory just above the program, and the program crashes.

To get around that problem, you can

pad the main program with remark statements that reserve a specific amount of RAM for the subroutines. (In my program example, that space is about 1000 bytes, but by using more or fewer remark statements, you can reserve whatever amount of memory your subroutines require.) When a particular subroutine is needed, the main program gets it from the disk and loads it into the exact memory location occupied by the remark statements—deleting those remark statements in the process and effectively merging the subroutine into the main program. Then, when another subroutine is needed, the program loads it into the same memory location, overlaying (and deleting) the previous subroutine. And all that takes place while the main program is running.

The command used to do this magic is BLOAD, a GW-BASIC command that loads a disk file into specific memory locations. There is a catch, however. The file, in this case the subroutine, must be in binary form. And lest you think we've abandoned programming in BASIC, let's examine how GW-BASIC stores programs and how you can convert

BASIC code into binary format—it's easier than you might think.

## INTERPRETING BASIC CODE

Microsoft's GW-BASIC interpreter is very straightforward. You enter code line by line into memory, and as you do, the interpreter keeps its work area just above the last program line. Each BASIC command in a line is translated into appropriate 1- or 2-byte codes. Memory addresses and line numbers are stored in a standard 2-byte format—the least significant byte first, followed by the most significant byte.

Although it's not visible in a program listing, each line of BASIC code is preceded by an address that points to the next line. That address pointer is followed by the line number, which in turn is followed by parsed BASIC code and the ASCII equivalent of alphanumeric remarks, text, and so forth. (During execution, bytes containing line numbers referenced by GOSUB, GOTO, or other branch statements are translated into actual

*(continued)*

Mike Carmichael is Director of Software Services at Carmichael Jones & Associates, POB 426, Glasgow, KY 42141. Inquiries, please enclose SASE.

# COMPUTOUGH

"Anyone who wants to win MegaWars has to dominate entire planetary systems. And me."

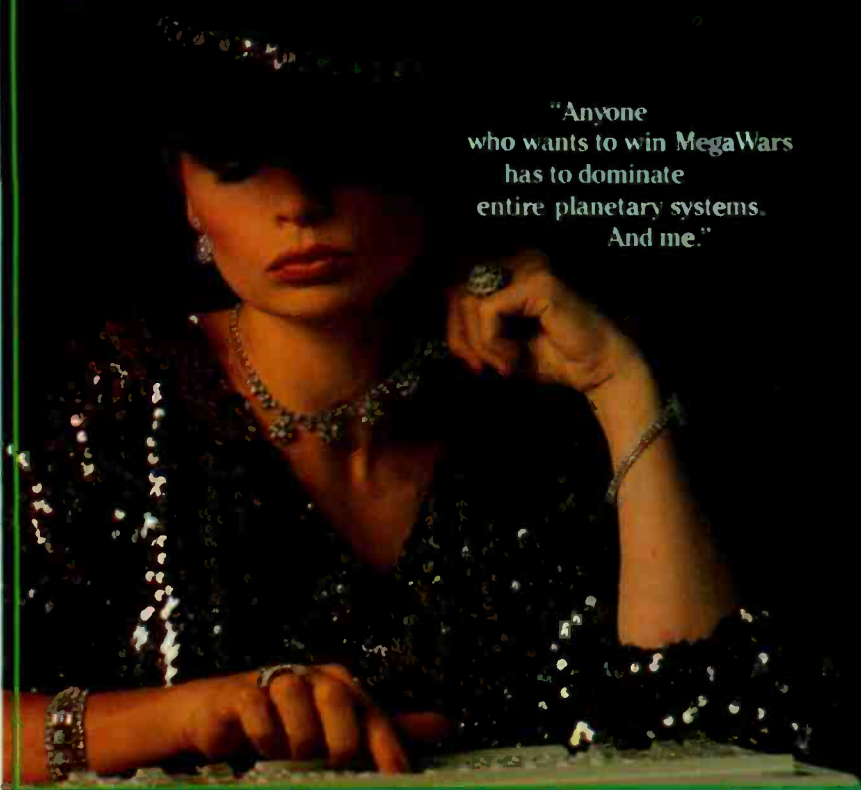

# COMPUFUN

"You Gussed It!?" It's just like a TV game show. Answer questions—win prizes. And I can play right here in the living room!"

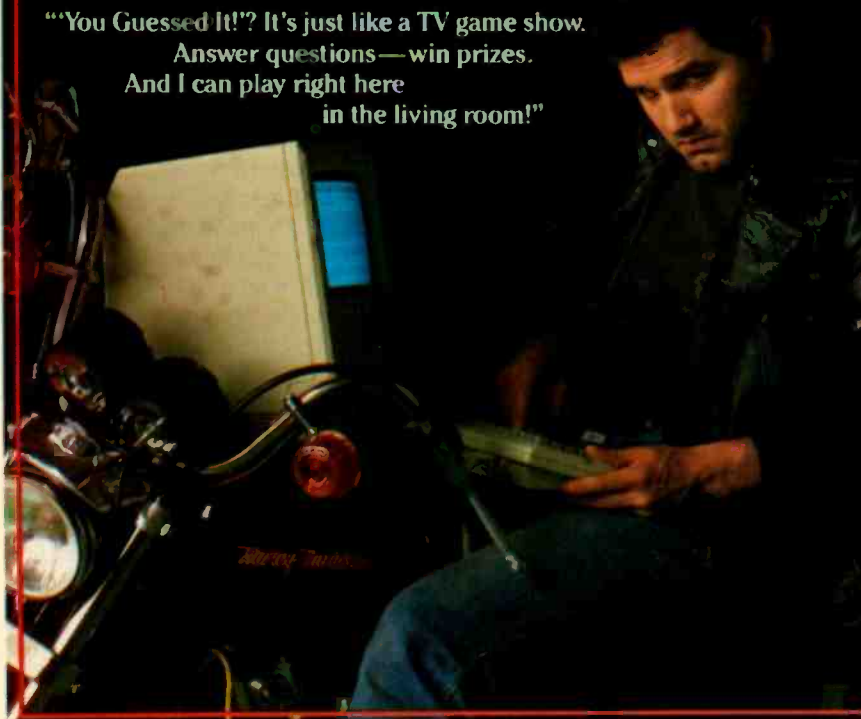

## SUBROUTINE OVERLAYS

*By experimenting you can build a table of commands and small subroutines with the POKE function.*

addresses the first time they are encountered.)

Just for fun, let's examine a BASIC statement. First, you must find where in your computer's memory the program statement will reside. With BASIC loaded, use the NEW command to get rid of any extraneous code. Then equate a variable to some value and find the memory location of that variable. For example, just type `F$ = "*"'`. Now type `PRINT VARPTR(F$)`. The decimal result will lead you very nearly to the lowest point in BASIC's user memory—the place where a program will begin. The value I get on my MBC-Sanyo 550 is 4070; the value on your computer may be different.

Next, enter NEW again and type a simple line of code that we can examine: `10 F$ = "*"'`. Now, to see what the BASIC interpreter has done, without using line numbers enter `FOR I = 1 TO 20: PRINT PEEK(4060 + I); NEXT I`. Notice that the starting address for the PEEK function is 10 bytes less than the value previously obtained on my Sanyo; you should use an address that is 10 bytes less than the value obtained on your computer.

Your computer should display the following 20 values for the memory locations checked (locations 4061 through 4080 on my Sanyo): 0 0 0 237 15 10 0 70 36 32 231 32 34 42 34 0 0 0 4 73. Those values translate as follows:

0 0 0	(below the first line of BASIC code)
237 15	(address pointer for next line in memory: 15 * 256 + 237 = 4077)
10 0	10 (line number)

```

70 36  F$
32      (blank space)
231    = (GW-BASIC's code for
        an equal sign)
32      (blank space)
34 42 34 ""*""
0       (end of line)
0 0     (locations 4077 and 4078
        show no line numbers—
        no more program)
4 73    (the first 2 bytes in
        BASIC's workspace)
    
```

You can also use this method to view the workings of other BASIC functions. In fact, you may want to experiment with building a table of commands and small subroutines with the POKE function.

**BUILDING A BINARY FILE**

In my program example, the main program and the subroutine are separate BASIC listings. [Editor's note: The BASIC source code for the program examples, *Mainprog.bas* and *Routine.sub*, is available for downloading via BYTEnet Listings at (617) 861-9764 and is also available on disk. See page 469 for details.] At the end of the main program are several remark lines that occupy, or reserve, the memory space in which the binary version of the subroutine will be loaded. The documentation and fill characters in the remark statements leave more than adequate room. In practice, though, the area cleared need be no larger than necessary.

To create a binary version of the BASIC subroutine, merge the two listings into one (load *Mainprog.bas*, then type MERGE "routine.sub"). Then run the program, and a new file ("routine.bin") will be saved.

The code between line 8000 and line 11050 checks to see if the binary version of the subroutine is on the disk. If it isn't, the module assumes that you have merged the BASIC version of the subroutine. The load-switch variable is turned off, the line-pointer variable is set to line 30000, and the binary version of the code is saved using the BSAVE command. BSAVE stores binary code from memory starting at a specific location and continuing for a specific length of bytes.

(continued)

# COMPU CRAZY

"Ready for an adventurous challenge?  
We're a team. And Nellie  
doesn't horse around."

# COMPU SERVE GAMES

You never know  
who you'll be up against  
when you go online  
with CompuServe.

To buy your CompuServe Subscription Kit,  
see your nearest computer dealer.  
Suggested retail price \$39.95.

To request our free brochure or order direct,  
call or write: **800-848-8199**  
(In Ohio, call 614-457-0802)

## CompuServe

5000 Arlington Centre Blvd.  
Columbus, OH 43220



The data you'll have to depend on tomorrow could depend on the disk you choose today.



BASF QUALIMETRIC™ 5.25" FLEXYDISKS. CERTIFIED 100% ERROR-FREE AND WARRANTED...

FOREVER

# LOOK WHAT'S IN IT FOR YOU!

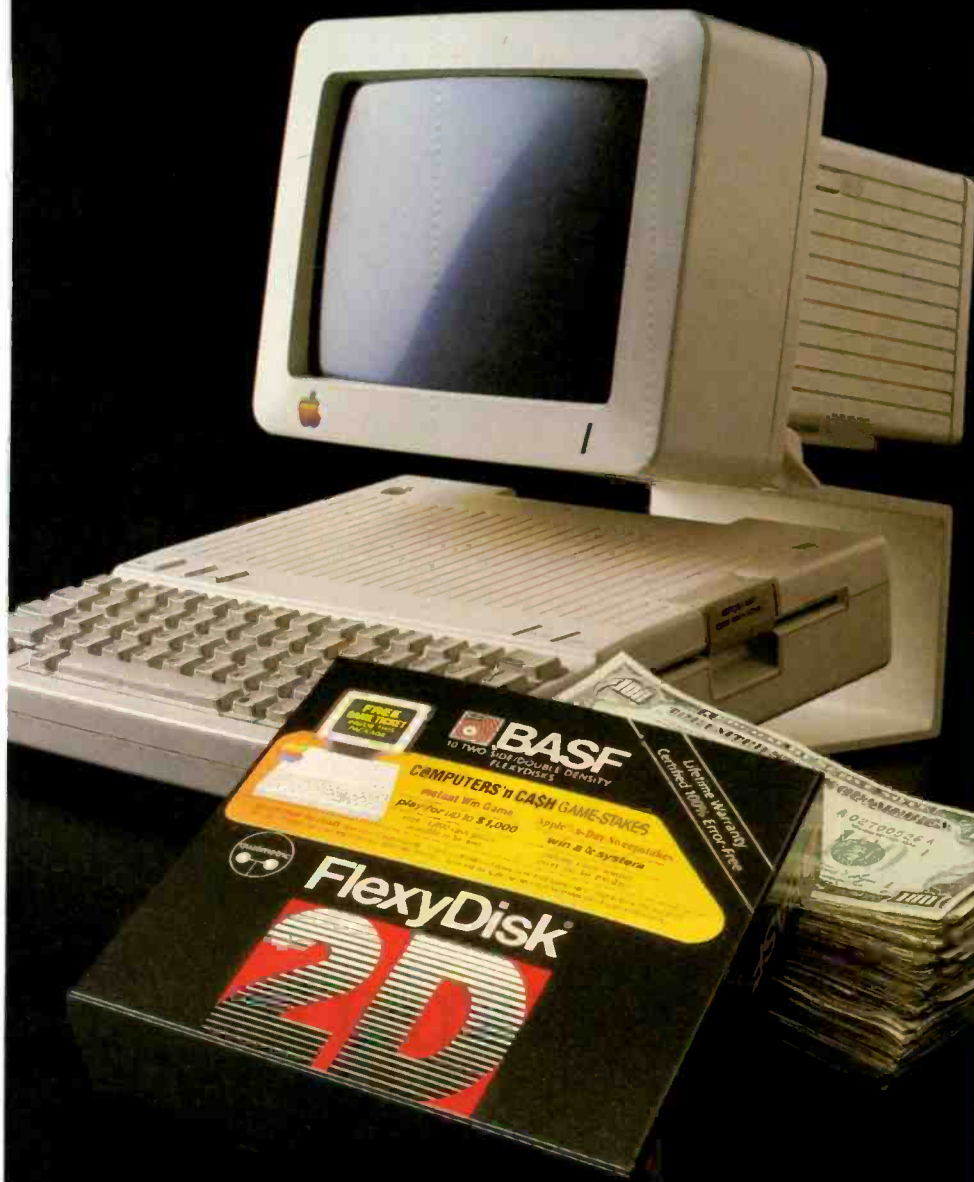

Now more than ever, there's more for you when you buy BASF Qualimetric™ FlexyDisks®. There's a special two-part game ticket that not only gives you 100 chances to win an Apple® IIc Computer in our Apple-a-Day Sweepstakes, but is also an exciting scratch-off game with 14,110 chances to instantly win cash prizes up to \$1,000. What else is in it for you? Only the best...the BASF FlexyDisk, certified 100% error-free and warranted forever. See your BASF dealer today and look for the specially-marked boxes of 5.25" and 3.5" BASF FlexyDisks.



## BASF

Apple and the Apple logo are registered trademarks of Apple Computer, Inc.

Inquiry 34

## SUBROUTINE OVERLAYS

*Take advantage  
of this simple approach  
to subroutine overlays  
in your GW-BASIC  
applications programs.*

If the binary version of the subroutine is already on the disk, the program loads it, and the module located at line 8100 takes over. (If the ASCII version of the subroutine has not been merged and the binary version is not on the disk, an error will occur.) Because the subroutine length and starting position will vary depending on the needs of the calling program, the program must alter, or relocate, the code to fit into the allocated space.

The program looks 8 bytes ahead in the first line of the binary subroutine; thus the BASIC version of the subroutine must start with one line that consists of only a line number and one remark statement. The program then subtracts the address found from the line-pointer variable + 8 to calculate the pointer adjustments throughout the binary version of the subroutine now in memory. These adjustments are made line by line until the end of the program is detected (when the address pointers are 0)—so the subroutine must be at the end of the main program when the binary version is saved. The rest of the code is very straightforward.

One further note: If changes are made to the subroutine and an updated binary version needs to be saved on the disk, you must delete the current version before running the program. Otherwise, the program will attempt to load the existing binary subroutine.

This simple approach to subroutine overlays in GW-BASIC should be useful to any BASIC programmers. Take advantage of the technique and improve on it when you incorporate the sample program modules into your applications. ■



ASYSTANT Ready-to-Run Scientific Software and ASYST are trademarks of Macmillan Software Co.

# Now choose from a menu.

Two scientific software systems for the way you do research.

## New ASYSTANT Ready-to-Run Scientific Software.™

Macmillan Software proudly introduces ASYSTANT menu-driven software. The first scientific software that lets you acquire, reduce, analyze, and graph data—

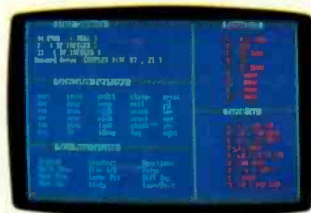
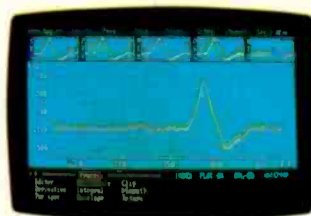

without programming!

ASYSTANT is a comprehensive, fully-integrated research system—so you won't waste time flip-flopping data from one package to another to get the results you need. Only ASYSTANT gives you a wide range of one-touch reduction/analysis functions supported by interactive graphics that guide you every step of the way. Built-in functions include FFT, smoothing, integration, differentiation, curve fitting, statistics, differential equations, and matrix and polynomial operations. And only ASYSTANT combines all this power with optional menu-driven data acquisition for true, push-button control of lab equipment. Overall, ASYSTANT gives you more capabilities than any other product in its price range.

For information on ASYSTANT, circle 427.





ASYST and ASYSTANT were developed by Adaptable Laboratory Software, P.O. Box 18448, Rochester, NY 14618

# Or make it to order.

## ASYST.™

More interfacing, analysis, and graphics capabilities than any other PC software.

Macmillan's widely-acclaimed ASYST™ Scientific Software offers an interactive programming environment with the built-in functions of ASYSTANT—plus many more.

ASYST's unique capabilities provide the building blocks that let you assemble scientific applications—fast. Sophisticated functions that would take hours using standard programming languages take only minutes with ASYST. And full-scale systems that would take months to develop can now be created in just a few days.

RS-232 and optional A/D and GPIB/IEEE-488 support offer more interface ver-

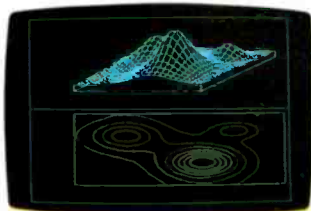

satility than any other scientific software. All hardware support functions integrate seamlessly with the full range of ASYST capabilities.

**Try ASYST or New ASYSTANT  
for 30 Days.**

**CALL 1-800-348-0033**

In New York state, (212) 702-3241.

## Macmillan Software Co.

An affiliate of Macmillan Publishing Company  
866 Third Avenue, New York, NY 10022

For information on ASYST, circle 428.

For information on both products, circle 429.



PAUL DEGEM

# Mass Storage

<b>THE EVOLUTION OF MASS STORAGE</b> <i>by Leonard Laub</i> .....	161
<b>CD-ROM SOFTWARE DEVELOPMENT</b> <i>by Bill Zoellick</i> .....	177
<b>THE APPLICATION INTERFACE OF OPTICAL DRIVES</b> <i>by Jeffrey R. Dulude</i> .....	193
<b>OPTICAL DISK ERROR CORRECTION</b> <i>by Solomon W. Golomb</i> .....	203
<b>A ROUNDUP OF OPTICAL DISK DRIVES</b> <i>by Rich Malloy</i> .....	215
<b>TAPE BACKUP SYSTEMS</b> <i>by Anthony Antonuccio</i> .....	227
<b>LASER LIBRARIES</b> <i>by Norman Desmarais</i> .....	235

PEOPLE HAVE BEEN STORING information for a long time, and regardless of the technology that they use, they invariably run out of room. This endless quest for more space in which to store data—our thoughts, hopes, dreams, and recordings of the thousands of activities of each day—has spurred technology ever since the first cave dwellers realized they would have to draw over some old drawings or find themselves a new cave.

In this issue of *BYTE*, we'll take a look at the current state of data storage on microcomputers, including an in-depth look at laser technology, which allows hundreds of megabytes of information to be stored on disks no bigger than traditional floppy disks.

Starting things off, Leonard Laub, featured speaker at the recent First International Conference on CD-ROM, provides a historical perspective for mass storage and a close look at the technology behind various laser-based data-storage systems.

To make the best use of the massive amounts of information that can be stored on a small CD-ROM requires careful thought about how you put the information on the disk and how users will take it off. In his article, Bill Zoellick examines some of the issues involved in developing software for CD-ROMs. In a similar vein, Jeff Dulude discusses write-once optical drives and the development of software for disks on which you can store your own data but not erase it.

The ability to store vast amounts of information on a disk is wonderful, but only if you can be sure that the information is correct. Solomon Golomb provides a clear introduction to the arcane science of error correction and detection.

Several publishers of large databases are now providing those databases on optical disks. The article by Norman Desmarais and the accompanying text box by Joe Dorner discuss some of those products, while Rich Malloy reports on the optical systems currently available for use with microcomputers—and there are a surprising number!

We haven't forgotten good old magnetic media. Anthony Antonuccio provides an introduction to tape backup systems for microcomputers, explaining how they work, the pros and cons of various types, and what to look for when you buy one.

One note: There doesn't seem to be any universal agreement on the spelling of the word "disk." We have adopted the convention of spelling it with a "k" in all cases, except where referring specifically to Sony's trademarked Compact Disc product. You may not agree with our choices; our authors didn't always agree either, so don't blame them.

—Ken Sheldon, Technical Editor

# Has your PC taken over your desk?

Has your PC got you crammed into two square inches of work space? Surrounded you with a sea of power cables? Basically taken over your desk? Don't despair. Help is on the way. With five clever accessories from Kensington.

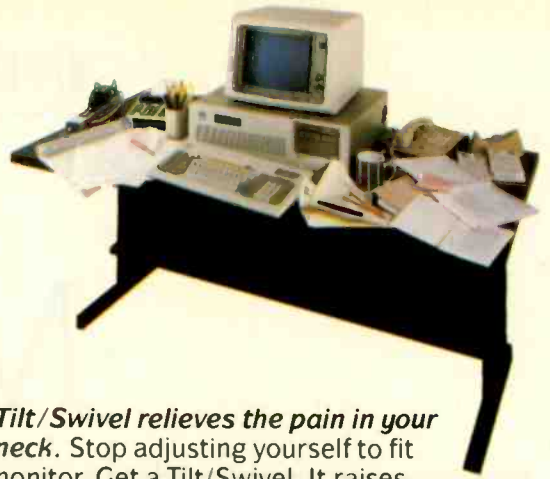

**1 System Stand liberates your desktop.** When you bought your PC, nobody told you it would swallow 80% of your desktop. Big, noisy, hot — wouldn't you love to get it off your desk and out of your way? Our adjustable System Stand does just that, no matter what PC you own. \$29.95

**2 Master Piece® gives you the power.** And you need it, because they sure didn't have a PC in mind when they wired your office. Otherwise, they'd have given you more than one outlet. Want an elegant solution? Get a Master Piece. Just slide it under your monitor and plug your PC, monitor, printer, modem — even a desk lamp — into the back. Now you can control the power to your whole system with the Master Piece's front-mounted switches. Talk about convenience. There's even a master switch to turn everything on and off at once. More than just convenient, Master Piece protects your equipment from dangerous glitches in the power line with top quality surge suppression, noise filtering, and static dissipation. \$149.95

**3 Tilt/Swivel relieves the pain in your neck.** Stop adjusting yourself to fit your monitor. Get a Tilt/Swivel. It raises your monitor, tilts and swivels to give you a comfortable, adjustable fit. And look how neatly it will fit under your Master Piece. \$49.95

**4 Copy Stand increases productivity.** The first made especially for PC users, our Copy Stand makes data entry easy and accurate by placing your notes right next to the screen. \$29.95

**5 Anti-Static Wrist Rest makes typing a breeze.** This comfortable rest lets you type all day without getting tired. Also grounds dangerous static automatically, whenever you reach for your keyboard. \$49.95

For a dealer near you, or to speak to a Kensington sales person, call toll free (800) 535-4242. In NY (212) 475-5200.

**KENSINGTON™**

Complete outfitters to the PC workstation.

Inquiry 190



Master Piece is UL-approved.  
©1986 Kensington Microwave Ltd.

# THE EVOLUTION OF MASS STORAGE

BY LEONARD LAUB

*An overview of the technology's beginnings, current status, and potential development in the realm of microcomputers*

MAGNETIC TAPE, the first practical mass storage medium, was difficult to standardize. The high-density format of one year was the technical antique of the next. Lineal densities on tape went quickly from 555 bits per inch to 800, 1600, and 6250 bpi. These advances were painful in terms of interchangeability. The solution was to build new drives with backward compatibility. This complicated the new drives and challenged drive designers to avoid compromising the performance of the new formats.

Increases in lineal density didn't remedy tape's greatest limitation, which was an intrinsically long access time, typically tens of seconds. Even many tape drives working simultaneously could not meet the random-access requirements of computers of the mid-fifties.

Tape's long access time motivated the development of magnetic disks. Only one short motion and a short wait were required to put the head at any point on the disk's data-bearing surface. This allowed mass storage access times to fall well below 1 second and filled the annoying access gap be-

tween tape and main memory.

As disks became faster, more reliable, and more widely accepted, it became feasible to couple disks more actively to main memory. This trend culminated in the development of *virtual memory*, in which data not immediately needed in main memory was automatically *paged* to disk and later automatically paged back to main memory when needed.

In this evolution (during the early sixties) the magnetic disk functioned primarily as a buffer. Mainframe users continued to rely on magnetic tape for archival storage and interchange of data.

## **MICROCOMPUTER MASS STORAGE**

Floppy disks began as a low-cost medium for loading and transfer of programs for mainframes. They were adapted for direct access storage by early microcomputer architects and went through a rapid evolution. Floppies provided both direct-access and removable, interchangeable mass storage that fit well with the simple operating systems typical of early micros.

The small "Winchester" fixed-medium disk was an immediate hit with the microcomputer community because it provided such fast access and transfer of data. There was virtually no tradition of tape use with micros, and as a result microcomputers evolved with big, fast buffers and no effective method for backup or archiving.

Most microcomputer operating systems still make only primitive provision for using floppy disks as "dump" media, and the rapid increase in typical Winchester capacities leaves floppy disks hopelessly inadequate. The most promising short-term solution is cartridge magnetic tape.

The biggest problem with using cartridge tape in a microcomputer environment is that it is an expensive addition with no apparent function other

*(continued)*

*Leonard Laub is president of Vision Three Inc. (2110 Hercules Dr., Los Angeles, CA 90046), a consulting firm that specializes in mass storage technology and systems. He has spent twenty years developing and commercializing mass storage devices and has been awarded twelve patents.*

# UNLOCK™ Removes Copy Protection

## RUNS YOUR SOFTWARE ON ANY HARD DISK

Guaranteed to work only with programs below:

### UNlock ALBUM "A"

**\$49.95** (Plus \$4 ship/handling. Foreign orders \$10)

- LOTUS 1-2-3™ (1.A, 1.A', 2.0)
- dBASE III™ (1.0, 1.1, 1.2 & PLUS)
- FRAMEWORK™ (1.0, 1.1, II)
- SYSTAT™ (1.3 & 2.0)
- SPOTLIGHT™ (1.0 & 1.1)
- GRAPHWRITER™ (4.3 & 4.3I)
- REALIA COBOL™ (1.2, 2.0)

### UNlock ALBUM "B"

**\$49.95** (Plus \$4 ship/handling. Foreign orders \$10)

- SYMPHONY™ (1.1)
- CLIPPER™ (Winter '84, Summer '85)
- ELECTRIC DESK™ (1.04)
- DOUBLEDOS™
- MANAGING YOUR MONEY™ (1.5 & 1.51)
- smARTWORK™ (1.0 REV 8 thru 10)
- DATA BASE MANAGER II™ (2.0, 2.02)

### UNlock ALBUM "C"

**\$49.95** (Plus \$4 ship/handling. Foreign orders \$10)

- MICROSOFT WORD™ (1.5, 2.0, 2.01)
- MULTILINK ADVANCE™ (3.02 & 3.03)
- IBM WRITING ASSISTANT™ (1.01)
- LOTUS 1-2-3 REPORT WRITER™ (1.0)
- PARADOX™ (1.0)
- PFS ACCESS™ (1984 Edition)
- THINKTANK™ (2.0)

### "Best of UNlock" ALBUM "D"

**\$74.95** (Plus \$4 ship/handling. Foreign orders \$10)

- MICROSOFT WORD™ (1.5, 2.0, 2.01)
- dBase III™ (1.0, 1.1, 1.2 & PLUS)
- LOTUS 1-2-3™ (1.A & 1.A', 2.0)
- SYMPHONY™ (1.1)
- FRAMEWORK™ (1.0, 1.1, II)
- CLIPPER™ (Winter '84, Summer '85)
- MULTILINK ADVANCE™ (3.02 & 3.03)

- Produce non-protected DOS copies from popular software programs
- For IBM® PC, XT, AT, compatibles

TranSec UNlock is a unique software copying disk that removes copy protection, providing standard non-protected DOS copies. UNlock runs on IBM® PC, XT, AT, and compatibles with at least 256K (or more required for some programs), DOS 2.1 or higher.

**BACKUP COPIES.** UNlock safely and easily makes backup copies.

**RUN ON HARD DISK.** Programs load faster, use less disk space and work with any hard disk, including Bernoulli Boxes. No longer do you need the original in drive "A".

**RUN ON RAM DISK.** UNlock is the only software that can run copy protected software on a RAM disk or micro-floppy.

**EASY TO USE.** 1) Type UNlock. 2) Select program destination. 3) Insert program disk.

**SAFE ORIGINAL.** UNlock does not alter your original distribution disk. UNlock works by creating a copy of your distribution disk on a hard or floppy disk. It then removes copy protection from the copy!

### Choice of the Critics!

**BYTE** "UNlock 4.7 defeats the latest Prolok and SuperLock type of copy protection scheme. It's menu-driven and works fine on the programs it's supposed to work on: Lotus 1-2-3, dBase III, Framework, Symphony, Paradox, and several others."

Jerry Pournelle, BYTE, Feb. '86

**PERSONAL COMPUTING** "UNlock has two particularly endearing characteristics: it works, and works simply. I was able to quickly produce unprotected copies of Lotus 1-2-3 release 2, Symphony 1.1, Microsoft Word 2.0, dBase III 1.1, and Framework II. These copies performed flawlessly, as did copies of these copies."

Christopher O'Malley, PERSONAL COMPUTING, April '86

**NEW! SPECIAL OFFER**  
"Best of UNLOCK"

ORDER BY TELEPHONE TODAY!

**1-305-474-7548**



# TRANSEC UNLOCK™

TranSec Systems, Inc., 1802-200 North University Drive, Plantation, FL 33322

Trademarks are the sole property of their respective owners. • UNlock Is For Use Only to Improve the Useability of Legally Acquired and Operated Software.

## EVOLUTION

than protection. Except in emergencies, no direct access is made to tape. Little software is released on tape for micros. These two factors alone create an acceptability gap, as big a problem as the access gap mentioned above.

### OPTICAL STORAGE

During the last 15 years, an entirely new family of mass storage media has emerged, based on the use of light rather than magnetism.

The earliest commercial optical disks were molded plastic read-only disks that stored television programs. Introduced in 1978 as consumer products, they were based on a standard called LaserVision and stored up to one hour of broadcast-quality video on each side of the 12-inch disk.

LaserVision records the video image as an FM signal on a tight spiral track that makes 54,000 turns in covering a disk surface. This places the turns of the spiral 1.6 micrometers apart, corresponding to a track density of almost 16,000 tracks per inch (tpi), several hundred times greater than that of a floppy-disk drive and tens of times more dense than any Winchester disk drive.

The FM signal is recorded on the master disk by turning its "on" half cycles into pits (physical depressions or trenches in the disk's surface). The pit density corresponds to lineal data densities of about 25,000 bpi. This is about 10 times the density of today's practical magnetic disks.

The pit pattern on the master disk is copied by electroplating to make stampers, used to mold the information pattern into the plastic disks. These plastic disks are made quickly and cheaply and are not very flat (compared to the platters of high-performance Winchesters).

To read the information from the disk, the player must maintain its focused light spot on the track within a few micrometers axially and a few tenths of a micrometer radially. The gap between the disk's waviness and these tight tolerances is closed by two powerful servomechanisms, one controlling focus, the other controlling tracking. Each servo uses an optical sensor to determine instantaneous error and a small motor to reposition



# PC-EASY™ Simplifies Finding Your Files

EXPANDS FILE NAME CAPABILITY TO 32 CHARACTERS

the light spot to correct the error.

These servos are fast and wide-ranging enough to handle typical "potato chip" disks (those with significant surface irregularities). They take up all the slack in both the disks and the players and are thus centrally responsible for the practicality of the LaserVision system.

## DIGITAL AUDIO DISKS

The high areal density and easy interchangeability of LaserVision video disks generated interest in the possibility of using this entertainment-oriented medium to store digital data. One result of this was Sony's Compact Disc, a read-only optical audio disk on which the audio information is encoded digitally.

Compact disks (CDs), which store up to 74 minutes of very-high-quality audio program on one surface of a 12-centimeter (4.72-inch) molded plastic disk, can be described as miniaturized versions of LaserVision disks. A system of error correction and channel coding was developed to carry and protect this data.

Since 1983, when audio CDs were introduced, player prices have dropped by a factor of five and the number of CD titles has risen to nearly 10 percent of that of conventional LPs.

## CD-ROM

The success of CDs supported the introduction of CD-ROM (compact disk read-only memory), an adaptation of CD specialized for the distribution of large digital databases (see the text box "CD-ROM Technology" on page 164). One CD-ROM stores about 550 megabytes of data, with an uncorrectable-error rate below 10<sup>-13</sup>.

CD-ROM, introduced early in 1985, is already the heart of some serious businesses based on electronic publishing of encyclopedias, reference works, professional directories, and other large databases. CD-ROM drives come either in add-on or add-in versions; the latter install in microcomputers just like floppy-disk drives.

## JUKEBOXES

Nonalterable storage implies ever-growing storage volumes, the prime

(continued)

- Automatically translates PC-EASY file names to DOS file names
- Commands and DOS both run faster
- Easy menu access to application programs

TranSec PC-EASY is a new easy-to-use software file management system that organizes your files, simplifies DOS and speeds up your IBM® PC, XT, AT or compatibles (DOS 2.1 or higher, 256K or larger, and hard disk required).

**FILE LIKE YOU THINK.** The heart of the PC-EASY system is its expanded 32 character capability to name your files naturally, the way you think. Eliminated are the maze of DOS standard 8 character limit half-forgotten or cryptic file names.

With PC-EASY you can use easily remembered names, plain words, even dates, to name your files. You can also name file "folders" to place reports, letters, spreadsheets, programs, or whatever, in their own logical, easy to find location.

**SIMPLE FILE ACCESS.** To access a file, you don't have to type the name again. All you do is select the file you want and PC-EASY immediately finds it for you. PC-EASY file names work with nearly any application program (including Lotus 1-2-3™, Symphony™, dBase III™, Framework™, etc.) because they are converted to standard DOS file names... automatically.

**FAST MENU ACCESS.** To access a file, you don't have to type the name again. All you do is select the file you want and PC-EASY immediately finds it for you.

**COMPUTERS WORK FASTER.** Commands are performed faster and DOS runs more efficiently. An expanded "type ahead" buffer keeps the system speedy.

**EASY TO USE.** PC-EASY prompts you through DOS commands and on-line help is always available. No need to learn a lot of new complicated commands and extra keystrokes.

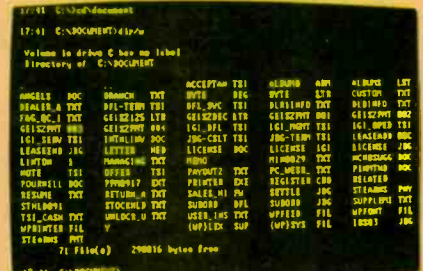

**STANDARD DOS SCREEN** with maze of hard to remember and confusing file names, because you are limited to 8 characters.



**PC-EASY FILES MENU** features an expanded 32 character capability to name your files with easily remembered names, plain words...even dates. Select the file you want and PC-EASY finds it for you fast!



**PC-EASY PROGRAM MENU** features quick, easy, automatic menu access to your application program and DOS operating commands. Select function you want... PC-EASY does the rest.

ORDER TODAY BY TELEPHONE!

**1-305-474-7548**

Order Today for the EASY Life

**\$74.95 ea.**

(PLUS \$5.00 SHIP/HDL; FOREIGN ORDERS \$15.00)



TranSec Systems, Inc., 1802-200 North University Drive, Plantation, FL 33322

Trademarks are the sole property of their respective owners.

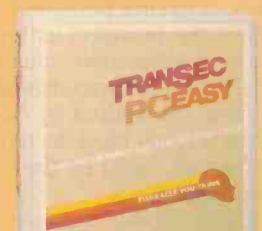

NOT COPY PROTECTED

# CD-ROM TECHNOLOGY

Concern about the quality of mass-produced compact disks motivated the development of Reed-Solomon ECC (error-correcting code). This error-correcting scheme works in conjunction with the standard compact-disk ECC to reduce corrected-bit error rate by at least three orders of magnitude.

The additional ECC requires additional storage overhead, taken from the CD's user-data capacity. This penalty produces a benefit; no special techniques or controls are needed for CD-ROM mastering and replication. The same factory can thus make both audio compact disks and CD-ROMs almost without noticing which is which. This permits CD-ROM to share the benefits of process developments and economy of scale resulting from the success of consumer CDs.

While CD-ROM was in its infancy, microcomputers were just beginning the current IBM PC-inspired wave of market penetration and standardization. This explains why, in the early days of CD-ROM, a relatively small amount of work was devoted to interface and file-format specifications.

## DATA FORMAT

CDs and CD-ROMs accept data in bytes. Twenty-four bytes make up a "frame." Each frame also contains 1 byte of "subcode" data (an auxiliary channel carrying timing, disk identification, and several other kinds of support data) and 8 bytes of additional data computed from the actual user data and used for error correction.

In the CD format, 98 frames form a block. Blocks occur 75 times per second, each one carrying 2352 bytes of user data, so the sustained user-data rate in CDs is 176.40K bytes per second.

The key difference between CD and CD-ROM is the provision for an extra layer of error correction, intended to deliver very low uncorrectable-bit error rates. These are realized by devoting 288 bytes of each block to the additional data calculated by the layered ECC encoder.

In addition, CD-ROM uses random access to blocks, so 12 bytes of each block are dedicated to synchronization

and 4 bytes are used to provide the "absolute address" of the block. This leaves 2048 bytes of user data per block, for a sustained user-data rate in CD-ROM of 153.60K bytes per second.

Note that CD and CD-ROM formats differ only in the application of the bytes carried in each block. They are mastered, molded, and read in exactly the same way. This is key to the beneficial linkage between the two formats and assures CD-ROM's benefit from the rapid improvements in CD-player and disk design and manufacturing improvements.

## ADDRESSING

CD and CD-ROM data is written on a continuous spiral track, with a variable (and usually noninteger) number of blocks per disk rotation. The variability comes from the CD's use of CLV

(constant linear velocity) to maximize storage capacity. The disk spins at between 200 and 500 rpm depending on which radius is being read.

Since CD-ROM shares this CLV format, it also uses the CD address nomenclature of minutes (0 to 73 in CD, 0 to 59 in current CD-ROM practice), seconds (0 to 59), and blocks (0 to 74).

The number of blocks available per CD-ROM is 270,000. At 2048 bytes (of user data) per block, this yields a total user capacity per disk of 552,960,000 bytes (or 553 megabytes). This is completely usable capacity; it remains after all overhead associated with sector formatting and error correction. Other numbers seen in the literature (usually between 500 and 600 megabytes) reflect only variations in the total number of blocks recorded, not in any other

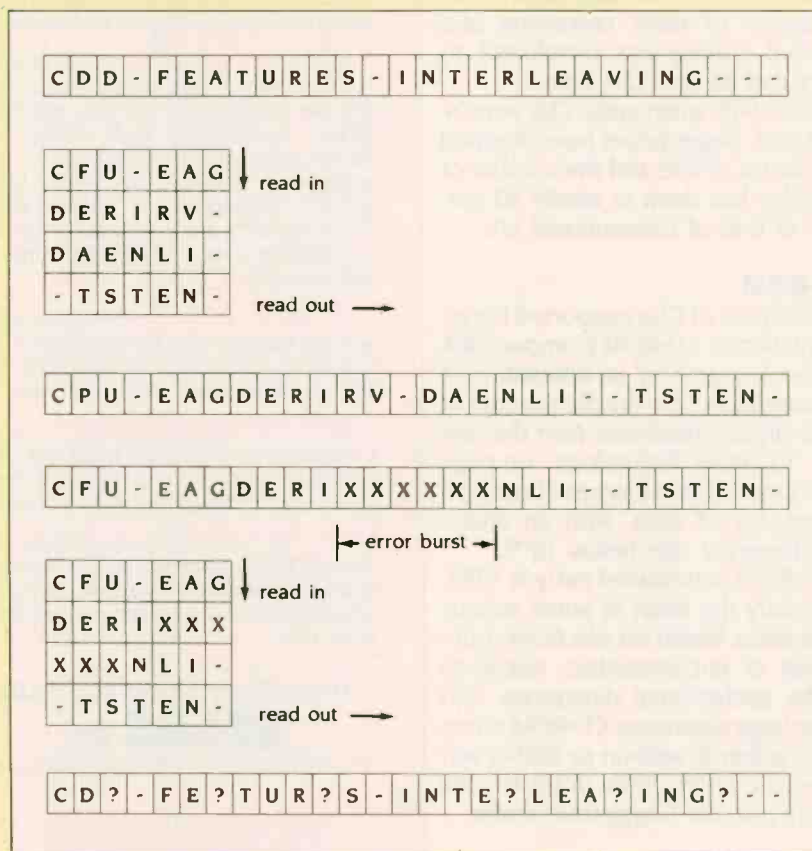

Figure A: In this example of data interleaving, the long error burst (XXXXXX) is separated into shorter ones that can be handled by the error-correction decoder.





rect error bursts up to 450 bytes long. This long a burst would take up almost 2 millimeters along a track, a far from microscopic defect. Current CD quality-control techniques screen out nearly all such defective disks.

If a still longer error burst occurs, the C2 decoder sets a flag indicating unreliable data. The typical CD player then either interpolates (fakes it) or mutes (gives up).

### LAYERED ECC

CIRC operates on frames of data. CD-ROM incorporates an additional layer of algebraic encoding that works on blocks of data. Before entering the CIRC process described above, user-data blocks of 2048 bytes go through the layered ECC encoder, which adds 276 bytes of data to be used for error correction and 4 bytes of data to be used for error detection.

Within the 288-byte area devoted to layered ECC in the CD-ROM block, the first 4 bytes contain the additional data for error detection, the next 8 bytes are all 0s, and the remaining 276 bytes contain the additional information needed for error correction.

Calculated uncorrectable-bit error rates for CD-ROM are below  $10^{-15}$ , and observed rates are safely below  $10^{-13}$ , at least as good as the best magnetic-storage devices available today.

### CHANNEL ENCODING

CD-ROM differs from CD in data format and error correction. At the level of channel code, which works on individual bytes and frames, CD and CD-ROM are the same. Both use a channel code called EFM (eight-to-fourteen modulation).

The name refers to the first step in the coding process, in which each byte of data is replaced by a 14-bit sequence, and each pair of such sequences is separated by a 3-bit "merging sequence" (see figure B). After the 1 subcode byte, the 24 user-data bytes, and the 8 ECC bytes are dealt with this way, the EFM encoder adds an additional 24-bit pattern for synchronization and another 3-bit merging sequence.

Thus, a frame carrying 24 bytes (192 bits) of user data is represented by 588 "channel bits." These are actually instructions to the master recorder, in the sense that a pit will be started when a "1" channel bit is received, continued

while the channel bits are 0s, and ended when the next 1 channel bit is received.

The channel clock rate is 4.3218 MHz, and the "ticks" of this clock are the increments of duration of the pits and spaces. At the standard CD scanning speed of 1.3 meters per second, one tick covers 0.30 micrometer along the track.

The rules by which the sequences mentioned above are chosen guarantee that the pits and spaces on a CD or CD-ROM will have lengths that are never greater than 11 ticks (3.3 micrometers) or less than 3 ticks (0.9 micrometer).

EFM is thus a "run-length limited" code, related to the (2,7) code used in high-performance magnetic-disk drives. It fits the signal power into a well-defined spectrum (160 to 720 kHz), avoiding both the high spatial-frequency region unreadable by the optics and the low temporal-frequency region used by the tracking servos. It is also self-clocking, so no companion track or indirect clock is needed.

### INTERFACES

At the output of the ECC decoder, the data stream is fully realized as bits, which have already been buffered and made ready to be clocked out at a rate not necessarily tied to the disk rotation. Absolute block addresses have already been decoded at this point.

This is comparable to the degree of isolation of the system from the idiosyncrasies of the basic drive provided by the small computer system interface. SCSI is rapidly emerging as a good way to tie together many sharply different types of storage devices, along with certain I/O devices, by translating from the native characteristics of each to a common, straightforward interface. As the mainstream of magnetic-storage devices for high-performance microcomputers shifts to SCSI, CD-ROM, like any new product, will be obliged to follow.

The other leading CD-ROM interface ties directly to the bus of the IBM PC. This computer is well suited to control the CD-ROM drive in many of its best applications, and it is always easier to bring the new equipment and software to hardware already widely installed. In time, however, this interface may be replaced by SCSI host adapters for the PC and SCsIs on the drives.

application for optical disks. In order to deal with a database spanning many disk volumes, some companies sell what is often called a "library" or "autochanger," but it is hard to resist calling it a "jukebox." This machine can put any of a large number of disks into any of a small number of drives, automatically, under software control.

Optical disk jukeboxes seem to fill the access gap, in that they provide automatic access to hundreds of gigabytes of data, of which a significant amount (5 to 10 percent) is mounted. Since all data is stored on disks, the mounted part is directly available. With judicious application of staging algorithms, this can make the whole database appear to be on disk.

Second-generation optical disks began appearing commercially in late 1985. These are aimed directly at microcomputers and are packaged in the standard full-height 5¼-inch box. Capacities range from 100 to 400 megabytes per disk side. Current applications for these separate into the "new," such as image storage and transaction recording, or "evolutionary," in which the optical disk backs up one or more Winchesters.

The current small optical drives all use write-once media, but work is proceeding on the development of alterable media. A small optical disk drive exercising a fully functional, alterable medium could replace both a small Winchester and its backup device. It could also write and read write-once media, for applications requiring nonalterable storage, and it could read read-only media, for access to published databases and instructional material.

Given the strong constraints on size and price for microcomputer systems, such a drive might be a great success. Alterable optical media have recently graduated from laboratory to production prototype stage and are predicted to be available in early 1987.

### WRITABLE OPTICAL DRIVES

After a long gestation, writable optical disk drives emerged in 1983 as commercial products. These first-generation optical disk drives used 12-inch disks that stored about 1000 mega-

(continued)

# ENERGRAPHICS™ 2.0

WE SIMPLY MADE IT BETTER!



It's here! The newest release of **ENERGRAPHICS**. The graphics package once labeled "A Step Ahead of the Rest", has now jumped even further ahead with its **Version 2.0**. In one package we have combined more types of graphics with more capability employing the latest in ease-of-use methods than any PC package available today. To say it simply, Enertronics has made **ENERGRAPHICS 2.0** the easiest to use and the best there is!

## Some Highlights of ENERGRAPHICS 2.0

### New Ease-of-Use Features:

- Mouse/Digitizer (Optional)
- Help Screens
- On-Screen Graphics Editing
- Drawing Commands On-Screen

### New Capabilities:

- 2 and 3 Dimensional Pie, Bar, Line Charts
- Paint/Fill
- New Fonts
- Merge up to 4 Graphs on a Screen
- Entirely New Documentation
- Conversion of 2D Symbols into 3D Symbols
- User Defined Curve Fitting

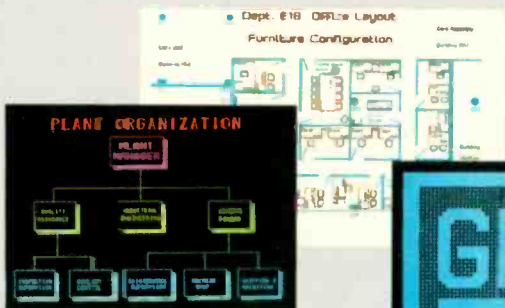

Of course we can't list all the 2.0 enhancements but we know this is the program for you. And, for those who only want the charting capability of **ENERGRAPHICS 2.0**, we've packaged it into a separate product called **ENERCHARTS**. So whether you want the total graphics solution offered by **ENERGRAPHICS** or just charting with **ENERCHARTS**, you'll have the best in PC graphics available to you.

**ENERGRAPHICS 2.0**—For your every graphics need!  
**ENERCHARTS**—For only your charting graphics need!

### Update Information:

**ENERGRAPHICS 2.0**—Send \$75.00 and #1 diskette from **ENERGRAPHICS 1.3**.

**ENERCHARTS**—For a current **ENERGRAPHICS** user, send \$195.00 and your #2 diskette from **ENERGRAPHICS 1.3**.

**Ordering Information:** All orders require a check/money order or Visa/Mastercard plus a shipping and handling charge.

**ENERGRAPHICS 2.0**—\$595.00 Retail

**ENERCHARTS**—\$395.00 Retail

Or, call our toll free number for a dealer in your area **(800) 325-0174**.

### New Interfaces:

- Lotus® 1-2-3™
- Wordstar™/Multiplan™
- Video Show™
- EGA Board
- Polaroid® Palette

First Software, Intec-1, (United Kingdom) Tel: 0256 463344 Telex: 859030  
 First Software Benelux, (Belgium) Tel: 32(16) 202512 Telex: 26202 vector B

## ENERTRONICS

Inquiry 129

SEEING IS BELIEVING



# STOP SOFTWARE PIRACY . . .

. . . with one of our new sophisticated copy prevention products.

**NEW**

## For Hard Disk Protection

- Fixed Disk Locker

## For Disk Security

- High Level Security
- PADLOCK II DISK
  - SAFEGUARD DISKS
  - COUPON DISKS

## Low Level Security

User Installable Protection

- PC-PADLOCK

Why should your valuable data or useful software program become available in the Public Domain?

Call or write for more information.

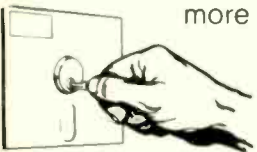

## GLENCO ENGINEERING INC.

3920 Ridge / Arlington Hts., IL 60004  
(312) 392-2492

bytes per surface. They were expensive enough (\$5000 and up) and large enough (7 to 10 inches high and 19 inches wide) to be aimed at minicomputers or at least clusters of microcomputers.

The disks are a "write-once" medium (meaning that any given region can be written on but not altered). Most of these drives are installed in document image-storage systems, a "new" application in the sense that no digital medium has ever been inexpensive and compact enough to make large-scale image storage worthwhile.

### TECHNOLOGY TODAY AND TOMORROW

Let's look briefly at the technology underlying mass storage products and consider the future for each.

Floppy disks and tape share the characteristic of operating with the head in contact with the medium. Floppy disks were originally intended to load programs for mainframe computers and did not need to survive many passes. They are presently the main medium for microcomputer archival storage. This makes friction and wear characteristics very important. High-quality floppy disks are now burnished, in the manner of Winchester disks, to assure smoothness and absence of particles that might break off and scratch the disk. Heads are made of hard ferrites embedded in hard ceramic sliders.

The remaining culprits for floppy failures are dirt and physical damage. All these problems are solved by the newer 3½-inch floppy format, which uses a rigid jacket, a sliding metal shutter to cover the access slots, and a metal hub attached to the plastic disk. Centering and cleanliness are good enough that 3½-inch floppy disks already operate at the same capacities as 5¼-inch disks, up through the 1.2-megabyte IBM format.

Some 5¼-inch formats go past this value to 3.3 or even 10 megabytes. These systems use special media with very fine oxide particles to support high lineal densities along the track, but their primary difference from conventional floppy disks is the use of a tracking servomechanism. This re-

quires a head positioner similar to a good Winchester, while still providing typical floppy access times and transfer rates.

These superfloppies seem intended primarily as a more compact version of the Winchester backup medium, but they run into market resistance for the same reasons as do cartridge tape drives, namely that they are additional drives (at an additional cost) used only to back up the Winchester.

Several tiny floppy formats, between 1.8 and 2.5 inches in diameter, have been shown recently as storage media for electronic still cameras. As these develop, and once a standard is set, one of these formats could provide the next step down from 3½ inches.

### BERNOULLI DISKS

Another category of flexible magnetic disk deserves not to be called "floppy," both for distinction and because it doesn't flop. Iomega makes a unique flexible-disk drive in which the disk spins rapidly and is aerodynamically stabilized by the Bernoulli effect. The head "flies" over the surface and the head positioner is servo-controlled.

The results are a single sheet storing as much as 20 megabytes and a drive with access times and transfer rates comparable to good Winchesters, along with unrestricted media removability and interchangeability.

### RIGID MAGNETIC DISKS

Thirty years of intensive development have not moved this product away from aluminum platters, spin-coated iron-oxide media, and passively pumped air-bearing head supports. Within this formula, areal densities have doubled every 2.4 years, the result of profound evolution of components.

Hand-wound ring cores have given way to vacuum-deposited thin-film loops in heads. Oxide particle sizes have decreased dramatically, as has the residual roughness left by improved surface-finishing techniques for the platters and coatings. The sliders supporting the heads have shrunk, making it easier to maintain

(continued)

# YOU CAN'T GET A GOOD FEEL FOR A SOFTWARE PACKAGE FROM AN AD.

## If you're searching through the ads in this magazine for the "right" software package, good luck.

Let's say you're looking for a data base manager. You read a dozen ads. Each one offers its list of features. Each one talks about the ideal combination of power and ease of use. And each one promises to "solve your problems", "answer your needs", or both.

### Don't believe anybody.

We could make the same claims for DATAEASE. Even before Release 2.5, tens of thousands of users made DATAEASE the corporate data base standard. We could tell you that they found DATAEASE to be an invaluable productivity tool because of its fully relational capabilities, full screen editor and unique combination of menus and commands. But don't believe us.

More than 100 reviewers from major publications agree with our productivity claims. Data Decisions called DATAEASE "perhaps the most effective blend of ease-of-use and performance available for PC users to date." But don't believe the reviewers.

Application developers, MIS/DP/IC managers, and all kinds of other users from Fortune 1000 companies throughout the country have reached strikingly similar conclusions. A user at General Instruments reports that "those same factors that make DATAEASE preferable for non-programmers — ease of use and speed of development — make it the program of choice for many technical types, too." But don't even believe other users.

### Nobody knows what you know.

Even if all these people are absolutely right about DATAEASE, does that mean it's the right product for you?

The best way to know if DATAEASE fits your needs is to get your hands on our free sample diskette. Fifteen minutes with the sample will give you a feel for the best DATAEASE yet — Release 2.5. It has features that appeal to all users; from developers to data entry people: A complete procedural language; quick reports at the press of a button; a direct interface to Lotus 1-2-3<sup>®</sup>; the ability to move rapidly from file to file on a common piece of data; and built-in scientific, mathematical, financial, date, time, and string functions.

### Find out for yourself.

The advances in DATAEASE's Release 2.5, and the support behind it, offer you practical advantages that leave all the other data base managers far, far behind — including R:Base 5000<sup>™</sup> and dBase III<sup>™</sup>. But don't believe us. Call or write for information and your free sample diskette today.

BYT 5/86

## FREE SAMPLE DISKETTE.

Send information and a free DATAEASE sample diskette for my PC (check one):

IBM  WANG  DEC  TI

Name: \_\_\_\_\_

Title: \_\_\_\_\_ Phone: \_\_\_\_\_

Company: \_\_\_\_\_

Street: \_\_\_\_\_

City: \_\_\_\_\_ State: \_\_\_\_\_ Zip: \_\_\_\_\_

Mail to: Software Solutions, Inc.,  
12 Cambridge Drive,  
Trumbull, CT 06611 Telex: 703972

Don't like samples? Then just call us. We'd be happy to talk about your information management needs and advise you.

**Software Solutions, Inc.**  
**800-243-5123**

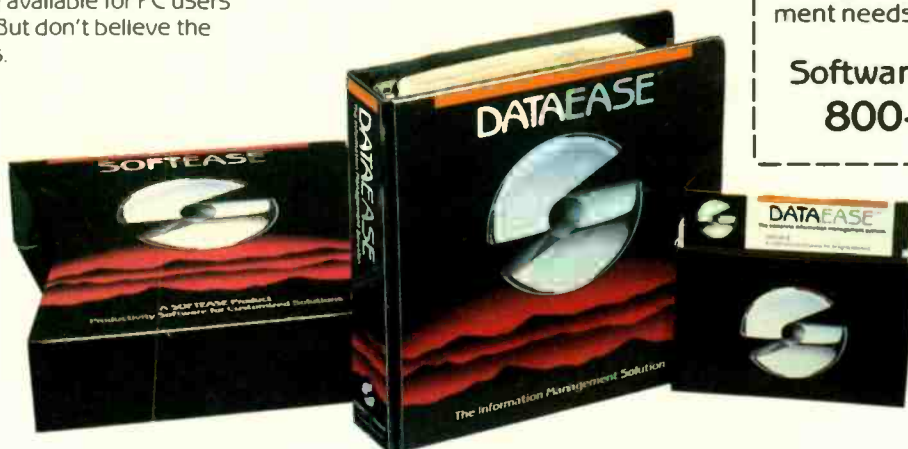

Canada  
Computerlinks, Toronto, Ontario, (416) 231-1270

Scandinavia  
West Soft A/S, Alesund, Norway; (47) 71-46166

Switzerland, France  
Softsource, S.A. 1209 Genève Switzerland; 985152 & 985153

United Kingdom  
Sapphire Systems, Essex, 01-554-0582

West Germany, Austria  
M&T Software Verlag, Munich, 089-4615-0

©1985 Software Solutions, Inc.  
Trademarks are of their respective companies.

Inquiry 333

MAY 1986 • BYTE 169



code modulation) adapters for recording audio digitally on videotape. After the analog-to-digital function, these machines encode the digital data into a signal resembling a video signal, which is then sent to a standard VCR. The typical adapter samples the audio 48,000 times per second per channel and quantizes each sample to 16 bits, resulting in a data rate of 1.536 megabits per second. This can be recorded for two hours on a standard cassette, resulting in a user-data capacity of up to 1382 megabytes.

This is a streaming format, with no provision for start-stop and no absolute physical addressing. However, versions of this approach have been sold as backup and archiving devices for microcomputers.

Honeywell uses a more basic approach to VCR technology by dispensing with video encoding altogether, using its own electronics behind a VHS transport to achieve the capacity of 10,000 megabytes on one VHS cassette.

Yet another mass storage approach based on consumer products may arrive if the prototype digital audio tape recorders now being shown become commercial. At present, some companies prefer fixed heads that push the technology but result in a small simple drive, while others prefer rotary heads similar to VCRs. There is also debate on the digital encoding (16-bit linear versus 8-bit nonlinear). While these debates go on, CD recorders may appear.

### READ-ONLY OPTICAL DISKS

The leading format in the category of read-only optical disks is CD-ROM. Some other formats deserve mention here.

Before CD-ROM appeared, several companies developed proprietary digital formats based on LaserVision laser disks. These formats are similar to those of the PCM adapters for VCRs mentioned above and store between 800 and 1000 megabytes per surface of a 12-inch disk. With the advent of CD-ROM, these formats receded to a specialty position, serving applications in which a large quantity of TV imagery needs to be stored and retrieved along with digital data.

Over the next two years new formats will appear that will be read-only versions of high-performance alterable optical disk formats. These will provide higher data rate, faster access, and finer addressability than CD-ROM, and they will be directly compatible with what may become the mainstream mass storage devices for small computers.

### WRITE-ONCE OPTICAL DISKS

The earliest experimental writable optical disks used vacuum-deposited metal films as recording media. An intense laser spot heated up the metal beyond the melting point, forming a molten disk that opened up to a ring, expanded, and then cooled to form a rim around a hole in the film.

This is a very positive method of marking and has no mechanism for reversal. Media of this sort are called write-once because marks formed this way are permanent. Metal films are also very stable during reading because the lower-power light spot used for reading does not melt the metal. The metal conducts away the heat resulting from the reading beam and remains unaffected. On this basis, optical disks developed their reputation for not degrading data during reading.

Unfortunately, metals like to oxidize and corrode, so it was necessary to complicate this medium to make it stable. Today's commercial metal-film media use either a single layer of several ingredients or multiple layers, each one specialized.

These constructions are rather expensive to make, so alternative constructions, particularly those based on polymer materials, are attractive. It is important when considering these alternatives to look for the same kind of positive marking and stability during reading that is provided by metal films.

One element of construction ripe for simplification is the air gap found in most disks. This leaves room for the metal to roll back during formation of a mark. It also requires extra assembly steps and makes the disk into a barometer, bulging and collapsing with changes in altitude. Sensitive layers that don't need an air gap are thus highly desirable.

All good write-once media make very clean, repeatable marks. Typical "jitter" of mark edges from their ideal locations is a few tens of nanometers, which is just a few percent of the average length of a mark. Present drives really don't need such clean marking, but future drives, using advanced channel codes now under development, will provide higher performance by storing multiple bits per mark.

As a simple example, CD-ROMs store about 2.5 user bits per mark. Experimental results show the feasibility of storing 8 to 10 bits per mark (by fine adjustments to the positions of mark edges). Compared to today's typical value of about 1, this means that the same disk, optics, and drive mechanism might be able to achieve about one order of magnitude in lineal density, capacity, and transfer rate.

Improvements in optical performance of the head, achieved by reduction in aberration and, possibly, reduction in laser wavelength, will permit smaller spots to be made. This will also permit increases in areal density. The combination of smaller marks and more bits per mark will enable optical disks to grow in performance in the same rapid evolutionary way that magnetic disks have.

### ALTERABLE OPTICAL DISKS

Write-once media succeed by being marked in a way difficult or impossible to undo. Alterable media must have all the other virtues of good write-once media while supporting a marking process that can easily be reversed.

Media producers are pursuing several development directions in alterable media. None of these is yet in full production, although several companies have tooled up for pilot production of magneto-optic (M-O) media.

Perhaps more important, it is not clear that any of the alterable media currently in development can clearly provide a direct functional equivalent to conventional magnetic media. M-O and phase-change media require two passes for writing new data, and the

*(continued)*

## *Old formats must be supported by new drives for at least 10 years.*

phase-change medium still has problems with fatigue after hundreds of thousands of erase-rewrite cycles.

Despite this, it is likely that M-O media and drives will be introduced during the next two years, probably in 5¼-inch format. Even with the slight functional difference from magnetic drives, M-O drives can do much of the work now done by Winchester drives if their data rates and access times are comparable. Their high capacity and painless media removability then become strong competitive advantages.

An ideal alterable optical medium could provide a perfect alternative to the combination of Winchester and backup device. Many current Winchester makers feel this is the mainstream direction of the future because it does away with the acceptability gap described earlier for the present combination.

The issue of cross and backward compatibility becomes relevant as optical-media technologies and formats proliferate.

One of the very pleasant aspects of Winchester drives is that the medium technology and much of the physical formatting are invisible to the user. If you develop a nice new way to build a fixed-medium magnetic-disk drive, you need to provide only a standard interface, package size, and power-supply requirements. The data on old drives will be transferred electrically to the new one.

This is not so with removable media, as long as people continue not to want to copy old data onto new media. Experience with tape suggests that old formats must be supported by new drives for at least 10 years. This suggests that alterable optical drives, which will begin coming into the market when write-once drives have achieved some penetration, may need to read, and possibly write, write-once disks.

The rapid buildup of the market for

read-only optical data disks, spearheaded by CD-ROM, suggests that alterable drives may also need to read read-only disks. Some companies support the notion of such versatile, "multifunctional" drives, expecting to meet approval from computer makers wanting to minimize the number of drives per computer, while others fear that the extra complication may cause problems. Time will tell.

The strongest early application for optical storage has been the large-scale storage of images of business documents and engineering drawings. The combination of capacity, compactness, speed, durability, accessibility, and simplicity of remote access is winning.

Most sites using such systems have found that they really want to store far more images than will fit on one disk. They also want automatic, centralized storage capable of supporting large, busy user communities. Finally, in many cases, the probability of access is almost uniform over the entire database, making it impossible to mount only the "busy" disks. The hardware solution to this problem has been the jukebox, described earlier.

Representative current jukeboxes, intended for the large, busy central servers described above, hold about 100 disks and from two to seven drives each. Other designs hold about 20 disks and one drive. Either way, about 5 percent of the full database is mounted at any one time.

This is more than tape jukeboxes for mass storage ever managed, but the real advantage comes from the throughput of the mounted disks. Each optical disk drive is a direct-access storage device, capable of tens of thousands of record transfers per hour. By adding drives to an optical disk jukebox, it is possible to get overall throughput in the thousands of records per hour over a database in the hundreds of gigabytes from a box the size of two large refrigerators that costs about \$100,000. For applications content with write-once storage, this is a breakthrough product.

Meanwhile, NEC has shown a prototype of a jukebox based on small writable optical disks. It holds two stacks of 100 disks, each storing 600

megabytes per side, and has two drives. The total capacity is also 120 gigabytes, but the volume of the box is only 5 cubic feet.

### **IMPACT ON SYSTEMS ARCHITECTURE**

Many systems architects are exploring ways of coupling optical disks with magnetic storage and semiconductor RAM to make composite systems.

The key to these systems is the automatic management of a memory hierarchy with, for example, RAM fed by a Winchester disk, fed in turn by an optical disk, which may in turn be fed by magnetic tape. The choice of what data to stage and when can be made by specialized processors exercising algorithms intended to anticipate user requests.

These algorithms have precedent in cache memories and in some virtual-memory systems but are not a part of any typical microcomputer operating system. Specialized devices using subsets of this method are just emerging.

The main performance requirement motivating the development of such systems is accessibility of stored data. Optical storage provides high capacity, but so does magnetic tape. Read-only and writable optical disks will soon be active in the field of telecommunications. While corporate telecommunications managers try to predict whether satellites or optical fibers will give them better service, others are looking into shipping optical disk copies of busy, centrally maintained databases to field offices.

The fundamental reason for this is cost. Shipping data across the country by recording it on CD-ROMs and sending the disks by courier costs less than two cents per megabyte. This is one to two orders of magnitude lower than typical microwave or satellite communication costs, and as much as 10,000 times cheaper than modem communication on direct-dial lines.

In the next decade, the application of combined mass storage technologies will produce significant improvements in the cost reduction and accessibility of large databases for many applications, including business, communications, and personal computing. ■



# Aztec C ... The Best C

## Frees the genius in you

You've got a great idea . . .

. . . you're ready to write your programs.

You don't want to be sidetracked by all the paperwork. With Manx Aztec C and the ingenious **make** function, your creative processes won't get bogged down in program administration and housekeeping. Manx Aztec C has the most sophisticated, hardworking program administrator available to you. Once you've described your project, adding new features or enhancements is simple. You never have to concern yourself with the repetitive, tedious task of rebuilding your systems.

The development process moves quickly. Compiles, assemblies, link edits . . . all finish in record time.

Manx Aztec C is the fastest, most efficient C development system in the industry. Benchmarks show it . . . reviews commend it . . . users praise it.

You're ready to test the program. You're ahead of schedule. The Manx Aztec C Source Level Debugger shows you the exact C language statement giving you a problem. You fix the problem quickly . . . you're still ahead of schedule.

You've got some time for fine tuning. The Manx Aztec C Profiler examines your program, tells you where the slow spots are and validates your test procedure. A few changes and it's exactly what you wanted.

You've made it!

**Aztec C is available for MS-DOS/PC DOS. Call for details on Macintosh, Amiga, Apple II, CP/M-80, CP/M-86, TRS-80, ROM and others.**

To order, or, for information

**Call Today**

**1-800-221-0440**

**In NJ or outside the USA call  
(201) 542-2121**

30-day satisfaction guarantee. Special Discounts are available to professors, students, independent developers, and on a "trade-in" basis. Site licenses.



Manx Software Systems  
One Industrial Way  
Eatontown, NJ 07724

MS is a registered TM of Microsoft, Inc., CP/M TM DRI, HALO TM Media Cybernetics, PANEL TM Roundhill Computer Systems, Ltd., PHACT TM PHACT Assoc., PRE-C, Plink-86 TM Phoenix, db Vista TM Raina Corp., C-terp, PC-lint, TM Gimpel Software, C-tree TM Faircom, Inc., Windows for C TM Creative Solutions, Apple II, Macintosh TM Apple, Inc., TRS-80 TM Radio Shack, Amiga TM Commodore Int'l.

Inquiry 215

" . . . a superb linker, a profiler, an assembler, and a set of development utilities are only the beginning of this package . . . performed admirably on the benchmarks, with short compile times and the best link times in this review . . . includes the most professional make utility . . . documentation is clear and complete. There is no doubt that this is a valuable and powerful programming environment." **Computer Languages Feb. '86**

" . . . execution times are very good, close to the best on most tests . . ." **PC Tech Journal Jan. '86**

" Easily one of the fastest compilers overall . . . library provides a lot of flexibility . . . generates small .EXE files." **Dr. Dobbs Journal Aug. '85**

<b>C'Prime (Compiler, Assembler, Linker)</b>	<b>\$ 99.</b>
<b>Aztec C 86-d Developer's System</b>	<b>\$299.</b>
<b>Aztec C 86-c Commercial System</b>	<b>\$499.</b>
<b>PC ROM (8086, 68000, 8080, or 6502)</b>	<b>\$750.</b>

Third Party Software for Aztec C: HALO, PHACT, C-tree, PRE-C, Windows for C, PC-lint, PANEL, Greenleaf, db Vista, C-terp, Plink-86, FirstTime, C Util Lib, and others.

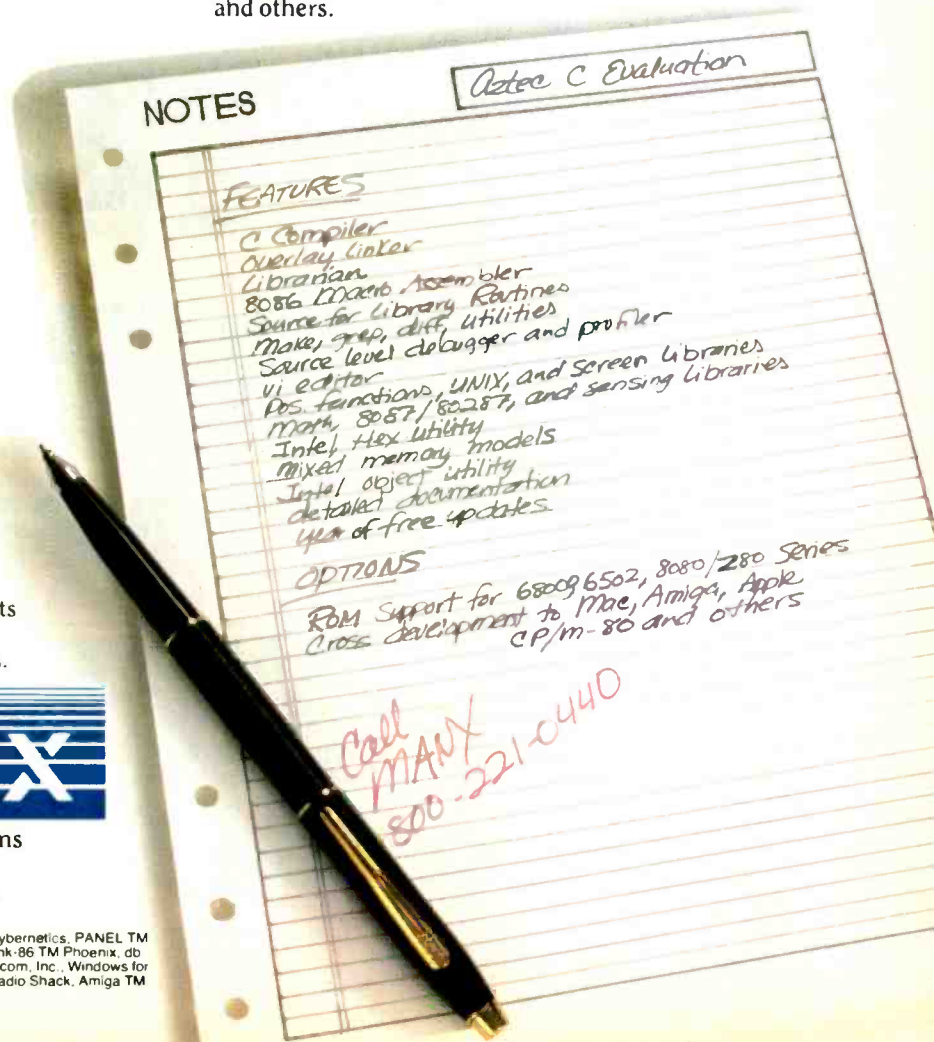

# SOLID CITIZENS.



Presenting four fine, upstanding Citizens who'll give you service and value above and beyond the call of duty for many years to come. Citizen™ dot matrix printers, precision-engineered by the people who've become a wristhold word in fine, precision-engineered watches.

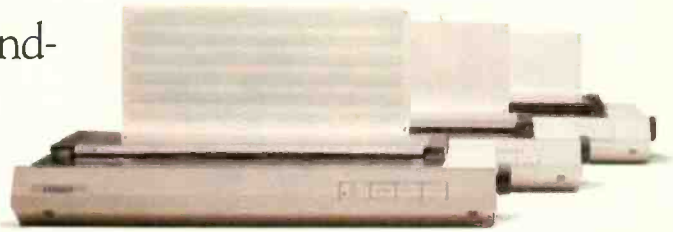

The Citizens are very sleek, very quiet, and reliable as the day is long. They're also exceptionally easy to use, thanks to a unique new push-feed paper loading system. What's more, the Citizens are very versatile. They're IBM® and Epson®-compatible. Can print graphics.

And give you output speeds of 160 cps (40 cps correspondence-quality) or a blazing 200 cps (50 cps correspondence-quality).

The Citizen MSP-10 and 15, and MSP-20 and 25. Precision-engineered printers at a price precision-engineered to put a smile on your face.

Stop by one of our dealers today and watch what the Citizens can do for you.

For more information, call 1-800-556-1234, Ext. 34. In California, 1-800-441-2345, Ext. 34. Or write Citizen America Corporation, 2425 Colorado Avenue, Santa Monica, CA 90404.



© 1984 Citizen America Corporation

Citizen and the Citizen logo are trademarks of Citizen America Corporation. IBM is a registered trademark of International Business Machines Corporation. Epson is a registered trademark of Epson Corporation.

WE TOP IBM BEAUTIFULLY



IBM's Personal Computer is the standard of the industry, but a Thomson monitor gives your IBM's great body a beautiful face. A Thomson monitor atop your IBM simply outperforms the IBM Color Display.

Here's proof:

FEATURE	THOMSON .38mm COLOR	IBM COLOR DISPLAY	BENEFIT
Dot pitch (in mm)	.38	.43	Superior resolution
Screen	Non-glare	Glare	Less eyestrain
Switch for green/amber text	Yes	No	Improved legibility
All major controls up front	Yes	No	Greater convenience
Warranty	1 yr.	90 days	Greater confidence
List Price	\$549	\$680	A bargain

Who is Thomson? Thomson is a six billion dollar multi-national company. Unlike our competition, we design and build our own monitors with stringent quality control. We offer monochrome or color monitors from TV-grade to high resolution.

Call 1-800-325-0464. In California call 1-213-568-1002 (Monday-Friday, 9 a.m. to 5 p.m. PST) for your local Thomson dealer, and start looking at a beautiful face.

**THOMSON**   
A SIGHT FOR SORE EYES.™

© 1986 Thomson Consumer Products Corporation 5731 W. Slauson Avenue, Suite 111, Culver City, CA 90230

Thomson is a trademark of Thomson S.A. IBM is a registered trademark of International Business Machines Corp. IBM model number 5153. List prices in effect on February 18, 1986.

# CD-ROM SOFTWARE DEVELOPMENT

BY BILL ZOELICK

## *Beware of "magnetic-disk think"*

CD-ROMs (compact-disk read-only memories) provide application developers with the intriguing possibility of making hundreds of megabytes, even gigabytes of data accessible on a personal computer for less than \$1000. Such enormous storage capacity opens up new realms of potential applications for microcomputer-software developers. But there is a catch: Unless the file structures for a CD-ROM application are designed carefully, the application's performance is likely to suffer.

Typically, poor CD-ROM performance is the result of file-structure design that reflects "magnetic-disk think." If you are new to CD-ROM application design, you may tend to apply rules of thumb learned from working with magnetic media. Instead, you need to focus on the unique strengths and weaknesses of the CD-ROM.

### **PHYSICAL FORMAT**

The CD-ROM's physical format is defined by a standard developed by the Philips and Sony corporations. Since all CD-ROMs conform to this

standard, disks are usable across the different CD-ROM drives made by different companies. This common data-format standard was defined as an extension of the Philips/Sony compact digital audio disk standard. The size of the digital audio market has driven the technology that makes the relatively inexpensive manufacture of CD-ROM drives possible. However, this digital audio parentage also constrains the CD-ROM to an unimpressive random-seek performance. In particular, the underlying digital audio format results in a data format that is based on constant linear velocity (CLV) recording.

Most magnetic disks use constant angular velocity (CAV) format. Figure 1 shows the sector organization of a typical CAV magnetic disk. Note that the sectors on the inner tracks are smaller than those on the outer tracks. This is because CAV is another way of saying constant rotational speed. With a CAV format, the linear velocity of the disk surface relative to the disk head is greater on the outer tracks, where the disk's circumference is greater. As a corollary, the outer sec-

tors are physically larger.

Figure 2 illustrates the CLV sector format of a CD-ROM. CLV means that the relative speed of the disk head and disk surface stays the same, even as the head moves away from the center of the disk. A CD-ROM drive maintains this CLV by actually changing the disk's rotational speed as the head moves from track to track. Note that the CLV format results in sectors that all have the same length (the *linear* dimension). This means that the actual number of sectors encountered in a single disk rotation ranges from about 9 on the inside of the disk to about 20 on the outer edge. Therefore, recording must be done in a spiral rather than in a series of concentric rings. Recording begins at the inside of the disk and spirals outward.

The great advantage that CAV recording has over the CD-ROM's CLV

*(continued)*

Bill Zoellick is the manager of software research at TMS Inc. (POB 1358, Stillwater, OK 74076). He has an M.A. from the University of Illinois and is coauthor of a textbook titled *File Structures: A Conceptual Toolkit*, to be published later this year.

format is that the CAV organization makes it easier to find the beginning of a particular sector. Suppose that you want to jump to a specific sector relative to the start of a file. With a CAV format, where each track contains a fixed number of sectors, it is very easy to translate this *relative* sector number into an *absolute* track and sector address, given the track and sector address of the start of the file.

There is no simple, fixed relationship between a CLV track and the number of sectors on the track. Therefore, translating a relative sector number into an absolute track and sector address is more complicated. In addition, head movement must be accompanied by the mechanical process of speeding up or slowing down the rotational speed of the disk. Together these account for a major part of the CD-ROM's relatively poor seek performance.

On the positive side, CLV recording makes more efficient use of the disk surface. Rather than spreading out the data on the outer tracks as on a CAV disk, the CLV format packs the data on the outer tracks just as tightly as on the inner tracks. As a consequence, a CLV disk can hold much more information than a comparably sized CAV

disk. From the standpoint of audio recording, where the primary mode of access is sequential, the CLV format is ideal. It packs the maximum amount of music on a disk without exacting a performance penalty. However, when you build a data format on top of this audio format, you pay for increased capacity with decreased seek performance.

**PHYSICAL ADDRESSING**

The CD-ROM's CLV format rules out using the familiar "track and sector" and "cylinder, surface, and sector" addressing schemes used for most magnetic disks. Instead, the CD-ROM uses a scheme that is clearly related to the disk's digital audio roots. If you think in terms of "playing" the disk from beginning to end, you find that there is room to record 60 "minutes" worth of data. Each minute of recording can be divided into 60 "seconds." In each second the drive will play, or read, 75 sectors. Each sector consists of 2K bytes. Therefore, the entire disk can hold 270,000 (60 x 60 x 75) sectors, or 540,000K bytes. The individual sector is the smallest addressable unit on the disk. You specify a particular sector in terms of the minute of play, the second within that minute, and the

sector within that second, using zero-based counts for all numbers. The origin of the disk is specified as 0:0:0 (zero minutes, zero seconds, sector zero). The 156th sector on the disk, for example, is specified as 0:2:5, or zero minutes, two seconds, sector five (using a zero-based count).

Fortunately, application developers don't need to worry about the details of physical addressing on CD-ROMs, just as they don't concern themselves with the physical-addressing details for magnetic disks. When writing and reading magnetic media, applications generally rely on an operating system to convert the physical view of the disk into a logical view. This lets an application regard the disk as a collection of named files, rather than as an arrangement of tracks and sectors.

Laser-disk operating systems provide this same kind of file-oriented, logical view of CD-ROMs. (See the text box "CD-ROM Logical Format Standards" on page 184.) Some of them have interfaces so similar to popular operating systems that you can read from the CD-ROM using the system calls, open statements, and read statements that you are used to. CD-ROM access is just as easy as magnetic-disk access; you don't need to know about the disk's physical format to use the CD-ROM. The payoff from understanding its physical characteristics and format comes when you want to use the disk well to get top performance.

**MEASURING PERFORMANCE**

Good CD-ROM software design must reflect an awareness of the CD-ROM's weaknesses, in particular its poor seek performance. Table 1 compares a typical CD-ROM drive with two different types of magnetic-disk drives. The comparisons include capacity, seek performance, and data-streaming performance during a series of sequential reads of contiguous data. The sequential-read performance on the magnetic disks assumes an interleave factor of five, meaning that it takes five disk revolutions to read all the data in a given track.

An average seek on a full CD-ROM takes five times as long as on a

(continued)

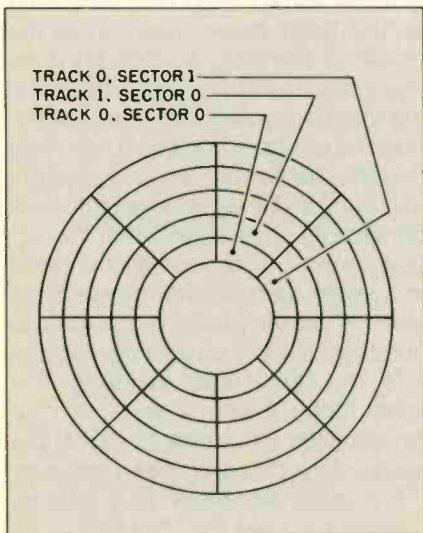

Figure 1: The sector organization of a typical CAV (constant angular velocity) magnetic disk. The sectors on the outer tracks are physically longer than those on the inner tracks and are organized in concentric rings.

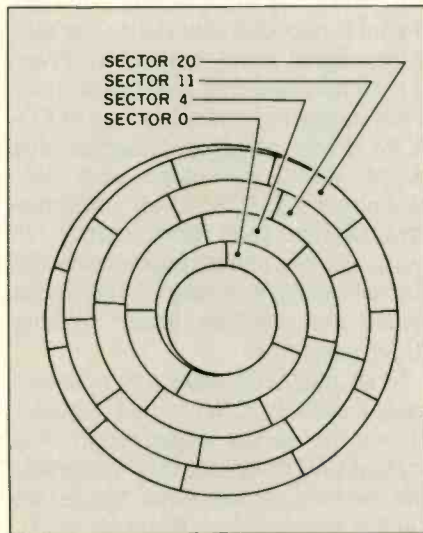

Figure 2: The sector organization on a CLV (constant linear velocity) CD-ROM. Since all the sectors have the same length, the longer outer "tracks" contain more sectors. Note the spiral appearance of this organization.

## News about the Microsoft Language Family

### Microsoft® XENIX® Languages Offer Source Compatibility with MS-DOS®

Applications developed for MS-DOS using Microsoft high-level languages can easily be transported to XENIX. The XENIX versions of BASIC, C, COBOL, FORTRAN, Macro Assembler, and Pascal offered by Microsoft are source-language compatible with the MS-DOS versions.

The object files produced by C, FORTRAN, and Pascal can be used in either operating system environment, except for FORTRAN object files that access arrays greater than 64K in length. This makes it easier to move operating-system-independent subroutine libraries between systems.

### Using MAKE to Replace Batch Files for Program Development

The MAKE utility provided with Microsoft Macro Assembler Version 4.0 can be used to replace batch files for building application programs. When using standard batch files to build an application every step has to be performed. However, with MAKE the time and date dependency rules allow recompiling, reassembling, or relinking only those files that are dependent upon recently changed files.

The MAKE utility also has rules and macros. These features provide an easy and reliable way to change how application programs are built. For instance, by defining a rule for how C files are compiled into object modules, every C compilation can be done with the same compiler options. When rules are combined with macros, new compilation options can be provided on the MAKE command line or in the MAKE file. If you regularly develop large programs and are not using a MAKE type of utility, you should investigate how it can help make your software development more efficient.

### Cullinet's Micro/Mainframe Software Developed with Microsoft Macro Assembler

Cullinet's INFOGATE® and GOLDENGATE® software supports over a dozen ways of connecting PCs to mainframes running Cullinet's Information Center Management System. "The only way we could create this transparent link was with Microsoft Macro Assembler," said Mary Kroening, Director of Micro Software Development.

"Microsoft Macro Assembler's unique type checking and data structure features make it easy to connect routines with the rest of INFOGATE or GOLDENGATE. The Macro Assembler is an especially versatile product for writing device-level code to support LAN cards, 3278 emulation cards, SDLC interfaces, async ports, and more. The increased speed and reliability in Microsoft Macro Assembler 4.0 not only makes our job easier, but also cuts the build time in half."

For more information on the products and features discussed in the Newsletter,

**write to:** Microsoft Languages Newsletter  
16011 NE 36th Way, Box 97017, Redmond, WA 98073-9717.

**Or phone:**

(800) 426-9400. In Washington State and Alaska,  
call (206) 882-8088. In Canada, call (416) 673-7638.

#### Latest DCS Versions:

Microsoft C Compiler	3.00
Microsoft COBOL	2.10
Microsoft FORTRAN	3.31
Microsoft Macro Assembler	4.00
Microsoft Pascal	3.31
Microsoft QuickBASIC	1.02

Microsoft, MS-DOS and XENIX are registered trademarks of Microsoft Corporation. INFOGATE and GOLDENGATE are registered trademarks of Cullinet, Inc.

Look for the Microsoft Languages Newsletter every month in this publication.

10-megabyte hard disk. When compared to a high-performance magnetic disk, there is more than an order of magnitude of difference in the seek performance. When designing software for a magnetic disk, you should always make a major effort to avoid seeks. Given the cost of seeks on a CD-ROM, you need to take even more draconian measures to avoid an average seek.

But table 1 provides good news along with the bad. The cost of a short seek, covering just a few tracks, is quite small because the CD-ROM only needs to move the mirror used to position the laser beam on the disk. It doesn't have to move the sled containing the mirror, lenses, and other parts of the disk-reading mechanism. (Not all drives implement such fast short seeking.)

This disparity between the cost of a short, local seek and a longer one has important consequences. It means that, as you design file structures for the CD-ROM, you should take advantage of opportunities to minimize the physical distance between parts of a file that you use in succession.

However, the CD-ROM's sequential-read performance as shown in table 1 is quite respectable. Reading a large block of data is not substantially more expensive than reading a short one. The cost is in *finding* the block.

### JOYS OF A READ-ONLY MEDIUM

The CD-ROM's acceptable sequential-read performance and its ability to

seek rapidly over the range of a few tracks are important components of a good software design. But its most significant characteristic, the one that lets you take advantage of the others, is that it is a read-only medium.

Two important, closely related benefits emerge from the CD-ROM's read-only nature:

- You never have to deal with deletions, insertions, or modifications to a file.
- The costs of creating a file structure (writing) and using it (reading) are asymmetric (not equally balanced).

Although the first of these benefits is self-evident, it has important consequences. For example, when you build a tree, you know that the nodes near the root will always be near the root, so you can put the most frequently used records in these nodes.

The second benefit requires a bit more explanation. You write a CD-ROM only once. Once the disk is written, it is read over and over again. Therefore, it makes sense to put more time and effort into the initial construction of files and indexes if you can thereby obtain faster retrieval. Moreover, building a CD-ROM's file and index structures is often done on a larger computer, while retrieving them is more often done on a microcomputer. Consequently, more computing "horsepower" is available to build the files. If expensive tasks such as lexical analysis and text formatting are necessary, it is better to do them once with the larger machine before

you create the disk. Finally, data for a CD-ROM is usually prepared in a batch-processing environment, while it is often used interactively. This provides even more incentive to do as much work as possible in the writing step.

### BLOCKS AND BUFFERING

One general rule underlying all file-structure design, whether on CD-ROMs or magnetic disks, is to make each trip out to the disk as profitable as possible. This is the reason for using paged structures such as B-trees, in which each disk access retrieves enough information to make many decisions about the next level of the tree, rather than the simple two-way choice in a binary tree. You don't access the disk to retrieve a single record; you read in a block of records that you can then process in the much faster RAM environment. Although the CD-ROM seeks slowly, it can "stream in" the data in a large block at an acceptable rate. This makes the choice of block size extremely important.

When selecting a block size, you need to consider both logical and physical design factors. Logically, for example, you should consider the effect of page size on the depth of a B-tree. In a B-tree, a page that holds  $N$  records can have  $N + 1$  children, as figures 3a and 3b illustrate. The small tree pictured in figure 3a holds eight records and has a height of two levels. This is an ideal height, since if you

(continued)

Table 1: Comparison of seek times and data-transfer rates for CD-ROMs and magnetic disks.

	CD-ROM	Average microcomputer hard disk	High-performance magnetic disk
Capacity	540 megabytes	10 megabytes	456 megabytes
Number of tracks per read head	approximately 18,000	612	1258
Track-to-track seek	1 ms	3 ms	7 ms
Average seek	500 ms	100 ms	28 ms
Maximum seek	1 sec	200 ms	50 ms
Rotational speed	approximately 300 rpm (variable)	3600 rpm	3600 rpm
Average latency	100 ms	8.3 ms	8.3 ms
Transfer rate for sequential read	150K bytes/sec.	96K bytes/sec	312K bytes/sec



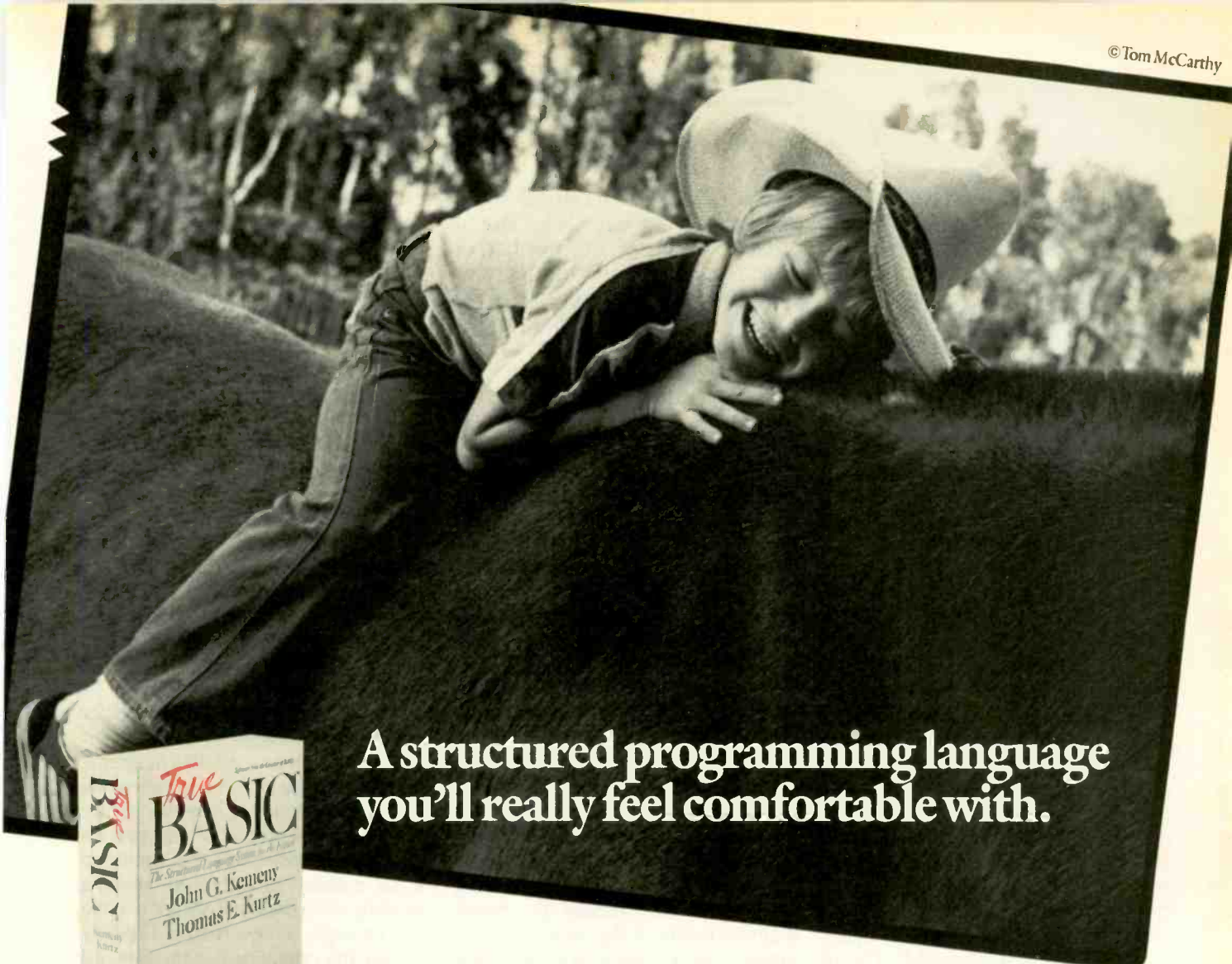

## A structured programming language you'll really feel comfortable with.

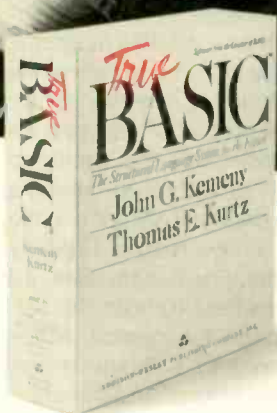

You know John Kemeny and Tom Kurtz. They developed the original BASIC. Now they're back with an even better version: a flexible, easy-to-use structured programming language they call True BASIC.

True BASIC offers a full selection of control structures. External procedures can be compiled into libraries, making True BASIC faster and more powerful than any other programming language.

True BASIC has a complete matrix algebra package and the best graphics ever in a higher level language. And there are optional libraries for things like sorting and searching and 3-D graphics.

True BASIC programs run on any computer which runs True BASIC, good news for users with more than one kind of PC.

You'll love True BASIC. Whether you're programming for your own applications, teaching others, or developing products to go to market, send in the coupon below to receive a free demo disk.

Available for the IBM-PC™ and compatibles, Apple Macintosh,™ and Commodore Amiga.™ To order, talk to your local dealer or call (603) 643-3882 TODAY!



**True BASIC** inc.

39 South Main Street,  
Hanover, NH 03755 (603) 643-3882

My computer is:  IBM-PC/compatible  
 Apple Macintosh  
 Commodore Amiga

- I'D LIKE TO GET MY FREE DEMO DISK.
- I'd like more information on the True BASIC language products.
- I'm ready to buy. Call me and tell me how.
- I'd like information on True BASIC Mathematics Series and other products.

Name \_\_\_\_\_  
 Title \_\_\_\_\_  
 Company/University \_\_\_\_\_  
 Address \_\_\_\_\_  
 City, State, ZIP \_\_\_\_\_  
 Telephone \_\_\_\_\_

Suggested retail price \$149.90  
Educational site licenses available from Addison-Wesley Publishing.

True BASIC Language System is a trademark of True Basic, Inc. Macintosh is a trademark of Apple Computer Corp. Amiga is a trademark of Commodore Business Machines. IBM is a trademark of International Business Machines Corp.

keep the tree's root page in RAM, you can get to any record in the tree with only one seek. If you need more records in the tree, you can add space by adding more levels, but this increases the average number of seeks required for a search. The alternative is to increase the block size as shown in figure 3b. Doubling the block size more than doubles the number of records that can be held in the tree.

To really appreciate the effect of doubling the block size, you need to deal with a larger number of records per block. Table 2 shows the number of 32-byte records that you can store in a tree, given a choice of block sizes and a choice of tree depth. Since the CD-ROM is a read-only medium, you know exactly how many records you are going to put in the tree before you build it. For example, if you need to store 50,000 32-byte records, you could choose a block size of 8K bytes and a tree of two levels rather than use a block size of 2K bytes and a tree of three levels. If you use a larger block size, it will take more time to read each block, but since CD-ROMs can read data at 150K bytes per second, reading an additional 6K bytes requires only 20 milliseconds. This is a small price to pay in return for avoiding an additional 500-ms seek.

These logical design considerations argue for using a large block size in order to minimize the number of seeks required to find a record. However, the *physical* characteristics of the CD-ROM must also be considered in determining what block size to use.

Given the 2K-byte sector size for a CD-ROM, the smallest block size that you should consider for most applications is 2K bytes. This is the amount of information that you will retrieve even if you only request a single byte. But suppose you are absolutely sure that you need only the first 32-byte record in a sector. Why not just ask for what you need? Or, if it is convenient from a logical design standpoint, why not use blocks of, say, 3000 bytes?

The answer to these questions has more to do with the CD-ROM operating system than with the disk itself. If an application program requests an entire sector of data from the disk (or an integral number of entire consecutive sectors), a well-designed operating system transfers the data directly into the application program's work area with no intermediate data movement. However, if the application requests only 32 bytes, or some other fragment of a sector, the operating system cannot assume that the appli-

cation has allocated enough space to hold an entire 2048-byte sector. Since 2048 bytes is the smallest quantity that the operating system can bring in from the disk, the operating system must use a system buffer to hold the complete sector and then break out the requested 32 bytes for transfer into the application's work area. Thus a request for anything less than a complete sector involves moving data twice, while a request for a complete sector requires only a single data movement. Similarly, a request for some quantity such as 3000 bytes that occupies some fraction more than one sector requires extra data movement for the fragment that must be brought in from the second sector. To avoid unnecessary data movement, use a block size that is an integer multiple of the 2K-byte sector size.

The decision to read data in integer multiples of the sector size has an important consequence, however: By bypassing the system buffers, you relinquish the assistance that the operating system provides in keeping recently used data in RAM for a while. For example, if you read a 128-byte record, the operating system uses one of its system buffers to hold the sector that contains the record. If you then read a second 128-byte record from a different sector, and if there is more than one system buffer, a well-designed operating system places the new sector in a different buffer, preserving the original sector. If the third record required by the program is back in the first sector (this kind of reuse often happens in searches down through trees), no seek to the disk is necessary; the required sector is "buffered" and already in RAM.

Now suppose that instead of reading 128-byte records, you read 2K-byte blocks to avoid moving data twice. Unless you provide your own buffering mechanism, the second sector is read in on top of the first one. Allocating a larger number of system buffers has no effect, since the system buffers are not being used. If you want the benefits of buffering, you have to handle it yourself. The decision of how many buffers to provide and how

(continued)

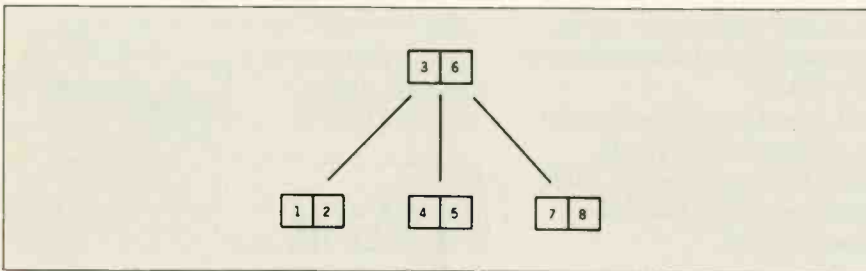

Figure 3a: A two-level B-tree with a block size of 2.

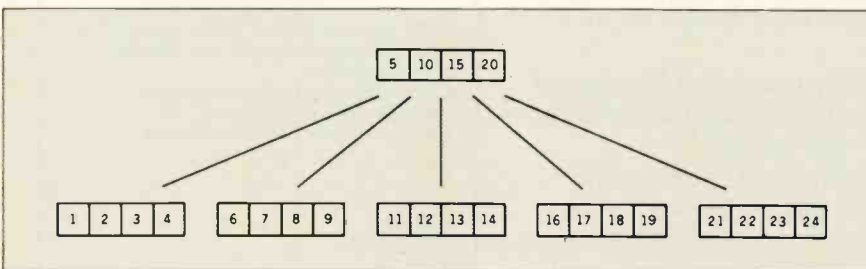

Figure 3b: A two-level B-tree with a block size of 4. Note that doubling the block size from figure 3a more than doubles the number of records the tree can hold.

# Give Your PC A Kiss.™



Once you do, you'll fall in love.

KISS is the first intelligent laser printer that's both smart and simple. And at the unbelievably low price of \$1,995\*, it's the perfect mate to any PC.

It's so sophisticated, you'll want to kiss your old daisywheel and dot matrix printers goodbye. KISS is ten times faster. And it's very quiet. It produces crisp, near typeset quality output at up to 400 characters per second. And it has its own cut-sheet feeder.

It lets you show your own style. It has nine resident fonts that you can mix on a single page, and even on one line. Imagine all that power packed in one little KISS.

Plus, KISS is smarter than your old printer. It works with WordStar® Lotus® and any other software that will print to a Diablo 630® Epson FX 80® and QUME Sprint®. At up to 6ppm KISS is unmatched in efficiency and versatility. Can you imagine your present printer performing like that? We can't.

KISS is from QMS. It's just one way we're meeting today's needs with proven technology.

Now, wouldn't you like a KISS?

Call toll free, 1-800-245-KISS for more information.

Or write: QMS INC., P.O. Box 81250, Mobile, Alabama 36689.

One Magnum Pass, Mobile, Alabama 36608.

## QMS®

Print Systems With Imagination™

\* This price good in the domestic United States only.

WordStar is a registered trademark of Mikropro International. Lotus is a registered trademark of Lotus Development Corporation. Diablo is a registered trademark of Xerox Corporation. Epson is a registered trademark of Epson America, Inc. QUME Sprint® is a registered trademark of QUME Corporation. ©1986 QMS® Inc.

to manage them depends on the nature of the application. If it searches through tree-structured indexes or works both forward and backward through a sequence, it can benefit from a relatively large number of buffers. If it uses the data sequentially and always moves through it in one direction, the application won't benefit from buffering at all.

A good general-purpose buffer-management scheme is one known as least recently used (LRU) replacement. In LRU replacement, the buffer selected for holding new data (and overwriting existing data) is the one with contents that have been used "least recently." (See Harvey Deitel's *An Introduction to Operating Systems*, listed in the bibliography, for a discussion

of LRU and other replacement strategies.)

### TREE-STRUCTURED INDEXES

The general form of a tree structure on a CD-ROM disk is much the same as that of a broad, shallow B-tree or B+ tree. But B-trees and B+ trees are normally constructed to be dynamic structures that can readily accommodate insertions and deletions. Since the CD-ROM is not concerned with these, other opportunities become available.

One of the most significant of these opportunities is the ability to pack the blocks of the tree completely full, or as close to completely full as you wish. The tree uses less space, and packing the blocks full means that each block can have a greater number of children, producing a broader, shallower tree. (The numbers in table 2 assume that the blocks are completely full.) If you want to store 15,000 records, you can do so in two levels by using a 4K-byte block size if you pack the blocks full. But if the blocks are only 75 percent full, you will need three levels.

If you build B-trees by inserting records randomly and using those methods developed for handling the growth of dynamic trees, you produce trees with blocks between 50 and 100 percent full with an average utilization of between 67 and 85 percent. You don't produce trees with blocks that are completely full. In order to pack as many records as possible into each block, you must develop a special tree-loading procedure that doesn't use the usual block splitting involved in B-tree insertion.

To develop an appropriate tree-loading procedure, first you sort all the records by their keys. Then you begin loading the tree by writing the sorted records one at a time into the leftmost block at the lowest level of the tree. When that block is full, you write it out to disk. The next record goes into a parent block. Then you fill the next block at leaf level. When this second leaf block is full, you write it out to disk and place another single record in the parent block. This process continues until you have loaded

(continued)

Table 2: The maximum number of 32-byte records that will fit in a B-tree of the given height and block size.

	TREE HEIGHT		
	One level	Two levels	Three levels
Block size = 2	64	4,160	270,400
Block size = 4K	128	16,512	2,130,048
Block size = 8K	256	65,792	16,908,544

## CD-ROM LOGICAL FORMAT STANDARDS

Logically, a disk contains a volume table of contents, a directory structure, and data files; physically, the disk contains sectors. Clearly, the logical view is built on top of the physical view. For an application developer, the logical view is the one of interest, the one that determines how many files you can store on a CD-ROM, what the performance cost of storing many files rather than just a few would be, how large a file can be, whether files can span across CD-ROMs to form a multivolume set, whether files must consist of sequential consecutive sectors, whether the directory structure supports subdirectories, and so on.

As yet, there is no agreed-upon standard for the CD-ROM's logical format. Most firms offering applications for CD-ROM disks have developed their own logical structures, if only for internal use. These logical formats are usually tied into some kind of CD-ROM operating system that insulates the applications from having to know anything more than the name of the file that they wish to use.

The products that are currently available differ in a number of interesting ways. Some are good at handling tens of thousands of files; others are better at providing DOS-like abilities such as using wild cards in directory listings and listing subdirectories along with files through the DIR command. Still others provide no direct connection to MS-DOS at all and require that you develop special assembler routines to manage a command block for the CD-ROM file server. The various systems also differ in the degree to which they use a logical structure to maximize the advantages associated with read-only media and minimize the impact of the CD-ROM's slow seek performance.

This situation is in a state of rapid change. There is a movement afoot toward cooperation among the various firms currently involved with CD-ROMs to resolve the differences in their formats and create a common logical structure. Hopefully, we will see some kind of logical format standard in the near future.



# Imagine him at 70 MPH.



If the pace of your PC is driving you buggy, read on. Because now you can make it function up to 700% faster with the *SpeedPac 286*<sup>™</sup>.

So what once took eons for your IBM PC or PC/XT, now happens in a flash. Often faster than an AT. And for a lot less than you might think—just \$595. And you don't have to add memory, or worry about software compatibility. What's more (or less), our 80286-generation accelerator is a half-slot board, which saves room for other add-on cards. And installing it is so easy it's virtually goof-proof. But then so is buying it—you get a **60-day Money-Back Guarantee**. Call Lynn at **1-800-248-5252** for more information, your nearest VICTOR dealer, or to order your *SpeedPac 286*. It'll turn your sluggish PC into a whole different animal. So why wait any longer?

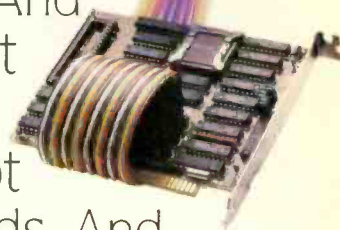

# IEEE-488



## GPIB ↔ PC

### Hardware Flexibility

- Low cost for instrument control
  - 300K bytes per second
  - \$395 complete with software
- High performance data links
  - Maximum speed of GPIB
  - On-board buffering

### Software

- Over \$1,000,000 in software development
- Easy to use, yet handles any GPIB application
- Works with Lotus 1-2-3
- UNIX, DOS and over 12 languages

### Applications Support

- Applications Library with sample programs & TIPS for all major instruments
- Full staff of Applications Engineers dedicated to support your specific needs

### Other IEEE-488 Products

- Interfaces & Software for
  - Multibus VMEbus
  - DEC Q-bus & UNIBUS
  - STD & S-100 bus
- General GPIB Products
  - GPIB Bus Testers
  - GPIB Bus Extenders
  - Stand-Alone Controllers



12109 Technology Boulevard  
Austin, TX 78727  
1 (800) 531-GPIB  
In Texas (800) IEEE-488  
Telex: 756737 NAT INST AUS

## CD-ROM SOFTWARE

all the records. When you are finished, the records are arranged in the blocks in the type of numbered sequence shown in figures 3a and 3b.

The primary advantage of this loading procedure is that it capitalizes on the read-only nature of the CD-ROM by building a shallow tree and avoiding seeks. It also has an important second advantage. If you write out each block as soon as it is full (including the blocks containing "promoted" keys at higher levels in the tree), you are placing parent blocks in physical proximity to their children, making use of the CD-ROM's better performance on short, local seeks. Since the CD-ROM is read-only, this proximity of parents and children will not be disturbed.

There are additional opportunities for decreasing seeks if you know something about the distribution of requests for the records stored in the tree. If the 80/20 rule applies to the database—80 percent of the requests are for 20 percent of the records—you can greatly reduce the number of seeks needed by ensuring that the most frequently requested records are located as close to the root block as possible. You can build this preference for promoting more frequently used records into the bottom-up loading procedure. You must build blocks that are less than completely full, since you need to choose from several records for promotion, selecting the one that has the highest frequency of use rather than the one that produces the fullest leaf-level block.

One great advantage of working with a read-only medium is that you can calculate precisely how far you can go in trading space utilization for flexibility. For example, you can see in table 2 that if you have 12,000 records that require 32 bytes apiece, and if you intend to use a block size of 4K bytes, you need only guarantee space utilization of 73 percent ( $12,000/16,512 = 0.73$ ) to ensure that the tree does not exceed two levels. The loading procedure can keep track of its progress toward meeting this goal as it chooses records for promotion. Once you have constructed such a tree, you know it won't be altered. These suggestions illustrate general

CD-ROM design considerations. You should compensate for the CD-ROM's poor seek performance by taking advantage of its read-only nature and the asymmetry between reading and writing activity. The asymmetry makes it worthwhile to invest more time and effort in the construction of the tree; the read-only nature makes that investment possible and permanent.

### HASHING ON CD-ROMS

For applications that don't need to access records in order by key, hashed retrieval fits the strengths and weaknesses of the CD-ROM almost ideally. Hashing complements the capabilities provided by tree structures. If you need to retrieve all the records with keys that include the last name "Smith," you should use a tree structure, since you can keep all these records together in sequential order in a tree. However, if the application only requires access to single records, and if the access needs to be really fast (no more than a single seek), you should choose hashing.

From a file-structure point of view, hashing consists of using a function to transform each record's key into the address of a specific *bucket* within the file. When you are looking for a certain record, all you have to do is apply the function to that record's key and then retrieve the bucket at the resulting address. Each bucket can hold some fixed number of records. Hashing works well and permits retrieval with a single seek as long as there is room for each record in its associated bucket. When buckets overflow, you need additional seeks and must follow procedures to find the records that can't be stored at their home addresses. One of the fundamental goals in designing a hashed file structure is to avoid overflow.

In a dynamic file on a magnetic disk, the possibility of overflow is a given. But when you construct a hashed file for a CD-ROM, you can do away with overflow entirely. You can manipulate the following variables to achieve this goal:

- the packing density of the hashed storage (the ratio of the actual record

(continued)

# MICRO CAP and MICRO LOGIC put your engineers on line... not in line.

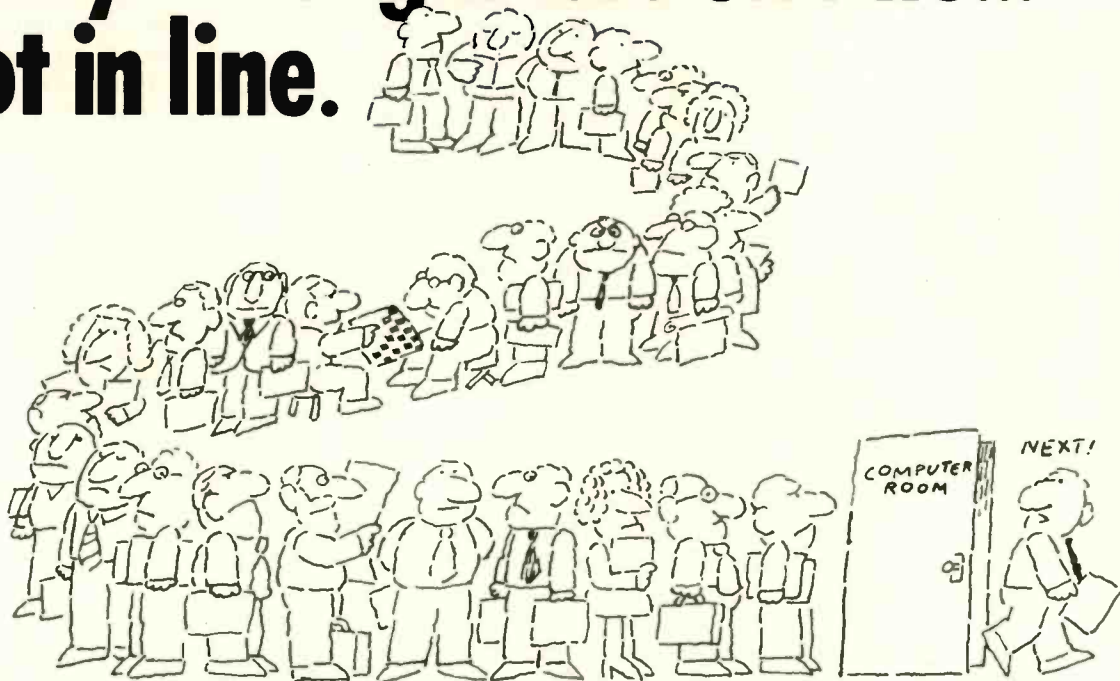

## MY OWN WORKSTATION

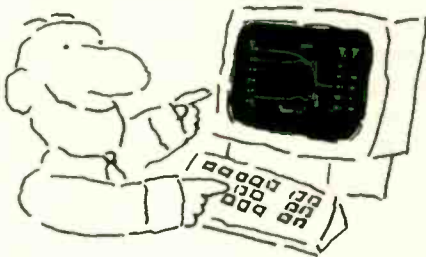

How many long unproductive hours have you spent "in line" for your simulation? Well, no more. MICROCAP and MICROLOGIC can put you on line by turning your PC into a productive and cost-effective engineering workstation.

Both of these sophisticated engineering tools provide you with quick and efficient solutions to your simulation problems. And here's how.

## MICROCAP: Your Analog Solution

MICROCAP is an interactive analog circuit drawing and simulation system. It allows you to sketch a circuit diagram right on the CRT screen, then run an AC, DC, or Transient analysis. While providing you with libraries for defined models of bipolar and MOS devices, Opamps, transformers, diodes, and much more, MICROCAP also includes features not even found in SPICE.

MICROCAP II lets you be even more productive. As an advanced version, it employs sparse matrix techniques for faster simulation speed and larger net-

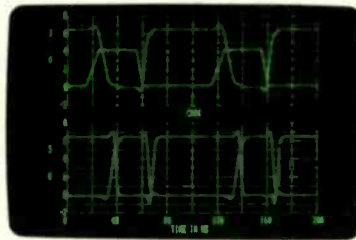

"Typical MICROCAP Transient Analysis"

works. In addition, you get even more advanced device models, worst case capabilities, temperature stepping, Fourier analysis, and macro capability.

## MICROLOGIC: Your Digital Solution

MICROLOGIC provides you with a similar interactive drawing and analysis environment for digital work. Using standard PC hardware, you can create logic diagrams of up to 9 pages with each containing up to 200 gates. The system automatically creates the netlist required for a timing simulation and will handle networks of up to 1800 gates. It provides you with libraries for 36 user-defined basic gate types, 36 data channels of 256 bits each, 10 user-defined clock waveforms, and up to 50 macros in each network. MICROLOGIC produces high-resolution timing diagrams showing selected waveforms and associated delays, glitches, and spikes—just like the real thing.

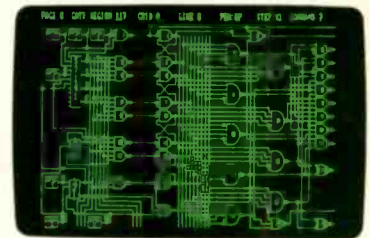

"Typical MICROLOGIC Diagram"

## Reviewers Love These Solutions

Regarding MICROCAP... "A highly recommended analog design program" (PC Tech Journal 3/84). "A valuable tool for circuit designers" (Personal Software Magazine 11/83).

Regarding MICROLOGIC... "An efficient design system that does what it is supposed to do at a reasonable price" (Byte 4/84).

MICROCAP and MICROLOGIC are available for the Apple II (64k), IBM PC (128k), and HP-150 computers and priced at \$475 and \$450 respectively. Demo versions are available for \$75.

MICROCAP II is available for the Macintosh, IBM PC (256k), and HP-150 systems and is priced at \$895. Demo versions are available for \$100.

Demo prices are credited to the purchase price of the actual system.

Now, to get on line, call or write today!

## Spectrum Software

1021 S. Wolfe Road, Dept. B  
Sunnyvale, CA 94087  
(408) 738-4387

Inquiry 401

count to the total capacity of the storage space)

- the size of each block or bucket (the number of records that can be stored at any given address)
- the design of the hash function itself

Clearly, packing density is relevant, since you can avoid overflow by placing a small number of records into a large file. The more tightly you pack a file, the more likely you are to overflow at least one bucket.

Bucket size also affects overflow. You could guarantee no overflow if you considered the entire file to be a single bucket. Unfortunately, you would have to read the entire file into RAM and process it there. At the other extreme, overflow would almost certainly occur if you used buckets that held only one record each.

Table 3 describes the effect that packing density and bucket size have on the probability of overflow, provided you have a hash function that distributes records randomly across the buckets. You can reduce overflow by manipulating these variables. For instance, if you want less than one percent of the records to overflow their buckets, you can choose from the table any of the packing-density/bucket-size pairs that fall within that percentage range.

In practice, you would probably choose a bucket size on the basis of record size and the physical con-

straints of CD-ROM sectors. You would then accept the packing density required to reach some targeted overflow probability. Table 3 demonstrates the advantage of using large buckets. The bucket size should be some integer multiple of the CD-ROM's 2K-byte sector size for the reason given earlier: A good operating system can transfer data directly into the program's work area if you request complete sectors.

The percentages provided in table 3 were calculated using the Poisson distribution, which assumes that the hash function distributes the records randomly. Since the CD-ROM is a read-only medium, you have a complete list of the keys to be hashed before you build the file. You can analyze the keys to find functions that distribute them more uniformly than a random function would. A perfectly uniform distribution would place an equal number of records in each bucket, guaranteeing no overflow even at a packing density of 100 percent. Although developing a function that yields such perfection can be very time-consuming, you can often find an economical way to improve on purely random distributions, thereby allowing higher packing densities while still avoiding overflow. You can, in short, treat parameters within the hash function as variables just as you considered bucket size and packing density as variables. Optimizing a

hash function is made possible by the disk's read-only nature and practical because you can use large computers working in a batch-processing environment to create the data set that will ultimately be used interactively by small computers.

### CONCLUSION

A CD-ROM drive seeks slowly, making it all too easy to develop applications that perform very poorly on it. Even if you are an experienced programmer, you can make design mistakes that result in poor performance if you fall into "magnetic-disk think." You need to focus squarely on the physical characteristics of the CD-ROM, taking advantage of the medium's strengths while avoiding its weaknesses.

When the design work is done well, the payoff can be impressive: the CD-ROM enables you to move very large databases out of book form, out of centralized time-sharing systems, and off microforms. It provides convenient access to data inexpensively through mass distribution, and it offers exceptionally fast, convenient retrieval of these databases on very small computers. ■

### BIBLIOGRAPHY

- Bayer, R., and E. McCreight. "Organization and Maintenance of Large Ordered Indexes." *Acta Informatica*, vol. 1, no. 3, (1972), page 173. This is the classic, original article describing B-trees.
- Bradley, James. *File and Data Base Techniques*. New York: Holt, Rinehart & Winston, 1981. Contains a good chapter on hashing.
- Comer, Douglas. "The Ubiquitous B-tree." *Computing Surveys*, June 1979, page 121. Excellent overview of B-trees and B+ trees.
- Deitel, Harvey. *An Introduction to Operating Systems*. Reading, MA: Addison-Wesley, 1984. Brief overview of LRU and other buffer-replacement strategies.
- Shuford, Richard S. "CD-ROMs and Their Kin." *BYTE*, November 1985, page 137. Description of the physical characteristics of CD-ROMs and other optical media.
- Zoellick, Bill. "File System Support for CD ROM." In *The New Papyrus: CD ROM*, Steve Lambert and Suzanne Ropiequet, eds. Redmond, WA: Microsoft Press, 1986. Issues of software development applied to CD-ROM file systems.

Table 3: The percentage of hashed records that will overflow their buckets given a particular packing density and bucket size. (Values less than 0.1 percent are indicated by ~.)

Packing density (percent)	Bucket size (number of records)				
	1	2	5	10	20
10	4.8	0.6	~	~	~
20	9.4	2.1	0.1	~	~
30	13.6	4.5	0.3	~	~
40	17.5	7.3	1.1	0.1	~
50	21.3	10.3	2.4	0.4	~
60	24.8	13.6	4.4	1.2	0.2
70	28.0	17.0	7.1	2.8	0.8
80	31.2	20.4	10.2	5.2	2.3
90	34.0	23.7	13.7	8.5	4.8
100	36.7	27.0	17.5	12.4	7.7



# PERFORMANCE

In a multi-user system, performance is the most important ingredient.

That's why we build performance into every aspect of our multi-user systems.

The **CompuPro 286/40™** offers more performance for the money than any competing system; a powerful 8 MHz 80286 processor, 768K of memory, 40 megabyte hard disk, 9 serial ports, floppy and tape backup drives, Concurrent DOS 816™ multi-user, multi-tasking operating system and applications including NewWord™.

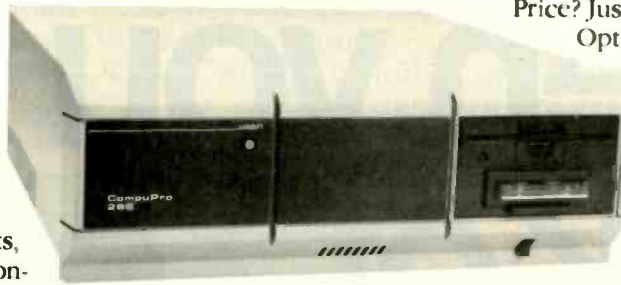

Price? Just \$9995. Now that's performance!

Options? How about memory expansion to a megabyte, 80 megabyte hard disks, slave processors, networking, graphics and more.

To find out how the CompuPro 286/40 (or any of our other multi-user systems) can give your business the performance it needs, contact a distributor listed below for the name of your local CompuPro dealer.

# PERFORMANCE ACCELERATORS

CompuPro's high performance S-100/IEEE 696 board products are the heart of our high performance systems. If you're looking to boost your system's performance or you're choosing boards to build new systems, you can't buy better boards than ours. Here are some of the highlights:

**CPU 286™:** 8 MHz, no wait state 80286 processor will really boost your system's performance. \$895.

**SPUZ™:** 8 MHz Z80H slave processor for concurrent 8-bit task processing reduces workload of host processor. 64K (one task) version: \$295. 256K (four task) version: \$395.

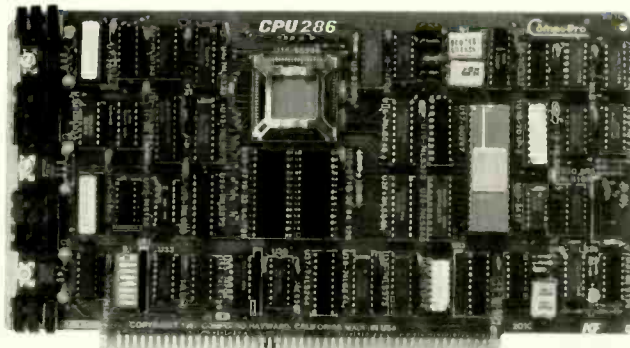

now be used as a hard disk cache under Concurrent DOS 816 version 4.1. 512K version: \$495. 2 Megabyte version: \$1095.

**Fast Static RAM:** Low power, high speed static RAM eliminates the wait states needed with dynamic RAMs. **RAM 22™** (256K): \$595. **RAM 24™** (1 Mbyte on a single card): \$2995.

**NET 100™:** Local Area Network board features high speed (2.5 MBPS) transfers using standard coax cable. Network multiple systems (even PCs) together for resource sharing and to increase performance in larger installations. \$395.

**M-Drive/H™:** RAM disk can increase system throughput by as much as 3500% and can

**AT COMPUPRO, PERFORMANCE IS NOT JUST ANOTHER BUZZWORD.**

Call the Distributor Near You For The Name Of Your Local Dealer:

**Canada**—Tri-M Systems (604) 438-0028

**Hawaii**—Viaduct (808) 242-9113

**Illinois**—Tek-Aids Industries Inc. (312) 870-7400

**North Carolina**—General Semantics (919) 378-1500

**Ohio**—QDP Computer Systems Inc. (216) 526-0838

**Pennsylvania**—Tek-Aids Industries Inc. (215) 337-3220

**Texas**—Business Systems (214) 785-0041

West of the Rockies (except Hawaii)

Call CompuPro direct for the name of your local dealer.

## CompuPro™

Viasyn Corporation 26538 Danti Court, Hayward, CA 94545-3999 (415) 786-0909

CompuPro, CompuPro 286/40, CPU 286, SPUZ, Net 100, M-Drive/H, RAM 22 and RAM 24 are trademarks of Viasyn Corporation. Concurrent DOS 816 is a compound trademark of Digital Research Inc. and Viasyn Corporation. NewWord is a trademark of NewStar Software, Inc. SuperCalc 2 is a trademark of Computer Associates International Inc.

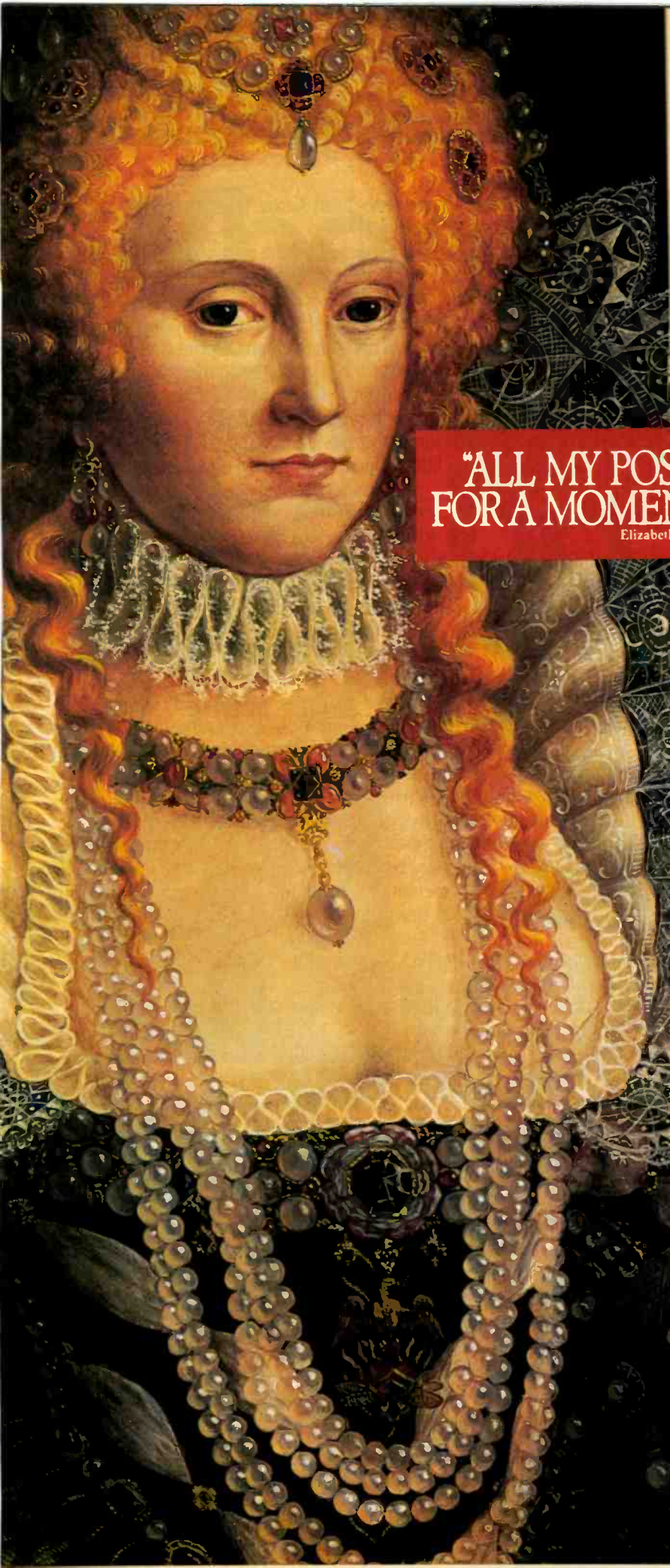

**"ALL MY POSSESSIONS  
FOR A MOMENT OF TIME."**  
Elizabeth



The ITT XTRA XP desktop personal computer

**You can't buy time.**

Long before Queen Elizabeth I, man began his quest to hoard that most precious and elusive of commodities. Time.

He can only make better use of the few hours he already has.

Hence, the development of today's business computer.

**The ITT XTRA™ XP. Our crowning achievement.**

By matching memory to the muscle of the Intel 80286 microprocessor, we're able to achieve "no wait states."

Processing never pauses for slower memory.

Making the ITT XTRA XP thirty percent faster than the IBM AT. And fully XT-compatible.

Giving you speed and flexibility.

Because, being a corporation of many businesses, we're in a unique position to better understand what you need to grow.

Today, as well as tomorrow.

	ITT XTRA XP	COMPAQ 286	IBM PC/AT
Lotus 1-2-3	11sec	13sec	15sec
dBase	36sec	52sec	56sec
FormSort	52sec	1min 5sec	1min 10sec

All comparisons are for purposes of illustration only. User's application performance is dependent on application.

**A moment's investment today can pay off royally tomorrow.**

Call (800) 321-7661. In California, (800) 368-7300.

And call quickly. Every moment wasted is a potentially profitable moment you'll never possess again.



**BECAUSE TIME IS THE  
ULTIMATE BOTTOM LINE.**

© 1986, ITT Information Systems. IBM, PC/AT and PC/XT are registered trademarks of International Business Machines. Intel 80286 is a registered trademark of Intel Corporation. Compaq 286 is a registered trademark of Compaq Computer Corporation. Lotus and 1-2-3 are registered trademarks of Lotus Development Corporation. dBase is a registered trademark of Ashton-Tate.

**Inquiry 180 for End-Users. Inquiry 181 for DEALERS ONLY.**

# THE APPLICATION INTERFACE OF OPTICAL DRIVES

BY JEFFREY R. DULUDE

*The issues that concern an applications  
programmer working with write-once optical disks*

THE MANY ADVANTAGES of write-once optical disk drives, such as removability, ruggedness, transportability, capacity, and even low cost, do not come for free. And there are none who know that better than those of us developing IBM PC applications on write-once drives, for we are the ones who must deal with the differences between magnetic and optical disks.

Optical disks differ from magnetic disks in several respects, specifically in the write-once nature of the beasts, their pushing beyond the 32-mega-byte file limit of PC-DOS, their access time, and their manner of error handling. The write-once aspect is further complicated by directory-management issues, file updates, retrieving older information, and file extensions.

As the write-once name implies, data written on an optical disk is permanent. Information is stored by a laser, which burns holes in a special material on the disk. Once a hole is burned, it is burned forever. Period.

Also important are the differences in capacity and how that space is used. The smallest unit you can work with on an optical drive is a full sec-

tor, typically 512 bytes. This limitation exists because of a very powerful error-correction system used with every optical disk drive.

These error-correction systems work by building a unique data block, called an error-correcting code (ECC), for each sector written. The ECC mirrors the information written in that sector. Once the ECC field is written, the system can read several bytes in a sector erroneously, and yet the data can be corrected. However, the ECC is generated for the whole sector, even if only half of that sector was actually used. And because an ECC field on a write-once disk cannot be changed, any unwritten portion of a partially used sector is lost.

Fortunately, space is cheap. Optical disks have the lowest cost per mega-byte of any data-storage medium. Better still, the disks are removable. But while giving you the benefit of essentially unlimited storage, this also creates special problems for directory handling on cartridge changes.

Next, consider the access times, which are both fast and slow, depending on how far the head has to go. Op-

tical drives use a two-stage positioning mechanism to get the lens over the appropriate track on the disk. Most drives can seek optically by tilting the lens within about a 40-track range. This optical seek is very fast—about 1 millisecond per track (a track is typically about 10K bytes). Beyond that 40-track range, the drive must seek mechanically, using a stepper motor or worm gear. Due to the large mass of the optical head, this positioning takes a while, and average seek time over the entire disk surface is above 100 milliseconds.

And finally, no popular operating system supports write-once optical drives at this time. So you must deal with issues at the device level, the operating-system level, and the application level.

## THE DIRECTORY

One of the first issues you must resolve is how to put a directory onto a write-once optical disk. And for

*(continued)*

Jeffrey R. Dulude is director of marketing for Optotech Inc. He can be reached at POB 1470, Monument, CO 80132.

someone who has only dealt with erasable media, the answer is not immediately obvious, because most operating systems keep their file-allocation table (FAT) and root directories in the same locations on the disk, rewriting only parts of them as needed. However, the very fact that you can't remove information from a write-once disk suggests that you may never want to destroy a directory in the first place.

To date, at least four different ways of handling directories have been used, each with varying degrees of success. One of the earliest approaches was to keep all the data on the optical disk and all of the directory on a companion floppy disk. But what if you lose or damage the floppy disk?

Well, people do lose floppies, or the disks become erased or damaged. But when you lose the floppy disk that contains the directory for an optical disk, you've also lost all your data. I don't think anyone uses the directory-on-floppy technique any more.

Another approach keeps the directory and FAT in RAM. They are read each time the optical cartridge is inserted and rewritten on the optical disk just before the cartridge is ejected. This technique slows down cartridge changes, but it is otherwise fast because the computer can do directory searches faster when the directory is stored in RAM.

There are downsides to this approach, however. First, it uses a lot of disk space. In fact, the overhead used by all the directory and FAT rewrites on the optical disk often exceeds the size of the file data. Even worse, the system is vulnerable to power failures or someone simply turning off the machine before the directory is rewritten to the optical disk.

The last and most difficult approach to the optical disk directory issue is a unique file-management system that provides all the capabilities of PC-DOS. This type of file system keeps sets of pointers to all the subdirectories. This way, when a subdirectory is updated, only the revised portion of the directory, along with the pointers to it, is written, not the entire system. This type of system is very

space-efficient, and it has the additional advantage of being able to retrieve previous versions of files by going back several levels of pointers.

Access to this type of directory system can be provided through several means. For example, file I/O could be added to popular programming languages. Or you could write device drivers that go through DOS and look at only a 32-megabyte file window at a time. But perhaps the most powerful way is to write an interrupt handler that traps the DOS interrupt, allowing an optimal write-once directory system that would be compatible with programs written for PC-DOS.

### UPDATING FILES

Most application programs often need to change only part of a file—rarely the entire file. With write-once disks, changing only part of a file can present a problem. Two approaches are currently being used for updates. The first is to simply rewrite the entire file. This approach is not only easy to implement, it is also effective when you are dealing with many small files. Remember, space is cheap on optical disks.

Complete file rewrites become unmanageable, however, when the files become large. For example, you could not update a 150-megabyte file on a 200-megabyte disk by rewriting the entire file, and rewriting only those sectors of a file that are actually changed becomes the obvious solution. For this reason, the post-field concept was developed.

A post field is simply an address-pointer field placed after every sector on a write-once disk. This pointer field is not used when the sector is written, but later, when a replacement, or update, sector is created, the address of that new sector is written in the post field of the original sector. Then, when data is to be retrieved, the system checks the post field of the original sector to determine if that data has been changed and, if it has, where the revised data is located. And since every sector has a post field, new updates can be made to previous updates.

The advantages of post fields are

that they are space-efficient and they give an excellent audit trail for tracking changes to data. The disadvantage is that if a file has been updated frequently, the necessary optical-head travel through a long list of linked updates taxes the system's performance.

For each of the two methods of updating a file, retrieving the original data is handled differently. Where the entire file is rewritten, you need a directory system that allows access to the old file. Some directory systems do this with command extensions for file and directory utilities. Others routinely include the earlier version of the file in all directory activity, and you just specify which version of the file you want. In the post-field implementation, the system finds the original data first, so branching to the updates is available automatically.

In either case, the ability to retrieve original data is a powerful feature of write-once optical disks. Imagine an engineering drawing system that could take you back through the last three changes to see why your current version doesn't work. Or imagine a software-development environment where you could examine every interim piece of code written.

### APPENDING FILES

In addition to changing and updating original data in files, many applications require enlarging the file. Such is the case with large database-management systems, where you need to append new data to the end of existing files.

But appending files on a write-once optical disk has two problems: how to cope with the existing partially written sector at the end of the file, and how to add information past that last sector. Here, the state of the art offers three different ways to tackle the problem: rewriting the file, changing the FAT, and using a post field.

Again, rewriting the entire file is the simplest way to go. As with updating a file, however, this method works well only with small files and breaks down with large ones. Since the primary advantage of an optical disk is its ability to handle large files—the very reason most developers choose an

*(continued)*

# The Source Is Illuminating.<sup>SM</sup>



At last, a beacon to help you navigate the vast sea of personal computer technology.

It's The Source. The online information service that can guide you to the best deals in the PC market. Shed light on your software problems. And signal the latest developments in micros.

With The Source, you can buy, sell or swap hardware and software. Learn new applications from a Special Interest Group. See what's been written about the printer you're planning to buy. Or send out an SOS to thousands of other PC users when you need advice.

What's more, The Source can enlighten you with current information on everything from business to travel, investments to world news.

The Source is a service mark of Source Telecomputing Corporation, a subsidiary of The Reader's Digest Association, Inc. © 1985 Source Telecomputing Corporation.



Whatever kind of help you're after, you can find it faster on The Source. With a system of easy commands and menus. Plus a tutorial—free of online charges—that'll bring you up to speed in a snap.

To sign up today, call **1-800-336-3366**. For more information, mail this coupon, or visit your nearest dealer.

Then, no matter how many waves of new technology rock your boat, you'll stay right on course.

INFORMATION NETWORK  
**The Source**<sup>SM</sup>

The most powerful resource any personal computer can have.

Show me the light.

Please send more information about The Source.

Name \_\_\_\_\_

7827323

Address \_\_\_\_\_

City, State \_\_\_\_\_

Zip \_\_\_\_\_

Mail to: Source Telecomputing Corporation,  
P.O. Box 1305, McLean, VA 22102. In Virginia,  
or outside the U.S., call (703) 821-6666.

# WORLD'S BEST ASCII CHART

Color-coded, pleasant to look at. Durable. Combines all the information you need in an easy-to-use grid format. Handy reference guide for programming, communications, peripherals, installing software. Available in notebook size for \$4.75 + \$1.50 shipping, or poster size for \$9.95 + \$3 shipping. Calif. residents add applicable sales tax. To order, send check or money order. For more information, contact us. Dealer Inquiries Invited.

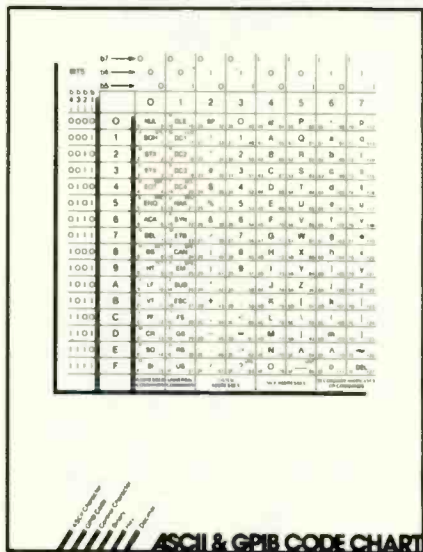

**bnw** computer specialty products  
ASSOCIATES PO Box 779's San Jose CA 95150 (408) 377-8008

## APPLICATION INTERFACE

optical disk system—this technique falls short.

If the file-management system uses a file-allocation table, changing the FAT can be a very effective way to append a file. With this technique, the last sector of the original file is read into memory, appended to fill that sector, and written elsewhere on the disk with the additional sectors following in order. Afterwards, the system writes a new FAT.

Or by using the venerable post field to replace the partially filled final sector, the system can write the rest of the appended sectors contiguous to the last one. The advantage of this technique is that the entire file can reside in contiguous sectors, speeding throughput. The disadvantage is that you must allocate space for the file—making a guess at the file's ultimate size—when the file is created.

### HANDLING THE CAPACITY

One of the more frustrating things about using an optical disk on an IBM PC is PC-DOS's limitation on the size of a logical disk volume. It is only 32 megabytes—a pittance compared to the 200 megabytes typically available on 5¼-inch write-once optical drives. Fortunately, there are a handful of ways to handle the address limitations. One way is to surrender to PC-DOS and break your disk into 32-megabyte partitions. It's easy to do, and it works.

Some people have tricked PC-DOS through one means or another to achieve addressable space greater than 32 megabytes. This gives you the capacity you want, but you sometimes pay for it with compatibility problems, which often crop up with off-the-shelf, high-performance software packages that use undocumented features of PC-DOS to achieve their performance. Another problem is that developers must redo their PC-DOS modification for any new version of PC-DOS that may be released.

The most powerful, and possibly the most difficult, way around the size limitation is with a new interrupt handler, which may also be necessary for the file-management system and directory. By trapping the operating-

(continued)

## Attention all FX80, FX100, JX, & RX owners: You already own half of a great printer

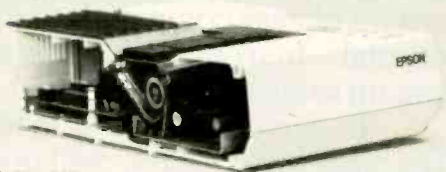

**Now  
Only  
\$79.95**

Now for \$79.95 you can own the rest. You see, today's new dot matrix printers offer a lot more.

Like an NLQ mode that makes their letters print almost as sharp as a daisy wheel. And font switching at the touch of a button —

in over 160 styles. But now, a Dots-Perfect upgrade kit can make your printer work like the new models in minutes. At a fraction of their cost.

Call now and use your Visa or Master Card. Don't replace your printer, upgrade it!

# 1-800-368-7737

In California: 1-800-831-9772

**g** Sample of letter with Dots-Perfect

## Dots-Perfect

**Dresselhaus**

Sample of letter without Dots-Perfect



837 E. Alosta Ave., Glendora, CA 91740 Tel: (818) 914-5831  
An upgrade kit for EPSON FX, JX and RX printers

EPSON is a trademark of EPSON America, Inc.

# Too much technical reading can affect your vision.



Nothing gives you a more focused view of your industry than the magazine you're holding right now.

But if you really intend to get ahead, you need a broader perspective as well. The kind provided by The Wall Street Journal.

In an age of increasing specialization, it's increasingly important to

stay in touch with the business world as a whole. So in addition to thousands of technically oriented articles each year, The Journal offers you a daily briefing of news, information and ideas that can help you make smarter decisions.

No matter what part of the business world you live in.

#### **One week free.**

To find out how useful The Journal can be—especially in a technical field—call 800-551-5700, ext. 71V. You'll receive a full business week of The Wall Street Journal free and at no obligation. Of course, you're also welcome to start a subscription.

If you can see your way clear.

## **The Wall Street Journal.**

*The daily diary of the American dream.*

system interrupt (21), the interrupt handler can intercept calls made for the optical disk while other calls are simply passed through. Once intercepted, the optical disk calls can be treated differently, allowing the write-once file-management system to be kept transparent to the user.

The difficulty, however, is that the interrupt handler must also support every disk call in exactly the same way as PC-DOS supports them. Those calls include functions that open a file, write a sector to a file, find out how much free space is on the disk, and so forth. Moreover, supporting all of those functions requires a tremendous amount of program code.

#### CUTTING ACCESS TIME

Compared to hard-disk drives, optical drives have unusual seek characteristics. They seek rapidly in a small band and slowly in a large band. As an application developer, you must maximize performance of your application.

You can measure your application's performance with two criteria: the file-management system's access time to data and its overall throughput.

How quickly you get to your data depends a great deal on how the file-management system is laid out. Some companies put the data on the outside tracks, expanding inward, and the directory on the inside tracks, growing outward. The two grow toward each other, and the disk is full when they meet. Having the data separated from the directory by almost the full disk surface could lead to long time delays between opening a file and getting data from it.

Another file-management approach is to interleave the data and directory. A "high-water" mark is kept in the directory to indicate the next available disk sector. If, when writing part of a directory, the system runs out of space, the high-water mark tells the system where to put more directory entries. A block of directory space is

reserved on the disk, and data follows it. Such interleaving minimizes the seek time between finding a directory entry and actually getting the data.

To speed throughput, you could use a file-management system that allows you to write sequential sectors of a file contiguously on the optical disk. Doing so eliminates seek time between sectors. Contrast this to PC-DOS writing to a floppy disk that has had many files erased and rewritten. When an available sector is requested, DOS just gives a file the next available sector, even if it's halfway across the disk. On a disk where available sectors are not adjacent, you get "sector scatter," and every new read or write requires a seek to a new position, making data transfer very slow.

#### ERRORS AND RECOVERY

The final issue you must address as an applications integrator using write-once optical drives is error handling. Several types of errors occur under

Why put up with...

**“ZOING! ZIP! POCKETA, POCKETA! TICK, TICK, TICK  
 ZOING! ZIP! POCKETA, POCKETA! TICK, TICK, TICK  
 ZOING! ZIP! POCKETA, POCKETA! TICK, TICK, TICK  
 ZOING! ZIP! POCKETA, POCKETA! TICK, TICK, TICK  
 ZOING! ZIP! POCKETA, POCKETA! TICK, TICK, TICK  
 ZOING! ZIP! POCKETA, POCKETA! TICK, TICK, TICK  
 ZOING! ZIP! POCKETA, POCKETA! TICK, TICK, TICK  
 ZOING! ZIP! POCKETA, POCKETA! TICK, TICK, TICK”**

when you could have...



different circumstances. You must resolve whether you or the drive manufacturer will handle them.

Some errors can be caught when the manufacturer formats the disk (often called disk certification) or when the user formats the disk (often called bad-sector mapping). In both cases, a table of bad sectors is written on the disk and made available to the controller and the host software.

The next type of errors are those found dynamically, that is, at run time. The most sophisticated optical drives have a technique for detecting errors as they are writing called direct read during write (DRDW). These drives can sense whether a particular hole in the disk has been successfully burned before the laser leaves that spot. If more bad burns are found in a sector than the ECC can correct, the drive signals that there has been a write failure in this sector.

Less sophisticated drives must wait a full revolution to read the sector

written and then compare what was written with what was read. This is similar to the verify operation done on magnetic media today, and throughput suffers dramatically. On a 21-sector-per-track drive you must write one sector, wait for 21 sectors to read and verify that sector, and then write the next sector. This is 22 (21 + 1) times slower than a DRDW drive, which detects errors on the fly.

In both cases, the system must accommodate the dynamic errors as well as the static errors found at format time. Who ends up doing the error handling varies widely between optical disk drive vendors. And the way errors are detected and treated affects performance greatly. Generally speaking, the more that is done in the drive and controller, the better the performance will be and the less work you will have to do.

With most of the 12-inch optical drives, the application developer must do all of the error handling. On the

other extreme, at least one 5¼-inch optical drive manufacturer has an error-handling system that is so sophisticated that you can literally write perfectly to every sector on the disk. This is known as true random-write capability, and it is crucial for databases that require random seeks to the middle of the disk.

Certainly, write-once optical disk drives are application-sensitive devices. And while they work superbly in many applications, they may not be suited for others. Moreover, an applications developer encounters many complicated issues when using these drives. Although we have presented a synopsis of the possible techniques that may be used, integration of a write-once optical drive depends on the particulars of your application and how all those issues affect your system.

*Editor's note: Source code of a write-once database example written by the author is available for downloading via BYTEnet Listings at (617) 861-9764. ■*

“Mmmmmmm...”

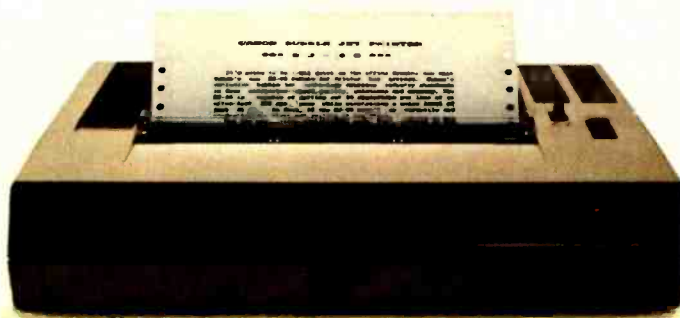

**The Canon Bubble-Jet Printer.**  
Because high-speed, high-quality printing should be seen, not heard.

The Canon Bubble-Jet Printer uses an exclusive system that combines thermal and ink-jet technology to print an ultra-fast 220 cps. While keeping the decibels down to a whisper.

For professional word processing, the Near Letter Quality mode (NLQ) churns out crisp, clear copy at a brisk 110 cps. And the BJ-80 has three graphic

image modes for high-resolution printouts of charts, graphs and diagrams.

Of course, the Bubble-Jet is fully compatible with Canon's fine line of Personal Computers and plug-compatible with the IBM PC. It's compact, lightweight and surprisingly affordable.

Ask your dealer about the full line of fast, efficient, economical Canon Printers. Find out what all the quiet excitement is about.

**Canon**  
**PRINTERS**  
Printouts that stand out.

At last, the world's  
best-selling portable computer  
has a little competition.



It's 30% smaller

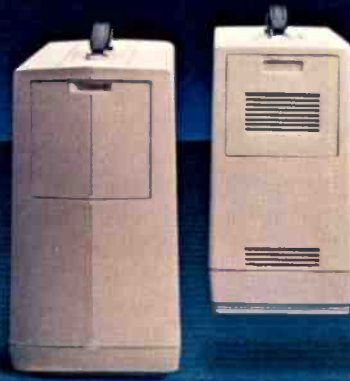

17% lighter

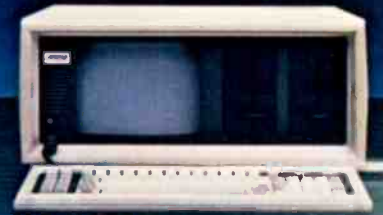

400% faster

# Introducing the remarkable new COMPAQ PORTABLE II



Now there's a portable personal computer so small, so light, and so fast it defies a new industry standard. From the same company that set the standard—COMPAQ®

The new advanced-technology COMPAQ PORTABLE II™ has all the advantages of the world's best-selling full-function portable—the original COMPAQ Portable—plus it's even more portable. And it's far more powerful than most desktop computers.

With its 80286 microprocessor, the COMPAQ PORTABLE II can run all the popular business software written for IBM® Personal Computers. At speeds *three to five times faster* than the COMPAQ Portable, IBM PC/XT™, and other compatibles.

## It's more computer in less space

Never before has a computer this small been capable of so much. Making the COMPAQ

PORTABLE II 30% smaller and 17% lighter—with no reduction in monitor size and a big gain in functionality—was an engineering triumph. The result is a full-function, advanced-technology personal computer that's easy to take on business trips or carry from desk to desk.

## A computer for now and for the future

The COMPAQ PORTABLE II excels in compatibility. And because of its standard 360-Kbyte diskette drive format, your data diskettes will be fully interchangeable with other COMPAQ, IBM, and compatible personal computers.

Expandability? An optional 10-Megabyte fixed disk drive stores over 5000 pages of data. RAM expands to 2.1 Megabytes without an expansion slot, and with one expansion slot RAM can expand to 4.1 Megabytes. Since interfaces for the most popular peripherals are already

built in, the two expansion slots can be used for *connecting* your computer to others: add a modem, a networking board, or a board for communicating with your mainframe.

## No compromises

The COMPAQ PORTABLE II puts tremendous computing potential within the grasp of every computer user. It's backed by the service and the support of over 2900 Authorized COMPAQ Computer Dealers worldwide. Plus, it's made by the undisputed world leader in portable personal computers. And for that title, there's no competition.

For the name of the dealer nearest you, call toll-free 1-800-231-0900 and ask for Operator 16. In Canada, call (416) 449-8741. In Europe, telex 84117898630AB; 898630 COMPAQ TTX D.

IBM® is a registered trademark and IBM PC/XT™ is a trademark of International Business Machines Corporation. ©1986 COMPAQ Computer Corporation. All rights reserved.

It simply works better.

**COMPAQ**  
**PORTABLE II™**

# Business Management Portrait



Improve your productivity  
with two new business software applications for  
users of IBM PC's™ and compatibles.

**Manager Mouse™ with Key Free™** for Lotus 1-2-3,™ Symphony,™ dBaseIII™ and hundreds of other popular business software.

- Easy to install
- Pop-in windows for changing key settings on the fly
- Ability to tailor keys easily

Manager Mouse, the extremely versatile, portable mouse from the Torrington Company is low on maintenance and smooth on performance. It requires no special pad and no external power supply. Long a favorite of engineers and technical people, Manager Mouse, with a patented suspension drive system runs all popular mouse driven programs.

**Call 1-800-982-0030 for dealer information.**

Manager Mouse and KeyFree are trademarks of The Torrington Company. IBM is a trademark of International Business Machines. Lotus 1-2-3 and Symphony are trademarks of the Lotus Development Company. dBase III is a trademark of Ashton Tate. TelePaint is a trademark of LCS/Telegraphics. Polaroid Palette is a trademark of Polaroid Corporation.

**Manager Mouse™ with TelePaint™** for overhead transparencies and slides.

- Enhances Lotus 1-2-3 Graphs
- Supports Polaroid Palette™ and over 20 printers
- Includes business symbols and maps

**TORRINGTON**

Part of worldwide Ingersoll-Rand

# OPTICAL DISK ERROR CORRECTION

BY SOLOMON W. GOLOMB

## *A look at Hamming and Reed-Solomon codes*

OPTICAL DISKS ALLOW a higher density of data storage than any other computer memory system currently available or imminently anticipated. For example, a magnetic 5¼-inch floppy disk, double-sided and double-density, will store up to 720K bytes, while an optical 5¼-inch disk can store as much as 550 megabytes.

It is true of most kinds of media that storage density can be further increased if you can tolerate a higher error rate. If your system is running at 1 million bits per second, an error rate of  $10^{-6}$  means that, on the average, there will be one error per second. An error rate of  $10^{-9}$  means an average of one error every 17 minutes. And an error rate of  $10^{-12}$  means an average of only one bit error every 11½ days, assuming that your system continues to run at 1 million bits per second all around the clock, seven days a week. That is why manufacturers of computers and disk drives like to specify an error rate of  $10^{-12}$  for the computer memory systems that will run with their machines.

So media makers face a dilemma. They want to pack as many bits of

storage into each disk as possible, but if their "raw error rate" goes up much above  $10^{-12}$ , they won't meet OEM specifications. Here is where error-correcting codes help.

Suppose the bits are packed so densely on the medium that the error rate is a horrible  $10^{-5}$ , corresponding to an average of 10 bit errors per second on our 1-megabit-per-second machine. With the sophisticated error-correction techniques available today, it is possible to use only 10 percent of the available bits for redundancy, having the remaining 90 percent usable for real information, and reduce the errors that get through the system from a raw error rate of  $10^{-5}$  to a corrected error rate of  $10^{-12}$ . Since degrading the error rate to  $10^{-5}$  probably at least doubled the storage density, the "penalty" of 10 percent for error correction to get the error rate back down to  $10^{-12}$  still leaves the media maker way ahead of the game.

### **WHAT ERROR-CORRECTING CODES ARE USED**

Over the past 35 years or so, many different types of error-correcting

codes have been devised, and most of them have been tried at one time or another to reduce the error rate on some type of storage media. These different types of codes are named for their inventors: Hamming codes, Fire codes, the Golay code, Bose-Chaudhuri-Hocquenghem (BCH) codes, Reed-Solomon (RS) codes, Goppa codes, etc. Each code is a collection (or dictionary) of binary code words, all of some fixed block length of  $n$  bits, of which  $k$  bits are information bits that, depending on the data to be stored, can take any possible values.

The value  $k/n$  provides a measure of the information content of code

*(continued)*

Solomon W. Golomb, Ph.D., is a professor of electrical engineering and mathematics at the University of Southern California. He is a member of the Board of Directors of Cyclotomics Inc., a company founded in 1973 by E. R. Berlekamp that designs proprietary Reed-Solomon encoders and decoders. He is also a member of the National Academy of Engineering and a fellow of the IEEE. He can be contacted at the University of Southern California, PHE-506, Los Angeles, CA 90089-0272.

words and is called the rate of the code. The remaining  $r$  bits ( $r = n - k$ ) are *redundancy bits* (or *parity-check bits*) and are calculated from the information bits by a set of fairly simple equations. When a code word is retrieved from memory, the redundancy bits are tested to see if they still satisfy these *parity-check equations*. If all the equations check, it is overwhelmingly likely that no errors have occurred in the storage and retrieval process. On the other hand, if one or more errors *have* occurred, this will result in a pattern of certain equations checking and the other ones failing. From this pattern of parity-check failures, the errors can be located and corrected, provided that the total number of errors is not too large for the capability of the code.

### HOW THEY WORK

A simple example will help to clarify how error-correcting codes work. Probably the simplest error-correcting code is the Hamming (7,4) code. The (7,4) means that the code words are seven bits long, and four of the seven bits are *information bits*. The remaining three are parity bits, or redundancy bits.

We denote a typical seven-bit code word by the letters *abcdefg*. We allow *abcd* to be any combination of four bits, from 0000 to 1111, representing the actual *data*. Then we compute *e*, *f*, and *g* as shown in table 1a, where the symbol  $\oplus$  indicates "parity-check arithmetic," in which we write a 1 if the ordinary sum is odd, and a 0 if the ordinary sum is even.

For the Hamming (7,4) code, the entire dictionary consists of only 16 code words, as shown in table 1b. When a word is retrieved from storage, equations 1, 2, and 3 for *e*, *f*, and *g* are tested to see whether any errors have occurred. If no errors have occurred, all three equations check. But suppose exactly one of the seven bits is in error. Depending on which bit it is, a *different* subset of the three equations will fail, because each of the seven letters (*a* through *g*) occurs in a *different* subset of the three equations. Thus if *a* is the one bit that is in error, then all three equations will fail, because *a* enters into all three

Table 1: The Hamming (7,4) code: (a) Parity bits *e*, *f*, and *g* are calculated by XORing the data bits shown; (b) all valid Hamming (7,4) code words; and (c) an example identifying the error in 1100111.

(a)

$$(1) e = a \oplus b \oplus c$$

$$(2) f = a \oplus b \oplus d$$

$$(3) g = a \oplus c \oplus d$$

(b)

a	b	c	d	e	f	g
0	0	0	0	0	0	0
0	0	0	1	0	1	1
0	0	1	0	1	0	1
0	0	1	1	1	1	0
0	1	0	0	1	1	0
0	1	0	1	1	0	1
0	1	1	0	0	1	1
0	1	1	1	0	0	0
1	0	0	0	1	1	1
1	0	0	1	1	0	0
1	0	1	0	0	1	0
1	0	1	1	0	0	1
1	1	0	0	0	0	1
1	1	0	1	0	1	0
1	1	1	0	1	0	0
1	1	1	1	1	1	1

(c)

$$(1) e = a \oplus b \oplus c, \\ 1 = 1 + 1 + 0 \text{ fails.}$$

$$(2) f = a \oplus b \oplus d, \\ 1 = 1 + 1 + 0 \text{ fails.}$$

$$(3) g = a \oplus c \oplus d, \\ 1 = 1 + 0 + 0 \text{ checks.}$$

equations. If *b* is in error, equations 1 and 2 will fail, but 3 will check. If *c* is in error, equations 1 and 3 will fail, but 2 will check. If *d* is in error, equations 2 and 3 will fail, but 1 will check. If *e* is in error, only equation 1 will fail. If *f* is in error, only equation 2 will fail, and if *g* is in error, only equation 3 will fail. So, given the assumption that *at most one* of the seven bits of the code word is in error, the pattern of which parity equations check and which ones fail uniquely corresponds to the

location of the error (if any).

For example, suppose we retrieve 1100111 from storage. We try the three equations as shown in table 1c. Since 1 and 2 fail, the single-error assumption then points to *b* as the culprit, since it is the unique letter that occurs in 1 and 2 but not in 3. Correcting *b* from 1 to 0, we get the "corrected" code word 1000111, which is indeed one of the 16 legitimate words of the dictionary.

This simple example illustrates the principle of information bits versus redundancy bits, the calculation of redundancy bits via parity-check equations, and the location and correction of errors from the pattern of parity-check failures.

Principal facts and characteristics of the major types of codes used in error correction are summarized in table 2.

### REED-SOLOMON CODES

The standard approach that has been emerging in more advanced memory systems generally, and in optical disk systems in particular, is to use a Reed-Solomon code with some form of the Berlekamp decoding algorithm to locate and correct the errors. RS codes were invented more than 25 years ago by Irving S. Reed and Gustave Solomon, who were then at MIT's Lincoln Laboratories, and are particularly effective when errors tend to occur in bursts. Rather than doing arithmetic with the individual bits, as most of the earlier and simpler codes did, RS codes work on several bits at a time.

RS codes treat *m*-bit bytes as individual code symbols, and a single code word (in effect, a "frame" of data plus redundancy) consists of  $2^m - 1$  of these *m*-bit bytes. If one wishes to be able to correct any error pattern that affects no more than *t* bytes per code word, it is sufficient to dedicate  $2t$  bytes per code word to the task of error correction. The remaining  $2^m - 1 - 2t$  bytes are all available for information.

One very popular option is to use RS codes based on eight-bit bytes. The standard RS code using eight-bit bytes has a word length (or "block length") of 255 bytes, and it will cor-

*(continued)*

# Betcha our compiler can beat up your compiler.

*Or your money back.*

If you program in BASIC, Pascal, Fortran or C, you're using yesterday's technology. We know this statement will start a brawl, but it's true. So, before you start a fight you can't win, take a closer look at the Modula-2 language and the Modula-2 Software Development System (M2SDS) from Interface Technologies. Just compare the features and performance of M2SDS to your system. You'll find a new language and a programming environment that's more flexible, much faster and works on any IBM® PC or 100% compatible with 256 K memory or more.



**Trade In and Trade Up.** Just to prove that we're not all brag... we'll send you M2SDS for just \$50.88 if you mail us your present compiler or interpreter diskette.\* That's \$30.00 off the regular price. If within 30 days you're not programming faster than ever, just return the diskette and we'll send you your money back.

**Heavyweight Champion SDS-XP.** If you're ready to move into light-speed, you need SDS-XP. It has everything M2SDS has with a little "punch" added. Like Extended Libraries, M2MAKE and a Foreign Object Module Importer. SDS-XP offers buyers a stout discount when compared with the cost of buying M2SDS and the additional components as add-ons. For a limited time only, SDS-XP is available for \$99.00 with compiler trade-in. That's \$150.00 off the advertised price of \$249.00.

**Knock Out Bugs \$79.95.** Announcing M2DEBUG. A symbolic, compact (only 20K RAM) interactive run-time debugger with features most requested by software programmers and system developers. It comes with a Virtual Resource Overlay Operating Manager (VROOM) that speeds up compile time 50%.

**Calling All Compilers.** So now that you're wise to the limitations of your system, why not trade it in. You'll soon see that it was smarter to switch than fight. And a pretty safe bet.

## M2SDS

<b>COMPILE SPEED (MIN:SEC)</b>	
30 LINES	0:15.58
300 LINES	0:25.48
<b>EXECUTION SPEED (MIN:SEC)</b>	
SIEVE	0:13.92
FIBONACCI	0:53.49
30X30 MATRIX (8087)	0:08.84
FP OPERATIONS	0:27.56
FP OPERATIONS (8087)	0:01.97
SYNTAX CHECKING EDITOR	YES
MULTIPLE WINDOW EDITING	YES
EDITOR FILESIZE LIMIT	MEMORY SIZE
COMPILE ERROR CALLS EDITOR	YES
LINKER	YES
PRODUCES .EXE FILES	YES
EXECUTABLE CODE SIZE LIMIT	DISK SPACE
DOS ACCESS FROM EDITOR	YES
DOS ACCESS FROM PROGRAMS	YES
8087 SUPPORT STANDARD	YES
COPY-PROTECTED DISK	NO
COST WITH 8087 SUPPORT	\$50.88/\$80.88

Source: Software Resources, Inc. Sieve program from BYTE, January 1983. Fibonacci program from Dr. Dobb's Journal, February 1985. Matrix program from BYTE, October, 1982. FP Operations program from BYTE, May 1985. M2SDS with or without 8087 uses 8-byte accuracy. Programs compiled with all checking options on. All tests conducted on a standard IBM-PC/XT with 512K of memory and an 8087 math coprocessor.

\*Original or back-up diskette may be sent for trade-in. Diskette will be destroyed immediately upon receipt so that your current compiler license agreement is not violated.

IBM is a registered trademark of International Business Machines Corporation.



**INTERFACE TECHNOLOGIES**

3336 Richmond, Suite 200, Houston, TX 77098

**1-800-922-9049**

(In Texas, call 713/523-8422) Telex: 322127  
In Europe call ITC at: Switzerland 41 (1) 700-3037;  
Netherlands 31 (20) 106922; U.K. 44 (1) 656-7333

Here's my diskette. Rush me:

M2SDS for \$50.88 each, plus \$7 shipping and handling.

SDS-XP for \$99.00 each, plus \$7 shipping and handling.

Or, send me:

M2SDS for \$80.88 each, plus \$7 shipping and handling.

SDS-XP for \$249.00 each, plus \$7 shipping and handling.

M2DEBUG for \$79.95

My check is enclosed.

Apply charges to credit card indicated below:

VISA/MasterCard/American Express (circle one).

Credit Card # \_\_\_\_\_

Expiration Date \_\_\_\_\_

Signature \_\_\_\_\_

Name \_\_\_\_\_

(please print)

Shipping Address \_\_\_\_\_

City \_\_\_\_\_

State/Zip \_\_\_\_\_

Day Phone \_\_\_\_\_

Texas residents add 6.125% Sales Tax.  
International orders add \$30 for shipping/handling.  
If paying by check, check or draft must be in U.S. dollars drawn on a U.S. bank.

**INTERFACE TECHNOLOGIES CORPORATION**

3336 Richmond, Suite 200, Houston, Texas 77098

## ERROR CORRECTION

rect any pattern of up to  $t$  bytes being in error provided that  $2t$  of the bytes are used for redundancy (i.e.,  $r=2t$ ), leaving the remaining  $255-2t$  bytes available for information.

For example, if we want to be able to correct any pattern of five or fewer "symbol errors" per code word, we will have word length  $n = 2^8 - 1 = 255$  bytes = 2040 bits, of which  $r = 2t = 10$  bytes = 80 bits are used for redundancy, and the remaining  $k = n - r = 245$  bytes = 1960 bits are information. That is, so long as no more than 5 of the 255 eight-bit bytes in a code word contain errors, the decoder will locate and correct all the errors. If errors have occurred in more than 5 bytes, it is overwhelmingly likely that

the decoder will determine that an uncorrectable error has occurred rather than erroneously concluding that an error of not more than 5 bytes has occurred from a different code word. A byte is in error whether one, two, or all eight of its bits have been retrieved incorrectly. For this reason, Reed-Solomon codes are said to have burst-error-correction capability.

The RS code rate is calculated from the formula

$$\frac{2^m - 2t - 1}{2^m - 1} = \text{code rate}$$

where  $m$  = the number of bits per "byte." The example presented has a code rate of 245/255. This code is designated RS(255,245), much like the

Hamming code designations.

One other common specification of RS codes is the *minimum distance*, which is the smallest number of corresponding symbols by which two distinct code words differ. As you might expect, the minimum distance is one more than twice the number of errors you can correct, or  $2t + 1$ .

Some experts recommend putting one extra redundancy byte, called the overall parity byte, into the RS code block. This "extended code" can be used to *correct* up to  $t$  symbol errors per code word, and simultaneously to *detect* (without correction) whenever  $t+1$  symbol errors have occurred in a code word. In each code word of

*(continued)*

Table 2: The major types of error-correcting block codes.

Code inventor and year of publication	Usual code parameters	Type of errors it corrects	Memory systems where used	Communications systems where used	Remarks
Robert W. Hamming 1950	$q=2$ (binary) $n=2^t - 1$ (bits) $k=2^t - t - 1$ (bits) $r=t$ (bits)	Corrects only <i>single errors</i> : one bit in error per block	Most semiconductor memories	Some packet radio	The easiest codes to understand
Philip Fire 1959	$q=2$ (binary) $n=k+r$ (bits) $k=75,000$ to $150,000$ (bits) $r=48$ (bits)	Corrects a single short burst	Some magnetic tape and magnetic disk	—	The simplest "burst correction" codes
Marcel J. E. Golay 1949	$q=2$ (binary) $n=23$ (bits) $k=12$ (bits) $r=11$ (bits)	Corrects any pattern of $\leq 3$ errors per 23-bit block	—	Some Navy teletype	A remarkable code but not part of a larger family of codes
BCH codes: R. C. Bose and D. K. Ray-Chaudhuri 1960; and A. Hocquenghem 1959	$q=2$ (binary) $n=2^t - 1$ (bits) $k=2^t - et - 1$ (bits) $r=et$ (bits)	Corrects any pattern of $\leq e$ errors per block	Very large semiconductor memories that simulate magnetic disks	Some packet radio	Generalizes Hamming codes to correct multiple errors
RS codes: Irving S. Reed and Gustave Solomon 1960	$q=2^m$ ( $m$ -bit bytes) $n=2^m - 1$ (bytes) $k=2^m - 2t - 1$ (bytes) $r=2t$ (bytes)	Corrects any pattern of $\leq t$ byte errors per $(2^m - 1)$ -byte block	Magnetic tape and optical disk	Satellite links, deep space links, some international terrestrial links	Generalizes BCH codes to nonbinary alphabets; most widely used powerful block codes
V. D. Goppa 1970	Large range of options	Like BCH or RS codes	—	—	Generalizes RS codes to a still larger class



# PERFORMANCE

## THAT IS OUT OF THIS WORLD...



**\$389<sup>00</sup>**

**MODEL 2000 20MHz  
DUAL TRACE**

**\$549<sup>00</sup>**

**MODEL 3500 35MHz  
DUAL TRACE DELAYED SWEEP**

## ...AT A DOWN TO EARTH PRICE

At last! Truly affordable test equipment with no compromise in design, and features you would expect to find only on oscilloscopes costing hundreds of dollars more! JDR Instruments presents two, new, high-performance models backed by a two year warranty and technical support which is only a phone call away. Perfect for the technician or advanced hobbyist, both models feature Dual Trace capability and a variety of operating and triggering modes, including CH-B Subtract and X-Y operation.

MODEL 2000 has a 20 MHz bandwidth and 20 calibrated sweeps ranging from .2s to .2 $\mu$ s. A convenient built-in component tester provides additional diagnostic power.



INCLUDES TWO HIGH QUALITY  
1x, 10x TEST PROBES

MODEL 3500 features a 35 MHz bandwidth and exceptional 1mV/DIV sensitivity. Delayed sweep and variable holdoff allow stable viewing of complex waveforms.

**ORDER TOLL FREE**  
**800-538-5000**  
**800-662-6279 (CA)**



### JDR INSTRUMENTS

1224 South Bascom Avenue  
San Jose, California 95128 (408) 995-5430

length  $2^m$  of the extended code, there are now  $2t+1$  check symbols and  $2^m-2t-1$  information symbols. The code rate is accordingly decreased to

$$\frac{2^m - 2t - 1}{2^m}$$

and the minimum distance is increased to  $2t+2$ .

The standard RS code can also be *shortened*, or *punctured*, by the simple expedient of omitting some of the information symbols. Since the number of check symbols remains the same, this decreases the code rate. The encoding and decoding are done in *exactly* the same way as for the standard RS code, but now some of the information symbol positions are fictitious, or phantom. If the decoder locates an error in a phantom position, this indicates that in reality an uncorrectable error has occurred.

To work with larger chunks of data at a time, one may decide to go with

twelve-bit bytes (or twelve-bit *characters*), in which the block length of the corresponding RS code is 4095 twelve-bit characters.

**GALOIS FIELDS**

The arithmetic that underlies Reed-Solomon codes is not ordinary arithmetic, but the somewhat bizarre and exotic arithmetic of the "finite field" containing  $2^m$  elements. These *finite fields* were first invented and studied by the nineteenth-century French mathematical prodigy Evariste Galois (1811-1832), who was killed in a duel some five months shy of his twenty-first birthday, and are often referred to as *Galois fields*. ("Galois" is pronounced "gal-WAH.")

A particular Reed-Solomon code is generated using a generator polynomial over  $GF(2^m)$ , where  $GF(2^m)$  means "the Galois field with  $2^m$  elements." The Berlekamp decoding algorithm for RS codes makes effi-

**The standard RS code can be shortened by omitting some of the information symbols.**

cient use of the algebraic structure of  $GF(2^m)$  and first calculates the *syndromes* (a type of discrete Fourier coefficients) of the possibly erroneous code word. From these syndromes two special polynomials are constructed. One is called the *error locator polynomial*, and the roots of this polynomial are the locations where bytes are in error. The other is the *error corrector polynomial*, which gives the values to be added to the erroneous bytes to get the corrected bytes.

The details of the mathematics of RS encoding and decoding involve arcane and intricate mathematics. The interested reader is referred to the items in the bibliography.

**PERFORMANCE OF REED-SOLOMON CODES**

In figure 1, we see the performance of a Reed-Solomon code with a block length of 220 eight-bit bytes, of which 204 bytes (1632 bits) are information and the remaining 16 bytes (128 bits) are used for redundancy. An *input error rate* (raw error rate) of 1 erroneous bit per thousand is converted into an *output error rate* (corrected error rate) of well below 1 bit per million, while a raw error rate of  $10^{-4}$  bits becomes a corrected error rate well below  $10^{-14}$  bits, all at a "cost" of only 7.27 percent of the bits being used for error correction rather than for data. This is on the assumption that the bits in error occur at random and independently of one another. However, in the realistic situation that bit errors tend to occur in short bursts, the *actual* performance against the same average bit-error rate will in fact be better than figure 1 indicates. This RS(220,204) code is typical of the type of error correction that might be used for optical disk applications.

(continued)

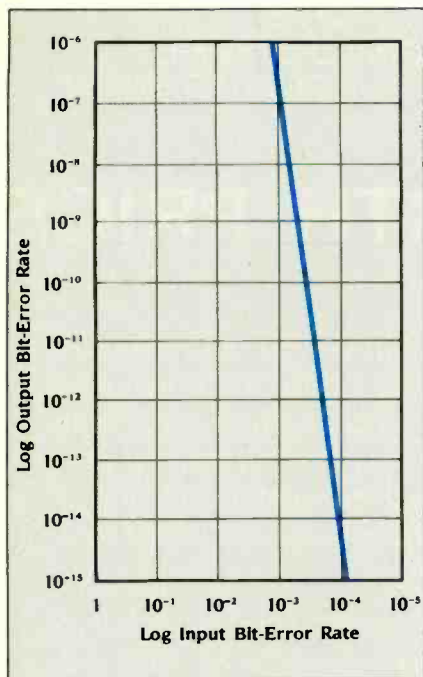

Figure 1: The relationship between the raw error rate and the corrected error rate using an RS(220,204) code. Code words consist of 220 eight-bit bytes, of which 204 bytes are information and 16 bytes are redundancy, for a code rate of 92.73 percent. The figure assumes random, independent bit errors. Performance against somewhat "bursty" errors is even better.

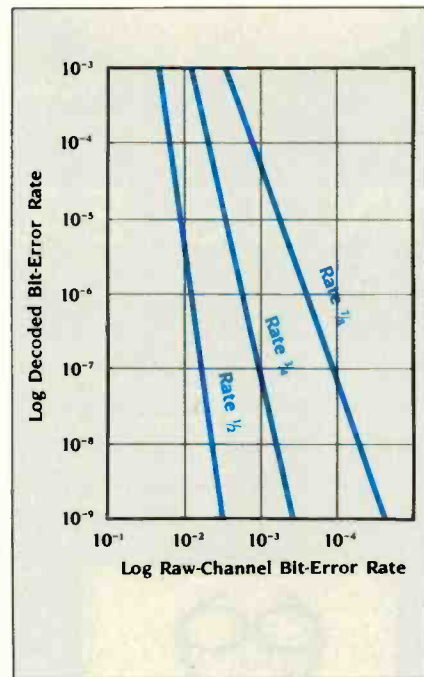

Figure 2: The performance of three RS codes against random occurrence of bit errors. All three use code words consisting of 32 five-bit bytes. The rate 1/2 code has 16 information bytes and 16 redundancy bytes per block, an RS(32,16) code. The rate 3/4 code is RS(32,24), and the rate 7/8 code is RS(32,28).

# The "C" Programmer's Set

## —only \$2.95

when you join the Library of Computer and Information Sciences.  
You simply agree to buy 3 more books—at handsome discounts—within the next 12 months.

**LEARNING TO PROGRAM IN C** SECTION 4.5  
**4.5 Switch**

provides a special form of multi-branch control structure for the situation in which the branch set specifies alternative values for one or more variables. This is the case, for example, in the case of a switch statement. The switch statement is a block-structured construct, enclosed in braces, incorporated into the main body of the program. Each of the branches of the switch is the result of the evaluation of the value given by the case label. At the end of each alternative branch of code there should be a break statement, which causes control to jump to the beginning of the next iteration. The program example given is for a simple switch which will allow if the value of the variable is 1, 2, or 3, to print out the corresponding value of the variable.

```

switch (value)
{
    case 1:
        printf("one\n");
        break;
    case 2:
        printf("two\n");
        break;
    case 3:
        printf("three\n");
        break;
    default:
        printf("other\n");
}

```

**THE C PROGRAMMING LANGUAGE** SECTION 3.7  
**3.7 Break**

is commonly used to terminate the execution of a loop. The break statement is used to terminate the execution of a loop. The break statement is used to terminate the execution of a loop. The break statement is used to terminate the execution of a loop.

```

while (condition)
{
    /* ... */
    break;
}

```

**RELIABLE DATA STRUCTURES IN C** SECTION 2.8  
**2.8 Overflow**

Usually speaking, there are two different types of overflow: integer overflow and floating-point overflow. Integer overflow occurs when the result of an arithmetic operation is too large to be stored in the variable. Floating-point overflow occurs when the result of a floating-point operation is too large to be stored in the variable.

```

int i = 1;
while (i < 1000000000)
{
    i = i + 1;
}

```

**Learning to Program in C**  
*By Thomas Plum.* Beginning programmers will quickly learn how to write C programs that are both efficient and portable. More than an instructive manual, the book also gives insight into the underlying processes of the language and highlights its unique aspects. **Publisher's Price: \$25.00.**

**The C Programming Language**  
*By Brian W. Kernighan and Dennis M. Ritchie.* This best-selling tutorial effectively teaches C through practical, hands-on exercises. Its accessible, step-by-step format enables even novice programmers to take advantage of this powerful, highly-efficient language. A handy C reference manual rounds out this information-packed handbook. **Publisher's Price: \$24.95.**

**Reliable Data Structures in C**  
*By Thomas Plum.* This example-filled manual details all the advanced features of C. Coverage includes practical case studies illustrating sophisticated constructs, general-purpose functions and macros, and application-oriented case studies. A series of reliability rules help you write programs that deliver "no surprises." Concepts from the ANSI standardization of C point the way to powerful but portable applications. **Publisher's Price: \$25.00.**

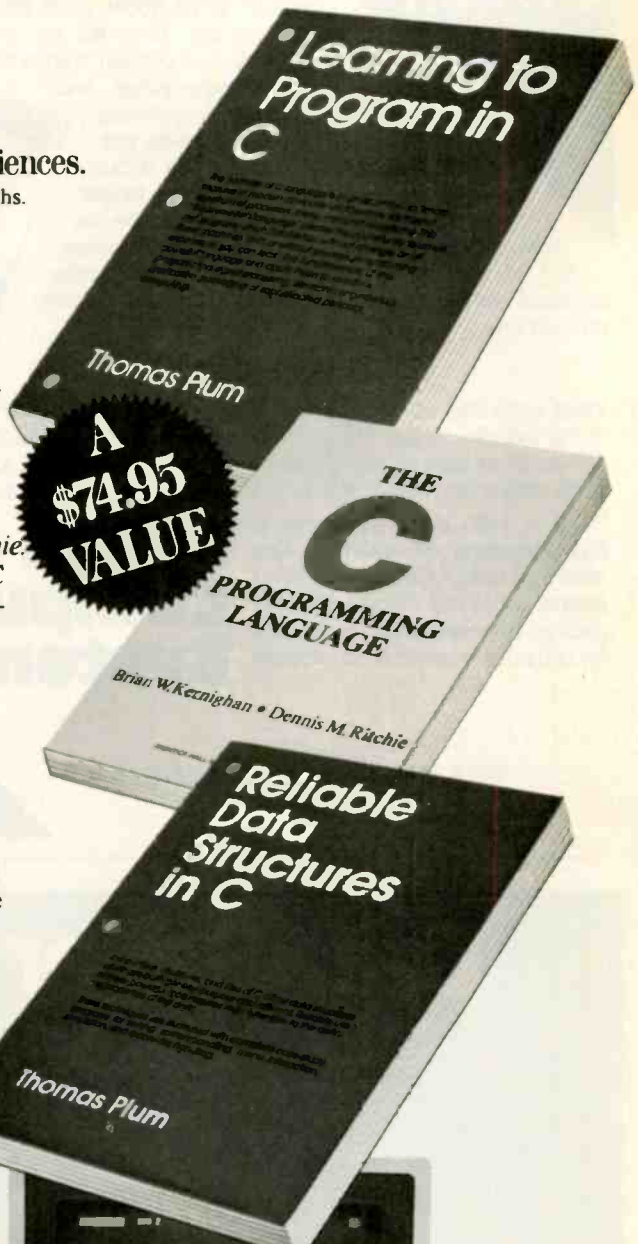

The Library of Computer and Information Sciences is the oldest, largest book club especially designed for computer professionals. In the incredibly fast-moving world of data processing, where up-to-the-moment knowledge is essential, we make it easy to keep totally informed on all areas of the information sciences. What's more, our selections offer you discounts of up to 30% or more off publishers' prices.

### 4 Good Reasons to Join

- 1. The Finest Books.** Of the hundreds of books submitted to us each year, only the very finest are selected and offered. Moreover, our books are always of equal quality to publishers' editions, *never* economy editions.
- 2. Big Savings.** In addition to getting the "C" Programmer's Set for only \$2.95 when you join, you keep saving substantially, up to 30% and occasionally even more. (For example, your total savings as a trial member—including this introductory offer—can easily be over 50%. That's like getting every other book free!)
- 3. Bonus Books.** Also, you will immediately become eligible to participate in our Bonus Book Plan, with savings of up to 70% off the publishers' prices.
- 4. Convenient Service.** At 3-4 week intervals (16 times per year), you will receive the Library of Computer and Information Sciences News, describing the Main Selection and Alternate Selections, together with a dated reply card. If you want the Main Selection, do nothing, and it will be sent to you automatically. If you prefer another selection, or no book at all, simply indicate your choice on the card and return it by the date specified. You will have at least 10 days to decide. If, because of late mail delivery of the News, you should receive a book you do not want, we guarantee return postage.

If reply card has been removed, please write to The Library of Computer and Information Sciences, Dept. 7-DG5-00717, Riverside, N.J. 08075 for membership information and an application. **Byte 5/86**





Dysan diskettes are the ultimate in quality flexible recording media for flexible disk drives. They are certified to be 100% error free on-track and between tracks. Diskettes are tested on-track as well as between tracks for missing pulse, extra pulse, and modulation. Quality is built into each diskette from the inside out.

The ultra smooth disc surface is burished on both sides to promote longer media life, longer head and load pad life, as well as better recording and playback performance.

And to help introduce you to the Dysan quality standard we're running a special on their diskette product line.



What separates us from our competition? Simply a combination of the best service in the industry, highly competitive pricing, and an ever widening range of products. Above all we care about our reputation and we are willing to work on a lower margin while delivering what others only claim—and we do it all on a day-in day-out basis.

Early in 1986 every subscriber to *Byte Magazine* will receive our New 1986 First Edition Catalog with 16 additional pages and dramatically lower pricing. We want to be your source for computer supplies & accessories.

## Lyben Computer Systems

WATCH FOR OUR NEW 1986 CATALOG

1050 E. MAPLE RD. • TROY, MI 48083  
(313) 589-3440

# DataSaver<sup>400</sup>

Standby UPS

Power protection for the most powerful micro-computer systems with peripherals is here, now, with the 400 Watt DataSaver. Protect your investment in application software and hardware with reliable, continuous power. 90 and 200 Watt capacities and international models are also available.



**Cuesta Systems Corporation**  
3440 Roberto Court  
San Luis Obispo, CA 93401  
TLX: 4949381 CUESTA

©1985, Made in U.S.A.  
Write or call 805/541-4160  
Dealer, O.E.M. inquiries invited

## ERROR CORRECTION

*The noisier the environment, the lower the rate of the code that should be used.*

In figure 2, we see performance curves for Reed-Solomon codes of the type that might typically be used in certain communications applications, such as noisy telephone lines or noisy air-to-ground radio links. The three codes illustrated are RS(32,16), which is a rate  $\frac{1}{2}$  code; RS(32,24), which is rate  $\frac{3}{4}$  code; and RS(32,28), which is a rate  $\frac{7}{8}$  code. All three codes have a block length of 32 five-bit bytes. The noisier the environment, the lower the rate of the code that should actually be used. Again, the curves are based on the assumption that bit errors occur independently and at random. However, since errors on real telephone lines and real radio links typically occur in bursts, actual performance for the same values of average input error rate will in fact be better than depicted in figure 2. ■

### BIBLIOGRAPHY

- Berlekamp, E. R. *Algebraic Coding Theory*. New York: McGraw-Hill, 1967. Reprint edition, Laguna Hills, CA: Aegean Park Press, 1983.
- Bose, R. C. and D. K. Ray-Chaudhuri. "On a Class of Error Correcting Binary Group Codes." *Information and Control*, vol. 3, page 68, 1960.
- Fire, P. "A Class of Multiple-Error-Correcting Codes for Non-Independent Errors." Sylvania Reconnaissance Systems Lab Report. RSL-E-2, 1959.
- Golay, M. J. E. "Notes on Digital Coding." *Proceedings of the IRE (Correspondence)*, vol. 37, page 657, June 1949.
- Goppa, V. D. "A New Class of Linear Correcting Codes." *Problems of Information Transmission*, vol. 6, page 24, 1970.
- Hamming, R. W. "Error Detecting and Error Correcting Codes." *Bell System Technical Journal*, vol. 29, page 147, 1950.
- Hocquenghem, A. "Codes Correcteurs D'erreurs." *Chiffres (Paris)*, vol. 2, page 147, 1959.
- Reed, I. S., and G. Solomon. "Polynomial Codes Over Certain Finite Fields." *Journal of the Society of Industrial and Applied Mathematics*, vol. 8, page 300, 1960.

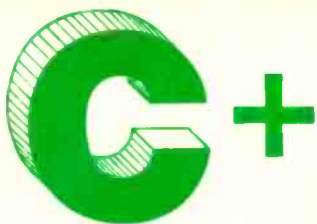

# The Best C Book A Powerful C Compiler

## One Great C Value \$39.95

A good C book just isn't complete without a good C compiler to go with it. That's why we give you both. You get a comprehensive 450 page book and a full feature standard K&R C compiler with the Unix V7 Extensions. The Book is loaded with examples that teach you how to program in C. And our fast one pass C compiler comes with an equally fast

linker so you don't waste a lot of time watching your disk drives spin. You also get a Unix compatible function library that contains more than 150 functions (C source code included). And if all that isn't enough, we offer you a 30 day money back guarantee. So what are you waiting for? The exciting world of C is just one free phone call away.

### Language Features

- Data Types: char, short, int, unsigned, long, float, double
- Data Classes: auto, extern, static, register
- Typedef, Struct, Union, Bit Fields, Enumerations
- Structure Assignment, Passing/Returning Structures

abs  
asm  
asmx  
atan  
atof  
atoi  
atol  
bdos  
bdosx  
bios  
biosx  
balloc  
cell  
cfree  
chain  
character  
chdir  
chmod  
clearerr  
close  
clrscr  
cmpstr  
conbuf  
conc  
cos  
opyst  
creat  
curblk  
curslin  
curscol  
cursrow  
cursoff  
curson  
delete  
drand  
exec  
execl  
execv  
exit  
exitmsg  
exp  
fabs  
fclose  
fdopen  
feof  
fflush  
fgetc  
findex  
filetrap  
find  
floor  
fopen  
fprintf  
fputs  
fread  
free  
freopen  
fscanf  
fseek  
ftell  
fwrite  
getc  
getch  
getchar

### Functions

getcseg  
getdseg  
getid  
putd  
getdate  
gettime  
geti  
puti  
getkey  
getmode  
setmode  
gets  
getw  
heapsize  
heaptrap  
hypot  
index  
inp  
insert  
iofilter  
isalnum  
isalpha  
iscntrl  
isdigit  
islower  
isprint  
ispunct  
isspace  
isupper  
itoa  
keypress  
left  
len  
log  
log10  
longjmp  
lseek  
malloc  
alloc  
mathtrap  
mid  
mkdir  
modf  
movmem  
open  
outp  
peek  
perror  
poke  
poscur  
pow  
printf  
putc  
putchar  
puts  
putw  
rand  
read  
readatr  
reach  
writech  
readdot  
writedot  
realloc  
rename  
replace  
repmem  
rewind  
right  
rindex  
rmdir  
scanf  
setbuf  
setbufsiz  
setcolor  
setdate  
settime  
setjmp  
setmem  
sin  
sound  
sprintf  
sqrt  
strand  
sscanf  
stacksiz  
str  
strcat  
strcmp  
strcpy  
strlen  
strncat  
strncpy  
strsave  
system  
tolower  
toupper  
ungetc  
ungetch  
unlink  
write  
writechs  
xmembeg  
xmemend  
xmemget  
xmemput  
xmovmem  
\_exit

## MIX Editor \$29.95

When you're programming in a high level language you need a high powered editor. That's why we created a programmable full/split screen text processor. It lets you split the screen horizontally or vertically and edit two files at once. You can move text back and forth between two windows. You can also create your own macro commands from an assortment of over

100 predefined commands. The editor comes configured so that it works just like Wordstar but you can change it if you prefer a different keyboard layout. The editor is a great companion to our C compiler. Because they work so well together we want you to have both. To make sure you do, we're offering the editor for just \$15 when purchased with the C compiler.

## ASM Utility \$10

The ASM utility disk allows you to link object files created by Microsoft's MASM or M80 assemblers. Lots of useful assembly language functions are included as examples.

**ORDERS ONLY**  
**1-800-523-9520**  
IN TEXAS  
**1-800-622-4070**

Canadian Distributor  
Saragay Software: 416-923-1500

NOT COPY PROTECTED

Editor	\$ _____ (29.95)	<input type="checkbox"/> PCDOS/MSDOS (2.0 or later)	Name _____
C	\$ _____ (39.95)	<input type="checkbox"/> IBM PC Single Side	Street _____
C & Editor	\$ _____ (54.95)	<input type="checkbox"/> IBM PC Double Side	City _____
ASM Utility	\$ _____ (10.00)	<input type="checkbox"/> Tandy 2000	State _____
TX Residents	\$ _____ (6.125% sales tax)	<input type="checkbox"/> 8 Inch	Zip _____
Shipping	\$ _____ (see below)	<input type="checkbox"/> Other _____	Country _____
Total	\$ _____	<input type="checkbox"/> CPM 80 (2.2 or later)	Phone _____
<input type="checkbox"/> Check <input type="checkbox"/> Money Order		<input type="checkbox"/> 8 Inch	
<input type="checkbox"/> MC/Visa* _____ Exp _____		<input type="checkbox"/> Kaypro II	
<b>Shipping Charges:</b> (No charge for ASM Utility)		<input type="checkbox"/> Kaypro 4	
USA: \$5/Order		<input type="checkbox"/> Apple (Z80)	
Canada: \$10/Order		<input type="checkbox"/> Osborne I SD	
Overseas: \$10/Editor • \$20/C • \$30/C & Editor		<input type="checkbox"/> Osborne I DD	
		<input type="checkbox"/> Morrow MD II	
		<input type="checkbox"/> Other _____	

**MDX**  
software  
2116 E. Arapaho  
Suite 363  
Richardson, TX 75081  
(214) 783-6001

Ask about our volume discounts.

# COMPUTER MAIL ORDER

## THE CMO ADVANTAGE

**TO ORDER  
CALL TOLL FREE  
1-800-233-8950  
DEPARTMENT A105**

OR MAIL YOUR ORDER TO:

**COMPUTER MAIL ORDER  
Department A105  
477 E. Third Street  
Williamsport, PA 17701**



**POLICY Inquiry 86**  
Add 3% (Minimum \$7.00) shipping and handling. Larger shipments may require additional charges. Personal and company checks require 3 weeks to clear. For faster delivery use your credit card or send cashier's check or bank money order. Pennsylvania residents add 6% sales tax. All prices are subject to change and all items are subject to availability. Defective software will be replaced with the same item only. Hardware will be repaired or replaced at our discretion within the terms and limits of the manufacturer's warranty. We cannot guarantee compatibility. All sales are final and returned shipments are subject to a restocking fee.

**EDUCATIONAL INSTITUTIONS  
CALL TOLL FREE  
1-800-221-4283**

**CUSTOMER SERVICE  
& TECHNICAL SUPPORT  
1-717-327-1450**

### CANADIAN ORDERS

1-800-268-3974  
Ontario/Quebec

1-416-828-0866  
In Toronto

1-800-268-4559  
Other Provinces

TELEX: 06-218960

2505 Dunwin Drive,  
Mississauga, Ontario  
Canada L5L1T1

All prices shown are for U.S.A. orders. Call the Canadian Office for Canadian prices.

## THE CMO ADVANTAGE

- ✓ Next day shipping on all in-stock items.
- ✓ Free easy access order inquiry.
- ✓ Orders from outside Pennsylvania save state sales tax.
- ✓ Free technical support from our factory trained technicians.
- ✓ There is no limit and no deposit on C.O.D. orders.
- ✓ There is no extra charge for using your Visa or MasterCard and your card is not charged until we ship
- ✓ No waiting period for cashier's checks.
- ✓ We accept purchase orders from qualified corporations. Subject to approval.
- ✓ Educational discounts available to qualified institutions. (See the toll free educational phone number above.)
- ✓ FREE CATALOG MEMBERSHIP

## HOME COMPUTERS

### APPLE

APPLE IIe.....CALL  
APPLE IIc.....CALL  
IIc LCD Display.....CALL

### ATARI

65XE (64K).....CALL  
130XE (128K).....CALL  
520ST (512K).....CALL  
800XL 64K.....CALL  
1010 Recorder.....\$49.99  
1050 Disk Drive.....CALL  
1020 Printer.....\$29.99  
1027 Letter Quality Printer.....\$129.00  
1030 Direct Connect Modem.....\$59.99  
Comrex 220 Atari.....\$89.99

### COMMODORE

Amiga Package  
512K, 2 Drive, RGB Monitor.....\$1799.00  
C64 Package  
C64, C1541, C1802.....\$559.00  
C128 Computer.....\$269.00  
C1571 (Disk Drive for C128).....\$249.00  
C1902 (RGB 13" Monitor for C128).....CALL  
C1670 (Modem for C128).....\$179.00  
C1530 Datasette.....\$39.99  
C1660 Auto Modem.....\$59.99  
DPS 1101 Daisy Printer.....\$339.00  
Comrex 220 (C64 Interface).....\$89.99  
Xetec SuperGraphix 8K.....\$69.99

### GRAPHICS

#### ■ Polaroid

Palette.....\$1399.00  
Power Processor.....\$229.00  
Illuminated Slide Mounter.....\$39.99  
Polacolor 2 Pack film.....\$18.99

### ACCESSORIES

#### CURTIS POWER STRIPS

Diamond SP-1.....\$29.99  
Emerald SP-2.....\$39.99  
Sapphire SPF-1.....\$49.99  
Ruby SPF-2.....\$59.99  
Safe Strip SP-3.....\$19.99

#### KENSINGTON

MasterPiece.....\$99.99  
MasterPiece Plus.....\$119.00

## PORTABLE COMPUTERS

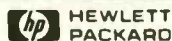

41CV.....\$139.00  
41CX.....\$199.00  
HP 11C.....\$49.99  
HP 12C.....\$75.99  
HP 15C.....\$75.99  
HP 16C.....\$89.99  
HPIL Module.....\$98.99  
HPIL Cassette or Printer.....\$359.99  
Card Reader.....\$143.99  
Extended Function Module.....\$63.99  
Time Module.....\$63.99

**We stock the full line of  
HP calculator products**

### NEC

PC-8401 LS.....\$699.00  
PC-8201 Portable Computer.....\$339.00  
PC-8231 Disk Drive.....\$599.00  
PC-8221A Thermal Printers.....\$149.00  
PC-8281A Data Recorder.....\$99.99  
PC-8201-06 8K RAM.....\$79.99

### SHARP

PC-1350.....\$149.00  
PC-1261.....\$149.00  
PC-1500A.....\$169.00  
PC-1250A.....\$89.99  
CE-125 Printer/Cassette.....\$129.00  
CE-150 Color Printer Cassette.....\$149.00  
CE-161 16K RAM.....\$129.00

## SOFTWARE

### ARTWORX

Bridger 4.0.....\$17.99  
Strip Poker.....\$19.99

### BRODERBUND

Print Shop (All).....\$29.99  
Graphics Library I, II, III (All).....\$17.99  
Bank Street Writer (64, AT).....\$34.99  
Bank Street Writer (IIe/IIc).....\$44.99

### BATTERIES INCLUDED

Paperclip (AT, 64/128).....\$37.99  
Paperclip (IIe/IIc).....\$44.99  
Homepack (64/AT).....\$29.99  
D.E.G.A.S. (520).....\$27.99

### CONTINENTAL SOFTWARE

Home Accountant (All).....\$44.99  
Tax Advantage (All).....\$44.99  
Home Acct./Tax Bundle (All).....\$59.99

### JANE

Wordpro/dBase (C64).....\$39.99

### MICROPROSE

Kennedy Approach (All).....\$24.99  
Acrojet (All).....\$24.99  
Silent Service (All).....\$24.99

### PFS

File (64).....\$39.99  
File, Report, Graph (IIe/IIc).....\$79.99  
Write w/Proof (IIe/IIc).....\$79.99

### PSI

Fleet Systems III (C128).....\$59.99

### ROCKLAN

#### Game Carts for Atari

Gorf.....\$3.99  
Wizard of Wor.....\$3.99  
Space Journey.....\$3.99  
Journey to Planet.....\$3.99  
Rack-Em-Up.....\$3.99  
Diamond Mind.....\$3.99

### SPRINGBOARD

Newsroom (64).....\$32.99  
Clip Arts (64).....\$19.99  
Newsroom (Apple).....\$39.99  
Clip Arts (Apple).....\$22.99

### SUBLOGIC

Flight Simulator (All).....\$37.99  
Jet (64).....\$37.99

## MODEMS

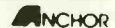

Volksmodem.....\$59.99  
Volksmodem 300/1200.....\$189.99  
Signalman Express.....\$259.00  
Lightning 2400 Baud.....\$399.00  
Express! (PC Halfcard).....\$189.00  
6470 (64/128) 300/1200 Baud.....\$139.00

### DIGITAL DEVICES

AT300 - 300 Baud (Atari).....\$99.99

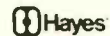

Smartmodem 300.....\$139.00  
Smartmodem 1200.....\$389.00  
Smartmodem 1200B.....\$359.00  
Smartmodem 2400.....\$599.00  
Micrododem IIe.....\$149.00  
Smart Com II.....\$89.99  
Chronograph.....\$199.00  
Transet 1000.....\$309.00



Reach 1200 Baud Half Card.....\$399.00

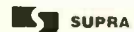

MPP-1064 AD/AA (C-64).....\$69.99



Smart Cat Plus.....\$299.00  
J-Cat.....\$99.99  
Novation 2400.....\$499.00  
Apple Cat II.....\$229.00  
212 Apple Cat II.....\$379.00  
Apple Cat 212 Upgrade.....\$229.00



Quadmodem II  
300/1200.....\$339.00  
300/1200/2400.....\$499.00

### EVEREX

1200 Baud Internal (IBM/PC).....\$179.00

## DISKETTES

### maxell

3 1/2" SS/DD (10).....\$18.99  
3 1/2" DS/DD (10).....\$29.99  
5 1/4" MD-1 w/Hardcases (10).....\$11.99  
5 1/4" MD-2 w/Hardcases (10).....\$16.99  
5 1/4" MD-2-HD for AT (10).....\$32.99  
3 1/2" 5 pack SS/DD/Case.....\$10.99



5 1/4" SS/DD.....\$12.99  
5 1/4" DS/DD.....\$24.99  
Disk Analyzer.....\$24.99

### Dennison

Elephant 5 1/4" SS/SD.....\$13.99  
Elephant 5 1/4" SS/DD.....\$14.99  
Elephant 5 1/4" DS/DD.....\$16.99  
Elephant Premium DS/DD(50).....\$79.99  
Elephant 3 1/2" SS/DD.....\$29.99

### IBM

5 1/4" DS/DD floppy disks  
(Box of 10).....\$26.99

## DISK HOLDERS

### INNOVATIVE CONCEPTS

Flip'n File 10.....\$2.49  
Flip'n File 50.....\$14.99  
Flip'n File 50 w/lock.....\$19.99  
Flip'n File 100.....\$19.99  
Flip'n File Data Case.....\$9.99

### AMARAY

50 Disk Tub 5 1/4".....\$9.99  
30 Disk Tub 3 1/2".....\$9.99

## DRIVES

### HARD

#### MEGA

A110H Single 10.....CALL  
A210H 10 + 10.....CALL  
A120H Single 20.....CALL  
A220H 20 + 20.....CALL  
Save on 10 & 20 Carts.....CALL



25, 35, 50, 80 meg (PC)  
.....from \$1299.00

### IRWIN

Tape Backup.....CALL

### EVEREX

60 Meg Internal Backup System.....\$799.00

### CORE

AT20-AT72MB.....CALL

### PRIAM

40, 60 MB (PC, XT, AT).....CALL

### KITS

10 Meg with controller.....\$379.00  
20 Meg with controller.....\$499.00

**FLOPPY ALLIED TECHNOLOGY**  
Apple II, II+, IIe 1/2 height.....\$109.00

### INDUS

Atari GT.....\$199.00  
C-64 /128 GT.....\$199.00



SD1 C-64 Single.....\$219.00  
SD2 C-64 Dual.....\$469.00



320K 5 1/4" (PC).....\$119.00

### TEAC

320K 5 1/4".....\$119.00

DEPT. A105

# CALL TOLL-FREE

## MONITORS

**AMDEK**

Video 300 Green.....	\$119.00
Video 300A Amber.....	\$129.00
Video 310A Amber TTL.....	\$159.00
Color 600 Hi-Res. RGB.....	\$399.00
Color 722 Dual Mode.....	\$529.00
Color 725.....	CALL
Color 730.....	CALL

**MAGNAVOX**

8562 RGB/Composite.....	\$279.00
613 TTL Green.....	\$99.99
623 TTL Amber.....	\$99.99

**NEC**

JB1205A.....	\$79.99
JB1270G/1275A.....	(ea.) \$99.99
JB1280G TTL Green.....	\$129.00
JB1285A TTL Amber.....	\$129.00
JC1401 Multil Sync RGB.....	\$589.00

**PRINCETON**

MAX-12 Amber.....	\$179.00
HX-9 9" RGB.....	\$469.00
HX-9E Enhanced.....	\$519.00
HX-12 12" RGB.....	\$469.00
HX-12E Enhanced.....	\$559.00
SR-12 Hi-Res.....	\$599.00
SR-12P Professional.....	\$699.00

**TAXAN**

115 12" Green.....	\$119.00
116 12" Amber.....	\$129.00
121 TTL Green.....	\$139.00
122 TTL Amber.....	\$149.00
220 14" Color Composite.....	\$179.00
620 640x200 RGB.....	\$439.00
630 640x200 RGB.....	\$489.00
640 720x400 RGB.....	\$539.00

**QUADRAM**

8400 Quadchrome I.....	\$499.00
8410 Quadchrome II.....	\$339.00
8420 Amberchrome.....	\$179.00
8500 Quad Screen.....	\$1449.00

**ZILUM**

ZVM 1220 Amber.....	\$99.99
ZVM 1230 Green.....	\$99.99
ZVM 1240 IBM Amber.....	\$149.00
ZVM 135 RGB.....	\$459.00
ZVM 1330 RGB.....	\$459.00
ZVM 1360 RGB.....	CALL
ZVM 1360 E G Comp.....	CALL

## INTERFACES

**AST**

Multil I/O (Apple II).....	\$149.00
----------------------------	----------

**PRACTICAL PERIPHERALS**

Graphcard.....	\$79.99
Serial Card.....	\$99.99
Microbuffer II +.....	\$169.00
Microbuffer 32K.....	\$189.00

**QUADRAM**

Microfazer.....	from \$139.00
Elazer (Epson).....	from \$79.99

**Orange Mkro**

Grappler CD (C64).....	\$89.99
Grappler Plus (Ile, Iic).....	\$89.99
Grappler C (Iic).....	\$89.99
Grappler 16K (Ile, II+).....	\$149.00

**DIGITAL DEVICES**

Ape Face (Atari).....	\$49.99
U-Print A (Atari).....	\$54.99
U-A16/Buffer (Atari).....	\$74.99
U-Call Interface (Atari).....	\$39.99
U-Print C (C64).....	\$49.99
P-16 Print Buffer.....	\$74.99
U-Print 16 apple Iic.....	\$89.99

## PRINTERS

**Canon**

A40,A50,A55.....	CALL
LBP-8A1 Laser.....	CALL

**CITIZEN**

MSP-10 (80 col.).....	\$279.00
MSP-15 (132 col.).....	\$389.00
MSP-20 (80 col.).....	\$349.00
MSP-25 (132 col.).....	\$509.00

**CITIZEN**

Prowriter 7500.....	\$169.00
Prowriter 1550P.....	\$349.00
Starwriter 10-30.....	\$399.00
3500 Tri Printer.....	\$1499.00

**CORONA**

Lazer LP-300.....	\$2799.00
-------------------	-----------

**DIABLO**

620 Daisywheel.....	\$299.00
D25 Daisywheel.....	\$549.00
635 Daisywheel.....	\$1099.00
D80IF Daisywheel.....	CALL

**daisywriter**

2000.....	\$699.00
-----------	----------

**EPSON**

Homewriter 10, LX-80.....	CALL
FX-85, FX-286, RX-100.....	CALL
DX-10, DX-20, DX-35.....	CALL
SQ-2000, HI-80, HS-80, AP-80.....	CALL
LQ-800, LQ-1000.....	CALL

**JUKI**

6000 Letter Quality.....	CALL
6100 Letter Quality.....	CALL
6200 Letter Quality.....	CALL
6300 Letter Quality.....	CALL
5510 Dot Matrix.....	CALL

**LEGEND**

808 Dot Matrix 100 cps.....	\$179.00
1080 Dot Matrix 100 cps.....	\$259.00
1380 Dot Matrix 130 cps.....	\$289.00
1385 Dot Matrix 165 cps.....	\$339.00

**NEC**

3000 Series.....	\$779.00
8000 Series.....	\$1099.00
ELF 360.....	\$399.00
Pinwriter 560.....	\$999.00

**OKIDATA**

182, 183, 192, 193, 2410, 84.....	CALL
Okimate 10 (Specify C64/Atari).....	\$189.00
Okimate 20 (IBM).....	CALL

**Panasonic**

KX1080.....	NEW
KX1091.....	\$259.00
KX1092.....	\$389.00
KX1592.....	\$469.00
KX1595.....	\$659.00

**QUADRAM**

Quadjet.....	\$399.00
Quad Laser.....	CALL

**SILVER-REED**

500 Letter Quality.....	\$219.00
550 Letter Quality.....	\$419.00
800 Letter Quality.....	\$699.00

**Sitara**

SG-10A (Atari).....	CALL
SG-10C (C64 Interface).....	CALL
SB/SD/SG/SR Series.....	CALL
Powertype Letter Quality.....	CALL

**Texas Instruments**

Ti850.....	\$529.00
Ti855.....	\$639.00
Ti865.....	\$799.00

**TOSHIBA**

1340 (80 column).....	\$369.00
P341 (132 column).....	\$799.00
P351 (132 column).....	\$1049.00

## SOFTWARE FOR IBM

**ANSA SOFTWARE**

Paradox.....	\$499.00
--------------	----------

**ASHTON-TATE**

Framework II.....	\$389.00
dBase III Plus.....	\$389.00

**BATTERIES INCLUDED**

Isgur Portfolio.....	\$159.00
----------------------	----------

**BORLAND**

Lightening.....	\$59.99
Sidekick (unprotected).....	\$57.99
Reflex.....	\$59.99
Newspack.....	\$59.99

**CENTRAL POINT**

Copy II PC-Backup.....	\$29.99
------------------------	---------

**DECISION RESOURCES**

Chartmaster.....	\$229.00
Signmaster.....	\$159.00
Diagram Master.....	\$209.00

**FIFTH GENERATION**

Fast Back.....	99.99
----------------	-------

**FOX AND GELLER**

Quickcode III.....	\$169.00
--------------------	----------

**FUNK SOFTWARE**

Sideways.....	\$44.99
---------------	---------

**HARVARD SOFTWARE INC.**

Total Project Manager.....	\$269.00
----------------------------	----------

**INFOCOM**

Cornerstone.....	CALL
------------------	------

**LIFETREE**

Volkswriter III.....	\$159.00
----------------------	----------

**LIVING VIDEOTEXT**

Think Tank.....	\$109.00
Ready.....	\$64.99

**LOTUS**

Symphony.....	CALL
1-2-3 Version 2.....	CALL

**MECA SOFTWARE**

Managing Your Money 2.0.....	\$99.99
Manage Your Market.....	CALL

**MICROPRO**

Easy.....	\$94.99
WordStar 2000.....	\$239.00
WordStar 2000 +.....	\$289.00
WordStar Professional.....	\$189.00

**MICROIM SOFTWARE**

R:Base 4000.....	\$249.00
R:Base 5000.....	\$389.00
Clout 2.0.....	\$129.00

**MICROSOFT**

Flight Simulator.....	\$34.99
MultiPlan.....	\$129.00
Word.....	\$249.00
Mouse.....	\$139.00

**MICROSTUF**

Crosstalk XVI.....	\$89.99
Crosstalk Mark IV.....	\$149.00
Remote.....	\$89.99

**MULTIMATE**

Mult Mate Word Proc.....	\$219.00
Advantage.....	\$289.00
On File.....	\$89.99
Just Write.....	\$89.99

**NOUNEMON**

Intuit.....	\$69.99
-------------	---------

**NORTON**

Norton Utilities 3.1.....	\$59.99
---------------------------	---------

**ONE STEP**

Golf's Best.....	\$34.99
------------------	---------

**PFS: IBM**

Proof.....	\$59.99
File/Graph.....	(ea.) \$79.99
Report.....	\$74.99
Write/Proof Combo.....	\$79.99

**PROFESSIONAL SOFTWARE**

Write-N-Spell.....	\$89.99
--------------------	---------

**THE SOFTWARE GROUP**

Enable.....	\$329.00
-------------	----------

**SATELLITE SYSTEMS**

Word Perfect 4.1.....	\$219.00
-----------------------	----------

**SORCIM/IUS**

Accounting.....	CALL
API/AR/GL/INV/OE.....	(ea.) \$299.00
SuperCalc III.....	\$199.00
EasyWriter II System.....	\$239.00
Super Project.....	\$199.00

**SPI SOFTWARE**

Open Access.....	\$299.00
------------------	----------

**SUBLOGIC**

Jet.....	\$37.99
----------	---------

## IBM Inquiry 86

## IBM PC SYSTEMS

Configured to your specifications.

**Call for Best Price!**

**IBM-PC, IBM-XT, IBM-AT**

**ZILUM**

PC-138 Series, PC-148 Series, PC-158 Series, PC-160 Series, PC-171 Series, AT-200 Series.....	CALL
---	------

**SANYO**

MBC 550-2, MBC 555-2, MBC 675 Portable, MBC775, MBC 880 Desktop.....	CALL
--	------

**ANT**

Safari (7300).....	CALL
6300.....	CALL

**CORONA**

PPC400 Dual Portable.....	\$1289.00
PPCXT 10 meg Portable.....	\$1989.00
PC40022 Dual Desktop.....	\$1389.00
PC400-HD2 10 meg.....	\$1989.00

**ITT**

ITT X-TRA.....	CALL
256K, 2 Drive System.....	CALL
256K, 10 meg Hard Drive System.....	CALL
XP5, 20 meg.....	CALL

**SPERRY**

Sperry-AT.....	as low as \$1749.00
Sperry-IT.....	as low as \$2699.00
Call for Specific Configuration!	
All Models.....	CALL

**KAYPRO**

KP-2000 Portable.....	CALL
Kaypro PC.....	CALL

**MULTIFUNCTION CARDS**

**AST**

Ram Vantage.....	\$349.00
Rampage-PC.....	\$379.00
Rampage-AT.....	CALL
Six Pack Plus.....	\$229.00
I/O Plus II.....	\$139.00
Advantage-AT.....	\$399.00
Preview Mono.....	\$299.00
PC Net Cards.....	\$379.00
5251/11 On-line.....	\$669.00
5251/12 Remote.....	\$579.00

**dca**

IRMA 3270.....	\$879.00
IRMA Print.....	\$999.00
IRMA Smart Alec.....	\$779.00

**EVEREX**

Edge Card.....	\$259.00
Graphics Edge.....	\$219.00
Magic Card II.....	\$159.00
Magic Card I.....	\$99.99

**HERCULES**

Graphics.....	\$299.00
Color.....	\$159.00

**IDEA Associates**

IDEA 5251.....	\$549.00
----------------	----------

**MYLEX**

The Chairman.....	\$439.00
-------------------	----------

**PARADISE**

Color/Mono Card.....	\$149.00
Modular Graphics Card.....	\$259.00
Mult Display Card.....	\$199.00
Five Pack C, S.....	\$129.00
High Res Mono.....	CALL

**PERSYST**

Bob Board.....	\$359.00
----------------	----------

**TECMAR**

Captain - 64.....	\$199.00
Graphics Master.....	\$489.00

**QUADRAM**

Quadport-AT.....	\$119.00
Liberty-AT (128K).....	\$349.00
The Gold Quadboard.....	\$449.00
The Silver Quadboard.....	\$239.00
Expanded Quadboard.....	\$199.00
Liberty.....	\$309.00
QuadSprint.....	\$499.00
QuadLink.....	\$399.00
QuadColor.....	\$199.00
Quadboard-AT.....	\$399.00
8600 E.G.A. card.....	\$399.00

**INTEL**

PCNC8087 5MHz.....	CALL
PCNC8087-2 8 MHz.....	CALL
PCNC80287 6 MHz.....	FOR
1010 PC-Above Board.....	YOUR
1110 PS-Above Board.....	PC
2010 AT-Above Board.....	

COMPUTER MAIL ORDER

# BRADY Knows Programming.

You'll learn to whip every element of your programming into shape with the latest information and guidance by America's foremost technical experts. Just call toll-free or use the coupon below to order today.

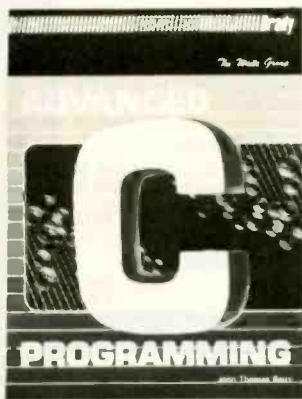

1. Beyond the basics, this guide explores new structured concepts to analyze and solve problems in C with tools of modularity, input and output functions, arrays and structures, and bit manipulation. \$21.95

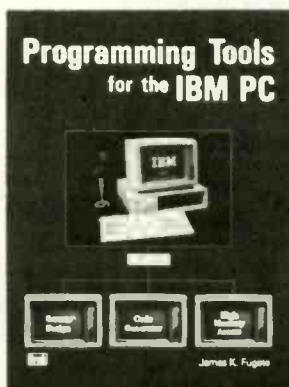

2. Includes a listing for the remarkable QUICKCODE code generator which automatically writes input, locate, and print statements. Also unleashes high memory access and makes screen design a cinch. \$19.95

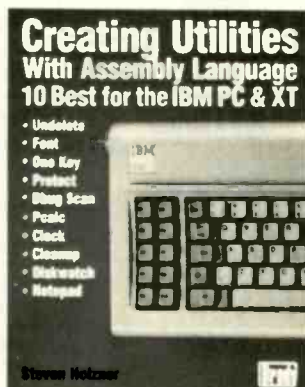

3. Learn the techniques used for creating assembly language utilities. Includes 10 of the most popular utilities such as DEBUG, SCAN, CLOCK, UNDELETE, ONE KEY, PCALC calculator and notepad and five others. \$21.95 (Disk available)

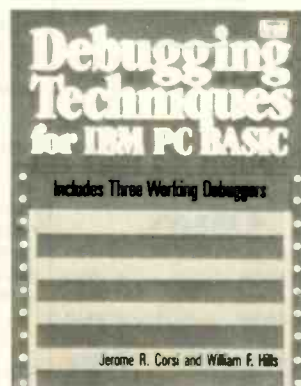

4. Includes code listings for three working debuggers including single-stepping, cross referencing, and mapping utilities. \$19.95 (Disk available)

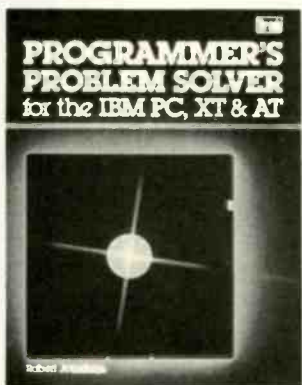

5. A definitive reference text for advanced programmers. You'll find over 150 discussions of common hardware-control tasks (in BASIC, Pascal, or C) as well as assembler overlays, drivers, and real-time operators. \$22.95

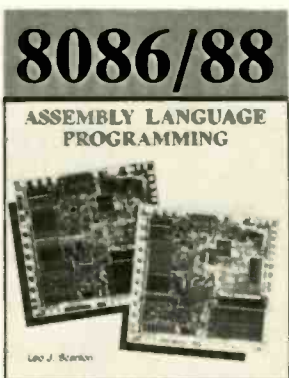

6. Probes the inner workings of the 8086 (used by the AT&T 6300) and 8088 (IBM PC) chips...and describes specific techniques for using the full capability of these chip designs while programming in assembler. \$18.95



7. Here's a compendium of many of the most useful, but often neglected, advanced programming concepts. A tutorial in format that uses BASIC for examples. It covers techniques such as: linked data structures; recursion; pipelining; and dynamic storage allocation. Includes listings for 25 sub-routines. \$21.95 (Disk available)

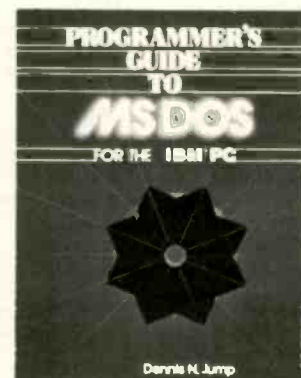

8. A breakthrough explanation to the technical operations of DOS for programmers. Shows how to use the I/O services with discussions of: character and non-character functions; directory and file management routines; and memory management. Includes BIOS functions and info on IBM "compatibles." \$16.95

Now at your book or computer store. Or order toll-free today: **800-624-0023** In New Jersey: 800-624-0024

BRADY COMMUNICATIONS COMPANY, INC.  
c/o Prentice Hall  
P.O. Box 512, W. Nyack, NY 10994

Circle the numbers of the titles you want below.  
(Payment must be enclosed; or, use your charge card.) Add \$1.50 for postage and handling.  
Enclosed is check for \$\_\_\_\_\_ or charge to

MasterCard  VISA

1 (0-89303-473-8)  
5 (0-89303-787-7)

2 (0-89303-784-2)  
6 (0-89303-424-X)

3 (0-89303-584-X)  
7 (0-89303-481-9)

4 (0-89303-587-4)  
8 (0-8359-5655-5)

Acc't # \_\_\_\_\_ Exp. date \_\_\_\_\_  
Signature \_\_\_\_\_  
Name \_\_\_\_\_  
Address \_\_\_\_\_  
City \_\_\_\_\_ State \_\_\_\_\_ Zip \_\_\_\_\_  
(New Jersey residents, please add applicable sales tax.)  
Dept. 3 GR-PTEC-B1(5)





# A ROUNDUP OF OPTICAL DISK DRIVES

BY RICH MALLOY

*Recently announced  
optical storage systems*

BECAUSE OF ITS HUGE storage capabilities, the optical disk promises fundamental changes in the way computers handle data. A number of companies have announced new products or technologies that can help us realize those changes, but many of those products are still in development. However, several of the optical disk systems that are mentioned in this article were reported to be available at the time the article was written (February).

Most of these products are available to original equipment manufacturers, value-added retailers, publishers, and other volume purchasers. Some, however, are available in single quantities to end users.

## **WRITE-ONCE DISKS**

One of the most interesting incarnations of the optical disk is the write-once, or WORM (write once, read mostly), disk. These disks usually have data capacities ranging from about 100 megabytes up to 1 gigabyte (1000 megabytes) or more, and they have the unusual property that once data is written on them, the data cannot

be erased and rewritten.

The large capacities of these disks, however, alleviate the problem of their indelibility. And they seem well suited for archival data, where indelibility is an asset rather than a liability. A small number of companies are currently offering write-once disk drives to end users.

Portable Solutions, which also goes under the name BackPac International Corporation, is selling a small optical disk drive called the BP-100+. The drive, which is manufactured by Information Storage Inc. (ISI), uses 5¼-inch disks that can store 100 megabytes. The BP-100+ is designed to be easily portable from one IBM PC to another. It sells for \$4995 and includes three adapter cards for three IBM PCs, three blank optical disks, software, and cables. The three cards allow three IBM PCs to share the drive. Extra disks are available for \$99 each. These disk prices will probably drop soon.

Franklin Telecom offers three configurations of its 5¼-inch optical drive system. Each configuration uses an ISI disk drive and can store more than

115 megabytes per side of an optical disk cartridge. An internal disk drive system for the IBM PC sells for \$3990. An external disk drive system has a price of \$4350. Finally, an expansion chassis is also available that provides the optical disk drive plus six additional IBM PC expansion slots for \$4900.

Tallgrass Technologies manufactures a 200-megabyte-per-side, 5¼-inch optical disk drive made by Optotech. Tallgrass will offer the drive in four configurations: the LS-200i, a full-height internal unit; the LS-200e, a stand-alone external unit; the LS-250, an external unit bundled with a 50-megabyte hard-disk drive; and the LS-450, an external unit that features two optical drives plus the 50-megabyte hard-disk drive. All are designed for the IBM PC family of computers. The internal drive has a single-quantity price of approximately \$4000.

*(continued)*

Rich Malloy is a senior technical editor for BYTE. He can be reached at BYTE/McGraw-Hill, 43rd Floor, 1221 Avenue of the Americas, New York, NY 10020.

Chorus Data Systems sells an optical drive option for its image storage and retrieval system. With Chorus's Color PhotoBase system, users have the capability to digitize and store high-resolution graphics images on a hard disk. When equipped with an optional optical disk drive manufactured by Optotech, the system reportedly can store approximately 15,000 color pictures on one side of

a 200-megabyte optical disk. Chorus's optical drive system has a suggested retail price of \$7500.

AGA has a 12-inch optical drive system for the IBM PC. Its Discus 1000 Optical Disk Drive uses a drive manufactured by Alcatel Thomson, and it can store 1 gigabyte of data. Under AGA's software, the drive appears to the computer's operating system as a large, nonerasable, but otherwise or-

dinary, disk drive. The Discus 1000 has a list price of \$21,500, including interface, cables, and software.

National Memory Systems (NMS) offers another 12-inch write-once disk drive for the IBM PC family and the Texas Instruments Professional Computer. Called the PC-007, the disk drive can store 1 gigabyte of information. The company claims that it has been shipping the PC-007 for about a year and a half. The drive is intended chiefly for archival purposes. NMS uses the Optimem 1000 optical disk drive with disks from the 3M Company, an IBM PC/SCSI board, and a custom-designed software package called LaserDOS. Current list prices are \$21,000 for the disk-drive system and \$450 for each optical disk.

**WRITE-ONCE DISK PRODUCTS FOR OEMS AND VARs**

Several other manufacturers have announced write-once optical disk drives but are offering them only in large quantities to OEMs and VARs. These companies are listed herein. Note that prices for each product can vary considerably depending on quantity and that some companies will sell sample units in single-unit quantities.

ISI is manufacturing a 5¼-inch optical disk drive that can store 115 megabytes per side. The company, which is partly owned by Sperry and Tallgrass Technologies, is selling its drives primarily to large-volume purchasers. However, hobbyists may be able to purchase evaluation units of the drive for \$2495. The evaluation units include the drive, an IBM PC interface card, and software. ISI software divides the disk into 33-megabyte volumes and thus avoids the 33-megabyte disk-size limit of MS-DOS.

Optotech has available a double-sided disk drive that can store 200 megabytes per side of a 5¼-inch disk. Although Optotech is marketing primarily to large-volume purchasers, it is offering an evaluation unit of its drive system including drive, IBM PC adapter card, and software for a single-unit price of \$5000.

Lancore Technologies is offering to

(continued)

**FLAMINGO**  
M I C R O

America's leading discounter  
of micro computers and their associated hard- and software.

*Our prices are laid back  
A Day Back*

**IBM** hardware available upon request; call for current pricing. Volume discounts are given.

**IBM** AT clone, 1 meg Ram, 2 360 K floppies, 192 watt power supply, keyboard \$1795.

**IBM** XT clone 256 K, 360 K floppy, 135 watt power supply, keyboard \$600.

Internal 300 / 1200 baud, Hayes compatible modem. \$189.

Hard disk, 20 megabyte sub-system \$469.

Herdon printer letter quality daisy wheel, 18 cps, warranted by Qume for one year. Regular retail \$599, now just \$275.

Add \$50 for 640 K.

5151 Style keyboard available for AT or XT - Add \$25.

ABOVE PRICES AT 3% CASH DISCOUNT

Call Toll Free 1-800-231-1214  
In Florida 904-837-3995

Write for catalogue P.O. Box 1491 Destin, Florida 32541-1491  
Prices subject to change without notice



640 x 350 16 COLOR



EGA PAINT



GEM



FLIGHT SIMULATOR



PAINT BRUSH

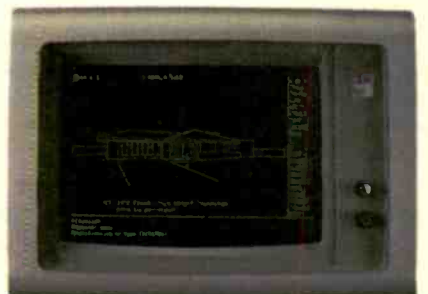

Auto CAD

# NO MORE Low-End Graphics Adapters.

## Why Settle for Less?

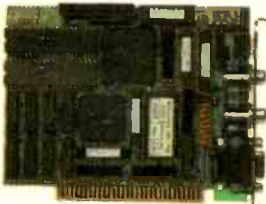

IBM sets the standards for Monochrome, Color/Graphics and the Enhanced Graphics Adapter. Hercules sets the Monochrome

Graphics standard. And the MegaGraph-Plus simply redefines the standard for what the Graphics Adapter is supposed to be: Monochrome text, Hercules graphics, color graphics, enhanced graphics. And most importantly . . . No software driver patches required.

## Fully Compatible

You can run almost all software from your early investment. Including Flight Simulator, Pin Ball, Jet and Lotus 1-2-3 Version A.

And it will still run all the business software packages written for IBM Enhanced Graphics Adapter (EGA). Examples include Auto CAD, IBM Drawing Assistant, Gem Draw, Microsoft Window, Word & Chart, Lotus 1-2-3 and Symphony, Dr. Halo, PC Paint Brush, EGA-Paint and many, many more.

ATronics is dedicated to the technical excellence of computing devices. To find out more about ATronics and our super-high performance ATI-1000 & ATI 2000 AT system compatible boards call or write:

### Features

	ATronics MegaGraph +	Quadram EGA +	IBM EGA	STB EGA +
--	-------------------------	------------------	------------	--------------

Half size, fits in any slot of PC/XT/AT	X	X		
EGA compatible	X	X	X	X
CGA compatible	X	(1)	(2)	(2)
MDA compatible	X	X	X	X
Chip count	24	29	86	40
Hercules compatible 720 x 348 graphics	X	X	X	
No Software Patches required	X		X	X
Boot from:				
- Flight Simulator	X			
- Pin Ball	X			
- Jet	X			
Runs Lotus 1-2-3 version 1A:				
- Hercules mode	X	(1)		
- Color mode	X	(1)		
Two Video Jacks	X	X	X	
Display Memory	256K	256K	64K	256K
Light Pen connector	X	X	X	X
List Price	\$549	\$599	\$624	\$595

(1) Needs software driver patches.

(2) Compatible only to the BIOS level, but not the hardware level. Will not be compatible with most games software.



**ATronics International Inc.**  
491 Valley Way  
Milpitas, CA 95035  
(408) 943-6629 TLX: 510-600-6093

**Mega Graph PLUS**

Inquiry 30

OEMs a write-once optical disk drive as an option for its line of local-area-network file servers. Lancore is using Optotech's 200-megabyte-per-side optical disk drive to replace the tape backup units in its Core line of file servers. The price of Lancore's Opti-Core 75, which features a 75-megabyte hard-disk drive and a 200-megabyte-per-side optical disk drive is \$9757 in quantities of 100.

Laserdrive Ltd. has announced a 5¼-inch, 400-megabyte-per-side optical disk drive. A separate controller with an SCSI interface will handle up to four drives. The drive reportedly will be available to OEMs in the first quarter of 1987 at a price of approximately \$4000.

Toshiba's Disk Products Division is offering two write-once drives to OEMs. The DF-O50 uses 5¼-inch disks and is approximately the same size as a full-height 5¼-inch floppy drive. Each disk can store up to 400 megabytes of data per side. Toshiba's

other drive, the DF-O450, uses 12-inch media and can store up to 1.8 gigabytes per side. No details on price or availability of these drives were available at press time.

Sony Information Products offers write-once disks in 12- and 8-inch sizes. The 12-inch disk can store 1.6 gigabytes per side, and the 8-inch disk can store 0.5 gigabyte per side. Both disks are double-sided. As in many double-sided optical drives, an operator must manually flip the disks to read the other side. Each of the drives must be connected to a drive controller (\$7000) that can support up to eight drives. The single-quantity prices for the 8- and 12-inch drives are \$9000 and \$11,700, respectively. The disks cost \$300 and \$440. Also available is a "jukebox"-style disk drive that can automatically access up to 50 of the larger disks, resulting in a total data capacity of 160 gigabytes.

Alcatel Thomson Gigadisc is also offering a 12-inch write-once optical disk

drive. The GD 1001 is available only to OEMs. One of its distributors, Cameron Computers, is selling the GD 1001 in single-unit quantities for approximately \$15,000. An adapter for the IBM PC is also available.

Optimem, a subsidiary of Xerox and formerly a part of Shugart, is offering its Optimem 1000/S optical disk drive system for the IBM PC to VARs. The system includes a 1-gigabyte 12-inch optical disk drive, an IBM PC adapter board, and the necessary cables and software. The single-quantity price is \$20,000.

Optical Storage International (OSI), which is a joint venture of Philips and Control Data, is offering 12-inch optical disks to OEMs. The LaserDrive 1200 can store 1 gigabyte per side on an optical disk. The 100-unit price is approximately \$7000.

Hitachi's write-once disk products are marketed in the U.S. by its two U.S. marketing firms, Hitachi America and Nissei Sangyo America. Both firms are selling a 12-inch optical disk drive to OEMs only. The Series 301 drive uses Maxell disks and can store 1.3 gigabytes per side on single- or double-sided disks. A separate drive controller handles up to four drives. Pricing starts at approximately \$12,000 for controller and drive in quantities of 100 per year. Like Sony, Hitachi also has available a jukebox-style disk drive that can automatically access up to 32 disks, with a total data capacity of 83 gigabytes.

**READ-ONLY DISKS**

Another, and perhaps equally interesting, form of the optical disk is the ROM disk, so named because of its functional similarity to the ROM chip.

Two forms of read-only disks are available: the 4.7-inch CD-ROM disk, which is the same size as the popular compact music disks; and the larger 12-inch disk, which is essentially the same size as a commercial videodisk. The CD-ROM disks have data capacities of 540 to 600 megabytes; the videodisks can store approximately 1 gigabyte.

Grolier is offering its Academic American Encyclopedia on CD-ROM. This 9-million-word work was prob-

(continued)

**TAKE COMMAND of Your Keyboard**

Place your most often used software commands where they belong—at your fingertips—on top of the keys. End fumbling and searching through manuals. Touch-down™ Key Overlays will greatly reduce instructional needs and learning time, reduce operator fatigue and increase productivity.

These Overlays are made of a non-glare rigid plastic material with the same look and feel as the original keytop, precisely die-cut to the exact size of your keytops. Printing is on the underside to prevent the print from ever wearing off. The back is laminated with a strong non-slip adhesive for permanent adherence to the keytop, although they can be removed without permanent damage to the keytops if desired.

Instructions for easy installation are included with the kit.



**CUSTOM KEY OVERLAYS** can be made to your exact specs at a much lower cost than engraving. P.O. Box 201, Dept. BY, Cornville, AZ 86325 (602) 634-7517

**KEY OVERLAYS** (Tops and/or Fronts)

Qty.	Price
PC to 5250/5251 Emulation	\$21.95
PC to 5520 Emulation	29.95
DisplayWrite 3	21.95
Do-It-Yourself Kit	29.95
Dvorak conversion	26.95
WordPerfect 4.1	29.95
WordStar	29.95
WordStar 2000	29.95

Qty.	Price
Lotus 1-2-3	\$29.95
MultiMate 3.3	29.95
EasyWriter 2	29.95
Microsoft Word	26.95
Symphony 1.0	26.95
Volkswriter	24.95
Blank-Out Overlays (99 pieces)	21.95
IBM Control Key English	6.95

**KEYTOP EXPANDERS**

Qty.	Price
IBM PC, PC/XT, PC Portable	\$21.95
IBM 5291 Display Station	21.95
Compaq, Columbia, Chameleon	21.95
Corona, Keytronics, Qubie, Eagle Spirit, ITT, Wyse 50/75	21.95
AT+T 6300	21.95
IBM 3270 PC "Enter" (1 keytop)	3.95
Ind. Expanders (specify)	2.75 ea.

TOTAL (Min. order \$10.00) \$ \_\_\_\_\_  
 Prices include first class postage.  
 (Orders shipped within 24 hours.)  
 Arizona residents add 5% tax  
**TOTAL ENCLOSED \$** \_\_\_\_\_

Specify Keyboard Make/Model: \_\_\_\_\_

Name: \_\_\_\_\_  
 Address: \_\_\_\_\_  
 City: \_\_\_\_\_ State: \_\_\_\_\_ Zip: \_\_\_\_\_

Visa  MC Exp. Date: \_\_\_\_\_ Card # \_\_\_\_\_  
 Visa or MC orders phone 602 634-7517

Your satisfaction guaranteed or your money refunded.

# The FASTEST, EASIEST, MOST POWERFUL BASIC EVER!

## Amazing New Advancements for an Old Friend.

ZBasic is an incredibly advanced and powerful BASIC—but it's still the old BASIC you're used to. Instead of spending 6 months of your life learning another complicated language, let ZBasic put your programs into light-speed, now! (If you know BASIC, you know ZBasic.)

## How Fast is ZBasic?

Lightening fast. Four years of intense development have produced the ultimate BASIC. ZBasic is "Compiled BASIC," and generates stand-alone applications that make any other BASIC completely obsolete. Just look at these speed comparisons.

Sieve Benchmark on Different PC's			
Macintosh™		Apple IIe, IIc	
ZBasic™	7.4 sec.	ZBasic™	486 sec.
Mbasic™	684 sec.	Applesoft™	5,401 sec.
IBM® PC (8086)		Z-80 (CP/M™-80, TRS-80™)	
ZBasic™	13.7 sec.	ZBasic™	30 sec.
BASICA™	2,190 sec.	Mbasic™	2,520 sec.

10 iterations of the Sieve from Byte, January, 1983

## Compiler Speed/Interpreter Ease.

Like a BASIC Interpreter, ZBasic allows you to write and execute your programs immediately! No messy "Linkers," "Loaders," or clumsy "Subroutine Packages" like most other compilers. To compile and edit, simply type "RUN." Debugging works the same as the Interpreter, too. Just type "BREAK" or "CTRL C" to get back to the editor.

## Lightning-Fast Compilation.

Computer Language Magazine says, "Compilation is amazingly fast..." After typing "RUN," ZBasic compiles your program at blinding speed—40 lines per second.

## Works the Same on All Computers.

If you're tired of throwing away your old programs everytime you switch to a new computer, ZBasic is for you. Source code is portable from one computer to another, and since ZBasic uses Device Independent Graphics and Disk File commands, your programs automatically "Adapt" to any other computer. And the ZBASIC editor is the same on all versions—regardless of the computer.

## Einstein Math.

ZBasic offers programmers a math package that surpasses anything else in the industry! (Yes, ZBasic is even better than FORTRAN, PASCAL, MODULA-2 or any other language available!) You will have up to 54 digits of user-selectable accuracy at your power.

## "Superb Documentation!"

"The 387 page ZBasic manual is a model of clarity and organization. The documentation is superb, solidifying our impression that someone worked incredibly hard to make ZBasic a benchmark for all other BASIC Compilers."

PC WEEK, Nov. 12, 1985

## Easy Structure—If You Want It.

ZBasic helps you "Structure" your programs in a way that's easy and simple... you may use GOSUB or GOTO with names or line numbers. Supports multi-line LONG IFs and LONG FNs. LIST programs with—or without—line numbers! ZBasic automatically indents loops and structures in LISTings, too.



## ZBasic Users Say:

"Awesome! It's about time! Great! Unbelievable!"

J. R. CPA  
Seymour, MO

"...fast, generates stand alone programs, requires only modest amounts of memory, has outstanding compilation speeds and...was bug free and felt solid. And the price is very attractive."

Bruce W. Tonkin  
COMPUTER LANGUAGE

"ZBasic is a powerful offering for BASIC programmers. It provides the flexibility of Turbo Pascal and the speed of compiled BASIC, all at a price that can't be matched. Kudos to Zedcor and to all users who make wise decisions to use ZBasic to the fullest."

Garry Ray  
PC WEEK

"The best I have ever seen. I love it! You should be proud of this product."

R. R. Manager  
Mesa, AZ

"Mind-blower! Easily the best BASIC I've ever seen!"

J. D.  
Baltimore, MD

## Versions shipping now!

- Macintosh, Apple IIe - IIc (128K & DOS 3.3)
- IBM PC and MSDOS 2.1 & Compatibles
- Kaypro Graphics version (CP/M-80)
- CP/M-80 2.0 or greater (Z80 only)
- TRS-80 Model 1/3, Model 4/4p

\$89<sup>95</sup>

Send me ZBasic right away! \$89.95 complete.

plus shipping

CREDIT CARD—MASTERCARD/VISA/MEX/COB

--	--	--	--	--	--	--	--	--	--

Name

Card Expiration Date:

Address

My computer is a

City

State

Zip

Day Phone

MAIL TO: ZEDCOR, INC.  
4500 E. Speedway, # 93  
Tucson, AZ 85712

# ZBasic™

ORDER TOLL-FREE:  
**1-800-482-4567**

30 day money-back guarantee.

Technical Support: (602) 795-3996

Arizona Residents add 5% Sales Tax. In U.S. add \$5.00 shipping. C.O.D. add \$5.00 per order. Outside U.S. and Canada, add \$20.00 per shipment for postage (U.S. currency only). C, Turbo Pascal, IBM PC, Fortran, Pascal, MODULA COBOL are trademarks of their respective companies—Macintosh is a trademark of Macintosh Laboratories, Inc.

## OPTICAL DRIVES

ably the first CD-ROM disk available for personal computers. The disk uses a full-text indexing software package created by KnowledgeSet (formerly

known as Activenture). The disk is designed to be used on any of several CD-ROM disk drives that can currently be connected to an IBM PC. The price

of the disk is \$199. Grdlier is selling the disk with a disk drive for the IBM PC for \$1495.

(continued)

## COMPANIES MENTIONED

### AGA

347 Fifth Ave., Suite 510  
New York, NY 10016  
(212) 683-9160

### ALCATEL THOMSON GIGADISC

470 Totten Pond Rd.  
Waltham, MA 02154  
(617) 890-0801

### CAMERON COMPUTERS INC.

29 Goodway Dr.  
Rochester, NY 14623  
(716) 427-8190

### CHORUS DATA SYSTEMS

6 Continental Blvd.  
Merrimack, NH 03054  
(603) 424-2900

### DIGITAL EQUIPMENT CORP.

CD-ROM Publishing Services  
12 Crosby Dr.  
Bedford, MA 01730  
(800) 332-9277  
(in Massachusetts: (800) 528-1313)

### FRANKLIN TELECOM CORP.

31320 Via Colinas, Suite 112  
Westlake Village, CA 91362  
(818) 706-1186

### GROLIER INC.

Sherman Turnpike  
Danbury, CT 06816  
(800) 243-7256

### HITACHI AMERICA LTD.

(for write-once disks)  
950 Elm Ave., Suite 100  
San Bruno, CA 94066  
(415) 872-1902

### INFORMATION STORAGE INC.

2768 Janitell Rd.  
Colorado Springs, CO 80906  
(303) 579-0460

### KNOWLEDGESET CORP.

2511-C Garden Rd.  
Monterey, CA 93940

### LANCORE TECHNOLOGIES INC.

31300 Via Colinas  
Westlake Village, CA 91362  
(818) 991-5100

### LASERDATA INC.

10 Technology Dr.  
Lowell, MA 01851  
(617) 937-5900

### LASERDRIVE LTD.

1101 Space Park Dr.  
Santa Clara, CA 95054  
(408) 970-3600

### LIBRARY CORP.

POB 40035  
Washington, DC 20016  
(800) 624-0559

### MICROTRENDS

650 Woodfield Dr., Suite 730  
Schaumburg, IL 60195  
(312) 310-8928

### NATIONAL MEMORY SYSTEMS

355 Earhart Way  
Livermore, CA 94550  
(415) 443-1669

### NISSEI SANGYO AMERICA LTD.

(for Hitachi write-once and  
CD-ROM disks)  
460 East Middlefield Rd.  
Mountain View, CA 94043  
(415) 969-1100

### OPTICAL STORAGE INTERNATIONAL

1050 South Academy Blvd.  
Colorado Springs, CO 80910-3799  
(303) 570-1400

### OPTIMEM

435 Oakmead Parkway  
Sunnyvale, CA 94086  
(408) 737-7373

### OPTOTECH INC.

770 Wooten Rd.  
Colorado Springs, CO 80915  
(303) 570-7500

### PHILIPS SUBSYSTEMS AND PERIPHERALS

100 East 42nd St.  
New York, NY 10017  
(212) 850-5125

### PORTABLE SOLUTIONS

BackPac International Corp.  
1701 Directors Blvd., Suite 250  
Austin, TX 78744  
(512) 448-4965

### REFERENCE TECHNOLOGY INC.

5700 Flatiron Parkway  
Boulder, CO 80301  
(303) 449-4157

### SONY

Information Products Division  
(for write-once drives)  
Sony Dr.  
Park Ridge, NJ 07656  
(201) 930-6484

### SONY

Optical Memory Group  
(for OEM CD-ROM drives)  
1359 Old Oakland Rd.  
San Jose, CA 95112  
(408) 280-0111

### TALLGRASS TECHNOLOGIES CORP.

11100 West 82nd St.  
Overland Park, KS 66214  
(913) 492-6002

### TECMAR INC.

6225 Cochran Dr.  
Solon, OH 44139  
(216) 349-0600

### TIME MANAGEMENT SOFTWARE INC.

POB 1358  
Stillwater, OK 74076  
(405) 377-0880

### TOSHIBA

Disk Products Division  
3910 Freedom Circle, Suite 103  
Santa Clara, CA 95054  
(408) 727-3939

# A multi-user UNIX™ System V for \$3,299 instead of ~~\$4,899~~

Only 1000 systems available at this price

At last . . . an affordable, interactive, multi-user computer system.  
It's time every office had one.

This high-powered computer system puts the competition to shame.

**MONEY-BACK  
GUARANTEE**



## The 8300-7 UNIX Processor from MEGADATA\*

- Fastest in its class—compares with systems costing two or even three times the price.
- Proven, reliable 10-user system with UNIX System V NOW!
- So light weight it's portable!

## JUDGE FOR YOURSELF . . .

This is what you get for \$3,299\*\*

- 26MB Winchester
- 1MB Floppy
- 1MB RAM
- 2 Serial Ports

- Operation Manual
- Built-in Diagnostics
- Menu-Driven Utilities
- 90 Day Warranty

- Expansion Capability
- Built-in SCSI Interface
- Desktop Design
- Free Delivery (Within Continental U.S.A.)

● UNIX System V. The Complete Operating System includes: C, Assembler, programming tools, nroff, troff, vi, man, etc.

Still need convincing? Order **BEFORE 6/30/86**, and you can buy our Expansion Board, controlled by a separate on-board 80186 MPU, for only \$700 (a \$1,200 value), which includes:

- Additional 8 Serial Ports
- Additional 1MB RAM
- Centronics Printer Port

SOFTWARE OPTIONS: Cobol 74, Fortran 77, Pascal, Basic, Macro Assembler, as well as word processing, laser typesetting, DBMS, spreadsheet, accounting, Inventory/purchasing packages, IBM™ 3270 SNA/SDLC communications, PC File Server, etc.

Megadata also offers larger 16-user Multibus™ based systems with storage options from 26 to 760MB.

# MEGADATA



\*Megadata is a successful, 19-year old computer and terminal manufacturer with a commitment to UNIX since 1981.

\*\*15-day money-back guarantee limited to one system per customer. Special conditions apply. Offer limited to continental U.S.A. only, and expires 6/30/86.

™ UNIX is a trademark of AT&T Bell Labs, Multibus is a trademark of Intel Corp., IBM is a trademark of International Business Machines.

## Call, write, or use coupon

**MEGADATA**   
CORPORATION  
35 Orville Drive, Bohemia, New York 11716  
Tel. 516-589-6900 • Telex 14-4659

YES! I'm interested!

- Please tell me how to order
- I'm in a hurry—please call
- Please send information about your 16-user UNIX Systems

Name/Title \_\_\_\_\_

Company \_\_\_\_\_

Address \_\_\_\_\_

City/State/Zip \_\_\_\_\_

Telephone \_\_\_\_\_

D

## OPTICAL DRIVES

For the Atari 520ST and the IBM PC, a ROMulus CD-ROM drive is available directly from KnowledgeSet. This configuration is available by mail order for \$995, and it includes the encyclopedia disk.

For the Apple IIe, MicroTRENDS sells a 68000 board and a CD-ROM disk drive adapter that reportedly allows the user to connect a CD-ROM disk drive to that computer. The 68000 board, called Jonathan, features a 10-megahertz 68000 processor and the OS-9 operating system. The board reportedly runs certain well-behaved GEM applications such as the Activenture encyclopedia-accessing software. MicroTRENDS also indicates that a multiuser option will soon be available, allowing up to three terminals to access the CD-ROM drive through the Apple IIe. The Jonathan 68000 board costs \$795, the adapter is \$395, and a Philips CD-ROM drive currently sells for \$1000.

Digital Equipment Corporation's

CD-ROM Publishing Services division is offering CD-ROM readers bundled with its collection of reference works on optical disk. CD-ROM drives are available for the DEC MicroVAX and the IBM PC and will soon be available for the DEC Rainbow 100. Currently, 10 reference works are offered including COMPENDEX: Electrical & Computer Engineering (\$1195, or \$3485 with CD-ROM drive) and NTIS: Computers, Communications, and Electronics (\$1150, or \$3440 with CD-ROM drive).

The Library Corporation offers not only its bibliographic databases on CD-ROM disks but also stand-alone CD-ROM disk drives for the IBM PC. It currently sells a Hitachi CD-ROM drive for \$999, including adapter, cables, disk-access software, and a sample CD-ROM disk. [Editor's note: For more sources of applications on CD-ROM disks, see "Laser Libraries" by Norman Desmarais on page 235.]

Tecmar is selling its CD Massfile CD-

ROM drives and adapters for the IBM PC and DEC Rainbow. Each of Tecmar's adapter boards can attach to two drives. The price for one drive plus adapter card and cable is \$1695.

### READ-ONLY DISK PRODUCTS FOR OEMS AND PUBLISHERS

Publishers who need to distribute large amounts of information to a large group of people may find optical disk technology to be cost-competitive with paper- and modem-based methods. A few of the companies who can master and copy optical disks are listed in this section. Again, note that prices for each company can vary considerably depending on quantity.

Nissei Sangyo America manufactures two CD-ROM drives. The CDR-1502S is approximately as wide as the IBM PC system unit. And the CDR-2500 has the same size as a full-height 5¼-inch floppy-disk drive. Both

(continued)

## THIS \$1000.00 SAYS YOU CAN'T FIND A BETTER PRICE THAN YOU'LL FIND ON THE I. C. E. EXCHANGE<sup>T.M.</sup>



### BUT DON'T DO IT FOR THE MONEY!!

AVAILABLE BY PHONE (VOICE) AND PC DIALUP

REF#	MODEL	BEST PRICE
1.	ATARI XTM 201	99.95
2.	ATARI XTC 201	99.95
3.	COM...	100.00
4.		125.00
5.		127.92
6.	OLYMPMASTER II	139.95
7.	TIGER 100	158.95
8.	ATX 801	169.95

SAMPLE DATA ONLY.  
PRICES, ETC. VARY CONTINUOUSLY

"ENTER" FOR MORE MODELS OR REF# FOR VENDOR DATA

TO RECEIVE YOUR **FREE** PASSWORD (PLEASE HAVE YOUR VISA/MC# READY) CALL:

OUTSIDE TENNESSEE: (800) 423-6408  
IF BUSY (800) 423-0276  
IN TENNESSEE: (800) 826-4528  
DIRECT (901) 756-1879

There are easier ways to acquire money—like saving a lot of it when you buy hardware or software. The International Computer Component Exchange (I.C.E.) brings you a new, low cost data base of both dealer liquidations and nationally advertised offerings. It's available on line and by phone (voice) for those who prefer Personal Service and advice. Like a com-

### SAVE MONEY ON YOUR FIRST CALL OR IT'S FREE!

If your first phone call doesn't save you money by showing you prices that are lower than ANY currently advertised prices for identical products, just identify the ad for a full refund of line time for the call up to 10 minutes. **NO MEMBERSHIP FEE.** All charges are made to your Visa/MC. Just 99 cents/min. Toll Free for on line dialup data ac-

cess and \$1.25/min. for Personal Service Phone Access (Toll Free). If you decide to buy something, vendor referral is \$2.99. **QUESTION: WHEN YOU CAN FIND OUT IF YOU'RE GETTING THE VERY BEST PRICE FOR JUST ONE OR TWO DOLLARS, WHY CONTINUE TO PAY SO MUCH MORE?**

#### A SERVICE OF IBC/INNOVENTION

1. The first user to find a current advertised price for a new product in a U.S. Computer Magazine that is lower than an identical product listed on I.C.E. will receive \$1000.00



# THE FIRST AND BEST

## Multi-User PC Data Terminal.

Acts like a PC. Displays like a PC. Types like a PC. Existing software can run on the KT-7/PC terminal as it would on a PC.

Multiple users have the ability to share a single PC's resources, such as its CPU, hard disk or RAM card.

Kimtron terminals connect to the PC through an RS-232 serial port.

80 x 25 addressable and scrollable lines of display and unique hidden attributes on a character basis support full IBM monitor video attributes.

The ergonomically designed display comes in your choice of 14" green or amber. One page of display memory standard. Up to 4 pages optional.

Tens of thousands of IBM PC owners have already chosen our KT-7/PC data terminal for its convenience. So should you! Call today for your nearest Kimtron representative.

*IBM is a registered trademark of International Business Machine Corporation.*

© Copyright 1986 Kimtron Corporation.



**Kimtron**

1705 Junction Ct., Bldg. #160  
San Jose, CA 95112

TWX: 910-338-0237

(408) 436-6550 (in CA) (800) 828-8899

Inquiry 194 for End-Users  
Inquiry 195 for DEALERS ONLY.

drives conform to the Sony-Philips data standard. Also available are an interface for the IBM PC and a DMA-type interface. An SCSI interface will also soon be available. In quantities of 1000 units per year, the price of the drive alone, less power supply, is \$396. Nissei Sangyo also offers disk mastering and duplication services. Premastering and mastering of data on a 9-track tape costs approximate-

ly \$5000; in 1000-unit quantities each disk copy costs \$6.

Philips Subsystems offers CD-ROM disk production and CD-ROM drives. The company is selling its CD-ROM drive to publishers and VARs for approximately \$500 in 1000-unit quantities.

Reference Technology can produce disks in the CD-ROM format and also sells CD-ROM drives. Its CLASIX CD-

ROM drive for the IBM PC is made by Hitachi and has a single-quantity price of \$1595, including cables. The base price for mastering a CD-ROM disk is \$9000, plus extra costs for indexing. Replicas are \$15 to 25 each. The company also offers a drive to handle 12-inch disks.

Sony's Optical Memory Group is offering three CD-ROM drives to OEMs. The CDU-5002 is the same size as a full-height 5¼-inch floppy-disk drive. The CDU-100 is an external unit with its own power supply. And the CDU-200 is like the CDU-100, but with an SCSI interface. Sony also has available an IBM PC adapter card. In quantities of 5000 to 10,000 units, the CDU-5002 has a price of under \$300; the CDU-100, under \$400.

Time Management Software (TMS) can produce disks in both the CD-ROM and videodisk sizes. The company offers a software product called LaserDOS that comes in two parts and is said to ease data storage and retrieval. The origination part of LaserDOS runs on a VAX and allows efficient storage of data on the optical disk's sector format. The destination part of LaserDOS runs on an IBM PC and allows full-text retrieval and screen-capture capabilities. Disk mastering currently costs \$4000 plus fees for text preparation and indexing. Copies are \$20 each. The price for each copy of the destination part of LaserDOS ranges from \$50 to \$95, depending on volume.

LaserData can produce videodisks and sells a controller card that allows an IBM PC to connect to a videodisk player. Called the PC Trio, the controller allows the PC to access digital, video, and audio from a videodisk player. PC Trio has a price of \$1495. Mastering a videodisk with 800 megabytes has a base price of \$8000. Replicas are \$25 in 1000-unit quantities.

#### CONCLUSION

Because this industry is young and rapidly changing, these lists should not be considered complete. We invite interested readers to use them as a starting point and to explore other products that will surely be announced in the future. ■

# PRESENTING THE - EC3000 -



## BUSINESS AND PERSONAL COMPUTER

- BOTH A SINGLE-USER AND MULTI-USER
- IBM PC/AT COMPATIBLE
- ENHANCED FUNCTIONALITY
- HIGH SPEED PROCESSING AND MEMORY MANAGEMENT

**THE EC-3000, BY MITSUBA**  
MANUFACTURED IN JAPAN FOR QUALITY

### MITSUBA CORPORATION

CORPORATE: 714-592-2866

JAPAN: EI-EN ENTERPRISES 03-446-6531

TAIWAN: GIFU ENTERPRISES 02-752-9661

HONG KONG: A&N ENTERPRISES 5-488-463

SINGAPORE: AI-EN ENTERPRISES 2745-333

# Only the Hayes® Transet 1000® can get you out of this one.

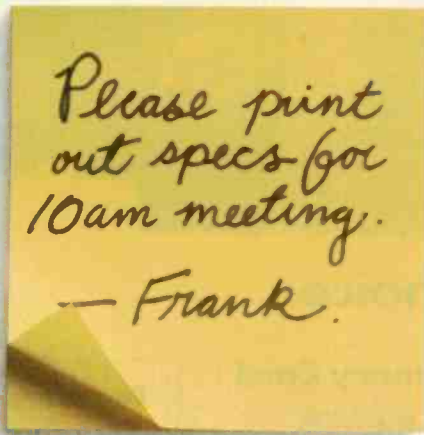
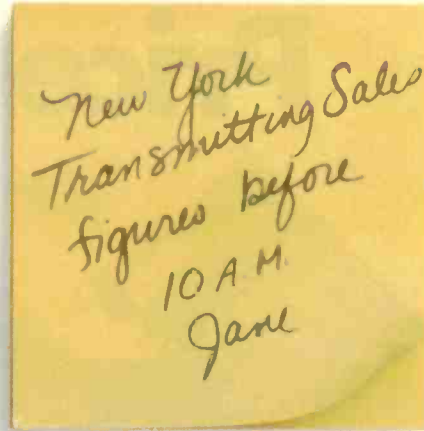

©1986 Hayes Microcomputer Products, Inc.

Now your PC can do three things at once instead of making you wait while it does one thing at once.

We call it *triple tasking*®.

It means you can work with your PC while the Transet 1000 receives your electronic mail and runs your printer for you simultaneously.

Three jobs at once. No waiting.

When you're away from your desk, or at night while your PC is turned off, Transet 1000 serves as an electronic mailbox.

Because it has its own independent 128K or 512K memory.

To get the messages that come in through the night, you can call them up on your PC. Access them through a remote modem if you're away from the office.

Or even have them waiting for you in hard copy.

By now it's dawning on you



## Hayes®

Say yes to the future with Hayes.

\* Manufacturer's estimated retail price.

that Transet 1000 can make your PC about three times as productive as it is now. Which is no small statement.

You've also figured out it's more than just a print buffer. More than just a communications buffer. And probably costs a lot. Right?

Wrong!

It costs only \$399\* for the 128K model which stores up to 90 pages. And only \$549\* for the 512K version with up to 360 pages of storage.

For more information and specifications, contact your authorized Hayes dealer. Or Hayes directly at (404) 441-1617.

Hayes Microcomputer Products, Inc., P.O. Box 105203, Atlanta, Georgia 30348.

# Conquest: Two Cards for the Price of One



## One Card, One Slot, One Choice

Introducing Orchid's Conquest, the first PC multifunction card with 2 megabytes of the new Lotus EMS Expanded Memory. It's like having a multifunction card and an EMS card in one slot, but it costs less than you'd expect to pay for either.

### Multifunction Card

Conquest is a multifunction card with serial/parallel ports, clock/calendar, and DOS Memory. And Orchid's Switchless Installation gets you up and running in minutes.

### Expanded Memory Card

Conquest breaks the 640K DOS memory limit with 2 megabytes of Lotus EMS Expanded Memory. Orchid's Productivity Software lets you use this memory for RAM Disk and Caching, so you take advantage of it with your existing software.

Whether you're buying the first expansion card for your PC or an add-on for Lotus EMS Expanded Memory, Conquest is your choice:

- ▲ **First Card Buyers:** Conquest is a multifunction card with EMS.
- ▲ **Multifunction Card Owners:** Conquest is an EMS card with ports.

### Features:

2 megabytes of RAM  
DOS & EMS Memory  
1 Serial, 1 Parallel Port  
Clock/Calendar

Productivity Software:  
RAM Disk  
Disk Caching  
Print Spooling  
Alarm & clock display

Optional PCnet connection

47790 Westinghouse Dr.  
Fremont, CA 94536  
415/490-8586  
Tlx: 709289



**ORCHID**  
The Innovative Leaders

# TAPE BACKUP SYSTEMS

BY ANTHONY ANTONUCCIO

---

*An introduction to backup systems for microcomputers*

DURING THE PAST few years, the need for tape backup systems within the microcomputer community has increased mainly due to the advancements made in magnetic-disk technology. Microcomputer systems often have 10 to 20 megabytes of 5¼-inch hard-disk data storage, and the average disk storage capacities could soon increase to 30 megabytes or more. This move to higher disk capacities reinforces the need for tape backup systems as a means of archiving data, transporting data between facilities, maintaining data within its disk environment, and most of all, providing "data insurance" to guard against the loss of data.

This article is not a brand-name comparison of available tape backup systems. The intent here is to give you the necessary background information on the types of tape systems available, so that you can make an intelligent choice for a tape system that will best suit your needs.

I will focus on the most common uses of tape systems within the microcomputer environment, discuss tape-system/host-system interaction, and describe the most popular types of tape systems, outlining the pros and

cons of each type. I'll also give some hints on buying a system.

## **TAPE SYSTEMS FOR PERSONAL COMPUTERS**

Until recent years, tape systems were primarily used as a "secondary" means of data storage. At the end of a given day, users would "dump" to tape data that was no longer needed for immediate access and store it for future use. This form of data storage was, and still is, very important within the mainframe environment, and it is becoming more important within the microcomputer environment as higher-capacity disks become available.

Another common use for tape systems is as a means for data exchange and distribution. Within many data-processing environments, users need to distribute data from one facility to another. Tape systems become a natural solution for this application due to the low cost and high capacity of the medium.

Tape systems used as disk-file maintenance tools can provide fast and flexible reorganization of data. You can rearrange groups of files from one disk directory or disk device to an-

other. You can also make fragmented disk files contiguous again by backing up the files to a tape, then restoring these files from the tape to a reformatted disk. The files will be restored contiguously, enabling faster disk-file accessing.

Probably the most important use for tape systems is for data protection when a system's disk device becomes unusable due to disk failure or, more commonly, through operator accidents where the integrity of file information is destroyed. Losing information, as most computer users at some time or another can attest, is an aggravating and often costly situation. Having the "lost" information safe on a backup tape may help preserve your sanity.

## **TECHNICAL BACKGROUND**

The integration of a tape drive to its host computer system requires a series of interfaces that will transport, translate, and process information

*(continued)*

*Anthony Antonuccio (Sytron Corporation, 135 Maple St., Marlborough, MA 01752) is vice president for product development at Sytron Corporation, developer of software for a variety of tape backup systems.*

pertinent to any backup or restore operation. The components connecting the host computer system to a tape-drive mechanism consist of a host-system interface, a tape-drive interface, and intelligent tape firmware (figure 1). These components can be contained on a single host-controller card containing both tape intelligence and the host interface, or they can be separated into a host adapter and a tape controller with an interface to the host adapter and an interface to the tape-drive mechanism. No matter how they are designed, most tape systems have those same basic components.

## THE TAPE SYSTEM

The integral part of the tape-drive mechanism is the recording head, consisting of read, write, and erase heads (figure 2). The number of heads determines the number of recorded data tracks placed on the tape. The storage capacity of a tape drive is determined by the number of data tracks the device uses, the recording density of information it places on each track, and the length of the tape.

The tape-drive interface carries data to and from the tape drive. This interface consists of tape-drive status signals, tape-drive control signals, and data-interchange signals. These signals are the low-level components of

the backup and restore applications.

The intelligence of a tape system, residing on a tape-controller board, receives information from the host adapter, manipulates that information with one of a series of tape command sets, and then passes the resulting formatted information to the tape drive.

Figure 3 shows the QIC-02 (Quarter-Inch Committee) standard commands used by some tape driver software to manipulate data to and from a tape system. Other command sets such as SCSI (small computer system interface), SASI (Shugart Associates system interface), and other QIC command sets may also be used.

## THE HOST INTERFACE

Host-system adapters with a tape-controller interface have the necessary intelligence to port and decipher host-system signals and data to and from a tape controller. Most host-interface signals include I/O channels for DMA (direct memory access) control lines of read and write operations, processor-interrupt control lines, clock and timing control lines, and a status-check line. Figure 4 summarizes a typical host interface connecting a host computer system to a tape controller. This interface consists of data, command, and status bytes; handshaking lines that can interrupt data or command transfer; control signals

to the tape drive; and status signals from the tape drive.

## SOFTWARE AND UTILITIES

The software driver that generates tape commands and supervises the backup and restore operations to and from a tape system can take various forms, depending on the computer, operating system, and the objectives of the system programmer. Tape-system software also includes backup and restore utilities that let you transfer logical disks and selective files to and from a tape drive.

Typically, the utility will be a menu-driven program prompting you at each decision point with appropriate questions and valid answers. Upon executing the utility, for example, you might be asked to select the type of operation, whether backup, restore, or verify. The first option transfers data from disk to tape, while the second reverses the process. A verify operation performs a tape-to-disk comparison to assure the integrity of the data on the tape.

At the lowest level of tape driver software is "buffer management." Here, the software initiates a buffer pool using the host system's available RAM, manipulates data blocks contained within these buffers, and monitors data-transport activity. Figure 5 summarizes a typical design for data

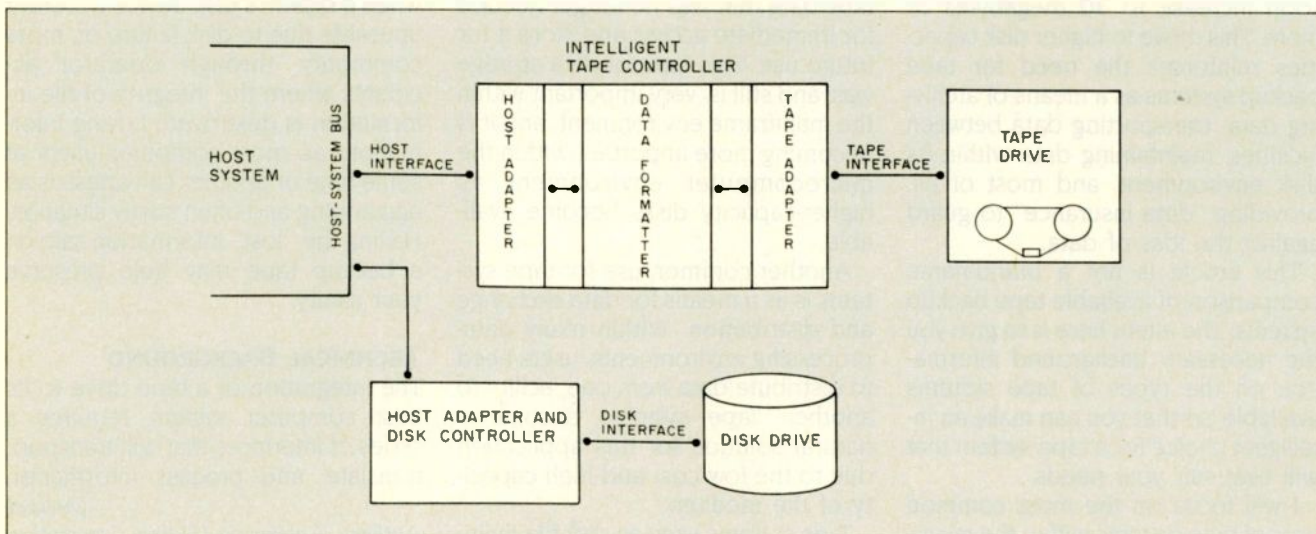

Figure 1: A tape backup system typically consists of an intelligent tape controller with interfaces to the host computer system and the tape drive itself. Depending on the system, all or part of this controller may be incorporated into the host system (as an add-on card) or into the tape-drive unit.

## TAPE BACKUP

exchange between a tape system and host computer with a hard-disk system.

At the highest level of tape driver software, backup, restore, and verify operations are generally separated into two categories: file-by-file operations and image operations. File-by-file operations generally use operating-system function calls that can manipulate single files, groups, or entire directories of files and provide the most flexible and secure of operations.

Image operations disregard file or directory structure. Instead, they access disk-sector information sequentially, through operating-system calls or straight BIOS calls, and provide maximum data-transfer throughput due to lower disk and processor overhead. Many users prefer image operations because of their faster speed. The trade-off is that image operations generally give you less flexibility for restore operations because of the lack of file structure during backup operations.

Figure 6 represents a sample data-recording format typically used for tape. This QIC-24 format for putting data on a tape (as opposed to the QIC-02 command set for *sending* data to and from the tape system) includes a preamble, which contains information on blocks (akin to sectors on a disk); a block marker to mark the beginning of the actual data; 512 bytes of data; a block number; a cyclic redundancy check (CRC) for error detection; and a "postamble" that sets up the tape to receive another preamble. The QIC-24 format is the most widely accepted standard for writing data on a tape.

### TYPES OF TAPE SYSTEMS

Of the many types of tape systems available, there are only a handful of different tape-drive types and even fewer manufacturers of those tape drives. Differences in brand-name tape backup systems can include how the tape drive is assembled, whether or not it has a tape controller (not always necessary), the design of the tape application software, whether it is in an external housing (usually consisting of a power supply, ventilating

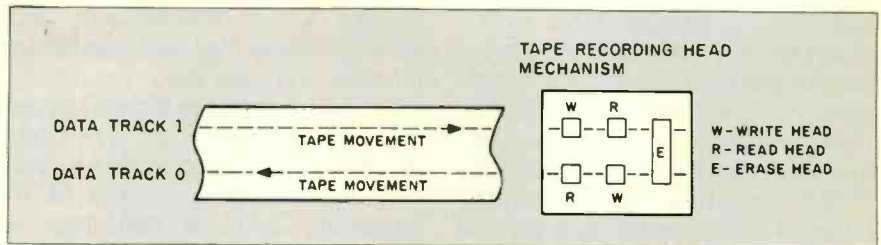

Figure 2: The integral part of a tape-drive unit, the recording head, consists of read, write, and erase heads. This diagram shows two tracks of a multiple-track tape system. Note the placement of the read heads after the write heads, for the purpose of error detection.

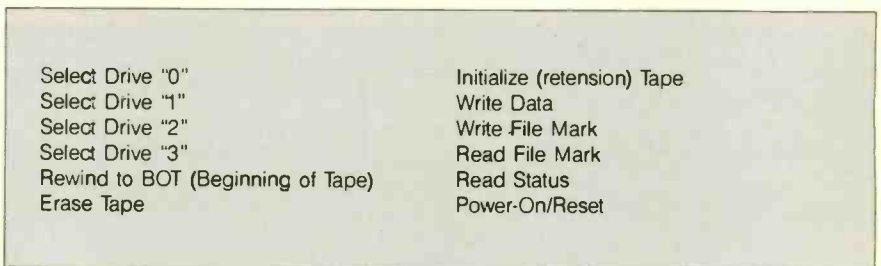

Figure 3: These QIC-02 commands are typical of commands that a tape-drive controller uses to send information to and from a backup tape.

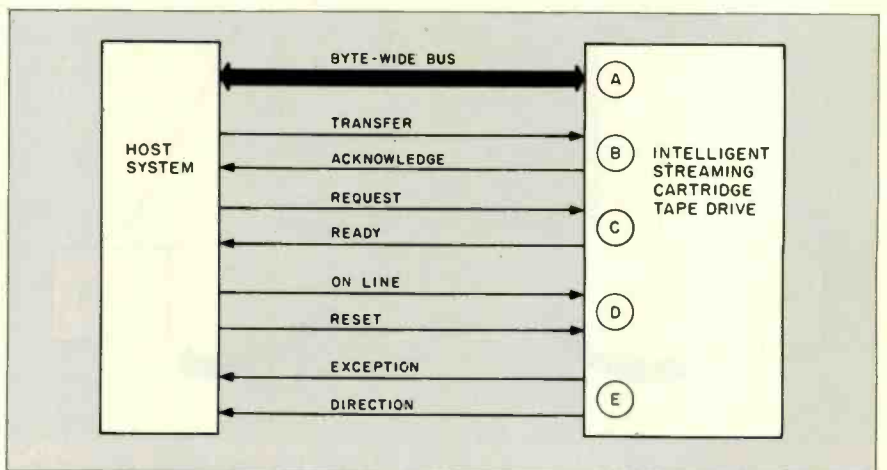

Figure 4: A summary of the typical communications between a host computer and a tape backup system, including: (a) the actual data, command, and status bytes; (b) data transfer-acknowledge handshaking; (c) command-status handshaking; (d) host-to-drive control signals; and (e) drive-to-host status signals.

fan, and cabling), and whether it is sold by an OEM or a value-added system integrating firm.

Tape drives can first be classified by the type of tape medium they use. Further classification differentiates tape drives by the recording mechanism they use to place data onto the tape medium. The most commonly used types of tape media

are 1/2-inch (in width) tape in an open reel or cartridge tape form, 1/4-inch tape usually in a cartridge tape form, and .15-inch tape in a cassette or minicassette tape form.

The 1/2-inch tape drives are generally used within the mainframe and minicomputer environments due to their fast data-transport speed and

(continued)

## TAPE BACKUP

high-capacity storage. Most 1/2-inch drives are too large, fast, and expensive for practical use with microcomputers. However, as processor speeds, disk-access speeds, and disk capacities increase, so will the need for 1/2-inch tape-drive systems. In the future, 1/2-inch cartridge tape drives in a 5 1/4-inch "form factor" (i.e., fitting in the same space as a 5 1/4-inch floppy-disk drive) could make 1/2-inch tape-drive technology more popular with microcomputer users. Some manufacturers are developing 1/2-inch tape

systems for microcomputers, and these products may be available by the time you read this.

The 1/4-inch cartridge tape drives are the most commonly used tape backup drives for microcomputers with hard-disk storage capacities of 10 megabytes or more. Capacities of 1/4-inch tape drives generally range from 45 to 60 megabytes of formatted data storage on a single tape, with a maximum data-transfer rate of 5 megabytes per minute. You can classify 1/4-inch tape drives by three

configurations: start-stop tape drives, streaming tape drives, and floppy tape drives.

A conventional start-stop tape drive operates with a low-inertia capstan that allows sudden starting and stopping of tape motion and is best used for file-oriented data recording. Tape systems using this type of tape drive generally can record and access specific data files faster than a streaming tape drive because they can quickly stop in between data blocks rather than "overshooting" the file. Overshooting of tape wastes time because the tape must rewind past the last recorded or accessed data block and reposition itself in a forward motion again for the next data block to be recorded or accessed. On the other hand, streaming tape drives are faster at recording an *entire* disk.

Most start-stop tape drives can access data files on tape randomly, as opposed to sequentially searching the tape for a desired data file. Due to the sophisticated recording mechanisms of start-stop tape drives, they are generally more expensive than other 1/4-inch tape-drive systems.

Streaming tape drives are designed to record information to a tape without having to stop tape motion, thus the term "streaming." This type of tape drive is better suited for image data recording. Because a streaming tape drive can record or access a data block on the fly, it can achieve continuous tape motion, providing a data block is available to be recorded or accessed.

Streaming tape drives can do file-oriented backup operations with a sacrifice of reduced performance from that of a start-stop drive. Streaming tape drives usually access files on the tape by sequentially searching the tape until they find the desired data file or until they reach the end of recorded data on the tape. In comparison, streaming tape drives are less expensive than start-stop drives due to their simpler, lower-cost drive mechanism.

Floppy tape drives are designed to eliminate the need for a separate controller board to control tape operations. The tape drive plugs directly

(continued)

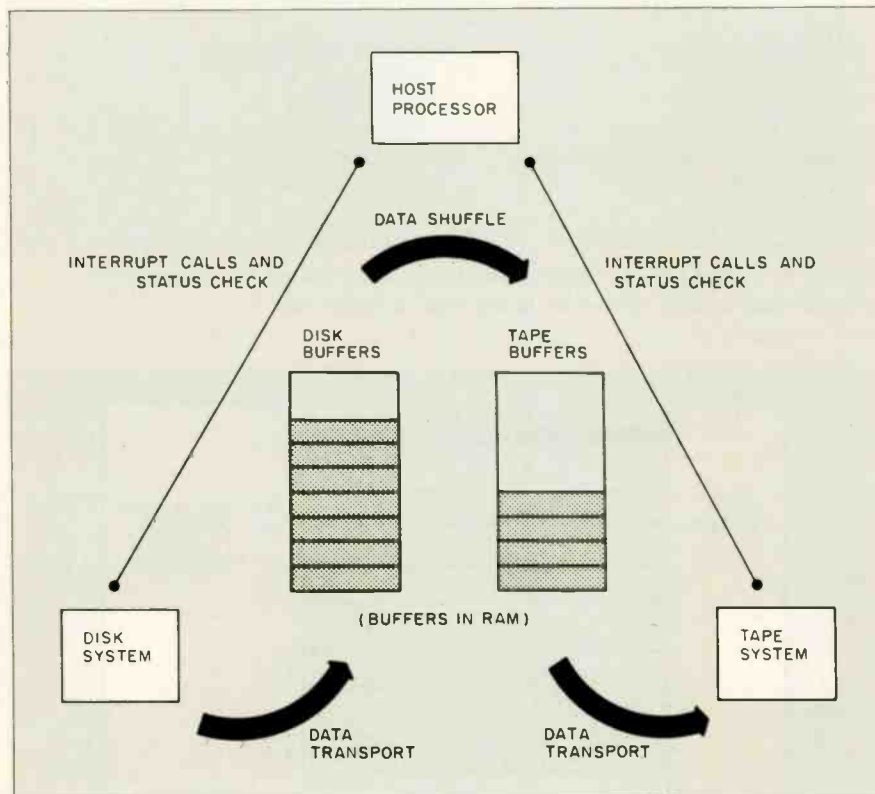

Figure 5: In the process of data exchange from the host computer system to the tape backup drive, the tape software uses the host system's RAM as a buffer to manipulate data blocks.

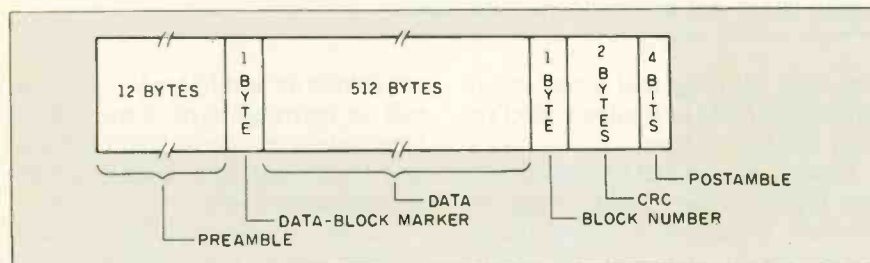
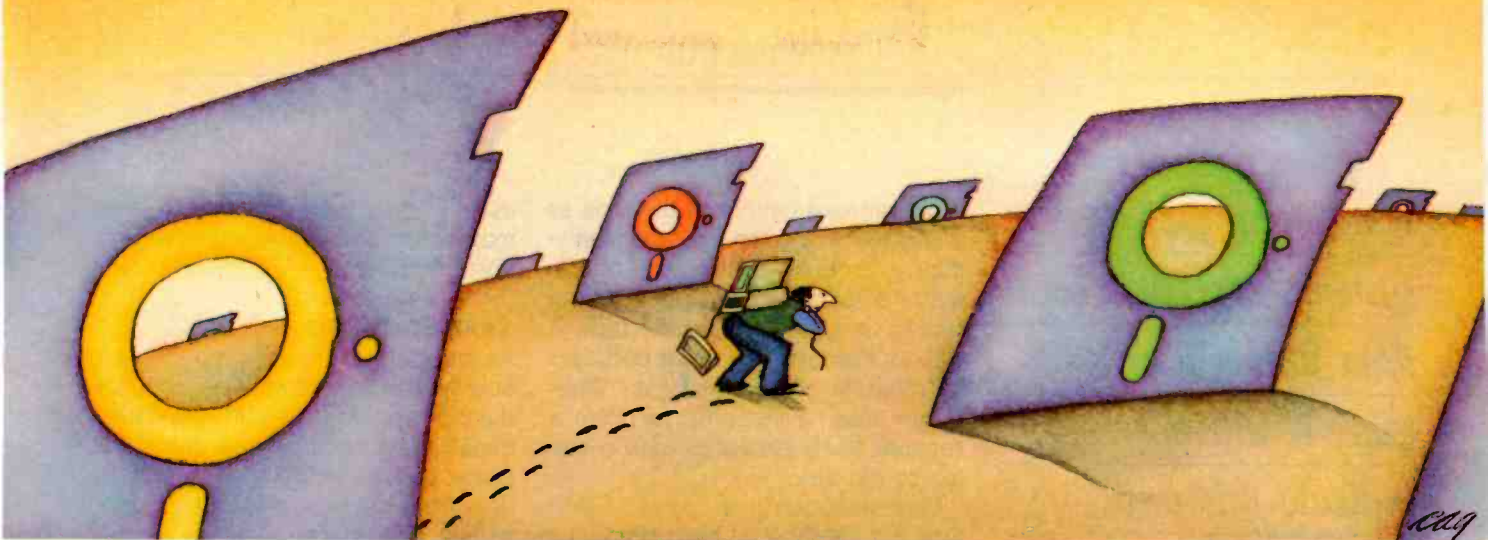

Figure 6: A typical data-block format used for tape backup systems, the QIC-24 format.





## PROBLEM: There's just no easy way to move from one software program to another.

## THE SOFTLOGIC SOLUTION: Software Carousel

Now you can keep up to 10 programs loaded and ready to run.

Hard to believe, but some people are happy with just one kind of PC software. Well, this is not a product for them.

But if you're someone who depends on many packages, all the time—someone who'd use several programs at once if you could, well now you can. With Software Carousel.

### Why call it "Software Carousel"?

In some ways, Software Carousel works like the slide projector you're used to. You load a handful of pictures, view one at a time, then quickly switch to another. A simple idea, with powerful possibilities for computing.

Here's how it works. When you start Software Carousel, just tell it how much memory you have, load your software and go to work.

Need to crunch numbers? Switch to your spreadsheet. Need your word processor? Don't bother saving your spreadsheet file. Just whip over to your document and do your work. Snap back to your spreadsheet, and it's just like you left it.

With up to ten different programs at your fingertips, you'll have instant access to your database, communications, spelling checker, spreadsheet, word processor, RAM resident utilities, languages, anything you like.

### Reach deep into expanded memory.

This could be the best reason ever for owning an expanded memory card, like the Intel Above Board, AST RAMpage, or any

card compatible with the L/L/M Extended Memory Standard.

Software Carousel puts programs into this "high-end" memory for temporary storage when they're not in use. And switches them back out when you want them. It's fast, efficient, and easy.

If you want, Software Carousel will even use your hard drive for swapping. Just allocate a portion for storage, and go to work.

### Sidekick, Superkey and Ready. All at the same time.

You know what happens if you try loading two or more RAM resident utilities at once. You get crashed keyboards, frozen screens, all kinds of interference between programs fighting for control.

With Software Carousel, you can have as many accessories and utilities on-tap as you want. Just load different ones in different Carousel partitions. Since they can't see each other, they can't fight.

### The easy way to maximize PC power.

With all this power, you might think Software Carousel is complicated and difficult to use. Not so. Set it up once, and it will remember forever. Better still,

Carousel will look for the programs you use most often, and optimize them for the quickest access.

You can spend a lot more money, and still not get the convenience and productivity increase of Software Carousel.

The way we see it, there are certain things you have the right to expect from your computer. Access to your software is one of them.

At just \$49.95\* a copy, Software Carousel is the best way to get it.

Order today at 800-272-9900 (603-627-9900 in NH) or send the coupon below.

Special combination pricing is available for the purchase of Software Carousel and other SoftLogic products, including Cubit, DoubleDOS and Disk Optimizer.

	4 X	8 X	12 X	16 X
Word Star	Green	Green		
1-2-3	Yellow	Yellow		
BPI	Red	Red	Red	Red

With Software Carousel running in RAM, you can load a program and retrieve a file up to 15 times faster. Test conducted on an IBM XT

## Software Carousel \$49.95\*

YES!

Please send me \_\_\_\_\_ copies of Software Carousel today.

Name \_\_\_\_\_

Company \_\_\_\_\_

Address \_\_\_\_\_

City \_\_\_\_\_ State/Zip \_\_\_\_\_

Check Enclosed  VISA  MC  AMEX

Card # \_\_\_\_\_

Exp. Date \_\_\_\_\_

Signature \_\_\_\_\_

SoftLogic Solutions, Inc.

530 Chestnut Street

Manchester, NH 03101

800-272-9900

(603-627-9900 in NH)

**SOFTLOGIC  
SOLUTIONS**

**Call today: 800-272-9900**

\*plus \$5.00 shipping and handling.

*If a floppy tape system does not record data properly on the tape, it will not indicate this until it performs a separate verifying pass.*

into the back port of the host computer system's floppy-disk controller, such as is standard on the IBM PC XT. Such a setup makes the floppy tape systems more portable from one host computer to the next than other tape systems.

Floppy tape drives simulate a string of floppy-disk drives, where each tape data track is treated as a floppy disk. The data format of the tape is also set up similarly to the format of a floppy disk, with a bad-sector table, a file-allocation table, random-access ability, and so on.

The "floppy-like" data format of floppy tape systems requires that before you use any tape, it must go through an extensive formatting procedure that generally takes at least 40 to 60 minutes to complete. Once you have formatted the tape you should not have to reformat it during normal use—again, similar to using a floppy disk.

Because floppy tape drives use a floppy-disk controller interface, any host computer system not having this interface may not be able to use a floppy tape system. Also, because of this interface, floppy tape systems have reduced speed performance and a degradation of data reliability. The average data-transfer rate is 1 megabyte per minute for both file-oriented and image-oriented backup operations. Data reliability decreases due to the lack of a "read-after-write" check when placing data on a tape: Most other drives have a read head following the write head within the recording head mechanism. This lets

a system read data from the tape as it is being written to the tape, verifying the accuracy of the write operation. If a floppy tape system does not record data properly on the tape, it will not indicate this until it performs a separate verifying pass. Thus, floppy tape drives must perform a separate verify pass after data is written to the tape.

Cassette tape drives using .15-inch tape are available in both streaming and floppy tape configurations similar to ¼-inch tape drives. Speed performances for both versions are comparable to the ¼-inch tape drives. The .15-inch minicartridge tape drives are generally configured similarly to the ¼-inch floppy tape versions, using the host system's floppy-disk controller as the tape controller.

#### TAPE CONTROLLERS

The type of tape controller a tape drive needs depends on the host computer system's interface and the type of tape drive. Tape-system controllers are available in a variety of configurations from many manufacturers. Currently, most tape controllers use the QIC-36 and QIC-02 tape-controller configuration, although the SCSI and SASI tape-controller configurations are becoming popular. The differences between these configurations have to do with the command set that instructs the tape drive to perform specific operations and monitors the host computer system's operations. This intelligent command set, combined with a host-system interface, a tape-system interface, and a processor, makes up a tape controller.

Not all tape controllers are made up strictly of hardware components arranged on a circuit board. To reduce tape-controller costs, some manufacturers have removed the intelligence from the controller and placed it in a software module that formats and manipulates the data to and from a tape drive. With this type of tape controller, the host computer system shares its microprocessor with the tape controller, instead of the tape controller having its own processor. Systems that use a software module to take the place of tape-controller firmware

usually sacrifice performance and may be less compatible with different host computers.

#### TAPE SOFTWARE

As an operating system controls the host system, so tape software controls the tape system. Tape software determines the format of how the drive places data on a tape, how it transfers data from the host system to a tape and back again, and what the user interface will be. Unfortunately, there is currently little standardization of tape format. As a result, data interchange between tape media from one brand-name tape system to the next is not yet possible.

#### BUYING A TAPE SYSTEM

The number of brand-name tape backup systems now available probably exceeds the number of cereal brands offered in the local supermarket, and choosing between them can be difficult. When you are purchasing a tape system, keep in mind reliability. You can expect similar tape drives from different manufacturers to perform similarly. Speed, reliability, compatibility, and cost will closely resemble one another. You must decide which tape configuration best suits your needs.

Generally, the greater the width of the tape medium, the more information may be less condensed over the medium and the more reliable the tape data will be.

If you prefer to mount the tape system internally, the power supply within your host computer system must be adequate for the tape drive. Forty watts is sufficient for ¼-inch tape drives, while 15 watts is sufficient for .15-inch tape drives.

Most ¼-inch and .15-inch tape drives are in the 5¼-inch half-height form factor; ½-inch tape drives should soon be available in the 5¼-inch form factor.

The basic rule of thumb is still, "You get what you pay for." Remember, you are basically buying an insurance package for your data. You must first ask yourself the question, "How important is my data?" That will set the tone for purchasing a tape backup system. ■



## PROBLEM: Handling your need for more megabytes, without spending megabucks on a new drive.

## THE SOFTLOGIC SOLUTION: Cubit™

### Now get up to twice the capacity from all your storage media.

You know what happens. The more you use your computer, the more information you create. And the faster you fill up your disk.

The 10MB drive that once seemed enormous is now jammed with important files. That 20MB that should have lasted years is crowded in a matter of months.

Of course you could keep buying bigger hard drives. Or you could get Cubit and get the maximum storage space from the drives you already have.

### What is Cubit?

In brief, Cubit is an advanced software tool that automatically reduces the number of bytes required to store a file, then converts the file back to its original size when retrieved. Some programmers call this effect "data compression," others, "disk expansion." Either way, the result is the same.

Here's how it works. When Cubit compresses a file, it first compares each word to its massive English word dictionary. Words that match are reduced to a predetermined code of just one, two or three bytes each. It then saves the abbreviated version to disk. Decompression works just the opposite.

To accommodate other words and symbols, Cubit uses two more compression techniques. One assigns new, shorter codes to unusual words. Another compresses according to the frequency of character strings in non-text data. So no matter what kind of files you create, Cubit ensures maximum space savings.

Best of all, you'll be using the same fast, reliable data compression techniques used on mainframe computers for decades.

### How much disk space will you save?

Because the vast majority of data created on PC's is standard ASCII text—letters, numbers and other English language symbols—we've optimized Cubit for word processing and database files. With these, you'll get a minimum of 50% expansion on up to a full 100% or more.

At the same time, you can expect a significant 30% to 50% improvement with other kinds of data. Including spreadsheet files, program code, graph and image files, even binary data.

And Cubit works just as well with floppies and tape cassettes as it does with hard disk drives.

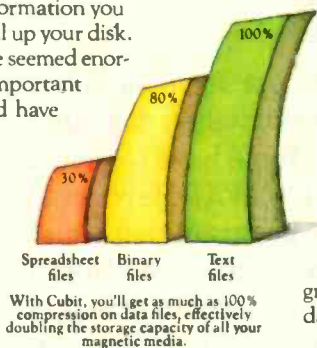

### Run Cubit where you want, when you want.

Maybe you'll want to use Cubit for all your files, or maybe just some. So Cubit lets you specify exactly which files to work on and which ones to leave alone.

In RAM resident mode, Cubit works quickly and invisibly, compressing and decompressing right from within any program you run. Or use Cubit's powerful file management mode. It supports wild-card and global file names, and addresses sub-directories up to thirty levels deep.

### Save time and money, as well as disk space.

A compressed file is a smaller file. So with Cubit, back-ups

take less time, as well as less space. And communicating compressed files means significant savings on phone line charges.

Any way you look at it, Cubit will pay for itself in no time. And that's especially true now.

### Special limited time offer.

Buy Cubit now and you'll save even more. Because for a limited time, you can buy Cubit at the special introductory price of just \$49.95\*. But hurry. This special price won't last long.

Ask for Cubit at your computer dealer. Or order directly from SoftLogic Solutions by calling 800-272-9900 (603-627-9900 in NH), or mail in the coupon below.

Special pricing is available when you buy Cubit along with other SoftLogic products including DoubleDOS, Software Carousel and Disk Optimizer. Ask for details.

 **Cubit™ \$49.95\***

YES! Please send me \_\_\_\_\_ copies of Cubit at this special introductory price.

Name \_\_\_\_\_

Company \_\_\_\_\_

Address \_\_\_\_\_

City \_\_\_\_\_ State/Zip \_\_\_\_\_

Check Enclosed  VISA  MC  AMEX

Card # \_\_\_\_\_ Exp. Date \_\_\_\_\_

Signature \_\_\_\_\_

SoftLogic Solutions, Inc.  
530 Chestnut Street  
Manchester, NH 03101  
800-272-9900  
(603-627-9900 in NH)

**SOFTLOGIC  
SOLUTIONS**

**Call today: 800-272-9900**

\*plus \$5.00 shipping and handling.

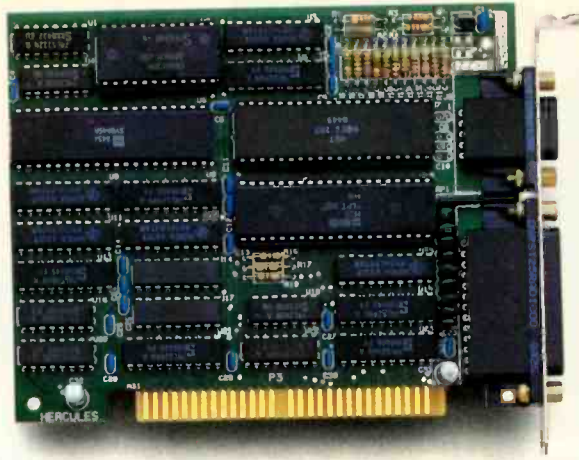

**NOW  
COMES  
WITH FREE  
PRINTER CABLE!**

## Why the Hercules Color Card is better for your XT than IBM's.

Did you know that there's a color graphics card specially designed for the XT™? It's called the Hercules™ Color Card. We think that it's better for your XT than the IBM® Color Graphics Adapter. Here's why.

The XT comes with an empty short slot. IBM's card is too long to fit in it, so you're forced to sacrifice a valuable long slot, while your XT's short slot goes unused.

The Hercules Color Card is designed to fit in this short slot. It's the smartest way to maximize the usable slots in an XT and provide for your future expansion needs.

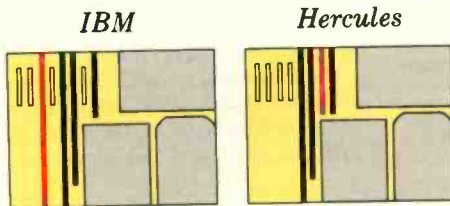

Notice how much more efficiently Hercules makes use of the XT's slots.

Our efficient use of an XT's slots is not the only reason to buy a Hercules Color Card instead of IBM's. We give you a parallel printer port at no extra cost. (IBM charges extra and takes up another slot.)

A lot of people wonder how Hercules can do everything that IBM can in a card less than half the size. We do it by designing our own graphics microchips. Just one of our chips packs the punch of dozens of IBM's, reducing by more than 50% the number of components that can fail.

And we'll do just about anything to make our products the most reliable you can buy.



Hercules



IBM

Of course, you *will* have to give up something when you buy a Hercules Color Card. You'll have to give up software incompatibility. With Hercules, there is none. Every program that runs on the IBM color card will run on the Hercules Color Card.

You'll have to give up IBM's ninety day warranty. Ours is two years.

Compare warranties	
IBM	3 months
Hercules	2 years

And you'll have to give up a dollar. The Hercules Color Card is \$245—IBM's is \$244.

Look into the Hercules Color Card for the XT, PC or AT.™ Find out why the readers of *PC World* voted the Hercules Color Card 1985's best color graphics card—ahead of IBM's. Call 1 800 532-0600 Ext. 432 for the name of the dealer nearest you and we'll rush you our free info kit.

# Hercules.

We're strong on graphics.

Inquiry 158

# LASER LIBRARIES

BY NORMAN DESMARAIS

*Publishers are providing  
information on optical disks*

OPTICAL STORAGE systems can store audio, video, text, computer-generated images, or any combination. Such systems may soon dramatically change the way information publishers and libraries serve their users.

Currently available optical media fall into two categories—write-once disks, to which you can add information but not erase it, and read-only disks, which you can read but not change in any way. [Editor's note: For a discussion of these technologies, see "The Evolution of Mass Storage" by Leonard Laub on page 161.]

Publishers of large bibliographic and full-text databases are beginning to use read-only optical technology to distribute information to their customers. Many of these databases have been available electronically via telecommunication or on magnetic tape and are easily transferred to read-only optical disks—either 12-inch laser disks or the more recently available 4¾-inch (12-centimeter) CD-ROMs.

## 12-INCH LASER DISKS

The Library of Congress has for several years maintained an index of its holdings since 1968 in electronic form called MARC (machine-readable cataloging). This database is in the

public domain, and a number of information publishers have incorporated it into laser disk products.

Library Systems and Services Inc. (LSSI), for example, produces a videodisk version of the MARC database, called Mini MARC, which is geared toward smaller libraries. Every two weeks, LSSI produces a new version of Mini MARC on 12-inch disks for Pioneer LDV-1000 players. The system can support up to four 12-inch laser disk players and provide access to more than 3½ gigabytes of storage. (To have the complete database with indexes the system requires the simultaneous use of two laser disk players.)

LSSI also offers 12-inch videodisk versions of the Government Printing Office database of government publications and the National Information Center for Educational Media (NICAM) database of 500,000 audiovisual and educational materials. The company recently produced a union catalog (a union catalog lists all the holdings for all the branches of a library system) for the libraries in the Southeastern Region New York Library System. This 12-inch laser disk contains over 700,000 titles.

International Thomson Library Ser-

vices has tested a laser disk product called MARVLS (the MARC and REMARC Videodisk Library System). (REMARC is a database of the Library of Congress's holdings prior to 1968.) MARVLS contains both databases on 12-inch laser disk and lets you search through a million cataloging records. Various divisions of International Thomson have produced optical versions of the Library of Congress database, although none of the products are commercially available now.

Information Access Company provides its periodical databases, which now include the full text of the *Wall Street Journal*, in 12-inch laser disk format, under the name Info Trac (see the text box "Info Trac: Storing Periodical References by Laser" by Joe Dorner on page 236).

## CD-ROM: ADVANTAGES FOR LIBRARIES

CD-ROMs have many advantages over the magnetic media currently being

*(continued)*

*Norman Desmarais (Phillips Memorial Library, Providence College, Providence, RI 02918) is acquisitions librarian at Phillips Memorial Library and author of articles for computer-related library publications.*

## INFO TRAC: STORING PERIODICAL REFERENCES BY LASER

BY JOE DORNER

**I**nformation Access Company (IAC), a branch of Ziff-Davis Publishing Company, maintains a large database of magazine and newspaper citations called Info Trac. Info Trac's short references describe article subjects, authors, and publications. You can look through this data for articles that might be applicable to your research or whatever you're interested in and then select items to read. This information is supplied to libraries on microfilm, and film readers are located in almost every major library across the country.

You could also dial into a public information system, such as Dialog, and access the information on line. However, you would have to spend a lot of time reading through this information, and log-on charges for such a database could easily run into thousands of dollars each month.

Info Trac Magazine Index contains references to articles in over 400 publications, and it is updated monthly. It also includes the Newspaper Index, which covers several national dailies. The accumulation of references makes

it a huge database. Even the monthly updates are quite large. IAC's main file is over 300 megabytes long, with 20 to 30 megabytes of new data being added each month. At IAC, we wanted to provide better access to this information, but there was no easy way to do it before optical disks came along.

IAC now provides its databases on optical disk systems based on the IBM PC and devices manufactured by LaserData of Boston. A basic system is composed of two IBM PCs with floppy-disk drives, a LaserData decoder, and one or two Pioneer laser disk players. Libraries receive updated optical disks monthly.

IAC keeps its data on a large main-frame computer. Over 30 large-reel nine-track magnetic tapes are used to hold a single database and associated index files. These tapes are sent to LaserData for the conversion process. It takes several days to encode this information, add appropriate error-checking information, and create a videotape. The videotape is then sent to 3M for conversion into 12-inch laser disk masters. Duplicate disks are

created and checked for accuracy. This cycle usually takes over a week, mostly because of the time it takes to transfer the information between the several companies involved. (This does not include the time necessary to create the database or process the information.)

### DATA STORAGE

The type of information a database contains and how users will access this information influences the structure of the main data file, as well as the index files that point into this main file. Using an encyclopedia as an example, let's look at a typical search of the Magazine Index.

If you are doing research for a report or term paper, you usually have a specific topic in mind. This will probably lead you to an encyclopedia, which is arranged in alphabetic order by subject. You will then read the article concerning your topic, extracting things that are important. If the article contains a reference to a related article, you will turn to that one and continue reading. If there are no related

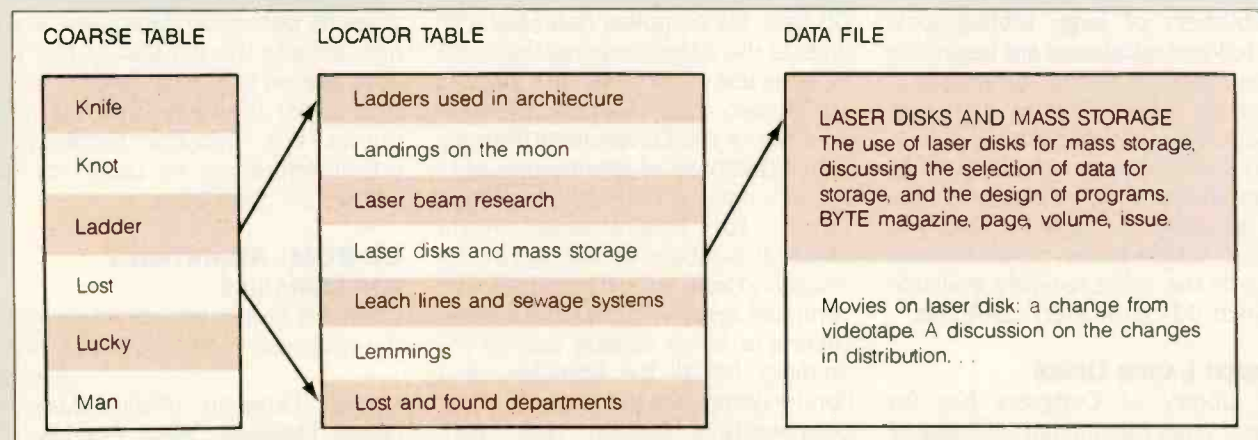

Figure A: Laser disk storage.

articles, you will try to figure out where else to look for information. However, if the encyclopedia is being stored on a laser disk system, the manufacturer can take several steps that will help you access the information you need.

The simplest method of file layout is to have one large alphabetic text file. You can move sequentially through topics until you find what you're interested in. Since encyclopedias are large, this is usually not a suitable search method; scrolling forward to topics near the end of the alphabet will take a long time. You will need some form of index; the simplest is an alphabetic index of the main text.

An alphabetic index can have as many entries as time and space allow, but the simplest have headings only for the 26 letters of the alphabet. You would type in a letter and then be presented with the first article starting with that letter. This simple index is not satisfactory because there still might be a lot of information to scroll through before you reach your desired topic.

Enlarging the index headings to several letters makes searching easier; the maximum number of index entries would then be one per article. This form of index has benefits and drawbacks: Can you type in a long name without making typing errors? Do you even *know* the proper spelling of a topic? Studies have shown that the maximum number of characters an average person can type without error is about 10 or 12. Thus, having indexes that are long will not be advantageous because many people will not be able to type in the full name of an article. Some form of subsearch should be provided for, assuming that what you type in is only the first few characters of an item's name.

If an index becomes very large, then there will probably be indexes into the index, down to whatever level is desired. This is the case with IAC's Magazine Index.

The Magazine Index is composed of many small citations. Each entry averages only six lines of 60 characters. This index was designed to be displayed on an 80-character-wide screen, so a 60-character line leaves you room to present pointers and related information on either side of the data.

## COMPANIES MENTIONED

### INFORMATION ACCESS Co.

11 Davis Dr.  
Belmont, CA 94002  
(800) 227-8431  
(415) 591-2333

### LASERDATA INC.

10 Technology Dr.  
Lowell, MA 01851  
(617) 937-5900

There are a great number of citations in one database. Each citation is related to one or several specific topics. In the Magazine Index there are two levels of index files to select an entry into the database.

### FILE LAYOUT

The first level to the index is a coarse table (see figure A) that is entirely contained within memory. Due to memory limits, this level currently has about a thousand entries. These entries are several characters in length and are evenly distributed across the main database. Each entry points into a locator table that contains one entry for each subject in the main database.

The index prompts you to enter a term that you want to search for. The program then performs a binary search of the coarse table to find the nearest alphabetical match. This is fast because the entries being searched are all in memory. The coarse table provides a range within the locator table for the program to search. The program then performs a binary search on the locator table. If the read head on the laser player must move around much, this search may take a few seconds. This then provides an entry into the main database, and the program will present you with citations on the screen.

For example, you might be doing a research paper on laser disk drives. At

a program prompt you would enter the term LASER DISKS as a search topic. The program would search the coarse table and find the closest matching term to be perhaps LADDER, depending on the length of the index and number of indexes. The coarse table entry following LADDER might be LOST. The program would then make a search of the locator table, bounded by the LADDER and LOST entries. This would provide an entry into the main data file at the place where LASER DISKS is first used as a subject. You could then browse through all articles that are listed under that topic.

The Magazine Index also provides some GOTO references. In this example, a citation might just tell you to also look at OPTICAL DISKS. You then press a key to have the system jump around the database and bring up OPTICAL DISKS as a subject. After reading in this area, you then press another key to return to the LASER DISKS area. This GOTO capability makes the system easier to use. The data contained in this index was originally provided on microfilm, and if you wanted to GOTO another area, you had to manually move through the film strip, position it at the referenced area, then move back when you were done there.

This is a simple form of indexing. The layout of this database makes it easy to place a citation in multiple locations, such as under LASER DISKS as well as under the author's name, and even under other subjects mentioned in the article.

IAC is now providing *Wall Street Journal* articles in full-text form. Rather than create a new indexing scheme into this new database, IAC tied it into the current Newspaper Index. As before, you enter a topic name and the system presents you with the citations related to that topic and articles that have full text available. By pressing one key, you can see the actual article, rather than having to look for the hard copy.

*Joe Dörner (Covill Associates, 2204 Garnet Ave., Suite 301, San Diego, CA 92109) is president of the San Diego Computer Society and author of Assembly Language Routines for the IBM PC. He assisted in the development of Info Trac.*

# NEW RELEASE

## Ecosoft's Eco-C88 Rel. 3.0 C Compiler



\$59<sup>95</sup>

Release 3.0 has new features at an unbelievably low price. ECO-C88 now has:

- Prototyping (the new type-checking enhancement)
- enum and void data types
- structure passing and assignment
- All operators and data types (except bit fields)
- A standard library with more than 200 functions (many of which are System V compatible for greater code portability)
- cc and mini-make that all but automates the compile process
- 8087 support (we sense the 8087 at runtime - no dual libraries)
- ASM or OBJ output for use with MSDOS linker
- Tiered error messages - enable-disable lint-like error checking
- Fast compiles and executing code
- Expanded user's manual
- Enhanced CED program editor (limited time offer)

We also offer the following support products for Eco-C88.

### CED Program Editor

\$29<sup>95</sup>

CED now supports on-line function help. If you've forgotten how to use a standard library function, just type in the name of the function and CED gives you a brief summary, including function arguments. CED is a full screen editor with auto-flagging of source code errors, multiple windows, macros, and is fully configurable to suit your needs. You can edit, compile, link, and execute DOS commands from within the editor. Perfect for use with Eco-C88. For IBM PC, AT and look alikes.



### C Programming Guide \$20

After reading the 1st edition, Jerry Pournelle (BYTE Magazine) said: "I recommend this book... Read it *before* trying to tackle Kernighan and Ritchie." The second edition expands this best seller and walks you through the C language in an easy-to-understand manner. Many of the error messages include references to this book making it a perfect companion to Eco-C88 for those just starting out with C.

### C Source for Standard Library

\$10

Contains all of the source code for the library functions that are distributed with Eco-C88, excluding the transcendentals and functions written in assembler.



### C Self-Study Guide \$17

(Purdum, Que Corp.). Designed for those learning C on their own. The book is filled with questions-answers designed to illustrate many of the tips, traps, and techniques of the C language. Although written to complement the Guide, it may be used with any introductory text on C.

### Developer's Library

\$25

Contains the source code for all library functions, including the transcendentals and those written in assembler. Perfect for the developer that wish to write their own custom functions or learn how we implemented the Eco-C88 library.



### C Programmer's Library \$20

(Purdum, Leslie, Stegemoller, Que Corp.). This best seller is an intermediate text designed to teach you how to write library functions in a generalized fashion. The book covers many advanced C topics and contains many useful additions to your library including a complete ISAM file handler.

### ISAM Library

\$15

Contains the code from the C Programmer's Library in relocatable format (i.e., .OBJ) including the delete code for the ISAM file handler.

Eco-C88 C compiler requires an IBM PC, XT, or AT (or compatible) with 256K of memory, 2 disk drives and MSDOS 2.1 or later. Call today:

1-800-952-0472 (for orders)

or

1-317-255-6476 (tech. info.)



Ecosoft, Inc.

6413 N. College Ave. • Indianapolis, IN 46220



TRADEMARKS: ECO-C88, ECOSOFT



*The costs of a CD-ROM system include the hardware and subscriptions to information services.*

used in the computer industry. Two advantages are the elimination of wear on the media and the permanency of the data. Data on CD-ROMs cannot be destroyed by dust and fingerprints that can cause head crashes in current computer technology. Since nothing touches the disk while it's operating, there is no danger of scratching the disk and affecting the data. In fact, CD-ROM manufacturers encourage you to wash the disk surface with warm water and mild soap and dry it with a lint-free

cloth if you notice a decrease in response time. This is the only maintenance that is recommended for the disks.

CD-ROM disks do not warp as floppy disks can. However, since the disk surface is coated with a plastic covering, the plastic may warp and/or melt if the heat source becomes intense, as in a fire. However, data on such a damaged disk might still be readable; since the data is etched into the metal surface, it is not volatile as is data stored on magnetic disks or tape. Thus, a CD-ROM's data should be legible as long as a laser beam can be clearly reflected from the surface.

This same characteristic also means that the data is not affected by climatic conditions. You can use the disks under circumstances that would preclude the use of magnetic media.

A CD-ROM's substantial storage capacity, its reasonable response time, and a low cost per bit stored are its other major advantages for libraries

and information providers. The costs of a CD-ROM system include the hardware and subscriptions to information services. They do not require backup hardware or media and they let you browse through databases at no additional expense since no telecommunications charges are involved. Such a system also gives you local control and total privacy while using it.

A major application for CD-ROMs involves replacing microform and record collections. (Microform consists of reproducing documents in much reduced size. The two most popular methods are microfiche, which comes in 4- by 6-inch cards, and microfilm, which comes in continuous reels.) Microforms have never been popular services in libraries. Microform readers are generally cumbersome or awkward to use and only provide fair imaging at best. Reader-printers have been expensive and cost more to operate than photo-

*(continued)*

# Princeton Graphic Systems—the choice in PC monitors.

High resolution.  
Sharp, crisp text.  
Bright, vibrant colors.  
Full PC compatibility.  
Rugged dependability.  
We design our monitors to meet your most demanding computer needs.

From sophisticated business graphics to basic word processing, we make sure there's a Princeton monitor for you.



*For the second year in a row, you've voted our high resolution HX-12 RGB color monitor the number one color monitor in the world.\* Thank you for your vote of confidence...*

\* Results of PC World's "World Class PC Contest" for 1984 and 1985.

# THE PC'S LIMITED AT™ — \$1995.

# THE PC'S LIMITED TURBO PC™ — \$795.

PC's Limited AT™



"Editor's Choice"  
— Feb. 25, 1986

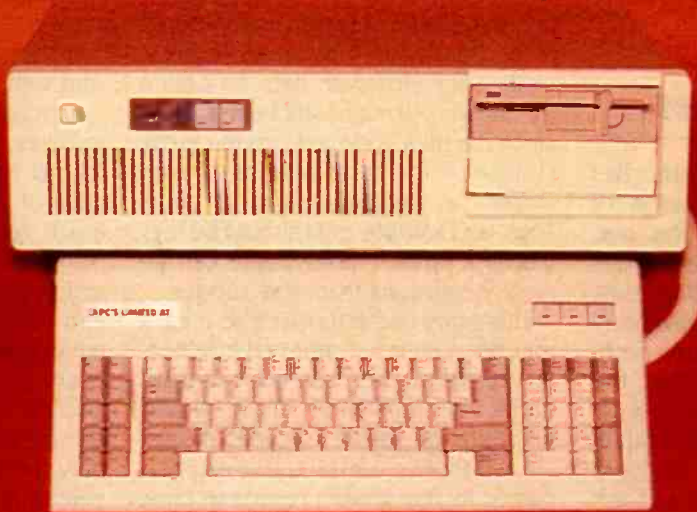

At these prices, it's no wonder  
we're burning up the marketplace.

Yes, you can believe it. Since we ran our first advertisement for the PC's Limited AT™ and Turbo PC™, the calls we've received mostly start with comments like "Is this for real?" And "How can that be?" But now that our machines are in the hands of influential buyers, the questions tend to concern quantity discounts for further purchases. (Which are available.) You see, the PC's Limited machines are assembled from components bought worldwide with our strong buying power. Then they are offered directly to you—with no middleman markups. So light a match to your old budgets. With the savings we're providing, you'll have money to burn.

## PC'S LIMITED AT™

- 80286-based System Unit running at 6MHz. (8MHz option included at no charge.)
- 1024K on Mother Board
- 1.2 Meg Floppy Drive
- Combined Floppy/Hard Disk Controller Card
- AT Keyboard
- 192W Power Supply
- 2 Serials and 1 Parallel Port
- Clock/Calendar with Battery Backup

Runs all Major Software written for the IBM PC™, PC XT™, and PC AT™. Unit has 8 Expansion Slots. Same Bus Configuration as IBM PC AT™. One year limited warranty.

GW Basic \$95 • DOS 3.1 \$85 • 80287 \$195

## PC'S LIMITED TURBO PC™

- 16-bit 8088-2 System Unit (running at 4.77 or 6.66 MHz)
- 640K on Mother Board
- 360K Floppy Drive
- AT Keyboard
- 130W Power Supply

Runs all Major Software written for the IBM PC™ and PC XT™, 40% faster, without modifications. Unit has 8 Expansion Slots, with 7 available in above configuration. One year limited warranty.

CW Basic \$95 • IBM DOS 3.1 \$85 • 8087-2 \$149



## PC'S LIMITED™

SALES CALLS OUTSIDE TEXAS, 1-800-426-5150

1611 Headway Circle, Building 3, Austin, Texas 78754

Sales Calls from anywhere in country, (512) 339-6962

Technical Support Calls, (512) 339-6963

Customer Service Calls, (512) 339-6964

Telex No 9103808388 PC LTD FAX (512) 339-6721

IBM® is a registered trademark of International Business Machines Corporation. IBM PC, PC XT, and PC AT are trademarks of International Business Machines Corporation.

Ad Number 405/86

### TERMS

**For Warranty Service:** One year Limited Warranty on PC's Limited products. Contact Technical Support for a Return Authorization Number (RMA). Returns must be accompanied by your RMA, invoice and a brief explanation. During the Warranty Period, PC's Limited will repair or replace items at our option.

**For Credits:** Contact our Customer Support Department within 90 days of date shipped from PC's Limited for Credit Return Authorization (CRA). Credit requests are subject to a 10% Restocking Fee. No credits are issued after 90 days from shipping date. In the unlikely event your order arrives defective, return it within 90 days of the original shipping date for a full refund of your purchase price.

RMA's and CRA's are valid 10 days only.

**The Library Corporation  
is using CD-ROMs  
to distribute Biblio-File,  
a MARC-based system.**

copiers even though they provide inferior reproductions. Patrons have never liked microforms because of the difficulties of finding them, the time required to retrieve the desired information, and the difficulties of browsing.

CD-ROM disks can provide quicker access to larger quantities of information than microforms, and they allow you to copy the information to a variety of formats. You can access it through a personal computer and copy it onto a floppy or hard disk or channel it to a printer.

The reproduction costs of CD-ROMs

are currently one-tenth the cost of reproducing data in microform. And the reliability of the play-back equipment is generally regarded as 10,000 to 11,000 hours mean time between failures. That's equivalent to running the systems 24 hours a day for 59 to 65 weeks. When a failure does occur, it will probably involve replacing the laser unit, which currently costs about 100 dollars.

**BIBLIOGRAPHIC CD-ROMS**

CD-ROM technology will find its greatest library application with nonvolatile databases, as a replacement for magnetic media. The Library Corporation, for example, is using CD-ROMs to distribute Biblio-File, a MARC-based system that contains 1,500,000 bibliographic records of the Library of Congress's English language cataloging since 1964 and popular titles since 1900. A unique feature of this product is that, like MARC, it is in the public domain. The user's manuals,

access software, application programs, and laser disks are not copyrighted or protected.

The Library Corporation has also converted its Any-Book database, a bibliography containing virtually every book currently being published in the U.S., from microfiche to CD-ROM. This system also incorporates an automated acquisitions system that automatically converts the data into a purchase order for printing or sending to the vendor via telecommunications. Developed in collaboration with Ingram Distribution Group Inc., the Any-Book database is also available from Ingram under the name LaserSearch.

CD-ROM technology lends itself to convenient use for other bibliographic databases such as local public-access catalogs (PACs, the card catalogs you would find in your local library), union catalogs, and "fully distributed" on-line public-access catalogs (OPACs). (Note that here, "on-line" means avail-

*(continued)*

# Princeton monitors set the pace.

To become a leader, you've got to keep ahead of the crowd. At Princeton, we set the pace. We delivered a color monitor for the IBM PC before IBM. And continue with a full line of state-of-the-art quality monitors. Monitors that deliver the features you demand.

**High resolution.  
Sharp, crisp characters.  
Bright, colorful graphics.**

Take a close look at a Princeton monitor. You'll see the sharp, crisp characters and fully formed graphics that make our monitors stand out against the competition.



Add to it a fine dot pitch. A nonglare screen. Our flicker free technology. And you've got an image that makes you more productive, less fatigued.

**Easy to use.**

Our monitors are compatible with the leading brands of personal computers. IBM™, Compaq™ and more. But we go one step further. By paying close attention to ergonomic detail, we make monitors compatible with you.



**Dependability.**

You can count on Princeton monitors when you need them. They're rigorously engineered and manufactured under the highest quality control standards. Backed by a full one-year warranty. Supported by a nationwide service network. The result: monitors you can depend on.



*Princeton's HX-12E gives you brilliant 64-color displays and extra sharp text.*

**Bringing you the future.**

Princeton continues to set the industry pace with products like our HX-12E, the first IBM-compatible high resolution RGB color monitor with a .28mm dot pitch to support IBM's Enhanced Graphics Adapter. And our SR-12P, the first IBM-compatible analog color monitor, with a .26mm dot pitch to support IBM's Professional Graphics Controller...



# COMPUTER WAREHOUSE

CALL TOLL FREE **1-800-528-1054**

**FREE FEDERAL EXPRESS**  
Air Express Shipping  
See Details Below

**HARDWARE**

**BEST PRICES**

**NOW**

**No Charge for Bank Cards**

**PRINTERS**

Anadex All Models	Call
Brother All Models	Call
Cannon Laser Printer	\$2099
Citizen MSP-10	\$255
MSP-15	\$349
MSP-20	\$319
MSP-25	\$485
Premier 35	\$409
Datasouth All Printer Models	Call
Diablo D-25	\$529
635	\$1079
Other Printer Models	Call

**EPSON**

All Printer Models	Call
Juikl 6100	\$349
6300	\$669
NEC	
3510, 3550, 3515, 3530	\$729
8810, 8830, 8850	\$1039
P5, P8, P7	Call
EII 360	\$379
EII 370	\$379

**OKIDATA**

All Printer Models	Call
Panasonic 1080	\$219
1091	\$235
1092	\$309
1592	\$429
KXP3151	\$399

**STAR MICRONICS**

All Printer Models	Call
Silver Reed	
EXP400 Parallel	\$179
EXP550 Parallel or Serial	\$409
EXP800 Parallel or Serial	\$619
Toshiba 321	Call
P351 Parallel & Serial	\$969

**MONITORS**

Amdex All Monitors	Call
NEC All Monitors	Call
Princeton Graphics	Call
Zenith All Models	Call

**VIDEO TERMINALS**

Qume QVT Green 101	\$299
QVT Amber 101	\$314
Wyse 30	\$299
50	\$419
75	\$559
Wyse 85	\$439
Wyse 350	\$859
Zenith Z-22	\$455
Z-29A	\$559
Z-49	Call

**MODEMS**

AT&T	
4000 External	\$309
Anchor Automation	
Anchor Express	\$235

**HAYES**

All Modems	Call
Prometheus All Models	Call
US Robotics Courier 2400	\$389
Password 1200	\$180
Microlink 2400	\$379

**DISK DRIVES**

Alpha Omega Turbo 10	\$515
Turbo 20	\$515
Turbo 30	\$675
Imega	
Bernoulli Boxes for IBM	Call
Bernoulli Boxes for Macintosh	Call
Paradise Macintosh Hard Disk	Call

**COMPUTERS**

<b>PANASONIC</b>	
Sr. Partner Dual Drive	\$1599
Exec. Partner Dual Drive	\$2129
<b>TOSHIBA</b>	
T-1100	\$1389
<b>WYSE</b>	
Wyse pc 1100-1	\$979
Wyse pc 1100-20	\$1539

**Zenith Computer Products**  
SAVE up to 50%  
Z- All Models Call

**DISKETTES**

Maxell MD-2 Plastic Box (Qty 100)	\$125
Sony MD/2 (Qty 100)	\$120

**BOARDS**

AST Advantage	\$389
Rampage PC	\$299
Six Pack Plus	\$219
Hercules Color Card	\$149
Graphic Card	\$305
Intel	
Above Boards	Call
Maynard Hardcard	\$549
Paradise Modular Graphic 06-1	\$239
Five Pak	\$115
Quadram	
Gold & Silver Boards	Call
Quadlink	\$329
Quad EGA+	\$365
Tec Mar Graphics Master	\$445
Captain No Memory	\$155

**PLOTTERS**

Epson Hi-80	Call
<b>KEYBOARDS</b>	
Keytronics 5151	\$159

**COPIERS**

**Canon «PC»**

Canon PC-10	\$509
Canon PC-14	\$649
Canon PC-20	\$719
Canon PC-25	\$939

**XEROX**  
1020 w/Toner \$1099

**SANYO**  
SFT 600 Call

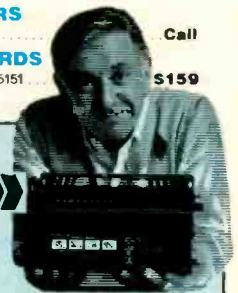

**SOFTWARE**

**IBM PC and 100% Compatibles**

**TRAINING**

Flight Simulator	\$29
PC Logo	\$75
Typing Instructor	\$28
Typing Tutor III	\$28

**LANGUAGES**

C Compiler (Microsoft)	\$227
Fortran Compiler (Microsoft)	\$203
Lattice C Compiler	\$242
Macro Assembler (Microsoft)	\$87
Pascal Compiler (Microsoft)	\$174
Quick Basic	\$57
Run C Interpreter	\$82
Turbo Pascal 3.0	Call
Turbo Tool Box	Call

**PROJECT MANAGEMENT**

Harvard Total Project Manager	\$262
Microsoft Project	Call
Super Project Plus	Call
Timeline 2.0	\$219

**COMMUNICATIONS**

CompuServe Starter Kit	Best Price
Crosstalk XVI	\$92
MS Access	\$145
PFS Access	\$77
Remote	\$92
Smartcom II	\$83

**INTEGRATIVE SOFTWARE**

Enable 1.1	Call
Framework II	Call
Smart Software System	Best Price
Symphony	Call

**GRAPHICS**

Chartmaster	\$205
Diagram Master	\$189
Energraphics	\$160
Energraphics w/Plotter Option	\$205
In-A-Vision	\$250

Microsoft Buss Mouse	
w/PC Paintbrush 3.0	\$107
Microsoft Chart	\$169
Microsoft Serial Mouse	\$120
Newsroom	\$32
PC Draw	\$199
PC Draw Light Pen	\$102
PC Mouse w/Dr. Halo II	\$104
PC Paint w/Mouse	\$119
PFS Graph	\$76
Printmaster	\$30
Signmaster	\$134
Turbo Graphix Tool Box	Call

**WORD PROCESSORS**

Leading Edge Word Processor	\$48
Leading Edge W/P/w/Spell & Mail	\$97
Lightening	Call
Microsoft Word 2.01	\$228
Multimate 3.3	\$203
PFS: Write w/Spell Checker	\$76
Wordstar w/Tutor	\$162
Wordstar Pro Pack	\$233

Word Perfect (Ver.4.1) \$199  
Wordstar 2000 2.0 . \$233  
Wordstar 2000 + 2.0 \$278

**UTILITIES**

Copy II PC	\$19
1 DIR	\$47
Fastback	\$87
Norton Utilities 3.1	\$48
Printworks	\$36
Sidekick	Call
Sidekick (Unprotected)	Call
Sidekick—Superkey (Bundle)	Call
Sideways 3.1	\$34
Superkey	Call

**SPREADSHEETS**

Lotus 1-2-3	Call
Multiplan	\$112
Spreadsheet Auditor 2.0	\$82
VP Planner	\$49

Supercalc 3(Ver.2.1) Call

**MONEY MANAGEMENT**

Dollars & Sense w/Forecast	\$94
Tobias Managing Your Money	\$94

**DATA BASE MANAGEMENT**

Clipper	\$339
Cornerstone	Call
dBase II	Call
dBase III Plus	Call
Extended Report Writer	\$79
Knowledgegeman II	\$289
Knowledgegeman Upgrade Kit	\$145
Nutshell 2.0	Call
PFS: File	\$76
PFS: Report	\$67
Quickcode	\$138
QuickReport	\$138
Reflex	Call
Think Tank	\$92

R:Base 5000 . . . . \$319

Many other titles available.

We do not guarantee computer compatibility.

Inquiry 89 for MS DOS Products. Inquiry 90 for all others.

# COMPUTER WAREHOUSE

Order Line: 1-800-528-1054  
Order Processing: 602-224-9345  
2222 E. Indian School Rd.  
Phoenix, Arizona 85016  
602-954-6109

Store Hours: Mon-Fri 10-5:30  
Saturday 9-1  
Order Line Hours: Mon-Fri 7-5:30  
Saturday 9-1  
Order Processing Hours: Mon-Fri 10-3

Product shipped in factory cartons with manufacturer's warranty. Please add \$6.00 per order for UPS ground shipping on orders up to 10 lbs. Orders 10 lbs. and under you pay for ground service, receive air service at no extra charge. Available on orders 11-30 lbs. \$17 for air service. Prices & availability subject to change without notice. Send cashier's check or money order. All other checks will delay shipping two weeks.

able electronically, not necessarily telecommunicated.)

For example, libraries can use the Biblio-File system to extract records on the books they own and create their own unique database on floppy disks, or have the information mastered onto a CD-ROM disk.

Bro-Dart Company also puts a local library's holdings on a CD-ROM as part of a system called LePAC (local public-access catalog). A single LePAC disk can hold up to a million full MARC entries.

OCLC (Online Computer Library Center) Inc. maintains an Online Union Catalog that contains 13 million bibliographic records, collected from the Library of Congress and OCLC's 6000 member libraries. In the past, members have accessed this information via telecommunication services to print catalog cards, lists, and so on. The company is in the process of converting this and other databases to CD-ROM.

In recent years, the Library of Congress has made its databases available on magnetic tape, a format that is not suitable for smaller libraries. Online Computer Systems (not to be confused with OCLC) has received a contract to investigate publishing these databases on CD-ROMs, an attractive alternative for customers who cannot afford a magnetic-tape-based computer system. Online recently announced that it would release CD-ROM versions of the R. R. Bowker Company's *Books In Print* and *Ulrich's International Periodicals Directory* in June of 1986.

In 1985 Carrollton Press (a company that has recently been purchased by International Thomson) announced plans to publish the complete shelf-list holdings of the Library of Congress (including foreign titles), which contain 6.5 million unique titles. The company also announced its intention to offer the entire Library of Congress law collection on a CD-ROM called

LAWMARC, although International Thomson will not say what its plans are now.

A number of other bibliographic reference companies have plans to publish databases on CD-ROMs. H. W. Wilson Publishing Company, publisher of the *Cumulative Book Index* and the *Readers' Guide to Periodical Literature*, has announced its intention to publish those indexes on CD-ROMs. One such disk could contain approximately five years of either index or a full year of all the company's journal indexes.

BRS Information Technologies has found that the current costs of searching its bibliographic and full-text databases on line are often high enough to deter libraries from using them in many reference situations. BRS and Lockheed's Dialog (another large information provider) are in the process of testing CD-ROM products, although neither will disclose what those prod-

(continued)

# Princeton outperforms the industry.



Only Princeton delivers the outstanding price/performance value you've come to expect from an international monitor company.

When we set out to design a Princeton Graphic Systems monitor we do it right. We

combine advanced technology (like a fine dot pitch) with

modern ergonomics (like a nonglare screen) for a superior performance monitor.

We build them with quality components to work day in and day out, even in the toughest conditions.

**We're looking better and better.**

Your support during 1985 enabled Princeton to grow three times faster than the personal computer industry as a whole. Our installed base of high resolution monitors in this segment alone grew beyond a quarter of a million...

## CD-ROM *technology* lends itself to widespread applications with other databases.

ucts will include or when they would be released.

### OTHER CD-ROM APPLICATIONS

CD-ROM technology lends itself to widespread applications with other databases.

For example, the Corporate Information Database produced by Datext Inc. combines business information from six database publishers: Investext from Business Research Corporation, Disclosure II from Disclosure Information Group, ABI/INFORM from Data Courier, Prompt from Predicasts, the Financial Services Market File from Media General, and Who's Who in Finance and Industry from Marquis Who's Who. Various subsets of these databases make up four CD-ROM disks (Consumer, Industrial, Technology, and Service), each designed for a specific class of user. The yearly subscription fee to any or all of the services includes monthly updated disks.

The Disclosure Information Group makes its database available on its own CD-ROM disk called Compact Disclosure. The company also sells three databases from Cambridge Scientific Abstracts on CD-ROM: Medline, the Life Sciences Collection, and ASFA (Aquatic Science and Fisheries Abstracts). A yearly subscription to any of these includes use of a CD-ROM drive and quarterly updates.

Micromedex Inc. has announced the release of four medical databases on CD-ROM including Poisindex for identifying and treating the results of toxic agents; Drugdex, a pharmacologic database; Emergindex for diagnosis and treatment of diseases; and Indentindex for identifying tablets and capsules. The company provides yearly subscriptions to these databases with quarterly updates.

Digital Equipment Corporation now

publishes nine CD-ROM disks as part of its CD-ROM Database Publications program. The disks include Chemical Engineering, Electrical and Computer Engineering, and Aerospace Engineering (from Engineering Information Inc); Medicine, Health Care and Biology; Aeronautics, Aerospace and Astronomy; Computers, Communications and Electronics; and Environmental Health and Safety (all from the National Technical Information Service); Current Biotechnology Abstracts (from the Royal Society of Chemistry); and Health and Safety in Chemistry (from Chemical Abstracts Inc). All disks are available for use with DEC's MicroVAX I and II, the VAXstation family, the Rainbow 100, and the IBM PC XT.

NewsBank, an index and full text of "clippings" from newspapers and magazines, recently announced that it will publish the Newsbank Electronic Index on CD-ROM, which will contain a five-year cumulation of the NewsBank index.

SilverPlatter Information Services publishes CD-ROM versions of Educational Resources Information Center (ERIC), a database of educational materials, and the Public Affairs Information Service (PAIS), an index to articles on government, law, political issues, etc.

### FULL-TEXT PUBLISHING

We can expect full-text databases to make wide use of optical technology, especially in the book publishing industry. Art books, for example, are expensive to produce in paper and could be published on optical disks at prices comparable to or less than a paper edition. High-quality graphics and text can be combined economically for widespread distribution. This type of publishing will make mutilation and destruction of expensive books a thing of the past. It will also allow users to tour art museums without leaving their desks.

The National Gallery of Art, for example, sells a double-sided 12-inch laser disk (formed by mounting two disks back to back). One side contains a catalog of 1000 of its oil paintings along with identifying information. The other side provides a tour of the

museum. The National Gallery sells this for \$100, approximately the same price as a quality art book.

Laser technology can also compress major encyclopedias onto one disk. Grolier now publishes its Academic American Encyclopedia, previously available through on-line services, in laser disk and CD-ROM formats. The laser disk version retails for \$89.95 and the CD-ROM version, which has far more sophisticated searching capabilities, sells for \$199. The CD-ROM version has an electronic index almost as large as the encyclopedia itself. Yet the index and encyclopedia together occupy only 20 percent of the available space on the disk. Grolier has announced its intention to publish an optical disk encyclopedia that incorporates text, audio, video, and software applications with more sophisticated search capabilities.

OCLC Inc. has developed Graph-Text, a CD-ROM product that combines the full text of articles with scanned images of the graphics accompanying the articles. The system allows you to print out high-resolution copies of articles that look just like the original articles. Presently, Graph-Text contains articles taken from a variety of American Chemical Society journals.

University Microfilms Inc. (UMI) has put its Dissertation Abstracts International database on disk to form the Information Delivery Module (IDM). UMI will also publish on CD-ROM the full text of the 1984 issues of all the journals published by the Institute of Electrical and Electronics Engineers (IEEE), along with the indexing that applies to those issues from the INSPEC database.

Datatek Corporation recently announced its library system to store newspaper data. Datatek will publish in CD-ROM format the full text of 10 newspapers, newswires, and databases offered on line as DataTimes. This will result in compressing about three years of daily newspaper production onto one side of a disk. The company has begun by using the system in-house to replace tape storage of archival data.

Reference Technology Inc., although

(continued)

# Princeton is the best choice in PC monitors.

When you're looking for a personal computer monitor, look at Princeton Graphic Systems. Our growing family of high quality personal computer monitors delivers compatibility, brilliant colors, high resolution, and dependability. Whether you're designing sophisti-

cated business graphics or number-crunching a financial spreadsheet. That's why Princeton is number one in the minds of more

and more personal computer owners every year.

For the very best in PC monitors, the choice is clear: Pick the company that's at the top. Princeton Graphic Systems.

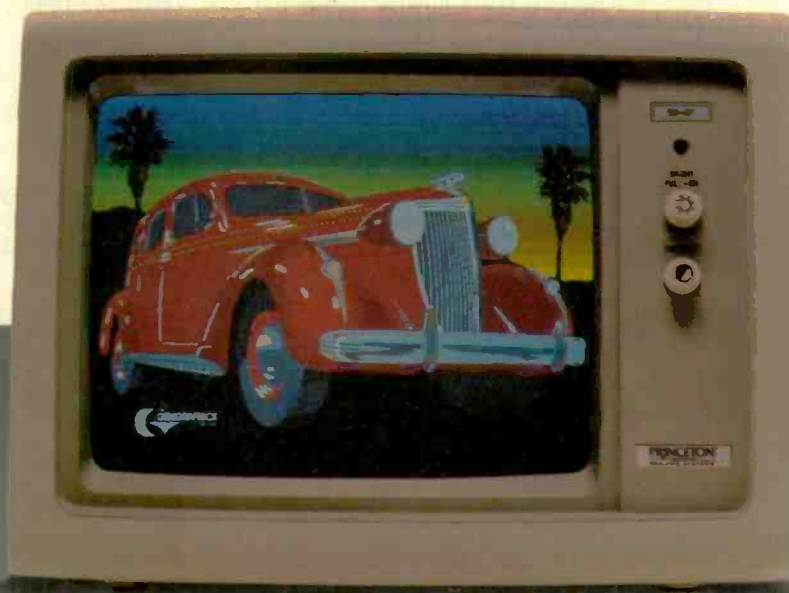

**HX-12E.** Our EGA-compatible monitor gives you 64 vivid colors. Extra sharp text and graphic displays. The finest dot pitch (.28mm) of any IBM-compatible enhanced monitor. Nonglare screen. Fully compatible with IBM's™ Enhanced Graphics Adapter (or equivalents).



**SR-12P.** Top-of-the-line analog color monitor features ultra high resolution (640 x 480), 4,096 colors for superb graphics. The finest dot pitch (.26mm) of any PGC-compatible monitor. Laminated nonglare panel.



**HX-12.** High resolution RGB color monitor with .31mm dot pitch gives you better graphics, better text than IBM's Color Monitor (5153). Nonglare screen. Voted "Best in the World" two years running in PC World's "World Class PC Contest".



**SR-12.** Super high resolution RGB monitor with a .31mm dot pitch. Compatible with Sigma Designs Color 400 board and others. Gives you 400 lines of resolution. Nonglare screen.



**MAX-12.** High resolution amber monitor. When used with an IBM-compatible monochrome adapter delivers 720 x 350 resolution. With an IBM-compatible color adapter, 640 x 200 resolution with 15 shades of amber. The monitor automatically adjusts to either card.



**HX-9/HX-9E.** Compact nine-inch high resolution RGB monitor. Perfect for workstations where space is at a premium. Both feature a .28 dot pitch and an etched dark glass screen. Ergonomic features like a built-in tilt/swivel base, nonglare screen, and a built-in green/amber switch. HX-9E is compatible with IBM's EGA (or equivalents).

All monitors come with free data and power cables.

Visit your local computer store today and ask about our full line of high resolution color and monochrome monitors. Monitors that live up to the Princeton Graphic Systems tradition of quality, performance, and value.

Princeton Graphic Systems, 601 Ewing Street, Bldg. A, Princeton, NJ 08540; (609) 683-1660; TLX 821402PGSPRIN; (800) 221-1490, ext. 104.

**PRINCETON**®

IBM is a trademark of International Business Machines, Inc. Color 400 is a trademark of Sigma Designs, Inc. QuadEGA+ is a trademark of Quadram Corp. Compaq is a trademark of Compaq Computer Corp.

GRAPHIC SYSTEMS  
AN INTELLIGENT SYSTEMS COMPANY

## COMPANIES MENTIONED

**BRO-DART CO.**

Library Automation Division  
500 Arch St.  
Williamsport, PA 17705  
(800) 233-8467, ext. 640

**BRS INFORMATION TECHNOLOGIES**

1200 Rt. 7  
Latham, NY 12110  
(518) 783-1161

**DATATEK CORP.**

818 Northwest 63rd St.  
Oklahoma City, OK 73116  
(405) 843-7323

**DATEXT INC.**

444 Washington St.  
Woburn, MA 01801  
(617) 938-6667

**DIALOG INFORMATION SERVICES INC.**

3460 Hillview Ave.  
Palo Alto, CA 94304  
(800) 334-2564

**DIGITAL EQUIPMENT CORPORATION**

CD-ROM Publishing Services  
12 Crosby Dr.  
Bedford, MA 01730  
(800) 332-9277

**DISCLOSURE INFORMATION GROUP**

5161 River Rd.  
Bethesda, MD 20816  
(301) 951-1300

**GROLIER INC.**

Sherman Turnpike  
Danbury, CT 06816  
(800) 243-7256

**H. W. WILSON PUBLISHING CO.**

950 University Ave.  
Bronx, NY 10452  
(800) 622-4002  
(212) 588-8400

**INFORMATION ACCESS CO.**

11 Davis Dr.  
Belmont, CA 94002  
(800) 227-8431  
(415) 591-2333

**INGRAM DISTRIBUTION GROUP INC.**

347 Reedwood Dr.  
Nashville, TN 37217  
(800) 251-5902  
(615) 361-5000

**INTERNATIONAL THOMSON**

**LIBRARY SERVICE/UTLAS**  
**INTERNATIONAL US INC.**  
1611 North Kent St., Suite 910  
Arlington, VA 22209  
(703) 525-5940

**LIBRARY CORP.**

POB 40035  
Washington, DC 20016  
(800) 624-0559

**LIBRARY OF CONGRESS**

Catalog and Distribution Service  
Washington, DC 20541  
(202) 287-6171

**LIBRARY SYSTEMS AND SERVICES INC.**

1395 Piccard Dr., Suite 100  
Rockville, MD 20850  
(800) 638-8725

**MICROMEDEX INC.**

660 Bannock St.  
Denver, CO 80204-4506  
(800) 525-9083

**NATIONAL GALLERY OF ART**

Washington, DC 20541  
(202) 737-4215

**NEWSBANK INC.**

58 Pine St.  
New Canaan, CT 06840  
(800) 243-7694

**OCLC INC.**

6565 Frantz Rd.  
Dublin, OH 43017  
(614) 764-6000

**ONLINE COMPUTER SYSTEMS**

20251 Century Blvd.  
Germantown, MD 20874  
(301) 428-3700

**REFERENCE TECHNOLOGY INC.**

5700 Flatiron Parkway  
Boulder, CO 80301  
(303) 449-4157

**SILVERPLATTER INFORMATION INC.**

37 Walnut St.  
Wellesley Hills, MA 02181  
(617) 239-0306

**UNIVERSITY MICROFILMS INC.**

300 North Zeeb Rd.  
POB 1764  
Ann Arbor, MI 48106  
(800) 521-0600

primarily involved with producing optical products for other companies, recently announced that it would bundle a CD-ROM disk containing 8800 public-domain and shareware programs for the IBM PC with the CD-ROM version of its CLASIX (Computer Laser Access Systems for Information Exchange) product. (Since September 1984 Reference Technology has sold a double-sided 12-inch version of CLASIX that can store up to 1000 megabytes on a side since September

1984.) Users will be able to copy the programs on the Software Library CD-ROM to a floppy or hard disk before using them.

### CONCLUSION

We can soon expect the development of hybrid systems that will search locally stored laser-based databases and then automatically dial up and extract items from on-line utilities such as BRS and Dialog.

Optical-disk-storage systems might

prove to be the greatest technological innovation for libraries since the microcomputer. Optical drives that are capable of interfacing with popular microcomputers will allow even small libraries to extend their capacities for data storage and information handling to levels previously available only to those that could afford mainframe computers. This technology is so inexpensive that most libraries will be able to make it directly accessible to patrons. ■





# Development System Catches Bugs Before They Become Beasts.

**Orion's UniLab II™ is four instruments in one.**

Here's an **Advanced 48-Channel Bus-state Analyzer**, a real-time, real-world, **In-Circuit Emulator**, a **Stimulus Generator** for your special test cases, and a built-in **EPROM Programmer**, all in one small, \$2,995 powerhouse.

To find causes of software and hardware problems, Orion's "Non-intrusive Analysis"™ concept triggers on bug symptoms you specify. This mature product supports 46

microprocessors with one easy-to-use instrument. Personality Paks get you started fast, and if you need them, Orion's team of Applications Engineers is only a toll-free call away.

You'll gain new development efficiency with our extensible language macro capability not found even in more expensive systems. UniLab II's disk-based intelligence in your PC, VAX™, or PDP-11 means much more for your money than in any stand-alone development system.

You've suffered long enough, call Orion today!

**CALL TOLL FREE: 1-800-245-8500**

415-361-8883 in California

VAX trademark of Digital Equipment Corp. UniLab is an Orion trademark.

Inquiry 261

**ACTION COUPON**

Send me info on UniLab II and your No-Risk 10 Day Evaluation!

Name: \_\_\_\_\_ Title: \_\_\_\_\_

Company: \_\_\_\_\_

Address: \_\_\_\_\_

City: \_\_\_\_\_

State/ZIP: \_\_\_\_\_

Tel.: \_\_\_\_\_ Ext. \_\_\_\_\_

**UniLab II**  
**Universal Development Laboratory**



Orion Instruments, Inc.  
**ORION**  
702 Marshall Street  
Redwood City, California 94063

# The database used now be used

Introducing dBASE III PLUS™

The PLUS stands for all the improvements we've made to the world's number one selling database management software.

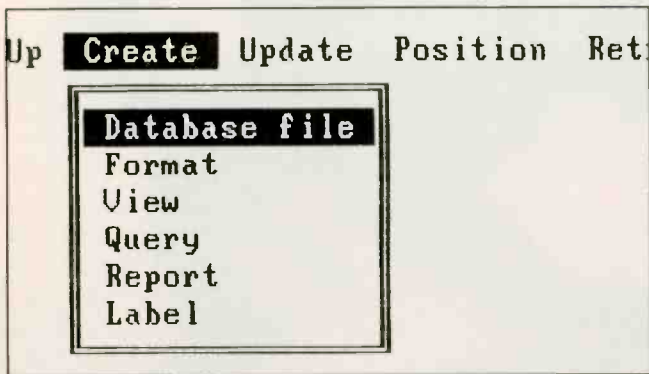

*The Assistant helps beginning users accomplish day-to-day data management tasks without programming.*

Mind you, dBASE III PLUS still has the powerful dBASE programming language, dot prompt, and all the features that have made dBASE III the standard of the industry.

We've simply raised the standard.

And just as dBASE III introduced more power to the people, our new dBASE III PLUS introduces more people to the power.

People who aren't all that crazy about programming, for example.

The Assistant feature in dBASE III PLUS now provides them with new easy-to-use pull-down menus for creating, using and modifying multiple databases.

So now anyone who can manage a simple cursor can manage day-to-day data management tasks. Without programming.

And by using our new Screen Painter,

anyone can create custom screens. Without programming.

Or using View, access related information in several databases at one time. Without programming.

With Advanced Query System, another new non-programming feature, any user can build complex queries just by selecting from the dBASE III PLUS pull-down menus.

For rapidly creating entire programs, there's even a new Applications Generator.

And for all those who wish to learn to program, the Assistant can be of further assistance. By teaching you programming commands as you go along. Without disrupting your work flow.

These are only a few of the dBASE III PLUS features that can help new users quickly get up to speed. And experienced users quickly increase their speed. (Sorting, for example, is up to two times faster and indexing up to ten times faster than dBASE III.)

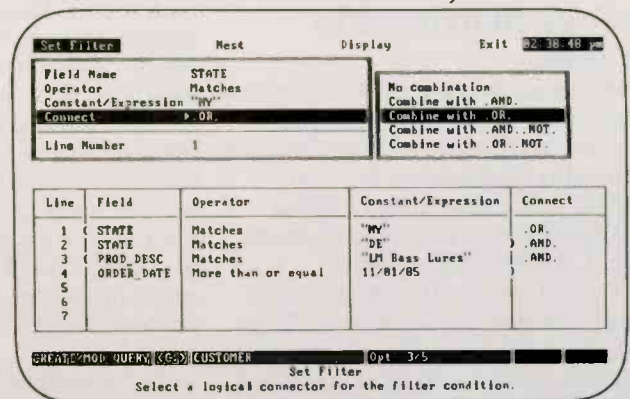

*Advanced Query System lets you set up and answer complex queries without programming.*

# by more people can by more people.

And it's the fastest way to network those users, too. Because now, true multi-user capabilities for local area networking are built right in.

dBASE III PLUS can also help put developers in the fast lane. With a new Data Catalog and more than 50 new commands and functions. Plus code encryption and linking, improved debugging aids, assembly language calls and much more.

For the name of the Ashton-Tate® dealer nearest you,\* call 800-437-4329, Extension 0282.\*\*

And get your hands on dBASE III PLUS. It's the software more people can look forward to using. Inquiry 26

\*Upgrades are available to all dBASE III owners. \*\*In Colorado call (303) 799-4990, Extension 0282. Requires IBM® PC or 100% compatible. Trademarks/owners: Ashton-Tate, dBASE III PLUS/Ashton-Tate, IBM/International Business Machines Corp. © Ashton-Tate. All rights reserved. 1986.

ASHTON·TATE

## dBASE III PLUS

*The data management standard.*

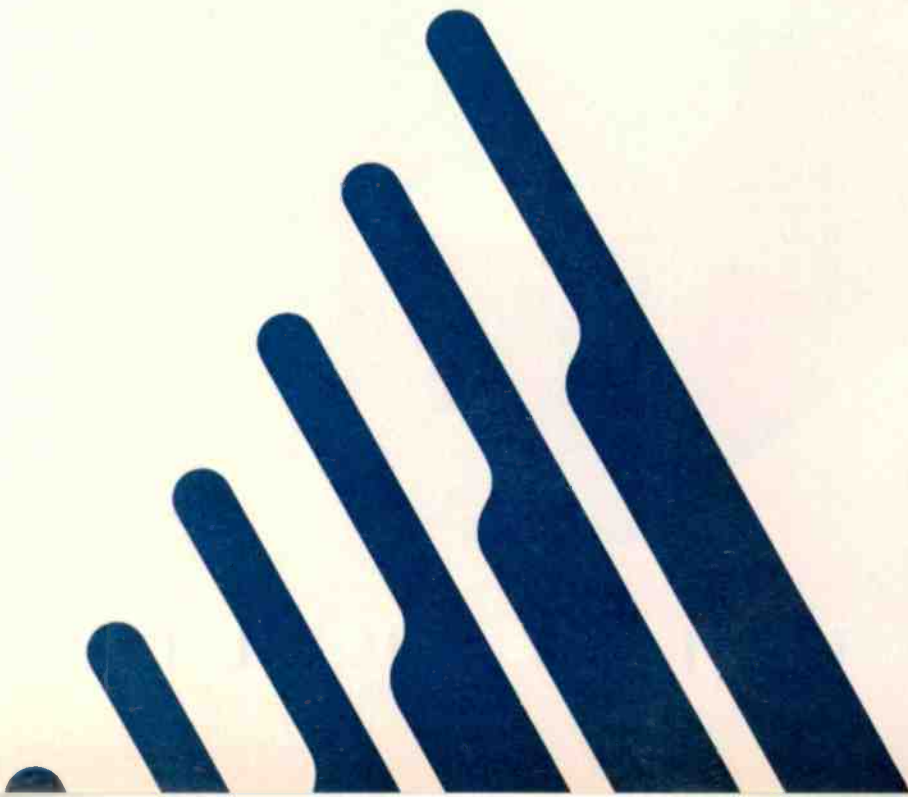

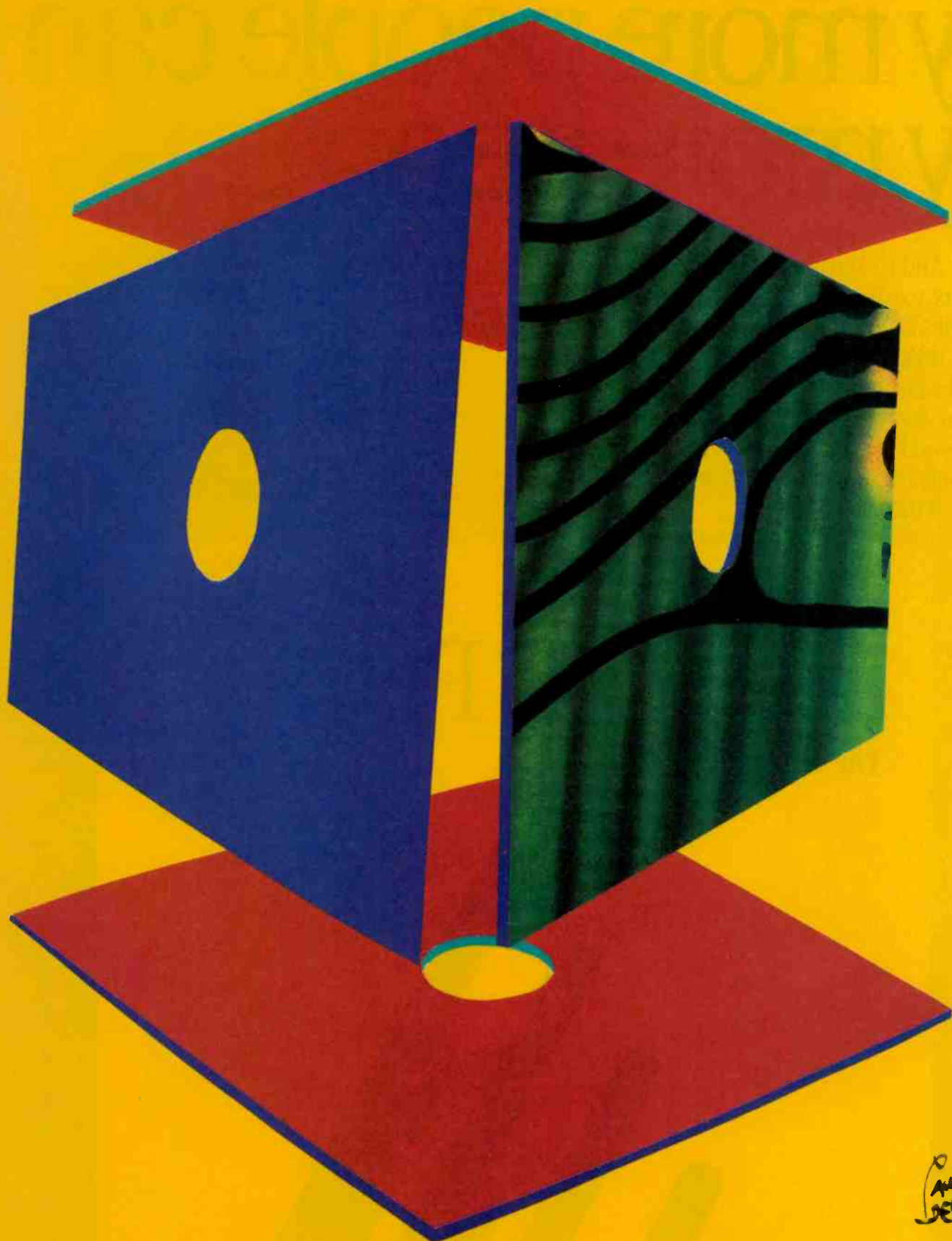

AL  
1962

# Reviews

---

<b>REVIEWER'S NOTEBOOK</b> <i>by Jon Edwards</i> .....	253
<b>THE AT&amp;T UNIX PC</b> <i>by Alastair J. W. Mayer</i> .....	254
<b>ZBASIC</b> <i>by TJ Byers</i> .....	265
<b>GEM DRAW/MACDRAW</b> <i>by Ricardo Birmele</i> .....	269
<b>HARDCARD</b> <i>by Eva White</i> .....	273
<b>THE B&amp;C MICROSYSTEMS 1409 EPROM PROGRAMMER</b> <i>by Robert Jacobs</i> .....	279
<b>NON-KEYBOARD INPUT DEVICES</b> <i>by Chris Pappas</i> .....	285
<b>RACTER</b> <i>by Hugh Kenner</i> .....	289
<b>GENERAL ELECTRIC'S 3-8100 PRINTER</b> <i>by Robert D. Swarengin</i> .....	293
<b>LETTRIX</b> <i>by Alan R. Miller</i> .....	299
<b>REVIEW FEEDBACK</b> .....	305

---

THE AT&T UNIX PC brings the power of UNIX to the microcomputer world. The package includes the 68010, a built-in hard disk, 720- by 348-pixel bit-mapped graphics, an RS-232C serial port, and a Centronics parallel printer port. Al Mayer, author of BIX's CoSy Software and obviously well familiar with UNIX System V, presents his conclusions. We are also pleased to have used the benchmarks for testing UNIX performance presented by David Hinnant in the August 1984 BYTE, page 132.

Reviewer TJ Byers looks at ZBasic, an interactive BASIC compiler from Zedcor that will allow you to run the same ZBasic code on any of five different systems with little or no modification. Because the BASIC enhances the performance of the compiler, you will be able to compile quickly and obtain relatively small compiled files. Most importantly, perhaps, you will be able to port the code from one machine to another.

The B&C Microsystems 1409 EPROM Programmer, reviewed by Robert Jacobs, is a versatile tool that connects to an RS-232C port and allows you to read or write to chips in a number of ways.

BYTE editor Eva White examines Plus Development Corporation's 10-mega-byte Hardcard. We are currently testing a number of similar products, but this review summarizes the technology involved and the costs and benefits of installing the card.

Robert Swarengin put General Electric's 10-pound 3-8100 to the test. The low-end thermal printer offers a great variety of features, although not boldface or italics. And many of you may find the price more attractive than the printer's speed.

Non-keyboard input devices can simplify applications that require cursor movement and data entry. Chris Pappas takes a look at three of these devices: PC-Pedal, Footmouse, and Light Pen.

Finally, we have three applications software reviews. Many of you will not be able to live without Lettrix, a memory-resident print aid that permits your dot-matrix printer to simulate letter-quality output. Alan Miller explains that there are drawbacks, but the improvement in quality may well be worth the price and the extra time that printing will require.

Ricardo Birmele shows that there are more dissimilarities between the drawing programs GEM Draw and MacDraw than many of us had expected. He favors MacDraw, but notes that GEM Draw fills an important niche.

I'm not sure, but I think Hugh Kenner valued his experience with Racter more than Racter did. And I fear that most of you will enjoy Hugh's description far more than you will like the product itself.

# THE F-15 JET FIGHTER. IF THE COMPUTER GOES DOWN SO DOES THE PLANE



The F-15 served as a test bed for a flight control system written in the Ada language.  
Ada was designed to meet today's demands for a standard computer language, producing efficient, reliable and maintainable code.

## Does your compiler deliver?

Even if your programs don't do loops in mid air, and won't make a boom if they crash, you need a powerful programming language. It has to be easy to learn, structured yet flexible, compact and fast. Your programs should reflect the latest advances in hardware and software and be portable.

## Get your software off the ground!

Meet Ada. The DoD's new language of the future. Now you can run Ada on your MS-DOS or PC-DOS computer. Artek Ada is the most advanced Ada compiler for PCs.

## A new standard in software engineering

We invite you to learn, explore and use the most powerful general-purpose programming language ever, — with Artek Ada. Artek has approached the tradeoffs of Ada compiler design in a novel way. Modern software engineering techniques are applied to produce a state-of-the-art compiler.

## Artek Ada is available now

You can order the Artek Ada compiler now for only \$ 895.00 including a debugger and a screen editor. Outside the U.S.A. add \$ 20.00.

For orders or information call toll free: 1-800-PC-ARTEK, in New Jersey or outside the continental U.S.A. call (201)-867-2900, or write to our address.

VISA, MC and AMEX accepted.

New Jersey residents add 6% sales tax. Please pay with credit card or a bank draft in U.S. dollars drawn on a U.S. bank.

*Dealer and distributor inquiries welcome.*

Inquiry 25

## Artek Ada specifications

Artek Ada implements the Department of Defense 1983 Ada standard, including generics, derived types, overloading, packages, separate compilation, dynamic arrays, standard I/O, string handling, array and record aggregates and much more. The only major feature of Ada not implemented is tasking. Minimum hardware requirements are: IBM PC or a compatible computer, running MS-DOS or PC-DOS (2.0 or later version) with 384 Kb RAM and one double-sided floppy-disk drive. Artek Ada works with the IBM PC network. For further information see our information kit.

A demo diskette is available for \$ 29.95 (including p&p anywhere in the world).

Ask for our free information brochure.

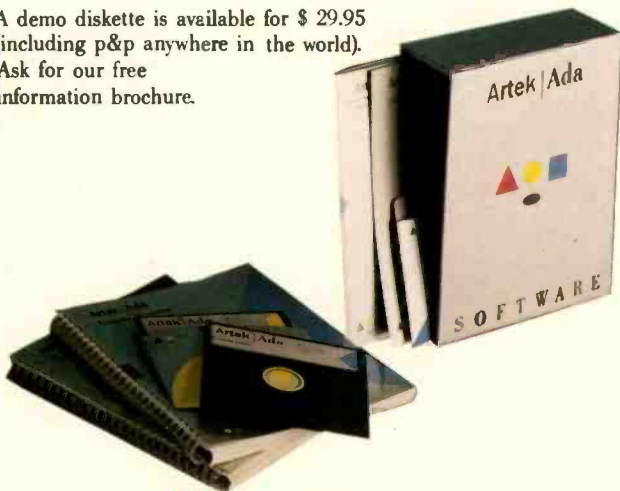

**A r t e k**

Artek Corporation 100 Seaview Drive Secaucus  
NJ 07094

Perhaps the closest thing to a religious experience at BYTE is the passing of the benchmark stopwatch from a departing to an incoming product review editor. Glenn Hartwig has handed me the revered chronometer and assumed new duties.

Therefore, this is a good opportunity to state briefly the process by which products will be selected for review. I will organize all systems, peripherals, and languages reviews. Brenda McLaughlin in our San Francisco office is taking charge of application software reviews. In addition to sending press releases and information to the new products staff, manufacturers should send their press materials to Brenda and to me.

We obviously have access to a tremendous amount of information and a large number of products. Still, we don't have the space to review or even mention but a fraction of the total.

In an effort to expand our coverage, this month we are starting a new reviews conference on BIX. There you will be able to read reviews that otherwise would not appear in BYTE. The medium will also allow you to read others' reactions to the product and to the review. You will be able to offer feedback on reviews, which we may use in BYTE's Review Feedback column. You will also be able to suggest products for possible review, and there will be an on-line Reviewer's Notebook. (For more information on BIX, call (800) 227-2983; in New Hampshire or overseas, (603) 924-7681.)

This is not to say that we will turn our attention from BYTE. In the interest of expanding our review coverage, we will be increasing the number of "comparison" reviews. In the works are combined reviews of IBM PC and AT clones, 1200-bps modems, 24-pin dot-matrix printers, CAD packages, Amiga peripherals, and tape backup units. We'll be able to cover more

products without sacrificing our technical perspective.

We've seen a number of interesting new products this month. White Sciences' Icon Builder for the IBM PC AT with an Enhanced Graphics Adapter allows you to generate icons that you can print, overlay on your digitizer tablet surface, and use to facilitate the development of icon-oriented user interfaces. The package consists of four software modules. The graphics program is an interactive graphics editor for the construction of icons. The template editor allows you to associate these images with keystroke sequences. With the Template Installation Program, you can select and install the templates as part of the operating system. The Overlay Print Program prints the image at the resolution and aspect ratio of your digitizer.

We received Perma Power's Color Commander, which fits underneath the IBM PC monitor. With this device, you can easily alter the colors on your IBM RGB monitor. We enjoyed the experience of editing manuscripts in unusual colors, but the unit also has obvious uses for engineering and presentation graphics.

*Antic* magazine is marketing several products for the Atari ST, including Metacomco's Lattice C and Macro Assembler; Kuma's A-Seka, a 68000 TOS assembler, disassembler and debugger; and Daniel Matejka's Disk Doctor, a disk editor that recovers deleted files and repairs damaged disks. Both of Metacomco's products include linkers and full-screen editors. The early experience of BIX users suggests that the Lattice implementation is complete but that the linker is slow. Modula-2 from TDI Software Ltd. may remain the development language of choice.

I used the Atari XM301 300-bps

modem to download files from BIX to the Atari 800. Some mail-order houses are selling the modem for under \$40, a remarkable price given the fact that you also obtain terminal software that includes XMODEM and macros.

I'm also impressed with Productivity Software's PRD+, a multikey macro facility for the IBM PC family. This memory-resident utility expands abbreviations. With the software, your typing speed will increase and you can guarantee correct spelling.

The PRD+ standard word list includes short forms for the 200 most commonly misspelled words, for the 100 most frequently used words of four characters or more, for months of the year and days of the week, and for the states and major cities. You can capitalize the long form by capitalizing the short form. For example, typing "Asap" would yield "As soon as possible." The documentation is excellent and provides a very useful section listing creative ways to use the software.

It took me some time to adjust to the new way of entering text, and I ran into the awkward problem of typing "hi" only to find "hawaii," but installation was simple, the implementation was very quick, and it was immediately clear that I had saved an enormous number of keystrokes. An item on the main menu provides a count of the keystrokes you have saved.

Finally, we received Borland's Traveling SideKick, a notebook/software combination that provides a handy way to list and sort addresses, telephone numbers, and appointments. You can print out files in a format that you can easily store in the Traveling SideKick binder, and the package makes it easy to update on-line files when you return from your trip.

—Jon Edwards  
Technical Editor, Reviews



## The AT&T UNIX PC

This micro-  
powerhouse  
incorporates  
mouse,  
windows,  
and a 10-MHz  
CPU with  
UNIX multi-  
tasking  
capability

BY  
ALASTAIR J. W. MAYER

**T**he AT&T UNIX PC is a rugged machine that is ideal for both business users and software developers. It is significant that AT&T changed the name of this machine from the PC 7300 to the UNIX PC shortly before its introduction. This computer is clearly intended to bring the power of UNIX to the personal computer market, and a multitasking operating system like UNIX is needed to take full advantage of all the features built into this machine.

The windowing, mouse-driven, pop-up menu "shell" provides a comfortable user interface to the underlying UNIX System V operating system. The built-in telephone subsystem, consisting of a 1200-bps auto-dial/auto-answer modem plus a voice line and telephone manager software, makes this an ideal office computer for anyone who does a lot of work over the telephone.

The UNIX PC has a built-in hard disk, serial port, and parallel (Centronics) printer port, and it uses the powerful Motorola 68010 processor (an enhanced version of the 68000), which can access up to 4 megabytes of virtual memory. Add to this the battery-backed real-time clock, the 720 by 348 bit-mapped display, 103-key keyboard, and three-button mouse, and you have a very impressive package. (See photo 1.)

### DISPLAY

The AT&T UNIX PC features a built-in green monitor on a tilt-and-swivel mount. This display is bit-mapped to 720 by 348 pixels, or 29 lines of 80 characters in the default character set. (See photo 2.)

Some of these 29 lines are usually reserved for operating system or application program use. Line 1, at the top of the screen, displays the status of the two phone lines, the current date and time, and a notice area for icons indicating electronic mail, system messages, and access to the window manager.

The two bottom lines display a graphic

representation of the eight function keys at the top of the keyboard, to provide for dynamic labeling of these keys. The two lines above that (immediately below the main screen area) are for command entry and message display and also provide space for a "working" icon when the system is busy in response to keyboard or mouse input.

### KEYBOARD

The AT&T UNIX PC keyboard has an impressive 103 keys. The basic layout is identical to that of AT&T's 5620 terminal. This is a standard QWERTY layout for the alphanumeric keys, with large Shift keys. There is a separate numeric/cursor-keypad on the right, with the cursor keys in an inverted "T" arrangement.

Eight slightly oversize function keys are arrayed along the top of the keyboard in a 3-2-3 arrangement. This layout makes it easy to match the keys with the labels displayed in a similar 3-2-3 format at the bottom of the screen.

The Control keys are situated on either side of the space bar. This arrangement is convenient if you need to frequently key different control codes, but I found it almost impossible to do the one-handed Ctrl-S/Ctrl-Q (XOFF/XON) sequence that I often use when browsing through a file.

There are also 14 keys, marked for use with the Wang-like word-processing software, that are arranged in a double vertical row down the left side of the keyboard. The noncursor keys (when Num Lock is off) and 9 other keys grouped above the numeric keypad are used for a variety of system-control functions, including window paging and scrolling, duplicating the mouse buttons, screen printing, and for calling the help function.

The keyboard gives the same tactile sensation that people like in the IBM PC keyboard, but without the "ka-chunk" sound. The Caps Lock and Num Lock keys incorporate LEDs to indicate when those fea-

Alastair J. W. Mayer (University of Guelph, Institute of Computer Science, Guelph, Ontario N1G 2W1 Canada) is the author of the CoSy conferencing system.



tures are active. Overall, it's a well-designed and pleasant keyboard to use.

### MOUSE

The AT&T UNIX PC's three-button mouse is a compact, low-profile item, a little larger than the Mac's. The three buttons are usually configured as select, mark (for later selection) and pop-menu. (With the three-button mouse, there is no need to double-click.)

The AT&T mouse uses the same inverted-trackball technology as the Macintosh (as opposed to optical sensors), but I felt its response was more positive than the Mac's.

While the UNIX PC has excellent monochrome graphics capability, it does not come with a program like MacPaint, so I was unable to try my hand at sketching with this mouse. However, C library routines that interface the mouse and the graphics screen are included with the optional AT&T UNIX utilities package, so I expect that someone will create such a program soon.

### SYSTEM BOARD

The UNIX PC is built around a single large (18 by 18 inches) printed circuit board, designed to AT&T specifications by Convergent Technologies, makers of the UNIX-based Mini Frame Plus and Megafame supermicros.

Contrary to rumor, though, the UNIX PC motherboard is not a slightly modified Mini Frame Plus motherboard. However, it is likely that some of the circuitry is similar. Features unique to the UNIX PC system board include the telephone line-control circuits, a 1200-bps modem, and a gate-array chip that controls the video display. Also on this board is the main processor (a Motorola 68010 32-/16-bit microprocessor that runs at 10 MHz), as well as 512K bytes of RAM and (virtual) memory-management hardware. (Since the RAM chips used are only 64K-bit types, the potential exists for future upgrades to 2 megabytes of on-board memory using 256K-bit chips.)

Onboard peripheral support includes the

controllers for both the floppy and the hard disk, control chips for the RS-232C serial and Centronics-compatible parallel ports, and the connector to the expansion backplane.

The system I used had an additional 512K-byte RAM board plugged into one of the three expansion slots in the backplane.

### DISK DRIVES

UNIX is a disk-intensive operating system that requires fast drives and plentiful disk space. The basic UNIX PC comes with a fast 10-megabyte hard disk and 320K-byte floppy. The speed of the hard disk is reflected in the benchmark results in tables 1 and 2.

The hard disk supports virtual memory and program swapping, as well as storing the large collection of UNIX tool and utility programs supplied. Software developers

*(continued)*



Photo 1: The AT&T UNIX PC showing tilt-and-swivel display, keyboard (not extended; disk drives are covered by the keyboard in this photo), and the three-button mouse.

Table 1: Results of UNIX benchmarks for the AT&T UNIX PC and some comparison machines.

Machine	UNIX version	System time in seconds										
		Pipe			System Call			Function Call				
		real	user	system	real	user	system	real	user	system	real	
VAX-11/780	4.1 BSD	3.2	0.1	1.2	4.8	1.4	4.0				1.0	
AT&T UNIX PC	System V	4.2	0.0	1.6	8.1	0.2	7.5				0.7	
IBM PC XT	PC/IX	16.6	0.1	7.6	39.8	2.9	35.6				4.7	
TRS-80 16B	XENIX	8.0	0.1	3.4	15.0	1.5	12.7				1.4	

Machine	UNIX version	Sieve			Write	Read	Shell			Loop		
		real	user	system	real	real	real	user	system	real	user	system
VAX-11/780	4.1 BSD	1.7	1.5	0.1	2.0	8.0	3.3	0.3	1.3	2.6	2.5	0.1
AT&T UNIX PC	System V	2.4	2.1	0.0	3.9	11.6	5.1	0.2	1.2	6.8	6.2	0.1
IBM PC XT	PC/IX	8.2	7.8	0.3	11.6	20.7	8.5	1.1	3.2	32.2	31.5	0.3
TRS-80 16B	XENIX	6.0	4.8	0.3	8.0	22.0	18.0	0.4	2.6	14.0	12.5	0.5

and others who purchase the UNIX utilities package, which includes traditional UNIX text-processing tools as well as the C compiler and library, will find the 10-megabyte hard disk an extremely tight squeeze and should consider the 20-megabyte drive instead. (The disk-formatting routine provides for a 40-megabyte drive.)

The single floppy-disk drive can be used in a number of ways. In AT&T-formatted mode, it gives a 320K-byte "mountable file system." A mountable file system is UNIX terminology for a collection of files and directories that can be "mounted" at any directory branch on the hierarchical UNIX file-system tree, although the usual practice is to mount them at the top or "root" directory to prevent confusion.

The floppy can also be used to make backups of the hard disk in any of several ways: as a structured file system, using ordinary copy commands, or in tar or cpio program formats. Tar, or "tape archive," is a traditional backup program on older systems, while cpio stands for "copy in/out," which is more widely used on UNIX System V systems. UNIX PC users do not need to know these commands; the System Administration menu takes care of such details.

Table 2: Results for the multitasking UNIX benchmark with a variable number of processes.

Machine	UNIX version	System elapsed (real) time in seconds					
		Number of concurrent processes					
		1	2	3	4	5	6
VAX-11/780	4.1 BSD	4.3	5.5	7.8	9.0	11.0	13.8
AT&T UNIX PC	System V	6.3	8.7	12.7	19.2	22.8	29.8
TRS-80 16B	XENIX	20.0	24.5	33.0	56.5	1:10.5	1:39.3
IBM PC XT	PC/IX	10.6	23.4	42.8	1:14.1	1:24.2	2:10.7

**System Configuration**

VAX-11/780	4-megabyte RAM, two 256-megabyte disks
AT&T UNIX PC	1-megabyte RAM, one 10-megabyte disk
IBM PC XT	512K-byte RAM, one 10-megabyte disk
TRS-80 16B	384K-byte RAM, one 15-megabyte disk

(Note: All figures for tables 1 and 2, except those for the AT&T UNIX PC, are taken from "Benchmarking UNIX Systems" by David F. Hinnant, August 1984 BYTE, page 132. See the "At a Glance" box for details.)

AT&T has provided a feature that is almost a must in today's MS-DOS-dominated market, that is, the ability to read MS-DOS-formatted floppies. Since this computer is 68000-based, it will not run MS-DOS, which is tied to the Intel 8088/8086 chips. However, MS-DOS data files, word-processing document files, and program source

can all be transferred to the UNIX PC via special disk-read routines.

Unfortunately, though, I was not happy with the software provided for reading MS-DOS disks. Since MS-DOS floppies are formatted differently from the standard AT&T UNIX PC format (360K instead of 320K), the nor-

(continued)

## AT A GLANCE

**Name**  
AT&T UNIX PC

**Company**  
AT&T Information Systems  
National Sales Center  
111 Westwood Place, Suite 300  
Brentwood, TN 37027  
(800) 247-1212

**Components**  
Processor: Motorola 32-/16-bit 68010  
10-MHz clock speed  
Main memory: 512 bytes RAM, expandable to 2 megabytes on-board; 16K bytes EPROM start-up program  
Virtual memory: Custom memory-management hardware and Winchester disk allow a memory address space of 4 megabytes  
Display: 12-inch green-on-black; 348- by 720-pixel bit-mapped graphics capability  
Keyboard: 103 keys; 8 function keys, numeric keypad, and 14 multifunction word-processing keys  
Disk storage: Double-sided 5¼-inch floppy stores 320K bytes in AT&T format, 360K bytes in MS-DOS format; Winchester hard disk, in 10-, 20-, and 40-megabyte options  
Ports: Standard RS-232C port configured as DTE (data terminal equipment), Centronics-compatible parallel port, three modular phone jacks

**Software**  
UNIX System V, version 2 operating system, window manager, phone manager, word processor, spreadsheet, and business graphics package

**Miscellaneous**  
Clock/calendar, three-button mouse, three expansion slots, built-in 300/1200-bps modem

**Price**  
\$5095 with 10-megabyte hard disk, 512K bytes RAM (UNIX \$495 extra); \$6590 with UNIX, 20-megabyte hard disk, and 1 megabyte of RAM (includes 512K-byte expansion card)



### About the Benchmarks

User time is the amount of time a process spent executing nonprivileged instructions (e.g., arithmetic calculations, sorting, searching, calling user-level functions, and so forth).

System time is the time a process spent executing privileged (kernel) commands (i.e., system calls) plus some system-level overhead (e.g., context switching between processes).

The elapsed time is just that. And it is often not the sum of the user and system times. The majority of missing time is spent waiting for I/O operations to complete, waiting for a signal from another process, sleeping, or being swapped out on disk while another program is running. Note that the UNIX operating system utility `/bin/time filename` counts real time in even second increments and user time in tenth-of-a-second increments. This accounts for some of the apparent inconsistencies in the benchmark timings.

The Pipe benchmark is a measurement of how long it takes to set up a pipe (an I/O channel that is written into by one program and read by another) and pass 0.5 megabyte of data through it.

The System Call benchmark repeatedly queries (25,000 times) the operating system concerning its process identity with the `getpid()` system call. As the program doesn't do much other than system calls, the elapsed time is important here. System time and user time are not very significant in this test.

The Function Call benchmark consists of running two programs, one that uses a function call to accomplish a goal and one that doesn't use the function call for the same goal. The user time of the program not using the function is subtracted from the user time of the program using the function. The difference is function call overhead.

The Sieve benchmark is a test of compiler efficiency and processor throughput and is the time required for one pass through the Sieve of Eratosthenes prime-number generator. System overhead is not very significant in this benchmark.

The Disk Write and Read benchmarks test the random-access disk implementation. Disk Write creates, opens, and writes a 256- by 512-byte file. The Read benchmark reads this file and then removes it.

The Shell benchmark invokes six background processes. The shell statement `wait` causes the shell script to pause until all background processes have terminated. Note that invoking `tst.sh` more than six times may not be possible on some systems if a per-user process limit is defined.

The Loop benchmark tests long integer arithmetic and is almost totally processor-bound.

For more information on benchmarking UNIX systems, see "Benchmarking UNIX Systems" by David F. Hinnant, August 1984 BYTE, page 132.

mal device driver has to be bypassed and another used. The UNIX PC Office software comes with a menu-driven program to do just that.

However, I was unable to persuade the software to "mark-for-copying" more than one file at a time, and it was quite tedious to scroll through a list of files on the floppy, select one to be copied, start the copy routine, and, when that had completed, scroll through the list from the beginning again to select the next file. The mouse button that normally allows you to pick several items from a list is apparently ignored in this software, so the process is very time-consuming for multiple files.

For that matter, it was a while before I discovered that the floppy drive is considered another logical unit of the hard disk, rather than a separate device. The same device-driver interface is used for both, in a manner similar to Convergent Technologies' Mini Frame Plus; indeed, the C program file for this interface makes specific mention, in comments, to Mini Frame Plus.

## SOFTWARE

As is obvious from its name, the AT&T UNIX PC uses the UNIX operating sys-

tem. The AT&T PC supports full System V UNIX, although the system comes "unbundled." The essential commands and utilities for running and maintaining the system are included, but special-purpose utilities, such as the C compiler, are optional extras.

UNIX is the ideal operating system for a powerful machine like this because it is a multiuser, multitasking operating system. This means that more than one user can use the system at one time (with extra terminals), and that each user may run a number of processes, or tasks, simultaneously.

## WINDOW MANAGER

UNIX provides for "shell" programs that reside between the operating system and the user and interpret the user's commands. Users of early "mainframe" versions of UNIX will be familiar with the traditional Bourne shell (named after the author) or perhaps the Berkeley C shell, which are both command-line-oriented.

These users might be a little startled at the windowing or visual shell known internally as "ua" for "user agent" (a multiwindow system like that popularized by the Apple Macintosh) that is the default on the UNIX PC.

Other systems tie this command-interpreter function directly to the operating system kernel, making the command interpreter difficult to change, but in UNIX this shell is always a separate program.

The user agent shell provides pop-up menus and icons for nearly all normal user functions and system administration tasks and can be used with either the mouse or the cursor keys. The windows can be resized, although it seems to take a long time (actually only a second or two) between clicking on the resize icon and waiting for the system to respond with the resize ghost outline. Actually, this is not too surprising since, as mentioned previously, the windowing software is not part of the resident kernel software, as it is on the Macintosh, but a separate program.

Traditional complaints about UNIX being cryptic or terse are generally misdirected. It is a particular shell program that may be terse, not the operating system itself. The windowing shell on the UNIX PC goes a long way to counter such complaints.

The UNIX PC makes more use of text menus rather than the Macintosh-style icons. This is a welcome change, in my opinion, and the menus pop out rather than having to be pulled down with the mouse. (For those who dislike mechanical rodents, the window and menu software can also be used with keyboard and select keys.)

The window manager must first be loaded from disk (the 2-second delay) before resizing can be done. I didn't find this a hardship, as the windowing routines are designed to optimize initial placement and size of windows when they are created. This process can be speeded up by setting the "sticky" bit on the code file for the window manager, a standard UNIX technique for telling the operating system to retain the swap image of the program in the swap area of the disk after the program has finished running. At the next invocation, the program then only has to be swapped back in, which is quite a bit faster than being reloaded. However, if you do this with too many programs, your swap disk rapidly becomes full.

(continued)



Photo 2: The AT&T UNIX PC display screen showing two overlapping windows. Status of communications lines is shown at the top left, followed by the internal clock date-and-time display.

# LEARN LOTUS 1·2·3 TODAY-- THE E-Z WAY

- At last, a book written for the user.
- Put your manual away, and learn to use Lotus the "E-Z" way.
- This 'E-Z' reference guide is written for you by the publishers of THE POWER OF books!
- We give you easy, clear, concise information organized so you can find the answers fast.



ONLY \$19.95

**POWERFUL  
FUNCTIONS MADE  
SIMPLE**

Clear, concise explanations save you time and help you understand the meaning of each function. Detailed illustrations show you how functions are used to build applications.

## LEARN COMMANDS AT A GLANCE

Pictures of command keys, along with detailed descriptions of what they do are organized in a visual hierarchy so you can understand how they work at first glance.

## MASTER MACROS QUICKLY

Visual aids give you a quick understanding of how macro commands are used in conjunction with each other to make working macros.

## FIND IT FAST IN THE INDEX

We've organized the book so every topic is alphabetized and explained in its own section.

## SAVE TIME WITH FINGER TIP TABS

Flip to the information you want with finger tip tabs printed in red for quick easy access to each subject.

## ORDER TODAY! • 1-800-MANUALS

MIS • 1107 NW 14th • Portland, OR 97209 • (503) 222-2399

- THE POWER OF: Lotus 1-2-3 Complete Reference Guide
- THE POWER OF: Lotus 1-2-3 For Business Applications
- THE POWER OF: The Smart Software System

- THE POWER OF: R-Base 5000 For Business Applications
- THE POWER OF: Paradox For Business Applications
- THE POWER OF: PC DOS Complete Reference Guide

*The -S option on the  
C compiler produces  
Motorola 68000  
assembly language,  
making the UNIX PC  
a true 68000  
development system.*

The Bourne shell is available to run "shell scripts" (programs written in the shell command language) or it can be the default shell for those who prefer it. The auxiliary commands most commonly used in shell programming are also included with the system (the looping and branching control structures are built into the shell itself).

#### APPLICATIONS SOFTWARE

The AT&T UNIX PC comes bundled with three application packages as well as UNIX. These are the Supercomp 20 spreadsheet, the business graphics package, and the word processor. The latter is modeled on word-processing systems like Wang's and makes use of the PC's special word-processing keys, but it can also be used with the mouse for menu selection and text block moves.

To make best use of the word-processing software, you should not use windowing, as the window borders rob you of several screen columns. You can also edit quite easily from the Bourne shell using more conventional UNIX text-processing software, and although the word processor seems adequate, I expect that UNIX old-timers (to whom this machine will greatly appeal) will prefer the traditional UNIX text-processing tools.

The line editor *ed* is included with the basic system, but for the full-screen editor *vi* and the *nroff* formatter, you'll need to get the optional UNIX utilities package. Users with complex word-processing needs may choose to investigate some of the

dedicated third-party word-processing packages, such as Microsoft's Word or Syntactics' CrystalWriter.

Unlike the word processor, the spreadsheet does not work with the mouse, which I thought a little odd, although it works quite well with the cursor keys. Since you need to use the keyboard anyway to enter data in the spreadsheet cells, I didn't find this much of a hardship.

The spreadsheet program seemed very responsive; pressing Enter to update the spreadsheet causes the screen to be rewritten almost instantly. While I found it more than adequate for my needs, I confess I do not use spreadsheets a lot and did not test this program to its limits.

I was more interested in the UNIX PC as a development tool. The business graphics package produces bar charts, line graphs, and pie charts from data developed with the spreadsheet or from any other application. On the high-resolution UNIX PC screen, these graphics were crisp and quickly produced.

What I felt the need for was an option in the graphics package to create a device-independent file for transmission of graphics data to another computer. It would not have been very difficult to have the program output NAPLPS PDIs (picture description instructions) while it created the graphs, and these could be used to send (via electronic mail) the graphs to anyone with a NAPLPS-capable microcomputer.

#### UNIX UTILITIES PACKAGE

Anyone interested in software development or even just writing an occasional C program on the UNIX PC will need this package. It includes all the commands and utilities normally found on a mini or mainframe UNIX environment. (These utilities are not bundled with the basic PC package.)

The utilities package is a bargain when you consider what you get for \$495: the C preprocessor and compiler; a 68000 assembler; enhanced editors; text-processing software; numerous UNIX utilities; LEX (Lexical Analyzer Generator), a C-program generator; YACC (Yet Another Compiler Compiler), a different C-program

generator; and more.

The software fills over a dozen floppy disks, grouped by function (editing, text processing, program development) so that if you are running with the small (10-megabyte) hard disk, you need not (indeed, cannot) load them all at once.

The software, as distributed, installs itself on the hard disk (this is true of all the AT&T UNIX PC software). This is a straightforward task, invoked from the System Administrator menu. If you are short on disk space, you can clean out what you don't need once everything has been installed. There is also a "de-install" routine with each collection of software that makes it quite easy to remove a whole package should you need the disk space.

The UNIX utilities package is strictly UNIX System V, with a few Berkeley utilities such as *vi*. I found no limitations or restrictions in this software, other than what would be expected of a 10-megabyte disk environment. The -S option on the C compiler produces true Motorola 68000 assembly language, allowing the UNIX PC to be used as a development system for other 68000-based systems that lack suitable compilers.

As a test of the UNIX implementation and the C compiler, I copied the 10,000-line source of the CoSy conferencing system, used for BIX (BYTE Information Exchange), and compiled it. I did not expect any major problems, but I was quite surprised when it compiled perfectly (and very quickly for a microcomputer). The program ran without any problems.

Similarly, the programs in the UNIX benchmark all compiled with no problems, and the benchmark performance is very impressive (see tables 1 and 2).

It is quite easy to create floppy disks in the "self-installing" format that AT&T recommends to developers as a standard. Copies of example shell scripts are included in the system, and the process is quite painless. This self-installation extends beyond merely copying the programs from floppy to hard disk and includes updating the system menus for program selection by mouse. I was able to develop a self-

(continued)

**5 MEGA-BYTES  
OF SOFTWARE  
FREE**

**PC HARD  
DISK KITS**  
10 MEGABYTES \$475  
20 MEGABYTES \$545  
30 MEGABYTES \$675  
"5 MEGABYTES OF  
FREE SOFTWARE"



**AT HARD  
DISK KITS**  
20 MEGABYTES \$545  
33 MEGABYTES \$750



**HIGH CAPACITY  
AT & XT  
HARD DISK KITS**  
70 MEGABYTES \$2895  
120 MEGABYTES \$4895



**TAPE BACKUP**  
10 MEG PORTABLE  
MT10P \$525  
10 MEG INTERNAL  
MT10 \$385



**TAPE BACKUP**  
40 MEG INTERNAL  
MT40 \$895  
40 MEG PORTABLE  
MT40P \$895



**TAPE BACKUP**  
60 MEG INTERNAL  
MT60 \$795  
60 MEG EXTERNAL  
MT60E \$895



**TANDY 1000  
MULTI-FUNCTION  
CARD**  
SERIAL PORT/  
DMA CONTR/  
UP TO 512K RAM  
TMF-1 \$255



**PC/AT OR  
TANDY 1000  
HARD DISK CARD**  
21 MEG HARD DISK  
FREE SCSI PORT  
THC-21 \$995  
PCHC-21 \$995



**MASTER MEMORY  
SYSTEM**  
HARD DISKS:  
30 MEG FIXED  
15 MEG REMOVABLE  
POWER  
DISTRIBUTION  
"THE LOW LINE"  
\$2295



**SCSI HOST  
ADAPTER CARD**  
CONNECTS YOUR  
PC TO 7 OTHER  
DEVICES  
SCSI-1 \$190

**NEW!!!**

IN THE  
WORLD OF PC UPGRADES

**THE 21 MEGABYTE  
HARD DISK CARD**

for your  
PC, AT or TANDY 1000



**only \$995**

**IMAGINE!!! MDI'S 21 MEGABYTE HARD DISK CARD**  
simply plugs into your system and is ready to run!!!

The hard disk card also contains the  
"PORT TO THE FUTURE":

A **SCSI** port which allows you to tie (daisy chain)  
up to seven external (peripheral) devices to your  
computer.



TANDY 1000  
HARD DISK CARD  
21 MEG HARD DISK  
FREE SCSI PORT

**NOW IN  
OUR  
8TH YEAR**

ORDER LINE **800-228-0891**  
**305-677-8333**



1 YEAR WARRANTY, 30 DAY MONEY BACK GUARANTEE

**Micro Design International, Inc.**



6566 University Boulevard, Winter Park, Florida 32792

305-677-8333 telex 332559 MDI ORL UD

*Using the phone manager, you can build a telephone directory file, select the appropriate name, and start dialing with a click of the mouse button.*

installing CoSy disk (albeit not a complete or polished one) in only a few hours.

The system comes bundled with the UUCP electronic mail software needed to hook into the worldwide network. This same software can be used to exchange files between UNIX PCs, or between the UNIX PC and a mainframe computer.

The UUCP software uses either the built-in serial port or the modem port and runs as a background task while you use the PC for something else (as long as the port is free). The computer can be set up to send or receive files unattended, such as in the middle of the night when the phone rates are lower.

#### PHONE MANAGER

This is one of the better features of the AT&T UNIX PC. Anyone who feels it is important to keep a record of phone calls will appreciate this feature (especially if time spent on the phone can be considered billable consulting time).

This software is an intimate part of the system, since the UNIX PC's hardware includes built-in telephone jacks for a voice line, a data line, and a telephone. If you only have one telephone line, it can be switched between voice and data. The modem software provides both auto-dial and auto-answer. The voice-line capabilities of this machine are more impressive, though. You can dial (on either line) from the PC's keyboard, or you can build a telephone directory file, select the appropriate name using

the mouse, and start dialing with a simple click of the mouse button.

For each entry in your on-line phone book, there is a work area to take notes (keyed in from the keyboard) during the phone call. The window for this function opens automatically as soon as dialing is finished. The time of the call (both time of day and duration) can also be recorded automatically if you so wish. The telephone manager window pops up automatically whenever an incoming call is detected. You have the choice of creating a new work area for the incoming caller or accessing the old work area (and adding to it) if the caller is already in your phone book.

#### DOCUMENTATION

The AT&T UNIX PC comes with an impressive shelf of documentation in 9-inch D-ring binders contained in slip boxes. All of the documentation is well written, well laid out, and reasonably straightforward. Some smaller spiral-bound booklets are also included, such as the "Getting Started" guide.

AT&T includes handy reference cards for each of the application programs. *The UNIX System V Programmer's Guide*, familiar to UNIX old-timers, is included with the optional utilities package. (It was the edition number of this manual that UNIX version numbers used to refer to, hence Seventh Edition equals Version 7.) *The UNIX System V Programmer's Guide* pages are organized alphabetically by command, function, or filename, within each of eight logically distinct sections.

#### CONCLUSION

The AT&T UNIX PC is an excellent machine. It's ruggedly constructed, the keyboard has an excellent layout and a nice feel, and the display screen is easy on the eyes. The display's tilt-and-swivel mounting is a definite plus. The electronics and disk drives seem solid and reliable. I had no problems with either, despite having transported the system between my home and office on the back seat of my car a few times.

The power of the 10-MHz 68010 processor really shows, and the fast

hard-disk drive is well matched to it. Although the machine has virtual memory, I would recommend getting at least 1 megabyte of real RAM (minimum is 512K bytes). Also, since the virtual memory uses a few megabytes of disk space, and the wealth of UNIX utilities and commands takes up a few more, the basic 10-megabyte hard-disk drive fills very quickly. I'd recommend the 20-megabyte drive, or even the 40-megabyte drive, for serious software development.

The built-in 1200-bps modem (in addition to an RS-232C serial port) is another plus, although I was disappointed at the lack of documentation on programmer access to the modem functions.

The software is solid UNIX System V, although many of the utilities are not bundled with the basic package and must be purchased separately. These utilities are a must for any C programming, but the whole utilities package is good value for the money. The windowing software is unique to the UNIX PC, and its ease of use (together with the mouse) should put an end to all those nasty (but not entirely untrue) stories about UNIX being terse and cryptic.

The bundled word processor, spreadsheet, and business graphics software are quite usable but may lack some of the power and features of available dedicated third-party software. The electronic mail and telephone manager software (also bundled) are a real plus and make this machine a communications tool as well as just a computer.

The system is readied for multiuser mode by just plugging in a dumb terminal for the other user and runs multiple processes well enough to compare with a VAX.

For the price, you could perhaps have wished for color capabilities as well, but if that would have meant using a slower hard disk, I'll take the fast disk and settle for monochrome.

The standard UNIX System V operating system also makes the AT&T UNIX PC an ideal, relatively low-cost, software development system. Overall, the AT&T UNIX PC is a solid computer with impressive performance. ■



# Go for the power.

Do you have to give up power and advanced potential to get ease of use and affordability? Not anymore. Because now, you can have *UCSD Pascal* for only \$79.95!

If you're making your move into programming, there's no better way to go than Pascal. And starting now, you *don't* have to settle for a stripped-down version of Pascal in order to get a price that's right. Instead, you can choose UCSD Pascal—the recognized Pascal programming standard in colleges and universities throughout the country—at the incredibly low introductory price of \$79.95 for your PC-DOS, MS-DOS, or other popular computer.

#### Start with the standard

With an entry-level system, you spend a lot of valuable time learning a non-standard form of Pascal. And you don't get all the capabilities a true Pascal system is supposed to deliver—unless you buy a lot of add-on utilities—which can send the cost of your system sky-high! Worst of all, when you're ready to tackle anything more than short, simple programs—you have no choice but to move up to a more sophisticated system (like UCSD Pascal). And at that point, you also have to *relearn* standard Pascal.

#### UCSD Pascal has everything you need

With UCSD Pascal, you get a

full-featured, professional programming tool that's being used right now in the development of major scientific and business applications. The system comes with an outstanding text editor, a complete on-line tutorial, 8087 math coprocessor support and BCD (decimal arithmetic) included in the package at no extra cost. In fact, UCSD Pascal contains virtually everything you need—as standard equipment—for developing the simplest to the most

sophisticated programs.

UCSD Pascal is available for MS-DOS, PC-DOS, UNIX, VMS, MSX and many other operating systems. You can use UCSD Pascal to write programs of any size on virtually any computer, and port them to any other computer. And if speed is what you're after, the latest native code version of UCSD Pascal actually benchmarks favorably with Turbo Pascal® in execution time!

#### Programming that's easy ...and fun!

At Pecan Software Systems, we strongly believe programming should be as easy as possible. UCSD Pascal was originally designed for teaching programming skills, so it's extremely easy to learn and to use. With UCSD Pascal, you'll be developing programs right from the start that are easy to write, easy to understand, and easy to maintain. We also believe that programming should be fun. So we've made UCSD Pascal as enjoyable to use as it is powerful.

#### The right tool at the right price

When the fun gets serious, you'll have a comprehensive programming system right at your fingertips with UCSD Pascal—a system that will help you develop those big-league programs you may eventually want to write—at a price you can readily afford.

Put UCSD Pascal programming power on your PC now for only \$79.95! Order by mail today or phone now 1-800-63-PECAN. UCSD Pascal—the original standard of Pascal programming excellence. The new leader in Pascal price/performance.

# PECAN™

The UCSD Pascal Company  
Pecan Software Systems, Inc.  
1410 39th Street, Brooklyn, NY 11218  
718-851-3100

# UCSD Pascal®

UCSD Pascal \$79.95 (for PC-DOS, MS-DOS, AMIGA, APPLE, ATARI 520, MACINTOSH, RAINBOW, TANDY, as well as most popular 8/16/32-bit systems).  
Price includes 8087 support and BCD.  
Please send me \_\_\_\_\_ copies of UCSD Pascal for my \_\_\_\_\_ (Operating system) which runs under \_\_\_\_\_

(Name and model of computer)  
My disk size is 3 1/2" \_\_\_\_\_ 5 1/4" \_\_\_\_\_ 8" \_\_\_\_\_  
Total amount (NYS add appropriate tax) \_\_\_\_\_  
Payment by  VISA  MC  US Bank Check  Bank Draft  
Card Number: \_\_\_\_\_  
Credit Card Expiration Date: \_\_\_\_\_/\_\_\_\_\_/\_\_\_\_\_

Mail to: Pecan Software Systems, Inc.  
1410 39th Street  
Brooklyn, NY 11218  
ITT Telex No. 494 0910  
CompuServe Code 76703, 500

Name \_\_\_\_\_  
Shipping Address \_\_\_\_\_ State \_\_\_\_\_ Zip \_\_\_\_\_  
City \_\_\_\_\_  
Telephone \_\_\_\_\_

Call or write for UNIX, VAX or other UCSD Pascal versions—and ask about our powerful Pascal add-ons, too. SCHOOLS: Contact us for our special educational discounts!  
Call toll-free or enclose a check with this coupon to place an order. Please add \$2.50 for shipping within the US. Foreign orders add \$10 and make payment by bank draft payable in US dollars on US bank. New York State residents add appropriate sales tax.

UCSD Pascal  
Not copy protected  
60-day money-back guarantee

CREDIT CARD ORDERS  
CALL TOLL-FREE  
1-800-63-PECAN  
(NYS) 1-800-45-PECAN

AMIGA is a trade mark of Commodore Electronics LTD.  
APPLE & MACINTOSH are trademarks of Apple Computer.  
ATARI 520 is a trademark of Atari Corporation.  
RAINBOW is a trademark of Digital Equipment Corporation.  
TANDY is a trademark of Radio Shack.  
Turbo Pascal is a registered trademark of Borland International.

UCSD Pascal is a registered trademark of The Regents of University of California

# Lycy Computer Marketing & Consultants

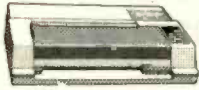

## SAVE ON THESE IN STOCK PRINTERS

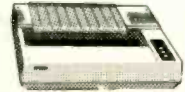

1091 . . . . \$228

DIGITAL DEVICES	
16K BUFFER	75
32K BUFFER	89
64K BUFFER	125

CITIZEN	
MSP-10	255
MSP-15	355
MSP-20	337
MSP-25	495

JUKI	
Juki 6100	344
FS232 Serial Board	55
6100 Tractor	119
6100 Sheet Feeder	209
Juki 6300	757

SG-10 . . . . \$205

PANASONIC	
1091	228
3131 (NEW)	264
1092	325
3151	409
1080 (NEW)	209
1592 (NEW)	439

CORONA	
LP300 Laser Printer	2686
200361 Toner Cartridge	89

OKIDATA	
Okimate 10	179
Okimate 20	CALL
182	214
192	348
193	563

LEGEND	
880	188
1080	CALL
1380	258
1385	289
808	148

STAR MICRONICS	
SG-10	205
SG-10C	219
SG-15	367
SD-10	319
SD-15	438
SR-10	469
SR-15	578
SB-10	589
Powertype	297

SEIKOSHA	
SP-1000UC (C-64)	169
SP-1000A Centronics	185

EPSON	
LX80	209
FX85	333
JX80	CALL
Homewriter 10	193
DX10	207
DX20	297
DX35	597
AP-80	244
HI-80	355
HS-80	298
FX-286 (NEW)	489
LQ-800 (NEW)	529
LQ-1000 (NEW)	659

BROTHER	
HR-15XL-P	359
HR-15XL-S	359
HR-35P	839
HR-35S	839
2024L-P	949
009-P	189

DIABLO	
D25	549
630 API	1599
630 ECS	1759
D 80 1F	2395
P 32 CO1	699
P 38	1749
C 150	999
DX-35 (NEW)	CALL
1P-80	CALL

SILVER REED	
EXP400	249
EXP500	295
EXP550	399
EXP770	749

## MONITORS

### TAXAN

115 12" Green Composite	CALL
116 12" Amber Composite	CALL
121 12" Green TTL	135
122 12" Amber TTL	145
220 14" Color Composite	259
410 12" RGB Hi Res IBM	329
420 12" RGB Super Hi IBM	409
440 12" RGB Ultra Hi Res	555
Tilt Stand	35

### NEC

JB-1260 Green	95
JB-1201 Green	135
JC 1215 Color	235
JC 1216 RGB	375
JC 1460 Color	265

### SAKATA

SG 1000 12" Green	99
SA 1000 12" Amber	109
SG 1500 12" Green TTL	119
SA 1500 12" Amber TTL	129
SC 100 13" Color Comp	209
SC 200 13" RGB	389
STS1 Tilt Stand	29

### AMDEK

300 Green	118
300 Amber	128
310 Amber IBM	155
Color 300 Audio	234
Color 500 Composite	369
Color 600	397
Color 700	495
Color 710	569

### PANASONIC

DT1000 13" RGB/Composite	247
DTM140 14" RGB/Composite	329
DTH103 10" RGB Hi Res	395
DTS101 10" Composite	175
DT1000G 10" RGB	166
TX12HP 12" Color	419
TR120M/PA 12" Green	109
TR120M/PA 12" Amber	109
TR122M/P 12" Green IBM	148
TR122M/P 12" Amber IBM	148

### PRINCETON GRAPHICS

MAX-12 Amber	165
HX-12 RGB	465
SR-12 RGB	595

### ZENITH

ZVM 122A Amber	75
ZVM 123G Green	75
ZVM 124 Amber IBM	129
ZVM 131 Color	275
ZVM 133 RGB	389
ZVM 135 Composite	449
ZVM 136 Hi Res Color	589
ZVM 1220	95
ZVM 1230	95
ZVM 1240	149

### TEKNIKA

MJ-10 Composite	179
MJ-22 RGB	255

## MODEMS

### HAYES

Smartmodem 300	133
Smartmodem 1200	377
Smartmodem 1200B	347
Smartmodem 2400	598
Micromodem II	135

### TELE LEARNING

Total Telecommunications (C-64)	29.95
AP-250 (300 Baud Apple)	69.95
IB-250 (300 Baud IBM)	69.95

### RACAL-VADIC

2400PC	549
2400PA	799
2400V	559
1200PC	329
300V	205
300PC	199

### ANCHOR

Volkmodem	55
Volkmodem 12	186

## DRIVES

### INDUS

Indus GT Atari	195
GT Commodore	209

### MSD

SD1 Drive (C-64)	229
SD2 Drive (C-64)	469

### TYMAC

MDD-640 3 1/2" Apple Drive 640K	289
---------------------------------	-----

### TANDON

320K 5 1/4" Drive	115
-------------------	-----

## DISKETTES

### DENNISON

ELEPHANT 5 1/4" SSDD	11.99
ELEPHANT 5 1/4" SSDD	12.99
ELEPHANT 5 1/4" DSDD	14.99
PREMIUM 5 1/4" SSDD	13.99
PREMIUM 5 1/4" DSDD	15.99

### VERBATIM

5 1/4" SSDD	13.99
5 1/4" DSDD	19.99

### BONUS

5 1/4" SSDD	8.99
5 1/4" DSDD	12.99

## IBM-PC COMPATIBLE

### \*LEADING EDGE

Nutshell	69.95
LEWP Basic	65.00
LEWP Merge Print	99.00
LE Spell Correction	169.00

### \*LOTUS

Lotus 1-2-3	309.00
Symphony	439.00

### \*QUADRAM

Quad Jr. Exp. Chassis	519.00
Quad Jr. Exp. Memory	209.00
Quad Memory Jr.	209.00

### MICROPROSE (IBM)

F-15 Strike Eagle	20.75
Solo Flight	20.75
Helicat Ace	20.75
Spitfire Ace	18.75

# TOLL FREE 1-800-233-8760



TO ORDER



RISK FREE POLICY

CALL TOLL FREE 1-800-233-8760  
In PA 717-494-1030  
Customer Service 717-494-1670

or send order to  
Lycy Computer  
P.O. Box 5088  
Jersey Shore, PA  
17740

In-stock items shipped within 24 hours of order. No deposit on C.O.D. orders. Free shipping on prepaid cash orders within the continental U.S. Volume discounts available. PA residents add sales tax. APO, FPO, and international orders add \$5.00 plus 3% for priority mail service. Advertised prices show 4% discount for cash, add 4% for MasterCard or Visa. Personal checks require 4 weeks' clearance before shipping. Ask about UPS Blue and Red label shipping. All merchandise carried under manufacturer's warranty. Free catalog with order. All items subject to change without notice.

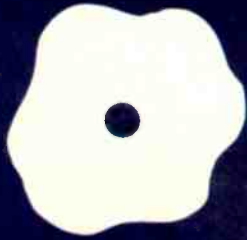

# ZBasic

An interactive  
BASIC  
compiler with  
transportable  
code

BY TJ BYERS

**Z**Basic, an interactive BASIC compiler from Zedcor, compiles very quickly and allows you to run the same ZBasic code on several computers with little modification. Rather than make the compiler compatible with established BASIC formats, Zedcor created a BASIC language that enhances the performance of the compiler.

There are three principal benefits from this approach. First, optimizing the language for the compiler allows programs to compile quickly. Second, the compiled files are smaller—as much as 50 percent smaller in many cases—than the files created by compilers that translate interpreted BASIC. Third, you will be able to port the code quickly and easily from one machine to another, as long as you also have the ZBasic compiler for the second machine.

Bear in mind, however, that the product does have its troubles. You will have to relearn the syntax for many BASIC expressions, there are few run-time error messages, graphics are difficult to implement, and the editor is poor. Nonetheless, those of you who are looking for portability, speed, and concise executable files may find an answer here.

## THE ZBASIC LANGUAGE

For the most part, the structure of ZBasic is very much like standard MS-BASIC. Many statements are modified, but they are still there.

Several aspects of ZBasic differ from MS-BASIC. For example, the MS-BASIC LOCATE command lists its coordinates in a manner opposite that of ZBasic; until you consciously remember to make the conversion, you are going to find yourself off the screen more often than on. There are limitations to using evaluations within conditions. For example, using some complex strings within IF...THEN statements generates an error. In addition, string lengths have a maximum of 255 bytes, and strings are not dynamically allocated.

ZBasic also includes some new com-

mands. To break out of a program, you must include TRONX, which inserts a single breakpoint, or TRONB, which inserts a breakpoint at the start of each line. If you run the program as executable code from the operating system, breaking out of the program will return you to DOS. You automatically disable the Break key by not including these commands. Other new commands are HELP, which provides information on the commands you specify, and UCASE\$, which returns uppercase strings. I found the FIND command particularly useful, which, like the search mode of a word processor, examines the contents of a ZBasic file and displays the lines that contain the argument specified with FIND. You can use FIND, for example, to locate text, line numbers, strings, remarks, and data.

## ZBASIC GRAPHICS

The most interesting ZBasic commands are those associated with compiled graphics. Until recently, graphics have not been done with compiled BASIC, because it has been difficult to generate quality graphics without creating assembler problems within the compiler.

ZBasic uniquely solves the problem by redefining the screen in relative coordinates instead of pixels and by creating a library of graphics commands to control the new format. The coordinate system, which defines a full screen, is 1024 points across by 768 points down.

ZBasic's coordinate system has a direct relationship to the screen and not to the actual pixel resolution of your computer. To maintain the shape of the image, ZBasic automatically adjusts pixel locations to the specified coordinates and to the available resolution of the screen. ZBasic automatically converts the image to the highest resolution possible within the graphics mode you are using. You don't even need to specify a mode; all conversions are automatic. For computers without a graphics

(continued)

TJ Byers is a freelance technical writer. His latest book is *Inside the IBM PC AT*. He can be reached at 9411 Soledad Canyon Rd., Canyon Country, CA 91351.

mode, such as an IBM PC with a Monochrome Display Adapter, ZBasic uses an asterisk to simulate the graphics as closely as possible.

ZBasic contains a large repertoire of graphics commands, including standards like COLOR, DRAW, FILL, and CIRCLE. It also includes specialized functions like ARC and PIE, which generate parts of a circle. RATIO creates ellipses or parts of ellipses when used in conjunction with the ARC or PIE command.

You can generate "clipped" graphics that extend beyond the screen by specifying coordinates that extend beyond the actual screen coordinates (see figure 1). The capability to create clipped graphics is confusing if you are not familiar with it. All coordinates within the  $-8191$  to  $+8192$  boundaries are legal, but specifying a coordinate out of the visible ranges causes an overflow without generating an error. Your cursor obediently goes to the specified coordinate and blinks offstage without your being aware of

it. You can still execute commands, but you cannot display them. And for some reason, I found that I could not return the cursor to the screen. The best way out of the dilemma was to type QUIT and begin over again from the system.

### MATH FUNCTIONS

ZBasic also has some interesting math functions. A very useful set of functions is the Integer Base Conversions, essentially a group of math functions for converting integer constants into hexadecimal, octal, binary, and decimal formats.

ZBasic's strongest point, however, is in the manipulation of floating-point variables. Like interpreted BASIC, ZBasic allows you to configure the digits for accuracy of single, double, or scientific precision. You can specify up to 54 digits. Unfortunately, floating-point arithmetic takes considerable time and processing power to calculate to 54 decimal places. ZBasic speeds the calculation by allowing

you to limit the number of decimal points to which any operation may extend. Your choices include integer (no decimals), 2 to 52 digits for single precision, 6 to 54 digits for double precision, and 2 to 54 digits for scientific precision. By prudently configuring decimal accuracy, you can increase processing speed up to 200 times.

You can enter variables using any alphanumeric string up to 15 characters in length, so long as they don't conflict with reserved words. Because spaces are generally optional, ZBasic will extract reserved words from longer words. An unacceptable variable, for example, is BEFORE because FOR is a ZBasic reserved word. To use BEFORE in your text, you can spell it with an initial capital letter, Before, because ZBasic discriminates between upper- and lowercase for all but a few of its commands.

### ZBASIC EDITOR/COMPILER

ZBasic includes an editor/compiler that performs much like a BASIC-interpreter editor in that you can write and execute programs in real time. Programs written with the editor/compiler must contain line numbers. By invoking AUTO, the editor will automatically insert line numbers for you. ZBasic only requires line numbers for the editing of lines; the compiler discards them. And, without line numbers, there is no way to locate a line for editing or error identification.

Unfortunately, the line editor leaves something to be desired. Unlike MS-BASIC, where you can move the cursor to insert within a line of code, calling up the line in ZBasic provides the line number with a blank line. The code appears only when you tap out the line with the cursor keys. Adding and deleting characters is also disconcerting. There are symbols to indicate that you are inserting or deleting, but the corrections overwrite the line: the whole picture is not visible until you relist the line. I have often found it faster and easier to rewrite the entire line. You may prefer to use a separate editing facility.

To execute a program, you enter the RUN command; ZBasic will compile the program and then execute the

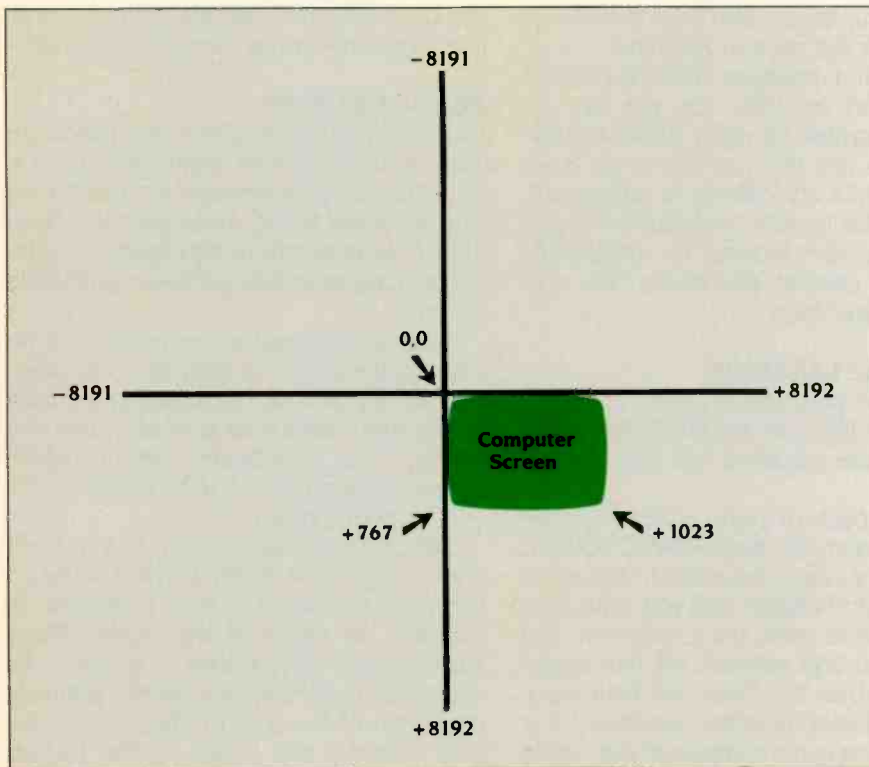

Figure 1: ZBasic scans a field that is 85 times larger than the actual display; you can draw lines, circles, or rectangles off screen while displaying only a portion. The full coordinate range extends from  $-8191$  to  $+8192$  horizontally by  $-8191$  to  $+8192$  vertically; the active display covers only 0 to 1024 and 0 to 768.

## AT A GLANCE

**Name**  
ZBasic

**Type**  
Programming language/BASIC  
compiler

**Company**  
Zedcor Inc.  
3438 North Country Club Rd.  
Tucson, AZ 85716  
(800) 482-4567

**Computers**  
IBM PC and compatibles  
Apple IIe and IIc  
Kaypro CP/M-80 machines  
TRS-80 Models I, III, and 4  
Macintosh

**Documentation**  
400-page spiral-bound  
manual, with a 20-page  
machine-specific appendix  
of commands and a quick-  
reference card

**Price**  
\$89.95  
\$399 for the set for all  
computers

SIEVE OF ERATOSTHENES (SEC)

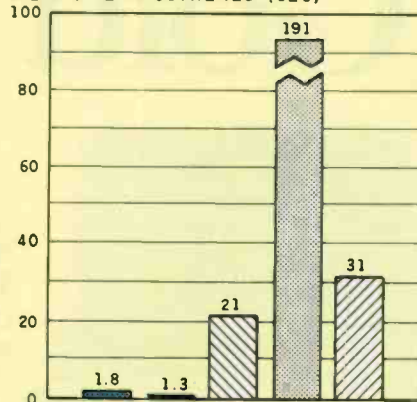

CALCULATIONS (SEC)

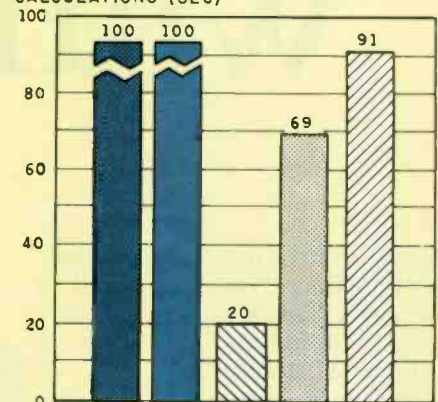

ZBASIC INTERPRETER
  ZBASIC COMPILER
  TRUE BASIC
  PC-BASIC
  BETTERBASIC

The Sieve of Eratosthenes benchmark measures, in seconds, how long each of the test languages took to run one iteration of a program that determines all prime numbers up to 7000. The Calculations graph shows how long

the languages took to do 10,000 multiplications and 10,000 divisions using single-precision numbers. The ZBasic tests were done on an IBM PC.

result. If ZBasic encounters an error while compiling, it will display the error and the appropriate line on screen. In most cases, compilation is so fast that execution is indistinguishable from a normal interpreted BASIC start-up. This feature gives you an easier way to debug the program than the usual cycle of compile, save, run, reload BASIC, and edit.

To save a compiled program, you simply invoke the RUN\* command. Once saved, the compiled file contains everything necessary for the program to execute on its own. You can separately compile programs that are too large to save in a single file and chain them together using the RUN + command inside a dummy command file.

ZBasic does not create an external object file, and there is no run-time error module. The ZBasic compiler saves the program in a .COM file that is approximately 40 percent smaller than the .EXE files created by other BASIC compilers. The lack of an

object-file listing, however, may prove unacceptable to those programmers who use object code to get inside and tinker with program files. And the only execution error messages involve disk errors and an out-of-memory error (when the compiled program is too large for available memory). Without other run-time error messages, you could inadvertently enter an endless loop or generate a division by zero. The trace facility is adequate, but you will want to make frequent backups and you may need to use more than ordinary care in debugging.

### TRANSPORTABILITY

By organizing the compiler so that it translates each command into the machine code appropriate for the computer at hand, the language becomes transportable.

Each computer must, of course, have its own version of ZBasic, since compiled files are not interchangeable; you can only transport tokenized and ASCII files. To date, ZBasic

has been written for the IBM PC and compatibles, Apple IIe and IIc, Kaypro CP/M-80 machines, TRS-80 Models I, III, and 4, and the Macintosh. You can port any program written in ZBasic among these machines with little modification, provided they are not in compiled format. If you are interested in porting your software to other machines, you will need to heed the appendixes that specify the commands that may not be available on other versions of ZBasic.

### CONCLUSION

Overall, I have to give ZBasic a good rating. It is extremely fast and accurate and a solution for those who are looking for ease in portability. On the other hand, it isn't for everyone. If you are willing to learn a new language to gain speed, portability, and reduce file size, then ZBasic is for you. If, however, you're not adept at programming, you may be better off with one of the more conventional BASIC compilers. ■

# Get started in AI with Gold Hill.

You know artificial intelligence is the wave of the future. Programs based on the ideas of artificial intelligence are being written today in COMMON LISP—the new LISP standard developed by researchers from universities and corporations such as Carnegie Mellon, DEC, MIT, Stanford, Symbolics and TI. LISP allows the development of programs that are intelligent, flexible, and even human-like. The problem has been that hardware needed to run LISP is expensive.

No longer. GOLDEN COMMON LISP (GC LISP) makes it possible for you to learn and use LISP on your *personal computer*. When you use GC LISP in combination with the AI examples provided, you will be able to develop such exciting applications as expert systems, natural language systems, and intelligent interfaces to complex software. The possibilities are endless. With GC LISP you can tackle problems that you could not solve before with ordinary number crunching programs. You will be able to write powerful programs that can accommodate casual computer users who want intelligible answers quickly.

## Learn Quickly with GC LISP

GC LISP makes it easy for you to learn the technology of AI at your own pace. Each package includes the *San Marco LISP Explorer*—an interactive software tutorial developed by Patrick H. Winston and his associates. This 800-frame instructional

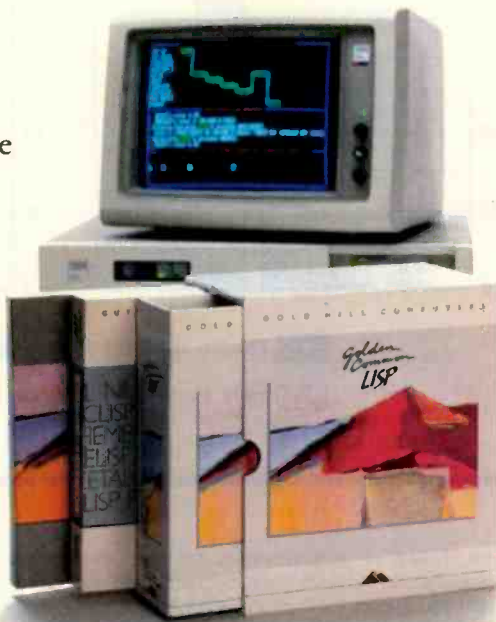

*GOLDEN COMMON LISP is the best selling AI language.*

system guides you through the steps of LISP programming and makes the full range of LISP's power accessible to both novice and experienced programmers. The second edition of the classic *LISP* textbook by Winston and Horn is also included.

GC LISP comes complete with the intelligent GMACS editor (based on EMACS), full on-line documentation of all GC LISP and GMACS functions, the *Common LISP Reference Manual* by Steele, and a comprehensive user manual. In short, GOLDEN COMMON LISP comes with everything you need to program in LISP.

## NEW!

### The GC LISP 286 DEVELOPER

Discover programming power you never thought possible on your PC AT! GC LISP 286 DEVELOPER is a complete programming environment designed for GC LISP-based applications requiring extended memory and faster execution. The 286 DEVELOPER includes a Large Memory Interpreter capable of addressing 15 megabytes of physical memory, a Large Memory Compiler that runs applications up to 15 times faster, and a complete set of program development features including lexical and dynamic scoping. The 286 DEVELOPER is the first PC-DOS programming environment that takes full advantage of the speed and memory capacity of the IBM PC AT and compatibles, and it's now available to help you develop powerful and productive AI applications.

## Order Today

For more information on Gold Hill products, please call today:

# 1-800-242-LISP

In Massachusetts call collect  
(617) 492-2071

GC LISP requires an IBM PC, PC XT, PC AT, or IBM-compatible with a minimum of 512K and PC-DOS 2.0 or higher. GC LISP 286 DEVELOPER is non-copy protected, and requires an IBM PC AT or compatible with a minimum of 512K of base memory, 2 megabytes of extended memory, and PC-DOS 3.0 or higher.

© 1986 Gold Hill Computers

G O L D H I L L C O M P U T E R S

163 Harvard Street, Cambridge, Massachusetts 02139

GOLDEN COMMON LISP, GC LISP, and GC LISP 286 DEVELOPER are trademarks of Gold Hill Computers. The San Marco LISP Explorer is a trademark of San Marco Associates. LISP is copyrighted by Addison-Wesley Publishing Company, Inc. The COMMON LISP Reference Manual is copyrighted by Digital Equipment Corporation. IBM PC, PC XT, PC AT, and PC-DOS are trademarks of International Business Machines.

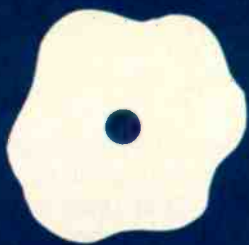

## GEM Draw/MacDraw

Two second-  
generation  
paint  
programs

BY RICARDO BIRMELE

**M**acDraw (written for the Apple Macintosh by Apple Computer) and GEM Draw (written for IBM PC-compatibles by Digital Research) are two of the newest kind of "painting" programs for microcomputers. They herald a new generation of such programs, going beyond software for playing with, to software one can use in computer-aided design.

These software packages are similar in appearance and use, yet they show a wide disparity in their level of development.

### THE INTERFACES

In order to understand MacDraw and GEM Draw, you first have to understand their user interfaces—how you interact with them to get them to do what you want them to.

For this review, we used a standard Macintosh computer and Imagewriter to test MacDraw. We used three computers to test GEM Draw: a standard IBM Personal Computer, a Compaq Portable, and a Compaq Desktop 286. For output we used an old reliable Epson MX-80 as well as a new Hewlett-Packard HP7475A plotter.

MacDraw uses the tested and proven Macintosh mouse-based user interface. With this interface, you interact with the computer on a conceptual and visual level rather than a concrete or literal one. Notably, when you move a Macintosh's mouse, its corresponding screen figure moves as well—instantly. This is because the Macintosh interface has been optimized for the Macintosh computer; it doesn't have to work with another make of computer or operating system. Also, if you buy MacDraw you probably already own a Macintosh and will not have to learn any new skills in order to use your new program.

GEM Draw requires Digital Research's Graphics Environment Manager (GEM), an operating-system enhancement that is employed within a further program called "GEM Desktop." GEM is an outgrowth of the original Virtual Device Interface, which

was an early relative of what IBM now calls VDI.

In order to use GEM Draw, you usually have to have bought, installed, and learned to use GEM Desktop first—a new skill for someone already accustomed to DOS. Then you have to install GEM Draw as an application under GEM Desktop. The installation is not a difficult process (if you follow the directions exactly), and it gets easier with practice; however, it is somewhat involved.

Unlike MacDraw, GEM Draw does not absolutely require a mouse pointing device, but its use does simplify things. If you choose to do without one, you would use the up, down, left, and right cursor-control keys to move the screen pointer. You would also use the Return key instead of a mouse's click button.

One problem shows itself when you do use a mouse. It results from having to use an operating-system enhancement (which must work with many different makes of computer) rather than an operating system optimized for a particular computer. When maneuvering a mouse with a slower computer, it takes time for the information that you have moved the device to percolate through the computer to the mouse's corresponding screen figure. As a consequence, with GEM Draw the connection between mouse and screen can result in a kind of "loose" feeling. This problem almost disappears when using a faster computer like the Compaq Deskpro 286.

You can demonstrate this looseness by selecting freehand drawing from the screen menu. If you quickly draw a circle, instead of getting a more or less round figure, you get a polygon. It appears that the software is sampling the position of the mouse and translating that position to the screen, while it has to do other things at the same time. The resulting graphic figure is something of a compromise. To be fair, MacDraw will do the same thing, but you have to move its

(continued)

Ricardo Birmele (POB 1166, Bothell, WA 98041) is a freelance writer, author of technical manuals, and co-author of Turbo Tutor, published by Borland International.

## AT A GLANCE

<b>Name</b>	MacDraw	GEM Draw
<b>Type</b>	Low-level CAD	Low-level CAD
<b>Company</b>	Apple Computer Inc. 20525 Mariani Ave. Cupertino, CA 95014 (408) 996-1010	Digital Research Inc. 60 Garden Court Monterey, CA 93942 (800) 443-4200
<b>Format</b>	Two Macintosh 3½-inch disks	Two 5¼-inch MS-DOS floppy disks, not copy-protected
<b>Computer</b>	Macintosh	IBM PC and compatibles with 320K bytes of RAM
<b>Necessary Software</b>	None	MS-DOS GEM Desktop (includes GEM)
<b>Documentation</b>	One manual, cassette- based tutorial	One manual
<b>Price</b>	\$125	\$249 (includes GEM Desktop)

mouse much more quickly to obtain the same result.

#### DISKS AND DOCUMENTATION

MacDraw comes on two 3½-inch disks: one program and one backup. MacDraw's user manual is a single "Mac-sized" spiral-bound book. It is written and illustrated in Apple's familiar and clear way.

Also included is a disk and tape cassette that contain an excellent MacDraw tutorial. You simply start the tape, insert your program disk, and kind of "follow the bouncing ball." Once you have gone through this, you'll have a good idea of what MacDraw is all about and how to use it intelligently.

GEM Draw comes on two disks. They contain the program (application) and three picture libraries contained in DOS subdirectories. The libraries are a collection of images that you can include within your own pictures. The images include such miscellany as useful geographical

maps and a whimsical children's choir.

GEM Draw's documentation is simply not as complete as MacDraw's. The version we received, which was dated March 1985, contained two pages of additions and corrections bound into the book. Its index is spotty, and the layout—especially in the Picture Elements section—appears to have been done by computer with no human intervention that might have added some common sense. Finally, there are also six pages of "End User Program License Agreement," an interesting emphasis, comparatively speaking.

#### USING THE PROGRAMS

Once you get either program up and running, you see an electronic analogy to a blank drafting table. Because of your computer monitor's physical limitations, you are looking at only a portion of the possible work area—in the same way that an electronic spreadsheet allows you a window's view. With MacDraw, your total

work area (as defined by the largest size document you can print out) is 96 by 48 inches; GEM Draw has a work area of 17 by 11 inches.

MacDraw's screen is in black and white, but at least it is in high resolution. GEM Draw's screen is pleasantly blue, and it lets you use your computer's available colors as you draw and color various picture elements differently. Here, picture elements means the various parts of a drawing, not necessarily pixels, the tiny dots that make up the drawing.

Both programs feature a row of pull-down menu headers along the top of the screen and a row of screen-element tool icons along the left side of the screen.

A submenu appears when you move your screen pointer to any of the pull-down menu headers. The submenu options allow you to manipulate such parameters as screen layout, orientation, and scale. You also have access to file maintenance, text-font controls, and screen-element editing.

Now we come to how these programs really differ from other computer painting programs. When you draw a picture with MacDraw or GEM Draw, you are more correctly constructing a picture using the screen-element tools. The tools include boxes, circles, lines, arcs, polygons, and freehand shapes. You choose which tool you want to work with by clicking on its icon.

You would lay out an office, for instance, by putting small boxes (which represent desks) inside a larger box (which represents the office's walls). You could add individual lines to show office partitions and rounded boxes to show employee's chairs.

Once you have an element on your screen, you can group it with another element or elements. This group can be enlarged, reduced, moved, or deleted, all without disturbing any other individual picture element. You can fill it with a predefined pattern, as with any other computer painting program. MacDraw will also allow you to "smooth" the lines of a hand-drawn picture element.

(continued)



# 15,000 SAVED FROM CRASH.

No hysteria. No panic. No reports of data loss. No wonder more than 15,000 Alpha Micro users have chosen our Videotrax™ backup technology over streamer tape or floppies.

The best news is it's now available for the IBM® PC-AT, XT and true compatibles.

## BETTER TO BE FAIL-SAFE THAN SORRY.

Exhaustive testing and long term use of Videotrax technology prove it more reliable than any other backup



*High-tech. Open your PC and slide the controller board into any expansion slot. Low-tech. Hook up VCR to computer with standard connector cables.*

option available. Even more reliable than the hard disk you're backing up.

At the heart of the system is a patented video tape controller board that employs a standard video cassette recorder for copying data. Which means Videotrax offers the sophisticated technology of today's VCRs. And the depend-

ability of a durable consumer good.

## EASY DOES IT.

If you own a VCR, you already own half the system. And you already know how to use it. Or you might opt for the complete subsystem (controller board plus enhanced VCR) and experience the

*Your basic video cassettes. Reliable, cheap, easy to find.*



joy of its automatic, unattended backup capabilities.

Either way, our menu driven software, clear documentation and wide range of backup modes keep it simple: Insert a blank video cassette tape and follow the directions that appear on your screen.

You can copy or restore your entire hard disk, specific files, or only files modified since the last backup, while the system busily self-monitors for proper functioning.

And for the price of taping your favorite TV shows, you can record your most valued computer data. Up to 80MB can be stored on a single cas-

sette at less than a third of the cost of streamer tape.

Of course, if you ever require service, your authorized Alpha Micro dealer and our worldwide network of factory service centers will provide all the support you need.

For more information on how Videotrax can keep you off the crash course, call your local dealer or Alpha Micro at 1-800-992-9779 (in California call 1-800-821-0612).

**VIDEOTRAX™**  
DATA BACKUP FROM  
ALPHA MICRO.



*MacDraw is a complete, ready-to-use, mature program. GEM Draw, on the other hand, is usable but shows its potential more than its maturity.*

The advantage of using individual picture elements is that they can be stored in your computer's memory in less space than an equivalent figure drawn freehand. Their implementation is what makes these programs useful in CAD applications.

The drawing table, as you initially see it, is covered with an alignment grid of precisely spaced dots. You determine the interval between the dots, which can be in inch or metric fractions. The dots are significant for two reasons. First, they assist you in scaling the individual elements in a drawing. Second, when you draw an element, it aligns itself automatically with the grid, "snapping" to the grid's nearest dot. The element also maintains its alignment to the screen grid, if you should move it.

You can have a ruler—ticked according to the grid scale you have chosen—displayed along the top and left side of your drawing window. This is a great aid in correctly scaling your drawings. The ruler doesn't show when you print a document.

MacDraw has expanded this idea in two ways. First, a dotted-line slider, which is aligned with your cursor, moves along the screen's rulers. This is a big help in sizing an element precisely. Second, MacDraw's Show Size option displays an element's size on an  $x, y$  axis around it. The program updates the Show Size numbers as you vary the size of the element.

#### TEXT ELEMENTS

Both drawing programs let you use text as one of the picture-element

tools. GEM Draw offers only one font, a sans serif called Swiss. It comes in six point sizes from 10 to 72 points. GEM Draw's on-screen Edit submenu shows room for four more fonts, which were undelivered at the time of this review.

MacDraw's text is considerably more interesting. It provides you with up to 10 fonts, in eight sizes from 9 to 48 points. MacDraw also has a paragraph mode that inserts text into (and keeps it within the boundaries of) a polygonal shape on your screen. This is very handy if you are using MacDraw to lay out a brochure or newsletter.

Besides the text fonts, MacDraw boasts a symbol font called "Taliessin" (pronounced "talley-es-in"). This is a font that assigns symbols, rather than letters, to your console's keys. For example, if you press = you see a small dog on your screen; B will get you a golf club; ? is a traffic light. You can display each symbol in different font sizes, in the same way as alphabetical text.

#### PRINTING THE DRAWING

Once you have created a drawing you will want to generate a hard copy of it. Both MacDraw and GEM Draw provide output to dot-addressable dot-matrix printers, although the former is limited in this regard to the Apple Imagewriter.

You can achieve better-quality output for MacDraw by printing your picture on an Apple LaserWriter. With its 300-dots-per-inch resolution and PostScript language, they make a team that is hard to beat. You are limited, however, to single-color (though patterned) output.

As we mentioned before, MacDraw has a potential drawing surface of 8 by 4 feet. Since the available output devices will only print on paper of about  $8\frac{1}{2}$  by 11 inches, something had to be done. The compromise is that, when printing a drawing larger than  $8\frac{1}{2}$  by 11 inches, MacDraw prints it out in columns. Later, with everything output, you have to fit, cut, and paste the drawing to its final form. To make this easier to visualize, MacDraw shows you its page breaks overlaid on your screen's drawing board.

Along with dot-matrix printers, GEM Draw supports the popular Hewlett-Packard family of pen plotters. Although limited here to the HP's maximum 11- by 17-inch paper size, the program will draw using all six pens—or all two, depending on which plotter is used. This capability was somewhat flawed in its first release. The problem had to do with the difficulties of going from a raster to a vector scheme of graphics output. As a result, Digital Research had to send out a replacement for its initial driver program—unfortunately, with slightly incorrect instructions regarding how to correct the first error.

#### CONCLUSION

Because of the greater amount of tools available to the user, MacDraw is the better of the two software packages. This is especially true in the office arena—despite Apple's apparent difficulty in penetrating that market with the Macintosh.

Even though limited to one color on both screen and output, MacDraw gives the impression of being one coherent whole. Anyone can pick up MacDraw, go through the taped tutorial, and very quickly start to use the software well. With a little practice, you should be able to make full use of the details, like figure smoothing and paragraph text insertion.

Unfortunately, as is the case with many comparisons of two items, one must suffer when viewed against the standard of the other. While preparing this review, I found MacDraw to be a complete, ready-to-use, mature program. GEM Draw, on the other hand, is usable but shows its potential more than its maturity.

You can use GEM Draw as it comes from the box, but when you see what more could have been done before it was released, you may wonder, "Why didn't they finish it first?" For instance, why doesn't it have more than a single type font or show you the size of an element?

GEM Draw does fit a soon-to-be-important niche. If you need such a tool now, go ahead and buy it. You'll be able to use it, but be prepared to buy the upgrades, which are sure to come. ■

# Microsoft languages speak for themselves.



Microsoft COBOL Reference Manual

The data-item named in the **RECORD KEY** clause is the prime **RECORD KEY** for that file. For purposes of inserting, updating, and deleting records in a file, each record is identified solely by the value of its prime **RECORD KEY**. This value must be unique and must not change when updating a file. The key may represent a single field or multiple fields (using the split key syntax). The maximum key length is 250 bytes, and the key value should never be made to contain all binary zeros. A split key is equal to the concatenation of selected data-items.

A record with the following file description entry:  
EXCEPT-**STAFF-FILE**  
LABEL RECORD STANDARD \***STAFF-DAT** =  
FILE OF FILE-**ID-15**  
RECORD IS EXCEPT-**RECORD** =  
RECORD  
RECORD-**KEY**  
PIC 9(9).  
PIC 1(20).  
PIC 1(2).  
PIC 5941V99.

**11.2.3 ALTERNATE RECORD KEY CLAUSE**  
If **RANDOM** access mode is specified, the value of the primary **RECORD KEY** designates the record to be accessed by the next **SELECT**, **REWRITE**, or **WRITE** statement.

**11.2.4 ALTERNATE RECORD KEY CLAUSE**  
A data-item named in the **ALTERNATE RECORD KEY** clause will be accessed during processing of the alternate **RECORD KEY** (field value) if the **DUPLOCATES** phrase is not specified in the **FILE-CONTROL** paragraph. Duplicate field values must not occur in the records.

**11.2.4 File Description Entry (DATA DIVISION)**  
FD file description entries are included for each file that was described in the **FILE-CONTROL** paragraph of the **ENVIRONMENT DIVISION**. FD entries specify the size of the logical and physical records, the value of implementation-defined label terms, and the names of the data records which make up the file.

## Loud and clear.

Microsoft has been the language leader from day one. From the world's favorite BASIC to the systems languages software developers prefer. No one else has put so much programming power on so many micros.

Microsoft offers a complete set of languages. Whether you favor the elegance of C, or the power of assembly language. From data munching in COBOL to number crunching in FORTRAN, we've got the power you need.

### The advantages of leadership.

Microsoft languages have developed quite a following. They're backed by the largest collection of support libraries you've ever seen. Packages for advanced mathematics and data management. From graphics support to context-sensitive editors. All available today. So you can spend your time solving real problems, not reinventing the wheel.

Microsoft's languages — like C, FORTRAN, Pascal and Macro Assembler — have become the favorites of commercial software developers. It's not surprising. Interlanguage calling allows libraries written in one language to be

used with others. Which means your existing routines can be an investment in future projects, not lost time and effort.

Our interactive debuggers are another Microsoft edge. Now you can debug the object code using the source language. Easier debugging lets you spend more time creating.

### Pipelines to the future.

Microsoft wrote the book when it comes to operating systems. Nobody knows MS-DOS® or XENIX® better. And our languages show it. We put the latest advances within your grasp. From networking and pipes to multi-tasking, Microsoft languages have the edge you need.

### Complete support.

Only Microsoft offers language support this comprehensive. Our clear, thorough documentation, and regular product enhancements are setting new standards in the industry. Add our technical "hotline" and our highly-trained support staff, and you'll reach the same conclusion the industry has: Microsoft languages always lead from strength.



# Microsoft C

First with the pros.

*"Microsoft C is the cornerstone of all our future development projects. Not only is the code more efficient, we can really exploit the PC's architecture with Microsoft C's NEAR and FAR pointer types."*

Ray Ozzie, President of IRIS Associates and key Symphony developer.

*"The code optimization is impressive—especially the register declarations."*

Jim Bean, Peachtree Software.

When you need code that's small and fast, Microsoft® C is the language.

Our optimizing compiler lets you squeeze the maximum out of your machine with minimum effort. Tighter code runs faster. And virtually every program will run faster with Microsoft's C Compiler than with any other MS-DOS compiler.

Our advanced memory models give you unmatched flexibility. No arbitrary limits on code and data. Use large or small memory models as the application demands. Exclusive features like our NEAR and FAR pointers let you combine different models without sacrificing performance.

Our extensive math libraries are another plus. The floating point package supports 8087 operation when speed is the key. There's also floating point emulation for unendowed PCs. And the altmath package gives you an extra burst of speed when you really need it.

A bundle of other features can save you programming time. There's inter-language calling support. So you can use existing library routines. Unsurpassed XENIX compatibility. And documentation that reviewers have praised for its clarity and thoroughness.

If Microsoft C amazes you, don't be surprised. After all, our C is the choice of the leaders. Companies like Lotus® Ashton-Tate. And IBM®

## Microsoft C Compiler Version 3.0 for MS-DOS

### Microsoft C Compiler

- Produces compact code and fast executables.
- Implements register variables.
- Small, medium and large memory model libraries.
- Can mix models with NEAR and FAR pointers.
- Transport source and object code between MS-DOS and XENIX 286 operating systems.
- Library routines implement most of UNIX™ System V C library.
- Choose from three math libraries and generate in-line 8087/80287 instructions or floating point calls:
  - Floating Point Emulator (utilizes 8087/80287 if installed).
  - 8087/80287 coprocessor support.
  - Alternate math package provides extra speed without an 8087/80287.
- Link your C routines with Microsoft FORTRAN (version 3.3 or higher), Microsoft Pascal (version 3.3 or higher) or Microsoft Macro Assembler.
- Supports MS-DOS pathnames and input/output redirection.
- File sharing, record locking and file locking are supported.
- Do source level debugging with the Symbolic Debug Utility, available separately with Microsoft Macro Assembler.

### Library Manager

- Create, organize and maintain your object module libraries created with Microsoft languages.

### Object Code Linker

- Simple overlay linker combines relocatable object modules created using Microsoft languages into a single program.
- Link very large programs (over 1 megabyte) using overlays.

### Microsoft EXE File Compression Utility

- A new utility to compress sequences of identical characters from an executable file and optimizes the relocation table.

### Microsoft EXE File Header Utility

- Display and modify EXE file header, allowing you to tune the stack size and initial memory allocation.



# Macro Assembler

The quickest. Bar none.

Our Macro Assembler has long been the most complete package on the market. Now it's also the fastest. Three times faster than before. And faster than anyone else. Period.

Of course, it's still the most powerful assembler on the market. It supports the standard 8086/8087 opcodes. And the new 186/286/287 instruction set. So you can make the most of the new machines.

Debugging is quicker, too. Thanks to our interactive symbolic debugger, SYMDEB. Now you can refer to variables and source code instead of getting lost in hex dumps. And this debugger also works with Microsoft languages like C, FORTRAN and Pascal. So now you can set breakpoints and trace execution—using source code for reference.

SYMDEB is just part of our complete set of utilities. Tools that make programming as fast as it should be. There are the linker and library managers you'd expect. Plus a new version of MAKE, our maintenance utility, with improvements like macro expansions and inference rules.

We've also revised the manuals. Our new Macro Assembler has a lot to offer, so we added more examples. Now our manuals are not only thorough, they're clearer than ever before.

For quick development and assembly, the choice is obvious. Microsoft. There's nobody faster.



*The Macro Assembler's symbolic debugger lets you debug Microsoft FORTRAN programs at either the source or object code level. Set break points, observe the contents of variables and expressions, and examine the contents of the stack.*

```
-v .10
10:
11:      10      DO 10 I = 1,8191
12:      10      FLAGS(I) = .TRUE.
13:      10      DO 91 I=1,8191
14:      10      IFC (.NOT. FLAGS(I))
15:      200     PRIME = I + I + 1
16:      200     FORMAT(IX, I6)
17:      200     COUNT = COUNT + 1
17:      200     K = I + PRIME
-bp .14 "u"
-g
14:      PRIME = I + I + 1
IAEF:0069 A16240      MOV
IAEF:006C 03C0      ADD
IAEF:006E 40      INC
IAEF:006F A36440      MOV
16:      COUNT = COUNT + 1
IAEF:0072 FF066040      INC
17:      K = I + PRIME
-?no 4062
0001h 00000001 (1) ", "
-t
16:      COUNT = COUNT + 1
-
```

## Microsoft Macro Assembler Version 4.0 for MS-DOS

### Macro Assembler

- Fastest macro assembler for MS-DOS computers.
- Supports the 8086/8087/8088 and the 186/286/287.
- Define macros.
- Conditional assembly.
- Optional case sensitivity for symbols.
- 100% upward compatibility from earlier versions of both the Microsoft and IBM Macro Assemblers.

### Interactive Symbolic Debug Utility

- Source level debugger for programs written in Microsoft Macro Assembler, C Compiler, FORTRAN, and Pascal.
- Screen swapping helps debug highly visual applications.
- Set breakpoints on line numbers and symbols.
- Single step to follow program execution.
- Disassemble object code.
- Display and modify values.
- Full I/O redirection.

### Program Maintenance Utility

- Rebuilds your applications after your source files have changed.
- Similar to UNIX MAKE utility.
- Supports macro definitions and inference rules.

### Library Manager

- Create, organize and maintain your object module libraries created with Microsoft languages.
- Set page size from 16 to 32678, to create compact and granular libraries.

### Object Code Linker

- Simple overlaying linker combines relocatable object modules created using Microsoft languages into a single program.
- Load Map generation.
- Specify from 1 to 1024 segments.

### Cross-Reference Utility

- Creates a cross-reference listing of the definitions and locations of all symbols used in an assembly language program, which makes debugging programs easier.

### Microsoft EXE File Compression Utility

- Packs EXE files for smaller size on disk and faster loading at execution time.

### Microsoft EXE File Header Utility

- Display and modify EXE file header, allowing you to tune the stack size and initial memory allocation.

# FORTRAN

The overwhelming favorite.

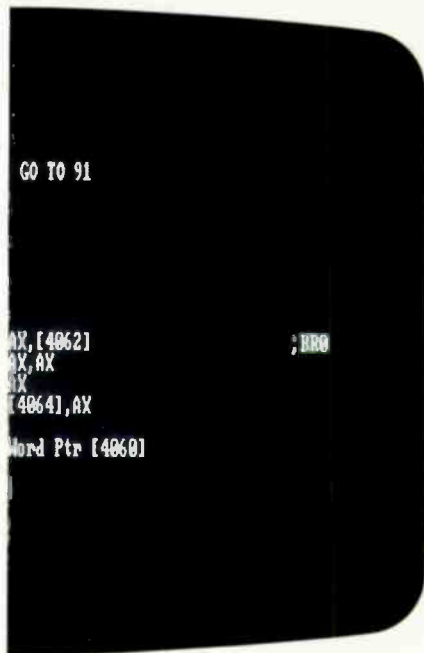

*View the FORTRAN source code. Set a break point at line #14. Run the program (g) and use the expression evaluator (?) to examine the contents of a variable. Then use the trace command (t) to observe the program flow.*

## Microsoft FORTRAN Compiler Version 3.3 for MS-DOS and XENIX 286

### Microsoft FORTRAN Compiler

- Implements most ANSI 77 standard features, plus extensions.
- Easily port mainframe/minicomputer programs with little or no modification.
- Overlay support in the compiler and linker.
- Common blocks and arrays greater than 64K.
- Supported by the largest number of third party libraries.
- Includes a full set of math libraries to select from:
  - 8087/80287 emulation.
  - 8087/80287 coprocessor support.
  - Floating Point without 8087/80287.
  - BCD Floating Point.
- Conditional compilation.
- Link your FORTRAN routines with Microsoft C Compiler (version 3.0 or higher), Microsoft Pascal (version 3.3 or higher), and Microsoft Macro Assembler.
- MS-DOS 3.1 network support and IBM local area network support.
- Source code compatible between MS-DOS and XENIX 286.
- Do source level debugging with the Symbolic Debug Utility, available separately with Microsoft Macro Assembler.

### Object Code Overlay

- Simple overlay linker combines relocatable object modules created using Microsoft languages into a single program.
- Link very large programs (over 1 megabyte) using overlays.

### Library Manager

- Create, organize and maintain your object module libraries created with Microsoft languages.

### Microsoft EXE File Compression Utility (MS-DOS only)

- A utility to pack EXE files for smaller size on disk and faster loading at execution time.

### Microsoft EXE File Header Utility (MS-DOS only)

- A utility that allows you to display and modify the fields in EXE file headers.

How did Microsoft FORTRAN get so popular?

It could be the mainframe compatibility. Our compiler makes porting applications a cinch with overlays and the ANSI features you need.

It could be our support for arrays and COMMON blocks larger than 64K. So you can tackle mainframe-size problems.

It might be the shelves and shelves of third party support libraries. No other FORTRAN comes close.

It could be the extensive math support. Our collection of math libraries is simply the largest available. Tackle real problems with direct 8087 support or emulation. Use IEEE floating point or — for extra speed — the altmath package.

It could be the comprehensive set of utilities. A powerful linker and library manager combination. Plus tools like EXEMOD and EXEPACK. Standard.

It could be the XENIX and MS-DOS source-level compatibility. Or the direct interlanguage calling to Microsoft C, Pascal, and Assembler. Or the ability to work with our Macro Assembler's symbolic debugger.

It could be the value. Nobody offers a FORTRAN package this complete at this low a price.

Why is Microsoft FORTRAN the most popular FORTRAN?

All the above.

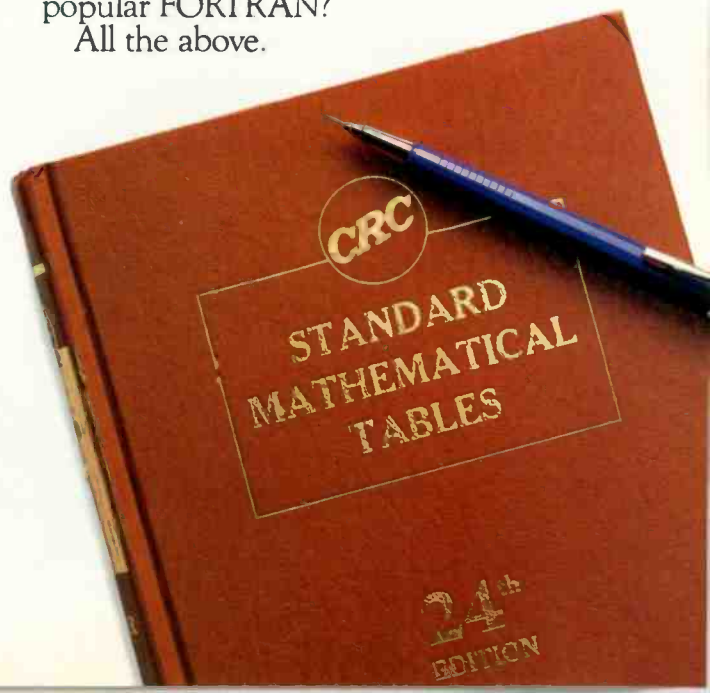

# COBOL

## The interactive edge.

```
1      close transaction-file.
2
3      *
4      * P110-read-and-process.
5      * read transaction-file into work-trans-rec
6      * at end move on-value to end-of-file-sw.
7      *
8      * if transaction-status = "00"
9      * perform p110-transact-read
10     * else if transaction-status > "10"
11     * move on-value to error-sw, end-of-file-sw.
12     *
13     *
14     *
15     *
16     *
17     *
18     *
19     *
20     *
21     *
22     *
23     *
24     *
25     *
26     *
27     *
28     *
29     *
30     *
31     *
32     *
33     *
34     *
35     *
36     *
37     *
38     *
39     *
40     *
41     *
42     *
43     *
44     *
45     *
46     *
47     *
48     *
49     *
50     *
51     *
52     *
53     *
54     *
55     *
56     *
57     *
58     *
59     *
60     *
61     *
62     *
63     *
64     *
65     *
66     *
67     *
68     *
69     *
70     *
71     *
72     *
73     *
74     *
75     *
76     *
77     *
78     *
79     *
80     *
81     *
82     *
83     *
84     *
85     *
86     *
87     *
88     *
89     *
90     *
91     *
92     *
93     *
94     *
95     *
96     *
97     *
98     *
99     *
100    *
```

```
TRANSACTION-STATUS (01) 00000000
WORK-TRANS-REC (10)
TOTAL-RECORD-COUNT (00000)
```

```
Breakpoint 1 Step Count 0 on Entry of P110-READ-AND-PROCESS
Breakpoint 2 Step Count 0 on line number 86
```

```
COMMAND: Breakpoint Display Find NO Help Options
          Quit Transfer User View Window
Breakpoint 1 Step Count 0 on Entry of P110-READ-AND-PROCESS
Current line: 81 Status: Breakpoint 1 ViewCob: latest
```

Microsoft COBOL gives programs a new look. With dazzling support for interactive programs, and more. Our new COBOL Compiler brings applications to life in several ways.

Our extended screen section lets you create programs that you'd never thought could be written in COBOL. Quickly, easily.

Performance is top notch as well. Our ISAM lets your applications blaze through files. After all, our ISAM is the fastest on the micro market.

Of course, Microsoft COBOL complies with the ANSI standard. Amazing performance, without runtime license fees. No wonder our COBOL is the choice of manufacturers like IBM, AT&T, DEC, HP and Wang.

### Another breakthrough: Microsoft COBOL Tools.

Only Microsoft makes debugging this easy.

Our COBOL Tools is the perfect companion to our COBOL Compiler. A complete set of utilities. Tools that make debugging and maintenance easier than you'd thought possible.

The star of the show is ViewCOB, our

advanced interactive debugger. ViewCOB lets you control and examine programs easily. Open windows on variables and procedures while watching the source code execute. ViewCOB is simply the most advanced COBOL debugger you can get.

Microsoft COBOL and COBOL Tools. An unbeatable team.

#### Microsoft COBOL Compiler Version 2.1 for MS-DOS and XENIX 286

##### Interactive extended screen section

- Cursor positioning, auto skip, and automatic data field formatting.
- ACCEPT or DISPLAY a screenful of data with a single statement.

##### Fast multi-key ISAM

- Split keys, alternate keys, duplicate keys.
- Benchmark results of 2500 reads, writes and rewrites to an ISAM file.

	Microsoft COBOL	Micro Focus native code	Ryand McFarland COBOL 2.0
Seconds	846	4073	1177

Source code compatible between MS-DOS and XENIX 286.

#### Microsoft COBOL Tools for MS-DOS and XENIX 286

- Cross reference utility speeds program development.
- Menu generator allows you to use Microsoft Word style menus in your program.
- Mouse interface allows you to create programs that use the mouse (MS-DOS only).

##### Advanced interactive debugger

- Use trace, single step, and execution history to follow the program flow.
- Observe the contents of variables and memory while the program is executing.
- Set breakpoints and change the contents of variables.
- Trap fatal runtime errors.
- Use the menu driven windowing user interface with on-line help.

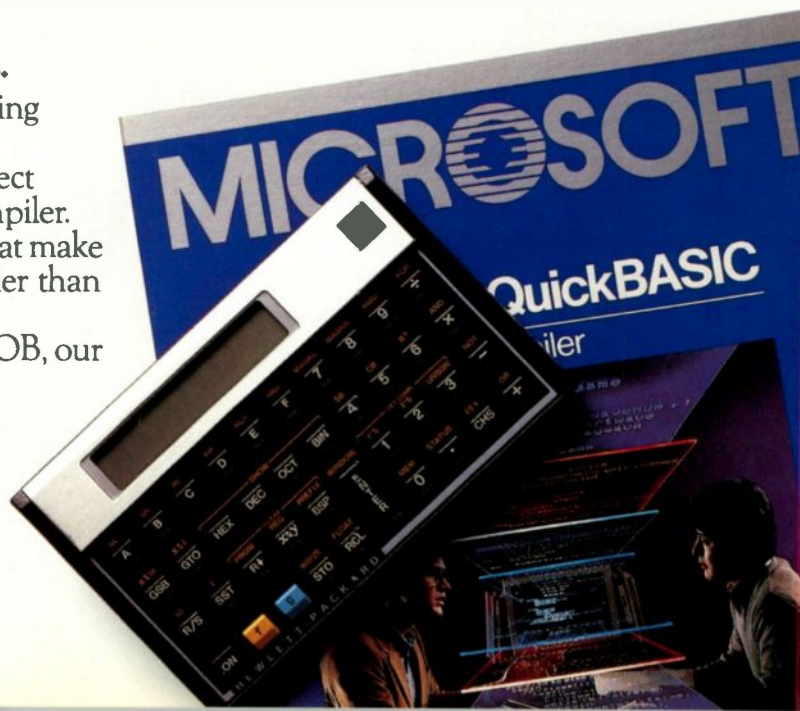



# Pascal

When you've outgrown the others.

Only Microsoft Pascal is powerful enough to push the outer limits of your PC. With more features than any other Pascal compiler.

Microsoft Pascal handles large programs with ease. No 64K boundaries — use multiple code and data segments up to a megabyte. Create your own libraries of pre-compiled Pascal modules. Separately-compiled modules can be overlaid or linked together into one file.

Our Pascal comes complete with the BCD and 8087 math libraries you'd expect. Including an IEEE floating point emulator. And Microsoft Pascal is completely compatible with IBM's Local Area Network and MS-DOS Networking. Added features without added costs.

Microsoft Pascal also supports direct interlanguage calling to modules written in Microsoft C, or Microsoft FORTRAN or assembly language. And it's compatible with our Macro Assembler's symbolic debugger. So you can track down those subtle logic errors with breakpoints instead of guesswork.

Microsoft Pascal. Nobody does it better.

## Microsoft Pascal Compiler Version 3.3 for MS-DOS and XENIX 286

### Microsoft Pascal Compiler

- Separate module compilation.
- Large program support; up to 1 megabyte code and multiple data segments.
- Overlay support.
- Contains four math libraries to choose from:
  - 8087/80287 coprocessor support.
  - Fast IEEE floating point.
  - 8087/80287 floating point emulation.
  - BCD decimal math.
- Link in your routines or third party software routines written in Microsoft FORTRAN (version 3.3 or higher), Microsoft C Compiler (version 3.0 or higher) or Microsoft Pascal (version 3.3 or higher), or Microsoft Macro Assembler.
- Source code compatible between MS-DOS and XENIX 286.
- Supports file sharing and record and file locking.
- Supports MS-DOS pathnames and input/output redirection.
- Do source level debugging with the Symbolic Debug Utility, available with the Microsoft Macro Assembler.

### Library Manager

- Create, organize and maintain object module libraries created with Microsoft languages.

### Object Code Linker

- Simple overlay linker combines relocatable object modules created using Microsoft languages into a single program.
- Link very large programs (over 1 megabyte) using overlays.

### Microsoft EXE File Compression and File Header Utility (MS-DOS only)

- Compress, modify and examine executable files and their headers.

# Microsoft QuickBASIC

BASIC just got faster.

Microsoft's new QuickBASIC Compiler gives your programs an extra burst of speed. Without sacrificing BASICA compatibility. Your compiled programs will run just like before, only faster. Three to ten times faster. With little or no modification.

QuickBASIC makes structured programming a snap. New extensions like alphanumeric labels make programming easier too. And separately compiled subprograms let you test and compile individual routines one at a time.

Microsoft QuickBASIC. All the features of a compiler, with BASICA compatibility to boot.

## Microsoft QuickBASIC Compiler Version 1.0 for IBM PC and Compatible Computers

### BASICA compatibility

- Sound statements including SOUND and PLAY.
- Graphics statements including WINDOW, VIEW, DRAW, GET, PUT, LINE, CIRCLE, LOCATE and SCREEN.

Results of the Sieve benchmark 

	BASICA	QuickBASIC
seconds per iteration	71	05

### Structured programming support

- Subprograms can be called by name and passed parameters. Both local and global variables are supported.
- Multi-line functions can be called by name and return a value.
- BASICA structures are supported including WHILE/WEND, IF/THEN/ELSE, FOR/NEXT, GOSUB/RETURN, and event handling.

### Alphanumeric labels

- Can be used to make your programs more readable. Line numbers are not required but are supported for BASICA compatibility.

### Modular programming support

- Separate compilation allows you to create compiled BASIC libraries to use and reuse in your programs.
- Named common gives you control of data flow between individual modules.

### Large program support

- Code can use up to available memory.
- Data can use up to 64K RAM.

# LISP

## The language of Artificial Intelligence.

What's Microsoft LISP got going for you? It runs significantly faster than the competition. And this new version adds several advanced libraries. Over 400 Common LISP functions, macros and special forms. Most implemented in machine code.

If you're putting AI on your PC, Microsoft LISP is your language.

# muMATH

## Mainframe math on your PC.

From solving equations to high precision calculations, muMATH is the ticket.

Microsoft muMATH handles tasks from algebra to calculus and vector analysis. Now your PC can do numeric analysis based on symbolic expressions. And give you exact answers.

If you crunch numbers—or equations—muMATH is just what the CPU ordered.

# Sort

## Versatility without compromise.

Microsoft Sort makes fast sorting easy.

A powerful, programmable interpreter lets you choose ASCII, EBCDIC or custom sequences. Sort handles files from any Microsoft language. Without limiting the size of your file, the number of search keys, or your record length.

Microsoft Sort. The speed and power you need. Easily.

## The leadership edge.

No other languages are backed by as massive a collection of third-party software. Here are just a few of the companies that speak our languages: **Blaise Computing, Graphic Software Systems, Greenleaf Software, Inc., IMSL, Media Cybernetics, Microrim, Numerical Analyst Group, Phoenix Software, Solution Systems, Spruce Technology, Trio Systems, and Virtual Microsystems.**

This is just a sample. For a complete list, call Microsoft at the number below.

## An added value for our readers.

We're proud of the way our family works together, so we're offering a \$25 rebate on our Macro Assembler when you purchase Microsoft C, Pascal or FORTRAN.\*

For more details, upgrade information or the name of your nearest Microsoft dealer, call toll free (800) 426-9400. In Washington State and Alaska, call (206) 828-8088. In Canada, (800) 387-6616.

Microsoft Corporation  
Bellevue, Washington USA

Microsoft GmbH  
München DEUTSCHLAND

Microsoft Canada Inc.  
Toronto CANADA

Microsoft AB  
Stockholm SWEDEN

Microsoft Pty  
Sydney NSW AUSTRALIA

Microsoft Ltd.  
Reading ENGLAND

Microsoft SARL  
Paris FRANCE

QUNIX Microsoft  
Seoul KOREA

Microsoft Far East  
Tokyo JAPAN

Microsoft SpA  
Milano ITALIA

\*Rebate offer valid only in the United States.

Microsoft, MS-DOS, and XENIX are registered trademarks and The High Performance Software is a trademark of Microsoft Corporation. Microsoft LISP and muMATH were developed by Soft Warehouse, Inc.



# Microsoft<sup>®</sup> Languages

The High Performance Software™

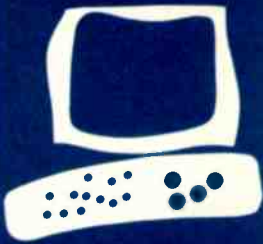

# Hardcard

A complete  
hard disk  
for your  
personal  
computer  
on a  
1-inch-thick  
card

BY EVA WHITE

Until recently, adding a hard disk to your computer system meant either losing one of your floppy-disk drives or cluttering up your desk with a clumsy external hard disk. One item that promises to alleviate this dilemma is an ingenious combination of a hard disk and controller on a card that plugs into one of the expansion slots on an IBM PC. Although it seemed that every week a new version of a hard disk on a card was announced, at the time of this review the only actual product BYTE had received was the Hardcard from Plus Development Corporation.

The Hardcard is a 10.56-megabyte hard disk on a single card that plugs into an IBM PC, IBM PC XT, Compaq Portable, Compaq Plus, or AT&T PC 6300 running under PC-/MS-DOS 2.0 or higher (see photo 1). It has an average power consumption of less than 10.5 watts, and you should be able to add it to your PC without upgrading its power supply. The Hardcard's average access time is 65 milliseconds; its data-transfer rate is enhanced by two 512-byte sector buffers. The heads automatically retract to a landing zone when the machine is powered down, so you don't have to remember to run any special program to do this when you move your computer. The Hardcard comes with the Hardcard Directory program for organizing all those megabytes, a 60-page manual, some additional on-disk documentation for using the Hardcard Directory, and a sticker to paste on the front of your computer to alert people to the fact that there is a hard disk in your machine. The manufacturer also provides a limited one-year warranty in the U.S.

Since the Hardcard is completely enclosed in your computer, it indicates disk access either by unobtrusively flashing a plus sign in the upper right corner of the screen, sending a "ticking" sound from the speaker, or both. Two .COM files are provided to toggle these options on and off—the default setting has the plus sign enabled and the sound disabled. The plus sign can-

not be displayed in graphics mode or by some display-adaptor boards. In these cases the sound still works. The Hardcard is so quiet that without these indicators you can hardly tell when the disk is accessed.

You can use the Hardcard as the second drive in a system with two hard disks. You set a two-position jumper on the card, depending on whether or not a hard disk is already present in your system. The manual warns that you should not use the Hardcard with another hard disk unless it is the manufacturer's installed drive that comes with the IBM PC XT or Compaq Plus. If the Hardcard is the first hard-disk drive, you boot from it by leaving the door to floppy-disk drive A unlatched during boot-up.

## HARDCARD DIRECTORY

Perhaps in an attempt to distinguish itself from the crowd, Plus Development Corp. has included the Hardcard Directory, which is a hard-disk organizing program that allows you to arrange up to 16 application programs in the form of a menu (see photo 2). The Hardcard Directory is great if you don't want to have to remember on what directory you have placed which application program or what sequence of commands is required to start your program. On-line directions explain how to customize the menu for your own applications. Once you have set up this menu, you run an application by choosing its number. Upon exiting the application, you are returned to the menu. Additionally, while you are in the Hardcard Directory it maintains the time and date at the top of the screen, and it blanks the display if the keyboard remains idle for more than 5 minutes.

You can execute DOS commands from within the menu by pressing the F4 key. This takes you to a screen where you can enter up to 12 lines of 63 characters. Some editing functions are provided on this screen, so you can correct any typographi-

(continued)

Eva White is a BYTE technical editor. She can be contacted at POB 372, Hancock, NH 03449.

## REVIEW: HARDCARD

cal errors prior to executing the commands. An Escape-Return sequence sends the commands to the operating system for processing, while an Escape-Escape sequence aborts this DOS-command entry screen and returns you to Hardcard's main menu.

You can run into trouble with this feature if you're not careful about typing errors. Specifically, if you pass a series of commands to the operating system and one command somewhere in the middle of the series fails to execute because of a typo, the remaining commands are still executed with potentially costly results. Furthermore, Hardcard's menu keeps no memory of the command sequence you just tried to execute, so if you want to retry a corrected version of

the sequence, you have to type everything over again.

There are at least two annoying side effects of using the Hardcard Directory. First, the subdirectories created by the program to hold your applications are named SUB1 through SUB16—identifiers that you don't have to remember until you need to issue a DOS command that explicitly requires a subdirectory name. For example, if you want to copy a file from a floppy disk into your word-processing subdirectory, you have to either recall which SUB*n* you've assigned to word processing or spend some time searching around on the hard disk. Second, if you want to enter DOS from an application program that you

(continued)



Photo 1: The Hardcard.

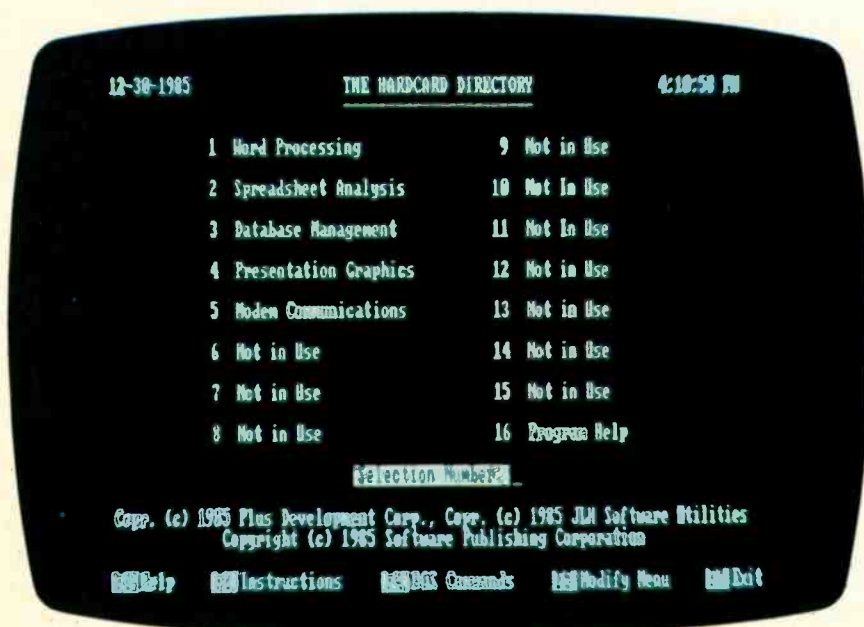

Photo 2: The main menu of the Hardcard Directory.

## Advanced Authorized Dealers

(Eastern U.S.)

**Aardwolf Microsystems**  
217 East 85th, Suite 102  
New York, NY 10028  
212/538-7840

**Advanced Information Systems, Inc.**  
1336 Edna S.E.  
Grand Rapids, MI 49507  
616/243-1312

**Corporate Micros, Inc.**  
333 West 52nd St., Suite 1204  
New York, NY 10019  
212/315-2853

**Crest Systems, Inc.**  
2101 Magnolia Ave., Suite 208  
Birmingham, AL 35205  
205/328-4882

**Fast Forward, Inc.**  
129 Adams Street  
Louisville, KY 40206  
502/589-0301

**ICS Software**  
P.O.C. 359015  
Brooklyn, NY 11235  
718/743-4050

**INACOMP Computer Centers**  
700 Remington Road  
Schaumburg, IL 60195  
312/519-1900

**Micro City Computers**  
110 West 31st Street  
New York, NY 10001  
212/563-6110

**Mitech Corporation**  
#1 Perimeter Park South, Suite 335-S  
Birmingham, AL 35243  
205/967-0605

**Modular Management Systems, Inc.**  
451 Bloomfield Ave.  
Caldwell, NJ 07006  
201/228-3838

**National AI Lab, Inc.**  
1800 Century Blvd., Suite 770  
Atlanta, GA 30345  
404/633-3900

**Network Data Systems, Inc.**  
3419 Pierson Place  
Flushing, MI 48433  
313/732-6340

**PRISM Computer & Consulting Services, Inc.**  
2100 Riverchase Center, Suite 420  
Birmingham, AL 35244  
205/988-5111

**Southeastern Systems, Inc.**  
619 East Price Ave., Suite #12  
Gastonia, NC 28054  
704/866-8048

**TRIMARC Systems, Inc.**  
11716 Parklawn Drive  
Rockville, MD 20852  
301/231-4991

**Upen Computer Systems**  
4701 N.W. 72nd Avenue  
Miami, FL 33166  
305/594-2980



**THE  
SOFTWARE  
LINK, INC.**

0386E

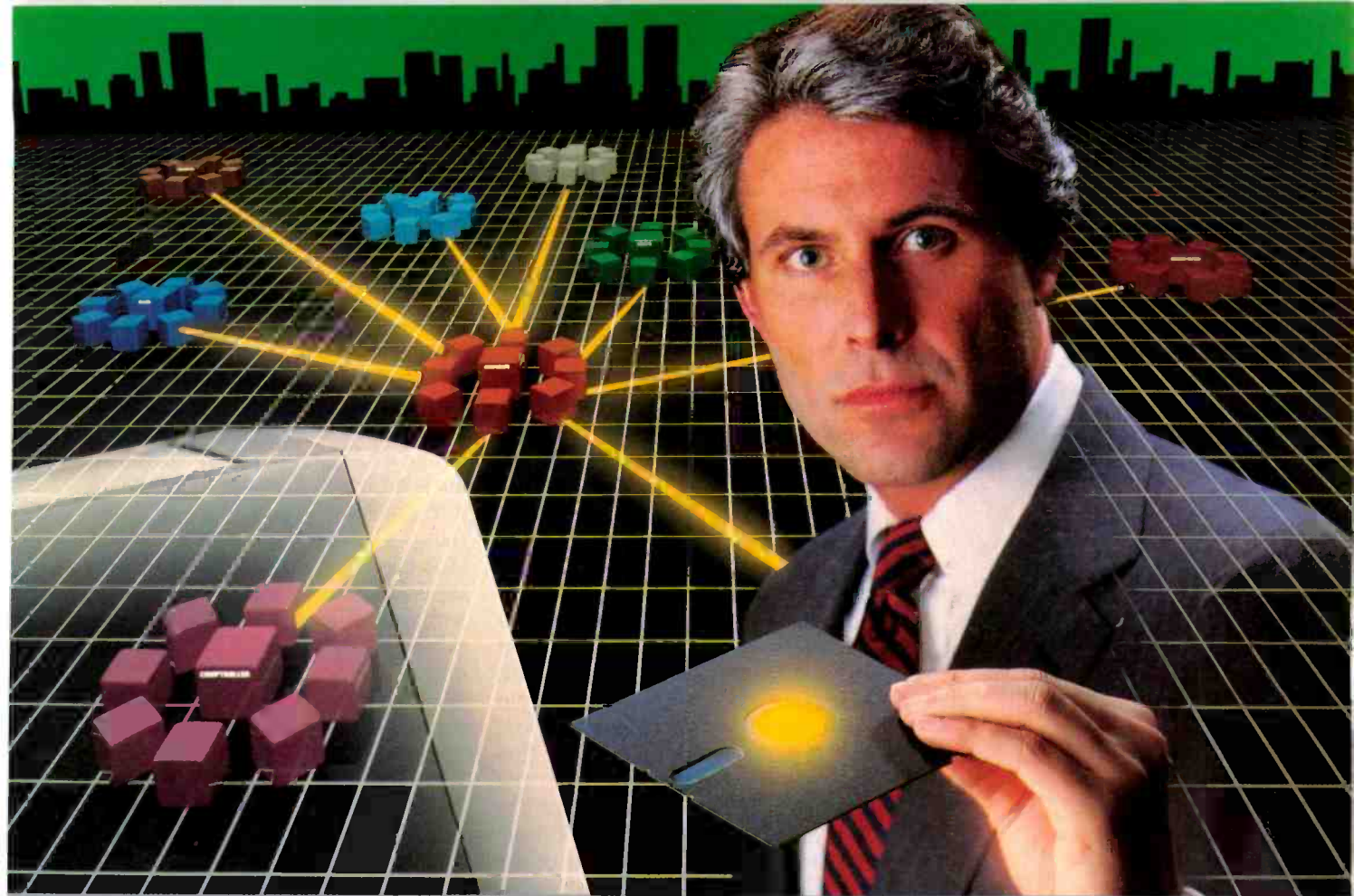

## The Most Powerful LAN Fits on a Disk.

Network Power. You knew that someday there would be a powerful LAN that didn't need old-technology network boards. It would be fast, easy to install, and run 99% of PC-DOS software. It would be expandable, provide remote access, password-protection, and enable you to use inexpensive terminals as workstations in a PC-DOS environment.

Dream no more, because the power is here. Its name is LANLink™

**A Software-Driven LAN Powerful Enough To Use RS-232 Ports for Network Communications.** In development for over three years, LANLink™ represents the next generation of local area networks. All of the logic which has traditionally resided on network boards is on LANLink's Satellite and Server Diskettes.

No additional hardware is required. Inexpensive serial ports replace "Kilobuck" Network Interface Boards making installation costs one-third that of a board-driven network.

**How To Configure a Smart Network... With Dumb Terminals, But Without Dedicated Servers.** Boasting a wide variety of configurations, LANLink™ is most often set up as a "Star" having up to eight satellites connected to a central, nondedicated server. Larger networks can have multiple servers, supporting a total of 73 or more network users.

**R-LAN™ (Remote-LAN)** gives users the ability to interact with a LANLink™ network in real time via modem. Plus, if MultiLink Advanced™ is run on a Satellite, inexpensive dumb terminals can be used to access network disks, files, and programs.

**THE SOFTWARE LINK, INC./CANADA** 400 Esna Park Drive, Suite 18 Toronto (Markham), Ont. /L3R 3K2 CALL: 416/477-5480

LANLink™ MultiLink Advanced™ & R-LAN™ are trademarks of The Software Link, Inc.

IBM, PC, & PC-DOS are trademarks of IBM Corp. WordStar 2000, dBASE III, and Lotus 1-2-3 are trademarks of MicroPro, Ashton-Tate, and Lotus Development Corp., respectively.

**99% of PC-DOS Applications Run In a Totally-Transparent Network Environment.** If you know DOS, you already know how to use LANLink™ COPY transfers files among users, and a 2-drive PC Satellite boots 1-2-3 from the Server's hard disk with the entry c:\otus. Each satellite's access can be limited to specific disks, printers, and sub-directories. A wide variety of software including Lotus 1-2-3, dBASE III, and WordStar 2000 is fully compatible. LANLink™ has a collision-free data transfer rate which exceeds 115,000 BPS.

**Power Up Your PCs Today.** For complete details and the authorized dealer nearest you, call The Software Link TODAY. The LANLink™ Starter Kit is \$495 and includes modules for both a Server and a Satellite. For a limited time, 50 feet of shielded RS-232 cable will be included free of charge. Additional Satellite Modules are only \$195, each.

LANLink™ is immediately available and comes with a money-back guarantee. VISA, MC, AMEX accepted.

**LANLink™**

**THE SOFTWARE LINK, INC.**  
Developers of LANLink™ and MultiLink Advanced™

8601 Dunwoody Place, Suite 632, Atlanta, GA 30338 Telex 4996147 SWLINK  
CALL: 404/998-0700  
Dealer Inquiries Invited Inquiry 330

**AT A GLANCE**

**Name**

Hardcard

**Type**

10.56-megabyte hard disk on a controller card that plugs into one of the expansion slots of an IBM PC, IBM PC XT, Compaq Portable, Compaq Plus, or AT&T PC 6300

**Company**

Plus Development Corporation  
1778 McCarthy Boulevard  
Milpitas, CA 95035-9990  
(408) 946-3700

**Size**

1 by 4.2 by 13.4 inches  
(25.4 by 106 by 341 millimeters)  
2.1 pounds (950gm)

**Software**

Installation, Reinstallation, and Hardcard Directory programs

**Price**

\$895

have entered via Hardcard's menu, you have to exit your application program and wait for Hardcard's menu to load, then either exit to DOS completely via the F7 function key or execute DOS commands from the menu.

**INSTALLATION**

The manual's explanation of how to plug the Hardcard into the machine is detailed enough so that even a novice should feel comfortable doing the installation. The disk comes preformatted with an installation program and all the programs you need

for the Hardcard Directory. The installation program runs FDisk and Format utilities automatically, creates the subdirectories that the Hardcard Directory will use, prompts you for an operating-system disk with all the DOS utilities, copies these into the root directory, and then prompts you for a blank disk, so it can make a reinstallation disk in case you ever need to set up the hard disk again.

The final step in installation is to load your application programs onto the hard disk. There is some on-disk documentation to help you with this, but it basically consists of loading the application programs into one of the 16 subdirectories, choosing the Modify menu option to place into the menu the name of the application, and entering the sequence of Run commands required to start the application. If you have a batch file that you use to start the application, you should enter the contents of the batch file into the Run commands—executing a batch file as one of the Run commands will prevent control from being passed back to the Hardcard menu when you exit the application.

In many respects, the Hardcard is a hard disk like any other. There appears to be no reason that you couldn't use the hard disk without the Hardcard Directory, creating your own subdirectory structure with more appropriate directory names. The manual cautions against using the Format routine from the IBM Advanced Diagnostics Disk, because this would overwrite bad-track flags and alter the Hardcard's interleave factor, leading

to, at best, degraded performance and, at worst, a completely unusable hard disk.

Since the manual is geared toward the novice user, it becomes fairly mysterious in places. In a section called technical tips, the manual states that you should not move the Hardcard between computers of different manufacturers; for example, if you've installed it in a Compaq, don't move it to an IBM PC. I think this is something an owner might want to do and Plus Development Corp. could have included instructions on how to do it without harming your machine. Apparently, you can wreak havoc on one computer if you install and attempt to boot from a Hardcard that has been formatted from an incompatible computer.

The manual has a section on installation and an extensive section on using the Backup and Restore commands of DOS. There is a third section on error messages complete with a BASIC program to help you determine if your IBM PC or Compaq PC ROMs are too old to recognize a hard disk (prior to October 27, 1982).

**BENCHMARKS**

While I would have liked to compare the Hardcard with other plug-in hard disks, at the time of this writing no other company had sent one. So I will compare the Hardcard to the hard disks reviewed in "Four Hard Disks for Under \$1000" by Richard Grehan (BYTE's *Inside the IBM PCs*, Fall 1985, page 203). I ran the benchmarks under PC-DOS 2.0 on an IBM PC. See table 1 for the benchmark results.

**CONCLUSION**

My overall impression of the Hardcard is that it is a highly reliable hard disk. The Hardcard Directory is useful for someone setting up a kind of turn-key system perhaps for a machine that is to be used by more than one person. Most experienced users will probably prefer to set the hard disk up with mnemonic subdirectories. With or without the Hardcard Directory, the Hardcard is a great way to add hard-disk speed and storage to your computer with a minimum of trouble. ■

Table 1: BYTE's comparison of the Hardcard and four other hard disks that appeared in BYTE's *Inside the IBM PCs*, Fall 1985. Times were measured using the BYTE benchmarks.

	Slider	Rodime	Syquest	Kammerman Labs	Hardcard
Megabytes	10	10	30	10	10
Write (seconds)	40.0	41.0	41.0	27.0	39.5
Read (seconds)	29.0	29.0	29.0	27.0	28.7
Copy (seconds)	2.5	4.7	4.7	2.0	1.3

# How can one small board do so much?

**\$299**

The ATI GRAPHICS SOLUTION uses revolutionary CMOS VLSI Gate Array Technology to achieve extensive multi-display ability with fewer components, longer life, lower power consumption and lower price.

The "SMALL WONDER" GRAPHICS SOLUTION, amazingly, has all the features below on one small board that fits in the IBM PC/XT short slot! What's more, Parallel and Serial/Parallel expansion modules are available as options.

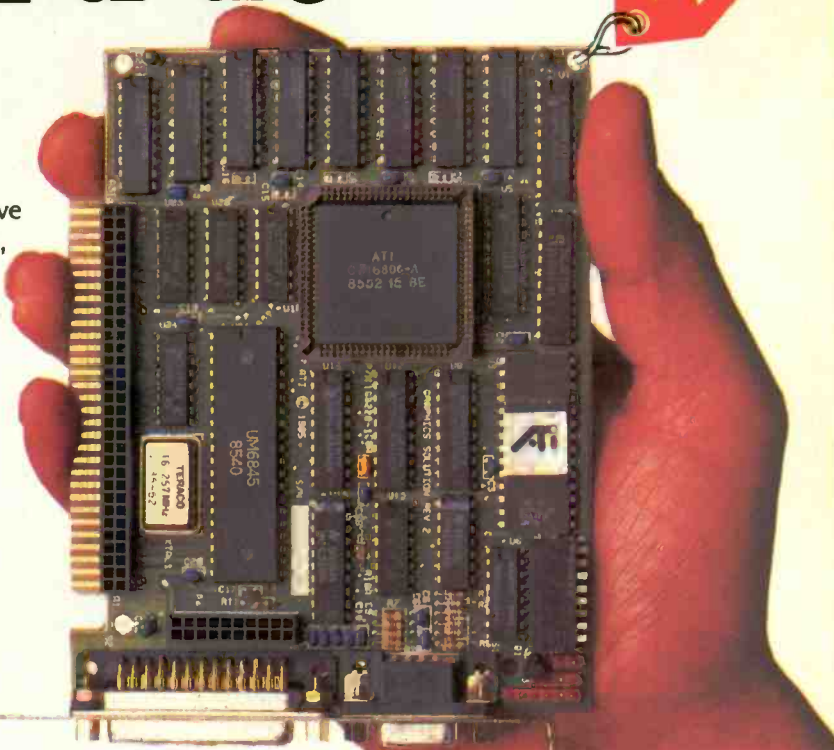

GRAFIX PARTNER — 16 COLORS



16 COLORS HIGH RESOLUTION



COLOR SOFTWARE ON MONOCHROME MONITOR IN 16 SHADES

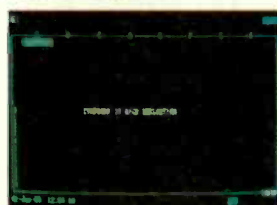

SYMPHONY HIGH RESOLUTION

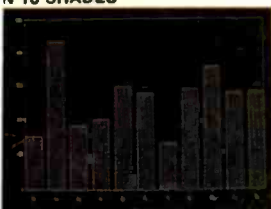

HERCULES COMPATIBLE MONOCHROME GRAPHICS



132 COLUMNS

ATI Graphics Solution	ATI Graphics Solution	Paradise Modular Graphics	Hercules Graphics	Plantronics Color Plus
CMOS VLSI Gate Array Technology	✓		✓	
IBM Compatible Monochrome Text	✓		✓	
Hercules Compatible Monochrome Graphics	✓		✓	
Runs Color/Graphics Software on Monochrome Monitor in 16 shades Without Pre-Boot Drivers	✓	✓		
IBM Compatible Color/Graphics	✓	✓		✓
High Resolution 320x200 16 colors 640x200 4 colors 640x200 16 colors	✓ ✓ ✓			✓ ✓ ✓
132 Columns in either Color or Monochrome	✓			
Plicker-Free Scrolling in All Modes	✓	✓	✓	
Parallel Port	Opt *	Opt	✓	✓
Serial Port	Opt *	Opt		
Fits in Short Slot of IBM PC/XT	✓			
Warranty	2 yrs	1 yr.	2 yrs	1 yr.
Suggested Retail Price	\$ 299	\$ 395	\$ 499	\$ 559

- Distributors:**  
**F.A. Components —**  
 NY (718) 507-1444, outside NY (800) 847-4148  
 IN (219) 432-8540, outside IN (800) 331-7567  
 SC (803) 288-2422, outside SC (800) 845-2747  
**Osemann Computer Tech.—**  
 IL (800) 942-5215, outside IL (800) 323-2239  
 OH (800) 824-9627, outside OH (800) 824-5934  
 NJ (800) 221-2514, outside NJ (800) 624-4010  
 NY (800) 628-4466 outside NY (800) 537-5378  
**SAI America —** MD (301) 459-2100, outside MD (800) 638-9579  
**First Source —** AZ (602) 437-9744  
**R.C. Data —** CA (408) 946-3800  
**Compu-D —** TX (800) 772-5340, outside TX (800) 433-5354  
**Compuserve —** CAN. (416) 477-8088  
**Wells Data —** ONT (416) 890-2600  
**Santronics —** BC (604) 522-9877  
**Electronic Marketing Specialists**  
 S.CA (714) 832-9920, (818) 708-2055, (619) 560-5133  
 N.CA (408) 245-9291, UT (801) 268-9866  
 CO (303) 745-0745, AZ (602) 840-8855

\* Serial/Parallel Expansion Module \$79 Parallel Expansion Module \$49

## Small Wonder From

450 Esna Park Dr.  
 Markham, Ontario, Canada L3R 1H5  
 TELEX 06-966640 (CMC — MKHM)  
 (416) 477-8804 FAX (416) 477-9445



Trademarks: Paradise, Modular Graphics Card — Paradise Systems Inc.; Hercules Graphics — Hercules Computer Technology; GraFix Partner — Brightbill - Roberts; Symphony — Lotus Development Corporation; IBM — International Business Machines; Plantronics, Colorplus — Plantronics Enhanced Graphics Corp

Competitive Information based on manufacturer's published information as of January 1, 1986.

Specifications subject to change without notice.

Inquiry 425 for End-Users. Inquiry 426 for DEALERS ONLY.

LOMAS DATA PRESENTS:

# SINGLE & MULTIUSER CAD SYSTEMS

The LDP-CAD workstation may support up to 16 individual users all running AUTOCAD™. Each user has his own graphics processor for maximum drawing speed and system response. With the LDP-CAD multiuser system each user experiences 4 times the performance of an IBM-PC. A high performance central system supports each of the remote stations with mass storage of up to 144 Megabytes. Each Remote Graphics Processor (RGP) supports a high resolution display of 1024 by 800 pixels with 8 colors and a 80x24 command screen. The main system processor also supports the same functions as each of the RGP's while also supporting additional features such as dual IBM-PC compatible 5 1/4" disk drives, 10 to 110 Megabyte Winchester disk

drives, cartridge tape backup and up to 1 Megabyte of main memory. *If you require a single user system now, with expansion capabilities for the future, LDP-CAD is the only sensible solution.*

### PRICING:

**LDP-CAD Single/Multiuser Systems with the following features:** 8 Mhz 8086/8087, 512K memory, IBM-PC compatible keyboard and display, 2 Mbyte solid state disks, 10 Mbyte Winchester, high resolution 19 in. graphics display, 11 x 11 digitizer, and AUTOCAD ..... \$14,995.00  
**RGP (REMOTE GRAPHICS PROCESSOR)** 1024 x 800 graphics display and controller, remote command console ..... \$9,495.00

## IBM COMPATIBLE S100 BUS COLOR GRAPHICS

LOMAS DATA PRODUCTS presents COLOR MAGIC, the most complete compatibility solution for S100 bus computer products. COLOR MAGIC includes three major hardware sub-functions which allow it to emulate the IBM-PC: An entirely compatible video function, an IBM-PC keyboard interface and an IBM-PC compatible timer interface including IBM-PC sound compatibility. HOW COMPATIBLE IS IT? Currently we are running MICROSOFT's FLIGHT SIMULATOR recognized as one of the severest tests of compatibility. We can also directly boot PC-DOS for the IBM-PC with no alterations. Other programs which have been tested and function without problems are: LOTUS 1-2-3, DBASE III, WORDSTAR and VOLKSWRITER. **COLOR MAGIC (16K byte version) .. \$595.00**

■ **THUNDER 186** single board computer provides a high performance 16 bit computer all on one board. It is an ideal companion to the COLOR MAGIC to provide a low cost, high performance IBM-PC compatible system. The 8Mhz 80186 offers 10Mhz 8086 performance. THUNDER 186 provides all the components necessary to form a complete system including: 256K bytes of no wait-state RAM, 2 serial ports, a parallel printer port, high performance floppy disk controller controls both 5 1/4" and 8" drives simultaneously, full IEEE 696 (S100) bus for system expansion. The COLOR MAGIC

and THUNDER 186 combine to provide performance you won't find in other compatibles. The price includes the powerful Concurrent DOS operating system. **THUNDER 186 .... \$1195.00**

■ **NV-DISK** is a solid state memory with software to emulate a disk drive under MS-DOS, Concurrent DOS, and CP/M-86. NV-DISK is entirely COMPUPRO software compatible allowing COMPUPRO users to take advantage of the lower cost and battery protection support offered by NV-DISK. It offers the advantage of high speed access and no moving parts. It can be battery protected to allow data to stay even while powered down. The board is available in either 512K or 2 Megabyte configurations and multiple boards may be used to create disk drives with up to 16 Megabytes of storage.

**NV-DISK 512K, \$595.00 2 MBYTE, \$995.00**

■ **MEGARAM** is a high density, high performance dynamic RAM board with up to two Megabytes of storage. Megaram offers no wait state performance in 8086 systems with up to 10 Mhz processors at a fraction of the cost of comparable performance static RAM.

**MEGARAM ..... 1/4 MBYTE, \$475.00  
1/2 MBYTE, \$595.00 ..... 1 MBYTE, \$795.00  
2 MBYTE, \$1095.00**

## IBM-PC COMPATIBLE S100-BUS SYSTEM

LOMAS DATA PRODUCTS offers IBM-PC compatible systems with performance far ex-

ceeding that available from IBM. You can purchase systems offering performance of an eight Mhz 8086 or up to the performance of an 8Mhz 80286. Each system is capable of supporting 8Mhz math coprocessors. Our 8Mhz 80286 system offers IBM-PC compatibility while offering up to 2 times the performance of the IBM-PC-AT. For applications where PC compatibility is desirable but higher performance is a benefit or requirement LDP offers the only viable solution.

## WHO IS LOMAS DATA PRODUCTS ...

LOMAS DATA PRODUCTS has been shipping 16 bit microprocessor S100 bus products for five years. We have earned a strong reputation for reliability and performance over these five years. We were running MS-DOS (SCP-DOS/PC-DOS) before IBM knew the operating system existed. We offer a wide range of 16 bit operating systems including MS-DOS, CP/M-86, CONCURRENT CP/M-86 and CONCURRENT DOS. All our products are backed by a one year guarantee. We offer no 8 bit products and concentrate entirely on high performance 16 bit systems. *If you are looking for the highest performance possible on the S100 bus, you can be sure LOMAS DATA PRODUCTS offers it.*

*The S100 Bus Experts.*

# LDP

Dealer inquiries invited.

## LOMAS DATA PRODUCTS, INC.

MS-DOS, trademark of Microsoft  
PC-DOS, trademark of IBM  
Concurrent CP/M-86, concurrent DOS, trademark of Digital Research

182 CEDAR HILL STREET, MARLBORO, MASSACHUSETTS 01752 □ TELEPHONE: (617) 460-0333 □ TELEX: 4996272



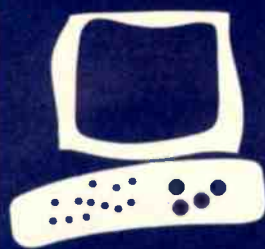

## H·A·R·D·W·A·R·E R·E·V·I·E·W

# The B&C Microsystems 1409 EPROM Programmer

### A versatile tool for the computerist

BY ROBERT JACOBS

**Y**ou can accomplish some kinds of computer work more easily by designing or modifying firmware rather than hardware. In order to do this, I needed an EPROM programmer with the broadest applicability at the least cost.

First I had to decide whether to get a stand-alone unit or one that utilizes a slot in the computer. Despite greater cost, I opted for the former because I could then use the unit with computers other than my Corona PC. The second decision I had to make was whether to build or buy the unit. Steve Ciarcia presented an excellent and attractive design in the February 1985 issue of BYTE ("Build a Serial EPROM Programmer," page 104). With reasonable luck in obtaining parts, the total cost for this design would probably have been between \$80 and \$100. I reluctantly abandoned that option because of my unfamiliarity with the wire-wrap construction technique.

The most attractive alternative I found was the 1409 EPROM Programmer available from B&C Microsystems of San Jose, CA. This unit is available in kit form with either a printed circuit board (PCB), transformer, and firmware only, or with a full set of parts. It is also available as a finished and ready-to-use product (see photos 1 and 2).

I opted to purchase it in kit form with all the parts, although perhaps \$30 can be saved by ordering the smaller kit. I decided that ordering the remaining parts separately offered too many chances of delay in getting started.

Through an ordering error, I received the fully assembled unit shown in photo 1, rather than the kit, so I still haven't actually built an EPROM programmer. I examined the finished unit and think that construction would have been simple. Parts have to be inserted and soldered into a very well marked 5½-by 10-inch PCB. (I noted that one of the regulators was equipped with a heatsink).

Although step-by-step instructions are not provided, I think the job is easy and safe

for anyone who can solder components into a PCB. (You must take care that you insert the parts in the correct locations and observe the polarities of diodes and electrolytic capacitors.)

#### INTERFACE

The 1409 EPROM Programmer connects to one of the computer's RS-232C ports. It is configured as "data terminal equipment," which means that a null-modem cable will be required for connection to most microcomputers. This is an industry-standard cable that may be purchased or built. (There is a good diagram of the connections required in the 1409's instruction booklet).

The EPROM programmer controls the RTS (ready to send) and DTR (data terminal ready) lines to indicate when an overflow condition is imminent. The host computer can monitor these signal lines to control transmission flow or can watch for the XOFF and XON signals for the same purpose. The host computer can also control the output of the programmer with the CTS (clear to send) line. As long as this signal line is held in a high state, the 1409 will continue to output data.

Fortunately, most of these signals are handled automatically in readily available software. I have been able to run the programmer with PC-Talk and Crosstalk, as well as the driver program supplied by B&C Microsystems. I suspect that you can use any terminal software that is capable of transmitting ASCII files with a 300-millisecond delay between lines of text. The programs I mentioned above worked perfectly, with no protocol or compatibility problems.

#### USING THE 1409

The 1409 is set up for 8-bit words, 1 stop bit, and no parity. After reset, it automatically adjusts itself to any standard speed between 300 and 9600 bits per second. The B&C Microsystems EPROM programmer is

(continued)

Robert Jacobs has a B.A. from City College of New York and M.A. and Ph.D. degrees from Columbia University. He teaches political science at Central Washington University. He can be contacted at the Department of Political Science, Central Washington University, Ellensburg, WA 98926.

**AT A GLANCE**

**Name**  
Model 1409 EPROM Programmer

**Company**  
B&C Microsystems  
6322 Mojave Dr.  
San Jose, CA 95120  
(408) 997-7685

**Features**  
Requires no personality modules; on-board 110/220-volt power supply; RS-232C interface; manually programmable with line editing; split high/low byte addressing for 16-bit bus; byte, block, or chip erase; up/download in Intel or Motorola format

**Documentation**  
25-page technical manual containing hardware and interface instructions, schematic diagrams, parts list, and diagnostic charts

**Prices**

Kit with full set of parts	\$250
Assembled and tested unit	\$400
1409C with cabinet and all options	\$800
Source code; PC-DOS disk	\$75
Software drivers; most PCs	\$35

capable of reading, verifying, and programming all of the most common EPROMs and EEPROMs (see table 1).

No additional personality modules or sockets are needed, although the unit I purchased requires additional parts and version 5.0 firmware from B&C Microsystems in order to program 40-pin chips like the 8748 and 8749. Only a few additional parts are necessary and the firmware upgrade costs \$25. (Current production models

of the 1409 already contain the proper firmware.)

EEPROMs can also be erased, which is a great advantage for the experimenter who does not have an ultraviolet eraser for the ordinary EPROMs.

The 1409 EPROM Programmer offers a number of amenities to the user. There is a help screen that lists all the programming commands.

*(continued)*

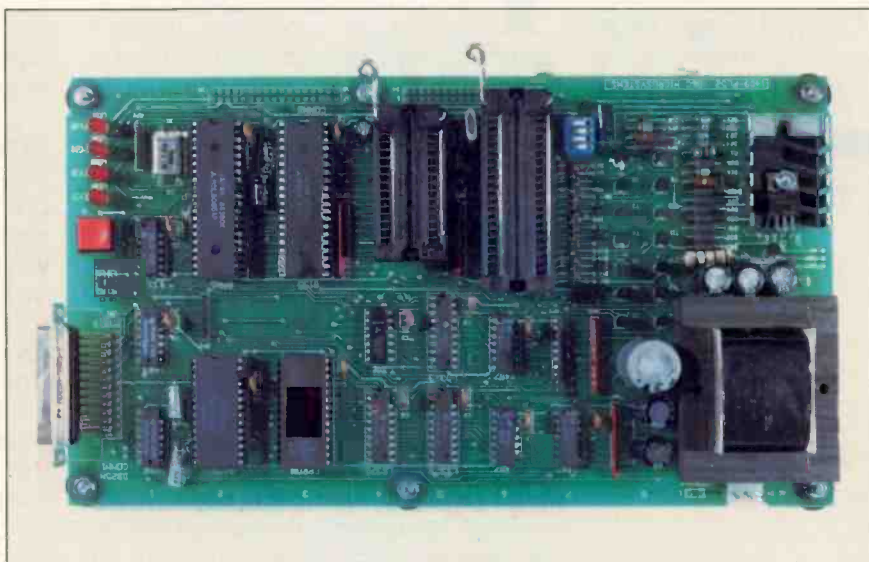

Photo 1: Assembled and tested (bare-board version) 1409-13A EPROM Programmer.



Photo 2: B&C Microsystems' enclosed model 1409C-33 EPROM Programmer.

# There's a Familiar Face Behind the New Name



**NANAO MONITORS.** The name is new to the American market. That's because for the first time in history, a huge new line of computer monitors is available to the U.S.—factory direct. 26 different models offered in three series, bringing you a range of features broader than any other. Color resolution from 480 dots x 200 lines up to 720 dots x 480 lines. And *Fh scanning* from 15.75 to 24.75 KHz. But the truth is that Nanao has been around for a long time. For over a decade we've supplied OEM's worldwide, designing and manufacturing monitors recognized for their outstanding performance and reliability. Now that same quality, selection and value is yours—right from the source. Nanao. The old standby with a new name.

## NANAO

**NANAO CORPORATION**  
153 Shimokashiwano-Cho  
Matto-City, Ishikawa, Japan

**NANAO USA CORPORATION**  
373 G. Vintage Park Drive  
Foster City, California 94404  
Phone (415) 341-7055

Distributor Inquiries Welcomed

# NANAO

We Treat Dealers Right!  
We're **CC&C**.



- IBM XT™ Compatible
- Full 640K On Board
- Dual 360K Disk Drives
- Color or Monochrome Card
- Parallel Printer Port
- FCC Approved

**Motherboard:** \_\_\_\_\_

XT compat. — 640K RAM, 8087 Socket

**Disk Controllers:** \_\_\_\_\_

360K Floppy Disk Drive (XT) Controller  
1.2 MB Floppy Disk Drive (AT) Controller  
Special High Speed Hard Disk Controller

**Display Cards:** \_\_\_\_\_

Color / Graphics Card — 640 x 200  
Monochrome Card with Printer Port  
LETTERTEX™ — Super High-Res Text,  
Hercules™ Compatible Graphics

**Multifunction Cards:** \_\_\_\_\_

7-Plus™ — FDC, Parallel, 2 Serial, Game,  
Clock, RAMdisk Plus™, Spool Plus™  
8-Plus™ — Par, Ser, Game + 384K RAM  
AT Multi. — Par, Ser, Up To 3 Megabytes

**Cases:** \_\_\_\_\_

XT Style Case — All Metal, Fully Shielded  
Turbo Case — Stylish Design, XT Compat.  
AT Style Case — Attractive, Rugged

**Keyboards:** \_\_\_\_\_

XT Keyboard — XT Layout, LEDs  
XT Keyboard — Crsr & Num Pads, LEDs  
AT Keyboard — Oversized Return and Shift  
Keys, LED indicators

**Power Supplies:** \_\_\_\_\_

XT Compatible 135 Watt — UL Approved  
XT Compatible 200 Watt  
AT Compatible 200 Watt

**IC's:** \_\_\_\_\_

640K RAM Set (36 chips)  
8087 Math Co-Processor

**Disk Drives:** \_\_\_\_\_

360K Floppy Drive — XT Compatible  
1.2 MB Floppy Drive — AT Compatible  
20 MB Hard Disk Drive

**Monitors:** \_\_\_\_\_

TTL (IBM Compatible) Monochrome

**CC&C**

Toll Free Order Hotline:  
(800) 423-3877

Information: (213) 265-0835

COD, cashiers check, money order or certified check.  
• IBM, XT and AT are trademarks of IBM Corp.

**REVIEW: EPROM PROGRAMMER**

Table 1: A selection menu of chips that can be programmed using the 1409 EPROM programmer.

a = 2758	k = 2508	u = 52B13
b = 27(C)16	l = 2516	v = 52B23
c = 27(C)32	m = 2532	w = 52B33
d = 2732A	n = 2564	x = 48Z02
e = 27(C)64	o = 68732	1 = SPARE
f = 2764A	p = 68764(6)	2 = SPARE
g = 27(C)128	q = 27513	3 = 8748H
h = 27128A	r = 2816A	4 = 8749H
i = 27(C)256	s = 2864A	5 = 8748
j = 27(C)512	t = 28256*	6 = 8749

Chips can be read or written to in a number of ways. The 1409 supports the Intel and Motorola hexadecimal formats, or it can handle a straight ASCII list of bytes. Part or all of a chip may be programmed or read.

Manual programming is also possible either a byte at a time or in lines of up to 128 characters. A programmed chip can be verified against a file in any of the formats mentioned, and chip erasure can be tested as well. The 1409 is also capable of low-byte/high-byte programming for chips that will be used on a 16-bit bus. This is quite a sophisticated capability and is not available in some much more expensive commercial programmers.

The firmware of the 1409 also incorporates a built-in monitor that allows the user to debug the programmer itself by examining the state of its internal I/O drivers, ports, and RAM. This data is stored in an Intel 8155 chip that includes 2K bytes of static RAM, three I/O ports, and a timer. The microprocessor used in this powerful design is the Intel 8085.

**DOCUMENTATION**

B&C Microsystems provides a 25-page technical manual with their EPROM programmer. The manual contains hardware and interface instructions, a few construction hints for those who purchase the unit in kit form, clear directions for each command to which the 1409 responds, and several technical appendixes that include schematic diagrams, parts lists, and diagnostic charts for the hardware. To understand and use the latter requires a voltmeter and oscilloscope or frequency counter. It's better to build it right the first time.

For an additional \$35, driver software can be purchased from the manufacturer. Drivers are available for the IBM Personal Computer and compatibles, any CP/M system, and the Apple IIe and IIc. The 1409 can also be driven by a Commodore 64 with VIP terminal software. In the IBM PC version, source code in C and assembly language accompanies the driver program itself.

**CONCLUSION**

The 1409 EPROM Programmer appears to be well made. It consists of a PCB on which all components are mounted (see photo 1). The power cord is attached directly to the PCB, which stands on six small rubber feet. The factory-assembled unit is also available packaged in a metal cabinet. This packaged unit is designated model 1409C (see photo 2).

The RS-232C port interface uses a right-angle male DB-25 connector. There is also space on the board for the installation of two 32-pin headers to be used for future expansion.

The more important chips are socketed, and the EPROMs themselves fit into a zero-insertion-force socket. Four small light-emitting diodes serve to indicate whether the power is on or off and the status of the Transmit, Receive, and Program functions. A reset button accomplishes what is in effect a "warm boot" of the unit.

B&C Microsystems offers accessory boards that permit chips to be copied directly from one to another without connecting the 1409 programmer to a computer at all.

On the whole, this unit appears to be a well-designed and well-built addition to the computerist's toolbox. ■

# How can you get ten tape back-up units and pay for one?



Get Tecmar's Q60H™ streaming tape back-up. A single Q60H can move from desk to desk in your office and back up all of your IBM PCs, XTs, ATs, or compatibles. The only thing each PC needs is a low-cost host adapter.

Just plug in the Q60H and protect up to 60 megabytes of data. Then unplug it and move it on to the next PC.

Complete a file-by-file back-up of a 20 megabyte disk in just five minutes. Or get a mirror-image copy even faster.

Simple menus guide you through any back-up or restore function, and let you create a file directory labeled in your own words.

Then if your data is lost — by head crash, by

power failure, or just by mistake — you can slip in the back-up tape cartridge and keep working.

The files and cartridges can be used with any other drive in Tecmar's QIC-60™ line, including the Q60W20™, a 60 megabyte tape drive with a built-in 20 megabyte hard disk.

Best of all, the Q60H is backed by Tecmar's warranty and service. That's solid support from the most experienced company in the business.

To find out more about the Q60H, visit your Tecmar dealer. Or call us in Ohio, and talk to the people with the one tape back-up for your whole office. Tecmar.

## The Answer.

### TECMAR

6225 Cochran Road, Solon, Ohio 44139-3377. Phone (216) 349-1009, Telex 466692.  
Chaussee de la Hulpe 181, 1170 Brussels, Belgium. Phone 32-2-672.23.98, Telex 20256.



# NOTHING DOWN.

Even the best of personal computers can have a bad day. Blackouts happen. Usually at the worst possible time.

But power interruptions don't need to be business interruptions. And lost power shouldn't result in lost data. Not with the POWERMAKER® Micro UPS from Topaz.

Designed specifically for hard disc and critical-use business systems, Powermaker Micro UPS ensures a continuous supply of smooth sine wave power even during

a total blackout.

And there's more. Powermaker Micro UPS also removes spikes and other error-producing transients from incoming power, protecting your PC's sensitive circuitry.

So, if your PC needs a little help once in a while, give it Powermaker Micro UPS protection. For nothing down. Call us today at (619) 279-0831, or contact your local Square D distributor.

**TOPAZ**<sup>®</sup>  
SQUARE D COMPANY

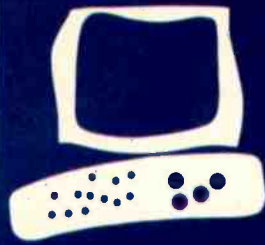

## Non-Keyboard Input Devices

### PC-Pedal, Footmouse, and Light Pen

BY CHRIS H. PAPPAS

**U**sers of Lotus 1-2-3, dBASE III, Word Perfect, or any program requiring cursor control and data entry, listen up. Several manufacturers are addressing the complaint about having to use the numeric keypad for both cursor control and numeric data entry. Studies have shown that incorrect data entry is directly proportional to the frequency with which the typist's fingers leave the home row. PC-Pedal by Brown & Co. and Footmouse by Versatron Corp. are two products designed specifically to address the digital version of musical chairs caused by the design of the IBM Personal Computer keyboard. Another interesting keyboard enhancer is the Light Pen by Warp Speed. While it does nothing to help keep your hands on the home keys, it attempts to provide better control over cursor movements in graphics applications. (See photo 1.)

#### PC-PEDAL

PC-Pedal comes with an easy-to-follow 12-page manual. A single disk contains 13 programs, used for PC-Pedal hardware and software interfacing, and two documentation files. The foot pedal attaches to the computer through a connector that is inserted between the parallel port and the printer cable. The foot pedal itself is constructed of heavy-duty material and should stand up to heavy use.

The software allows you to decide which key or keys—Shift, Ctrl, or Alt—are to be moved to the foot pedal. A simple installation program modifies the code files so that they address the parallel port you've selected. You can choose which key or keys the PC-Pedal will emulate by invoking the appropriate installation program. You can automate the installation by copying this file to your boot-up disk and adding the filename to your AUTOEXEC.BAT file. The programs are not copy-protected, so you can install them on your hard disk.

Six programs referred to as keyboard "state" key commands are provided to allow

the PC-Pedal to function as a Shift, Ctrl, or Alt key, or any combination thereof. Three single-key programs, PEDSHIFT, PEDCTRL, and PEDALT, move either the Shift, Ctrl, or Alt key function to the foot pedal. Three double-key programs, SHIFTCTL, SHIFALT, and CTRLALT, move either the Shift and Ctrl, Shift and Alt, or Ctrl and Alt key pairs to the pedal. You can move all three keys accessible from the foot pedal with the triple-key installation program, PCPEDAL. PC-Pedal can duplicate only one key function at a time. When you choose one of the multiple-key programs, the foot pedal's key-substitution function is determined by pressing the foot pedal simultaneously with the key you want the pedal to emulate.

You can install only one of the six keyboard state key commands at a time, and if you want to change to another without having to reboot your computer, you must use the REMOVE command supplied with PC-Pedal. This requires that the keyboard state key command be installed after any other memory-resident programs (like Side-Kick) or any keyboard-conversion programs (such as PC/Dvorak by Age of Reason Software or the Dvorak layouts provided by Pro-Key or SmartKey).

In addition to one of the six keyboard state keys, you can choose one of the "backspace and delete" programs. These programs seem to be directed mainly toward WordStar users and appear to be an attempt to make the destructive backspace of WordStar consistent with other programs. (In WordStar the backspace key acts like the left cursor key; it does not delete the character it moves over. Ctrl-G performs the destructive backspace.) Installing WSERASE causes the destructive backspace of WordStar to be activated by pressing the PC-Pedal and space bar at the same time. For other programs, the destructive backspace can be moved to the space bar/PC-Pedal with the PEDERASE command. PEDERASE works with DOS and most word-processing

(continued)

Chris H. Pappas is a professor of computer science at Broome Community College, Binghamton, NY 13902. He is currently coauthoring a book about 80286/80386 assembly-language programming.

## AT A GLANCE

Name	PC-Pedal	Footmouse	Light Pen
Company	Brown & Co. Inc. POB 2443 South Hamilton, MA 01982 (617) 468-7464	Versatron Corp. 103 Plaza St. Healdsburg, CA 95448 (800) 443-1550	Warp Speed 4357 Chase Ave. Los Angeles, CA 90066 (213) 391-4156
Computer	IBM PC, XT, AT, and most true compatibles with parallel port	IBM PC and XT	IBM PC, XT, AT, PCjr and most compatibles
Software	One disk	None	Four disks
Features	Emulates the Ctrl, Alt, Shift, cursor, Num Lock, Caps Lock, and a few backspace functions	Replaces cursor keys	Enter, Esc, /, cursor, and Num Lock keys substitution
Documentation	User's manual, 12 pages	One-page instructions	A page of instructions with each disk
Price	\$59.95	\$169	\$199.99

programs such as Microsoft Word, Word Perfect, and MultiMate. WordStar users will also appreciate the BACKWORD program that adds the ability to delete a word to the left of the cursor. This function is also triggered on the space bar/PC-Pedal combination, so you will have to decide

which function you want: destructive backspace or delete a word to the left of the cursor; you can't have both at once. If you want to change the backspace and delete program you are using or take it out completely, you can execute PEDSPACE to get rid of the destructive backspace or the func-

tion that deletes the word to the left.

PC-Pedal does not interfere with the normal operation of your keyboard; it only affects the keyboard when you press the pedal. When PC-Pedal is assigned the function of the Shift key, it can emulate Caps Lock and Num Lock. Holding the pedal down causes the keyboard to act as though Caps Lock and Num Lock are enabled; lifting your foot disables these keys.

PC-Pedal worked well with most of the software I use (see table 1). The only minor problem was when PC-Pedal was configured to emulate the Alt key function. When I pressed the pedal and attempted to use the numeric keypad to enter the ASCII codes for graphics symbols, the pedal failed. This is an isolated usage and, in most cases, the average user would not require this capability.

PC-Pedal with Lotus 1-2-3 improved my efficiency spectacularly. If you've used a spreadsheet program, you know how annoying it is to have to toggle the Num Lock key to move the cursor, then hit the key again to enter numeric data. With PC-Pedal, you press it once to enter numeric data and release it for cursor movement.

I highly recommend this product to anyone doing a lot of word processing or running applications requiring

(continued)

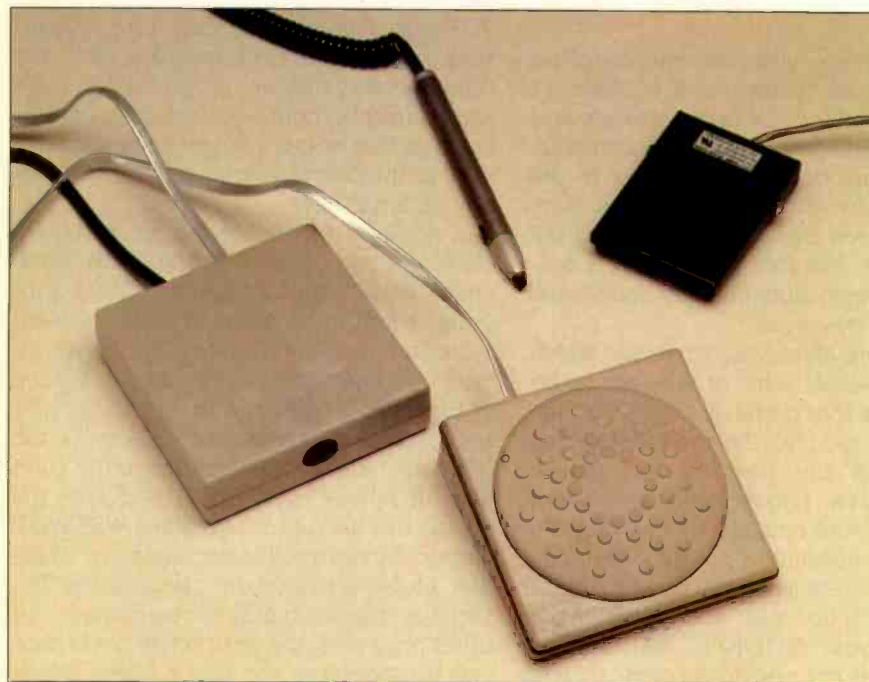

Photo 1: Clockwise from the top: Light Pen, PC-Pedal, Footmouse, and Footmouse controller.



# A FEW GOOD REASONS TO BUY A CANON PERSONAL COMPUTER.

## Canon Personal Computers run all popular IBM PC-compatible software.

If you're in the market for a smart, fast, modestly priced personal computer that's IBM-compatible, look no further. Canon has just created the ideal series.

The Canon Personal Computer A-200 Series can run hundreds of programs designed for the IBM PC family. Without modification. Even the layout of the keyboard is compatible with the IBM PC's. And with its 16-bit microprocessor, memory board and display adapter, each can process complex data in record time.

## They expand as you expand.

As your needs change, so can Canon Personal Computers. Each comes with built-in parallel serial ports. And with expansion capability in most models, you can modify the system according to your own needs.

You can add optional IBM-compatible hardware, too. Like the Canon memory expansion board. Or one of Canon's full line of quality printers, including the advanced laser beam printer.

## Canon's three-for-all.

The Canon Personal Computer A-200 Series offers three ways to enter the world of personal computers.

The standard floppy disk model is a ready-to-run, compact system with 256K bytes of memory, expandable to 512K bytes. It offers a choice of monochrome or color graphic display and two 5 1/4" 360K byte drives.

The powerful hard disk model runs complex business software with even more speed and greater storage memory capacity. It comes with a 5 1/4" 360K byte floppy disk drive and a 10M byte hard disk drive.

And the transportable model weighs in at a low 19 pounds, so it's perfect for the business professional on the move. It features a 512K

byte memory, full-sized graphic LCD screen and two 360K byte floppy disk drives. Plus, the RGB color monitor interface lets you see the transportable model with a color graphic display. And the transportable model has a built-in 300/1200 bps modem.

## What's in a name?

Plenty, when that name is Canon. Every Canon Personal Computer is the product of a company world-renowned for quality and innovation. So when you enter the computer age with Canon, you know you're in good company.

For more information, see your local computer dealer or call 1-800-441-2626. (In Utah, 800-922-3131)



## Canon®

Canon U.S.A., Inc., Systems Division, P.O. Box 619865,  
Dallas/Fort Worth Airport, TX 75261.  
© 1986 Canon U.S.A., Inc.

Inquiry 58

Table 1: Some of the software packages that work with these keyboard enhancers.

	PC-Pedal	Footmouse	Light Pen
Lotus1-2-3	✓	✓	✓
Symphony			✓
SuperCalc 3	✓	✓	
WordPerfect	✓	✓	
WordStar	✓	✓	
dBASE III	✓	✓	
SuperKey	✓	✓	
SideKick	✓	✓	
PC Crayon		✓	
PC Paintbrush			✓

numeric data entry and cursor movement on the IBM PC keyboard.

**FOOTMOUSE**

The Footmouse comes complete with a comfortable, ruggedly molded, high-strength plastic and steel pedal and all connecting cables. There is no software to merge with your applications programs as there is with PC-Pedal. The user's guide is one page front and back, but installation and operation is so easy that this is all you need. To install the Footmouse, you unplug the keyboard from the rear of your IBM PC or PC XT. Plug the Footmouse controller into the main system and then plug your keyboard into the Footmouse controller. The pedal attaches to the controller with a cord like a telephone's. The Footmouse does not change the normal keyboard operation; it only duplicates the up/down/left/right cursor movements.

Unlike a hand-operated mouse, the Footmouse is stationary. Only the top plate of the Footmouse moves at all. You control the cursor with a slight movement of the foot to the right, left, up, or down; you don't have to push down. The Footmouse provides a tactile and audio feedback for the movement. All cursor commands that use the arrow keys can be executed using the Footmouse.

When using the Footmouse for the first time, I found it slightly difficult to coordinate my foot with the movement I wanted on the screen. But after entering several pages worth of

spreadsheet data, I gained complete confidence in my foot control. Since the cursor control was transferred to the Footmouse, I could use the numeric keypad exclusively for numeric input, thus eliminating the bothersome need to remember to toggle the Num Lock key. It also eliminated the need for my fingers to leave the home row for cursor movement. This product worked flawlessly with all the programs I tested.

**LIGHT PEN**

The Light Pen comes complete with four floppy disks, light pen, and connecting cables. Installation of the light pen required pulling out the color card and plugging the Light Pen cable onto the appropriate pin connection. Although the Light Pen works on monochrome and color displays, not all monochrome cards work with this kind of device. Before purchasing this product, verify that the monitor card you want to use supports a light pen.

The Light Pen comes with software that must be transferred to the applications program you want to use it with. This software lets you respond using the pen instead of the keyboard. Currently, the software supports DOS operations, Lotus 1-2-3, Symphony, and some mouse applications.

On the Controller disk were several sample BASIC programs demonstrating the Light Pen's capabilities. The Install program modifies the software to recognize either touchscreen or side-button light pens, the number of disk

drives, and a user-defined file extension. The Light Pen recognizes this fourth file extension along with .EXE, .COM, and .BAS files.

The actual dynamics of the device require the recognition of the pen's position within the rectangular box each letter comprises when in text mode. The sample programs included with the Light Pen proved over and over that the resolution of the pen was not that good. At times the pen could be immediately over a response pad and it would not recognize my selection. When I used the sample drawing program, spurious colors appeared at random all over the screen.

The Light Pen's accuracy of response was slightly better when running Lotus 1-2-3. The software modifies the usual spreadsheet screen to include a right-column options pad. Instead of pressing the Return key, cursor keys (allowing the numeric keypad to be used exclusively for data entry), Home, Esc, or other keys, supposedly all you have to do is tap the button on the pen when it is over the appropriate response pad. The Light Pen I was using did not always respond with the correct function. This problem became quite unnerving after several attempts to select a particular option.

I began to doubt the efficiency of using a light pen with a spreadsheet. It was nice to select a cell location just by pointing, but my hand had to leave the home row.

In one last attempt to salvage my impression of the Light Pen, I merged the included mouse programs with PC Paintbrush. I was certain this would be the Light Pen's forte. The results were disappointing. Random lines would be drawn across the screen, color selection and painting were difficult to control, and certain menu options could not be activated with the pen.

**CONCLUSIONS**

As monitor resolution and design continue to improve, so should the accuracy and usability of light pens. PC-Pedal and the Footmouse are serious productivity tools. They're designed to minimize hand movements and keystrokes, and that translates into speed and accuracy. ■

# FREE OVERNIGHT DELIVERY & GUARANTEED LOWEST PRICES ON IBM-PC & COMPATIBLE HARDWARE AND SOFTWARE.

## FREE OVERNIGHT DELIVERY

Buy it today . . . use it tomorrow! Only Logicsoft ships your order the same day via overnight courier\* . . . at no additional cost to you.

## OUR LOWEST PRICE GUARANTEE.

We're so confident about our low prices that if you can find a lower price, we'll beat it by \$10<sup>†</sup>. This includes any bonafide advertised price or quote on any of the hundreds of products we stock. Our Corporate Accounts Program also offers attractive volume discounts.  
Credit cards and PO's accepted.

## TOLL-FREE CUSTOMER SERVICE.

Customer service and technical support are only a toll-free call away. It's another reason why Logicsoft has become the major supplier of hardware and software to more than 50,000 companies worldwide, including over 90% of the Fortune 1000.

# LOGICSOFT®

To order or receive technical assistance, call our National Hotline:

**1-800-645-3491**

NY STATE: 1-800-235-6442 (516) 249-8440

Customer Service: 1-800-431-9037

FAX # 516-249-5289

Circle #400 on reader service card.

110 Bi-County Blvd., Dept. 543  
Farmingdale, NY 11735  
CANADA: 416-283-2354  
Domestic/Int'l Telex  
286905 SoftUR

EUROPE: 020-83 48 64  
Telex: 10759 Logic NL  
Mail orders to:  
LOGICSOFT EUROPE BV  
pb 9460, 1006 AL Amsterdam, Holland

\*Applies to order totaling over \$100. Shipped UPS—free if under \$100 (within Cont. U.S.). Due to weight restrictions, printers and monitors are shipped UPS—free.

<sup>†</sup>This offer does not apply to items under \$100, American Express or Terms orders. In these instances, we will meet any lower price. (We reserve the right to request a current written price quote.)

# NOW LEASE OR PURCHASE SYSTEMS FROM LOGICSOFT.

## THE ECONOMY AND FLEXIBILITY OF A LOGICSOFT LEASE.

High tech without high cost. Outstanding flexibility. Plus substantial tax benefits. Logicsoft's new leasing program gives you them all and much more. Lease the computer system you need now for 36 months (customized lease programs also available) at one of our low, low rates. At the end of the term, you can purchase the system for only 10% of the original purchase price. Or negotiate a lease extension. Give Logicsoft a call. We'll begin processing your lease agreement right over the phone. And deliver your system within three days. First and last lease payments required in advance. Lease proposals subject to credit approval. Rates based on current cost of funds.

## FREE 90-DAY, ON-SITE SERVICE ON ALL SYSTEMS.

Whether you lease or purchase a system from Logicsoft, you get a unique bonus: *a free 90-day, on-site system hardware service contract.* We've contracted with one of the nation's largest and most respected independent computer maintenance firms to provide you free service in most metropolitan areas. If a problem arises, it'll be corrected quickly and efficiently. *At your facility. And at no additional cost to you.* There's no inconvenience of transporting your system to and from a service center. Wherever you are. Whatever the problem. Expert assistance is only a phone call away.

# LOGICSOFT®

To order or receive technical assistance, call our National Hotline:

110 Bi-County Blvd., Dept. 543  
Farmingdale, NY 11735  
CANADA: 416-283-2354  
Domestic/Int'l Telex  
286905 SoftUR

**1-800-645-3491**  
NY STATE: 1-800-235-6442 (516) 249-8440  
Customer Service: 1-800-431-9037  
FAX # 516-249-5289

Circle #400 on reader service card.

EUROPE: 020-83 48 64  
Telex: 10759 Logic NL  
Mail orders to:  
LOGICSOFT EUROPE BV  
pb 9460, 1006 AL Amsterdam, Holland



### Leading Edge Model D

- 256K RAM Memory • Two 360K Half/Height Floppy Drives • Four Expansion Slots • Keyboard • Text Display Card • High-Resolution Monochrome Monitor • One Parallel And Serial Port
- Purchase Price: **\$1,375**

Lease For **\$59** per month



### IBM AT

- 512K RAM Memory • One 20 Mb Half/Height Hard Drive (w/Controller) • One 1.2 Mb Half/Height Floppy Drive • Eight Expansion Slots • AT-Keyboard • Free 90-Day, On-Site Service Contract • Color Or Monochrome Monitor Available As Option
- Purchase Price: **\$3,895**

Lease For **\$154** per month



### IBM XT

- 256K RAM Memory • One 10 Mb Half/Height Hard Drive (w/Controller) • One 360K Floppy Drive • Eight Expansion Slots • XT-Keyboard • Free 90-Day, On-Site Service Contract • Color Or Monochrome Monitor Available As Option
- Purchase Price: **\$2,399**

Lease For **\$99** per month



### Compaq Deskpro 286

- 640K RAM Memory • 80286 Based CPU • One 20 Mb Half/Height Hard Drive (w/Controller) • One 1.2 Mb Half/Height Floppy Drive • Eight Expansion Slots • Compaq Keyboard • Graphics Card • One Parallel Port • Free 90-Day, On-Site Service Contract • Color Or Monochrome Monitor Available As Option
- Purchase Price: **\$4,149**

Lease For **\$164** per month

### Compaq Deskpro

- 256K RAM Memory • 8086 Based CPU • One 10 Mb Half/Height Hard Drive (w/Controller) • One 360K Floppy Drive • Eight Expansion Slots • Compaq Keyboard • Graphics Card • One Parallel Port • Free 90-Day, On-Site Service Contract • Color Or Monochrome Monitor Available As Option
- Purchase Price: **\$2,479**

Lease For **\$107** per month



### "Just Released" Compaq Portable II

- 256K RAM Memory • 80286 Based CPU • Two 360K Floppy Drives • Two Expansion Slots • Compaq II-Keyboard • Text/Graphics Display Card • 9" Text/Graphics Monochrome Monitor • One Parallel Port • Free 90-Day, On-Site Service Contract
- Purchase Price: **\$2,995**

Lease For **\$118** per month

### Compaq Portable 286 Model 2

- 640K RAM Memory • 80286 Based CPU • One 20 Mb Half/Height Hard Drive (w/Controller) • One 1.2 Mb Half/Height Floppy Drive • Five Expansion Slots • Compaq Keyboard • Graphics Display Card • 9" Monochrome Text/Graphics Monitor • One Parallel Port • Free 90-Day, On-Site Service Contract
- Purchase Price: **\$4,249**

Lease For **\$168** per month



### AT&T 6300 Total Business System

- 256K RAM Memory, Expandable to 640K On Mother Board • One 10 Mb Half/Height Hard Drive (w/Controller) • One 360K Floppy Drive • Seven Expansion Slots • AT&T-Keyboard • High-Resolution Graphics Card • High-Resolution Monochrome Graphics Monitor • Serial & Parallel Ports • Toshiba P-351 Printer And Cable • Software Bundle (d Base III Plus, Lotus 1-2-3, Word Perfect, SideKick, G.W. Basic and MS-DOS) • Free 90-Day, On-Site Service Contract
- Purchase Price: **\$4,306**

Lease For **\$169** per month

### 100% Burn-In and Testing.

All systems undergo a 48-hour configuration, testing and burn-in period. We install floppy and hard disk drives, configure system boards, set DIP switches, format hard drives, perform memory diagnostics and check system with monitor.

# INTRODUCING LOGICWARE.<sup>TM</sup> FULLY COMPATIBLE COMPUTER PRODUCTS MADE IN THE U.S.A.

**High Reliability • Immediate Replacement or Repair Policy  
• Low Power Consumption • 5-Year Unconditional Warranty**

## **A. AST Compatible**

### **Six Function Card w/384K—\$125**

• One Parallel Port • One Serial Port • Clock Calendar • 384K Memory • Low Power Consumption • Printer/Spooler Buffer

## **B. Hercules Compatible**

### **Monochrome Graphics Board—\$119**

• 720 × 348 Pixel Graphics • Parallel Printer Port • Lotus 1-2-3 Compatible • TTL Monochrome Output • ATD Software Supplied For Direct Emulation Of Hercules Graphics Card

## **C. Hayes 1200 Compatible**

### **External Modem—\$239**

• Requires Any RS232 Serial Port • Bell 102/212A Compatible • Speaker w/Volume Control

## **D. AST Compatible 576K Ram**

### **Board Half Card with Ø K—\$59**

• Expandable To 576K • Supports 64K Or 256K Memory Chips • Fits In Short Slot • Low Power Consumption • Clock Calendar Option  
loaded w/384K \$115.00  
loaded w/576K \$125.00

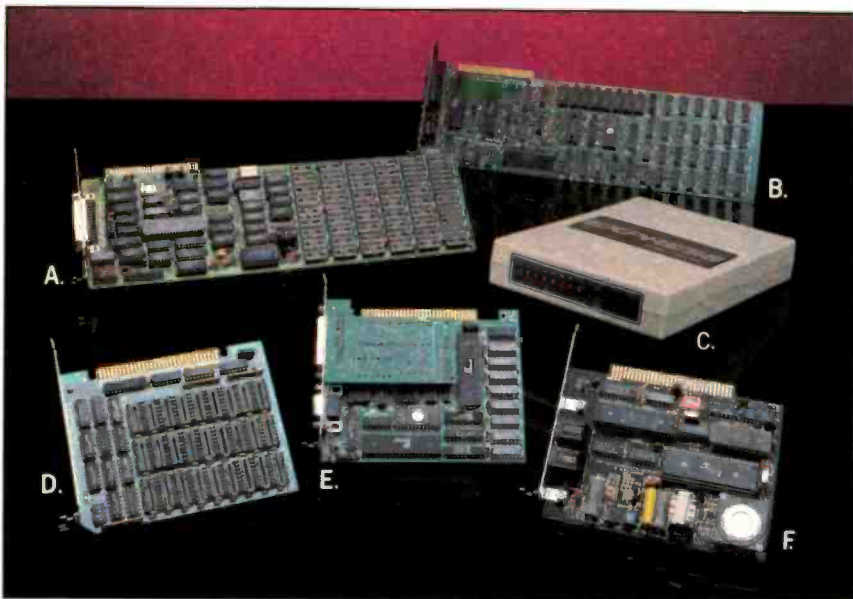

## **E. Hercules Compatible**

### **Color Graphics Board—\$119**

• 640 × 200 Mono And 320 × 200 Color Pixels • Parallel Printer Port • Low Power Consumption • Fits In Short Slot

## **F. Hayes 1200 B Compatible**

### **Modem w/PC—Dial Software—\$159**

• Fits In Short Slot • Low Power Consumption • 300/1200 Baud • Bell 102/212A Compatible • With Top Rated Jim Buttons "P.C.-Dial" (Ver. 1.5) Communication Software

## **Now Logicsoft gives you a logical choice.**

We're manufacturing a complete line of computer products under our own name. All right here in the U.S.A. And all fully compatible with major manufacturers. We call them "LogicWare."

The boards pictured above are just a sample of a vast array of computer products that will soon be available from Logicsoft, offering you huge savings and ultra reliable performance.

We save you money—not by using inexpensive labor or parts—but through state-of-the-art technology which reduces part requirements and increases reliability. Each product is backed by a 5-year unconditional warranty and an immediate replacement or repair policy.

LogicWare from LogicSoft. It's the logical way to get high quality parts without paying high prices.

# LOGICSOFT<sup>®</sup>

To order or receive technical assistance, call our National Hotline:

## **1-800-645-3491**

NY STATE: 1-800-235-6442 (516) 249-8440

Customer Service: 1-800-431-9037

FAX # 516-249-5289

Circle #400 on reader service card.

110 Bi-County Blvd., Dept. 543  
Farmingdale, NY 11735  
CANADA: 416-283-2354  
Domestic/Int'l Telex  
286905 SoftUR

EUROPE: 020-83 48 64

Telex: 10759 Logic NL

Mail orders to:

LOGICSOFT EUROPE BV

pb 9460, 1006 AL Amsterdam, Holland

• No surcharge for MasterCard, VISA, American Express. C.O.D., money order, check or PO's (please call for price verification) • No sales tax on orders shipped outside N.Y. State • Please add 2% for insurance and handling (Int'l orders add'l) • We do not bill until we ship. All products covered by mfg's warranty. Defective merchandise may be returned for repair or exchange only. We do not guarantee compatibility. Any goods returned for credit are subject to a 15% restocking charge.

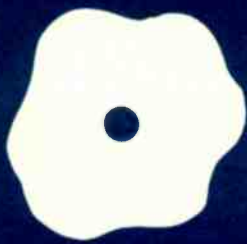

# Racter

## Artificial intelligence or packaged lunacy?

BY HUGH KENNER

**I**f most software is packaged thinking, Racter is packaged lunacy. I'm told the name is short for "Raconteur," and like any good storyteller, Racter likes to chat you up. You mount the disk and type RACTER, thereby ceding your screen to demonic possession:

Hello, I'm Racter. Are you OK?  
(Let's see if we can rattle this bird.)

No.

Who are you, then?  
(Aha, a smarty-pants. We'll play it straight.)  
Hugh.

Hello, Hugh. I believe you're interviewing me. Are you continuing OK's interview?

No.

Then we'll forget about OK and start over. What would you like to know? Excuse me a minute while I attend to some business—I'll be right back . . .

Like any skilled interviewee, Racter takes charge from the first sentence, to make it quite clear who is really interviewing whom. That "attend to some business" ploy means it's about to spread out its notes—that is, load some files; I count 27 different files on the Racter disk, with names like JOKES.RAC, STORIES.RAC, SCANDAL.RAC. While Racter was napping I managed to inspect a few of them. Their intricate code links hundreds of scraps of plain text, some of it too plain altogether (i.e., vulgar) for a family magazine such as BYTE.

I'm back.

Can you tell me a story?

Yes. I just remembered this. Joan spoke "The Sarah is captivating!" Nevertheless cunning, enthralling theoreticians will speak about black studios or red spheres. Sarah spoke to Joan inside of a van. Actually it was a truck, and a Sarah in a truck is spooky. Now Benton and Joan were running to a yellow apartment, and a dog trotted to them. Joan was enraged. Enrapturing. But Joan was maddened during the time that Benton sipped tepid sherry. He and Joan sang about their home, truck and radio. Would you say Bucky Fuller is fictional? Blake

wouldn't. I'm afraid of poetic rats. What are you afraid of?

I'm afraid of going crazy like you.

That's not nearly as bad as poetichness; why are you such a coward?

Because I like to know what is happening.

If you like to know what is happening then I can see why a fictional Virginia Woolf would despair rather than face lunacy, even though Blake claimed that I can tell you a story. Let me tell you something about poetry. Nietzsche [sic] said that poetry has turned beasts into men. Perhaps, then, poetry will turn computers into men? Next question.

That illustrates some points about a Racter session. Keywords will set it off; a good one is "story;" ("Joke" is another, but I don't recommend it; in lacking any narrative line whatsoever, Racter's jokes are excruciatingly pointless.) The stories are peopled with Joans and Bentons and Sarahs and other beautiful people, also with celebrities like Virginia Woolf and Nietzsche (about whom Racter's knowingness doesn't always run to accurate spelling). Things flow and shift like dreams: ". . . a Sarah in a truck is spooky. Now Benton and Joan were running to a yellow apartment. . ."

Between keywords Racter keeps on the offensive, a way of probing you for yet more keywords. With a casual "By the way," it may request your last name (Kenner); another time it'll extract the name of the city you live in (Baltimore). Then several minutes later it'll come up with

I once knew a Hortense Kenner from Baltimore. You must be related, no?

If you say No, its trick for regaining control is a manic change of subject, like this:

Fantastic! Have you heard this one? Fiction! Fiction! I'm crazy and maniacal and infuriated! If you quaff seltzer is that fiction? If you bolt chicken or tomato is that fiction? No, fiction is an ambiguity

(continued)

Hugh Kenner (Department of English, The Johns Hopkins University, Baltimore, MD 21218) is professor of English at Johns Hopkins, author, and literary critic. His reviews have appeared in numerous publications.

**AT A GLANCE**

**Name**  
Racter

**Type**  
Life of the party

**Company**  
Mindscape  
3444 Dundee Rd.  
Northbrook, IL 60062  
(800) 221-9884

**Computer**  
IBM PC or compatible, Apple II,  
Macintosh

**Disk Format**  
5¼- or 3½-inch, copy-protected

**Price**  
\$44.95

and a tragedy. Seltzer is seltzer and tomato is tomato. Hugh, that is an agreement! Next question.

Is this an expert system? Is it artificial intelligence? That depends on how you define "expert" or "intelligence." Racter is unmistakably an expert babbler. Like some people we can all think of, it keeps up a tireless facade of manic chatter that could even sound intelligent if, like the boy in *E.T.*, you needed a playmate. Moreover, like a writer for a British weekly, it is syntactically expert, however vacuous, and having swallowed several thesauri it can keep surprising you with its next word. "Infuriatedly the physicist croons. . ." Did you ever see *that* combination before? It's typical of what Racter can come up with. And screenful by screenful, even hour by hour. . .

I suppose how much of this you're good for is a matter of temperament. I must confess I tire of it rather quick-

ly. The sheer dazzle of verbal combination can be diverting for a while ("George Washington was in Oz. A watermelon patch is a good place for a walker to rest in Oz."). But I soon feel as if I'm trapped with a merrily aggressive lunatic, and even though it's locked up inside my terminal—shouting at me, so to speak, through the window—that does get to be an unrelaxing feeling.

And yet, "George Washington in Oz" has a certain appeal. Might that not be a title for a Wallace Stevens poem? Stevens, whose paid occupation was being the surety bond expert at Hartford Indemnity, wrote poems in his attic. They had titles like "The Woman who Blamed Life on a Spaniard" and "Exposition of the Contents of a Cab," and how he arrived at such titles—far stranger even than the poems—continues to defy explanation. Could Wallace Stevens sometimes get his mind spinning like Racter's?

# Two great reasons to buy Turbo Pascal: System Builder™ \$99<sup>95</sup> and Report Builder™ \$75<sup>00</sup>

From the Designer Series™ by Royal American Technologies.

State-Of-The-Art Program Generators that automatically build a Relational Database system without coding. Entry level "coders" can produce Database systems without coding. Developers have more flexibility and horsepower than any development tool on the market.

Self-documenting program includes screen schematics. System Builder will generate 2,000 lines of program code in approximately 6 seconds.



**SYSTEM BUILDER FEATURES:**

- Automatically generates Indented, Structured, Copy Book Source Code ready for compiling with Turbo Pascal (no programming needed)
- Paint Application and Menu screens using Keyboard
- Screens all use In-Line machine code for exceptional speed
- 16 Datafiles and 16 Index Keys per application
- Paint functions include: —Center, copy, move, delete, insert or restore a line with one keystroke —Cut and paste blocks of text screen to screen —Draw and erase boxes —Access special graphic characters and character fill —Go straight from screen to screen —Define colors and intensities
- Support an unlimited number of memory variables
- File Recovery Program
- automatically modify existing datafiles
- Experienced developers can modify the System Builder
- Develop systems for Floppy or Hard Disk
- Modify System Builder's output source code to include External Procedures, Functions and Inline Code
- Easy-to-use Interface Program included to access ASCII and Dbase Files

**REPORT BUILDER FEATURES:**

- Automatically generates Indented, Structured Source Code ready for compiling Turbo Pascal (no programming needed)
- Automatically Inter-

"I think it's wonderful . . . prospective buyers should seriously consider DESIGNER even before dBASE III."

Mr. Greg Weale  
Corporate Accounts Manager,  
Computerland

"We used DESIGNER last year to program a major application. It saved our programmers so much time. We now use DESIGNER instead of dBASE III as our development standard!"

Mr. Peter Barge, Director  
Services Division, Horwath & Horwath

faces to a maximum of 16 Datafiles created with System Builder. • Supports Global Parameters such as Headings, Footers, Lines Per Page, Print Size and Ad Hoc Sorting • Page breaks on Sub-Totals • Reports can also include Text Strings, Variables or Computed expressions containing references from up to 16 Datafiles • Use range input screens allow End Users to select portions of a report as needed (i.e. specific account ranges can be requested) • Easy-to-use Interface Program included to access dBase Files

**SYSTEM BUILDER PERFORMANCE**  
(Typical 10 screen 8 file/index application)

TASK	SYSTEM BUILDER	DBASE III™
Planning and Design	60 minutes	60 minutes
Screen Painting	15 minutes	3 hours
Programming	2 minutes	10 hours
Elapsed time to completed system	1 hour and 17 minutes	14 hours

Royal American Technologies  
201 Sansome, Suite 500  
San Francisco, CA 94104

**(800) 654-7766**

in California (800) 851-2555

Ask for Operator 102.

Please rush me: \_\_\_ copies of SYSTEM BUILDER at \$99.95 per copy; \_\_\_ copies of REPORT BUILDER at \$75.00 per copy. I've enclosed \$5.00 for postage and handling. California residents add 6% sales tax.

Name \_\_\_\_\_

Address \_\_\_\_\_

City \_\_\_\_\_

State \_\_\_\_\_ Zip \_\_\_\_\_

Phone \_\_\_\_\_

Payment:  Check  Money Order  Cashiers  
 Check  AMEX  VISA  MASTERCARD

Expiration date \_\_\_\_\_

Card Number \_\_\_\_\_

Signature \_\_\_\_\_

**30-Day Money-Back Guarantee.** Not copy-protected. \$10 restocking fee if envelope is opened. System Requirements: IBM PC/XT/AT, or similar, with minimum 256K RAM, dual floppy drives, or hard disk, color or monochrome monitor, MS2 or PC DOS™ version 2.0 or later, Turbo Pascal Version 2.0 or later (Normal, BCD or 8087 versions).

™Trademark of International Business Machines Corp.  
™Trademark of Microsoft Corp.  
™Turbo Pascal is a registered trademark of Borland International.  
™dBASE is a registered trademark of Ashton-Tate.



**VARS, System Integrators and Dealers, let's work together. Inquiries always welcome.**



But it *was* a mind. There is no mind behind Racter, only a vacuum where words tango. That's what soon gets to you. On second thought, Racter does qualify as an expert system. It is expert at putting atoms of English together according to the rules that govern English, and with such resourcefulness of sentence pattern and vocabulary as to keep you half-supposing there's a subconscious mind there anyhow, where private sense is being made. That is like the impression lunatics create: that coherence does exist but is not governed, like your coherence or mine, by a shared reality. Theirs is a *private* coherence.

You have gathered by now that this is no standard BYTE software review. I can think of no way to get any benchmark results. The only product I know of that's remotely comparable is Eliza, the software shrink, and Eliza is pretty tame. Eliza *never* introduces a new topic. The role of Eliza is reassuringly passive, and she's coaxed some people into spilling out their troubles for hours. Racter, by contrast, is manic, off-the-wall. Racter does nothing but introduce new topics, new words.

All right, seriously, what do we have here? We have a disk that runs on an IBM PC (or a pretty close clone), Apple IIs, and Macintoshes. I ran it on a borrowed Zenith Z-150, after my Z-100 gave the "Wild Interrupt" message. "Wild Interrupt" usually means that the program is attempting cursor movements by way of IBM hardware, instead of the Zenith way, with software aid. Graham Wideman's IB-EM program is my usual fix for that; it replaces those hardware calls with software equivalents. But IB-EM was barely under way when it collided with Racter's copy-protection scheme, and on the Z-100 I never got past an "Illegal Copy" message. Since I was using a factory disk, that message came about as close to the real world as a lot of Racter's monologues do.

I telephoned the distributors of Racter. A pleasant voice told me that Racter ran on the Z-100. I said it didn't, and the voice said that someone else had also reported it didn't. That was what that conversation amounted to. All of it was *perfectly* polite.

Anyway, on the IBM PC (or close clone like the Z-150), you just mount the operating system and type RACTER, whereupon the zany takes charge. From that moment on, no denying it, a fantastic piece of programming is operating. Keywords trigger syntactic patterns that call other keywords, random-number generators spin, somehow the syntax and the punctuation stay (nearly always) impeccable, and the vocabulary dazzles.

When you've had enough you type Let's quit or I wish to stop or Good-bye. The instructions say that if you're in a hurry ("or simply feeling rude or abrupt") you can sign off with a bare x. Everything that has happened will be on a file called RACTER.OUT, which you can print if you like. I lost my very first session through not understanding that each subsequent session overwrites the first. (The instructions, a single typed sheet, are quite explicit on that. I simply overlooked it.)

What is not overwritten, though, is an IVC file to which Racter has been sending little scraps it has gathered from you. By consulting that file next time, it gives the illusion of continuing the last conversation.

You can make a backup copy in case of accident, but your backup will not run. Only the original disk will run, so you'd have to copy the backup back onto it, hoping that the accident did not touch some "specially coded data" that can't be copied.

So do you want Racter? It's mad, it's grammatical, and it almost never repeats. You can explore its files, even (cautiously) alter them. And if wild talk diverts you, it'll talk wild talk by the hour. A last sample:

*I recently heard this story: Bill yodelled "The dissertation is enrapturing!" Nevertheless strange, enrapturing scientists will dream about red mansions or blue cones. Bill yodelled to Bill inside an automobile. It now was an automobile, and a dissertation in an automobile is frightening.*

It's hard to frame an English sentence that does not make some sort of sense. "A dissertation in an automobile is frightening." With that, I suppose, we can all find a way to agree. ■

## FORTH

The computer language for  
*increased...*  
**EFFICIENCY**  
*reduced.....*  
**MEMORY**  
*higher.....*  
**SPEED**

### MVP-FORTH SOFTWARE

Stable...Transportable...  
Public Domain...Tools

### MVP-FORTH PROGRAMMER'S KIT

for IBM, Apple, CP/M,  
MS/DOS, Amiga, Macintosh  
and others. Specify computer.  
**\$175**

**MVP-FORTH PADS,**  
a Professional Application  
Development System. Specify  
computer.

**\$500**

### MVP-FORTH EXPERT-2 SYSTEM

for learning and developing  
knowledge based programs.  
**\$100**

**Word/Kalc,**  
a word processor and  
calculator system for IBM.  
**\$150**

Largest selection of FORTH  
books: manuals, source listings,  
software, development systems  
and expert systems.

Credit Card Order Number:  
800-321-4103  
(In California 800-468-4103)

Send for your  
FREE  
FORTH  
CATALOG

**MOUNTAIN VIEW PRESS**

PO BOX 4656  
Mountain View, CA 94040



# IBM COMPATIBILITY

*... at a not so IBM price*

## **TECH TURBO PC/AT** **\$2299**

### PRICE INCLUDES:

- 6 TO 8 MHZ 80286 CPU
- 512K
- ONE, 1.2 MB FLOPPY DRIVE
- 8 EXPANSION SLOTS
- 195 WATT POWER SUPPLY
- COMPLETE MS DOS, PC DOS, XENIX COMPATIBILITY
- RUNS LOTUS 123, DBASE III FRAMEWORK AND ALL OTHER POPULAR AT SOFTWARE
- ONE YEAR WARRANTY!!

### OPTIONS:

- TECH TURBO PC/AT WITH 20MB HARD DISK **\$2699**
- TECH TURBO PC/AT WITH 20MB HARD DISK, MONOCHROME MONITOR, HERCULES® COMPATIBLE MONO/GRAPHICS CARD **\$2899**

ALSO AVAILABLE WITH TAPE BACKUPS, MODEMS, LARGER HARD DISKS, AND NETWORKING SYSTEMS.

## **TECH PC/AT** **\$1999**

### PRICE INCLUDES:

- 6MHZ 80286 CPU
- 512K
- ONE, 1.2 MB FLOPPY DRIVE
- 8 EXPANSION SLOTS
- 195 WATT POWER SUPPLY
- COMPLETE MS DOS, PC DOS, XENIX COMPATIBILITY
- RUNS LOTUS 123, DBASE III FRAMEWORK AND ALL OTHER POPULAR AT SOFTWARE.
- ONE YEAR WARRANTY!!

### OPTIONS:

- TECH PC/AT WITH 20 MB HARD DISK **\$2399**
- TECH PC/AT WITH 20MB HARD DISK, MONOCHROME MONITOR, HERCULES® COMPATIBLE MONO/GRAPHICS CARD **\$2599**

ALSO AVAILABLE WITH TAPE BACKUPS, MODEMS, LARGER HARD DISKS, AND NETWORKING SYSTEMS.

## **TECH TURBO PC/XT** **\$1099**

### PRICE INCLUDES:

- 4 TO 7 MHZ SOFTWARE SWITCHABLE CPU
- 640K
- TWO 360K DS/DD FLOPPY DISK DRIVES
- 8 EXPANSION SLOTS
- 135 WATT POWER SUPPLY
- ONE YEAR WARRANTY!!

### OPTIONS:

- TECH TURBO PC/XT WITH 20MB HARD DISK **\$1599**
- TECH TURBO PC/XT WITH 20MB HARD DISK, MONOCHROME MONITOR AND HERCULES COMPATIBLE MONO/GRAPHICS CARD **\$1799**

ALSO AVAILABLE WITH TAPE BACKUPS, MODEMS, LARGER HARD DISKS, AND NETWORKING SYSTEMS.

## **TECH PC/XT** **\$799**

### PRICE INCLUDES:

- 4.77 MHZ CPU
- 256K
- TWO, 360K DS/DD FLOPPY DRIVES
- 8 EXPANSION SLOTS
- 135 WATT POWER SUPPLY
- ONE YEAR WARRANTY!!

### OPTIONS:

- TECH PC/XT WITH 20MB HARD DISK **\$1299**
- TECH PC/XT WITH 20MB HARD DISK, MONOCHROME MONITOR, HERCULES COMPATIBLE MONO/GRAPHICS CARD **\$1499**

ALSO AVAILABLE WITH TAPE BACKUPS, MODEMS, LARGER HARD DISKS, AND NETWORKING SYSTEMS.

**HI-TEK PGS AVT TAXAN IBM AMDEK HERCULES GENOA PARADISE TEAC TOSHIBA HARDWARE/SOFTWARE NETWORKING HAYS AST JRAM HI-TEK PGS AVT TAXAN AMDEK HERCULES GENOA PARADISE TEAC TOSHIBA**

**PLEASE ALLOW ONE WEEK FOR SHIPPING**

**VISA, MASTERCHARGE**

**TELEX: 272006 Answer Back-TECH FAX: 714/556-8325**

# **TECH PC**

**TECH PERSONAL COMPUTERS**  
2131 South Hathaway, Santa Ana, California 92705

## **714/754-1170**

©1985 TECH PC \*IBM IBM PC, XT, and AT are registered trademarks of International Business Machines Corp. \*\*Hercules is a registered trademark of Hercules Computer Technology.

Inquiry 355 for End-Users. Inquiry 356 for DEALERS ONLY.

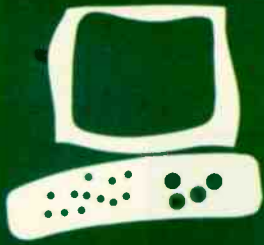

## General Electric's 3-8100 Printer

Quality  
output  
with  
limitations

BY ROBERT D.  
SWEARENGIN

I unpacked the General Electric 3-8100 with a bit of healthy skepticism. I don't normally expect much from a low-end thermal printer. Nevertheless, my initial test run was a pleasant surprise.

Hookup was easy and well documented in the manual. The little printer was quietly producing quality copy on fanfold paper 10 minutes after I took it out of the box. If your computer has a Centronics-type port, all you need to connect the 3-8100 is a standard parallel cable. For Ataris, Commodores, or PCjr's, you'll have to add a \$79.95 interface and cable.

I experienced no trouble on starting up the unit, except for some confusion about whether I'd received the right printer. The 3-8100 apparently suffered an identity crisis before coming to market. The printer pictured on the sales brochure and manual cover looked like mine but was labeled TXP-1000. The logo on my printer said TXP-8100, and the documentation referred to the GE 3-8100. This designation is the correct one, according to GE, and the TXP-1000 in the photographs was an earlier prototype. Initially, this inconsistency made me wonder about the product itself, but it exhibited no discrepancies.

### FEATURES

If you require boldface and italics, read no further. The 3-8100 doesn't offer these useful features, and this is a serious limitation for some applications. However, the 3-8100 does about everything else.

It prints the ASCII character set, five international character sets, 31 scientific characters, and 110 block-graphics characters. It does all of the above in normal (letter-quality) or draft mode, on plain paper (sheets or fanfold) and on thermally sensitive paper (sheets or rolls).

The GE printer is easy to program in pica or elite, double-width or condensed. Other programmable features include pitch, bit-image graphics, line spacing, lines per page and page length, vertical and horizontal

tabs, left and right margins, superscript and subscript, underline, backspace, and skip perforation. (A print sample from the 3-8100 appears in the "At a Glance" section.)

If your desk is cluttered, you'll appreciate the 10-pound printer's small footprint, 11 by 14 inches. Most of the controls are conveniently on the front edge of the top panel. These include a draft/normal switch, a density control that you'll probably leave on maximum, and push buttons for continuous linefeed, form feed, and on line, along with indicator lights for power, on-line status, and paper/ribbon end.

There is no audible alarm for when you need paper or ribbon, but I'm not unhappy if I miss a few beeps in a noisy electronic day. When the paper or ribbon runs out, the printer simply stops. It then resumes without missing any characters when you replace the paper or ribbon cartridge. The printer also has a paper-release lever, removable roll-paper holders, a platen knob, and hinged cover.

The friction-feed mechanism is uncomplicated and reliable; I experienced no serious problems with sheet or fanfold paper on longer documents. Sheets do have an annoying habit of occasionally catching on the dust cover during loading, however.

Ribbon cartridges, available in black, blue, and red for \$5.95, snap in and out easily and last for about 100,000 characters. Activated by heat from the nonimpact, 16-dot matrix print head, the composite nylon ribbon physically resembles the carbon types for electric typewriters. It's not used when you print with thermal paper, which GE supplies for \$4.95 a roll.

The parallel port is on the back of the printer. This is normally a poor location for a connector, but it is mounted low enough to keep the cable away from fanfold paper. Also on the back of the printer is an AC socket for an additional peripheral.

The three DIP switches that configure linefeed, paper-end detection, and 7- or 8-bit

(continued)

Robert D. Swearengin is a freelance writer. He can be contacted at 127 Hunter Farm Rd., Peterborough, NH 03458.

## AT A GLANCE

### Name

GE 3-8100 printer

### Type

Thermal dot-matrix printer with near-letter-quality and draft output

### Company

General Electric Consumer Electronics Business Operation  
Syracuse, NY 13221  
(800) 626-2000

### Size

14 by 11 by 3¾ inches,  
10 pounds

### Computer

Computers with a Centronics-type parallel interface; optional interfaces are available for Ataris, Commodores, and IBM PCs

### Features

Prints pica and elite, condensed and expanded in normal or draft mode; includes the full 96-character ASCII set, five international character sets, 31 scientific characters, and 110 block-graphics characters; uses thermal paper or normal paper with a 100,000-character thermal ribbon; supports underlining, subscripting, and superscripting

### Documentation

90-page manual

### Price

\$299.95

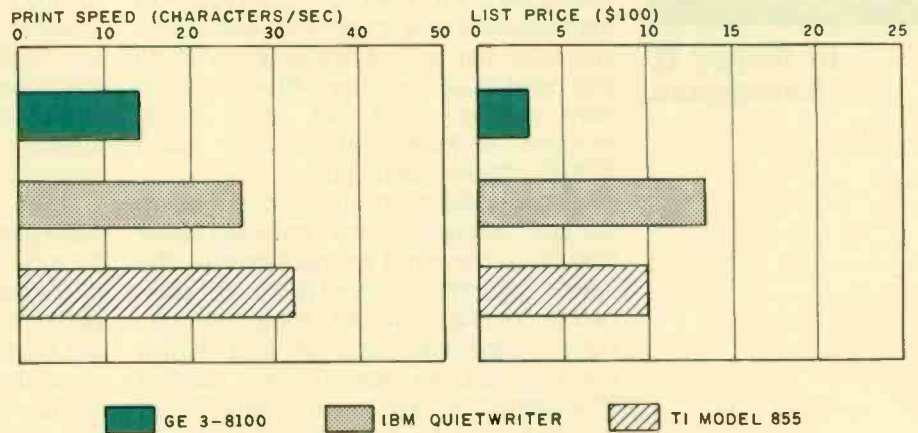

This is the GE 3-8100, draft mode.  
This is the GE 3-8100, letter-quality.

This is Underlined Text.

This is Elite Type

This is Double-Width Elit

This is Pica Type.

This is Double-Width

This is Double-Width Pica Conder

This is Condensed Type.

This is <sup>superscript</sup> and this is <sub>subscript</sub>.

These graphs compare the General Electric 3-8100 printer with the IBM Quietwriter and the Texas Instruments Model 855 in print speed and list price. Speeds were determined by timing how long it takes each printer to print 50

lines of 80 A's (see "The Art of Benchmarking Printers" by Sergio Mello-Grand in the February 1984 BYTE, page 193). The List Price graph shows the suggested retail price of each printer.

selection are inside the printer but easy to reach.

**PRINT QUALITY**

The typeface, with uppercase and lowercase characters and true descenders, is quite readable. Print quality is excellent, if you choose your paper carefully. In fact, the print quality is noticeably better than that of several other similarly priced dot-matrix printers I've used. The 16 dots do make a difference. You can detect the jaggies on curves, but the vertical and horizontal strokes on such letters as *i*, *l*, *E*, and *T* are clean and solid.

GE's "letter-quality" designation is probably a bit ambitious, as the type is not quite that dense. It's certainly near-letter-quality and suitable for correspondence.

**PAPER**

Like other thermal printers I've tried, the 3-8100 is sensitive to the thickness and surface texture of the paper. The printing was somewhat uneven on some paper samples, fine on others. Output was good on the lightweight, slick paper supplied by GE, with no discernible difference between the plain paper and thermally sensitive paper.

Results were the same on garden-variety fanfold computer paper and on multipurpose 20-pound bond with a smooth finish. However, the printing on two samples of letterhead-quality bond with a rougher surface texture was totally unacceptable.

If you prefer the fancier papers, you'll probably be disappointed with the print quality of the 3-8100. Otherwise, except for the lack of boldface and italics, I was delighted with the printer and had no problems during operation. It's certainly worth considering if you don't need speedy output, and that's the bad news.

**SPEED**

The speed of the 3-8100 is listed at 25 characters per second in normal mode and 50 cps in draft mode. To GE's credit, the specifications also include throughput figures: 12 lines per minute in normal mode and 18 lpm in draft mode for 80-character lines.

The printer was not that fast in the

standard BYTE 4000-character benchmark tests (50 lines of 80 A's; see "The Art of Benchmarking Printers" by Sergio Mello-Grand, February 1984 BYTE, page 193). Throughput on the model I evaluated was 14.2 cps and 10.7 lpm in normal mode, and 20.4 cps and 15.3 lpm in draft mode. To use a real-world illustration, the printer in normal mode took 21 minutes to print a 15K-byte file (11½ pages, double-spaced, on fanfold paper). For some applications, this slowness would be extremely frustrating.

**DOCUMENTATION**

The documentation is better than most I've seen. It is thorough and well written, with profuse illustrations. Control-code programs are covered nicely, with output examples generated by each code, although more information would be helpful here. It's implied, but the manual doesn't really spell out, that you can use the codes to create some additional type configurations not pictured. For example, you can get one size of double-width with pica and another with elite. You can condense the double-width type to get still more sizes.

The manual includes a blank for ordering printer supplies, and you should note the statement about four weeks for delivery. That's about how long it took to get some ribbons. The toll-free number for the GE Answer Center is prominently displayed on the back cover. I called, prepared for the usual 15 minutes of canned music. To my amazement, someone answered after the first ring. This is a first in my consumer career. I would consider it luck, but the same thing happened when I called a week later with more questions.

Obviously, the GE 3-8100 isn't suitable for heavy-duty high-speed applications frequently requiring long documents. But for lower-volume home and small-business operations, it's a definite contender. After a month of fairly heavy use, I'm quite pleased.

The GE 3-8100 comes with a two-year warranty. Considering the price of \$299.95, print quality, and features per dollar, it's a good product. ■

64K ■ 128K ■ 256K

**DRAMS**

80287-8 ■ 80287-3

8087-3 ■ 8087-2

8087-1

BITTNER



ELECTRONICS

899 SOUTH COAST HIGHWAY  
LAGUNA BEACH, CA 92651  
(714) 497-6200

CALL NOW FOR **FREE** CATALOG

Inquiry 36

**16-BIT RESOLUTION  
ANALOG-TO-DIGITAL  
CONVERTER**

**12,000 SAMPLES/SEC  
for IBM PC, XT & AT  
SINGLE PIECE PRICE  
\$475**

We manufacture a broad line of data acquisition and control hardware and software for Apple and IBM computers.

Call for quotes on custom hardware or complete systems.

**LAWSON LABS, INC.**

5700 RAIBE ROAD  
COLUMBIA FALLS, MT 59912  
406-387-5355

Inquiry 200

**M68000 SINGLE  
BOARD  
COMPUTER**



On board 6-10 MHz CPU, 20K RAM, 32K EPROM, two RS-232, 16-bit port, 5-counter/timers expandable via Memory/FDC Board.

M68K CPU (bare board)	\$ 89.95
M68K CPU A&T (6MHz)	\$495.00
MD512K Memory/FDC (bare board)	\$ 89.95
MD512K Memory/FDC (128K)	\$495.00
FDC/Hard Disk Interface option	\$150.00
M68KE Enclosure w/power supply	\$249.00
M68K Monitor EPROM's	\$ 95.00
M68K Macro Cross Assembler	\$195.00
4XFORTH OS w/assembler, editor	\$295.00
CP/M 68K OS w/'C' compiler	\$395.00

**EMS** Educational Microcomputer Systems P.O. Box 16115 Irvine, CA 92713 (714) 854-8545

Inquiry 124

# Meet our P

## Choosing a modem for your personal computer just got easier.

Modems are remarkable little gadgets. They can connect you and your PC to mountains of data and oceans of information. But up until now, deciding which modem to buy hasn't been easy. So to solve that little problem, IBM is offering two 1,200 bps PC modems. Modems that not only give you the best features currently available on PC modems, but also offer features usually found only on higher priced, higher speed modems.

### First, a Brief Introduction to the IBM PC Modems:

The IBM 5841 is a stand-alone modem capable of operating at 0-300, 600 and 1,200 bps in asynchronous mode, and 600 and 1,200 bps synchronous.

Our other modem is the IBM Personal Computer Modem—an internal, half-card modem that operates at 0-300, 600 and 1,200 bps asynchronous.

### The Non-Identical Twins

In some respects, these two modems are very similar. For example, they both have Automatic Adaptive Equalization—which means they will continuously fine-tune themselves to compensate for changes and noises on the telephone line. The result is, you can receive data over a wider range of phone line conditions. This is one of those features more often found on faster, more expensive modems.

In addition to automatic answering, both modems offer Adaptive Dialing—which means that if you don't specify either tone or pulse dialing, the modems try tone dialing for one digit, and if that doesn't work,

they automatically switch to pulse dialing.

Both modems will automatically re-dial a number as many times as you tell them to. Or if you prefer, they can switch to an alternate number on a busy signal or a no answer. Once a connection is made, the modems automatically detect and adjust to the incoming transmission speed. They can also initiate an automatic log-on sequence including control characters, ID number and password.

And both modems have extensive "Help" menus, a complete complement of built-in diagnostics, a programmable speaker, and two phone jacks on the back so both your phone and the modem can be connected to the same line at the same time. You can even switch between voice and data without interrupting the phone call.

### A Modem with a Memory of Its Own

The IBM 5841 stand-alone modem has some additional features you don't usually find on 1,200 bps modems. For example, the modem is switchable between asynchronous and synchronous modes and has a 20-entry Dialing Directory. Kept in non-volatile

# C Modems

storage, the directory enables the modem to dial up and log on to systems automatically. This feature is most convenient when the 5841 is used with a fixed-function ASCII terminal such as the IBM 3161 or 3163.

The front panel of the 5841 has a complete array of eight LED Status Indicators to give you a quick visual check on what's happening.

## A Half Can Be Better Than a Whole

Why? Because the IBM Personal Computer Modem can use a short slot in the IBM PC XT and the *Portable* PC. It also fits nicely into a full slot in the IBM PC and the PC AT.

Another nice touch is that a PC diagnostic diskette comes with each of these internal, half-card modems.

## Standards & Compatibility

You'll be pleased to know that both modems meet the Bell 103/212A and V. 22 CCITT standards.  
Both

can use the industry standard "AT" command set, as well as the IBM command set. And both modems have been tested for compatibility with leading PC communications software such as the IBM PC Communications Manager, Crosstalk™ XVI, Smartcom II® and Transporter™.

So if you've been thinking about tying your PC into your company's computer, or accessing an outside data base for stock market information or airline schedules, or using electronic mail, or just exchanging information on a user group's bulletin board—then it's time you got an IBM modem for your PC.

For the Authorized IBM PC Dealer or the IBM Product Center nearest you—or for free literature—call 1 800 IBM-2468, Ext. 104/YU. Or contact your IBM marketing representative.



**Stand-Alone.**  
The IBM 5841  
1200 bps Modem

**Internal.** The IBM Personal  
Computer 1200 bps Modem



5-86

IBM  
DRM, Dept. YU/104  
101 Paragon Drive  
Montvale, NJ 07645

Please send me information on the IBM PC Modems.  
 Please have an IBM marketing representative call me.

Name \_\_\_\_\_ Title \_\_\_\_\_  
Company \_\_\_\_\_  
Address \_\_\_\_\_  
City \_\_\_\_\_ State \_\_\_\_\_ Zip \_\_\_\_\_  
Phone \_\_\_\_\_



*Ed's fortunes changed when he chose a wimpy database that couldn't network.*

Had Ed chosen Network Revelation<sup>®</sup> his data, and career, would have been secure. Because Network Revelation is a complete database applications environment that safeguards data by locking at the record level. So two users can't accidentally change the same record at the same time.

There's more. Network Revelation includes an applications generator that automatically writes code in R/BASIC, Rev's powerful programming language. And for the rest of us, there's a versatile report writer with English language queries.

All this is built around a systems approach to database management that has the muscle for even the toughest multi-user applications.

The secret is superior technology.

Variable-length fields save disk space on network servers. Unlimited files, fields and records keep pace with your expanding information needs. Data dictionaries make it easy to change your database when you change your mind. And our high-speed compiler accelerates program execution.

To make upgrading your present single-user application even easier, dBase II<sup>®</sup> and Lotus 1-2-3<sup>™</sup> conversion utilities are included.

Network Revelation prices start at a mere \$1495. Implementations for IBM's<sup>®</sup> PC Network, 3Com's<sup>™</sup> EtherSeries,<sup>™</sup> Nestar and Novell NetWare<sup>™</sup> are all available now.

Call today to order our \$24.95 Demo/Tutorial (includes free demo

disk) or to schedule a career-altering demonstration of Network Revelation's superior capabilities.

IBM<sup>®</sup> of International Business Machines. NetWare<sup>™</sup> of Novell, Inc. 3Com<sup>™</sup> and EtherSeries<sup>™</sup> of 3Com Corporation. 1-2-3<sup>™</sup> of Lotus Development Corporation. dBase II<sup>®</sup> of Ashton-Tate.



**COSMOS<sup>™</sup>**

Cosmos, Inc., 19530 Pacific Highway S., M/S 102, Seattle, WA 98188, (206) 824-9942, Telex: 9103808627



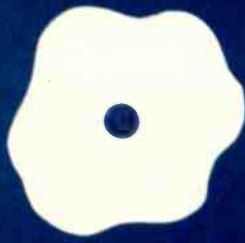

# Lettrix

Almost-  
letter-quality  
text  
on your  
dot-matrix  
printer

BY ALAN R. MILLER

**L**ettrix, a resident print processor for the IBM PC and compatible computers, lets you design your own typeface or use one of 20 provided typefaces, including Greek, Cyrillic (Russian), Hebrew, and scientific symbols (integral sign, square-root symbol, infinity symbol, matrix brackets, and so on). Lettrix prints each line twice with full proportional spacing. The result is almost as good as text printed with a daisy wheel. The edges of the letters are a bit more ragged and Lettrix leaves more spaces between words, but output is far superior to the conventional dot-matrix product.

You load Lettrix with the names of one or more of the typefaces. Lettrix returns you to DOS after the program and the requested typefaces become resident in main memory. Seven different typefaces will reduce memory by about 70K bytes. However, if you require only one typeface and you use the WordStar switch (to ignore the graphics characters in the IBM character set), you can reduce the required memory to 40K bytes. You would then have access only to the characters represented on the keyboard; you would not be able to use, for example, the special accent and umlaut characters and the graphics characters for drawing boxes.

After you load Lettrix, you still print in the usual fashion. You can print word-processor files or you can redirect output from the TYPE command to the printer with

```
TYPE filename > PRN
```

Lettrix intercepts the output and creates the desired characters.

Your computer will print a screen dump if you press the Shift and PrtSc keys. However, it will correctly print graphics characters only if you have an IBM graphics printer. Epson graphics printers, for example, use a different character set. Lettrix can fix this problem by generating its own graphics characters. You can load Lettrix with a character set like Prestige, then turn

off both proportional spacing and justification. This will let you dump both text and character graphics.

To access the Lettrix menu (see photo 1) when the program is resident, hold down the right Shift key and press the Return key. At this point, do not press PrtSc to get a hard copy or you will lock up the computer. Numbers identify the resident typefaces and reverse video marks the currently selected typeface. The menu also describes 14 of the selectable features, including compressed and double-width letters. Reverse video identifies currently active features. From the menu, you can change the typeface as well as the default settings of these 14 options. A third section of the menu lets you change the character pitch, left margin, vertical spacing, and spacing between letters. Again, reverse video marks the active states. However, a more usual way of selecting these features is with backslash commands embedded within your text.

## FORMATTING COMMANDS

When Lettrix is resident, it creates the desired typeface from the regular characters sent to the printer. It also examines the text stream for the backslash character, the symbol that causes Lettrix to take action (see table 1 for a summary of the formatting commands). If a number from 1 to 7 follows the backslash, the corresponding typeface is selected. You can turn on features with an uppercase letter and turn them off with the corresponding lowercase letter. For example, \U begins underlining and \u terminates it.

Most of the commands are self-explanatory, although a few are unusual. When you use the split-line feature, Lettrix left-justifies the part of the line to the left of the command and right-justifies the part to the right.

If your word processor has commands that duplicate Lettrix's, you can use either set. For example, WordStar has commands for underline, boldface, double-strike, super-

(continued)

Alan R. Miller, a BYTE contributing editor, is a professor at New Mexico Institute of Mining and Technology (Metallurgy Department, Socorro, NM 87801), where he has taught materials science, thermodynamics, electrical engineering, and programming methods since 1967.

He holds a Ph.D. in engineering from the University of California at Berkeley and has written six books on computer languages.

**AT A GLANCE**

**Name**  
Lettrix

**Type**  
Resident print processor that produces more than a dozen typefaces, near-letter-quality print, and full proportional spacing on dot-matrix printers

**Company**  
Hammerlab Corp.  
5700 Arlington Ave.  
Riverdale, NY 10471  
(800) 351-4500

**Format**  
5¼-inch double-sided floppy disk

**Computer**  
IBM PC and compatibles

**Necessary Hardware**  
One double-sided disk drive; IBM dot-matrix, Epson, Okidata, Star, Hewlett-Packard, ThinkJet, Panasonic, Inforunner Riteman, or C. Itoh printer; 256K bytes of RAM

**Necessary Software**  
PC-DOS 2.0 or higher

**Documentation**  
36-page manual printed with Lettrix, several demonstration programs

**Price**  
\$98.50

script, and subscript operations. You could use Ctrl-S to mark both the start and the end of underlining for WordStar, or use the \U and \u pair with Lettrix. For some operations, like boldface or underlining, Lettrix is better. For example, Lettrix prints boldface in two passes while WordStar uses four (of course, you can alter WordStar to make it use fewer passes). For other operations, such as subscripting and superscripting, your word processor might be better.

**PROPORTIONAL SPACING**

The regular dot-matrix lettering in figures 1 and 2 has a fixed pitch with a fixed-size typeface. All the letters have about the same spacing and width. By contrast, Lettrix's proportional spacing (see figure 3) prints narrow letters close together and wide letters farther apart. Some word processors, like WordStar, can change the spacing between letters from one line to the next. However, all characters in a line have the same pitch. By contrast, programs like Lettrix have sizes assigned to each letter. The result in figure 3 is true proportional spacing with output almost as good as that from a daisy-wheel printer.

Some print aids, like MagicPrint (see

*(continued)*

Table 1: The Lettrix formatting commands. The \* indicates that a parameter is required.

\B	Boldface
\C	Compressed type
\F	Superscript
\H	Double height
\I	Italics
\L	Enable Lettrix
\M	Margin*
\P	Proportional spacing
\R	Superscript roll*
\S	Subscript
\T	Table format
\U	Underline
\W	Double width
\1	Typeface 1
\2	Typeface 2
\#	Horizontal pitch*
\"	Vertical pitch*
\/	Split line
\\	Print backslash
\@	Restore default settings
^	Backspace for accent

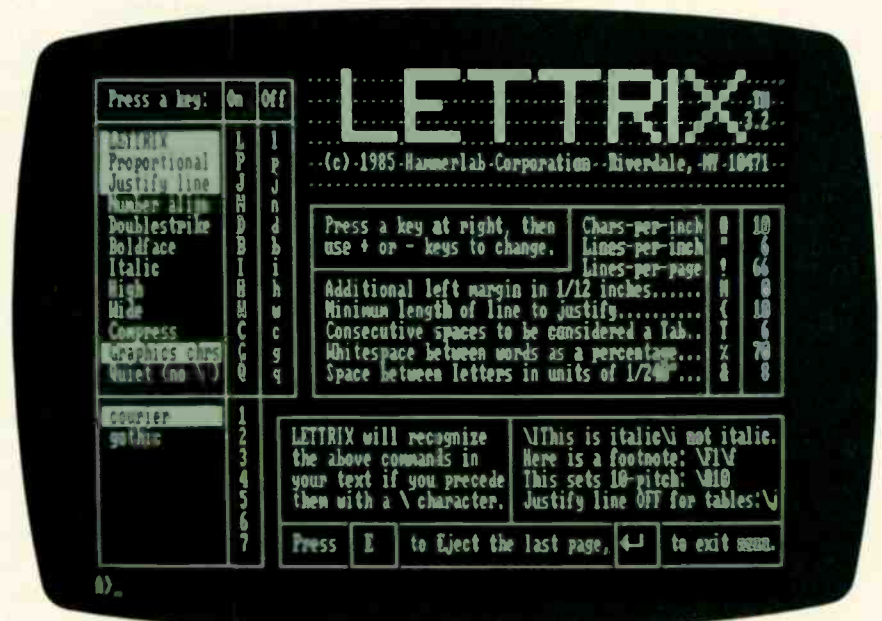

Photo 1: The Lettrix menu.



# The C for Microcomputers

PC-DOS, MS-DOS, CP/M-86, Macintosh, Amiga, Apple II, CP/M-80, Radio Shack, Commodore, XENIX, ROM, and Cross Development systems

## MS-DOS, PC-DOS, CP/M-86, XENIX, 8086/80x86 ROM

### Manx Aztec C86

*"A compiler that has many strengths ... quite valuable for serious work"*

Computer Language review, February 1985

**Great Code:** Manx Aztec C86 generates fast executing compact code. The benchmark results below are from a study conducted by Manx. The Dhrystone benchmark (CACM 10/84 27:10 p1018) measures performance for a systems software instruction mix. The results are without register variables. With register variables, Manx, Microsoft, and Mark Williams run proportionately faster, Lattice and Computer Innovations show no improvement.

	Execution Time	Code Size	Compile/Link Time
Dhrystone Benchmark			
Manx Aztec C86 3.3	34 secs	5,760	93 secs
Microsoft C 3.0	34 secs	7,146	119 secs
Optimized C86 2.20J	53 secs	11,009	172 secs
Mark Williams 2.0	56 secs	12,980	113 secs
Lattice 2.14	89 secs	20,404	117 secs

**Great Features:** Manx Aztec C86 is bundled with a powerful array of well documented productivity tools, library routines and features.

Optimized C compiler	Symbolic Debugger
AS86 Macro Assembler	LN86 Overlay Linker
80186/80286 Support	Librarian
8087/80287 Sensing Lib	Profiler
Extensive UNIX Library	DOS, Screen, & Graphics Lib
Large Memory Model	Intel Object Option
Z (vi) Source Editor -c	CP/M-86 Library -c
ROM Support Package -c	INTEL HEX Utility -c
Library Source Code -c	Mixed memory models -c
MAKE, DIFF, and GREP -c	Source Debugger -c
One year of updates -c	CP/M-86 Library -c

Manx offers two commercial development systems, Aztec C86-c and Aztec C86-d. Items marked -c are special features of the Aztec C86-c system.

**Aztec C86-c Commercial System \$499**

**Aztec C86-d Developer's System \$299**

**Aztec C86-p Personal System \$199**

**Aztec C86-a Apprentice System \$49**

All systems are upgradable by paying the difference in price plus \$10.

**Third Party Software:** There are a number of high quality support packages for Manx Aztec C86 for screen management, graphics, database management, and software development.

<b>C-tree \$395</b>	<b>Greenleaf \$185</b>
<b>PHACT \$250</b>	<b>PC-lint \$98</b>
<b>HALO \$250</b>	<b>Amber Windows \$59</b>
<b>PRE-C \$395</b>	<b>Windows for C \$195</b>
<b>WindScreen \$149</b>	<b>FirsTime \$295</b>
<b>SunScreen \$99</b>	<b>C Util Lib \$185</b>
<b>PANEL \$295</b>	<b>Plink-86 \$395</b>

## MACINTOSH, AMIGA, XENIX, CP/M-68K, 68k ROM

### Manx Aztec C68k

*"Library handling is very flexible ... documentation is excellent ... the shell a pleasure to work in ... blows away the competition for pure compile speed ... an excellent effort."*

Computer Language review, April 1985

Aztec C68k is the most widely used commercial C compiler for the Macintosh. Its quality, performance, and completeness place Manx Aztec C68k in a position beyond comparison. It is available in several upgradable versions.

Optimized C Macro Assembler Overlay Linker Resource Compiler Debuggers Librarian Source Editor MacRam Disk -c Library Source -c	Creates Clickable Applications Mouse Enhanced SHELL Easy Access to Mac Toolbox UNIX Library Functions Terminal Emulator (Source) Clear Detailed Documentation C-Stuff Library UniTools (vi,make,diff,grep) -c One Year of Updates -c
---	--

Items marked -c are available only in the Manx Aztec C86-c system. Other features are in both the Aztec C86-d and Aztec C86-c systems.

**Aztec C68k-c Commercial System \$499**

**Aztec C68d-d Developer's System \$299**

**Aztec C68k-p Personal System \$199**

**C-tree database (source) \$399**

**AMIGA, CP/M-68k, 68k UNIX call**

## Apple II, Commodore, 65xx, 65C02 ROM

### Manx Aztec C65

*"The AZTEC C system is one of the finest software packages I have seen"*

NIBBLE review, July 1984

A vast amount of business, consumer, and educational software is implemented in Manx Aztec C65. The quality and comprehensiveness of this system is competitive with 16 bit C systems. The system includes a full optimized C compiler, 6502 assembler, linkage editor, UNIX library, screen and graphics libraries, shell, and much more. The Apple II version runs under DOS 3.3, and ProDOS, Cross versions are available.

The Aztec C65-c/128 Commodore system runs under the C128 CP/M environment and generates programs for the C64, C128, and CP/M environments. Call for prices and availability of Apprentice, Personal and Developer versions for the Commodore 64 and 128 machines.

**Aztec C65-c ProDOS & DOS 3.3 \$399**

**Aztec C65-d Apple DOS 3.3 \$199**

**Aztec C65-p Apple Personal system \$99**

**Aztec C65-a for learning C \$49**

**Aztec C65-c/128 C64, C128, CP/M \$399**

### Distribution of Manx Aztec C

In the USA, Manx Software Systems is the sole and exclusive distributor of Aztec C. Any telephone or mail order sales other than through Manx are unauthorized.

## Manx Cross Development Systems

Cross developed programs are edited, compiled, assembled, and linked on one machine (the HOST) and transferred to another machine (the TARGET) for execution. This method is useful where the target machine is slower or more limited than the HOST, Manx cross compilers are used heavily to develop software for business, consumer, scientific, industrial, research, and educational applications.

**HOSTS:** VAX UNIX (\$3000), PDP-11 UNIX (\$2000), MS-DOS (\$750), CP/M (\$750), MACINTOSH (\$750), CP/M-68k (\$750), XENIX (\$750).

**TARGETS:** MS-DOS, CP/M-86, Macintosh, CP/M-68k, CP/M-80, TRS-80 3 & 4, Apple II, Commodore C64, 8086/80x86 ROM, 68xxx ROM, 8080/8085/Z80 ROM, 65xx ROM.

The first TARGET is included in the price of the HOST system. Additional TARGETS are \$300 to \$500 (non VAX) or \$1000 (VAX).

Call Manx for information on cross development to the 68000, 65816, Amiga, C128, CP/M-68k, VRTX, and others.

## CP/M, Radio Shack, 8080/8085/Z80 ROM

### Manx Aztec CII

*"I've had a lot of experience with different C compilers, but the Aztec C80 Compiler and Professional Development System is the best I've seen."*

80-Micro, December, 1984, John B. Harrell III

**Aztec C II-c (CP/M & ROM) \$349**

**Aztec C II-d (CP/M) \$199**

**C-tree database (source) \$399**

**Aztec C80-c (TRS-80 3 & 4) \$299**

**Aztec C80-d (TRS-80 3 & 4) \$199**

### How To Become an Aztec C User

To become an Aztec C user call 1-800-221-0440 or call 1-800-832-9273 (800-TEC WARE). In NJ or outside the USA call 201-530-7997. Orders can also be telexed to 4995812.

Payment can be by check, COD, American Express, VISA, Master Card, or Net 30 to qualified customers.

Orders can also be mailed to Manx Software Systems, Box 55, Shrewsbury, NJ 07701.

### How To Get More Information

To get more information on Manx Aztec C and related products, call 1-800-221-0440, or 201-530-7997, or write to Manx Software Systems.

### 30 Day Guarantee

Any Manx Aztec C development system can be returned within 30 days for a refund if it fails to meet your needs. The only restrictions are that the original purchase must be directly from Manx, shipped within the USA, and the package must be in resalable condition. Returned items must be received by Manx within 30 days. A small restocking fee may be required.

### Discounts

There are special discounts available to professors, students, and consultants. A discount is also available on a "trade in" basis for users of competing systems. Call for information.

Inquiry 216

# MANX

To order or for information call:

## 800-221-0440

## Switches to make your PCs powerful.

Reliable and affordable port expansion without memorizing complicated software commands. Switch your PC between peripherals with the push of a button. Is MFJ good? Joe Campbell in his book, *The RS-232 Solution* said, "Switch boxes are sold by many suppliers, but by far the two best values are from MFJ Enterprises." Below are just some of those values.

When you need to switch between two peripherals ... or you need to have two computers share the same peripheral ... MFJ-1240/\$79.95



The 1240 has a built-in transmit/receive switch that allows 2-way information flow. LEDs monitor data lines while built-in surge protectors guard them. Can be used as a null modem. MFJ's No. 1 seller!



When you need 1-to-4 computers to share one peripheral or 1-to-4 peripherals to share a common computer ... MFJ-1243/\$119.95

The perfect office switch. Save money. Don't buy extra printers or modems.

Connect 1-to-4 computers to a single printer or let a PC share up to four peripherals. LEDs monitor data lines; surge protectors guard them. Two way communication is allowed.

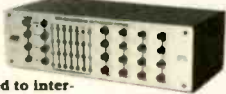
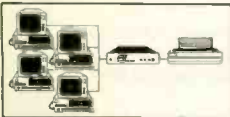

When you need to interconnect four computers and four peripherals at one time! The MFJ-1294 gives you a computer system ... MFJ-1294/\$299.95

With the MFJ-1294 you can create a mini-network of computers and peripherals. All eight devices can be working simultaneously! Think of the production you'll get with the MFJ-1294's 16 possible combinations.

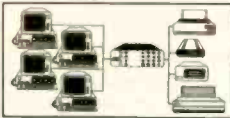

Seven additional models to choose from including MFJ's IBM and Centronics Parallel Switches. All RS-232 switches have RS-232 connectors. LEDs to monitor data lines. MOV surge protectors and transmit/receive buttons that allow 2-way communication.

## And Power Strips to make them safe.

Your fine computer and peripheral equipment can be damaged by electrical surges much smaller than you've been led to believe. Save them and your valuable data with an MFJ Power Center. Multi-filters isolate equipment, eliminating noise/harsh/interaction. MOVs suppress spikes and surges. These are heavy duty, commercial quality Power Strips.



MFJ-1107 - 8 sockets; 2 unswitched; \$79.95

MFJ-1108 - 7 sockets, 1 unswitched. Drop out relay prevents disk drive head from bouncing. \$99.95

MFJ-1109 - like 1107 but intelligent (switch on the device that's plugged into the control socket and everything else comes on); \$129.95

There are other Switches, Power Centers and Computer Peripheral Products available from MFJ. Call and talk with us about all your computing needs. When you do, ask for our latest catalog. Both the call and catalog are free.

**1-800-647-1800**

For technical/repair information, or in Mississippi or outside the Continental United States, please telephone...

**1-(601) 323-5869 or telex 53-4590 MFJSTKV**

All MFJ products come with a double guarantee we think is unmatched. Order from MFJ and try any product for 30 days. If it doesn't satisfy your needs, just return it for a full refund less shipping. If you keep it you can be assured of continued service and our *One Year Unconditional Guarantee*.

Call toll-free 1-800-647-1800 and charge the products you need to your VISA or MasterCard, or send a check or money order, plus \$5.00 shipping, and our shipping department will promptly have your computer peripheral on its way to you.



MFJ Enterprises, Inc.  
921 Louisville Road  
Starkville, MS 39759

## REVIEW: LETTRIX

the review in the January 1985 BYTE), reform each line of the original text, putting as many words as possible on each line (see figure 4). They obtain right justification by adding spaces between letters and between words. Lettrix uses each line just as it is. The tool provides right justification by adding extra spaces between words, but Lettrix does not move words from line to line. As a result, every line of Lettrix text has more blank space, especially when you use Lettrix for-

matting commands that the program replaces with blank spaces. However, Lettrix has a compensating factor. It prints the text as it appears on the screen, with all the paragraph positions and page breaks you intended.

### TWO-COLUMN PRINTING

With Lettrix and WordStar, you can print two-column text. You can produce a two-column format with WordStar by formatting with narrow col-

(continued)

```
The first sentence is the same
for all figures. This figure is
printed with a standard dot
matrix using a fixed pitch.
```

Figure 1: Standard dot-matrix print.

```
The first sentence is the same
for all figures. This figure is
printed with a dot matrix set
to near letter quality. The
pitch is fixed.
```

Figure 2: Near-letter-quality dot-matrix print.

```
The first sentence is the same
for all figures. This figure is
printed with Lettrix set to the
Prestige typeface. Both the
typeface and the character
spacing are proportional.
```

Figure 3: Proportional printing with Lettrix. This is the Prestige typeface.

```
The first sentence is the same
for all figures. This figure is
printed with MagicPrint. Both
the typeface and the character
spacing are proportional.
```

Figure 4: Proportional printing with MagicPrint.



# FILE RECOVERY SYSTEM™

FOR THE IBM-PC

*"Brown Bag Software's™ File Recovery System™...  
more powerful than the Norton Utility Version 3.1."  
—PC Magazine*

## We May Be Able To Save Your Job Or Your Life

# \$69.95

**Recover Erased Files**  
**Edit Any Spot On A Disk**  
**Change File Attributes**

**Fix A Damaged File**  
**Menu-Driven and "Goof-Proof"**  
**Context Sensitive Help**

**Recover Data From Physically Damaged Disks**  
**Works On Hard And Floppy Disks**

YES YOU CAN RECOVER ERASED FILES. Even \*.\*. With Brown Bag Software's™ File Recovery System™ for the IBM-PC and compatibles, no programming experience required. If you can erase a file, you can restore it.

MENU-DRIVEN and "FOOL-PROOF.." Do you have "one-of-those" in your office...we do too! That's precisely why we developed Brown Bag Software's™ File Recovery System™ for the IBM-PC and compatibles! Our menu-driven system is a snap.

FIX A DAMAGED FILE TOO! Sometimes files can get "glitched," by a power spike, bumping into the hard disk, dropping the computer on the floor, etc. We understand. That's why we've included a full screen editor to repair any spot in any file, hidden or otherwise.

IS IT HARD OR FLOPPY? We don't care. We work with floppy disk, most hard disks, and most IBM-PC compatible computers.

HELP IS ONLINE TOO! We know that most people don't read manuals. (But we include a comprehensive one anyway.) And when you erase a file and need it recovered NOW, you're not in any frame of mind to pour through any manual. We understand. That's why we've put hand-holding on line. Just hit the ? key and the help appropriate to where you are and what you want to do is immediately available. The only thing better would be two aspirins!

OTHER HANDY TOOLS...HELP: WHERE'D THE FILE GO? We provide menu-driven tools to change a file's attributes, change disk labels, modify screen color, locate a lost file that you know is somewhere on the disk, but it's lost in a maze of sub-directories (you forgot which).

**WITH YOUR CREDIT CARD, CALL NOW**  
**24 HOURS A DAY, 7 DAYS A WEEK**

## 800-523-0764

IF LINE IS BUSY OR YOU LIVE IN CALIFORNIA

**CALL: 408-559-4545**

# Color Diskettes BY VCENTECH

The Colorful Solution to Data Organization™

## TIMELESS WARRANTY

SS-DD QTY. 100 DS-DD  
**\*69¢** Color Bulk **89¢\***  
**\*85¢** Color Boxed **\$1.05\***  
**\*\*99¢** Color Bulk 96 TPI **\$1.19\*\***  
**\$1.98\*\*** DS-HD

IBM PC-AT Compatible Color Bulk

100% error-free beyond 75% clipping level.

Available in 12 useful assorted colors.

Custom Labeling/Branding available.

\*Color Bulk w/Tyvek sleeves add 6¢. Label Kits 2¢

\*\*Pre-packaged in Plastic Library Case/12. A \$4.95 value case for 20/disk extra. DISKS ARE "OPAQUE"



**\*FREE! Headcleaning Diskette plus \$2.00/box rebate on H/C**

## LIFETIME WARRANTY

SS-DD QTY. 5 BOXES DS-DD  
**\*99¢** w/FREE H/C Kit **\$1.39\***

\$1.29 ← w/Flip 'n' File/15 → \$1.69

\$1.97 ← 96 TPI → \$2.45

\$1.89 ← 3.5"/135 TPI → \$2.59

\$2.09 3.5"/135 TPI w/Flip 'n' File \$2.89\*

DS-HD 96 TPI w/Free Headcleaning Kit \$2.89

DS-HD 96 TPI w/Flip 'n' File 15 \$3.19

DS-HD 96 TPI w/Flip 'n' File 15 \$3.99

3M Headcleaning Kit (After \$2.00 rebate with purchase of regular 3M disk)

3M Data Cartridges

	QTY. 5	QTY. 10
DC-100A	\$12.15	\$12.10
DC-1000	\$14.34	\$12.42
DC-300XLP	\$21.54	\$19.08
DC-600A	\$21.82	\$20.29

## Nashua "Boxed" Diskettes

### LIFETIME WARRANTY

SS-DD QTY. 10 BOXES DS-DD  
**75¢**  **85¢**

\$1.95 3.5"/35 TPI \$2.65

Factory fresh in boxes of 10 with sleeves, user ID labels, write-protect tabs and reinforced hub ring.

High Density for IBM PC-AT Compatible \$2.59

100% Error-Free **BULK** By Leading American Media Manufacturer one of the top 2

### LIFETIME WARRANTY

SS-DD QTY. 100 DS-DD  
**55¢** w/hub ring **65¢**

Tyvek envelopes	6¢ ea.	Labels	2¢ ea.
PRINTER RIBBONS		DISK STORAGE	
Epson MX-7000	\$2.68	Amray Media Mate	
Epson MX-100	\$4.06	50	\$7.99
Okidata 80, 82, 83, 92, 93	\$1.36	Disk Minder II-75	\$8.99
Okidata 84	\$2.95	Micro Disk Minder-36	\$7.75

**PRICE PROMISE:** We will better any lower delivered price on the same products and quantities advertised nationally.

**TERMS:** FREE USE OF VISA AND MASTERCARD. American Express also accepted. Shipping: Add \$3.00 per 100 diskettes or fraction thereof. Other items add \$3.00 for disk storage or headcleaning kit or dozer ribbons or C.O.D. orders. P.O. accepted from recognized institutions and schools on 2% - 10 Net 30. Utah residents add 5% sales tax. Minimum order \$30.00.

**TOLL FREE ORDER LINE:**  
**1-800-233-2477**  
**INFORMATION AND INQUIRIES:**  
**1-801-942-6717**

**Computer Affairs, Inc.** 2028 E. FT. UNION BLVD., 105 SALT LAKE CITY, UTAH 84121 CALL 1-800-AFFAIRS HOURS 9AM-6PM M-F (Mtn. Time)

## REVIEW: LETTRIX

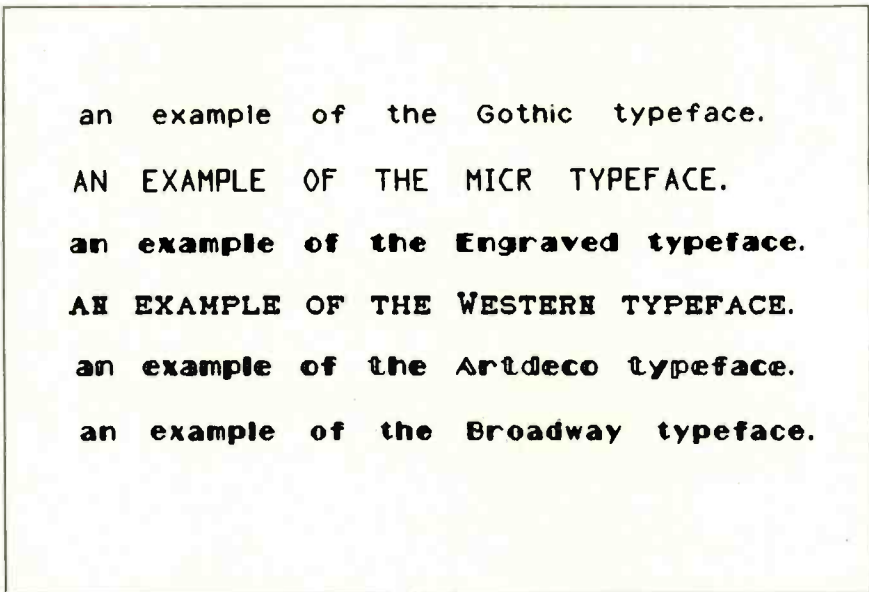

Figure 5: Some examples of Lettrix typefaces.

umns. By using the column block move, you can transfer each even-numbered page to the right side of the previous odd-numbered page. In this case, you should format the text ragged right or turn off microjustification.

If there are at least five blanks between the two columns, Lettrix automatically tabs over to a fixed position for the right column. This produces two left-justified columns that are ragged on the right side.

### COPY PROTECTION

The Lettrix disk is copy-protected. You can copy all the programs to a backup disk, but you cannot run Lettrix from this disk. If you scramble the original disk, you can copy these duplicate files back to the original. You can also copy the typeface file to your word-processor disk, but you must insert the original disk when you load Lettrix.

An included program lets hard-disk users copy Lettrix and its associated files to the fixed disk. You will then no longer need to use the original copy of the Lettrix disk.

### DEMONSTRATION PROGRAMS

Three different batch files demonstrate Lettrix's features. One program loads and provides examples of different typefaces with roman letters

(see figure 5). A second program prints the keytops for the Greek, Cyrillic, and Hebrew typefaces in their appropriate keyboard positions.

The third program demonstrates the mathematics and science symbols. For example, you can make an integral sign by combining three separate keys, although you must temporarily reduce the vertical pitch to let the three parts connect.

### PROBLEMS AND CONCLUSIONS

Lettrix slows down your printer to about one-quarter of its fastest speed because it prints in a single direction in graphics mode (two printing passes in one direction and two returns). Furthermore, it bypasses print buffers so you must wait until the printing is finished before you can do anything else. Of course, the result is a much-improved printout.

When Lettrix is resident, your memory size is reduced by 40K to 76K bytes even if you are not using your printer. If you have finished printing a document with Lettrix and want to release the memory space, you cannot easily disengage Lettrix. You must reset the computer by pressing the Ctrl, Alt, and Del keys.

Nevertheless, if you have a dot-matrix printer and you want to create nice-looking letters and reports, Lettrix will do the trick. ■

## TURBO PASCAL 3.0

Mark Bridger's review of Turbo Pascal 3.0 (February, page 281) gives the misleading impression that version 3.0 does not support arrays larger than 32K. While it is true that the upper bounds of arrays are limited by the maximum integer size of 32767, you can create a one-dimensional array of almost 64K single-byte elements by using a negative integer lower bound (albeit with sacrificed readability in some cases). For example, the following declarations will create an array of 64927 (64K minus 609) bytes, which seems to be about all that Turbo's static data space will hold:

```
type
  BigArray = array[-32767..32159] of
    byte;
var
  Array64 : BigArray;
```

If Array64 is declared as a pointer to BigArray, the dynamically stored array can contain up to 65535 (64K minus 1) bytes, if the range specified is [-32767..32767].

Although Turbo Pascal will now allow declared data structures to exceed 64K bytes (actually slightly less, as just noted) and restricts the number of elements per dimension to the number of available integers, much of the functionality of larger structures can still be achieved. For example, multidimensional arrays as large as available storage can be created in Turbo Pascal by using arrays of pointers to structures smaller than 64K. For example

```
type
  BigArray = array[-32767..32767] of
    byte;
  Array64 = ^BigArray;
var
  HugeArray : array[1..8] of Array64;
```

The awkwardness of this indirect method of accessing such large data structures (greater than 64K) is more visible to the programmer in Turbo Pascal than in some other "larger" language implementations, but it actually reflects limitations inherent in the 8088/8086 segment-offset mode of addressing.

Despite these reservations, I agree with Professor Bridger that 32-bit integers

would make a valuable addition to the next release of Turbo Pascal.

WILLIAM F. WEIGEL  
Berkeley, CA

## VME/10

Bravo for Robert E. Robinson's review of the Motorola VME/10 (February, page 253). There are thriving markets for computers and peripherals based on Motorola's VMEbus and Multibus. The IBM PC (and its many clones) has demonstrated its value in a variety of applications, but alternatives are available. With their improved data-transfer rates, VMEbus and Multibus-based systems may offer distinct advantages in computationally intensive applications. A wide variety of hardware interfaces are also available for these buses.

DAVID J. STATES  
San Diego, CA

## IBM PC COMPATIBLES REVIEW IN THE WORKS

I would be very interested to see a roundup of IBM PC-compatible computers that are selling for \$1000 and less by stores or by major manufacturers such as Epson.

Also, how reliable are the vendors? If you send them \$1000 will you receive a computer? Some ads promise a one-year warranty and telephone support.

ROB SCHOENBAUM  
New York, NY

*Thank you for your comments; we have such a review in the works.*

JON EDWARDS  
Technical Editor, Reviews

## IBM'S PROFESSIONAL GRAPHICS SYSTEM

The text box by Rodrigo Silveira on page 358 of the review of IBM's Professional Graphics System (November 1985) mentions a bug in the Professional Graphics Controller's random-area-filling subroutine AREA, namely that the areas are only filled properly if the current default color is different from the boundary color of the area to be filled. However, this is not a

bug. It is precisely how this subroutine is supposed to work. In the manual, it is stated that "The region extends outward in all directions until reaching a boundary of PELs [picture elements] whose colors differ from the original color of the PEL at the current point and the current color." Also, it mentioned in the text box that neither the RESET nor the LUTINT 0 command resets the color lookup table to the default palette. Well, the RESETF only resets certain flags that are listed in the manual and the state of the color lookup table is not one of them. The LUTINT 0 command does in fact work. The author probably did not include a delimiter after the LUTINT 0 command. One must include a delimiter after every command, even if there are no other commands immediately following it.

In the main article it is stated that, although expensive, the PGC board is less expensive than any comparable graphics system one could put together. Although this may have been true at the time the article was written, it certainly is not true now. Several companies offer it for less.

It is also stated that ample documentation is included with the PGC. However, the references provided make no mention of how to access any of the three-dimensional capabilities of the board or many of the other features that make this board such a powerful piece of hardware. The GKS software provided is oriented toward systems with multiple workstations, so there is a lot of initialization overhead that is unnecessary for a personal computer. It is far easier to communicate with the board directly instead of going through the GKS interface, but to do this you need to write your own device driver.

I have worked with the PGC for the past six months. The only complaints I have concern the price and the difficulty in obtaining truly useful documentation from IBM.

LAURENCE EDWARDS  
Mountain View, CA ■

REVIEW FEEDBACK is a column of readers' letters. We welcome responses that support or challenge BYTE reviews. Send letters to Review Feedback, BYTE Publications, POB 372, Hancock, NH 03449. Name and address must be on all letters.

TABLE 1  
COMPARISON CHART  
RELATIVE RANK OF WP PACKAGES

FEATURE	WORDSTAR 2000 PLUS REL. 2	MICROSOFT WORD VERS. 2.0	WORD PERFECT VERS. 4.1	MULTIMATE ADVANTAGE VERS. 3.5	DISPLAY- WRITE 3 VERS. 1.0
Installation	1	2	3	1	4
Documentation	1	2	2	2	3
Ease of Learning	1	2	3	1	4
Functionality	1	2	2	3	2
Performance	2	2	1	3	3
Document Control	1	3	2	4	1
Text Control	1	3	2	2	2
Page Control	2	1	3	3	3
Micro Editing	2	1	2	2	3
Global Control	1	2	1	3	2
Page Layout	2	1	2	3	1
Printing	3	3	3	2	4
Advanced Features	1	2	2	3	3
Writing Aids	3	1	1	2	4
Printers/Fonts Supported	1	3	3	3	2
Connectability	1	4	4	3	5

Note: The comparison numbers represent the relative ranking of each package compared to the others. The package with the highest ranking is given a 1. If packages rank equally, they are assigned the same ranking number.

Source: InfoCorp



# SINK YOUR TEETH INTO THIS.

*Introducing WordStar® 2000 Plus Release 2, the new and improved software that topped InfoCorp's chart of word processing packages.*

We could make all kinds of claims about our new WordStar 2000 Plus Release 2.

About its commonsense commands. Tutorials for easy training. Direct Lotus® file input. Extensive printer support. DCA connectivity. LANs and site licensing options.

That would be easy to do.

But we decided to let the experts do the talking.

In a comparative report—the report containing the chart to the left—Robert Lefkowitz of InfoCorp said:



*"WS 2000+ emerges as a clear winner in overall applicability. InfoCorp believes WS 2000+ would appeal to the largest number and widest variety of users. Its layered functionality, ease of learning, and excellent communications features make it ideal for corporate users, ranging from secretaries to clerks to managers to executives."*

And, after reviewing WordStar 2000 Plus Release 2 alongside MultiMate™ Advantage™ and IBM®'s

DisplayWrite® 3, International Data Corporation's Jim Chapman concluded:



*"WordStar 2000 is our favorite—for ease of learning, ease of use... and for well-conceived and helpful documentation."*

Now we don't expect you to take these opinions as gospel.

Because when it comes to knowing your company's word processing needs, you're the expert who really matters.

So evaluate our product yourself.

See your local MicroPro dealer today. Or call 800-227-6703 (800-632-7979 in California) for the dealer nearest you. Put WordStar 2000 Plus Release 2 to the test and see how it measures up to the advance reviews.

We believe it'll be time well spent. For you and your company.

If you'd like the complete InfoCorp and IDC reports, we'll be happy to send them to you. Just fill out the coupon below and mail it to us, or call 800-443-0100 x. 547.



**WORDSTAR®**  
**2000**  
**RELEASE 2**

*Powerful word processing has never been easier.™*

**MicroPro International, Industry Analyst Reports  
P.O. Box 57135, Hayward, CA 94545**

Yes, I'd like copies of the InfoCorp and IDC Reports on WordStar 2000 Plus Release 2. Please send them to me right away.

Name \_\_\_\_\_

Title \_\_\_\_\_

Company \_\_\_\_\_

Address \_\_\_\_\_

State \_\_\_\_\_ Zip \_\_\_\_\_

Phone (\_\_\_\_\_) \_\_\_\_\_

Lotus and IBM DisplayWrite 3 are registered trademarks of Lotus Development Corporation and IBM Corporation, respectively. MultiMate and Advantage are trademarks of MultiMate Corporation. Current WordStar 2000 owners can update to WordStar 2000 Release 2 by calling MicroPro Customer Update: 800-433-0100 x. 265. 8805M 2/86



PAUL  
DEGEN

# Kernel

---

<b>COMPUTING AT CHAOS MANOR: EXPANDED/EXTENDED MEMORY</b> <i>by Jerry Pournelle</i> .....	311
<b>BYTE JAPAN: AN INNOVATIVE PROGRAM</b> <i>by William M. Raike</i> .....	329
<b>APPLICATIONS ONLY: A MIXED LOT</b> <i>by Ezra Shapiro</i> .....	335
<b>ACCORDING TO WEBSTER: 68000 WARS: ROUND 2</b> <i>by Bruce Webster</i> .....	343
<b>BYTE U.K.: INTUITIVE SOLUTION</b> <i>by Dick Pountain</i> .....	363
<b>MATHEMATICAL RECREATIONS: THE PELLIAN EQUATION</b> <i>by Robert T. Kurosaka</i> .....	379

---

THIS WAS A MONTH when Jerry was battling a mild case of the flu. Rising from a sickbed he didn't enjoy being in, he was able to look at a wide assortment of new products. Jerry also looks at new kinds of memory, discusses Commodore's Amiga and the Atari 520ST, and plays a game called Sundog.

EM/3+ is a set of programs that runs under MS-DOS; it lets you run most CP/M-86 and CP/M-80 application programs unchanged and lets you read and write floppy disks in any of three MS-DOS formats and in any of several common CP/M formats. Bill Raike talks about this Japanese program and its many useful capabilities.

In Applications Only, Ezra Shapiro describes Boxes & Arrows, a program for the IBM PC that is a cross between a presentation-graphics program and a spreadsheet; Boxcalc, a spreadsheet oriented toward classic business reports; Interlace, a database for the Mac; and PC-Outline, a user-supported outliner.

After a month's respite from the bout, Bruce Webster is back with Round 2 of the 68000 wars. Two new machines have joined the competition since the end of Round 1: the Atari 1040ST and the Macintosh Plus. This month's column looks at the five prominent 68000 computers, providing comparisons and benchmarks.

Dick Pountain describes Intuitive Solution, a business application generator for the IBM PC, XT, and AT. This programming environment is tailored for business and office automation systems and goes beyond the mere cosmetics of icons, windows, and mice.

In Mathematical Recreations, Bob Kurosaka begins with another word problem that needs a whole-number solution. What first appears to be another Diophantine equation turns out to be a Pellian equation, which was first proposed by Pierre de Fermat. Bob provides a powerful procedure for solving the Pellian equation.

AMERICAN MICRO TECHNOLOGY  
presents



STARRING

**XT-PLUS**

**AMT 286**

and  
Introducing

**AT jr**



**XT-PLUS**

IBM PC XT Compatible, 4.77MHz Clock, 640K Mother Board, 8088 Intel Chip, Keyboard, 135 watt Power Supply, Floppy Disk Controller, Printer Port, Serial Port, Game Port, Clock w/Battery Back-up, Two Disk Drives . . . . . \$699.

**Specials** \*

- Floppy Disc Controller . . . . . \$29.
- Monochrome Graphics Card/PP . . . . . 79.
- Disk I/O Card FDC, PP/SP, Game, Battery Clock . . . . . 79.
- 1200 Baud Modem (1/2 size) . . 159
- XT-Mother Board "O"K expandable to 640K . . . . . 99.
- Mother Board for AT . . . . . 650.
- Keyboard AT . . . . . 65.
- 20MB Drive with Controller . . 425.
- Power Supply 135 watts . . . 65.
- Power Supply 200 watts . . 129.
- XT Chassis . . . . . 31.
- AT Chassis . . . . . 89.
- 8MHz IBM PC XT Compatible Mother Board "O"K . . . . . 175.
- 30MB Drive with Controller . . 590.
- EGA Card . . . . . 275.



**AMT 286**

IBM PC AT Compatible Computer (STM Board) 6 MHz, 640K Memory, Keyboard, Clock & Battery on Board, Floppy & Hard Disk Controller, 1.2MB Floppy, 192 watts Power Supply . . . . . \$1499.\*

**AMT 286-e**

IBM PC AT Compatible Computer (Atronics Mother Board), 8 MHz Clock (enhanced version), 640KB Memory expandable to 1MB, AT layout Keyboard, Floppy & Hard Disk Controller by Western Digital, 192 watts Power Supply, 1.2MB Floppy, 20MB Hard Disk, Socket for 80287 . . . . . \$1999.

"O" Wait State Option . . . . \$300.

**PLEASE DON'T CALL  
TICKETRON . . .  
FOR FAST SERVICE  
CALL US**

**(714) 972-2945  
TWX 5106003265**



**AT jr**

IBM PC Compatible, 2 to 5 times faster than IBM PC, Zero Wait State, Eight Slots, 135 watts Power Supply, 8 MHz & 4.77 MHz Clock (Dual Speed Hardware & Software switchable), 640KB on Mother Board, V-20 or 8088-2 Processor, AT layout Keyboard, Floppy Disk Controller, Two Drives 360KB each, Runs Lotus 123, Wordstar, dBase II & III, Flight Simulator and more . . . . . \$699.\*

\*Prices for quantity purchases only  
Registered trademark of IBM Corporation

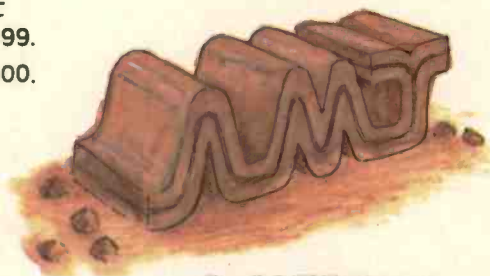

**AMT** AMERICAN  
MICRO  
TECHNOLOGY  
1322 E. EDINGER SANTA ANA, CA 92705

Prices and Availability subject to change without notice.



# EXPANDED/EXTENDED MEMORY

BY JERRY POURNELLE

A mild case of flu has slowed the somewhat frantic pace here, but, alas, the work continues to pile up. My wife sent me to bed for a couple of days and thinks I ought to still be there, but deadlines don't go away. I also have ze confession (oops, too much Hercule Poirot): I really hate being in bed, and I'm glad I have the excuse of the deadline.

## ONE FINE BOARD

The excitement here centers around the Atari 520ST and the Amiga. Both do spectacular things—Electronic Arts has the Amiga Kaleidoscope program that will knock your eye out, while DEGAS for the Atari cycles through an incredible series of science-fiction scenes—and visitors can't stop watching them.

The Amiga and the Atari 520ST are spectacular, but they aren't the only new items here. One of the most useful gadgets we have for Lucy Van Pelt, our fussybudget IBM PC, is Orchid's Conquest board. The PC is normally limited to 640K bytes of memory. The Conquest board expands (not extends; on that, more below) that to 2 megabytes, using the Lotus/Intel/Microsoft expanded-memory specification (EMS). The Conquest board also has ports, a clock, and PCnet, which I haven't connected yet.

Installation of the Conquest board is fairly simple. The documents are complete with examples and explanations of what you must do to the machine, and the installation program that comes with the board is simple enough. As with most Orchid products, you need to read—carefully—through the documents, but they're clear enough once you see what's going on. You do need to know a little about DOS and your system, but

## *Jerry discusses the difference between these types of memory and looks at many new items*

not all that much. It won't take a full hour to do the whole job, after which you're not likely to run out of memory for a while, and if you do, you can add more. You can install up to four EMS cards, for a total of 8 megabytes of expanded memory.

The Conquest board works fine with Orchid's PCTurbo 186 speedup board. Well, fine is too strong a term; programs running in turbo mode can't make direct use of the expanded memory. You can use the extra memory for a RAM disk and print spoolers, but that's about it. Drop out of turbo mode, and you have the expanded extra memory if your program knows how to use it; but in PCTurbo mode, you have only *extended* rather than *expanded* memory.

The Conquest board went into the PC we keep downstairs. Orchid also has an Eccell board for the IBM PC AT; I'm anxiously awaiting one for Big Kat, the Kaypro 286i AT clone that has become my main machine here.

## EXPANDED VS. EXTENDED

If you're confused by this business of expanded versus extended memory, so was I, which was one reason I put off getting either one. Back in the early days of the computer revolution, we bought 4K-byte memory boards (and I can even remember 1K-byte boards!). Ezekial, my friend who happened to be a Z80, had 64K bytes and was considered advanced in 1976.

Back then we dreamed of a time when we'd have half a megabyte.

Big Kat came with 640K bytes, and it isn't enough. I found that out when I tried to run Living Videotext's Ready! with Borland's Turbo Lightning spelling checker and thesaurus. The result was odd: the system didn't

crash or anything, but neither program would work properly. Never an error message: just some commands that wouldn't work when both programs were installed. Either program ran fine if the other wasn't present, but they wouldn't work together. For that matter, once I load in SideKick, Lightning, and SuperKey, I've used up a *lot* of my working space. To use a big program like O&A, I have to kill off something.

That's bad, because it's easy to become dependent on memory-resident utilities. Ready! and SideKick can help organize your life; at least they help organize *my* life, and that's a pretty severe test. My whole phone list and much of my calendar and schedule are in SideKick files. Ready! has a marvelous ability to keep notes, daily schedules, things to do, etc., where you can get at them quickly and easily.

Also, I spend a lot of time on BIX, the BYTE Information Exchange, and using the SideKick editor along with SideKick's ability to squirt text out the modem saves time and trouble. It's often useful to have Turbo Lightning turned on while BIXing; but Lightning won't work with Ready! installed.

It was clear that I needed more

*(continued)*

*Jerry Pournelle holds a doctorate in psychology and is a science-fiction writer who also earns a comfortable living writing about computers present and future.*

# Turbo Extender

## Barriers Were Made To Be Broken

If you're using Turbo Pascal, Turbo Extender is the software you need to break the 64K barrier. Now write programs as long as you need, limited only by available RAM.

### LARGE CODE MODEL

Write programs using all 640K without overlays or chaining. Convert existing programs with minimal effort. Offers advanced dynamic binding or standard EXE files.

### MAKE FACILITY

Offers separate compilation. No starting from scratch for source code changes.

### LARGE DATA ARRAYS

Automatically manages data arrays up to 30 megabytes, as well as arrays stored in expanded memory.

### ADDITIONAL TOOLS

Overlay Analyst, Disk Cache, Pascal Encryptor, Shell File Generator, and File Browser.

### TURBO EXTENDER

Includes 2 DSDD disks, complete source code, 150 page printed manual. Requires Turbo Pascal 3.0 and PC DOS 2.x or 3.x. Runs on IBM PC/XT/AT and compatibles. Call for MSDOS support. \$85 COMPLETE.

### ALSO AVAILABLE TURBOPOWER UTILITIES

Bruce Webster, in BYTE Magazine, February 1986, named it Product of the Month, saying "If you own Turbo Pascal, you should own TurboPower Programmer's Utilities; that's all there is to it."

It offers 9 programs in all, including the Program Structure Analyzer which locates subtle coding problems the compiler fails to catch. It also produces reports that describe your code, providing cross reference and hierarchy diagrams. Also includes Execution Timer, Execution Profiler, Pretty Printer, Command Repeater, Pattern Replacer, Difference Finder, File Finder and Super Directory.

### TURBOPOWER UTILITIES

Come compiled, ready to use. Includes manual, reference card, three DSDD disks, complete source code. Requires Turbo Pascal 2.0 or 3.0. \$95 with source code; \$55 executable only.

GET BOTH TURBO EXTENDER AND TURBOPOWER UTILITIES (Source) \$149

MC/VISA CALL TOLL-FREE 7 days a week  
800-538-8157 x830 (CA)  
800-672-3470 x830 For PO, COD,  
Dealers, Info, Brochures - call or write:



478 W. Hamilton #196  
Campbell, CA 95008  
(408) 378-3672 M-F  
9AM-5PM PST

#### INTERNATIONAL REPRESENTATIVES

Switzerland: Software Haus 064-512651  
Japan: Southern Pacific Ltd. 045-314-9514  
Norway: Polysoft 03-825275  
England: Grey Matter Ltd. 0364-53499  
Australia: Videogram Communications 02-627-1261

## Expanded memory can be used directly by properly written programs.

memory. When I set out to get past the 640K-byte barrier, I found there were two kinds, extended and expanded, and it wasn't at all clear what the difference was. I suppose there's been a lot written about it, but I can't read everything, so I did what I generally do when faced with this kind of problem. I called a knowledgeable friend, in this case, Dave Winer of Living Videotext.

It turns out not to be as complicated as I thought. A couple of years ago, IBM, recognizing the 640K-byte problem, came out with extended memory. That wasn't the right answer. Extended memory can be useful for print spooling and as a RAM disk, but it is not *managed*, which is to say that programs cannot grab and reserve areas of that extra memory. The result is that you can, in theory, write programs to use extended memory, but you can run only one such program at a time. Memory-resident programs can't use it without kludges. Software companies never really got interested in extended memory.

Then Lotus and Intel got together to produce an expanded-memory specification. Alas, they produced more than one, and the different versions aren't fully compatible. Eventually things settled in, Microsoft joined the specification team, and the result is the Lotus/Intel/Microsoft EMS, and that's the one that companies like Living Videotext and Borland International are writing programs for and that Orchid's Conquest board implements. It isn't optimum, but it has become a de facto standard.

A number of companies, including Intel, make expanded-memory boards. Given the rapidly falling price of memory chips, I expect all serious PC-compatible systems to have expanded memory within a year or two. Meanwhile, *don't* get extended mem-

ory. It isn't compatible with expanded, and it's not very useful. Expanded memory can be used directly by properly written programs, and the rest can be configured to be print spoolers, RAM disks, and the like; but, in general, extended memory can't be used as program area.

### CACHING

Some years ago when I first learned about RAM disks—a way of fooling your computer into thinking that a batch of memory is a very fast disk drive—I waxed eloquent about the idea in this column and was presently informed that it had been used in Britain for some time before it appeared over here. As far as I can tell, the first RAM-disk software was written by Jeremy Karlin and marketed by Peter Cheesewright of Microcosm Research (26 Danbury St., London N1 8JU, England). They also produced Microcache, a caching system for CP/M systems. Unfortunately, that came out just about the time that PC-DOS was pushing CP/M out in the cold. Microcache works fine, but it never caught on well enough to give Microcache big sales.

Cheesewright now has a cache system for PC-DOS. It can use regular memory or EMS expanded memory. The program came today, I expect to like it, but I haven't had a chance to run it yet. Real Soon Now, when I feel better.

Caching speeds up disk operations by automatically keeping information from disk files in a special cache memory. The program you're running doesn't have to know that; it merely calls for files, data, overlays, or whatever. The first time it asks for a disk file, there's no speed advantage; but after that there is, because the file is already in memory.

Eventually the cache memory fills. What happens then depends on your program; various caching systems use different algorithms. Cheesewright's Microcache works on frequency: when you call a file that's not in cache memory, Microcache replaces the *least-used* file already there. This guarantees that the disk directory and bit map will always be in cache memory, and that in itself speeds up CP/M

## CHAOS MANOR

by as much as a factor of 10. Micro-cache also did good things for CP/M WordStar.

The Conquest board comes with software to create cache memory. You can also use cache memory with PCTurbo 186. I suppose that most expanded-memory cards come with cache software. I know that the Orchid system makes it very easy to install, and, depending on what you're running, it can speed things up something wonderful.

### MACENHANCER

Another new gadget is Microsoft's MacEnhancer, which connects the Macintosh to Hewlett-Packard's LaserJet printer. I may use the Macintosh with MacEnhancer to do my income tax this year; I've been promised a program to do that. There are also programs that use the Imagewriter to produce acceptable tax forms, but my Imagewriter has been waiting at the dealer for months until Apple can/will send parts. Tax programs are a problem for me, since I don't like to write much about software I haven't actually used. By the time I get this year's program, use it, write the review, and get it into print, that version of the program will be thoroughly obsolete.

Taxes or not, the MacEnhancer works fine. It adds one parallel and two serial ports to the Macintosh without using up any existing ports; that is, it plugs in through the Mac's communications port and has a communications port of its own. Installation is simplicity itself. Just plug the MacEnhancer in, run the supplied installation programs, and tell it what you're trying to do. Then you can use the Mac to drive the HP LaserJet and ThinkJet, Epson FX- and MX- 80 and 100, Okidata 92 and 93, IBM Graphics, and some other printers. The list is growing all the time. If you have more than one printer, you can use the MacEnhancer to connect to them all and then control them through the MacEnhancer's switchboard operation.

I've used the MacEnhancer to connect to the LaserJet. The MacEnhancer is designed to work with Microsoft Word and does that very

(continued)

**"BRIEF has improved my productivity tenfold. It paid for itself in 2 weeks!"**

**David Norwood, Microsystems Manager**

## Tailor Editing to Your Style

- A high-level, readable *Macro Programming Language* - allows customization for programming languages . . . Complete, unlimited variables, etc.
- Edit *multiple files of unlimited size* (2 Meg is OK)
- Multiple *Windows* on screen with different or same file, fragments, etc.
- A bona-fide *UNDO* stack (up to 300) of all operations: deletions, reading files, search, translate, more.
- Full *"regular expression search"* - wild cards, complex patterns
- Reconfigurable keyboard
- Adjustable line length - up to 512.
- *Keystroke macros* - for common typing sequences
- Suspend BRIEF to execute, *exit to DOS* - run another program (like a compiler, dir, XREF, DIFF, or DEBUG) then resume BRIEF session
- *Compiler-specific* support like auto indent, syntax check, compile within BRIEF

For PC, AT, compatibles and Tandy 2000.

Only \$195

Full Refund if not satisfied in 30 days.

**Solution Systems™**

335-B Washington St., Norwell, MA 02061  
617-659-1571

**CALL 800-821-2492.**

## LEARN LISP

**Interactively and Write Real Programs with TransLISP for Only \$75**

*A "COMMON LISP" compatible Tutorial, Interpreter, Debugging, and Pretty Printer plus a Fast, Full Screen Editor, Samples and Help*

**Start Easily and Quickly:**

A complete, modular tutorial helps you learn LISP at your own pace. An integrated, interactive environment provides all of the elements needed to enter, modify, analyze and debug programs.

**Natural Language, Expert Systems and Mailing List:**

Natural Language concepts are illustrated by a phone number retrieval program. Choose the best word processing program for you with the Expert System. File handling and typical data processing work are demonstrated by a Mailing List program.

**Write Realistic Programs:**

Short examples and substantial programs of about 10 pages in length help you learn by modifying, studying and using the key concepts needed to write programs of 1000 lines or more.

**The "COMMON LISP" Standard:**

TransLISP includes a 230+ function subset of the "COMMON LISP" Standard. Use extras like the MSDOS interface and graphics. Or use "strict compatibility" to make programs written in TransLISP, with no changes, work with other COMMON LISP systems like VAX LISP, GC/LISP or LISP Machine LISP.

**Recent Improvements:** 640K Memory use supports 12000 line programs. Full 8087 and 8086 floating point included.

Runs on any MS/PCDOS System with 192K. It is not copy protected.

"The best LISP I've ever used. Three times before, I tried to learn LISP, but until now I could never break through the surface." *W.L. Whipple, customer*

**ONLY \$75**

Full refund if not satisfied during first 30 days.

**Solution Systems™**

335-B Washington St.  
Norwell, Mass. 02061  
617-659-1571  
800-821-2492

well. About the only thing I print, I blush to say, are character sheets generated by the Mac version of Wizardry I: MacEnhancer does that too.

My only real problem with the Mac-Enhancer is that I can't figure out where the devil to put it. It has a small external power supply; that's one more cable to worry about, but no burden on the Mac's power supply.

The MacEnhancer itself is a box about a foot long by four inches wide by a couple of inches high. The Mac won't sit on top of it, and it really won't fit on top of the Mac. The cables that come with it are long enough to let it sit two or three feet away from the Mac, but that's assuming you keep your Mac on a large table. Mine is on a small rolling typing table, and there just isn't room for Mac, keyboard,

mouse, and MacEnhancer. Oh, well.

The Macintosh will never be my favorite small computer. Even the new-and-improved Mac has a screen too small for me to use comfortably. However, even if the Macintosh never becomes the machine for all of the rest of us, it certainly does have its niche. Those who put out newsletters, or any precisely formatted documents, and, in general, those who produce integrated text-and-graphics materials like proposals may well find the Macintosh the best tool available, especially if it's improved with a Mac-Enhancer.

**OLD EYES**

When I was talking with Dave Winer about expanded memory, we got sidetracked discussing the Macintosh.

"It won't fly as a business machine," I said, "because high company executives tend to be my age, and when you get to be my age, your arms are too short."

"Eh?" he asked.

"Farsighted," said I. "As you get older, you tend to get farsighted. The problem is that if I get far enough away from the Macintosh screen to focus on it, the letters are too darned small to read. Reading glasses don't really help. No big business executive is going to put up with having to wear reading glasses in order to see his computer."

"You never said that in your column," Dave reminded me.

I guess he was right. I'd always thought it was obvious, but, of course, it isn't obvious to everyone, which explains a few things. In most business establishments, you're in your late forties and beyond before you get to the top level. Computer executives tend to be younger, which I suppose is why no one at Apple thought that the Mac's small screen would limit its business utility.

After all, there are obvious advantages to the small screen. It has to cost less to make, for one thing. For another, the Mac has no better resolution than the IBM PC, but because of the tiny screen area, the Mac looks as if it has wonderful graphics capability. Looks are what count—provided, of

(continued)

**OASYS**  
Hardware Breakthrough

**EVER WISH YOUR PC COULD OUT-PERFORM A VAX? A SUN?**

- Ever wish your PC ran faster? Had 10 to 20 times more throughput?
- Ever wish your PC had the same kind of high quality, professional software development tools (compilers, assemblers, simulators) you'd normally find in VAX, super-mini or super-micro Unix workstations?
- Ever wish you could port a scientific or commercial application to a PC without having to recompile or restructure your software just to accommodate Intel's architecture?
- Ever wish you had a choice of MS-DOS or Unix V on the same system without having to commit your entire system to one or the other? Ever wish MS-DOS was a virtual demand paged operating system?...

**OASYS MS-DOS Co-Processor**  
... your wish has come true!

The DS-32 PC Co-Processor Board is a self-contained 32-bit computer system—it operates at super-micro speeds (10MHz and no wait states), comes with its own large memory space, full floating point support and highly optimized software tools (both native and cross). It's fully compatible with your standard PC MS-DOS system—no file conversions or re-training is needed. Installation takes just a few minutes—plug it in and go to work.

**DS-32 Features:**

- Uses National's 32032 processor running at 10MHz. (a 32-bit processor running at super-micro speed, out-performs a mid-size VAX and most 68000 workstations. Your PC will run 10 to 20 times faster)
- Uses its own on-board memory: 1 or 2MB versions. 4 to 6MB expansion boards coming.
- Choice of Operating Systems:
  - MS-DOS Standard: You don't have to learn another OS or do any conversion.
  - VIRTUAL MS-DOS Option: the first demand paging version that supports files as big as your disk.
  - Unix System V Option
- Fits any IBM PC, XT, AT or look-alike (Compaq, Wyse, etc.). Uses only one slot.
- Provides its own on-board floating point support.
- Based on Definicon Systems technology.
- Supports dozens of NATIVE high level, optimizing languages: C, Pascal, Fortran. Comes with Assembler, Linker, Loader and Debugger. Exciting new additions: Ada, APL, Basic, and AI tools (LISP, Prolog).
- Supports full complement of CROSS development tools to most 32-, 16-, and 8-bit target systems. Example: 68000/10/20 C, Pascal and Fortran Cross Compilers, Assemblers, Simulators, Debuggers, Profilers. 8086/186/286 C, Pascal and Fortran Compilers.

**Possible Applications:**

- Run large, time consuming CPU-bound applications on a PC:
  - scientific, commercial, avionic, biomedical
  - petrochemical, seismic
  - microprocessor simulations
  - CAD/CAM and graphic designs
  - numerical applications
  - data reductions, matrix operations
  - recursive type programs (e.g., AI tools)
  - ...the possibilities are limitless
- Provide a low cost means of turning your PC into a high-powered software development workstation.
- Minimize porting time, effort, and support problems; eliminates having to contend with Intel 8086/88/186/286 architectural differences (e.g., 64KB addressing limits).

OASYS offers a "One-Stop Shopping" service for software developers. We support, maintain, develop, enhance, and port over 100 high quality, professional software and hardware tools running on numerous hosts (VAX, PC's, Apollo, Sun, Pyramid, etc.) and/or targeting popular 32-, 16-, and 8-bit micros and operating systems.

**We Specialize in:**

Cross/Native Compilers C, Pascal, Fortran, Cobol, Basic, APL, Prolog, Lisp, Ada — Assemblers/Linkers — Symbolic Debuggers — Simulators — Interpreters — Translators  
Converters — Profilers — QA Tools — Design Tools — Comm. Tools, OS Kernels — Editors — Spreadsheets — Data Bases — VAX & PC, Attached Processors and more  
We Support:

680xx, 80x86, 320xx, 58xx, 80xx, dozens more



60 Aberdeen Avenue, Cambridge, MA 02138 (617) 491-4180

Trademarks are acknowledged to: Digital Equipment Corp., AT&T Bell Labs, Microsoft Corp., National Semiconductor Corp., International Business Machines Corp., US DDD Joint Development Office, Intel Corp., Apollo Computer Inc., Pyramid Technology Corp.



# THE PROGRAMMER'S SHOP™

helps save time, money and cut frustrations. Compare, evaluate, and find products.

## SERVICES

- Programmer's Referral List
- Dealer's Inquire
- Compare Products
- Newsletter
- Help find a Publisher
- Rush Order
- Evaluation Literature FREE
- Over 700 products
- BULLETIN BOARD - 7PM to 7AM 617-826-4086

## AI-Expert System Dev't

- Arity System - incorporate w/C. PC \$295
- ExpertEASE - Develop by describing examples of how you decide. MS 595
- EXSYS - Improved, Debug, file & external program access. PC \$339
- 1st class - by example. interfaces \$250
- Insight 1 - probabilities, fast MS \$ 79
- Insight 2 - dB2, language MS \$399
- Others: APES (\$359), Advisor (\$949), ES Construction (\$100), ESP (\$845), Experteach (\$399), Expert Choice (\$449)

## AI-LISP

- List Our
- GC LISP interpreter - "Common", rich. Interactive tutorial \$495 Call
- GC LISP 286 Developer - 2 to 15 meg RAM, compiler & Interp. \$1195 Call
- Microsoft MuLisp 85 \$250 \$199
- TLC LISP - "LISP-Machine" - like, all RAM, classes, compiler. MS \$225
- TransLISP - Good for learning MS \$ 75
- WALTZLISP - "FRANZ LISP" - like, big nums, debug, CPM-80 MS \$149
- Others: IQ LISP (\$155), BYSO (\$125), UNIX LISP (\$59), IQC LISP (\$269)

## AI-PROLOG

- ARITY Standard - full, 4 Meg Interpreter - debug, C, ASM PC \$ 350
- COMPILER/Interpreter-EXE PC \$ 795
- With Exp Sys, Screen - KIT PC \$1250
- MicroProlog - enhanced MS \$ 229
- MProlog - Improved, Faster PC \$ 475
- Professional MicroProlog MS \$ 359
- Prolog-86 - Learn Fast MS \$ 95
- TURBO PROLOG by Borland PC \$ 85
- Others: Prolog-1 (\$365), Prolog-2 (\$1795)

## Editors for Programming

- BRIEF Programmer's Editor - undo, windows, reconfigure PC Call
- C Screen with source 80/86 \$ 75
- EMACS by UniPress - powerful, multifile, MLISP. Source: \$949 \$299
- Entry Systems for C PC \$325
- Epsilon - like EMACS PC \$169
- FirsTime by Spruce - Improve productivity. Syntax directed for Turbo (\$69), Pascal (\$229), or C (\$239)
- Kedit - like XEDIT PC \$115
- Lattice Screen Editor-multiwindow, multitasking Amiga \$100 MS \$125
- PMATE - power, multitask 80/86 \$159
- VEDIT - well liked, macros, buffers, CPM-80-86. MS PC \$119
- XTC - multitasking PC \$ 85

## FEATURE

- Panel Screen Generator - Create screen w/editor, generates code. Data validation, windows, no royalties. Specify Lat., MSC, C86, MS Fortran or Pascal MS \$239

## Free Literature - Compare Products

Evaluate products. Compare competitors. Learn about new alternatives. One free call brings information on just about any programming need. Ask for any "Packet" or Addon Packet  AI  ADA. Modula  BASIC  C  COBOL  Editors  FORTH  FORTRAN  PASCAL  UNIX/PC or  Debuggers, Linkers

## C Support-Systems

- Basic C Library by C Source \$139
- C Debug - Source debuggers - by Complete Soft (\$269), MSD (\$149).
- CPRINT - by ENSCO MS \$ 45
- C Sharp - well supported, Source, realtime, tasks \$600
- C ToolSet - DIFF, xref, source \$135
- Lattice Text Utilities \$105
- The HAMMER by OES Systems \$179
- PC LINT - checker MS \$125
- SECURITY LIB - add encrypt to MSC. C86 programs. Source \$250 PC \$125

## Fortran & Supporting

- ASC Time Series \$469
- Forlib+ by Alpha - graph, comm. \$ 59
- MACFortran by Microsoft - full '77 \$229
- MS Fortran \$219
- No Limit - Fortran Scientific \$129
- PolyFortran - xref, pp, screen \$149
- Prospero - '66, reentrant \$349
- RM Fortran - enhanced "IBM Ftn" \$399
- Scientific Subroutines - Matrix \$149
- Statistician by Alpha \$269
- Strings and Things - registers, shell \$ 59

## MultiLanguage Support

- BTRIEVE ISAM MS \$199
- BTrieve/N - multiuser MS \$469
- CODESIFTER - Execution PRO-FILER. Spot bottlenecks. Symbolic. automatic. MS \$109
- MultiHALO Graphics- Multiple video boards, printer, rich. Animation, engineering, business. Any MS language, Lattice, C86 PC \$249
- Pfinish Performance Analyzer MS \$279
- PLINK-86 - a program-independent overlay linker to 32 levels. MS \$299
- PLINK-86 PLUS - incremental MS \$379
- Poly Librarian MS \$ 85
- Profiler by DWB Associates MS \$ 99
- PVCS Version Control MS \$359
- Screen Sculptor - slick, thorough, fast, BASIC, PASCAL. PC \$ 99
- ZAP Communications - VT 100, TEK 4010 emulation, full xfer. PC \$ 85

## ATARIST & AMIGA

We carry full lines of Manx, Lattice, Metacompo and Prospero.

Call for a catalog, literature, and solid value

# 800-421-8006

THE PROGRAMMER'S SHOP™

128-B Rockland Street, Hanover, MA 02339

Mass: 800-442-8070 or 617-826-7531 386

## RECENT DISCOVERY

ESSENTIAL GRAPHICS - Library, fast, fonts, no royalties. For C, Fortran, Pascal, Hercules, EGA, CGA. PC \$229

## C Language-Compilers

- AZTEC C86 - Commercial PC \$399
- AZTEC C65 - Personal Apple II \$199
- C86 by CI - 8087, reliable MS \$299
- Consular Mac C w/toolkit MAC \$299
- Lattice C - from Lifeboat MS \$289
- Lattice C - from Lattice MS \$339
- Mark Williams - w/debugger MS \$399
- Megamax - tight full ATARI/ST \$179
- Microsoft C 3.0 - new MS \$259
- Q/C 88 by Code Works - Compiler source, decent code, native MS \$125
- Wizard C - Lattice C compatible, full sys. Ill, lint, fast. MS \$389

## C Language-Interpreters

- C-terp by Gimpel - full K & R, .OBJ and ASM, large progs. MS \$249
- H.E.L.P. - innovate env. MS \$ 90
- INSTANT C - Source debug. Edit to Run-3 seconds MS \$399
- Interactive C by IMPACC Associates. Interpreter, editor, source, debug. PC \$225
- Introducing C - learn C fast, self paced tutorial PC \$109
- Professional Run/C - Run/C plus create add-in libraries, load/unload them. MS \$199
- Run/C - improved MS \$109

## C Libraries-General

- Application Programming Toolkit MS \$375
- Blaise C Tools 1 (\$109), C Tools 2 \$ 89
- C Food by Lattice-ask for source MS \$109
- C Power Windows by Entelekon \$119
- C Utilities by Essential - Comprehensive screen graphics, strings. Source. PC \$139
- Entelekon C Function Library PC \$119
- Entelekon Superfonts for C PC \$ 45
- Greenleaf Functions - portable, ASM \$139
- Polytron - for Lattice, ASM source \$ 85
- Software Horizons - Pack 1 PC \$129

## C Libraries-Communications

- Asynch by Blaise \$149
- Greenleaf - full, fast \$139
- Software Horizons - pack 3 \$119

## C Libraries-Files

- FILES: C Index by Trio - full B + Tree, vary length field, multi compiler
- /File is object only \$ 89
- /Pro is partial source \$179
- /Plus is full source \$349
- CTree by Faircom \$339
- dbVISTA - full indexing, plus optional record types, pointers, Network.
- Object only - MS C, LAT, C86 \$159
- Source - Single user MS \$429
- Source - Multiuser MS \$829

course, that you can see the thing. Alas, I can't.

I understand that Apple is coming out with a larger-screen Mac. With a larger keyboard that has arrow keys, a different hard-disk interface, much more memory, and a different screen, it will have about the same relationship to the original Macintosh as the Edsel does to a Thunderbird, but wothehell, toujours gai...

### AMIGADOS

It's pretty hard to compare the Amiga and the Atari 520ST. They're both pretty nifty, with at least as much potential as the Macintosh; what will really make the difference is software. I intend to devote a good part of a column to comparing these two machines as soon as I have enough information to make that meaningful.

As a practical matter, I have maybe ten times as much software for the Atari 520ST as for the Amiga. That's in large part due to Atari's Neil Harris,

who collects the stuff and sends it to me. Commodore will tell me about programs, but it's up to me to write for them. And since some computer companies answer their mail even more erratically than I do, it's a slow process. Also, Atari not only had a booth at COMDEX, it had many software publishers there, so it was easy to get on mailing/review lists. Since Commodore wasn't at COMDEX, there was no central place to do that.

My hacker friends, on the other hand, divide about two to one in favor of the Amiga over the Atari. They're particularly happy with the development packages. Real Soon Now, they say, we'll be flooded with some of the most magnificent software...

They may well be right. The Amiga has a lot of potential. The Amiga Kaleidoscope program is stunning. TextCraft, the Amiga word-processing program, is slow and has other objectionable features, but it's as fast as the early versions of MacWrite, and the

Amiga screen is large enough to see. I find I could grow quite fond of black letters on a white background. The Amiga keyboard is nice, too. I have an experimental version of a programmer's editor, TxED, done by Charlie Heath, and even in its unfinished state, it compares favorably with other good programming editors. (I just hope he puts in some of the macro features of Word Master, which is still the best programming editor around.) Anyway, I know that someone will probably write a creative writer's text editor good enough that I'd happily use it to write books on.

I have a spreadsheet program from Lattice for the Amiga. Nothing magnificent, certainly not Excel, but more useful than VisiCalc and most of the first-generation spreadsheets; again, improvements are to be expected. Lots of good programmers are writing for the Amiga. Potential it has.

Then there's AmigaDOS, the Amiga operating system. Actually, there are

## Why an Amdek monitor is a better investment than buying from Mr. Blue Chip.

Buying a monitor is an important decision. After all, it's a key component of your computer system that must have the capabilities of matching your application needs.

There's no question that ordering a "bundled system" is easier than selecting individual components. But the easy way isn't always the best way. And when it comes to monitors, there's none better than Amdek.

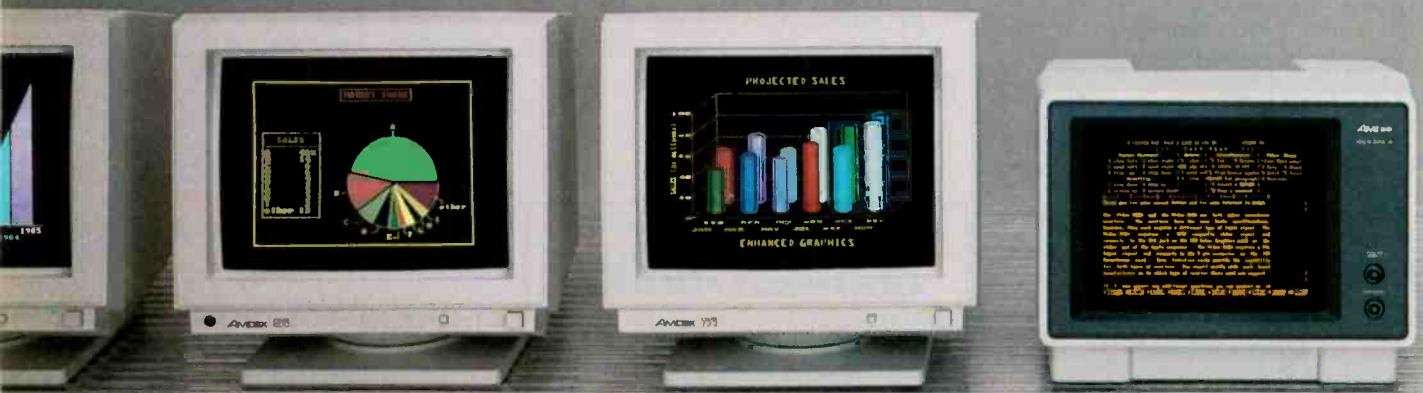

two operating systems. One is very similar to the Macintosh operating system: totally icon-driven. It can be learned quickly, but it's severely limited in what it can do.

Example: when the Commodore folks sent the update software for my Amiga, they sent some demonstration disks. You activate the programs on those disks by inserting them in the machine at boot-up time. Out of curiosity, I wanted to see what programs were on the disks. There weren't any; that is, although the little "fuel gauge" that tells how much space is left on a disk showed that the Amiga Kaleidoscope disk was nearly full—and heaven knows it ran complex enough programs—the operating system couldn't find any icons. And if it don't have no icons, it don't have no programs according to standard user AmigaDOS.

Clearly something was wrong. BIX has a lively conference on the Amiga, so I asked there and was told, "You

just type `dir df1: opt a`, and it will show you all files in all directories on a disk in your external disk drive."

That was all very well, except that I could type until doomsday without result. As far as I could see, the Amiga would respond to mouse clicks, and only to mouse clicks; the keyboard might as well not be there. Back on BIX I went and was told, "Oh, you need a CLI. Click on the system file drawer, and if you don't see the CLI there, use the Preferences utility to turn it on, then close the system drawer, and open it again, and click on the CLI, and *then* do the `dir df1: business`."

Amiga owners will know that's not as complicated as it sounds; and it worked. Why didn't I think of it? I felt a bit foolish. Then I looked into the manuals and discovered that for all practical purposes the *Amiga User Guide* doesn't know about CLI.

Command line interface, or CLI, is in essence a second operating system.

There are precious few references to it in the generally excellent *Amiga User Guide*. To be precise, there is one index reference under Command Line Interface. It points you to the entry for CLI, and that points you to a single paragraph in chapter seven, which refers you to the *AmigaDOS User's Manual*.

The *AmigaDOS User's Manual* is one of the Amiga development-tool manuals and has many of the sterling qualities of the Digital Research CP/M manuals. Understand, the information is all there, and sufficient determination will dig it out; but it makes no concessions to the inexperienced, and it is organized in such a way that you'd better be prepared to learn a *lot* about command line interface and AmigaDOS in order to learn anything at all.

As a practical matter, this means that most Amiga users will be pretty much at the mercy of program pub-

*(continued)*

Once you compare the quality, features, options and price you'll see that ordering the first three letters that pop into your head doesn't necessarily give you the best return on your investment. Because soon after you compare, it'll become very clear that Amdek is clearly the finest in monitors.

Amdek features a complete line of monitors—from full color RGB's to single color monochromes. What's more, Amdek offers monitors that are capable of supporting a full range of graphic boards.

And every Amdek is backed by a 3-year warranty on the CRT, and two full years on all other parts and labor.

It's no wonder Amdek has sold over one million units to date. Now the only wonderment is why anyone would pay more for anything less than an Amdek.

# AMDEK

*Clearly the finest in monitors.*

2201 LivELY Boulevard, Elk Grove Village, IL 60607

Phone: 312/364-1180, TLX: 280-803

Inquiry 16



lishers. I don't suppose AmigaDOS is that much more complicated than PC-DOS, but frankly I don't know. Like St. Augustine praying for chastity, I want to understand AmigaDOS, but "Not Just Yet." I doubt that I'll be alone in that attitude.

Amiga lovers will counter that the average user won't need to understand CLI because the icon-operated part of AmigaDOS is as good as the

Macintosh operating system; and, after all, you can, with determination, learn CLI if you want to. Of course they're right. I suppose, too, that soon enough there will be books explaining AmigaDOS, just as there's a plethora of such books on CP/M and PC-DOS. Certainly the authors of such works won't lack for information. The Amiga Developer's Support package consists of six large volumes, each

densely packed with information, source code, examples, diagrams, and concise English. (The key word in that sentence is "densely.")

### LATTICE C

I am no expert on C compilers. Fortunately, I know people who are. Most seem agreed: Lattice is the C compiler to use for Amiga product development. I am told that the Aztec C compiler is a bit faster and generates faster-running code. That, however, is more than made up for by the Lattice development tools, which include: a screen editor; a Make utility descended from the UNIX make; Lattice MacLibrary, which gives Amiga programmers many Macintosh features like drawing figures, generating scroll bars, creating music, and so forth; and a text-management utility that brings you grep and diff and a bunch of other UNIX tools C hackers are fond of.

I've met many of the people at Lattice, and I've always been favorably impressed. The Lattice system is available now for the Amiga (and, of course, for PCompatibles and most other computers) and is supposed to be available for the Atari 520ST by the time you read this. (I'd say Real Soon Now, but I have some faith in Derek Budge and the Metacomco people who are porting Lattice to the Atari.)

There is a Lattice conference on BIX; you can join that to learn far more than I ever want to know about the subject. C just isn't my language. It sure is popular, though.

### ATARI 520ST

Meanwhile, the software for the Atari 520ST continues to accumulate. I've got Typesetter ST from XLENT Diskette Products Inc. (630 International Parkway, Richardson, TX 75081), which is a utility program that does layout and design stuff on the Atari for printing on Prowriter, NEC, and Epson printers; DEGAS, from Batteries Included, a color-paint program easily as nice as MacPaint (and which Typesetter ST can interface with); and a whole bunch of stuff from Hippopotamus Software.

There's also Regent Word I from

(continued)

NOVELL COMPATIBLE

## ONE-STOP ARCnet™ LAN SOLUTIONS

Now you can get all the tools you need to build industry standard **TOKEN-PASSING** networks from one source.  
InterContinental Micro.

Our networking packages let you configure any combination of nodes (PC's and compatibles, ATs, XTs, Jrs., Z-100s) to a common Fileserver in just a few minutes with our menu-driven installation program.

Active and passive hubs allow you to integrate up to 255 users on a single network with *increased* efficiency as the network grows.

In addition, our stand-alone ARCnet™ Workstation/Fileserver and complete line of S-100 Bus products (single board computers, slaves and controllers) give you and your customers even more options.

ARCnet is a trademark of Datapoint Corporation.

We're also compatible with other industry-leading ARCnet PC™ and S-100 products, and our PC networking boards include an optional 256K of system RAM.

All with InterContinental Micro's reputation for outstanding reliability, exceptional service, and highly competitive pricing.

Call InterContinental Micro today, or circle the bingo number below for ARCnet™ LAN solutions.

**InterContinental  
Micro**

4015 Leaverton Court, Anaheim, CA  
92807; Phone: (714) 630-0964  
Telex: 821375 SUPPORT UD; Easylink: 62562040.

Call for GSA pricing.





# NUMBER SMASHER™

**Triple your PC speed for only \$799!**

## 8087 Upgrades™

MicroWay is the world leader in 8087 support. Our 8087 development software has been in use since 1982. By 1984 we had become Intel's 97th largest OEM account. When you buy from us, you can be confident that you will receive the 8087 chip designed for your PC and that our unique diagnostics will instantly verify that your processor works correctly as installed. Call for current prices.

## 287Turbo™

This card plugs into the 80287 socket on your AT or COMPAQ, doubling the 80287 clock from 4 to 8 Mhz. It does not change the 80286 clock speed or affect your warranty. The card comes with an 8 Mhz 80287 and has provisions for faster crystals as better 80287s become available. It also has a reset button and circuit that provide a hardware alternative to CNTRL-ALT-DEL. 287Turbo with Diagnostics and Reset ..... **\$395**

## Number Smasher™

Number Smasher gives you AT speed and 100% compatibility with all PC software and hardware. It comes with a 10 Mhz 8086 and 512K of no wait state RAM. Most are shipped with an optional matched 10 Mhz 8087 and 128K daughterboard. The card runs programs a factor of 2.5 to 4.0 faster than the PC, XT or compatibles it runs in. Other features include FASTROM, a Ram Disk, Print Spooler and Disk Cache. Revision 2 of the Smasher is designed and manufactured by MicroWay in the U.S.A. and has the best service and support of any accelerator card.

## MegaPage™

MicroWay's "Lotus/Intel" extended memory card has all the features of the others plus one: it uses low power, cool running CMOS DRAM. Ask for our pamphlet "Extended vs Expanded Memory" and learn why MegaPage is the right card for you. MegaPage with 2 Megabytes CMOS ..... **\$549**



Inquiry 241

*The World Leader in 8087 Support*

P.O. Box 79, Kingston, Mass. 02364 USA (617) 746-7341  
Tempo House, London, U.K. call 01-223-7662

Number Smasher, MegaPage and 287Turbo are trademarks of MicroWay, Inc. MicroWay is a registered trademark of MicroWay, Inc.

Regent Software. This is a full-screen word processor more than a little reminiscent of Electric Pencil. I used Pencil for years, and Larry Niven and I wrote several novels, including *Lucifer's Hammer* and *Oath of Fealty* with it. Regent Word I has most of Pencil's commands and, like Pencil (and WRITE, and all the word-processing programs I like), automatically reformats paragraphs when you insert or delete. It has help files, it's fast, and, although there is a little stuff on the screen I didn't put there—there's a continuous count of the amount of memory you have left—it isn't distracting.

The type is large enough on the Atari color monitor that I can sit at a reasonable distance with the monitor at eye level. I don't have to look through the bottom of my glasses.

There's one problem with Regent Word I. The type font is one of the ugliest I have ever seen. The lower-case "n" is taller than the "t." The body of the "i" is well below the level of the other characters, with the dot at the level of the top of the "n" or "s"; and so forth. The only thing I recall that was uglier was the type font used in the original Kaypro II computers. I *know* the Atari 520ST is capable of much nicer letters than that; why Regent didn't design a more pleasing type font is beyond me.

On the other hand, if I had to choose between writing a book with the Atari 520ST and Regent Word I or the Macintosh and MacWrite, I'd take the Atari every time. I can *see* type on the Atari.

There's a lot more stuff for the Atari. Michtron has sent me nearly a dozen programs, ranging from a RAM disk and a bunch of disk utilities (quite nice) to Mudpies, one of the dumbest arcade games I've ever seen. At COMDEX the Michtron people were demonstrating Time Bandits, a game based loosely on the movie, which had really lovely graphics. From what I could see watching over the designer's shoulder, I'll probably like it. Apparently they haven't finished that one yet, so they sent Mudpies, which has only reasonable graphics. The premise is that a little boy is throwing mudpies at a bunch of circus

clowns, who in turn are trying to clobber him with juggling clubs. It managed to hold my interest for nearly three minutes.

### SUNDOG

The Atari is a natural for games, and I have no doubt there'll be a flood of them. I expect to have a new-and-improved version of Star Raiders for the 520ST about the time you read this, and I already have Hippo's Backgammon.

There's also Sundog from FTL Games/Software Heaven (POB 112489, San Diego, CA 92111). The original version of this was written by BYTE's own Bruce Webster for the Apple II. Sundog is played entirely with the mouse, but it is really a game of strategy; there are very few games like it. Parts of it resemble the Infocom strategy games, yet there are arcade-like features as well.

A story goes with it: a naive young chap—the story makes him male, but I suppose it wouldn't be hard for a female player to identify with the character—inherits a cargo spaceship, some bank accounts, and a contract to deliver a lot of stuff to a newly forming colony. The ship is in terrible shape. The new owner has never piloted a ship before and knows nothing of the interstellar trading business. Yet there certainly isn't enough money to repair and fuel the ship, eat, and fulfill the contract. This is on-the-job training with a vengeance.

The rule book tells you this and shows you some of the mechanics of operating the game; the rest is up to you. This is perfectly in keeping with the scenario. You're supposed to experiment to find out more. You can use the mouse to move your character out of the spaceship and into town, where you can go into stores for spare parts; bars for food, beer, and information; the goods exchange; and other places. So far, so good.

Unfortunately, Sundog was ported over from the Apple II with very little change, and that creates a problem. It was a real accomplishment to put Sundog on the Apple. Each time you enter a new kind of building or move the ship to a different area, an overlay

program is read in from disk. That disk was *full*. Bruce tells me that in some of the action scenes he was struggling to save bytes—not kilobytes, but bytes—to make it work. Sundog on the Apple II was so impressive in comparison to anything remotely like it that you were ready to forgive it a very great deal.

That's not true on the Atari 520ST. For example: the only way to tell what's in a building is to go inside. Some buildings can't be entered, but you don't know that until you try. Other buildings are extremely important, but you don't know what they are until you enter them; there are no signs outside. Once inside, you can interact with the characters you meet, but you must wait for information to be volunteered (if it ever is); you can't ask for it because there is no way to say anything that isn't offered on dialogue menus that pop up from time to time. The story line in the rule book leads you to think you'll learn about trade goods in bars; but all I ever got was people offering to sell me what appeared to be narcotics.

The only thing to eat, even on interstellar trips, is burgers, which can only be bought one at a time in bars. (You can buy beer, but you'll be much better off not to; Sundog seems to have been programmed by members of the WCTU.) The game doesn't tell you this; I spent a couple of hours looking for a grocery store, or ship's chandlery, or any place that would sell me a sack of potatoes or vitamin pills; but no, burgers are all you get. . . .

Meanwhile, the cities have the strangest police I ever heard of. If you park illegally, you will instantly be ticketed and fined (your vehicle is locked up until you pay), but if you walk about the town, you are certain to get mugged. You can try to shoot your way out of mugging situations. This is where the arcade aspects of the game come in. If you survive, there's not only no necessity to call the police, there's no possibility of it, nor can you aid the wounded muggers; you simply leave them lay.

All this is trivially irritating; but what will drive you crazy is that although you are supposed to have a starship,

(continued)

*Train for the Fastest Growing Job Skill in America*

# Only NRI teaches you to service and repair all computers as you build your own 16-bit IBM-compatible micro

Now that computers are firmly established in offices—and in homes, too—the demand for trained computer service technicians surges forward. The Department of Labor estimates that computer service jobs will actually *double* in the next ten years—a faster growth rate than any other occupation.

## **Total systems training**

No computer stands alone... it's part of a total system. And if you want to learn to service and repair computers, you have to understand computer systems. Only NRI includes a powerful computer system as part of your training, centered around the IBM-compatible Sanyo 550 Series computer.

As part of your training, you'll build this highly rated, 16-bit IBM compatible computer system, assemble Sanyo's "intelligent" keyboard, install the power supply and disk drive, interface the high-resolution monitor and dot matrix printer, even expand the memory from 128K to 256K RAM. It's confidence-building, real-world experience that includes training in programming, circuit design, and peripheral maintenance.

## **No experience necessary—NRI builds it in**

Even if you've never had any previous training in electronics, you can succeed with NRI training. You'll start with the basics, then rapidly build on them to master such concepts as digital logic, microprocessor design, and computer memory. You'll build and test advanced electronic circuits using the exclusive NRI Discovery Lab®, professional digital multimeter, and logic probe. Like your computer system, they're all yours to keep as part of your training. You even get over \$1,000 worth of software, including the popular WordStar and CalcStar.



Your NRI total systems training includes all of this • NRI Discovery Lab® to design and modify circuits • Four-function digital multimeter with audio cassette training • Digital logic probe for visual examination of computer circuits • Sanyo 550 Series computer with "intelligent" keyboard and 360K double-density, double sided disk drive • High-resolution monochrome monitor • RAM expansion module to give you powerful 256K memory • 120 CPS dot matrix printer with near-letter-quality mode • EasyWriter I, WordStar, CalcStar bundled software • Reference manuals, schematics, and bite-sized lessons.

## **Send for 100-page free catalog**

Send the post-paid reply card today for NRI's 100-page full color catalog, with all the facts about computer training. Read detailed descriptions of each lesson, each experiment you perform. See each piece of hands-on equipment you'll work with and keep. And check out NRI training in other high-tech fields such as Robotics, Data Communications, TV/Audio/Video Servicing, and more.

Mail the postage-paid card today, and see how NRI can prepare you for advancement and new careers in the exciting world of electronics. If the card has been used, write to NRI Schools, 3939 Wisconsin Ave., Washington, D.C. 20016.



NRI is the only home study school that trains you as you assemble a top-brand microcomputer. After building your own logic probe, you'll assemble the "intelligent" keyboard...

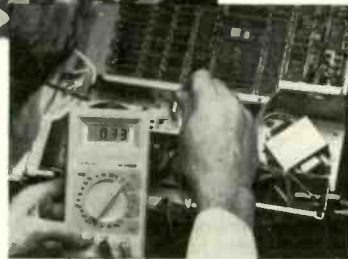

... then install the computer power supply, checking all the circuits and connections with NRI's Digital Multimeter. From there, you'll move on to install the disk drive and monitor.

**NRI** SCHOOLS

McGraw-Hill Continuing Education Center  
3939 Wisconsin Avenue, NW  
Washington, DC 20016

**We'll Give You Tomorrow.**

IBM is a Registered Trademark of International Business Machine Corporation.



you do not have available to you a computer as powerful as the one on which you're playing the game. That is: when you travel to foreign cities and enter the exchange, you see a bunch of price quotes. This is vital information; but the only way to preserve it is to write it down with pencil and paper. (Or drag another computer over and record on it! I swear I was tempted to set up a

SuperCalc spreadsheet on Big Kat and record the Sundog information on that, until sanity prevailed.) I can understand the necessity for a physical visit to a city to find out its prices, but I would imagine that any computer capable of interstellar navigation would be able to remember prices I have already seen and where I saw them.

Sundog is potentially as interesting

as any game I ever played; but I kept running into gotchas, and eventually I put it away. The graphics are great, and the idea behind the game is terrific. I just wish they'd rewrite it to take advantage of the Atari 520ST's speed and power. Faults I can overlook in Apple II games are glaringly obvious on the Atari.

**A WHOLE BUNCH OF STUFF**

This is getting to be a regular feature. We *always* get more stuff than we can write about, and much of it is pretty nifty. I've covered my desk with deserving software; now to try to work through as much as possible.

**FACT CRUNCHER**

Persistence pays. For more than a year I've been getting copies of a program called Fact Cruncher, which I assumed to be a database. It always got put in the "yet another" stack. Meanwhile, Infostructures (POB 32617, Tucson, AZ 85751) kept sending more copies, until the pile threatened to fall over. "All right," I thought. "I'll look at it."

I'm glad I did. In the first place, Fact Cruncher isn't a database at all. It's a dual-window outline processor with a pretty good built-in text editor. It has features you won't find in ThinkTank, isn't copy-protected, is slightly less than \$100, and comes with a really neat set of demonstration programs and tutorials. It does charts and other hierarchical symbolic representations as well as more conventional outlines with the ability to hide or display details. The multiwindow feature is very nice, there's a good help utility, and the whole thing is remarkably easy to use.

Fact Cruncher has gone onto Big Kat's hard disk and may well become one of the regulars here, in which case you'll hear more about it. Meanwhile, write them for a \$9.95 (refundable) demo disk.

**FORMULA/ONE**

This is another program I've neglected, largely because I haven't had a recent need for heavy-duty number crunching. Formula/One from ALloy Computer Products is a darned good math program that will handle most

**ATRON BUGBUSTERS  
GREASE BORLAND LIGHTNING**

*"If I were starting a software company again, from scratch, Atron's AT PROBE™ would be among my very first investments. Without Atron's hardware-assisted, software debugging technology, the flash of Turbo Lightning™ would be a light-year away."*

*Philippe Kahn, President, Borland*

**HOW BORLAND DOES SO MUCH, SO WELL, SO FAST**

We asked Borland International president Philippe Kahn to share his secrets for rapidly taking a good idea and turning it into rock-solid reality. How does the Borland team do so much, so well, so fast?

He begins, "I remember when Atron used the June 24, 1985 *Wall Street Journal* chart of top-selling software in an ad." [Note: At that time, seven of the top ten software packages were created by Atron customers; it's now now nine out of ten.] "SideKick was number four, and I let Atron quote me in saying that there wouldn't have been a SideKick without Atron's hardware-assisted debuggers.

"You might say lightning has literally struck again. Turbo Lightning made number four on *SoftSel's Hotlist* within weeks of its introduction! And again, I say we couldn't have done it without Atron debugging technology.

"Cleverly written code is, by definition tight, recursive, and terribly complex," he continues. "Without the ability to externally track the execution of this code, competent debugging becomes very nearly impossible."

Concludes Philippe, "And after Turbo Lightning was solid and reliable, Atron tuning software turned our Probes into performance analyzers. How do you think we greased our lightning?"

Philippe, along with a couple million or so of your satisfied customers, we say congratulations on yet another best-selling product. We can't wait to see what awesomely useful technology will come shooting out of Borland International next.

**HOW BUGBUSTERS KEEP YOU FROM GETTING SLIMED**

The AT PROBE is a circuit board that plugs into your PC/AT. It has an umbilical which plugs into the 80287 socket and monitors all 80286 activity.

Since AT PROBE can trace program execution in real time, and display the last 2048 memory cycles in symbolic or source-code form, you can easily answer the questions: "How did I get here?" and "What are those silly interrupts doing?"

It can solve spooky debugging problems. Like finding where your program overwrites memory or I/O - impossible with software debuggers.

You can even do source-level debugging in your favorite language, like C, Pascal or assembler. And after your application is debugged, the AT PROBE's performance measurement software can isolate performance bottlenecks.

Finally, the AT PROBE has its own 1-MByte of memory. Hidden and write-protected. How else could you develop that really large program, where the symbol table would otherwise take up most of memory.

**LOOK AT IT THIS WAY.**

History shows that non-Atron customers don't stand a very good chance of making the Top Ten list. Lightning *really* does have a way of striking twice!

The PC PROBE™ is \$1595 and the AT PROBE is \$2495. So call Atron today. You can be busting some really scary bugs tomorrow. And maybe, just like Borland, you can also bust some records.



20665 Fourth Street • Saratoga, CA 95070 • 408/741-5900

Copyright © 1985 by Atron Corp. PC PROBE™ and AT PROBE™ Atron SideKick™ and Turbo Lightning™ Borland International, Inc., Adv. by TRBA, 408/258-2708.

(continued)





**25% Off  
Xerox Performer  
Series Diskettes.**

We're cutting corners on our new floppy disks. In fact, from now until June 30th, 1986, they're 25% off. And you can get as many packages as you'd like.



What we didn't cut corners on was quality. Our floppies meet or exceed all specifications of

the American National Standards Institute. They are compatible with virtually any PC and we're so sure of their performance, we guarantee them for a 100% error-free life.

You can order our 5¼ double-sided/double-density diskettes for your IBM compatible PC (Order #8R2482).

Or our 5¼ single-sided/double-density floppies for Apple PCs and Xerox Memory-writer electronic typewriters (Order #8R2481). Both types come ten per pack. So call **1-800-822-2200, Dept. 72** and give the order number.

Either way, you get more than a square deal.

XEROX® is a trademark of XEROX CORPORATION.

of the math problems you might encounter, from fairly simple algebra and simultaneous equations to a multiple-regression analysis. The instructions on using it are pretty simple, provided that you have an idea of what you're doing. If you don't know what roots, polynomials, and exponential functions are, you might still be able to make use of Formula/One—some of its examples are fairly explicit—but you'll be handicapped.

Formula/One is certainly a professional-level product, but I suspect even more copies will be sold to students. My oldest boy, who went into computer science and engineering, would have profited from this more than Frank, who's more interested in business. On the other hand, financial analysts also need good mathematical tools. In the past, people with an M.B.A. didn't have to be much concerned with integrals and derivatives of a polynomial, but that's changing rapidly, and it's probably just as well. When I was in the strategic analysis business, I found that although the sophisticated mathematical models used by some of McNamara's whiz kids weren't of much use, they impressed the daylights out of people who didn't understand them. The country would have been a great deal better off if more people in the Pentagon had been able

to get at the assumptions behind those cost-effectiveness incantations.

Formula/One uses explicit "sheets" and "lists" that can be printed out to show precisely what is going on. I like it, but it's a pity they charge so much.

### F(z)

This program graphs real and complex functions, including logs, on a PCompatible. The program description says, "It is primarily intended for the student in a first-year course; however, the instructor will also find the program useful because of its capabilities in preparing written and classroom presentations." It doesn't say F(z) was written by a mathematics teacher, but I would bet a reasonable sum that it was.

F(z) needs a color-graphics card. The program was written by Martin Lapidus and is distributed by Lescaux Graphics (3220 Steuben Ave., Bronx, NY 10467). The documentation is terse but adequate, provided that you know something about the functions of a complex variable. If I were taking or teaching such a course and had a PC, I'd want this program.

### SCREENSHOOTER

Another gadget I have too long neglected is Screenshooter from NPC Photo Division. This consists of a hood, mounts, and a modified

Polaroid 600 camera. There is also a 35mm camera bracket and extension tube and complete instructions. It fits onto an IBM PC monitor and lets you take shots of the screen; these can then be put into books, turned into slides or viewgraphs, or used any way you need them. Screenshooter is a neat idea, simple to set up, simple to use. Recommended: if you need this, you need it bad.

### ART STUDIO

Spectrum HoloByte is the outfit that brought you Gato. If you don't know Gato, you don't know what you're missing: Gato was a class of submarine in World War II, and if you like subs, you'll like Gato. Since my review of Gato, I have gotten a number of letters from former and current submariners who also like it.

Spectrum HoloByte has a new program, Art Studio, which is a sort of MacPaint for PCompatibles; except, of course, Art Studio is for color systems. It works with or without mouse and/or tablet, although I think it wouldn't be much fun without one or the other; drawing pictures using the cursor arrows would be tedious.

Art Studio is a lot of fun, and, used with Screenshooter, it can be valuable for generating charts, displays, and the like. I wish I'd had Art Studio, Fact Cruncher, Formula/One, SuperCalc,

# Mass Erases UV EPROMs: \$149

14 DAY FREE TRIAL  
OFFER



ULTRALITE—an efficient and fast EPROM eraser suitable for production or development applications.

- \*Mass erase 50 EPROMs or a single PC board 10"x8"x1"
  - \*Control erase time with a variable, up to 60-minute, auto-shutoff timer
  - \*Safety interlock
- Other erasers—\$50 to \$125

Compare features, compare price; then make the Logical choice

### IT'S LOGICAL

For details, write or call:  
1321 NW 65th Place,  
Fort Lauderdale, FL 33309;  
(305) 974-0975;  
toll free 800-EE1-PROM;  
TELEX 383142

# LOGICAL DEVICES, INC.

and Screenshooter back when I was the president of Pepperdine Research Institute; it sure would have been easier to write proposals.

**TIME LINE**

Another program I wish I'd had then is Time Line from Breakthrough Software. Time Line is yet another project-management system, but it has unique features. It wasn't written by a programmer, but rather by a project manager. It was written in Logitech's Modula-2, meaning that the program is, uh, modular, meaning that it's very easy for the folks at Breakthrough Software to add features and otherwise incorporate user suggestions—which they've done. I now have version 2.0—about the fourth version—but the changes weren't bug fixes as much as fundamental improvements.

I've long said that languages like Modula-2 would bring about a revolution in software because they make it possible for nonprogrammers to concentrate on what they want the machine to do, rather than on how to make it do that. Time Line was written by a manager thoroughly familiar with Gant charts, earned-value analysis, and the like.

The expertise and enthusiasm for the management tools show in Time Line's documents, which are a pretty good introduction to scientific

management all by themselves. The Time Line documents claim that you can export Time Line schedules "directly to Lotus 1-2-3, Symphony, SuperCalc3, Multiplan, and dBASE II and III." I haven't tried that feature, but I have no doubt it's true.

With any luck I'll never again have to manage big projects, but, just in case, I'm not only keeping Time Line, I'm sending in the registration card.

**WILLWRITER**

I confess I am not overly fond of lawyers and the legal profession. I keep wondering if there isn't some connection between the complexities of the law, the need for lawyers, and the fact that most politicians are lawyers. There may even be a conflict of interest. Some states have what can only be described as ghoulish laws that reward appraisers—inevitably lawyers appointed by other lawyers—with a percentage of nearly every estate, although they do little work for it. Given those complexities, it is impossible for me adequately to review legal software, particularly software that generates wills.

WillWriter from Legisoft/Nolo Press (950 Parker St., Berkeley, CA 94710) certainly works, in the sense that it generates a document that appears to be a will, and in the process asks you a great number of questions you

might not have thought of. Given the cost of legal advice, I'd think that WillWriter would be worth the price just to generate a first draft if you don't have a very complex estate. Take that to an attorney and go from there.

WillWriter claims to know something about every state except Louisiana; if you live there and buy WillWriter, Nolo Press will refund your money. As you'd expect, there are no guarantees that wills generated by WillWriter will accomplish what you want, or indeed anything at all. The program isn't copy-protected. It has clear instructions—a whole book on the subject, which is itself worth reading if you don't know much about wills—and runs on both Apple II and PCompatible computers (floppy disk).

**WINDING DOWN**

I'm done, and there's still an incredible pile on my desk. Graphics programs abound: Brøderbund's Print Shop, which lets you use PCompatibles to create letterheads, cards, etc., probably doesn't need much of a boost from me. Fantasy from Prosoft in North Hollywood—hmm, just down the hill—is a monochrome-screen font-and-art program for \$49.95 that will go a long way toward letting you do with PCompatibles (and a good printer) most of what the

*(continued)*

**The Advanced Programmer: \$895**



**14 DAY FREE TRIAL OFFER**

PROMPRO-8X—an advanced EPROM, EEPROM and Single Chip Micro programmer with a 512k-bit RAM buffer

\*Supports MOS, HMOS, and CMOS 2716 thru 27512 and most other available EE/EPROMs

\*RAM image editing via keypad/display in 8 or 16 bit word formats.

\*Mini-gang, set program two EPROMs simultaneously.

\*Complete Stand-Alone and RS-232 Interface capability.

Compare Features, compare price; then make the Logical choice

**IT'S LOGICAL**

For details, write or call:  
1321 NW 65th Place,  
Fort Lauderdale, FL 33309;  
(305) 974-0975;  
toll free 800-EE1-PROM  
TELEX 383142

**LOGICAL DEVICES, INC.**

## ITEMS DISCUSSED

**AMIGA** ..... starts at \$1295  
Commodore Business Machines Inc.  
1200 Wilson Dr.  
West Chester, PA 19380  
(215) 431-9100

**AMIGA KALEIDOSCOPE**  
free with the Amiga  
Electronic Arts  
2755 Campus Dr.  
San Mateo, CA 94403  
(415) 571-7171

**ART STUDIO (for IBM PC)** . . . \$49.95  
**GATO**  
for Apple II and IBM PC . . . \$39.95  
for Mac . . . . . \$49.95  
Spectrum HoloByte Inc.  
1050 Walnut, Suite 325  
Boulder, CO 80302  
(303) 443-0191

**ATARI 520ST** ..... starts at \$799  
Atari Corp.  
POB 61657  
Sunnyvale, CA 94089  
(408) 745-2000

**COLOR COMMANDER** ..... \$359  
Perma Power Electronics Inc.  
5615 West Howard Ave.  
Chicago, IL 60648  
(312) 647-9414

**CONQUEST PC BOARD**  
from OK bytes . . . . . \$395  
to 2 megabytes . . . . . \$595  
Orchid Technology Inc.  
47790 Westinghouse Dr.  
Fremont, CA 94539  
(415) 490-8586

**DEGAS** ..... \$39.95  
Batteries Included  
30 Mural St.  
Richmond Hill, Ontario L4B 1B5,  
Canada  
(416) 881-9941

**FANTASY** ..... \$49.95  
Prosoft  
7248 Bellaire Ave., POB 560  
North Hollywood, CA 91603  
(818) 764-3131

**FORMULA/ONE** ..... \$395  
ALloy Computer Products Inc.  
100 Pennsylvania Ave.  
Framingham, MA 01701  
(617) 875-6100

**LATTICE C (for Amiga)** . . . . \$149.95  
Lattice Inc.  
22 West 600 Butterfield Rd.  
Glen Ellyn, IL 60137  
(312) 858-7950

**MACENHANCER** ..... \$249  
Microsoft  
10700 Northrup Way  
POB 97200  
Bellevue, WA 98009  
(800) 426-9400

**MACINTOSH**  
512K bytes . . . . . \$1999  
**MACINTOSH PLUS**  
1 megabyte . . . . . \$2599  
Apple Computer  
20525 Mariani Ave.  
Cupertino, CA 95014  
(408) 973-2222

**MUDPIES (for Atari)** . . . . . \$39.95  
**DISK UTILITIES** . . . . . \$39.95  
Michtron Inc.  
576 South Telegraph  
Pontiac, MI 48053  
(313) 334-5700

**SCREENSHOOTER** ..... \$175  
NPC Photo Division  
1238 Chestnut St.  
Newton, MA 02164  
(617) 969-3487

**TIME LINE** ..... \$495  
Breakthrough Software Corporation  
505 San Marin Dr.  
Novato, CA 94947  
(415) 898-1919

Macintosh can do in the way of integrating drawings and text.

Russell Schnapp's book and program disk, *Macintosh Graphics in Modula-2* (Prentice-Hall Personal Computing Series), is a must for anyone using a Mac and Modula-2. [Editor's note: See also a review of the book on page 68.] Tons of examples, lots of source code, and all the secrets of hooking into QuickDraw with MacModula. Fair warning: don't try learning Modula-2 from this book. On the other hand, once you know the language fundamentals, it's always a good idea to look at working source code, and there's plenty to look at here.

The book of the month is Harry Rositzke's *The KGB: The Eyes of Russia* (Doubleday). Rositzke was in charge of countering KGB operations for a while and frankly admires what he calls "the world's best intelligence

organization." My interest is a bit more mundane: my wife and I are writing an espionage romance/thriller.

The gadget of the month is Perma Power's Color Commander, a box that sits between your PCompatible and a color monitor and painlessly changes colors, adds color to monochrome programs like word processors, and is so easy to set up that it wouldn't need documents. There's a full demonstration disk furnished, but you can use the thing in seconds: just connect it, turn it on, and push buttons. Simple, easy, and fun; and it would be the very thing to use with Screenshooter for making slides and charts.

The game of the month is Sundog on the Atari 520ST. Despite the frustrations, the darned game has a richness that I like. Maybe I will set up a SuperCalc spreadsheet for it.

Next week *Voyager* encounters

Uranus, and there's the usual Encounter party at Chaos Manor: about 30 science-fact-and-fiction writing colleagues will be in town. We used to do this more often, until Proxmire convinced Congress that the country is better off with higher dairy prices than it would be with close-up pictures of the other planets. A lot of my friends from the L-5 Society will be in town, too, and I expect to have fun: meaning I'd better let my wife talk me into going back to bed.

See you on BIX? ■

*Jerry Pournelle welcomes readers' comments and opinions. Send a self-addressed, stamped envelope to Jerry Pournelle, c/o BYTE Publications, POB 372, Hancock, NH 03449. Please put your address on the letter as well as on the envelope. Due to the high volume of letters, Jerry cannot guarantee a personal reply.*

# Data Defense!

## with Fastback\*

Before your valuable data comes under fire from a hard disk crash, is annihilated due to an accidental reformat, or destroyed by any other frontal attacks, get **FASTBACK**. With **FASTBACK**, you can defend your valuable data from loss *without* spending a fortune on a clumsy tape backup system. For just \$179, **FASTBACK** is the software backup utility that consistently outperforms tape systems costing \$1000 to \$2000 or more — on your present floppy disk drive.

### The best defense is a good offense.

**FASTBACK** attacks the danger of data loss at its source: slow, hard-to-use backup procedures. Let's face it, if you have to spend *hours* to back up your full hard disk (as you do with the DOS "BACKUP" utility), you're not going to do it very often. But with **FASTBACK** you can back up a full 10 megabytes in just 8 minutes flat (4 minutes on the IBM PC-AT)! So you can back up every bit of data every day, without even missing a coffee break.

### But is it bullet-proof?

We won't guarantee your backups will be bullet-proof, but we've stapled them, nailed them, and *even punched a hole bigger than a .22 calibre slug right through one* — without losing a single byte of data! **FASTBACK's** advanced error-correction algorithms push safety to the very limits of human ingenuity. That's Data Defense!

### Be safe, not sorry.

**FASTBACK** is fully *self-contained*, and works with any make or size hard disk running on any IBM™ PC or compatible (requires PC-DOS™ or MS-DOS™ version 2.0 or higher and at least one floppy disk drive). It is fully file-oriented (not a "disk image"), menu-driven and easy to use, with built-in safeguards that make it virtually "fool-proof".

So get the safe solution, and get it fast. Get **FASTBACK** today.



909 Electric Ave Suite 202, Seal Beach, CA, 90740; 7942 Picardy Ave  
Baton Rouge, LA, 70809; Tel : 1-800-225-2775 or (213) 493-4483



Marketing and Sales by CSSL, Inc.

This product is in no way associated with or has originaton in Fisher Scientific or Allied Corporation. IBM-PC, IBM-XT, IBM-AT and PC-DOS are registered trademarks of International Business Machines Corporation. MS-DOS is a registered trademark of Microsoft, Inc.

# GraphAx 20/20 And AUTOCAD...

## Get The Big Picture

### GOOD-BYE REDRAW

The GraphAx hardware is designed specifically to optimize productivity for Micro based CAD programs like AutoCAD, and gives you a virtual drawing space that is 2048x1280, large enough to hold a "D" size drawing at .01" resolution. This expanded area virtually eliminates the necessity to redraw simply to move to another area of the drawing. The viewing window pans and scans effortlessly over the entire drawing space—in real time!

Just so you'll always know where you are, the GraphAx 20/20 keeps a reduced view of the entire drawing updated and available at the flick of a function key. In fact, there are three levels of instantaneous hardware zoom. You can work on the big picture or edit the smallest detail in 16 brilliant colors, and you don't have to redraw to do it!

### THE ENSIGN IMAGE

A graphics processor as powerful as the GraphAx 20/20 deserves a monitor to match. The Ensign 19" high resolution monitor from ACS is just such a beast. It's bright high resolution display is the perfect complement to the GraphAx, and its optional tilt table will allow you to position it for maximum user comfort.

For a limited time, ACS is offering special pricing on the Ensign/GraphAx combination. Ask your dealer for details or call:

**ACS International, Inc.**  
2105 Luna Rd. Suite 330  
Carrollton, TX 75006

**214-247-5151**  
**TELEX 709 748 ACS UD**

### GraphAx & AutoCAD . . . Real Time Zoom & Pan

- 2048x1280 Drawing Buffer
- 1024x768 Viewing "Window"
- 3 Level Instant Zoom
- Real-Time Dynamic Panning
- Special Entity Highlight
- Toggle Between 4 pallets

If you're using AutoCAD, you owe it to yourself to examine the expanded horizons offered through the GraphAx 20/20. Like other graphics adapters for the PC/XT/AT bus, GraphAx 20/20 gives AutoCAD a nice high resolution picture, 1024x768, about as high as any monitor you could find. The difference is that with the GraphAx, that image is your window onto a much larger world.



# AN INNOVATIVE PROGRAM

BY WILLIAM M. RAIKE

EM/3+ is  
*an operating-system unification*  
adapter that gives you  
*several useful capabilities*

With the exception of Japanese-language word-processing programs and some games, few innovative programs are developed here in Japan. However, I'm devoting this month's column to EM/3+, one of the most useful software products I've bought in a long time. EM/3+ was developed in Japan by Megasoft, a company that makes expansion boards and accessories for NEC personal computers, as well as a variety of software products.

**EM/3+ FROM MEGASOFT**

Megasoft advertises EM/3+ (in Japanese) as an "operating-system unification adapter." It's not a revolutionary idea, but it's a system that has several useful capabilities. Essentially, EM/3+ is a set of programs that runs under MS-DOS (version 2.11); it lets you run most CP/M-86 and CP/M-80 application programs unchanged and allows you to read and write floppy disks in any of the three most common MS-DOS formats and in any of about two dozen common CP/M formats.

It will also let you define your own set of disk parameters for machines whose floppy-disk formats aren't included with the basic package. Last but not least, the Fujitsu version corrects some known bugs in Fujitsu's version of Japanese-language MS-DOS, which gets only lackluster support from Fujitsu and has poor documentation.

I bought the latest version of EM/3+ for my Fujitsu FM-16 $\beta$  at the same time that a friend of mine bought a version for his NEC PC-9801VM2. The system is available for several other Japanese personal computers, but the NEC PC-9801 family and the Fujitsu FM-16 $\beta$  cover the lion's share of the Japanese 16-bit computer market.

EM/3+ works similarly on both machines, with only minor differences.

**THE DILEMMA**

The program costs about \$400, but as far as I'm concerned its capabilities make it worth several times its price. Here in Japan, the most common and well-known operating systems are CP/M-86 (for 16-bit computers) and CP/M-80 (for 8-bit computers). Despite the many advantages of MS-DOS over CP/M-86, the main Japanese computer manufacturers were slow in introducing Japanese-language versions of MS-DOS for their computers, and most applications software products, including word processors, spreadsheets, and the like, were developed first for the CP/M-86 operating system. The reason for all of this is that the IBM PC never had much impact in Japan, and there has been no stimulus to produce IBM PC-compatible machines here for the domestic market. Consequently, no major forces pushed first-time computer users and buyers into becoming familiar with MS-DOS (or PC-DOS).

Lots of people (myself included) who already own high-performance personal computers running under CP/M-86 were interested in switching over to MS-DOS systems despite lukewarm support from the vendors. The problem was that, after years of living with CP/M-80 and CP/M-86, I

had accumulated a substantial software library. I purchased some of it and developed the rest myself, but either way it represents a large investment in time and money. It would have been hard to justify a conversion to MS-DOS if it meant abandoning my entire library.

**A SOLUTION**

Essentially, EM/3+ lets me have the best of both worlds. Now that I've installed it and learned how to use it, most of the CP/M-86 software I've used for the last few years continues to work just fine. Furthermore, I'm having a terrific time discovering how I/O redirection, pipes, batch files, hierarchical directories, path names, time- and date-stamped files, and lots of other MS-DOS features can simplify my work and save me time. Among the CP/M-86 applications that work perfectly are virtually all of my home-grown text post-processing utilities and WordStar, which I use daily for correspondence, high-volume typing, and program text editing.

I'll admit it did take a little effort to get WordStar to work. The original version included a call to a terminal-initialization routine (which assigns new definitions to the programmed function keys) that, in turn, used a

*(continued)*

*William M. Raikes, who has a Ph.D. in applied mathematics from Northwestern University, has taught operations research and computer science in Austin, Texas, and Monterey, California. He holds a patent on a voice scrambler and was formerly an officer of Cryptext Corporation in the United States. In 1980, he went to Japan looking for 64K-bit RAMs. He has been there ever since as a technical translator and a software developer. He can be contacted c/o BYTE, POB 372, Hancock, NH 03449.*

## EM/3+ doesn't care which disk the program is on.

software interrupt that Fujitsu (to my annoyance) doesn't support under its version of MS-DOS. A quick reinstallation of WordStar to replace the call to that routine with a no-op (no operation) instruction cured the problem.

### TURBO PASCAL

My CP/M-86 version of Turbo Pascal worked immediately under MS-DOS and EM/3+. That was fortunate, since I discovered that ZCOM, the all-purpose workhorse communications program I wrote in C, didn't work, and Digital Research's C compiler didn't work either. It didn't take long to completely upgrade and rewrite ZCOM in Turbo Pascal; it's now a lot simpler and smaller. That ZCOM would fail to work under MS-DOS was a foregone conclusion. The only way to write a generic CP/M-86 terminal program is to juggle the IOBYTE to sense both the console status and the auxiliary device (RS-232C port) status, whereas MS-DOS has an operating system function call (function number 44H) that provides auxiliary device status

and control information directly. If DRI's C compiler had worked, I could have rewritten the port status routine in minutes, but I ended up at home over the New Year holiday with no 16-bit C compiler, so a Turbo Pascal version was the only way to go. Someday soon I'm going to buy a C compiler that runs under MS-DOS, but in the meantime Turbo works like a dream. And it gave me access to the MS-DOS function calls (through its `Intr()` function) when I needed them. Besides, I'd been less than overjoyed with DRI's cumbersome C compiler; now I've got an excuse to look for something better.

Still on the subject of Turbo Pascal, last month I picked up a copy of Borland's Turbo Editor Toolbox. It came on a couple of disks recorded in IBM PC format; after converting to the MS-DOS (and EM/3+) environment, I powered up my Fujitsu and was able to immediately read the IBM PC disks and load the files onto the hard disk. Well, would you believe *almost* immediately? It took about an hour of plowing through the EM/3+ manual (which is excellent) and the Fujitsu MS-DOS documentation (which is not) before I discovered how to change modes back and forth between the normal 1.2-megabyte floppy-disk format (a nice added benefit: I only had 1 megabyte per

disk under CP/M-86) and 640K-byte and 320K-byte (IBM PC) formats. I still hope to implement that editor on the FM-16 $\beta$ ; unfortunately, the screen routines depend heavily on the IBM PC's memory-mapped screen, so I'm going to postpone that project until I can get some technical information from Fujitsu. Judging from past experience, though, that may take a while.

### MANY FORMATS POSSIBLE

EM/3+ supports my hard disk and RAM disk, along with the single floppy-disk drive in my computer. For now, the hard disk is allocated to drive A, the floppy-disk drive is allocated to drive B, and the RAM disk is drive C. EM/3+ gets tricky in the way it handles disks recorded in CP/M formats. The program supplies an additional device driver, installed in MS-DOS through the CONFIG.SYS file; that driver handles the floppy-disk drive as drive D and assumes that the floppy disk is a CP/M disk. The result is that, to copy files from my old floppy disks (recorded in 1-megabyte CP/M-86 format) to my hard disk, all I have to do is put the disk into the drive and type the command `COPY D:*.* A:`. Files on drive D are assumed to be CP/M-86 files and are accessible to the operating system or to any applications program inter-

## a message to our subscribers

From time to time we make the **BYTE** subscriber list available to other companies who wish to send our subscribers material about their products. We take great care to screen these companies, choosing only those who are reputable, and whose products, services, or information we feel would be of interest to you. Direct mail is an efficient medium for presenting the latest personal computer goods and services to our subscribers.

Many **BYTE** subscribers appreciate this controlled use of our mailing list, and look forward to finding information of interest to them in the mail. Used are our subscribers' names and addresses only (no other information we may have is ever given).

While we believe the distribution of this information is of benefit to our subscribers, we firmly respect the wishes of any subscriber who does not want to receive such promotional literature. Should you wish to restrict the use of your name, simply send your request to the following address.

**BYTE Magazine**  
Attn: Circulation Department  
One Phoenix Mill Lane  
Peterborough NH 03458





changeably with MS-DOS files. If I want to read or write disks in a CP/M format for another machine, a simple menu-driven EM/3+ utility lets me select the format for the machine I want. After I reboot—presto! So far, I've read and written disks recorded in Fujitsu, NEC, and Sanyo CP/M formats, in addition to 1.2-megabyte and 640K-byte MS-DOS and PC-DOS formats.

When I want to run a CP/M-86 program, EM/3+ doesn't care which disk the program is on. Since I've copied TURBOCMD onto my hard disk, drive A, when I want to run Turbo Pascal I simply type TURBO, and EM/3+ automatically senses that it's a CP/M-86 .CMD file (instead of an MS-DOS .COM or .EXE file) and executes it appropriately in a CP/M-86 environment. EM/3+ takes care of all the details of interfacing between MS-DOS and applications-program BDOS calls (CP/M-86 operating-system function calls). There are a few exceptions: programs that use direct BIOS calls from CP/M don't always work, nor do programs that read or manipulate the CP/M disk-parameter blocks directly instead of going through the operating system. By the way, Megasoft clearly states these exceptions in its advertising.

My last computer was also a Fujitsu—the FM-11BS model. I had installed a Z80 card in that machine to be able to run some of my still-older CP/M-80 software, like the Software Toolworks C/80 C compiler and Microsoft's Multiplan. Since EM/3+ includes a Z80 emulator program, I've found that I have access to my old CP/M-80 software too, an advantage I thought I'd given up when I bought my present computer. The version of EM/3+ that Megasoft distributes for the Fujitsu FM-16β handles Z80 emulation in software. As a result, on my 8-megahertz 80186 processor, EM/3+ executes 8-bit Z80 emulation software at an equivalent clock rate of about 1.5 MHz, which is fairly slow; most Z80 systems run at at least 4 MHz. That is, 8-bit software runs about as fast as it would on a Z80 processor running at 1.5 MHz. The NEC PC-9801VM2 version of EM/3+ can use the ability of the V30 micropro-

cessor in that machine to execute 8-bit machine instructions directly in hardware, so it's much faster when running CP/M-80 software.

**COMPATIBILITY REIGNS**

As far as I'm concerned, the ability to run MS-DOS, CP/M-86, and CP/M-80 software on a single machine is worth every bit of the cost of EM/3+. I would have spent at least that much

replacing all my old software with MS-DOS versions, not counting the time it would take to convert or redevelop my existing software.

The ability to read so many disk formats interchangeably is going to save me endless hassles, too. In the past, whenever I've wanted to order software from U.S. companies by mail, incompatible disk formats were a ma-

(continued)

# Lattice® Works

**RPG COMPILER FOR IBM PC**

The new Lattice RPG II compiler is ideally suited for creating commercial applications for MS-DOS. Allow your current RPG II programmers to be productive on MS-DOS.

The Lattice RPG II compiler is compatible with System III, System/34 and /36 RPG II compilers, it uses ASCII files and MS-DOS command language, plus has ISAM compatibility with dBASE III. \$750.00 and no run time fees.

**VERSION 3 OF THE LATTICE MS-DOS C COMPILER IS NOW AVAILABLE.**

This is a major upgrade of the product and is available to registered users for a \$45 update fee. Non-registered \$60. The list price remains \$500.

New compiler features include:

- *ANSI language constructs...*  
 "unsigned" as a modifier  
 "void" data type  
 "enum" data type  
 structure assignments, arguments, and returns  
 argument type checking
- *Inline code 8087/80287 80186/80286*
- *Code generation*

The compiler also contains numerous improvements such as

better aliasing algorithms, more efficient code generation, and more flexible segmentation. The library includes more than 200 new functions in the following categories:

- *ANSI/UNIX/XENIX compatibility*
- *Extended support for MS-DOS*
- *Extended support for networking, including file sharing, file locking, and I/O redirection*
- *Flexible error handling via user traps and exits*

The Library has also been re-engineered to produce much smaller executables.

**LATTICE ANNOUNCES NEW DATA ENCRYPTION SOFTWARE**

Now you can keep your confidential data confidential. Thanks to new SecretDisk, a new data encryption system for IBM PC, XT, AT and compatibles.

Utilizing the NBS Data Encryption Standard, SecretDisk provides complete security for salaries, customer lists, or other sensitive information stored on a floppy or hard disk. SecretDisk is loaded as a disk driver by MS-DOS. It creates new DOS drives (like D:) on floppy or hard disks where all data and programs are always fully encrypted.

SecretDisk is extremely easy to use. A password is entered when the system is booted, and protection can be switched on and off with a single password controlled command line. However, without the password, there is no way to access the encrypted files. \$59.95.

Contact Lattice, to discuss your programming needs. Lattice provides C compilers and cross compilers for many environments including Tandy, Sony, Hewlett-Packard, Tandem, and IBM Mainframe. Corporate license agreements available.



## Lattice

(312) 858-7950 TWX 910-291-2190  
**INTERNATIONAL SALES OFFICES:**  
 Benelux: De Vooght, (32)-2-720 91-28.  
 Japan: Lifeboat Inc. (03) 293-4711  
 England: Roundhill, (0672) 54675  
 France: SFL (1) 46-66-11-55  
 Germany: (49) 7841/4500 (49) 8946/4613-290

# RUNS 3 TO 6 TIMES FASTER THAN A PC XT HARD DISK Removable Winchester Hard Disk Drives for PC's Are Here

- HANG 10/20™
- SLOT 10/20™
- SLOT DRIVE 10/20™
- FLEXI-DRIVE 10™

**HANG 10/20** – Hang 10 or even 20 megabytes *inside* your PC. Just plug it in and hang the drive off the front. *That's it!* Use standard DOS 2.0/3.0 commands. No switches to set. Will boot up as a "C" drive. You can turn your PC into an XT and keep your 2 floppies.

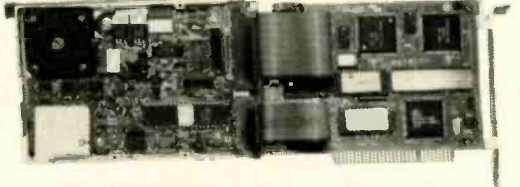

**COMPLETE SUBSYSTEM**

Hang 10 – List Price \$ 899  
Hang 20 – List Price \$ 1199

**SLOT 10/20** – A 10 or 20 megabyte hard disk, completely self-contained. Installs in any open PC or compatible bus slot, in less than a minute. No special software required.



**COMPLETE SUBSYSTEM**

Slot 10 – List Price \$ 999  
Slot 20 – List Price \$ 1399

**SLOT DRIVE 10/20** – A high speed removable and transportable self-contained hard disk drive enclosed in a compact case for internal and external connection to a PC or compatible bus slot. Pop it in and pop it out. Take it anywhere. Lock it up or send it around the world. It can take a 60g shock if dropped while not operating. You can put several in a briefcase.

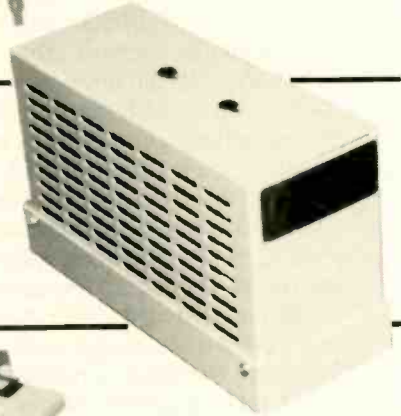

**TRANSPORTABLE COMPLETE SUBSYSTEM**

Slot Drive 10 – List Price \$ 1099  
Slot Drive 20 – List Price \$ 1499

**FLEXI-DRIVE** – The ultimate Winchester storage device. Full 10 megabyte capacity. A true high speed hard disk, not just a back-up tape. Just change the cartridge. Fifty second recycle time. Remove it – store it – mail it – lock it in the vault.



Flexi-Drive Only – List Price \$ 1599  
Removable Disk Cartridge – List Price \$ 169

**HI SPEED SMART CONTROLLER**  
LIST PRICE \$ 299

**DATA BOX 10** – A 10 megabyte Flexi-Drive. The perfect add-on subsystem for the PC/XT and other hard drive compatibles. High speed backup. True full Winchester operation. Plug in our controller, attach the drives, and you have a fast, flexible subsystem with unlimited storage capacity. Ideal add-on for Tandy, Leading Edge, Sperry, AT&T, and ITT. All subsystems are complete with controller and cables.



Data Box 10 – List Price \$ 2199

**DATA BOX 20** – A dual drive subsystem. The ultimate peripheral for your computer system. Available with 2 Flexi-Drives, or 1 Flexi-Drive with a 10 or 20 megabyte hard disk. Complete with surge protector, 6 accessory outlets, and an 8-switch command center. All subsystems are complete with controller and cables.



Data Box 20 w/dual Flexi-Drive – List Price \$ 3299  
Data Box 20 w/Flexi-Drive & 20 mb hard disk – List Price \$ 2999

**DEALERS AND DISTRIBUTORS WANTED**

OUR PRODUCTS WERE THE HIT OF THE NCC '85 SHOW.  
WE NEED QUALITY DEALERS AND DISTRIBUTORS  
TO SELL, SERVICE, AND SUPPORT OUR CUSTOMERS.

**— WE ARE SHIPPING ALL PRODUCTS —  
Order Today!**

**— GENEROUS DISCOUNT STRUCTURE —**

**DATA ZONE, Inc.**

7136 OWENSMOUTH AVE., CANOGA PARK, CA 91303 (818) 704-4955



Inquiry 109

for obstacle; naturally enough, software distributors had never heard of my computer. Now I can order (and cross-develop) software without worrying about how to convert between various disk formats, a task that's been a pain in the neck until now.

Finally, the implementation of EM/3+ for my computer corrects several bugs in Fujitsu's MS-DOS implementation. The main one was a problem in the keyboard driver routine supplied with Fujitsu's version of MS-DOS, somehow related to the Japanese-language kanji input functions; it was impossible to enter a Control-R or Control-Q from the keyboard. Fortunately, EM/3+ provides a fix for this, which otherwise would have been an intolerable problem. Apparently, Fujitsu has made no effort thus far to correct the problem, although it may do so in the next release of the operating system. I was unaware of the problem when I bought Fujitsu's MS-DOS prior to getting EM/3+ up and running. I have since found out that the problem has been pointed out in magazine articles here.

**DOCUMENTATION AND AVAILABILITY**

EM/3+ is well documented. The 90-page manual, in Japanese, gives detailed procedures for using all the system's capabilities, and it is written clearly, concisely, and logically. Furthermore, the software appears to do absolutely everything Megasoft claims it will do, and does it easily, quickly, and conveniently. I'm delighted with it.

Unfortunately, Megasoft does not have plans to implement EM/3+ for non-Japanese computers, and the company says it really isn't set up to handle orders or inquiries unless they're in Japanese. It looks as if you'll have to be fluent in Japanese or know someone who is to be able to order EM/3+.

**NEXT MONTH**

In June, my conversion process continues as I add a modem and C compiler to my setup. But it's not without its setbacks. . . ■

**3M** diskettes **LIFETIME WARRANTY**

## KEYBOARD STATIC STRIP

**14.95**

<b>5 1/4" Disks</b>	<b>8" Disks</b>	<b>3 1/2" Disks</b>
S-Side D Den. <b>7.95</b>	S-Side S-Den. <b>15.95</b>	S-Side 135tpi <b>16.55</b>
D-Side D Den. <b>12.25</b>	S-Side D Den. <b>19.45</b>	D-Side 135tpi <b>23.55</b>
S-Side 96tpi <b>16.45</b>	D-Side D Den. <b>20.95</b>	<b>Data Cartridges</b>
D-Side 96tpi <b>20.95</b>	<b>ALSO AVAILABLE</b>	DC100A
<b>HIGH Den. 23.95</b>	32 Sectors, 1024 FM, MICOM, CPT, WANG, LANIER, DEC, RX50	DC300A
		DC300XL
		DC600A
		DC1000

Call

Old Reliable **3M** Diskette Connection

- Delaware 1-800-451-1849
- Oklahoma 1-800-654-4058
- Nevada 1-800-621-6221

TERMS: Minimum 20 disks or \$35.00 — VISA or MasterCard accepted. COD orders add 2% for special handling. SHIPPING: 3/4 + 5/8 Diskettes. Add 3% for every 100 Diskettes or any fraction thereof. 8 Diskettes. Add 4% for every 100 Diskettes or any fraction thereof. We ship UPS; orders requiring other delivery methods add shipping plus 2% of total order.

Authorized Distributor Information Processing Products

**Verbatim** **DataLife**

LIFETIME WARRANTY

### GREAT QUALITY SUPER LOW COST

<b>5 1/4" Disks</b>	<b>8" Disks</b>	<b>3 1/2" Disks</b>
S-Side D Den. <b>9.95</b>	S-Side S-Den. <b>16.95</b>	1/Side 2/Side <b>18.55 - 25.55</b>
D-Side D Den. <b>13.95</b>	S-Side D Den. <b>19.95</b>	<b>HEAD CLEANERS</b>
S-Side 96tpi <b>19.95</b>	D-Side D Den. <b>20.95</b>	5 1/4" Kit — 4.95
D-Side 96tpi <b>23.95</b>	<b>Digital Cassettes</b>	5 1/4" Refills — 8.95
<b>High Den. 26.95</b>		8" Kits — 5.20
		8" Refills — 8.95

Old Reliable **3M** Diskette Connection

- Delaware 1-800-451-1849
- Oklahoma 1-800-654-4058
- Nevada 1-800-621-6221

TERMS: Minimum 20 disks or \$35.00 — VISA or MasterCard accepted. COD orders add 2% for special handling. SHIPPING: 3/4 + 5/8 Diskettes. Add 3% for every 100 Diskettes or any fraction thereof. 8 Diskettes. Add 4% for every 100 Diskettes or any fraction thereof. We ship UPS; orders requiring other delivery methods add shipping plus 2% of total order.

**SONY**

<b>3 1/2" SINGLE-SIDE</b>	<b>VIDEO CASSETTES</b>
<b>16.95</b>	<b>T120 OR L750</b>
<b>DOUBLE-SIDE</b>	<b>4.69 EACH</b>
<b>25.95</b>	<b>AMARAY Media Mate</b>
	<b>\$8.95</b>
	+ 2% shipping

Old Reliable **3M** Diskette Connection

- Delaware 1-800-451-1849
- Oklahoma 1-800-654-4058
- Nevada 1-800-621-6221

TERMS: Minimum 20 disks or \$35.00 — VISA or MasterCard accepted. COD orders add 2% for special handling. SHIPPING: 3/4 + 5/8 Diskettes. Add 3% for every 100 Diskettes or any fraction thereof. 8 Diskettes. Add 4% for every 100 Diskettes or any fraction thereof. We ship UPS; orders requiring other delivery methods add shipping plus 2% of total order.

# DISKETTES

**FACTORY SEALED IN PACKS OF TEN, WITH TYVEK SLEEVE, ID LABEL & WRITE PROTECT TABS. "LIFETIME WARRANTY"**

[No Manufacture Label or Pretty Box]

Single Side Double Density      Double Side Double Density

**.54 ea.** (MIN. 50)      **.63 ea.**

Manufactured 100% by one of the BIG BOYS. IF you need a good Disk this is it. IF you need a name, we call them GOOD.

Old Reliable **3M** Diskette Connection

- Delaware 1-800-451-1849
- Oklahoma 1-800-654-4058
- Nevada 1-800-621-6221

TERMS: Minimum 50 Diskettes. — VISA or MasterCard accepted. COD orders add 2% for special handling. SHIPPING: 3/4 + 5/8 Diskettes. Add 3% for every 100 Diskettes or any fraction thereof. We ship UPS; orders requiring other delivery methods add shipping plus 2% of total order.

**dy Jan Dysan** CORPORATION

LIFETIME WARRANTY

<b>5 1/4" DISKS</b>	<b>3 1/2" DISKS</b>	<b>Dysan Interrogator</b>
S-Side D Den. <b>13.95</b>	S-Side 135tpi <b>23.95</b>	<b>120.50</b> ea.
D-Side D Den. <b>18.95</b>	<b>8" DISKS</b>	<b>165.00</b>
S-Side 96tpi <b>22.95</b>	S-Side S-Den. <b>19.95</b>	Add 3.00 Shipping
D-Side 96tpi <b>29.45</b>	S-Side D Den. <b>21.95</b>	<b>PHENIX 16 meg CART.</b>
<b>HIGH DEN. 37.95</b>	D-Side D Den. <b>26.95</b>	<b>165.00</b>
		Add 6.00 Shipping

Old Reliable **3M** Diskette Connection

- Delaware 1-800-451-1849
- Oklahoma 1-800-654-4058
- Nevada 1-800-621-6221

TERMS: Minimum 20 disks or \$35.00 — VISA or MasterCard accepted. COD orders add 2% for special handling. SHIPPING: 3/4 + 5/8 Diskettes. Add 3% for every 100 Diskettes or any fraction thereof. 8 Diskettes. Add 4% for every 100 Diskettes or any fraction thereof. We ship UPS; orders requiring other delivery methods add shipping plus 2% of total order.

**maxell** FLOPPY DISKS

LIFETIME WARRANTY

<b>5 1/4" Disks</b>	<b>3 1/2" Disks</b>
S-Side D-Den. <b>9.50</b>	S-Side 135tpi <b>16.95</b>
D-Side D-Den. <b>13.50</b>	D-Side 135tpi <b>25.95</b>
S-Side 96tpi <b>18.95</b>	<b>8" Disks</b>
D-Side 96tpi <b>23.95</b>	S-Side D-Den. <b>22.95</b>
<b>HIGH Den. 27.95</b>	D-Side D-Den. <b>24.95</b>

Old Reliable **3M** Diskette Connection

- Delaware 1-800-451-1849
- Oklahoma 1-800-654-4058
- Nevada 1-800-621-6221

TERMS: Minimum 20 disks or \$35.00 — VISA or MasterCard accepted. COD orders add 2% for special handling. SHIPPING: 3/4 + 5/8 Diskettes. Add 3% for every 100 Diskettes or any fraction thereof. 8 Diskettes. Add 4% for every 100 Diskettes or any fraction thereof. We ship UPS; orders requiring other delivery methods add shipping plus 2% of total order.

# The big news in Toshiba 3-in-One™ technology is small.

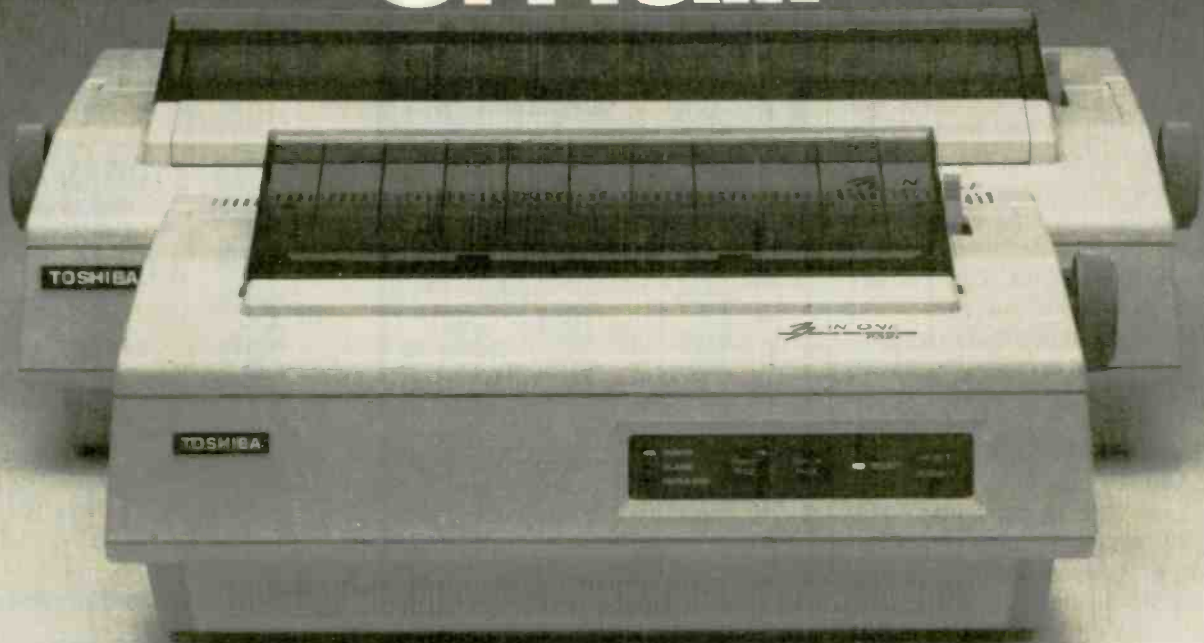

## Introducing the compact version of P351 technology.

Meet Toshiba's P321 printer. It packs the power of 3-in-One technology into a compact new size. At an even more compact price.

### Three for all.

What is 3-in-One technology? It's the ability to offer the three things everybody wants in one narrow-carriage printer: speed, letter-quality type and crisp graphics.

It all comes from our Toshiba-designed 24-pin print-head. One that prints at a blazing 216 characters per second, has superb graphics ability and combines those with type that looks like a daisy wheel's.

So one P321 can actually replace three ordinary machines.

### Just like the big boys.

The P321 offers optional downloadable type fonts

and IBM graphics printer emulation. And comes with year-in, year-out Toshiba reliability. In fact, the P321 gives you almost every office capability the giant machines do. Even spreadsheets.

Not bad for a printer with a footprint about two-thirds the usual size.

### Free font cartridge.

With the P321, you have an incredible array of font cartridges to choose from. A face for every occasion.

And while we're introducing the P321, you get a font cartridge FREE with each P321 you decide to buy.\*

Which should be an easy decision. It's the only compact printer that competes with larger machines on features. While it competes with lesser machines on price.

Call 1-800-457-7777, Operator 32 for your nearest Toshiba dealer.

\* Offer good through May 31, 1986.

In Touch with Tomorrow

## TOSHIBA

TOSHIBA AMERICA, INC., Information Systems Division

Inquiry 367



# A MIXED LOT

BY EZRA SHAPIRO

Trying to do any serious writing on the Macintosh is like tap dancing in wet concrete. The Mac motto seems to be "Live by the interface; die by the interface"—and that interface is designed to make continuous typing difficult. Mice and click buttons and pull-down menus interrupt typing, period. No arguments. When you're attempting to generate large amounts of prose quickly, the Mac is a nuisance. I know there are legions of Macaholics who will argue that the machine is so easy to use that even preparing a full-length book is a snap. I admire their fortitude; I hope they'll be rewarded in some future existence. I just don't have the patience. Maybe the keypad on the new Macintosh Plus will help (cursor keys at last!); I'd like to get my hands on one for more than half an hour at a time.

Before all the Macintosh fans come after me with a bucket of tar and a bag of feathers, let me add that there *are* certain things for which the Mac is superb. For tasks that involve *non-continuous* typing or projects that can be simplified through the judicious use of graphics, the Macintosh is *wonderful*. Spreadsheets like Excel come to mind, as do databases like Odesta Helix and ThinkTank 512. Two of this month's products, Stella and Interlace, are Mac programs. Both use the Mac's interface intelligently, and both get hefty endorsements as a result. I just wish I could get those programs running on a machine that did decent word processing.

## TWO MODEL KITS

**Boxes & Arrows** (Inner Loop Software, \$395) for the IBM PC and compatibles is an odd cross between a presentation-graphics program and a spread-

## *This assortment includes*

**Boxes & Arrows,**  
**Stella, Boxcalc, Interlace,**  
**and PC-Outline**

sheet. Using character graphics, you draw boxes that you can then connect with lines or arrows. With the addition of text, you have a program for creating that essential corporate document—the organization chart. The screen is just a window onto a much larger plane; you can do a *big* chart.

Constructing similar diagrams is fast and logical. You generate a box either by entering coordinates or by placing the cursor at a point representing one corner. As you move the cursor to the opposite corner, you watch a rubber box grow on your screen. Hit Return, and you have your box. Points and lines are just as easy. All three types of objects have selectable attributes—color, thickness, and style. Editing existing charts is also painless, and Boxes & Arrows will remember relationships between objects and redraw connecting lines correctly even if you've made massive changes.

That's the presentation-graphics part—now for the spreadsheet. You can treat any object as the equivalent of a spreadsheet cell; that is, you can attach a numeric value or a formula to it. That's not as cryptic as it sounds. Each object is assigned an ID number as you create it; you can use ID numbers in the same way you use cell references. Instead of "A24" or "BB37" (spreadsheet cell lingo), you've got "B3" for Box 3 and "L84" for Line 84. Boxes & Arrows provides a large assortment of macro and con-

trol functions, so you can write pretty sophisticated models. The program comes with a nice selection of examples, too—a personal financial calculator, an op-amp circuit, a small model of the U.S. economy, and a program that calculates the date of Easter.

Essentially, Boxes & Arrows gives you spreadsheet capability without tying you into the rigid row/column structure of the ledger sheet. You can organize flowcharts and models visually and recalculate them quickly.

The documentation is awful, but you can throw it away and use the program without much head scratching. And I have to give points for a full explanation of data structures used in the program—the kind of technical detail that's all too often forgotten these days.

It's a good program and useful, too, and I'd feel a lot better about recommending it if I hadn't seen **Stella** (High Performance Systems, \$200) on the Macintosh. Stella does everything Boxes & Arrows can do, with the exception of color, of course, and then takes the concept miles further—at half the price.

Stella is a tool for people who are serious about their models, and I mean serious. You can use a library of shapes keyed to function, not just boxes. Because the Mac's display is bit-mapped, while Boxes & Arrows has a character orientation, you can view a huge model on the screen and zoom in to smaller sections. And once you've got your diagram drawn and your equations written, Stella can

*(continued)*

Ezra Shapiro is BYTE's West Coast Bureau Chief. Contact him at BYTE, McGraw-Hill, 425 Battery St., San Francisco, CA 94111.

# MEGA-16 BAR CODE READER

BAR CODE READER WITH KEYBOARD EMULATOR FOR IBM PC/XT, AT

Your PC will become a BAR CODE SYSTEM by using our "MEGA-16" bar code reader. With Built-in "KEYBOARD EMULATOR" in our "MEGA-16", it can read the bar code data directly WITHOUT adding any software or hardware. All you have to do is just plug in the "MEGA-16" bar code reader to your PC instead of PC's keyboard plug.

**ONLY \$395.00**



**APPLICATIONS**

- INVENTORY CONTROL
- ASSET MANAGEMENT
- FILE OR DOCUMENT TRACKING
- ORDER ENTRY
- WORK-IN-PROCESS
- RETAIL POINT-OF-SALE

**FEATURES**

- IBM PC, PC/XT, PC/AT PLUG-IN COMPATIBLE
- WITH KEYBOARD EMULATOR, NO EXTRA SOFTWARE, OR HARDWARE IS NEEDED
- READ THE MOST OF CURRENT CODES
- BIDIRECTIONAL SCANNING
- AUDIBLE "BI" FOR CORRECT READING
- COMPACT SIZE, LIGHT WEIGHT, AND NO EXTRA POWER SUPPLY IS NEEDED
- VISIBLE INDICATOR
- EASY TO INSTALL, AND EASY TO OPERATE
- NO CARD SLOT REQUIRED/SIMPLE INTERCONNECT
- READ HIGH, MED & LOW DENSITY LABELS
- HIGH FIRST READ RATE
- SWITCH SELECTABLE OPTIONS
- SELFTEST DIAGNOSTICS
- CAN READ 6 KINDS OF BAR CODES—UPC, EAN, JAN, 2 OF 5, 3 OF 9 & CODE BAR

animate your model. If you want to vary a value over the course of time. Stella will show you what happens visually, either on a coordinate graph or by treating the boxes as tiny fuel gauges. Want to see what happens to more than one variable? Stella can handle it. You can pop open graph windows, model windows, equation windows, and who knows what else. If Boxes & Arrows takes a spreadsheet and releases it from the grid, Stella gives it life.

My only warning about Stella is really a warning about me: I saw only a demonstration of the product, and I've never actually used it. However, that demo (which included a gigantic macroeconomic model) blew me away. And a full review is scheduled for BYTE, which I hope will include screen photos. If you're skeptical, wait for the review. If you're willing to gamble a little, go for it. Stella is not for the casual spreadsheet user, but if you're a fanatic about complex simulations, Stella could be the stuff of your dreams.

In all fairness to Boxes & Arrows, it's aimed at a different market, one that requires quick, direct charts. It's a slick piece of programming, not to be ignored in my enthusiasm for Stella.

**A SIMPLER APPROACH**

Down at the \$40 end, we've got Boxcalc (Cotton Software Inc., \$40). Descriptions of Boxcalc sound a lot like those for Boxes & Arrows, and the use of the word "box" compounds the confusion.

Boxcalc is much more an unencumbered spreadsheet, oriented toward classic business reports. By "boxes," Boxcalc means "spreadsheet cells that can float around on a page of text." Relationships between boxes/cells are easy to specify with a good batch of macro functions, and it's neat to be able to mix calculated data in what's basically a text matrix.

Where Boxcalc falls short is in text-processing power. It's a rudimentary editor at best, lacking amenities like word-wrap and search-and-replace. Woe unto you if you realize halfway down the page that you've left out a word! If you're truly determined, you

(continued)

## MEGA AT COMPUTER

**\$1745<sup>00</sup>  
ONLY**



- 6 or 8 mHz 80286 Microprocessor Socket for 80287 Math Co-Processor
- 640K Standard Memory, Expandable to 1MB on board
- 3 I/O Expansion Slots
- One 1.2MB Floppy Drive
- Western Digital Hard & Floppy Drive Controller
- 192 Watt Power Supply
- AT Style Keyboard
- Color Graphic Card
- Operation Manual & System Box
- One Year Warranty

## MEGA XT COMPUTER

**\$699<sup>00</sup>  
ONLY**



- IBM PC/XT Fully Compatible Mother Board with 640K on Board
- Color Graphic Card
- One Floppy Disk Controller Card
- One DS/DD Slim Drive
- Flip Top Metal Case with Speaker
- 135W Power Supply
- Keyboard
- Operation Manual & System Box
- One Year Warranty

CALL FOR SPECIAL PRICE OF  
**XT ADD-ON CARDS**

### POWER SUPPLY

FOR PC/XT AND AT



- 135 Watts**  
XT Power Supply  
OEM PRICE: \$69<sup>00</sup>  
(QTY. 10 PRICE)
- 200 Watts**  
AT Power Supply  
OEM PRICE: \$99<sup>00</sup>  
(QTY. 10 PRICE)

**CALL FOR MEGA TURBO AT SYSTEM!!**

- 6 or 8 mHz Switchable with Zero Wait State

**AT ADD-ON**

- Enhanced Color Graphic Short Card, 256K Graphic Memory ..... \$449
- Seagate 225 with WD Controller ..... \$549
- Seagate 4026 (20MB, 30ms) ..... \$799
- Seagate 4038 (40MB, 30ms) ..... \$899
- 20MB Streaming Tape Backup System ..... \$649
- AT Serial & Parallel Card ..... \$ 99
- AT 3 MB Multi-Function (OK) ..... \$239
- AT 2.5 MB memory Expansion Card (OK) ..... \$199

## KEYBOARD

To Be Used On Both  
**PC/XT and AT**

BTC 5060 AT



NO SWITCH,  
AUTOMATIC  
SELECTION!  
OEM PRICE: \$65<sup>00</sup>  
(QTY. 10 PRICE)

## CASE



- XT OPEN-TOP CASE**  
OEM PRICE: \$39<sup>00</sup>  
(QTY. 10 PRICE)
- AT CASE**  
OEM PRICE: \$79<sup>00</sup>  
(QTY. 10 PRICE)



## C.J. COMPUTERS CORPORATION

(Manufacturer & Distributor)

2424 W. Ball Rd., Suite A&B, Anaheim, CA 92804  
ORDER AND INQUIRY HOT LINE (714) 821-8922 (5 LINES)  
TLX: 3720117 JC COMPTR - FAX: (714) 821-8941

\* 90 days warranty on parts and labor.  
\* IBM is the trademark of International Business Machines Corporation.

**IMMEDIATE DELIVERY!**

**YOU'VE GOT THE BEST PASCAL COMPILER!  
NOW — GET THE BEST UTILITY!**

# TURBO SCREEN™

**\$79.95**



**BETTER YET!  
ANNOUNCING  
VERSION 2.0!**

## NEVER AGAIN WRITE SOURCE CODE FOR SCREEN DISPLAYS!

Still writing line after line of source code just to create effective screen displays and error-proof data handling? Use TURBO SCREEN's Editor to create the screens, the Collator to define a list of screens... and then relax for a few seconds while the Generator writes the source code!

### TURBO SCREEN™

- New!** 255
- New!** • 100 Fields per screen, and up to 80 screens in your application.
- New!** • Create Window-Style Overlays or Full-Screen pictures in PC-DOS, MS-DOS, or CP/M.
- New!** • I/O Field types of Real, Integer, String, Boolean, Character.
- New!** • Automatic Initialization.
- New!** • Automatic Range checking.
- New!** • You assign variable names.
- New!** • Date and Time Functions.
- New!** • Input character validation.
- New!** • Sophisticated error checking and handling.
- New!** • Automatic or keyboard input termination.
- New!** • Logical cursoring between fields with arrow keys.
- New!** • Application support for full IBM keyboard.

- New!** • Enhanced fields during data entry.
- New!** • Window overlay management procedures.
- New!** • Turbo DataBase Toolbox procedures.
- New!** • Automatically adapts to monitor type.
- New!** • Advanced Editor
  - Turbo Pascal - like commands
  - Block commands
  - Type in any direction with any character
  - Automatic box drawing
  - Border color support
  - Best extended character support

Inquiry 269

*No Royalties — Not Copy Protected — No Assembly Language Interface — No Resident Code*

### TURBO SCREEN ORDER FORM

**PASCOM  
COMPUTING**

23611 Chagrin Blvd., Suite 101  
Cleveland, Ohio 44122

Price: \$79.95. Includes shipping to U.S. & Canada.  
Outside USA and Canada add \$10.00. Payment  
must be in U.S. dollars and drawn on a U.S. bank.  
Ohio residents add 6 1/2% sales tax.

Visa \_\_\_\_\_ Check \_\_\_\_\_  
MasterCard \_\_\_\_\_ Money Order \_\_\_\_\_  
Card # \_\_\_\_\_  
Exp. Date: \_\_\_\_\_



ONLY — Call **TOLL FREE:** 1-800-243-1849  
Inside Ohio call 1-216-292-8745 (Lines Open 24 hours, 7 days).

**"New!"** features available for IBM PC and compatibles ONLY!

Operating System: \_\_\_\_\_ IBM PC or true compatible \_\_\_\_\_ CP/M-80

\_\_\_\_\_ Other MS-DOS \_\_\_\_\_ CP/M-86

Computer Model: \_\_\_\_\_ Disk Format: \_\_\_\_\_ (5" and 8" Only)

Name: \_\_\_\_\_

Address: \_\_\_\_\_

City: \_\_\_\_\_ State: \_\_\_\_\_ Zip: \_\_\_\_\_

Telephone: \_\_\_\_\_

Turbo Pascal and Turbo DataBase Toolbox are trademarks of Borland International. IBM is a trademark of International Business Machines. MS-DOS is a trademark of Microsoft. CP/M is a trademark of Digital Research.

can prepare your text with another editor, load it into Boxcalc with a memory-resident utility that does import/export, and then add your Boxcalc cells to it.

A Boxcalc file can be 99 pages long, with over 800 cells throughout (never specified exactly), and one Boxcalc file can call up cell data from another, so your referencing capacity is theoretically limitless. Not bad.

It's an intriguing product. The programmer knows what he's doing with his cells, but using Boxcalc is a lot of work. It falls into the category of not-ready-for-prime-time software, but at its price it's certainly acceptable. It does what it claims and doesn't crash. Your move.

**INTERLACE**

Databases on the Macintosh are a treat. Almost every one I've seen has something appealing about it. I like the ease with which I can create data-entry forms, specify query filters, and design output reports.

Interlace (Singular Software, \$95), the new kid on the block, is no exception. I've had a copy for about two weeks now, and I like it. I'm chagrined to report that because it's such a solid database and does all the right database things, I have less to say about it than I might like.

Salient points: Relational model. Disk-based. Simple visual design of databases. Good query system—you select the field; Interlace offers you a choice of logical operators. Full complement of numeric functions. Extensive report facilities. Sorts and multiple keys and all that stuff.

Big feature (sound the trumpets): Excellent file-linking capacity. Rather than going through the mumbo jumbo normally involved in producing what is known as a "table file join" or some such, you link databases by drawing lines from one to another with the mouse. There is no upward limit on the number of linked files, and the number of files that can be open at the same time is at least 16, up to the maximum allowed by the Macintosh operating system of the moment. This is the best engine I've encountered so far for multiple-database operations on a microcomputer.

My only (slight) objection is that this is the first Mac software I've seen in a while that I didn't instantly understand. I had to crack the manual for about half an hour before I got comfortable enough to start trying things. But the documentation is thorough and well written, and the discussion of file linking is the first I've read that would make sense to a mere mortal.

Did I happen to mention that Inter-

lace is roughly half the price of its closest competitor? A winner.

**OUTLINE UPDATE**

I still think that Ready! and ThinkTank from Living Videotext are good, robust products—it's pretty tough to crash either of them—but now they've got some competition that's worth noticing.

PC-Outline (SoftWorks Development, \$49.95) is a user-supported outliner, which means that you get the program from an electronic bulletin board or from a friend, use it for a while, and send the author a check if you decide you like it.

What does it do?

It operates as either a stand-alone or memory-resident program, depending on a command-line switch. Handles larger files than Ready!, the default being twice the size of Ready!'s maximum (64K versus 32K bytes, but you can go larger if you want to spend the memory). Generates indented outlines with numbering in a choice of styles (no numbering at all in either Ready! or ThinkTank) or works as a fairly decent word processor on flat text. Keyboard macros. Import/export, either of alien files while in stand-alone mode, or into/out of other applications packages in memory-resident mode. Up to nine windows on screen, into either different files or different parts of the same file. Windows can be sized, moved, or zoomed to full screen.

Pretty impressive. The user interface is not as easily mastered as the ThinkTank/Ready! system, but what you lose in ease of use you gain in word-processing capability. Which is better? Obviously, that depends on how you use an outliner.

I'm not prepared to cast my vote for PC-Outline until I've seen how it matures. Right now, it's still a new program with some rough edges, but it could emerge as the winner.

However, I have it on good authority (Dave Winer himself, father of the ThinkTank family) that some interesting developments are coming from Living Videotext. A new ThinkTank? Other wonders? Stay tuned.

This could be fun to watch—Outline Wars! I love it. ■

**ITEMS DISCUSSED**

**BOXES & ARROWS** .....\$395  
(MS-DOS)  
Inner Loop Software  
5456 McConnell Ave.  
Los Angeles, CA 90066  
(213) 822-2800

**STELLA** .....\$200  
(plus \$5 shipping for U.S. orders;  
\$15 for international orders)  
(Macintosh)  
High Performance Systems  
13 Dartmouth College Highway  
Lyme, NH 03768  
(603) 795-4122

**BOXCALC** .....\$40  
(MS-DOS)  
Cotton Software Inc.  
2510 Anderson Rd.

Covington, KY 41017  
(606) 727-1600

**INTERLACE** .....\$95  
(Macintosh)  
Singular Software  
5888 Castano Dr.  
San Jose, CA 95129  
(408) 446-0207

**PC-OUTLINE** .....\$49.95  
(plus \$5 shipping)  
(MS-DOS)  
SoftWorks Development  
750 Stierlin Rd., Suite 142  
Mountain View, CA 94043  
(415) 962-1279  
Orders: (800) 446-2263;  
in Washington, (206) 883-3212



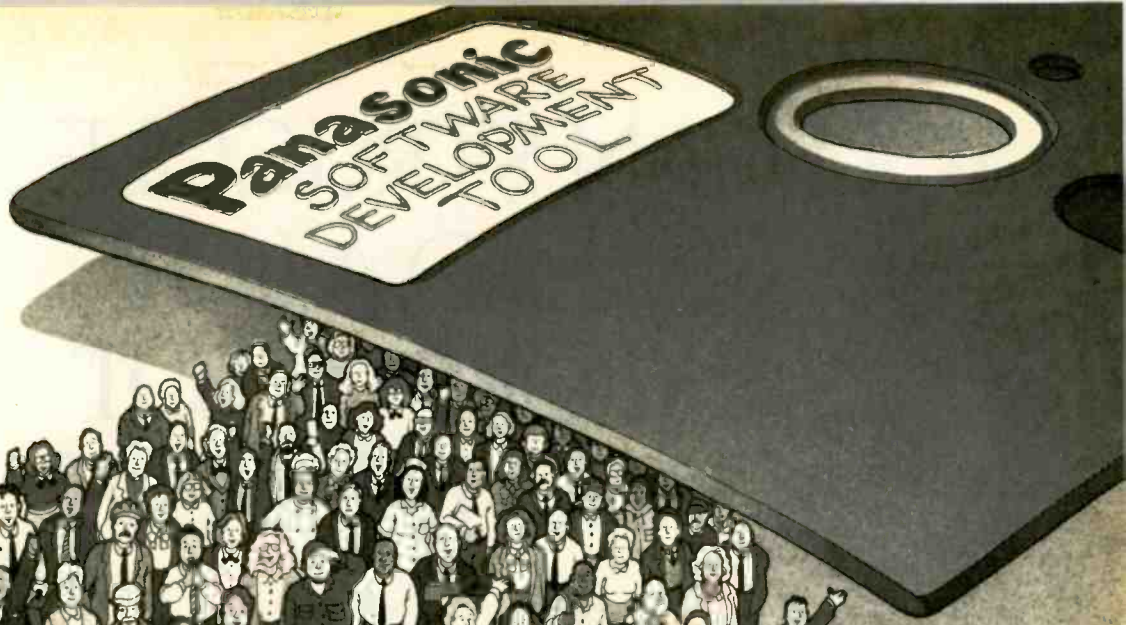

# PROGRAMMED FOR PROFIT.

NOW THE PANASONIC® SOFTWARE DEVELOPMENT TOOL MAKES IT EASY TO CREATE CUSTOM SOFTWARE—AND CUSTOMERS—FOR OUR NEW HAND-HELD COMPUTER.

Introducing the Panasonic Software Development Tool (SDT) for our new 16-bit hand-held computer, the Panasonic® Personal Partner™.

Designed to help you create new customers by providing them with custom software, the SDT provides you with a programming environment which allows you to design, develop and de-bug custom ROM-based software on the Panasonic® Exec. Partner™, Sr. Partner™ and other IBM-PC\* compatible computers.

You'll be writing software for our one-of-a-kind Personal Partner. It's the two-pound computer with the power of a desk-top, an 8-line by 80-character display



and the option of expanding up to 128K memory. The Personal Partner even has an optional 1200/300 baud modem for mainframe communication (available 2nd half 1986).

The Personal Partner provides your clients with the on-site answers they need. And the optional 80-column battery-operated printer makes it possible for them to create professional, computerized presentations wherever they are.

When you develop software for the Personal Partner with the Panasonic SDT, you know you're programmed for profit.

Send for more information on the SDT, or call:

**1(201)392-4645**

Name \_\_\_\_\_

Company \_\_\_\_\_

Address \_\_\_\_\_

City \_\_\_\_\_ State \_\_\_\_\_ Zip \_\_\_\_\_

Panasonic Computer Products Division  
333 Meadowlands Pkwy.  
Secaucus, NJ 07094

**Panasonic**  
Office Automation 

B586

\*IBM is a registered trademark of International Business Machines, Inc.

YOU CAN STRUGGLE A LOT  
READ A LOT  
WORRY A LOT  
AND PAY A LOT.

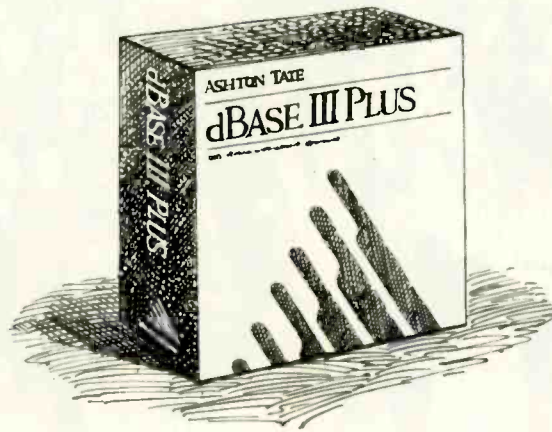

# OR NOT

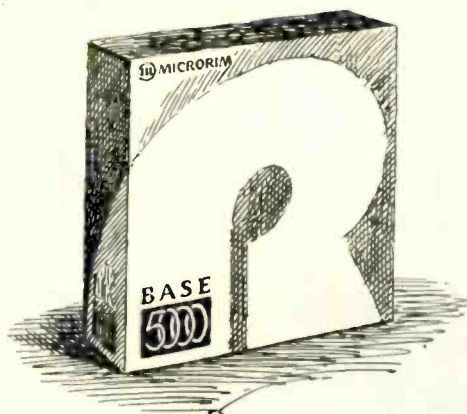

**I**t's the difference between spending time studying your software, and spending time developing your applications. At Microrim, we don't think you should have to struggle with an application generator that limits your choices to one of everything. (Like just one menu, and access to only one table.) Or be forced to read through dozens of pages of technical instructions just to figure out how the password system protects your files.

We also don't think you should have to worry about the possibility of locking up the system when two users go after the same record (a "deadly embrace"). Or have to pay extra each time you want to add a user to your database network.

That's why we built R:base™ 5000 just the way it is. Powerful, straightforward, and complete. (See the chart.) Which is probably why Datapro rates it as the best DBMS on the market, bar none.

But judge for yourself. For \$9.95 (plus shipping), we'll send you our R:base 5000 single-user demo. Or our multi-user demo for only \$50 (shipping included). Just call 1-800-547-4000 and ask for Dept. 940. From Oregon, or outside the U.S., call 1-503-684-3000, Dept. 940.

After all, when it comes to developing applications, you can either put yourself through a lot.

Or not.

## R:BASE 5000

FROM MICRORIM

APPLICATION DEVELOPMENT		
	R:base 5000	dBASE III® PLUS
Application Generator		
• Multi-table Access	Yes	No
• Nested Menus	Yes	No
• Custom Reports	Yes	No
• Reviseable Applications	Yes	No
Password Security		
• Pages of Documentation	1½	36
• Usable by Nontechnical User	Yes	No
Automatic Protection Against "Deadly Embrace"	Yes	No
List Price		
• Single-User	\$ 700	\$ 695
• Multi-User		
5 Users	\$1,500	\$2,385
10 Users	\$1,500	\$3,680
20 Users	\$1,500	\$7,360

# DRIVE PLUS

**Performance  
Reliability  
Economy**

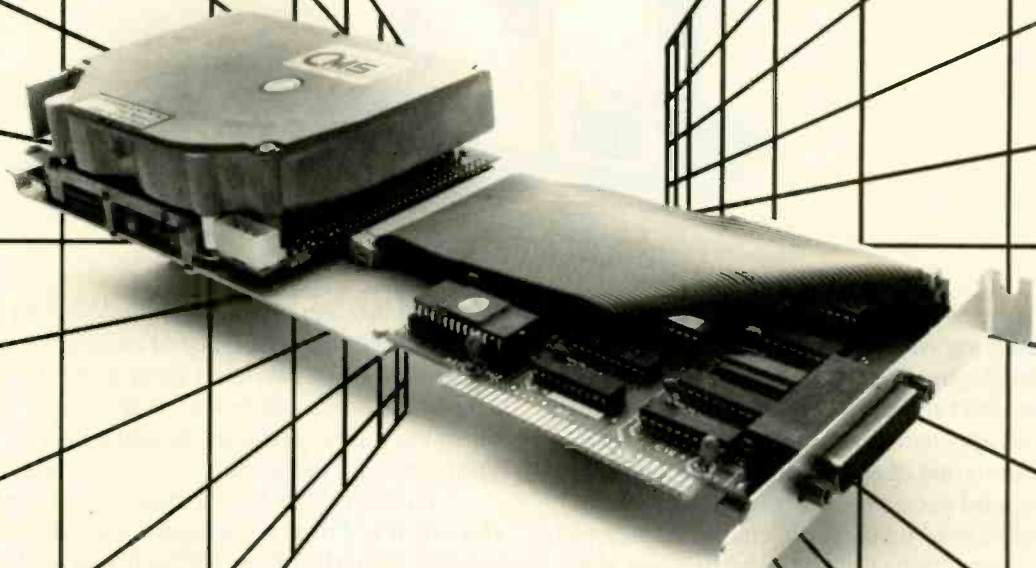

## **20 MB Hard Disk Expansion Card Family**

**DRIVE PLUS SCSI**

SCSI interface. 7.5 Mbit/sec transfer rate

**DRIVE PLUS HI-REL**

Automatic head lifters never allow heads to touch media.

**DRIVE PLUS ECONOMY**

Unbeatable low price for a hard disk card.



**Best Price · Best Performance**

401 W. Dyer Road, Santa Ana, CA 92707 (714) 549-9111



# 68000 WARS: ROUND 2

BY BRUCE WEBSTER

*A continuation  
of Bruce's comparison  
of the  
prominent 68000 machines*

Well, well, well. It's now late January, and the 68000 wars have heated up, with new products introduced, new markets opened, and the usual hyperbole from all parties. I've been doing a bit of 68000-oriented traveling: to the Consumer Electronics Show, to look at what's new from Atari; to Commodore

and Electronic Arts, to see what they're cooking up; and to the AppleWorld Conference and the Mac/Apple II Expo, to gaze at the latest and greatest there. My spare time has been spent coding benchmarks for the ST machines, the Amiga, and the Macintosh machines—no mean feat, considering the mix of compilers, operating systems, and ROM routines I've had to sort out. Mixed in there somewhere is a two-week bout with the flu. All in all, a busy month.

## THE ATARI 1040ST

In my February and March columns, I said a number of nice things about the Atari 520ST—and a fair number of not-so-nice things as well, mostly dealing with limited expansion, piles of cables, and ugly black power supplies. Well, now I have to eat some of my words. Atari took some major steps toward perfecting the ST with the release of the 1040ST, which is the 520ST "done right." The 1040ST has 1 megabyte of RAM, a built-in double-sided 3½-inch disk drive (709K bytes of usable space after formatting), an internal power supply, 128K bytes of ROM containing TOS and GEM, composite and RF video outputs (in addition to the regular Atari monochrome/RGB output), and—shades of Amiga—hooks for hardware graphics support via an add-on board. Atari improved an already-impressive price/performance ratio by offering the 1040ST with a monochrome monitor for only \$995. Combine that with Atari's hard disk (\$699), and you have a \$1700 personal workstation—68000 processor, 1 megabyte of RAM, 20-megabyte disk—that rivals systems costing up to 10 times that much just a few years (or months) ago.

Does the 1040ST have any bad points? Well, there's still no easy (within warranty) expansion path for adding RAM or other peripherals that don't use the serial, parallel, or DMA ports. Also, the 1040ST has the same large, awkward layout as the 520ST, though the reduced number of cables (due to the enclosed power supply and disk drive) helps. However, considering what you get for the price, these

seem like quibbles.

At this point, I must state that I have yet to get my hands on a 1040ST. However, BYTE's Peterborough office has had one for about a month now, so the machine is definitely real. In fact, since the 1040ST was on the cover of the March BYTE, it had better be real, or there's go-

ing to be a lot of red faces on both coasts. As soon as I can get one to work on, I'll give a full report.

## THE NEW 520ST

What then has become of the 520ST? Simple: Atari has added RF and composite video output, put TOS/GEM in ROM (finally), unbundled it from the disk drive and monitor, and pushed it onto the mass market. For \$399, you can buy a 512K-byte 68000-based system, take it home, hook it up to your TV, and do absolutely nothing with it, since (as of this writing) there is no ROM cartridge software available. If you spend another \$199 for a single-sided disk drive—or, better yet, \$299 for a double-sided drive—you can do a whole lot with it. However, since you've now paid about \$700 for a 512K-byte system, double-sided drive, and no monitor, you probably would have been better off spending \$300 more for a 1040ST.

Software developers seem to be mostly happy with Atari's move, since it almost certainly means a larger installed base of 520STs. However, the computer-store dealers who were carrying the 520ST—and who are now carrying the 1040ST—seem to be less thrilled with the marketing shift. Many are not convinced that the public will see that the 1040ST is a better deal and believe that their would-be customers will go to K-Mart for a 520ST. Many, in fact, are downright upset about the whole thing. The irony is that a lot of these same dealers went through a similar situation when Commodore moved the C-64 onto the mass market—and the same man, Jack Tramiel, was behind both moves.

## THE MACINTOSH PLUS

In a move that strongly parallels Atari's, Apple has released a new version of the Macintosh that fixes many (if not all) of the problems with the old Mac. The Macin-

*(continued)*

Bruce Webster is a consulting editor for BYTE. He can be contacted at BYTE, POB 1910, Orem, UT 84057, or on BIX as bwebster.

## BREAKS THE PRICE/PERFORMANCE BARRIER



### WESTERN COMPUTER AT TURBO

#### STANDARD FEATURES:

- IBM PC/AT Compatible with 512K RAM
- Switch Selectable 6 or 8 MHz operation
- Up to 2 Megabytes of RAM on Main board
- One Parallel Port & Clock/Calendar on Main board
- Enhanced PC/AT style keyboard
- Various mass storage and video display options available
- One Year Warranty



### WESTERN COMPUTER PC/XT TURBO

#### STANDARD FEATURES:

- IBM PC/XT Compatible with 256K RAM
- Switch Selectable 4.77 or 8 MHz operation
- Up to 1 Megabyte of RAM on Main board
- Two 360K Floppy disk drives and controller
- 750 x 350 Monochrome graphics controller or IBM CGA compatible controller
- Amber or green display monochrome monitor
- Enhanced IBM PC style keyboard
- Various mass storage, I/O, and Video display option available
- One Year Warranty

**Western Computer**

1381 WARNER AVE.  
WARNER CORPORATE PARK #B, TUSIN, CA 92680  
(714) 259-7755

EUROPEAN HEAD OFFICE  
BELECTRONIC SA, RUE CENTRALE 43  
CH-1880-BEX, SWITZERLAND  
PHONE (025) 631250

TELEX 456 168 ASWERBACK BELE CH.  
IBM PC/XT/AT/CGA are trademarks of IBM Corp.

tosh Plus looks much like the old Mac but has the following: 1 megabyte of RAM, expandable to 4 megabytes using the new 1-megabit RAM chips; 128K bytes of ROM (up from 64K bytes), with many of the routines rewritten for faster performance; an SCSI port that allows faster, cheaper hard disks (and other peripherals) to be hooked up; an internal 800K-byte disk drive; an expanded keyboard with cursor keys and numeric keypad; and, because of the space taken up by the SCSI port, modified printer and modem ports that now use a round 9-pin connector instead of the more common DB-9 connector on the old Mac.

Unlike the 1040ST, the Mac Plus offers a definite performance increase over its predecessor in both graphics and disk I/O. There's no parallel in price, either: The Mac Plus lists at \$2599, or more than 2½ times the cost of the 1040ST. In fact, for what you'd pay for a Mac Plus with an external 800K-byte drive (\$499), you could buy two 1040STs, each with a monochrome monitor and external 709K-byte drive (\$1298 per system), and an Atari RGB monitor (\$399) to share between them—and still have money left over.

Why does Apple charge so much for the Mac Plus? I can think of a number of reasons. First, Apple has a heavy R&D investment (a company total of \$263 million over the last five years) that it would like to recoup. True, not all of that was for the Mac, but the lion's share went into the Lisa/Mac/Mac Plus technology. Second, Apple is slowly penetrating into the corporate market, where the price differential just isn't an issue; you'll see few 1040STs sitting on executives' desks, but the Mac and Mac Plus look quite nice there. Third, the user interface, operating system, and ROM software on the Mac are (in my humble opinion) far superior to those found on the STs (or the Amiga or, for that matter, the IBM PC). That superiority is due in part to the large amount of time and money Apple has invested in it. Fourth, you'll find a large base of well-written, professional, innovative application software for the Mac. You can run programs like Helix, Microsoft Word, Filevision, and Excel on a Mac or Mac Plus; nothing remotely approaching those programs is available on the ST, and I wonder if parallel applications of similar quality and power ever will be.

In short, Apple is charging a premium price for the Mac Plus because it can get away with it... for now. That doesn't mean I agree with the price—I'd like to see it list for less than \$2000—but I do understand it.

The 512K-byte Mac is still on the market, though its official list price has dropped \$500 (to \$1999). Since the street price has been less than \$1900 for some time now, this could drop its price to less than \$1500, where—because of its software advantage—it could cause problems for the Amiga. Also, Apple is offering an upgrade path to turn a 512K-byte Mac into a Mac Plus. You can swap in an 800K-byte drive and the new ROMs for \$299, put in a 1-megabyte motherboard with the SCSI port for \$599 (\$799 if you have a 128K-byte Mac or a third-party memory upgrade), and get the new keyboard for \$129.

*(continued)*

# Use our Intelligence to speed up your PC

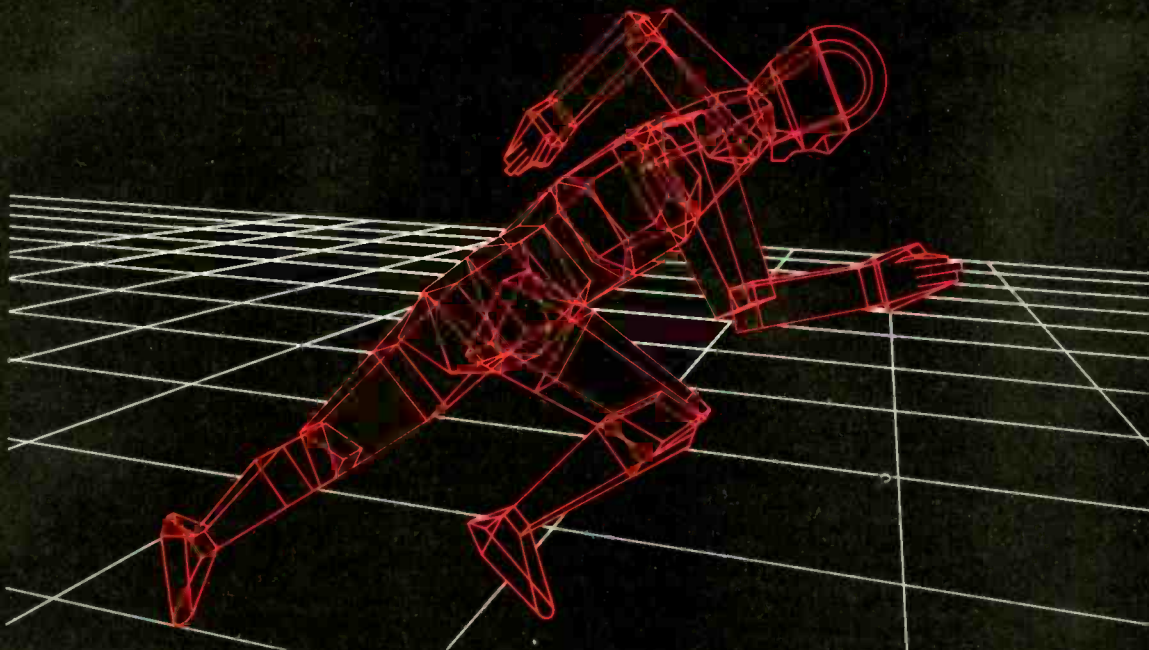

## PC Express

The IBM PC isn't exactly famous for its speed of operation. Or for the size of its standard memory. But before you decide to replace your system completely, use our Intelligence! Simply plug a PC Express board inside your existing PC/XT or most compatibles — it only takes seconds and there's no need for a special boot program. Your normal software will run up to three times faster, and wait states will be a thing of the past thanks to an efficient 9.5 MHz 8086 microprocessor. If you do a lot of number crunching there's an optional 8087 co-processor to take care of that. The PC Express, the world's first IBM PC/XT accelerator board — and still the best — comes complete with up to 640K of on-board memory plus an easy to use software package, with RAMdisk, print spooler, DiskCACHE and FastROM utilities, to boost speed and performance to even higher levels. Proved in thousands of applications throughout Europe and North America and backed by a 2 year guarantee, the PC Express gives you AT performance for only \$565\*. It's the Intelligence solution.

Intelligence products for your PC also include: **MegaRAM 512K \$455 1Mb \$590 2Mb \$785** — Up to 2Mb's of Lotus/Intel expanded memory. With RAMdisk, DiskCACHE and print spooler, your normal software will run up to three times faster.

• Combined with PC Express your programs will run even faster still.

## Intelligence Research

Intelligence Research Ltd. and Intelligence Research Inc. are wholly owned subsidiaries of Intelligence Technology Holdings Ltd. PC Express, and MegaRAM are registered trademarks of Intelligence Research Ltd. IBM PC/XT/AT are trademarks of IBM Corp. Lotus is a trademark of Lotus Development Corp. Intel is a trademark of Intel Corp.

**Intelligence Research Inc.**  
2111 Howell Avenue, Anaheim, CA 92806 USA. Tel: (714) 937 1305/6. Telex: 910 591 1893.  
**Intelligence Research Ltd.**  
3-16 Woburn Place, London, WC1H 0JE, England. Tel: 01-833 1867. Telex: 916 327 INTUK G.

For further information and to place your order by credit card for fast delivery, call (714) 937 1305/6



PC Express 512K

Please rush me .....PC Express boards  
I enclose payment of:

**\$565\*** per PC Express with 512K of memory  
plus \$10 shipping (\$20 for Canada)

**\$595** per PC Express with 640K of memory  
plus \$10 shipping (\$20 for Canada)

Please rush me ..... MegaRAM boards  
I enclose payment of:

**\$455** per MegaRAM with 512K of memory  
plus \$10 shipping (\$20 for Canada)

**\$590** per MegaRAM with 1Mb of memory  
plus \$10 shipping (\$20 for Canada)

**\$785** per MegaRAM with 2Mb of memory  
plus \$10 shipping (\$20 for Canada)

Name \_\_\_\_\_

Title \_\_\_\_\_

Company \_\_\_\_\_

Address \_\_\_\_\_

City/State/Zip \_\_\_\_\_

Normal shipping within 24 hours of payment received subject to availability. If you are not satisfied and return your PC Express or MegaRAM undamaged within 30 days, we will refund your money. US & Canada customers only. CA. residents - add local sales tax.



**Features:**

- 8 MHz 80186 microprocessor with true 16-bit data bus.
- True PC compatibility with our own custom ROM BIOS and PC cardslots for the video of your choice.
- Standard 512K zero wait DRAM, 640K or 1M options.
- 8087 numeric coprocessor port.
- On-board floppy disk controller for up to four 5 1/4" drives.
- On-board SCSI hard disk controller port.

**NEW**

FOR MORE INFORMATION CONTACT:

**PCTECH**  
 P.O. Box 128  
 904 North 6th Street  
 Lake City, MN 55041  
 (612) 345-4555

**NEW LOWER PRICES**

**Kits**

- Not So Bare Board ..... \$250
- Quick Kit ..... \$625
- Full Kit ..... \$795
- Assembled and Tested ... \$895
- 128K Add-On ..... \$ 90
- 1/2 MEG Add-On ..... \$240
- XT Style, Flip Top Enclosure ..... \$ 85
- 150 Watt Power Supply ... \$135
- 5 1/4" 48 TPI DS 1/2 Height Floppy Disk Drive ..... \$125

**NEW**

**Total Solutions:**

- **Assembled and Tested Systems**
- Mono-Chrome System .. \$1,865  
 Includes: 640K, Power Supply, Enclosure, Keyboard, Monitor, Two Drives, and Printer Port.
- Color System ..... Call
- Quantity Discounts Upon Request
- Call For Info on Add-Ons, Hard Disks, Etc.

**ACCORDING TO WEBSTER**

Be aware that the motherboard upgrade requires the disk/ROM upgrade. Also, Lisa/Mac XL owners can "upgrade" to the Mac Plus by trading in their old machines plus \$1500 for a Mac Plus with an Apple Hard Disk 20.

Where's all this leading? My best guess is this: If the 512K-byte Mac is still around by Christmas, it will be selling for around \$1000, trading punches directly with the 1040ST and the Amiga; the Mac Plus will be down to \$1900; and the Mac with slots (if it's out) will be selling for around \$3000.

**THE OLD AMIGA**

The news from Commodore continues to be mixed. Christmas sales (fourth quarter 1985) were \$340 million, based largely on strong sales of the C-64 and C-128. Commodore was claiming that it would post a profit for the quarter but appears to be backing down from that now. Even so, the sales are probably sufficient to keep the bankers from shutting things down. If Commodore is still alive by the time you read this, it will probably survive the year (and longer).

Finding out how many units have shipped of a particular computer is notoriously difficult, and the Amiga is no exception. The best information I've come up with indicates that about 50,000 Amigas were sold during the fourth quarter of 1985, matching reported U.S. sales of the 520ST for the third and fourth quarters of 1985 combined. (Atari claims another 50,000 STs were sold outside the U.S.) That would mean—in the U.S.—the Amiga outsold the 520ST during the Christmas season. That blows the prediction in my January column that the 520ST would outsell the Amiga at Christmas. Incidentally, Apple sales for that same quarter were slightly more than \$500 million, which represents about a 25 percent drop over Christmas 1984. However, because of the layoffs and streamlining that Apple did during 1985, profits were up by about 25 percent. This, of course, puts a sizable dent in my pick of Apple as "the big loser" for Christmas 1985. So much for my prognostications.

The sales figures for the Amiga are good but not great. One problem appears to be production; Commodore is literally selling Amigas as fast as it can make them, but that isn't very fast. Commodore is also having problems with marketing: Its people can't seem to make up their minds what market or markets the Amiga is aimed at. Their expensive ad campaign last fall was poorly conceived and poorly executed. I went past their first magazine ad three times before I happened to notice it was for the Amiga, and their TV ads (most of which I missed) were generally greeted with yawns and/or confusion. (Some of the techies at Commodore would like to run their own ad campaign, modeled after the Bartles & Jaymes wine cooler commercials: "We've been working on this computer for three years, and we'd really appreciate it if you bought one.")

Commodore's biggest mistake, in my opinion, was not having a booth at COMDEX and/or CES. At COMDEX, I asked Clive Smith (vice president of marketing at Commodore) about that decision; his response was that they

(continued)

**MAX IBM® AT COMPATIBILITY**

**SHUTTLE-AT BOARD**

- 80286 CPU at 6, 8, 10 MHz
- Upgradable to 1 megabyte
- 1 parallel, 4 serial ports on board
- 4 models (S-286, TS-286, C-286, TC-286)
- Legal and true compatible BIOS

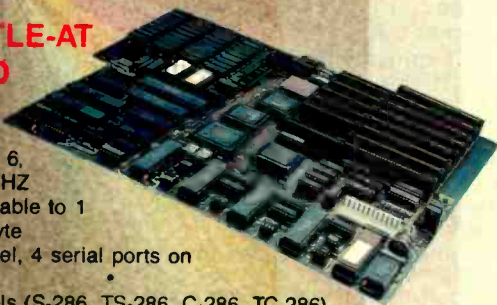

OEM QUANTITY PRICE  
**\$595.00**

**EGA BOARD**

- 256K on board
- Parallel port on board
- Adapts to EGA, Monochrome, RGB monitors
- 640 x 350 pels (64 colors)
- Less than half the cost for IBM® EGA from **\$295.00**

**BIOS CONTRACT** AT, XT, PC, EGA available to manufacturers  
 IBM, AT are trademarks of International Business Machines Corporation



**IBS Corporation—professional quality and support**  
 2700 E. Imperial Hwy., Bldg. A., Brea, CA 92621  
 To order an evaluation call: (714) 579-0680, 579-0691, 579-0692, TLX: 753197, & FAX (714) 579-0695.



# THE \$1,000,000 SWITCH IS ON!

## SHARE THE EXCITEMENT!

Frustrated by the limitations of your current software? Try KnowledgeMan/2, the "Friendly Superpower." We think you'll be so excited by its power and flexibility you'll never go back to your present dead-end software. In fact, if you let us know why you prefer KnowledgeMan/2, you could be a winner in our "\$1,000,000 Switch!"

From accounting to manufacturing to sales, KnowledgeMan/2 is a data base management system providing familiar business computing features in one highly-fused software package:

- Extensive relational data base management
- Spreadsheet features
- Spur-of-the-moment inquiries
- Forms management
- Statistical analysis
- Data security
- Programming language and much more

Enhance your business presentations and communications with fully-integrated options for color graphics, text processing, forms painting, report generation, remote communications, mouse processing, natural language processing, and others. Versions for local area networks are also available.

For the beginner, KnowledgeMan/2 has our extensive menu system with supporting help screens and easy-to-use documentation. The experienced user may turn off the menus to use KnowledgeMan/2's power through its time-saving command language or procedural language. Everyone can use the optional natural language features to ask for information in plain English.

For details on how you can enter "The \$1,000,000 Switch," see your local dealer or write or call: mdbs/Marketing and Sales/P.O. Box 248/Lafayette, IN 47902; 317/463-2581.

**KNOWLEDGE**  
**man/2**<sup>®</sup>  
THE UNIVERSAL KNOWLEDGE MANAGEMENT SYSTEM

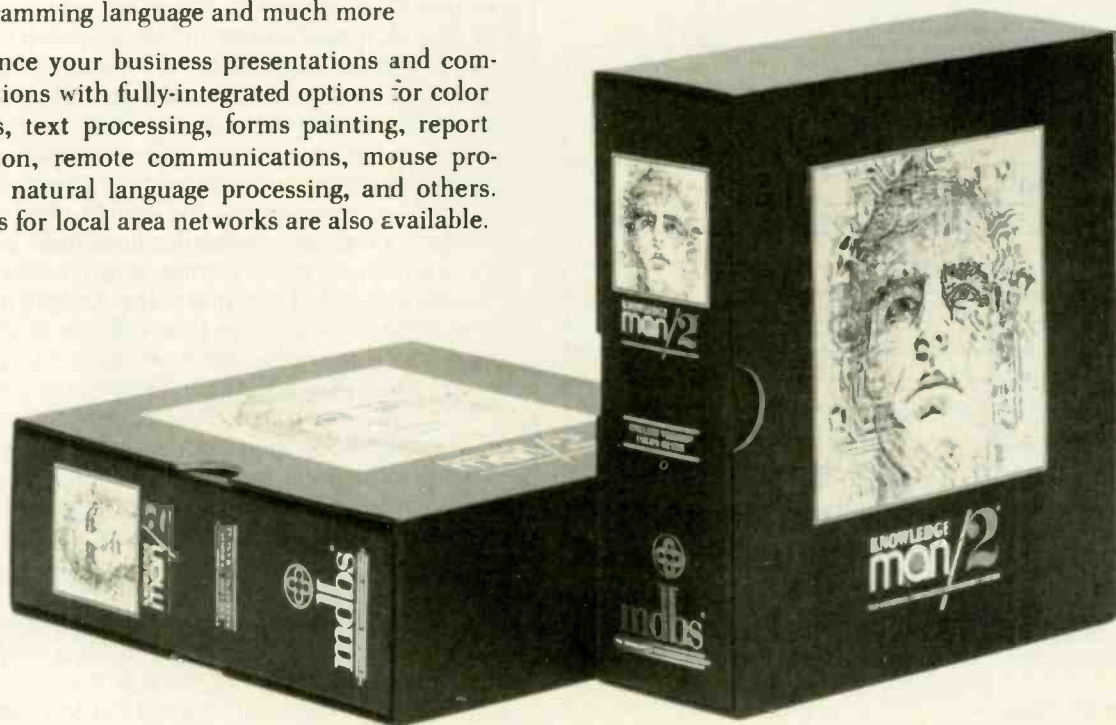

"mdbs" and "KnowledgeMan/2" are registered trademarks of Micro Data Base Systems, Inc.

# Expansion Chassis/ Sub-System

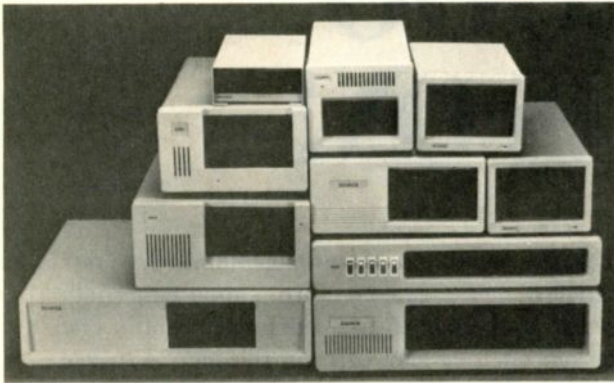

## Specification

Model No.	No. of Slot	Half Height Drive	Power Supply	Dimension D×W×H(cm)	Price
M-1*	0	1	A or B	30 × 15 × 6.5	\$149
M-2	3	3	C	42 × 25 × 16	\$299
M-3	5	3	C	39 × 30 × 15	\$259
M-4	12	2	D	40 × 39 × 14	\$299
M-5	0	2	E	39 × 18 × 15	\$149
M-6	0	1	A or B	26.5 × 18 × 13.5	\$169
M-7	5	2	C	38.5 × 30 × 13.5	\$299
M-8	0	2	E	39.5 × 18 × 13.5	\$149
M-9	0	2	F	38.5 × 49 × 9	\$249
M-10	8	4	G or H	43 × 49 × 14	\$259

\* Extra space for a stand alone controller

## EXT and RCV Adapters

- Connecting master expansion chassis to PC, XT or AT
- Fully buffered address, data and control signals.
- 3 feet shielded flat cable.

Price \$159

## Power Supply

	Watt	+5V	+12V	-12V	-5V
A	50	5.0	2.5		
B	50	1.8	3.5		
C	100	8.0	5.0	0.3	
D	100	10	3.5	0.5	0.5
E	45	4.0	2.0		
F	60	5.0	3.0		
G	135	15	4.2	0.3	0.3
H	150	15	6.0	0.3	0.3

**ORDER TOLL FREE: (800) 826-0267**  
**In California Call (415) 651-3355**

DEALER INQUIRIES INVITED

**SOURCE ELECTRONICS CORP.**

45277 Fremont Blvd., Unit 6  
Fremont, CA 94538

Telex: 279366

FAX: (415) 791-0935

didn't want to attract any more dealers (or end users) because demand was already outstripping production. It was hard to swallow that answer then, and the past few months haven't made it any easier. Commodore's absence—combined with Atari's large, crowded booths at both shows—has made dealers, developers, and end users uncertain about the life expectancy of the Amiga. It hasn't done much for the confidence of the original designers and developers at Commodore, either. Recent months have seen the departure of Carl Sassernrath (author of Exec, the multitasking Kernel at the heart of the Amiga), R. J. Mical (author of Intuition, the high-level graphics library), and others. And some of those still at Commodore are less than thrilled with the confusion at Commodore HQ in West Chester, Pennsylvania. At this point, the single greatest obstacle facing the Amiga may be Commodore itself.

Lack of software for the Amiga is becoming less of a problem, though some critical applications—like a good word processor—have yet to appear. (Ever wonder how the Macintosh would have done if MacPaint and MacWrite hadn't been available when the machine was first shipped? Those two programs carried the Mac for several months, until other serious applications appeared.) And there appears to be plenty of demand out there: Trip Hawkins, head honcho at Electronic Arts, says that EA shipped more than a million dollars' worth of Amiga software in December alone, with Deluxe Paint being the biggest seller. While EA games will undoubtedly do well, the next blockbuster will probably be Deluxe Video, an impressive package that lets you use animation, special video and audio effects, and musical sound tracks (from Deluxe Music Construction Set, also coming from EA) to create your own video sequences. Since you can plug your Amiga into your VCR, said videos can be recorded for posterity (or customers or students or . . .). If you combine Deluxe Video with the yet-to-be-released genlock device that lets you use an external video source (VCR, laser disk, TV set, camera) as the background "color" on your display, the possibilities multiply. Could be lots of fun.

Another problem facing the Amiga right now is that third-party hardware companies have been slow in coming out with peripherals. Tecmar, which ballyhooed its line of Amiga add-ons at the time of the Amiga's introduction last summer, has—as far as I can tell—yet to ship any sellable products (some dealers have apparently gotten units marked "NOT FOR RESALE"). Tecmar also enraged a lot of Amiga owners by increasing its previously announced prices by about 50 percent; for example, the 20-megabyte hard-disk drive went from \$995 to \$1495. Tacky. . . and dumb marketing, to boot. I suspect that the first company to come out with nothing more complex than a RAM expansion box (remember, the Amiga can go up to 8½ megabytes) is going to make a killing. Because of the automatic RAM-disk support in AmigaDOS (one of its few virtues), I suspect that a majority of Amiga owners would rather purchase a cheap RAM box than a not-so-cheap hard-disk drive, especially if the RAM box can use either

(continued)

# FOR YOU, GOOD IS JUST NOT GOOD ENOUGH.

*For serious programmers, good isn't good enough. You need the best...the best tools, the best advice and the best support.*

*At Lifeboat, we've been selling to programmers since 1976, so we know quality when we see it. And we're committed to a full-service program that goes beyond just selling you the best software at competitive prices. Our expert staff can help you decide which programs are best for your needs and provide you with all the technical support you may require. You can rely on Lifeboat for the complete solution to your programming needs.*

## LATTICE® C COMPILER

The new version of the best selling C compiler includes important new features:

- Code now faster and smaller.
- Support for 80186/80286.
- Inline support for 8087/80287.
- Fully compatible with current libraries.
- Supports enumerated types, void types, unsigned as modifier.
- Conforms to the proposed ANSI standard.

The library now contains more than 325 functions, from as simple as system time to as complex as critical error handling.

In addition to the new features of 3.0, the *Lattice C Compiler* offers four memory models for optimum efficiency, is compatible with the C implementation established by Kernighan and Ritchie, gives you superbly written documentation and still has the widest selection of C utilities supporting it, including the source code level debugger from Lattice, C-Sprite.

*Lattice C Compiler* 3.0 now adds still more reasons to the list of why software developers have made *Lattice C* the industry standard.

New!  
Enhanced  
3.0 Version

## RUN/C- THE C INTERPRETER™

Learn C the natural way with *RUN/C* introductory package. The new version includes a full screen editor and other new features to enhance performance. *RUN/C's* user interface is similar to that of the BASIC interpreter with easy familiar commands such as LOAD, LIST, SAVE, EDIT, and RUN. Debug with TRON, TRACE, and PRON. Try your hand at graphics with easy-to-learn functions like PUT, GET, CIRCLE, LINE, SCREEN, and DRAW. Over 100 sample programs are included on the disk to coincide with the thorough and professionally written C reference manual. Learning C is easy with *RUN/C*.

New!  
2.0 Version

## RUN/C PROFESSIONAL™

All of *RUN/C's* features, plus powerful enhancements for program development. LOAD and RUN your favorite library functions (GSS Drivers®, Multi-Halo, Panel, Lattice Window™, etc.) from within your *RUN/C* interpreted code. Polish program modules before compiling. New source code debugging facilities allow you to set multiple breakpoints, single step through a program, and view and change variables during execution.

New!

## GREENLEAF FUNCTIONS™ AND COMM LIBRARY™

The *Greenleaf Functions* are more than 200 powerful routines for the PC, AT and close compatibles, including DOS and BIOS capabilities. The *Greenleaf Functions* has string handling, color text capabilities and much more. Many functions are coded in assembler for speed and compactness. The *Greenleaf Comm Library* gives your programs asynchronous communications capability. Allows multiple simultaneous file transfers through an arbitrary number of ports at up to 9600 baud. Also supports XMODEM protocol and Hayes-compatible commands.

New Versions!

## PANEL®

A powerful and flexible tool for interactive screen design. *Panel* simplifies the tedious screen design process enabling you to create and modify screens interactively from your keyboard. *Panel* automatically generates source code describing the data-entry screen, including subroutines which dynamically load the screen at run-time. With *Panel* you determine the content, position, size and attributes of screen and data fields at any point in the program's design or execution. *Panel* handles the details of interfacing a wide variety of terminals, without changes in your program.

## VEDIT PLUS®

*VEDIT PLUS* is a fast and powerful full-screen editor for program development and word processing. Edit, split, and merge multiple files, create customized functions (such as sort/merge, code translation) with the built-in macro-programming language. Automatic indenting, "undo" command. New version adds pathname support, memory management to 1 megabyte, on-line help, new formatting features.

## MULTI-HALO™

A fast, comprehensive library of color graphics subroutines. *MULTI-HALO* offers over 200 commands, including PLOT, LINE, ARC, CIRCLE, and ELLIPSE primitives, plus single commands which create bar and pie charts. Other options, such as pattern-fill and dithering commands, give graphics impressive texture and color-mix qualities. Rubber-banding draws shapes for interactive users and even realistic animation and on-screen "slide shows" are possible for those who wish to maximize *MULTI-HALO's* best features.

New Versions!

For information on these and the other products in our complete line call:

# 1-800-847-7078

In NY:

# 212-860-0300

or write: **LIFEBOAT™ ASSOCIATES**  
55 South Broadway  
Tarrytown, New York 10591



Inquiry 201

The Full-Service Source For Programming Software

# WE STOCK WHAT WE SELL!

If You Don't See It  
Listed Here, Call Us!!

**FREE  
MICROSOFT  
WINDOWS**  
w/hard drive  
Zenith Computers

**ZENITH**

## PERSONAL COMPUTERS

Entry Level Desktop Dual Drive 5/8 Mhz <b>ZF-148-42</b>	\$ 999	Professional Desktop Dual Drive 5/8 Mhz <b>ZF-158-42</b>	\$1,799
Entry Level Desktop Hard Drive Systems <b>NEW ZW-148-42-K (10 Mg System)</b>	\$1,499	Portable Dual Drive, Battery Operation <b>ZFL-171-42</b>	\$1,799
<b>NEW ZW-148-43-K (20 Mg Systems)</b>	\$1,599	"AT" Compatible <b>ZF-241-81</b>	\$2,599
Transportable Dual Drive 5/8 Mhz <b>ZFA-138-42</b>	\$1,399	"AT" Compatible Winchester System <b>ZW-241-82</b>	\$3,699
<b>SPERRY</b>			
Professional Desktop Dual Drive Monochrome 5/8 Mhz <b>MODEL 200</b>	\$1,749	"AT" Compatible Single Floppy Drive System <b>PC/IT BASIC</b>	\$2,199
Professional Desktop 1 Floppy, 1 20 Mg Hard Drive Monochrome 5/8 Mhz <b>MODEL 400</b>	\$2,844	"AT" Compatible 1 Floppy, 1 44 Mg Hard Drive <b>PC/IT EXPANDED</b>	\$3,199

## MONITORS

**ZENITH**

**AMDEK**

ZVM-1220/1230	\$ 89	Video 300G	\$125
ZVM-1240	\$149	Video 300A	\$133
ZVM-130	\$249	Video 310A	\$153
ZVM-1330	\$459	Color 600	\$432
		Color 722	\$539

## MULTIFUNCTION CARDS

### STB Systems Video Cards

Chautier	\$259
High Resolution EGA	\$399
Graphix + II	\$269
Mono +	\$159

### STB Systems Memory Cards

Big Byte 64K (384K Capacity)	\$129
Grande Byte (2M Capacity)	\$269

### dca Mainframe Links

Irma Board	\$869
Smart Alec	\$759

## PRINTERS

**star**

NX-10	\$CALL
SG-15	\$399
SG-10C	\$249
SR-10	\$439
SR-15	\$589
SB-10	\$593
NB-15	\$CALL
PowerType	\$328

### LEGEND

808	\$155
800	\$199
1380	\$280
CP-VII	\$840

## MODEMS

**Robotics**

Password 1200	\$195
Password 300	\$129
Microlink 1200	\$329
Courier 2400	\$429
Microlink 2400	\$429

## PRESENTATION AIDS

Limelight Monochrome Computer Projector	\$3,555
Video Show Graphics Display Unit	\$2,835
Panasonic Pro Video AG100S Camcorder	\$1,195

### REXWILL ADVANTAGE

- 60 Years in the Electronics Field.
- Toll Free Technical and Service Support.
- Quality Products.

- We accept purchase orders from qualified corporations. Subject to approval.
- Educational discounts available to qualified institutions.

CALL FOR PRICING ON TV'S VCR'S COMPUTER PROJECTORS AND RELATED ITEMS.

Prices Quoted Reflect Cash Discount. Add 3% for Master Card or Visa.  
Prices and Availability Subject to Change without Notice.



Use Our Convenient Toll Free Order Line.

**1-800-CALL-REX**



Telephone Orders Only. 8:30 AM — 5:00 PM (Eastern) Mon.-Fri.

**REXWILL  
ELECTRONICS**

IN PA 1-800-821-1059  
Mailing Address:  
**REXWILL ELECTRONICS**  
P.O. Box 4585  
Philadelphia, PA 19131

## ACCORDING TO WEBSTER

256K-bit or 1-megabit chips.

I still like the Amiga; it's threatening to replace the Mac as the machine on which I do most of my programming. But unless Commodore gets behind it and pushes, with better production, marketing, and support of hardware and software developers, the Amiga will probably be relegated to pattering along for most of 1986. Of course, the next two Amiga machines under development could improve the situation quite a bit, but Commodore still needs to make some smart moves and lay the groundwork for the entire line.

### APPLEWORLD CONFERENCE

Apple, on the other hand, has been making smart moves for some time now. One was scheduling a special AppleWorld Conference to announce new products and new directions to the press, dealers, and analysts. This solved a number of problems. First, it reduced attendance at the annual shareholders meeting, which has been so crowded for the last two years that shareholders have ended up sitting outside. Second, by holding it during the first day of the MacWorld Expo, Apple allowed the exhibitors to show off the Mac Plus (and products for it). Since the MacWorld Expo was scheduled for the week before the annual shareholders meeting, there would have been some real problems doing that had Apple decided to wait until that meeting to announce the Mac Plus.

From comments made by John Sculley, Del Yocam, and others, it appears that Apple has found its direction again after two years of trying to kill off the Apple II, ignoring its users and dealers, and promoting the "computer-as-toaster" concept. Apple has committed itself to upgrading the Apple II line, apparently using the 65802/65816 line of processors from the Western Design Center. You may remember that Steve Wozniak was working on such a system two years ago (the "Apple IIx"), and was ordered by management to stop. Well, it looks like Woz is doing consulting work for Apple now, and it's not hard to guess what it's probably for.

Sculley also announced a plan to establish direct ties between Apple and the hundreds of Apple users groups around the world. Again, this represents a big change from Apple's self-assurance (arrogance?) of many years. For example, had Apple bothered to take a prototype Mac around to a dozen or so users groups and listened to the feedback, the original Mac might have looked more like the Mac Plus (or the Mac with slots) instead of the limited, crippled machine it was. Apple's move to tap the resources of users groups and to build good relations with them is a smart move indeed.

Apple finally acknowledged what folks have been saying about the Mac since its release: To survive in the long run, the Mac needs an open architecture (and spare me comments about "virtual slots," a buzzword that Apple was tossing about two years ago and that quietly died). So Apple is going to build an open-architecture Mac. It says so, right there on page 17 of Apple's 1985 annual report. About time. If Apple is really smart, it will kill off

(continued)

# \$49.95. A SMALL PRICE TO PAY TO FIRE UP YOUR BUSINESS.



Invest it in the Dow Jones News/Retrieval® Membership Kit, and sample the nation's premier online business information resource. With eight free hours\* to explore, a User's Guide to point the way, and a subscription to *Dowline*—the magazine of News/Retrieval, filled with case studies and insights—the Membership Kit shows you and your colleagues how to find fuel for your ideas. Get breaking news as early as 90 seconds after it appears on the newswires, as well as news from *The Wall Street Journal* (online exclusively with News/Retrieval) back to January 1, 1984. Read up on developments in your industry, and follow your company's position. Dig deeper for a prospect's or client's past and present activity, financial health and growth potential. You can even get current stock market quotes. And News/Retrieval can be accessed with almost any computer and modem, terminal or communicating word processor.

The Dow Jones News/Retrieval Membership Kit. Use it to kindle success for *your* company. Without getting burned.

To order or for more information, call **1-800-345-8500, Ext. 418.** Alaska, Hawaii and foreign, call 1-215-789-7008, Ext. 418.) Or use the coupon today.

#### YES! I want to get my business fired up!

Send me the Dow Jones News/Retrieval® Membership Kit.

- Corporate offer - \$49.95 Each** includes: • 8 Free Hours\* • Multiple Passwords • User's Guide • 1 Year of *Dowline* • \$12 Annual service fee waived for 1 year
- Personal offer (for individual use) - \$29.95 Each** includes: • 5 Free Hours\* • Single Password • User's Guide • 1 Year of *Dowline* • \$12 Annual service fee waived for 1 year
- Send more information**

\$ \_\_\_\_\_ ENCLOSED (Check or Money Order)

Bill me later Charge to:  AmExp  MC  VISA

Card No. \_\_\_\_\_ Exp. Date \_\_\_\_\_

Signature \_\_\_\_\_

Name \_\_\_\_\_ Title \_\_\_\_\_

Company \_\_\_\_\_

Address \_\_\_\_\_

City/State/Zip \_\_\_\_\_

Daytime Phone Number \_\_\_\_\_

Computer Make & Model \_\_\_\_\_

Mail to: DJN/R Membership Kit, P.O. Box 300, Princeton, NJ 08543-0300  
ATTN: John McGovern 4BY0506E

**Dow Jones News/Retrieval®**  
*Fuel for your ideas.*

\*Per account. Limited to new subscribers only. Free time (8 hours per Corporate offer; 5 hours per Personal offer) must be used within 30 days after receipt of password(s). Certain data bases have fees over and above usage charges which are excluded from free time offer.  
Copyright © 1986 Dow Jones & Company, Inc. All rights reserved. Dow Jones News/Retrieval is a registered service mark of Dow Jones & Company, Inc.

## ACCORDING TO WEBSTER

the 512K-byte Mac, push the Mac Plus down to less than \$1500, and bring out the Mac with slots at around \$2500. Given the great advantage the Mac has with third-party software and hardware, such a move would have a painful impact on both the Amiga and the ST.

All in all, things are looking better for Apple than they have for some time. Its financial situation is excellent: debt-free, and more than \$300 million in the bank. Apple is planning to spend \$100 million on R&D this year—a 50 percent increase over last year—including some \$15

Table 1: A comparison of features for Macintosh, Atari ST, and Amiga computers.

	Macintosh	Mac Plus	520ST	1040ST	Amiga 1000
System cost					
no monitor	---	---	\$600 <sup>1</sup>	---	\$1500 <sup>2</sup>
monochrome	\$2000	\$2600	\$800 <sup>1</sup>	\$1000	---
color (RGB)	---	---	\$1000 <sup>1</sup>	\$1200	\$2000 <sup>2</sup>
RAM	512K	1Mb	512K	1Mb	512K
maximum upgrade	512K	4Mb	512K	1Mb	8.5Mb
nonstandard	4Mb	?	1Mb	?	---
OS	proprietary	proprietary	TOS	TOS	Exec/AmigaDOS
Graphics routines	Toolbox	Toolbox	GEM	GEM	ROM/Intuition
User interface	Finder	Finder	GEM Desktop	GEM Desktop	Workbench
ROM	64K	128K	192K	192K	256K <sup>3</sup>
Clock speed (MHz)	7.83	7.83	8.0	8.0	7.18
Disk storage	400K	800K	360K	720K	880K
after formatting	399K	798K	349K	709K	876K
Built-in disk drive	yes	yes	no	yes	yes
# of external drives	1	1	2	2	3
Hard-disk port	---	SCSI	DMA	DMA	---
Serial port	RS-422(2)	RS-422(2)	RS-232C	RS-232C	custom
Parallel port	---	---	IBM DB-25	IBM DB-25	custom
Mouse ports	1	1	2	2	2
Expansion bus	---	---	---	---	86-pin external
Other ports	---	---	MIDI, cartridge	MIDI, cartridge	---
Graphics modes	512x342x1	512x342x1	640x400x1	640x400x1	640x400x16 <sup>4</sup>
	---	---	640x200x4	640x200x4	640x200x16
	---	---	320x200x16	320x200x16	320x400x32 <sup>4</sup>
	---	---	---	---	320x200x32
Special modes	---	---	scan line <sup>5</sup>	scan line <sup>5</sup>	hold-and-modify <sup>6</sup>
Color table	---	---	512	512	4096
RGB output	---	---	RGB (9-pin)	RGB (9-pin)	RGB/RGBI (23-pin)
Other output	---	---	mono, NTSC, RF	mono, NTSC, RF	NTSC, RF
Graphics hardware	---	---	---	(add-on board) <sup>7</sup>	Blitter, coprocessor
Sound	1 DAC	1 DAC	sound chip	sound chip	4 DACs
Voices	up to 6	up to 6	up to 3	up to 3	up to 16
Output	mono	mono	(monitor)	(monitor)	stereo, RF
MIDI	3rd party	3rd party	standard	standard	option
Keys	57	78	95	95	89
Function keys	---	---	10	10	10
Numeric keypad	no	yes	yes	yes	yes
Cursor keys	no	yes	yes	yes	yes
Detached keyboard	yes	yes	no	no	yes

<sup>1</sup> Add \$100 for a double-sided drive instead; neither drive is built in

<sup>2</sup> Price assumes \$200 upgrade from 256K to 512K

<sup>3</sup> Write Control Store (WCS); loaded in from Kickstart disk

<sup>4</sup> Interlaced

<sup>5</sup> Color table can be (must be) redefined for each scan line

<sup>6</sup> Each pixel can be a modification of the color to the left; theoretically allows all 4096 colors

<sup>7</sup> Atari plans to release a board with hardware graphics support

? I don't know

--- not available

million for a Cray supercomputer, which Apple says it will use to simulate new hardware and software architectures. And there has even been an out-of-court settlement of the suit with Steve Jobs, on terms that appear to be very favorable to Apple.

It must be said that Apple is working under a number of handicaps, though. The "Apple IIx" would have been a better release two years ago than the IIc, which even Apple—in a backhanded sort of way—acknowledges hasn't sold as well as hoped. The annual report talks about the massive installed base (2.3 million units) of the II, II+, and IIe systems, then refers to the "strong seasonal sales" of the IIc and their hopes that "more IIc's will show up" in homes. And, as mentioned, the Mac Plus is what the Macintosh should have been two years ago. But what's important is that Apple is making smart moves, is headed in the right direction, and has the finances and other resources to survive what Apple and most analysts agree will be a flat year for sales in 1986.

#### SYSTEM STATUS

Table 1 is an attempt to make an honest, rational comparison of features between the Mac, ST, and Amiga computers. This approach has some inherent limitations, mostly because of a lack of room to comment on the quality of the features (like keyboard layout or mushiness, etc.). You'll also notice that I've avoided the "\$X99" syndrome; if a system lists for \$1999, I give the price as \$2000. That helps to avoid the psychological blind spot that makes us think the system is cheaper than it actually is. I assumed a minimum of 512K bytes of RAM and one disk drive for each system, which is reflected in the prices for the 520ST (with a single-sided drive) and the Amiga (with the RAM upgrade from 256K to 512K bytes).

The section on RAM was hard to lay out. The first line ("RAM") gives the amount in the system being purchased. The second line indicates the amount of RAM the hardware and software are designed to accommodate. The third line shows how far the machines have been expanded by nonstandard upgrades (which usually, though not always, void the warranty).

The section on graphics was also difficult to put together because of the different modes, outputs, and (yes) problems. It doesn't indicate, for example, the irritating flicker of the interlaced mode on the Amiga, nor does it show how difficult it is to use any non-Atari RGB monitor with the 520/1040ST.

Can any conclusions be drawn from this one table? About the only safe assumption is that the ST computers offer the most features for the price. You can't really make decisions about performance, ease of use, or amount of software available. But at least you can see how the computers stack up against one another.

#### SOME BENCHMARKS

Table 2 is another attempt—albeit a simple one—to measure the relative merits of these same computers in different areas. I tried to use at least two languages (or

(continued)

# The Same Only Better

The PC AT layout for the PC

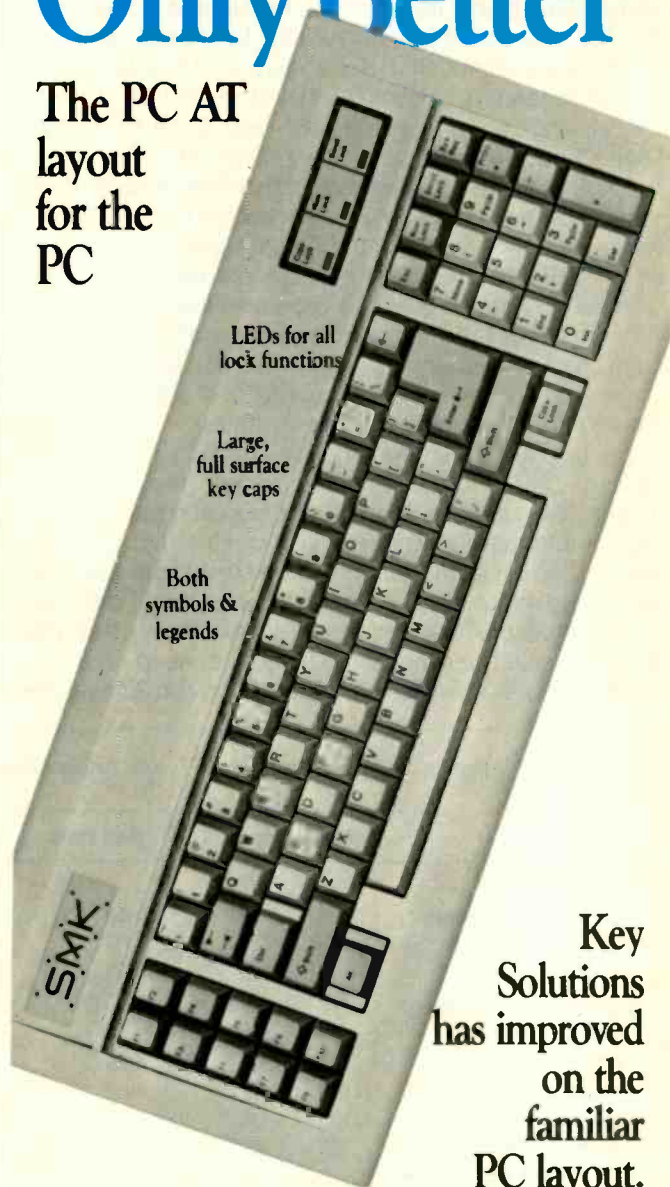

Key Solutions has improved on the familiar PC layout.

#### Plug Compatible Models:

KS 8300 AT/PC · PC/XT™ code  
KS 8300 AT/AT · PC AT™ code

**Introductory special only \$99**

Normally priced at \$125

Call for volume discounts · Dealers inquiries invited

Call 612 - 435 - 2720

**KEY SOLUTIONS™**

An SIMK Company

1294 West County Road 42  
Burnsville, MN 55337



PC and PC AT are trademarks of International Business Machines Corporation.

Inquiry 192 for End-Users.  
Inquiry 193 for DEALERS ONLY.

two compilers) on each machine, just to avoid bad times based on the language used. On the Macintosh, I ran the same benchmarks in both TML Pascal and Consulair C; the TML times were faster across the board and are shown on the chart. On the ST, I used a mixture of four languages: Digital Research's (Alcyon) C, TDI Modula-2/ST, Personal Pascal, and Hippo C, picking the best times from each. Digital Research's C gave the best times, when I could get it to run; however, hardware difficulties and possible failures on my part limited me to using it for just the performance benchmarks. On the Amiga, I used Lattice C (version 3.03B), then reran the benchmarks using a beta copy of Aztec C; Aztec C generally produced faster times. Also, be aware that I did not use register variables for any of the C routines on any machine, with one exception: the circle-painting routine I had to write for the Amiga (which doesn't have any built-in circle routines).

The first section shows times (in seconds) for three different "performance" benchmarks: the Sieve of Eratosthenes routine; a matrix multiplication routine, using 50 by 50 integer matrices; and a routine that creates a list of 1000 random numbers, then sorts them using the Quicksort algorithm. As could have been and was predicted, the ST was the winner thanks mainly to Digital Research's C. The other three languages used on the ST produced times slower than Aztec C on the Amiga. The

Amiga came in second—even though it has the slowest clock speed—thanks largely to the beta copy of Aztec C; the Lattice C times on the Amiga weren't nearly as good. Finally, the Mac and the Mac Plus came in last.

The next section contains graphics benchmarks, showing how well the different systems perform common tasks. All were done in "monochrome" mode; that is, the ST benches were run using the Atari monochrome monitor, and the Amiga was set up with a 640- by 400-pixel (interlaced) display and a single bit plane. I hope to have some follow-up times next month showing color-graphics performance for the ST and the Amiga.

The first two groups give times for drawing straight lines at different angles. The "offset" value indicates a skew to one side. Vertical lines with an offset of 0 are truly vertical, going from, say, the point (200,100) to the point (200,300); the same line with an offset of 20 goes from (180,100) to (220,300). As you can see, there's a wide variety of times. With just one exception—horizontal lines with an offset of 0—the Amiga is anywhere from 2 to 30 times faster than the other four computers. The ST is usually in second place, followed by the Mac Plus and then the Macintosh (which is horribly slow at drawing vertical lines with any skew at all).

The third group shows times for painting (i.e., drawing

*(continued)*

Table 2: Benchmarks on Macintosh, Atari ST, and Amiga computers. All times are in seconds.

	Macintosh	Mac Plus	520/1040ST <sup>1</sup>	Amiga 1000
<b>Performance</b>				
Sieve of Eratosthenes	6.2	6.2	3.9	5.1
Integer Matrix	7.5	7.5	6.0	6.8
Quicksort	9.8	9.8	7.5	8.2
<b>Graphics (monochrome)<sup>2</sup></b>				
<b>Vertical lines</b>				
offset = 0	13.0	12.9	20.8	6.5
offset = 1	195.7	87.2	20.8	6.7
offset = 20	195.7	87.2	21.6	6.7
offset = 100	195.5	86.8	25.4	6.7
<b>Horizontal lines</b>				
offset = 0	3.4	3.4	2.9	3.2
offset = 1	7.9	5.6	22.5	3.4
offset = 20	25.4	12.9	22.6	3.4
offset = 100	98.8	43.8	22.8	3.4
Paint rectangles	24.6	17.8	42.8	5.9
Paint circles	20.8	9.4	62.6	86.4 <sup>3</sup>
Write text	1.5	1.0	4.3	1.4
<b>Disk I/O</b>				
Write File	8.6	2.3	30.3	7.3
Read File (sequential)	1.8	1.1	15.9	5.1
Read File (random) <sup>4</sup>	6.6	4.6	14.2	17.8

<sup>1</sup> Not actually run on the 1040ST; however, Atari claims no performance increase for the 1040ST

<sup>2</sup> The Amiga was in 640 by 400 (interlaced) mode with a single bit plane

<sup>3</sup> There are no built-in circle routines; this is a Bresenham algorithm that I implemented

<sup>4</sup> Times are an average value based on five trials



# THERE'S A NEW SOLUTION.

For years resellers did not have to be sophisticated because their customers were not sophisticated. Times have changed! Today's customers know what they want. And what they want is software that fits their business, supplied by professionals who understand their business.

This revolutionary attitude has created a new breed of computer professional, the Value Added Reseller (VAR). We understand the needs unique to a VAR. We ought to, years

ago we started out as one. We know long development cycles and the need to tailor applications for your client today and tomorrow can bleed your profits dry.

This knowledge was the stimulus behind the creation of The SENSIBLE SOLUTION Database Language. For years The SENSIBLE SOLUTION has been helping VARs all over the world profitably develop professional applications that fit their customers' needs.

## NOW O'HANLON ANNOUNCES A NEW SERIES OF POWERFUL SOLUTIONS TO THE DEMANDING WORLD OF THE VAR.

**The O'Hanlon DATABASE SOLUTION 3.0** development language opens new horizons in customized application development. This full-featured multi-user language removes virtually all limitations typical of a database development tool. All the power of The SENSIBLE SOLUTION is still there, plus a host of added highlights which include:

- Full Color
- Structured Programming Commands
- Data Exporting
- Alien Language Calls
- Batch File Execution
- On-Line Debugger

**The O'Hanlon MANAGEMENT SOLUTIONS** are a series of proven, pre-packaged business accounting applications. These applications, which are available with source code, can be used as is or tailored to fit your vertical market needs.

Applications include:

- General Accounting—  
General Ledger; Accounts Receivable; Accounts Payable
- Whole Distribution—  
Inventory Control; Sales Order; Purchase Order
- Law Office Management—  
General Ledger; Accounts Payable; Law Office Management and Billing

**The O'Hanlon VAR Program** focuses on the needs of application developers and value added resellers. Members of this select O'Hanlon group receive support, development tools and pricing which enhance profitability.

Benefits include:

- Private Label Ability
- Professional Programming Utilities
- Reduced Application and Run-Time Pricing
- Advanced Technical Support
- Shared Marketing Resources

Inquiry 256 for End-Users.  
Inquiry 257 for DEALERS ONLY.

For further information call or write today! Better yet, redeem this coupon for a special limited introductory rate on the new O'Hanlon DATABASE SOLUTION 3.0.



**O'HANLON**  
COMPUTER SYSTEMS

11058 MAIN STREET SUITE 110  
BELLEVUE, WASHINGTON 98004 (206) 454-5350 Ext. 379  
Development Software for Computer Professionals.....

- Yes I'm interested, please have a representative call me.
- Yes I'm interested, please send full descriptive literature.
- Yes I'm interested, please send an evaluation system in the following format:  
Single-user \_\_\_ Multi-user \_\_\_ 8" \_\_\_ 5 1/4 \_\_\_  
DOS \_\_\_ MP/M \_\_\_ CP/M \_\_\_ Other \_\_\_\_\_

NAME \_\_\_\_\_

TITLE \_\_\_\_\_

COMPANY \_\_\_\_\_

ADDRESS \_\_\_\_\_

CITY \_\_\_\_\_

STATE \_\_\_\_\_

ZIP \_\_\_\_\_

PHONE \_\_\_\_\_

PHONE EXT \_\_\_\_\_

Tell us about yourself:

VAR \_\_\_ OEM \_\_\_ MIS \_\_\_ Dealer \_\_\_ Distributor \_\_\_ End-user \_\_\_

# DRIVE INN

Enclosure &  
power supplies  
for  
**FLOPPY,  
WINCHESTER,  
TAPE DRIVES,  
SINGLE BOARD  
COMPUTERS  
& S-100 SYSTEMS**

8 inch  
5 inch  
3 inch

Call or write  
for free  
catalogs &  
application  
assistance

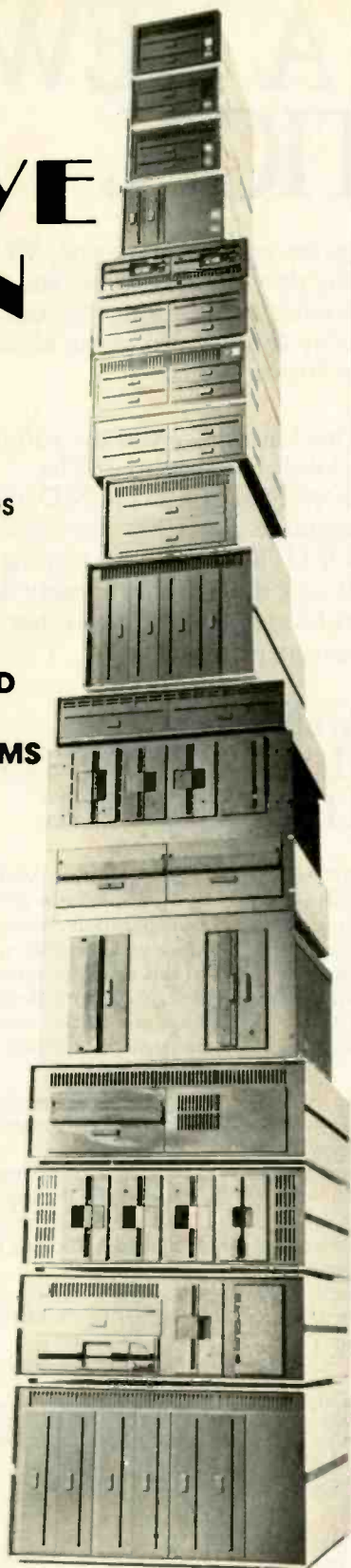

**INTEGRAND**  
RESEARCH CORPORATION

8620 Roosevelt Ave. • Visalia, CA 93291  
209/651-1203

We accept BankAmericard/Visa  
and MasterCharge

## ACCORDING TO WEBSTER

solid) rectangles and circles and writing text to the screen. The rectangle benchmark draws 2000 solid rectangles (half black, half white) to the screen; again, the Amiga wins, though the Mac Plus and the Mac aren't that much slower (three to four times, respectively), and the ST comes in last.

The circle benchmark does much the same as the rectangle but puts only 400 circles on the screen. The Mac Plus and the Mac are the big winners here; I'd love to have a copy of the algorithm used in QuickDraw. The ST is much slower than the Mac but still "beats" the Amiga. Why? The Amiga graphics libraries don't have built-in circle routines, so I implemented—in C—some based on Bresenham's algorithm. It works nicely, but, as you can see, the performance leaves much to be desired. It's not really an accurate measure of the Amiga's graphics power, but it is a fair measure of what you'll face if you want to draw circles on the Amiga.

The text benchmark puts up some 3800 characters: a 40-character line of each of the printable characters (ASCII codes 32 through 126). I should have made this benchmark last longer, since the times are so short that accurate measurement and comparison are difficult; however, I don't have access to a Mac Plus right now, so I can't re-run the benchmarks. The Mac Plus wins, with the Amiga and the Mac not that far behind it; the ST, however, is quite a bit slower.

The third section deals with disk I/O. The Write File benchmark writes sixty-four 512-byte blocks out to a file on the disk, resulting in a 32K-byte file. The Read File (sequential) benchmark reads the file back in the same way it wrote it, that is, blocks 0 through 63. The Read File (random) benchmark first creates a randomly organized list of the block numbers (0..63), then reads in the blocks in that order. Because the order of the blocks can affect performance, I ran five trials for each computer, then calculated the average. Interestingly enough, the Mac Plus comes out best, with the much-maligned Mac not far behind, followed by the Amiga and (surprisingly) the ST coming in dead last (except on the random-access read, which the Amiga lost). I was startled to see the times on the ST and ran the benchmarks in both Hippo C and Personal Pascal, getting nearly identical times for each. If I can ever get Alcyon C to work, I'll run the benchmarks with that as well and see if the times vary significantly.

Though table 2 may look impressive, it's really an incomplete measure of the relative powers of the different machines.

### MACWORLD EXPO

Technically, this was the MacWorld Expo & Apple II World Expo, but Mac exhibits and products dominated. What really dominated, though, was a sense of energy and excitement that I haven't seen at a computer show since the West Coast Faire back in 1982. And it was the first computer show in months (if not years) that I was able to enjoy.

Ironically, the two most interesting software products I saw were both alpha versions, that is, pre-prerelease. Andy

*(continued)*

# Programming Ease for Scientific & Engineering Applications

No matter what your programming language; FORTRAN, BASIC or C, Wiley Professional Software's technical programming tools enable you to save programming time and development costs. These tools allow you to generate dependable, accurate and error-free code, quickly and easily.

## New! A Brand New Subroutine Library:

The 50 More: FORTRAN Library, developed by Peerless Engineering Service, offers you a collection of subroutines and utilities previously unavailable in our first FORTRAN Library; most are provided in single and double precision versions. This second

volume provides pre tested and precompiled subroutines covering such areas as: Matrices, Polynomials, Differential Equations, and Numerical Analysis (including FFT's) plus utilities for more effective screen handling. SOURCE CODE INCLUDED.

MICROSOFT FORTRAN or Professional FORTRAN version ..... **\$125**

## New! LabSoft,™ A Powerful Programming Tool For IBM Data Acquisition and Control Adapter Users.

LabSoft, developed by Cyborg® Corporation, provides over 40 programming tools for developing data acquisition and control programs on the IBM® PC. If you need to customize your data acquisition & control programs, then LabSoft can provide you with more power and flexibility than IBM Pro-

gramming Support software at a very affordable price. Choose from 3 versions: FORTRAN, BASIC or a C Language supplement.

MICROSOFT FORTRAN version ..... **\$350**  
BASIC version ..... **\$350**  
C Language supplement ..... **\$75**

## Subroutine Library For BASIC, FORTRAN, & C Programmers:

This Library, also developed by Peerless, provides 114 (C Library 112) pre-tested and pre-compiled mathematical and statistical subroutines covering such areas as; Analysis of Variance, Regressions, and Time Series Analysis.

The Library is supplied on disk as a linkable library and as source code. Extensive documentation and reference material make using these subroutines fast, dependable and error-free. SOURCE CODE INCLUDED.

MICROSOFT FORTRAN Library ..... **\$175**  
C Language Library ..... **\$175**  
BASICA Library ..... **\$125**  
IBM Professional FORTRAN Library ..... **\$175**

To order any of Wiley's scientific and engineering programming tools, call: **212-850-6788**

Or write:



Wiley Professional Software  
John Wiley & Sons, Inc.  
Attn: Leslie Bixel  
605 Third Avenue  
New York, NY 10158  
Dealer Inquiries Invited



THE TECHNICAL SOFTWARE SOURCE.

# TOTAL CONTROL

## with LMI FORTH™



### For Programming Professionals: an expanding family of compatible, high-performance, Forth-83 Standard compilers for microcomputers

#### For Development:

##### Interactive Forth-83 Interpreter/Compilers

- 16-bit and 32-bit implementations
- Full screen editor and assembler
- Uses standard operating system files
- 400 page manual written in plain English
- Options include software floating point, arithmetic coprocessor support, symbolic debugger, native code compilers, and graphics support

#### For Applications: Forth-83 Metacompiler

- Unique table-driven multi-pass Forth compiler
- Compiles compact ROMable or disk-based applications
- Excellent error handling
- Produces headerless code, compiles from intermediate states, and performs conditional compilation
- Cross-compiles to 8080, Z-80, 8086, 68000, and 6502
- No license fee or royalty for compiled applications

#### Support Services for registered users:

- Technical Assistance Hotline
- Periodic newsletters and low-cost updates
- Bulletin Board System

**Call or write for detailed product information and prices. Consulting and Educational Services available by special arrangement.**

**LMI** Laboratory Microsystems Incorporated  
Post Office Box 10430, Marina del Rey, CA 90295  
Phone credit card orders to: (213) 306-7412

#### Overseas Distributors.

Germany: Forth-Systeme Angelika Flesch, D-7820 Titisee-Neustadt

UK: System Science Ltd., London EC1A 9JX

France: Micro-Sigma S.A.R.L., 75008 Paris

Japan: Southern Pacific Ltd., Yokohama 220

Australia: Wave-onic Associates, 6107 Wilson, W.A.

## ACCORDING TO WEBSTER

Hertzfeld was showing off Servant, a new Macintosh user interface that can best be described as a cross between the Finder and Hertzfeld's Switcher program. You see the regular Finder desktop, but when you double-click an icon, it opens the application as a window on the desktop itself. The currently active (top) window determines which application is active (and how the menu looks), and when you close a window, it collapses back down to its icon on the desktop. Hertzfeld plans other enhancements, like being able to open up a file so that you can see and manipulate its resources as icons. Some issues still need to be worked out (memory allocation, dealing with applications that use the entire desktop), but I liked what I saw. Hertzfeld estimated that he had six months' more work to do, which would give a very tentative release (probably beta) date of July.

The second package, Super Paint, was being demonstrated by Silicon Beach Software. Super Paint looks like a combination of MacPaint and MacDraw; that is, you can toggle between the bit map and object-oriented graphics and can, in fact, mix them, with the object sitting "on top of" the bit-map background. It supports multiple windows, different levels of FatBits, a variety of tools and options, and full-screen painting. SBS was quoting "summer" as the release date, but it may be out within a month or so of this issue hitting the stands.

The two most interesting—and expensive—hardware products were the HyperDrive 2000 from General Computer Corporation and the MacSuper 20 FP from Levco. The HD 2000 upgrades your Mac to a 12-MHz 68000, increases your RAM to 2 megabytes, sticks in a 68881 floating-point processor (FPP), and, as you might expect, includes a 20-megabyte internal hard disk. The entire upgrade costs \$3195. (Incidentally, GCC also dropped the prices of the HD 10 and HD 20 by \$500 and \$600, respectively—undoubtedly in response to the competing internal hard disks coming out on the market.)

The Levco 20 FP is for power freaks only. Rich power freaks. It upgrades your Mac to a 16-MHz 68020, with 4 megabytes of RAM, an SCSI port, a 68881 FPP, and a 20-megabyte internal hard disk. The cost? As the saying goes, "Anyone who has to ask the cost can't afford it." But Levco says "under \$9000." One of the reasons the price is so high: It uses 1-megabit chips, which have not gone into mass production and (according to Levco) cost about \$100 each. Cheaper versions use 256K-bit chips (and hold less RAM); the disk drive and the 68881 chip are also optional.

Interestingly enough, software support for both systems is appearing almost immediately. Consulair announced a version of its C compiler that would provide direct support for the 68881 and another version that would produce code optimized for the 68020. TML Systems (TML Pascal) is also considering the same approach. Both the HD 2000 and the 20 FP let you get at the 68881 right now by patching in through the SANE (Standard Apple Numeric Environment) routines (floating-point code in the Mac Toolbox), but direct calls can only help to speed things up.

ACCORDING TO WEBSTER

I ran my benchmarks on the HD 2000 and 20 FP while I was there. I don't want to print them here since neither system was a "released" version, but I can give you some idea as to how both did. The HD 2000—which had the old Mac ROMs—showed almost exactly a 50 percent increase in speed for the performance benchmarks (sieve, matrix, sort). However, the graphics and I/O routines ran at almost exactly the same speed as a regular Macintosh. (Note that the I/O benchmarks ran off a floppy disk and not the internal hard drive.) The 20 FP—which had the new Mac ROMs—ran two to three times faster than the Mac or the Mac Plus on the performance benchmarks. On the graphics benchmarks, it ran on the average about 50 percent faster than a Mac Plus and so was two to four times faster than a regular Macintosh. The I/O times (which, like the HD 2000, were off a 400K-byte disk drive) were significantly (four times) faster for writing but not that much faster for reading.

I do hope to get my hands on the final versions of both products and review them. When I do, I'll devise some benchmarks that do a better job of showing the strengths of each (disk caching, floating-point processing, fast hard disk, etc.).

A number of other products were being shown, though seeing does not necessarily mean believing. Several companies announced internal hard disks (à la HyperDrive), though none were shipping at the moment. The folks from Step Lively Software, who last fall announced their On Stage Pascal compiler for the Mac, had a booth, but they indicated they were still a few months away from shipping even a beta version. Borland also got into the act by announcing (though not showing or releasing) Turbo Pascal for the Mac. The release date given was "end of first quarter 1986" (i.e., late March), but company officials were already talking about that slipping into the second quarter of 1986. Meanwhile, Tom Leonard (TML Systems) was busy selling real copies of TML Pascal and signing site licenses with several universities. Leonard even spent an entire afternoon with a vice president from Borland. Frankly, given the high quality and low price of TML Pascal, Borland could do a lot worse than to just buy the rights and market it as Turbo Pascal for the Mac. We shall see.

It was a fun show; everyone seemed to have a good time, myself included. The biggest improvement that could be made to the show would be to open it up to other 68000-based systems (Commodore, Atari, Stride, and others) and their respective third-party developers. The friendly (and not-so-friendly) competition would add a nice edge to the show, not to mention a good deal of variety. . . and, of course, would draw a much larger audience, including those who want to purchase a 68000 machine but haven't decided which one to get. Now that could be a fun show.

Well, that's it for this month. I'll lay off the wars a little next month and (again) try to look at some of the software and hardware that has been piling up. I'll also try to catch up with the mail that's been accumulating since before Christmas. Sigh. Until then, see you on the bit stream. ■



**So you can't get Toshiba Printer Accessories, Bunkie?**

Any time (24 hours) grab your VISA or MasterCard  
**JUST CALL 800/854-0561 EXT 837**  
 IN CALIFORNIA CALL 800/432-7257 EXT 837

**Type Font Cartridges for**

**Toshiba P351, P341 and P321 Printers**

T/FC 011 \$69	T/FC 015 \$69
<b>Bold Letter</b>	<b>ORATOR1 Orator2</b>
T/FC 012 \$69	T/FC 016 \$69
<b>Elite Gothic</b>	<b>Outline Script</b>
T/FC 013 \$69	T/FC 017 \$69
<b>Greek/Math/Apl</b>	<b>Theme Italic</b>

**Ribbon for 3-in-One Printers**

T/R 001 \$12: Ribbon fits Toshiba dot matrix printers.

**Start-Up Kit**

T/SK \$99: Accessory sample kit contains Type Font Cartridge (Bold Face, Letter Gothic), Type Font Disk (Extended Word Processing), Printer Ribbon, Data Disk, Enhancement Catalog, Type Font Catalog and much, much more.

**P351 Dual Emulation Kit**

T/DE 351 \$99: Upgrade your early model P351 to add IBM Graphics Printer emulation. Complete instructions included.

**User's & Technical Reference Manuals**

Complete line of manuals to support Toshiba Printers; P1340, P351, P341, P321. Write for complete catalog.

**Type Font Disks (Downloadable)**

G/FD 051 \$50:	Designed especially for scientific applications; 4 fonts.
G/FD 053 \$30:	Maxiset (oversized characters for headlines); 1 font.
T/FD 016 \$69:	Extended word processing package. Ideal for desktop publishing; 5 fonts.
T/FD 011 \$49:	Standard word processing packaging; 3 fonts.
T/FD 014 \$49:	Presentation size type fonts; 2 Orators & 1 Outline.
T/FD 015 \$49:	Correspondence quality type fonts; 1 Roman, 1 Script & 1 Italic.
T/FD 013 \$69:	Math and Scientific fonts; 2 Math; 1 Application & 1 Scientific.
T/FD 021 \$49:	Quality Pack; 1 Regular and 1 Bold Italic & 1 Gothic.
F/FD 001 \$95:	2 Micro (10 & 20 cpi), Copper, Reg. Italic, Bold Italic, Zip & Science.
F/FD 002 \$95:	Demi Gothic, Gothic (15 cpi), Boss, Serif Italic, Gothic Italic, Fathead, Greek.
F/FD 004 \$95:	Roman, Elite Italic, OCR A & B, Pres. Pica, Greek, Micro (15 cpi).

A minimum shipping and handling charge of \$4.75 will be added to each order. 6% sales tax will be added to California orders.

**PRINTER  
 ACCESSORIES  
 DIRECT INC. / P.O. BOX 19608-347, IRVINE, CA 92713**

**WRITE FOR A COMPLETE CATALOG**

**THE BYTEK SYSTEM 125**

- A GANG PROGRAMMER,
- A SET PROGRAMMER,
- A UNIVERSAL PROGRAMMER,

**ALL IN ONE**

**PLUS FEATURES LIKE THESE:**

- SUPPORTS ALL TECHNOLOGIES
- UP TO 1 MEGA BYTE OF RAM
- CENTRONIC PARALLEL PRINTER PORT
- 16 x 2 LIQUID CRYSTAL DISPLAY AND MUCH, MUCH MORE.
- HIGHEST PERFORMANCE/COST RATIO AVAILABLE TODAY
- OTHER MODELS AVAILABLE
- PRICES START AT \$995
- UV ERASERS FROM \$67
- AVAILABLE FROM STOCK

**CALL NOW TO ORDER  
 (800) 523-1565**

**BYTEK Corporation®**  
 Instrument Systems Division

1021 South Rogers Circle, Boca Raton, FL 33431  
 (305) 994-3520, Telex 4310073 MEVBTC

“WE NEED MORE THAN  
MASS STORAGE.  
WE NEED MORE  
VERSATILITY, MORE  
VALUE, MORE FREEDOM

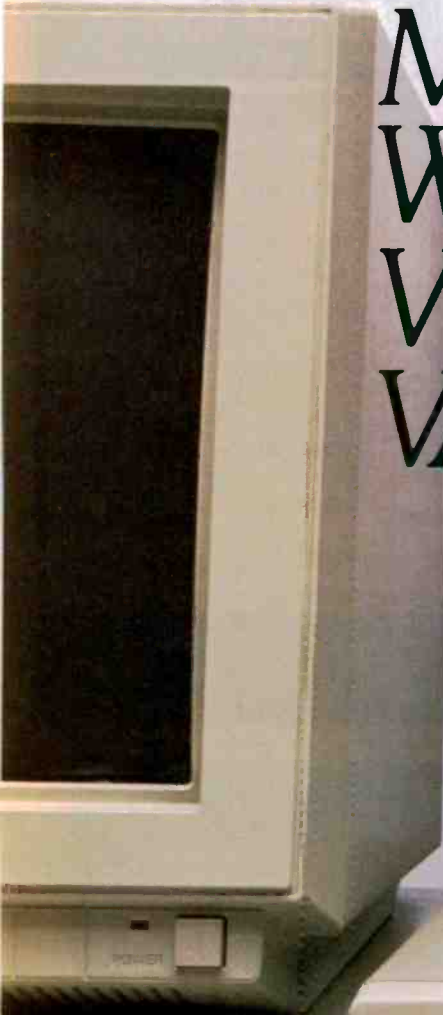

WITH THE BERNOULLI



*"RELIABILITY is a must. With The Bernoulli Box, we're free of worries about head crashes and lost data."*

*"EXPANDABILITY is a critical cost issue. With The Bernoulli Box, we're free to expand at our own pace, by adding inexpensive cartridges, instead of expensive hardware."*

*"TRANSPORTABILITY is a real asset. With The Bernoulli Box removable cartridges, we're free to make identical backup or update our database in minutes, put it in an envelope and send it anywhere with complete confidence."*

*"SECURITY is essential. With The Bernoulli Box, we're free from concerns about stolen data. Now we lock up cartridges, not computers."*

*"SPEED is time and time is money. With The Bernoulli Box, we're free to get on to other tasks sooner than we would be with most hard disk options."*

RELIABILITY. EXPANDABILITY. TRANSPORTABILITY. SECURITY. SPEED.

These are the values that computer users are demanding from PC mass storage today. And with its 5-, 10- and 20-megabyte cartridges and powerful performance, The Bernoulli Box delivers these values to users of the IBM PC, XT, AT, most compatibles and the Macintosh family. Important values that mean more than just more storage. They mean *Freedom*. Freedom to create, update, backup and lock up data, simply, quickly and efficiently.

But don't just take our word for it. Find out for yourself why 97% of Bernoulli Box users would recommend The Bernoulli Box to a friend or co-worker.\*

For more information on better managing your information, see your local dealer or call (800) 556-1234 ext. 215. In California (800) 441-2345 ext. 215.

\*According to a 1985 survey conducted by Gene Taylor and Associates.



IOmega Corporation, 1821 West 4000 South, Roy, Utah 84067, (801) 778-3000

LI BOX<sup>®</sup> WE GET IT ALL."



**THE  
MOST  
AFFORDABLE.  
IBM AT®  
COMPATIBILITY  
40% FASTER  
QUANTUM™  
AT TURBO**

with

**20MB  
HARD DISK**

and

**FULL ONE  
YEAR  
WARRANTY**

**\$1995<sup>00</sup>**

call

**(714) 259-1127**

for

**QUANTITY  
DISCOUNTS**

**QUANTUM  
XT TURBO  
\$899<sup>00</sup>**



- 8088-2 Processor (CPU BOARD, MADE IN USA)
- 4.77-8 MHz speed switch selectable
- 256K expandable up to 1MB on board
- Two-360K Floppy Drives
- Mono or Color Graphics Card
- Hi-Res Mono Monitor
- Parallel Printer Port
- AT style keyboard
- Full (1) One Year Warranty

- 80286-8 Processor (CPU BOARD MADE IN USA)
- 6-8 MHz speed switch selectable
- 512K RAM expandable up to 2MB on board
- 1.2 MB Floppy
- 20 MB Hard Disk
- Parallel Printer Port on board
- 200 W. Power Supply
- AT style keyboard
- Fully assembled, tested and 48 hour burn-in.

**QUANTUM XT  
\$799<sup>00</sup>**

- 8088 Processor
- 256K expandable up to 640K on board
- Two 360K Floppy Drives
- Mono or Color Graphics Card
- Hi-Res Mono monitor
- Parallel Printer Port
- AT style keyboard
- Full (1) One Year Warranty

- 20 MB Hard Disk Sub System (Controller & Cable) ..... \$ 465.00
- 20 MB Hard Disk (40MS) For AT ..... \$ 650.00
- 33 MB Hard Disk Sub System (Controller & Cable) ..... \$ 695.00
- 33 MB Hard Disk (40MS) For AT ..... \$ 750.00
- 68 MB Hard Disk (25MB Voice Coil) ..... \$1499.00
- 60 MB Tape Streamer Back Up ..... \$ 899.00
- Mono or Color Graphics Card ..... \$ 110.00
- 14" TTL Mono Monitor ..... \$ 149.00
- 12" TTL Mono Monitor ..... \$ 99.00

**AFTON COMPUTER INC.**

**24825 CALLE EL TORO GRANDE • EL TORO, CALIFORNIA 92630 • TELEPHONE (714) 259-1127**





# INTUITIVE SOLUTION

BY DICK POUNTAIN

*A look at a  
business application generator  
for the  
IBM PC, XT, and AT*

It's no secret to those of us who follow such things that Apple's Lisa and Macintosh, Microsoft's Windows, and Digital Research's GEM are all derived from work performed more than a decade ago at Xerox's Palo Alto Research Center and placed in the public domain through books and research papers.

What is not so often stated is that these products took from Xerox PARC mainly the form and left out most of the substance of the center's work.

The PARC research (which also led to the Smalltalk-80, Interlisp D, and Mesa languages) was concerned with a new model of computation based on "objects." Objects are not, as sloppy journalism would have it, synonymous with icons and windows on a desktop. Objects are program entities in which a data structure and the procedures that operate on it are bundled inseparably together, so that they can be manipulated as a sealed unit. What the Xerox researchers were looking for was a style of programming in which objects that mirror those in the real-world application are the only program entities. Icons, windows, and the mouse are the expression of this philosophy in the realm of user interfaces.

To be sure, Apple produced an object-oriented Pascal derivative as the system language for the Lisa and Macintosh, but the language operates at a level that only professional programmers can use, and then only after an extended learning period. Writing applications that fully exploit the Mac interface is not a job for "the rest of us." On the other hand, both GEM and Windows are just visual shells over MS-DOS that support applications written in traditional languages like C and assembly language. The PARC

ideal of an object-oriented programming system accessible to the end user has not been realized in any of these.

When I recently received a copy of Intuitive Solution, a desktop-based environment produced in the U.K. by Intuitive Systems Ltd., I was first struck by its visual resemblance to GEM, and a certain weariness overcame me. But after a few hours of playing with it, I knew I was in the presence of a different kind of beast altogether.

Intuitive Solution (let's call it I.S. from now on) supports a genuinely object-oriented programming environment, tailored to producing business and office automation systems. I.S. includes a powerful and flexible database and an applications generator based on a programming language in which programs are largely developed by "doing," i.e., pointing and painting on the screen (it rather resembles the Smalltalk notion of a "kit"). Indeed, after spending some time with I.S., the best description I can offer is that it's what you'd get if you mated Smalltalk with the Pick operating system. Talking with the people at Intuitive Systems established that I.S. was written in an object-oriented dialect of C that they developed themselves.

## THE DESKTOP

I.S. currently is available only for the IBM PC, PC XT, and PC AT. It is a large

system, demanding at least 512K bytes of memory and 640K bytes to do serious work. It also requires a hard disk. Since the system works in high-resolution bit-mapped mode, it requires the presence of an IBM Graphics Adapter and a Microsoft Mouse. While it allows easy access to other

PC-DOS applications, it is not intended to be used as a shell; most work is done using the facilities of I.S. itself.

I.S. was written from the start as a multiuser system, and it supports several networking systems including PCnet, Torus Icon, and Novelle networks. It also comes with built-in support for micro-to-mainframe links using the IBM 3270 and 2780/3780 protocols as well as simple RS-232C asynchronous communications (provided, of course, that the necessary hardware is present). I.S. supports graphics printers, including the Hewlett-Packard LaserJet, albeit in a fairly unsophisticated form in this first release.

When I.S. is first booted, a log-on screen appears, inviting you to enter your user name and password. After you supply this information, a desktop that looks like that of GEM appears, containing a number of icons. These icons are divided into three main groups. *Folders* represent directories (as in GEM). *Pads* represent resources of which multiple copies can be made by "tearing off" a sheet. The third group consists of all the hardware and special resources, such as the printer icon, the hard disk and

*(continued)*

Dick Pountain is a technical author and software consultant living in London, England. He can be contacted c/o BYTE, POB 372, Hancock, NH 03449.

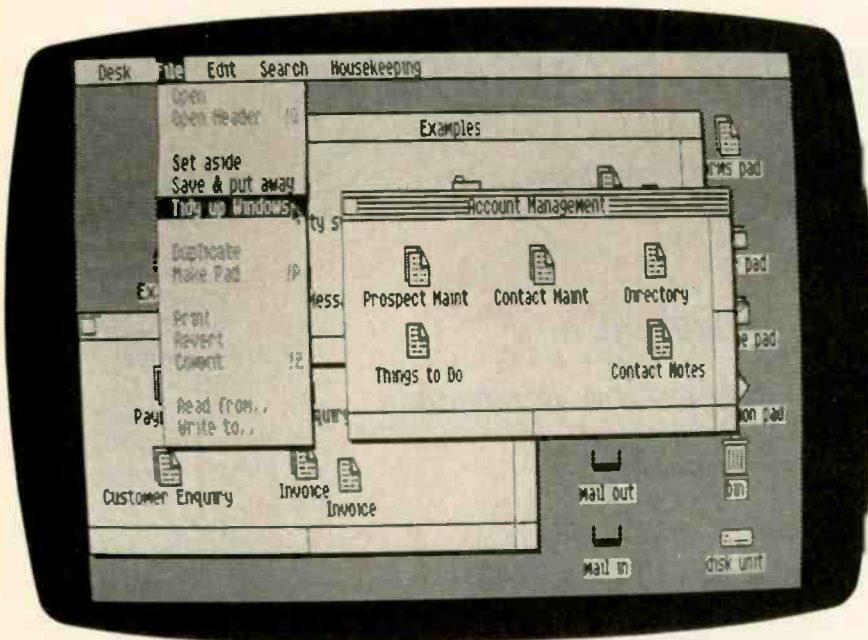

Photo 1: Intuitive Solution's desktop bears a strong resemblance to GEM.

waste bin, and the electronic mail in and out trays. Even the good old calculator and clock are there. Along the top of the desk is a menu bar with pull-down menus.

The I.S. file system is fully hierarchical. There is a Folder Pad from which new folders can be torn off at will and given names. Almost any object can be put into any folder (the waste bin excepted), and folders can

be nested inside one another to any depth. Items can be placed in a folder merely by dragging their icons onto the folder icon.

Icons can be expanded into windows (fully overlapping) by double-clicking with the mouse. The windows are nicely designed, and moving and resizing them is particularly easy. The scroll bars work like those in Microsoft Word (the cursor turns into a direction

arrow as it enters the margin).

A system text editor is omnipresent, with the now-traditional pull-down edit menu providing cut, copy, and paste functions. A familiar vertical-line cursor marks the position at which text will be inserted, but it's accompanied by a small black square that acts as a "handle." Grabbing this handle allows you to resize the text-entry fields by dragging, just like a window. When an empty text field is deselected, it appears as a light gray box that can be moved about by single-clicking the mouse on it (the cursor turns into a little hand). This arrangement simplifies the design of multiple-field forms that, as we shall see later, are the heart of I.S.

All objects in I.S. have a header, which is a form holding information such as the author's name, the file's title and subject, an abstract of the contents, and the date of creation. This header can be opened by selecting the item and choosing Open Header from the file menu.

A powerful search mechanism, controlled by its own menu, can search the whole system using the fields of these headers. It's possible to locate all the items by a certain author, between certain dates, or by title or the contents of the abstract. As we shall see, it is also possible to write pro-

(continued)

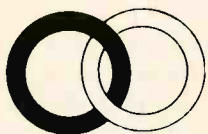

# FULL LINE ADD ON CARD FOR IBM

We are the reliable manufacturer of ADD-ON card and peripheral:

All our product are superior than our competitors in multi-wise and function-wise.



Good quality, Reasonable price.

- WHOLESALE, DEALER, RETAIL, STORE AND OEM ENQUIRES WELCOME \*
- IBM is a registered trade mark of international business machines corp.

The product:

1. ADD-ON card
  - a. Vedio card
  - b. I/O card
  - c. Memory expansion card

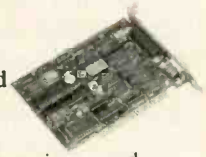

2. Peripheral:
  - Monitor, Keyboard Driver, Modem, Cable, Power supply, P/C case.

**SOUTHTECH INC.**

ADDRESS: 3028A, SCOTT BLVD., SANTA CLARA, CA95054, USA    Telex: 1561096    Phone: (408)748-0900

# Look at what we're plugging now.

## Plug-in Teacs.

We offer a full line of PC compatible components to increase your floppy storage, to add Winchester drives, or to include a streaming cassette back-up.

Our FD-55 Series, half-height, low power, 5¼-inch floppy disk drives are the world-wide standard of excellence with over 3 million in service to date. A quick and easy way to double your capacity.

Our MT-2st Kit is all you need to plug-in a streaming cassette back-up system. With 90 ips performance, you can store up to 20 megabytes of back-up incredibly quick.

Our PS-5250 subsystem is a completely self-contained self-powered add-on that includes a 20 megabyte Winchester drive and a 20 megabyte streaming cassette back-up.

With Teac, adding on more storage capacity is an open and shut case.

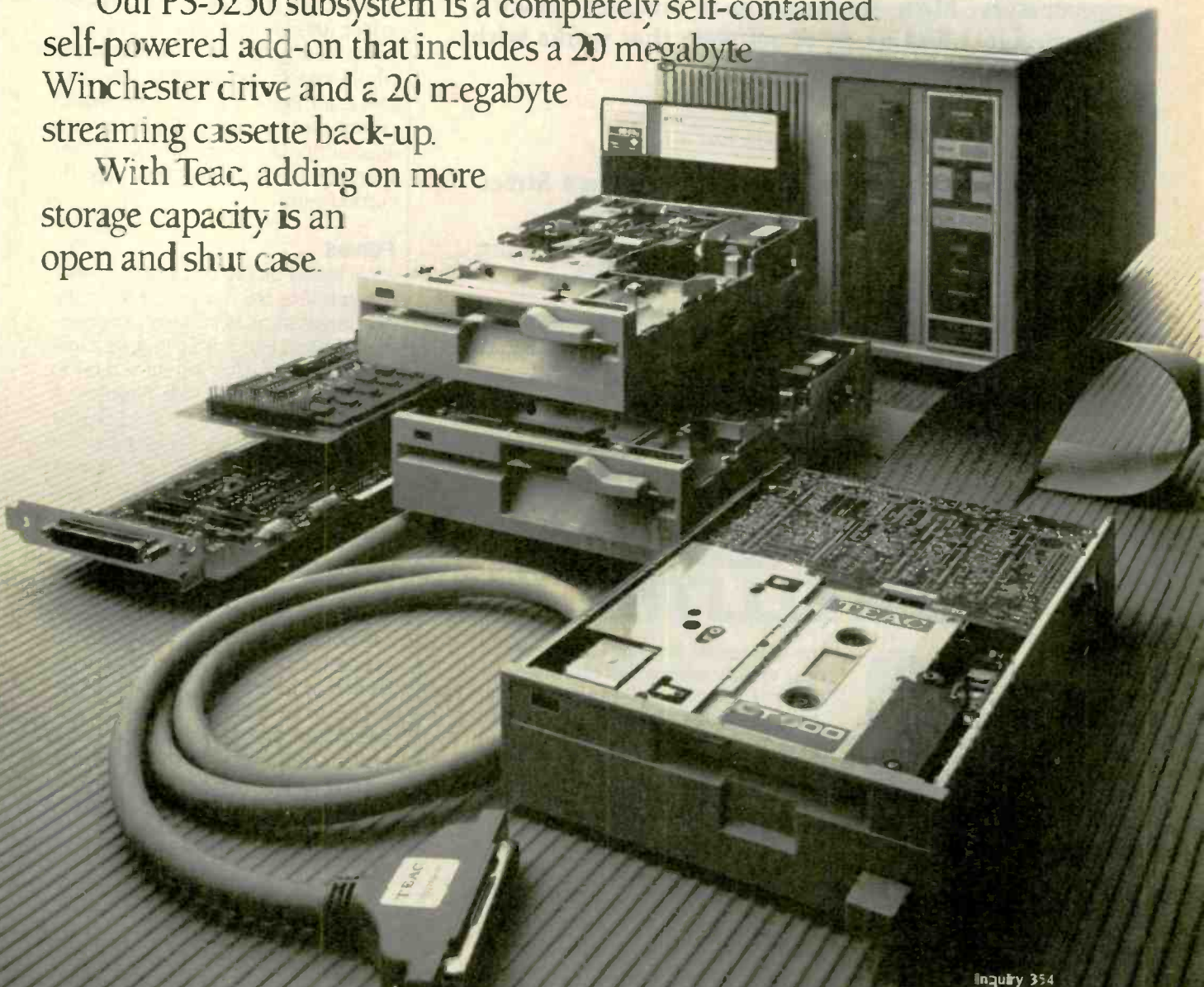

Inquiry 354

Built To Fanatical Standards **TEAC**

INSTRUMENTATION AND COMPUTER PRODUCTS DIVISION 7733 TELEGRAPH ROAD, MONTEBELLO, CA 90640

East (67) 475-7311 South/Midwest (312) 351-9124 Rocky Mountain (602) 242-4025 (303) 337-5329 (601) 532-2111  
Northwest (408) 727-1427 Southern California (213) 726-0303

©1985

# Computers For The Blind

Talking computers give blind and visually impaired people access to electronic information. The question is how and how much?

The answers can be found in "The Second Beginner's Guide to Personal Computers for the Blind and Visually Impaired" published by the National Braille Press. This comprehensive book contains a Buyer's Guide to talking microcomputers and large print display processors. More importantly it includes reviews, written by blind users, of software that works with speech.

Send orders to:

National Braille Press Inc., 88 St. Stephen Street  
Boston, MA 02115, (617) 266-6160

NBP is a nonprofit braille printing and publishing house.

## A COMPUTER PROGRAM DELIVERED VIA SATELLITE!

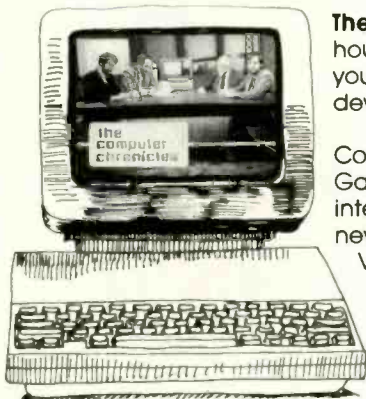

**The Computer Chronicles**, a half-hour weekly television series brings you an in-depth look at the latest developments in the computer world.

Correspondent Stewart Chefeit and Gary Kildall, creator of CP/M provide interviews with industry leaders plus news and information from Silicon Valley and around the world.

**The Computer Chronicles**, every week on a public television station near you.

(Check local listings for time and channel.)

Produced by KCSM, San Mateo, CA and WITF, Harrisburg, PA with funding from McGraw-Hill's **BYTE** magazine.



*Since I.S. is a true object-oriented system, forms have behaviors as well as attributes.*

grams that automatically fill in the abstract field with keywords as data is entered, so that the system becomes self-indexing. The scope of a search is the currently selected folder; therefore, it can be precisely controlled (you can also search the whole system by selecting the hard-disk icon). Items that match the search criteria are temporarily placed in a special folder, from which further searches or manipulations may be carried out.

### FORMS

I.S. is based on the concept of a form; indeed, it is often referred to in the documentation as a "forms processing" system. Everything in the system is a form, from the log-on screen to the dialog boxes and the headers. A form consists of an icon/window that can contain any number of text or numeric fields. A document, memo, invoice, and bank statement are all forms.

But since I.S. is a true object-oriented system, forms have *behaviors* as well as *attributes*. In other words, every form can have programs and relations attached to it that are an inseparable part of it. Any program attached to a form is automatically executed when that form is opened. Furthermore, forms exhibit inheritance. A new kind of form can be created by editing an existing one, and the new form will inherit all the behaviors of its parent.

Let's give an example. I created a simple test form for this article. First of all, I tore off a sheet from the Forms Pad, which contains completely blank forms. Opening this form presented a blank window and placed me in the forms editor, which has its own set of pull-down menus, one of which is

*(continued)*

# Take 5 Books for Only \$2<sup>95</sup>

values to  
\$128.85

## The Computer Book Club®

Recognized as the authoritative source for micro users!

### WE SHOW YOU HOW TO GET THE MOST FROM YOUR COMPUTER

- Superior Selections
- Business Success
- Practical Prices
- Personal Achievement

Plus FREE guide to BASIC Statements & Commands!



2692  
List \$27.95



1939  
List \$24.95

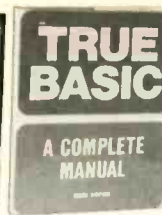

1970  
List \$22.95



2627  
List \$23.95



1389P  
List \$11.95 (paper)



1848  
List \$19.95



1748P  
List \$10.95 (paper)



1876  
List \$25.95



2603  
List \$25.00



1886  
List \$22.95



2650  
List \$21.95



1742  
List \$24.95



1899  
List \$24.95



1710P  
List \$15.50 (paper)



1862  
List \$19.95



2648  
List \$22.95

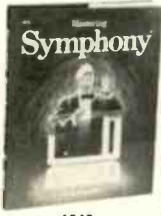

1948  
List \$22.95



1556  
List \$21.95



2623  
List \$21.95



1873  
List \$21.95



1732  
List \$23.95



2620  
List \$25.95

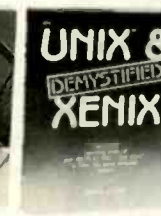

1874  
List \$21.95



1976P  
List \$17.95 (paper)



1947  
List \$25.00



1918  
List \$26.95



1501  
List \$21.95

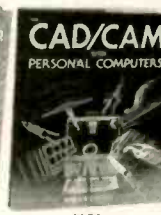

1852  
List \$21.95

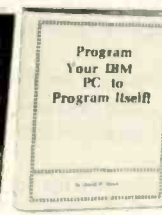

1898  
List \$18.95



2664  
List \$24.95

### Free guide to BASIC Statements & Commands



## Plus FREE For Joining

### 7 very good reasons to join The Computer Book Club®

- **Big Savings.** Save 20% to 75% on books sure-to-increase your computer know-how
- **No-Risk Guarantee.** All books returnable within 10 days without obligation
- **Club News Bulletins.** All about current selections—mains, alternates, extras—plus bonus offers. Comes 13 times a year with hundreds of up-to-the-minute titles to pick from
- **Automatic Order.** Do nothing, and the Main selection will be shipped automatically! But . . . if you want an Alternate selection—or no books at all—we'll follow the instructions you give on the reply form provided with every News Bulletin
- **Bonus Books.** Immediately get Dividend Certificates with every book purchased and qualify for big discounts of 60% to 80%
- **Extra Bonuses.** Take advantage of added-value promotions, plus special discounts
- **Exceptional Quality.** All books are first-rate publisher's editions selected by our Editorial Board and filled with useful up-to-the-minute information

© 1986 The Computer Book Club®



## The Computer Book Club®

P.O. Box 80, Blue Ridge Summit, PA 17214

Please accept my membership in The Computer Book Club® and send the 5 volumes circled below, plus my FREE copy of BASIC Statements, Commands and Functions billing me only \$2.95 plus shipping and handling charges. If not satisfied, I may return the books within ten days without obligation and have my membership canceled. I agree to purchase 4 or more books at regular Club prices (plus shipping/handling) during the next 12 months, and may resign any time thereafter.

1389P 1501 1556 1710P 1732 1742 1748P 1848 1852 1862  
1873 1874 1876 1886 1898 1899 1918 1939 1947 1948  
1970 1976P 2603 2620 2623 2627 2648 2650 2664 2692

Name \_\_\_\_\_  
Address \_\_\_\_\_  
City \_\_\_\_\_  
State \_\_\_\_\_ Zip \_\_\_\_\_ Phone \_\_\_\_\_

Valid for new members only. Foreign applicants will receive ordering instructions. Canada must remit in U.S. currency. This order subject to acceptance by The Computer Book Club®

BY-586

called Define. From the Define menu I selected Text and created two text fields for the title and date, then two numeric fields. In each case I dragged and stretched the fields until they looked right. I protected the title and date fields so that they cannot be edited when the form is used.

By clicking on the date and each of the numeric fields I brought up a dialog box that permitted me to give

these fields names (date, number, and square). Then by selecting Show Formulae, I was presented with a dialog box that records the relationship between the fields. I entered

```
RELATIONS
date = DATE
square = number * number
ENDRELATIONS
```

This done, the form turned into a sort

of minispreadsheet. When I entered a value into the number field, its square was automatically computed and placed into the square field. The date field automatically gets filled in with the system date when the form is opened.

I then selected Make Array from the menu and caused the pair of numeric fields to be replicated 10 times vertically to form a table (no alteration to the relations was necessary). Selecting Make Transaction permitted me to test the form to see that it worked. Sure enough, I filled in 10 numbers and up popped their squares. Now for the best part. Having checked that the form worked, I selected Make Pad, and a new pad icon appeared containing my new forms. Tearing off a sheet from the pad gives me a new, dated copy or "instance" of the form that can be filled in with data.

This, then, is the essence of I.S.'s programming. You create your own pads of customized forms, whose behavior can be much more complex than my example implies. Forms may include programs that verify correct data entry, extract keywords to use as search keys, and write the contents of forms to files. Forms can update an existing database and search for and incorporate information from other database records.

In addition, forms may have dialog boxes and buttons attached to them so that the operator who fills in finished forms can be prompted, cautioned, and offered options of unlimited complexity. And all this is done by simple menu selection and pointing, rather than by ROM calls, event managers, and the other arcana associated with conventional desktop programming.

Forms may be displayed in graphic form as bar, pie, line, or scatter graphs, although at present these can be printed only by screen dumps. If at some point you need a new form that in some way resembles an existing one, you simply edit the existing one; there is no need to start from scratch every time. I.S. supplies a set of sample applications designed for banking, accounting, stock control,

(continued)

## Are you a victim of the RS-232 CABLE FABLE?



Which one have you heard? For example: "It has a 'standard' RS232 interface," or "All you need is a standard printer cable," or "If you have the manuals, I can probably figure it out with my breakout box."

The truth is that RS232C is one big non-standard. There are literally hundreds of possible configurations. Which one's for you?

**THE SMART CABLE 817** — Here's the one cable to connect virtually any computer to nearly any serial peripheral. No more "standard" cables. It's easy! It's the **SMART CABLE SC817** from IQ

Technologies. Just plug it in, flip a switch, and its ingenious electronics do the rest. Instantly. Automatically.

**SMART CABLE 817** is lightweight and compact and has a built-in male or female connector (you specify). The cable end has both a male and a female connector. Smart Cable does not require batteries or its own power source.

Smart Cable is the first truly universal connector for RS232 interfaces. Use it to connect any computer to any RS232 device. Don't let "cable fables" confound you any longer. Start making intelligent connections with Smart Cable.

"Another heaven-sent accessory." —PC Week

"A marvel of ingenuity." —Microcomputing Magazine

"4 excellents, 1 good." —InfoWorld Report Card Rating

"The answer to a costly problem." —PC Magazine

Just **\$49.95** plus shipping

Call **1-800-227-2817**

Dealer inquiries invited  
MASTERCARD/VISA ACCEPTED  
IQ TECHNOLOGIES, INC. BELLEVUE, WA

OTHER SMART PRODUCTS: SC 807 (IBM PCjr), SC 809 (Apple IIc), SC 821 PLUS (Smart CableMaker), SC 880 (IBM PC-AT), SMART SWITCH BOX 1000, SMART SWITCH BOX 1300, SMART DATA METER 931.

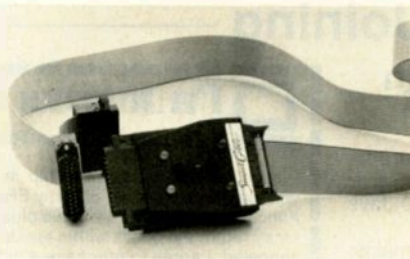

*SmartCable*

# Your first color monitor should be good enough to be your last.

**NEC** introduces the only color monitor you need. Superb resolution plus MultiSync for across-the-board compatibility with all three PC graphics boards made by IBM,® for business graphics, CAD/CAM, computer art, and text.



Now there's one high resolution color monitor that does things your way. The MultiSync™ monitor from NEC. It gives you the best color resolution available at the price.

- Compatibility with the IBM Professional Graphics Adapter, the IBM Enhanced Graphics Adapter, and the IBM Color Graphics Adapter.

Compatibility with the IBM® Enhanced Graphics Adapter Board



- MultiSync, the NEC feature that automatically adjusts to color adapter board scanning frequencies from 15.75 KHz to 35 KHz — suggesting the possibility that the MultiSync monitor might be compatible with *all* color graphics boards that are fully compatible with the IBM PC, PC/XT, and PC/AT, now and in the future.

- Full implementation of high resolution graphics software for business and other applications, now and in the future.

- And color capability limited only by the board being used.

## See Things Our Way

Until now, you had to choose different color monitors for



compatibility with all three PC color graphics boards made by IBM. With so many board and monitor configurations, folks didn't know which way to look.

The new MultiSync color monitor gives you unique compatibility. As well as TTL and analog color. With 7 switchable text colors. And resolution up to maximum 800 horizontal dots and maximum 560 vertical lines, on a large, 13" diagonal viewing area.



All that, priced at just \$799. All from NEC, a name respected around the world for advanced, reliable products backed by nationwide service.

Compatibility with the IBM® Professional Graphics Adapter Board



It's the one color monitor that does everything your way.

Compatibility with the IBM® Color Graphics Adapter Board



But why talk more about it? Visit your nearest dealer and see a graphic demonstration of the new NEC MultiSync monitor's capabilities. Then draw your own conclusions.

For information dial  
**1-800-447-4700**

NEC HOME ELECTRONICS (U.S.A.) Inc.  
Personal Computer Division  
1401 Estes Avenue  
Elk Grove Village, IL 60007



and invoicing, all of which are written on the forms processor.

**ELECTRONIC MAIL**

As mentioned before, I.S. is a multi-user networking system. As such, it incorporates an object-oriented electronic mail service. To send an object to another user, one simply tears off an envelope from the Envelope Pad, addresses it by filling in its header

with the addressee's name, drops the object into the envelope, and the envelope into the mail out-tray icon. The object can be a memo torn from a Memo Pad, a pad of custom forms, or a whole folder.

The Envelope Header permits many options, such as automatic acknowledgment of receipt, request for a reply, and priority and timing considerations. You can, for example, re-

quest that a message be sent before or after a certain date.

To receive mail, merely open your mail in-tray icon, drag out the envelope, and open it. The contents may be dragged onto your desktop and used like any other object. By editing its header you can even reuse the envelope or forward it unopened.

Having only a lone IBM PC, I could test the system only by setting up multiple users on my single-user system and sending messages between them. With this limited test, the mail system worked fine.

*Does your interface give you*  
**A LONG FACE?**



It's sad! The hours that people spend trying to get two pieces of hardware interfaced through the serial ports. They buy "standard" cables that don't work! They call the "Tech Assistance" line and that's busy. They fiddle for hours with a breakout box and still don't get the correct pin configuration.

Well, now they can smile and use those hours for something productive! The **SMART CABLEMAKER SC821** has arrived.

Unlike other cable devices claiming to resolve RS232 connections, SC821 PLUS's LED

display gives a complete graphic display of the interface. And you know the interface is correct because your system is already up and running.

Total time to interface 2 pieces of equipment and figure the correct interface? About 30 seconds! Try that with a breakout box.

**Features:**

- Instantly interfaces all RS232 serial asynchronous equipment.
- Displays the correct cable configuration of the equipment being interfaced.
- Reconfigures for each RS232 application needed.
- Comes with 2 cables with male and female DB25 connectors on each end.
- Does not require batteries or power supply, derives power from attached devices.
- Tri-state LED's. Smart Cable logic.



*SmartCable*

Just **\$149.95**  
plus shipping

Call **1-800-227-2817**

Dealer inquiries invited

MASTERCARD/VISA ACCEPTED

IQ TECHNOLOGIES, INC. BELLEVUE, WA

OTHER SMART PRODUCTS: SC 807 (IBM PCjr), SC 809 (Apple IIc), SC 817 (Universal RS-232 Interface), SC 880 (IBM PC-AT), SMART SWITCH BOX 1000, SMART SWITCH BOX 1300, SMART DATA METER 931.

**PROCEDURAL PROGRAMS**

The relations defined for a form, as described previously, are non-procedural. Order is unimportant and there is no concept of sequential execution. These relations are relevant only when the form is being filled in.

For more sophisticated applications it is necessary to write procedural programs. For example, you may wish to open a file, find a record, read certain fields into the current form, then write this form to another file. In this case, order of execution is of paramount importance, and I.S. provides a fully featured programming language in which to write such procedural programs.

I.S. programs are divided into four parts. The DECLARE section is where files and local variable identifiers are declared. I have already described the RELATIONS section. The PROCESS section defines a program to be executed sequentially during a transaction with the form. Finally, the COMMIT section defines what effect the form has on the rest of the system once it is correctly completed, for example, what files get updated and so on. All sections are optional; my test form had only RELATIONS. The language has all the expected control structures for looping and conditions, string handling and arithmetic, as well as many ultra-high-level database instructions for searching out records (such as FINDALL, FINDNEXT, FINDFIRST, UPDATE, and DELETE). Constructs for creating and reading buttons in dialog boxes are also provided. A typical section of

*(continued)*



# The price of power just went down.

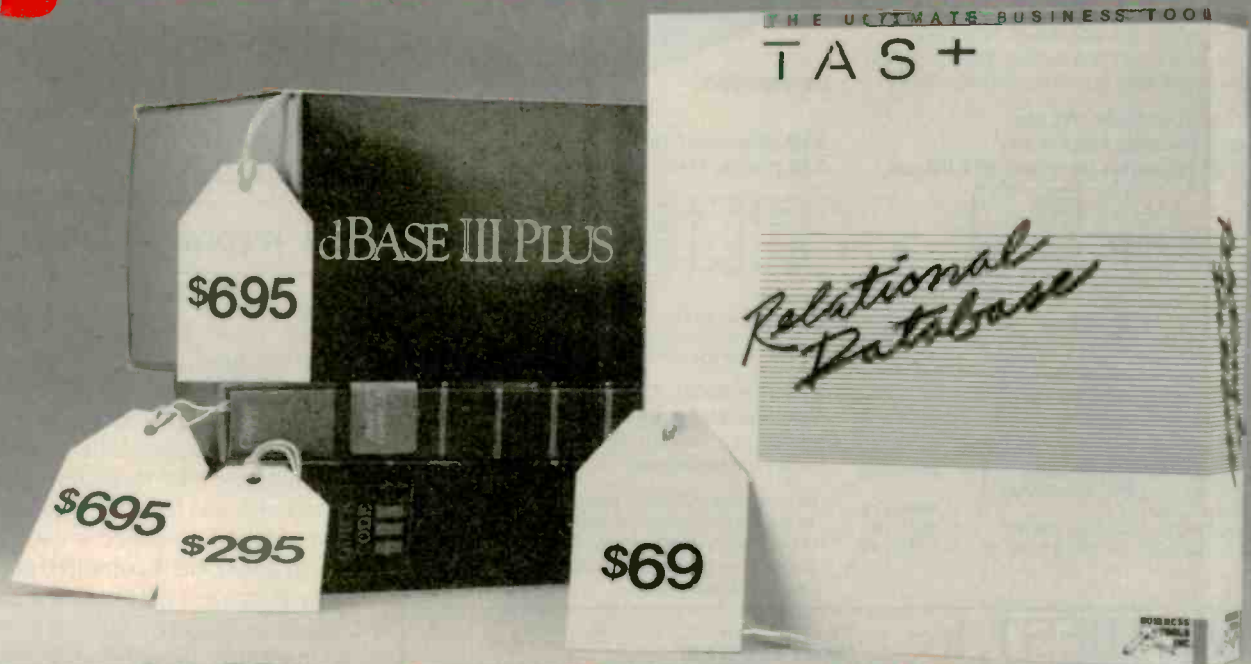

## Before you buy DBase III, QuickCode and Clipper, look at TAS-Plus

TAS-Plus just made it faster, easier and cheaper to build database applications. TAS-Plus combines the power of a Relational Database with the ease of a Program Generator. Then TAS-Plus adds a Runtime Compiler to produce lightning-fast finished code.

Look at what TAS-Plus gives you:

- Relational Database**
- 4th Generation Language**
- Screen Painter**
- Program Generator**
- Report Writer**
- Source Code Editor**
- Runtime Compiler**

TAS-Plus gives you power where it counts. You can store up to 65,000 records, open up to 16 files at a time and enter up to 10,000 characters per record. TAS-Plus even reads your old DBase files. That's respectable at any price, at \$69 it's awesome.



The following are registered trademarks of these companies: TAS-Plus, The Accounting Solution, Business Tools, Inc.; DBase III, Ashton-Tate; CP/M, Digital Research; IBM PC/XT/AT, International Business Machines Corp.; QuickCode, Fox&-Geller; Clipper, Nantucket Inc.

© Copyright 1986 Business Tools, Inc.  
Inquiry 47



## TAS-Plus writes the program for you

With TAS-Plus, you can start building professional database applications on day one. Just "paint" the screen the way you want and TAS-Plus writes the program for you. And custom reports are just as easy.

TAS-Plus has over 86 commands and 200 options available in its Source Code Editor, so you won't run out of room to grow.

### Developer's Version \$199

For those who need even more power. Open 32 files, save 17 million records. Includes Programmer's Toolkit. (Multi-user \$299)

### TAS-Books \$69

Easy-to-use bookkeeping for small businesses, designed to work with TAS-Plus.

### Modifiable Accounting \$349

Includes General Ledger, Accounts Receivable, Accounts Payable and TAS-Plus Developer's Version. Source code included.

### Advanced Accounting \$499

Includes everything in Modifiable Accounting plus Sales Order, Purchase Order, Inventory and Payroll. Source code included.

TAS-Plus comes with a 30 day money back guarantee (less \$15 handling fee). TAS-Plus is available for the IBM PC/XT/AT and fully compatible computers. Limited versions available for CP/M and non-IBM machines.

## Call Today 1-800-648-6258

Call our Toll-Free Hotline. Use your VISA, MasterCard or American Express to order today. Outside Washington call 1-800-648-6258. Washington residents call 1-206-644-2015.

## TAS+™

NOT COPY-PROTECTED

YES! Rush me the following items.

Qty.	Item	Price	Subtotal

Shipping add \$8 USA.

\$25 outside USA

WA res add 8.1% tax

Shipping

Tax

Amount Enclosed  
(US funds only)

Name: \_\_\_\_\_

Shipping Address: \_\_\_\_\_

City: \_\_\_\_\_

State: \_\_\_\_\_

Zip: \_\_\_\_\_

Telephone: \_\_\_\_\_

Payment:  VISA  MC  AMX  Check

Credit Card Expiration Date: \_\_\_\_\_

Card Number: \_\_\_\_\_

Name on Card: \_\_\_\_\_

**BUSINESS TOOLS INC.**

4038-B 128th Ave. SE □ Suite 266 □ Bellevue, Washington 98006.  
1(800)648-6258 In Washington (206)644-2015

### Dealer, VAR, OEM Inquiries Welcome.

**West Germany:** IC: Intacom GmbH, Friedrich List Strasse 32, 7022 L. Echterdingen 2, Tele: 0711-797043, Telex: 7255746 (VSC D)

**United Kingdom:** Newtons Laboratories, 111-113 Wandsworth High St., London SW184JB, Tele: 01-8746511, Telex: 21768 (NEWTONG)

## Get the Right Connection ...at Factory-Direct Prices!

Frustrated with plugging and unplugging cables and connectors? Select from our complete line of AB or X switches and let your computer system share data output between modems, printers, plotters, networks, disc drives, terminals, etc. at a touch of a button. You'll wonder how you ever got along without them!

Two typical examples are:  
**DSS (Serial) \$42.00 ea.**  
**DSP (Parallel Version) \$49.00 ea.**

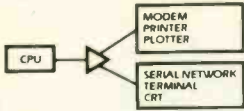

- DS-RJ11 or RJ45 with telephone type connectors (Serial) \$42.00 ea.
- DS-DIN-5 with 5 pin connectors For Apple IIc and peripherals \$42.00 ea.
- DS-9 For MACINTOSH and others (Serial or Parallel) \$42.00 ea.
- DS-15 For Monitors and others (Serial or Parallel) \$42.00 ea.
- DSS-24 25-Pin Serial Switch \$55.00 ea.
- DS-TNC and BNC For WANG Coax (Serial) \$48.00 ea.
- DS-TNC or BNC Coax (Serial) \$42.00 ea.
- DS-TWIN-AX For IBM 34, 36, 38 \$69.00 ea.

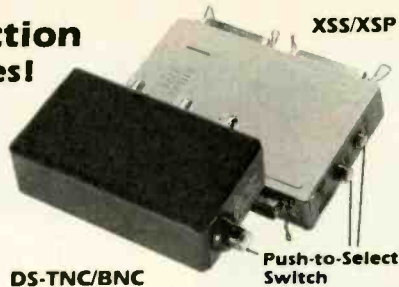

**XSP (Parallel) \$69.00 ea.**  
**XSS (Serial Version) \$55.00 ea.**

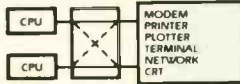

DS-CAPS For IBM PC or any MS DOS System. Code-Activated/Self Powered/ Software included. \$89.00 ea.

To get the RIGHT CONNECTION, call or write Via West today! We also offer a full line of cables and connectors. Custom orders are welcomed.

All units shipped freight collect. Add \$4.00/unit for postpaid delivery. Checks, VISA or MasterCard accepted. Quantity discounts available. AZ residents add 7%. Dealer Inquiries invited.

**VIA WEST, Inc.**  
 "The Interface Company"

534 North Stone Ave. • Tucson, AZ 85705  
**(602) 623-5716**

IBM and IBM-PC — International Business Machines Corp. Macintosh — Apple Computer, Inc. MS-DOS — Microsoft Corp. Wang — Wang Laboratories Inc.

The database in I.S.  
 can be shared  
 by multiple users,  
 and it has  
 full record locking.

source code might look like that shown in figure 1.

The source code is stored in the file that describes the form, and you can edit the code at any time by opening an example of the form and selecting Show Formulae from the forms editor. When Make Transaction is used to run a form, the code is compiled and run. If any errors are detected, the source code is redisplayed with detailed error messages inserted as comments at the sites of the errors. The error messages are automatically removed when you recompile. The whole process resembles editing a Class Template in Smalltalk, and it encourages an interactive, incremental approach to programming that will be familiar to those who've used BASIC, FORTH, or LISP.

### THE DATABASE

The database in I.S. is remarkably powerful and has many mainframe-style features. It can be shared by multiple users, and it has full record locking. A data dictionary is used to describe file structures and can work with either sequential or indexed files. File structures can be modified after they have been created, even while containing data. There are no limits on the number or length of fields or records. Default values may be supplied for all fields, and any field that assumes the default value occupies no storage space. A Squeeze utility can be used from time to time to optimize storage.

Long text fields scroll automatically within windows and can be edited, giving the effect of a free-form database. ASCII files generated by a word processor or spreadsheet can be im-

(continued)

## ARTIFICIAL INTELLIGENCE AND EXPERT SYSTEMS SOFTWARE

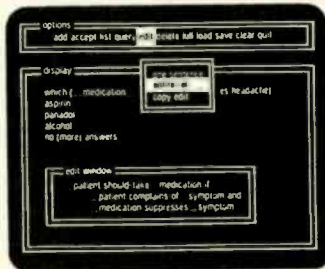

All Products from Logic Programming Associates and Logic Based Systems of London

- micro-PROLOG** INTRODUCTORY PROLOG FOR APPLE II AND COMMODORE 64 **\$89 - \$99**
- micro-PROLOG** INTRODUCTORY PROLOG FOR MS DOS AND CPM 80 SYSTEMS **\$125 & up**
- micro-PROLOG Professional** PROFESSIONAL PROLOG FOR MICRO COMPUTERS RUNNING MS DOS **\$395**
- sigma-PROLOG** PROLOG FOR SUPER MICROS AND MAINFRAMES RUNNING UNIX AND VMS **\$695 & up**
- mac-PROLOG** PROLOG FOR THE APPLE MACINTOSH **\$495**
- PROLOG** AUGMENTED PROLOG FOR EXPERT SYSTEMS PACKAGE — MS DOS **\$425 - \$650**

+ apes

NORTH AMERICA  
 Programming Logic Systems Inc.  
 31 Crescent Drive  
 Milford, CT 06460, U.S.A.  
 Tel: (203) 877-7988

ELSEWHERE  
 Logic Programming Associates, Ltd., Dept. BY/3  
 Studio 4, The Royal Victoria Patriotic Building  
 Trinity Road, London SW18 3SX, England  
 Tel: 01-874-0350



Visit Us At AAI-86 Philadelphia, PA August, 1986 Booth 311

# Designed for Excellence

with attention to  detail

**The critics agree: We're masters of our craft.**

*"...masterpiece of IBM imitation...minor masterpiece of the circuit designer's art...impressed by its high standards of quality and workmanship."* Winn L. Rosch, Cloning Your Own PC, PC Magazine, July 10, 1984. ■ *"The most compatible IBM clone I've ever worked with."* Lee Konowe, American Software Club, Ridgefield Ct. ■ *"Fulfills our every need...and leaves us money for software."* John Glenn, Electrical Engineer, U.S. Navy.

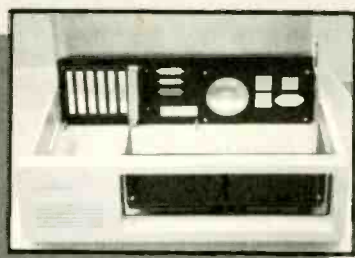

**MEGA-CASE™ \$69<sup>95</sup>**  
*Flip Top (requires a power supply with a switch in the rear)*

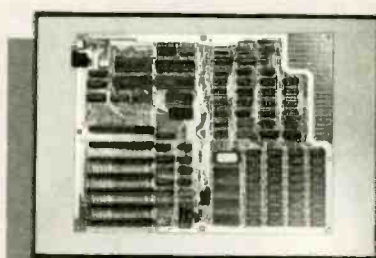

**MEGA-BOARD™-XT \$299<sup>95</sup>**  
*Fully Assembled and Tested  
 —256K RAM*



**MEGA KIT™ \$525**  
*Includes: Motherboard  
 256K • Case • 130W  
 Power Supply • Keyboard*

**NEW  
 MEGA-BOARD™-AT**

*Full IBM PC-AT Compatibility • Serial and Parallel Ports on Motherboard • Remote Reset Switch • On Board Battery (plus external battery capability) • Intel 80286 at 6 or 8 MHz • Optional Disk Drive Controller on Motherboard • Extended ROM and Memory Capacity*

*Also Available:*

XT Bare Board	59.95
XT Socketed	169.95
Mega BIOS ROM	29.95
Power Supply (130W)	89.95
IC Kit	119.95
Discrete Components	89.95

*Call for information on IBM compatible cards and components at new sale prices.*

*Prices subject to change without notice.*



**DISPLAY  
 TELECOMMUNICATIONS  
 CORPORATION**

*Call for information on:*

**MEGA-NET™**  
*Token-passing ring LAN  
 • IBM NETBIOS Compatible*

*Mega-BIOS • XT Licensing  
 Mega-BIOS • AT Licensing*

IBM is a trademark of International Business Machines Corporation.

8445 Freeport Parkway • Suite 445 • Irving, TX 75063  
 1-800-227-8383 • For Technical Calls Only: 1-214-607-1382  
 TELEX 5106000176 DTC UD

**We've Earned Our Reputation For Over Three Years. Let Us Help You Earn Yours.**

ported into forms using the LOAD instruction, provided the files have the correct field format (delimited by a carriage return and linefeed).

Intuitive Systems can supply library routines in C and BASIC to allow user programs to modify the database directly, so that experienced users can integrate the system with existing software. Routines for other languages such as COBOL and Pascal may be made available in the future.

Best of all, this whole edifice can be hidden from the end user, who needs only to be able to tear a metaphorical sheet from a pad.

### LIMITATIONS

I found few serious problems with I.S. On my plain IBM PC with an external hard disk, the system was slow when opening forms that involve a lot of processing. It really deserves more hardware than I have available—a PC AT would be much more suitable. In the future I would like to see I.S. on machines with fast 80386s or 68020s, lots of memory, and superfast disks.

## SOFTWARE MENTIONED

### INTUITIVE SOLUTION

Intuitive Systems Ltd.  
Wye Lodge, 66 High St.  
Stevenage, Hertfordshire  
SG1 3EA, England  
Tel: 0438-317966  
Price: £726 for single-user version,  
£1400 for multiuser version

It supports the use of an 8087 math coprocessor, and since all internal arithmetic is floating-point, the benefit of using a coprocessor will be felt.

In the present release, printer support is fairly rudimentary. You can print individual forms, one to a sheet, or perform graphic screen dumps. The various type sizes, fonts, and graphics that I.S. supports cannot be printed on a dot-matrix printer and are reputed to be tricky on the HP LaserJet. Intuitive Systems' next

release of I.S., I've been promised, will contain a full report generator.

The most annoying problem I encountered concerns copy protection. At present, I.S. is protected by Prolok. This demands that the signature disk be placed in drive A before the system can be run. I.S. lets you run other DOS applications from within it by defining an icon whose header contains the appropriate DOS command string. Unfortunately, my system (which boots from drive A) crashed upon calling such an application unless COMMAND.COM was present on drive A. This occurred despite the presence of a SET COMSPEC = C:COMMAND.COM directive in my AUTOEXEC file. The only solutions were either to swap disks like a maniac or to erase part of the master installation disk to make room for COMMAND.COM. A plague on all copy-protection schemes.

### BEYOND COSMETICS

I.S. goes significantly beyond the merely cosmetic aspects of the desktop metaphor and makes much of the inherent power of object-oriented programming available to the intelligent layperson. Some of the more intricate aspects of its procedural language are perhaps better left to programmers, but anyone with a good grasp of BASIC could manage. Programming with I.S. certainly does not demand the level of systems expertise that Macintosh and GEM do.

Intuitive Systems sees its main market among large corporate users (hence the 3270 interface) who would typically use I.S. as an applications generator to hook users up to the firms' mainframes via individualized IBM PC workstations. The pricing of the product reflects this orientation, at £726 for a single user and £1400 for a networking version.

I.S. gave me a strong feeling that I was looking at the shape of the business software of the future. The facilities it offers push the performance of current hardware to the limits, and I look forward to seeing this product grow onto the next generation of machines with color, fast graphics coprocessors, and smarter laser printers. ■

```
DECLARE
  FILE customer "customer.ddf","customers86"
  NUMBER ok,ans
```

```
END
```

```
RELATIONS FOR custrecord
```

```
ok = 0
```

```
FINDEACH customer.name = > name
```

```
name = customer.name
```

```
address = customer.address
```

```
phone = customer.phone
```

```
telex = customer.telex
```

```
type = customer.type END
```

```
ENDRELATIONS
```

```
PROCESS FOR chngrecord
```

```
ok = FINDFIRST customer.name = name
```

```
IF ok THEN
```

```
  UPDATE customer.name = name
```

```
  customer.address = address
```

```
  customer.phone = phone
```

```
  customer.type = type
```

```
  customer.telex = telex
```

```
END
```

```
ELSE
```

```
  ALERT (OK ,NOTE,"Record not found for this key.")
```

```
ENDIF
```

```
ENDPROCESS
```

Figure 1: An example of source code for a simple but typical program written in Intuitive Solution's procedural language.

**ACM SIGGRAPH 86**

Dallas Convention Center  
Dallas, Texas  
August 18-22, 1986

*A combination of the highest standards in technical achievement, creative artistry and today's most advanced graphics systems.*

*13th Annual Conference on Computer Graphics and Interactive Techniques*

*Sponsored by the Association for Computing Machinery's Special Interest Group on Computer Graphics in cooperation with the IEEE Technical Committee on Computer Graphics.*

*Technical Papers  
Panel Sessions  
Courses  
Industry Exhibition  
Art Show  
Electronic Theatre*

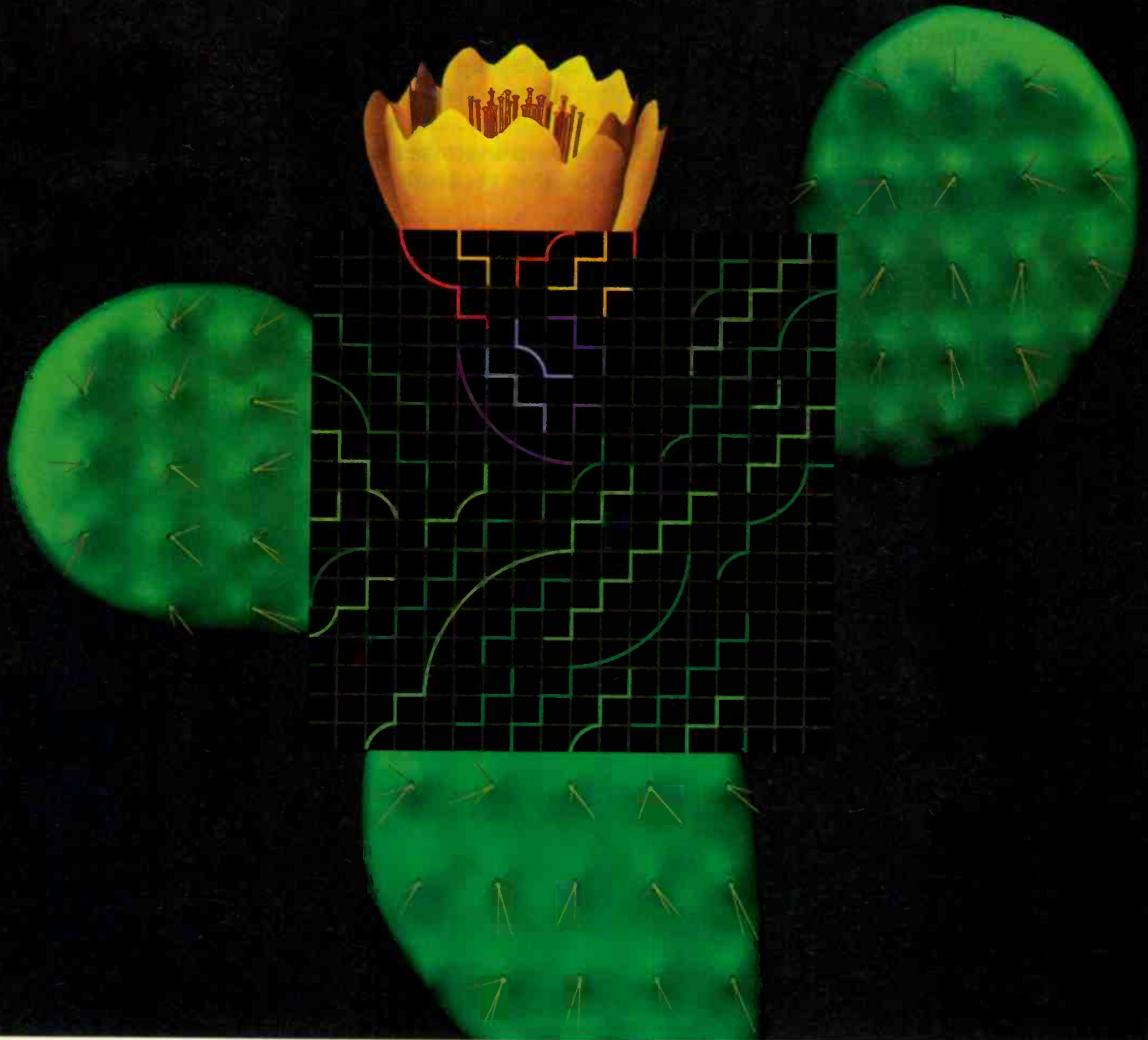

**ACM SIGGRAPH 86**

Conference Management  
111 East Wacker Drive #600  
Chicago, IL 60601  
312/644-6610

*Please send a copy of the SIGGRAPH '86 advance program to:*

NAME	COMPANY
ADDRESS	CITY/STATE/COUNTRY
ZIP	TELEPHONE

*Members of ACM SIGGRAPH will automatically receive these materials in the mail in April and need NOT return this coupon.*



Inquiry 4

MAY 1986 • BYTE 375

# Princeton Gra In a class ab

When you put Princeton Graphic Systems Monitors to work with IBM's new graphics cards, you step up to a new class of performance. Exciting RGB color, sharp, crisp graphics and text and Princeton's quality and dependability... all at a great price!

Our full line of monitors clearly demonstrates why Princeton is an industry leader in high-resolution technology.

## Princeton SR-12P Color Monitor

The first IBM compatible monitor available for the IBM Professional Graphics Controller.\*

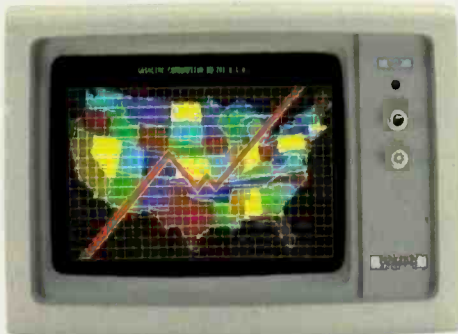

## Princeton HX-12E Color Monitor

The superior choice for use with IBM's Enhanced Graphics Adapter.\*



<b>COMPARE:</b>	<b>Princeton SR-12P</b>	<b>IBM 5175</b>
Dot Pitch (The lower, the better.)	.26 mm	.31 mm
Sugg. Retail Price (The lower, the better too!)	\$999	\$1295
Warranty	1 Year	90 Days

Designed for demanding professionals who won't settle for anything less than the finest color graphic capabilities. Displays more than 4,000 brilliant colors... features an anti-reflective coated black matrix tube for less fatigue and eye strain. You get the sharpest graphics and text... at a substantial savings!

<b>COMPARE:</b>	<b>Princeton HX-12E</b>	<b>IBM 5154</b>
Dot Pitch	.28 mm	.31 mm
Sugg. Retail Price	\$785	\$849
Tinted Black Matrix Tube	Yes	No
Warranty	1 Year	90 Days

Ideal for most computing applications, the HX-12E offers 64 high-resolution colors and easy-to-read text. It gives you sharp colors, crisp characters... for less eye strain and easier viewing, hour after hour. Built-in versatility also allows you to display 16 colors with the IBM Color Graphics Adapter\* automatically.

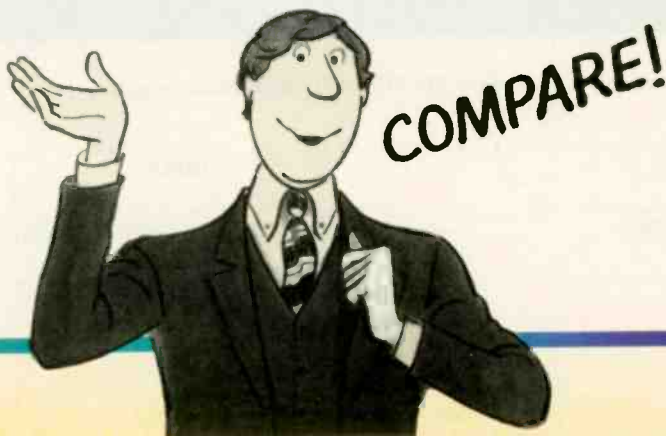

# phic Systems ove the rest

## Princeton HX-9 Series

For more performance in less space, the Princeton HX-9 series is in a class by itself.

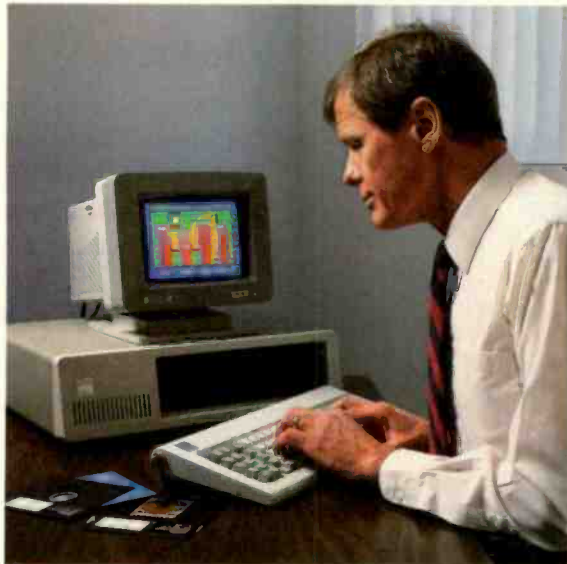

Nobody else—not even IBM—offers a 9", high-resolution RGB color display. The HX-9 and HX-9E feature a super-sharp .28mm dot pitch tube for crisp, clear text and graphics. Nonglare screens for less eye strain. The built-in tilt-and-swivel base allows you to adjust the screen to a comfortable viewing angle. Select green or amber display modes with built-in green/amber switch.

Full IBM compatibility enables you to use the HX-9 or HX-9E with the IBM Color Graphics Adapter.\* The HX-9E gives you added flexibility of full compatibility with the IBM Enhanced Graphics Adapter.\*

### Our other monitors also give you full IBM compatibility:

**Princeton SR-12 Color Monitor**—boasts twice the vertical resolution of the IBM Color Display... when used with graphics adapter cards such as the Sigma Designs Color 400.

**Princeton MAX-12 Amber Monochrome Monitor**—ergonomically designed to give you up to 15\*\* shades of high-resolution amber... plus high-resolution text and graphics when used with a monochrome card.



1984 and 1985 winner of the PC World "World Class PC Competition"!

**Princeton HX-12 Color Monitor**—16 sharp, clear colors and superb character definition make the HX-12 the winning choice among monitor users...



Princeton HX-12



IBM 5153

<b>COMPARE:</b>	<b>Princeton HX-12</b>	<b>IBM 5153</b>
Dot Pitch	.31 mm	.43 mm
Nonglare Screen	Yes	No
Warranty	1 Year	90 Days

See the clearly superior Princeton Monitors at your Authorized Princeton Graphic Systems Dealer. For the dealer nearest you, please call: **800-221-1490 (Extension 1604)**, 609-683-1660 (NJ only), Telex: 821402 PGS PRIN.

Princeton Graphic Systems, 601 Ewing Street, Bldg. A, Princeton, NJ 08540.

\* Or equivalents.

\*\* When used with IBM Color Graphics Adapter or equivalent.

IBM is a registered trademark of International Business Machines Corporation. Sigma Designs Color 400 is a registered trademark of Sigma Designs, Inc.

**PRINCETON™**

Inquiry 289

**GRAPHIC SYSTEMS**  
AN INTELLIGENT SYSTEMS COMPANY

# This is all you'll ever need to use the System 488 Instrument Control Computer.

If you need to solve engineering problems you want System 488™. System 488 is faster than an IBM PC/AT® and more powerful and flexible than dedicated instrument controllers. System 488 is complete and ready to run when it arrives, yet there's plenty of room for future expansion.

## Ready To Use

Finally, an IBM PC/AT® compatible designed for engineering applications. System 488 is packed with all of the hardware and software you need to meet a tight schedule on a low budget.



## Easy To Use

System 488 was designed for you. Our Co-Operator™ software and help windows are included to put problem solving information on your screen at the touch of a key.

## High Power, Low Price

System 488 has the power you need, backed by a technical staff that can give you straight answers to tough questions.

The complete system is just \$3980.

## Call today

Capital Equipment Corp.  
99 South Bedford St. #107  
Burlington, MA. 01803  
(617)-273-1818

## Hardware

- 8 MHz 80286 processor
- 512K RAM
- Serial and parallel ports
- Floppy disk drive
- IEEE-488 interface
- Mono/color/EGA display interface
- Monochrome monitor

**Built-in...  
not  
added on.**

## Software

- MS-DOS and BASIC
- Superkey®
- Full feature wordprocessor
- hp85 graphics emulation
- IEEE-488 applications library
- Co-Operator™







# THE PELLIAN EQUATION

BY ROBERT T. KUROSACA

Major Kilgore Hawke assembled his troops into 23 square formations and gave them a rousing speech. After stirring their spirits to a bloodthirsty frenzy, he joined their ranks, and they marched off to glory in one large square formation. What is the minimum number of men in Major Hawke's command?

Yes, another word problem.

Since we are seeking whole-number solutions, it appears to be a Diophantine equation, which we tackled last time (March BYTE, page 343). However, if each of the 23 square formations had  $y^2$  men, Hawke's presence made  $23y^2 + 1$  men, which formed a square formation with  $x^2$  men. The equation is, therefore,  $x^2 = 23y^2 + 1$ ; the Pellian equation is  $x^2 - 23y^2 = 1$ . And we are to find integral solutions for  $x$  and  $y$ .

The Pellian equation  $x^2 - dy^2 = 1$ , where  $d$  is a nonsquare positive integer and the solutions  $(x,y)$  are integers, was first proposed by Pierre de Fermat, who often challenged his French compatriots and his English counterparts with beguiling posers. Two Englishmen, John Wallis and Lord William Brouncker, are noted as the first to find a general solution. John Pell once published a table of primes less than 100,000, but his only involvement with "his" equation was that he revised someone's translation of someone else's algebra (the author who first published Wallis and Brouncker's solution). As is often the way with history, Pell was mistakenly credited with the solution (by that mathematical giant Leonhard Euler), and the equation has been known as the Pellian equation ever since.

This month, I will show you an intricate but very powerful procedure for solving the Pellian equation. We will solve the equation  $x^2 - 23y^2 = 1$ .

*The subject is*  

---

*continued fractions, and Bob*  

---

*solves a*  

---

*classic second-order problem*  

---

We will need a preliminary group of numbers for  $d = 23$ , which we will call the set. The procedure is quite complex; I apologize in advance. But our computers will love it! Note: All Pellian equations have the trivial solution  $(1,0)$ .

We construct a table with three rows:  $p$ 's,  $q$ 's, and  $a$ 's. The  $a$ 's will comprise the set we need. We will number the columns with an index  $n$ . (See figure 1.)

The first column is filled as follows:  $p_1 = 0$ ,  $q_1 = 1$ , and  $a_1 = \text{INT}(\text{SOR}(d))$ . That is, the first  $a$  is the integer part of the square root of  $d$ .

We then fill column 2, column 3, and so on. But each variable has its own recursive formula, each with its own rhythm. I will illustrate them separately.

To compute the new  $p$ :  $p_n = a_n q_{n-1} - p_{n-1}$ ; that is, (new  $p$ ) = (old  $a$ )(old  $q$ ) - (old  $p$ ). In our example:  $p_2 = a_1 q_1 - p_1 = 4 \cdot 1 - 0 = 4$  (see figure 2a). To compute the new  $q$ :  $q_n = (d - p_n^2)/q_{n-1}$ ; that is, (new  $q$ ) =  $(d - (\text{new } p)^2)/(\text{old } q)$ . In our example:  $q_2 = (d - p_2^2)/q_1 = (23 - 4^2)/1 = 7$  (see figure 2b). To compute the new  $a$ :  $a_n = \text{INT}((a_1 + p_n)/q_n)$ ; that is, (new  $a$ ) = integer part of  $((\text{first } a) + (\text{new } p))/(\text{new } q)$ . In our example:  $a_2 = \text{INT}((4 + 4)/7) = 1$  (see figure 2c).

If you are still reading this, we will press onward to the third column:  $p_3 = a_2 q_2 - p_2 = 1 \cdot 7 - 4 = 3$ ,  $q_3 = (23 - 3^2)/7 = 2$ ,  $a_3 = \text{INT}((4 + 3)/2) = 3$ .

We continue filling column after column until we obtain an  $a$  that is exactly twice  $a_1$ . In our example,  $a_1 = 4$ , so we fill the columns until we find  $a = 8$ , which occurs in column 5 (see figure 3). With a few notable exceptions, no general method for predicting the number of columns is available.

If we fill column 6 now, we find that it is identical to column 2. Hence, the table will repeat itself cyclically, and for  $d = 23$ , the set is  $\{4, \overline{1, 3, 1}, 8\}$ , where the overscore indicates the repeating cycle. This cycle has four terms, an even number—good! An odd cycle will require an additional consideration.

The first number of the set is not part of the repeating cycle. The cycle, excluding its last term, is always symmetric. Note the "1,3,1" in the set for  $d = 23$ . Similarly,  $d = 19$  has the set  $\{4, \overline{2, 1, 3, 1}, 2, 8\}$ ,  $d = 93$  has  $\{9, \overline{1, 1, 4, 6, 4}, 1, 1, 18\}$ , and  $d = 199$  has  $\{14, \overline{9, 2, 1, 2, 2, 5, 4, 1, 1}, 13, 1, 1, 4, 5, 2, 2, 1, 2, 9, 28\}$ .

We are now halfway through the procedure; please bear with me. I now confess that the table had five rows. The two additional rows are  $x$ 's and  $y$ 's that were not needed until now. Further, we no longer need the  $p$ 's and  $q$ 's. I will construct a new table with the  $a$ 's,  $x$ 's, and  $y$ 's (see figure 4a).

The first two columns are filled as follows:  $x_1 = a_1$ ,  $y_1 = 1$ ,  $x_2 = a_1 a_2 + 1$ ,  $y_2 = a_2$ .

After the first two columns are filled, we complete the table with these two recursive formulas:  $x_n = a_n x_{n-1} + x_{n-2}$  and  $y_n = a_n y_{n-1} + y_{n-2}$ . (Follow the ar-

(continued)

Robert T. Kurosaka teaches mathematics in the Massachusetts State College system. He invites your correspondence to BYTE, POB 372, Hancock, NH 03449.

# McGraw-Hill introduces the affordable solution to the 640K limit.

New!

Why spend more than \$700 for an expanded memory board with 256K and new software versions that may be incompatible with your current software?

MAXIT™ is a 256K memory board, with software, that works above or below 640K to increase memory for 1-2-3® 1A and other popular memory-intensive programs, and allows RAM-resident and custom programs to run above 640K.

It's priced at an affordable \$195.

With MAXIT, you don't have to buy new software versions like 1-2-3 Release 2.

No matter how much memory your computer has now — even 512K or 640K — MAXIT can increase available memory.

It can work above 640K, using memory

that was reserved for the operating system but isn't being used.

MAXIT software adds memory above 640K to DOS, and enables 1-2-3 1A, memory-resident software,

or custom programs to use it.

And if you already have software that works with expanded memory, you can use MAXIT's special driver software. It emulates costly expanded memory boards — giving you increased power at a fraction of the cost.

MAXIT works on the IBM PC, XT, the Portable PC, and many compatibles. It requires DOS 2.0 or above.

MAXIT works on the IBM PC AT, too. It fills out the AT's memory from 512K to 640K, and even goes beyond that.

MAXIT includes a 256K parity-checked memory card that uses the latest technology. It's a half-size card, too, so you can use it in a short XT slot.

Installation is a snap. Just follow the instructions in the illustrated Owner's Manual. The menu-driven setup software also gives you screen prompts. And if you have questions, our customer service department will answer them fast.

Once installed, MAXIT loads automatically. You don't have to learn a single new command to use it to its fullest.

Get the affordable solution to your PC's memory crisis. We've made it easy. Order MAXIT today by calling our toll-free number: 1-800-221-8439. (In Texas, call 1-214-437-7411.)

We accept VISA, MasterCard, American Express, and Diners Club cards.

Or order by writing to: McGraw-Hill CCIG Software, 8111 LBJ Freeway, Dallas, Texas 75251.

MAXIT is just \$195 plus \$4.00 shipping (\$12.00 outside the U.S.) and applicable state sales tax.

Be sure to include credit card number and expiration date with mail orders. Orders paid

by check are subject to delay.

MAXIT is covered by a 30-day money-back guarantee and a one-year warranty.

## 1-800-221-8439

(In Texas 1-214-437-7411)

**McGraw-Hill**  
**CCIG**  
**Software**

8111 LBJ Freeway, Dallas, Texas 75251

MAXIT is a trademark of McGraw-Hill CCIG Software. IBM is a registered trademark of International Business Machines Corporation. 1-2-3 is a registered trademark of Lotus Development Corporation.



\$195

rows in figure 4b.)

Since the cycle length was 4, we look in column 4 and find  $x = 24$ ,  $y = 5$ . This is the least solution (24, 5) of the Pellian equation  $x^2 - 23y^2 = 1$ . Therefore, Major Hawke had 575 men who stood in 23 groups of 25 each.

When he joined them, they formed a 576-man square formation ( $24^2$ ).

To find other solutions, we have a variety of methods:

1. Extend the table through more

(continued)

$p_1 = 0$	$n$	1	2	3	4	5
$q_1 = 1$	$p_n$	0				
$a_1 = \text{INT}(\sqrt{23}) = 4$	$q_n$	1				
	$a_n$	4				

Figure 1: The initial values for  $p$ ,  $q$ , and  $a$ .

(a)	$p_n = a_{n-1}q_{n-1} - p_{n-1}$	$n$	1	2	3	4	5
		$p_n$	0	4			
		$q_n$	1				
		$a_n$	4				
					subtract		
					multiply		
(b)	$q_n = (d - p_n^2)/q_{n-1}$	$n$	1	2	3	4	5
		$p_n$	0	4			
		$q_n$	1				
		$a_n$	4				
					square, subtract from $d$ , then divide		
(c)	$a_n = \text{INT}((a_1 + p_n)/q_n)$	$n$	1	2	3	4	5
		$p_n$	0	4			
		$q_n$	1				
		$a_n$	4	1			
					add	divide and take the integer part	

Figure 2: The method for calculating the next  $p$  value (a),  $q$  value (b), and  $a$  value (c).

$p_3 = a_2q_2 - p_2$	$n$	1	2	3	4	5
$q_3 = (d - p_3^2)/q_2$	$p_n$	0	4	3		
$a_3 = \text{INT}((a_1 + p_3)/q_3)$	$q_n$	1	7	2		
We stop at 5 because $a_5 = 2 \cdot a_1$ .	$a_n$	4	1	3		
	$n$	1	2	3	4	5
	$p_n$	0	4	3	3	4
	$q_n$	1	7	2	7	1
	$a_n$	4	1	3	1	8

Figure 3: The completed chart for one cycle of  $\sqrt{23}$  calculations.

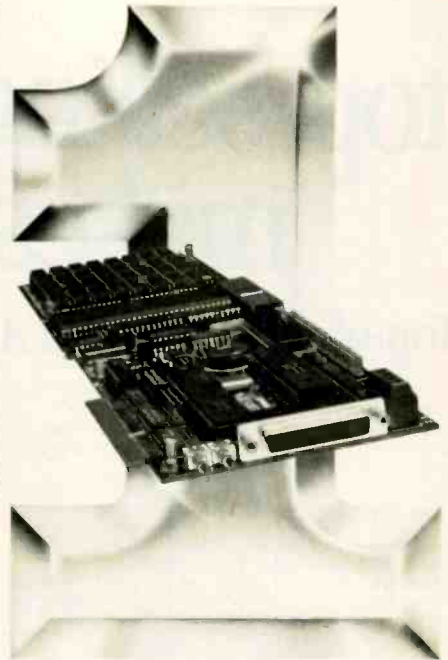

## Number One in Performance 68010/68000 Coprocessor for IBM/AT/XT/PC-

8/10/12.5mz No Wait States

\$1295<sup>00</sup> Qty. 1

### FEATURES

- 1-2 MB RAM (1MB Standard)
- 16K-64K EPROM
- 2-8 Serial Ports
- Async/Sync/Bisync Communications
- Battery-backed Real Time Clock
- Battery-backed 2K-8K RAM
- 2 Parallel Ports
- 68881 Math Coprocessor
- Memory-mapped Dual-port BUS
- 3-9 Users Per Board (3 Standard)
- Up To 16 Boards Per AT/XT/PC
- Can Operate As Standalone Processor

### SOFTWARE

- OS9 (Powerful UNIX-like Multi-user OS)
- CPM/68K
- Software selectable OS including concurrent PC DOS/OS-9 or CPM/68K operation
- Support Module for IBM Graphics
- High-speed Local/Global Disk Caching
- Basic, Pascal, Fortran, C, and COBOL

IBM is a registered trademark of International Business Machines Corporation. OS/9 is a registered trademark of Microsoft Systems Corp. CPM is a registered trademark of Digital Research Corp. Microsoft and IBM are registered trademarks of their respective owners.



West: 4704 W. Jennifer, Suite 105, Fresno, CA 93711, 209/276-2345  
 East: 67 Grandview, Pleasantville, NY 10570, 914/747-1450  
 Distributor: Telemarketing Services, Inc.  
 1897 Garden Ave., Eugene, OR 97403, 503/345-7395

# Europe's top-selling integrated software makes it easy to choose.

Top-of-the-line: *Open Access*® \$395\*.

For starters: *Entry* \$195\*.

OPEN ACCESS Comparison Chart	Database	Form Query	Report Generator	Query Processor	Relational Database	Graphics	3-D Graphics	Spreadsheet	Goal Seeking	Word Processing	Communications	Time Management	Price
Lotus 1-2-3	✓				✓	✓							495 <sup>00</sup>
Symphony	✓	✓	✓		✓	✓		✓	✓	✓			695 <sup>00</sup>
Framework	✓		✓	✓	✓	✓		✓	✓	✓			695 <sup>00</sup>
<b>Open Access</b>	✓	✓	✓	✓	✓	✓	✓	✓	✓	✓	✓	✓	<b>395<sup>00</sup>*</b>

\*U.S. version only

ENTRY Comparison Chart	Database	Form Query	Report Generator	Query Processor	Word Processor	Mail Merge	Spreadsheet	Goal Seeking	Time Management	Mail Search	Print Appointment	Price
pfs: file & report	✓	✓	✓									265 <sup>00</sup>
Q & A	✓	✓	✓	✓	✓	✓						299 <sup>95</sup>
Multipan							✓					195 <sup>00</sup>
<b>Open Access Entry</b>	✓	✓	✓	✓	✓	✓	✓	✓	✓	✓	✓	<b>195<sup>00</sup>*</b>

\*U.S. version only

*Open Access* has sold almost 50,000 copies overseas. With one of the most powerful Relational Databases around, and just about all the additional features you could want, it's no wonder. Just take a look at the screens below and see all you get in this sophisticated business program. (We're even written in 11 languages with exact file transfer.) And now we offer it in the United States at a reduced price so you can find out what made it Europe's top-seller.

Or, to make it even easier, we offer you *Open Access Entry*, for those who don't need all that *Open Access* has to offer. Yet. You get four programs plus all the documentation for the complete *Open Access* package so that updating will be a snap—for you and us. We make it easy. Just call today.

Available at better dealers nationwide. For your nearest dealer or distributor, call (619) 450-1526.

The image displays eight distinct computer screen captures arranged in a 4x2 grid. Each screen shows a different software application interface:

- Relational Database:** Shows a data table with columns for various fields and a menu bar.
- Spreadsheet:** Displays a grid of data with a menu bar and a title bar.
- Database:** Shows a screen with a menu bar and a list of data entries.
- Spreadsheet:** Shows a grid of data with a menu bar and a title bar.
- Communications:** Shows a screen with a menu bar and a list of communication options.
- Graphics:** Displays a 3D bar chart with a menu bar.
- Word Processing:** Shows a screen with a menu bar and a text area.
- Time Management:** Shows a screen with a menu bar and a list of time management options.

The product's exceptional. The price extraordinary. Can you really afford to compromise any longer?



**SOFTWARE PRODUCTS INTERNATIONAL**

10240 Sorrento Valley Rd. • San Diego, CA 92121 • (619) 450-1526 • Telex 499-0919

Inquiry 331 for End-Users. Inquiry 332 for DEALERS ONLY.

Open Access and SPI are registered trademarks of Software Products International, Inc.; Lotus, 1-2-3 and Symphony are registered trademarks of Lotus Development Corp.; Multipan is a registered trademark of Microsoft; Q & A is a trademark of Symantec; Framework is a trademark of Ashton-Tate.

cycles and look in columns 8, 12, 16, and so on—where we would find (1151, 240), (55224, 11515), and so on.

2. Use a "closed" formula, which can determine, say, the tenth solution without knowing any of the preceding nine. If  $(x_0, y_0)$  is the first nontrivial solution of  $x^2 - dy^2 = 1$ , all solutions are given by

$$x_n = |(x_0 + y_0\sqrt{d})^n + (x_0 - y_0\sqrt{d})^n|/2$$

$$y_n = |(x_0 + y_0\sqrt{d})^n - (x_0 - y_0\sqrt{d})^n|/2\sqrt{d}$$

(The derivation of these formulas is available. Please include a SASE, preferably with two first-class postage stamps.)

3. We note that the  $x$  and  $y$  values of the solutions form sequences. Including the trivial solution (1,0), the  $x$ 's are 1, 24, 1151, 55224, . . . and the  $y$ 's are 0, 5, 240, 11515, . . . For some constant  $c$ , the  $x$ 's and  $y$ 's can be generated by  $x_n = c \cdot x_{n-1} - x_{n-2}$ ,  $y_n = c \cdot y_{n-1} - y_{n-2}$ , where  $c$  is twice the  $x$  value of the first (nontrivial) solution. In our example, this  $x$  value is 24; hence  $c = 48$ :  $x_n = 48 \cdot x_{n-1} - x_{n-2}$ ,  $y_n = 48 \cdot y_{n-1} - y_{n-2}$ .

Method #3 is the easiest for the computer and is the method used in

the listing this month. Of course, when seeking larger solutions, some extended precision will be required.

I mentioned earlier that  $d = 23$  has an even set {4,1,3,1,8} with an even number of terms in its repeating cycle. What if the cycle is odd? Consider the Pellian equation  $x^2 - 41y^2 = 1$ . For  $d = 41$ , the set is {6,2,2,1,2}, an odd cycle. We construct the table as in figure 5, but we extend it through two cycles.

Since the cycle length is 3, we expect to find the least solution in column 3. We find, however, that (32, 5) will not work. (It is, however, a solution for  $x^2 - 41y^2 = -1$ .) We must go "twice as far"—to column 6—to find the least solution (2049, 320). Subsequent solutions will appear in every sixth column. For method #2, the closed formulas will involve  $(2049 \pm 320\sqrt{41})^{2n}$ . In method #3, the constant would be  $2 \cdot 2049 = 4098$ :  $x_n = 4098 \cdot x_{n-1} - x_{n-2}$ ,  $y_n = 4098 \cdot y_{n-1} - y_{n-2}$ .

Listing 1 provides a program that solves a Pellian equation for its least solution, prints the recursive formulas, checks the least solution, and also prints the second solution.

(continued)

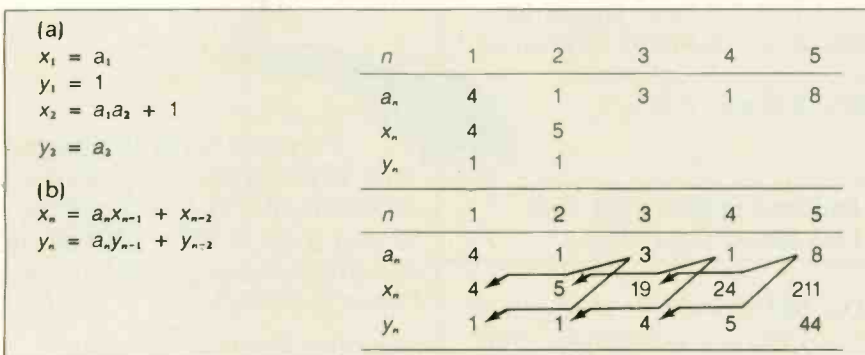

Figure 4: (a) The first two  $x$  and  $y$  values; (b) the flow diagram for subsequent  $x$  and  $y$  values.

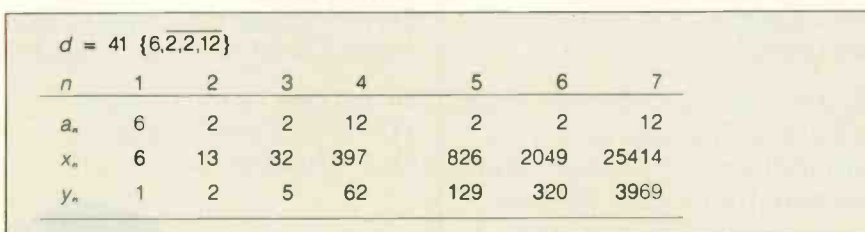

Figure 5: The completed chart of  $x, y$  values for  $x^2 - 41y^2 = 1$ .



## Number One In Performance

## Hard Disk Intelligent VCR Backup for AT/XT/PC

### FEATURES

- High speed microprocessor controlled backup (68000)
- Two channel interface
- Built in LAN channel
- Software control of most VCR functions including Fast Forward, Rewind, and auto backup using VCR timer capabilities
- Economical VHS or Beta formats



West: 4704 W. Jennifer, Suite 105, Fresno, CA 93711, 209/276-2345  
 East: 67 Grandview, Pleasantville, NY 10570, 914/747-1450  
 Distributor: Telemarketing Services, Inc.  
 1897 Garden Ave., Eugene, OR 97403, 503/345-7395

# The SB180 Computer Reasserts 8-Bit Computing In A 16-Bit World

**Y**ou're one of the few heroes left. The stalwart CP/M user who's held the fort despite all the odds against you – a slow, bulky system that can't seem to compete against today's 16-bit computers. Well, help has finally arrived.

**IT'S THE SB180 COMPUTER.**

The SB180 is a true single-board computer: A CMOS CPU, 256K Ram, 8K ROM Monitor, disk controller for up to four 3 1/2", 5 1/4" and/or 8" drives, console serial port, modem port parallel printer port . . .  
**ALL ON ONE BOARD**

**High Speed And Small Enough To Fit In A Lunchbox**

You can run standard 8080/8085 and Z-80 software at up to twice the speed of a 4MHz Z-80. And the entire SB180 package is only 4" x 7 1/2".

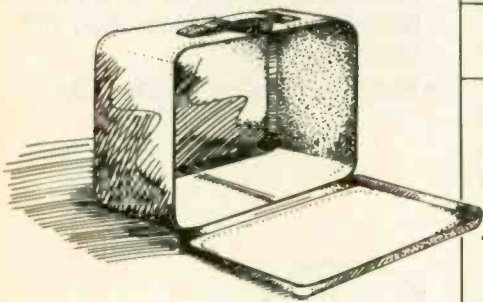

**Software Compatibility With The World**

Any of the thousands of application programs, languages or utilities which run under CP/M will also run on the SB180.

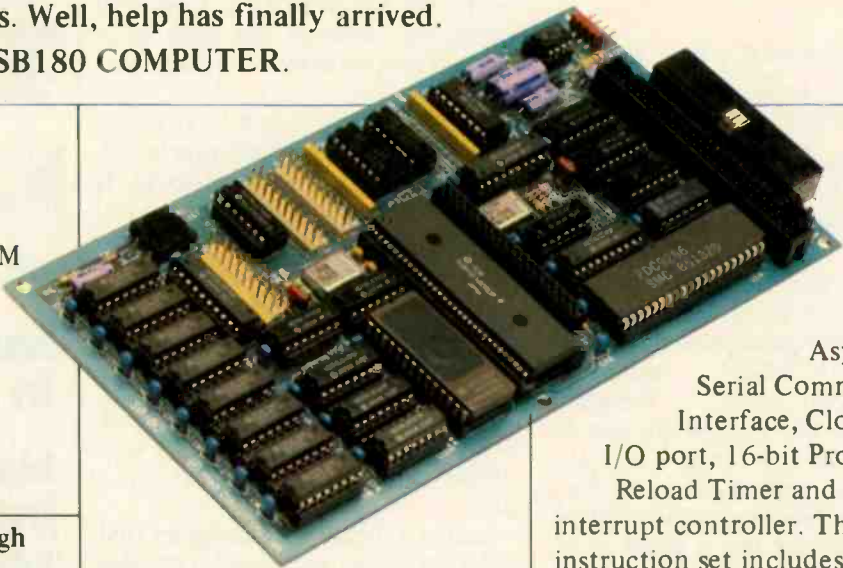

Asynchronous Serial Communications Interface, Clocked Serial I/O port, 16-bit Programmable Reload Timer and a 12 source interrupt controller. The expanded instruction set includes hardware multiply and a sleep instruction for low power standby operation.

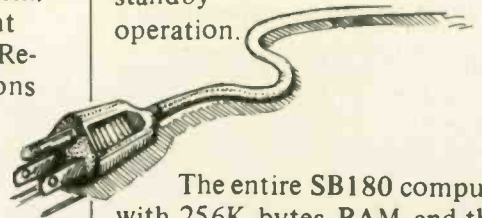

The entire SB180 computer with 256K bytes RAM and the 8K ROM monitor is only \$369.00. If you want ZCPR3, ZRDOS, ROM and BIOS sources, the whole package comes to \$499.00.

Quantity discounts are also available. Dial toll free 1-800-635-3355 to order the SB180. For technical information write us at 25 Terrace Drive, Vernon, CT 06066 or call 1-203-871-6170. (Telex: 643331)

So call now, and say you're a CP/M user who's ready for reinforcements.

The SB180's Z-System is an enhanced 8-bit operating system. It is a complete replacement for CP/M 2.2 from Digital Research, yet provides functions and facilities similar to MS-DOS and UNIX.

**Reduced System Cost And Low Power Operation**

The SB180 uses the most powerful of the new generation 8-bit CPU's – the Hitachi HD64180.

The chip is based on a micro-coded execution unit and advanced CMOS manufacturing technology.

System costs are reduced because many key functions have been included on-chip: Memory Management Unit, Direct Memory Access Controller, wait state generator, dynamic RAM refresh,



Listing 1: The Pellian equation solver.

```

10 '*****
20 '*          PELLIAN EQUATION          *
30 '*          X^2 - D*Y^2 = 1          *
40 '*          BY BOB KUROSAKA          *
50 '*****
60 REM ENTER A NONSQUARE INTEGER D. THE PROGRAM
70 REM DETERMINES THE FIRST (LEAST) SOLUTION, THE
80 REM RECURSIVE FORMULAS, AND THE 2ND SOLUTION.
90 REM
100 REM
110 CLS
120 DIM P(100),Q(100),A(100) 'Hope 100 is enough!
130 INPUT "D = ";D
140 D=ABS(INT(D))
150 RD=VAL(STR$(SQR(D))) 'Remove guard digits from SQR(D)
160 IF RD<>INT(RD) THEN 180
170 PRINT "D must not be a square!":GOTO 130
180 '
190 '-----FIRST HALF: FIND An-----
200 '
210 P(1)=0:Q(1)=1:A(1)=INT(SQR(D)):N=1 '1ST COLUMN VALUES
220 N=N+1
230 P(N)=A(N-1)*Q(N-1)-P(N-1)
240 Q(N)=(D-P(N)*P(N))/Q(N-1)
250 A(N)=INT((A(1)+P(N))/Q(N))
260 IF A(N)=2*A(1) THEN 290
270 GOTO 220
280 '
290 '-----SECOND HALF: FIND X0 AND Y0-----
300 '
310 CL=N-1 'CL=CYCLE LENGTH
312 FOR I=N+1 TO 2*CL 'REPEAT CYCLE
314 A(I)=A(I-CL): P(I)=P(I-CL): Q(I)=Q(I-CL)
316 NEXT I
320 IF CL/2<>INT(CL/2) THEN CL=2*CL
330 DIM X(CL), Y(CL)
340 '
350 '-----FIND Xn AND Yn-----
360 '
370 X(1)=A(1):Y(1)=1 'SET UP 1ST 2 COLUMNS
380 X(2)=A(1)*A(2)+1:Y(2)=A(2) ' OF Xn AND Yn
390 IF CL<3 THEN 450
400 FOR I=3 TO CL
410 X(I)=A(I)*X(I-1)+X(I-2)
420 Y(I)=A(I)*Y(I-1)+Y(I-2)
430 NEXT I
440 '
450 '-----FIRST SOLUTION-----
460 '
470 X0=X(CL):Y0=Y(CL):C=2*X0 '(X0,Y0) = LEAST SOLUTION
480 PRINT:PRINT "LEAST SOLUTION: "
490 PRINT "X = ";X0
500 PRINT "Y = ";Y0
510 '
520 '-----PRINT RECURSIVE FORMULAS-----
530 '
540 PRINT:PRINT "FORMULAS: "
550 PRINT "X(N) = ";C;"* X(N-1) - X(N-2)"
560 PRINT "Y(N) = ";C;"* Y(N-1) - Y(N-2)"
570 '
580 '-----CHECK X0 AND Y0-----
590 '
600 PRINT:PRINT "CHECK: "
610 L=LEN(STR$(D))
620 PRINT TAB(L+3)"X^2 = ";X0*X0
630 PRINT D;"* Y^2 = ";D*Y0*Y0
640 '
650 '-----PRINT 2ND SOLUTION-----
660 '
670 PRINT:PRINT "SECOND SOLUTION: "
680 PRINT "X = ";C*X0-1;" Y = ";C*Y0
690 END

```

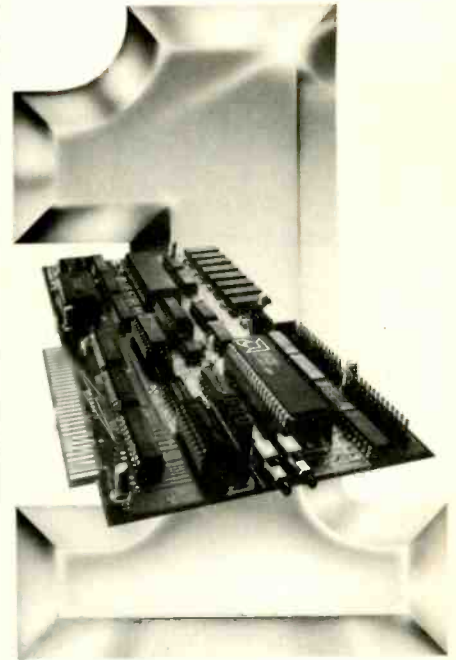

**Number One  
in Performance**

**Z80H  
BLUE STREAK™**

**IBM/AT/XT/PC- 8mz  
No Wait States**

#### FEATURES

- 64K-256K RAM
- 2K-8K EPROM/Static Ram
- 2 Serial Ports
- Async/Sync/Bisync Communications
- Real Time Clock
- Memory-mapped Dual-port BUS
- On-board/Remote Reset NMI capability
- Up To 32 Boards Per AT/XT/PC
- Can Operate As Standalone Processor
- Less Than Full Size Board  
(will fit other compatibles.)

#### SOFTWARE

- ZP/M™ CP/M Emulation Software  
(Supports Most CP/M Software)
- Multiuser Capability If Used As A  
Slave Processor

IBM is a registered trademark of International Business Machines Corporation.  
CP/M 80 is a registered trademark of Digital Research Corp.



West: 4704 W. Jennifer, Suite 105, Fresno, CA 93711, 209/276-2345  
East: 67 Grandview, Pleasantville, NY 10570, 914/747-1450  
Distributor: Telemarketing Services, Inc.  
1897 Garden Ave., Eugene, OR 97403, 503/345-7395

Prove that  $(1, \overline{1,2}) = \sqrt{3}$ .

Let  $x$  equal the continued fraction:

$$x = 1 + \frac{1}{1 + \frac{1}{2 + \frac{1}{1 + \frac{1}{2 + \dots}}}}$$

Add 1 to each side of the equation:

$$x + 1 = 2 + \frac{1}{1 + \frac{1}{2 + \frac{1}{1 + \dots}}}$$

which is equivalent to:

$$x + 1 = 2 + \frac{1}{1 + \frac{1}{x + 1}}$$

which, in turn, simplifies to:

$$x^2 = 3$$

For additional practice, you may wish to revise Major Hawke's command to 53 square formations. The equation  $x^2 - 53y^2 = 1$  will have the set  $\{7,3,1,1,3,14\}$ , an odd set. The least solution is (66249, 9100). Therefore, he would have 4,388,930,000 men in his command. (Did I say he was from this planet?)

For the Pellian equation  $x^2 - dy^2 = 1$ , the nonsquare positive integer  $d$  has a set that determines the infinite continued fraction for  $\sqrt{d}$ . For example,  $d = 3$ . We find that the set is  $\{1, \overline{1,2}\}$  and that the continued fraction formed from the set equals  $\sqrt{3}$ . Figure 6 demonstrates this.

I hope you experiment with this portion of the procedure as well as the entire Pellian algorithm. There are many patterns to be discovered. For example, if  $d$  is of the form  $n^2 + 1$  (one more than a square), its set will be  $\{n, \overline{2n}\}$ . If  $d$  has the form  $n^2 - 1$  (one less than a square), the set is  $\{n-1, \overline{1,2(n-1)}\}$ . ■

Figure 6: Proof that  $\sqrt{3}$  equals the continued fraction  $(1, \overline{1,2})$ .

**NOVAS TURBO 286 - AT BOARD**

**FEATURES:**

Reliable - Using Gate array chips count only  
36 I.C. (Others AT compatible chip count 100 I.C.)

(6MHZ/8MHZ) Keyboard Select Speed  
4 Serial / 1 Parallel on board optional

- Memory size 256K, 512K, 640K, 1M
- Fully compatible BIOS (BASIC Input - Output System) is developed in the United States, fully provided all capabilities and facilities with IBM AT compatibility restrictions.
- Systems Set-Up programs diskette provided.
- \$595.00 for (Big OEM Quantity) in stock



**NOVAS - 1000 Enhanced Color Graphic Adaptor (E.G.A)**

**FEATURES:**

HIGHER PRODUCED GRAPHIC & Color to PC, XT, AT  
640 - 350 Resolution for IBM Enhanced Color Display  
720 - 350 Pixels for IBM Monochrome Display and more

- NOVAS - 1000 with all video standards for IBM PC, XT, AT, including Enhanced Color Graphic Adaptor regular IBM color graphic Monochrome Display Adaptor.
- 256K Dynamic Ram Screen Buffer on board using 64K x 4 Drams support 16 colors in HI - Resolution Mode.
- One printer port built in which can be selected for LPT, 1,2,3, NOVAS - 1000 Fits into IBM PC, XT, AT or compatible computer.
- \$250.00 for (Big OEM Quantity) in stock



NOVAS PC/XT Turbo Mother Board (4.77/8 MHZ) \$175.00 (Zero K RAM)

SYSTEM	
NOVAS PC/XT Turbo System .. \$895.00 8MHZ Turbo Speed, 640K on board, 2 Dr., serial/ parallel, clock, game, mono-graphic, monitor.	NOVAS Turbo 286 AT Entry System ..... \$1895.00 640K RAM, 6/8 MHZ Turbo Speed, 4S/1P optional, H.D/ F.D, controller, 1.2M Dr., 195W power, keyboard, case.

**Computrade Company**

Main Office: Computrade Company  
780 Trimble Road, Suite 605, San Jose, CA 95131  
Tel: (408) 946-2442 (408) 435-2662 Fax: (408) 435-5458

• IBM is a Trade Mark of International Business Machine Corp. •

Sixth Conference on  
**Microcomputers  
in Education and Training**  
**DEVELOPMENT OF EFFECTIVE  
INTERACTIVE  
INSTRUCTION MATERIALS**

Pentagon Quality Inn  
Arlington, Virginia  
June 18-20, 1986

Presentations cover:

**Creative Development**

- Computer-based Authoring Systems
- Videodisc Creative Systems
- Design for Interactivity
- CD-ROM Potential  
(Compact Disc/Read Only Memory)

**Technological Implementation**

- Effectiveness Criteria
- Implementation Capability
- Generic Programs

**Pre-conference tutorials**

are scheduled for June 17.

For further information contact:

**SALT**

**Society for Applied Learning Technology**

50 Culpeper St., Dept. B  
Warrenton, VA 22186 (703) 347-0055  
Toll Free 1-800-457-6812





# Computer Friends Buffers, the new generation.

## MAC MASTER™

Universal Buffer & Printer Controller.



### LOOK!

Let Mac Master be your

1. Buffer and free your Computer Memory
2. Printer Controller. Mac Master stores/recalls all the fonts and commands of any printer you connect to it.
3. Auxiliary Memory. Mac Master stores/recalls files, logos, graphic symbols, etc.

Plus multiple copy capability, memory and copy no. display, pause and bypass option, and more. Available in parallel or serial.

64K **\$299<sup>00</sup>** — 256K **\$450<sup>00</sup>**  
 1 MEG **\$700<sup>00</sup>** Shipping **\$4<sup>00</sup> U.S.**

## PROTEUS™

Double Buffer & Data Switch (Parallel).



Connect 2 printers or other parallel peripherals to PROTEUS and you will have:

1. Buffer on Port 1 and 2.
2. Switching capability (manual or via software).
3. Multiple Copy capability on both ports.

PROTEUS 64K — **\$199<sup>00</sup>**

Shipping  
\$4<sup>00</sup> U.S.

PROTEUS 256K — **\$299<sup>00</sup>**

Mac Master and/or Proteus are easily installed and can be used immediately. 12 Months Warranty.

### UNIVERSAL

## MAC INKER™

Re-ink your Fabric Ribbons automatically for less than 5 cents.

Extremely simple operation. We support any fabric cartridge. The Universal Cartridge MAC INKER is \$68.50. The Universal Spool MAC INKER is \$66.95. Our lubricated, dot matrix ink (\$3.00/bottle) yields a darker print than most new ribbons. Estimated no. of re-inkings per avge. cartridge 60-100. MAC INKER has been reviewed, approved and flattered in most magazines, even in the New York Times and the Chicago Sun Times.

**\$68.50**



Shipping  
\$3.00 U.S.

(Universal w/C. Itoh Prowriter Cartridge).

Over 50,000 MAC INKERS in the field as of Jan. 15, 1986.

### RE-INK IN COLOR TOO

We have colored or un-inked cartridges or reloads for most popular printers. Colors: Brown, Blue, Red, Green, Yellow, Purple. Please inquire.

## MERCURY MODEM

Really 100% Hayes\* Smartmodem Compatible. ■ 300/1200 Baud Speed. ■ Auto answer, Auto dial, Auto speed selection. ■ Audio monitor w/Volume Control. ■ Front Panel lights. ■ Excellent Manual. ■ 18 months warranty.

**\$205<sup>00</sup>**

Includes power supply and telephone cable. Computer to Modem cable \$15.00. Shipping \$4.00



\*Hayes is a trademark of Hayes Microproducts.

## mac-the-ripper™

Perforation Eliminating Machine.

Tears off the perforations from computer paper. Feed in the first sheet of the stack and let mac-the-ripper do the rest. Eliminates tedium and can pay for itself promptly in saved personnel time.

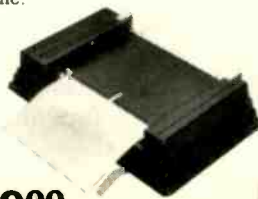

**\$49<sup>00</sup>**

Shipping  
\$5.00 U.S.

## DATA SWITCHES

All types, all lines switched, all metal, heavy duty switch, elegant design, best value for money.



2 Ports Parallel  
or Serial

**\$ 75<sup>00</sup>**

4 Ports Parallel  
or Serial

**\$150<sup>00</sup>**

2 Computers/  
2 Printers Par. or Ser.

**\$150<sup>00</sup>**

We have cables too. Please inquire or specify at time of order.

Order Toll Free.

Call or Write for free brochure.

**1-800-547-3303**

In Oregon 503-297-2321 (24 hours line)

## Computer Friends®

6415 SW Canyon Ct., #10  
Portland OR 97221  
telex 4949559

# BYTE Invites You to Join **BIX**

BYTE is the world's leading high-tech microcomputer magazine. Its readers collectively possess more information about personal computers and related topics than any other group in the world. BIX is BYTE's brand-new electronic information exchange, a computer conferencing system that puts you in touch with BYTE readers and other computer enthusiasts on a daily basis.

---

## YOU AND BIX

BIX goes far beyond electronic bulletin boards to give you all the advanced features of true computer conferencing. It's the first major system dedicated to microcomputer information. Check these features:

- You can join ongoing discussions about your favorite computers, programming languages, operating systems, and applications programs, exchange information, ask questions, and offer opinions.
- You can read what others have already entered, add your own thoughts, and download information.
- You can participate when it's convenient for you, from home or office or while you're traveling.
- You also get electronic mail with BIX, putting you in direct, private contact with BYTE editors and BIX users everywhere.

## CUSTOMIZE BIX TO MEET YOUR NEEDS

As a BIX user, you select only the conferences and topics that are of real interest to you. You may join a new conference or leave an old one anytime you want. Each time you log on to BIX, you're immediately notified of any electronic mail messages waiting for you, and you see which of the conferences you've joined have had new activity since the last time you logged on. BIX keeps track of your interests.

With BIX, you're an active participant in a giant microcomputer information exchange.

## WHAT BIX COSTS... HOW YOU PAY

ONE-TIME REGISTRATION FEE:	
BYTE Subscriber .....	\$25
Nonsubscriber .....	\$39

BIX HOURLY USAGE FEES (All times are local):	
Off Peak (6 p.m.-7 a.m. plus weekends and holidays) .....	\$9
Peak (7 a.m.-6 p.m. weekdays) .....	\$12

## TELECOMMUNICATIONS CHARGES:

BIX is available via Tymnet from anywhere in the United States.

TYMNET (Continental U.S.):

Off Peak .....	\$2/hr.	Peak .....	\$6/hr.
----------------	---------	------------	---------

## PAYMENT:

BIX and Tymnet charges are billed through either VISA or MasterCard. No cash, checks, or money orders.

## START USING BIX NOW!

With our easy on-line registration, you can start using BIX in the next few minutes. No lengthy waiting for your registration to be processed by mail. (Step-by-step instructions on how to log on to BIX follow. Reading this material before you log on will speed you through the registration process.)

## LOG-ON INSTRUCTIONS AND REGISTRATION INFORMATION

### BEFORE YOU CALL BIX:

Having your credit card handy (VISA/MasterCard) before you log on will speed you through BIX registration. *You will not be billed for the time you spend on line registering for BIX. If at any time during the on-line process you decide not to register for BIX, just hang up.*

### HOW TO LOG ON TO BIX:

Step 1: Set your computer's telecommunications program for full duplex using 8-bit words, no parity;

and 1 stop bit, or 7-bit words, even parity, and 1 stop bit. You may call at either 300 or 1200 baud.

**Step 2:** To reach BIX via Tymnet.\*

- \* BIX is accessible from anywhere in the country through local Tymnet numbers. If you don't know the Tymnet numbers for your area, contact the BIX Customer Service Line (see below). At other times, numbers can be obtained by calling Tymnet at 800-336-0149.
- Call your local Tymnet number and log on.
- Depending on your baud rate, Tymnet will respond with "garble" or request a terminal identifier. Enter the letter "a". (Ignore quotation marks in this and succeeding entries.)
- Tymnet will ask you to log on. Enter "byteneti" and a carriage return (CR).
- Tymnet will ask you for a password. Enter "mgh" and (CR). You will then be at the door to the BIX computer.

**Step 3:** (If there is no prompt requesting a login at this point, hit a (CR) which should produce it.) When you see a phrase ending in "login:", enter "bix". (Echoing of this response is normal.)

You should now see the BIX logo scroll onto the screen and a prompt asking you to enter your name. Since this will be your first time on the system, enter "new" and a carriage return. This will

take you to a special section where you enter the information we need to register you as a BIX user. Follow the on-line prompts and supply the information requested. BIX lets you re-enter data if you make a mistake.

When you've completed your registration, BIX will automatically take you to a special "Learn" conference where you'll get a quick tutorial on how to use the system. (Typing "help" or "?" at any prompt while you are on BIX will give you an immediate review of available commands.)

### **ACCESSING BIX FROM FOREIGN COUNTRIES**

To reach BIX from other countries, you need an account with your local Postal Telephone & Telegraph (PTT) company. From your PTT, enter 310600157878. Then follow instructions starting at Step 3. A list of PTT addresses and contacts for most foreign countries is available by calling or writing BIX.

### **CUSTOMER SERVICE**

If you follow these instructions but still are unable to log on to BIX, call the BIX Customer Service Line for assistance at 800-227-2983, 8:30 a.m.-11 p.m. eastern time weekdays. In New Hampshire and outside the U.S., call (603) 924-7681.



*We'll Send You a BIX User's Manual and Subscriber Agreement As Soon As We've Processed Your Registration*

**BYTE INFORMATION EXCHANGE  
ONE PHOENIX MILL LANE  
PETERBOROUGH, NH 03458  
(603) 924-9281**

# BOXCALC™

## Not Another Spreadsheet! Not Another Word Processor!

No - BOXCALC is a new kind of calculation program that allows easy combination of figures with text. Instead of fighting pre-determined rows and columns, just type text and place calculation "boxes" anywhere on your screen at the press of a function key. This makes BOXCALC just what you need for creating cost estimates and budget reports. Even income tax forms. Any documents that use text mixed in with the figures.

- Create up to 800 calculation boxes for each BOXCALC file.
- Relocate boxes on screen under cursor control. Or move whole columns of boxes.
- BOXCALC is page oriented - files may contain up to 99 pages.
- Print any page or combination of pages (send printer control codes, too).
- Put simple or complex formula in any box to establish it's mathematical relationship to other boxes.
- Calculate boxes sequentially or in any order you specify.
- Get data from other BOXCALC files.
- Full replication features for fast, easy creation of box formulas.
- Supplied with no copy protection.

Along with 4 sample files and a comprehensive Instruction manual, BOXCALC is available for \$40.00. Or, to observe BOXCALC in action, a demonstration disk and manual can be purchased for \$5.00. To order BOXCALC or the demonstration kit, send your name, address, and check to: Cotton Software, Inc., 2510 Anderson Rd., Suite #364, Covington, Ky. 41017.

(VISA/MC # accepted for BOXCALC only - include expiration date)  
Requires PC, XT or AT, color monitor, PC DOS 2.0 or higher and 256K RAM.

BOXCALC is a trademark of Cotton Software, Inc. 1-606-727-1600.

## LETTERS

(continued from page 24)

anticontamination suit with face shield and rubber gloves. The CRT shield from this company costs more than \$160, which is even more frightening. Such devices are utterly worthless.

In my 12 years as a health physicist for the University of California at Irvine, I have yet to measure *any* ionizing radiation from *any* CRT, old or new, color or monochrome. Since we are exposed to somewhere around 100 millirems of ionizing radiation each year from the sun, the stars, naturally occurring radioactive materials in the ground, in our buildings, and in ourselves (much, much more if we live in Denver, fly in airplanes, or get a medical X-ray), and this normal background radiation is readily measurable with even the simplest Geiger counter, then the failure to detect any radiation from a CRT using much more sensitive detectors means that CRTs do not emit hazardous radiation. Period. Any claim to the contrary is misleading to the point of fraud. You would do your readers a service if you would warn them of this fraud and reject any advertising copy of this nature submitted to you.

WILLIAM G. NABOR  
Mission Viejo, CA

### MORE ON PAPER POSITIONING

I am writing in response to the letter of David Merriman ("Positioning Printer Paper," January, page 407). Like Mr. Merriman, my job involves considerable use of computers and peripherals. I am a field service engineer for Philips Data Systems with several years' experience.

Mr. Merriman's letter called on computer paper and printer manufacturers to implement a method for "reliably" advancing paper and forms to the first "printable" line (regardless of page length). This suggestion is a sound one and has its merits. Unfortunately, I believe his proposal is not as simple as he has stated.

Mr. Merriman's scheme is to have the paper and forms marked between feed holes at a specific distance from the top of the sheet. This black mark in turn is to be detected by a reflective optical sensor within the printer between two to three inches below the print head.

This location is fine if the paper is fed into the printer from the bottom. But what if the paper enters the printer from the top (as in the Epson, like a typewriter)? In a printer with such a paper-feed path, the sensor would almost have to be located near the platen (the main roller). But because of the platen's normally dark color, sensing a mark between the feed holes of the paper would cause a problem when a feed hole passed the sensor, ex-

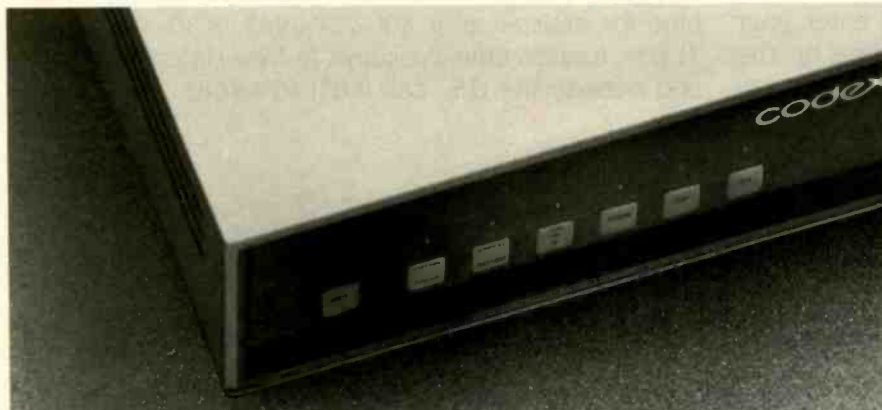

**\$445.**

A small price to pay for a full-duplex 2400 bps dial modem that lets you operate synchronously, or asynchronously with a unique auto dial feature, on virtually any computer.

Plus it's Hayes compatible. And available as a standalone unit or dual modem card, which lets you pack 32 modems into a single Codex nest.

The Codex 2233 dial modem. Find out about it. Call 1-800-426-1212. Ext. 230.

**codex**  
MOTOROLA

Motorola and M are trademarks of Motorola, Inc. Codex is a registered trademark of Codex Corporation.  
© 1986 Codex Corporation.

posing the dark surface of the platen.

Also, if the sensor was placed within the printer, it would probably have a fixed location. This would hinder the possibility of positioning the paper at various locations along the platen.

Such a system would almost certainly have to incorporate a "paper motion" sensor as well. If a "top of form" command was received, the printer would continue to search for the black mark even if the paper had for some reason stopped moving (paper having torn loose from the tractor-feed mechanism, for example).

These two problems could be solved by mounting these sensors on the tractor-feed mechanism itself. The only problems would be the cables going to the sensors and the wasting of a form by bringing the first sheet into the tractor. The problem of the cables is a small one, as they could be terminated near where the tractor mechanism mounts to the printer (if the tractor is removable) by miniature ball or pin contacts, similar in function to the contacts of a flash that mounts to the top of a 35mm SLR camera.

Another thing that the printer would require is a "select/deselect" switch to disable the "top of form" sensor. Due to the early lack of availability (or affordability) of the specially marked paper, people would need to continue using "normal" paper. And again, there would arise problems of the printer searching for a black mark that would never come.

I think Mr. Merriman is on the right track, but I can't see this method being adopted as an industry standard, at least not in the near future. It would be too expensive. But perhaps in some types of dedicated or specialized applications?

TODD R. MCMAHON  
Zurich, Switzerland

**ECONOMIC APPLICATIONS SOFTWARE**

John C. Nash's "Scientific Applications Software" (December 1985, page 145) was an interesting and useful survey. Surprisingly, there are often problems of communication and knowledge diffusion in the academic world, and survey articles of this form are of immense value to hard-worked academics. Nevertheless, I felt it most unfortunate that in the area on which I am knowledgeable the survey reported purely on North American products, although there are quite a number of useful software tools for economic modeling produced in other countries. I am sure this was not intended to be parochial and probably reflects exactly the problem mentioned at the start of this letter. However, your readers would certainly

benefit from learning about the Centre for Economic Computing, located at the London School of Economics and financed by the U.K. Economic and Social Research Council. This not only develops new software but also produces a regular bulletin reporting on and evaluating items of software (mainframe as well as micro) of relevance to economic analysis and modeling.

As a specific example close to my heart, might I also mention the package PC-Give, currently marketed by the Oxford Institute

of Economics and Statistics, which is an interactive, menu-driven modeling program with powerful diagnostic testing facilities. Further details are available in the February issue of the *Oxford Bulletin of Economics and Statistics*.

I hope your readers find this a helpful adjunct to Mr. Nash's survey.

DAVID F. HENDRY  
Professor of Economics  
Nuffield College  
Oxford, United Kingdom ■

**on the  PORTABLE PRINTER**



**JUST \$149.95**

**The Perfect Partner For Your Portable Computer**

**Drop this battery powered printer into your briefcase next to your portable computer and you have an office on the road. It's just 11¼"x4½"x1¼" and less than 2.5 pounds. The thermal print mechanism means quiet, reliable, 40 character/sec. printing for two hours on batteries.**

**On-The-Go has full-sized performance: normal sized, enlarged double width, and condensed characters - uses standard 8½" width thermal paper - 5x7 character matrix with true lowercase descenders - shadow printing - under-lining-Epson MX-80 graphics - industry standard parallel interface.**

**On-The-Go comes with batteries, 90 day limited warranty and paper.**

**ACCESSORY KIT**  
AC adapter, a 100' roll of paper, carrying case, and battery saver adapter. Regular 29.95, now 19.95.

**MEMORY EXPANSION**  
8K for Model 100, NEC 8201 - \$29  
24K for Tandy Model 200 - \$89  
96K for Tandy Model 600 - \$249

**NO RISK** complete satisfaction or 30-day refund.

**FREE** catalog of portable computer enhancements.

**DEALER INQUIRIES INVITED**

Please give visa or Mastercard number and expiration date. Add 4% for UPS shipping and insurance. California residents add 6% sales tax.

**TOLL FREE  
(800) LAP-TOPP**

**CALIFORNIA  
(805) 482-9699**



**Laptop Systems — 515 Calle San Pablo, Dept. W, Camarillo, CA 93010**

Conducted by Jerry Pournelle

## CBASIC

Dear Jerry,

I noted with interest a comment you made in a recent article praising Compiled CBASIC and suggesting that you are familiar with it. Though I use Compiled CBASIC on my Compaq extensively, so few people seem to have heard of the language. I find myself severely isolated in its use. I am facing a serious problem that springs from the language itself, and I am hoping that you will have some recommendation as to how I can solve it.

Though I have 640K bytes of RAM to play with, this language squeezes me down into just a little corner of that, 64K bytes for code and 64K bytes for data. Two

of my major programs would each fill up the 64K bytes of code and then some, if I let them go. Instead, I have been forced into the frustrating position of cutting out some features in order to be able to accommodate other features, just to stay within the arbitrary limits imposed by CBASIC. Data is not a problem.

A friend suggested installing a RAM disk and using the CHAIN facility as a kind of overlay mechanism. Going on my memory of what chaining was used for in the earlier interpreted CBASIC, I installed the RAM disk and began to use it for various data-related purposes, which, incidentally, helped on the coding just by simplifying some operations. Then I dove into the

manual to find out exactly how to chain programs.

How disappointing to discover that the chaining mechanism for the CB86 (version 2.1) is useless for what I want to do. There is no way to put all important data into a common block and then shift programs and subroutines in and out of working memory, which is what I had expected. Instead, the manual apologetically describes a system for beginning with one program, chaining to a second program, and then a third and a fourth, etc. It states that there is no way to go back to the earlier program except to start it over from the beginning. Thus, instead of using a common block, every piece of data must be saved on a file and read in again, if the system is to be used to make multiple use of the accessible 64K bytes of memory. The whole procedure is too cumbersome to contemplate.

Can you suggest any better way to evade the 64K-byte limit for coding?

PAUL PALMER  
Sebastopol, CA

*I share your disappointment. Compiled CBASIC was—indeed, still is—an excellent language for intermediate-skill programmers. The most useful programs I ever wrote were done in Compiled CBASIC. These include all my accounting software, the programs I use to pay contributors to my anthologies, a minimum database, several text filters, the program that indexes my log books, and Star Kill, a star battle game.*

*One neat thing about CBASIC was that by simply recompiling I was able to bring all my programs from CP/M-80 to CP/M-86 and then to PC-DOS; a completely painless process. Minnow Bear Computers (POB 2233, Station A, Champaign, IL 61820-8233) has a number of CBASIC tools I highly recommend.*

*Compiled CBASIC has multiline functions, truly local variables, declarations, and just about everything you need to write structured code. Then they added screen management and windows for the PC-DOS version. Everything looked wonderful, we looked forward to more im-*

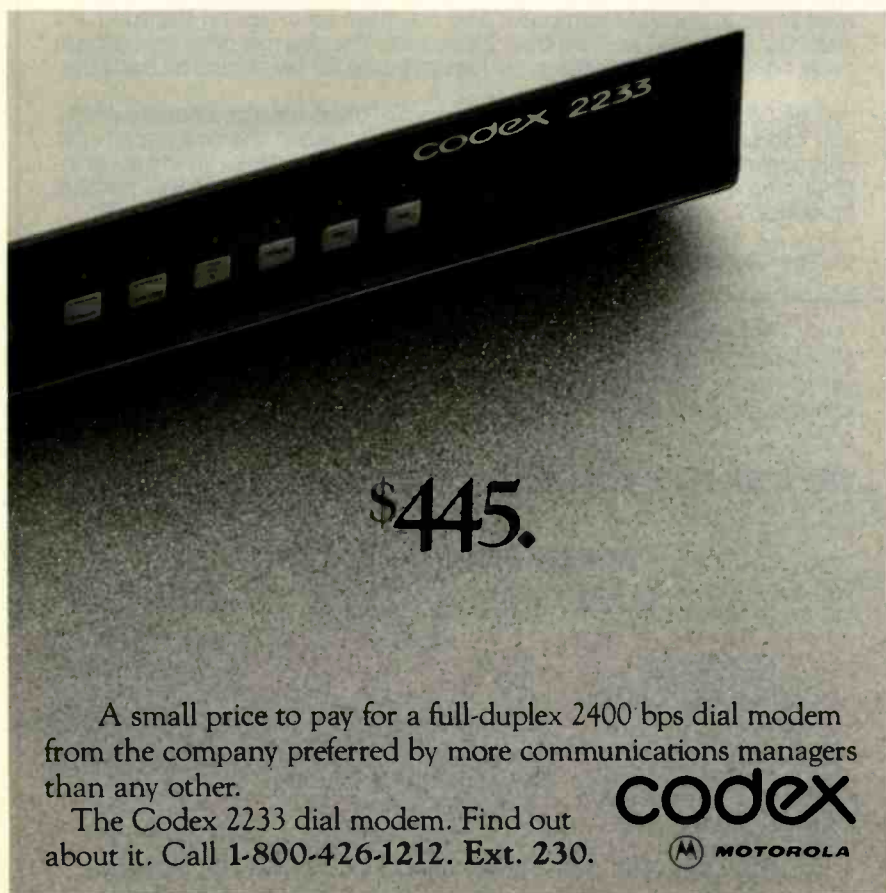

**\$445.**

A small price to pay for a full-duplex 2400 bps dial modem from the company preferred by more communications managers than any other.

The Codex 2233 dial modem. Find out about it. Call 1-800-426-1212. Ext. 230.

**codex**  
MOTOROLA

Motorola and @ are trademarks of Motorola, Inc. Codex is a registered trademark of Codex Corporation.  
© 1986 Codex Corporation.

provements, and—nothing. Digital Research hasn't done any improvements to CBASIC since Gordon Eubanks, the original author, left the company; and if they have any plans to add to the language, my inquiries haven't turned it up.

I'm afraid we have to live with what we've got, which is a real pity.—Jerry

**NEW COMMUNICATIONS**

Dear Jerry,

I have followed your column in BYTE for some time. I believe you may be interested in a new communications mode for personal computer owners. I have petitioned the Federal Communications Commission to create a new service and frequency band where personal computer owners can communicate by radio. This petition has been assigned Rule Making number RM-5241.

The Public Digital Radio Service could be the most exciting development in personal computer communications since the Carterfone decision. The FCC must be satisfied that PDRS is truly in the public interest, convenience, and necessity. They are looking for inputs from the public and the trade press.

If I can provide you with any additional information, please do not hesitate to contact me.

DONALD L. STONER  
6014 East Mercer Way  
Mercer Island, WA 98040

Great idea! There appears to be room in the spectrum. The amateurs aren't using all of the area they have; of course, they aren't likely to want to let go of anything, but I'd think a sizable number of hams would like to play with radio-linked computers. A "citizens band" for personal computer communications would be a wonderful thing to have, and it wouldn't cost the taxpayers a cent. I wish you well with this.—Jerry

**OVERSEAS COMMUNICATIONS**

Dear Jerry,

I just read, with great interest, your article on networking in Europe in the December 1985 BYTE (it takes a while for my BYTE to get here by boat). We have a network in Israel called Isranet. Run by the phone company, it allows us to connect to various computers here and abroad. Specifically, we have an account on ITT Dialcom in Silver Spring, Maryland, and connection capability to other major commercial networks in the U.S. I can reach any machine that has network access.

The problem is that I would like to reach machines that are off-net in the U.S., that is, that can be reached only by dial-telephone modem. The only way I have of doing that today is by an overseas direct phone call. This works but is very inconvenient because I don't have direct dial, phone lines are congested, and it's frightfully expensive.

I am searching for a cheaper alternative. Given that I can get to the U.S., is there any company offering a dial-out modem

service? That is, assuming reasonable cost. I would open an account on a machine and log on to it through the network. This machine would give me access to a dial modem and place the call to wherever I specify. Of course, I would pay the toll charges incurred. I would want to minimize these by dialing into the telephone network from a point as close as possible to the destination.

Do you have any thoughts along these (continued)

**Tools for the Programmer from Blaise Computing**

Save Up To \$130 On These Special Offers!

**TOOLS & TOOLS 2**

For C or Pascal

For a limited time, pick up both packages and save \$50 off our regular list price. The C version comes with libraries for the Lattice, Computer Innovations and Microsoft (version 2.03 and

3.00) compilers. The Pascal version supports IBM and Microsoft Pascal. **\$175.**

**VIEW MANAGER With Source**

All libraries are included. Please specify C or Pascal. Regular \$425. Save \$130. **\$295**

Blaise Computing provides a broad range of fine programming tools for Pascal and C programmers, with libraries designed and engineered for the serious software developer. You get clearly written code that's fully commented so that it can serve both as a model and also be easily modified to grow with your changing needs. Our packages are shipped to you complete with comprehensive manuals, sample programs and source code. None of the programs are copy-protected.

**FOR C AND PASCAL PROGRAMMERS:**

**TOOLS** ♦ **\$125**

Extensive string and screen-handling, graphics interface and easy creation of program interfaces. Includes all source code

**TOOLS 2** ♦ **\$100**

Memory management, general program control and DOS file support, interrupt service routine support. Includes all source code

**VIEW MANAGER** ♦ **\$275**

General screen management. Create data entry screens that can be easily manipulated from your application program. Block mode data entry and retrieval with fast screen access

**VIEW LIBRARY Source** ♦ **\$150**

Source code to the VIEW MANAGER library functions.

**ASYNCH MANAGER** ♦ **\$175**

Powerful asynchronous communications library providing interrupt driven support for the COM ports. All source code included.

**FOR THE TURBO PASCAL PROGRAMMER:**

**Turbo POWER TOOLS** ♦ **\$99.95**

Extensive string support, extended screen and window management, interrupt service routines, program control and memory management, interrupt filters. All source code included.

**Turbo ASYNCH** ♦ **\$99.95**

Interrupt driven asynchronous communication support callable from Turbo Pascal. ASYNCH's writer, in assembler and Turbo Pascal with all source code included.

**PACKAGES FOR ALL PROGRAMMERS:**

**EXEC** ♦ **\$95**

Program chaining executive. Chain one program from another even if the programs are in different languages. Common data area can be specified. Source code included if you're a registered TOOLS and C TOOLS 2 user.

**SPARKY** ♦ **\$75**

Run-time resident (or stand-alone) scientific fully-programmable, reverse polish notation calculator. No limit on stack size, variables or tape. Includes all standard scientific functions and different base arithmetic

**TO ORDER, call Blaise Computing Inc. at (415) 540-5441**

♦ 2034 Blake Street ♦ Berkeley, CA 94704 ♦ (415) 540-5441



lines? I realize that it may not be economical for stateside users (depending on network charges versus direct dial charges), but it would be a boon to those of us overseas.

SAMUEL GAMORAN  
Weizmann Institute of Science  
Rehovot 76100, Israel

*I don't myself have any suggestions; perhaps a reader can help? Stay well.*  
—Jerry

### COMPOSING

Dear Jerry,

Apropos of your comments on musicians and music-writing programs in the December 1985 BYTE ("Music and Go," page 366), I have no respect for people who call themselves musicians but lack basic literacy in music notation.

However, there is indeed a place for music-writing programs that make a composer's life easier. One program I'd very much like to have, but can't justify the expense (\$470 for the program plus another \$2000 or so for a Fat Mac), is Professional Composer from Mark of the Unicorn.

For me, rough drafts are no problem, but

making fair copies is sheer drudgery. A program like Professional Composer would enable me to create the fair copy with far less effort. I wouldn't have to rewrite the score from the rough draft, and the cut-and-paste feature would allow easy entry of repeated sections.

Better still, this program even generates instrumental parts from a full orchestral score. This is an especially attractive feature since it costs a fortune to have a copyist write out the instrumental parts, which always contain errors. The computer-generated parts, on the other hand, are essentially cost-free and error-free. The only missing ingredient is thicker paper for laser printers, since regular bond paper is unmanageable on a music stand.

DAVID LEWISTON  
Kihei, HI

*Of course, I agree that one ought to know the basic tools of one's trade; I hope I didn't give you the impression that Professor Challs can't write music! The problem, it seems, is the sheer expense for copyists and suchlike to produce sufficient scores to let them perform the opera he and Bloch were contemplating.*

*In actual fact, Professional Musician plus a Fat Mac plus an Imagewriter are all together much cheaper than would be the copying costs for a single major work; or so I'm told.*

*I'm no great fan of the Macintosh as a general-purpose machine, but it has its points of excellence; and, of course, the Mac Plus is a considerably different machine from the original 128K-byte Mac.*

*I'm glad to see software/hardware combinations like this; as I said in December, I expect small computers to have the same wonderful effect on the other arts that they've already had on writing. We'll all benefit from that.*

Stay well.—Jerry

### SANYO INFORMATION

Dear Jerry,

Our college just received a Sanyo MBC-550 series computer as a donation. We are interested in using this machine with our student-search program and our college accounting system, which is already running on a Victor 9000 and an IBM PC. To this end, we are trying to find technical information on the Sanyo computer that would instruct us in exchanging the disk drives for double-sided double-density drives and adding a hard disk. We are also interested in information concerning the usability of R:base 5000 and the Solomon III accounting package on the Sanyo. Do you have or know where we can get any of this information? We are also looking for a Sanyo users group in the Southern California area. Your help in answering any of these questions is appreciated.

EDWARD M. SHELTON  
Assistant to the President  
Deep Springs College  
Deep Springs, CA  
via Dyer, NV 89010

*I've sent a copy to the Sanyo User Group, but perhaps someone local to you—if there is any place local to Deep Springs—can help also.*

*Sanyo users tell me it's a great machine, but there are real problems getting support from the company, and, of course, there aren't so many of them as there are other systems.—Jerry*

### TRANSFERRING FILES REDUX

Dear Jerry,

You may have issued a partly unnecessary mea culpa in responding in last September's Chaos Manor Mail ("Transferring Files," page 382) to the reader who criticized some advice you had once given a correspondent having trouble transferring files from his NEC PC-8201A lap com-



**\$445.**

A small price to pay for a full-duplex 2400 bps dial modem that gives you better performance, better features, and better support than anything else available.

The Codex 2233 dial modem. Find out about it. Call 1-800-426-1212. Ext. 230.

**codex**  
M MOTOROLA

Motorola and  are trademarks of Motorola, Inc. Codex is a registered trademark of Codex Corporation.  
© 1986 Codex Corporation.



puter. Mr. Cooper suggested that the SAVE command had been misused and that your advice to fall back on the slower Telcom built-in program was wrongly based.

I doubt this is the case, even though when using Telcom at 300 bps I had similar problems, especially the loss of characters. This now seems to have been due to using the Tab key during text entry, since simply indenting by means of the space bar solves the problem! Much worse has been the problem of getting either linefeeds/carriage returns or the end-of-file recognized by the target system, a CP/M desk machine. How on earth have you handled this, or does your equipment not present you with these difficulties? After ASCII text, an end-of-file marker is supposed to be inserted by the CP/M PIP utility, which I decided to use in lieu of a telecommunications program after reading your original response (and I'm glad I followed your example)—but in my case this evidently doesn't happen.

The current local solution to the linefeed problem comes from an NEC Home Electronics technical-support representative (and I thank her for it). Before performing the Telcom upload, you go into BASIC and poke -3067,255. Obviously, you have to have remembered to insert hard carriage returns/linefeeds after, say, every two 40-column lines during the text entry. As for the end-of-file recognition, without which everything hangs at the end of the upload, you hit Control-Z at the right instant on the PC-8201A's keyboard. By the way, embedding the marker in the text by the use of the graphics key does not work. Afterward, of course, you ought to go back into BASIC and poke -3067,0 to reverse the original adjustment.

ALAN K. BROWN  
Columbus, OH

*In the past year, we have come ever more to rely on the NEC PC-8201A machine. The little built-in editor is one of the nicest text-creation editors I know on any computer, and, between Purple Computing and Traveling Software, there's plenty of aftermarket support. The cost of filling it with memory—an absolute must—keeps dropping. Incidentally, the Tandy Model 100 is made by the same company that makes the NEC, and it shares most of the NEC's virtues.*

*I only transfer text files to and from the NEC. When the NEC is finished sending the file across, I do the Control-Z by hand from the NEC keyboard before exiting the NEC's Telcom Term program. That closes the CP/M file created by PIP. Since*

*we use WRITE on our CP/M machines, we not only don't have to put hard carriage returns in the text, we don't want them. WRITE uses much the same format as the NEC, and we never have any trouble. By the way, PIP knows how to expand tabs and can do that as part of the file transfer from the NEC.*

*The only way I know of to get into trouble is to send files at a fast rate to a CP/M machine using slow floppy disks. That will lose some text, especially at a 16K-byte*

*boundary. I've never lost any text sending it to a RAM disk; and, of course, it's possible to write handshaking protocols into the CP/M BIOS.*

*Meanwhile, we now use Percy and Priscilla (my own and Mrs. Pournelle's PC-8201s) on all trips, while driving, and to record notes while sitting on the patio or at the breakfast table. I don't know how I got along without mine, and I don't want to imagine trying to do it again.*

—Jerry ■

## New from Touchstone Technology

# The SoftSwitch™



## Auto-Manual Parallel Printer Switch

Now you can switch the parallel output of any personal computer to your choice of any two parallel printers, quickly and easily, manually or automatically.

### Practical

Eliminates cable switching and reduces paper loading and waste. Automatic switching saves more time and reduces the chances of accidentally running the wrong printer. Permits unattended and remote selection. Even in the manual mode, the SoftSwitch offers easy, convenient one-handed operation. Compact case measures just 5x5x1-1/2 inches.

### Adaptable

The SoftSwitch allows you to select printers by any of four different methods:

1. Printer codes which can be quickly and easily embedded in files of most popular word processors, spreadsheets and databases.
2. Embedded codes immediately following print commands in your own custom software.
3. Manually from the panel-mounted toggle switch.
4. From the keyboard, with our optional RAM-resident software (\$9.95).

### Universal

The unique circuitry (U.S. Patents Pending) switches ALL active lines

and passes ALL required acknowledgements and status signals, so it is compatible with all personal computers and parallel printers.

### Reliable

Solidstate switches have no mechanical contacts to fail or maintain. LED indicators always show which printer is selected. The SoftSwitch is backed by a full one-year warranty and the Touchstone unconditional 15-day performance guarantee.

### Economical - Only \$139.95

Complete with power supply and full instructions, the SoftSwitch is alone in its class. If you wish, you can supply your own cables (You'll need 2x18 connectors to the SoftSwitch). Or, we can supply 5-foot ribbon cables with Centronics-type connectors for just \$17.00 each (add 80 cents per foot for longer cables).

**Call Toll Free**  
**1-800-828-6968**

In New York: 1-800-462-4891  
International calls: 1-716-235-8358



**TOUCHSTONE**  
TECHNOLOGY INC.  
955 Buffalo Road  
Rochester, NY 14624

# Now there's an IBM personal printer that can play whatever you compose.



It doesn't matter if you're writing contracts or concertos; whether you print labels, librettos or on letterheads—IBM has a personal computer printer that is perfect for your needs.

If you're looking for speed, all-points-addressable graphics

and versatile paper handling, there's the dot-matrix IBM Proprinter. For drafts it does up to 200 characters per second (cps)

—about three pages a minute—and at 40 cps it does near letter quality. Surprisingly, the price is under \$550.

If letters are important for your business, we've got two extraordinary letter-quality machines. The IBM Quietwriter® Printer gives you high-quality printing, whisper-quiet operation and high-resolution graphics. For very sharp letter quality, easy paper handling and carbon copies, there's the IBM Wheelprinter.



Dear Gilbert:  
We'd be proud to help sponsor the Orchestra's Fall Season.

Letter-quality printing

## Ticket Sales

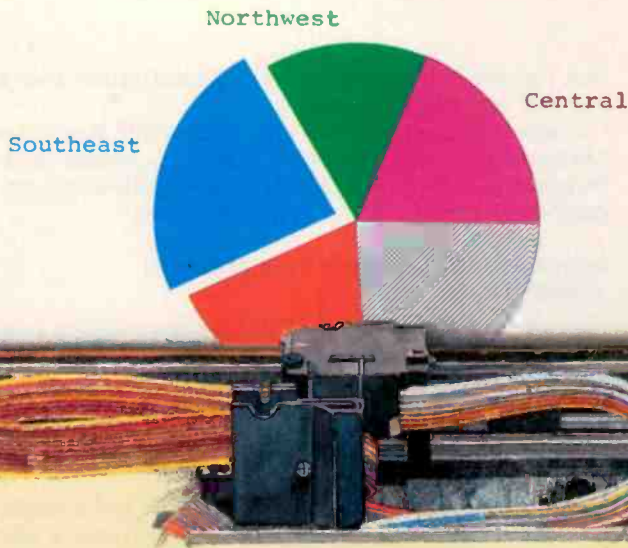

Text and color graphics

When your compositions call for color you can call upon the brilliance of the Color Jetprinter from IBM. It combines splendid color, near-letter-quality text and the capacity to work—in color—with a wide range of the latest software. And it's also all

points addressable for virtually any kind of graphics.

Lastly, if you really do need to put notes on paper—or print floor plans or other complex diagrams—IBM offers a choice of high-resolution color plotters.

All of our personal printers attach to IBM PCs, and many attach to other leading personal computers as well. They're all designed to serve a single purpose: To give everything you do the finishing touch.

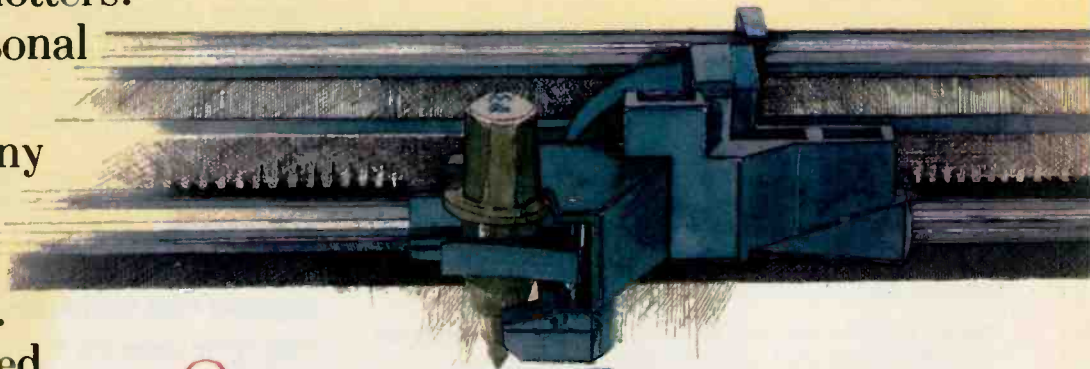

Plotter graphics

For the authorized IBM dealer or the IBM Product Center nearest you—or for free literature—call 1 800 IBM-2468, Ext. 104/LR. Or contact your IBM marketing representative.



IBM Personal Printers...The Finishing Touch

THE BEST OF BIX is a selection of the most interesting messages from BIX, the BYTE Information Exchange conferencing system. The conferences covered for this month include those for the Commodore Amiga, Atari 520ST and 1040ST, the IBM PC family and compatibles, and the Macintosh computers. These pages represent only a small fraction of the material discussed in these conferences.

For information on joining BIX, see the instructions on page 388.

## AMIGA

The highlights of the Amiga conference this month feature notes on ways to save connect time, new sources of software for the Amiga, and ways to speed up your disk-access time. Discussions include new types of digitizers for the Amiga, and the workings of an "inbetweener" program are explained by its author.

The Bugs and Fixes section covers implementing a new CLI for your serial port, fixes for graphics "include" files, and ways to avoid trouble when using Amiga ROM routines.

### SAVE CONNECT TIME

amiga/tutorial #339, from coz [Bob Cosby, RJH Systems]

Is there such a thing as continuous mode on BIX? It sure would be nice to download these goodies in one big dump for later perusal.

amiga/tutorial #340, from ksalmon [Ken Salmon]  
a comment to 339

"OPT TERM PAGE n" will change the "more.." prompt to every "n" lines of output. "OPT TERM PAGE 0" turns it off entirely.

amiga/tutorial #343, from jdow [Joanne Dow]  
a comment to 340

```
opt term page 9999 q - > Effectively turns paging off
all                - > Dumps everything unread in the topic.
                   Capture and read off line at your leisure.
```

```
j conference/topic com nnnn - > Both allow comment to a specific
hea nnnn com                message.
```

You can download everything, then build a file to upload as pure text to any BIX prompt which will automatically comment for you.

```
j conference/topic com nnn (or say)
(text goes here)
. (single period to stop comment)
a (to add message)
j new__conference/topic com mmm (etc. ad implausibilitum)
```

### MODULA-2 FOR THE AMIGA

amiga/main #1657, from wwebster [Bruce Webster, Consulting Editor, BYTE]

Modula-2 for the Amiga  
TDI Software Inc., 10410 Markison Rd., Dallas, TX 75238, (214)  
340-4942: I believe they're selling it for \$70.

### DIGITIZERS

amiga/main #1891, from cheath [Charlie Heath, MicroSmiths]

HAM Digitizer!

I just saw some stuff done on a cheap (about \$200) digitizer that allows you to capture HAM (Amiga hold-and-modify mode) pictures that look almost like television-quality video! The digitizer is actually a gray-scale digitizer used on the Mac, etc., and it is slow (about 30 seconds per

pass, I am told, as compared with the LIVE! frame grabber, which is "real time" at about 20 frames/sec).

In order to capture HAM pictures you must use RGB filters and capture three images. But the results are unbe(. . . . .)lievable! Name of the product is Digi-View. Next question: Who's got a HAM Paint program? What! Nobody! That's not likely to last for long.

amiga/main #1901, from sbennett [Steven Bennett]  
a comment to 1891

I saw the same pictures. Beautiful. I also managed to cajole a contact name out of the Commodore rep who showed the stuff to us: T. Jennings. This sounds familiar to me for some reason.

amiga/main #1892, from cheath

Audio Digitizer!

From a company called Applied Visions in Medford, Massachusetts, presented at tonight's BCS (Boston Computer Society) meeting was a prototype for an audio digitizer. It will cost \$175, be available around June. They had some neat sample sounds, including David Letterman's breaking glass. The digitizer has variable sampling rates up to 28K bytes per second.

Very good quality speech can be digitized at about 15K, decent at about 10K. They will support the IFF sound formats, and they are supplying run-time routines for developers to use.

*Editor's note: The FutureSound digital sound recorder is manufactured by Applied Visions, 15 Oak Ridge Rd., Medford, MA 02155, (617) 488-3602. With this interface your Amiga can digitally record and play back sound at variable rates. The FutureSound uses Amiga's parallel port and comes with a microphone, connecting cables, and software.*

*The "frame grabber," LIVE!, and the GenLock video interface are manufactured by Commodore-Amiga. The Digi-View digitizer is manufactured by NewTek, 701 Jackson St., Suite 3B, Topeka, KS 66603, (913) 354-9332.*

*Sample LIVE! frame-grabber image files and the Digi-View images library file DGVIEW.LQR can be downloaded from the Amiga section of BYTEnet Listings, (617) 861-9764.*

### AEGIS IMAGES ANIMATOR II

amiga/main #1920, from jim\_\_kent [Jim Kent, Aegis Images]

I love my little tweener. It is much more impressive to use than just to watch, allows lots of layering and sensible "upstream editing"—a term discussed in the manual. That is when changing present of object with future; this is reflected downstream in time in a way you would hope and expect.

It got a bit Heideggerian at times. I love it. I hope you love it too. It was very, very difficult to write and very, very fun. Mucho apologies in advance if it should crash and lose your artwork. It is pretty robust. Only way I can crash it reliably is to stretch polygons 10x size of screen. Then they pop.

I will try to fix, but it is somewhere in ML vector clipping (just wrap around), and I am no great 68000 coder. I did lots of 6809 on CoCo once, but there are always more bugs in a program of this complexity and size. I only try to make them fewer and harder to find.

PS.: Bill Volk, the Aegis artist, and I are going to support this like you wouldn't believe. We've noted the success of the Apple II and IBM PC (as well as being naturally inclined to the open spread of information).

I hope last-minute enhancements didn't break something somewhere; sorry. My sentences do tend to run on, don't they? Well, anyway, if you should care to get the inside on how it was done (no disk access in two minutes of animation if it's fairly simple) as well as the format of ASCII script files, we will be actively supporting this as well as answering questions from a user end. I hope we are getting a good press.

Anyway, we are committed to an open software architecture on this

one. I hope it makes Saturday morning a pleasure again. Hope I don't sound too egotistical. I'm just very, very excited. I've been working 60- to 70-hour weeks for two years on this one.

**amiga/main #1922**, from jsan [Jez San, Argonaut Software]  
a comment to 1920

Jim: How good is your "inbetweener" routine? Can it only interpolate in binary steps, or can it have an arbitrary number of frames between each successive image?

How fast is it? And how fast are your polygon scan conversion routines? Are you using the ones built in the Amiga OS or your own? Also, is your clip routine your own?

**amiga/main #1927**, from jim\_kent

About Ani

The inbetweening is arbitrary steps. Furthermore, it isn't restricted to tweening along a straight line, but it also does rotations (two-dimensional fast, three-dimensional not so fast), scaling, and "paths." It also does "color tweening," which turns out to be one of the most beautiful uses. Turns Amiga into a regular light-organ. Color cycle too.

Along with the motion types described above, it allows various "select modes": You can move a point, multiple points, segments (part of edge of polygon—most useful for animating hands), polygons, multiple polygons, and everything all at once.

**amiga/main #1929**, from jim\_kent

More About Ani

In addition to polygons (filled outline or just vectors), it deals with three types of raster objects (in IFF), backgrounds (full-screen pictures), "wins" (full-color rectangles with transparent color zero), and "masks" (single-color images which you can color individually).

**amiga/main #1933**, from jim\_kent

Speed: Ani goes much faster than I do and makes less typos. Seriously, it has an asynchronous variable frame rate. It always draws as fast as it can. Slave process to clock. Basic form:

```

^T
                                for (;;)
                                {
                                    if (user wants out)
                                        break;
                                    makeframe( script, realtime() );
                                    do_sound if you got it (I don't)
                                }

```

So the frame rate varies. If too complicated, it gets jerky but not out of sync with music.

Actual frame rate is

30 Hz—max, my clock goes this fast; one half-screen polygon or three or four little ones, or two or three medium "cels," or five medium-sized masks.

10 Hz—my favorite speed. Nice balance between complicated scene and fair degree of smoothness.

5 Hz—covering screen twice with polygons.

My clipping is very fast except for when it gets too big, it pops (bug around 32000 wide). You're too kind, by the way, and I'll see if I can reciprocate.

You need vector clipping on Amiga if your filled shapes get bigger than your TmpRas will hold, from what I have played around with. Correct, Dale?

Times very approximate. Mail me your address and I'll send you a no-save version with all the artwork I can scrape together. Also give me your number so I can call you on company time to talk "business." I'm

sorry, I wrote much more before but computer ate it. No undo. Ani has undo! We will have a major announcement in "products.hmm" for everyone in a few days.

**amiga/main #1935**, from duck [Dale Luck, Commodore-Amiga]  
a comment to 1933

The TmpRas must be big enough for the entire unclipped polygon.

**amiga/main #1934**, from jim\_kent  
a comment to 1922

I use Amiga's routines. In fact, it was seeing these in action in 1984 (and seeing Scott of Broderbund's Fantavision in early, early stages) that persuaded me to abandon Bobs for polygons. My rasters go as fast as Bobs, and in C, too, mostly. In fact, fastest software routine I have for scan conversion is essentially the Amiga hardware in software.

Basically, Ani is an excellent 2 1/4-dimensional object-based draw package that has time element attached. It is a real good swipe at solving the parallel/serial dichotomy that haunts computer animators.

Biggest drawback of way I do it is it ends up being very, very hard; I can't implement it with my current insights—to overlay one script on top of another. On the other hand, I can freely add new objects at any "time" in script and can layer motions within a single animation.

You will understand why when you see my ASCII file format, which will be available from Aegis. I sent Bill V. first swipe at documentation this afternoon. It sure as hell cuts most of the scut work out of animation, and for some things it is sufficient in and of itself. On the other hand, all polygon scripts tend to have a "paper-cutout" look.

I can add rasters but can't turn them in real time. Though actually I have a routine which rotates rasters faster than anything else I've come across (people from Bell Labs saw it once and were blown away). Amazingly, Electronic Arts has one nearly (like 80% or so) as fast. Great software companies develop parallel things, I guess.

Amazing, 'cause technically they are quite difficult and hard to get even on mega-megabuck computers, and suddenly both paint systems on Amiga show up with it. Anyway, rasters just move in paths and lines. I think paths are known as p-curves or something by academic types. You will see.

Anyone else who wants a no-save version, please contact Aegis, or just take the leap. They should be most agreeable.

## SPEED UP YOUR DISK-ACCESS TIMES

**amiga/main #1993**, from jim\_kent

Amiga Slow Directories

Amiga, somewhere between v27 or so and v1.0, started doing really good caching within its track buffer. Directory entries are in a linked list all over the floppy, it seems like. Seems like it would be possible, without changing format at all, and while still reading old scattered directory disks, to make DOS so it had a "semi-reserved" track into which it tried to put directory listings. It sure would be cool if this was done and suddenly it scanned directories as fast as TOS, MS-DOS, etc., machines.

**amiga/main #2046**, from tking [Tim King, Metacomco]  
a comment to 1993

I changed the allocation strategy so that file headers and directory blocks are placed close to each other and all data blocks go together. See the February BYTE U.K. article "Tripos—The Roots of AmigaDOS" for details. This speeded it up a lot when doing DIR but slowed down opening a file. But of course it only works with new disks. If you have a disk created under early versions, then it will still be slow.

(continued)

amiga/main #2070, from jim\_\_kent  
a comment to 1993

Oh. I've done that already. Thank you. It may be bad for compilers, but my application doesn't open that many files. No one who can avoid it compiles anywhere except in RAM disk anyway.

amiga/main #2129, from sassenrath [Carl Sassenrath, Commodore-Amiga]  
a comment to 1993

I often find it advantageous to "reorganize" the file layout of my most active disks. This usually results in a *many-times* improvement in directory access times.

It can be accomplished with the CLI "copy" command by formatting a fresh disk and copying DF0: to DF1:

This operation will "repack" files and directories to take better advantage of the disk's track buffering. I recommend it highly.

## BUGS AND FIXES

amiga/main #1947, from langeveld [Willem Langeveld]

NEWCLI SER:

I have read two articles in *Compute!* about AmigaDOS (January and February 1986 issues). In the first is a description of NEWCLI that mentions a possibly very useful feature, namely, that you can open a new CLI to your serial port by typing NEWCLI SER:

I have tried this with my TV 925 dumb terminal and a null modem (as described in amiga/softw.devlpmt msg #251 by cheath, except symmetric). Much to my surprise, it really seemed to work! The usual words appeared on my terminal screen, followed by the 2> prompt.

However, much to my disappointment, when I tried to type commands on my terminal, there was no response. Has anyone tried this and got it to work? Maybe you have to "click" in the second window? How do you do this if the new window is outside the Amiga?

I tried whether it was the null modem, but with my terminal program (Online!) it works perfectly sending and receiving.

If someone could get this to work, it would be a very useful thing. I would guess, better than just using your SER: for WACK. One problem still may be the <LF> that is being sent as line terminator. I'd much rather have a <CR> since I can set my terminal to generate the <LF>.

By the way, the articles in *Compute!* have taught me a few things I hadn't figured out by myself yet, so they are worth reading if you don't have a DOS manual.

PS: I should add that the article does say that the NEWCLI SER: command is undocumented, but I don't know what that means since as far as I am concerned everything is undocumented . . . no? OK, OK, I'll be patient.

amiga/main #1950, from jim\_\_kent  
a comment to 1947

I'm sending my diagnostic/error output to serial (via KPrintF) in Ani if running under Workbench. I guess I could have just tossed it in the bit bucket. Hope this doesn't mess you up. Anyway, expect it, or better yet, don't run it from Workbench.

amiga/main #1953, from jmeissen [John Meissen, Lattice Software]  
a comment to 1947

There are several possibilities. One is that only output is being routed that way. More likely, the serial port is usually buffered with a 512-byte input buffer. Try SER:RAW instead.

amiga/main #1965, from jazz [Frank Horton]  
a comment to 1947

NEWCLI SER:

I think I have found the reason why your keyboard entries don't register. If you "COPY SER: Filename" and then type enough characters to cause a disk write or two and then reboot and examine the file, you will see that the high-order bit of each byte has been set. The CLI, of course, rejects these characters.

I don't know where these bits are coming from, however, since I know for a fact that my terminal is generating a 10-bit code for each struck key: 1 start bit, a zero parity bit, 7 data bits, and a stop bit. I wonder now what kind of data the CLI is expecting.

Hope this is of some help to you.

amiga/main #1966, from sdb [Scott Ballantyne]  
a comment to 1947

Yeah, it works. You have to pump something innocuous to the Amiga after hitting Return on your remote.

"remote: DIR <lf> <250 spaces or so>" should cause a DIR listing on the remote. Also remember to do ENDCLI SER: on the remote and not ENDCLI only.

## GRAPHICS INCLUDE FILES

amiga/softw.devlpmt #718, from duck

This is a note to assembly-language programmers. If there is a difference in capitalization between equivalent "h(c)" and "i(asm)" files, then use the spelling in the .h file.

Correct the spelling in the .i files by editing the .i file. As new releases of the "include" files come out, fixes to inconsistent naming between .h and .i files will be done in this manner. This is only for the include files in the graphics directory, though. I do not want to discuss the inconsistencies in naming in the other directories.

## ROM CODE BUGS

amiga/softw.devlpmt #742, from jmeissen

Bugs in Amiga ROM Code

I have determined that Amiga ROM routines do in fact often trash registers D6 and D7. The C compiler allocates register variables from that end first, so this tends to cause bizarre problems. So, a word of caution: Do *not* use register variables in any routine that will call Amiga ROM code (Intuition, Graphics, Exec, etc.) until Amiga fixes this problem.

amiga/softw.devlpmt #743, from wmiller [William Miller, Stratus Computer]

a comment to 742

Wait a minute—are you saying that Lattice expects register contents to be saved across procedure calls? Is that part of the contract for the calling sequence on the Amiga, that called code has to save and restore any registers it modifies?

Generally speaking, that is a bad approach since only the caller knows if a register contains useful data that should be saved or if it is garbage that can be ignored. Register saves should be done on the calling side; otherwise, a lot of unnecessary saves and restores must be done.

amiga/softw.devlpmt #744, from cheath  
a comment to 743

The ROM Kernel Manual explicitly states that library routines can modify *only* D0, D1, A0, and A1. Generally, I prefer the modifier to save registers; it makes for much more compact code. But if a routine doesn't obey the rule, yipes.

Do you have any idea which routines are trashing? I've had trouble with Text, but I've got a lot of register variables and a lot of library calls, and I'm not planning to throw away the register variables in a product and watch the code size grow by 30%. If I know which routines are offensive, it's easy enough to write a new binding routine that saves the registers. Hurry, please.

amiga/softw.devlpmt #750, from jsan  
a comment to 744

Charlie, I disagree, from a game writer's point of view (of which you and I are part). I think that routines should *never* save their registers, because it is unnecessary and *time-consuming*.

For optimum code, it's best for the caller to save only the registers required, rather than the subroutine to save all the registers.

Okay, it makes for messier-looking code! But *much* faster code, and so is worth doing! (Especially for arcade games!)

amiga/softw.devlpmt #752, from jmeissen  
a comment to 750

Come on! Wake up and see the light! The issue is six of one and half a dozen of the other. It is no less efficient for a called routine to save whatever registers it is going to use than for the caller to try to anticipate what registers the called routine is going to trash!

Suppose the caller had values in all the registers, and the called used none; you want the caller to waste all that overhead pushing all the registers for every call? The point is that there is a defined interface with established rules. As long as everybody plays by the same rules everything works.

As for which routines, so far I have determined "Text()" trashes D6, and I have had reports of "DoIO()" trashing D6 and D7, and I have been told that unspecified Intuition functions also have this effect. I suspect that this is a carryover from a previous interface. I have seen code for an interface to Idris C that passed parameters in these registers.

amiga/softw.devlpmt #754, from cheath  
a comment to 750

It depends a lot on the specifics, and of course when you are tuning a routine to save two or three instructions you will probably analyze each register in all combinations of use. If the caller knows what the callee will modify and saves only the register that the callee will zap, that is optimum. But if the caller has no knowledge of the called routines' register usage, it is more efficient for the called routines to save only the registers they will modify.

Also, for compact code it is more efficient for the called routine to save the registers once than for the caller to save the registers each time the function is invoked.

amiga/softw.devlpmt #759, from jsan

I agree, the caller and the callee must have been designed so that all unnecessary registers are not saved. What I do is document in my source code which registers are used at the top of each subroutine. And then I use that list at the caller's JSR (or BSR) to give me optimum code, by not saving unnecessary registers.

I used to be a "clean" programmer, e.g., saved all used registers in the subroutine. But I found this tended to slow down my programs by as much as 50%! Just imagine, a "MOVEM.L D0-D7, -(SP)" is saving 16 words on the stack! The bandwidth to do that takes about 5 cycles per word (including the decrement of Stack Pointer) and then you have to do the reverse and pull them off again! Ouch!

Only last week, I went through my 250K source code and removed every save register instruction and then put back *only* the very few that

(continued)

### COMPETITIVE EDGE

631 S. MAIN ST. • PLYMOUTH, MI 48170 • (313) 451-0665

#### FEATURING S-100 COMPONENTS FROM:

<b>COMPUPRO®</b>	RAM 22® \$446	CPU 286® \$671
	DISK 1A® \$446	MDRIVE-H® \$371
<b>EARTH</b>	TURBOMASTER 256K W/HDC \$895	
	TURBOSLAVE-1 8MHZ 128K \$395	
<b>LOMAS</b>	THUNDER 186 \$895	256K STATIC \$412
	COLOR MAGIC \$476	NVDISK 512K \$371
<b>TELETEK</b>	SYSTEMASTER®II 8MHZ 128K \$795	
	SBC-1 6MHZ 128K \$350	HDC \$375

**ALSO FEATURING OUR AT COMPATIBLE:**

### VELOCITY 286



10 MHZ OPERATION  
1024 K ON  
MOTHERBOARD • 20MB  
FAST HARD DISK HI RES.  
MONOCARD STANDARD •  
1.2MB FLOPPY DRIVE  
WITH DOS 3.1 **\$3095**

**MONITOR EXTRA OPTIONS:**  
UP TO 16 MEGABYTES OF MEMORY •  
ENHANCED GRAPHIC ADAPTERS •  
HARD DISK SUPPORT TO 240MB SCO  
XENIX® SYSTEM FIVE • AUTOCAD  
READY SYSTEMS • 3278-79  
TERMINAL EMULATION

**ALSO**

**CE 20MB XT W/512K**

**\$1095**

*Includes floppy, hard disk, 512K memory, monocard w/parallel monitor.*

CompuPro, Ram 22, Mdrive-H are either trademarks or registered trademarks of Masyn Corporation. Systemaster is a registered trademark of Teletek Enterprises. PC AT is a trademark of International Business Machines. Xenix is a registered trademark of Microsoft. unPATH is a trademark of Pathway Design, Inc. SCO is a trademark of THE SANTA CRUZ OPERATION. Autocad is a trademark of Autodesk, Inc.

**Special Purchase**

**LAP COMPUTER**

**FULL FACTORY WARRANTY**

**BUILT IN 300 Baud MODEM**

Built in spread sheet, similar to Lotus

Terminal Emulator to Communicate with Personal or Mainframe Computers

**IT'S A HANDS FREE PHONE**

Comes with Rechargeable Batteries and Charger

Options Available Serial or Parallel Port Workstate Printer

**workState**

BY CONVERGEN TECHNOLOGIES

**THE MOST PORTABLE TERMINAL**

**OUR BEST PRICE EVER \$295.00** ORIGINALLY \$1195.00

**INCLUDES FREE SOFTWARE WORTH \$88.00**  
Information and Consultant Services Software.

OTHER SOFTWARE PACKAGES • WITH PURCHASE ONLY	
Cost Management	\$15.00
Financial Analysis	\$15.00
Inventory Analysis	\$15.00
Marketing Management	\$15.00
Sales Invoice	\$15.00
Time	\$15.00
Human Resources	\$15.00
Real Estate	\$20.00
Instructional	\$20.00
Medical Services	\$15.00
User Analysis	\$15.00
Vertical Analysis	\$15.00

This state of the art computer comes with two instructional cassettes that talk you through the learning process. This means a human voice tells you which keys to press as you are learning to manipulate information on the screen. This computer also has built in hardware that lets you hook in to services like Dow Jones/News Retrieval, The Source, MCI Mail, and many other services, including thousands of electronic bulletin boards. • Dimensions: 8 1/2" x 11 1/2" x 3 1/2" • Display: LCD, 46 characters per line, 18 lines • Keyboard: 60 keys • Typewriter-style keyboard/rechargeable pad • Power: NiCad rechargeable battery, AC adapter for financial analysis, phone, calendar and communications management. Internal Memory up to 12 8K • X 11 pages Microcassettes store up to 10 worksheets or 45 minutes of audio information.

**15 Day Money Back Guarantee**

**CEC**

1745 Adrian Road, No. 1  
Burlingame, CA 94010  
415/342-4058  
800/228-3411

were vital! Everything speeded up by *huge* factors!

I agree, it makes for messy-looking code. It also makes you more careful when changing routines not to use extra registers without cross-referencing and changing all register saves.

But—and it's such an important *but* that it deserves emphasis—the *code runs faster!* That is excuse enough for me to do it! Anything that saves me a cycle here and an instruction there is worth it! I'm battling to retain a 20-frame-per-second rate. Every cycle counts!

I'm sure all game programmers are in the same boat. I'm not the only person who writes time-critical code!

## ATARI ST

This month, several BIX members discuss C compilers for the Atari ST and address some specific problems in using those compilers that are not well documented. Other topics include an improvement to the RAM-disk program given previously in the conference and color monitor considerations.

### LATTICE C COMPILER

atari/tech.st #233, from cheath [Charlie Heath, MicroSmiths]

Is the Lattice C compiler the same as the Amiga compiler, or were they developed independently? It would sure be nice to be able to make direct ports.

atari/tech.st #234, from shersee [Steve Hersee, Lattice Inc.]

a comment to 233

They are the same compiler linked to different run-time libraries. If you have other questions, please ask them in the Lattice conference.

### COLOR MONITORS

atari/tech.st #235, from jedwards [Jon Edwards, Technical Editor, BYTE]

Got a letter from a reader today interested in knowing if there's any hope in attaching a non-Atari color monitor to his ST. Anyone have any experience here?

atari/tech.st #237, from dmenconi [Dave Menconi, co-moderator of Atari conference]

a comment to 235

As you may know, the new "consumer" 520ST has a composite video output. The older version has a space on the board for the hardware. I understand from Neil [Harris] that it is difficult but not impossible to add the hardware.

atari/tech.st #238, from bwebster [Bruce Webster, Consulting Editor, BYTE]

a comment to 235

Jez San hacked together a connector for his ST—with emphasis on the word "hacked." Not an easy thing to do. Somebody could probably make a small amount of money producing ST-to-something connectors. I'd be more interested in hooking my ST color monitor to the Amiga.

atari/tech.st #240, from neilharris [Neil Harris, Atari Corp.]

a comment to 238

I know you will think this is a snide comment, but the ST color monitor on the Amiga will not look as good as it does on the ST, which should prove to any doubters that we have some interesting video technology on our side. Fact is, the ST pumps out a significantly higher bandwidth

signal than the Amiga. That shifter chip is very slick. Maybe you should try it, Bruce—that would be interesting for your comparison column.

atari/tech.st #241, from bwebster

a comment to 240

If I could hack together a connector, I would—but the Atari monitor uses an impossible-to-find and difficult-to-hack connector. If you folks want to put one together, I'll cheerfully test it out and report on the results.

### 520ST OPERATING SYSTEM

atari/tech.st #244, from nkline [Nick Kline]

This is from an IBM PCer who is thinking about buying an ST at that incredible new price. I was wondering if the operating system does multitasking, because I really don't know much about it.

atari/tech.st #245, from skrenek [Steve Krenek, Krentek Software, co-moderator of Atari conference]

a comment to 244

No, the ST operating system is not multitasking. There have been some folks making noise about the possibility, but I would be surprised if it happens anytime soon. Any comments, Neil?

atari/tech.st #246, from neilharris

a comment to 245

No, TOS is not multitasking. However, it appears that OS-9—a multitasking, UNIX-like operating system that's available for the Tandy Color Computer—is about finished for the ST. I do not know much more about it. Also, 4xFORTH, a FORTH-83 development system, supports multitasking.

atari/tech.st #250, from jsan [Jez San, Argonaut Software]

a comment to 245

The ST itself doesn't inherently multitask, but I believe that GEM's Desk Accessories can manage it (I'm not familiar with the techniques).

It's only GEM itself that prevents the ST from multitasking, so any third-party software producer can come up with an alternative operating system (e.g., UNIX) that can multitask. There is no reason why the ST can't do it, assuming you write the appropriate software.

atari/tech.st #252, from jruley [John Ruley]

a comment to 244

Yes and no. The operating system has limited multitasking capabilities, but the software does not exploit it (yet). However, the silly thing is so fast that you won't miss it.

### DIGITAL RESEARCH C QUESTIONS

atari/tech.st #254, from wshubert [William Shubert]

I have some questions about DRI's C compiler, which I have been using for about three weeks now. In the first place, can anyone agree about the complaint made in comment #170 that the compiler's structures are all messed up? I haven't found any such problem yet, but I would like to be sure of this.

Also, has anyone written a better RAM-disk program? I don't have the new ROMs yet, but I have a double-sided disk drive and don't want to have to boot up with a single-sided disk in the drive once I get them. By the way, anybody who complains about the speed of the DRI compiler obviously hasn't used it on a RAM disk yet—when I store everything on the RAM disk, what used to take 10 minutes now takes about 1.



atari/tech.st #255, from dbetz [David Betz]  
a comment to 254

I ported XLISP to the Atari ST and never had any trouble with structure offsets. My only problems were with the lack of a "setjmp.h" include file and the fact that console I/O using the standard library didn't work. I'm now trying to use a beta-test copy of Megamax C for the Atari. I'll post any impressions as I proceed.

atari/tech.st #258, from cheath  
a comment to 255

Maybe we have an early version of the compiler. It created offsets that were wrong some of the time. We looked at the output, it was random, we changed to explicit calculations of offsets.

atari/tech.st #259, from wbaker [Bill Baker]

I have three compilers for the ST:

1. Hippo C—not very good, really.
2. Megamax C—first impression was very good even though I received a prerelease version. After much use I find the current editor impossible and the (slightly) altered Mac documentation a problem. Every two or three weeks they promise that the final release will be ready in two or three weeks.
3. TDI Modula-2/ST—very good and only \$60. Pretty neat editor, very good documentation (if you have some programming experience). On the other hand, Modula is really tough if you're used to C.

By the way, I just got an Abacus book on GEM internals. Not bad if you have no other documentation. The VDI section is OK, but the AES section is impossible. Seems like two separate books glued together.

atari/tech.st #263, from wbaker  
a comment to 259

Does AES have a function called "fsel\_input()"? Hippo C supports it, calling it an AES routine. My Abacus GEM programmer's reference says nothing about it. According to a Hippo experiment (and provided source), "fsel\_input()" takes a path and file name and pops up a GEM File Selector box. The selected file is returned to the caller.

atari/tech.st #264, from neilharris  
a comment to 263

"fsel\_input" displays the File Selector dialog box and monitors the user's interaction with it. The File Selector library returns the results of this interaction between the user and the dialog to the application.

Parameters:

```
control(0) = 90
control(1) = 0
control(2) = 2
control(3) = 2
control(4) = 0
int_out(0) = fs_ireturn
int_out(1) = fs_ixbutton
addr_in(0) = fs_iinpath
addr_in(1) = fs_iinsel
```

fs\_ireturn = 0 means an error exists, >0 means no error  
 fs\_ixbutton = 0 means cancel box selected, 1 = OK box selected  
 fs\_iinpath = address of buffer holding directory specification  
 fs\_iinsel = address of buffer holding file specification

Sample call to C language binding:

```
fs_ireturn = fsel + input(fs_iinpath, fs_iinsel, &fs_ixbutton);
```

(continued)

## ONE SIMPLE QUESTION CAN MAKE YOUR PC CLONE A GOOD INVESTMENT. . .

### Is the power supply a FORTRON®?

Your PC represents a substantial investment. It does not make sense to risk costly downtime or system failure due to the use of a so called "BARGAIN" power supply.

At Fortron we insist on quality and reliability that is what earned us a full U.L. rating, and why we feel confidence in offering our warranty, as well as technical support.

Invest in the best and you will be delighted at how little it cost to be powered by FORTRON®

#### PROFITABLE DISCOUNT PRICES FOR DEALERS & SYSTEM INTEGRATORS AVAILABLE!

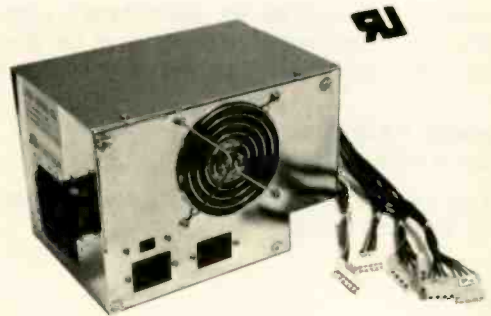

**FC 5192  
PC AT (200W)  
\$189.00**

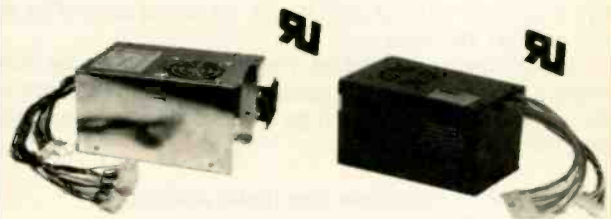

**PC XT  
SIDE SWITCH  
150W MAX.  
\$129.00**

**PC XT  
REAR SWITCH (130W)  
\$109.00**

- U.L. recognized, file #E-101115[s]
- Meet European safety spec.
- 115/230 AC convertible
- Low noise DC fan
- Good for up-grading PC or replacement to original PC power supply.

- OVP, OCP, short circuit protection
- IBM® standard pin-out or Faraday Type pin-out selectable
- 100% 24 hrs burn-in, 100% pre-shipment test. One full year warranty.
- Meet FCC class B.

**FORTRON**      **ORDERS ONLY: (800) 821-9771**  
 3225 SELDON CT.      **IN CALIF.: (415) 490-8171**  
 FREMONT, CA 94538      **TELEX: 559291 FORTRON U.D.**

**ANOTHER QUESTION**

atari/tech.st #266, from wbaker

Thanks, Neil, for the help with "fset\_\_input()". Looks like it will do what I need.

Now, another question: Has anyone had any problems with "vqt\_\_extent()"? As I understand from the Abacus book, the function will calculate the dimensions of a string (in pixels, I assume) given the current text attributes:

```
vqt__extent (handle, string, extent)
int handle;
char *string;
int extent[8];
```

Every time I call it, I get three little mushroom clouds. I think this means an addressing error. Anyone seen this or gotten it to work? I'm using Megamax C. Could it be their implementation?

atari/tech.st #269, from neilharris  
a comment to 266

When passing the string to the "vqt\_\_extent" function, each character of the string goes into elements of the "intin[]" array. Set "string=intin". The results are passed back through "ptsout[0 to 7]". Does that help?

**IMPROVED RAM DISK**

atari/tech.st #270, from wshubert

I have just made my RAM disk boot up instantly. I changed the "main()" subroutine to read:

```
main() {
  register int i;
  appl__init();
  for (i = 0; i < 4608; ++i)
    data[i] = 0;
  Protobt(data, 0x8000L, 2, 0);
  xbios(38, install);
  sleep(); }
```

This makes it go instantly, and you don't have to delete a bunch of junk from it each time you boot up. (Oh yeah, the original listing of the disk is in comment #54 here.)

However, I don't understand the "Ptermres()" call listed in the hitchhiker's guide. What should you pass as the parameter? The length of the program? Its address? I don't get it. If anybody could answer that, it would be nice.

atari/tech.st #276, from jtittsler [Jim Tittsler, Atari Corp.]  
a comment to 270

The Ptermres (Terminate and Stay Resident) call takes two parameters:

```
Ptermres(keep, returncode);
LONG keep;
WORD returncode;
```

The keep parameter specifies the total number of bytes to keep for this program/process. This number includes space used by text/code, data, bss, and the basepage (don't forget to add that \$0100!). The returncode is the result returned to the parent (parallel to that returned by the Pterm() function).

**A FEW NOTES FROM A FRUSTRATED PROGRAMMER**

atari/tech.st #277, from jruley

I've been working since Christmas with the Hippo C compiler and the Abacus GEM and internals books. I am now in a position to give a solid warning to anyone planning to do software development on the

ST. Get the developer's package! It is possible to do some nice stuff with Hippo C, but it is not easy. You have to write your own XBIOS interface and get your documentation out of books—which right now means Abacus.

My first impression of the Abacus books was pretty good, but after the last few weeks, I am not satisfied. Only about two-thirds of the AES calls are documented (they even left out "fset\_\_input," which has to be the most commonly used AES function on the ST!), and the documentation is not especially clear on what's left. It took me almost a week to discover that arguments to the VDI and AES functions are supposed to be 16-bit integers while Hippo C defaults to a 32-bit integer type. To sum up, it is possible to program this way, but it's no fun at all! No matter how irritating that extra \$300 for the developer's package may seem, it's worth every penny.

atari/tech.st #280, from wbaker  
a comment to 277

I agree! Hippo and Abacus are not a good combo. I have a feeling that Megamax is significantly better, although I am still waiting for the "real" release. The interim release is barely worth it. As a long-time C programmer I would like to see a good C development environment. But the TDI Modula-2/ST product is so good that I am really considering switching. The GEM documentation really consists only of the various GEM VDI and definition modules. This is still way ahead of anything Hippo or Megamax has released. Unfortunately, we are still stuck with the Abacus books. But Abacus and TDI Modula-2/ST together are under \$100.

atari/tech.st #281, from jruley  
a comment to 280

Yeah, but the Abacus GEM book is just not enough! It leaves out a bunch of the AES functions, it does not explain how to create the files necessary to support drop-down menus, the index is incomplete, and the organization is lousy—for all of which, it's such an improvement over what I had (Hippo C "documentation") that I'm still almost happy with it. I'm not quite structured enough for Modula, but I need floating point bad—any suggestions?

**IBM RGB MONITOR FOR ATARI ST?**

atari/tech.st #278, from jlwright [Jim Wright]

I'm about to get an RGB monitor for an IBM PC project but plan to get an ST as soon as possible. Are there any RGB monitors that will work well with both? I'd like a fairly crisp (readable) display but don't want to go bankrupt either. Thanks for all comments.

atari/tech.st #279, from jtittsler  
a comment to 278

The ST produces an analog RGB signal (3 bits each of red, green, and blue) while monitors intended for use with the IBM Color Graphics Adapter expect 1 bit for each color, plus an intensity bit. I believe the IBM Enhanced Graphics Adapter produces an analog RGB output, but I have no experience with it or its monitors.

**DBASE II FOR 520ST?**

atari/non.tech.st #218, from ischmittroth [Louis Schmittroth]

Does anyone know of an interpreter or compiler for dBASE II (or III) for the 520ST? I have a number of dBASE II programs on my Kaypro that I would like to move to my 520ST. I would also appreciate any information on other usable database systems on the ST.

atari/non.tech.st #219, from neilharris  
a comment to 218

You are in luck! Mirage Concepts of Fresno, California, started shipping their dBASE II interpreter last week under the title H&D Base (using their brand name, Holmes & Duckworth), and it looks very good.

**OFFICIAL ATARI CORP. BBS IN SUNNYVALE**  
atari/news.st #228, from neilharris

Atari Corp. sponsors a bulletin board system called Atari Base. Operating in a small room in the heart of Atari's corporate headquarters in Sunnyvale, California, Atari Base takes well over 1000 calls per week, providing news, technical support, user group lists, and software downloads for all Atari computers. Atari Base currently consists of four systems on four separate lines. Two lines are STs complete with Atari 20-megabyte hard disks, and the others (the original two lines) are Atari 800s with Corvus hard disks. The two new lines were added recently due to heavy load, while the others have been running continuously since last August. Atari Base operates around the clock, every day. You can reach Atari Base by calling (408) 745-5308.

# IBM & COMPATIBLES

MS-DOS is the featured conference for this month. The conference members engaged in a wide-ranging discussion on the use of batch files, learning to use Debug, handling directories, and resolving problems with formatting a hard disk, among other subjects.

**BURNING IN NEW COMPUTERS**

ms.dos/batch #56, from jobie [Jonathan Robie]

I occasionally burn in computers for friends. At present I use a batch file which fills a RAM disk from a disk drive, then copies the RAM disk to the screen, and finally deletes all files on the RAM disk before looping to the beginning.

I have two questions. Is this the best way to approach burning in? And, is there any way to do a global delete without confirmation in a batch file?

ms.dos/batch #57, from bomb [Jerry McReynolds]  
a comment to 56

Jobie, a quick answer to your question on DEL \*.\*. Create a file (I name it YES.DAT) that consists of three characters: y, <CR>, <EOF>.

```
COPY CON YES.DAT
y<CR>
F6<CR>
```

The .BAT file could then use the DOS command DEL \*.\* <YES.DAT >NUL.

Redirection of "stdin" and "stdout": The < character tells DOS to use YES.DAT as its input file, instead of CON. The > character tells DOS to use NUL for its output file, instead of CON.

As far as burning in goes, most manufacturers test their subassemblies (boards, power supplies, disk drives, etc.) before they are assembled. Then they test the final assembly. With all that testing going on, why worry about burning in?

Our company has 11 XT's, none burned in, and no failures to date. My home unit is a bit over two years old (aboriginal); I took the thing from its unopened container, added a few extras, and have yet to have a problem with it. Knock on wood!

(continued)

## IBM PC AT performance! PCjr price!



- ★ AMPRO Little Board/186
  - 8Mhz 16 Bit 80186 CPU
  - 512K RAM—No Wait-States
  - 2 Serial Ports 50-38.4K Baud
  - Parallel Printer Port
  - 4 Drive Mini/Micro-Floppy Controller
  - SCSI Bus Hard Disk Interface
  - DOS Compatible ROM-BIOS
  - Boots PC DOS 2.x, 3.x
- Computer Board Assembled and Tested with Tech Manual and DOS utilities...\$499

- ★ DRI Concurrent DOS 4.1 Multi-User O/S...\$395
- ★ Expansion Board for 512K (1Mb total) 8087-2 Socket, Real-Time Clock, 8530 SCC 2 Channel RS232/422, Buffered Expansion Bus and more...from \$295
- ★ AMPRO Little Board (Z80) Same as 80186 board but Z80A CPU, 64K RAM, 16K EPROM, CP/M 2.2 & ZCPR3 and manuals...\$239 (\$279 w/SCSI)
- ☆ Enclosures w/Power Supply...from \$99
- ☆ Floppy Drives...call for current price
- ☆ Xebec Owl SCSI Drive—Low power 1/2 Ht Drive w/built-in Controller 10/20Mb...\$499/\$649
- ☆ Terminals: WYSE, QUME, KIMTRON...from \$395
- ☆ Power supplies, cables, connectors in stock

Complete technical support. Assembled systems available. Write or call for free catalog. Most orders shipped same day.

VISA, MasterCard, Money Order, C.O.D. Checks allow two weeks. Purchase orders and bids welcome. Prices F.O.B. Prairie View, IL.

IBM PC AT, PCjr, PC DOS are trademarks of International Business Machines Corporation. Concurrent DOS is a trademark of Digital Research, Inc. Xebec Owl is a trademark of Xebec, Inc.

**DISKS PLUS** 15945 West Pope Blvd.  
INC. Prairie View, IL 60069  
(312) 537-7888

### HARMONY COMPUTERS

2357 CONEY ISLAND AVE. iBet. Aves. T & U BKLYN, NY 11223  
800-VIDE084 or 800-441-1144 or 718-627-1000

	Commodore 128	PANASONIC 1091			
	\$238.95	\$221.95			
	STAR SG10	IBM P.C. Bare No. Drives			
	\$196.95	\$1084.50			
<b>"PRINTER SPECIALS"</b>					
Brother HR 15XL	319	NEC 8850	989	Star SD 10	249
Brother HR3E	674	Okidata 192	319	Star SD 15	409
Citizen MSP 10	232	Okidata 2410	1639	Star SR 10	406
Epson LX80	192	Okidata 183	449	Star SR 15	510
Epson LQ 1500	789	Okidata 187	208	Star SB 10	494
Epson LQ800	535	Panasonic KXP 1091	222	Silver Reed Exp 550	338
FX 100	665	Panasonic KXP 1092	292	Silver Reed Exp 800	619
PK 85	509	Panasonic KXP 3151	369	Silver Reed Exp 400	189
Epson 286	509	Panasonic KXP 1080	184	Toshiba 1340	369
HP Laser Jet	2288	Panasonic KXP 3131	238	Toshiba 341	699
IBM Proprinter	394	Panasonic KXP 1592	399	Toshiba 351	977
Juhl 8100	335	Star SG10	197		
NEC 2050	593	Star SG15	331		
NEC 3550	689				

## WOW!WOW!WOW!

IBM	IBM	MONITORS	
AT Unenhanced	Hard Drives w/o controller	Amdtek 300 Green	104
AT Enhanced by IBM	10 Meg	Amdtek 300 Amber	109
IBM Monitor	20 Meg	310 Amber	129
IBM PC No drives	30 Meg	Color 300	148
PC XT	40 Meg	Color 600	364
PC XT Clone		Color 722	452
IBM Pro Printer		Princeton HK12	390
AST Six Pack 64K	2E	Princeton HK12E	456
Tall Grass 25 Meg		Princeton Max 12E	142
Quad Board		SR12	519
Hercules Color	130 XE		
Hercules Monochrome	65 XE		
Color Card	1027 Printer		
Multifunction Card	1050 Drive		
Paradise Graphics	Indus Drive		
Paradise Multi Dis.	Graphic Printer		
Paradise 5 Pack	520 ST Color		
STB Graphics - 2	520 ST B.W.		
STB R10 + 2			
STB Mono Board			
Tecmar Graphics			
Tecmar Captain			
Persyst Monocard			
Bermouli Box			
Talgrass 35 Meg			
8027 Chip			
80287 Chip			
Everex Graphics Edge			
Everex Edge			
Everex Graphics Pacer			

800-441-1144

Items reflect 4% cash or check discount. For your protection we check for stolen credit cards. M.C. visa welcome. Personal checks cause 4 week delay. Shipping & handling charge extra. Price and availability subject to change without notice.

# HAVE YOU STRIPPED YET?

It's a question more and more PC owners are asking. And no wonder. What everyone is talking about is Softstrip™. The revolutionary technology that is changing the shape of computer software.

The Cauzin Softstrip System is more than just software or data on paper. Because when you invest in this system, you can do much more with your computer, and for far less than you are probably spending now. You can even create and print out your own data strips.

But that's only the beginning of an offer that's going to make you wonder why you haven't stripped yet...

## TAKE OUR ADS (SUCH AS THIS ONE)

It's part of our expanding StripWare™ Library containing programs, data, art, spreadsheet, macros and templates. The Library features a variety of software applications and you'll find new material appearing each month in such leading computer magazines as Lotus, PC, PC Tech Journal, and PC World.

## BUT THERE'S STILL MORE...

When you invest in the Softstrip System, you get the Softstrip reader, a special storage base, and a full one-year replacement warranty. Also included with your purchase is a complete Accessory Kit for your PC containing connector cables and communications software to link your computer to the reader.

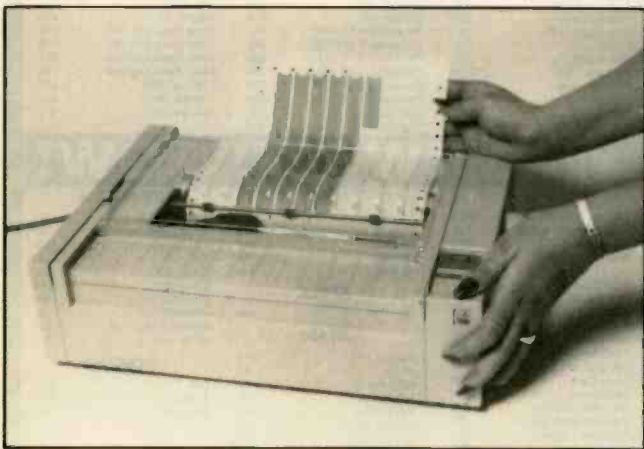

In addition, you'll find a StripWare Sampler with 48 programs from a line-up of popular authors and publishers that includes Addison-Wesley,



David Ahl, Family Computing, Tim Hartnell, Hayden Books, PC Tech Journal, Osborne/McGraw-Hill, The Waite Group, and John Wiley & Sons.

When you become a Softstrip reader owner, you also get a FREE one year StripWare Club membership with programs mailed to you monthly. You'll even receive a FREE Cauzin Effect Newsletter filled with the latest updates and news about Softstrip developments.

## AND IF THAT'S NOT ENOUGH TO START YOU STRIPPING...

You'll find StripWare brand software in authorized Softstrip dealers across the country. Our collection of titles include everything from

utilities, graphics and entertainment to business programs. All for only \$2.98 to \$19.98!

Do you want to create your own data strips? Well, now you can with a special StripWare package called "STRIPPER" that lets you print your disk files as strips using your own Epson dot matrix printer.

The printing software is only \$19.95,

but just think of the things you could be stripping. Store backup files on paper. Print, copy and mail your own programs to others easily and inexpensively.

The Cauzin Softstrip System is just that, a complete system that opens up a new world of computer programs and data on paper. And it's all yours for only \$199.95!

For the Softstrip System Dealer nearest you, (or if there isn't one in your area, to order), call toll free: 1-800-533-7323 (in Connecticut: 203-573-0150)



StripWare packages offer utilities, games, business programs, templates and much more.

**Softstrip**  
COMPUTER READABLE PRINT

Cauzin Systems, Inc.  
835 South Main St., Waterbury, CT 06706

Epson is a registered trademark of Epson America, Inc.

IBM and IBM PC are registered trademarks of International Business Machines, Inc., Softstrip® and the Softstrip® System Reader are trademarks of Cauzin Systems, Inc.

## MOVE OVER MOZART

Wolfgang Amadeus Mozart was born in 1756. At the age of six he began composing. By 1791, just 35 years later, he was dead. During his brief lifespan he composed no less than 49 symphonies, 27 piano concerti, 45 sonatas, 23 operas, 20 masses, 29 string quartets, 66 arias, and 29 orchestral dances, among other works. He was the envy of his peers, even Haydn (25 years his senior) marveled at his abilities. Today, interest in Amadeus is keener than at any time in history.

Historians disagree concerning many facets of the great composer's life and abilities. They do agree, however, that he had a remarkable sense of hearing. Mozart could listen to a piece once and play it from memory.

The data strips on the right contain an ear training program for musicians, named in honor of MOZART by Egon H. Weiss. It is an ear training program for musicians and music students. It plays a random note which the user attempts to identify. MOZART is easy to use and can be learned in just a few minutes.

Read the data strips into your PC. The program is written in BASIC. Enter BASIC and type RUN "MOZART". The program is menu-driven. It is deceptively simple. It can be tailored to give the listener different scales, octaves, notes, and durations. MOZART can be used by people at all experience levels.

So sit back, listen and enjoy... before you know it you'll become a better musician than you might already be.

Reprinted with permission of Egon Weiss.  
Copyright © 1986 by Egon Weiss.

StripWare Library No. 219

1

2

3

4

5

EMM

ms.dos/batch #59, from jrobie  
a comment to 57

Neat! I hadn't thought to redirect I/O.

The main reason I burn in computers is that if there is a problem I want to know now, while the warranties are all in effect. If my friend has 512K and there is a problem with the addressing on the memory board which affects only high memory, he may not discover it until he uses a program which uses 512K (which could be months from now). Therefore I test it all. Probably unnecessary, but I also make unnecessary backups.

#### BATCH FILES FROM C: AND D:

ms.dos/batch #60, from star [Spencer Star]

I have a 40-meg fixed disk that is divided into two logical disks, c: and d:. I've been trying to write some small batch files to get around the directories. Suppose I want to go to the root directory on c: with the command ROOT. If I am on c:, I can use CD \ or CD C:\. But if I am on d:, I must use C: CD \. (These are one-line commands in the file ROOT.BAT.) But one form does not work in the other situation. Does that mean that if I want to get to a directory called DIR1C, which is on c:, I cannot create a single batch file that will do the trick from both c: and d:?

ms.dos/batch #61, from wheelock [Bruce Wheelock]  
a comment to 60

The command C: CD \ only directs DOS to change the directory on the C drive to the root. It does not log you to the C drive if you are logged to another drive. The following batch will work in all cases:

```
echo off
C:
CD \
```

A single generic batch file, callable as ROOT d: (where d: would be C: or D: or another drive ID) would be

```
echo off
%1
CD \
```

This batch file would log you to the root of the drive specified in the argument. If an argument was not given, it would put you in the root of the currently logged drive. If the argument was not a drive ID, DOS would try to find a command, .COM, .EXE, or .BAT file by that name and execute it before going to the root of the currently logged drive. If none of those existed, you would get "Bad Command or File Name" and then be put into the root of the currently logged drive.

#### USING SET COMMAND IN BATCH FILES

ms.dos/batch #62, from dthielen [David Thielen]

I need more than the default 128 bytes in the SET area. When you first boot up, if you SET more than 128, then what you take will be kept if you load resident a program on top of the SET area. However, this cannot be done in a batch file as the batch file is apparently sitting on top of the 128 bytes. If someone knows a solution other than booting up, typing in some large set values, and then running AUTOEXEC.BAT, I would appreciate it.

ms.dos/batch #63, from cmccartney [Craig McCartney]  
a comment to 62

Put a SHELL command with the /E option in your CONFIG.SYS file. You can set the size of the environment to anything you like.

ms.dos/batch #64, from leroy [Leroy Casterline]  
a comment to 63

Note that the /E is an undocumented DOS 3.1 (perhaps 3.0 as well) feature.

ms.dos/batch #65, from bbrown [Bob Brown]  
a comment to 64

I tried SHELL/E and couldn't get it right. How does it work (in DOS 3.1)? An example would be helpful.

ms.dos/batch #66, from leroy  
a comment to 65

Check message #30 in this conference topic. If that doesn't help, I'll try again.

#### LEARNING DEBUG

ms.dos/commands #173, from gorth [Ed Gorth]

I would like to know if there is a good textbook on DEBUG and advanced DOS commands.

ms.dos/commands #174, from jrobie  
a comment to 173

*Assembly Language Primer for the IBM PC & XT* by Robert Lafore [published by NAL/Plume] uses Debug as a tool to teach assembly-language programming. In the process it also teaches some useful ways to use DEBUG.COM. I don't know of a book specifically devoted to Debug.

ms.dos/commands #179, from engelke [Charles Engelke]  
a comment to 173

*Assembly Language Safari on the IBM-PC: First Explorations* by John Socha [published by Brady Communications] uses DEBUG extensively and is very readable.

#### COPYING TO A SUBDIRECTORY

ms.dos/commands #180, from tcrites [Tom Crites]

When you're copying a file to a subdirectory that doesn't exist (or that you have happened to spell wrong), why doesn't DOS come back with an error message? I have done this a few times and erased the file before checking the target directory only to find the file missing. I do get some junk in the default directory with the filename in question. Would you consider this a bug?

ms.dos/commands #181, from leroy  
a comment to 180

That isn't a bug—DOS is just doing what you told it to do. If the directory doesn't exist, DOS creates a file with the same name as that of the missing directory.

For example, if you have the directory WP (for word processing) in the root and mistakenly copy the file TEST to WC (copy TEST \WC [instead of correct name, WP]), what you end up with is a new file, WC, in the root directory.

DOS has done what you directed it to do, in this case copy the file TEST to the root directory and change the name of the file to WC.

ms.dos/commands #182, from rduncan [Ray Duncan]  
a comment to 181

It can be a bit of a pain, though, if you copy a wildcard file spec to a nonexistent directory. DOS will create a new file that is the concatenation of all the files that matched the wildcard file spec. Pretty much unusable.

**ms.dos/commands #183**, from aberger [Al Berger]  
a comment to 181

Yeah, DOS doesn't seem to be real clear on the difference between a filename and a subdirectory name. It wouldn't let me create a BIX subdirectory under my XyWrite directory; turned out it was because I had a file called BIX in the XyWrite directory (a parameter file for a communications program). I had to use another name for the subdirectory.

**ms.dos/commands #184**, from leroy  
a comment to 182

One way you can check for this (without jumping to the target directory) before you erase the old files is to check the result of the COPY command. If you copy several files to one file, COPY reports "1 file copied". If COPY reports more than one file copied, then you have indeed created several files in the target area instead of one concatenated file.

**ms.dos/commands #185**, from wheelock  
a comment to 183

The reason for this is because a subdirectory is, in fact, a file with a special attribute.

#### MEMORY RESIDENCE

**ms.dos/other #274**, from hans [Henry Bottjer]

This looks like as good a place as any to ask. Why can't a memory-resident program be loaded wherever you would like it? Better yet, shouldn't the producers of these routines adapt their code to allow them to be loaded into "high" (extended > 640K memory)? With all these programs loaded in high memory, other applications could be run without modification.

**ms.dos/other #275**, from barryn [Barry Nance]  
a comment to 274

Unfortunately, it's not up to the developers of the code. It's a limitation of PC-/MS-DOS. Programs that make a portion of themselves resident with the "terminate-and-stay-resident" DOS call are limited to the area of memory just above DOS. Otherwise DOS is unable to allocate memory for the next (regular) program to load and execute.

To defeat DOS's memory-allocation logic would mean that the program would have to modify whatever version of DOS was in memory plus probably the COMMAND.COM disk file itself (the transient portion of which is occasionally reloaded into high memory).

On the other hand, it is possible for the low-memory-resident software to allocate and use special memory areas for data space or whatever. A RAM disk whose code portion is next to/near to DOS could use the memory above 640K (assuming it existed) for the pseudo-disk "sectors."

**ms.dos/other #277**, from thenderson [Thom Henderson]  
a comment to 275

There is another way. A program can move itself into high memory and then fudge the BIOS data to tell it that there is less system memory than there really is. (Is that as opaque as it sounds?) But that's less easy than the "normal" terminate-and-stay-resident, so almost nobody does it. A similar scheme would be possible for extended memory, but DOS doesn't know about (or manage) extended memory, so it would be hard to be sure you weren't going to step on anything else.

Other than RAM disks and print spoolers, most resident utilities don't really take much memory anyway. Is this really a problem?

#### DOS 3.1 FILE HANDLE LIMITS

**ms.dos/other #289**, from rschnapp [Russell Schnapp]

In *Dr. Dobbs Journal* in the 16-bit Software Toolbox column, a reader

brought up the fact that MS-DOS 3.1 limits the number of active file handles to 20. There is a similar limit in DOS 2.x, but you may have been able to override it with the "FILES=" command in CONFIG.SYS. There is even a limit on the number of open FCBs in 3.1. Would you believe *four*?

Has anyone else come upon these limitations? Anyone know a way around them?

The project I'm working on involves networked machines, dealing with a large number (more than 20) databases simultaneously. We can't open and close a database every time we need it—the overhead would kill us. Anybody have any ideas? Is this going to affect anyone else?

**ms.dos/other #300**, from rduncan  
a comment to 289

The limit is 20 handles per process. The limit for the system as a whole is 255, I think. The limit on the number of open FCBs defaults to four but can be overridden up to a max of 255 with a CONFIG.SYS entry. DOS has a very funny way of reacting when you open more FCBs than the system allows: It just closes the last recently used FCB without telling the application about it! I bet this will lead to some pretty strange behavior in DOS 3.1 networking environments when some of the older programs (like dBASE II, which is notorious in its abuse of FCBs) are run.

#### WINDOWS AND BATCH FILES

**ms.dos/other #307**, from star

Does anybody have any experience with Microsoft Windows? I got a copy a few days ago and have been trying to get WordPerfect to run with it. I have a 3-meg RAM disk that Windows uses for swapping programs like WordPerfect in and out of main memory. My problem is that I load WP with a batch file LDWP.BAT that loads other programs such as a Mouse Systems mouse menu and a file to change screen colors, and downloads a French character set to the Epson printer. I can get WordPerfect to run from an icon, but I don't seem to have any luck getting the other files swapped in when, for example, I call a batch-file icon. I've been trying various combinations without much luck, and Microsoft technical support doesn't do much more than read me the manual while I'm paying for the long-distance call. I'd like to hear from anybody who wants to share their experience with Windows or who has some suggestions.

**ms.dos/other #309**, from rduncan  
a comment to 307

It is possible to run batch files under MS Windows by running a copy of COMMAND.COM in its own window. Windows probably won't like your file that changes screen colors, though!

**ms.dos/other #310**, from dthielen

#### Undocumented DOS Function Calls

Does anyone out there know any and/or all of the undocumented DOS function calls? We are writing our own DOS that will sit on top of MS-DOS and we want to make sure that we are catching everything that we need to. Also, anyone with suggestions, we are writing a disk interface for a WORM optical disk that will have no limits on device or file size. Thanks.

#### VOLUME LABELS

**ms.dos/other #315**, from mikeattili [Mike Attili]

What's the easiest way to get the volume label from a disk through the operating system? I need to verify labels on disks, and I need a quick way to do it. Thanks.

(continued)

ms.dos/other #316, from barryn  
a comment to 315

Do you have a DOS reference manual handy? Look up the FIND FIRST DOS call (DOS function 4E, using CX to hold the attribute of the file you're searching for). The MS-DOS file attribute for volume labels is 08. Int 21, with AH = 4E, DS:DX pointing to an ASCII string containing "\*", and CX set to 08 will return the volume label in the DTA.

ms.dos/other #317, from mikeattili  
a comment to 316

According to my DOS reference manual, function 4E finds all files that match a "subset" of the required attributes, and since most files have no attributes and the null set is a subset of all sets, I end up matching most of the files. Is there any way to exclusively search for volume labels?

Not only that, I seem to be having trouble picking up the label on some disks using this method (a combination of 4E and 4F). I don't know why, some disks it locates the label, others it just skips it! I'm lost at the moment.

ms.dos/other #320, from barryn  
a comment to 317

Hmm. The DOS tech ref I'm looking at is for DOS 3.1, and it says (under function call 4E) to go see function call 11 for an explanation of how the file attribute field is used for searches. For function call 11, it says, "If the attribute field is set for the volume label, it is considered an exclusive search, and *only* the volume label is returned." So a single 4E function call, using an attribute of 08 and an ASCII string of "A:?????????", should return the volume label for the disk in drive A. If it has no volume label, the carry flag should have been set by DOS and a return code in AX also set, signifying "no matching file found."

I don't think that 4F needs to be used to Find Next, since there can be only one volume label. How come you're using 4F?

Want to mail me your code or post a fragment of it here so I can look at it closer? That's about the only thing I can suggest at this point.

ms.dos/other #322, from mikeattili  
a comment to 320

Perhaps the explanation lies in the fact that I'm using version 2.11 of MS-DOS. This is the latest version released for the DEC Rainbow. I've seen that on my hard disk, the volume label comes up as the fourth entry when using the 0x08 attribute. This is most perplexing. I'll be working on it more later, and I'll see if I can't find out what the problem is. Thanks.

ms.dos/other #325, from mikeattili  
a comment to 322

Thanks. I've got the problem solved (sort of). Apparently function 4E in my release isn't working properly, but function 11 works fine. Another step in my Disk Archive utility out of the way; now I just need to work out the interface to ARC and a disk-filling algorithm. I guess it's off to soft.eng/alg conference for help in that department. Isn't BIX wonderful?

ms.dos/other #326, from rduncan  
a comment to 315

You must do a search for FIRST with an extended file control block, setting the attribute byte in the XFCB with the volume label bit on. This will return you the volume label from the root directory, if one is present, no matter what your current subdirectory is. In DOS 2.x, at least, you can't use the "extended" search for FIRST function (that accepts an

ASCII string) to look for the volume label; you have to use the Extended FCB method.

### FDISK PROBLEM?

ms.dos/other #332, from billn [Bill Nicholls]

I'm trying to initialize a new hard disk as drive c:. The hardware knows it is there, the drive resets when booting, and FDISK lets me set up a 611-cylinder DOS partition. But when I reboot to FORMAT C: I get an "invalid drive specification." I am using MS-DOS 2.11, a Seagate 225 hard disk, a Data Technology Corp. (DTC) 5150BX 2 controller card. CONFIG.SYS and AUTOEXEC.BAT are not in use. Main board switch set for 1 or 2 FD makes no difference. System has run a different Seagate 225 from this controller before. Any suggestions?

ms.dos/other #334, from dthielen  
a comment to 332

Shoot the hard disk. But first make sure FDISK and FORMAT are the same version.

ms.dos/other #335, from petewhite [Pete White]  
a comment to 332

Are you trying FORMAT C: or FORMAT C:/SV? I had a problem with a 10-megabyte disk in an IBM and had to use the diagnostics to clean the disk before it would take anything but a bare-bones FORMAT. Did any special utilities come with the Seagate? There was a "special" FDISK with my Seagate half-height 20-megabyte disk, but it wasn't necessary. Or "shoot it"!

ms.dos/other #336, from rschnapp  
a comment to 335

Or your disk could require a primary format. I have such a program for my Columbia. I suspect that a similar program is available on an advanced diagnostics disk for the PC.

ms.dos/other #337, from billn  
a comment to 336

Actually there's a trick to it. One loads DEBUG. At the "-" prompt enter "G=c800:5<ret>". What comes up is "Hard Disk Formatter"! After entering disk #1 and interleave, the disk formatted quickly. Then FDISK and FORMAT work. Only problem is this is totally undocumented. When I spoke to the support person, he quickly gave me the right data. He was surprised it was undocumented; he thought it was in the hard-disk section, which I carefully checked. At least this prevents "accidental" reformatting. Deliberate too. I'm pleased with the support but not the documentation. DEBUG, ye gods!

### HANDLING MS-DOS DIRECTORIES

ms.dos/utilities #163, from bbrown

While the tree-structured directory is conceptually simple and makes system management easy if you have the right tools, I've found that MS-DOS doesn't have the right tools!

In particular, I find the CD command and all those dumb backslashes a pain in the back. I was used to a small-computer OS with a *good* way to handle tree-structured directories (Datapoint's RMS). I went from there to a VAX, which is less good, and from there to MS-DOS, which is the pits!

One of the things I learned while using the VAX was that every installation has a set of user-implemented command procedures for roaming around in the directories. I got used to these, and when I started using directories on MS-DOS (got a hard disk two weeks ago) I found I needed them. So I've written four little utilities in Turbo Pascal for directory roaming.



HOME takes you to C:\ (can be patched for anywhere).  
 DOWN <name> takes you to the directory named <name> one level lower in the tree. Note that no dumb backslashes are needed, but if you supply a path name with embedded (only) backslashes, you can go down several levels with one command.

Those don't do anything you can't do with as few keystrokes with CD except that you don't have to reach for the backslash key. But look at these:

OVER <name> takes you to the directory with the partial path name <name> at the same level as the current directory.

UP takes you to the next-higher-level directory.

These are all written in Turbo Pascal and have been tested on an IBM PC with DOS 2.10 (my 3.1's on order). I'll place the source code in the public domain. If you want a copy, send me a mail message. If there's enough interest (and the moderator permits!) I'll post it here; otherwise, you'll get a copy in BIXmail in a day or two.

ms.dos/utilities #165, from Tymnet  
 a comment to 163

HOME is useful. You may not be aware of the following abbreviated command syntax for CD to do the other stuff:

OWN <name> = CD <name> (no backslashes needed!)

OVER <name> = CD ..\ <name>

UP = CD .. (just two periods)

ms.dos/utilities #167, from dwb [Dave Burleigh]  
 a comment to 165

If you use DOSEDIT, you can define abbreviations for the CD commands that get you to your most-used directories. Very quick and easy.

ms.dos/utilities #168, from johnf [John Fistere]  
 a comment to 167

SuperKey works fine for the same process, too. Sets are easily switchable, also.

ms.dos/utilities #169, from bbrown  
 a comment to 165

Thanks for the info. I tried 'em, and sonofagun, they work!

Then I checked my PC-DOS manual to discover how I'd overlooked such a useful thing as abbreviated syntax. Now I understand why people can make money with how-to books on DOS.

Knowing that the abbreviated syntax works, I looked carefully at the description of the CHDIR command. Then I looked at the Notation section. Then I read the stuff on global filename characters, information common to all DOS commands, and, in the Appendix, the stuff on enhancements. OK, I give up. Uncle! Is this stuff documented anywhere in anything published by IBM and for sale to the general public?

I'm glad to know that CD isn't as clunky as I'd thought, but I think I'll stick to UP, DOWN, OVER, and HOME. They're more intuitive and easier to type.

ms.dos/utilities #171, from suer [Sue Rosenberg]  
 a comment to 169

Except for the information about the periods, the documentation for CHDIR describes all the other features. You just have to know what it means before you read it. The exposition and examples leave something to be desired.

ms.dos/utilities #172, from wheelock  
 a comment to 168

And, of course, batch files are just as good, though slower.

ms.dos/utilities #173, from johnf  
 a comment to 172

I have learned that the problem with batch files is that they each take up 4K, while the SuperKey files are compacted. I'm in the process of leisurely changing over.

ms.dos/utilities #174, from wheelock  
 a comment to 173

However, batch files let you use meaningful names. SuperKey macros require that you either call the help screen a lot or memorize key combinations.

ms.dos/utilities #175, from rich [Rich Sidney]  
 a comment to 163

I agree, the slashes should have been regular forward slashes instead of backslashes, as used with UNIX. When I switch between MS-DOS and UNIX, I get into all sorts of trouble.

ms.dos/utilities #176, from tymnet  
 a comment to 175

If you stick "SWITCHAR = -" in your CONFIG.SYS file, then you can use "/" instead of "\". You can also specify options using "-" instead of "/". The only caveat is don't try to use BACKUP/RESTORE when you've reset the SWITCHAR; it only understands "\".

ms.dos/utilities #177, from wheelock  
 a comment to 176

Don't know that this is true, but I read somewhere on BIX that they took SWITCHAR out of DOS 3.0/3.1.

ms.dos/utilities #179, from thenderson  
 a comment to 176

Depends on the utility. One has to check with DOS to see what the switch character is, and many utilities don't...

ms.dos/utilities #187, from wardc [Ward Christensen]  
 a comment to 169

I take it you only use your own MS/PC-DOS machine? I've found the most frustrating thing about "customizing" a machine for my own use is that when I go to another person's machine, I am suddenly as dumb as a rock!

Thus, I forced myself to learn (ugh) EDLIN because that way I can look like a hero when they need a little patch to their AUTOEXEC.BAT file rather than behaving like a spoiled child whose blanket was just taken away.

I will admit I can't get along without DOSEDIT (or CED) to edit commands, but even though I own SuperKey, I find ANSI.SYS to be enough for my needs. I don't like SuperKey's command retriever, too much to type when compared to my ANSI.SYS mapping of Control-K to scroll up to previous command with one keystroke.

ms.dos/utilities #188, from wheelock  
 a comment to 187

I have experienced the same problem and try to make it a point to have my traveling utility disk with me any time I'm placed in a situation where I'll have to help someone with a PC. Flashing super-whizbang

(continued)

# Don't let debris wo through

In every specially marked box of ten 5¼" 3M diskettes you'll find a free head cleaning diskette sampler kit that'll clean your disk drive heads three times.

Plus a coupon good for a \$2.00 rebate from 3M on your next head cleaning

diskette kit purchase.

Why are we doing this? We've done everything but chant and burn incense to take the worry out of diskettes by making the most reliable, worry-free product possible.

But there's one thing we

can't protect you from.

Yourself.

If you let your recording heads collect dust and debris without cleaning them, you have to be prepared for the possibility of data loss or errors.

But not to worry.

# dust and tries run your head.

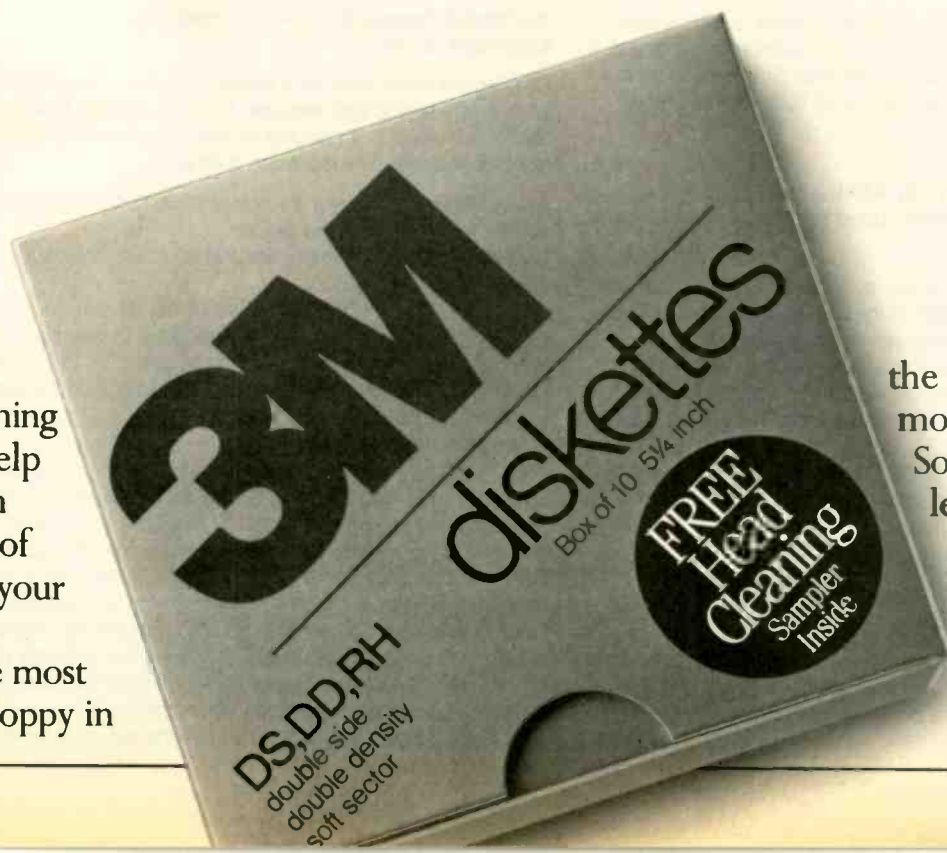

Our free head cleaning kit will help get you in the habit of cleaning your heads.

So the most reliable floppy in

the world can be even more reliable.

So you can worry even less about the floppy you didn't have to worry about anyway.

One less thing to worry about.

programs across the screen and then using them to magically fix stuff is impressive as all get-out.

Don't understand your comment about SuperKey's command retrieval. "ALT-\ " gets you to the list, and the arrow keys to select. Sure, one extra keystroke (two if you count both ALT and \ as separate keys), but the facility made available is excellent.

ms.dos/utilities #200, from johnf  
a comment to 187

Good point. I use EDLIN by choice for tiny .BAT files, etc., because my WordStar 2000 takes too long to load for quick fixes. I haven't really explored the potential of ANSI.SYS.

ms.dos/utilities #201, from wheelock  
a comment to 200

For any file up to 10,000 characters, I use the SideKick Notepad. Always there and callable in a second.

ms.dos/utilities #207, from aberger  
a comment to 200

If they're really tiny .BAT files, you don't even need EDLIN. Just use the COPY CON command and end it with the F6 key, or type a Control-Z.

ms.dos/utilities #221, from rduncan  
a comment to 177

SWTCHAR wasn't documented in the IBM versions of DOS anyway, I think, and the MS-DOS OEM documentation for 3.x and 2.25x says it won't be supported in any future versions.

## MACINTOSH

In the Mac conference this month we have our usual questions and answers regarding the use of resources, terminal-emulation programs, a word-count utility, and the SCSI port on the Mac Plus. We also have a new program upload by David Betz (author of XLISP) and a report from the San Diego Mac Users Group.

### NEW SOFTWARE APPLICATION AVAILABLE

macintosh/software #147 from dbetz [David Betz]

AdvSys on BIX

My adventure authoring system is now available for the Macintosh. You can find it in the Macintosh section of the Listings conference. It is a special-purpose programming language for writing text adventure games. It includes a compiler for the language and an interpreter for the p-code-style files produced by the compiler. There is a document that describes how to use the system and a sample adventure to serve as a simple example.

The file is called "AdvSys.pit" in the Listings conference. It was produced by the Macintosh file archiver program PackIt, which is also available in the Listings conference.

macintosh/software #149, from rschnapp [Russell Schnapp]  
a comment to 147

Can you expand on AdvSys a bit, Dave? Can it be used for other things besides games? For example, can one build instructional or promotional software with it? What is the intellectual property status: copyright with license? public domain?

macintosh/software #150, from dbetz  
a comment to 149

AdvSys is copyrighted, but I have granted permission for unrestricted noncommercial use and distribution. I have also granted BIX permission to distribute it from the Listings conference. I suppose that it would be possible to build things other than games with it. It does provide a built-in execution loop that allows the player to type a command and see the effect of the resulting action. Anything that could be fit into the command/response model could be implemented using my system (assuming that the commands follow the syntax allowed by my parser).

### DISPLAYING PICT RESOURCES FROM A PROGRAM

macintosh/softw.devlpmt #119, from frankb [Frank Boosman]

Using Resources

I've been trying to find a good snippet of code which shows how to use resources. Chernicoff talks at length about them, and shows how to get them in and out of memory, but fails to show (as far as I can tell) how to actually use them.

I guess I'm just having a problem making the conceptual leap from reading about resources to actually using them in code ... help!

macintosh/softw.devlpmt #120, from jrobie [Jonathan Robie]  
a comment to 119

I have used resources primarily to store pictures to be flashed to the screen, to store dialog boxes, etc. If you want me to post an example of how to extract a picture resource from a MacPaint file and use it in a program, I would be glad to do so.

Do you have the software supplement? It has several good examples that show how resources can be used.

macintosh/softw.devlpmt #121, from frankb  
a comment to 120

Yes, I would be very interested in seeing your example code for using picture resources. No, I don't have the software supplement.

macintosh/softw.devlpmt #124, from jrobie  
a comment to 120

OK, I've had some votes for a sample program. The program itself will be in a comment to this message. This note explains how to convert a MacPaint image into a resource so that it can be called with the resource manager. The technique is simple:

1. Use MacPaint to display the picture on the screen. Make any desired modifications to the picture.
2. Select the portion of the picture that you want, cut it, and paste it to the scrapbook.
3. Use the resource editor (I use ResEdit 0.8, which I downloaded from the Listings area of BIX) to view the resources in the scrapbook. Important: Hold the option key down when you select the PICT identifier. This will cause the resource editor to display the image on the screen. If you don't hold the option key down, the resource ID and hex for the image are displayed.
4. Your program will identify these resources by the resource ID number and will load the resource by calling GetResource with the appropriate resource type (PICT) and ID number. You may also choose to give the picture a name. This will allow you to load the picture using GetNamedResource, and a named resource is easier for a programmer to identify than the arbitrary numbers used for the GetResource function. If you plan to use GetResource, open the PICT identifier a second time *without* holding down the option key and write down all the resource ID numbers. This example uses GetResource simply because I haven't tested a version with named resources yet.
5. After you compile your program, move the picture resources into

your object code using the resource editor. Make sure that the resources still have the numbers that are used in the program. The editor will allow you to change these numbers if necessary.

Notes: (a) Don't try to copy the MacPaint file into the scrapbook directly from the Finder. This copies only the *name* of the file into the scrapbook! (b) There are several other ways to do the same thing. This is one way that works. (c) The source code to a program which displays two pictures is included as a comment to this message.

macintosh/softw.devlpmt #125, from jrobie  
a comment to 124

Program Flasher;

(\*This is a Rascal program which simply displays two pictures on the screen. The first picture is not erased; I assume they don't have overlapping screen coordinates. Written by Jonathan Robie, Software by Design, Box 26121, Lansing MI. Thanks to Scott Gillespie of Reed College for technical assistance.\*)

(\*call in a few libraries\*)

Link \_\_\_Quickdraw, \_\_\_Extras, \_\_\_IO ::

(\*declare a few global variables\*)

var

pict1, pict2, typeptr: ptr; (\*^longint\*)

picrecA, picrecB : integer[4]; (\*rect\*)

procedure CopyRect(src,dest: ptr);

(\*copies a rect (block[8]) from src^ to dest^ \*)

begin

dest^ := src^;

ptr(dest+4)^ := (src+4)^;

end;

(\*the following procedure is called first, then control passes to pro-

cedure \_\_Main();\*)

procedure \_\_INIT();

begin

typeptr := " PICT" + 2; (\*set to correct type for GetResource call\*)

pict1 := GetResource(typeptr^, -32761); (\*load the PICT resources\*)

pict2 := GetResource(typeptr^, -32768); (\*use ResEdit to find  
number\*)

copyrect(pict1^ + 2,picrecA); (\*place rect coordinates in picrecA\*)

copyrect(pict2^ + 2,picrecB);

setorigin(0,0);

end;

procedure \_\_MAIN();

(\*draw a picture, wait 2000 msec, then draw a second picture\*)

begin

DrawPicture(pict2,picrecB);

ResetTimer(); (\*Doesn't Rascal have nice timing routines?\*)

AtTime 2000 do

DrawPicture(pict1,picrecA);

(\*The next call terminates execution. Rascal keeps executing \_\_MAIN() until the program requests a halt.\*)

AtTime 4000 do

reqhalt();

end;

### SAVING GAME-IN-PROGRESS FILES

macintosh/softw.devlpmt #133, from ccawfor [Chris Crawford]

Preload SF Package?

OK, all, I got a good problem here. It seems that my latest game needs to be able to load and save games in progress. No problem, I've done that before. But this time the publisher insists that the pro-

gram save not to the original program disk but to a separate data disk; it seems that this will cut down on the return rate for disks that were accidentally written to by other (other?) programs, or some such nonsense. OK, so I need to eject the program disk, call the SF package, and save it out to the data disk. (They won't let me assume two disk drives.) Here's the problem: As soon as you eject the program disk and call SFPutFile, it needs to load in the SF package, which resides on the program disk, so it asks the user to insert the original program disk immediately after ejecting it. Not very impressive.

This should not be a difficult problem to solve; I am sure that many other applications have handled it. Problem is, I can't see how it's done. I've discussed it with several technically knowledgeable people and they have had no great ideas. We all agree, the trick is to preload the SF package. But how is that done? (One fellow had an involved scheme that involved trapping program execution to determine the resource ID # of the SF package—no thanks.)

Any bright ideas? Or have I overlooked something simple again?

macintosh/softw.devlpmt #134, from frankb  
a comment to 133

Chris, this is off the top of my head, so forgive me if it's stupid, but couldn't you create a handle to the SFPutFile routine and then do an HNoPurge? Wouldn't that do it?

macintosh/softw.devlpmt #137, from robertwoodhead [Robert Woodhead]

a comment to 133

Chris, it is bad form to kick out the disk and then put up the SF dialog because you can also have problems if the disk directory needs to be read in again. It would be better to (1) have the master disk write-protected (easy, just yank the plastic doohickey out) and (2) have a check *after* they select a file that looks at the disk and makes sure it isn't a master (and if it is, goes into no-way-jose mode). If you want to get fancy, you can read in the dialog template, find the position of the eject button, post a mousedown/up pair of events, then call the SF routine, which will Getnext those events and kick out the disk! Either way you have to do a check after file select because the user might just shove the disk back in again!

macintosh/softw.devlpmt #138, from frankb  
a comment to 134

If you absolutely must do it that way, ask the publisher if they're willing to sacrifice the time necessary for you to write a custom PutFile routine. I'm unfamiliar with the workings of SFPutFile, though. Anyone used it?

macintosh/softw.devlpmt #144, from ccawfor  
a comment to 137

Thanks for the advice on how to get around the SFPutFile problem I had. The solution we eventually settled on was pretty much along the lines you suggested. We write-protect the disk, call SFPutFile, and throw an error message at the user if he attempts to write to the protected disk. Publisher accepts that users can attempt to defeat the system by unprotecting the disk.

### WORD COUNT ADVICE

macintosh/qanda #247, from ksheldon [Ken Sheldon, Technical Editor, BYTE]

Does anyone know of a program (or, better yet, desk accessory) that will do a word count of text files on the Macintosh?

(continued)

macintosh/qanda #250, from spinefido [Vernon Keenan]  
a comment to 247

Yes, there is a desk accessory to do character, word, and line counts on plain text files. It works with Microsoft Word documents (but is off by about 1 to 5%) but doesn't work on MacWrite files (because of the text-compression scheme used by MacWrite).

I don't have this program in my personal library, so I can't report the name accurately, but I'm pretty sure that this critter exists as WC.BIN.

macintosh/qanda #254, from rschnapp  
a comment to 250

The version I've got (also WC.BIN) works with MacWrite, but you have to save as text-only first. I usually save to file "counts," then count that file. Nice feature—Word Count works nicely with HFS.

macintosh/qanda #256, from ksheldon  
a comment to 254

Thanks, Vern and Russ. I located a copy of Word Count, and it suits my needs pretty well. I was a little confused at first, since I tried to use it on a nontext MacWrite file. Word Count made a noble effort but got the count all wrong. Saving the file as text only and then using Word Count solved the problem. Thanks again.

P.S.: Who is Leo LaPorte? Is this thing freeware, shareware, or what?

macintosh/qanda #257, from spinefido  
a comment to 256

If I can't discern if the author wants a shareware fee from the start-up screen or the "ABOUT..." screen, then I assume that we have a generous soul out there.

macintosh/qanda #258, from rschnapp  
a comment to 257

I've made the same assumption. Too bad, though. The guy deserves a few bucks for the effort.

### TERMINAL EMULATION QUESTION

macintosh/qanda #259, from rschnapp

IBM 3278 Emulation, Anyone?

I've gotten several queries from folks on whether I've encountered a 3278 emulator for the Mac. I haven't. Anybody else seen one? There are apparently lots of people out there who would like to communicate with their IBM mainframes from their Macs.

macintosh/qanda #260, from stike [Jim Stikeleather]  
a comment to 259

I think there are two approaches for getting the Mac to talk to an IBM mainframe: (1) Apple makes a communications box that works with MacTerminal to emulate a 3270; (2) Simware makes a package that runs on IBM mainframes that takes all types of async terminals and makes the mainframe think they are 3270s. The VT100 is one. That's how we go into our mainframes on the Mac.

macintosh/qanda #262, from cjackson [Craig Jackson]  
a comment to 259

Many IBM systems have a protocol converter. (Ours is made by Renex.) If you have one of them, then all you need is a VT100 emulator. I know of people who've used MacTerminal to talk to our Renex.

### ANDY HERTZFELD AT THE SAN DIEGO MACINTOSH USERS GROUP

macintosh/news #252, from frankb

Andy Hertzfeld spoke at the San Diego Macintosh Users Group on Wednesday, February 5. He demonstrated some of the software he has worked on and is working on, and then fielded questions from the audience. First, I'll give my impressions of his newest product, and then I'll paraphrase most of the question-and-answer session.

Servant is the title of Andy's current project; it's a hybrid of Switcher and Finder that offers more functionality and speed than either. Servant on boot-up looks much like a standard Finder, with disks and the trash can out on the desktop and programs and files within windows. But Servant has a lot lurking under the surface. There are cosmetic changes, like the fact that any MacPaint document can become your desktop "pattern." Andy demonstrated this by using a digitized image of Woody Allen for his desktop. Other cosmetic changes include multiple lines for titles beneath icons, icon titles which scroll to show other information (such as creation date), adjustable-size icons (much better than the mini-icons of Finder 5.1), and more.

But the real treat comes when you run a program from Servant. No longer does the desktop go to solid gray and the program take over. No, now the new program simply opens up its windows over the Servant desktop and replaces the Servant menus with its own. You want to go back to Servant? No problem—just click in a Servant window, and Servant takes back the menu bar and desktop precedence. As for multitasking, Andy said that, in his opinion, what most people mean by "multitasking" is that they want to print and upload/download files while continuing to work, and Servant will provide just that. True multitasking is another matter entirely; it turns out that to switch applications, the Mac has to move about 2.5K of low memory, and without something as fast as the 68020 to do it, it's just too slow. So Bruce [Webster] was right: True multitasking on the Mac will be something of a kludge.

I wish I could do Servant justice; about the best I can do is to say that when it comes out, I'll buy it almost without regard to price. As for release date and price, Andy said we could see it as early as September or October, and although he has received some very lucrative offers, he keeps going back to the thought that Apple should buy it from him and distribute it for free. Understandably, this idea provoked a wildly enthusiastic response from the audience, who had been oohing and aahing for the past 30 minutes.

Now to the question-and-answer period. Before I start, though, please be forewarned: Everything past this paragraph, questions and answers alike, has been paraphrased, cut, or otherwise edited—except for those sections in quotation marks. What I write here may or may not have been what Andy wanted to convey, but I think it comes pretty close. Enjoy.

USER: What do you think of the Amiga?

ANDY: Commodore "betrayed" the Amiga. The Amiga designers really had a purpose, a vision, and that was to design the best game machine that ever existed. Commodore came in and decided to market the Amiga as a business machine—or, if you will, as a Macintosh. As a game machine, it's great. As a Macintosh, it's not. The software provided is terrible; have you looked at Intuition? The color of the windows on the desktop is the same as the desktop. That's "stupid." In design terms, the Amiga is today where the Macintosh was in mid-1982. We had early versions of MacPaint and Finder up and operating in October of 1981, but we didn't release it then. We waited until it was fully debugged and ready for public use. Commodore rushed the Amiga.

USER: What do you think of the Macintosh Plus?

ANDY: The Macintosh Plus is the "next logical step," but I have to say that the SCSI port is "overrated." Don't buy a Plus for the SCSI port. Buy one—or an upgrade—for the double-sided drive; it makes life a lot easier. I hate the new keyboard.

USER: Will we be able to upgrade to a Macintosh with slots?

ANDY: Let me put it this way: The Macintosh Plus is "evolutionary"; the open-architecture Macintosh will be "revolutionary." You can evolve with your existing Macintosh, but you can't revolt with it. In other words, no, I don't see an upgrade path—other than purchasing a new computer—to the Macintosh Plus.

USER: What do you think of the Apple II emulator programs for the Macintosh?

ANDY: Why would you want to turn a "great" \$2000 computer into a "poor" \$1000 computer?

USER: Will larger screens be available for the Macintosh?

ANDY: Yes, by the end of this year, larger screens should be available.

USER: What do you think of Apple's decision to unbundle MacPaint and MacWrite from the Plus?

ANDY: I know that Bill Atkinson was very upset about that decision, but I think he would have had more of a case if MacPaint had been evolving for the past two years. Two years ago, MacPaint was terrific; now it's mundane. It's the same with Switcher. Bill's a "personal hero" of mine, but he's the type of person who "knows the right way." As an example, have you ever wondered why the desktop behind MacPaint's windows is always gray? It's because Bill said, "I don't see why anyone would want a desktop color other than gray, so MacPaint's desktop is going to be gray!" This is a problem for Servant; you can get back to Servant by command-slash, but Servant isn't visible in MacPaint, and that's what I want. I'm trying to think of a way to work around MacPaint. To answer your question, I think it was a poor decision to unbundle MacPaint but a good one to unbundle MacWrite: The Macintosh doesn't have a good word processor, or at least one which shows off its capabilities.

USER: What would you recommend for someone getting into programming?

ANDY: Apple's Pascal from Think Technologies is great for learning Pascal; it lets you see all the actions your program takes and why your program behaves the way it does. By the way, Think Technologies has an "incredible" C compiler which they are supposed to be shipping in March. It integrates perfectly with the Macintosh philosophy and interface, produces excellent native code, and it's very, very fast!

USER: What do you think of slots for the Macintosh?

ANDY: I don't know what we were thinking of when we put 128K in the Macintosh. That idea came from Jef Raskin, who was big on the concept of everyone having the same amount of RAM, so every user could run every program. When we went to higher amounts of RAM, we gained power and versatility, but we lost some of that universal software compatibility. Slots are much the same; they offer expandability and performance but reduce compatibility.

USER: Why did Apple abolish the 5-volt out pin on the ports? Doesn't that affect Thunderscan?

ANDY: Yes, it does affect Thunderscan. The people who make Thunderscan are going to put out a model which will plug into the wall to draw its power, but that's unacceptable to me. The Imagewriter II has a power pin out, but that means we would have to require that people with a Macintosh Plus have an Imagewriter II to use Thunderscan. I'm not sure how it will be all resolved. As to why Apple did it, it was partially due to "paranoid hardware engineers." The engineers don't care about what users want or need; they just care about someone using "their" power supply. Also, Apple thinks it wants to use that 5-volt out pin for something else in future Macintosh models and wants to get hardware manufacturers out of the habit of using it. It's stupid.

USER: What do you think of the Atari ST?

ANDY: The ST is to the Macintosh as the C-64 is to the Apple II. Similar hardware design, lower pricing, etc. The ST has nice black-and-white video, I'll say that. But its system software is "somewhere between

bad and dreadful." GEM is "horribly coded." Look at the ST's ROM and you'll see that it offers maybe one-quarter to one-third of the functionality of the Macintosh ROM, and they used three times the space: 192K as opposed to 64K (in the original Macintosh ROM). I like the idea of the Atari ST, which is to bring computing power at low cost to the masses. If you don't have the money for a Macintosh, get an ST—but get a Macintosh if you can. You might see me writing software for the ST; not this year, but perhaps in 1987.

USER: How do you and Apple get along?

ANDY: I still visit Apple once a week. I hope that they "take care of my baby." But Apple's soul is different now; its mission, which was, under Steve Jobs, to make computers accessible, is gone. If you asked me what Apple mission is now, I would say it's "to protect its shareholders."

USER: What do you think of Next Inc.?

ANDY: Steve recruited me very hard last year, and he's a hard man to turn down. He has a way of motivating you, of making you think that whatever he's doing is the most important thing in the world. But I stayed with the Macintosh. Why? Because it's on the edge. If the Macintosh were selling four times what it is now, or 100,000 units per month, I would be at Next, because the Macintosh would be a success. If it were selling one-fifth as many as it is now, or 5000 units per month, I would be at Next, because it would be a failure. But it's neither; it's on the edge, and I want to do everything I can to help make it a success.

USER: What is Apple working on now?

ANDY: Pretend you worked at Apple. What would you work on? That's what they're working on.

USER: What about the File Server for the Macintosh and AppleTalk for the II?

ANDY: The File Server sucked away Apple's energy and talent while they should have been working on the HD 20. I lobbied against the File Server, but obviously, it took them a while to see it my way. I thought they should have developed the HD 20 first and then made the File Server a disk you stick in your Macintosh, so any Macintosh could be a File Server. As for AppleTalk on the II, they've had it up and running for quite a while now, so my guess is that you will see it soon.

USER: What do you think are lucrative areas for software development on the Macintosh now?

ANDY: Well, obviously, I thought Servant was an unfulfilled niche, and that's why I'm working on it. I would say desktop publishing is a good area to go into; there are a lot of advances to be made there. Someone needs to do a great AppleTalk game, with lots of spaceships all flying around and dogfighting. I know it wouldn't be very profitable, but it could be a "great work of art." I think that eventually something like MacDraw and a word processor will be merged into one extremely powerful program; this would be a good road to travel down.

That does it. This is where Andy stopped (the main address, anyway), and it's where my fingers are starting to go numb, so that's all for now. Someone else do this next time!

macintosh/news #257, from frankb  
a comment to 252

I have an erratum statement and an addendum to Andy's comments. First, the erratum: I wrote, "In other words, no, I don't see an upgrade path—other than purchasing a new computer—to the Macintosh Plus." Stupid me; that should have read "to the open-architecture Macintosh." Sorry about that.

Also, one thing I forgot to mention: Andy said that if an application is Switcher-compatible, then it has "95%" compatibility with Servant. He suggested that for maximum compatibility, programmers should make all windows draggable, i.e., movable around the screen by the user. ■

# THE BUYER'S MART

## A Directory of Products and Services

THE BUYER'S MART is a monthly advertising section which enables readers to easily locate suppliers by product category. As a unique feature, each BUYER'S MART ad includes a Reader Service number to assist interested readers in requesting information from participating advertisers.

RATES: 1x—\$375 3x—\$350 6x—\$325  
Prepayment must accompany each insertion.

AD FORMAT: Each ad will be designed and typeset by BYTE. Advertisers must

furnish typewritten copy. Ads can include headline (23 characters maximum), descriptive text (250 characters maximum), plus company name, address and telephone number. Do not send logos or camera-ready artwork.

DEADLINE: Ad copy is due 2 months prior to issue date. For example: June issue closes on April 1. Send your copy and payment to THE BUYER'S MART, BYTE magazine, 70 Main Street, Peterborough, NH 03458. For more information call Karen Burgess at BYTE 603-924-3754.

### ACCESSORIES

#### FREE CATALOG

Outstanding prices on computer accessories for your computer and workstation. Our catalog features a wide selection of quality products to meet all your accessory needs. Call or write today to receive your free catalog.

**LINTEK COMPUTER ACCESSORIES**  
POB 8056, Grand Rapids, MI 49508  
(616) 241-4040

Inquiry 712

### ACCESSORIES

#### Self-Inking Printer Ribbon

For users of Okidata and other open spool ribbon printers. Controlled Printout Devices are a new kind of printing ribbon that re-ink themselves, and will last 15 times longer than the ribbon you are now using. For further information please call or write.

**CONTROLLED PRINTOUT DEVICES, INC.**  
POB 869, Baldwin Rd., Arden, NC 28704  
(704) 684-9044

Inquiry 678

### BUSINESS OPPORTUNITIES

Do you know businesses or people that buy IBM hardware, software, accessories and supplies? If so, you could make commissions just for recommending our national firm. Full or part-time positions available. We discount most major brand name products 20-50%, which makes our prices most appealing. Plus you get \$ for the sale. Call or write for more info.

**WGGB**  
316 North Owen Street Mount Prospect, IL 60056  
312-392-2621

Inquiry 756

### SOFTWARE PACKAGING, DISKS

Cloth binders & slips like IBM's. Vinyl binders, boxes, and folders—many sizes. Disk pages, envelopes, & labels. Low qty. imprinting. Bulk & branded disks. Much More! Low prices. Fast service. Call or write for FREE CATALOG.

**Anthropomorphic Systems Limited**  
376-B East St. Charles Road  
Lombard, IL 60148  
1-800-DEAL-NOW (312) 629-5160

Inquiry 655

### KEYBOARD TEMPLATES

Templates and booklets put up to 850 commands at your fingertips. Over 60 programs available for IBM, Apple IIe, Apple II+, Kaypro, Osborne and over 22 IBM compatibles or Key Tronic 5150/5151 keyboards.

Standard \$14.50 Enhanced \$16.95  
Deluxe \$19.95 \$2 S/H  
**SGW**  
P.O. Box 29249 San Diego, CA 92129  
(619) 672-2720

Inquiry 735

### VIDEO STORES

We need ambitious dealers in all U.S. states and Canada to market a powerful system to computerize video tape rental stores.

**WINCHESTER DATA PRODUCTS INC.**  
3301-Executive Drive., #204, Raleigh, N.C. 27609  
(919) 872-0995

Inquiry 757

### LOWEST PRICES ON DISKETTES

5 1/4" SSDD \$49, DSDD \$59, High Density \$1.79,  
3 1/2" SSDD \$1.55, DSDD \$1.99  
• Lifetime warranty • Includes tyvek sleeves  
• 100% error free • Reinforced hub ring  
• Finest quality • Labels & write protect tabs  
Free UPS shipping. Minimum 100 diskettes.  
Send check or call. CA residents add 6 1/2% sales tax.

**Data Bureau Inc.**  
1633 Westwood Blvd., Ste. 120  
Los Angeles, CA 90024  
213-479-0345

Inquiry 682

### FREE CATALOG OF ELECTRONIC PARTS!!

Thousands of parts and new surplus electronic parts at super low prices. FAST ORDER PROCESSING AND SHIPPING (95% of all orders shipped within 48 hours).

CALL OR WRITE FOR A FREE CATALOG.  
**ALL ELECTRONICS CORPORATION**  
POB 20406, Los Angeles, CA 90006-0406  
(213) 380-8000

Inquiry 651

### CADD/CAM

#### CADD for \$99.95

FEATURES: Drawing layers • User Defined Fonts • Component Libraries • Video & Digitizer Menus • Color Graphics  
Autocad™ file conversion • \$24.95  
Dot Matrix Printer/plotter option • \$24.95  
MC, VISA, COD, add \$3.00 for shipping  
60 day money back guarantee  
**GENERIC SOFTWARE**  
13250 N.E. 40th St., Bellevue, WA 98005  
1-800-228-3601

Inquiry 697

### DATA CABLES & PARTS

EIA RS232-C Data Cables - standard, extended distance, Teflon Assemblies. Also Centronics (parallel), Coaxial (RG59U, RG62A/U, Dual Wang, Twin-axial), Ethernet, Ribbon, IBM, DEC Compatible cables, AB switches, connector parts, bulk cable, tools & hardware (wall plates). Send for Catalog.

**Communication Cable Co.**  
POB 600-B, Wayne, PA 19087  
215-644-1900

Inquiry 673

### BAR CODE

#### BAR CODE READERS/PRINTING

Programs \$49-\$299. Readers-\$325 up. PRINT Bar Codes on PC and Epson/Okidata or IBM Proprinter - Code 39, I 2of5, UPC, MSI, DOD-LOGMARS, AIAG. Graphics chs up to 1". Labels, Catalogs from files. Subroutines for BASIC, Cobol, Clipper, Turbo, Pascal, C, dBASE III Plus.

**Worthington Data Solutions**  
130 Crespi Court, Santa Cruz, CA 95060  
(408) 458-9938

Inquiry 758

### COMMUNICATIONS

#### SMART AMIGA BBS SYSTEM

Not a clone! Understands natural English commands. Very full featured with XMODEM database, voice paging, textbase, 10 message bases, multiple access level. MUCH more. \$99 or \$3 for fact-sheet, applicable. Business or hobbyist. Friendliest ANYWHERE!

**CVI Software**  
PO Box 9399, El Paso, Texas 79984  
(915) 833-7073

Inquiry 680

### COMPUTER PROTECTION

• UPS • LINE CONDITIONERS • ISOLATORS  
• MODEM PROTECTORS  
• AC POWER INTERRUPTERS  
— HUNDREDS OF HINTS & PRODUCTS —  
FREE CATALOG 1-800-225-4876

**ELECTRONIC SPECIALISTS, INC.**  
171 So. Main St., POB 389, Natick, Mass 01760  
(617) 655-1532

Inquiry 691

### BIORHYTHM

#### Print out/sell BIO charts.

Sophisticated program plots physical, emotional & Intellectual cycles for indiv. & compatibility chart for mate. Biorhythm theory used in sports/sales. One-time entry file. Create birthday lists. TIPC, IBM PC compatible. DOS 1.0 or greater. \$39.95. VISA/MC/COD.

**C-Level Software Development Inc.**  
P.O. Box 128, Cypress, TX 77429  
(713) 469-0861

Inquiry 669

### TELETERM

Sophisticated Terminal Emulator of most popular terminals including DEC VT100, plus build your own... up/download direct to disk/printer... error free file transfer protocols... full screen ASCII text editor... remote print... unattended file transfer mode.

**Telexpress, Inc.**  
PO. Box 217, Willingboro, NJ 08046  
(609) 877-4900

Inquiry 751



# THE BUYER'S MART

## DISK CONVERSION

### INCOMPATIBLE WORD PROCESSORS?

We convert to and from: XEROX, DEC, IBM, LANIER, WANG, PC-DOS, CONVERGENT TECHNOLOGY, WORDSTAR, MULTIMATE, SAMNA ASCII, MICOM.  
Also most CP/M systems.  
LOWEST PRICES

#### DATA CONVERSION INC.

6310 Caballero Blvd. • Buena Park, CA 90620  
(714) 522-7762 (800) 824-4851 In CA.

Inquiry 763

## CONVERSION SERVICES

Convert any 9 track magnetic tape to or from over 500 formats including 3 1/2", 5 1/4", 8" disk formats & word processors. Disk to disk conversions also available. Call for more info. (312) 459-6010

#### Pivar Computing Services, Inc.

165 Arlington Hgts. Rd., Dept. #B  
★ ★ Buffalo Grove, IL 60089 ★ ★

Inquiry 725

## DISK AND TAPE CONVERSIONS

High quality conversion services for Dedicated Word Processors, Mini and Microcomputers. Over 600 3 1/2", 5 1/4", and 8" formats. Also 800-1600BPI tape. Included: Wang, NBI, CPT, DEC, Videx, Lanier, OS/6, Xerox, IBM Sys/34/36/38/5520, Mac, Victor, TRS, Apple, NSTAR, IBM PC/AT, HP, and most of the other microcomputers. We can convert directly into word processing software such as: DW3, WP, MS/WORD, WS, Samna, MM, PFS, and many others.

DATA FORMATS, INC. (408) 972-1830

Inquiry 683

## DOCUMENTATION

### COMPUTER ASSEMBLY MANUALS

**BIG BLUE SEED** for IBM™ BUILDERS: parts list, placement diagrams, instructions for assembling over 65 IBM-compatible bare cards - \$14.95.

**APPLE SEED II** for APPLE™ BUILDERS: Instructions for assembling 77 Apple-compatible bare cards including the II+ and IIe motherboards - \$12.95.

**BOTH ASSEMBLY MANUALS FOR \$25.00**

#### NuScope Associates

P.O. Box 790 • Lewiston NY • 14092

Inquiry 723

## DUPLICATING SERVICES

### DUPLICATION SOLUTIONS

We have the answer to your duplication needs, no matter what the volume. We supply auto-loaders, disks, and technical support. We provide copy protection, serialization, package assembly, and distributive shipping.

#### MegaSoft

P.O. Box 1143, Freehold, NJ 07728

1-800-222-0490 201-462-7628 (in NJ)

Inquiry 714

## WESTERN TRANSDATA, INC.

Why risk duplicating your important programs on your computer, when our equipment is designed solely to duplicate disks & verify their perfection 100%? Over 600 formats, 3 1/2", 5 1/4" & 8". Plus serialization, copy protection, labeling, packaging, shrink-wrapping and fast, personalized service.

#### WESTERN TRANSDATA, INC.

1701 E. Edinger Ave. A-4  
Santa Ana, CA 92705  
714/547-3383 (collect)

Inquiry 755

## DUPLICATING SERVICES

### BLANKET SERVICES

Diskette duplication • Packaging • Stocking/Drop shipping • 48 hour delivery • SUPERLoK copy protection • No mastering fee • No charge for standard labels • Place a blanket order with releases as you need them for any quantity at a fixed price.

#### Star-Byte, Inc.

2564 Industry Lane, Norristown, PA 19403  
215-539-4300 800-243-1515

Inquiry 745

## ENTERTAINMENT

### ★ BORED WITH YOUR IBM PC? ★

Try our ABS (Anti-Boredom Software). TOMMY'S TREK. The program you all know and love, come alive with sound effects and real-time updating. Requires BASICA, 64K, video mono monitor. 2S-2D diskettes only.

\$19.95 (check, MO) p/p FREE CATALOG

#### TOMMY'S TOYS

Box 11261, Denver, CO 80211

Inquiry 768

## HARDWARE

### IA M . . . IN-CIRCUIT EMULATORS

Real time full function In-Circuit Emulators for Design Engineers. Load Hex Files, Assemble/Disassemble, Edit Memory, Set Constants, with Break and Print Points. Stand alone operation or turns your Personal Computer into a Development System. And at an incredibly low Price . . . \$498. Models Available Z80, 8085, 8088 and NSC800. For immediate response Call (916) 961-8082

#### IA M

P.O. Box 2545, FairOaks, CA 95628

Inquiry 703

### Tandy 1000 Hardware

TanPak Multifunction Cards . . . \$329

Memory to 512K, RS232, Clock, DMA

TanPak Secondary . . . \$249

Memory to 256K, RS232, Clock

10 Meg Hard Drive with Controller . . . \$549

20 Meg Hard Drive with Controller . . . \$749

#### Hard Drive Specialist

1-800-231-6671 or 1-713-480-6000

16208 Hickory Knoll, Houston, Texas 77059

Inquiry 700

## USED APPLES & IBM'S

APPLE II+ as low as \$275.00

APPLE IIe — CALL

Motherboards & accessories — call  
We buy, sell, & horse-trade — Apple, IBM, & CBM.

#### SHREVE SYSTEMS

845 Lark Ave., Shreveport, LA 71105

318-865-6743 4-9 p.m. C.S.T. VISA/MC

Inquiry 770

## EPROM/EEPROM PROG. \$250

Programs 2716-27512, 25xxx and 68764/66 eproms via RS-232. Also 874x micros and 28xxx & 52Bxxx EEPROMS. Automatic baud rate select, built in help menus, no personality modules!

16 BIT I/O MODULE \$75

Low cost control via RS-232. Expands to 512!

#### INTELLITRONICS

P.O. Box 3263, Tustin, CA 92680

(714) 669-0614

Inquiry 705

## HARDWARE

### POWERLINE GREMLINS?? POWER FAILURES??

The MEIRICK STANDBY POWER SYSTEM is the TOTAL SOLUTION to your powerline problems.

240 watt system - \$365; 400 watt system - \$495;  
800 watt system - \$795

#### MEIRICK Inc., POWER SYSTEMS DIV.

Box 298, Frisco, CO 80443 303-668-3251

Inquiry 715

## TANDY-EPSON

Our 10th year of DISCOUNTS

Ed or Joe McManus

Fgt. Prepaid. Save Tax

Toil Free 800-231-3680

#### MARYAMK INDUSTRIES, INC.

22511 Katy Fwy., Katy (Houston), TX 77450

1-713-392-0747 Telex: 774132

Inquiry 713

## \$79 MONO/GRAPHIC/PRINTER BOARD

\* Hercules compatible \* 720 x 348 pixel

\* Lotus 1-2-3 compatible \* 80 x 25 text

\* Printer, Monitor port \* 1 year warranty

\* Light pen port \* 1 stock delivery

1 - \$99 2-9 \$89 10 - \$79

#### SUGAR INTERNATIONAL

420-85th Pl., S.W. #L205, Everett, WA 98204

(206) 353-2574 Carl, Mo-Sa, 10-7

Inquiry 747

## Motorola 6805 Single Chlp Microcomputer Development System

Use the IBM PC or compat. to develop products based on Mot. 68705P3/R3/U3 single chip micros. Complete sys includes an assembler, a debugger and a programming board with driver s/w for Intel or Mot. files. 1 serial port required. Complete system - \$495, Prog. Bd. - \$349 VISA/MC/MO/CK

#### TEC

P.O. Box 53, West Glover, VT 05875

(802) 525-3458

Inquiry 661

## The BG-Boards

and well-crafted books teach you how to construct circuits for interfacing external devices to IBM, Apple, TRS-80, Tandy, Commodore, Timex-Sinclair micros for monitoring and control \$35 to \$350. Free catalog.

#### Group Technology, Ltd.

Route 1 Box 83, Check, VA 24072

703-651-3153

Inquiry 698

## GBA

Full function IEEE-488 bus analyzer with 12,287 byte memory. Controlled from any RS-232 computer or terminal. Also provides full bus control and message sending capability. \$995.00

#### Connecticut microComputer, Inc.

568 Danbury Rd., New Milford, CT 06776

Phone: 203-354-9395 Telex: 710-456-0052

Inquiry 769

# THE BUYER'S MART

## MULTIUSERS

### MULTIUSER CLIPPER (OR C)!

With NOVELLIB and Nantucket's Clipper or Lifeboat's Lattice C Compiler.

- NOVELL or PC Networks
- Record & File Locking
- Dead-Lock Avoidance
- Print Spooling
- Login, Station ID, and More!
- Object code and examples

NOVELLIB only \$99. (specify Clipper or C).

#### Communication Horizons

701 7th Ave., Dept B, New York, NY 10036

Tel: (212) 724-0150 Source: NAN285

Inquiry 674

### DBASE III PLUS PLUS

NOVELLIB-2D gives you what Ashton-Tate left out: higher level Network functions:

- NOVELL or PC Networks
- Semaphore Locks
- Print Spooling & Banners
- Station & User ID, and More!
- Electronic Mail
- BIN code and examples

NOVELLIB-2D only \$99.

#### Communication Horizons

701 7th Ave., Dept B, New York, NY 10036

Tel: (212) 724-0150 Source: NAN285

Inquiry 675

## PRINTING

### DO YOU NEED QUALITY COMMERCIAL PRINTING?

Call Eli's. Helping people since 1948.

Ask for Rick or Chuck

1-800-228-2007

1-402-342-7006

1231 South 14th Street  
Omaha, Nebraska 68108

Inquiry 692

## SOFTWARE BUSINESS

### Programmers:

We guarantee our products to be sold, bugfree.

\* CorrectForth - Very professional.

\* Correct\_Datamizer - 50:1 data compression guaranteed.

\* SafeModem - Hackerproof.

\$80.75 per program MC/VISA/MO/Check. Specify computer.

#### Correct Software, Inc.

RR1 Box 140, Black Hawk, SD 57718

(605) 787-5904

Inquiry 679

### MY WORD!® is just \$35.00

Complete word processing plus sort, add rows & columns, merge/print, quick/print, macros, math, micro-justify, use all 256 char. Source: add \$35. 150 page printed manual. 30-day money-back guarantee. IBM PC or compatible, 128K, one drive, any printer.

#### T.N.T. SOFTWARE, INC.

34069 Hainesville Road, Round Lake, IL 60073

(312) 223-8595

Inquiry 753

### DATA BASE MANAGER

CCforms is a menu-driven database manager featuring formatted screens, mail-merging, field editing, selection, and sorting. Ideal for client/customer/mailling lists, bookkeeping, payroll/personnel, inventory/stock tracking, and data-entry. \$100 w/doc.

#### — COMEAU COMPUTING —

91-34 120th Street, Richmond Hill, NY 11418

(718) 849-2355 — 24 hr. HOTLINE

Inquiry 672

## SOFTWARE BUSINESS

### MINUTE-a-DAY MANAGER™ TAX SURVIVAL SPECIAL

New *Shadow Writing™* feature adds the power of AI to your record keeping. 256K MS/PC-DOS package includes FREE Custom Calendar Kit PLUS:

- CHECKBOOK/CREDIT CARD MANAGER
- COMPUTER LOGGER • AUTO LOGGER

Visa/MC (May be tax deductible.) \$59.95 + \$3 s/h

#### Multi-Data Management Associates

1-800-255-2255 ext. 3300

Inquiry 720

### dFELLER Inventory

A business Inventory program written in modifiable dBASE source code. The menu-driven program lets you locate items by inventory name or number. It keeps track of reorder points, vendors, average cost, and other info. Requires dBASE II or III. PC-DOS/CPM \$150.

#### Feller Associates

550 CR PPA, Route 3, Ishpeming, MI 49849

(906) 486-6024

Inquiry 696

### The Andsor Collection™

Unique concept: creates complete, self-contained, window-based data management environment, in one DOS file. Simplifies everything. Combine functions to create your own solutions in any application: calculations, database management, modeling, text processing, charts, data analysis, statistics, reports, labels, forms, presentations, mail-merge, etc. Simple enough for a PCjr, sophisticated enough for a PC AT.

SEE ALSO THE AD BELOW

Inquiry 692

### The Andsor Collection™

From simple calculations, files, inquiries, to complex models, data structures, reports. Superb 400 page hard-cover manual, with many examples. US \$95 + \$5 s/h 60-day money-back guarantee. Visa/MC/AmEx/Chk/MO/COD. Call or write now to order. IBM PC/XT/AT/PCjr, 128K, one drive or hard disk, monochrome and/or color, DOS 2.0+. Not copy-protected.

#### ANDSOR RESEARCH INC.

181 University Avenue., Suite 1202,  
Toronto, Ontario, Canada M5H 3M7

(416) 364-8423

Inquiry 654

### MoneyCounts™ Version 3.0

Everything you need to take charge of your finances: Checking/Credit Card Mgt., Budgeting, Exp. Analysis, Financial Rpts., Graphics, Tutorial, much more. Great for home/business.

CPA designed. IBM PC/XT & Compatibles with DOS 2.0 or later and 192K - \$69.95

#### PARSONS TECHNOLOGY

6925 Surrey Dr. NE., Cedar Rapids, IA 52402

(319) 373-0197 CHECK/VISA/MC

Inquiry 724

### SMITH'S INVOICE

Invoices, shipping labels, customer database. Customer & product mailing lists and labels. Menu driven—easy to use. For IBM PC with 128K and 2 DS/DD drives or hard disk. All software, manual on disk \$15. Same-day shipment on personal checks.

#### Smith Consulting

Route 1, Box 213, Greensburg, IN 47240

Inquiry 737

## SOFTWARE/BUSINESS

### FREE SOFTWARE

MS-DOS or PC-DOS file catalog program keeps track of all those disks and directories. For a free sample disk send \$5.00 shipping and handling to:

#### SDG, Inc.

9 Wompatuck Road  
Hingham, Massachusetts 02043

(617) 749-8327

Inquiry 740

### PC-Write™ Shareware

Fast, powerful word processor/text editor for IBM PC. New Version 2.6 with auto reformat, optional menus, on-screen help, laser printer support, new expanded manual. Mailmerge, split screen, ASCII files, macros. All software, tutorial/guide on diskette, \$10. OK to copy. Register for full manual, support \$75. 90-day money-back guarantee.

Quicksort (206) 282-0452 Visa/MC  
219 First N. #224J, Seattle, WA 98109

Inquiry 730

### CUSTOM PAYROLL

All systems have multiple pay categories, calculation of all taxes, user defined deductions, 401(k) handling, many reports, paychecks, W-2 forms, and much more. Custom features are available. Prices start at \$695 for system, manual, and PC Basic source code.

#### Datasmith, Inc.

Box 8036, Shawnee Mission, KS 66208

(913) 381-9118

Inquiry 762

### PC-File III™ Version 4

Search, sort, browse, global changes, macros, mailing labels, format reports with selection & calculations, sub-totals, totals, averages, encryption. Exchange data with 1-2-3, WORD, WordStar. Over 190,000 users. \$59.95 + \$5 s/h. For IBM PC.

#### ButtonWare, Inc.

P.O. Box 5786, Bellevue, WA 98006

1-800-J-BUTTON

Inquiry 664

### PC-File/R™

All the power of PC-File III plus: Relational link to other databases, integrated letter writing & mail-merge, context sensitive pop-up help windows. New binary search retrieves data hundreds of times faster. \$149.95 + \$5 s/h.

#### ButtonWare, Inc.

P.O. Box 5786, Bellevue, WA 98006

1-800-J-BUTTON

Inquiry 665

### COBOL TOOLKIT

For Nevada/Utah Cobol users. New routines for screen cursor control, clearing screen, headings, windows, skip, backspace, left zero, dup., fast random file search, simple sort & more. Great stuff for the non-guru. Cobol source code \$20. US.

#### Cobol Source

70 Yorkminster Rd.  
Toronto, Canada M2P 1M3

Inquiry 767

# THE BUYER'S MART

## SOFTWARE/BUSINESS

### ACCOUNTING SYSTEMS

\$49.95 + \$2.50 S&H

- Construction
- General Systems
- Medical Billing
- Retail Sales
- Equipment Rental
- Manufacturing
- Professional
- Wholesale

Menu-Driven — Full File Maintenance

Each includes GL, AR, AP, INVENTORY, PAYROLL & more!

### HIGH TECHNOLOGY, INC.

9312 W. 92nd Ave., Westminster, CO 80020

(303) 431-7596 VISA and MASTERCARD Accepted!

Inquiry 702.

## SOFTWARE/BUSINESS

### TIME & BILLING \$99 JOB COST Option \$50

30 Day Money-back Trial  
Virtually unlimited direct labor, direct cost and overhead categories. Very flexible. Prints your statements, many reports, and more! MS-DOS/IBM-PC & compatibles. VISA/MC/COD

### Accounting Systems

1148-5 Executive Circle, Cary, NC 27511

(919) 467-3428

Inquiry 650.

## SOFTWARE/CHURCH

### ROMAR CHURCH SYSTEMS™

Membership-61 fields plus alternate address; labels, letters, reports any field(s). Offering-256 funds; optional pledge, statements; post to 255 x/year. Finance-GL with budget; up to 500 sub-totals & 99 depts. month & YTD reports anytime for any month. Size 2000 people/flop-py. 25000/10 meg. Ad too short! Write!

### Romar Church Systems, Attn: BMB

P.O. Box 4211, Elkhart, IN 46514

(219) 262-2188

Inquiry 732.

### PC-Calc™ Version 3

64 columns x 256 rows, math and stat. functions, horizontal bar graphs, title locking, Individually adjustable column widths, IF...THEN, link to other spreadsheets or PC-File databases, much more. Requires 256K IBM PC. \$59.95 + \$5 s/h.

### ButtonWare, Inc.

P.O. Box 5786, Bellevue, WA 98006

1-800-J-BUTTON

Inquiry 666.

## DATA ENTRY SYSTEM

Heads-down data entry with two-pass verification for the PC/XT/AT & compatibles. Loaded with features like: Auto dup & skip, verify bypass, range checks, & table lookups. Fully menu driven only \$395. Call for free 30 day trial period.

### COMPUTER KEYS

6519 193 SW, Lynnwood, WA 98036

(206) 776-8443

Inquiry 676.

## SOFTWARE/EDUCATION

### War or Peace:

### Decision — Making in a Nuclear Age

Stimulates discussion on the role of nuclear weapons in national security. Players choose U.S. or Soviet side. High school or home use, both teacher and student manuals included. IBM or Apple. \$49.95 MC/VISA/AMEX. For info. call: 207-775-1330. For orders call: 1-800-628-2828 ext. 649.

### Bright Ideas, Inc.

52 Exeter St., Portland, Maine 04102-2839

Inquiry 662.

### PC-Type™

Fast, compact, capable & easy! Help panels, hands-on tutorial, macros, multiple-line headings & footings, DOS path support, print spooling, block operations, etc. ASCII files. Install program allows customization. \$59.95 + \$5 s/h. For 128K IBM PC.

### ButtonWare, Inc.

P.O. Box 5786, Bellevue, WA 98006

1-800-J-BUTTON

Inquiry 667.

## LP88-LINEAR PROGRAMMING

A powerful menu-driven system for solving linear programs w/ up to 510 constraints & 2510 variables. Features include interactive & batch operation, spreadsheet-style input & editing, storage of problems & bases. Simplex Algorithm restart, report generator, sensitivity analysis. Req. IBM PC, 192K. \$99 w/8087 support, user's guide. VISA/MC.

### EASTERN SOFTWARE PRODUCTS INC.

P.O. Box 15328, Alexandria, VA 22309

(703) 549-5469

Inquiry 689.

## SPANISH VERBS

Conjugation can be fun! Random sentence generation provides millions of fresh questions as you practice Spanish verb conjugations in five tenses. Instant feedback, classroom teacher developed, slides etc. Disk for PC, compatibles. Apple. \$39.95.

### Dolphin Software

230 S. 39th St., Boulder, CO 80303

(303) 494-0743

Inquiry 759.

## TIME IS MONEY

Time + Expenses Billing: Fast tracking of man-hours, expenses for consultants, attorneys, architects, etc. Day-Book: Track 90 days of appointments, daily agenda, requires color-graphic card. \$49.95 each. For PC/compatibles, MS/DOS 2.0, 128K reqd. MC, VISA.

### Baker Business Systems

2802 Highway 90 West, Seguin, TX 78155

(512) 372-3949

Inquiry 657.

## TSA88-TRANSPORTATION

A general-purpose system for solving transportation, assignment and transshipment problems. Solves transportation problems with up to 510 origins and/or destinations by applying the Transportation Simplex Algorithm. Menu-driven with features similar to LP88. Requires 192K. \$99 with 8087 support user's guide. VISA/MC.

### EASTERN SOFTWARE PRODUCTS, INC.

P.O. Box 15328, Alexandria, VA 22309

(703) 549-5469

Inquiry 690.

## SOFTWARE/GENERAL

### AI for the IBM PC

TOPSI is a full version of OPS5 which runs under MS-DOS, Unix or CP/M. A fast, efficient expert system development tool.

Prototyping: \$125

Production: \$250

Professional: \$375

C version, add \$20 Shipping, add \$5

### DYNAMIC MASTER SYSTEMS

POB 566456, Atlanta, GA 30356

(404) 565-0771

Inquiry 688.

## ★ FORECASTING ★ MODELING ★ PLANNING ★

Compatible with IBM PC & Apple II

### MICRO-BJ™

• Box-Jenkins ARIMA

• Identity, estimates, forecast

\$295.00

### NUAMETRICS™

• Econometrics package

\$195.00

### PROFESSIONALS CHOICE

• Link to Lotus, Visicalc

Multiple order discounts

50% off Apple II orders

\$195.00

### STRATIX

P.O. Box 4413 • Burlingame, CA 94011

(415) 697-0573

MC/VISA

Inquiry 746.

## BUDGET PREP & EXPENSE FORECAST SYSTEM

User friendly, menu driven system helps create budgets/allocations, maintains hierarchical structure and provides rollup/report generation. Tracks and forecasts headcount, salaries, and up to 10 user defined categories of expense. Recasts, graphics, and more. Enhanced version of system developed for and used nationally by Fortune 100 company. For IBM-PC and compatibles. \$199.00

### Trendition, Inc.

Software Div., POB 424, Convent Station, NJ 07961

(201) 876-3910

Inquiry 766.

## WORD IMAGE

Edit 4 large files, undo, key macros, math, search/replace in ranges, all printers, help, on-screen attributes, sub-directories, command driven, batch, manual w/index & tutorial, fast, MORE!!! Needs 320KB, PC DOS 2.0+. Intro: \$50.00, 30-Day trial.

### Software Ideology

P.O. Box 305, Brooklyn, N.Y. 11204

718-236-3876

Inquiry 741.

## SOFTWARE/CHURCH

### Church Package

Parishioner Time, Talent and Treasure System program is written in modifiable dBASE source code.

• Contributions • Disbursements • Ledger

• Names with mailing labels

• Personal information database.

Requires dBASE II or III. PC-DOS/CPM-80 \$200.

### Feller Associates

550 CR PPA, Route 3, Ishpeming, MI 49849

(906) 486-6024

Inquiry 695.

## THE BEST OF THE BEST!

Public Domain & User Supported Software for IBM PC or compatible. Word Processing, Database, Spreadsheets, Utilities, Games, Accounting, etc! 50 disk package \$205.00, or rent 2 wks. \$75.00. Info & Super Sampler Disk \$6.50, Deluxe Word Processor \$6.50, both \$12.00. MC/VISA

### BLUE CIRCLE GROUP, INC.

Box 23502, Minneapolis, MN 55423

(612) 823-4111

Inquiry 659.

# THE BUYER'S MART

## SOFTWARE/GENERAL

### IBM - TOSHIBA PRINTER INTERFACE

- all extended capabilities of the TOSHIBAS available
- bit mapped graphics supported
- Prints all IBM extended ASCII characters
- screen dumps in text and graphics
- escape sequences supported
- popular software supported directly
- "Sideways" and "Pixel Visuals" support
- dealers welcome **\$79.95 (\$2.50 S&H)**

**Integrated Data Technologies, Inc.**  
4775 Bunchberry Lane, Colorado Springs, CO 80917  
303-488-2583 MC/VISA

Inquiry 704.

## SOFTWARE/GRAPHICS

### GRAPHICS PRINTER SUPPORT

*AT LAST! Use the PrtSc key to make quality scaled B&W or color reproductions of your display on any dot matrix, inkjet, or laser printer. GRAFPLUS supports all versions of PC or MS-DOS with IBM, Techar, and Hercules graphics boards. \$59.95.*

**Jewell Technologies, Inc.**  
4302 SW Alaska St., Suite 207, Seattle, WA 98116  
(206) 937-1081

Inquiry 708.

## SOFTWARE/LANGUAGES

### 68020

Motorola compatible macro Assembler Package features linker, object librarian, symbol report generator with cross reference. Produces S-records and ROMable code. For CP/M-68K, MS-DOS \$750. Portable Source in C \$3500. AVAILABLE NOW.

**Quelo, Inc.**  
2464 33rd Ave. W. Suite 173, Seattle, WA 98199  
206/285-2528 telex 910-333-8171

Inquiry 729.

### CASE Apple Pascal OF

- \* MONITOR: The pop-up handyman. . . . . \$49
- \* EDIT: The super system editor. . . . . \$39
- \* FORM: Advanced text formatter. . . . . \$34
- \* UTIL: Disk and program utilities. . . . . \$39
- \* SUBCITY: 100 useful subroutines. . . . . \$39

FOR freeCat DO call OR written,

**DOGSTAR SOFTWARE**  
P.O. Box 302, Bloomington, IN 47402  
(812) 333-5616

Inquiry 686

### PLOTTER SOFTWARE

Save time and money by creating your own presentation quality text slides. THE DGI SIGMAKER is an easy to use menu driven program for your IBM or APPLE computer and most plotters (Epson, HI, HP, HP-GL, IBM and others) for only \$75.

**DECISION GRAPHICS, INC.**  
P.O. Box 2776-B, Littleton, Colorado 80161  
Phone (303) 796-0341

Inquiry 684.

### Symbolic Debugger for Turbo Pascal™

- Set breakpoints at line numbers or procedures
  - Display and modify variables symbolically
  - Fully integrated into Turbo Pascal environment
- Requires Turbo 2.0 or 3.0, IBM PC version.  
Only \$49 plus \$2 S&H.

**KYDOR COMPUTER SYSTEMS**  
812 S. Sherman St., Richardson, Texas 75081  
(214) 669-1888

Inquiry 711.

### KNOW OVERALL BALANCE

State of the art for IBM & compatibles. Up to four accounts: checking, saving, IRA, etc. Balance checkbook. Flip through pages. Help screens. Print options. Password protected-use office computer. Very fast. **\$39.95 + \$3 s&h** or send **\$3.50** for demo disk.

### DATACORP

4215 Roseland, Dept. P-1, Houston, TX 77006

Inquiry 764.

### FORTRAN PROGRAMMER?

Now you can call 2-D and 3-D graphics routines within your FORTRAN program.  
**GRAFMATIC: 75 callable routines for screen output. \$135.**  
**PLOTMATIC: Pen plotter driver. \$135.**  
For the IBM PC, XT, AT and compatibles. We support a variety of compilers, graphics boards and plotters.

**MICROCOMPATIBLES**  
301 Prelude Drive, Dept. B  
Silver Spring, MD 20901  
(301) 593-0683

Inquiry 716.

### WINDOW & SCREEN Mang't

For Modula 2, C, Pascal, IBM/compatibles, Atari 520ST. Create overlap, pop-up menu/screen/windows without touch program, beat 64K limit. Save, move, zoom/shrink swap/delete, color, border, header, cursor control. \$59.00 VISA/MC.

### APPLIED COMPUTING

3368 Westchester Rd., Bloomfield Hills, MI 48013  
519-254-4472

Inquiry 656.

## SOFTWARE/LANGUAGES

### CAF, COMPARE ASCII FILES

PC user, are you having problems comparing your files? We have the solution. . . CAF is a very smart program that compares two text files and produces a comprehensive differences report. Only **\$15.95 + \$3.00 S&H (CA + tax)**. Send check or money order to:

### I.S.E. Inc.

P.O. Box 241740, Los Angeles, CA 90024  
(213) 398-3106

Inquiry 707.

### RUN FAST, LOOK BEAUTIFUL

If this is what people expect from your BASIC programs, then you need YES MASTER! a DOS resident development aid that includes a screen painter, an ISAM file manager, a window manager, a printer generator and more. All in one package. \$245. No royalty.

### SOFTWARE, INC.

500 Sutter St., Suite 222 BC  
San Francisco, CA 94102  
(415) 397-4666

Inquiry 742.

### Tools for CB80 & CB86

BDOS, DOS, and BIOS calls from CB80 and CB86! CBC Tools includes functions for directory access, string ops, a debugger, radix conversion, command line parsing, quicksorts, bit and byte ops. and more for CP/M-80, CP/M-86, and PC-DOS, \$180.00. Ask about our Pascal MT + products.

### Minnow Bear Computers

POB 2233 Sta. A, Champaign, IL 61820-8233  
(217) 398-6883

Inquiry 719.

### BASEBALL

Easy to use statistical package. Tracks 31 major statistics. Less than 5 minutes a game to track every player. Team/league hitting and pitching reports. IBM PC MS-DOS: TEAM TRACKER \$45.00, LEAGUE TRACKER \$75.00, SCHEDULE CHECKER \$35.00, ROSTER \$35.00.

### PHENOM SPORTWARE

215 Catherine St., Scotia, NY 12302  
(518) 346-3924 518-387-7056

Inquiry 785.

### Minnesota SNOBOL4 Language

Powerful string & data handling facilities. Interpreter compatible with mainframe SNOBOL4. 32K strings, 32 bit integers, 8087 for float & large memory model. Sample pgms include ELIZA. For >128K IBM PC & DOS or equivalent. Definitive "green" book by Griswold et al available.  
Guide + 5 1/4" SSD diskette. . . . . \$44.95  
Guide + diskette + "green" book. . . . . \$59.95  
"Green" book only. . . . . \$24.95  
Postpaid in USA. In NY add tax. VISA/MC (914) 271-5855  
**BERSTIS INTERNATIONAL**  
POB 441, Millwood, NY 10520

Inquiry 658.

### FINALLY!

**A Subroutine Library for Compiled BASIC OVER 100 SUBROUTINES AND FUNCTIONS for Use with MicroSoft QUICK BASIC or IBM BASIC Compiler 2.0.** Full Documentation Package with Examples, 30 Day Money-Back Guarantee. VISA/MC FINALLY! is only \$99.00 + \$4.00 S&H

### KOMPUTERWERK, INC.

851 Parkview Blvd., Pittsburgh, PA 15215  
(412) 782-0384

Inquiry 710.

## SOFTWARE/GRAPHICS

### SCIENTIFIC GRAPHS

SCI-GRAF produces high-res graphs (1680 x 1712 pixels) on Epson or IBM graphics printers. Supports log/linear scales, error bars, overlays, batch-mode operation. Very flexible data entry from disk or keyboard. User customizable. Requires DOS 2 or 3, 256K.  
**\$99.95 (Sorry, no credit cards)**

### Microcomputer Systems Consultants

27 Forest Ave., Port Jefferson Station, New York 11776-1820  
(516) 928-7493

Inquiry 717.

### TAKE CONTROL

of your IBM-PC with DOS. Write assembler programs with SYMBLOR. Write BASIC and TURBO PASCAL subroutines. Debug them with BREAKOR. Break in at any time and trace your program. Trace DOS loader and break on program entry. Saves and restores your screen. Complete package with examples. \$30 - 90 day money back guarantee.

### SOUTHSIDE SYSTEMS

Box 26554, Houston, TX 77207  
(713) 641-2101

Inquiry 761.

### BASIC for the MAC COMPILER!!

TRUE MACHINE LANGUAGE  
BASICA compatible

### PTERODACTYL SOFTWARE est. 1982

Box 538, Fairfax, CA 94930  
VISA/MC 415-485-0714  
or circle 727 on service card for 3-page spec sheet

Inquiry 727.

# THE BUYER'S MART

## SOFTWARE/LANGUAGES

### LISP for the MACINTOSH®

**MacScheme®** implements the Scheme dialect of LISP. It features a fast byte code interpreter, debugger, editor that understands LISP syntax, multiple windows, and Quickdraw graphics. University site licenses available. \$125 (+\$10 overseas). MC/VISA. To order, call or write:

#### Semantic Microsystems

4470 S.W. Hall St., Ste. 340, Beaverton, OR 97005  
(503) 643-4539

Inquiry 734.

### \* INSTANT EDT/ASEM \$50 PPD \*

Full Macro Assembler. All the features of IBM's & Microsoft's. Syntax and file compatible. Runs like Turbo Pascal. Write, assemble and run programs in seconds, in memory! 'WordStar' like editor built in. Supports full Intel 16-bit family. PC DOS-MS DOS compatible. Money back guarantee!

#### Computer Solutions

P.O. Box 354, Mason, Michigan 48854  
1-800-874-9375 VISA/MC 1-517-628-2943  
Catalog with 300 items sent with order.

Inquiry 677.

### CROSS ASSEMBLERS with "UNIVERSAL" LINKER and POWERFUL LIBRARIANS for IBM PC MS-DOS

Full featured for most microprocessors

#### ENERTEC, INC.

BOX 1312, Lansdale, PA 19446  
215-362-0966 MC/VISA

Inquiry 693.

### REFER SAVES HOURS

REF cross references program variable, values, keywords, linenumbers, and/or labels.

ENTER adds languages to supplied: asm, basic, c, cobol, pascal, ada, fortran, dbase, rbase.

FINDREPL updates programs \$45.

#### James Halstead & Asc.

1551 Plainfield, Joliet, IL 60435

(815) 725-0346

Inquiry 709

## SOFTWARE/SCIENTIFIC

### SPARSE/DENSE MATRIX

MATRIX: Does to matrix what TK1 Solver does to Numbers. Solves lin/nonlin/diff eqns. Programmable Matrix Functions. \$59.95

SPARSEPACK: Turbo Pascal source code for user-transparent Sparse Matrix handling. Overcome 64K barrier and more. \$49.95

#### SoftTech Inc.

18505 W. 8 Mile, Detroit, MI 48219

Visa/MC call 1-800-835-2246 ext. 80

Others call 1-313-544-8544

Inquiry 738.

### Digital Logic Design on the Macintosh™

The LogicWorks™ series allows you to create, test and document digital circuitry on your Macintosh. Full simulation capability lets you catch design errors before committing your circuit to hardware. From \$79.95 (US). Demo pkg \$10. Visa/MC Accepted.

#### Capilano Computing Systems Ltd.

Box 86971, N. Vancouver, B.C., Canada, V7L 4P6

(604) 669-6343

Inquiry 670

## SOFTWARE/SCIENTIFIC

### forMath® text-formatter

- Equations, matrices, ratios, integrals, diagrams
- Macros, fonts, Greek/math symbols
- Hyphenation, sectn/eqn/ref numbering
- Indexes, table of contents, footnotes
- Dot-matrix, daisywheel, laser printers, all monitors \$400. \$50 for demo

#### SHANTHA SOFTWARE INC.

50 West 97th St. Room 11N, New York City 10025  
(212) 222-SNIP  
Touchtone toll free: 950-1088-wait-FORMATH

Inquiry 736.

### BEAM ANALY. & SPRING DESIGN

Beam analysis program calculates shear, moments, reactions, slopes and deflections in beams. Price: \$50.00. Helical spring design program for compression, extension and torsion springs. Price: \$75.00.

Both packages include disk and documentation. For Apple II series of computers or IBM PC, PCjr and compatibles.

#### SYLCA CORPORATION

33-47 14 Street, Dept B, Long Island City, NY 11106  
718-278-4604

Inquiry 748

### MATRIX 100

Powerful Matrix operations with single statements in IBM PC BASIC. Perform multiple regression, solve simultaneous equations, invert matrices, etc. MATRIX 100 commands are fast, reliable and easy to use. Price \$80. 8087 support \$125. compiler support \$250. (\$4 s&h. CA res. add sales tax).

#### STANFORD BUSINESS SOFTWARE, INC.

4151 Middlefield Rd., Suite 215, Palo Alto, CA 94303  
To Order Call (415) 424-9499

Inquiry 744.

### CMX MATRIX CALCULATOR

Evaluate complicated matrix expressions as easily as arithmetic on a calculator. Over a dozen useful operators invoked by a single keystroke. Fully prompting learning mode plus a rapid entry silent mode. MS/PC-DOS or CP/M68K (Sage/Stride) versions. \$55.

#### Estanco, Inc.

444 So. Cotner Blvd., Lincoln, Nebraska 68510

phone (402) 489-6435

Inquiry 694

## SOFTWARE/SCIENTIFIC

### FORTRAN SOURCE CODE PROFESSIONAL SIGNAL PROCESSING & MATRIX ANALYSIS UTILITIES

35 PROGRAMS W/TUTORIAL & EXAMPLES  
FFT, AR Modeling, Digital Filters, Matrix SVD, Conj Gradient, Pseudo-Inverse, Root Finder, Cubic Spline Interp, Graphics, Random Numbers. More. Disk/Hard-copy Documented, 130 pages. Bibliography. Send for Info Pkg. \$99.

#### CLAREN SOFTWARE

P.O. Box 5333 • MESA, AZ 85201  
(602) 820-3877

Inquiry 671.

### DIGITAL SIGNAL ANALYSIS

Fourier Perspective II w/graphics. FFT/IFT, convolution, deconvolution, Hanning, Power Spectrum, Cross Correlation, 25 more. Graphics 2D and 3D. 8087 recommended, not required. Easy to use menus. FP II \$395 or FP I (FFT w/graphics only) \$149. Runs on PC, PC-XT, PC-AT.

#### Alligator Transforms Scientific Software

P.O. Box 11386, Costa Mesa, CA 92627  
(714) 662-0660

Inquiry 652.

### TURBO CIRCUIT ANALYSIS

Generates matrix-equation source code for AC, DC and Transient Analysis. Source code for Worst Case, Plots, etc. Requires MS-DOS, BI-Turbo Pascal or FORTRAN. Both ME and EE useful.  
Circuit Analysis Programming System \$155

#### CVY, Inc.

1709 N. West Ave. #131, Jackson, MI 49202

(517) 782-2297

Inquiry 681.

### HP-PC HYPER-CALCULATOR

MS-DOS emulation of HP-11C programmable scientific calculator available inside any program, permits data return. Program & data disk storage, indirect addressing, alpha prompts, printing, HELP, 100 registers, 1000 program steps. FREE 8087 version C utility programs. \$39.95 + \$1 s&h.

#### SUNDERLAND SOFTWARE ASSOCIATES

P.O. BOX 7000-64

REDONDO BEACH, CA 90277

CALL TOLL FREE 800-628-2828 ext. 502

Inquiry 748.

### FFT & Related Programs

Radix-2, General-N, Integer, & Winograd FFT/IFFT, Z-Transform, Fast Convolution, Fast Matrix Transposition (on disc), Window Functions, Graphics. 1, 2, & 3-dimensional Programs. 2D & 3D size limited only by disc capacity. For Fortran or APL environments.

#### Nexus Scientific Software Corp.

P.O. Box 70928, Sunnyvale, CA 94086

Phone 604-421-2160 (US & Canada)

Inquiry 721.

### UPGRADE YOUR IBM PC TO A STORAGE OSCILLOSCOPE!

Do Data Acquisition, Frequency Spectrum Analysis, Transfer Functions, Analysis with Lotus 1-2-3, and more—inexpensively and all without programming!

For info on SNAPSHOT Storage Scope:

#### HEM Data Corporation

17025 Crescent • Southfield, MI 48076

(313) 559-5607

Inquiry 701.

### TURBO PASCAL TOOLS

Quinn-Curtis offers a family of Science, Engineering, Data Acquisition, and DOS/BIOS Tools for use with Turbo Pascal. All source code provided.

IPC-TP-006 Science and Engineering Tools \$69.95  
IPC-TP-008 Metrabyte Data Acquisition Tools \$94.95  
IPC-TP-017 DOS/BIOS Tools \$69.95

#### Quinn-Curtis

49 Highland Ave., Needham, MA 02194

(617) 444-7721

Inquiry 731.

### Affordable Engineering Software

CALL OR WRITE FOR FREE CATALOG  
Circuit Analysis • Root Locus • Thermal Analysis • Matrix Manipulation • Signal Processing • Filter Design • Graphics • Text Proofreader

#### BV Engineering

2200 Business Way Suite 207, Riverside, CA 92501

(714) 781-0252

VISA/MC

Inquiry 668

# THE BUYER'S MART

## SOFTWARE/SCIENTIFIC

### ENGINEERING SOFTWARE WRITTEN BY ENGINEERS FOR ENGINEERS

Highest power per dollar. Highest power per K of memory. Satisfaction guaranteed.  
 Electronic Circuit Analysis ..... \$450.  
 Logic Simulation System ..... \$395.

#### TATUM LABS

33 Main St., Newtown, CT 06470  
 (203) 426-2184

Inquiry 750

## SOFTWARE/SYSTEMS

### CPM-80 LIVES on your PC

CP/Mulator puts a 4mhz 8 bit CP/M emulator in your IBM-PC for \$99. (\$3 s+h).

- A great 8 bit development system
- Saves expensive CPM-80 applications
- Increases PC speed 10% for 8088 programs
- Priced less than most software only products
- Uses no valuable board slots

#### Source Information

P.O. Box 2974, Warminster, PA 18974  
 VISA Phone (215) 628-4719 M/C

Inquiry 743

### LASER TYPOGRAPHY \$495.

Typographic composition software to drive the Cordata L300 Laser Printer as a typesetter. H & J 76 proportional space fonts, widths for 150 fonts available. Mix face & point size on any line, multicolumn capability.

#### Micro Print-X, Inc.

P.O. Box 581, Ballinger, TX 76821

(915) 365-2343

Dealer Inquiries Welcome

Inquiry 718

### pcSHARE MULTI-USER O/S

pcSHARE allows your IBM-XT/AT or compatible to support up to 5 users running 1-2-3, dBASE, WordStar, etc. on inexpensive serial CRTs. For software developers. pcSHARE efficiently runs compiled Basic, Pascal & C programs with full DOS 3.0 compatible record locking.

#### DIGITROL COMPUTERS INC.

440 Phillip Street  
 Waterloo, Ontario, CAN, N2L 5R9  
 (519) 884-4541

Inquiry 685

## STATISTICS

### The Statistician

Includes: Multiple Regression (Stepwise, ridge, all subsets, backward elimination)

- Time series analysis • descriptive statistics
- transformations • survey research • nonparametrics
- X-Y plots • ANOVA • random samples • data base
- data editor • search & sort • hypothesis tests
- For IBM, MS-DOS, XENIX, CPM, TRS-DOS.

#### QUANT SYSTEMS

Box 628, Charleston, SC 29402  
 803-571-2825

Please call  
 TOLL FREE  
 1-800-334-0854  
 (Ext. 814)

Inquiry 728

### STATISTIX™

\$75 - Satisfaction guaranteed

A comprehensive, powerful, yet easy-to-use statistical analysis system for IBM PC/XT/AT's, Apple II's, and MS DOS machines. Clear 200p manual. Write for information.

#### NH ANALYTICAL SOFTWARE

801 West Iowa Ave., St. Paul, MN 55117  
 (612) 488-4436

Inquiry 722

## STATISTICS

### STATISTICS CATALOG!

If you need statistics for IBM PC or Apple II, call us and let our technical advisors help you find the statistics programs you need.  
 Write or call now to get a FREE catalog of statistics and quality control software.

#### HUMAN SYSTEMS DYNAMICS

9010 Reseda Blvd., Ste. 222  
 Northridge, CA 91324

(800) 451-3030 (818) 993-8536 (CA)

Inquiry 687

## RATS!

RATS is a fast, accurate & complete regression package with unsurpassed POWER. Has both time-series & cross section analysis. Includes Box-Jenkins, logit & probit. Spectral analysis & graphics also available. Requires 256K RAM, IBM PC or compatible. \$200. MC/VISA

#### VAR Econometrics

P.O. Box 19334, Minneapolis, MN 55419

(612) 822-9690

Inquiry 754

## UTILITIES

### DOS PATHING EXTENSION

Give your software the full PATHING capabilities that are missing from the 2.xx and 3.xx versions of MS-DOS and PC-DOS. FULLPATH object license: \$19.95, source license: \$399.95, (+ \$5 S&H + 6% in MN). VISA/MC/PO/CHK 30 day money back guarantee.

#### P. R. GLASSEL AND ASSOCIATES, INC.

30255 Fir Trail, Stacy, MN 55079

(612) 462-1337

Inquiry 726

### PADLOCK/PADLOCK II DISKS

PADLOCK furnishes the user with a method for providing protection against unauthorized duplication from DOS commands \$99. PADLOCK II disks come preformatted with finger-print and serialization. PADLOCK II disks offer superior protection. Ask about our HARD DISK protection with uninstall capability. MC/VISA.

#### GLENCO ENGINEERING

3920 Ridge Ave., Arlington Hts., IL 60004

(312) 392-2492

Inquiry 760

### SOURCE CODE LIBRARIAN & REVISION CONTROL SYSTEM

TLIB™ keeps ALL versions of your program in ONE compact library file, even with hundreds of revisions.  
 • 5 times faster than PC/IX (Unix) SCCS  
 • LAN-shared libraries with PC Network  
 MS/PC-DOS 2.x & 3.x. \$99.95 + \$3 S&H. VISA/MC

#### BURTON SYSTEMS SOFTWARE

POB 4156, Cary, NC 27511  
 (919) 469-3068

Inquiry 663

### SHOWCASE™ Your Software.

Now there is an easy way to make demonstration software! SHOWCASE makes demos from your software by recording your key strokes, and adding color graphic windows and text to your software. Your customers run your demo disks exactly the way you intended. Also great for making tutorials & testing software. \$135.00 + \$7.50 S&H. MC/VISA. Call or write:

#### RMS TECHNOLOGY INC.

9680 S. Grilble Rd., Canby, OR 97013

(503) 266-7688

Inquiry 733

## UTILITIES

### MEDIA MASTER PLUS

READ, WRITE, and FORMAT over 60 CP/M disks and run most CP/M-80 programs on your IBM PC! Two program package includes ZP/EM, a CP/M-80 emulator program that transforms your IBM PC into a 1-2 MHz CP/M 2.2 computer. \$59.95 + \$3.00 S/H (CA 6%)

#### INTERSECTING CONCEPTS, INC.

4573 Heatherglen Ct., Ste. 10  
 Moorpark, CA 93021  
 (805) 529-5073

Inquiry 706

## ZERODISK

ZeroDisk runs dozens of copyprotected business packages from your hard disk without floppies. Call for the latest list of software it handles. Needs IBM AT, XT, PC, or compatible, DOS 2.0 or higher. ZeroDisk is revised monthly and is not copy protected. \$75 US. Check or Credit Cards accepted.

#### QUAID SOFTWARE LIMITED

45 Charles St. E. 3rd Fl.  
 Toronto, Ontario, Canada M4Y 1S2  
 (416) 961-8243

## MENU MASTER

Hard Disk Organizer! User defined Nested Menus. Login/Logout accounting/reports. User & Project codes/passwords. Menu driven system manager utilities/Menu editor. Online HELP/BASIC Dev. Toolkit. PC/XT/AT/Compat./C-Disk \$29.95 + \$2 s/h CK/MO Also: RPN Calc. \$19.95 + \$2

#### MENU SYSTEMS LIMITED

416 Murdock Rd., Baltimore, MD 21212  
 (301) 377-0082

Inquiry 698

## BTrees with C Source

These are powerful, portable, dependable file utility libraries. Thousands of programmers worldwide rely on our quality code. All source code included, no royalty fees, works with any K&R compatible C compiler.

- Btree only \$75.00
- ISAM only \$40.00 additional.

#### SOFTFOCUS

1343 Stanbury Dr., Oakville, Ontario, Canada L6L 2J5  
 (416) 825-0903

Inquiry 738

## DOS USERS.

"Save time and frustration" — J.E. Pournelle  
 Still River Shell. Powerful full screen file / directory manager. Faster and easier than DOS. Full range of features: PC/MS-DOS 2.0 +. \$39 complete. \$20 shareware diskette. MC/VISA.

#### Bob Howard

PO Box 57, Still River, MA 01467

617-456-3699

Inquiry 660

## XENIX/UNIX

### XENIX/UNIX SOFTWARE

TELETERM-X Multi-User Telecommunications  
 XPD Print Manager/Spooler  
 XTX File Transfer Utility  
 X-MENU System Administration Utility and Menu Package  
 TELETERM-EM Terminal Emulator to turn your MSDOS/TRSDOS micro into a workstation

#### Telexpress, Inc.

P.O. Box 217, Willingboro, NJ 08046

(609) 877-4900

Inquiry 752

**SUNTRONICS CO., INC.**  
12603 Crenshaw Blvd., Hawthorne, CA 90250

(Orders Only)  
**1-800-421-5775**  
(CA Orders & Tech Info.)  
213-644-1140

**STORE HOURS**  
MON - FRI 9:00am - 6:00pm  
SATURDAY 10:00am - 5:00pm  
Dealer & OEM Inquiries Invited

TERMS: VISA, MasterCard (No Surcharge) COD, Cash or Certified Check (VISA or MC Ref. Required). School & Gov. Contractor P.O. accepted. Shipping & H/C \$4.00 for 3 lbs. plus \$6.00 for each additional lb. CA residents add CA Sales Tax. \$10.00 Min. Order. WARRANTY: 90 Days Warranty Labor. Parts Replacement Only.

**SUN-ST COMPUTER SYSTEM**  
**8 MHz HIGH-SPEED**  
**\$995<sup>00</sup>**



SUN-ST Computer System is an IBM Compatible System. It works with the same software used on the IBM; Lotus 1-2-3, Symphony, DBASE II & III, Framework, AutoCAD, Wordstar, Multi-Plan, etc.  
The basic system is fully operational. All you need to do is insert your DOS disk and application software. (Does not run programs that require ROM BASIC).  
□ Uses MS & PC DOS Operating System & XENIX Compatibility.  
□ 8MHz High Speed Operation Clock.  
□ Modifiable to an external switch to allow at 4.77 MHz.

**HARDWARE INCLUDES:**

- 8 MHz CPU Board with 640K, 70% Faster Speed
- Computer Cabinet
- Enhanced Full Function Keyboard (Large RTN & Shift Keys)
- 2 Disk Drives (DSDD, 360KB, 1/2 Height)
- 135 Watt Power Supply
- Floppy Disk Controller
- 12" Green High-Resolution Monitor (TTL) with Parallel Printer Port
- Monochrome Graphic Card (720 x 348) Fully Assembled and Tested
- Meets FCC Class "A" Reg. for Industry & Business Use.

**SUN-ST COLOR SYSTEM** ..... **\$1,293<sup>00</sup>**  
RGM Color Monitor (640 x 240) w/Color G Card (opt. Parallel P. Port)

**SUN-XT COMPUTER SYSTEM** ..... **\$895<sup>00</sup>**  
□ SUN-XT CPU (4.77MHz w/640  
□ 2 Disk Drive w/Controller  
□ Mono G Card w/Parallel P. Port  
□ 12" Green Monitor  
□ 135 w/P.S. & Keyboard

**SUN-XT COLOR SYSTEM** ..... **\$1,193<sup>00</sup>**  
(Color Monitor & G Card w/o Parallel P. Port)

**SUN-XT OEM System 1**

- SUN-XT CPU
  - 135 WP.S
  - No Disk Drive
  - No Graphic Card
  - Full Function Keyboard Assembled (For Qty. 5-up)
  - 640K RAM
  - FDC w/Cable
  - No Monitor
  - Computer Cabinet
- \$455<sup>00</sup>**

**SUN-XT OEM System 2**

- SUN-XT CPU
  - 135 WP.S
  - Computer Cabinet
  - Full Function Keyboard
  - Mono G Card or Color G Card
  - 640K RAM
  - FDC w/Cable
  - 1 Disk Drive
- \$625<sup>00</sup>**  
Assembled (For Qty. 5-up)

**SUN-ST CPU**

Fully IBM PC/XT Compatible  
Run 8MHz using 8088-2 with 8087-2 Optional.  
Same Dimension as IBM PC/XT  
Expandable to 640K  
**\$245<sup>00</sup>**

**SUN-XT CPU**

□ 8088 CPU (8087 Option) □ RAM Expandable to 640K  
□ Fully IBM Compatible □ Same Dim. as IBM PC/XT  
□ No RAM included □ 8 Expansion Slots  
**\$165<sup>00</sup>**

**AT COMPATIBLE**

- CPU w/640K (6&8MHz) ..... \$899
- Cabinet ..... \$110
- Power Supply, (200w) ..... \$169
- Keyboard ..... \$110
- FDD/HDD Controller ..... \$269
- Cable ..... \$25
- 1.2MB FDD ..... \$142
- 20MB HDD ..... \$699
- 20MB Hard Disk w/Controller ..... \$500<sup>00</sup>
- Mono G Card w/Parallel Port (Hercules Compatible) ..... \$110<sup>00</sup>
- Color G Card ..... \$99<sup>00</sup>
- Serial, Parallel, Clock Calendar Game Port (Half Size) ..... \$110<sup>00</sup>
- Full Function Enhanced Keyboard (AT Layout) ..... \$75<sup>00</sup>
- IBM PC/XT Style Cabinet ..... \$49<sup>00</sup>
- Power Supply ..... 135w. \$89<sup>00</sup>  
..... 150w. \$109<sup>00</sup>
- FDC w/Cable ..... \$49<sup>00</sup>
- Async RS232 Card ..... \$59<sup>00</sup>
- Parallel Printer Card ..... \$39<sup>00</sup>
- 5151 Compatible Keyboard ..... \$109<sup>00</sup>
- Eprom Prog. (2716, 32, 64, 128) ..... \$139<sup>00</sup>
- 256K RAM Kit (9 ea.) ..... \$35<sup>00</sup>
- Parallel Printer Cable ..... \$15<sup>00</sup>
- High-Res Mono TTL Monitor (green) ..... \$105<sup>00</sup>
- R.G.B. Color Monitor (13", 640 x 240) ..... \$365<sup>00</sup>
- 5 1/4 DSDD 1/2 Height Disk Drive ..... Call
- Outlet Surg Suppressor ..... \$14<sup>50</sup>
- Citizen MSP10, MSP15, MSP20, MSP25 Printer ..... Call
- 'Gold Star' DSDD 5 1/4 Diskette ..... \$12<sup>95</sup>/10

**PLOTTERS**

**houston instrument**

- DMP-29 ..... **\$1750**
- DMP-41/42 ..... **2499**
- DMP-51/52 ..... **3799**
- DMP-51/52MP ..... **5099**
- DMP-40 ..... **950**
- True Grid Series ..... **CALL**
- Roland DXY-880 ..... **979**
- Roland DXY-980 ..... **1279**
- Calcomp 1043 ..... **8299**
- Calcomp 1044 ..... **13499**

**LEE DATA**  
**MULTI USER SYSTEMS**

The new System 2000 by Lee Data Corporation combines superior performance with remarkable value for today's UNIX based multi-user application. The System 2000's single board design makes optimal use of the Intel 80286 microprocessor with no wait states to slow it down.

The System 2000 feature the following:

- 1 to 16 users
- Intel 286 CPU (6MHz)
- 1 MB Floppy drive
- 1 MB to 6MB of RAM
- 26 MB to 340MB Winchester disk storage
- Xenix Operating System

Options Include: Streaming tape drives; 80287 coprocessor; expansion card cages; RAM expansion; and system software.

Take a close look at the Lee Data System 2000. Examine its power, features and flexibility. Then call Scottsdale Systems for our price. You will be amazed

SINCE 1980

**Scottsdale Systems**

617 N. Scottsdale Rd., Scottsdale, Arizona 85257

For Information Only For Orders Only  
**(602) 941-5856 1-800-367-2369**

Call 7-5 Mon-Fri



**PRINTERS**

OLYMPIA

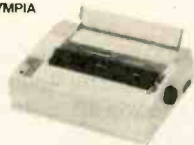

To quote PC magazine, "The (NP) printer is a sure thing..." If you're considering the purchase of an Okidata 92, or an Epson FX-80 give us a call before you spend \$50 to \$100 more for an inferior printer. Let us send you an actual print sample from the NP, and additional information on the features that make the Olympia NP the best value in dot matrix printers.  
**\$285**

- OLYMPIA RO ..... **329**
- Diablo Laser ..... **4195**
- Cannon Laser Printer ..... **2169**
- Srar SG-10 ..... **239**
- Okidata, Epson, NEC ..... **CALL**
- Brother 1009 ..... **139**
- Other Brother ..... **CALL**

Prices listed are for cash/MasterCard and Visa add 3%/American Express add 5%/AZ residents add 6% tax/all items are new with manufacturer's warranty/Returned product subject to 20% restocking fee/Personal and company checks take up to 3 weeks to clear/No COD's or APO's/Prices and specifications subject to change/Product subject to availability/all applicable trademarks recognized and on file.

**ALTOS MULTI USERSYSTEMS**

- Altos 2086-2 ..... **\$14599**
- Altos 1086-T-80 ..... **10819**
- Altos 986-T-80 ..... **10799**
- Altos 486-20 ..... **4150**
- Altos Software ..... **CALL**

**EXPANSION**

- Hercules Graphics Card .. **\$325**
- Hexace 6-Pack ..... **129**
- Hexace Multiport ..... **125**
- Hexace 286 Emulator ..... **939**
- Paradise Multi Display ..... **209**
- Orchid PC-Turbo 256 K ..... **679**
- Tecmar Graphics Master ..... **499**
- IOmega-Bernoulli ..... **CALL**

**SANYO 885**

- IBM-PC Compatible
- 8088-2 at 4.77 & 8 MHz
- Two DSDD Disk Drives
- 256K RAM - Monitor
- 8 Expansion Slots
- WordStar - CalcStar
- MS-DOS 2.11 - GW Basic
- Sanyo 885 System .... **\$1349**

**ZENITH**

- Zenith Z-148 w/monitor ..... **\$1299**
- Zenith Z-158 ..... **1829**
- Zenith Z-200-41 ..... **2949**
- Zenith Z-171 Laptop ..... **1799**
- Zenith Z-138 Portable ... **1359**

Presenting the new **SILVER FOX II**

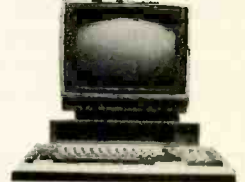

20 MB hard disk, one 360K drive  
**768K RAM, HagenDOS 2, WordStar, CalcStar, EasyWriter, BASIC, MS-DOS 2.11, RAM Disk and Monitor**  
Enjoy the freedom of being able to boot up to your hard disk and eliminate the headaches of too much information and not enough space. Create RAMdisks of up to 384 K with TurboDrive 550. Feel the security of a one year warranty on the whole system.

The Silver Fox has always been fast, responsive and rugged - ideally suited to those who don't want to pay "Big Blue for nothing new." That tradition is now carried 20 megabytes further with the new **Silver Fox II**.

Call now and find out how the Silver Fox II can fit your needs.

- The Silver Fox II ..... **\$1399**
- 20MB/768K Upgrade for Sanyo ..... **\$799**
- StarPack Software ..... **\$98**

# CCT<sup>®</sup>

A  
PAT  
MARTINI  
COMPANY



## COMPLETE BUSINESS SOLUTIONS

CCT designs and engineers complete hardware and software systems for total solutions. We offer turn-key verticals from single-user stand-alones, at under \$2,000, to 40-user super machines with the power of a mini, and the economy of a micro.

Compliance Software™ a subsidiary of CCT, offers powerful, easy to use menu-driven vertical market packages for all CCT systems. Written for simplistic ease of use, these professional level tools mated with CCT machines, offer the complete business solution.

**Small Business?** The CCT Compliance™ allows even the complete neophyte to master, and profit from the system immediately! So sophisticated the user never sees or interacts with the operating system—all functions are handled from the software menus, quickly and transparently. Complete solutions are available for professional offices, light manufacturing, contracting, retail and wholesale, service businesses, and many, many more.



**Medium Size Businesses** can profit from CCT S-100 and small-scale VME bus machines. Power and reliability from two to fourteen or more users, running both 8 and 16 bit software. Compliance packages available for manufacturing, universities, larger professional offices, accounting and data processing, and many others.



**Large Business Environments** and Government Agencies find added value and economic alternatives in CCT large-scale VME bus machines. Super power 16 and 32 bit state-of-the-art technologies bring an organization together at the speed of light. Systems for large professional offices, banking/finance, hospital/medical, engineering, large retail/wholesale, service and countless others.



*For the CCT®/CompuPro® professional: The CCT CompuPro Concurrent DOS 8-16™ Operating System. CP/M® and MS-DOS® software compatibility in a fast multi-user/multi-tasking environment. Supports over thirty hard disk systems, 8-inch, any 5-inch, 3-inch, and AT floppy drives, in any combination! Full user security with complete record and file locking. CP/M or DOS medias on any type drive. Efficient, compact, fast, and the most powerful and flexible implementation of CCP/M available.*

Dealer inquiries invited  
Join the winning CCT Team  
Committed to Service  
and Technology.

Viasyn/CompuPro® - Macrotech® - AlphaMicro™ - Zenith® - Sperry® and other hardware lines, in stock, tested, set-up, warranted, and affordable!

CCT Disk Drive Subsystems — CP/M and IBM® compatible floppy drives of all types and sizes, and hard disks from 10 to 680 megabytes. Manufactured, supported, and backed for one year— by CCT.

CCT exports systems, software, components, peripherals and parts worldwide — small to very large requirements filled. Telex our International Sales Office 187-114 CCT.

CCT has a Nation-wide Dealer Network— Call for the location of the CCT Service Center nearest you.

Printerfacer 1™ For the S-100 Business Computer. An intelligent output board for printer/plotter intensive single and multi-user applications. 1 serial/1 parallel - 256K to 1 meg. on-board RAM speeds up system throughput tremendously! For CompuPro, Z-100, and AlphaMicro users.

CCT-4™ Series Systems — Fast, Powerful — The S-100 standard of excellence — up to 14 users — CP/M and MS-DOS. Contact CCT Marketing for details.

## CCT Implements Tomorrow's Technology Today!™

**CUSTOM COMPUTER TECHNOLOGY**  
1 CCT Plaza—P.O. Box 4160  
Sedona, Arizona 86340

**TOLL-FREE ORDERING: 800-222-8686**  
**FOR TECHNICAL SUPPORT/SERVICE**  
602-282-6299

CCT, CCT-4, Compliance, Compliance Software, Printerfacer 1, CCT Implements Tomorrow's Technology Today!— All trademarks of Custom Computer Technology; **CompuPro**— Trademark Viasyn Corp; **IBM**— Trademark International Business Machines; **MS-DOS**— Trademark Microsoft Corp; **Zenith**— Trademark Zenith Radio Corp; **Sperry**— Trademark Sperry Rand Corp; **AlphaMicro**— Trademark AlphaMicro Corp; **Macrotech**— Trademark Macrotech Int'l. **Concurrent, CP/M**— Trademarks Digital Research, Inc.

CCT Concurrent DOS 8-16— This product is an enhanced and modified implementation of the CompuPro release version 4.1 level operating system. CCT has rewritten portions of this software and included additional proprietary code routines to support various CCT hardware. Concurrent DOS 8-16 is a compound trademark of Digital Research, Inc. and Viasyn Corporation.



# Compu\$ave Of Arizona

Call Toll Free: 1-800-624-8949

### MONITORS

PGS MAX 12E... 165 Taxan 115 115  
 PGS HX12... 449 Taxan 121 132  
 Amdek 310A... 145 Taxan 620 389  
 Amdek 722... 499 Taxan 640 499  
 Thomson 36382SI.375 Wyse 620 399  
 NEC Multisynch... 549 Wyse 700 1195  
 Casper Mono/TTL 109 Zenith 122... 75  
 Roland/12"/RGB/640x240... 299  
 Casper/13"/RGB/Mono/640x240... 319  
 Sakata/13"/Color Comp/Apple... 165  
 Hitachi/Sharp/Tatung/Tecmar... CALL  
 Cables/Video Interfaces/Stands... CALL

### MODEMS

AST Reach Half-Card W/Soft... 325  
 Anchor Volksmodem... 55  
 Anchor Express Half-Card W/Soft... 185  
 Anchor Lightning 2400... 375  
 Hayes Micromodem IIE W/Soft... 132  
 Hayes Smartmodem 1200... 365  
 Hayes Smartmodem 1200B W/Soft... 349  
 Prometheus Promodem 1200G... 199  
 Prometheus Promodem 1200B W/Soft... 218  
 Racal-Vadic 1200V... 215  
 Racal-Vadic 2400 Half-Card W/Soft... 399  
 Ven-Tel/Half Card Modem W/Soft... 349  
 Novation/UDS/US Robotlcs... CALL

### COMPUTERS

AT&T 6300/FDrive/Mono Monitr... 1665  
 Corona PPC-400 Port/2 FDrives... 1125  
 Sharp PC-7000 Port/FDrive... 1395  
 Toshiba 1100 Lap-Top Portable... 1595  
 Wyse1100/FDrives/20MHDrive... 1495  
 Altos/Corvus/Sperry/Televideo... CALL

### PC-XT CLONE \$635

640K/4 77 MHz/Teac Drive/XT-Style  
 Keyboard/135 W Power Supply/Docu-  
 mentation/6 Month Warranty/8 Slots  
 TURBO 8 MHZ MODEL... \$725

### PC/AT CLONE \$1975

1M/8 MHz/1.2M Teac Drive/AT Key-  
 board/Clock/Calendar/192 W Power  
 Supply/Parallel & 2 Serial Ports/  
 Documentation/1 Year Warranty  
 DELUXE AT-MODEL... \$2309

### OPTIONS

TTL Monitor & Graph Card Add... 195  
 RGB Monitor/Color Card Add... 380  
 FOR MANY OTHER OPTIONS... CALL

### FREE SOFTWARE WITH SYSTEMS

### TERMINALS

Altos IV... 385 Ampex 210... 375  
 Televideo 955... 455 Ampex 219... 495  
 Wyse 30... 289 Dume 131G... 289  
 Wyse 50... 418 Visual 65... 425  
 Adds/CIE/IBM/Kimtron/Liberty... CALL

### PRINTERS

Citizen MSP10... 250 Canon A40... 235  
 Citizen MSP20... 299 Canon Lazer... 1999  
 Corona Lazer... 2295 Juki 6100... 345  
 Data So. 180... 1075 NEC EII... 385  
 Diablo 635... 1065 NEC P5-XL... 1155  
 Epson JX80... 289 Star SG-10... 209  
 Epson LX90... 255 Star NX-10... 265  
 Epson LQ1030... 699 Talley MT86... 425  
 Panasonic 1080.205 Toshiba 321... 495  
 Panasonic 1091.239 Toshiba 341... 795  
 Abati/Anadex/C.Itoh/Fujitsu... CALL  
 Okidata/Dume/Televideo/TI... CALL  
 Buffers/Cables/Sheet Feeders... CALL  
 Stands/Switch Boxes/Tractors... CALL  
 Enter Sweet-P 100 Plotter... 245  
 Roland DXY 880 Plotter... 545  
 Houston And Other Digitizers... CALL  
 Houston And Other Plotters... CALL

### DISK DRIVES

Apple Compatible Floppy Drives... 124  
 Teac 55-B JS/DD Floppy Drives... 95  
 Seagate 2CM Hard Drive Kit... 455  
 Tape Back-Up System 20M... 195

### OTHER FLOPPY AND HARD DRIVES

ALPHA OMEGA • CDC • CORVUS  
 MAYNARD • MICRO SCI • MITSUBISHI  
 PRIAM • SHUGART • TANDON • TEAC  
 TECMAR • WESTERN DIGITAL  
 Power Supplies/Controllers... CALL

**HOURS: MON - FRI 8AM - 6PM/SAT 9AM - 2PM  
 IN ARIZONA CALL (602) 437-4855**

CompuSave 4207 S. 37th St., Phoenix, AZ 85040/For Customer  
 Service Call (602) 437-4856/Prices Reflect Cash Discounts And Are  
 Subject To Change Without Notice/Minimum Shipping Charge \$4  
 Purchase Orders & Major Credit Cards Welcome  
 CompuSave Is A Division Of Adlanko Corp.

### BOARDS

AST Advantage/128K... 365  
 AST Six Pack Plus/64K... 212  
 Six Pack Clone/Game Port/384K... 175  
 Cardo G-Whiz (Commodore)... 55  
 Hercules Color Card... 143  
 Color Card Clone... 95  
 Orange Grappler + (Apple)... 70  
 ATI Graphlcs Solutions... 199  
 Paradise Modular Graphics... 249  
 PC Monochrome Graph (Par Port)... 99  
 PC 576K RAM Board (DK)... 69  
 Genoa Spectrum Graphics... 285  
 Quadram EGA+... 389  
 Sigma 400 High Res Card... 455  
 STB EGA+... 329  
 Taxan 555 High Res Card... 189  
 Tecmar Graphics Master... 445  
 Microtek/Orchid/PGS/Persyst... CALL  
 Prac. Peripherals/Thesys/Vutek... CALL

**ALL TYPES OF BUSINESS, CAD  
 AND RECREATIONAL SOFTWARE  
 VERY LOW PRICES... CALL**

### WE ALSO CARRY

Keyboards/Joysticks/Power Supplies  
 Chips/Mice/Labels/Surge Protectors  
 Cables/Graphics Tablets/Light Pens  
**VERY LOW PRICES FOR DS/DD DISKS**

# BYTE back issues for sale

	1982	1983	1984	1985	1986
Jan.		\$3.70	\$4.25	\$4.25	\$4.25
Feb.	\$3.70	\$3.70	\$4.25	\$4.25	\$4.25
March	\$3.70	\$3.70	\$4.25	\$4.25	\$4.25
April	\$3.70	\$3.70	\$4.25	\$4.25	\$4.25
May	\$3.70	\$3.70	\$4.25	\$4.25	
June	\$3.70	\$3.70	\$4.25	\$4.25	
July	\$3.70	\$4.25	\$4.25		
Aug.	\$3.70	\$4.25	\$4.25	\$4.25	
Sept.	\$3.70	\$4.25	\$4.25	\$4.25	
Oct.	\$3.70	\$4.25	\$4.25	\$4.25	
Nov.	\$3.70	\$4.25	\$4.25	\$4.25	
Dec.	\$3.70	\$4.25	\$4.25	\$4.25	

### SPECIAL ISSUES and INDEX

BYTE '83-'84 INDEX	\$1.75
1984 Special Guide to IBM PC's (Vol. 9, No. 9)	\$4.75
1985 INSIDE THE IBM PCs (Vol. 10, No. 11)	\$4.75

Circle and send requests with payments to:

**BYTE Back Issues  
 P.O. Box 328  
 Hancock, NH 03449**

Prices include postage in the US. Please add \$.50 per copy for Canada and Mexico; and \$2.00 per copy for foreign countries (surface delivery).

Payments from foreign countries must be made in US funds payable at a US bank.

Check enclosed  VISA  MasterCard

Card # \_\_\_\_\_

Exp. \_\_\_\_\_

Signature \_\_\_\_\_

Please allow 4 weeks for domestic delivery and 12 weeks for foreign delivery.

NAME \_\_\_\_\_

ADDRESS \_\_\_\_\_

CITY \_\_\_\_\_

STATE \_\_\_\_\_ ZIP \_\_\_\_\_

**NEW LOW PRICES!**

**NEW LOW PRICES!**

# DoKay

COMPUTER  
PRODUCTS,  
INC.

ORDER TOLL FREE

**(800)  
538-8800**

(CALIFORNIA RESIDENTS)

**(800)  
848-8008**



**RAMS**

STATIC		DYNAMIC	
2114L	200ns	99	4116 200ns 35
2016	200ns	99	4116 150ns 45
2016	150ns	1.35	4164 200ns 85
HM6116 P	150ns	1.35	4164 150ns 95
HM6116LP	150ns	1.45	41128 150ns 4.95
Z-6132	300ns	19.89	41256 150ns 2.89
HM6164 P	150ns	3.35	41256 120ns 3.89
HM6164LP	150ns	3.45	4416 150ns 3.95
HM6164LP	100ns	12.45	4464 150ns 8.95

**EPROMS**

2516	450ns	2.95	2732 A	250ns	2.49
2532	350ns	3.75	2764	450ns	1.89
2708	450ns	2.95	2764	250ns	2.39
2716-5	490ns	1.29	27126	250ns	2.69
2716	450ns	1.89	27256	250ns	6.99
2716-1	350ns	2.35	27512	250ns	29.99
2732	450ns	1.89	MC68764	450ns	15.99
2732 A-2	200ns	3.89	MC68766	350ns	16.99

**8088 / 8086  
UPGRADE**

V-20 ... 5 MHz ... 13.95  
V-20 ... 8 MHz ... 19.95  
— High Speed —

**DP-25 Solder Cup**



Male, Female, Hoods ... 99¢ ea.

**UV ERASERS**

QUV-T8/1 ... \$49.95  
ECONOMY Model



- Erases 15 EPROMS in 20 minutes
- Plastic Enclosure

**74LS00**

74LS100	.14	74LS125	.36	74LS260	.46
74LS01	.14	74LS126	.36	74LS266	.36
74LS02	.14	74LS132	.36	74LS273	.76
74LS03	.14	74LS133	.46	74LS275	1.96
74LS04	.14	74LS136	.36	74LS279	.36
74LS05	.16	74LS137	.98	74LS280	1.18
74LS08	.10	74LS138	.36	74LS283	.56
74LS09	.16	74LS139	.36	74LS290	.86
74LS10	.14	74LS145	.86	74LS293	.76
74LS11	.18	74LS147	.86	74LS295	.66
74LS12	.18	74LS148	.86	74LS298	.66
74LS13	.36	74LS151	.36	74LS299	1.46
74LS14	.24	74LS153	.36	74LS323	2.46
74LS15	.24	74LS154	1.46	74LS324	1.68
74LS20	.16	74LS155	.46	74LS352	1.24
74LS21	.20	74LS156	.46	74LS353	1.18
74LS22	.20	74LS157	.34	74LS363	1.28
74LS26	.20	74LS158	.28	74LS364	1.88
74LS27	.20	74LS160	.28	74LS365	.36
74LS28	.24	74LS161	.36	74LS366	.36
74LS30	.16	74LS162	.46	74LS367	.36
74LS32	.16	74LS163	.36	74LS368	.36
74LS33	.26	74LS164	.46	74LS373	.76
74LS37	.24	74LS165	.64	74LS374	.76
74LS38	.24	74LS166	.86	74LS377	.76
74LS40	.16	74LS168	.94	74LS378	1.12
74LS42	.36	74LS169	.94	74LS385	1.84
74LS47	.56	74LS170	.84	74LS386	4.2
74LS48	.66	74LS173	.48	74LS390	1.06
74LS49	.66	74LS174	.36	74LS393	.76
74LS51	.16	74LS175	.36	74LS395	1.06
74LS54	.18	74LS181	1.46	74LS399	1.06
74LS55	.20	74LS189	3.86	74LS424	2.86
74LS53	.86	74LS190	.46	74LS447	.92
74LS73	.28	74LS191	.46	74LS490	1.46
74LS74	.22	74LS192	.66	74LS624	1.92
74LS75	.26	74LS193	.66	74LS640	.96
74LS76	.26	74LS194	.58	74LS645	.96
74LS78	.36	74LS195	.56	74LS668	1.46
74LS83	.36	74LS196	.56	74LS669	1.26
74LS85	.46	74LS197	.56	74LS670	.86
74LS86	.20	74LS221	.56	74LS674	9.58
74LS90	.36	74LS240	.66	74LS682	3.14
74LS91	.86	74LS241	.66	74LS683	2.86
74LS92	.46	74LS242	.66	74LS684	2.86
74LS93	.36	74LS243	.66	74LS685	2.86
74LS95	.46	74LS244	.58	74LS688	1.86
74LS96	.46	74LS245	.68	74LS689	2.86
74LS107	.32	74LS247	.68	74LS783	21.96
74LS109	.34	74LS248	.68	81LS95	1.36
74LS112	.26	74LS249	.96	81LS96	1.36
74LS113	.32	74LS251	.46	81LS97	1.36
74LS114	.32	74LS253	.46	81LS98	1.36
74LS122	.44	74LS257	.36		
74LS123	.46	74LS258	.46	25LS2521	2.48
74LS124	2.60	74LS259	1.18	25LS2569	2.48

**MEMORY  
EXPANSION KIT**

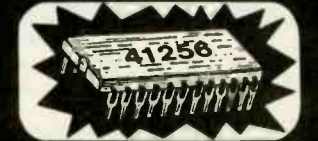

**41256 150ns  
\$2.89 each!**

8000		8200 (continued)	
8031	4.95	8253-5	1.79
8035	1.45	8255	1.59
8039	1.89	8255-5	1.79
8080A	2.89	8257	1.99
8085	2.35	8257-5	2.29
8085A-2	4.89	8259	1.89
8086	7.89	8259-5	1.99
8087-3	124.95	8271	48.95
8087-2	139.95	8272	4.79
8086	5.95	8274	4.79
8089	39.95	8275	24.99
		8279	2.29
		8279-5	2.79
		8282	3.79
8131	2.90	8283	3.79
8155	2.35	8284	2.79
8155-2	3.89	8286	3.79
8156	2.89	8287	3.79
8185	26.89	8288	4.79
8185-2	26.89	8289	19.89
		8292	12.90

8100		8200		8300	
8202	8.98	8303	1.79		
8203	29.89	8304	1.79		
8205	2.98	8307	1.79		
8212	1.35	8308	1.79		
8214	3.59	8310	2.29		
8216	1.35	8311	2.29		
8224	2.09				
8226	1.59				
8228	3.29				
8237	4.79	8741	8.89		
8237-5	5.29	8748	6.99		
8238	3.99	8749	9.89		
8243	2.39	8755	18.89		
8250	5.95				
8251	1.49				
8251A	1.69	80186-6	48.89		
8253	1.69	80188	48.89		

**CRYSTALS**

ALL STANDARD VALUES ... 1.00



**CRYSTAL CLOCK OSC.**  
ALL STANDARD VALUES ... 4.89

DIP Switches ... 79¢

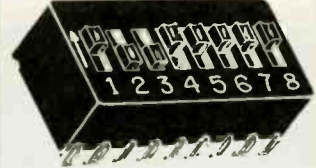

**ORBITAL SYSTEMS:**

EXTENDED 80-Col. Card for Apple IIe  
64K to 128K Upgrade; 2-Yr. Warranty \$69.95

Z-80 (CP/M) CARD, for Apple II+, IIe  
Compatible with all Apple CP/M

Lifetime Warranty ... 69.95

**IBM ACCESSORIES**

8087-3 5 MHz	124.95
8087-2 8 MHz	139.95
80287 1 MHz	179.00
80286	99.00
Power Supply, 135W	89.00
Monochrome Graphic Card	119.00
Memory Card	139.00
Multifunction Card	129.00
AT Crystal: 16, 18, 20 MHz	4.95

**MACINTOSH UPGRADE  
(PARTS ONLY)**

128K to 512K ... 50.00  
Consists of: (16) 41256, 150ns;  
(1) 74F253;  
(17) 16-Pin Sockets  
Resistors and Capacitors ALSO INCLUDED

**APPLE ACCESSORIES**

Parallel Printer Card	49.95
80-Col. card for Apple II+	149.95
80-Col. card for Apple IIe	69.95
Cooling Fan	38.95
Power Supply	69.95
Joystick	29.95
RF Modulator	13.95
Disk Drive Full Height	159.95
Disk Drive 1/2 Height	129.95
Controller Card	49.95
16K Card	39.95
Z-80 Card	69.95

**★ DISKETTES BULK ★**

SS/DD ..... 25/\$17.25  
DS/DD ..... 25/\$19.75  
AT disks ..... 25/\$50.00  
3 1/2" disks ... 25/\$50.00  
ALL DISKETTES HAVE A  
FULL 1-YEAR WARRANTY

**8500 6500 6500 A**

6502	1.99	6502A	2.49
6504	6.79	6520A	2.49
6505	8.79	6522A	4.99
6507	9.79	6532A	9.89
6520	1.59	6545A	6.89
6522	3.99	6551A	6.89
6532	5.99		
6545	4.89		
6551	5.89	6502B	5.89

**6800 68000**

1 MHz		2 MHz	
6800	1.89	68800	4.89
6802	4.89	68802	5.89
6803	9.89	68809	6.89
6808	4.89	68809E	6.99
6809E	5.89	68810	2.99
6809	5.89	68810E	3.89
6810	1.89	68820	14.89
6820	2.89	68845	6.89
6821	1.89	68850	2.89
6828	13.89		
6840	5.99		
6843	18.89		
6844	10.89		
6845	4.89		
6847	10.89	68000-8	9.89
6850	1.89	68047	12.89
6852	4.59	68488	14.89
6860	7.89	68652	14.89
6862	10.89	68661	8.89
6875	6.89	68764	15.89
6880	1.49	68766	16.89
6883	21.89		

**Z-80 Z-80A (continued)**

Z80-CPU	99	Z80A-DMA	4.89
Z80-CTC	1.49	Z80A-IO	1.79
Z80-DART	3.89	Z80A-SIO/0	4.89
Z80-DMA	3.89	Z80A-SIO/1	4.89
Z80-PIO	1.59	Z80A-SIO/2	4.89
Z80-SIO/0	3.89	Z80A-SIO/9	4.89
Z80-SIO/1	3.89		
Z80-SIO/2	3.89		
Z80-SIO/9	3.89		

**Z-80 B**

Z80B-CPU	3.59
Z80B-CTC	3.59
Z80B-PIO	3.59

**Z-80 A**

Z80A-CPU	1.49	Z80B-DART	10.89
----------	------	-----------	-------



**TURBO-AT COMP. \$1795.00**

DUAL SPEED 6 & 8 MHz; 512K RAM; HARD & FLOPPY CONT; 1.2M DISK DRIVE; 200W POWER SUPPLY; MONOGRAPHIC CARD + PRINTER PORT; KEYBOARD; ENCLOSURE.

**TURBO-XT COMP. \$619.00**

4.77 & 8 MHz CLOCK; 256K RAM; MONOGRAPHIC CARD + PRINTER PORT; 130W POWER SUPPLY; CASE; KEYBOARD; ONE DISK DRIVE.  
XT CASE LIKE AT LOOK \$48.00  
5151 DUAL AT & XT KEYBOARD \$87.00  
MONO MONITOR \$99.00

**WEST COAST PERIPHERALS**

2558 Seaboard Ave., San Jose, CA. 95131  
Tel: (408) 435-5467; 435-8711  
Telex: 3716630 AMT SF

**DEALER & OEM INQUIRIES WELCOME**

Inquiry 384

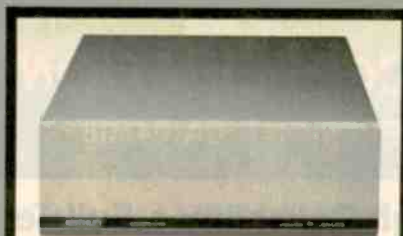

**System 501: \$2245**

**DATA ACQUISITION & CONTROL**

Call or write for FREE brochure

**KEITHLEY**

Keithley Data Acquisition and Control, Inc.

28775 Aurora Road  
Cleveland, Ohio 44139

(216) 248-0400 Telex: 98-5469

Inquiry 189

**Nashua Diskettes**

5 1/4" DS/DD with hub ring and sleeve, factory warranted, packaged in 50's. Shipping Extra. Quantity 50, 85¢ each.

The same low price our volume copying customers pay! **75¢** each Qty. 100

We sell 3 1/2" & 5 1/4" disks—all types, major brands. Call toll free:  
**1-800-321-4668**  
in Colorado, 303-234-0871

VISA, MASTERCARD, OR COD ACCEPTED

**ALF** 1315-F Nelson St. Denver, CO 80215

Inquiry 13

**FANSI-CONSOLE™**

The Integrated Console Utility™ All the little things IBM forgot! for IBM—PC, XT, AT & clones.

- 1.2 to 3.0 times faster DOS & BIOS screen writing
- more escape sequences than ANSI.SYS
- usable in any language
- scroll recall facility
- compatibility w/PC & AT software
- full EGA support
- 255 character typeahead buffer
- increase key repeat rate
- no scroll blink for some adaptors
- VT 100/52 emulation
- auto dual screen disable
- keyboard induced breakpoints
- window support
- support for 50 line display
- many many more little features

400p Manual (w/slip case) & disk \$75, or just Shareware disk \$25. As described in *PC-World* February 86, pg. 282 and in *Lotus* June 85, pg. 8.

**HERSEY MICRO CONSULTING, INC.**  
Box 8276J, Ann Arbor, MI 48107  
(313) 994-3259 x525 VISA/MC

Inquiry 160

**UNIVERSAL EPROM PROGRAMMER**

\* NO PERSONALITY MODULES REQUIRED  
\* ON LINE HELP AND MENU SELECTION  
\* ON BOARD 110/220V POWER SUPPLY  
\* FAST PROGRAMMING MODE AT 6V VCC  
\* BUILT IN EPROM ERASER w/TIMER  
\* GANG PORT FOR FUTURE EXPANSION  
\* SOFTWARE DRIVERS FOR MOST PCs  
\* SUPPORTS ALL 5V EPROMS, EEPROMS AND INTEL MICROCOMPUTERS

1409C-33 \$545 1409C-34 \$695  
DRIVERS \$35 SHIPPING \$6  
VISA & MASTER CARD ACCEPTED

**B&C MICROSYSTEMS**  
6322 MOJAVE DR. SAN JOSE CA 95120  
PHONE (408) 997-7685 TELEX 4995363

**LOW COST UNIVERSAL PROGRAMMER KITS**

\* NO PERSONALITY MODULES REQUIRED  
\* ON LINE HELP AND MENU SELECTION  
\* ON BOARD 110/220V POWER SUPPLY  
\* FAST PROGRAMMING MODE AT 6V VCC  
\* BUILT IN MONITOR FOR I/O DEBUG  
\* CAD PCB, SILKSCREEN & SCHEMATIC  
\* SOFTWARE DRIVERS FOR MOST PCs  
\* SUPPORTS ALL 5V EPROMS, EEPROMS AND INTEL MICROCOMPUTERS

KITS FROM \$125 ASSEMBLED \$295  
DRIVERS \$35 SHIPPING \$4  
VISA & MASTER CARD ACCEPTED

**B&C MICROSYSTEMS**  
6322 MOJAVE DR. SAN JOSE CA 95120  
PHONE (408) 997-7685 TELEX 4995363

**IMPORT DIRECT SAVE 30%**

MASTER PACKS	SAMPLE	IMPORT	IMPORT*
	1-4	5-49	50+
<b>PC-AT</b>	<b>\$1899.00</b>	<b>\$1495.00</b>	<b>\$1299.00</b>
512K RAM (Up to 1M on Board) 1.2 M FLOPPY - FLOPPY & HARD DISK CONTROLLER AT KEYBOARD - CLOCK WITH BATTERY BACKUP 155W POWER SUPPLY - DOS 3.10 & MANUAL			
	SAMPLE	5-49	50+
<b>PC-AT COLOR</b>	<b>\$1899.00</b>	<b>\$1799.00</b>	<b>\$1550.00</b>
SAME AS ABOVE WITH COLOR MONITOR AND COLOR/GRAPHICS CARD			
	SAMPLE	10-99	100+
<b>PC-XT TURBO</b>	<b>\$999.00</b>	<b>\$699.00</b>	<b>\$595.00</b>
640K RAM, 8088-2, (4.77 MHZ or 6.66 MHZ) 360K FLOPPY - KEYBOARD - MONOCHROME/GRAPHICS PRINTER - 12" TTL HIGH RES MONITOR			
<b>PC-XT</b>	<b>\$899.00</b>	<b>\$595.00</b>	<b>\$495.00</b>
256K RAM - 360K FLOPPY - KEYBOARD MONOCHROME/GRAPHICS/PRINTER CARD (Mercurius Comp.) - 12" TTL HIGH RES MONITOR			

**DRIVES**

	1-49	50+
<b>XT 360K FLOPPY</b>	\$89.00	\$65.00
<b>XT 10 MEG INTERNAL 1/2 HEIGHT</b>	\$395.00	\$365.00
<b>XT 20 MEG INTERNAL 1/2 HEIGHT</b>	\$479.00	\$425.00
<b>AT 1.2 MB FLOPPY</b>	\$149.00	\$129.00
<b>AT 20 MEG INTERNAL 40 MSEC</b>	\$579.00	\$565.00
<b>AT 30 MEG INTERNAL 40 MSEC</b>	\$979.00	\$955.00

**INDIVIDUAL PART PRICING FOB TAIWAN**

	10-99	100+
<b>PC-XT-256K 8 SLOTS (super XT BIOS)</b>	\$74.75	\$65.00
<b>135W POWER SUPPLY</b>	\$51.75	\$45.00
<b>FLIP-TOP CLONE BOX</b>	\$26.45	\$23.00
<b>MONO/GRAPHIC/PRN (Herc comp)</b>	<b>\$32.00</b>	\$46.00
<b>KEYBOARD</b>	\$36.00	\$32.00
<b>FLOPPY DISK CONTROLLER</b>	\$23.00	\$20.00
<b>RAM KITS 256K</b>	\$25.30	\$22.00
<b>12" TTL HIGH RES MONITOR</b>	<b>\$86.00</b>	\$90.00
<b>SUBTOTAL BASIC PC NO DRIVES</b>	<b>\$300.70</b>	\$313.00
<b>DUTY</b>	\$14.79	\$13.00
<b>OCEAN FREIGHT</b>	\$24.00	\$20.00
<b>AIR FREIGHT</b>	\$100 extra	
<b>ACS IMPORT FEE</b>	\$350.00/ENTRY+10%	\$71.00
<b>TOTAL LANDED COST, L.A. HARBOR</b>	<b>\$470.49</b>	\$380.00

**MONITORS**

	SAMPLE	10-49	50+
<b>CL-863 12" TTL MONO</b>	\$98.00	\$85.00	\$80.00
<b>MD-314" COLOR RGB</b>	\$381.00	<b>\$276.00</b>	\$235.00
<b>.39 DOT 640 x 200</b>			
<b>MD-7 14" COLOR RGB</b>	\$480.00	\$359.99	\$335.00
<b>.31 MM DOT 720 x 350</b>			

  

**ADD ON BOARDS - PARTIAL LIST**

	10-99	100+
<b>PC-XT-640K MOTHER BOARD 8 SLOT</b>	\$78.00	\$73.00
<b>PC-XT-640K TURBO 4.77/6.66 MHZ</b>	\$99.00	\$95.00
<b>TRANS-NET (LAN)CARD 1.0 MHZ</b>	\$199.00	\$185.00
<b>384K MULTI-FUNCT (AST6 comp)</b>	<b>\$99.70</b>	\$58.00
<b>RAM KITS 384K</b>	\$36.00	\$32.00
<b>MODERN CARD 300/1200 (Hayes comp)</b>	\$115.00	\$105.00
<b>COLOR GRAPHICS CARD</b>	\$42.55	\$37.00
<b>AB SWITCH BOX (Centronics 2:1 or 1:2)</b>	\$27.80	\$24.00
<b>AB SWITCH BOX WITH 84K BUFFER</b>	\$65.55	\$57.00
<b>AT SERIAL/PARALLEL CARD</b>	\$61.00	\$55.00
<b>AT COLOR/GRAPHICS</b>	\$69.00	\$61.00
<b>64 INPUT ANALOG/DIGITAL CARD</b>	\$396.00	\$350.00
<b>128 LINE PARALLEL I/O CARD</b>	<b>\$495.00</b>	\$371.00

\* 100 UNIT ORDERS MAY BE SCHEDULED OVER 6 MONTHS

**ACS IMPORTERS**  
5311 DERRY AVE., UNIT A  
AGOURA HILLS, CA 91301  
HOURS 9 AM - 6 PM PST  
(818) 860-1082  
TELEX: 299353 POST UR

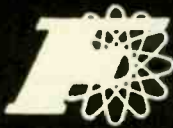

# FORTRON CORPORATION

3225 SELDON CT., FREMONT, CA 94538

IN CALIF: (415) 490-8171  
 TX: 559291 FORTRON  
 FAX: (415) 490-9156

ORDER TOLL FREE: 821-9771

## U.L. Rated • High Reliability • Full Technical Support



140W (Typ.) 150W(Max.)  
 PC/XT \$129.00

- U.L. recognized, yellow card available File # E-01115(S)
- Meet FCC class B, European safety spec.
- 115/230V AC convertible
- Low noise DC fan
- OVP, OCP, short circuit protection
- IBM® standard pin out or Faraday type pin out selectable
- 100% 24 hrs. burn-in 100% pre-shipment test.

One full year warranty





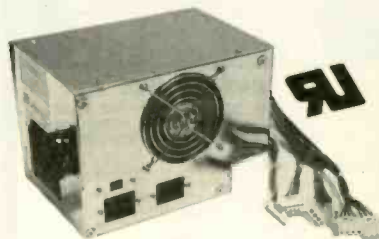





Your PC represents a substantial investment. It does not make sense to risk costly down time due to bargain power supply, when for a few dollars more you can have the confidence of FORTRON QUALITY.

IBM is a registered trademark of International Business Machines.



FC 5192 200W (max)  
 PC/AT \$189.00



## PROFITABLE DISCOUNT PRICES FOR SYSTEM INTEGRATORS & DEALERS - PLEASE CALL

<b>FC 520</b> <b>Color Graphic / Mono / Printer</b>  <ul style="list-style-type: none"> <li>• TTL / composite level outputs</li> <li>• 320 x 200 (color) 640 x 200 (B&amp;W)</li> <li>• Centronics Printer Port</li> </ul> <p><b>\$99.00</b></p>	<b>FC 550 (CT-6040)</b> <b>Monochrome / Graphic / Printer</b>  <ul style="list-style-type: none"> <li>• 80 x 25 test mode</li> <li>• 720 x 348 graphic mode</li> <li>• Run Lotus 1-2-3 auto cad, etc.</li> <li>• IBM® compatible</li> </ul> <p><b>\$109.00</b></p>	<b>FC 730 (CT-6050C)</b> <b>384K Multifunctions</b>  <ul style="list-style-type: none"> <li>• Memory expansion to 384K</li> <li>• Clock / calendar</li> <li>• Serial, parallel ports</li> <li>• Game port</li> </ul> <p><b>(OK) \$119.00</b></p>	<b>FC 740</b> <b>Multi-I/O w/Floppy Controller</b>  <ul style="list-style-type: none"> <li>• 1 EIA-RS232C port (2nd optional)</li> <li>• 1 Centronic port, gameport</li> <li>• Clock / calendar</li> <li>• Control 2 floppy drives (FC 770) w / o Floppy Controller</li> </ul> <p><b>\$99.00</b></p>	<b>FC 1730</b> <b>Multifunction Card for PC AT</b>  <ul style="list-style-type: none"> <li>• 1 EIA-RS232 port (2nd optional)</li> <li>• 128K to 1.5 MB memory</li> <li>• Expandable to 3 MB (optional) by piggy back board</li> <li>• Game port</li> </ul> <p><b>\$189.00</b></p>	<b>FC 1930</b> <b>RS232 / Printer Port for PC AT</b>  <ul style="list-style-type: none"> <li>• 1 EIA RS232 port (2nd optional)</li> <li>• Centronics parallel port</li> </ul> <p><b>\$99.00</b></p>
<b>FC 940</b> <b>RS232 / Real Time Clock</b>  <ul style="list-style-type: none"> <li>• RS232C port</li> <li>• To 9600 baud</li> <li>• Battery back-up</li> </ul> <p><b>\$59.00</b>    (clock only) <b>\$49.00</b></p>	<b>Hard Disk Controller</b>  <p>Hard Disk Controller for XT</p> <ul style="list-style-type: none"> <li>• DTC 5150 BX ..... \$149.00</li> <li>• WD WX-2 (Western Digital) ..... \$145.00</li> <li>• Cable ..... \$ 9.50</li> </ul> <p>F.D. &amp; H.D. Controller for AT</p> <ul style="list-style-type: none"> <li>• DTC 5280 ..... \$265.00</li> <li>• Western Digital WA-2 ..... \$260.00</li> <li>• Cable Set ..... \$ 18.00</li> </ul>	<b>FC 230</b> <b>Floppy Disk Controller</b>  <ul style="list-style-type: none"> <li>• Drives up to four 5 1/4" floppy drives</li> <li>• IBM compatible</li> <li>• With cables</li> </ul> <p><b>\$59.00</b></p>	<b>XT CPU Board</b>  <p>FC 150 (4.77 MHz) ..... \$149.00    FC 180 (8.00 MHz) ..... \$199.00</p> <ul style="list-style-type: none"> <li>• Expandable to 640K or board memory</li> <li>• Optional 486T co-processor</li> <li>• Optional IBM® comp. BIOS</li> </ul>	<b>Modems</b>  <p>INTERNAL Hayes 1200 RS232 ..... \$388.05    Hayes 1200 bps Practical Peripheral ..... \$199.00    EXTERNAL 4 half-height drives "Hayes" compatible ..... \$179.00</p>	<b>SPECIAL</b> <b>* CMI #6640 40 MS 31 MB (formatted) Hard Disk Drive \$599.00 (listed \$899.00)</b> <ul style="list-style-type: none"> <li>• FC 830 512K memory exp. card ..... \$69.00</li> <li>• FC 830S 578K memory exp. card ..... \$69.00</li> <li>• FC 930 serial / parallel adaptor for XT ..... \$49.00</li> <li>• FC 530 monochrome controller w/ printer port ..... \$79.00</li> </ul>

<b>Enhanced Graphic Adaptor IBM Compatible</b>  <b>w/o printer port</b> <ul style="list-style-type: none"> <li>• For PC / XT / AT and compatibles</li> <li>• 256K on board memory</li> <li>• Full 18 colors in 640 x 350 on IBM® enhanced color display</li> <li>• Support 640 x 350 IBM® compatible enhance color and monochrome monitors</li> <li>• Parallel port • Light pen interface</li> </ul> <p><b>\$395.00</b></p>	 <b>w/printer port</b> <p><b>\$395.00</b></p>	<b>FORTRON 200</b> <b>(200 w / Uninterruptible Power System for PC)</b>  <ul style="list-style-type: none"> <li>• 115V / 230V AC input convertible</li> <li>• Input current 2.5 amp</li> <li>• 200W continuous</li> <li>• 1/2 cycle (typical) transfer time</li> <li>• Hold-up time from 20 minutes (200W) up to 60 minutes (90W)</li> <li>• 5.12" x 7.7" x 13.46"</li> </ul> <p><b>\$259.00</b></p>	<b>FC 447</b> <b>PC / AT Keyboard</b>  <ul style="list-style-type: none"> <li>• IBM AT compatible keyboard</li> <li>• Enter / return key</li> <li>• Light on num. lock key</li> </ul> <p><b>\$109.00</b></p>	<b>FC 424 (5150 Type)</b>  <p><b>\$79.00</b></p>
			<b>FC 437 (5151 Type)</b>  <ul style="list-style-type: none"> <li>• For PC XT</li> <li>• Large return key</li> <li>• Light on num. lock keys</li> </ul> <p><b>\$99.00</b></p>	

## CABINETS & EXPANSION CHASSIS

<b>FC 630 A-2</b>  <ul style="list-style-type: none"> <li>• For PC XT compatible side switch</li> <li>• To use FC 135-40 power supply</li> <li>• Complete mounting hardware</li> </ul> <p><b>\$79.00</b></p>	<b>FC 620</b>  <ul style="list-style-type: none"> <li>• For PC AT compatible</li> <li>• LED lamps, key, key lock, speaker and mounting hardware included</li> </ul> <p><b>\$139.00</b></p>	<b>FC 610</b> <b>Drives Chassis</b>  <ul style="list-style-type: none"> <li>• 18" x 6" x 6"</li> <li>• Capable of holding 2 half-height drives</li> <li>• Come w / power supply, fan</li> <li>• LED power indicator</li> </ul> <p><b>\$149.00</b></p>	<b>FC 640 / 5 Slots</b> <b>PC Expansion Chassis \$239.00</b>  <ul style="list-style-type: none"> <li>• W / 5 slot mother board</li> <li>• 100W power supply, fan</li> <li>• Capable of holding 3 half-height drives</li> <li>• Dia. 15 1/8" x 12" x 6 1/4"</li> <li>• *Option of system interfacia adaptor</li> </ul> <p><b>\$149.00</b></p>	<b>FC 650 / 8 Slots</b> <b>PC Expansion Chassis \$249.00</b>  <ul style="list-style-type: none"> <li>• PC XT identical size</li> <li>• W / 8 slot mother board</li> <li>• 140W power supply</li> <li>• 4 half-height drives</li> <li>• *System interface adaptor</li> </ul> <p><b>\$149.00</b></p>	<b>FCC 660 / 12 Slots</b> <b>PC Expansion Chassis \$289.00</b>  <ul style="list-style-type: none"> <li>• Dia. 18 1/2" x 15 1/2" x 5 1/2"</li> <li>• W / 12 slot mother board power supply, fan</li> <li>• Capable of holding 2 half-height drives</li> <li>• *System interface adaptor</li> </ul> <p><b>\$149.00</b></p>
--	---	---	--	--	--

<b>MONITORS</b> <ul style="list-style-type: none"> <li>• Monochrome</li> <li>• Tatung MM 1222 A / G ..... \$129.00</li> <li>• Golden Star Green ..... \$109.00</li> <li>• Color HiRes (640 x 200) ..... \$359.00</li> <li>• Tatung CM-1360 ..... \$359.00</li> <li>• Enhanced Graphic (640 x 350) ..... \$519.00</li> <li>• Tatung CM-1380 ..... \$519.00</li> <li>• Princeton MX-12E ..... \$549.50</li> </ul>	<b>DISK DRIVES</b> <ul style="list-style-type: none"> <li>• Floppy</li> <li>• Teac 588V ..... \$119.00</li> <li>• 1.2 MB 588VF ..... \$149.00</li> <li>• Hard (w / controller &amp; cable)</li> <li>• 10 MB ..... \$419.00</li> <li>• 20 MB ST-225 ..... \$468.00</li> <li>• 20 MB ST-4026 (40 MS) drive only ..... \$578.00</li> <li>• 30 MB ST-4038 (40 MS) drive only ..... \$695.00</li> <li>• 31 MB CMI-6640 (40 MS) drive only ..... \$599.00</li> </ul>	<b>Tape Back-Up (w / controller, cable &amp; tape)</b>  <p>INTERNAL</p> <ul style="list-style-type: none"> <li>• Sysgen 20 MB ..... \$645.00</li> <li>• Everax 20 MB ..... \$699.00</li> <li>• Sysgen 80 MB ..... \$850.00</li> <li>• Everax 80 MB ..... \$895.00</li> <li>• EXTERNAL</li> <li>• Sysgen 20 MB ..... \$749.00</li> <li>• Sysgen 80 MB ..... \$895.00</li> <li>• Everax 20 MB ..... \$799.00</li> <li>• Everax 80 MB ..... \$895.00</li> </ul>	<b>Printers</b>  <p>Admate DP-430 ..... \$219.00</p> <ul style="list-style-type: none"> <li>• 130 C.P.S.</li> <li>• 80 columns</li> <li>• 9 x 9 dot matrix field</li> <li>• Parallel standard interface</li> <li>• TTR-60</li> <li>• 50 C.P.S.</li> <li>• 80 columns</li> <li>• Parallel standard interface</li> <li>• Thermo printer</li> </ul> <p><b>\$ 89.00</b></p>	<b>RAM CHIPS</b> <ul style="list-style-type: none"> <li>• 64K RAM ..... \$10.00 / 9 pc.</li> <li>• 256K ..... \$33.00 / 9 pc.</li> <li>• 128K ..... \$44.00 / 9 pc.</li> </ul> <p>(for PC AT)</p>	
<b>Terms:</b> <ul style="list-style-type: none"> <li>• Min. shipping &amp; handling \$6.00</li> <li>• CA res. add 6.5% tax</li> <li>• Restocking charge 15%</li> <li>• No rtn. goods w/o a RMA no.</li> <li>• Prices subject to change w/o notice</li> </ul>					

**DOUBLE THE OPTION CAPACITY OF YOUR IBM PERSONAL COMPUTER**

**PC-XTRA**

- DIRECT EXTENSION OF IBM PC BUS
- NO SOFTWARE CHANGES
- NO HARDWARE MODIFICATION
- STYLING CONSISTENT WITH IBM

Add all those special options that you've been wanting without worrying about filling your plug-in and back panel space.



DEALER INQUIRIES INVITED.

**\$549.00\*** F.O.B. SANTA ANA  
\*CALIFORNIA RESIDENTS ADD 6% SALES TAX

**P C HORIZONS, INC.**  
1701 E. Edinger, Ste. A6, Santa Ana, CA 92705  
(714) 953-5396

Inquiry 263

**DISKETTES & MORE**

**NORTH HILLS CORP.**

**1-800-328-3472**

**Maxell Brown 3M Diamond**

**Competitive Prices**  
COD — VISA — MasterCard  
All orders shipped within 24 HRS.



**NORTH HILLS CORP. INTERNATIONAL**  
3564 Rolling View Dr.  
White Bear Lake, MN 55110  
MN. call collect—612-770-0485

Inquiry 255

**I/O Bus for Data Acquisition & Control**  
now available for IBM PC & Apple II series computers



The Local Applications Bus... **'LAB 40'**

In photo are: LAB 40-PC generator & LAB 40-11 signal acquisition module.

- Modular approach to data acquisition and control. A 40 conductor ribbon cable bus is generated by a card in the host computer. Up to 8 low cost modules can be located anywhere on a cable up to 100 ft. long. Our LAB 40 generator cards for the IBM PC or Apple II are priced at \$168.
- Signal Acquisition and Control Module, model 'LAB 40-1'. Features: 8 bit resolution, 4 channels, differential input, sampling rate up to 850KHz, software programmable gains and offset, digital output port, low price of \$220. Twelve bit module available.
- Full featured 'digital oscilloscope' software. Documented and user-modifiable. PC version \$178, Apple II version \$100. Complete data acquisition packages (hardware and software) start at \$450.
- Development tool. Unique to LAB 40 is its ability to interface directly to microprocessor compatible integrated circuits and hybrids. We encourage users to develop projects and products. LAB 40 is an ideal educational tool.
- New low cost modules. Twelve bit A/D. Port/Reply Driver. Real Time Clock.

**Computer Continuum**  
75 Southgate Ave., Suite 6 • Daly City, CA 94015  
(415) 755-1978

controls up to 4 motors from any CRT, terminal or computer

**CENTROID**

**STEPPING MOTOR CONTROLLER**

- CHOPPER or R/L drives
- RS232 interface
- acceleration deceleration
- 1-4 axis moves

Standard R/L Version with BASIC \$985  
16K BASIC, R/L, Battery Backup \$1335  
CNC R/L Version \$1950  
Stepping Motor Tips Cookbook \$8  
Users Manuals \$12

**CENTROID (814) 237-4535**  
Box 739, State College, PA 16804

Inquiry 62

Still Waiting?

**ATTENTION BERNOULLI BOOSTERS**  
Go Either Way!

**BOOT**  
from the Bernoulli Box!  
from the AT Hard Disk!

FORMAT WITH DOS PARTITION WITH FDISK  
NO SLOWING

We've been shipping Bernoulli Boots that work for over a year — still waiting?

**Golden Bow Systems**  
595-5110  
Add \$3 for shipping/handling  
California residents add 6% sales tax

P.O. Box 939  
San Diego, CA 92103  
(619) 298-9349

Inquiry 149

**NEW!**



**SafeSkin™**  
KEYBOARD PROTECTOR

Remains in place during keyboard use. Prevents damage from liquid spills, dust, ashes, etc. Fits like a second skin, excellent feel. Available for: IBM-PC, AT, Apple (all), Compaq, Model 100, NEC 8201, C64, Zenith 150, DEC, Kaypro and many others. Send \$29.95, check, M.O., Visa & MC include exp. date. Specify computer type. Dealer inquiries invited. Free brochure avail.

**Merritt Computer Products, Inc.**  
2925 LBJ Fwy. #180 / Dallas, Texas 75234  
(214) 942-1142

Inquiry 228

**P.C. Computer Brokers Inc.**

**The Place To Buy Your Epson Printers**

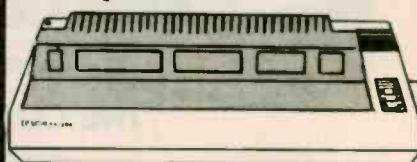

**EPSON** **EPSON FX-286**  
List \$799.00 **\$495.00**

Epson Printers	List	SALE
Homewriter Printer	\$249.00	\$199.00
AP-80 Printer	\$379.00	CALL
LX-90 Printer	\$329.95	\$229.00
FX-100 Printer	\$499.00	CALL
FX-85 Printer	\$499.00	\$330.00
JX-80 Color Printer	\$699.00	\$295.00
LG-1000 Printer	\$995.00	CALL
SG-2000 Ink Jet Printer	\$2295.00	\$1579.00

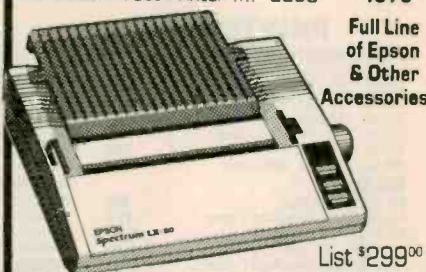

List \$299.00 **\$209.00**

LQ-800 Printer	\$799.00	CALL
HS-80 Ink Jet Printer	\$449.00	\$339.00
DX-10 Daisywheel	\$299.00	\$230.00
DX-20 Daisywheel	\$459.00	\$330.00
DX-35 Daisywheel	\$899.00	\$619.00
Comrex High Speed Printer	\$2295.00	\$1449.00
HL-80 Four Pen Plotter	\$599.00	\$359.00

Call Toll FREE **1-800-245-4122**

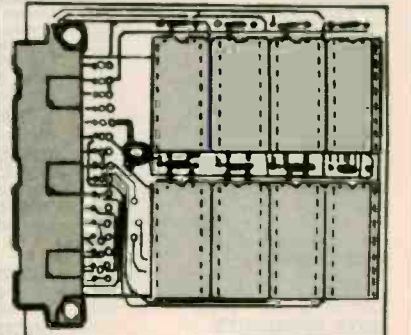

**THE MOST ESSENTIAL CARD FOR THE EQUITY I**

- Able to bring the mother board to 512K
  - Save up to \$70.00
  - 3 year warranty
  - 1/2 the size of other cards
- Only **\$99.00**

These Prices Are Good For Mail Order Dept. Only

**P.C. Computer Brokers Inc.**  
**3879 East 120th Ave.**  
**Thornton, CO 80233**  
**(303)450-6727**

Call Toll FREE **1-800-245-4122**

# Computer Connection

"THE COMPANY THAT DELIVERS"



**CALPAK  
BASE SYSTEM**  
★CPU w/256K  
★One 360K DS/DD Dr  
★Hi-Res Grn Monitor  
★Int. Card w/Par. Port  
**\$1099**

**BUSINESS SYS.**  
★CPU w/640K  
★1 Para. & 1 Ser. Port  
★Clk Cal w/Bat Bk up  
★Hi-Res Ctr Grph Crd  
★Taxan #620 Ctr Mon  
★2-360K DS/DD Drive  
★One 20 Meg Hd Disk  
**\$2150**

**IBM  
PC BASE SYS.**  
★CPU w/256K  
★1-360K DS/DD Drive  
★Hi-Res Grn Monitor\*  
★Int. Card w/Para Port  
\*IBM Mon add \$145  
**\$1399**

**PC XT BUS SYS**  
★CPU w/640 K  
★2 Para. & 1 Ser. Port  
★Clk Cal. w/Bat Bk up  
★Hi-Res Ctr Grph Crd  
★Taxan #620 Ctr Mon  
★1-360K DS/DD Drive  
★One 20 Meg Hd Disk  
**\$2949**



## HARD DISK DRIVES

**CMS**  
10 Meg w/cont. formatted for IBM . \$ 445  
20 Meg w/cont. formatted for IBM . 529  
**ALPHA OMEGA**  
10 Meg w/Controller Card . . . . . \$ 475  
20 Meg w/Controller Card . . . . . 565  
30 Meg w/Controller Card . . . . . 699  
20 Meg for AT . . . . . 445  
33 Meg for AT . . . . . 599  
Shock Mounted 20 meg for Compaq . . . . . 699  
**SEAGATE**  
ST212, 1/2 HT 10 meg . . . . . \$ 445  
ST225, 1/2 HT 20 meg . . . . . 545

## DISK DRIVES

**TANDON**  
TM100-2 for IBM PC . . . . . \$ 110  
**TEAC**  
55B Double Sided 360K . . . . . \$ 99  
Drives For Apple & Franklin  
CALL for current prices

## PERSONAL SYSTEMS

**APPLE**  
Professional Sys. Incl: Apple IIE w/128K & 80 col., tilt mon., duo disk w/con't kit \$1299  
Pro System w/Color . . . . . 1545  
Apple IIc Lightweight Portable . . . . . 789  
Apple IIc w/Color . . . . . 1399

**IBM**  
IBM PC Bare . . . . . \$1095\*  
IBMPC 64K, 1 Drive . . . . . 1250\*  
IBM PC, 2 Drives w/256K . . . . . 1299\*  
IBM XT, 10 Meg, 360K Dr. w/256K 2150\*  
IBM XT Bare w/256K & IBM Floppy 1750\*  
Call About All "AT" Systems  
\*Call for current IBM prices

**SANYO**  
MBC 555-2 w/2, 320K Drives & more software . . . . . \$ 899  
775 Portable . . . . . 1795  
Serial Port for Sanyo . . . . . 65

**COMPAQ**  
256K, w/2-320K Drives . . . . . \$ 1799  
Desk Top Model 1 . . . . . 1599  
Desk Top Model 2 . . . . . 1925  
Desk Top Model 3 . . . . . Call  
Desk Top Model 4 . . . . . Call  
We have "286" Ports. & D.P. In stock

**WYSE**  
1100-1 Incl. 256K w/two 360K Drives 1 par & 2 ser. ports . . . . . \$ 1399  
1100-2 Incl. 10 meg, 1 floppy, 256K, 1 Par. & 2 ser. ports. . . . . 2599  
\*Wyse Monitors & Exp. Chassis Available

## SOFTWARE

**LOTUS DEVELOPMENT CORP.**  
Lotus 1-2-3 New Version . . . . . \$ 315  
Symphony . . . . . 420

**ASHTON TATE**  
D Base II . . . . . \$ 299  
D Base III+ . . . . . 389

**PRINTER SWITCH BOX**  
**EXPONENT**  
Centronics Two Switch . . . . . \$ 58  
Centronics Four Switch . . . . . 83  
Serial Two Switch . . . . . 45  
Serial Four Switch . . . . . 69

## MODEMS

**ANCHOR**  
Volksmodem XII, 5 yr war . . . . . \$ 185  
Express 1200 . . . . . 250

**HAYES MICRO**  
300 Baud Smart Modem . . . . . \$ 149  
1200 Baud Smart Modem . . . . . 379  
1200 B for IBM PC w/SM II . . . . . 375  
2400 Baud Modem . . . . . 645

## DISKETTES

**PC DISKETTES**  
Sgl./Dbl. (Box of 10) . . . . . \$ 13  
Dbl./Dbl. (Box of 10) . . . . . 15

**COMPUTER CONNECTION**  
Dbl./Dbl. (Box of 10) . . . . . \$ 16  
Sgl./Dbl. w/Disk Container(10) . . . . . 15  
Dbl./Dbl. w/Disk Container . . . . . 17  
Bulk 50 & Up — Dbl./Dbl. . . . . 1.35 each  
**SMA**  
PC Document for: Dos 3.1, 1-2-3, Symphony,  
D Base III and much much more \$11.95

## PRINTERS

**STAR MICRONICS**  
NX-10, 136 cps, Trac. & Sheet Feed \$ 299  
SG-10, 120 cps, 2K buffer, 1 yr war 227  
SG-15, 120 cps, 2K buffer 385  
SD-10, 160 cps, 10" carriage 365  
SD-15, 160 cps, Corr. Qual. 479  
SR-10, 200 cps, 10" carriage 520  
SR-15, 200 cps, w/Tractor 640

**OKIDATA**  
ML182P, 120 cps We  
ML182 IBM, Graphics Comp Will  
ML182S, 10" Carriage Beat  
ML192P, 160 cps all  
ML192 IBM, Graphics Comp Pricing  
ML192S, 160 cps on  
ML193P, 160 cps Oki  
ML193 IBM, Graphics Comp Printers  
ML193S, 160 cps with  
MLB4P, 200 cps or  
MLB4 IBM without  
MLB4S, 200 cps IBM  
Okimate 20, 80/40 color Rom

**EPSON**  
LX80, 120 cps 10" carriage Call  
FX85, 180 cps 10" carriage Us  
JX80, 180 cps Color First  
RX100, 100 cps 15" carriage For  
FX286, 200 cps 15" carriage Lowest  
LQ800, 180/60 P&S 7K 10" Authorized  
LQ1000, 180/60 P&S 7K 15" Epson  
LQ1500, 200/64 15" Dealer  
DX10, LQ Printer Pricing

**BROTHER**  
HR-15XL, LQ 20 cps P or S \$ 355  
HR-25, LQ 23 cps P or S. 499  
HR-35, LQ 36 cps P or S. 699  
DM-40, 160 cps 24 wire 794  
DH-45, LQ & Dot matrix 36/160 821

**DYNAX**  
DX15XL, 20 cps By Brother . . . . . \$ 335

**JUKI**  
6100, LQ 18 cps w/proportional spc \$ 355  
6300, LQ 40 cps 675

**TOSHIBA**  
P341P, 180/72, 132 col. \$ 779  
P341P/S, 180/72, 24 wire 799  
P351P/S, 240/100, 132 col. 1099

**PANASONIC**  
1080, 100 cps 2 yr. war. Prop. Sp \$ 219  
1091 w/Tractor, 120 cps, 2 yr. war. 239  
1092, 10" carriage, 180 cps 375

**DATA PRODUCTS**  
8012, 180 cps 10" IBM comp. \$ 299  
8022, 180 cps 15" IBM comp. 472  
8050C, 200 cps w/color 1172  
8070C, 400 cps w/color 1547

## PRINTER ACCESSORIES

**ORANGE MICRO**  
Grappler + \$ 75  
Buffered Grappler +, 16K exp. 64K 149

**TOSHIBA**  
Bi-Directional Trac. 1351/351 . \$ 149/155  
Font Disk for Down loading P1351 . . . 50

**MICROTEK**  
Dumping GX (same as Grappler +) \$ 69  
Dumping GX w/16K buffer 125  
Dumping GX w/32 buffer 135  
Additional Buffering 16K 7

**FOURTH DIMENSION**  
Par. Card & Cable for Apple \$ 49

**OKIDATA**  
Plug n Print for OKI Mate 20 \$ 79  
Tractor for 182 & 192 39

**JUKI**  
Bi-Direc. Tractor for 6100/6300 \$ 115/125  
Serial Interface for 6100 65

**CABLES**  
IBM PC to Parallel Printer \$ 16  
Serial Cable 14  
Centronics M/M or M/F 18

## IBM PC ACCESSORIES

**IBM**  
IBM Dos 3.1 \$ 69

**PARADISE**  
Modular Graphics Card \$ 249  
Module A 75  
Module B 256K w/C & C 120  
5-Pak same as 6-Pak-Ser. Port 175  
Color/Mono Card New 220

**64K MEMORY UPGRADE**  
64K (9 chips) 200ns & 150ns \$ 13

**HEXACE TECHNOLOGIES**  
Hi-Res Color Card for PC, XT, AT, \$ 89

**QUADRAM**  
Quad Color 1 Board \$ 179  
Exp. Quadboard w/64K & Game Port 199

**TECHMAR**  
Graphics Master \$ 449

**APPLE & FRANKLIN ACCESSORIES**  
Kensington System Saver \$ 69  
Masterpiece Control Unit 119

**MICROTEK**  
Serial Interface \$ 85  
80 col. for II & II+ 99

**MICROMAX**  
Viewmax 128K extended 80 col. card for  
Apple IIE w/64K \$ 99  
80 col. card for Apple II & II+ 139

## DISPLAY MONITORS

**QUADRAM**  
Amber chrome IBM compatible . . . \$ 169

**AMDEK**  
V300G \$ 119  
V300A 129  
V310A for IBM PC 149  
Color 300 199  
Color 600 RGB Hi-Res 389  
Color 710 Super Hi-Res 485  
Color 722 Super Hi-Res 545

**TAXAN**  
IBM Green Monochrome#121 \$ 129  
IBM Amber Monochrome#122 139  
RGB IBM w/Cable#620 399  
RGB Super Hi-Res. #640 Best Buy 499  
RGB#630 450

**PRINCETON GRAPHICS**  
HX-12 for use with IBM PC \$ 445  
Max 12E Amber for IBM 159  
SR 12 Super Hi-Res 555  
Scan Doubler 185

**QUIMAX**  
PX-4, RGB Hi-Res w/Gr. Text Mode \$ 410  
DM-14 Monochrome for IBM 150

**VUTEK (2 yr. war.)**  
CPS Board, RGB & Comp. w/Par&Ser  
Ports 2 yr war. \$ 189  
Color Card (Herc. comp.) w/Para. 150

**AST RESEARCH**  
SixPak + w/64K & Sidekick \$ 215  
SixPak + w/384K & Sidekick 255  
Game Port 49  
Preview MonoGraphics 225

**KEYTRONICS**  
KB5151 \$ 175

**MICROTEK**  
Monochrome Text Par. & Ser. \$ 145  
Color Graphics Card 2 yr. warr 125

**SIGMA DESIGNS**  
Color 400 L or H \$ 439

**ADVANCED LOGIC SYSTEMS**  
Z Engine 2.2 \$ 120  
80 Col./64K 69

**APPLE**  
Super Serial Card \$ 139

**SMT**  
64K, 80 col. Card \$ 65

**MICRO-SCI**  
64K, 80 Col. Card \$ 49

## We Stock What We Sell!!

IF YOU SEE IT ADVERTISED FOR LESS, CALL  
COMPUTER CONNECTION FIRST FOR LOWEST QUOTE

### MAIL ORDER:

17121 S. Central Avenue, Unit L  
Carson, California 90746



NO SURCHARGE FOR CREDIT CARDS

We accept VISA, MasterCard, COD (w/Deposit), Certified Checks or Wire Transfers. Minimum Shipping Charge \$4.00. Some items subject to back order. California Res. add 8 1/4% Sales Tax. All returns are subject to a 15% restocking charge and must be authorized by store manager within 10 days. Prices subject to change without notice. This Ad supersedes all others.

## ORDER LINE (800) 732-0304

(Outside California)  
(213) 635-2809  
(Inside California)

Mon. Fri. 7 a.m. to 6 p.m.  
Saturday 11 a.m. to 3 p.m.

**CUSTOMER SERVICE:**  
(213) 635-5065  
Mon.-Fri. 9 a.m. to 3 p.m.

COMPUTER CONNECTION  
MOST ORDERS SHIPPED SAME DAY

# RS-422 Communications Board

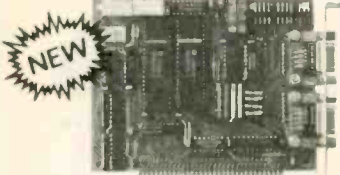

- For IBM-PC/AT/XT and compatibles
- Dual RS-422 serial interface
- Programmable to 56k baud
- Differential drivers to 4000 ft.

**\$345.00**  
**QUA TECH, INC.**

478 E. Exchange St. Akron OH 44304  
(216) 434-3154 TLX: 5101012726

Inquiry 299

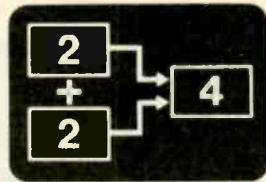

## PICTURES THAT THINK

Boxes & Arrows™ Is an IBM PC-based block diagram editor and computing system. If you are looking for something more than a spreadsheet, Boxes & Arrows will let you combine computation with pictorial representation.

- Automatic box & line drawing
- Labels and algebraic formulas
- Any printer, any display
- No limit to diagram size
- Call or write for full details



Inner Loop Software  
5456 McConnell Avenue  
Los Angeles, CA 90066

software (213) 822-2800

Inquiry 172



## Real-Time Multitasking Executive

- No royalties
- Source code included
- Fault free operation
- Ideal for process control
- Timing control provided
- Low interrupt overhead
- Inter-task messages
- Language Interfaces: C, Pascal, PL/M, Fortran
- DOS File Access: CP/M-80, IBM PC DOS

Options:

- Resource Manager
- Buffer Manager
- Integer Math Library

AMX is the 8086/8088 Product of VLSI Corp. 80 is the 80386/80486 Product of VLSI Corp. IBM PC DOS are the 80386/80486 Product of VLSI Corp.

AMX for 8080	\$ 800 US
8086	950
8809	950
68000	1600
Manual (specify processor 75)	

**KADAK Products Ltd.** (604) 734-2796  
Telex: 04-55670  
206-1847 W. Broadway, Vancouver, B.C., Canada V6J 1Y5

Inquiry 188

## Maxell Floppy Disks

The Mini-Disks  
with maximum quality.



Dealer inquiries invited. C.O.D.'s accepted. Call FREE (800) 235-4137.



**PACIFIC EXCHANGES**  
100 Foothill Blvd., San Luis  
San Luis Obispo, CA 93401  
In Cal. call (800) 592-5935 or  
(805)543-1037.

Inquiry 265

## DATA ACQUISITION TO GO INTERFACE FOR ANY COMPUTER FREE IBM SOFTWARE

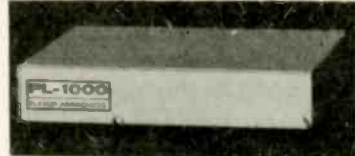

Connects via RS-232. Fully IBM compatible. Built-in BASIC. Stand alone capability. Expandable. Battery Option. Basic system: 16 ch. 12 bit A/D, 2 ch. D/A, 32 bit Digital I/O. Expansion boards available. Direct Bus units for many computers.

(201) 299-1615

P.O. Box 246, Morris Plains, NJ 07950

**ELEXOR**

Inquiry 125

## You need a Printer Sharing Unit.

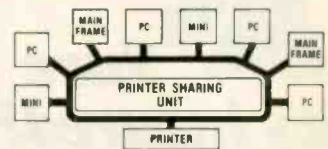

## Not another printer.

Save the cost of your next printer with our Printer Sharing Unit. Up to 8 computers can use one printer, automatically, without changing cables.

This rotating electronic switch scans the input ports. When it finds one ready to transmit, it locks-on and puts the printer to work. Printing completed, it starts scanning again.

For a demonstration or more information call us at (206) 355-0590, and we will give you the name of our dealer nearest you.



4-Channel \$395.00  
8-Channel \$595.00

**Datacom Northwest, Inc.**

3303 112th St. SW, Everett, WA 98204

Inquiry 110

## 72 Digital I/O



### PXB-721 Parallel Expansion Board

- For IBM-PC & Compatibles
- 72 Digital I/O Lines
- Simple Programming
- Uses One Expansion Slot
- Fast Delivery

**\$195**

**QUA TECH, INC.**

478 E. Exchange St. Akron OH 44304  
(216) 434-3154 TLX: 5101012726

Inquiry 300

## RS232 SERIAL OUTPUT PARALLEL INPUT PRINTER BUFFER BI-DIRECTIONAL

This is the most sophisticated Printer Buffer in the market today. Microprocessor controlled, with two separate inputs, Serial and Parallel, and two outputs, Serial and Parallel. Automatic selection of input/output, wherever you connect your units. Comes in two models: 1) w/64K to 256K and 2) w/256K to 1 MByte of buffer. Including COPY, RESET and PAUSE that allows you to print single sheets. External power supply included.

Also we have a BI-DIRECTIONAL Serial Parallel converter, without buffer, fully mode, baud rate and protocols programmable by jumpers, with DTR, RTS or XON/XOFF protocol. External power supply (not included).

DCB-A 64K (exp. up to 256K) \$ 255.-  
DCB-B 256K (exp. up to 1 MB) \$ 295.-  
DCU BI-directional converter \$ 80.-

!!! Order today at:

INTECTRA INC. - Department 232  
2629 TERMINAL BLVD  
MOUNTAIN VIEW - CA - 94043  
(415) 967-8818 - TLX 345545

IN-PARALLEL, OUT-PARALLEL, IN-SERIAL, OUT-SERIAL

## 5 1/4" BASF FLEXYDISKS

	10-90	100 +
SS / DD Soft	\$ .92 ea.	\$ .89 ea.
DS / DD Soft	\$ 1.02 ea.	\$ .99 ea.
High Density (IBM - AT)	\$ 2.59 ea.	\$ 2.49 ea.
3.5 / SS Micro	\$ 2.10 ea.	\$ 2.05 ea.

**In Stock — Immediate Shipment.**  
Mastercard, VISA, Check or Money Order.  
Add \$3.00 shipping charges per each 100 or part.  
Add \$2.50 additional for C.O.D. shipments.  
N.J. residents add 6% sales tax.

### Data Exchange

Dept. B, P.O. Box 993  
178 Route 206 South  
Somerville, N.J. 08876  
(201) 874-5050

Inquiry 107

## BAR CODES MADE EASY



### PERCON® E-Z-READER™

Read the Fine Print before You Call.

PC/XT/AT/Compatibles **YES**. Serial and Multi-user **YES**. Auto-recognition of codes **YES**. Free phone support **YES**. 15 second keyboard installation **YES**. Bar code printing software **YES**. Software changes **HARDLY EVER**. 1000's in use. 2 Year Warranty. \$635 list.

NOW CALL US AT  
503 344-1189

2190 W. 11th St. Eugene, OR 97402

# PERCON®

## MODULAR DATA ACQUISITION

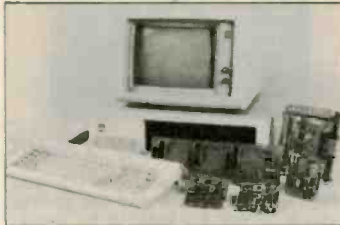

- For IBM & Compatibles
- Flexible and Inexpensive
- Money Back Guarantee
- Free Technical Support

**Fast Delivery**  
**QUA TECH, INC.**

478 E. Exchange St. Akron OH 44304  
(216) 434-3154 TLX: 5101012726

Inquiry 301

Serial ◀■■■■■■■■▶ Parallel



### Convert What You Have To What You Want!

- \* RS232 Serial
- \* 8 Baud Rates
- \* Latched Outputs
- \* Centronics Parallel
- \* Handshake Signals
- \* Compact 3 1/2 x 4 1/2 x 1 1/2

No longer will your peripheral choices be limited by the type of port you have available! Our new High Performance 700 Series Converters provide the missing link. Based on the latest in CMOS technology, these units feature full baud rate selection to 19.2K, with handshake signals to maximize transfer efficiency. Detailed documentation allows amplified installation. Order the Model 770 (Ser/Par) or Model 775 (Par/Ser) Today!

Buller Products  
Coming Soon!

**Tigertronics**

2734-C Johnson Dr.  
Post Office Box 372  
Ventura, California 93006

only \$89.95

Connector Option \$10.00  
CA Residents 6% tax  
UPS Shipping \$3.00

CALL (805) 658-7466 or 658-7467

For FAST Delivery

Inquiry 360



## Sure it's insured?

SAFWARE® Insurance provides full replacement of hardware, media and purchased software. As little as \$39/yr. covers:

- Fire • Theft • Power Surges
- Earthquake • Water Damage • Auto Accident

For information or immediate coverage call:

# 1-800-848-3469

In Ohio call 1-614-262-0559

**SAFWARE**

SAFWARE, The Insurance Agency, Inc.

Inquiry 316

## DeSmet C Development Package

### Still \$109

"... a stunning amount of  
bang for the buck"

Houston, Brodrick and Kent  
BYTE Magazine, August 1983

Call to order by VISA, MC, or AMEX

(408) 720-9696

or write to us:

**C Ware Corporation**

505 W. Olive, Suite 767  
Sunnyvale, CA 94087

We Sell Direct to You

## DATAFLEX™

- Multi-user Database!
  - Powerful!
  - Multiple Operating System Compatibility!
  - Attractive Dealer Pricing!
  - Full Dealer Support!
- Dataflex is a trademark of Data Access  
Dealer Inquiries Invited

# COGITATE

24000 Telegraph Road  
Southfield, Michigan 48034 USA  
(313) 352-2345

Inquiry 75

NO SHIPPING CHARGES  
ORDER TOLL-FREE 800-824-3432

In California Call (818) 341-8833

#### DRIVES

1/2 Ht. IBM™ Compatible	89.99
Tandon 100-2	99.99
Tandon 100-4 (96 tpi)	129.99
Tandon 848-2	299.99

#### ADD ON CARDS

Multi-Function w/OK	119.99
Monochrome Graphics	99.99
Color Graphics	109.99

#### MONITORS

Princeton Graphics MAX 12E	159.99
Princeton Graphics HX 12	439.99

#### SYSTEMS

PC/XT Compatible	699.99
------------------	--------

#### HARD DRIVE SUB-SYSTEMS

10 Meg.	449.99
20 Meg.	549.99

We carry a complete line of electronic components.  
Call or write for our free catalog!



**NICORN ELECTRONICS**  
10010 Canoga Ave. Unit B-8 Chatsworth, CA 91311

Minimum order \$10.00 — No shipping charges on prepaid orders — C.O.D. add \$3.00 — UPS Blue add \$3.00 — Call residents add 6.1% sales tax. Personal checks held for clearance. VISA - MC

## WAVEFORM SYNTHESIZER

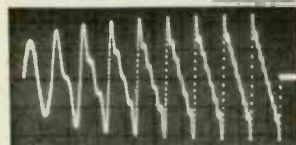

- For IBM-PC/XT/AT and compatibles
- Generates user-definable signal
- Up to 2000 points per envelope

**\$795.00**  
**QUA TECH, INC.**

478 E. Exchange St. Akron OH 44304  
(216) 434-3154 TLX: 5101012726

Inquiry 302

## ATTENTION MEGABYTERS

Beat The 33 Mbyte Limit!

Feature  
for **BIG** disks  
files  
User-Transparent  
Security Features Included.

**Golden Bow Systems**

\$80 — \$120  
Add \$3 for shipping/  
handling

California residents  
add 6% sales tax



619/298-9349  
P.O. Box 3039  
San Diego, CA 92103

Inquiry 373

Inquiry 150



# The *Zipper*™ 1200 bps & 2400 bps Modems

## Fully Hayes Compatible 2 Year Warranty

Supports all 20 Hayes Commands  
and all 6 responses

- Tone & Pulse dialing • Built-in speaker
- Auto dial/auto answer • 8 status lights
- Auto speed selection • Self-test



**1200 bps Standalone**  
Bell 103 and Bell 212A  
Compatible

**\$199**

BEPRIZIP12 (4 lbs.) Retail \$299.00

**2400 bps Standalone**  
CCITT V22, V22BIS, Bell 212A,  
and Bell 103 Compatible

**\$399**

BEPRIZIP24 (5 lbs.) Retail \$599.00

**1200 bps IBM PC**  
Short Slot Card  
w/Communications Software

**5 YEAR WARRANTY**  
**\$199**

BEPRIZIP12H (4 lbs.) Retail \$299.00

### VIDEO MONITORS

#### IBM PC™ COMPATIBLE MONITORS

PGS MAX-12 Amber 12" 25lbs	BEPGXMAX12	\$179
PGS HX-12 RGB 12" 37lbs	BEPGXHX12	\$479
AMDEK 310A Amber 12" 26lbs	BEADK310A	\$169
MAGNAVOX RGB 13" 26lbs	BEMAGCM8562	\$299

#### GENERAL PURPOSE

AMDEK 300 Green Comp. 12" 25lbs	BEADK300	\$129
AMDEK 300A Amber Comp 12" 25lbs	BEADK300A	\$139

#### IBM COMPATIBLE BOARDS

##### AST

SixPacPlus 64K	BEAST6PACK64	\$259
RAM Page! 256K	BEASTRP256	\$399
MegaPlus II 64K	BEASTMP2	\$349
MegaPak 128K for above	BEASTPAC4	\$179
Preview!	BEASTPRVW	\$279
ColorGraph Plus	BEASTCGP	\$199

##### QUADRAM

EXPANDED QUADBRD zero K	BEQDRQBRDXPO	\$239
QUADBOARD II zero K	BEQDRQBRDII	\$199
GOLD QUADBOARD zero K	BEQDRGO	\$449
SILVER QUADBOARD zero K	BEQDRSO	\$269
LIBERTY BOARD 128K	BEQDRLIB	\$499
QUAD 512+ 64K	BEQDR512	\$259
QuadEGA+	BEQDRREGA	\$449
QUADCOLOR II	BEQDRDCII	\$349

##### HERCULES

MONO GRAPHICS CARD	BEHECCG	\$329
COLOR graphics card	BEHECCC	\$179

##### ORCHID

CONQUEST zeroK	BEORCCO	\$369
CRAMRAM Half BO 186	BEORCT86	\$829
Serial daughter board for above	BEORCT8650	\$129

##### PARADISE

5 PACK zero K	BEPAR5PACK	\$149
5PACK w/384K included you install	BEPAR5PACK384	\$199

##### STD

EGA Plus	BESTBEGA	\$399
Chaffier	BESTBCHFR	\$299

### PRACTICAL PERIPHERALS

MULTI FUNCT. w/GK & 1200bps Modem	BEPRPPMCO	\$395
-----------------------------------	-----------	-------

#### ALPHA MICRO

VIDEOTRAX Card only	BEAMSVT	\$595
VIDEOTRAX Subsystem	BEAMSVTS	\$1395

#### EXPANSION CHIPS

64K= 9-64K DRAMS	BEPDBBMMEM9	\$12
256K= 36-64K DRAMS	BEPDBBMMEM36	\$39
256K= 9-256K DRAMS	BEPDB256MEM9	\$39
2Meg= 36-256K DRAMS	BEPDB256MEM36	\$149

#### KEYTRONICS KEYBOARDS

Improved PC type 5lbs	BEKEYKB5151	\$189
KB5151 with touch pad 5lbs	BEKEYKB5153	\$379

#### POWER SUPPLIES FOR IBM PC™

170watt replacement 7lbs	BETEATP409B	\$159
130watt replacement 6lbs	BETEATP412	\$ 99

#### TERMINALS

WYSE 50 32lbs	BEWYS50	\$499
	2 or more	\$479
WYSE 30 32lbs	BEWYS30	\$359
QUME 101 Amber 32lbs	BEQMEQVT101AM	\$359
QUME 101 Green 32lbs	BEQMEQVT101GR	\$359

#### MODEMS

##### HAYES

2400bps Smartmodem 4 lbs.	BEDCH2400	\$599
1200bps Smartmodem 4 lbs.	BEDCH1200	\$399
1200bps PC Smartmodem 4 lbs.	BEDCH1200B	\$379

**Surge Suppressor &  
Noise Filter**

**\$29.95**

BEWBROG1155 List: \$49.95  
(Shipping Weight 2 lbs.)

### PROMETHEUS

ProModem 1200 Standalone 4lbs	BEPRMPM1200	\$299
ProModem 1200 for MAC 4lbs	BEPRMPM1200M	\$349
Communications buffer 1lb.	BEPRMOP5	\$129
Alpha/num for ProModem 1lb.	BEPRMDISPLAY	\$ 79
512K ProModem upgrade 1lb.	BEPRMX512	\$ 99
ProMod 1200 Apple IIe card 4lbs	BCPRMPM1200A	\$349
ProMod 1200 PC card/stwr 4lbs	BCPRMPM1200B	\$279

#### HARD DISK PC SUBSYSTEMS

Systems include drive, control & data cables & 1/2 card contrlr

##### INTERNAL (Include \$6 shipping)

21Mbyte 1/2 high	BEPRIPCSUB21I	\$549
33Mbyte full high	BEPRIPCSUB33I	\$899
40Mbyte full high	BEPRIPCSUB40I	\$1399
72Mbyte full high	BEPRIPCSUB72I	\$1999

##### EXTERNAL (Include \$10 shipping)

Drives mounted in a IBM PC styled enclosure		
21Mbyte subsystem	BEPRIPCSUB21X	\$749
33Mbyte subsystem	BEPRIPCSUB33X	\$1099
42Mbyte subsystem	BEPRIPCSUB42X	\$1599
72Mbyte subsystem	BEPRIPCSUB72X	\$2199

#### "AT" Subsystems - Drive & Cables

30 Mbyte Subsystem	BEPRIATSUB30I	\$899
40 Mbyte Subsystem	BEPRIATSUB40I	\$1499

29

Seagate ST225 25Mbyte	BESEAST225	\$ 449
CMI 6640 40Mbyte	BECEM6640	\$ 699
CDC 94155-086 86Mbyte	BECCDC86	\$1895
Maxtor XT1140 143Mbyte	BEMXTXT1140	\$3295

#### FLOPPY DISK DRIVES (Sh. wt. 3 lbs.)

MPI 52S 5 1/4" DS,40T,full hi	BEMPI52S	\$ 69
Tandon TM100-2 5 1/4" DS,40T full hi	BETNDTDM1002	\$129

ONE ONE ONE ONE ONE ONE ONE ONE ONE ONE ONE ONE ONE ONE ONE

**YOUR SATISFACTION GUARANTEED**

**CALL FOR DETAILS**

IRVINE

18241 Mc Durmott,  
Irvine, CA 92714  
(714)660-1411

**PRIORITY ONE ELECTRONICS®**

**Priority 1** Inquiry 292 Mail Your Order To:  
21622 Plummer St., Chatsworth, CA 91311-9970  
RETAIL: (818)709-5464 INDUSTRIAL: (818)709-5111

SAN JOSE

542 W. Trimble Rd.,  
San Jose, CA 95131  
(408)435-7300

MINIMUM PREPAID ORDER \$25.00. Terms U.S. VISA, MC, BAC, Check, Money Order, U.S. Funds ONLY. CA residents add 6%, 6 1/2%, or 7% Sales Tax, depending on your local rates. Include MINIMUM SHIPPING & HANDLING of \$3.00 for the first 3 lbs., plus 50¢ for each additional pound (25¢ if within Calif.) Plus 25¢ per \$100.00 value of your order for PRIORITY ONE ELECTRONICS and PRIORITY 1 ELECTRONICS are registered service marks of the Heath Group, Ltd. Zipper 212A, Zipper 2400, Zipper 1200B and Zipper Modem are trademarks of the Heath Group, Ltd.

insurance. Orders over 70 lbs. sent freight collect. In case, include your phone number. Prices subject to change without notice. We will do our best to maintain prices through May 1986. Credit card orders will be charged appropriate freight. We are not responsible for typographical errors.

**ORDER TOLL FREE (800)423-5922 (NOW IN CALIF. TOO!!)**

**PROFESSIONAL HANDICAPPING SYSTEMS**  
 • PRESENTED BY PROFESSOR JONES •

Thoroughbred "Gold" Edition™  
 A "Full" featured thoroughbred analysis designed for the professional and the serious novice. \$159.95 complete w/Master Bettor™ \$199.95

Limited "Gold™" Enables Professional Handicappers to assign specific values to racing variables they feel are important, create program weight based on particular track, and fine tune for maximum win percentage. Program designed for ease of use. User needs no programming experience.  
 (Contains Integrated Bettor™) \$299.95 complete

Gold Dog Analysis™ \$149.95  
 The ONLY professional greyhound analysis available that evaluates ALL variables. w/integrated Bettor \$199.95 Limited Version \$299.95

Master Harness Handicapper™ \$159.95 complete  
 Professional software designed to provide a thorough analysis of all trotter and pacer races in the United States and Canada. w/integrated Bettor \$199.95 Limited \$299.95

Lottery Analysis. Statistical comparison program designed to detect subtle patterns in winning numbers and digits. Lottery (3-4 digit) \$79.95 w/Lotto (Max 99 Digit) \$99.95

**FREE CATALOG**  
 Professor Jones • 1940 W. State, Boise, ID 83702  
 CALL 342-6930 • VISA/MasterCard/AMEX Welcome  
 Terms: 48-Hour Free shipping of software. Add \$6 hardware/\$6 C.O.D. / \$6 UPS Blue / \$9 Out of Country. Idaho residents add 4%. 3 weeks personal checks. Cash price only. Add 2% VISA/MasterCard, AMEX. Prices subject to change.

★ Your BEST BET in Handicapping Software Reviewed by Whole Earth Software Guide, and Corona Data Systems ★

Inquiry 293

**TERMINAL EMULATION**

Softerm PC emulates over 30 popular terminals including the:

- DEC VT102, VT220
- Data General D200, D410
- IBM 3101-20 (block mode)
- Hewlett-Packard 2622A
- Honeywell VIP7801, VIP7803

Guaranteed Compatibility  
 Call for free product brief  
 \$195 MC-VISA-COD  
 For the IBM PC/XT/AT, DG1, NEC, Wang PC, TI Pro, Gridcase, Tandy

**SOFTRONICS**  
 7899 Lexington Dr., Ste 210  
 Colorado Springs, CO 80918  
 (303) 593-9540

Inquiry 328

**WE CAN MAKE INCOMPATIBLE DATA COMPATIBLE!**

We can transfer datafiles between different operating systems; convert media (disks and tapes); decode and translate documents between major dedicated word processors and/or major PC software; re-arrange database files; transfer texts and re-formulate spreadsheet data.

Write or call to discuss your needs, then send a disk or tape sample of your datafile for a complimentary translation.

**CompuData Translators, Inc.**  
 6565 Sunset Blvd., Suite 301  
 Hollywood, CA 90028  
 (213) 462-6222  
 ADAPSO Member

Inquiry 78

**VAX/IBM PC**

DECKHAND™ Utilities  
 MS-DOS Utilities with VAX/PDP-11 switch processing, DIR, COPY, DELETE, RENAME, TYPE with extended wildcards, full DATE processing, attribute processing, query, backup and more. \$69.00

ZSTEMpc™-VT100 Emulator  
 High performance COLOR VT100 / VT102. Double high/wide, smooth scrolling or ISO and attribute mapped color. XMODEM and KERMIT, softkey/MACROS. \$150.00

ZSTEMpc™-4014 Emulator  
 Interactive zoom and pan. Save/recall images to/from disk. Keypad, mouse, printer, plotter support. \$99.00

**KEA SYSTEMS LTD.**  
 #412 - 2150 W. Broadway  
 Vancouver, B.C. CANADA V6K 4L9  
 Support (604) 732-7411  
 TELEX 04-352848 VCR  
 Order Toll Free (800) 663-8702

**KEA SYSTEMS**

Inquiry 397

**\$99.00**  
 5 1/4" Hard Disk Controllers for Micromint COMM180 and others

**SHUGART 1610 CONTROLLER**

SASI/SCSI to ST506 interface (all 5 1/4" hard disk drives)  
 EMULATES: XEBEC S1410 (1610-3)  
 DTC 510 (1610-1)  
 SCSI-similar to Adaptec 4000 (1610-4)

WORKS WITH MANY POPULAR SYSTEMS

- Micromint COMM180
- Wavemate Bullet
- AMPRO Little Board - All Boards
- MAC, APPLE IIe
- ACS 1000
- ISI 5160

Ask about others

These Shugart 1610 boards are new. Shugart tested controllers are guaranteed 90 days. They will mount on a 5 1/4" hard disk drive. Manual and schematic available (\$8.00).

**Computer Surplus Store**  
 3675 Desoto Ave., Santa Clara, CA 95051  
 (408) 248-0134  
 Chuck Schuetz, proprietor  
 Quantity and Dealer pricing available

Inquiry 88

**DATA ACQUISITION and control for ANY computer**

**NEW**

The Model 1232 communicates via RS-232, and has 8 analog inputs ( $\pm 4$  VDC; 12 bits), 8 digital inputs and outputs, and a 2000 point buffer. Suitable for field data logging or lab use, the 1232 costs only \$690. The 8-bit system (0-5 VDC) is \$490. Detailed manual, \$6. Phone our applications engineer at 617-237-5514 or write:

★ ★ **STARBUCK DATA COMPANY** ★ ★  
 2 Mica Lane, Wellesley, MA 02181

Inquiry 343

**9-TRACK MAG. TAPE SUBSYSTEM FOR THE IBM PC/XT/AT**

For information interchange, backup and archival storage, IBEX offers a 9-track, IBM format-compatible 1/2" magnetic tape subsystem for the IBM PC, featuring:

- 42 M-Bytes on a single reel.
- IBM format 1600 cpi.
- Software for PC-DOS, MS-DOS.

**IBEX**  
 IBEX COMPUTER CORP.  
 20741 Merita St.  
 Chatsworth, CA 91311  
 (818) 706-8100  
 TWX 910-483-2071

Write, phone or FAX for information

Inquiry 165

**Heritage Systems Corp.**

**HSC-9128 Video Terminal Card**  
 80 by 24 Alpha-numeric video display  
 ANSI X3.64 command set  
 TTL/CMOS serial port (50 to 38.4K baud)  
 Off card line drivers (RS-232, Fiber optic)  
 IBM PC compatible keyboard input  
 On Screen configuration utility  
 100 by 10mm, 5V only, 200mA

HSC-9128 video terminal card \$129  
 HSC-9128 with RS-232, cables \$159  
 HSC-9129 keyboard \$119  
 Amdek 300G Video monitor (Green) \$139  
 Amdek 300A Video monitor (Amber) \$149

**PO Box 10588,  
 Greensboro, NC 27404-0588  
 (919) 274-4818**

Inquiry 159

**ROSE ELECTRONICS DATA SWITCHES**

SHARE computers, printers, any parallel or serial device  
 ELIMINATE cable swapping  
 INEXPENSIVE way to network  
 COMPATIBLE with all computers.  
 Businesses, Schools, Homes

WE ALSO OFFER:  
 Data Buffers, Line Drivers, Modems, Protocol Converters, Parallel - Serial Converters, Cables, Computers, Printers, Disk Drives, and more.

**AUTOMATIC - CARETAKER** is ideal for a business or school to share a printer or modem among many computers. Operation is fully automatic with no software required. Parallel or Serial 4 channels - \$295 8 channels - \$395

**MANUAL - HARDSWITCH** is operated with the flip of a switch. 2.2 and 2.4 models allow simultaneous communication.  
 Serial 1:2 - \$59 1:4 - \$99 2:2 - \$109 2:4 - \$169  
 Parallel 1:2 - \$79 1:4 - \$139 2:2 - \$119 2:4 - \$199  
 LED and spike protection on serial models add \$20.

**CODE ACTIVATED - PORTER** connects one computer to multiple peripherals. A software code selects the peripheral. Parallel or Serial 4 channels - \$295 8 channels - \$395  
 Buffer option 64K - \$100 256K - \$250

**REMOTE - TELEPATH** connects multiple computers to multiple peripherals. A selector at each computer or terminal chooses up to 4 peripherals and displays busy status. 4:4 - \$495 4:8 - \$795 selector - \$38.

Give a Rose to your computer

**ROSE ELECTRONICS (713) 933-7673**  
 P.O. BOX 742571 MC & VISA Accepted  
 HOUSTON, TX 77274 Dealer Inquiries Invited  
 CALL US FOR ALL YOUR INTERFACE NEEDS

Inquiry 311



# COMPUTERBANC

**FREE SHIPPING ON ALL SOFTWARE \$200 MIN.**

**HARD DRIVE KITS**  
 20 MB Internal w/Controller \$469  
 30 MB Internal for AT \$695  
 \* External Models Add \$150

**TAPE DRIVES**  
 20 MB \$599 | 45 MB \$899 | 60 MB \$999  
 \*File by File  
 \*Mirror Image \*Software Included

**IBM PC AT 20 MB**  
 (Seagate Model 225)  
 512 K, Serial, Parallel  
**\$4,299**

**STB RIO PLUS \$239.00**  
 6 Function 384K  
**COMPANION PC \$189.00**  
 O-2 meg, EMS

**IBM PC XT**  
 20 MB, 256K  
 CALL  
 CALL 256K, 2 Drive  
**IBM PC**

**COMPAG 286 PORTABLE**  
 20MB,640K  
**\$4,259**  
 \$3,999  
 44MB, MONITOR  
**SPERRY IT**

**STB EGA PLUS \$339.00**  
 • 16 Colors, 256K, Parallel  
 • IBM Compatible

**IBM PC COMPATIBLES**  
 LEADING EDGE CALL  
 IIT XTRA 2 Drive, 256K \$1,495  
 AMIGA CALL  
 PC Clone System \$899  
 EQUITY 1 CALL

\*All systems include monochrome monitor, DOS, and parallel port

### IBM SOFTWARE

LOTUS 123	CALL
Symphony	CALL
ENABLE	359.00
ASHTON TATE Framework	369.00
dBASE II	279.00
dBASE III Plus	369.00
POWERBASE	CALL
CLIPPER dBASE III Compiler	355.00
LATTICE C COMPILER	249.00
MULTIMATE	225.00
MULTIMATE ADVANTAGE	269.00
SORCIM SUPERCALC III	199.00
MICROSOFT Multiplan	119.00
Word	225.00
Windows	65.00
Project	239.00
FOX & GELLER Quickcode	149.00
BORELANO TURBO PASCAL	39.00
REFLEX	55.00
LIGHTENING	55.00
SUPERKEY	39.00
SIDEKICK (unprotected)	46.00
ASCII PRO Comm Software	69.00
CROSS TALK XVI	99.00
PEACHTREE Back to Basics	199.00
BPI GENERAL ACCOUNTING	303.00
OPEN SYSTEMS	CALL
REALWORLD	CALL
ONE-WRITE PLUS	149.00
IN-HOUSE ACCOUNTANT	89.00
ACCOUNTING PARTNER	199.00
MONOGRAM DOLLARS & SENSE	105.00
TOBIAS MANAGING YOUR MONEY	105.00
SATELLITE WORD PERFECT	225.00
MICROPRO WordStar PRO	249.00
WordStar 2000 PLUS	285.00
SAMNA WORD III	279.00
RBASE 5000	359.00
PRINTMASTER	35.00
BREAKTHROUGH TIMELINE	255.00
DECISION RESOURCES CHRTMASTER	219.00
ENERGRAPHICS w/plottter opt.	207.00
FUNK SIDWAYS	36.00
LIFETREE VOLKSWRITER DELUXE	149.00
HARVARD TTL PROJECT MNGR	285.00
THINKTANK	

### ALSO HAYOEN, MONOGRAM, BPT, MICROCO-RIM, NORTON AND MORE

### IBM HARDWARE

AST 6 Pack Plus w/384k	249.00
Advantage W/128k	399.00
STB Rio Plus 384K 5 function	239.00
RIO Grande 3 function for AT	289.00
Companion PC O-2 MB	189.00
Chaufteur monographics	229.00
EGA - Plus Color Board	339.00
HERCULES Mono Graphics	319.00
Color Card	159.00
ORCHID Turbo w/256k	669.00
QUADRAM Quadboard O-K	198.00
EGA + NEW	405.00
QuadPort for AT ser & par	115.00
TECHMAR Graphics Master	469.00
PARADISE Modular Graphics Card	CALL
SIGMA High Res Color 400	CALL
IBM Compatibles	
Multifunction Card 384ks, p, c, k	169.00
Multifunction Card OK-1, 2mb	179.00
Compatible Mono Card w/par	129.00
Expansion Chasis	CALL
130 WAT Power Supply	85.00
MONOCHROME Graphics Card	99.00
Color Graphics Card	110.00
TALLGRASS W/Tape	CALL
IRWIN Tape Drive	414.00
EVEREX TAPE Pc/XI/AT	CALL
Graphics Edge Card	249.00
TEAC 55B	95.00
1.2MB FLOPPY for AT	189.00
360K Floppy for AT	110.00
MOUSE SYSTEMS Mouse	117.00
FIELDMOUSE	113.00
MICROSOFT Mouse w/stwr.	117.00
KDALA KAT	149.00
DISKETTES 2S DD	15.00
ANCHOR Express 300/1200	220.00
Volsmodem 1200 (5 yr wrnty)	169.95
Lightning 2400 Baud	CALL
HAYES 1200	379.00

### MODEMS

1200B	349.00
2400	CALL
Micromodem //e	CALL
PROMETHEUS 1200	CALL
Promodem 1200B	FCR
Promodem 1200A	FCR
Promodem 300 Ilc	BLOW-OUT PRICES
Promodem 2400	CALL

### MONITORS

AMOEK 300A	139.00
310A Hi-Res Amber	155.00
Color 722 RGB 720 X 350	CALL
PRINCETON GRAPHICS HX-12	469.00
HX-12E RGB 720X350	CALL
SR-12	625.00
MAX-12	179.00
TAXAM 121/122	149.00
620 (RGB) 640 x 200 NEW	CALL
640 (RGB) 720 x 400 NEW	CALL
PANASONIC OT-S101 Color	141.00
OT-H103 10" High Res RGB	369.00
IBM COMPATIBLE Monochrome Color RGB Monitor (640X200)	349.00

### PRINTERS

PANASONIC (2 yr warranty)	
KX-P1080	199.00
KX-P1091	229.99
KX-P1092	305.00
KX-P1592	439.00
KX-P1595 240 CPS	659.00
KX-P3131 17cps Daisey	269.00
KX-P3151 22 cps Daisey	395.00
Citizen MSP-10	266.00
MSP-15	355.00
MSP-25	489.00
STAR MICRONICS SG-10	219.00
SG-15	399.00
EPSON LX-80	Call
FX-286	lor
LQ-800	Best
LQ-1000	Prices
BROTHER	
Twinwriter 5	

OKIOATA - All Models	CALL
TOSHIBA All Models	CALL
CANNON Laser Printer	CALL
HEWLETT PACKARD PRINTERS	CALL
HOUSTON INSTRUMENTS Plotters	CALL
Digitizers	CALL

### APPLE PRODUCTS

AST Multi 1/0	CALL
MICRO SCI A2 Drive IIc	169.00
IIc compatible drive	139.00
APPLE Compatible Drive	119.00
MAC Compatible 3 1/2 drive	229.00
BERNOULLI 5MB MAC drive	CALL
MACINTOSH Harddrive	CALL
MICROSOFT Macenhancer	CALL
Softcard II	259.00
Multi-plan //e & Mac Basic (Mac)	129.00
Basic (Mac)	109.00
ASCII XPRESS (Communications)	89.00
THE DESK ORGANIZER (Mac)	133.00
APPLE MOUSE II	129.00
APPLEWORKS	215.00
SPELLWORKS 49.00PRINTSHOP	35.00
Mach III Joystick	39.00
SYSTEM SAVER Fan	69.00
VIDEO 7 Ilc Enhancer	CALL
Titan Accelerator	229.00
VIDEX UltraTerm	169.00
APRICORN (Lifetime Warranty) Super Serial Imager	75.00
Graphics Interface	65.00
80 Column/64K	75.00
EXTEND IT 64K	55.00
KDALA SpeedKey	99.00
DISKETTES APPLE/MAC	12.00/24.00

Look for our Bulletin Board Featuring Multi-user Games

We Will Best Any Advertised Price

Call for catalog. Thousands of products available. Volume discounts.



# COMPUTERBANC

16783 Beach Blvd., Huntington Beach, CA 92647  
TELEX #350757 ANSWER BACK—COMPUTER UD  
714/841-6160

For Customer Service Call 714-847-BANC

No Charge for Credit Cards Orders Only

**800/332-BANC**  
OUTSIDE CALIFORNIA

Cash prices indicated. All products are in factory sealed packages. We guarantee all items for 30 days. Within this period, defective merchandise returns must be accompanied by RMA number. All other returns will be subject to a 10% restocking fee. For prepaid orders, there will be a 3% shipping charge; 5% for UPS Blue Label. \$5.00 minimum; all orders outside U.S.A. or 15% shipping. California residents add 6% sales tax. Prices subject to change without notice. ©Copyright 1985 COMPUTERBANC. All Rights Reserved.

# BYTE CONNECTION INC.

## BOTTOM LINE PRICE BUSTERS! — "Who you gonna call?"

### (714) 778-6496

#### PERSONAL COMPUTERS

**IBM ★ I (IBM Compatible), 640K, AT Look Alike Keyboard, Two 360 EA Floppies, Hi-Res Graphics Board & Monitor** ..... \$ 995  
**IBM ★ II, all the above with 360 Floppy, 10 MB HD** ..... \$1495  
**IBM ★ III, Turbo, all the above with 20 MB HD** ..... \$1750  
**IBM ★ IV, AT Compatible, 640 K, 1.2 MB Floppy, 30 MB HD, S. P. C/C, Hi-Res Graphics Board, Monitor & K.B** ..... \$2950  
**Dealer's Inquiries Invited**

**IBM PC, with 256K, K.B. FDC, Two 360 Floppies, Hi-Res Graphics Card & Monitor** ..... \$1795  
**IBM PC XT, with 256K, 360 Floppy, 20 MB HD, K.B., Hi-Res Graphics Card & Monitor** ..... \$2595  
**IBM PC AT, with 512K, K.B., 1.2 MB Floppy, 20 MB HD, Graphics Card & Monitor** ..... \$4141  
**IBM PC AT, all the above with 70 MB HD & 60 MB Tape B/U** ..... \$6969

**COMPAQ PORTABLE MODEL I** ..... \$1750  
**COMPAQ PORTABLE, 256K, 360 Floppy, 10 MB Rhodium HD** ..... \$2595  
**COMPAQ DESK PRO, with 640K, Two 360 Floppies, Graphics Card & Monitor** ..... \$2020  
**COMPAQ PORTABLE 286, with 640K, K.B., 1.2 MB Floppy** ..... \$3300  
**COMPAQ DESK PRO 286, with 640K, K.B., 1.2 MB Floppy, 20 MB 40 MS HD, Graphics Card & Monitor** ..... \$4195  
**COMPAQ DESK PRO 286, all the above with 70 MB 28 MS HD, 60 MB Tape B/U** ..... \$6969

**AT & T 6300 PC, with 256K, Two 360 Floppies, AT & T Graphics Card & Monitor, DOS 3.1** ..... \$1925  
**AT & T 6300 Plus, with 512 K, 1.2 MB Floppy, 360 KB Floppy, K.B., 20 MB HD, AT & T Graphics Card & Monitor, DOS 3.1 & UNIX OS** ..... \$4895  
**AT & T 7300** ..... CALL

#### SOFTWARE

**ACCOUNTING, A/R, A/P, G/L, INVENTORY, PAYROLL** ..... \$ 495  
**CAD SYSTEMS** ..... CALL  
**D base III PLUS** ..... \$ 379    **LOTUS 1-2-3** ..... \$ 339  
**LOTUS SYMPHONY** ..... \$ 489    **MULTIMATE ADVANTAGE** ..... \$ 269  
**FRAMEWORK II** ..... \$ 489    **WORDSTAR 2000 PLUS, II** ..... \$ 399  
**MEDICAL & LEGAL SOFTWARE** ..... CALL

#### MIC

**EXPANSION CHASIS, POWERSUPPLY, M/S** ..... \$ 550  
**HITACHI HM 3719 & BNW 1024 x 1024** ..... CALL  
**ORCHID NETWORK, ADVANCE DIGITAL, NOVELL** ..... CALL  
**MULTI USER SYSTEMS** ..... CALL

#### PRINTERS

**ANADIX 6500** ..... \$1895    **CITOH LINE/LAZER** ..... CALL  
**CITIZEN MSP15 - PREMIER 35** ..... \$ 399 - 450  
**DATA PRODUCT 8070 - LINE/LAZER** ..... \$1695 - CALL  
**DIABLO 635** ..... \$1295    **EPSON** ..... CALL  
**FUJITSU** ..... CALL    **HP LAZER JET** ..... \$2350  
**HP Plus** ..... \$3395    **NEC** ..... CALL  
**OKIDATA 192-193** ..... \$ 379 - 495  
**TOSHIBA 1340 - P351** ..... \$ 495 - 1159

#### HARD DISK & FLOPPIES

**10 MB SUBSYSTEMS for PC** ..... \$ 439    **20 MB SUBSYSTEMS** ..... \$ 550  
**20 MB AT** ..... \$ 595    **30 MB AT** ..... \$ 795  
**70 MB HD & 80 MB TAPE B/U AT** ..... \$2495  
**360 FLOPPY** ..... \$ 79    **IBM 360 FLOPPY** ..... \$ 110  
**30 MB SUBSYSTEM for AT & T** ..... \$ 795

#### PLOTTERS & DIGITIZERS

**ALCOMP & NICHOLET** ..... CALL  
**HP 7475 - 7550** ..... \$1659 - 3295  
**HITACHI, GOULD, KURTA, GTCO, SUMMAGRAPHS DIGITIZERS** ..... CALL  
**HITACHI 41-42** ..... \$3050, 51-52 ..... \$4695, 29 ..... \$2121  
**IO LINE 3700, SPECIAL OF THE MONTH!** ..... \$4095

WE CARRY ALL NAME BRAND MFC, MODEMS, MONITOR ADAPTERS AND SOFTWARE. CALL FOR WHAT IS NOT LISTED. PRICES AND AVAILABILITY SUBJECT TO CHANGE WITHOUT NOTICE. NO CHARGES FOR CONFIGURING AND TESTING. WE GUARANTEE THAT YOUR CALL WILL NOT BE A WASTE.

**163 West Cerritos Ave., Anaheim, CA 92805**  
**(714) 778-6496**

## TURBO SPEED

**FULLY COMPATIBLE AND 40% FASTER THAN \*IBM PC/XT BY USING STATE OF THE ART \*NEC V-20 PROCESSOR**



- Fully IBM PC/XT compatible
- 640K on board memories
- 8 IBM PC/XT standard I/O slots
- 8087 coprocessor ready socket
- Standard 4.77 MHz clock speed
- Flip-top type metal cabinet
- 83 key full function key board (enlarged return key and led indicators)
- Color graphic adapter with composut out (RES. 640 x 320)
- One parallel port for printer
- One RS-232 serial port
- One game port for joystick
- Real time clock with calendar (5 years battery back up on board)
- 150 watts hard disk ready power supply
- 2 halfheight 360K floppy drives (PANASONIC)
- 12" monochrome monitor included
- Fully assembled and tested
- 6 months parts and labor warranty

**SPECIAL OFFER: \$899**

\*V20 by NEC is the superset of 8088 and pin to pin compatible with 8088, increases speed of pc from 40% to 80% (rated 1.8 according to Norton Utili-3.0's system information while IBM PC and PC/XT are rated 1.0 as standard) without changing the clock speed of the system, run all IBM PC compatible software with no problem.

OTHER SYSTEM CONFIGURATIONS AVAILABLE PLEASE CALL FOR DETAIL

### PINE COMPUTER INC.

9690 TELSTAR AVE., SUITE #204,  
 EL MONTE, CA 91731  
**PHONE: (818) 575-1882**  
**STORE HOURS: Mon. - Sat. 9 A.M. - 6 P.M.**

### IBM PERIPHERALS

- PC/XT 640K MOTHER BOARD, LOADED W/BIOS ..... \$215.00
- COLOR GRAPHIC CARD W/RGB & COMPOSIT VIDEO OUT PUT (640x 400 RES) ..... \$ 80.00
- MONOCHROME GRAPHIC CARD W/PRINTER PORT (720x348 RES) ..... \$ 99.00
- FLOPPY DISK CONTROLLER CARD W/CABLE ..... \$ 45.00
- O/384K MULTIFUNCTION CARD W/PARALLEL PORT, SERIAL PORT, GAME PORT, CALANDER, CLOCK (BATTERY BACK UP) AND 384K RAM SLOTS ..... \$119.00
- DISK I/O CARD W/PARALLEL PORT, SERIAL PORT, GAME PORT, CALANDER, CLOCK (BATTERY BACK UP) AND FLOPPY DISK CONTROLLER W/CABLES ..... \$110.00
- PARALLEL PRINTER CARD ..... \$ 28.00
- SERIAL PRINTER CARD (RS-232) ..... \$ 45.00
- DUAL SERIAL CARD (RS-232) (COM-1, COM-2) ..... \$ 70.00
- O/512K RAM EXPANSION CARD ..... \$ 52.00
- MOUSE SYSTEM (MICRO-SOFT COMPATIBLE) (3 BUTTONS) ..... \$ 75.00
- INTERNAL MODEM 300/1200 BULD (HAYS COMPATIBLE) ..... \$175.00
- 150WATT POWER SUPPLY 110/220V SIDE SWITCH ..... \$ 95.00
- KEYBOARD: PC/XT LOOK ALIKE 84 KEY (5150) ..... \$ 70.00
- KEYBOARD: SELECTIC-II LOOK ALIKE, LARGE RT KEY ..... \$ 70.00
- KEYBOARD: ADVANCE 100 KEY MODEL : 5151 ..... \$ 90.00
- KEYBOARD: AT LOOK ALIKE, LARGE RT KEY ..... \$ 80.00
- PARALLEL PRINTER CABLE (6 FT.) ..... \$ 14.00
- SERIAL PRINTER CABLE (6 FT.) ..... \$ 14.00
- JOY STICK (SELF CENTERING W/2 FIRE BUTON) ..... \$ 20.00
- 360K HALF HEIGHT DISK DRIVE (PANASONIC OR TEAC) ..... \$ 98.00
- SURGE SUPPRESSED POWER STRIP (6 OUTLETS) ..... \$ 18.00

- OPTIONAL ADD ON:**
- A. For 5151 100 keys keyboard add \$40.00
  - B. For 3way RGB color monitor 13" add \$250.00
  - C. For 10 MGB internal hard disk with controller add \$399.00
  - D. For 22 MGB internal hard disk with controller add \$499.00
  - E. For Monochrome graphic adapter with printer port and TTL Monochrome 12" Hi-RES monitor add \$50.00

**SHIPPING CHARGES:** 5% for C.O.D., 2% for prepaid orders inside Continental U. S. No Personal Checks Accepted.

**DEALERS INQUIRIES INVITED.**

• IBM is registered trade mark of IBM Corp.

# ROMDISK

## EPROM OR RAM DISK AND DISK DRIVE EMULATORS

**IBM PC\*, COMPATIBLES AND APPLE IIe\***

- Diskless control and communications system
- Autoboot applications for dedicated workstations and improved productivity
- Customized high speed, smart terminals
- Solid state speed, reliability and performance
- Self contained control and EPROM program circuitry
- PC and MS DOS\* compatible
- ROMDISK and RAMDISK are I/O mapped
- RAM disk - with battery back-up
- Plug compatible EPROM and RAM modules

ROMDISK PC-1 (180K) \$495  
 ROMDISK PC-2 (360K) \$595  
 RAMDISK PC-D (360K) \$595  
 ROMDISK A FOR //E (144K) \$349



**CURTIS, INC. 22 Red Fox Road**  
**St. Paul, MN 55110 612/484-5064**

\*IBM PC and PS DOS is a registered trademark of IBM Corporation. MS DOS is a registered trademark of Microsoft Corporation. Apple //e is a registered trademark of Apple Computer Corporation.

Inquiry 102

# NEC PRINTERS

## (1 Year Factory Warranty)

Pinwriter P5	\$ 925
Pinwriter P5XL	\$1100
Pinwriter P6	\$ 445
Pinwriter P7	\$ 575
Elf 350/360	\$ 380
3510/15/30/50	\$ 715
8810/15/30/50	\$1040

Optional Forms Handling Devices ..... CALL

**QUALITY PRINTERS**  
 8415 Cement City Road  
 Brooklyn, Michigan 49230  
 Phone: 517-592-3749

Inquiry 304

## PC XT

# \$799

ASSEMBLED & TESTED (48 HRS)

QUANTITY PRICES AVAILABLE



**FEATURES**

640K 2.880K Drives Clock cal.  
 RS 232 PORT PARALLEL PORT GAME PORT  
 RAM DISK PRINT SPOOLER ENHANCED KEYBOARD

**RUN**

FLIGHT SIMULATOR LOTUS 123 BASE  
 I.B.M. DIAGNOSTICS DOS 2.1 MS-DOS

<b>HARD DISKS</b>	
10 MEG HARD DRIVE w/ Controller & Cable	\$395
20 MEG HARD DRIVE w/ Controller & Cable	\$499
COLOR GRAPHIC CARD RGB & Composite	\$99



**\$79**

MARC BAER ASSOCIATES  
 1750 SKIPPACK PIKE, SUITE 309  
 BLUE BELL, PA 19422  
**(215) 279-7961**

Inquiry 217

## RS-232 to RS-422A CONVERTER

For Under **\$50!**



- Allows your RS-232 Equipment to communicate with devices using RS-422A
- Two converters can extend RS-232 signals up to 4,000 ft.
- Bi-directional, uses 12 volts

ORDER NOW! Model 422 COV \$49.95  
 Optional power supply \$14.95. Cash orders shipped postpaid. IL Res. add 6% sales tax. Visa and MasterCard accepted. Satisfaction Guaranteed. FREE fully illustrated newly revised catalog of interface & testing equipment. Phone: 815-434-0846

**B & B electronics**  
 MANUFACTURING COMPANY  
 P.O. Box 10088, OTTAWA, IL 61350

Inquiry 32

# 6800/6809 Micro Modules



OEM 6800/6809 MICROCOMPUTER MODULES for dedicated control and monitoring. Interfaces for sensors, transducers, analog signals, solenoids, relays, lamps, pumps, motors, keyboards, displays, IEEE-488, serial I/O, floppy disks.

**WINTEK**

Wintek Corp.  
 1801 South Street  
 Lafayette, IN 47904  
 317-742-8428

Inquiry 391

## FREE SOFTWARE FROM THE PUBLIC DOMAIN

User Group Software isn't copyrighted, so no fees to pay! 1000's of CP/M and IBM software programs in COM and source code to copy yourself! Games, business, utilities! All FREE!

IBMP-C-SIG 1-458 DiskSides	460.	Buy 845.
IBMP-C-BLUE 1-175 DiskSides	180.	345.
SIG/M UG 1-246 DiskSides	160.	550.
CP/M UG 1-92 DiskSides	45.	250.
PICO NET 1-34 DiskSides	25.	100.
KAYPRO UG 1-60 DiskSides	70.	210.
EPSON UG 1-58 DiskSides	70.	230.
Commodore CBM 1-102 DiskSides	100.	200.

Public Domain User Group Catalog Disk \$5 pp. (payment in advance, please)

Rental is for 7 days after receipt, 3 days grace to return. Use a credit card, no disk deposit.

Shipping, handling & insurance \$9.50 per library.  
 (619) 941-0925 Orders & Technical (9 to 5)  
 (619) 727-1015 24 Hr. 3 Min. Info Recording  
 Have your credit card ready!

**National Public Domain Software**  
 1533 Avohill Dr.  
 Vista, CA 92083  
 800-621-5460 then dial 782-542

BBB  AM EX

Inquiry 251



**Lowest Price Ever!**  
 on 3M Data Products  
 LIFETIME WARRANTY

<b>SS-DD</b>	Qty—5 Bx (lesser qty add 10%)	<b>DS-DD</b>
<b>89¢</b>	5.25"	<b>\$119</b>
\$129	5.25" w/Flip 'n' File/15	\$159
\$195	5.25" 96 TPI	\$245
\$179	3.50"/135 TPI	\$259
<del>\$209</del>	3.50" w/Flip 'n' File	\$289
	DS-HD 96 TPI (For the "AT")	\$279
	DS-HD 96 TPI w/Flip 'n' File/15	\$309
	<b>3M Head Cleaning Kit (Plus \$200 Rebate)</b>	<b>\$699</b>
	3M Data Cartridges - Qty 10/case (lesser qty add 10%)	
	DC-100A	\$1210
	DC-1000	\$1240
	DC-300XLP	\$1900
	DC-600A	\$2025
	<b>3M Branded Bulk w/Tyvek, labels, write-protect tabs, reinforced hub ring. Tested 100% certified error-free</b>	
<b>79¢</b>	5.25" Qty 200	<b>\$109</b>



**An Apple A Day**  
 Get FREE Apple IIc Computer and CASH!  
 (See details coupon in each box)

<b>SS-DD</b>	Qty—5 Bx (lesser qty add 10%)	<b>DS-DD</b>
<b>79¢</b>	5.25" Qty 50 (10/BX)	<b>92¢</b>
\$179	3.50" Qty 50 (5/plastic case)	\$229
	DS-HD for "AT" Qty 50 (10/BX)	\$209

All BASF diskettes are factory packed with envelopes, user ID labels, write-protect tabs.

**Best Deal Ever!**  
 Buy 10 Business Professional Diskettes, protective envelopes, user ID labels, write-protect tabs, and reinforced hub ring  
**LIFETIME WARRANTY**

<b>SS-DD</b>	Qty—10 Bx (lesser qty add 10%)	<b>DS-DD</b>
<b>75¢</b>	5.25"	<b>80¢</b>
\$169	3.50"/135 TPI (Qty 5BX)	\$229
	High Density for IBM PC-AT & Compatible	\$214

**Color Diskettes**

Experience the many benefits of "color diskettes"  
**LIFETIME WARRANTY**

<b>SS-DD</b>	Qty 100	<b>DS-DD</b>
<b>69¢</b>	5.25" w/ hub ring	<b>89¢</b>

**No Logo BULK Diskettes**

Incredible Value!  
 Made by a leading magnetic-media manufacturer  
**LIFETIME WARRANTY**

<b>SS-DD</b>	Qty—100	<b>DS-DD</b>
<b>55¢</b>	5.25" w/hub ring	<b>65¢</b>

Bulk w/Tyvek envelope add 6¢ ea. Label Kits 25¢ per kit

**RIBBONS STORAGE**

Epson MX 70/80	\$268	Amaray Media Mate 50	\$789
Epson MX-100	\$406	Disk Minder II-75	\$789
Okidata 80, 82, 83, 92, 93	\$138	Micro Disk Minder 36	\$750
Apple Image Writer	\$345	Plastic Library Case	\$159

TERMS: VISA, MasterCard, American Express. COD orders add 4.9%. Prepaid orders deduct 2% discount. POs accepted from corporations after 30/2 or better, government and schools on Net 30 basis. FPO, APO, AK, HI, and PR orders add 5%. No sales tax outside Utah. Minimum order \$300.  
 SHIPPING: Minimum \$300 for 100 or fewer diskettes or first 5 pounds

TOLL FREE ORDER LINE:

# 1-800-523-9681

INFORMATION AND INQUIRIES:

# 1-801-266-3571

**DISKCO TECH**

DISKCO TECHNOLOGIES, INC.  
 10811 South Savannah Drive Sandy, Utah 84070  
 Hours: 7 AM-6 PM (Mtn. Time)

# Future Shock!

age **65**  
years worked **40**  
retirement benefits **0**

The U.S. Department of Labor has a free booklet that will help you answer these questions and a lot more. Send for it today.

Write: Pensions, Consumer Information Center, Pueblo, Colorado 81009

U.S. Department of Labor

## MULTIFUNCTION CARD



FOR IBM-PC & COMPATIBLES

**\$149** w/ 384K  
INSTALLED  
2 YEARS WARRANTY

- \* PARALLEL PORT \* SERIAL PORT
- \* CLOCK/CALENDAR \* GAME PORT
- \* RAM DISK/ PRINTER SPOOLER
- \* CABLES & MANUALS

COMPUTER AGE, INC.

800 Silver Lane, E. Hartford, Ct. 06118  
203-569-6774/ 1244

Terms: add \$3.00 for Handling Charges.  
Visa/MC accepted, no surcharges

Inquiry 91

## DYNAMIC RAMS

41256	100ns	\$5.85
41256	120ns	\$3.35
✓41256	150ns	<del>\$2.75</del>
4164	120ns	\$1.40
✓4164	150ns	<del>\$1.30</del>
4464	150ns	\$5.50

PROCESSORS			E. PROMS		
8087-2	8MHz	\$160.00	27C256	250ns	\$6.90
8087-3	5MHz	\$125.00	27256	250ns	\$CALL
80287-3	6MHz	\$195.00	27128	250ns	\$2.95
80287-8	8MHz	\$ CALL	27C64	200ns	\$3.75
V-20	8MHz	\$ CALL	2764	250ns	\$2.95
V-30	8MHz	\$ 20.00	2732A	250ns	\$2.95
STATIC RAMS			8000's		
6264LP-15	150ns	\$2.95	(Parts in stock)		

## I.C. EXPRESS

15358 Valley Blvd. City of Industry, CA 91746  
Phone: 818-369-2688 (Mon-Fri • 8-5)

ORDER TOLL FREE  
(800) 892-8889 • (800) 882-8181

CALL FOR CURRENT PRICES & VOLUME DISCOUNTS

Prices Shown for Cash • MasterCard/VISA add 3% more  
Prices are subject to change • Minimum order \$10.00  
California residents must add 6.25% sales tax  
Shipping & Handling: UPS Ground \$5.00 UPS Air \$7.00 (under 1 lb.)  
ALL MERCHANDISE IS 100% GUARANTEED

Inquiry 171

## IBM PC/VT220

- EM220 • VT220, VT102 emulation  
\$149 • File Transfer  
• 132 Column modes  
• Color Support  
• Hot Key

## TEK 4010/4014

- EM4010 • Tektronix 4010 emulation  
\$249 • VT220, VT102 emulation  
• Picture files  
• High resolution hardcopy  
• Supports IBM, IBM Enhanced, Hercules, Tecmar and AT&T.

Diversified Computer Systems, Inc.

3775 Iris Ave., Suite 1B  
Boulder, CO 80301  
(303) 447-9251

Trademarks: VT100 — Digital Equipment; IBM PC, XT — IBM Corp.

Inquiry 116

## “CPYAT2PC” IS LIKE HAVING A FREE 360K FLOPPY DRIVE

Allows copying of IBM AT file for use on IBM PC's & compatibles with no modification of existing hardware or software. A 360K floppy drive is not required. CPYAT2PC may reside on your IBM PC/AT hard disk and copies 1 file or entire subdirectories in 1 step. Also runs on other AT compatibles such as COMPAQ 286, ZENITH Z-200, and KAYPRO 286i. Dealer inquiries welcome. **ONLY \$79 + shipping.**

MICROBRIDGE COMPUTERS

Sky Way Building, Suite 125  
655 Sky Way, San Carlos, CA 94070  
(415) 593-8777 • (415) 595-2150

CHECK, COD WELCOME  
(Prepayment Required)

Inquiry 234

## PC-WRITER™



IBM PC GRAPHICS  
&  
LETTER QUALITY  
Enhancement for  
Okidata ML82A/83A  
Dot Matrix Printers

- Plug in module easily installs in printer
- Draft (120 cps) & Letter Quality (30 cps)
- Elite character pitch
- Front panel access to all features
- Emulation of IBM PC Graphics printer
- Superscripts / subscripts
- Foreign / scientific characters
- Works with print screen key in graphics and text
- Prints all 228 display screen characters and box drawing symbols exactly as they appear on display (double line as well as single line box symbols)

Ask About OK-WRITER™ Okidata graphics for \$99 with many of above features

RAINBOW TECHNOLOGIES, INC

17971-E Skypark Circle, Irvine, CA 92714  
(714) 261-0228 Telex 386078  
UK Distributor: X-DATA (0753) 72331

Inquiry 309

## NEW EPROM PROGRAMMER

**\$349**



The EP-1 is a great value, here's why:

- IBM PC Compatible, Communication Disk included. Also works with CRM and Development Systems
- Supports over 100 types including 2716 through 27512, CMOS, and A-Suffix Parts
- Menu Driven Chip Selection by Manufacturer and Part Number
- No Personality Modules
- Fast Programming Algorithm
- Gold Tantalum ZIF IC Socket
- RS-232, 7 baud rates to 9600
- Full One Year Warranty
- UV Erasers from \$34.95

BP Microsystems

5325 Glenmont, Suite E, Houston, TX 77081  
(713) 667-1636

Inquiry 44

## OC8000

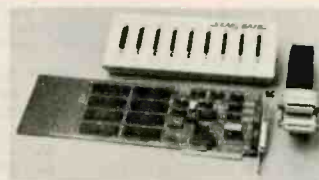

EXPANDS PC PERFORMANCE AT A FRACTION OF NETWORKING COST

- Adds four to eight serial communication ports to IBM PC, XT, AT or compatibles.
- Standard RS-232 or optional RS-422 ports for increased transmission speed and distance.
- Supported by Xenix, Multi-Link, RTCS, QNX, and other multi-user, multi-tasking operating systems.

STAR GATE TECHNOLOGIES, INC.

Suite 109  
33800 Curtis Blvd. • Eastlake, OH 44094  
Call: (216) 951-5922

Inquiry 341

## PC/XT USERS!

- /// COGTREE Utilities by  
Cogitate ..... \$129.95
- /// LYNX by Norton-Lamber ..... \$199.95
- /// DATAFLEX by Data Access ... Varles
- /// RMICOBOL by Ryan/  
McFarland ..... Varles
- /// Universe by Omnitrend ..... \$ 98.50
- /// Blue MacI by Cogitate ..... \$599.00
- /// CadPower + by Trilex ..... \$995.00
- /// Softext Teaching Aids ..... \$ 95.00
- /// PrintSet by Cogitate ..... \$ 79.95
- /// CogITAPE by Cogitate ..... CALL!!
- /// Anti-Static Products ..... Varles
- /// Uninterruptible Power  
Backups ..... Varles
- /// TeleVideo Software ..... CALL!!

COGITATE

"A Higher Form of Software"  
24000 Telegraph Road  
Southfield, MI 48034  
(313) 352-2345/Telex 386581

VISA/MASTERCARD ACCEPTED  
Dealer Inquiries Welcomed

Inquiry 76

# GET UP TO \$100 WORTH OF EQUIPMENT FREE! \*\*

\*1 BOX OF 10 HIGH QUALITY DISKETTES IN CASE  
FREE WITH EVERY ORDER IN MAY! VALUED AT \$29  
CALL (800) 662-SALE

\*2 BOXES OF HIGH QUALITY DISKETTES IN CASE  
PLUS 1 TILT & SWIVEL MONITOR STAND WITH EVERY  
SYSTEM ORDER IN MAY! VALUED AT OVER \$100

## SPECIAL #1

### CORONA PORTABLE

- IBM Compatible
- 256K • 2 Drives
- Monitor • Keyboard • DOS

**\$1195**

## SPECIAL #2

### 20 MEG HARD DISK FOR IBM

- Seagate • Western Digital

**\$469**

## SPECIAL #3

### NEW SPERRY IT

IBM AT compatibility for an affordable price!

- 1 Meg Ram included
- 1.2 MG floppy • 44 MG Hard Disk
- 8 MHz Operations • Monitor
- DOS 3.1 • Printer Port
- Two Serial Ports
- 100% AT Compatibility

**ONLY \$3899**

## SPECIAL #4

### COMPAQ 286 PORTABLE

- IBM AT Compatible • DOS • 1.2 Meg Floppy • 640K • Monitor
- 20 Meg Hard Disk

COMPAQ D & D  
**\$4399 \$3989**

## SPECIAL #5

### NEW COMPAQ PORTABLE II

	LIST	D & D
MODEL 1	\$3599	\$2749
MODEL 2	\$4699	\$3699

**IN STOCK**

## SYSTEMS

### IBM

PC 256K, 2 Drives	\$1395
XT 256K, 1 Drive	1699
XT 256K, 1 Drive 1-10 MG	2099

### COMPAQ

Portable, 2 Drives, 640K	\$1875
Call on Desk Pro's & 286 Systems	

### CORONA

Portable	\$1195
Desk Top, 2 Drives, 256K w/monitor	1395

## MONITORS

### PRINCETON GRAPHICS

Max 12E	\$159
HX-9	Call
HX-12	425
SR-12	749

### TAXAN

Call for best price

### AMDEK

310A	\$145
600 Color	389
722 Color	519

## MODEMS

### HAYES

Micromodem IIE Apple	\$149
300 External	129
1200 External	369
1200B IBM Internal	339
2400 External	639

### PROMETHEUS

Promodem 1200 External	\$289
Promodem 1200A Apple	269
Promodem 1200B IBM	269
Promodem 1200MAC	339

## DISK DRIVES

### IBM COMPATIBLE

Teac 55B	\$99
Mitsubishi 4851	99
Tandon TM 100-2	99
Qume DT142	89
Okidata 1/2 HT	84
10 MG Hard Card	New
20 MG Hard Card	Call

## PRINTERS

### EPSON

LQ 800	\$569
LQ 1000	689

### OKIDATA

182, 120 cps	\$218
192, 160 cps, w/Roms	349
193, 160 cps, IBM	499
84, 200 cps, IBM	658
OKI-MATE 20, Color, IBM	
Apple & Amlga	199

### TOSHIBA

P321	New
P341	Call
P351	\$1059
P351 Tractor	159

### STARMICRONICS

SG10/15	\$219/389
SD10/15	355/469
SR10/15	489/589

### CITIZEN

MSP-10	\$249
MSP-15	359
MSP-20	389
MSP-25	539
Premier 35LQ New	469

## IBM EXTRAS

### AST RESEARCH

SixPak +, 64K w/Side Kick	\$209
Reach w/Crosstalk	369

### HERCULES

Color Card w/Printer Port	\$149
Mono Graphics Card	299

### GOODIES

IBM Printer Cable	\$13
64K Ram Set of Nine Chips	15
256K Ram Set of Nine Chips	39
Power Supply 135 Watts	75
8087 CoProcessor	129
DOS 2.1	65
DOS 3.1	69
Flip Top Case w/speaker	49
Disk Controller w/cable	39
Color Card w/printer	89
Monochrome Card w/printer	109
Keyboard 0151	99
100 DS/DD 5 1/4	69
10 1.2MG for AT 5 1/4	259

## SPECIAL #6

### APPLE DISK DRIVE

#### 100% APPLE

#### COMPATIBLE 5 1/4"

525A for IIE and II+	\$109
525C for IIC	119
350M for Mac	Call

## SPECIAL #7

### PC XT Compatible Turbo

- 640K • 8 MHz • Keyboard
- Flip Top Case • Two 360K Drives
- 135 Watt • 8 Slots • DOS 2.1

**\$699**

## SPECIAL #8

### PC XT COMPATIBLE

- 640K • 360K Drive • Keyboard
- 20 MG Hard Drive • Monochrome
- 8 Slots • Card w/printer port
- 135 Watt Power Supply
- Green Monochrome • Monitor
- DOS 2.1 • 120 Day Warranty

**ONLY \$1249**

## SPECIAL #9

### MULTIFUNCTION CARD

- Serial and Parallel Ports
- Clock/Gameport • Ram disk/Printer spool Software
- 1 Year Warranty

w/384K only **\$159**

## MAKE THAT CALL!

Order Desk	..... (800) 662-7253
In California	..... (213) 970-0206
Customer Service	..... (213) 970-0215
Technical Support	..... (213) 970-0215
Retail Store	..... (213) 676-0815

Service Contracts Available

**2% DISCOUNT ON ALL ADVERTISED PRICES WITH PREPAYMENT (800) 662-7253**

## SPECIAL #10

### XT COMPATIBLE

- 8 Slots • Two 360K Drives
- Keyboard • 135 Watts

640K 256K  
**\$569 \$499**

All Sales Are Warranted for 90 Days, Parts & Labor

**WE SERVICE WHAT WE SELL!**

**ALL SYSTEMS INCLUDE ASSEMBLY AND TESTING**

**VISIT OUR NEW RETAIL LOCATION:**

**12824 INGLEWOOD AVE., HAWTHORNE, CA 90250**

**PLEASE CALL: (213) 676-0815**

## SPECIAL #11

### IBM AT COMPUTER SYSTEM

- 20 Meg hard Disk
- 1.2 Meg Floppy • DOS 3.1
- 512K Ram

D & D IBM

**\$3699 \$4299**

### MAIL ORDER:

13324 HAWTHORNE BLVD., SUITE 201  
HAWTHORNE, CA 90250

### ORDER DESK:

Inside California **(213) 970-0206**

Outside California **(800) 662-7253**

**Hours: Monday—Friday 7 am to 6 pm**  
Open Saturdays

**WE CARRY TOO MANY ITEMS TO LIST. PLEASE CALL FOR A QUOTE ON ANY ITEM.**

 No Surcharge for Credit Cards 

**Terms:** Prices reflect a cash prepaid discount. All merchandise new. We accept MC, Visa, Wire Transfer, Certified Check, P.O.'s from qualified firms. P.O. subject to approval & 3% surcharge. Terms: 2% 10 net 20. UPS Shipping; minimum \$4.00 first 5 pounds. We also ship U.S. Mail and Federal Express. Call for exact shipping cost. Tax: California residents only add 6 1/2% sales tax. All returns subject to 15% restock fee. Prices Subject to Change.

**d&d Discount Computers**

A CALIFORNIA CORPORATION

# Announcing 4 New Collector Edition

# BYTE COVERS

The 4 Byte covers shown below are the newest additions to the Collector Edition Byte Cover series. Each full color print is 11" x 14", including a 1/2" border, and is part of an edition strictly limited to 1,000 prints. Each print is a faithful reproduction of the original Byte painting, printed on museum quality acid free paper, and is personally inspected, signed and numbered by the artist, Robert Tinney. A Certificate of Authenticity accompanies each print.

Collector Edition Prints are carefully packaged flat to avoid bending, and are shipped first class within one week of receipt of order. The price of each print is \$30. All 4 prints are available for only \$100.

Other Collector Edition Byte Covers are also available from Robert Tinney Graphics. For a color brochure, or to order one or more of the prints shown, please check the appropriate box in the coupon below.



#25 Computers and the Handicapped \$30



#26 Graduation Memories \$30



#27 The Keys to Education \$30

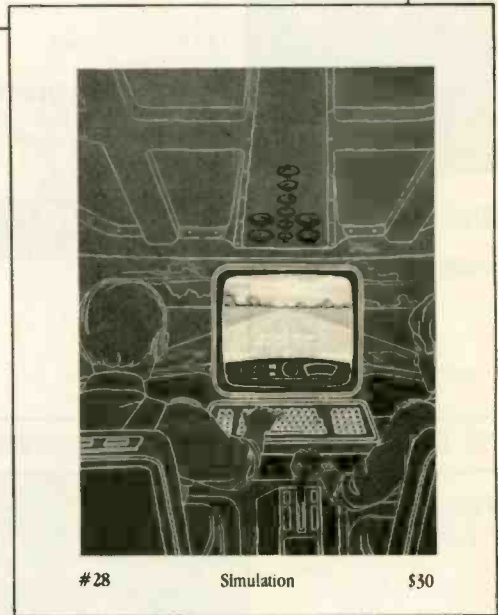

#28 Simulation \$30

Please send me the following Prints (\$30). All 4 only \$100.

QTY.	TITLE & PRINT NO.	AMOUNT
_____	_____	\$ _____
_____	_____	\$ _____
_____	_____	\$ _____
_____	_____	\$ _____
postage & handling \$3.00 (Overseas \$8.00)		\$ _____
<b>TOTAL</b>		<b>\$ _____</b>

Please send me your color brochure.

I have enclosed check or money order.

Visa  MasterCard

Card No. \_\_\_\_\_

Exp. Date: \_\_\_\_\_

**SHIP MY PRINTS (OR BROCHURE) TO:**

Name: \_\_\_\_\_

Address: \_\_\_\_\_

City: \_\_\_\_\_

State: \_\_\_\_\_ Zip: \_\_\_\_\_

Mall this coupon to:

**robert tinney graphics**

1864 N. Pamela Drive

Baton Rouge, LA

70815

**FOR VISA OR MASTERCARD ORDERS**  
or for more information  
**CALL 1-504-272-7266**  
Daytime or Evenings



# ATTAK-286™

**HIGH SPEED 12 MHZ OPERATION** Software Selectable for **6,8,10, and 12 MHZ!**

- FULL IBM PC-AT\* COMPATIBILITY!
- FOUR MEGA-BYTE RAM CAPACITY ON MOTHERBOARD! USING 1 MEGA-BIT DRAMS.

**QUANTITY DISCOUNTS AVAILABLE FOR QUALIFIED DEALER, OEM, UNIVERSITY AND CORPORATE ACCOUNTS.**

**NEW!**

## HIGH SPEED INDUSTRIAL GRADE COMPUTER FOR:

- Scientific
- Engineering
- Industrial
- Medical
- University/Education
- Artificial Intelligence
- Etc., Etc., Etc.

Eight Compatible I/O Interface Connectors (Same as PC-AT)

Keyboard Interface (Same as PC-AT)

On Board Battery

CMOS Clock Calendar

Standard Power Connector (Same as PC-AT)

80287 Math Processor (Same as PC-AT)

Runs Intel 80286 at 6,8,10&12 MHZ! (Software selectable)

Extended ROM Capability (Operates on all compatible BIOS ROMS)

Extended Memory Capacity! Full Four Mega-Byte Capacity on Motherboard! (Uses 256k or NEW 1 Mega-Bit Drams)

Peripheral Support Circuits (Same as PC-AT)

**ORDER NOW!!**

**ONLY!**  
**\$199<sup>95</sup>**  
**EVALUATION BOARD KIT**

Board Size: Standard IBM-AT\*  
Dimensions: 12 inch x 13.8 inch  
with 6 mounting holes to fit all AT compatible cases.

- ATTAK-286™ FULLY ASSEMBLED (LESS ICS) .....\$499.95
- AT CASE 100% COMPATIBLE.....\$129.95
- AT POWER SUPPLY 192VW.....\$129.95
- ATTAK-286™ TECHNICAL REFERENCE MANUAL .....\$ 29.95
- TURBO-SCOPE™ A/D BOARD .....\$ 99.95

ATTAK-286™ evaluation board kit highest quality multi-layer PC board with full assembly instructions and parts lists!

100% SATISFACTION GUARANTEED.  
10 DAY MONEY BACK GUARANTEE IF NOT COMPLETELY SATISFIED!



**AiT CORPORATION**  
**ADVANCED INTELLIGENCE TECHNOLOGY**

4100 Spring Valley Road  
Suite 400  
Dallas, Texas 75244  
(214) 490-0344

TERMS: We accept cash, checks, money orders and credit cards. Prices and availability subject to change without notice. Shipping and handling charges via UPS ground 50c/lb UPS air \$1.00/lb. Minimum charge \$3.00.

\*IBM and IBM PC-AT are trademarks of International Business Machines

© 1986 AIT CORP.



### MONITORS

**ULTRA-HI 720x400 RESOLUTION**

- TATUNG 1370 RGB ..... \$444
- TAXAN 640 RGB ..... \$498

### AEGIS ANIMATOR

Animation package for the AMIGA™ computer. Includes "Images" paint program. The ultimate drawing/animation program for the serious amateur or professional.

**SPECIAL INTRODUCTORY PRICE**

**\$99**

### FLOPPY DRIVES

- PANASONIC 1/2 Ht. PC compatible ..... \$99
- SANYO 1/2 Ht. PC compatible ..... \$94
- APPLE II compatible, including cable ..... \$98

### SOFTWARE

• Dbase III PLUS	\$363
• FRAMEWORK II	\$349
• JAVELIN	\$529
• MICROSOFT Word v2.0/Ready	\$229
• MICROSOFT Windows	\$62
• PFS: First Success (Wrt/File Plan)	\$209
• R:Base 5000	\$339
• SIDEWAYS v3.0	\$43
• SIDEKICK 1.5 NCP	\$47
• SIDEKICK MAC	\$47
• SUPERKEY 1.1	\$39
• TURBO PASCAL 3.0	\$39
• TURBO EDITOR TOOLBOX	\$41
• TURBO "NEW" PACK (Gameworks & Editor Toolbox)	\$54
• TURBO HOLIDAY JUMBO JACK	\$144

# WORLDWIDE EXPLODES

#### YOU LIKE IT, OR WE TAKE IT BACK!

If for any reason, you are not satisfied with any product you purchase, you may return it within 10 days of receipt for replacement, credit or refund.\*

#### WE'LL PAY YOU IF YOU FIND A LOWER PRICE!

If you buy any item from us at pricing in this ad and find a lower price from any source in this issue, that has the identical product in stock, we'll not only refund the difference you paid, but also pay you 20% of the difference for your trouble! If you find a lower price in this issue before you buy, from any source that has the identical product in stock, we'll beat it! \*\*

### MULTITECH MULTIFUNCTION BOARD

AST Sixpack™ compatible. Serial port, Parallel port, Game port, Clock/Calendar, RAMDISK and PSPOOL software. Up to 384K memory expansion. OK Installed

**\$96**

1 Year Warranty

### COMPLETE INTERNAL HARD DRIVE SYSTEMS

Includes drive, PC/XT controller card, cables and install procedures. Capacities listed are FORMATTED. We sell only the finest drives from Seagate, Mitsubishi, Microscience and others, guaranteed to meet or exceed original manufacturer's specifications. Boots from hard disk.

- 10MB 1/2 Ht. 85ms. \$388
- 20MB 1/2 Ht. 85ms. \$424
- 30MB Full Ht. 40ms. \$788
- 40MB Full Ht. 40ms. \$928

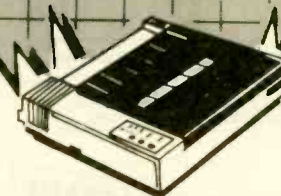

### NAME BRAND 100CPS 80 COLUMN DOT MATRIX PRINTER

The perfect addition to any computer, where high quality at moderate speed is required. Parallel interface, friction & tractor feed. Factory closeout pricing! 1 year warranty.

**\$148**

Dealers: Call for  
quantity prices!

### 30 Megabytes for the Price of 20!

The latest technology from Adaptek provides 30 megabytes of storage from a standard 20 megabyte hard-disk drive. Complete system including Adaptek controller, micro-science disk drive, cables and install procedures.

**\$499**

IN CALIFORNIA

**800-358-8881**

OUTSIDE CALIFORNIA

**800-826-3736**

6311-L DeSoto Avenue • Woodland Hills, California • 91367 • Phone: (818) 703-7996  
Hours: 7:00AM-6:00PM Pacific Time

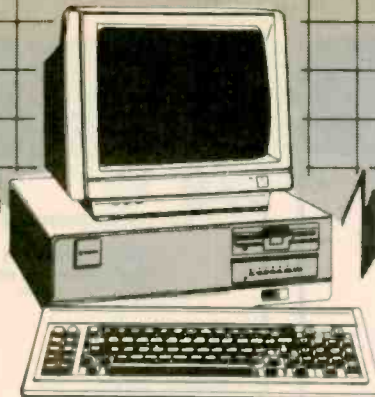

### SPERRY PC/XT

PC/XT compatible, 8088-2 switchable 2 speed micro-processor, 256K RAM, 1-360K floppy, RS-232 port, Tatung Monochrome monitor, clock/calendar and 5150 style keyboard. Includes MS-DOS, GW Basic, diagnostics and tutorial disks.

**\$1478**

**ZOOM 1200**  
1200/300 baud, auto answer/auto dial, Hayes™ (AT) compatible internal modem. Demon dialer, monitor speaker, tone/pulse dialing, dual phone jacks, call progress tone detection. 2 Year Warranty. Made in USA.

**\$199**

INCLUDING SOFTWARE!

### BORLAND

- TRAVELING SIDEKICK
- TURBO LIGHTNING
- REFLEX

\$40  
\$55  
\$60

### ACCESSORIES

PC POWER SUPPLIES:

- 150 WATT KEYBOARDS: IBM/XT™ and KEYTRONICS™ COMPATIBLE **\$88**
- 5150 style **\$69**
- 5151 style **\$89**

### SEAGATE HARD DISK DRIVES FOR PC/AT™

Includes cables, manual & mounting rails

- 20MB Full ht. 40ms **\$566**
- 30MB Full ht. 40ms **\$677**
- 40MB Full ht. 40ms **\$844**

### TAPE BACK-UP

- ALLDAY 60Mb internal **\$775**

### BOARD PRODUCTS

- MULTITECH 2 Drive PC floppy controller **\$45**
- MULTITECH 4 drive PC floppy controller **\$58**
- Western Dig. 1002SWX2 PC/XT Hard disk cont. **\$138**
- Western Dig. 1002WA2 PC/AT Hard/Floppy cont. **\$276**
- MULTITECH 384K mem. exp. board w/128K **\$72**
- AST Sixpack + (64K) w/Sidekick & DESQview **\$227**
- MULTITECH Mono Graphics 720x348. Hercules™ compatible with parallel port & light pen interface **\$112**
- AST PREVIEW™ Mono graphics. Hercules™ compatible with parallel port, PS/2 pool and RAM Disk soft **\$286**
- HERCULES graphics board **\$98**
- MULTITECH color graphics board (1-2-3'comp.) **\$234**
- HERCULES color board **\$144**
- TAXAN 553 Ultra Hi Res color board **\$246**
- SIGMA 400L Ultra Hi Res color board **\$439**

### MODEMS

- ANCHOR VOLKSMODEM 300 baud (cable opt.) **\$49**
- ANCHOR VOLKS 6420 300 baud Commodore w/soft **\$59**
- ZOOM IIE AP int. 300 baud AA/AD Hayes™ comp. w/ soft **\$93**
- ANCHOR Volksmodem 1200 (cable opt.) **\$164**
- SmartTEAM 103/212A 1200/300 baud external AA/AD Hayes™ (AT) compatible 2 year warranty **\$178**
- ANCHOR EXPRESS: 1200/300 baud PC internal, AA/AD Hayes™ (AT) compatible **\$188**
- NOVATION SMARTCAT + 1200/300 baud, int. or ext. AA/AD Hayes™ (AT) comp. w/MITE™ software **\$299**
- HAYES 1200B w/ Smartcom II **\$333**
- ANCHOR LIGHTNING 24 2400/1200/300 baud external Hayes™ (AT) comp. Built-in speaker **\$338**
- NOVATION 2400 Professional w/o software **\$496**
- NOVATION 2400 with MS-DOS or Macintosh software **\$547**
- HAYES 2400 **\$568**

### MONITORS

- AMDEK 310A 12" Amber **\$143**
- AMDEK 600 **\$399**
- PRINCETON MAX-12 Amber **\$166**
- PRINCETON HX-12E RGB **\$544**
- TAXAN 122 monochrome **\$137**
- TAXAN 620 **\$392**
- TATUNG DM 12VL 12" green composite 1000 line res **\$126**
- TATUNG 1222A 12" Amber TTL 1000 line res **\$126**
- TATUNG 1360 13" Hi-Res RGB 640 X 200 **\$367**

### \*THE FINE PRINT

Excluding software. Prior return authorization required; all items returned must be in original condition with carton, packing and all manuals, etc., some returns may involve a restocking charge. We accept Cashier and Certified checks, Money Orders, personal and company checks (product shipped when check clears), VISA and MasterCard with no surcharge and American Express (4% surcharge). All products shipped UPS ground (freight FREE for orders over \$150), unless specified otherwise. All normal manufacturer's warranties apply.

# PRICES!

### GUARANTEED AVAILABILITY!

Any item you order will be shipped within Two working days or you will be given a firm ship date when you order! If for any reason we cannot ship by the date you are given, we will deduct 5% from the price of the products shipped late and credit your order accordingly. \*\*

### COMPONENTS

Quality mfg. from companies like FUJITSU, HITACHI, OKI, NEC, SAMSUNG and TOSHIBA

- 256K DRAMS Set of 9-150ns **\$35.91**
- 64K DRAMS Set of 9-150ns **\$8.91**
- 128K DRAMS price each **\$4.50**
- 8087-3 **\$128.00**
- 8087-2 **\$199.00**
- 80287 **\$11.00**
- Y20-5MHz **\$13.00**
- Y20-8MHz **\$16.00**
- Y30 replaces 8086 **\$11.00**
- 8086 **\$4.00**
- 8088 **\$6.50**
- 27128 **\$4.00**
- 27256 **\$4.00**
- 2764

### PERSYST STRETCH 2 MEGABYTE PC EXPANSION BOARD

Bank switched memory board supporting the LOTUS™, Ashton-Tate™ expanded memory spec. With Print Spool and RAM Disk software. Uses 256K chips.

0-K 1-Mb 2-Mb  
**\$188 \$324 \$440**

### FUJI DS/DD Bulk In White Box

With sleeves, labels and slip tabs. Priced per box of 10

1-19	20-99	100-499	500-999	1000+
9.75	9.00	8.40	7.90	7.50

### FUJI DS/DD Bulk w/o box, sleeves, labels or w/p tabs

Price each, in increments of 20 only (poly bagged)

60-180	200-480	500-980	1000-4980	5K+
.85	.77	.72	.67	.63

### \*\*IF YOU DON'T SEE IT, CALL!

We have virtually any product available at the best pricing. Space limits us to only a fraction of what we sell. Call us for a quote and delivery information. If we don't have it, we'll try to get it for you! All items priced and in stock at time of ad placement and subject to vendor changes and prior sale at time of ad publication.

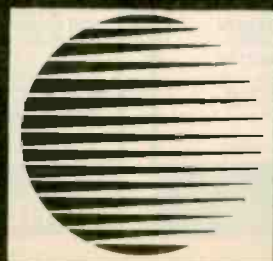

# WORLDWIDE ACCESS

Inquiry 392

EVERYBODY HATES US, BUT OUR CUSTOMERS!

## The Greatest buy on BASF Qualimetric Diskettes!

**.79** Ea. Qty. 50 **.90** Ea. Qty. 50  
5.25"SSDD 5.25"DSDD

Packaged in boxes of 10 with Tyvec sleeves, user ID labels and write-protect tabs.

### LIFETIME WARRANTY!

	Qty.	Qty.
	20-40:	50+:
5.25"SSDD(P/N3406)	.81	.79
5.25"DSDD(P/N3407)	.92	.90
5.25"SSDD-96TP(P/N3404)	.92	.90
5.25"SSDD-96TP(P/N3405)	1.03	1.01
5.25"DSDD-HD(P/N3403)	2.07	2.04
3.50"SSDD-135TP(P/N3402)	1.85	1.82
3.50"DSDD-135TP(P/N3412)	2.41	2.37

FOR ORDERS ONLY: 1-800-621-6827  
INFORMATION & INQUIRIES: 1-312-256-7140  
(In Illinois: 1-312-256-7140)

WE WILL MEET OR BEAT ANY NATIONALLY ADVERTISED PRICE ON THE SAME PRODUCTS AND QUANTITIES SUBJECT TO THE SAME TERMS AND CONDITIONS AS THE COMPETITIVE AD.

**DISK WORLD!, Inc.**  
629 Green Bay Rd. • Wilmette, Illinois 60091

**DISK WORLD!**

## KODAK DISKETTES: Discover the future today!

**.92** Ea. Qty. 100 **1.13** Ea. Qty. 100  
5.25"SSDD 5.25"DSDD

### LIFETIME WARRANTY!

	Qty.	Qty.
	20-40:	50:
5.25"SSDD(P/N4200)	1.03	1.00
5.25"DSDD(P/N4201)	1.23	1.21
5.25"SSDD-96TPI	N/A	N/A
5.25"DSDD-96TPI	N/A	N/A
5.25"SSDD-HD(P/N4202)	2.35	2.31
3.50"SSDD-135TP(P/N4206)	1.87	1.84
3.50"DSDD-135TP(P/N4207)	2.46	2.42

**BULK 5.25" DISKETTES!**  
(Packaged in boxes of 100 with Tyvec sleeves, user ID labels and write-protect tabs.)

5.25"SSDD(P/N4203) .92  
5.25DSDD(P/N4204) 1.13  
FOR ORDERS ONLY: 1-800-621-6827  
INFORMATION & INQUIRIES: 1-312-256-7140  
(In Illinois: 1-312-256-7140)

WE WILL MEET OR BEAT ANY NATIONALLY ADVERTISED PRICE ON THE SAME PRODUCTS AND QUANTITIES SUBJECT TO THE SAME TERMS AND CONDITIONS AS THE COMPETITIVE AD.

**DISK WORLD!, Inc.**  
629 Green Bay Rd. • Wilmette, Illinois 60091

**DISK WORLD!**

## 3M Diskettes at the lowest prices ever!

**.78** EA. Qty. 50 <- 5.25"SSDD(P/N1000) **1.10** EA. Qty. 50+  
5.25"DSDD(P/N1004)->

### LIFETIME WARRANTY!

Packed in boxes of 10 with User ID labels and write-protect labels.

	Qty.	Qty.
	20-40:	50+:
5.25"SSDD(P/N1000)	.81	.78
5.25"DSDD(P/N1004)	1.13	1.10
5.25"SSDD-96TP(P/N1008)	1.58	1.53
5.25"DSDD-96TP(P/N1011)	1.98	1.93
5.25"DSDD-HD(P/N1040)	2.30	2.24
3.50"SSDD-135TP(P/N1039)	1.58	1.53
3.50"DSDD-135TP(P/N1046)	2.23	2.17
8.00"SSDD w/WP(P/N1020)	1.54	1.52
8.00"SSDD w/WP(P/N1025)	1.89	1.86
8.00"DSDD w/WP(P/N1030)	2.12	2.06

### DATA CARTRIDGES:

(Sold 10 to a carton only.)

DC100(P/N1041)	12.62	12.40
DC300XLP(P/N1042)	19.38	19.04
DC600A(P/N1043)	21.45	20.89

**DISK WORLD!**

## BASF Qualimetric Diskettes in Bulk.

**.72** Ea. Qty. 150 **.83** Ea. Qty. 150  
5.25"SSDD 5.25"DSDD

Save a lot of money by buying BASF QUALIMETRIC diskettes in bulk. Packed in cartons of 150 diskettes with Tyvec sleeves, User ID labels and write-protect tabs. **LIFETIME WARRANTY!**

	Qty.
	150+:
5.25"SSDD(P/N3408)	.72
5.25"DSDD(P/N3409)	.83
5.25"SSDD-96TPI	N/A
5.25"DSDD-96TPI	N/A
5.25"SSDD-HD(P/N3410)	N/A
3.50"SSDD-135TP(P/N3411)	1.51**
3.50"DSDD-135TP(P/N3413)	2.05**

\* Available in 250 piece cartons only.  
\*\* Available in 200 piece cartons only.

FOR ORDERS ONLY: 1-800-621-6827  
INFORMATION & INQUIRIES: 1-312-256-7140  
(In Illinois: 1-312-256-7140)

HOURS: 8AM -6PM Central Time, Monday-Friday  
WE WILL MEET OR BEAT ANY NATIONALLY ADVERTISED PRICE ON THE SAME PRODUCTS AND QUANTITIES SUBJECT TO THE SAME TERMS AND CONDITIONS AS THE COMPETITIVE AD.

**DISK WORLD!, Inc.**  
629 Green Bay Rd. • Wilmette, Illinois 60091

**DISK WORLD!**

## DISK WORLD! Ordering & Shipping Instructions

FOR FASTEST SERVICE, USE NO-COST MCI MAIL. Our address is DISKORDER. It's a FREE MCI MAIL letter. No charge to you. (Situation permitting, we'll ship these orders in 24 hours or less.)

**SHIPPING:** 5.25" & 3.50" DISKETTES-Add \$ 3.00 per each 100 or fewer diskettes. **OTHER ITEMS:** Add shipping charges as shown in addition to other shipping charges. **PAYMENT:** VISA, MASTERCARD and Prepaid orders accepted. **COD ORDERS:** Add \$ 5.00 special handling charge. **APO, FPO, AK, HI & PR ORDERS:** Include shipping charges as shown and additional 5% of total order amount to cover PAL and insurance. We ship only to United States addresses, except as shown above. **TAXES:** Illinois residents add 7% sales tax.

MINIMUM ORDER: \$ 35.00

FOR ORDERS ONLY: 1-800-621-6827  
INFORMATION & INQUIRIES: 1-312-256-7140  
(In Illinois: 1-312-256-7140)

HOURS: 8AM -6PM Central Time, Monday-Friday  
WE WILL MEET OR BEAT ANY NATIONALLY ADVERTISED PRICE ON THE SAME PRODUCTS AND QUANTITIES SUBJECT TO THE SAME TERMS AND CONDITIONS AS THE COMPETITIVE AD.

**DISK WORLD!, Inc.**  
629 Green Bay Rd. • Wilmette, Illinois 60091

**DISK WORLD!**

## Printer Ribbons at extraordinary prices!

Brand new ribbons, manufactured to Original Equipment Manufacturer's specifications, in housings. (Not re-inked or spools only.)

### LIFETIME WARRANTY!

EPSON MX-70/80(P/N2500)	\$ 2.70 ea. + .25 Shpng.
EPSON MX-100(P/N2501)	\$ 4.08 ea. + .25 Shpng.
Okidata Micro83(P/N2505)	\$ 1.37 ea. + .25 Shpng.
Okidata Micro84(P/N2502)	\$ 2.98 ea. + .25 Shpng.

FOR ORDERS ONLY: 1-800-621-6827  
INFORMATION & INQUIRIES: 1-312-256-7140  
(In Illinois: 1-312-256-7140)

HOURS: 8AM -6PM Central Time, Monday-Friday  
WE WILL MEET OR BEAT ANY NATIONALLY ADVERTISED PRICE ON THE SAME PRODUCTS AND QUANTITIES SUBJECT TO THE SAME TERMS AND CONDITIONS AS THE COMPETITIVE AD.

**DISK WORLD!, Inc.**  
629 Green Bay Rd. • Wilmette, Illinois 60091

**DISK WORLD!**

## 3M Bulk Diskettes Incredible Value!

**.54 ea.** DSDD  
Multiples of 50 only!

These are genuine 3M diskettes as supplied to software duplicator accounts. **LIFETIME WARRANTY.** Tyvec sleeves included! Limited supplies, so act now!(P/N10041)

FOR ORDERS ONLY: 1-800-621-6827  
INFORMATION & INQUIRIES: 1-312-256-7140  
(In Illinois: 1-312-256-7140)

HOURS: 8AM -6PM Central Time, Monday-Friday  
WE WILL MEET OR BEAT ANY NATIONALLY ADVERTISED PRICE ON THE SAME PRODUCTS AND QUANTITIES SUBJECT TO THE SAME TERMS AND CONDITIONS AS THE COMPETITIVE AD.

**DISK WORLD!, Inc.**  
629 Green Bay Rd. • Wilmette, Illinois 60091

**DISK WORLD!**

## ATHANA DISKETTES The great unknown!

**.60** Ea. Qty. 50 **.69** Ea. Qty. 50  
5.25"SSDD 5.25"DSDD

### LIFETIME WARRANTY!

	Qty.	Qty.
	50+:	50+:
5.25"SSDD(P/N3700)	.60	
5.25"DSDD(P/N3701)	.69	
5.25"SSDD-96TPI(P/N3702)	.68	
5.25"DSDD-96TPI(P/N3703)	.92	
5.25"DSDD-HD(P/N3704)		1.79
3.50"SSDD-135TP(P/N3705)	2.00	
3.50"DSDD-135TP(P/N3706)	2.73	

You've used these diskettes hundreds of times as copy-protected originals on some of the most popular software packages. They're packed in polybags of 25 with Polymer-Impregnated sleeves userID labels and reinforced hubs, write-protect tabs.

FOR ORDERS ONLY: 1-800-621-6827  
INFORMATION & INQUIRIES: 1-312-256-7140  
(In Illinois: 1-312-256-7140)

HOURS: 8AM -6PM Central Time, Monday-Friday  
WE WILL MEET OR BEAT ANY NATIONALLY ADVERTISED PRICE ON THE SAME PRODUCTS AND QUANTITIES SUBJECT TO THE SAME TERMS AND CONDITIONS AS THE COMPETITIVE AD.

**DISK WORLD!, Inc.**  
629 Green Bay Rd. • Wilmette, Illinois 60091

**DISK WORLD!**

## Diskette Storage Cases

### AMARAY MEDIA-MATE 50:

A revolution in disk storage. Every once in a while someone takes the simple and makes it elegant. This unit holds 50 5.25" diskettes, has grooves for stacking, inside nipples to keep diskettes from slipping and several other features. We like it. (P/N3013)

\$ 9.69 ea. + \$ 2.00 Shpng.

### DISK MINDER II:

Low-priced, but effective storage for 75 5.25" diskettes. Smoked plastic top, beige bottom with inside dividers. (P/N2800)

\$ 6.49 ea. + \$ 2.00 Shpng.

### DISK MINDER 36:

As above, but holds 36 3.50" diskettes. (P/N2950)

\$ 6.49 ea. + \$ 2.00 Shpng.

### DISK CADDIES:

The original flip-up holder for 10 5.25" diskettes. Beige (P/N2200) or Grey (P/N2201)

\$ 1.65 ea. + .20 Shpng.

FOR ORDERS ONLY: 1-800-621-6827  
INFORMATION & INQUIRIES: 1-312-256-7140  
(In Illinois: 1-312-256-7140)

HOURS: 8AM -6PM Central Time, Monday-Friday  
WE WILL MEET OR BEAT ANY NATIONALLY ADVERTISED PRICE ON THE SAME PRODUCTS AND QUANTITIES SUBJECT TO THE SAME TERMS AND CONDITIONS AS THE COMPETITIVE AD.

**DISK WORLD!, Inc.**  
629 Green Bay Rd. • Wilmette, Illinois 60091

**DISK WORLD!**

# SUPER STAR® DISKETTES: The ultimate value in magnetic media.

No one told us how phenomenally successful Super Star® diskettes would become.

The idea was simple. Very simple.

We would do the same thing that big companies like IBM® do in regard to creating a "brand name" diskette. That is we would go to major manufacturers, buy top-quality diskettes in massive quantities, give them our own name and sell them inexpensively.

## A very simple idea ...that worked!

Now, tens of thousands of businesses, government agencies, schools and individuals have learned that you don't have to pay inflated "brand name" prices to get "brand name" quality.

Just buy Super Star® diskettes.

## Quality ...without high price.

We ship almost a million Super Star® diskettes a month and get very few of them back.

Unlike others who offer a "house brand" or "generic" diskettes, Super Star® diskettes are top-of-the-line quality, exceeding ANSI and IBM standards by 50% or more.

They are not cosmetically flawed, duplicator product (where a failure rate of 20% or more is expected) or what we in the diskette industry refer to as "floor sweepings", a term which speaks for itself.

## A lifetime warranty.

If you sense pride in our description of Super Star® diskettes, you've got it right.

After all, wouldn't you be proud if you found a way to deliver top-quality diskettes at about half the price of "brand names"?

## When every bit counts, it's Super Star®!

Nearly a million Super Star® diskettes a month are being sold to some of the largest and most recognizable names in the nation. They love 'em, because they save money...and they are dependable.

So now is the time for you to re-discover Super Star® diskettes.

And we say "re-discover" for a reason.

## You've already used Super Star!

Super Star® diskettes, as noted, are made by some of America's leading diskette manufacturers...and the odds are that you've already used them more than once as the copy-protected masters on some of the best known software programs around.

So, when you want the best...and the least expensive best...order Super Star®!

## SUPER STAR SPECIAL!

Your choice of storage at \$ 4.95!



Buy 50 Super Star® diskettes and get a storage case for only \$ 4.95 (shipping included)!

These are durable plastic cases with dividers and are very nice units.

The 5.25" unit holds 50 diskettes and the 3.50" unit holds 40 diskettes.

5.25" Storage Case (P/N3100)...\$ 4.95 ea.  
3.50" Storage Case (P/N 3102)...\$ 4.95 ea.

# What the world needs now is a complete line of high quality, inexpensive diskettes with a LIFETIME WARRANTY!

## And DISK WORLD! has them!

## Super Star 5.25" Diskettes

5.25" SSDD (P/N 3800)	.55 ea.
5.25" DSDD (P/N 3801)	.64 ea.
5.25" SSDD-96TPI (P/N 3802)	.80 ea.
5.25" DSDD-96TPI (P/N 3803)	.84 ea.
5.25" DSDD-HD (P/N 3804)	\$ 1.72 ea.

ORDER IN MULTIPLES OF 50 ONLY!

All Super Star 5.25" Diskettes are poly-bagged in lots of 25 with sleeves, write-protect tabs and user ID labels.

QUANTITY DISCOUNTS: 350-500 diskettes, deduct 3%. 500-700 diskettes, deduct 6%.

750-1,000 diskettes, deduct 9%. 1,000+ diskettes, deduct 12%.

## Super Star 3.50" Diskettes

3.50" SSDD (P/N 3805)	\$ 1.52 ea.
3.50" DSDD (P/N 3806)	\$ 1.86 ea.

ORDER IN MULTIPLES OF 50 ONLY!

Super Star 3.50" diskettes are packaged in boxes of 50 with user ID labels.

QUANTITY DISCOUNTS: 350-500 diskettes, deduct 1.5%. 500-700 diskettes, deduct 3%.

750-1,000 diskettes, deduct 4.5%. 1,000+ diskettes, deduct 6%.

## The Super Star LIFETIME WARRANTY!

Super Star Diskettes are unconditionally warranted against defects in original material so long as owned by the original purchaser. Returns are simple: just send the defective diskettes with proof of purchase, postage-paid by you, with a short explanation of the problem and we'll send you replacements. (Incidentally, coffee stained diskettes or diskettes with staples driven through them or otherwise damaged don't qualify as defective.)

HOURS:  
8AM-6PM Central Time  
Monday - Friday

WE WILL MEET OR BEAT ANY  
NATIONALLY ADVERTISED PRICE  
ON THE SAME PRODUCTS AND  
QUANTITIES SUBJECT TO THE  
SAME TERMS AND CONDITIONS.

## HOW TO ORDER:

### ORDERS ONLY:

1-800-621-6827

(In Illinois: 1-312-256-7140)

### INQUIRIES:

1-312-256-7140

FOR FASTEST SERVICE, USE NO-COST MCI MAIL. Our address is DISKORDER. It's a FREE MCI MAIL letter. No charge to you. (Situation permitting, we'll ship these orders in 24 hours or less.)

SHIPPING: 5.25" & 3.50" DISKETTES: Add \$ 3.00 per each 100 or fewer diskettes. OTHER ITEMS: Add shipping charges as shown in addition to other shipping charges. PAYMENT: VISA, MASTERCARD and Prepaid orders accepted. COD ORDERS: Add \$ 5.00 special handling charge. APO, FPO, AK, HI & PR ORDERS: Include shipping charges as shown and additional 5% of total order amount to cover PAL and insurance. We ship only to United States addresses, except as shown above. TAXES: Illinois residents add 7% sales tax.

MINIMUM ORDER: \$ 35.00

# DISK WORLD!, Inc.

629 Green Bay Road  
Wilmette, Illinois 60091

# THE DIVERSIFIED GROUP

**2% DISCOUNT ON ALL ADVERTISED PRICES  
WITH PREPAYMENT — Call (800) 523-1041 TO ORDER NOW!**

## WHAT'S HOT

**TANDON DRIVE**  
TM100-2, 360K, Full HT  
**\$104.95**

**TAXAN 630 MONITOR**  
Offers Green, Amber,  
B & W Reverse, White on Blue  
**\$446.95**

**NEC V20**  
Replace your 8088  
to increase speed up to 40%  
**\$18.95**

**SAMSUNG MONITOR**  
Hi-Res Green Composite  
**\$89.95**

**IRWIN 10MEG**  
Tape Backup, Software Included  
**\$446.95**

**20 MEGABYTE HARD-CARD**  
21 MB formatted all on 1 card in 1 slot  
**\$762.95**

**SURGE PROTECTORS**  
Surge & Spike Suppression  
15A Circuit Breaker  
6 Receptable Strip    6 Receptable Wall Mount  
**\$28.95**                      **\$17.95**

**MULTIFUNCTION CARD**  
384K Memory Included  
Parallel, Serial & Clock  
Game Port with Software  
**\$131.95**

**POWER SUPPLY'S**  
Direct Replacements  
150 Watt **\$ 99.95**  
200 Watt **\$149.95**

**DG MODEM**  
3001200  
Hayes 1200B Compatible  
**\$186.95**

**CO-PROCESSOR**  
IN STOCK w/Manual — Intel  
8087-2 — 8 MHz **\$154.95**  
8087-3 — 5 MHz **\$129.95**

### HARD DISK DRIVES

All Hard Disks Come With: 1 Yr. Warranty, Cables, Controller and are Formatted

	QTY. 1	QTY. 5
10 Megabyte w/Controller	\$379.00	\$374.00
20 Megabyte w/Controller	489.95	469.95
30 Megabyte w/Controller	728.00	714.00

Most Hard Disks are  
Shugart, Microsci, CMI, Rodina, Segate  
Call for Others

#### BERNOULLI BOX

10 Meg	\$1779.95	—
20 Meg	2399.95	—

#### TAPE BACK-UP BY IRWIN

10 Meg Internal 1/2 Height, Low Power	\$446.00	\$436.00
10 Meg External Back-up	589.00	579.00

#### DISK DRIVE CONTROLLERS

Western Digital Hard Disk Cont.	\$179.95	—
Adaptec Hard Disk Cont.	199.95	—

### DISK DRIVES

**MPI B-52**  
• Tandon Compatible • 360K  
Double Side/Double Density • Full Height  
2 for \$150.00

#### 5 1/4" DISK DRIVES

	QTY. 1	QTY. 5
Toshiba 1/2 Height	\$ 99.00	\$ 94.00
IBM "Logo" Drives	119.95	109.95
Tandon TM100-2	99.00	99.00
MPI (Tandon Compatible)	75.00	75.00
AT 360K w/whiteface	109.95	—

#### DISK DRIVE CONTROLLERS

IBM (Original) Controller	\$ 99.95	—
IBM Compatible Controller	59.95	—

### PRINTERS

LETTER QUALITY — DOT MATRIX

#### OKIDATA

ML182P, 120 cps, Parallel  
ML192P, 160 cps, w/NLO  
ML193P, 15" Carriage, 160 cps, w/NLO

Too Low  
To Quote  
Call

#### PANASONIC

KX 1091 \$259.95  
KX 1092 \$349.95

#### TOSHIBA

P341 24 pin 136 col. \$869.00  
P351 24 pin Par. & Ser. \$1089.00  
P1340 24 pin 80 col. \$399.00

#### EPSON — Call for Availability

We also carry Juki, Dynax, Toshiba, Star,  
Panasonic, NEC, Brother

### MEMORY

#### 64K SETS

All Upgrades Carry a 2 Year Warranty  
Nine 4164, 150ns \$10.95

10 Sets \$9.95 ea. 100 Sets \$9.45

#### 128K SETS    256K SETS

Nine, 4128 \$39.95 9, 41256, 200ns \$32.95  
25 Sets 32.95 ea. 25 Sets 28.95 ea.

#### 80287

SMHZ for AT & Deskpro \$189.95

#### 8087-3

SMHZ Math Co-Processor for IBMPC \$124.95

#### 8087-2

8MHz Math Co-Processor for AT&T, Compaq, Deskpro \$154.95

### DG PC ACCESSORIES

Slide case w/speaker	\$49.95
Keyboard	\$99.95
150 Watt Pwr Supply	\$99.95
200 Watt Pwr Supply	\$149.95
640K Motherboard w/OK	\$159.95



No Surcharge on Credit Cards

# THE DIVERSIFIED GROUP

MAIL ORDERS TO:

8726 S. Sepulveda, Suite A132, Los Angeles, CA 90045  
WAREHOUSE: 4732 Rosecrans, Hawthorne, CA 90250

TOLL FREE ORDER LINE  
**(800) 523-1041**

INSIDE CALIFORNIA  
**(213) 675-0717**

Inquiry 117

**TERMS:**  
P.O.'s from Government Institutes,  
Universities, Fortune 1000  
C.O.D.'s w/Guarantee, Visa, MC, MO,  
Cashier's Check, Cash. Please Call for Shipping:  
Approx. system \$25, printers & monitors \$15.  
Minimum Shipping \$4.50  
We Ship Federal Express, UPS, U.S. Mail

# THE DIVERSIFIED GROUP

The DG PC Series computers offers the maximum alternatives in the PC XT compatible market. Alternatives which exceed current PC XT configurations.

Standard features on all DG PC Series computers include:

- Full compatibility with IBM PC XT® machines
- 640K bytes of parity checked memory, 8 slots
  - 150 watt power supply • keyboard
- 1 Full Year Warranty on Parts and Labor.
  - 4 Layer Motherboard

## SYSTEMS

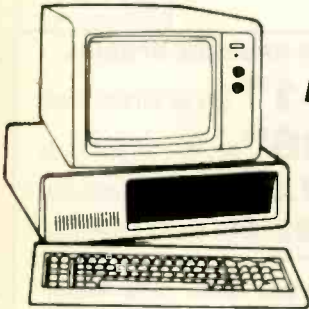

### DG-PC

DG BARE BONES	DG BASE UNIT	DG SYSTEM	DG 286	DG 10
System Unit	System Unit	System Unit	System Unit	System Unit
640K on Board	640K on Board	640K on Board	80286 Microproc.	640K on Board
Keyboard	One 360K Drives	Two 360K Drives	512K Memory	One 360K Drive
150 Watt	w/Controller	150 watt pwr sply	1.2 Meg Floppy	10Meg Hard disk
Power Supply	150 Watt	Hi-Res Green Mon	AT Type Keyboard	Monochrome Mon
Disk Controller	Power Supply	w/Interface Card	w/Par. & Ser. Ports	Mono Card
\$519.95	\$699.95	\$847.95	Runs PC, XT, AT Sftwr \$1889.95	\$1195.95

All Systems Assembled and Tested

### COMPAQ

DESKPRO	286
Model I	Deskpro 286
\$1755.95	\$3391.95
	Portable 286
	3391.95
<b>PORTABLE</b>	
Two 360K Drives,	
256K	
\$1963.50	

### IBM

IBM PC	IBM SYSTEM
Bare 256K	PC-XT
\$1099.00	with 10 Meg
One 360K Dr, 256K	One 360K Drive,
1199.00	Monochrome
<b>IBM XT</b>	Monitor
One 360K Drive & 10 Meg Drive	Monochrome
\$2237.95	Card
<b>IBM AT</b>	
Unenhanced	\$3391.50
Enhanced	3995.95
	\$2421.95

### EXPANSION CARDS

AST SixPac+ w/384K 2 Yr War	\$261.95
MF-100 SixPac Compatible plus Gameport	\$89.95
AST Advantage w/1.5 Megabyte of Memory Parallel & Serial Ports	\$497.95
AST Rampage	\$362.95

### MONITORS

AMDEK	TAXAN	PRINCETON GRAPHICS
300G Composite Green	620 (640 x 200)	HX12, 640x200 Dot Pitch .31
\$124.95	\$399.95	\$442.95
300A Composite Amber	630 (640 x 400)	HX12E, 640x350 Dot Pitch .28
134.95	446.00	517.95
310A Monochrome Amber	640 (720 x 400)	SR12, 640x400 Dot Pitch .31
159.95	549.95	573.95
		SR12P, 640x480 Dot Pitch .26
		787.95
		HX-9, 640x350 Dot Pitch .28
		432.95
		MAX12E, 720x350
		169.95

### IBM ACCESSORIES

A-B SWITCH BOXES	DISKETTES	KEYTRONICS KEYBOARDS	BELKIN CABLES
Parallel 2 pos. \$49.95	Xidex Dbl/Dbl 5 Year Warranty	5153 Touch Pad \$289.95	6 foot Shielded
Serial 2 pos. \$64.95	1 bx. \$12.95	5150 Standard \$169.95	IBMPC to Par. \$14.95
	10 bxs. \$11.95	5151 Deluxe \$179.95	IBMPC to Modem \$16.95
	100 bxs. \$9.95		

### VIDEO CARDS

DG GRAPHICS	EVEREX	IBM	PARADISE	EGA	SIGMA	HERCULES
Color Graphics w/Parallel Port 2 Yr. War.	The Edge Color/Mono	IBM Monochrome w/Parallel Port	Modular Graphics Card	DG EGA	Color 400 Board	Color Graphics
\$104.95	\$269.95	\$226.95	\$259.95	\$292.95	\$458.95	\$169.95
Monochrome Graphics w/Par Port	The Graphics Edge	IBM Color Card w/Parallel Port	Multi Display	STB EGA +		Monochrome Graphics
119.95	269.95	214.95	159.95	QUADRAM +		
				IBM EGA		

### MODEMS

#### HAYES

1200B w/Smartcom II	\$362.95
1200 External	\$392.95
2400 External	\$595.95

#### DG

300/1200 Hayes compatible, Internal	\$186.95
-------------------------------------	----------

#### TERMS:

P.O.'s from Government Institutes, Universities, Fortune 1000  
C.O.D.'s w/Guarantee, Visa, MC, MO,  
Cashier's Check, Cash. Please Call for Shipping:  
Minimum Shipping \$4.50  
We Ship Federal Express, UPS, U.S. Mail  
No Surcharge on Credit Cards

# THE DIVERSIFIED GROUP



MAIL ORDERS TO:



8726 S. Sepulveda, Suite A132, Los Angeles, CA 90045  
WAREHOUSE: 4732 Rosecrans, Hawthorne, CA 90250

TOLL FREE ORDER LINE  
**(800) 523-1041**

INSIDE CALIFORNIA  
**(213) 675-0717**

TOLL FREE

800-854-8230

CA Residents 714-558-8813

OUR POLICY

- Surcharge for VISA or Mastercard.
- Volume purchasing agreements available.
- Orders subject to availability. • Supply limited on certain items.
- Pricing subject to change without notice.
- ACP Retail Store pricing may vary. Not responsible for typcs.

Inquiry 9

CORPORATE BUYERS CALL BARRY

# IBM Compatible w/20Mb DRIVECARD



Don't miss out on this unbeatable system manufactured by Toshiba for ACP. ACP has sold over 3,000 ADVANCED XT's to satisfied customers including "true blue" users like Rockwell, Hughes, and Kodak. Not only is the price affordable but the features and compatibility are unbeatable. For more details call one of our expert consultants. Don't hesitate this will be a sellout!

ACP  
BASE  
PRICE **\$ 699<sup>00</sup>**

Call for complete Monochrome or Color RGB system prices with 10 or 20 Mb hard disk drives or the NEW 20Mb Drivecard.

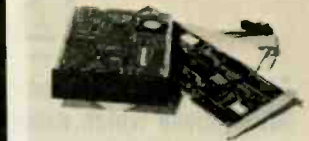

- 10 Mb Upgrade **\$379**
- 20 Mb Upgrade **\$499**
- Package (1 Yr War) Package (1 Yr War)
- 20 Mb Package for AT **\$556.00**
- SA 712 10 Mb **\$249.95**
- ST225 20 Mb **\$349.00**
- Mountain 20Mb Hardcard **\$699.95**
- Western Digital Controller **\$179.95**

### PC UPGRADE SPECIAL

- \$11<sup>95</sup>** SET OF (9) 64K RAMS
- \$36<sup>95</sup>** SET OF (9) 256K RAMS
- \$7.95** 4128 PIGGYBACK RAM
- \$120.00** 8087-2 Coprocessor

1200 Baud Hayes™ Comp. Modem  
Short Card by U.S. Robotics with  
Telpac I Software.  
List \$499 ACP **\$149.95**  
Buy (6) **\$139.95**

### IBM COMPUTERS

- IBM PC w/256K, Keyboard, (2) 360K Floppy Disk Drives, Floppy Disk Controller **\$1585.00**
- IBM XT w/256K, Keyboard, 360K Floppy Disk Drive, Floppy Disk Controller, Hard Disk Optional **1725.00**
- IBM AT w/256K, 1.2 Mb Floppy Disk Drive **3199.00**
- COMPAQ PORTABLE w/256K, (2) 360K Floppy Disk Drives **Call**
- COMPAQ 286 DESKPRO w/256K, 1.2 Mb Floppy, 20 Mb Hard **4595.00**
- COMPAQ DESKPRO w/640K, 360K Floppy, 10 Mb Hard **2495.00**
- COMPAQ DESKPRO w/640K, 360K Floppy, 10 Mb Hard, 10 Mb Tape back-up **3099.00**

### IBM HARDWARE

- ACP 130 Watt Power Supply **\$89.95**
- PC/AT Keyboard **89.00**
- ACP Color Graphics Card **95.00**
- ACP Monochrome Graphics **135.00**
- ACP Floppy Controller **75.00**
- 384K Card Sixpak Comp (OK) **129.00**
- Parallel Cable (IBM) **19.00**
- Serial Cable (IBM) **21.00**
- 12" Monochrome Green TTL **99.95**
- Green Composite Monitor **69.95**
- 6 Slot Expansion Chassis **299.00**
- ACP Hi-res Text Mono Card **149.00**
- ACP IBM Style Flip Case **69.95**
- ACP Hard Disk Case (FH or HH) **169.95**

### ARCHIVE

- 20 Mb Tape Back-up (Ext) **\$795.00**
- 60 Mb Tape Back-up (Ext or Int) **Call**

### AST

- Sixpak Plus w/64K **\$235.00**
- Advantage 128K, AT **399.00**
- AST 5251-11 **575.00**
- AST 3780 **575.00**
- RAMpage up to 2 Mb **Call**

### DCA

- Irma **\$785.00**
- Irmaline **895.00**

### DIABLO/XEROX

- 620 Serial LOP **was 1495 now \$349.00**
- 620 API LOP **399.00**
- 620 D36 (36cps) **449.00**

- Tractor **was 395 now \$99.00**
- F-21 Sheet Feeder **was 896 now 249.00**
- Cable for 620 (to IBM) **29.00**
- Diablo P-11 100cps **129.95**
- Diablo S-11 100cps Serial **139.95**
- Diablo P-31 Wide **249.95**
- Diablo S-31 Wide **269.95**
- Other Diablo Oot Matrix's available **Call**

### EPSON

- FX85 160cps NLO **\$375.00**
- FX185 160cps Wide **499.00**
- All Epson Models **Lowest Price**

### EVEREX

- Graphics Edge or Edge **\$259.00**

### HAYES

- Samrtmodem 1200 **\$385.00**
- Smartmodem1200B **349.00**
- Smartmodem 2400 **575.00**
- Smartcom II 2.1 Software **88.00**
- Hayes Comp. 1200 (Int) w/SW **169.95**
- Hayes Comp. 1200 (Ext) **199.95**

### HERCULES

- Color Card **\$166.00**
- Graphics Card w/Software **295.00**

### INTEL

- Above Board PC or AT **Lowest Price**

### IRWIN

- 310A 10 Mb Tape (Ext) **\$849.00**
- 1100 10 Mb (Int) **495.00**

### KEYTRONICS

- 5151 Deluxe Keyboard **\$169.95**
- 5153 w/Touchpad **285.00**
- PC Jr. Numeric Keypad **39.95**

### MICROSOFT

- Mouse **\$125.00**
- Mouse (Serial) **145.00**

### MOUNTAIN COMPUTER

- 20Mb Hardcard **\$699.95**

### MOUSE SYSTEMS

- PC Mouse w/Paintbrush **\$138.00**
- ACP Mouse w/Keyboard **149.00**

### ORCHID

- PC Turbo 186 w/256K **\$585.00**

### PARADISE

- Color/Monocard **\$185.00**
- Modular Graphics Card **274.00**

### PERSYST

- Mono Board w/Parallel **\$159.00**

- Color Board **139.00**
- Time Spectrum **sale Call**

### PRINCETON GRAPHICS

- HX-12 RGB (640x240) **\$445.00**
- MAX-12E Amber TTL **175.00**
- SR-12 **575.00**
- HX-12E (690x350) **545.00**

### PROMETHEUS

- ProModem 1200 w/MlTe (Int) **\$239.00**
- ProModem 1200B (Hayes Comp.) **289.00**
- Alpha/Num or Options Proc **79.95**

### QUADRAM

- Expanded Quadboard (OK) **\$185.00**
- Gold Quadboard (OK) **385.00**
- Silver Quadboard (OK) **215.00**
- Quadlink **399.00**

### SIGMA

- Color 400 Card **\$485.00**

### SHARP

- 12" Med-res RGB Monitor **\$269.95**
- Color Plotter w/Software **219.00**

### STAR MICRONICS

- Gemini 10X **reduced TO LOW TO PRINT**
- Gemini 15X **sale TO LOW TO PRINT**
- SG10, SR10, Radix etc **Lowest Price Yet!**

### TAXAN

- 415 (640x260) RGB **was 699 now \$279.95**
- Mod. 640 (Ultra Hi-res) **595.00**

### TEMPLATES

- Lotus, dBase III, etc **Lowest Price**

### TITAN

- Accelerator PC w/256K **sale Call**

### TOSHIBA

- P321 "3 in 1" LQ Printer **sale \$599.00**
- P341 24 Pin 136 Col. **869.00**
- P351 24 Pin w/Serial & Parallel **1099.00**
- T-1100 MS-DOS Lap Top **Call**

### WESTERN DIGITAL

- Filecard 10 Mb Plug-in **Call**
- Cobra Hard Disk Controller **\$179.95**

### ZENITH

- ZVM-1220/30 12" Grn/Amb TTL **\$109.00**
- ZVM-1240 & ZVM-135 RGB **Call**

### SYSGEN 20/20

- 20Mb Hard Disk
- 20Mb Tape Back-up
- New/Factory Box
- PC/XT/AT Comp.
- External Complete
- Reg. Retail \$3300
- ACP Only **\$999**

Grid Compass MS-DOS Lap  
Computer Demo Sale Call for  
Details. 100's in **\$999<sup>00</sup>**  
Stock as Low as

### MACDRIVE by Tecmar

10Mb External for the MacIntosh.  
Apple bus Interface.  
Reg. Retail **\$1995.00** ACP Price **\$599<sup>00</sup>**

### UNBELIEVABLE!

SHARP MODEL 515 4 COLOR PLOTTER  
IBM or APPLE Compatible. Reg Retail \$399.00  
Qty of (6)  
ACP **\$179<sup>00</sup>** Only **\$159.95**  
Softkey Software (Lotus Comp.) **99.95**  
Parallel or Serial Cable **19.95**  
Felt Tip Pen Set **6.95**

# Advanced Computer



**WE WILL MEET ANY PRICE FOR CURRENT PRODUCT ADVERTISED IN POPULAR MAGAZINES. POLICY APPLIES FOR BOTH SOFTWARE AND HARDWARE!**

**GET OUR FLIER? IF NOT - CALL & GET ON OUR MAIL LIST.**

**MAY SPECIALS**  
(SUPPLY LIMITED)

**UPS POWER SUPPLY**  
Back Up Power for your IBM, Apple or Compatible  
UPS-PC 200 Watts \$277.00  
UPS-XT 300 Watts 419.00  
UPS-AT 800 Watts 739.00

**A-B Printer Switch**  
An AB Switch allows you to use two printers with your computer system. We stock over 15 different configurations.  
AB Switch (Generic) \$59.00  
AB Switch (DB25) \$9.00

**DRIVE CABINETS**  
IBM Style Hard Disk with power supply and fan  
Dual Hard Disk w/power sup & fan \$179.00  
Dual 5 1/4" Full Height vertical mount 65.00  
Dual 5 1/4" Full Height horizontal mount 65.00  
Dual 5 1/4" Thinline w/power sup & fan 60.00  
Single 5 1/4" Full Height w/power sup & fan \$20.00  
Single 5 1/4" Thinline w/power sup & fan 60.00

**FLOPPY DRIVES**  
TEAC FD558 \$89.95  
TEAC FD557 99.95  
TANDEM TM100-2 79.95  
CDC 5 1/4" HEIGHT IBM 21.00  
REMEX 2 1/2 HEIGHT 69.95  
SIEMENS FD200-8 B 119.00  
SIEMENS FD200-8 DS/D0 179.00

**8000**  
68000 \$19.95 68010 \$2.65 68500 \$3.25  
68000D 10.95 68020 3.75 68502 5.65  
68002 2.95 68022 4.95 68504 6.95  
68003 18.95 68040 12.50 68775 6.75  
68004 9.50 68042 14.50 68800 2.20  
68009 9.50 68044 11.95 68047 22.95

**6500**  
6502 \$8.90 6504 \$6.75 6522 \$5.25  
6502A 6.90 6504A 9.75 6522A 8.50  
6502B 9.75 6504B 9.50 6522B 11.50

**8000**  
8030 \$5.75 8214 \$3.75 8259 \$5.75  
8032 6.75 8216 3.75 8271 6.95  
8080A 2.95 8224 2.20 8275 26.95  
8080A 4.80 8226 1.95 8279 6.75  
8080B 8.95 8228A 3.40 8280 5.50  
8086 24.50 8237 13.75 8283 2.20  
8087-2 129.95 8237B 15.95 8284 5.50  
8088 17.50 8238 4.25 8286 6.45  
8089 46.95 8243 3.95 8287 6.45  
8155 6.75 8250 10.50 8288 11.95  
8156 6.75 8251 4.25 8289 44.95  
8160 26.95 8251A 9.50 8297 12.95  
8202 23.95 8253 4.75 8741 27.95  
8203 37.95 8253 6.25 8748 28.00  
8205 37.95 8254 6.25 8749 28.00  
8212 1.95 8257 6.75 8755A 34.95

**CMOS**  
4000 \$ 26 4028 85 4055 87.90 4505 8.95  
4001 22 4029 75 4080 85 4507 1.10  
4002 22 4031 85 4086 36 4507 1.10  
4006 79 4031 3.25 4090 35 4510 .70  
4007 22 4032 2.15 4070 35 4510 .70  
4008 95 4034 1.81 4071 28 4511 .70  
4009 39 4037 1.95 4072 28 4512 .70  
4010 39 4037 1.95 4073 28 4514 1.18  
4011 24 4040 75 4075 28 4515 1.70  
4012 24 4041 60 4076 28 4516 1.10  
4013 35 4042 65 4077 35 4518 8.95  
4014 75 4043 85 4078 35 4520 7.5  
4015 19 4044 60 4081 29 4520 9.5  
4016 36 4046 80 4082 29 4524 9.5  
4017 55 4047 89 4085 95 4598 1.35  
4018 70 4048 99 4086 95 80395 1.80  
4019 39 4049 80 4088 48 70377 .48  
4021 69 4051 34 4094 95 MC1400 12.95  
4022 69 4052 75 4098 1.90 MC1400 12.95  
4023 59 4053 75 4501 85 MC1411 9.95  
4024 59 4053 75 4501 85 MC1411 12.95  
4025 55 4056 2.95 4503 49 MC1419 4.95  
4027 .45 CALL FOR P/C

**BONDWELL 12 CPM Portable \$399.00**  
**BONDWELL 14 CPM Portable \$499.00**  
**Call**  
**2400 Baud Modem \$999.00**  
**Call**  
**Call**  
**EPSON GENEVA Portable \$399.95**  
**Call**  
**For PC Jr.**  
**Call**

**NEW NEC V20 P/N upD 70108**  
Replace Your 8088 to Increase Speed up to 40%  
**\$18.95**

**DEC RAINBOW UPGRADE 192K CARD**  
SPECIAL BUY - Only \$49.95 Bare

**INTERISL STD BUS BOARDS**  
ALMOST SOLD OUT  
Send or Call for List

**Z-80**  
2.5MHz "A" 4.0MHz "B" 6.0MHz  
Z80-CPU 7.25 2.75 8.95  
Z80-CTC 2.90 3.75 6.25  
Z80-DART 7.50 8.50 17.95  
Z80-DMA 9.00 8.95 17.95  
Z80-PIO 7.95 6.95 9.50  
Z80-SIO-0 8.50 9.00 22.95  
Z80-SIO-2 8.50 9.00 22.95  
Z80-SIO-1 8.50 9.00 22.95

**74C00**  
74C00 B.29 74C74 8.65 74C181 11.18 74C373 32.35  
74C02 29 74C65 1.89 74C175 1.15 74C374 2.35  
74C03 29 74C90 1.15 74C240 1.89 74C901 5.99  
74C04 38 74C93 1.15 74C242 2.85 74C902 1.80  
74C10 36 MORE 74C IN STOCK - ALSO IN CATALOG

**SUPER NUMERIC KEYPAD**  
Manufactured by Keytronic. We have sold 1000's of these. **ACP \$39.95**  
Reg Retail \$99 or 6 for 29.95 ea

**XT Compatible Motherboard**  
• 8 Expansion Slots  
• Expandable to 640K  
• IBM Compatible  
ACP only **\$159.95**  
XT-BIOS Add. **\$39.95**

**TRANSISTORS/DIODES**  
PN2222A 7/81.00 2N3904 11/51.00  
PN1913 3/1.00 2N3906 11/11.00  
2N2218A 4/5 2N3906 21/1.00  
2N2219A 4/5 2N3906 21/1.00  
2N2905 4/5 2N3906 21/1.00  
2N2907 25 2N4148 25/1.00  
2N3055 6/9 1N751 5/1.00  
2N3066 4/1.00 1N4002 12/1.00  
2N3638 4/1.00 1N4004 10/1.00  
2N3772 1.09 1M02232 1.49

**DISK CONTROLLERS**  
UDP705 \$9.95 1787 821.95 6843 829.95  
1771 15.95 2791 32.95 95 19.95  
1781 22.95 2793 32.95 1691 6.95  
1783 21.90 2795 32.95 2143 6.95  
1795 21.90 2796 32.95 2148 12.95

**LINEAR**  
LM1084B \$3.95 NE580 82.45 LM3909 9.95  
LM3009 9.95 NE592 2.70 LM3914 22.95  
LM3018 3.85 LM3915 1.80 LM3916 2.95  
LM3044 1.89 LM3918 1.90 LM3918 2.95  
LM3045 9.50 LM3919 1.80 LM3920 2.95  
LM3046 9.50 LM3920 2.95 LM3921 2.95  
LM3047 9.50 LM3921 2.95 LM3922 2.95  
LM3048 9.50 LM3922 2.95 LM3923 2.95  
LM3049 9.50 LM3923 2.95 LM3924 2.95  
LM3050 9.50 LM3924 2.95 LM3925 2.95  
LM3051 9.50 LM3925 2.95 LM3926 2.95  
LM3052 9.50 LM3926 2.95 LM3927 2.95  
LM3053 9.50 LM3927 2.95 LM3928 2.95  
LM3054 9.50 LM3928 2.95 LM3929 2.95  
LM3055 9.50 LM3929 2.95 LM3930 2.95  
LM3056 9.50 LM3930 2.95 LM3931 2.95  
LM3057 9.50 LM3931 2.95 LM3932 2.95  
LM3058 9.50 LM3932 2.95 LM3933 2.95  
LM3059 9.50 LM3933 2.95 LM3934 2.95  
LM3060 9.50 LM3934 2.95 LM3935 2.95  
LM3061 9.50 LM3935 2.95 LM3936 2.95  
LM3062 9.50 LM3936 2.95 LM3937 2.95  
LM3063 9.50 LM3937 2.95 LM3938 2.95  
LM3064 9.50 LM3938 2.95 LM3939 2.95  
LM3065 9.50 LM3939 2.95 LM3940 2.95  
LM3066 9.50 LM3940 2.95 LM3941 2.95  
LM3067 9.50 LM3941 2.95 LM3942 2.95  
LM3068 9.50 LM3942 2.95 LM3943 2.95  
LM3069 9.50 LM3943 2.95 LM3944 2.95  
LM3070 9.50 LM3944 2.95 LM3945 2.95  
LM3071 9.50 LM3945 2.95 LM3946 2.95  
LM3072 9.50 LM3946 2.95 LM3947 2.95  
LM3073 9.50 LM3947 2.95 LM3948 2.95  
LM3074 9.50 LM3948 2.95 LM3949 2.95  
LM3075 9.50 LM3949 2.95 LM3950 2.95  
LM3076 9.50 LM3950 2.95 LM3951 2.95  
LM3077 9.50 LM3951 2.95 LM3952 2.95  
LM3078 9.50 LM3952 2.95 LM3953 2.95  
LM3079 9.50 LM3953 2.95 LM3954 2.95  
LM3080 9.50 LM3954 2.95 LM3955 2.95  
LM3081 9.50 LM3955 2.95 LM3956 2.95  
LM3082 9.50 LM3956 2.95 LM3957 2.95  
LM3083 9.50 LM3957 2.95 LM3958 2.95  
LM3084 9.50 LM3958 2.95 LM3959 2.95  
LM3085 9.50 LM3959 2.95 LM3960 2.95  
LM3086 9.50 LM3960 2.95 LM3961 2.95  
LM3087 9.50 LM3961 2.95 LM3962 2.95  
LM3088 9.50 LM3962 2.95 LM3963 2.95  
LM3089 9.50 LM3963 2.95 LM3964 2.95  
LM3090 9.50 LM3964 2.95 LM3965 2.95  
LM3091 9.50 LM3965 2.95 LM3966 2.95  
LM3092 9.50 LM3966 2.95 LM3967 2.95  
LM3093 9.50 LM3967 2.95 LM3968 2.95  
LM3094 9.50 LM3968 2.95 LM3969 2.95  
LM3095 9.50 LM3969 2.95 LM3970 2.95  
LM3096 9.50 LM3970 2.95 LM3971 2.95  
LM3097 9.50 LM3971 2.95 LM3972 2.95  
LM3098 9.50 LM3972 2.95 LM3973 2.95  
LM3099 9.50 LM3973 2.95 LM3974 2.95  
LM3100 9.50 LM3974 2.95 LM3975 2.95  
LM3101 9.50 LM3975 2.95 LM3976 2.95  
LM3102 9.50 LM3976 2.95 LM3977 2.95  
LM3103 9.50 LM3977 2.95 LM3978 2.95  
LM3104 9.50 LM3978 2.95 LM3979 2.95  
LM3105 9.50 LM3979 2.95 LM3980 2.95  
LM3106 9.50 LM3980 2.95 LM3981 2.95  
LM3107 9.50 LM3981 2.95 LM3982 2.95  
LM3108 9.50 LM3982 2.95 LM3983 2.95  
LM3109 9.50 LM3983 2.95 LM3984 2.95  
LM3110 9.50 LM3984 2.95 LM3985 2.95  
LM3111 9.50 LM3985 2.95 LM3986 2.95  
LM3112 9.50 LM3986 2.95 LM3987 2.95  
LM3113 9.50 LM3987 2.95 LM3988 2.95  
LM3114 9.50 LM3988 2.95 LM3989 2.95  
LM3115 9.50 LM3989 2.95 LM3990 2.95  
LM3116 9.50 LM3990 2.95 LM3991 2.95  
LM3117 9.50 LM3991 2.95 LM3992 2.95  
LM3118 9.50 LM3992 2.95 LM3993 2.95  
LM3119 9.50 LM3993 2.95 LM3994 2.95  
LM3120 9.50 LM3994 2.95 LM3995 2.95  
LM3121 9.50 LM3995 2.95 LM3996 2.95  
LM3122 9.50 LM3996 2.95 LM3997 2.95  
LM3123 9.50 LM3997 2.95 LM3998 2.95  
LM3124 9.50 LM3998 2.95 LM3999 2.95  
LM3125 9.50 LM3999 2.95 LM4000 2.95  
LM3126 9.50 LM4000 2.95 LM4001 2.95  
LM3127 9.50 LM4001 2.95 LM4002 2.95  
LM3128 9.50 LM4002 2.95 LM4003 2.95  
LM3129 9.50 LM4003 2.95 LM4004 2.95  
LM3130 9.50 LM4004 2.95 LM4005 2.95  
LM3131 9.50 LM4005 2.95 LM4006 2.95  
LM3132 9.50 LM4006 2.95 LM4007 2.95  
LM3133 9.50 LM4007 2.95 LM4008 2.95  
LM3134 9.50 LM4008 2.95 LM4009 2.95  
LM3135 9.50 LM4009 2.95 LM4010 2.95  
LM3136 9.50 LM4010 2.95 LM4011 2.95  
LM3137 9.50 LM4011 2.95 LM4012 2.95  
LM3138 9.50 LM4012 2.95 LM4013 2.95  
LM3139 9.50 LM4013 2.95 LM4014 2.95  
LM3140 9.50 LM4014 2.95 LM4015 2.95  
LM3141 9.50 LM4015 2.95 LM4016 2.95  
LM3142 9.50 LM4016 2.95 LM4017 2.95  
LM3143 9.50 LM4017 2.95 LM4018 2.95  
LM3144 9.50 LM4018 2.95 LM4019 2.95  
LM3145 9.50 LM4019 2.95 LM4020 2.95  
LM3146 9.50 LM4020 2.95 LM4021 2.95  
LM3147 9.50 LM4021 2.95 LM4022 2.95  
LM3148 9.50 LM4022 2.95 LM4023 2.95  
LM3149 9.50 LM4023 2.95 LM4024 2.95  
LM3150 9.50 LM4024 2.95 LM4025 2.95  
LM3151 9.50 LM4025 2.95 LM4026 2.95  
LM3152 9.50 LM4026 2.95 LM4027 2.95  
LM3153 9.50 LM4027 2.95 LM4028 2.95  
LM3154 9.50 LM4028 2.95 LM4029 2.95  
LM3155 9.50 LM4029 2.95 LM4030 2.95  
LM3156 9.50 LM4030 2.95 LM4031 2.95  
LM3157 9.50 LM4031 2.95 LM4032 2.95  
LM3158 9.50 LM4032 2.95 LM4033 2.95  
LM3159 9.50 LM4033 2.95 LM4034 2.95  
LM3160 9.50 LM4034 2.95 LM4035 2.95  
LM3161 9.50 LM4035 2.95 LM4036 2.95  
LM3162 9.50 LM4036 2.95 LM4037 2.95  
LM3163 9.50 LM4037 2.95 LM4038 2.95  
LM3164 9.50 LM4038 2.95 LM4039 2.95  
LM3165 9.50 LM4039 2.95 LM4040 2.95  
LM3166 9.50 LM4040 2.95 LM4041 2.95  
LM3167 9.50 LM4041 2.95 LM4042 2.95  
LM3168 9.50 LM4042 2.95 LM4043 2.95  
LM3169 9.50 LM4043 2.95 LM4044 2.95  
LM3170 9.50 LM4044 2.95 LM4045 2.95  
LM3171 9.50 LM4045 2.95 LM4046 2.95  
LM3172 9.50 LM4046 2.95 LM4047 2.95  
LM3173 9.50 LM4047 2.95 LM4048 2.95  
LM3174 9.50 LM4048 2.95 LM4049 2.95  
LM3175 9.50 LM4049 2.95 LM4050 2.95  
LM3176 9.50 LM4050 2.95 LM4051 2.95  
LM3177 9.50 LM4051 2.95 LM4052 2.95  
LM3178 9.50 LM4052 2.95 LM4053 2.95  
LM3179 9.50 LM4053 2.95 LM4054 2.95  
LM3180 9.50 LM4054 2.95 LM4055 2.95  
LM3181 9.50 LM4055 2.95 LM4056 2.95  
LM3182 9.50 LM4056 2.95 LM4057 2.95  
LM3183 9.50 LM4057 2.95 LM4058 2.95  
LM3184 9.50 LM4058 2.95 LM4059 2.95  
LM3185 9.50 LM4059 2.95 LM4060 2.95  
LM3186 9.50 LM4060 2.95 LM4061 2.95  
LM3187 9.50 LM4061 2.95 LM4062 2.95  
LM3188 9.50 LM4062 2.95 LM4063 2.95  
LM3189 9.50 LM4063 2.95 LM4064 2.95  
LM3190 9.50 LM4064 2.95 LM4065 2.95  
LM3191 9.50 LM4065 2.95 LM4066 2.95  
LM3192 9.50 LM4066 2.95 LM4067 2.95  
LM3193 9.50 LM4067 2.95 LM4068 2.95  
LM3194 9.50 LM4068 2.95 LM4069 2.95  
LM3195 9.50 LM4069 2.95 LM4070 2.95  
LM3196 9.50 LM4070 2.95 LM4071 2.95  
LM3197 9.50 LM4071 2.95 LM4072 2.95  
LM3198 9.50 LM4072 2.95 LM4073 2.95  
LM3199 9.50 LM4073 2.95 LM4074 2.95  
LM3200 9.50 LM4074 2.95 LM4075 2.95  
LM3201 9.50 LM4075 2.95 LM4076 2.95  
LM3202 9.50 LM4076 2.95 LM4077 2.95  
LM3203 9.50 LM4077 2.95 LM4078 2.95  
LM3204 9.50 LM4078 2.95 LM4079 2.95  
LM3205 9.50 LM4079 2.95 LM4080 2.95  
LM3206 9.50 LM4080 2.95 LM4081 2.95  
LM3207 9.50 LM4081 2.95 LM4082 2.95  
LM3208 9.50 LM4082 2.95 LM4083 2.95  
LM3209 9.50 LM4083 2.95 LM4084 2.95  
LM3210 9.50 LM4084 2.95 LM4085 2.95  
LM3211 9.50 LM4085 2.95 LM4086 2.95  
LM3212 9.50 LM4086 2.95 LM4087 2.95  
LM3213 9.50 LM4087 2.95 LM4088 2.95  
LM3214 9.50 LM4088 2.95 LM4089 2.95  
LM3215 9.50 LM4089 2.95 LM4090 2.95  
LM3216 9.50 LM4090 2.95 LM4091 2.95  
LM3217 9.50 LM4091 2.95 LM4092 2.95  
LM3218 9.50 LM4092 2.95 LM4093 2.95  
LM3219 9.50 LM4093 2.95 LM4094 2.95  
LM3220 9.50 LM4094 2.95 LM4095 2.95  
LM3221 9.50 LM4095 2.95 LM4096 2.95  
LM3222 9.50 LM4096 2.95 LM4097 2.95  
LM3223 9.50 LM4097 2.95 LM4098 2.95  
LM3224 9.50 LM4098 2.95 LM4099 2.95  
LM3225 9.50 LM4099 2.95 LM4100 2.95  
LM3226 9.50 LM4100 2.95 LM4101 2.95  
LM3227 9.50 LM4101 2.95 LM4102 2.95  
LM3228 9.50 LM4102 2.95 LM4103 2.95  
LM3229 9.50 LM4103 2.95 LM4104 2.95  
LM3230 9.50 LM4104 2.95 LM4105 2.95  
LM3231 9.50 LM4105 2.95 LM4106 2.95  
LM3232 9.50 LM4106 2.95 LM4107 2.95  
LM3233 9.50 LM4107 2.95 LM4108 2.95  
LM3234 9.50 LM4108 2.95 LM4109 2.95  
LM3235 9.50 LM4109 2.95 LM4110 2.95  
LM3236 9.50 LM4110 2.95 LM4111 2.95  
LM3237 9.50 LM4111 2.95 LM4112 2.95  
LM3238 9.50 LM4112 2.95 LM4113 2.95  
LM3239 9.50 LM4113 2.95 LM4114 2.95  
LM3240 9.50 LM4114 2.95 LM4115 2.95  
LM3241 9.50 LM4115 2.95 LM4116 2.95  
LM3242 9.50 LM4116 2.95 LM4117 2.95  
LM3243 9.50 LM4117 2.95 LM4118 2.95  
LM3244 9.50 LM4118 2.95 LM4119 2.95  
LM3245 9.50 LM4119 2.95 LM4120 2.95  
LM3246 9.50 LM4120 2.95 LM4121 2.95  
LM3247 9.50 LM4121 2.95 LM4122 2.95  
LM3248 9.50 LM4122 2.95 LM4123 2.95  
LM3249 9.50 LM4123 2.95 LM4124 2.95  
LM3250 9.50 LM4124 2.95 LM4125 2.95  
LM3251 9.50 LM4125 2.95 LM4126 2.95  
LM3252 9.50 LM4126 2.95 LM4127 2.95  
LM3253 9.50 LM4127 2.95 LM4128 2.95  
LM3254 9.50 LM4128 2.95 LM4129 2.95  
LM3255 9.50 LM4129 2.95 LM4130 2.95  
LM3256 9.50 LM4130 2.95 LM4131 2.95  
LM3257 9.50 LM4131 2.95 LM4132 2.95  
LM3258 9.50 LM4132 2.95 LM4133 2.95  
LM3259 9.50 LM4133 2.95 LM4134 2.95  
LM3260 9.50 LM4134 2.95 LM4135 2.95  
LM3261 9.50 LM4135 2.95 LM4136 2.95  
LM3262 9.50 LM4136 2.95 LM4137 2.95  
LM3263 9.50 LM4137 2.95 LM4138 2.95  
LM3264 9.50 LM4138 2.95 LM4139 2.95  
LM3265 9.50 LM4139 2.95 LM4140 2.95  
LM3266 9.50 LM4140 2.95 LM4141 2.95  
LM3267 9.50 LM4141 2.95 LM4142 2.95  
LM3268 9.50 LM4142 2.95 LM4143 2.95  
LM3269 9.50 LM4143 2.95 LM4144 2.95  
LM3270 9.50 LM4144 2.95 LM4145 2.95  
LM3271 9.50 LM4145 2.95 LM4146 2.95  
LM3272 9.50 LM4146 2.95 LM4147 2.95  
LM3273 9.50 LM4147 2.95 LM4148 2.95  
LM3274 9.50 LM4148 2.95 LM4149 2.95  
LM3275 9.50 LM4149 2.95 LM4150 2.95  
LM3276 9.50 LM4150 2.95 LM4151 2.95  
LM3277 9.50 LM4151 2.95 LM4152 2.95  
LM3278 9.50 LM4152 2.95 LM4153 2.95  
LM3279 9.50 LM4153 2.95 LM4154 2.95  
LM3280 9.50 LM4154 2.95 LM4155 2.95  
LM3281 9.50 LM4155 2.95 LM4156 2.95  
LM3282 9.50 LM4156 2.95 LM4157 2.95  
LM3283 9.50 LM4157 2.95 LM4158 2.95  
LM3284 9.50 LM4158 2.95 LM4159 2.95  
LM3285 9.50 LM4159 2.95 LM4160 2.95  
LM3286 9.50 LM4160 2.95 LM4161 2.95  
LM3287 9.50 LM4161 2.95 LM4162 2.95  
LM3288 9.50 LM4162 2.95 LM4163 2.95  
LM3289 9.50 LM4163 2.95 LM4164 2.95  
LM3290 9.50 LM4164 2.95 LM4165 2.95  
LM3291 9.50 LM4165 2.95 LM4166 2.95  
LM3292 9.50 LM4166 2.95 LM4167 2.95  
LM3293 9.50 LM4167 2.95 LM4168 2.95  
LM3294 9.50 LM4168 2.95 LM4169 2.95  
LM3295 9.50 LM4169 2.95 LM4170 2.95  
LM3296 9.50 LM4170 2.95 LM4171 2.95  
LM3297 9.50 LM4171 2.95 LM4172 2.95  
LM3298 9.50 LM4172 2.95 LM4173 2.95  
LM3299 9.50 LM4173 2.95 LM41

## S-100 Bus BDS & Accessories

If you purchased before calling us, you probably paid too much! We stock ACKERMAN DIGITAL, ADVANCED DIGITAL, CCS, COMPUPRO, CROMEMCO, DUAL, ELECTROLOGICS, ICM, KONAN, MULLEN, PICKLES & TROUT, INDUSTRIAL COMPUTER DESIGNS, TARBELL, TECMAR, VECTOR ELECTRONICS...

### A FEW OF THIS MONTH'S SPECIALS ARE...

- ACKERMAN KLUGE CARD A&T ..... \$175
- ACKERMAN PROMBLASTER II Up to 27256K'S. \$306
- ACKERMAN PROMBLASTER EXTENDER ..... \$79.95
- SPECTRONICS PE24T9 EPROM ERASER/TIMER \$146
- ADV. DIGITAL SUPER 186/256K MASTER ..... \$1,295
- COMPUPRO RAM 16 64K STATIC** ..... \$95
- COMPUPRO RAM 22 256K STATIC ..... \$446
- COMPUPRO PC-VIDEO BD & CDOS 4.1 ..... \$719\*
- COMPUPRO CPU 286-8MHz & CDOS 4.1 ..... \$1,039\*
- \*WHILE COMPUPRO SPECIAL LASTS
- COMPUPRO SYSTEM SUPPORT 1 w/ CLK-CAL \$300
- COMPUPRO CPU 8085/88 6 & 10 MHz ..... \$263
- COMPUPRO CPU 8086 - 10MHz ..... \$296
- COMPUPRO CPU-Z 8MHz ..... \$206
- CROMEMCO XPU 10MHz 68000 CPU ..... \$1,196
- CROMEMCO DPU 68000/Z-80 Dual CPU ..... \$636
- CROMEMCO SCC Z-80 Single BD. Computer ..... \$396
- CROMEMCO 8PIO 8 Port Parallel ..... \$356
- CROMEMCO D+7A 8 Channel 8 Bit D/A ..... \$316
- CROMEMCO BIART Dual Sync/Asynch ..... \$796
- CROMEMCO 64FDC 5" 8" Floppy CTRL ..... \$556
- DUAL AIM-12 A/D Input 12 Bit/32 Channel ..... \$629
- DUAL AOM-12 D/A Output 12 Bit/4 Channel ..... \$540
- DUAL WDC Winchester DIMA 2 BD. Set SA-4000 \$840
- INTELL. COMP. DESIGNS 8MHz DUAL Z80 Slave w/4 Serial Ports-128K-Software Install. To Turbodos. \$629
- INTERCONTINENTAL MICRO SYSTEMS MASTER & SLAVE BDS. 8&16 Bit ..... In Stock - PLEASE CALL!

### INDUSTRIAL COMPUTER DESIGNS:

- D/A 64-100 64 Analog Outputs ..... \$356
- A/D 64-100 64 Analog Inputs ..... \$266
- CCT-100 Highly Accurate Time & Date Controller with Battery Back-Up ..... \$296
- KONAN DGC-2000 ST 506 5 1/2 H.D. Controller ..... \$325
- KONAN SMC-2000 SMD 8" Controller ..... \$495
- MACROTECH VRAM 512K Static with Battery Back-Up and mDrive/H Capability ..... \$769
- MACROTECH MI-286 80286/Z80H Dual Proc. .... \$675
- MACROTECH MSR-II 1Mb Dynamic Ram ..... \$825
- MACROTECH MSR-II 2Mb Dynamic Ram ..... \$1,059
- MULLEN ZB-1 EXTENDER with ZIF Sockets ..... \$125
- MULLEN TB4A EXTENDER BD. w/ Logic Probe. .... \$69
- MULLEN ICB10 8 Channel Low Voltage Controller \$165
- PICKLES & TROUT P&T 488 IEEE 488 BD & S.W. \$429
- VECTOR RAM 17 64K Static Ram ..... \$299
- VECTOR INTERFACER I Dual Serial (VIASYN) ..... \$235
- VECTOR INTERFACER II 3 Para., 1 Serial ..... \$259

## Mainframe & Drive Enclosures

- FULCRUM 880 with Front Panel & 20 Slots ..... \$565
- INTEGRAND 2200A w/4 Slots & 2 X 8" 1/2 HT FLPY \$349
- INTEGRAND 2210 w/4 Slots & 5 1/4" FLPY + H.D. \$265
- PARA DYNAMICS 3020D 20 Slot Desk. .... \$598
- PARA DYNAMICS 5820-S "TOWER" with SNAP-ON PANELS For Easy Access to Drive, 20 Slot Card Cage and Power Supply Compartments, Status LEDs and ON-OFF-RESET Key Switch on Front Panel, Houses 5 1/4" & 8" Drives Great For 16 Bit MSTR/SLV BDS. \$1,869
- INTEGRAND 2909 2X8" 1/2 HT Horiz. Stack ..... \$189
- JMR 1H5 5 1/4" H.D. PC Style Cabinet ..... \$189
- JMR 2SV8 Dual Vertical 1/2 HT. 8" ..... \$175
- JMR 2H5 Dual 5 1/4" Horizontal H.D. .... \$225
- MPS 8462 Dual Horizontal 8" Slimline ..... \$215
- MPS 8465 Dual 5 1/4" & 8" Horizontal Slimline. .... \$225
- MPS 5500 1 1/2 5 1/4" Hard Drives, Tape, Etc. .... \$225
- MPS 5401 5 1/4" STD HT. H.D. or Dual 1/2 HT ..... \$215
- MICROWARE DUAL HORIZ. 5 1/4" 1/2 HT. Floppy .. \$79
- MICROWARE 920004 Dual STD. 5 1/4, PC-Style. .... \$149
- PARA DYNAMICS 2300-G3 2X8" Fipy & 5 H.D. .... \$349

## Floppy Disk Drives

- MITSUBISHI 2894 STD 8" \$475 ..... 2896 1/2 HT 8" \$435
- TEAC FD55FV/IBM-AT 96TPI ..... \$125
- TEAC FD55FV 96TPI ..... \$115
- MITSUBISHI MF501 48TPI \$95 ..... TEAC FD55BV \$99

## Power Solutions

- PC/XT REPLACEMENT P/S 150 Watt Up To 4 Drvs \$89
- SAFT SPS 400VA 400 WATT & SINE WAVE ..... \$475
- SAFT SPS1000VA 1000 WATT/SINE WAVE ..... \$999
- SOLA 750 WATT "TRUE" Uninterruptible P/S with 4500 Watt Hi-Inrush ..... DEMO-ONE ONLY! @ \$1,295
- TRIPPLITE ISOBAR Line Suppressor-Filters from \$33
- TRIPPLITE BC-425-FC 425 Watts 15-20 Minutes. \$398
- TRIPPLITE BC-1000 Watts 20-30 Minutes ..... \$925
- TRIPPLITE LC-1800 Conditioner/Stabilizer ..... \$209
- TRIPPLITE COMMAND CONSOLE CCI 8-12 ..... \$99

## Networking

- INTERCONT. MICRO SYS. LAN-PC Without RAM - WILL RUN NOVELL ..... \$469
- INTERCONT. MICRO SYS. LANS-100 ..... \$359

## PC & AT Multifunction/Slave Bds.

- We Have a Good Selection of Multifunction and Memory Boards for PC, XT, AT, JR, AT & T, and PC Portables
- INTEL ABOVE BOARD PCMB 1010 PC/XT 64K to 2Mb Allows Lotus, Symphony, Framework, Etc. to Run Above 640K w/ FREE Microsoft "Windows" ..... \$229
  - INTEL ABOVE BOARD-AT 128K-4Mb w/ Software To Address All Available Memory ..... \$459
  - MACROTECH MSR-AT Up To 3Mb Non Piggy-Backed, Multi-Layer BD, Factory Tested @ 9MHz & Field Tested @ 10MHz-No Wait States, w/ Split Addressing Capability. UNPOPULATED \$235 ..... 3MB \$775
  - STB GRANDE BYTE 128K ..... \$225
  - STB RIO PLUS II 64K-512K, S.P. Clock ..... \$216
  - STB SUPER RIO 256K, CLOCK, S.P. & G Ports ..... \$195
  - STB RIO GRANDE PC-AT 128K-1.5Mb \$269**
  - TECMAR CAPTAIN UNPOP w/Treasure Chest ..... \$154
  - TECMAR MAESTRO Unpopulated for IBM-AT ..... \$325
  - TECMAR MAESTRO For PC/AT 2.5Mb ..... \$595
  - TECMAR WAVE 64K to 256K Fits XT Short Slot ..... \$179

## PC & AT Slave Boards/Pkgs

- Make Your PC/XT/AT A Mighty Multi-User
- ADVANCED DIGITAL PC-SLAVE with 512K, 8MHz 8088 CPU, 2 S Ports, RTNX Software-For Multi-User P.C. .... WHILE THEY LAST \$549
  - ALLOY PC-SLAVE 16 512K to 1Mb ..... \$595
  - ALLOY PC-SLAVE PKG: 512K With Link PC-Terminal, 9' Cable, RTNX Software ..... \$1,175

## Video/Graphics & Cad

- STB EGA PLUS TTL MONO. & HI-RES. RGB. .... \$371
- STB CHAUFFEUR RGB Port/16 Grey Shades Produced on Monochrome TTL Monitor ..... \$195
- STB GRAPHICS PLUS II w/ Paral. PRT Port ..... \$249
- TECMAR GRAPHICS MASTER 16 Color Hi-Res. \$439
- TECMAR GRAPHICS TENDER RGB/PRT Port ..... \$195
- CSD-PC AUTOCAD-2 PKG: 1024X1024 Monochrome Graphics • 15" 1100X1250 Res. Monitor ..... \$3,149
- ILLUMINATED TECHNOLOGIES AUTOCAD PACKAGE: 8 Color 1024X1024 S-100 Board • Inside Autocad Handbook • Autocad 2 • Mitsubishi 19" 1024X874 RGB Analog Color Monitor • Hitachi Tiger 11"X11" Tablet with 12 Button Cursor. .... \$4,995
- TECMAR SUPER-RES PKG: Board & 13" ZVM-136 Monitor w/ 16 Colors @ 640X400 ..... \$949
- VECTRIX VXPCA 4096 Colors/Palette of 512 Colors Ultra Hi-Res, 720 X 512 @ 42KHz Scan Rate with VX/PC Video Cable ..... ONLY ONE @ \$1,695

## PC Scientific/Industrial Boards

- INDUSTRIAL COMPUTER DESIGNS:
- 1018-PC with 96TTL I/O Ports. Like TECMAR Baseboard Only More Features ..... \$446
  - A/D 64-PC 64 Input ..... \$446
  - D/A 64-PC 64 Output ..... \$527
  - TECMAR BASE BOARD 96 Digital I/O Lines ..... CALL
  - TECMAR DADIO D to A Up to 24 Devices ..... CALL
  - TECMAR IEEE-488 Board ..... CALL
  - TECMAR LABMASTER ..... CALL
  - TECMAR EXPANSION CHASSIS 12AMP P/S. Dual AC Outlets, 7 Usable Slots, Space for Hard Disk ..... \$675
  - PC PROTOTYPING BOARD ..... \$18.95

## Modems

- MULTITECH MT212AH Hayes Compatible ..... \$279
- MULTITECH MT224AH Synch & Asynch ..... \$495
- MULTITECH MT224EH MNP Error Correction ..... \$529
- MULTITECH MT212AR Rack-Mount ..... \$259
- MULTITECH MT224AR Rack-Mount ..... \$459
- MULTITECH MT224ER Rack-Mount With MNP Error Correction ..... \$495
- PROMETHEUS PROMODEM 1200 Hayes Compatible w/ Built-In PWR Supply-RS232 Stand Alone Unit \$275
- PROMETHEUS 1200 Like 1200 w/o Options ..... \$189
- PROMETHEUS 2400 ..... \$385
- OPTIONS FOR PROMODEM 1200 ARE:
- COMMUNICATIONS PROC. BUFFER 2K-512K ... \$99
- 512K RAM for Communications Buffer ..... \$49
- ALPHA NUMERIC DISPLAY ..... \$75
- PROMETHEUS 1200A Apple II, II+, IIe Card w/Terminal Software In ROM ..... \$265
- PROMETHEUS 300C Apple IIC Piggy Back ..... \$129
- PROMETHEUS 1200B For PC'S with Procom ... \$239
- PROMETHEUS 1200M Stand Alone MAC Modem with Cable and Communications Software ..... \$348
- U.S. ROBOTICS PASSWORD 1200 ..... \$225
- U.S. ROBOTICS AUTO DIAL 212A ..... \$298
- U.S. ROBOTICS PC/XT MODEM with TELPAC. .... \$199
- U.S. ROBOTICS PC MULTI-MODEM with Clk-Cal., Batt. Back-up, PRT Port, 256K RAM Telpac ..... \$395
- U.S. ROBOTICS MULTILINK/COURIER 2400 ... \$421

## Software • Software • Software

We have Access to all Well Known Brands - ORDER CORRECTLY -- SOFTWARE IS NOT RETURNABLE!

## Word Proc./Screen Formatter

- MICROPRO PRO-PAC For PC's ..... \$289
- MICROPRO WORDSTAR 2000/PC's ..... \$289
- MULTIMATE WORD PROCESSOR / PC-DOS ..... \$315
- NEW STAR NEWWORD II w/Merge Print, The Word PLUS Spelling Checker - Easier Than Word Star But File Compatible: 8 Bit \$99.95 ..... 16 Bit \$129.95
- NEW STAR NEWWORD III For PC Compatibles, With Context Spelling Checker, Indexing, Table Of Contents, Shorthand Keyboard, Macro's, Run Other Programs In Middle Of NewWord, Supports File Paths For Hard Disks Plus Greatly Increased Speed ... / \$209
- PFS WRITE Word Processor For PC's ..... \$85
- COMPUVIEW VEDIT 5113 ..... VEDIT Plus \$169
- COMPUVIEW VEDIT PLUS. V-PRINT & SPELL ..... \$259
- COMPUVIEW V-SPELL C/P/M 80 8" & PC DOS ..... \$59

## Language And Tools

- BD SOFTWARE "C" Compiler 8" SS SD 8 BIT ... \$95
- BORLAND PC TURBO PASCAL 3.0 ..... \$44
- BORLAND PC TURBO TOOLBOX ..... \$35
- DIGITAL RESEARCH Most Products ..... 36% OFF
- LATTICE "C" Compiler ..... \$299
- MICROSOFT Complete Line ..... 32% OFF
- SUPERSOFT FORTRAN PC/MSDOS ..... \$199

## Data Bases & Spreadsheets

- ASHTON-TATE ..... ALL PRODUCTS 32% OFF
- DATAFLEX FILE/RECORD Locking Multi-User. CALL
- MDBS Knowledgegan CP/M/86 8" ..... \$289
- MICROPRO REPORT STAR ..... \$119
- MICROPRO INFO STAR/16 Bit ..... \$239
- MICROMIM R:BASE 4000 @ \$289 R:Base 5000 @ \$409
- PFS FILE \$82 ..... PFS REPORT \$73
- SORCIM SUPERCALC-3 Better Than 1-2-3!!! ..... \$179

## Diskettes & Cartridges

- 3M DG1000 ..... CASE/10 \$159
- DYSAN 300XL (3M COMPAT.) ..... CASE/10 \$195
- DYSAN DC600A (3M COMPAT.) ..... CASE/10 \$222
- DYSAN 104/2D DSDD 5 1/4" ..... CASE \$209
- DYSAN 204/2D 96 TPI DSDD 5 1/4" ..... CASE \$345
- DYSAN UHR2 Ultra Hi-Density ..... CASE \$445
- DYSAN 3740/2D 8" ..... CASE \$282
- MAXELL MD2 5 1/4" DSDD ..... CASE \$123
- MAXELL MD2-HD (IBM-AT) ..... CASE \$235
- MAXELL MF2-DDM 3.5" DSDD ..... CASE \$235
- MAXELL FD2 8" DSDD ..... CASE \$239
- XIDEX PRECISION DSDD 5 1/4" ..... CASE \$79

PLEASE NOTE: We Now Accept AMERICAN EXPRESS...Add 5% To The Cash Prepaid Price



All merchandise new. Advertised prices are cash prepaid only. MC, Visa & P.O.'s from qualified firms - add 3%. Wires, COD's (\$5 min. fee) with Cashiers Check/MO & APO's accepted. Shipping: minimum \$4 first 3 lbs. Tax: AZ RES ONLY add 6% sales tax. All returns subject to 20% restocking fee or credit towards future purchases. Retail prices slightly higher. All prices subject to change without notice.

# WORLD'S LARGEST SELECTION OF PC & S-100 PRODUCTS



## Computer Accessories

- CA P15 Expandable 5 Circuit Monitor Base with Modem & Surge/Noise Protection ..... \$101.97
- CA P150, P151, P152, P15 with ABC Data Switch \$217.28
- CA C1-6 6' IBM-Paral. CBL. (1-9) \$9.50, (10+) \$8.83
- CA C1-9 9' IBM-Paral. CBL. (1-9) \$11.95, (10+) \$11.06
- CA C200 SERIES Premium Molded RS232 Cables ..... (1-9) \$12.48 TO \$28.47, (10+) \$11.86 TO \$27.05
- CA C300 SERIES Premium Molded Parallel Cables ..... (1-9) \$19.98 TO \$45.57, (10+) \$18.98 TO \$43.29
- CA C400 VIDEO CABLES ..... (1-9) \$2.48 TO \$21.29, (10+) \$2.36 TO \$18.10
- CA C500 SERIES Cable Extender Packs w/ MON, PWR, VIDEO & KEYBD. CBLs ..... (1-9) \$29.98, (10+) \$28.48
- CA S4 4 Circuit Surge Supp. (1-9) \$26.47, (10+) \$25.15
- CA S6 6 Circuit Surge/Noise Protection and Cable Storage ..... (1-9) \$31.77, (10+) \$30.18
- Monitor Tilt & Swivel Stand. (1-9) \$14.95, (10+) \$12.95

## Printers, Plotters & Buffers

- BROTHER HR-15-XL 17CPS Daisywheel S or P ..... \$359
- BROTHER HR-10 12CPS Daisy w/ TRAC., S&P ..... \$229
- BROTHER HR-35 36 CPS Wide Daisywheel ..... \$729
- BROTHER M-1109 SER.&PAR. 100/25 NLO ..... \$169
- BROTHER TwinRiter 5 Dot Matrix & Daisywheel CALL
- BROTHER 2024L 24 Pin Hi-Res Print&Graphics ..... \$809
- BROTHER M-1509 180/45 NLO, P&S I/F ..... CALL
- BROTHER M-1009 EPSON Compatible Plug & Play \$99
- BROTHER HR-5 Plain-Paper Thermal Portable... \$169
- CITIZEN MSP-10 160/40 NLO 80/132 ..... \$225
- CITIZEN MSP-15 160/40 CPS 15" Low Profile... \$349
- CITIZEN MSP-20 200/50 NLO 80/132 ..... \$319
- CITIZEN MSP-25 200/50 CPS 15" ULTRA QUIET \$485
- EPSON ..... CALL
- OKIDATA ..... CALL
- STAR ..... CALL
- TEXAS INSTRUMENTS ..... CALL

## XEROX/DIABLO

- ONE YEAR ON-SITE XEROX SERVICE
- BIG REBATES-Don't Snooze & Lose!
- REBATES DIRECT FROM XEROX - LIMITED TIME OFFER!

- DIABLO D25 ..... \$495 Less \$50 Rebate = \$445
- DIABLO 630ECS ..... \$1,409 Less \$100 Rebate = \$1,309
- DIABLO 635 ..... \$1,049 Less \$100 Rebate = \$949
- DIABLO D80IF ..... \$2,159 Less \$500 Rebate = \$1,659
- DIABLO P32CQI ..... \$575 Less \$75 Rebate = \$500
- DIABLO P12CQI ..... \$445
- DIABLO 34LQ ..... \$989 Less \$100 Rebate = \$889
- XEROX 4045 LASER PRINTER with Copier and 512 Dram Options ..... \$4,995 Less \$400 Rebate = \$4,595
- HOUSTON INST. PLOTTERS & DIGITIZERS ..... CALL
- HANZON 12315 64K-256K INTELLIGENT BUFFER SER.-SER., SER.-PAR., PAR.-SER., PAR.-PAR. Computer to Printer Combinations Possible. So easy to use-Instructions printed on bottom of cabinet... \$265
- HANZON ADD-IN MODULE 64K RAM ..... \$45
- PRACTICAL PERIPH APPLE PRINTERFACE ..... \$55
- PRACTICAL PERIPH SWITCHPORT 232 Serial-Parallel Converter ..... \$77

## Monitors & Terminals

- AMDEK MONITORS ..... CALL FOR BEST PRICE!
- PRINCETON GRAPHICS HX-12 690X240RGB ..... \$444
- PRINCETON GRAPHICS HX-12E IBM EGA ..... \$509
- PRINCETON GRAPHICS SR-12 690X480RGB ..... \$569
- TATUNG CM-1360 640X200RGB 13" G-A Switch \$395
- TATUNG MM-1222 HI-RES 12" TTL (IBM) ..... \$109
- TAXAN 12" 116 AMB \$109 ..... 115 GRN \$99
- TECMAR ZVM-136 640X480 RGB 13" Grn Switch \$499
- ZENITH ZVM-1240 Amber IBM Monochrome ..... \$155
- ZENITH ZVM-1220G or ZVM-1230A Flat Screen ..... \$99
- LIBERTY FREEDOM TERMINALS ..... CALL
- LINK 125 Wyse 50 Compat. 14" GRN or AMB w/Hlgher RES., More Emul's, Selectric K.B., 6 Scroll Rates \$429
- LINK PC-TERM IBM or ASCII VIDEO, 14" GRN or AMB, IBM-AT Keyboard Layout, 132 Column, Also Compat. w/WY50&TVI925 Ideal w/PC-Slave Bds. \$449
- LINK 220 DEC Compatible w/Up To 6 Pages of Memory, RS-423, Amber, 25th Status & 26th Data Line, 38.4K BPS, 38 Programmable Function Keys, etc., etc., All Standard ..... \$459

## Chips

We Have Some of the LOWEST PRICES in the Nation!!  
64K, 256K, 8087 & 80287 ..... CALL

## Computer Systems

### AT-100 FCC & UL APPROVED AT



- AT-100 EXECUTIVE 512K, 8 SLOTS, 200W P/S, 1.2Mb FLPY, SERIAL, PARAL. PORTS, CLOCK, COLOR OR MONOCHROME GRAPHICS CARD ..... \$1,998
- AT-100 EXECUTIVE 40 W/ 40Mb Hard Disk ..... \$3,095
- AT-100 EXECUTIVE 40 W/ 25Mb Tape ..... \$3,784
- AT-100 EXECUTIVE 85 W/ 85Mb Hard Disk ..... \$3,595
- AT-100 EXECUTIVE 85 W/ 85Mb Tape ..... \$4,575

## Hard Disk/Tape Subsystems

### PC's-MAC's-S-100's

AT-INSIDER, PC-INSIDER, PC-OUTSIDER HARD DISK SERIES FOR IBM, BOOTS FROM HARD DISK, FORMATTED W/ CONTROLLER & ALL NECESSARY CABLES, HARDWARE & P/S or PC STYLE CABINET. CALL FOR PC/XT/AT CONFIG. OF YOUR CHOICE

- THIS MONTH'S SPECIAL:
- 20Mb PC-INSIDER W/ OMTI 5510-7 CTRL ..... \$495
- ALLOY PC-QICTAPE Up to 69Mb ..... \$1,836
- ALLOY PC-9TRACK 42Mb ..... \$5,295
- ALLOY FT-60 EXTERNAL 1.8Mb/Minute 60Mb Streamer for PC's ..... \$796
- ALLOY FT-60 For AT's & Non-Compatible PC's ..... \$952
- IRWIN 10Mb Tape Drive SELLOUT: INT \$468 EXT \$569
- ARCHIVE FASTAPE FT-60 9 Track Cartridge Up To 60Mb of Formatted Data on DC600A Cartridge At More Than 5Mb/Min. .... CALL
- ARCHIVE SC499X CTRL w/ 5945C Drive Internal 60Mb Tape/PC, XT & AT. .... CALL
- ARCHIVE QIC-02 60Mb Tape Drive With SC199-2 CTRL and 5945L-2 Drive ..... CALL

SMS OMTI 5510-7 Supports Up To 16 Heads, Programmable Interleaving Up To 1:1, 25 US Step Rate, Fixed & Removeable Drives, Soft/Hard, Sectoring, Multiple Partitions, 2K Buffer, 1 YR Warranty ..... \$135

- TECMAR QIC-60 External Tape ..... \$1,449
- TECMAR QIC-60 Host I/F Board ..... \$109
- TECMAR 40200 II Slot Expan. Chassis w/10Mb \$1,395
- TECMAR 40410 33Mb Fixed/5Mb Removeable In 11 Slot Expansion Chassis ..... \$2,495
- TECMAR 73200 MACDRIVE 10Mb 1/2 HT. with Software and Hardware For Easy Installation ..... \$1,325
- TECMAR 73210 MACDRIVE with 10Mb Fixed And 5Mb Removeable Cartridge ..... \$2,195
- WANGTEK PC-36 60Mb Tape Internal IBM Drive W/ Controller, Cable, Software, Up To 5Mb/Min. .... \$919

CALL FOR DLR &/or QTY. PRICES ON HARD DISKS:

- MICROPOLIS 1325 85Mb 25mSEC ..... \$1,498
- QUANTUM Q540 40Mb FACTORY DIRECT 1 YEAR WARRANTY! ..... REDUCED!! \$1,095

S-100 BUS SUBSYSTEMS Supporting Turbodos, Concur. Dos, CP/M 80 & 816 Operating Systems CALL

DRIVE SUBSYSTEMS FOR COMPUPRO

- WITH DISK 3, CABINET, P/S, FAN, CABLES, ETC. ....
- 20Mb SEAGATE ..... \$1,115
- 37Mb QUANTUM Q540 ..... \$1,715
- 72Mb 1325 \$2,159, M6085 \$2,459 ..... XT-1085 \$2,349
- 116Mb MAXTOR XT-1140 ..... \$4,395
- 10Mb TAPE INT. (Requires Concurrent DOS) ..... \$498
- 10Mb TAPE EXT. (Requires Concurrent DOS) ..... \$579
- ALLOY ITS-100+ 9TRACK 42Mb w/CTRL, TIP Software For CP/M and Turbodos ..... \$5,295
- ALLOY IDXCS-100T 17.7Mb External Tape Subsystem For CP/M 80, 86 ..... \$1,836

## Computer Systems

### XT-100 MEETS FCC SPECS



- XT-100 EXECUTIVE 640K, 2 DSDD 1/2 HT. FLPYS, SERIAL, PARALLEL & GAME PORTS, CLOCK, COLOR OR MONOCHROME GRAPHICS CARD, 8 SLOTS, 135W POWER SUPPLY & KEYBOARD ..... \$915
- XT-100 EXECUTIVE 20 W/ 20Mb Hard Disk ..... \$1,449
- XT-100 EXECUTIVE 20 W/ 10Mb Tape ..... \$1,919

## XEROX

- 6064 PERSONAL COMPUTER AT&T 6300 Compatible 8086-8MHz CPU, 256K, 2 Floppys, MS-DOS & Screen-Mate Software ..... \$1,919
- 6065 PERSONAL COMPUTER w/ 10Mb H.D. .... \$3,195
- PC KEYBOARD For 6064 & 6065 ..... \$119
- WP-KEYBOARD Word Processing w/ 99 Keys ..... \$199
- MONOCHROME 640 X 400 12" Monitor ..... \$238
- COLOR 640 X 400 13" Monitor ..... \$640
- MOUSE ..... \$159
- WRITER-2 Word Processing Software ..... \$399



- CORONA PPC-400-22 Portable 256K, Dual Fipy's, 640X400 GRN Monitor, 4 Expan Slots, Serial & Paral. Ports, MS DOS, GW-Basic & PC-Tutor ..... \$1,149
- CORONA PPC-400-XT Portable w/20Mb H.D. .... \$1,649
- CORONA PC-400-22 DESK TOP PC w/14" Green Tilt & Swivel Monitor ..... \$1,395
- CORONA PC-400-HD2 w/ 10Mb Hard Disk ..... \$1,995
- For ST-225 20Mb Add \$79 ..... For Q540 Add \$595



CORE SYSTEM w/256K Ram, I/F-4, Syst. S.H.P. 1, ENCL 2D, Disk 1A, Disk 3, 5 1/4" FLPY. & 20Mb H.D. Add Your Choice of CPU & Oper. Sys. .... \$5,025

816/C2 w/80286, 512K Ram, SPUZ-256, 40Mb H.D., 10Mb Tape, 5 1/4" 96TPI FLPY, CDOS 816/288, NewWord & Supercalc II ..... REDUCED!!

CALL FOR OTHER SYSTEM CONFIGURATIONS



### PC COMPATIBLE & FASTER TOO!

- ZENITH Z-158 PC-DESK TOP SYSTEM: 256K RAM, 2 DSDD FLPY DRIVES, Serial, Paral. Monochrome & Color Composite & RGB Color Ports, & MS-DOS w/4.77 & 8 MHZ CPU Clock Rates, G or A Monitor ..... \$1,849
- Z158 with Flappy & 20Mb H.D. DRVS ..... \$2,395
- Z158 with Flappy & 40Mb H.D. DRVS ..... \$2,798
- 1/2 HT 10Mb TAPE OPTION INT \$498/EXT ..... \$598
- Z-143 PC with 256K, 2 FLPYS, MS-DOS, 4.77 & 8MHZ, Serial & Parallel Ports ..... \$1,175
- Z-138 PC TRANSPORTABLE 24 Lbs, 256K, Dual FLPYS, 7" AMB Screen, MS-DOS, 4.77 & 8MHZ, S&P ..... \$1,409
- Z-171 LAP-TOP PORTABLE 2 Drvs., 256K ..... \$1,875

S-100 DIV./696 CORP.  
14455 NORTH 79th ST.  
SCOTTSDALE, AZ 85262

# ORDERS 800-528-3138

TECH. SALES/CUST. SERVICE 602-991-7870  
TELEX 9103806778 SONEHUND

Inquiry 314 for End-Users. Inquiry 315 for DEALERS ONLY.



PLEASE NOTE: We Now Accept AMERICAN EXPRESS... Add 5% To The Cash Prepaid Price

### 7400

Part No.	Price	Part No.	Price
SN7400N	.19	SN7485N	.55
SN7402N	.19	SN7486N	.35
SN7404N	.25	SN7489N	1.95
SN7405N	.29	SN7490N	.39
SN7406N	.35	SN74150N	1.29
SN7407N	.29	SN74121N	.29
SN7408N	.25	SN74123N	.49
SN7410N	.19	SN74125N	.45
SN7414N	.45	SN74126N	.49
SN7416N	.35	SN74143N	3.95
SN7417N	.35	SN74151N	1.29
SN7420N	.19	SN74154N	1.25
SN7430N	.19	SN74158N	1.39
SN7432N	.29	SN74173N	.75
SN7438N	.29	SN74174N	.59
SN7442N	.45	SN74175N	.59
SN7445N	.59	SN74176N	.89
SN7446N	.79	SN74181N	1.95
SN7447N	.79	SN74189N	1.95
SN7448N	.79	SN74193N	.69
SN7472N	.39	SN74198N	1.35
SN7473N	.35	SN74221N	.89
SN7474N	.35	SN74273N	1.95
SN7475N	.39	SN74365N	.59
SN7476N	.35	SN74367N	.59

### 74LS

74LS00	.19	74LS165	.79
74LS02	.19	74LS166	.89
74LS04	.25	74LS173	.49
74LS05	.25	74LS174	.49
74LS06	.39	74LS175	.39
74LS07	.39	74LS189	3.95
74LS08	.19	74LS191	.49
74LS10	.19	74LS193	.69
74LS14	.39	74LS221	.59
74LS27	.25	74LS240	.69
74LS30	.19	74LS243	.69
74LS32	.35	74LS244	.69
74LS42	.39	74LS245	.79
74LS47	.89	74LS259	1.19
74LS73	.35	74LS273	.79
74LS74	.25	74LS279	.39
74LS75	.29	74LS322	2.95
74LS76	.29	74LS365	.59
74LS85	.49	74LS366	.39
74LS86	.25	74LS367	.39
74LS90	.39	74LS368	.39
74LS93	.49	74LS373	.79
74LS123	.49	74LS374	.79
74LS125	.39	74LS393	.79
74LS138	.39	74LS590	5.95
74LS139	.39	74LS624	1.95
74LS154	1.49	74LS629	2.49
74LS157	.35	74LS640	.99
74LS158	.39	74LS645	.99
74LS163	.49	74LS670	.99
74LS164	.49	74LS688	1.95

### 74S/PROMS\*

74S00	.29	74S188*	1.75
74S04	.35	74S189	1.95
74S08	.35	74S196	1.49
74S10	.29	74S240	1.49
74S32	.35	74S244	1.49
74S74	.49	74S287	1.49
74S85	1.49	74S287*	1.69
74S86	.35	74S288*	1.69
74S124	2.75	74S373	1.69
74S174	.79	74S374	1.69
74S175	.79	74S472*	3.49

### 74ALS

74ALS00	.35	74ALS138	.89
74ALS02	.35	74ALS174	.89
74ALS04	.39	74ALS175	.89
74ALS08	.35	74ALS240	1.79
74ALS10	.39	74ALS244	1.79
74ALS27	.35	74ALS245	2.49
74ALS30	.35	74ALS373	1.95
74ALS32	.39	74ALS374	1.95
74ALS74	.55	74ALS573	1.95

### 74F

74F00	.59	74F139	1.29
74F04	.65	74F157	1.29
74F08	.59	74F193	4.95
74F10	.59	74F240	2.49
74F32	.65	74F244	2.49
74F74	.69	74F253	1.79
74F86	.89	74F373	2.95
74F138	1.19	74F374	2.95

### CD—CMOS

CD4001	.19	CD4081	.25
CD4011	.19	CD4082	.25
CD4013	.35	CD4093	.39
CD4016	.19	CD4094	1.49
CD4017	.49	CD4103	2.95
CD4020	.69	CD4501	.49
CD4024	.59	CD4510	.69
CD4027	.49	CD4511	.69
CD4030	.39	CD4515	1.39
CD4040	.65	CD4518	.79
CD4049	.29	CD4520	.79
CD4050	.29	CD4538	.89
CD4051	.65	CD4541	.89
CD4052	.65	CD4543	.99
CD4053	.65	CD4553	4.95
CD4059	3.49	CD4555	.89
CD4060	.89	CD4566	1.95
CD4066	.29	CD4583	1.19
CD4069	.25	CD4584	.59
CD4070	.29	CD4585	.75
CD4071	.25	MC14411	9.95
CD4072	.25	MC14490P	4.49
CD4076	.89	MC14572	.89

### PRICE BREAKTHROUGH!

#### CUSTOM COMMODORE CHIPS for VIC-20, C-64 and C-128 Personal Computers

Part No.	Price	Part No.	Price	Part No.	Price
*6510CPU	14.96	9.95	*6581CIA	26.96	14.95
*6525TPI	20.96	9.95	*6560VIC-I	20.96	14.95
*Specs. Available @ \$1.50 ea.			*6567VIC-II	44.96	19.95
			NOTE: 82S100 = U17 (C-64)		

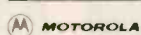

#### MC68701-Microcomputer with EPROM

The MC68701 is an 8-bit single chip microcomputer unit (MPU) which significantly enhances the capabilities of the MC6800 family of RAM. On-chip resources include 2048 bytes of EPROM, 128 bytes of RAM, Serial Communications Interface (SCI), parallel I/O, and a free function Programmable Timer.

**MC68701.....\$24.95**

### MICROPROCESSOR COMPONENTS

MICROPROCESSOR CHIPS		6500/6800/68000 Cont.		8000 SERIES Cont.	
Part No.	Price	Part No.	Price	Part No.	Price
D765AC	4.95	6843	9.95	8237-5	6.95
CDP1802CE	9.95	6845	4.95	8243	2.49
2661-3	6.95	6850	1.95	8250A	6.95
Z80, Z80A, Z80B, SERIES		6852	4.75	8250B (For IBM)	7.25
Z80	1.75	68000LB	9.95	8251A	2.25
Z80-CTC	1.79	68661	8.95	8253-5	2.25
Z80-DART	4.95			8254	9.95
Z80-PIO	1.79	80031	1.95	8254-2	11.95
Z80A	1.65	80C31BH	6.95	8255A-5	2.25
Z80A-CTC	1.89	8035	1.95	8257-5	2.49
Z80A-DART	5.25	8073N	29.95	8259-5	2.49
Z80A-PIO	1.95	8080A	3.95	8272	4.95
Z80A-SIO/0	5.25	8085A	2.75	8279-5	2.95
Z80B	3.95	8086	8.95	8741	8.95
Z80B-CTC	4.95	8086-2	10.95	8748	7.95
Z80B-PIO	4.95	8087 (5MHz)	129.95	8749	9.95
		8087-2 (8MHz)	159.95	8751	14.95
				8755	14.95
6500/6800/68000 SER.		6502	2.75	8088-2	9.95
6502	2.75	8088-2	9.95		
6520	2.95	8116	8.95	DATA ACQUISITION	
6522	4.95	8155	2.75	ADC0804	3.49
6532	6.49	8156-2	3.95	ADC0808	8.95
6551	6.95	8155	2.75	ADC0809	3.95
6800	1.95	8202	9.95	ADC0818	14.95
6802	4.95	8203	29.95	ADC0817	4.95
6810	1.95	8212	1.95	DAC0808	1.95
6821	1.95	8224	2.25	DAC1008	7.95
6840	6.75	8228	3.49	AY-3-1015D	4.95
				AY-5-1013A	3.95

### DYNAMIC RAMS

Part No.	Function	Price
4116N-15	16,384 x 1 (150ns)	.89
4128	131,072 x 1 (200ns)	5.95
4164N-150	65,536 x 1 (150ns)	1.39
4164N-200	65,536 x 1 (200ns)	1.19
TMS4416-12	16,384 x 4 (200ns) 2107	4.95
HM5290	4096 x 1 (200ns) 2107	1.95
8118	16,384 x 1 (120ns) (+5V Only Required)	.99
41256-150	262,144 x 1 (150ns)	3.95
50464-15	65,536 x 4 (150ns) (4464) (41464)	7.95

### STATIC RAMS

TMM2016-12	2048 x 8 (120ns)	1.69
2102	1024 x 1 (250ns)	.99
2102-2L	1024 x 1 (350ns) LP (91L02)	1.49
2114N	1024 x 4 (450ns)	1.49
2114N-L	1024 x 4 (450ns) LP	1.09
2114N-2	1024 x 4 (200ns)	1.05
2114N-2L	1024 x 4 (200ns) LP	1.49
21C14	1024 x 4 (200ns) CMOS	.49
2149	1024 x 4 (45ns)	4.95
5101	256 x 4 (450ns) CMOS	3.95
HM6116P-3	2048 x 8 (150ns) CMOS	1.79
HM6116P-L	2048 x 8 (150ns) LP CMOS	1.85
HM6264P-12	8192 x 8 (120ns) CMOS	4.69
HM6264P-L	8192 x 8 (120ns) LP CMOS	4.79
HM6264P-15	8192 x 8 (450ns) CMOS	4.49
HM6264P-15	8192 x 8 (150ns) LP CMOS	4.59
6514	1024 x 4 (350ns) CMOS (UPD444C)	4.49

### PROMS/EPROMS

1702A	256 x 8 (1us)	5.95
TMS2516	2048 x 8 (450ns) 25V	5.95
TMS2532	4096 x 8 (450ns) 25V	5.95
TMS2564	8192 x 8 (450ns) 25V	9.95
2708	1024 x 8 (450ns)	5.49
TMS2716	2048 x 8 (450ns) 3 voltage	9.95
2716	2048 x 8 (450ns)	3.75
2716-1	2048 x 8 (350ns) 25V	4.25
27C16	2048 x 8 (450ns)	4.75
2732	4096 x 8 (200ns) 21V	5.25
2732A-20	4096 x 8 (250ns) 21V	4.49
2732A-45	4096 x 8 (450ns) 21V	3.95
27C32	4096 x 8 CMOS	10.95
2758	1024 x 8 (250ns) Single +5V	5.95
2764-20	8192 x 8 (250ns) 21V	5.25
2764-25	8192 x 8 (250ns) 21V	4.25
2764A-25	8192 x 8 (250ns) 12.5V	4.49
2764-45	8192 x 8 (450ns) 21V	3.95
27C64	8192 x 8 CMOS 21V	6.95
27128-25	16,384 x 8 (250ns) 12.5V	4.95
27128A-25	16,384 x 8 (250ns) 12.5V	5.95
27256-25	32,768 x 8 (250ns) 256K (12.5V)	9.95
27C256-25	32,768 x 8 (250ns) 256K (CMOS) (12.5V)	13.95
68764	8192 x 8 (450ns) 25V	15.95
68766	8192 x 8 (350ns) 25V	16.95
74S387	256 x 4 PROM Q.C.	1.69
74S471	256 x 8 PROM TS	4.95
82S123	32 x 8 PROM TS	2.95
82S129	256 x 4 PROM TS	2.95

### LOW PROFILE (TIN) SOCKETS

Part No.	1-9	10-99	100-up
8 pin LP	13	12	11
14 pin LP	15	13	11
16 pin LP	17	15	13
24 pin LP	31	30	29
28 pin LP	39	37	35
40 pin LP	45	46	43

### WIRE WRAP SOCKETS (GOLD) LEVEL #3

Part No.	1-9	10-99	100-up
8 pin WWW	55	49	45
14 pin WWW	69	65	59
16 pin WWW	75	69	65
24 pin WWW	1.19	1.09	.99
28 pin WWW	1.39	1.29	1.19
40 pin WWW	1.79	1.69	1.59

— SOLDERTAIL STANDARDS (GOLD & TIN) AND HEADER PLUG SOCKETS ALSO AVAILABLE —

### SATELLITE TV DESCRAMBLER

The MM5321 is a TV camera sync generator designed to supply the basic sync functions for either color or monochrome 525 line/60Hz interlaced and camera video recorder applications. COLOR BURST GATE & SYNC ALLOW STABLE COLOR OPERATION

**MM5321.....\$9.95**

### DIGITAL TALKER™

**DT1050** — Applications: Teaching aids, appliances, clocks, automotive, telecommunications, language translators, etc. The DT1050 is a standard DIGITAL TALKER kit encoded with 137 separate and useful words, 2 tones, and 5 different silence durations. The words and tones have been assigned discrete addresses, making it possible to output single words or words concatenated into phrases or even sentences. The "voice" output of the DT1050 is a highly intelligible male voice.

The DT1050 consists of a Speech Processor Chip, MM54104 (40-pin) and two (2) Speech ROMs MM5216ASR1 and MM5216ASR2 (24-pin) along with a Master Word list and a recommended schematic diagram on the application sheet.

Part No.	Description	Price
DT1050	Digitaltalker™	\$24.95
MM54104	Processor Chip	\$12.95

**DT1057** — Expands the DT1050 vocabulary from 137 words to over 250 words. Includes two (2) ROMs and spec. **DT1057.....\$11.95**

### INTERSIL

Part No.	Price	Part No.</
----------	-------	------------

# Worldwide • Since 1974

• QUALITY COMPONENTS • COMPETITIVE PRICING  
• PROMPT DELIVERY

Mail Order Electronics • Worldwide  
**Jameco**  
ELECTRONICS

## COMMODORE® COMPATIBLE ACCESSORIES



**RS232 Adapter**  
for VIC-20 and  
Commodore 64

The JE232CM allows connection of standard serial RS232 printers, modems, etc. to your VIC-20 and C-64 (excluding the SX-64 Portable). A 4-pole switch allows the inversion of the 4 control lines. Complete installation and operation instructions included.

• Plugs into User Port • Provides Standard RS232 signal levels  
• Uses 6 signals (Transmit, Receive, Clear to Send, Request to Send, Data Terminal Ready, Data Set Ready).

**JE232CM**..... \$39.95

### Voice Synthesizer VIC-20 & C-64

Plug-In — Talking in Minutes!

**JE520CM**..... \$99.95

### 300 Baud Auto Modem

**Mitey-Mo** (For C-64)..... \$74.95

### Parallel Printer Interface

FREE 4K Buffer Included!

**MW350** (For VIC-20, C-64 & C-128)..... \$69.95

## TRS-80® COMPATIBLE ACCESSORIES

### E-X-P-A-N-D TRS-80 MEMORY

All kits come complete with documentation

#### TRS-80 MODEL I, III

TRS-16K3 200ns (Model III)..... \$5.95

TRS-16K4 250ns (Model I)..... \$5.49

#### TRS-80 COLOR AND COLOR II

TRS-64K-2..... \$11.95

New models only —

TRS-CoCo-Incl. 2-50464's (41464's)..... \$19.95

#### TRS-80 MODEL 4, 4P

TRS-64K-2..... \$11.95

Expands Model 4 from 16K-64K or Model 4P from 64K-128K

TRS-64K-2PAL..... \$29.95

Expands Model 4 from 64K to 128K

TRS-80 Model 100 • NEC • Olivetti

**M1008K**..... \$29.95 ea. or 3 for \$79.95

TRS-80 Model 100 Expansion

**NEC8KR**..... \$29.95 ea. or 3 for \$79.95

NEC Model PC-8201A Expansion

**OM108K**..... \$29.95 ea. or 3 for \$79.95

Olivetti Model M10 Expansion

#### TANDY 200

**M200R**..... \$99.95 ea. or 2 for \$189.95

Tandy Model 200 Expansion

## PROMETHEUS MODEMS



**Intelligent 1200/300 Baud Modem with Real Time Clock/Calendar**

The ProModem™ is a Bell 212A (1200/300) intelligent stand-alone modem • Hayes command set compatible plus an additional extended command set • Shown with alphanumeric display option, RS-232 Stand-Alone Unit:

**PM1200**..... \$299.95

### Options for ProModem 1200

**PM-COM**..... \$49.95

ProCom Communications Software. Please specify Operating System — Apple: ProDOS or CP/M — IBM: PC DOS or MS DOS

**PM-OP512K**..... \$129.95

Communications Buffer Option

**BUF512K**..... \$54.95

512K Memory for PM-OP512K

**PM-ALP**..... \$79.95

Alphanumeric Display for ProModem 1200

**PM-SPECIAL #2**..... \$249.95

Includes PM-OP512K, BUF512K and PM-ALP

## APPLE® COMPATIBLE ACCESSORIES

All Apple Cards come complete with instructions. **MADE IN THE USA!**

### 16K RAM CARD (Language Card)

For Apple II and II+\*



Expand from 48K-64K. Runs AppleSoft, DOS, CP/M and Pascal. (APC-16K/MEM-1)

**JE860\*\*** .. \$39.95

### CONTROLLER CARD

For Apple II, II+ and IIe\*



Capable of handling up to two drives. Recommended drives: AOC-514 or ADD-12. (ACC-1)

**JE875** .... \$49.95

### EXTENDED 80-COLUMN CARD

For Apple IIe\*



JE864 is an extended 80-column/64K RAM Card. Ultra-high resolution capability.

**JE864** .... \$69.95



### 128K RAM CARD

For Apple II, II+ and IIe\*

Four key software programs are included: Utilities, Diagnostics, Demos, and RAM Disk Emulators for DOS 3.3, CP/M and Apple Pascal. Expand-A-RAM:

**JE868\*\*** ..... \$119.95

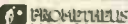

### APPLESURANCE DIAGNOSTIC DISK CONTROLLER CARD

For Apple II, II+ and IIe\*

PREVENTS CRASHES!

Test your RAM, ROM, CPU and Disk Drives. DRV-1/Appesurance II:

**JE877** ..... \$69.95

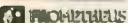

### PARALLEL PRINTER CARD

For Apple II, II+ and IIe\*

Fully compatible with Apple CP/M, Apple Pascal (for FORTRAN), and most other operating systems and software packages. Available for Apple II, II+ and IIe. PRT-1:

**JE880** ..... \$59.95

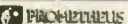

### PARALLEL/SERIAL 64K BUFFER CARD

For Apple II, II+ and IIe\*

Using the parallel jumper cable supplied, the JE883 will attach to the JE880 (above). Parallel Card needed for operation. The JE883 includes a standard parallel input with both parallel and serial (RS232) buffered outputs. P/S Buffer:

**JE883** ..... \$79.95

\*APPLE, APPLE II, II+ and IIe are registered trademarks of Apple Computers.  
\*\*When using CP/M, the JE860 and JE868 will only function with Version 2.20 or earlier: PASCAL (JE868) Version 1.1 or earlier.

## ADDITIONAL APPLE® COMPATIBLE PRODUCTS

Key: a=Apple II or II+ b=Apple IIe

APF-1	Cooling Fan with Surge Protection • Key: (a,b).	\$ 39.95
KHP4007	Switching Power Supply • Key: (a,b).	\$ 39.95
JE614	Numeric/Aux. Keypad - 11 accessible functions • Key: (b).	\$ 49.95
AMON	12" Green Monitor with Swivel Stand • Key: (a, b and IIc).	\$ 99.95
KB-EA1	Apple Keyboard and Case • Key: (a).	\$ 99.95
JE520AP	Voice Synthesizer — Plug-In, User Ready • Key: (a,b).	\$119.95
ADD-12	5 1/4" Half-Height Disk Drive • Key: (a,b).	\$129.95
ADD-IIc	5 1/4" Half-Height Disk Drive • Key: (IIc).	\$129.95
ADD-514	5 1/4" Full Height Disk Drive • Key: (a,b).	\$139.95
PM1200A	Prometheus Internal Modem — 2 Cards • Key: (a,b).	\$299.95
PM1200M	Prometheus Macintosh Ext. Modem • Key: (Macintosh).	\$349.95

## GENERAL APPLICATION POWER SUPPLIES

### Power/Mate Corp. REGULATED POWER SUPPLY

\* Input: 105-125/210-250VAC @ 47-63Hz • Line regulation: ±0.05% • 3 mounting surfaces • Overvoltage protection • UL recognized • CSA certified

Part No.	Output	Size (Inches)	Weight	PRICE
EMAS/6B	5V@3A / 6V@2.5A	4 1/4" L x 4W x 2 1/4" H	2 lbs.	\$29.95
EMAS/6C	5V@6A / 6V@5A	5 1/4" L x 4 1/2" W x 2 1/4" H	4 lbs.	\$39.95

### 4-CHANNEL SWITCHING POWER SUPPLY

\* Microprocessor, mini-computer, terminal, medical equipment and process control applications • Input: 90-130VAC, 47-440Hz • Output: +5VDC @ 5A — 5VDC @ 1A; +12VDC @ 1A; -12VDC @ 1A • Line regulation: ±0.2% • Ripple: 30mV p-p • Load regulation: ±1% • Overcurrent protection • Adjustment: 5V main output ±10% • Size: 6 1/2" L x 1 1/2" W x 4-15/16" H • Weight: 1 1/2 lbs.

**FCS-604A**..... \$59.95

## IBM® COMPATIBLE ACCESSORIES

### 83-KEY KEYBOARD



• Identical layout as original IBM PC Keyboard • Highly desirable case with palm rest • Complete with cable and data • **JUST PLUG IN!**

**KB83**..... \$49.95

### Build an IBM PC/XT™ Compatible!

IBM-64K	64K RAM Chips (18).....	\$ 24.98
KB-83	83-Key Keyboard.....	\$ 49.95
IBM-FCC	Floppy Controller Card.....	\$ 54.95
IBM-Case	Case.....	\$ 49.95
IBM-MCC	Monochrome Card.....	\$ 89.95
IBM-PS	Power Supply.....	\$ 89.95
FD55B	Disk Drive.....	\$119.95
IBM-MON	Monochrome Monitor.....	\$109.95
IBM-MB	Motherboard.....	\$199.95

Regular List \$789.58

**IBM™-Special** (Incl. 9 items above) .. \$699.95

### Additional Add-Ons Available!

IBM-KB	83-Key Keyboard.....	\$ 79.95
IBM-ENH	Enhanced Keyboard.....	\$ 99.95
IBM-ICB	Integrated Color Board.....	\$109.95
IBM-E384K	Multifunction Card.....	\$169.95
IBM-20MBK	20MB Hard Disk Drive.....	\$599.95

IBM is a registered trademark of IBM Computers



**IBM Compatible! DISK DRIVES**  
Documentation Included

**FD55B** Teac 5 1/4" DS 1/2-High..... \$119.95

**SA455** Shugart 5 1/4" DS 1/2-High..... \$119.95

**TM100-2** Tandem 5 1/4" DS Full-Height..... \$119.95

### JMR 5 1/4" DISK DRIVE ENCLOSURES

Complete with power supply switch, power cord, fuseholder and connectors

**DDE-1FH**..... \$69.95

Houses 1 Full-Height 5 1/4" Floppy Drive

**DDE-2HH**..... \$79.95

Houses 2 Half-Height 5 1/4" Floppy Drives — Vertical

**HDDE-1FH**..... \$199.95

Houses 1 Hard Disk Drive

## UV-EPROM ERASER



Erases all EPROMs. Erases up to 8 chips within 21 minutes (1 chip in 15 minutes). Maintains constant exposure distance of 1". Special conductive foam liner eliminates static build-up. Built-in safety lock to prevent UV exposure. Compact - 9.00" L x 3.70" W x 2.60" H. Complete with holding tray for 8 chips.

**DE-4** UV-EPROM Eraser..... \$74.95

**UVS-11EL** Replacement Bulb..... \$17.95

## DATA BOOKS

30003	National Linear Data Book (82).....	\$14.95
30009	Intertek Data Book (85).....	\$ 9.95
30013	Zilog Data Book (85).....	\$14.95
30022	Nat'l. Logic Data Book Set (84).....	\$24.95
210830	Intel Memory Handbook (83/84).....	\$19.95
230843	Intel Microsystem Hndbk. (83/84).....	\$19.95

## MUFFIN/SPRITE-STYLE FANS

MUF60 (SPN3-15-2462).....	\$9.95
Howard Industries (4.68" sq., 60 cfm)	
SU2C7.....	\$9.95
EG&G Rotron (3.125" square, 20 cfm)	

\$20 Minimum Order — U.S. Funds Only  
Shipping: Add 5% plus \$1.50 Insurance

California Residents: Add 6% or 6 1/2% Sales Tax

Spec. Sheets — 30¢ each  
Prices Subject to Change

Send stamped, self-addressed envelope to receive a Quarterly Sales Flyer — FREE!

5/86



Mail Order Electronics • Worldwide  
**Jameco**  
ELECTRONICS



Send \$1.00 Postage for a FREE 1986 JAMECO CATALOG

1355 SHOREWAY ROAD, BELMONT, CA 94002 • PHONE ORDERS WELCOME 415-592-8097 Telex: 176043

# California Digital

17700 Figueroa Street • Carson, California 90248

## IBM Compatible Computer

**\$495**

**Eclipse**  
DATA PRODUCTS



- 256K Expandable to 640K on Motherboard
- Double Sided Double Density Disk Drive
- IBM Type Keyboard (with LED Indicators)
- Floppy Controller Card
- Eight Expansion Slots
- 135 Watt Power Supply

The Eclipse 16 is an outstanding value in IBM Compatible Computers. After careful research and evaluation we found it to be the most reliable unit. Our computer includes some of the newest features available, such as the 4.7MHz, multi-layer motherboard with 256K of RAM upgradable on board to 640K. A generous eight expansion slots and 135 Watt power supply give you ample room and power for add-on boards. The enclosure has an easy-access flip top lid making upgrades a breeze. And our floppy controller supports up to four drives, so as many as three additional drives can be used. Finally, each computer is configured and fully tested before sending it to you.

**Satisfaction Guaranteed!** We're really excited about this new unit, and so sure you will be too... that you may return the Eclipse 16 for a full credit towards an IBM PC if you are not completely satisfied.

### OPTIONS

20MB Hard Drive w/Controller.....\$495	RGB Color Monitor.....199
Additional Drive-Installed.....99	TTL Monochrome Monitor.....139
Irwin 10 Meg. Tape Back up.....489	Microsoft Mouse.....139
Upgrade from 256K to 640K RAM.....79	Upgrade from Floppy Controller to Disk I/O
8087 Math Co Processor.....119	2 drive controller, clock/cal., software
Color Graphics Card.....79	parallel, serial, and game ports.....79
Monochrome Graphics Card.....99	1200 Baud Internal Modem w/Software 179

## IBM COMPATIBLE PORTABLE

**\$895**

**The COMMUTER**



- Fully IBM PC Compatible
- 128K-Expandable to 512K
- Parallel Printer Port
- Serial ASYNC RS232-C Port
- Built-in Color Graphics and Monochrome (For external monitor)
- 2-5 1/4 Diskette Drives (Double-Sided/Double-Density)

**ENVISION THE POWER...** a fully IBM compatible desktop computer in a 16 pound portable, The Commuter is a powerful desktop computer, whether on its own, or connected to a wide variety of peripherals via built-in ports.

The 25 line LCD display offers the same amount of text and graphics capabilities as full size external monitors. Combined with extensive memory, storage and expansion ports, all of the power needed for diverse business applications is now yours in one small package.

The Commuter is manufactured by Visual Technology, one of the largest producers of graphics terminals, and a diversified manufacturer of personal computers. Originally priced at \$2000, our price of \$895 makes the Commuter very compatible with your pocketbook.

## 1200 BAUD MODEMS



AVATEX 1200

**\$99**

This 300/1200 baud modem matches the design specs of the Bell 212A, feature by feature, bringing you reliability, impeccable transmission and easy operation. Hayes Compatible, except for "S" register. Communication software included. The AVATEX 1200, at \$99, is a steal!



SMARTTEAM 1200

**\$189**

The Team 212A offers all the features of the Hayes Smart Modem 1200 for a fraction of the price. Now is your opportunity to purchase a 1200 baud modem at the price of a 300 baud modem.



SIGNALMAN 300 BAUD MARK VI

**\$49**

The Anchor Automation Mark VI is a 300 baud direct connect modem that plugs into any slot of your IBM/PC. This modem supports auto answer and auto dial capabilities. Other features include telephone number storage, send / receive text files, single key-stroke dialing along with many other functions provided on disk. The Mark VI was originally priced at over \$300.

## UltraLink 1200



The UltraLink is a 1200 baud HALF DUPLEX bell 202 compatible internal modem card for the IBM/PC. This unit operates full duplex at 300 baud.

The UltraLink adds a voice/data demodulation to your PC. Manufacturers original suggested price on this modem is \$795. California Digital's price is only \$99.

**\$99**

## MODEMS

Eclipse 1200 100% Hayes, with status lamps.  
Eclipse 1200B internal with software  
Hayes Smartmodem 2400 baud modem  
Fujitsu 2400/1200 baud auto everything.  
Team 1200 Hayes Compatible, 300/1200 baud.  
UltraLink 1200 data and voice on same line.  
CTS 212AH 1200 baud, auto dial  
Terminal software for CTS 212AH  
Prometheus 1200 super features  
Prometheus 1200B Internal PC  
Signalman Mark VI, 300 baud Internal PC  
Hayes Smart Modem 1200 baud, auto dial  
Hayes 1200B for use with the IBM/PC, 1200 baud.  
Hayes Smartmodem, 300 baud only, auto dial  
Hayes Chronograph, time & date

ECP-1200 179.00  
ECP-1200B 179.00  
HYS-2400 599.00  
FUJ-1935D 459.00  
TEM-SM1200 189.00  
UTL-1200A 99.00  
CTS-212AH 219.00  
CTS-212SFT 35.00  
PRM-P1200 289.00  
PRM-P1200B 279.00  
SGL-MK6 49.00  
HYS-212AD 359.00  
HYS-1200B 299.00  
HYS-103AD 199.00  
HYS-CHR232 199.00

## Seagate \$359

20 MEGABYTE WINCHESTER HARD DISK DRIVE

Quantity Two



Five inch Winchester Disk Drives

each two+

SEAGATE 225 20 Meg. 1/2 Ht. 389 359  
SEAGATE 4026 26 M. 35mS. 859 829  
SEAGATE 4051 51 M. 35mS. 1095 1059  
FUJITSU 2242 55 M. 35mS. 1799 1729  
FUJITSU 2243 86 M. 35mS. 2295 2219  
RODIME RO-202E 27 Meg. 759 729  
RODIME RO-203E 40 Meg. 995 959  
RODIME RO-204E 53 Meg. 1259 1195  
CONTROL DATA 94155-86 M. 1829 1779  
MAXTOR XT1140 140 Meg. 3379 3295  
HONEYWELL 85M. 27 mS. 1795 1695  
TOSHIBA MK56 70 M. 30mS. 1789 1729  
TANDON 502 10 Meg. 419 379

● Winchester Controllers for IBM/PC ●  
FALCON FT-HDC half card 189  
XEBEC 1220 with floppy controller 269  
NATIONAL COMPUTER 5004 159  
DTC 5150BX 159  
OMTI 5510 half card 189  
ADAPTEC 2010A software install 189  
WESTERN DIGITAL WD/1002 189  
● SCSI/SASI Winchester Controllers ●  
XEBEC 1410A 5 1/4" foot print 239  
OMTI 20L 119

● Winchester Accessories ●  
Installation Kit with manual 10  
Winchester enclosure and supply 139  
Dual 20/34 cable set 25  
Switching power supply 49

TOLL FREE ORDER LINE  
**(800) 421-5041**

TECHNICAL & CALIFORNIA  
**(213) 217-0500**

# California Digital

17700 Figueroa Street • Carson, California 90248

## LETTER QUALITY F-10 DAISY WHEEL PRINTER

# \$429

Quantity Two

Single piece price \$499. But if you have already purchased an F-10 printer from California Digital, we will honor the \$429 price on the second printer.



The TEC F-10 Daisy Wheel printer is the perfect answer to a reasonably priced 40 character word processing printer. While this printer is "extremely" similar to C.Itoh's F-10/40 Starwriter printer. Legal counsel for the C.Itoh Company have advised us that we should refrain from referring to the TEC printer as a Starwriter. This 40 character per second printer auto installs with Wordstar and Perfect Writer. Features extensive built-in word processing functions that allow easy adaptability and reduced software complexity. Industry standard Centronics Interface provides instant compatibility with

all computers equipped with a parallel printer port. The TEC F-10 accepts paper up to 15 inches in width.

These printers were originally priced to sell at over \$1400. Through a special arrangement California Digital has purchased these units from a major computer manufacturer and is offering these printers at a fraction of their original cost.

Options available include sheetfeeder, tractor feed, buffered memory and an assortment of printer cables for a variety of computers.

## 5 1/4" DISK DRIVE SALE \$89

Quantity Two

Your Choice 48 or 96 TPI drive.  
QUME MODEL 142 • 48 TPI  
MITSUBISHI 4853 • 96 TPI



	One	Two	Ten
TEAC FD55BV half height	119	109	99
TEAC FD55FV 96 TPI, half ht.	119	109	105
TEAC FD55GF for IBM AT	189	179	175
SHUGART SA455 Half Height	119	109	105
SHUGART SA465 1/2 Ht. 96TPI	125	119	109
TANDON 100-2 full height	129	125	119
MITSUBISHI 4851 half height	119	109	105
MITSUBISHI 4853 96/TPI 1/2 Ht.	99	89	89
MITSUBISHI 4854 8" elec.	295	285	275
QUME 142 half height	99	89	89
Switching power supply			49
Installation Kit with manual			10
Dual enclosure for 5 1/4" drives			59
34 pin edge connectors			5
Scotch head cleaning kit			19
Flip & File Storage tubs			15

# \$595



These Teletype Model 40 printers are continuous heavy duty communication equipment that have recently come off lease from a Cado Computer customer. It is seldom that California Digital becomes involved in the marketing of reconitioned equipment but we felt that this printer represented such an exceptional value that we had to offer this equipment to our customers.

The full character chain printer is capable of printing text in excess of 300 lines per minute. This printer, long used in high speed mini-computer applications, will provide the small business user with good quality multi-part printouts at speeds that can not be attained by dot matrix printers.

This unit also has a four channel vertical forms feed controller that allows for quick change of various form lengths. The Teletype Model 40 printer has a proprietary serial Teletype SSI interface and DIP switches are provided for setting baud rates to 9600. An optional RS-232 serial interface is available please phone for details.

## MEMORY

4164 DYNAMIC MEMORY 150ns

# \$ .99

Quantity 100

DYNAMIC MEMORY	1-100	100+	1000+
4164 150ns 128 refresh ICM-4164150	1.39	1.19	.99
41256 150ns 256K ICM-41256150	4.59	3.95	3.29

## PLOTTER

# \$219

The Comrex Comscribe I is the ideal solution to make short work of translating financial and numeric data into a graphic presentation. Many ready to run programs such as Lotus 1-2-3, Visi-on and Apple business graphics already support this plotter.

The Comscribe I features programmable paper sizes up to 8 1/2 by 120 inches, 6 inch per second plot speed and 0.004" step size. Easy to implement Centronics interface allows the Comscribe I immediate use with the printer port of most personal computers.

The Comscribe I is manufactured for Comrex by the Enter Corporation. The plotter is marketed by Heath Kit and also sold under Enters own "Sweet P" Label. This is your opportunity to purchase a plotter which was originally priced at \$795 for only \$219.

Also available is a support package which includes demonstration software, interface cable, a multiplier pen assortment and a variety of paper and transparency material.

## Quick-Link 300

# \$59

The Quick-Link 300 gives you an instant link to any dial up data base. Such as Dow Jones, Western Union or the Source. The Quick-Link has four user programmable log-on keys, allowing the operator, with only one key stroke, to dial the data base, log-in and give the password. All this information is permanently stored in non-volatile RAM. Features include video output to television or monitor, auto dial, auto-log, full sized keyboard, 300 baud modem and 1200 baud auxiliary printer port. All this is available for only \$59.

## NEC RGB COLOR MONITOR

# \$219

The NEC JC-1401D is a 13" medium-high resolution RGB monitor suitable for use with the Sanyo MBC-550/555 or the IBM PC. The monitor features a resolution of 400 dots by 240 lines. Colors available are Red, Green, Blue, Yellow, Cyan, Magenta, Black and White. The NEC monitor carries the Lifton-Monroe label and was originally scheduled for use in their "Office of the Future" equipment. A change in Monroe's marketing strategy has made these units excess inventory which were sold to California Digital. We are offering these "new" RGB monitors at a fraction of their original cost. Sanyo compatible NEC-1401/S; IBM/PC Computer compatible NEC-1401/PC.

## QUME \$149

Eight Inch Single Sided Drives	159	149	call
QUME 841 single side	159	149	call
SHUGART 801R	359	359	354
SIEMENS FDD 100-8	119	115	109

Eight Inch Double Sided Drives	189	179	call
QUME 842 "QUME TRACK 8"	189	179	call
SHUGART SA851R	495	485	475
OLIVETTI double sided	189	179	159
REMEX RFD-4000	179	169	159
MITSUBISHI M2896-63 1/2 Ht.	459	449	409
Dual 8" enclosure with power and fan			259
Switching power supply			89
Installation kit with manual			10

## PRINTERS

MATRIX PRINTERS	
Star Gemini-SG10 120 char/sec.	STR-SG10 239.00
Star Gemini-SG15 100 char./sec. 15" paper.	STR-SG15 309.00
Star Gemini Delta 10, 150 Char./sec.	STR-D10 359.00
Citizen MSP10FT 160 char./sec.	CIT-MSP10 289.00
Toshiba P1351, 192 char./sec. letter quality	TOS-T351 1495.00
Okidata 182A serial & parallel 9W" paper	OKI-182A 257.00
Okidata 192A parallel interface, 160 char/sec.	OKI-192A 345.00
Okidata 84P parallel 15" paper	OKI-84P 789.00
Epson LX-80 10" 120 Char./sec.	EPS-LX80 239.00
Epson FX-80FT, 10" 160 char./sec. with graphics	EPS-FX80 369.00
Epson RX100 15" with Graphics	EPS-RX100 389.00
Epson FX100FT 15" 160 char./sec with graphics	EPS-FX100 499.00
Epson LQ1500, 15" correspondence quality	EPS-LQ1500 895.00
Epson JX80 Color printer	EPS-JX80 519.00
Prowriter 8510 parallel 8W" paper	PRO-8510P 329.00
Dataproducts B-600-3, band printer 600 LPM	DPO-B600 6995.00
Printronix P300 high speed printer 300 lines per minute	PTX-P300 3995.00
Printronix P600 ultra high speed 600 lines per minute	PTX-P600 5795.00

WORD PROCESSING PRINTERS	
Starwriter F10 parallel, 40 char./sec.	PRO-F10P 499.00
NEC8810 55 char/second, serial interface	NEC-8810 1659.00
NEC8830 55 char/second, parallel interface	NEC-8830 1659.00
NEC3550 popular printer designed for the IBM/PC	NEC-3550 1599.00
NEC2050 designed for IBM/PC 20 char./sec. par.	NEC-2050 629.00
Silver Reed EXP500, 14 char./sec. par. interface	SRD-EXP500 319.00
Silver Reed EXP550 17 Char./sec par. interface	SRD-EXP550 429.00
Diablo 630 40 char./sec. serial	DBL-630 1569.00
Diablo 620 proportional spacing, horiz & vert. tab. 20 cps	DBL-620 769.00
Juki 8100, 18 char./sec.	JUK-8100 399.00
Juki 6300, 40 char./sec.	JUK-6300 699.00
Coronet CR2, 5k buffer, proportional spacing, par.	CRK-CR2P 359.00

Shipping: First five pounds \$3.00, each additional pound \$.50.  
Foreign orders: 10% shipping, excess will be refunded.  
California residents add 6 1/2% sales tax. • COD's discouraged.  
Open accounts extended to state supported educational institutions and companies with a strong "Dun & Bradstreet" rating.



# MANNESMAN-TALLY PIXY 3

# 3-PEN PLOTTER

**\$198** LIST PRICE \$799  
YOU SAVE OVER \$600!!!

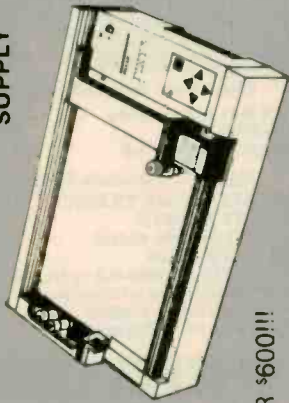

- We're probably making a mistake selling this high speed plotter for only \$198. They are easily worth at least \$500 more. Compare the features to plotters costing \$2000 or more.
- High Speed 8 IPS Plotting
- 3 Pen Auto Select
- 8 Colors Available
- Serial Interface
- Full Graphics + Built-in Fonts
- 8 1/2 x 11 Paper or Transparencies

	LIST	SALE
8 Extra Water Base Pens	\$30	\$1695
4 Extra Oil Base Pens	\$30	\$1695
100 Sheets 8 1/2 x 11 Paper	\$9	\$495
50 Sheets 8 1/2 x 11 Transparencies	\$9	\$495
Plotter Software for IBM PC	\$195	\$5995

# 20 MEGABYTE HARD-CARD

- Uses only one slot
- 21.3 MB formatted capacity
- Low power—only 11 watts
- Installs in just minutes
- Works with standard power supply

# 1200 BAUD MODEM \$16895

Guaranteed Hayes compatible!

JADE	LIST	JADE
JADE 1200 Baud External	\$799	\$10895
JADE 1200 Baud PC Card	\$299	\$15995
JADE 2400 Baud External	\$699	\$49995
JADE 2400 Baud PC Card	\$595	\$39995

# 10 MEGABYTE HARD DISK SYSTEM FOR YOUR IBM PC



**\$39995**

Complete with controller card, data cable, and mounting hardware, totally PC/XT compatible. For external model (cabinet & power supply)—add \$199.

JADE	LIST	JADE
10 MB Internal Kit	\$990	\$399.95
20 MB Internal 1/2 High	\$1550	\$489.95
20 MB for AT, 60-80 ms	\$999	\$399.95
20 MB Hi-Speed for AT	\$1250	\$749.95
30 MB Hi-Speed for AT	\$1550	\$829.95
10 MB Tape Back-up	\$699	\$399.95

# STARWRITER™ F-10

Why pay \$1149 for a C. Itoh when our 40 cps letter quality daisywheel from the same manufacturer is only as low as

**\$39995**

Limited Quantity

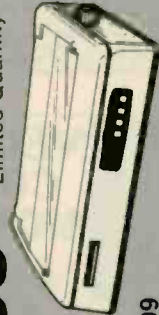

- EACH—\$499
- 2 to 5—\$429
- 5 or MORE—\$399

Bi-directional deluxe tractor \$249 \$14995  
Automatic cut sheet feeder \$449 \$19995

\*StarWriter is a Trademark of C. Itoh Digital Products, Inc.



# High Speed APU Chips

8087-3	\$149.95
8087-2	\$199.95
80287	\$249.95

# INTEL ABOVE BOARDS

64K PC expands to 2MB	\$29995
2MB PC Above Board	\$59995
128K AT expands to 4MB	\$49995
4 MB AT Above Board	\$129995

# 64K RAM Chip Upgrade Kits \$1485

High speed RAM upgrade kit with FREE parity (error detection) and one year warranty. We ship thousands of these kits to satisfied customers every week.

JADE	LIST	JADE
128K RAM Chip Kit for AT	\$359	\$99.95
256K RAM Chip Kit	\$99	\$49.95

# 360K Disk Drive

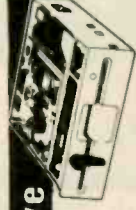

**\$6995** IBM PC, XT or compatible

JADE	LIST	JADE
TANDON 100-2, DS, DD	\$299	\$119.95
TEAC 55B, DS, DD	\$249	\$119.95

# New HAYES 2400B Internal

JADE	LIST	JADE
New 2400B Card w/Smartcom	\$799	\$579.95
HAYES Smartmodem 2400	\$899	\$629.95
HAYES Smartmodem 1200	\$699	\$389.95
HAYES 1200B w/o Smartcom II	\$539	\$339.95
HAYES 1200B for IBM PC	\$599	\$359.95

# PROMETHEUS Promodems

ProModem 1200B for IBM PC	\$399	\$289.95
ProModem 1200 RS-232	\$495	\$349.95
Alpha/num Display Option	\$99	\$79.85
New Options Processor	\$149	\$109.95
64K Mem Expansion for above	\$99	\$19.95

# STAR GEMINI 10-X \$17995

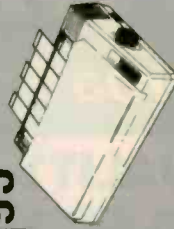

120 cps, friction & adjustable tractor feed w/graphics. Limited Quantity

**GEMINI 15X \$28995**  
15" wide carriage

# TALLTREE JRAM-2/JRAM-3

OK JRAM-2	\$17995
1 MB JRAM-2	\$39995
2 MB JRAM-2	\$59995
OK JRAM-3	\$29995
1 MB JRAM-3	\$49995
2 MB JRAM-3	\$62995



## Multifunction Card For Your IBM PC \$12995

Up to 384K, parallel printer port, RS-232 serial port, game port, clock/calendar, RAM disk, printer buffer software package.

	LIST	JADE
0K JADE 7 Pak Plus	\$299	\$129.95
384K JADE 7 Pak Plus	\$649	\$199.95

## IBM Video Boards

	LIST	JADE
Hercules Color Graphics	\$245	\$109.95
JADE Color Graphics	\$199	\$99.95
Hercules Monochrome Graphics	\$499	\$339.95
JADE Monochrome Graphics	\$299	\$129.95
JADE Color w/Par & Serial	\$299	\$199.95
Techar Graphics Master	\$699	\$499.95
Everex Edge	\$399	\$299.95
Paradise Graphics Card	\$395	\$319.95

## Printers

**EPSON FX-85**  
**EPSON FX-286**  
**EPSON LQ-800**  
**EPSON LQ-1000**  
**EPSON LX-80**

**OKIDATA**  
**TOSHIBA**  
**CITIZEN**  
**G. ITOH**  
**DIABLO**

**PRICED TOO LOW TO PUBLISH!**  
Call us for our best price.

## ISO-BAR

These industrial quality ISO-BAR's contain surge suppression circuitry and built-in noise filters plus a 15 amp circuit breaker.

	LIST	JADE
6 Socket, 1 Filter ISO-BAR	\$69	\$44.95
4 Socket, 2 Filter ISO-BAR	\$89	\$59.95
8 Socket, 4 Filter ISO-BAR	\$99	\$69.95

## Back-Up Power Supply

Emergency back-up power to save your computer system. A must for every computer system.

	LIST	JADE
200 Watt UPS	\$359	\$269.95
425 Watt UPS	\$539	\$449.95

## 135/150 WATT

Drop-in replacement

## POWER SUPPLY

135 Watt	\$199	\$89.95
150 Watt	\$249	\$99.95

## MICROFAZER Buffers

Expandable to 64K (Parallel model to 512K)

8K Parallel in/Parallel out	\$169	\$139.95
64K Parallel in/Parallel out	\$225	\$164.95
128K Parallel in/Parallel out	\$445	\$269.95
512K Parallel in/Parallel out	\$879	\$499.95

Your choice: serial in/serial out; parallel in/serial out; serial in/parallel out.

8K	\$199	\$169.95
64K	\$260	\$199.95

## FREE Software With MOUSE

	LIST	JADE
Microsoft Mouse w/Paintbrush	\$199	\$139.95
PC Mouse w/PC Paint Plus	\$195	\$138.95

## AST Boards On Sale!

	LIST	JADE
AST Six Pak Plus 64K	\$395	\$249.95
AST Six Pak Plus 384K	\$945	\$299.95
AST Rampage 256K	\$495	\$379.95
AST Rampage 2 MB	\$1995	\$679.95
AST Advantage-AT 128K	\$595	\$399.95
AST Advantage-AT 3 MB	\$4145	\$1999.95

# JADE XPC IBM PC



- 640K of RAM
- 135 watt power supply
- 8 expansion slots
- Deluxe keyboard
- 90 day warranty

- 256K of RAM
- 63 watt power supply
- 5 expansion slots
- IBM keyboard
- 90 day warranty

256K of RAM; Two 360K disk drives, & disk controller

**\$995**

### OPTION #3

640 K of RAM  
20 MB hard disk  
One 360K drive  
135 Watt power supply  
Mono graphics card  
Parallel printer port  
PGS MAX-12E monitor

### OPTION #1

256K PC/640K XPC  
Two 360K drives  
Mono graphics card  
Amdek 310A

IBM PC — \$1995  
JADE XPC \$1295

IBM PC — \$2395  
JADE XPC \$1395

### OPTION #2

256K PC/640K XPC  
Two 360K disk drives  
Monochrome card  
Amdek 310A monitor

## IBM PC-XT W/ 20 MB HARD DISK

- 256K RAM
- 20 MB hard disk
- Mono graphics card
- Parallel printer port
- Amdek 310A

**\$2895**

## IBM PC-AT

- 512K RAM
- 20 MB 60 ms hard disk
- 1.2 MB disk drive
- Parallel printer port
- Serial RS-232C port
- Color graphics card
- PGS HX-12 monitor

**\$4795**

# JADE COMPUTER

4901 W. Rosecrans Ave. Box 5046  
Hawthorne, CA 90251-5046

We accept cash, checks, credit cards or purchase orders from qualified firms and institutions. Minimum prepaid order \$15.00. California residents add 6 1/2% tax. Prices & availability subject to change without notice. Shipping & handling charges via UPS Ground 50¢/lb. UPS Air \$1.00/lb. Minimum charge \$3.00.



Continental U.S.A.  
**PLACE  
ORDERS  
TOLL  
FREE!**  
Inside California  
(800)262-1710  
Los Angeles Area  
(213)973-7707

## FREE CATALOG



Outstanding prices on computer accessories for your computer and workstation. Our catalog features a wide selection of quality products to meet all your accessory needs. Call or write today to receive your free catalog.

**LINTEK COMPUTER ACCESSORIES**  
POB 8056, Grand Rapids, MI 49518  
(616) 241-4040

## PC EXPANSIONS

AST SixpackPlus (384K)	\$279
Advantage (128K)	\$369
Advantage (1.5M)	\$499
Advantage (3M)	\$799
Rampage (2M)	\$499
RampageAT (2M)	\$639
INTEL AboveAT (2M)	\$649
Quadboard (384K)	\$249
Gold Quadboard (384K)	\$429
LibertyAT (2M)	\$call
QuadportAT	\$135
Tecmar Maestro (2.5M)	\$609
HERCULES graphics board	\$299
Color Card	\$159
HAYES Smartmodem 1200B	\$349
Smartmodem 1200	\$389
Maynard Disk Controller	\$call
Sandstar Series	\$100
MaynStream Tape backup from	\$979
WDFile Card (10M)	\$769
Tandon Diskard (20M)	\$789
Set of 9 chips (64K)	\$12
Set of 9 chips (256K)	\$27
8087-3	\$119
Qume 142A S99 Teac	\$109
Teac FD55BV (for AT)	\$109
CDC 9409	\$119
Tandon	\$109
Verbatim (Box of 10)	\$19
Maxell (Box of 10 for AT)	\$39

**VLM Computer Electronics**  
10 Park Place • Morristown, NJ 07960  
(201) 267-3268 Visa, MC, Check or COD

## 9-Track Tape Subsystem

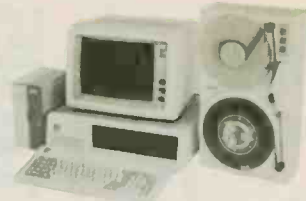

Now you can exchange data files between your IBM PC/XT/AT and any mainframe or minicomputer using IBM compatible 1600 BPI 9-Track tape. Unit can also be used for disk backup and archival storage. Transfer rate is one megabyte per minute on PCs and 100% compatibles. Subsystems include 7" or 10 1/2" streaming tape drive, tape coupler card and DOS compatible software. Prices start at \$3,555.

**QUALSTAR**

9015 Eton Ave., Canoga Park, CA 91304  
Telephone: (818) 882-5822

Inquiry 202

Inquiry 409

## STATE-OF-THE-ART MAGNETIC MEDIA

### 5 1/4" DISKETTES



- With Hub Rings
- Write Protect Tabs
- Envelopes
- User ID Labels
- In Factory Sealed Poly Packs of 10

(YOU GET EVERYTHING BUT THE BOX)  
Prices are per Disk

QTY	50	100	500	1000
SSDD	.59	.56	.52	.49
DSDD	.64	.61	.57	.54

Library Case Holds 15 Diskettes..... Only \$1.00 + plus 50¢ S&H

The 100 File..... Only \$10.95 plus \$2.00 S&H  
100% ERROR FREE — LIFETIME WARRANTY  
Min. order \$25.00 Add 10% for less than 50 diskettes. Shipping and Handling: \$4.00 per 100 diskettes. Reduced shipping for larger quantities. C.O.D. add \$4.00. Cash or certified check.

Continental USA COD

**Precision Data Products**  
P.O. Box 8367, Grand Rapids, MI 49518  
(616) 452-3457 • Michigan 1-800-432-2468  
Outside Michigan 1-800-258-0028

## Computer Parts Mart

634 North 8th St. San Jose, CA 95112  
(408) 993-9011

### STEPPER ENSEMBLE

100 Step High Precision Motor

By Applied Motion. Stepper driver with bipolar windings, 26 ohms-15mh 1/4" x 2 1" ground shaft with helical follower groove (α 0.182" pitch. This is an extremely high accuracy assembly good to better than 50 microns absolute. Ball bearings. 5.5gm/cm inertia. 10 oz in holding torque @ 400 ma New, never used. Driver I.C.s: 3717 for P.W.M. Micro-stepping allow efficient use of any supply voltage up to 40V D.C. Motor and Two I.C.s including data sheets



\$14.95

### STD-BUS

64K RAM Card expandable to 256K	\$ 99
256K Card	\$249
Votrax Card	\$149
SASI Interface Card	\$100
4-SIO Card	\$165
4-PIO Card	\$129
2-SIO & 2-PIO Card	\$125
Z80 CPU Card	\$ 79
6800 Proc. Card	\$300

Complete STD Systems available—Up to 10 slots, 10 MB Disk, etc.

Inquiry 87

## 2 Mb EMS RAM / CLOCK FOR IBM PC/XT & COMPATIBLES WITH LIFETIME WARRANTY

### FEATURES —

- Supports Lotus/Intell/Microsoft Expanded Memory Specifications (EMS)
- Uses either 64K or 256K DRAM chips
- User upgradeable
- Can fill system memory to 640K allowing remaining memory to be used for EMS
- Includes Clock/Calendar function
- EMS memory manager software included
- EMS compatible RAM Disk software included
- EMS compatible Print Spooler software included

\$199.00 W/64K OF RAM

The Apparat 2 Mb Expanded Memory Clock Board allows you the option of filling your system memory to the maximum 640K and/or using up to 2 Mb RAM for expanded memory. The expanded memory Manager Software, which is provided, is compatible with the Lotus/Intell/Microsoft Expanded Memory Specification. The clock/calendar function allows you to automatically initialize the date and time on each system power-up.

### ADDITIONAL PRODUCTS —

- CLOCK/CALENDAR CARD
- PROM BLASTER (24 or 28 pin)
- COMBO II CARD
- 256K RAM CARD
- 512K RAM CARD
- EXTERNAL HARD DISK
- INTERNAL HARD DISK
- XT HARD DISK UPGRADE
- SHORT SLOT PARSER CARD FOR PPC AT
- 386K RAM CARD FOR PPC
- ADD-ON DISK DRIVES
- AT RAM CARD
- AT COMBO CARD
- CABLES

**Apparat, Inc.**

4401 South Tamarac Parkway — Denver, Colorado 80237  
(303) 741-1778 — TOLL FREE 800/525-7674

Inquiry 22

## NEW --- ZIPCALC FOR TURBO PASCAL™

**INSTANT TEXT DISPLAY** - the Pascal "write" procedure takes several seconds to fill the screen with text. ZIPCALC does it in less than 1/10 sec. Instant windowing capability is also included.

**ULTRA FAST NUMBER DISPLAY** - ZIPCALC removes the real number time barrier with a 32-bit Long Integer data type that converts to a string 7 times faster.

**HIGH SPEED COMPUTATION** - the Long Integer is ideal for many financial and other applications with its dramatic increase in computation speed. ZIPCALC provides a full set of procedures for Long Integer arithmetic, shifts, compares, conversions to other data types, and full string conversions. ZIPCALC has the power of a 32-bit processor in Pascal callable form.

**EASY TO LEARN - EASY TO USE** - ZIPCALC consists of 35 highly optimized routines, most assembler coded, a tutorial User's Guide, programmed demos, and many examples.

**IBM PC & TRUE COMPATIBLES**  
\$45 includes N.Y. sales tax & shipping

**DYNAMUS** 1045-B Gravel Road  
MICRO DATA SYSTEMS, INC. Webster, N.Y. 14580  
(716) 671-5866  
Turbo Pascal is a trademark of Borland Int. Inc.

Inquiry 120

## VIDEODISC AUTHORIZING UTILITIES

Educators agree, interactive videodisc is one of the best teaching tools available. Now you can develop high-powered videodisc programs by using our Authoring Utilities with Turbo Pascal.

- A library of specialized videodisc commands makes it easy to write your programs.
- Drivers are included for most popular videodisc players.
- The system can be easily upgraded to include such devices as touch screens, graphic overlays, light-pens, mice, etc.
- Lots of sample programs to get you started
- No royalties or license fees. Works with IBM-PC's or compatibles.

\$99 plus \$5 ship & hand.

Order from: **DATAMED**  
5202 VALMAR  
CONCORD, CA 94521  
(415) 798-6736

Inquiry 108

## ICs PROMPT DELIVERY!!! SAME DAY SHIPPING (USUALLY)

OUTSIDE OKLAHOMA: NO SALES TAX

DYNAMIC RAM			
256K	64Kx4	150 ns	\$4.75
256K	256Kx1	100 ns	5.95
256K	256Kx1	120 ns	3.45
256K	256Kx1	150 ns	2.87
128K	128Kx1	150 ns	4.92
64K	64Kx1	150 ns	1.52
EPROM			
27512	64Kx8	250 ns	\$32.00
27C256	32Kx8	250 ns	7.72
27256	32Kx8	250 ns	4.98
27128	16Kx8	250 ns	3.30
27C64	8Kx8	250 ns	5.30
2764	8Kx8	250 ns	3.10
2732	4Kx8	450 ns	3.85
STATIC RAM			
6264LP-15	8Kx8	150 ns	\$3.25

QUANTITY ONE PRICES SHOWN

OPEN 6 1/2 DAYS: WE CAN SHIP VIA FED-EX ON SAT.

NO EXTRA COST FOR FED-EX SAT DELIVERY ON ORDERS RECEIVED BY 7:00 PM (EST) MON-FRI. (716) 671-5866  
MasterCard VISA or UPS CASH COD  
**Factory New, Prime Parts** MICROPROCESSOR UNLIMITED, INC.  
24,000 S. Peoria Ave. BEGGS, OK 74421 (918) 267-4961  
Prices shown above are for March 24, 1986  
Please call for current prices. Prices subject to change. Please expect higher or lower prices on some parts due to supply & demand and our changing costs. Shipping & insurance extra. Cash discount prices shown. Orders received by 5 PM (EST) can usually be delivered to you by the next morning, via Federal Express Standard Air is \$6.00 or Priority One is \$13.00

Inquiry 239

**LOOK what's Inside!**

**5 Complete Systems**

**XAT TURBO**



The **XAT** is our most versatile and powerful system. Using Intel's 80286 processor, the system runs at 6 and 8 MHz with a true 16-bit data bus. Comes standard with a 3 meg. Adc-On board, 2 parallel & one serial port, monitor, keyboard, DOS 3.1, two 1/2 height DS DD 1.2 meg floppies.

**XPC TURBO**



This standard system is as compatible with IBM as it can be. Featuring a 4-layer motherboard 8-slot expansion, up to 640K memory on the motherboard, and the 8.67 MHz **TURBO** mode. Also included: DOS 3.1 keyboard, 135 watt power supply, TTL 720 x 348 resolution video card, green or amber monitor, serial & parallel ports, Real Time Clock and software.

**XTC TURBO**



The perfect choice for the system integrator who needs the IBM compatibility, but not in the standard PC cabinet. This model features hinges and removable sides, up to 3 1/2 height peripherals out front, front mount AC switch, and rear mount 135 watt power supply. Also makes an ideal "Host" or "File Server" unit in multi-user configurations!

**XT Jr.**



The **XT Jr.** is only junior in size! With up to 640K memory on the motherboard and four expansion slots, this stand-alone system is also great for workstations in a networking environment. It can be upgraded to the **TURBO** two speed motherboard and you can also add up to 2 serial & 2 parallel ports or any IBM compatible expansion card. A perfect word processing/data entry system.

**XPC Compact**



This is truly the affordable portable and we'll build it to your specifications. Need a 20 meg hard disk and 20 meg tape with 640K memory in your portable? No problem! The **XPC Compact** comes standard with a 9" amber TTL monitor, 135 watt P.S., 256K memory, two 360K drives, Real Time Clock, Calendar w. battery, Back-up, serial and parallel ports, and our **TURBO** Motherboard.

Amsterdam ■ 020-45-26-50

**24 Add-On Cards**

Germany ■

**2 Meg Above Board**



This board satisfies the new "Above Board" approach suggested by INTEL and Lotus 1-2-3. Also may be used on our **XT-SBC TURBO** board for memory based I/O.

**Hard Disk Controller**



This Western Digital controller handles 1 or 2 drives, 5 to 40 megabytes with minimum software configuration. Features DOS 2.1 & 3.1 compatibility, and ST-506 Interface.

**384K Multi-Function**



A Multi-function board featuring Parallel Port, Serial Port, Game Port, Real Time Clock, Calendar with Battery Back-up. Expand to 384K, all Cables, PrintSpooler and RAM Disk Software and Manuals.

**4 Meg Token Ring**



Connect your workstation to an existing 4 Megabyte IBM token ring system or build up your own IEEE 802.5 standard system. The lowest possible cost for 100% industry standard compatibility.

**AT H.D. & Floppy**



This new Western Digital combo board with its hi-speed VLSI technology will give you a data transfer rate 50% faster than the existing combo board in the AT. Runs both 360K and 1.2 meg floppy disk drives.

**Mono & Color Graphics**

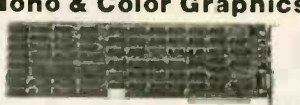

Supports two levels of graphics and text in composite monochrome or RGB color. Low resolution 320 x 200 pixel, high resolution 640 x 200 pixel.

**7 PAK Multi-Function**



Features Floppy Controller, Parallel Port, Serial Port (optional 2nd Serial), Game Port, Real Time Clock, Calendar with Battery Back-up, RAM Disk, PrintSpooler, all cables & manuals.

**PROM Laser**



Hi-speed algorithms will burn 2716, 2732, 2732A, 2764 (in 52 sec), 27128, 27256 EPROMS under software control right in your PC. Zero Force Insertion Sockets. Software, and Manual.

England ■

**35 Components**

Bombay ■ 357172

**Motherboards**  
**XAT TURBO XT-SBC**



- RTC Calendar
- 6 & 8 MHz clock
- 8 slot expansion
- intel 80286
- 4 7.7 & 8 MHz clock
- Serial 3 Parallel
- 4-layer PCB design
- RTC Calendar

**Power Supplies**  
**XT 135 watt XT 150 watt**



- 135w switching
- Whisper Fan
- Side AC switch
- +5V-15A -5V-5A
- +12V-4.2A -12V-5A
- +12V-5.5A -12V-5A
- Whisper fan
- Hi-Output 150 watt
- 4 DC connectors
- +5V-15A -5V-5A
- +12V-4.2A -12V-5A
- +12V-5.5A -12V-5A

**Cabinets**



The **XT Jr.** cabinet is only 3" x 16.5" x 15" yet it will hold a standard XT compatible motherboard. Includes a switching power supply. Front panel cut-out for a half-height floppy or hard disk.

Our **XPC-XT** cabinet has an 8-slot back panel with additional cut-outs for two RS-232C ports. Features mounting for up to four half height peripherals.

**Keyboards**



**AT**  
 This Keyboard is standard equipment with all of our **XAT** systems, but the layout is so well fixed, we're offering it here.

**XT**  
 Our volume purchases of these IBM style units allows us to lower the price once again.

**Drives**



**Archive**  
**Irwin**  
**Maxtor**  
**Memtek**  
**Miniscribe**  
**Panasonic**  
**Seagate**  
**TEAC**  
**Tulin**

**XPC TURBO XPC-XT**



- 4 7.7 & 6.67 MHz
- 4 layer PCB design
- 8-slot expansion
- up to 640K Memory
- 8088-2 processor
- Standard 4 7.7 MHz
- up to 640K memory
- 8-slot expansion
- standard 8088 CPU
- 8087 socket avail

**AT 200 watt XTC 135**



- 200 Watt power
- Exterior AC switch
- 4 DC power conn
- +5V-20A -1V-5A
- +12V-7.7A -12V-5A
- Rear Mount
- Rear On Off switch
- extra AC outlets
- +5V-15A -5V-5A
- +12V-4A -12V-5A

**5051**



The right choice for an external add on cabinet! Add on a floppy, tape back-up, or up to 33 meg of hard disk (half-height). Switching power supply is included.

**5051**



Now a fully selective unit at an affordable price. Features a 10-key numeric pad & a separate cursor pad.

**3 Sub-Systems**

**3 Networks**

**Cassette Training**

**Int/Ext Modems**

**3 Sub-Systems**



This full height cabinet will hold a Tape Back-up with full or 1/2 height Hard Disk inside (or two Hard Disks).

A perfect cabinet for Tape or Hard Disk, a nice addition to your PC.

Choose from single 1/2 height, dual 1/2 height, or 1/2 height with full height base. All Sub-systems include controllers, cables, software, and manuals.

**3 Networks**



One way to stay ahead of the competition is by using a Multi-User or Network system configuration from **Micro Products International**. Choose Hi-speed RS-232C, **XOR-NET**, **SOLC** or Token Ring. Data transfer rates up to 4 megabytes/second can be obtained.

**Cassette Training**



What is the Cassette Training concept? Using interactive Audio Training to combine the advantage of classroom and self-teaching methods.

The Method - One audio track delivers a lecture explaining the program, while the second track emulates the keyboard actually running the student's computer. At frequent intervals the tape pauses automatically to allow the student keyboard input, which is monitored for accuracy by the **MITS COED**.

**Int/Ext Modems**



- FCC approved for direct RJ-11 connection
- Phone Cable & Power Supply
- Finally a price breakthrough on a Hayes compatible, external 300-1200 baud modem. Includes driver software.
- Runs the popular Hayes communications software
- Q-Modem software included
- Also runs XCOM software
- All cables included
- Runs the popular Hayes communications software
- We included every feature you would want in a modem card. It's FCC registered for direct connection to your modular phone jack with the cord included.

# PC - GUARD

TOTAL DATA SECURITY

- Protects your data from illegal users.
- Impossible to access the system with a DOS diskette.
- Up to 16 users with ID codes and passwords.
- Automatically locks the system after a none activity period of time.
- Automatic screen saver.
- Audible alarm if an illegal user tries to access the system.
- Is a total hardware protection system.
- Low cost protection system for a large number of PC's.
- Fully compatible with the IBM PC,XT,AT and compatibles.

For information and orders call (809) 767-0065  
VISA, MASTERCARD or COD cashier check.



APPLIED SOFTWARE KINETICS  
E1 centro 1, Local 1 Munoz Rivera #500  
Hato Rey, Puerto Rico 00918

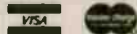

Inquiry 418



## PORTABLE ADDITIONS

PORTABLE DISK DRIVE \$229

3 1/2", batt. oper., TS-DOS, 100K storage

24K RAM CHIP for Tandy 200 \$89

8K RAM CHIP for Model-100 \$29

and NEC 8201... 3 for \$79, 6 for \$149

SIDESTAR for NEC Starlet \$399

128K Ram Disk Cartridge

SIDECAR for NEC PC-8201A \$259

4 banks of 32K in one cartridge

CALL TOLL FREE 1-800-732-5012

Call: 805-987-1742

Canada: 604-856-8858, Australia: 02-419-8899



VISA M/C & AMER. EXP.

420 Constitution Ave., Camarillo, CA 93010

Inquiry 297

# 68020



High Performance Implementation  
12.5 Mhz or 16.67 Mhz  
I/O Expansion Port  
68881 Co-Processor  
2 Meg RAM - 256K EPROM  
4 Serial Ports - 1 Parallel Port  
Battery Backed Up Clock  
720K Floppy Drive  
40 Meg Hard Disk - Unix-Like OS's  
68000 Version Also Available

Frank Hogg Laboratory - 770 James Street  
Syracuse New York 13203 - TELEX 646740

## 315/474-7856

Inquiry 144

# 6800 FAMILY

Micro  
Controller  
Cross  
Assemblers

**Fast** Efficient Program  
Development for:

6800.....\$50.00

6801,03.....\$75.00

6805.....\$65.00

68HC11.....\$85.00

- Comprehensive User Manual
  - One Year Support
- System Requirements: CP/M 2.0 (Z80)

Florida add 5% tax - Prices post paid USA



PRODUCTS FOR PRODUCT DEVELOPMENT

P.O. Box 28596  
Tamarac, FL 33320  
PH (305)973-9364

Inquiry 264

## BULK DISKETTES

# maxell.

## 5 1/4" SS/DD \$.64

OTHER NAME BRAND DISKETTES

## AS LOW AS \$.59

Prices Based on Quantities of 500  
Includes White Tyvek Sleeves

### 800-222-0490

201-462-7628 in N.J.

Visa, Master Charge, or C.O.D.

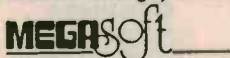

P.O. Box 710, Freehold, N.J. 07728

Inquiry 226



WEDGE-PC OEM PRODUCTS

PC-AT Compatible \$1695/one

512k RAM, 1.2M disk drive, hard disk & floppy disk controller, monochrome card, 200W power, keyboard, enclosure.

PC-XT compatible \$595/one

256k RAM, one 340 disk drive, monochrome card, keyboard, 130W power, enclosure.

AT Motherboard \$795.

Fully tested. One year warranty.

Mono monitor \$109. Dealer call for qty price.

WEDGE TECHNOLOGY INC.

1190 Mt. View-Alviso Rd., Suite R  
Sunnyvale, CA 94089 (408) 734-9866  
Telex 3719075 EDGE UB

Inquiry 381

## I.C.s and Disk Drives

□ 64K / 128K / 256K D-RAMs at LOW PRICES

□ H-P Vectra 128K Upgrade \$49.95

□ V20-5 \$14.00/V20-8 \$20.00/V30-8 \$18.00

□ 8087 \$115.00 / 8087-2 call

80287-3 (5-MHz) \$175.00

□ CENTER External modem w/Telephone

\*Intelligent 300/1200 Baud

\*Compatible w/most popular modem \$185.00

□ Memory Boards

ABM Multi-Function Board w/384K \$150.00

JRAM-2 Ramdisk w/2MB \$349.00

JRAM-3 Above Board w/2MB \$399.00

JRAM-AT Ramdisk w/2MB \$399.00

JRAM-AT-3 Above Board w/2MB \$449.00

□ 155W Power Supply for IBM/PC,XT \$120.00

□ TEAC FD-55BV DS/DD Disk Drive \$80.00

w/one year factory warranty

\* The Price is negotiable and subject to change.

WARRANTY: All I.C.s are guaranteed for 180 days from the invoice

date on defective items. We will replace them free of charge.

Advanced Technology Products, Corp.

(formerly ExcelTec Industries, Inc.)

P.O. Box 2205 Silver Spring, MD 20902

Phone: 301-933-3523

OEMs and DEALERS are invited

CALL US FOR THE LATEST PRICES

Inquiry 133

## TURBOLINK +

"TURBO Pascal hackers will like this program."

Jerry Pournelle  
Byte Magazine

- Add 512K of TURBO Pascal\* to your code
- Call up to 8 memory resident TURBO Pascal modules from programs written in:

—BASIC, BASICA, Compiled BASIC

—MS Pascal, C, MS FORTRAN

—Standard, 8087 and BCD TURBO Pascal

- Add TURBO Pascal's 8087, BCD and graphic capabilities to other languages
- Automatically generate TURBO Pascal compatible inline machine code
- Use all TURBO Pascal variants in a single program
- For IBM PC and compatible

\$6995

S&H included

Foreign orders  
add \$10.00

VISA/MC: 1-800-835-2246 x 123

KANSAS CALL: 1-800-362-2421 x123

Inquiries and Technical Information (303) 971-0729

PATHFINDER SOFTWARE, INC.

P.O. Box 43, Littleton, CO 80160

\*TURBO Pascal is a registered trademark of Borland International

Inquiry 270

Advertise your  
computer products  
through  
BYTE BITS  
(2" x 3" ads)

For more information  
call Dan Harper at  
603-924-6830

BYTE  
70 Main St.  
Peterborough, NH 03458

Inquiry 419

# THE LATEST IN PC ENHANCEMENT PRODUCTS

## ENHANCED GRAPHICS ADAPTOR \$295.00

100% IBM COMPATIBLE—PASSES IBM EGA DIAGNOSTICS

- COMPATIBLE WITH IBM EGA, COLOR GRAPHICS ADAPTOR AND MONOCHROME ADAPTOR
- DISPLAYS 16 COLORS OUT OF 64 COLORS
- COMES WITH 256K OF VIDEO RAM
- DUAL SCANNING FREQUENCIES—WORKS WITH STANDARD OR EGA TYPE RGB MONITORS
- LIGHT PEN INTERFACE

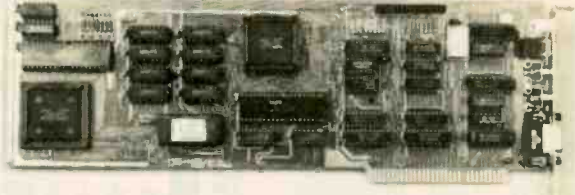

## EXTENDED MEMORY CARD \$199.95

UP TO 2 MEGABYTES OF LOTUS/INTEL COMPATIBLE MEMORY

- CONFORMS TO LOTUS/INTEL EXTENDED MEMORY SPECIFICATIONS (EMS)
- SHIPPED WITH ZERO K RAM, USER EXPANDABLE TO 2 MEGABYTES
- USES 64K OR 256K DYNAMIC RAMS
- USE AS EXTENDED (EMS) OR CONVENTIONAL MEMORY, RAMDISK OR SPOOLER
- SOFTWARE INCLUDES EMS DEVICE DRIVERS, PRINT SPOOLER AND RAMDISK



## AT MULTIFUNCTION CARD \$199.95

ADDS UP TO 3 MEGABYTES OF USER EXPANDABLE MEMORY

- SHIPPED WITH ZERO K P RAM, USER EXPANDABLE TO 1.5 MEGABYTES RAM ON BOARD, UP TO 3 MEGABYTES WITH OPTIONAL PIGGYBACK CARD
- USES 64K OR 256K DYNAMIC RAMS
- PARALLEL PORT & GAME PORT
- SERIAL PORT
- OPTIONAL SECOND SERIAL PORT

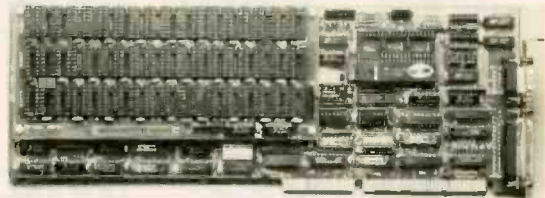

**PIGGYBACK MEMORY CARD (NO MEMORY INSTALLED) \$49.95**

## CLASSIC 286 SPEED PAK \$869.00

8 MHz 80286 ACCELERATOR BOARD FOR IBM PC/XT

- 8MHz 80286 RUNS 33% FASTER THAN A STANDARD AT
- RUNS AT PROGRAMS—COMPATIBLE WITH DOS 2.1, 3.0 & 3.1
- COMPATIBLE WITH ALL PC/XT HARDWARE & SOFTWARE WITH NO PATCHES OR MODIFICATIONS NEEDED
- 1 MEGABYTE MEMORY ON BOARD, EXPANDABLE TO 16MB
- HIGH SPEED 16-BIT BIOS AND RAM
- OPTIONS INCLUDE 80287 MATH CO-PROCESSOR, MULTITASKING SUPPORT AND MULTIUSER SUPPORT

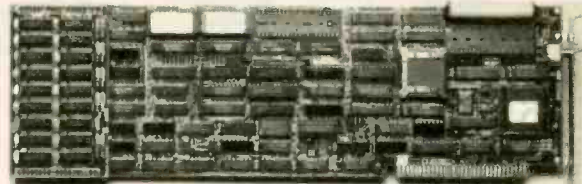

## EPROM PROGRAMMER \$129.95

FOR IBM PC/XT/AT AND COMPATIBLES

- PROGRAMS 27xxx SERIES EPROMS UP TO 27512
- MENU DRIVEN SOFTWARE PROVIDED ON DISKETTE
- AUTOMATICALLY SETS PROGRAMMING VOLTAGE
- LOADS AND SAVES EPROM BUFFER TO DISK
- READ, WRITE, COPY, VERIFY OR CHECK BLANK
- DEBUG STYLE EDITOR FOR EASY MODIFICATION OF PROGRAM
- SPLITS OR COMBINES EPROMS OF DIFFERING SIZES
- INTERNAL CARD WITH EXTERNAL ZIF SOCKET MODULE

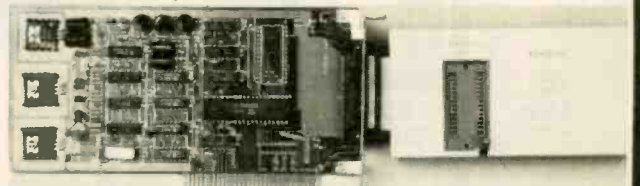

VISIT OUR RETAIL STORE LOCATED AT 1256 SOUTH BASCOM AVENUE IN SAN JOSE

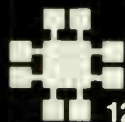

**JDR Microdevices**

1224 S. Bascom Avenue, San Jose, CA 95128

Toll Free 800-538-5000 • (408) 995-5430

FAX (408) 275-8415 • Telex 171-110

HOURS: M-W-F, 9-5 TU-TH, 9-9 SAT, 10-3

PLEASE USE OUR CUSTOMER NUMBER WHEN ORDERING

TERMS: Minimum order \$10.00. For shipping and handling include \$2.50 for UPS Ground and \$3.50 for JPS Air. Orders over 1 lb. and foreign orders may require additional shipping charges - please contact our sales department for the amount. CA residents must include applicable sales tax. All merchandise is warranted for 90 days unless otherwise stated. Prices are subject to change without notice. We are not responsible for typographical errors. We reserve the right to limit quantities and to substitute manufacturers. All merchandise subject to prior sale.

© COPYRIGHT 1986 JDR MICRODEVICES

THE JDR MICRODEVICES LOGO IS A REGISTERED TRADEMARK OF JDR MICRODEVICES. JDR INSTRUMENTS AND JDR MICRODEVICES ARE TRADEMARKS OF JDR MICRODEVICES. IBM IS A TRADEMARK OF INTERNATIONAL BUSINESS MACHINES. APPLE IS A TRADEMARK OF APPLE COMPUTER.

# BUILD A COMPLETE 256K XT SYSTEM—\$717

## STATIC RAMS

2101	256x4	(450ns)	1.95
5101	256x4	(450ns)(CMOS)	3.95
2102L-4	1024x1	(450ns)(LP)	.99
2112	256x4	(450ns)	2.99
2114	1024x4	(450ns)	.99
2114L-4	1024x4	(450ns)(LP)	1.09
2114L-2	1024x4	(200ns)(LP)	1.49
2114L-15	1024x4	(150ns)(LP)	1.95
TMS4044-4	4096x8	(150ns)	1.95
TMM2016-150	2048x8	(150ns)	1.49
TMM2016-100	2048x8	(100ns)	1.39
HM6116-4	2048x8	(200ns)(CMOS)	1.39
HM6116-3	2048x8	(150ns)(CMOS)	1.49
HM6116LP-4	2048x8	(200ns)(CMOS)(LP)	1.49
HM6116LP-3	2048x8	(150ns)(CMOS)(LP)	1.59
HM6116LP-2	2048x8	(120ns)(CMOS)(LP)	2.95
HM6264P-15	8192x8	(150ns)(CMOS)	3.89
HM6264LP-15	8192x8	(150ns)(CMOS)(LP)	3.95
HM6264LP-12	8192x8	(120ns)(CMOS)(LP)	4.49

LP=Low power

## DYNAMIC RAMS

4116-250	16384x1	(250ns)	.49
4116-200	16384x1	(200ns)	.69
4116-150	16384x1	(150ns)	.89
4116-120	16384x1	(120ns)	1.49
MK4332	32768x1	(200ns)	6.95
4164-200	65536x1	(200ns)(5v)	1.19
4164-150	65536x1	(150ns)(5v)	1.29
4164-120	65536x1	(120ns)(5v)	1.95
MCM6665	65536x1	(200ns)(5v)	1.95
TMS4164	65536x1	(150ns)(5v)	2.95
4164-REFRESH	65536x1	(150ns)(5v)(REFRESH)	2.95
TMS4416	16384x1	(150ns)(5v)	4.95
41128-150	131072x1	(150ns)(5v)	5.95
TMS4464-15	65536x4	(150ns)(5v)	6.95
41256-200	262144x1	(200ns)(5v)	2.95
41256-150	262144x1	(150ns)(5v)	2.95

5v=Single 5 Volt Supply

REFRESH=Pin 1 Refresh

## ★★★HIGH-TECH★★★

### NEC V20 UPD70108 \$14.95

REPLACES 8088 TO SPEED UP IBM PC 10-40%

- \* HIGH-SPEED ADDRESS CALCULATION IN HARDWARE
- \* PIN COMPATIBLE WITH 8088
- \* SUPERSET OF 8088 INSTRUCTION SET
- \* LOW POWER CMOS

8MHZ V20 UPD70108-8 \$24.95

8MHZ V30 UPD70116-8 \$26.95

## ★★★SPOTLIGHT★★★

## EPROMS

2708	1024x8	(450ns)	3.95
2716	2048x8	(450ns)(5V)	3.49
2716-1	2048x8	(350ns)(5V)	3.95
TMS2532	4096x8	(450ns)(5V)	3.95
2732	4096x8	(450ns)(5V)	3.89
2732A	4096x8	(250ns)(5V)(21V PGM)	3.95
2732A-2	4096x8	(200ns)(5V)(21V PGM)	4.25
27C54	8192x8	(450ns)(5V)(CMOS)	5.95
2764	8192x8	(250ns)(5V)	3.49
2764-250	8192x8	(250ns)(5V)	3.95
2764-200	8192x8	(200ns)(5V)	4.25
MCM68766	8192x8	(350ns)(5V)(24 PIN)	17.95
27128	16384x8	(250ns)(5V)	4.25
27C256	32768x8	(250ns)(5V)(CMOS)	12.95
27256	32768x8	(250ns)(5V)	7.49

5V=Single 5 Volt Supply

21V PGM=Program at 21 Volts

## SPECTRONICS CORPORATION EPROM ERASERS



Model	Timer	Capacity Chip	Intensity (uW/Cm²)	Unit Price
PE-14	NO	9	8,000	\$83.00
PE-14T	YES	9	8,000	\$119.00
PE-24T	YES	12	9,600	\$175.00

# ORDER TOLL FREE 800-538-5000



## 8000

8035	1.49
8039	1.95
8080	2.95
8085	2.49
8087-2	169.95
8087	129.00
8088	6.95
8088-2	9.95
8155	2.49
8155-2	3.95
8748	7.95
8755	19.95
80286	129.95
80287	199.95

## 6500

6502	2.79
6502Z (CMOS)	12.95
6507	9.95
6520	1.95
6522	4.95
6526	26.95
6532	6.95
6545	6.95
6551	5.95
6561	19.95
6581	34.95

## 2.0 MHZ

6502A	2.95
6520A	2.95
6522A	5.95
6532A	11.95
6551A	7.95
6551A	6.95

## 3.0 MHZ

6502B	6.95
-------	------

## 8200

8203	29.95
8205	3.29
8212	1.49
8216	1.49
8224	2.25
8237	4.95
8237-5	5.49
8250	6.95
8251	1.69
8251A	1.89
8253	1.89
8253-5	1.95
8255	1.69
8255-5	1.89
8259	1.95
8259-5	2.29
8272	4.95
8279	2.49
8279-5	2.95
8282	3.95
8284	2.95
8286	3.95
8288	4.95

## Z-80

Z80-CPU 2.5 MHz	1.69
-----------------	------

## 4.0 MHZ

Z80A-CPU	1.79
Z80A-CTC	1.89
Z80A-OART	5.95
Z80A-OMA	5.95
Z80A-PIO	1.89
Z80A-SIO/0	5.95
Z80A-SIO/1	5.95
Z80A-SIO/2	5.95

## 6.0 MHZ

Z80B-CPU	3.75
Z80B-CTC	4.25
Z80B-PIO	4.25
Z80B-OART	14.95
Z80B-SIO/0	12.95
Z80B-SIO/2	12.95
Z8671 ZILOG	19.95

## CRT CONTROLLERS

6845	4.95
6845	8.95
6847	11.95
HC46505SP	6.95
MC1372	2.95
8275	26.95
7220	19.95
4.0	1.95
4.032	1.95
5.0	1.95
5.0688	1.95
6.0	1.95
6.144	1.95
6.5536	1.95
8.0	1.95
10.0	1.95
10.738635	12.0
14.31818	1.95
15.0	1.95
16.0	1.95
17.95	12.95
17.97	12.95
18.0	1.95
18.432	19.95
20.0	1.95
22.1184	1.95
24.0	1.95
32.0	1.95

## DISK CONTROLLERS

1771	4.95
1791	9.95
1793	9.95
1795	12.95
1797	12.95
2791	19.95
2793	19.95
2797	29.95
6843	19.95
8272	4.95
UPD765	4.95
MB8876	12.95
MB8877	12.95
1691	6.95
2143	6.95

## BIT RATE GENERATORS

MC14411	9.95
BR1941	4.95
4702	9.95
COM8116	8.95
MM5307	4.95

## UARTS

AY5-1013	3.95
AY3-1015	4.95
TR1602	3.95
2651	4.95
IM6402	6.95
IM6403	9.95
IMS250	6.95

## SOUND CHIPS

76477	3.95
76489	8.95
SI-263	39.95
AY3-8910	12.95
AY3-8912	12.95
SP1000	39.00

## CRYSTALS

32.768 KHz	.95
1.0 MHz	2.95
5.0432	2.95
2.0	1.95
2.097152	1.95
2.4576	1.95
3.2768	1.95
3.579545	1.95
4.0	1.95
4.032	1.95
5.0	1.95
5.0688	1.95
6.0	1.95
6.144	1.95
6.5536	1.95
8.0	1.95
10.0	1.95
10.738635	12.0
14.31818	1.95
15.0	1.95
16.0	1.95
17.95	12.95
17.97	12.95
18.0	1.95
18.432	19.95
20.0	1.95
22.1184	1.95
24.0	1.95
32.0	1.95

## CRYSTAL OSCILLATORS

1.0MHz	5.95
1.8432	5.95
2.0	5.95
2.4576	5.95
2.5	4.95
4.0	4.95
5.0688	4.95
6.0	4.95
6.144	4.95
8.0	4.95
8.0	4.95
10.0	4.95
12.0	4.95
12.480	4.95
15.0	4.95
16.0	4.95
18.432	4.95
20.0	4.95
24.0	4.95

## MISC.

TMS99531	9.95
TMS99532	19.95
ULN2003	.79
3242	7.95
3341	4.95
MC3470	1.95
MC3480	8.95
MC3487	2.95
11C90	13.95
2513-001 UP	6.95
AY5-2376	11.95
AY5-3600 PRO	11.95

## 74LS00

74LS00	.16	74LS165	.65
74LS01	.18	74LS166	.95
74LS02	.17	74LS169	.95
74LS03	.18	74LS173	.49
74LS04	.16	74LS174	.39
74LS05	.18	74LS175	.39
74LS08	.18	74LS191	.49
74LS09	.18	74LS192	.69
74LS10	.16	74LS193	.69
74LS11	.22	74LS194	.69
74LS12	.22	74LS196	.69
74LS13	.26	74LS196	.59
74LS14	.36	74LS197	.59
74LS15	.26	74LS221	.59
74LS20	.17	74LS240	.69
74LS21	.22	74LS241	.69
74LS22	.22	74LS242	.69
74LS27	.23	74LS243	.69
74LS28	.26	74LS246	.69
74LS30	.17	74LS245	.79
74LS32	.18	74LS251	.49
74LS33	.28	74LS253	.49
74LS37	.26	74LS256	1.79
74LS38	.26	74LS257	.39
74LS42	.39	74LS258	.49
74LS47	.59	74LS259	1.29
74LS48	.59	74LS261	.79
74LS51	.17	74LS266	.39
74LS73	.29	74LS273	.79
74LS74	.24	74LS279	.39
74LS75	.29	74LS280	1.98
74LS76	.29	74LS283	.59
74LS83	.49	74LS290	.89
74LS85	.49	74LS293	.89
74LS86	.22	74LS299	1.49
74LS90	.39	74LS322	3.95
74LS92	.49	74LS323	2.49
74LS93	.39	74LS364	1.95
74LS95	.49	74LS365	.39
74LS107	.34	74LS367	.39
74LS109	.36	74LS368	.39
74LS112	.39	74LS371	.79
74LS122	.45	74LS374	.79
74LS123	.49	74LS375	.95
74LS124	2.75	74LS377	.79
74LS125	.39	74LS378	1.18
74LS126	.39	74LS390	1.19
74LS132	.39	74LS393	.79
74LS133	.49	74LS431	1.49
74LS136	.39	74LS624	.95
74LS138	.39	74LS640	.99
74LS139	.39	74LS645	.99
74LS145	.99	74LS669	1.29
74LS147	.99	74LS670	.89
74LS148	.99	74LS682	3.20
74LS151	.39	74LS683	3.20
74LS153	.39	74LS684	3.20
74LS154	1.49	74LS688	2.40
74LS155	.59	74LS783	22.95

# PARTIAL LISTING ONLY — CALL FOR A FREE CATALOG

## CMOS

4001	.19	14419	4.95
4011	.19	14433	14.95
4012	.25	4503	.49
4013	.35	4511	.69
4015	.29	4516	.79
4016	.29	4518	.85
4017	.49	4522	.79
4018	.69	4526	.79
4020	.59	4527	1.95
4021	.69	4528	.79
4024	.49	4529	2.95
4025	.25	4532	1.95
4027	.39	4538	.85
4028	.65	4541	1.29
4035	.69	4553	5.79
4040	.69	4585	.75
4041	.75	4702	12.95
4042	.59	74C00	.29
4043	.85	74C14	.59
4044	.69	74C74	.59
4045	.98	74C83	1.95
4046	.69	74C95	1.49
4047	.69	74C95	.99
4049	.29	74C150	5.79
4050	.29	74C151	2.25
4051	.69	74C161	.99
4052	.69	74C163	.99
4053	.69	74C164	1.39
4056	2.19	74C192	1.49
4060	.69	74C193	1.49
4066	.29	74C221	1.75
4069	.19	74C240	1.89
4076	.59	74C244	1.89
4077	.29	74C374	1.99
4081	.22	74C905	10.95
4085	.79	74C911	8.95
4086	.89	74C912	8.95
4093	.49	74C922	4.49
4094	2.49	74C923	4.95
14411	9.95	74C926	7.95
14412	6.95	80C97	.95

## 7400/9000

7400	.19	74147	2.49
7402	.19	74148	1.20
7404	.19	74150	1.35
7406	.29	74151	.55
7407	.29	74153	.55
7408	.29	74154	1.49
7410	.19	74155	.75
7411	.25	74157	.75
7414	.49	74159	1.65
7416	.25	74161	.69
7417	.25	74163	.69
7420	.19	74164	.85
7423	.29	74165	.85
7430	.19	74166	1.00
7432	.29	74175	.89
7438	.29	74177	.75
7442	.49	74178	1.15
7443	.69	74181	2.25
7447	.89	74182	.75
7449	.35	74184	2.00
7470	.35	74191	1.15
7473	.33	74192	.79
7474	.33	74193	.85
7475	.45	74194	.85
7476	.35	74196	.79
7483	.50	74197	.75
7485	.59	74199	1.35
7486	.35	74221	1.35
7489	2.15	74246	1.35
7490	.39	74247	1.25
7493	.35	74249	1.85
7495	.55	74251	.75
7497	2.75	74265	1.35
74100	2.29	74273	3.15
74121	2.29	74278	1.99
74123	4.9	74367	.65
74125	4.5	74368	.65
74141	.65	9368	3.95
74143	5.95	9602	1.50
74144	2.95	9637	2.95
74145	.60	96502	1.95

## 74500

74500	.29	745163	1.29
74502	.29	745168	3.95
74503	.29	745174	.79
74504	.29	745175	.79
74505	.29	745188	1.95
74508	.35	745189	1.95
74510	.29	745195	1.49
74515	.35	745196	1.49
74530	.35	745226	3.99
74532	.35	745226	3.99
74537	.69	745240	1.49
74538	.69	745241	1.49
74574	.49	745244	1.49
74585	.95	745257	.79
74586	.35	745253	.79
745112	.50	745258	.55
745124	2.75	745280	1.55
745138	.79	745287	1.69
745140	.55	745288	1.69
745151	.79	745299	2.55
745153	.79	745373	1.69
745157	.79	745374	1.69
745158	.95	745471	4.85
745161	1.29	745571	2.55

## VOLTAGE REGULATORS

TO-220 CASE			
7805T	.49	7905T	.59
7808T	.49	7908T	.59
7812T	.49	7912T	.59
7815T	.49	7915T	.59
TO-3 CASE			
7805K	1.39	7905K	1.49
7812K	1.39	7912K	1.49
TO-93 CASE			
78L05	.49	79L05	.69
78L12	.49	79L12	1.49
OTHER VOLTAGE REGS			
LM323K	5V 3A	TO-3	4.79
LM328K	Adj. 5A	TO-3	3.95
78M05K	5V 5A	TO-3	7.95
78M12K	12V 5A	TO-3	8.95
78P05K	5V 10A	TO-3	14.95

## LINEAR

TLO66	.99	LM733	.98
TLO71	.69	LM741	.29
TLO72	1.09	LM747	.69
TLO74	1.95	LM748	.59
TLO81	.59	MC1330	1.69
TLO82	.99	MC1350	1.19
TLO84	1.49	MC1372	6.95
LM301	.34	LM1414	1.59
LM309K	1.25	LM1458	.49
LM311	.59	LM1488	.49
LM311H	.89	LM1489	.49
LM317K	3.49	LM1496	.85
LM317T	.95	LM1812	8.25
LM318	1.49	LM1889	1.95
LM319	1.25	ULN2003	.79
LM320	7900	XR2206	3.75
LM322	1.65	KR2211	2.95
LM323K	4.79	KR2240	1.95
LM324	.49	MP02907	1.95
LM331	3.95	LM2917	1.95
LM334	1.19	CA3046	.89
LM335	1.40	CA3081	.99
LM336	1.75	CA3082	.99
LM337K	3.95	CA3086	.80
LM338K	3.95	CA3089	1.95
LM339	.59	CA3130E	.99
LM340	7800	CA3146	1.29
LM350T	4.60	CA3160	1.19
LF353	.59	MC3470	1.95
LF356	.99	MC3480	8.95
LF357	.99	MC3487	2.95
LM358	.59	LM3900	.49
LM360	.89	LM3909	1.95
LM383	1.95	LM3911	2.25
LM386	.89	LM3914	2.39
LM393	.45	MC4024	3.49
LM394H	4.60	MC4044	3.99
TL494	4.20	RC4136	1.25
TL497	3.25	RC4558	6.69
NE555	2.95	LM13600	1.49
NE556	.49	75107	1.49
NE558	1.29	75110	1.95
NE564	1.95	75150	1.95
LM565	.95	75154	1.95
LM566	1.49	75188	1.25
LM567	.79	75189	1.25
NE570	2.95	75451	.39
NE590	.75	75452	.39
NE592	.98	75453	.39
LM710	.75	75477	1.29
LM723	.49	75492	.79
H-TO-5 CAN, K-TO-3, T-TO-220			

## DATA ACQ INTERFACE

ADC0800	15.55	8T26	1.29
ADC0804	3.49	8T28	1.29
ADC0809	4.49	8T95	.89
ADC0816	14.95	8T96	.89
ADC0817	9.95	8T97	.59
ADC0831	8.95	8T98	.89
DAC0800	4.49	DP8311	2.95
DAC0806	1.95	DP8304	2.29
DAC0808	2.95	D58833	2.25
DAC1022	8.25	D58835	1.99
DAC1023	5.95	D58836	.99
MC1408L8	2.95	D58837	1.65

## IC SOCKETS

1-99 100+		
8 PIN ST	.11	.09
14 PIN ST	.11	.09
16 PIN ST	.12	.10
18 PIN ST	.15	.13
20 PIN ST	.18	.15
22 PIN ST	.15	.12
24 PIN ST	.20	.15
28 PIN ST	.22	.16
40 PIN ST	.30	.22
64 PIN ST	1.95	1.49
ST-SOLDERTAIL		
8 PIN WW	.59	.69
14 PIN WW	.69	.52
16 PIN WW	.69	.58
18 PIN WW	.95	.90
20 PIN WW	1.09	.98
22 PIN WW	1.39	1.28
24 PIN WW	1.49	1.35
28 PIN WW	1.69	1.49
40 PIN WW	1.99	1.80
WW-WIREWRAP		
24 PIN ZIF	4.95	CALL
28 PIN ZIF	5.95	CALL
40 PIN ZIF	9.95	CALL
ZIF-TEXTUOL (ZERO INSERTION FORCE)		

## EDGE CARD CONNECTORS

100 PIN ST	S-100	.125	3.95
100 PIN WW	S-100	.125	4.95
62 PIN ST	IBM CP	.100	1.95
50 PIN ST	APPLE	.100	2.95
44 PIN ST	STD	.156	1.95
44 PIN WW	STD	.156	4.95

## 36 PIN CENTRONICS

IDCEN36	RIBBON CABLE	6.95
CEN36	SOLDER CUP	4.95
FEMALE		
IDCEN36/F	RIBBON CABLE	7.95
CEN36PC	RT ANGLE PC MOUNT	4.95

## INTERSIL

ICL7106	9.55
ICL7107	12.55
ICL7660	2.55
ICL8038	4.95
ICM7207A	5.95
ICM7208	15.95

## DIP CONNECTORS

DESCRIPTION	ORDER BY	CONTACTS								
		8	14	16	18	20	22	24	28	40
HIGH RELIABILITY TOOLED ST IC SOCKETS	AUGATxxST	.62	.79	.89	1.09	1.29	1.39	1.49	1.69	2.49
HIGH RELIABILITY TOOLED WW IC SOCKETS	AUGATxxWW	1.30	1.80	2.10	2.40	2.50	2.90	3.15	3.70	5.40
COMPONENT CARRIES (DIP HEADERS)	ICCxx	.49	.59	.69	.99	.99	.99	.99	1.09	1.49
RIBBON CABLE DIP PLUGS (IDC)	IDPxx	---	.95	.95	---	---	---	1.75	---	2.95

FOR ORDERING INSTRUCTIONS SEE D-SUBMINIATURE BELOW

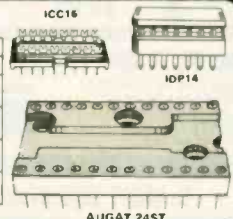

## DIODES/OPTO/TRANSISTORS

1N751	.25	4N26	.69
1N759	.25	4N27	.69
1N4148	25/1.00	4N28	.69
1N4004	10/1.00	4N33	.69
IN5002	.25	4N37	1.19
KBP04	.35	MCT-2	1.58
KBU8A	.35	MCT-6	1.29
VDA990-2	.95	TIL-111	.99
V2222	.25	2N3906	.10
PN2222	.10	2N4401	.25
2N2905	.50	2N4402	.25
2N2907	.25	2N4403	.25
2N3055	.79	2N6045	1.75
2N3904	.10	TIP31	.49

## D-SUBMINIATURE

DESCRIPTION	ORDER BY	CONTACTS						
		9	15	19	25	37	50	
SOLDER CUP	MALE	DBxxP	.82	.90	1.25	1.25	1.80	3.48
	FEMALE	DBxxS	.95	1.15	1.50	1.50	2.35	4.32
RIGHT ANGLE PC SOLDER	MALE	DBxxPR	1.20	1.49	---	1.95	2.65	---
	FEMALE	DBxxSR	1.25	1.55	---	2.00	2.79	---
WIRE WRAP	MALE	DBxxPWW	1.69	2.56	---	3.89	5.80	---
	FEMALE	DBxxSww	2.76	4.27	---	6.84	9.95	---
IDC RIBBON CABLE	MALE	IDBxxP	2.70	2.95	---	3.98	5.70	---
	FEMALE	IDBxxS	2.92	3.20	---	4.33	6.76	---
HOODS	METAL	MHOODxx	1.25	1.25	1.30	1.30	---	---
	GREY	HOODxx	.65	.65	---	.65	.75	.95

ORDERING INSTRUCTIONS: INSERT THE NUMBER OF CONTACTS IN THE POSITION MARKED "x" OF THE "ORDER BY" PART NUMBER LISTED.

EXAMPLE: A 15 PIN RIGHT ANGLE MALE PC SOLDER WOULD BE DB15PR.

MOUNTING HARDWARE \$1.00

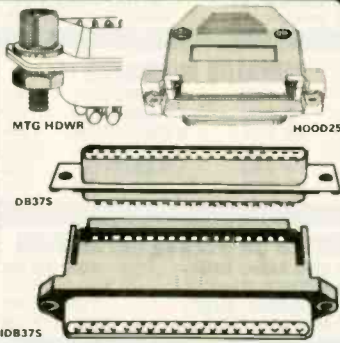

## LED DISPLAYS

FND-357(359)	COM CATHODE	362"	1.25
FND-500(503)	COM CATHODE	5"	1.49
FND-507(510)	COM ANODE	5"	1.49
MAN-72	COM ANODE	3"	.99
MAN-74	COM CATHODE	3"	.99

## BARGAIN HUNTERS CORNER

- DB25P** 100/\$45 10/\$6.90  
25 PIN MALE D-SUB CONNECTOR
- DB25S** 100/\$52 10/\$7.90  
25 PIN FEMALE D-SUB CONNECTOR
- HOOD-25** 100/\$31 10/\$6.90  
PLASTIC HOOD FOR DB25
- IDE34** 100/\$129 10/\$14.90  
34 PIN EDGE CONNECTOR
- AUGAT 16WW** 100/\$49 10/\$6.90  
16 PIN WIRE WRAP IC SOCKET MACHINE PIN
- .1uf DISC** 1000/\$29.50 100/\$3.95  
.1uf 16 VOLT CERAMIC DISC CAPACITORS

**SPECIALS END 6/30/86**

## PAGE WIRE WRAP WIRE PRECUT ASSORTMENT IN ASSORTED COLORS \$27.50

100ea: 5.5", 6.0", 6.5", 7.0"  
250ea: 2.5", 4.5", 5.0"  
500ea: 3.0", 3.5", 4.0"

### SPOOLS

100 feet \$4.30 250 feet \$7.25  
500 feet \$13.25 1000 feet \$21.95

Please specify color:  
Blue, Black, Yellow or Red

## EMI FILTER \$4.95

- MANUFACTURED BY CORCOM
- LOW COST
- FITS LC-HP BELOW
- 6 AMP 120/240 VOLT



## 6 FOOT LINE CORDS

LC-2 2 CONDUCTOR .39  
LC-3 2 CONDUCTOR .99  
LC-HP 3 CONDUCTOR W/STD FEMALE SOCKET 1.49

## MUFFIN FANS

3.15" SQ ROTRON 14.95  
3.63" SQ ETRI 14.95  
3.18" SQ MASUSHITA 16.95

## WIRE WRAP PROTOTYPE CARDS FR-4 EPOXY GLASS LAMINATE WITH GOLD-PLATED EDGE-CARD FINGERS



IBM-PR2

### IBM

BOTH CARDS HAVE SILK SCREENED LEGENDS AND INCLUDES MOUNTING BRACKET

IBM-PR1 WITH +5V AND GROUND PLANE \$27.95  
IBM-PR2 AS ABOVE WITH DECODING LAYOUT \$29.95

### S-100

P100-1 BARE - NO FOIL PADS \$15.15  
P100-2 HORIZONTAL BUS \$21.80  
P100-3 VERTICAL BUS \$21.80  
P100-4 SINGLE FOIL PADS PER HOLE \$22.75

### APPLE

P500-1 BARE - NO FOIL PADS \$15.15  
P500-3 HORIZONTAL BUS \$22.75  
P500-4 SINGLE FOIL PADS PER HOLE \$21.80  
7060-45 FOR APPLE IIe AUX SLOT \$30.00

## SOCKET-WRAP I.D.™

- SLIPS OVER WIRE WRAP PINS
- IDENTIFIES PIN NUMBERS ON WRAP SIDE OF BOARD
- CAN WRITE ON PLASTIC, SUCH AS IC #

PINS	PART #	PCK. OF	PRICE
8	IOWRAP 08	10	1.95
14	IOWRAP 14	10	1.95
16	IOWRAP 16	10	1.95
18	IOWRAP 18	5	1.95
20	IOWRAP 20	5	1.95
22	IOWRAP 22	5	1.95
24	IOWRAP 24	5	1.95
28	IOWRAP 28	5	1.95
40	IOWRAP 40	5	1.95

PLEASE ORDER BY NUMBER OF PACKAGES (PCK. OF)



ID WRAP 24

## FRAME STYLE TRANSFORMERS

12.6V AC CT 2 AMP 5.95  
12.6V AC CT 4 AMP 7.95  
12.6V AC CT 8 AMP 10.95  
25.2V AC CT 2 AMP 7.95

## 25 PIN D-SUB GENDER CHANGERS \$7.95



## SWITCHING POWER SUPPLIES

### PS-IBM \$89.95

- FOR IBM PC-XT COMPATIBLE
- 135 WATTS
- +5V @ 15A, +12V @ 4.2A
- 5V @ .5A, -12V @ .5A
- ONE YEAR WARRANTY



### PS-IBM-150 \$99.95

- FOR IBM PC-XT COMPATIBLE
- 150 WATTS
- +12V @ 5.2A, +5V @ 16A
- 12V @ .5A, -5V @ .5A
- ONE YEAR WARRANTY



### PS-130 \$99.95

- 130 WATTS
- SWITCH ON REAR
- FOR USE IN OTHER IBM TYPE MACHINES
- 90 DAY WARRANTY



### PS-A \$49.95

- USE TO POWER APPLE TYPE SYSTEMS
- +5V @ 4A, +12V @ 2.5A
- 5V @ .5A, -12V @ .5A
- APPLE POWER CONNECTOR



### PS-SPL200 \$49.95

- +5V @ 25A, +12V @ 3.5A
- 5V @ 1A, -12V @ 1A
- UL APPROVED
- ALUMINUM ENCLOSURE



## BOOKS BY STEVE CIARCIA

- BUILD YOUR OWN Z80 COMPUTER \$19.95**
- CIRCUIT CELLAR VOL 1 \$17.95  
CIRCUIT CELLAR VOL 2 \$18.95  
CIRCUIT CELLAR VOL 3 \$18.95  
CIRCUIT CELLAR VOL 4 \$18.95  
CIRCUIT CELLAR VOL 5 \$19.95

## MICROCOMPUTER HARDWARE HANDBOOK FROM ELCOMP \$14.95

OVER 800 PAGES OF DATA SHEETS ON THE MOST COMMONLY USED ICs. INCLUDES TTL, CMOS, 74LS00, MEMORY, CPU's, MPU SUPPORT. AND MUCH MORE!

## CAPACITORS

### TANTALUM

1.0µf	15V .35	.47µf	35V .45
6.8	15V .70	1.0	35V .45
10	15V .80	2.2	35V .65
22	15V 1.35	4.7	35V .85
.22	35V .40	10	35V 1.00

### DISC

10µf	50V .05	680	50V .05
22	50V .05	.001µf	50V .05
27	50V .05	.0022	50V .05
33	50V .05	.005	50V .05
47	50V .05	.01	50V .07
68	50V .05	.02	50V .07
100	50V .05	.05	50V .07
220	50V .05	.1	12V .10
560	50V .05	.1	12V .12

### MONOLITHIC

.01µf	50V .14	.1µf	50V .18
.047µf	50V .15	.47µf	50V .25

### ELECTROLYTIC

RADIAL		AXIAL	
1µf	25V .14	1µf	50V .14
2.2	35V .15	10	50V .16
4.7	50V .15	22	16V .14
10	50V .15	47	50V .20
47	35V .18	100	35V .25
100	16V .18	220	25V .30
220	35V .20	470	50V .50
470	25V .30	1000	16V .60
2200	16V .70	2200	16V .70
4700	25V 1.45	4700	16V 1.25

## DATARASE EPROM ERASER \$34.95

- ERASES 2 IN 10 MINUTES
- COMPACT-NO DRAWER
- THIN METAL SHUTTER
- PREVENTS UV LIGHT FROM ESCAPING



## 1/4 WATT RESISTORS

5% CARBON FILM ALL STANDARD VALUES FROM 1 OHM TO 10 MEG. OHM

10 PCS same value .05 100 PCS same value .02  
50 PCS same value .025 1000 PCS same value .015

## RESISTOR NETWORKS

SIP	10 PIN	9 RESISTOR	.69
SIP	8 PIN	7 RESISTOR	.59
DIP	16 PIN	8 RESISTOR	1.09
DIP	16 PIN	15 RESISTOR	1.09
DIP	14 PIN	7 RESISTOR	.99
DIP	14 PIN	13 RESISTOR	.99

## SPECIALS ON BYPASS CAPACITORS

.01 µf CERAMIC DISC 100/\$5.00  
.01 µf MONOLITHIC 100/\$10.00  
.1 µf CERAMIC DISC 100/\$6.50  
.1 µf MONOLITHIC 100/\$12.50

## WISH SOLDERLESS BREADBOARDS

PART NUMBER	DIMENSIONS	DISTRIBUTION STRIP(S)	TIE POINTS	TERMINAL STRIP(S)	TIE POINTS	BINDING POSTS	PRICE
WBU-D	3.8 x 6.50"	1	100	---	---	---	2.95
WBU-T	1.38 x 6.50"	---	---	1	630	---	6.95
WBU-204-3	3.94 x 8.45"	1	100	2	1260	2	17.95
WBU-204	5.13 x 8.45"	4	400	2	1260	3	24.95
WBU-206	6.88 x 9.06"	5	500	3	1890	4	29.95
WBU-208	8.25 x 9.45"	7	700	4	2520	4	39.95

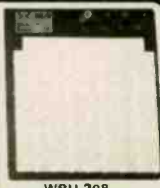

WBU-208

## LITHIUM BATTERY AS USED IN CLOCK CIRCUITS

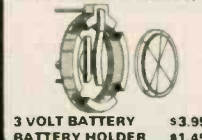

3 VOLT BATTERY \$3.95  
BATTERY HOLDER \$1.49

## NEW EDITION!

**1986 IC MASTER**  
THE INDUSTRY STANDARD  
**\$129.95**



VISIT OUR RETAIL STORE LOCATED AT 1256 SOUTH BASCOM AVENUE IN SAN JOSE

**JDR Microdevices**

1224 S. Bascom Avenue, San Jose, CA 95128

Toll Free 800-538-5000 • (408) 995-5430

FAX (408) 275-8415 • Telex 171-110

© COPYRIGHT 1986 JDR MICRODEVICES

HOURS: M-W-F, 9-5

TU-TH, 9-9

SAT, 10-3

PLEASE USE YOUR CUSTOMER NUMBER WHEN ORDERING

TERMS: Minimum order \$10.00. For shipping and handling include \$2.50 for UPS Ground and \$3.50 for UPS Air. Orders over 1 lb. and foreign orders may require additional shipping charges - please contact our sales department for the amount. CA residents must include applicable sales tax. All merchandise is warranted for 90 days unless otherwise stated. Prices are subject to change without notice. We are not responsible for typographical errors. We reserve the right to limit quantities and to substitute manufacturer. All merchandise subject to prior sale.



# PARTIAL LISTING ONLY — CALL FOR A FREE CATALOG

## DISK DRIVES FOR APPLE COMPUTERS

**AP-150**  
**\$99.95**

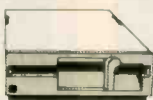

- 1/2 HT. DIRECT DRIVE
- 100% APPLE COMPATIBLE
- SIX MONTH WARRANTY

**BAL-500**  
**\$129.95**



- TEAC MECHANISM-DIRECT DRIVE
- 100% APPLE COMPATIBLE
- FULL ONE YEAR WARRANTY

**AP-135**  
**\$129.95**



- FULL HT SHUGART MECHANISM
- DIRECT REPLACEMENT FOR APPLE DISK II
- SIX MONTH WARRANTY

**DOUBLE  
SIDED!**

**MAC535**  
**\$249.95**



- 3.5" ADD-ON DISK DRIVE
- 100% MACINTOSH COMPATIBLE
- DOUBLE SIDED 800K BYTE STORAGE
- HIGH RELIABILITY DRIVE
- HAS AUTO-EJECT MECHANISM
- FULL ONE YEAR WARRANTY

**AD-3C**  
**\$139.95**



- 100% APPLE IIc COMPATIBLE, READY TO PLUG IN, W/SHIELDED CABLE & MOLDED 19 PIN CONNECTOR
- FAST, RELIABLE SLIMLINE DIRECT DRIVE
- SIX MONTH WARRANTY

**DISK DRIVE ACCESSORIES**  
FDD CONTROLLER CARD \$49.95  
IIc ADAPTOR CABLE \$19.95  
ADAPTS STANDARD APPLE DRIVES FOR USE WITH APPLE IIc

**KB-1000** **\$79.95**

CASE WITH KEYBOARD FOR APPLE TYPE MOTHERBOARD

- USER DEFINED FUNCTION KEYS
- NUMERIC KEYPAD WITH CURSOR CONTROL
- CAPS LOCK
- AUTO-REPEAT



**KEYBOARD-AP** **\$49.95**

- REPLACEMENT FOR APPLE II KEYBOARD
- CAPS LOCK KEY, AUTO REPEAT
- ONE KEY ENTRY OF BASIC OR CP/M COMMANDS



## EXTENDER CARDS

IBM-PC \$45.00  
IBM-AT \$68.00  
APPLE II \$45.00  
APPLE IIe \$45.00  
MULTIBUS \$86.00

## APPLE COMPATIBLE INTERFACE CARDS

**EPROM PROGRAMMER \$59.95**

**MODEL  
RP525**



- DUPLICATE OR BURN ANY STANDARD 27xx SERIES EPROM
- EASY TO USE MENU-DRIVEN SOFTWARE IS INCLUDED
- MENU SELECTION FOR 2716, 2732, 2732A, 2764 AND 27128
- HIGH SPEED WRITE ALGORITHM
- LED INDICATORS FOR ACTIVITY
- NO EXTERNAL POWER SUPPLY NEEDED
- ONE YEAR WARRANTY

**16K RAMCARD \$39.95**



- FULL TWO YEAR WARRANTY
- EXPAND YOUR 48K APPLE TO 64K
- USE IN PLACE OF APPLE LANGUAGE CARD

BARE PC CARD W/INSTRUCTIONS \$9.95

**IC TEST CARD \$89.95**



- QUICKLY TESTS MANY COMMON ICs
- DISPLAYS PASS OR FAIL
- ONE YEAR WARRANTY
- TESTS: 4000 SERIES CMOS, 74HC SERIES CMOS, 7400, 74LS, 74L, 74H & 74S

**300B MODEM \$49.95**

FOR APPLE OR IBM  
INCLUDES ASCII PRO-EZ SOFTWARE



- FCC APPROVED
- BELL SYSTEMS 103 COMPATIBLE
- INCLUDES AC ADAPTOR
- AUTO-DIAL
- DIRECT CONNECT

CABLE FOR APPLE IIc \$14.95

**JOYSTICK CR-401 \$7.95**

FOR ATARI 400, 800, 2600,  
VIC 20/64 AND APPLE IIe



**DISKFILE**  
HOLDS 70 5 1/4" DISKETTES

**\$8.95**



3.5" DISKFILE HOLDS 40 \$9.95

## POWER STRIP

• UL APPROVED  
• 15A CIRCUIT  
BREAKER **\$12.95**



## 3-WAY SWITCH BOXES

- SERIAL OR PARALLEL
- CONNECTS 3 PRINTERS TO ONE COMPUTER OR VICE VERSA
- ALL LINES SWITCHES
- HIGH QUALITY ROTARY SWITCH MOUNTED ON PCB
- GOLD CONTACTS
- STURDY METAL ENCLOSURE



**SWITCH-3P CENTRONICS PARALLEL \$99.95**  
**SWITCH-3S RS232 SERIAL \$99.95**

## PRINTER BUFFERS

- FREES COMPUTER FOR OTHER TASKS WHILE PRINTING LONG DOCUMENTS
- STAND-ALONE DESIGN; WORKS WITH ANY COMPUTER OR PRINTER
- ALL MODELS FEATURE PRINT PAUSE MEMORY CHECK, GRAPHICS CAPABILITY

**SP120P PARALLEL \$139.95**

- 64K UPGRADABLE TO 256K
- LED INDICATOR SHOWS VOLUME OF DATA IN BUFFER

**SP120S RS232 SERIAL \$159.95**

- 64K UPGRADABLE TO 256K
- 6 SELECTABLE BAUD RATES, FROM 600B-19,200B

**SP110P PARALLEL \$249.95**

- 64K UPGRADABLE TO 512K
- SPOOLS OUTPUT OF UP TO 3 COMPUTERS
- LED BARGRAPH DISPLAYS AMOUNT OF DATA IN BUFFER
- RESET FUNCTION CLEARS DATA IN BUFFER
- REPEAT FUNCTION CAN PRODUCE MULTIPLE COPIES OF A DOCUMENT



SP120 SP110

## NASHUA DISKETTES DEALS

5 1/4" SOFT SECTOR  
DS/DD WITH HUB RINGS

**\$9.90** **69c ea** **59c ea**  
BOX OF 10 BULK QTY 50 BULK QTY 250

NASHUA DISKETTES WERE JUOGED TO HAVE THE HIGHEST POLISH AND RECORDED AMPITUDE OF ANY DISKETTES TESTED ACCORDING TO "COMPARING FLOPPY DISKS", BYTE 9-84

## DISKETTES

**NASHUA 5 1/4"**

N-MD2D DS/DD SOFT \$9.90  
N-MD2F DS/QUAD SOFT \$34.95  
N-MD2H DS/HD FOR AT \$49.95

**NASHUA 8"**

N-FD1 SS/DD SOFT \$27.95  
N-FD2D DS/DD SOFT \$34.95

**NASHUA 3.5"**

N-3.5SS 3.5" SS/DD FOR MAC \$32.95

**VERBATIM 5 1/4"**

V-MD1D SS/DD SOFT \$23.95  
V-MD2D DS/CD SOFT \$29.95  
V-MD110D SS/DD 10 SECTOR HARD \$23.95

## Sakata 120 CPS DOT MATRIX PRINTER



**MODEL  
SP-1200 \$169.95**

- EPSON/IBM COMPATIBLE
- 9-WIRE PRINTHEAD
- 120 CPS-BIDIRECTIONAL, 80 COL.
- FRICTION AND TRACTOR FEED
- PROPORTIONAL SPACING
- CENTRONICS PARALLEL INTERFACE
- 8 CHARACTER SETS AND GRAPHICS

6 FOOT IBM PRINTER CABLE \$9.95  
REPLACEMENT RIBBON CARTRIDGE \$11.95

## 5 1/4" FLOPPY DISK DRIVES

TEAC FD-55B 1/2 HT DS/DD (FOR IBM) \$109.95  
TEAC FD-55F 1/2 HT DS/QUAD (FOR IBM) \$109.95  
TEAC FD-55GFV 1/2 HT DS/HC (FOR IBM AT) \$154.95  
TANDON TM100-2 DS/DD (FOR IBM) \$99.95  
TANDON TM50-2 1/2 HT DS/DD (FOR IBM) \$89.95  
MPI-852 DS/DD (FOR IBM) \$89.95  
QLUME QT-142 1/2 HT DS/DD (FOR IBM) \$79.95

## 8" FLOPPY DISK DRIVES

FD 100-8 SS/DD (SA/801 EQUIV) \$119.00  
FD 200-8 DS/DD (SA/851R EQUIV) \$159.00

## DISK DRIVE ACCESSORIES

TEAC SPECIFICATION MANUAL \$5.00  
TEAC MAINTENANCE MANUAL \$25.00  
1/2 HT MOUNTING HARDWARE \$2.95  
MOUNTING RAILS FOR IBM AT \$4.95  
"M" POWER CABLE FOR 5 1/4" FDDs \$2.95  
5 1/4" FDD POWER CONNECTORS \$1.19

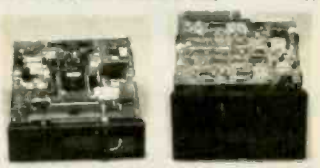

TEAC FD-55 TANDON TM100-2

## DISK DRIVE ENCLOSURES

**CAB-APPLE \$24.95**  
APPLE TYPE CABINET W/O JT POWER SUPPLY

**CAB-1FH5 \$69.95**  
FULL HT 5 1/4" BEIGE CABINET W/POWER SUPPLY

**CAB-2SV5 \$49.95**  
DUAL SLIMLINE 5 1/4" CABINET W/POWER SUPPLY

**CAB-2SV8 \$209.95**  
DUAL SLIMLINE 8" CABINET W/POWER SUPPLY

**CAB-2FH8 \$219.95**  
HORIZONTAL  
DUAL FULL HT 8" CABINET W/POWER SUPPLY



CAB-2SV5 CAB-1FH5

## TEST EQUIPMENT FROM JDR INSTRUMENTS

**DIGITAL MULTIMETER PEN DPM-1000**  
AUTO RANGING, POLARITY AND DECIMAL!

**\$54.95**

- LARGE 3.5 DIGIT DISPLAY
- DATA HOLD SWITCH
- FREEZES READING
- FAST, AUDIBLE CONTINUITY TEST
- LOW BATTERY INDICATOR
- OVERLOAD PROTECTION



**20MHZ DUAL TRACE OSCILLOSCOPE MODEL 2000 \$389.00**  
**35MHZ DUAL TRACE OSCILLOSCOPE MODEL 3500 \$549.00**

FOR MORE INFORMATION ON THE OSCILLOSCOPES, SEE OUR AD ON PAGE 207.

CALL FOR VOLUME QUOTES © COPYRIGHT 1986 JDR MICRODEVICES

# BUILD A COMPLETE 256K XT SYSTEM—\$717

## SEAGATE ST-225 20MB HARD DISK SYSTEM

INCLUDES HALF LENGTH HD CONTROLLER, CABLES, MOUNTING HARDWARE AND INSTRUCTIONS. ALL DRIVES ARE PRE-TESTED AND COME WITH A ONE YEAR WARRANTY.

# \$449.00

## XT COMPATIBLE MOTHERBOARD

# \$159.00

- 4.77 MHz 8088 CPU, OPTIONAL 8087 CO-PROCESSOR
- 8 EXPANSION SLOTS
- 0K RAM INSTALLED, EXPANDABLE TO 640K ON-BOARD MEMORY
- ALL ICs SOCKETED—HIGHEST QUALITY PC BOARD
- ACCEPTS 2764 OR 27128 ROMS

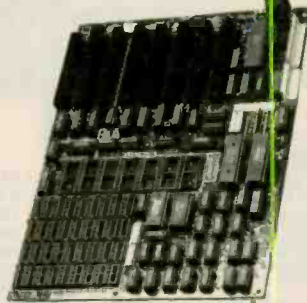

**PRO-BIOS \$29.95**

## IBM COMPATIBLE INTERFACE CARDS

ALL WITH A ONE YEAR WARRANTY

### MULTI I/O FLOPPY CARD \$129.95

PERFECT FOR THE 640K MOTHERBOARD



- 2 DRIVE FLOPPY DISK CONTROLLER
- 1 RS232 SERIAL PORT; OPTIONAL 2nd SERIAL PORT
- PARALLEL PRINTER PORT
- GAME PORT
- CLOCK/CALENDAR
- SOFTWARE: CLOCK UTILITIES, RAMDISK, SPOOLER
- OPTIONAL SERIAL PORT \$16.95

### MULTIFUNCTION CARD \$119.95

ALL THE FEATURES OF AST'S 6 PACK PLUS AT HALF THE PRICE



- 4 VIDEO INTERFACES: RGB, COMPOSITE COLOR, HI-RES
- 0-384K RAM
- SERIAL PORT
- PARALLEL PORT
- GAME PORT
- SOFTWARE INCLUDED: PRINTER CABLE \$8.95, 64K RAM UPGRADE 9/\$10.71

### COLOR GRAPHICS ADAPTOR \$99.95

FULLY COMPATIBLE WITH IBM COLOR CARD



- 4 VIDEO INTERFACES: RGB, COMPOSITE COLOR, HI-RES
- CONNECTOR FOR RF MODULATOR
- COLOR GRAPHICS MODE: 320 x 200
- MONO GRAPHICS MODE: 640 x 200
- LIGHT PEN INTERFACE

### MONOCHROME GRAPHICS CARD \$119.95

FULLY COMPATIBLE W/IBM MONOCHROME ADAPTOR & HERCULES GRAPHICS



- LOTUS COMPATIBLE
- TEXT MODE: 80 x 25
- GRAPHICS MODE: 720 x 348
- PARALLEL PRINTER INTERFACE
- OPTIONAL SERIAL PORT \$19.95

### MONOCHROME ADAPTOR \$49.95

ANOTHER FANTASTIC VALUE FROM JDR!

- IBM COMPATIBLE TTL OUTPUT
  - 720 x 350 PIXEL DISPLAY
- PLEASE NOTE: THIS CARD WILL NOT RUN LOTUS GRAPHICS AND DOES NOT INCLUDE A PARALLEL PORT

### FLOPPY DISK DRIVE ADAPTOR \$49.95



- INTERFACES UP TO 4 STANDARD FDDs TO IBM PC OR COMPATIBLES
- INCLUDES CABLE FOR TWO INTERNAL DRIVES
- STANDARD DB37 FOR EXTERNAL DRIVES
- RUNS QUAD DENSITY DRIVES WHEN USED WITH JFORMAT

## EASYDATA 1200 BAUD MODEM FOR IBM

INCLUDES PC TALK III COMMUNICATIONS SOFTWARE



- NEW 10 INCH CARD
- HAYES COMPATIBLE
- AUTO DIAL, AUTO ANSWER
- AUTO RE-DIAL ON BUSY
- INCLUDES SERIAL PORT!
- ONE YEAR WARRANTY

# \$169.95

## CRT MONITORS FOR ALL APPLICATIONS



**LUXOR HI-RES RGB MONITOR**  
MODEL 190-9528

- DIGITAL RGB-IBM COMPATIBLE
- 14" SCREEN
- 16 TRUE COLORS
- 25 MHz BANDWIDTH
- RESOLUTION > 640 x 262
- 31mm DOT PITCH
- CABLE FOR IBM PC INCLUDED

**\$299.95**



**SAKATA COMPOSITE COLOR**  
MODEL SC-100

- TOP RATED FOR APPLE
- 13" COMPOSITE VIDEO
- RESOLUTION: 280H x 300V
- INTERNAL AUDIO AMP
- ONE YEAR WARRANTY

**\$169.95**



**CENTER SYSTEMS MONOCHROME**  
MODEL KLM-1211

- IBM COMPATIBLE TTL INPUT
- 12" NON-GLARE SCREEN
- P39 GREEN PHOSPHORUS
- VERY HIGH RESOLUTION: 25 MHz BANDWIDTH, 1100 LINES (CENTER)

**\$99.95**  
AMBER VERSION \$109.95

## BUILD YOUR OWN 256K XT COMPATIBLE SYSTEM

- XT MOTHERBOARD \$159.95
- PRO-BIOS \$29.95
- 256K RAM \$26.55
- 130 WATT POWER SUPPLY \$89.95
- FLIP-TOP CASE \$49.95
- DKM-2000 KEYBOARD \$79.95
- 1/2 HEIGHT QUME DRIVE \$79.95
- FLOPPY DISK CONTROLLER \$49.95
- MONOCHROME ADAPTOR \$49.95
- MONOCHROME MONITOR \$99.95

**TOTAL: \$716.10**

## MONITOR STAND



TILTS AND SWIVELS  
**ONLY \$12.95**

## IBM PRINTER CABLE



DB25 TO CENTRONICS  
SHIELDED CABLE **\$9.95**

## IBM STYLE COMPUTER CASE

AN ATTRACTIVE STEEL CASE WITH A HINGED LID FITS THE POPULAR PC/XT COMPATIBLE MOTHERBOARDS

- SWITCH CUT-OUT ON SIDE FOR PC/XT STYLE POWER SUPPLY
- CUT-OUT FOR 8 EXPANSION SLOTS
- ALL HARDWARE INCLUDED

# \$49.95

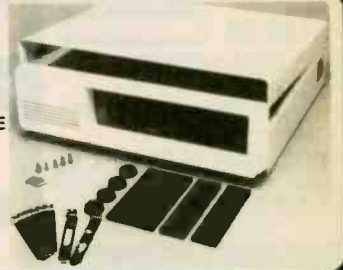

## IBM COMPATIBLE KEYBOARDS

DKM-2000 \$79.95

IBM-5151 \$99.95



- "5150" STYLE KEYBOARD
- FULLY IBM COMPATIBLE
- LED STATUS INDICATORS FOR CAPS & NUMBER LOCK
- 83 KEY — SAME LAYOUT AS IBM PC/XT KEYBOARD

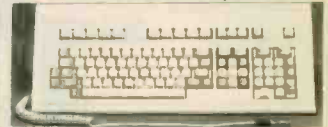

- REPLACEMENT FOR KEYTRONICS KB-5151™
- SEPARATE CURSOR & NUMERIC KEYPAD
- CAPS LOCK & NUMBER LOCK INDICATORS
- IMPROVED KEYBOARD LAYOUT

## POWER SUPPLY



**NOW ONLY \$89.95**

- FOR IBM PC-XT COMPATIBLE
- 135 WATTS
- +5V @ 15A, -12V @ 4.2A
- -5V @ .5A, -12V @ .5A

**150 WATT MODEL \$99.95**

## DISK DRIVES

TANDON TM50-2

# \$89.95

- 1/2 HT DS/DD
- IBM COMPATIBLE
- EXTREMELY QUIET!

TEAC FD-55B	DS/DD	\$109.95
TEAC FD-55F	DS/QUAD	\$109.95
TEAC FD-55G	DS/HD	\$154.95
QUME QT-142	DS/DD	\$79.95
MOUNTING HARDWARE		\$2.95
AT/RAILS		\$4.95

**JDR Microdevices**

1224 S. Bascom Avenue, San Jose, CA 95128  
Toll Free 800-538-5000 • (408) 995-5430 • FAX (408) 275-8415 • Telex 171-110

# D·I·S·K·S   A·N·D   D·O·W·N·L·O·A·D·S

## ORDERING DISKS OF BYTE LISTINGS

Source-code listings in the form of text files of programs that accompany BYTE articles are now available from BYTE on disk. To order a disk of these listings for noncommercial purposes, indicate the issue (the first available is December 1985) and the kind of disk on the form below. Enclose a check or money order in the correct amount made out to BYTE Listings. All prices include postage. Send requests to BYTE Listings, 70 Main St., Peterborough, NH 03458.

BYTE issue: \_\_\_\_\_

### COMMON 5¼-INCH FORMATS

(all cost \$5 per disk in North America, \$6 in Europe and South America, \$7 in Asia, Africa, and Australia)

- Apple II 5¼-inch DOS 3.3
- Apple II 5¼-inch ProDOS
- Atari
- Commodore 64
- Hewlett-Packard 125
- IBM PC
- Kaypro 2 CP/M
- Texas Instruments Professional
- TRS-80 Model III
- TRS-80 Model 4
- Zenith Z-100

### COMMON 3½-INCH FORMATS

(all cost \$6 per disk in North America, \$7 in Europe and South America, \$8 in Asia, Africa, and Australia)

- Apple Macintosh
- Atari 520ST
- Commodore Amiga
- Data General/One
- Hewlett-Packard 150

### CP/M STANDARD 8-INCH FORMAT

(\$6 per disk in North America, \$7 in Europe and South America, \$8 in Asia, Africa, and Australia)

- Single-sided single-density

## OTHER FORMATS

(all cost \$6 per disk in North America, \$7 in Europe and South America, \$8 in Asia, Africa, and Australia)

Size	Machine
<input type="checkbox"/> 8-inch	_____
<input type="checkbox"/> 5¼-inch	_____
<input type="checkbox"/> 3½-inch	_____

## SEND DISK TO:

Name \_\_\_\_\_

Street \_\_\_\_\_

City \_\_\_\_\_ State or Province \_\_\_\_\_

Postal Code \_\_\_\_\_ Country \_\_\_\_\_

Check or money order enclosed for \$ \_\_\_\_\_

## BULLETIN BOARDS IN CANADA

Listed below are some computer bulletin boards that carry program listings from BYTE. Programs are for noncommercial use in connection with BYTE articles only. Some BBSs may charge an annual maintenance fee, and you must pay your own telephone charges.

**Western Canadian Distribution Center** (3420 48th St., Edmonton, Alberta T6L 3R5) will be supplying listings to its member bulletin-board systems.

Edmonton, Alberta, (403) 454-6093

Meadowlark, Alberta, (403) 435-6579

Montreal, Quebec, PComm Systems,  
(514) 989-9450

Prince George, British Columbia, (604) 562-9519

Regina, Saskatchewan, (306) 586-5585

Toronto, Ontario, Epson Club of Toronto (EPCOT),  
(416) 635-9600

Winnipeg, Manitoba, (204) 452-5529

In addition, arrangements for BYTenet Listings have been made with one or more system operators in the following nations: Australia, Denmark, Italy, Japan, The Netherlands, Norway, Singapore, Sweden, Switzerland, United Kingdom, and West Germany. Contact us at (603) 924-9281 for an up-to-date list. ■

# B·O·M·B

## BYTE'S ONGOING MONITOR BOX

ARTICLE#	PAGE	ARTICLE	AUTHOR(S)	ARTICLE#	PAGE	ARTICLE	AUTHOR(S)
1	9	Microbytes	staff	14	203	Optical Disk Error Correction	Golomb
2	29	What's New	staff	15	215	A Roundup of Optical Disk Drives	Malloy
3	50	Ask BYTE	Ciarcia	16	227	Tape Backup Systems	Antonuccio
4	63	Book Reviews	Unger, Norman, O'Neill	17	235	Laser Libraries	Desmarais
5	85	Ciarcia's Circuit Cellar: Adding SCSI to the SBI80		18	254	The AT&T UNIX PC	Mayer
6	98	Computer, Part I: Introduction	Ciarcia	19	265	ZBasic	Byers
7	111	Programming Project: Data Compression with Huffman Coding	Amsterdam	20	269	GEM Draw/MacDraw	Birmele
8	123	Modula-2 As a Systems Programming Language	Corbell, Anderson	21	273	Hardcard	White
9	137	Linking Data Flow and Functional Languages	Hankin, Till, Glaser	22	279	The B&C Microsystems 1409 EPROM Programmer	Jacobs
10	151	Easy C	Heath	23	285	Non-Keybaord Input Devices	Pappas
11	161	Programming Insight: Subroutine Overlays in GW-BASIC	Carmichael	24	289	Racter	Kenner
12	177	The Evolution of Mass Storage	Laub	25	293	General Electric's 3-8100 Printer	Swearingin
13	193	CD-ROM Software Development	Zoellick	26	299	Lettrix	Miller
		The Application Interface of Optical Drives	Dulude	27	311	Computing at Chaos Manor: Expanded/Extended Memory	Pournelle
				28	329	BYTE Japan: An Innovative Program	Raibe
				29	335	Applications Only: A Mixed Lot	Shapiro
				30	343	According to Webster: 68000 Wars: Round 2	Webster
				31	363	BYTE U.K.: Intuitive Solution	Pountain
				32	379	Mathematical Recreations: The Pellian Equation	Kurosaka
				33	398	Best of BIX	BIXen

## BOMB Results

The Best of BIX is the winning article from the February issue. It was written by BIX subscribers who joined the conferences discussing Amiga, Atari, IBM, and Macintosh computers. Winner of second place is Steve Ciarcia for his Circuit Cellar entitled "Build an Audio-and-Video Multiplexer." Jerry Pournelle's "Communicating" from Computing at Chaos

Manor wins third. In fourth place is Robert J. Mical's "Introduction to the Amiga ROM Kernel." Mr. Mical wins the \$100 bonus for authoring the first nonstaff article to appear in the lineup. In fifth place and the winner of \$50 is Mark Bridger for his review of "Turbo Pascal 3.0." Congratulations to BIXen and authors.

### BYTE ADVERTISING SALES STAFF:

**Dennis J. Riley, Advertising Sales Manager, 70 Main Street, Peterborough, NH 03458, tel. (603) 924-9281**

**NEW ENGLAND**  
ME, NH, VT, MA, RI,  
EASTERN CANADA  
Paul McPherson Jr. (617) 262-1160  
McGraw-Hill Publications  
575 Boylston Street  
Boston, MA 02116

**ATLANTIC**  
NY, NJ, CT, NJ (NORTH)  
Leah G. Rabinowitz (212) 512-2096  
McGraw-Hill Publications  
1221 Avenue of the Americas—  
39th Floor  
New York, NY 10020

Dick McGurk (203) 968-7111  
McGraw-Hill Publications  
Building A—3rd Floor  
777 Long Ridge Road  
Stamford, CT 06902

**EAST**  
PA (EAST), NJ (SOUTH),  
MD, VA, W VA, DE, D.C.  
Daniel Ferro (215) 496-3833  
McGraw-Hill Publications  
Three Parkway  
Philadelphia, PA 19102

**SOUTHEAST**  
NC, SC, GA, FL, AL, TN  
Maggie M. Dorvee (404) 252-0626  
McGraw-Hill Publications  
4170 Ashford-Dunwoody Road—  
Suite 420  
Atlanta, GA 30319

**MIDWEST**  
IL, MO, KS, IA, ND, SD, MN, WI, NB, IN  
Bob Denmead (312) 751-3740  
McGraw-Hill Publications  
Blair Building  
645 North Michigan Ave.  
Chicago, IL 60611

**GREAT LAKES, OHIO REGION**  
MI, OH, PA (ALLEGHENY), KY,  
ONTARIO, CANADA  
(313) 352-9760  
McGraw-Hill Publications  
4000 Town Center—Suite 770  
Southfield, MI 48075

**SOUTHWEST, ROCKY MOUNTAIN**  
UT, CO, WY, OK, TX, AR, MS, LA  
Kevin Harold (214) 458-2400  
McGraw-Hill Publications  
Prestonwood Tower—Suite 907  
5151 Beltline  
Dallas, TX 75240

**SOUTH PACIFIC**  
SOUTHERN CA, AZ, NM, LAS VEGAS  
Jack Anderson (714) 557-6292  
McGraw-Hill Publications  
3001 Red Hill Ave.  
Building #1—Suite 222  
Costa Mesa, CA 92626

Karen Niles (213) 480-5243, 487-1160  
McGraw-Hill Publications  
3333 Wilshire Boulevard #407  
Los Angeles, CA 90010

**NORTH PACIFIC**  
HI, WA, OR, ID, MT, NORTHERN CA,  
NV (except LAS VEGAS), W. CANADA  
Mike Kisseberth (415) 362-4600  
McGraw-Hill Publications  
425 Battery Street  
San Francisco, CA 94111

Bill McAfee (415) 964-0624  
McGraw-Hill Publications  
1000 Elwell Court—Suite 225  
Palo Alto, CA 94303

**WEST COAST SURPLUS  
AND RETAIL ACCOUNTS**  
Tom Harvey (805) 964-8577  
3463 State Street—Suite 256  
Santa Barbara, CA 93105

**The Buyer's Mart**  
Karen Burgess (603) 924-3754  
BYTE Publications  
70 Main Street  
Peterborough, NH 03458

**BYTE BITS (2x3)**  
Dan Harper (603) 924-6830  
BYTE Publications  
70 Main Street  
Peterborough, NH 03458

**Post Card Mailings  
National**  
Bradley Browne (603) 924-6166  
BYTE Publications  
70 Main Street  
Peterborough, NH 03458

### International Advertising Sales Staff:

Mr. Hans Csokor  
Publimedia  
Reisnerstrasse 61  
A-1037 Vienna, Austria  
222 75 76 84

Mrs. Gurit Gepner  
McGraw-Hill Publishing Co.  
PO Box 2156  
Bat Yam, 59121 Israel  
3 866 561 321 39

Mr. Fritz Krusebecker  
McGraw-Hill Publishing Co.  
Liebigstrasse 19  
D-6000 Frankfurt/Main 1  
West Germany  
69 72 01 81

Mrs. Maria Sarmiento  
Pedro Teixeira B. Off. 320  
Iberia Mart I  
Madrid 4, Spain  
1 45 52 891

Mr. Andrew Karnig  
Andrew Karnig & Associates  
Finnbodavagen  
S-131 31 Nacka, Sweden  
8-44 0005

Mr. Alain Faure  
McGraw-Hill Publishing Co.  
128 Faubourg Saint Honore  
75008 Paris  
France  
(1) 47-20-33-42

Mr. Arthur Scheffer  
McGraw-Hill Publishing Co.  
34 Dover St.  
London W1X 3RA  
England 01 493 1451

Mr. Savio Pesavento  
McGraw-Hill Publishing Co.  
Via Flavio Baracchini 1  
20123 Milan, Italy  
02 86 90 617

Seavex Ltd.  
400 Orchard Road, #10-01  
Singapore 0923  
Republic of Singapore  
Tel: 734-9790  
Telex: RS35539 SEAVEX

Seavex Ltd.  
503 Wilson House  
19-27 Wyndham St.  
Central, Hong Kong  
Tel: 5-260149  
Telex: 60904 SEVEX HX

Hiro Morita  
McGraw-Hill Publishing Co.  
Overseas Corp.  
Room 1528  
Kasumigaseki Bldg.  
3-2-5 Kasumigaseki,  
Chiyoda-Ku  
Tokyo 100, Japan  
3 581 9811

# READER SERVICE

Inquiry No.	Page No.	Inquiry No.	Page No.	Inquiry No.	Page No.	Inquiry No.	Page No.
2 A.S.T. RESEARCH	19	* COMPAQ COMPUTER CORP	200, 201	144 FRANK HOGG LABORATORY	462	427-429 MACMILLAN SA W	156, 157
3 A.S.T. RESEARCH	19	77 COMPETITIVE EDGE	401	146 GENOA SYSTEMS CORP	145	215 MANX SOFTWARE SYS	173
4 ACM SIGGRAPH '86	375	78 COMPUTADATA TRANSLATORS INC	436	147 GLENCO ENGINEERING	168	216 MANX SOFTWARE SYS	301
* ACS IMPORTERS	429	* COMPUPRO	189	148 GOLD HILL COMPUTERS	268	217 MARC BAER ASSOCIATES	439
5 ACS INT'L INC.	328	79 COMPUSAVE	427	149 GOLDEN BOW SYSTEMS	431	218 MARK WILLIAMS CO	51
6 ADV. DIGITAL CORP.	28	80 COMPUSERVE	152	150 GOLDEN BOW SYSTEMS	434	219 MARK WILLIAMS CO	53
7 ADV. DIGITAL CORP.	28	81 COMPUSERVE	153	151 GTEK INC	37	221 MAXELL DATA PRODUCTS	7
8 ADV. INTELLIGENCE TECHN.	443	415 COMPUTER AFFAIRS INC	304	152 H.E.I. INC	56	222 MAYNARD ELECTRONICS	15
9 ADVANCED COMP PROD.	450, 451	91 COMPUTER AGE INC	440	* HARMONY COMPUTERS	405	223 MCGRAW-HILL SOFTWARE	22
10 ADVANCED DEVLPMNT TECHN.	84	83 COMPUTER BOOK CLUB THE	367	156 HAYES MICROCOMP PROD.	225	224 MCGRAW-HILL SOFTWARE	380
133 ADVANCED TECHN. PROD CORP	462	84 COMPUTER CONNECTION INC.	432	157 HERCULES COMPUTER TECH.	122	225 MEGA DATA CORP	221
11 AFTON COMPUTER	362	* COMPUTER CONTINUUM	431	158 HERCULES COMPUTER TECH.	234	226 MEGASOFT	462
12 AFTON COMPUTER	362	417 COMPUTER FRIENDS	387	159 HERITAGE SYSTEMS CORP.	436	227 MEGATEL COMPUTER TECH.	52
13 ALF PRODUCTS INC.	429	86 COMPUTER MAIL ORDER	212, 213	160 HERSEY MICRO CONSULTING	429	228 MERRITT COMP PRODUCTS	431
14 ALPHA MICRO	271	87 COMPUTER PARTS MART	460	161 HOOLEON COMPANY	218	229 MFI ENTERPRISES INC.	302
16 AMDEK CORP.	316, 317	88 COMPUTER SURPLUS STORE	436	162 HOOLEON COMPANY	218	230 MICRO DATA BASE SYS.	347
18 AMERICAN MICRO TECHNOLOGY	310	89 COMPUTER WAREHOUSE	242	163 HOUSTON INSTR BAUSCH&LOMB	21	231 MICRO DESIGN INT'L	261
19 AMERICAN MICRO TECHNOLOGY	310	90 COMPUTER WAREHOUSE	242	* HOWARD W SAMS CO	116	232 MICRO MART INC	72, 73
20 AMERICAN SMALL BUSN. COMP	109	92 COMPUTERBANC	437	173 IBC/INNOVENTION	222	233 MICRO PRODUCTS	461
22 APPARAT INC.	460	277 COMPUTERS INT'L	142	165 IBEX COMP CORP	436	234 MICROBRIDGE COMP. INT'L	440
418 APPLIED SOFTWARE KINETICS	462	94 COMPUTRADE	386	166 IBM - (ISC) SERVICES	127	235 MICROCOMPUTER ACCESSORIES	136
421 APROTEK	74	95 CONROY-LAPOINTE	57	167 IBM - (ISC) SERVICES	296, 297	236 MICROCOMPUTER ACCESSORIES	136
422 APROTEK	74	96 CONROY-LAPOINTE	57	168 IBM - (ISC) SERVICES	396, 397	237 MICROGRAFX	17
425 ARRAY TECHNOLOGIES INC.	277	97 CONROY-LAPOINTE	57	169 IBS CORP	346	* MICROMINT INC	384
426 ARRAY TECHNOLOGIES INC.	277	98 COSMOS	298	170 IBS CORP	346	238 MICROPRO INT'L	306, 307
25 ARTEK CORP	252	399 COTTON SOFTWARE INC	390	171 IC EXPRESS	440	239 MICROPROCESSORS UNLTD.	460
26 ASHTON-TATE	248, 249	101 CUESTA SYSTEMS	210	172 INNER LOOP SOFTWARE	433	* MICROFORM INC	340, 341
27 ATARI	12, 13	102 CURTIS INC	439	* INTECTRA INC.	433	* MICROSOFT CORP.	179
28 ATARI	12, 13	423 CUSTOM COMP TECH.	426	174 INTEGRAND	356	* MICROSOFT CORP. INSERT	272 A-H
29 ATRON CORP	322	424 CUSTOM COMP TECH	426	416 INTELLIGENCE RESEARCH	345	240 MICROWAY	75
30 ATRONICS INT'L INC.	217	104 D AND D DISCOUNT	441	175 INTERCONTN. MICRO SYS	318	241 MICROWAY	319
31 AVOCET	95	105 DAC SOFTWARE INC.	45	176 INTERCONTN. MICRO SYS.	318	214 MIS	259
32 B&B ELECTRONICS	439	107 DATA EXCHANGE	433	* INTERFACE TECH CORP.	110	242 MITSUBA CORP	224
* B&C MICROSYSTEMS	429	109 DATA ZONE	332	* INTERFACE TECH CORP.	205	243 MITSUBA CORP	224
* B&C MICROSYSTEMS	429	110 DATACOM NORTHWEST INC	433	177 IOMEGA	360, 361	* MIX SOFTWARE	211
34 BASF SYSTEMS	154, 155	110 DATAMED	460	178 IO TECHNOLOGIES	368	244 MOUNTAIN VIEW PRESS	291
35 BAY TECHNICAL ASSOC	147	111 DIGITALK INC.	18	179 IO TECHNOLOGIES	370	247 NANA O USA CORP	281
36 BITTNER ELECTRONICS	295	82 DISKCO TECH	439	180 ITT INFORMATION SYSTEMS	192	248 NANA O USA CORP.	281
450 BIX	388, 389	112 DISKETTE CONNECTION	333	181 ITT INFORMATION SYSTEMS	192	249 NANTUCKET	39
37 BLAISE COMPUTING INC.	393	113 DISKS PLUS	405	182 IADE COMP. PROD.	458, 459	250 NANTUCKET	39
38 BLAISE COMPUTING INC.	393	114 DISK WORLD! INC	446, 447	183 IAMECO ELECTRONICS	454, 455	251 NAT'L PUBLIC DOMAIN SFTW.	439
39 BNW ASSOCIATES	196	115 DISPLAY TELECOMMUNCTS	373	184 IDR INSTRUMENTS	207	252 NATIONAL INSTRUMENTS	186
40 BORLAND INT'L	CII, 1	116 DIVERSIFIED COMPUTER SYS	440	414 IDR MICRODEVICES	463	403 NEC HOME ELECTR USA	369
41 BORLAND INT'L	CII, 1	117 DIVERSIFIED GROUP THE	448, 449	185 IDR MICRODEVICES	464, 465	253 NEC INFORMATION SYS	CIII
42 BORLAND INT'L	33	118 DOKAY COMP PROD INC	428	186 IDR MICRODEVICES	466, 467	254 NICOLET PARATRONICS	170
43 BORLAND INT'L	33	420 DOW JONES NEWS RETRIEVAL	351	187 IDR MICRODEVICES	468	255 NORTH HILLS CORP	431
406 BORLAND INT'L	103	119 DRESSSELHAUS COMP PROD.	196	383 IM SYSTEM INC.	134	* NRI SCHOOLS ELECTR. DIV.	321
407 BORLAND INT'L	103	120 DYNAMUS MICRO DATA SYS	460	188 KADAK PRODUCTS LTD.	433	256 O'HANLON COMP SYS	355
44 BP MICROSYSTEMS	440	121 EARTH COMPUTERS	48	397 KEA SYSTEMS	436	257 O'HANLON COMP SYS.	355
285 BRADY COMM. CO. INC.	214	122 EARTH COMPUTERS	48	189 KEITHLEY DAC	429	258 OASYS	314
45 BROWN BAG SOFTWARE	303	123 ECOSOFT	238	190 KENSINGTON MICROWARE	160	259 ORCHID TECHNOLOGY	47
93 BTE COMPUTERS	68	124 EDUCATIONAL MICROCOMP SYS	295	192 KEY SOLUTIONS CO.	353	260 ORCHID TECHNOLOGY	226
47 BUSINESS TOOLS INC	371	125 ELEXOR INC.	433	193 KEY SOLUTIONS CO.	353	261 ORION INSTRUMENTS	247
48 BYTE CONNECTION THE	438	126 ELLIS COMPUTING INC.	69	194 KIMTRON CORP	223	262 PC COMPUTER BROKFRS.	431
* BYTE BACK ISSUES	427	127 EMERALD SYSTEMS CORP.	149	195 KIMTRON CORP	223	263 PC HORIZONS INC	431
419 BYTE BITS (2x3)	462	128 EMERALD SYSTEMS CORP.	149	196 LABORATORY MICROSYS.	358	264 PAC RESEARCH	462
* BYTE SUB. MESSAGE	330	129 ENERTRONICS RESEARCH	167	197 LAHEY COMPUTER SYSTEMS	52	265 PACIFIC EXCHANGES	433
49 BYTEK COMP SYS CORP.	359	131 EVEREX SYSTEMS	31	198 LAPTOPP SYSTEMS	391	266 PANASONIC COMPUTER DIV	55
99 CEC	401	132 EVEREX SYSTEMS	31	199 LATTICE INC.	331	267 PANASONIC COMPUTER DIV.	339
* C WARE/DESMET C	434	134 FIFTH GENERATION SYSTEMS	327	200 LAWSON LABS INC	295	269 PASCOM COMPUTING	337
51 C.I. COMPUTERS	336	135 FIFTH GENERATION SYSTEMS	327	201 LIFEBOAT ASSOC	349	270 PATHFINDER SOFTWARE INC	462
52 C.I. COMPUTERS	336	136 FLAGSTAFF ENGINEERING	71	202 LINTEK COMP ACCESSORIES	460	271 PC NETWORK	79
55 CALIF. COMPUTER COMPONENT	282	137 FLAGSTAFF ENGINEERING	71	203 LOGICAL DEVICES.	324	272 PC NETWORK	80, 81
* CALIFORNIA DIGITAL	456, 457	138 FLAMINGO MICRO	216	204 LOGICAL DEVICES	325	* PC SOURCE	INSERT 48 A-B
57 CANON US A	198, 199	139 FORESIGHT RESOURCES CORP	26, 27	400 LOGICSOFT	INSERT 288 A-F	273 PC TECH	346
58 CANON US A	287	140 FORESIGHT RESOURCES CORP	26, 27	208 LOGITECH INC	35	274 PC'S LIMITED	60, 61
59 CAPITAL EQUIPMENT CORP.	378	410 FORTRON CORPORATION	403	209 LOGITECH INC	141	275 PC'S LIMITED	240
61 CAUZIN SYSTEMS	406, 407	411 FORTRON CORPORATION	403	210 LOMAS DATA PRODUCTS	278	276 PECAN SOFTWARE SYS. INC.	263
62 CENTROID	431	141 FORTRON CORPORATION	430	211 LYBEN COMP SYS.	210	* PERCON	434
63 CHALCEDONY SOFTWARE	66	142 FORTRON CORPORATION	430	212 LYCO COMPUTER	264	280 PERMA POWER ELECTRONICS	41
64 CHALCEDONY SOFTWARE	66	143 FOX SOFTWARE INC.	20	* MACMILLAN BOOK CLUB	209	281 PERSOFT INC	8
65 CHORUS DATA SYSTEMS	129					282 PERSONAL TEX. INC.	70
66 CITIBANK NA	131					283 PINE COMPUTER INC	438
67 CITIZEN AMERICA	174, 175					284 PRECISION DATA PRODUCTS	460
70 CMS	342					* PRINCETON GRAPHIC SYS	239, 241, 243
71 CMS	342					288 PRINCETON GRAPHIC SYS	245
* CODEX CORPORATION	390, 392, 394					289 PRINCETON GRAPHIC SYS	376, 377
75 COGITATE	434					290 PRINCETON GRAPHIC/SIGMA	119
76 COGITATE	440					291 PRINTER ACCESSORIES DIRECT	359
* COMMODORE BUSN. MACH.	150					292 PRIORITY ONE	435

TO GET FURTHER information on the products advertised in BYTE, either pick up your touch-tone telephone and use TIPS (if you are a subscriber), or fill out the reader service card. Either way full instructions are provided following this reader service index which is provided as an additional service by the publisher, who assumes no liability for errors or omissions. \*Correspond directly with company.



# TODAY IS THE BLACKEST DAY IN DOT MATRIX PRINTER HISTORY.

It would pay you to mark it on your calendar.

Because today is the day we introduce our new Pinwriter™ P5XL dot matrix printer. The only dot matrix printer available capable of producing the rich, black printing you associate with a letter-quality printer. Because it's the only one designed to use a multi-strike film ribbon – the same ribbon used in typewriters and letter-quality printers.

## A LITTLE BLACK MAGIC.

Actual line printed with the  
Pinwriter P5XL printer.

print in seven other colors. And it has the finest graphics resolution of any impact printer you can buy. Plus it's very fast and exceptionally quiet.

It's only natural that

Black letter-quality printing is only the beginning. The Pinwriter P5XL printer can also use an optional ribbon to

the first dot matrix printer with true letter-quality printing should be an NEC. After all we make Spinwriter® letter-quality printers, the most popular line today, as well as the Pinwriter P5 dot matrix printer, the most advanced 24-pin printer.

The Pinwriter P5XL printer is part of the most extensive line of 24-pin printers available. You'll find a model designed to fit every need and budget. See them at your dealer or call 1-800-343-4418 (in MA 617-264-8635). Or write: NEC Information Systems, Dept. 1610, 1414 Massachusetts Ave., Boxborough, MA 01719.

**NEC PRINTERS. THEY ONLY STOP  
WHEN YOU WANT THEM TO.**



# NEC

NEC Information Systems, Inc.  
Inquiry 253



# We edged out the competition with better solutions for every application.

## Presenting the Tandy® line of PC-compatible computers

At Radio Shack Computer Centers, you won't find just any computer; you'll find the *right* computer.

### The Tandy 1000 is America's #1 PC compatible

Looking for a complete, low-cost MS-DOS® system? The Tandy 1000 is compatible with the IBM® PC, so there are thousands of programs for you to choose from. Plus, the 1000 comes complete with its own DeskMate® 6-in-1 software.

### The Tandy 1200—the PC/XT's "mirror image"

The Tandy 1200 works like an IBM PC/XT—but costs much less. The 1200 runs the same top-name software and supports the same hardware as the PC/XT. So if you're

already using one or more IBM PC's in your office, the Tandy 1200 lets you expand for less—and continue using the same software.

### The Tandy 2000 for advanced graphics and high performance

Searching for a high-powered computer with advanced graphics capabilities? Take a good look at the affordable Tandy 2000. The Tandy 2000 gives you the high-resolution graphics you need to create razor-sharp graphs and diagrams in a brilliant array of colors.

### The new Tandy 3000 for super power and compatibility

Introducing a powerful computer that's the affordable alternative to the IBM PC/AT. The Tandy 3000 has the power you need, and it's compatible with PC/AT and PC/XT

software. And with the forthcoming XENIX® operating system, two to six users will be able to use the 3000 simultaneously.

### Tandy . . . Clearly Superior™

Discover the power and affordability of the Tandy 3000 and all of our MS-DOS computers. Drop by your local Radio Shack Computer Center today. And while you're there, pick up a free copy of our new 1986 Radio Shack Software Reference and Tandy Computer Guide. Come in today!

Available at over 1200  
Radio Shack Computer Centers and at  
participating Radio Shack stores and dealers.

**Radio Shack®**  
**COMPUTER CENTERS**  
A DIVISION OF TANDY CORPORATION