

# BYTE

THE SMALL SYSTEMS JOURNAL®

MARCH 1986 VOL. 11, NO. 3

\$3.50 IN UNITED STATES  
\$4.25 IN CANADA / £2.10 IN U.K.  
A MCGRAW-HILL PUBLICATION  
0360-5280

ATARI 1040ST

HOMEBOUND  
COMPUTING



SAVE OVER 30% ON OUR GIFT PACKS!

**TURBO "NEW" PACK \$95.00**

You get both our terrific new Turbos, and pay only \$47.50 each. Sold separately, they're \$69.95 each.

- Turbo GameWorks™
- Turbo Editor Toolbox™



**TURBO HOLIDAY PACK \$125.00**

At about a 30% savings, you get our standard holiday special.

- Turbo Pascal® 3.0
- Turbo Tutor®
- Turbo DataBase Toolbox™

All this for only \$125.00. See the order form at right.

Turbo Pascal and Turbo Tutor are registered trademarks, and Turbo Database Toolbox, Turbo Graphics Toolbox, Turbo Editor Toolbox, Turbo GameWorks, and MicroStar are trademarks of Borland International, Inc. WordStar is a trademark of MicroPro International Corp. Multi-Mate is a trademark of Multi-Mate International Corp. Microsoft is a registered trademark and Windows a trademark of Microsoft Corp. WordPerfect is a trademark of Software International.

# Announcing Borland's New Turbo Editor Toolbox™ \$69.95

**IT'S ALL YOU NEED TO BUILD YOUR OWN WORD PROCESSOR FOR ONLY \$69.95!**

You get all the modules you need to build your own word processor.

- You get ready-to-compile source code.
- You get a full-featured WordStar™-like word processor, we call it MicroStar™. You get a 200-page manual that tells
- you how to integrate the editor procedures and functions into your programs.

You can use Turbo Editor Toolbox "as is" or modify it any way you want.

And you don't get a bill for Royalties. Because Borland doesn't believe you should pay for something more than once.

All this and more for only \$69.95.

And until March 1, 1986 you can get Borland's new Turbo Editor Toolbox for even less! (Only \$47.50 when you buy the special Turbo New Pack.)

**YOU CAN HAVE MANY WINDOWS ON THE WORLD.** The new Turbo Editor Toolbox features windowing, a technique that lets you see several documents—or several parts of the same document—at once. You know best what your needs are. Turbo Editor Toolbox lets you open the windows you want. And to make those windows part of your program.

**WITH TURBO EDITOR TOOLBOX YOU CAN HAVE THE BEST OF ALL WORD PROCESSORS IN YOUR WORD PROCESSOR.** You can make WordStar behave like Multi-Mate. Support windows just like Microsoft's® Word™. And do it as fast as WordPerfect does it. Incorporate your new "hybrids" into your programs to achieve incredible control and power.

Turbo Editor Toolbox. It's the kind of tool that almost everyone needs—and we're the kind of company to give it to you at a reasonable price, without any compromise on quality. (We're so sure you'll be satisfied that we offer a 60-day money-back guarantee—something no one else does.)

### THE CRITICS' CHOICE

"Turbo Pascal has got to be the best value in languages on the market today—and Borland International, by delivering excellent products at reasonable costs, is leading the software industry where it has to go. Turbo Pascal is more than just a good program at a low cost. It's also a low-cost, well-conceived programming language making it possible for lots of people to produce good programs."

**Jerry Pournelle, BYTE**

"This compiler, produced by Borland International, is one of the best programming tools presently available for the PC."

**Michael Covington, PC Tech Journal**

"Language deal of the century... Turbo Pascal."

**Jeff Duntemann, PC Magazine**



# Three Special Gift Packs

60-DAY MONEY-BACK GUARANTEE

# Introducing Borland's New Turbo GameWorks™ \$69.95

**THE GAMES YOU CAN PLAY, REPLAY, REVISE AND REWRITE BUT CANNOT RESIST.**  
(Turbo Pascal Source Code included!)

We give you the source code, the manual, the diskettes, the 60-day guarantee and the competitive edge. Let the games begin. Chess. Bridge. Go-Moku.

State-of-the-art games that let you be player, referee, and rules committee—because you have the Turbo Pascal source code. Which means that you can play a game or create a game, any time and any way you want.

Borland's new Turbo GameWorks lets you combine gamesmanship with craftsmanship. Discover the secret techniques and moves used by the Old Masters. Learn exactly how state-of-the-art computer games are made—so you can go off and make your own. Since you have the source code, you can always change the game. Or rig the game, if no one's looking. Pure Magic. That's Turbo GameWorks. And part of the "sorcery"—Turbo GameWorks is only \$69.95. When combined with our new Turbo Editor Toolbox in the Turbo New Pack, it's only \$47.50.

**SHORT CUTS, SECRETS AND STRATEGIES.** The Turbo GameWorks manual takes you step-by-step through all the games. How to play them. How to modify them. How to use the power of Turbo Pascal to write new games.

You'll learn general problem analysis, how to identify all possible moves, "rule of thumb" strategies, procedures for testing strategies, and ways to rate options. You'll also be introduced to "top down" program design, the development of basic algorithms, the use of constants and data structures and ways to design short cuts with incremental updating.

On top of all that, you'll have a lot of fun (if you want to).

So go to play (and work) with Borland's new Turbo GameWorks. It's unique. It's fascinating. And it's brand-new. Be first with the latest and greatest—order your Turbo GameWorks today.

4585 SCOTTS VALLEY DRIVE, SCOTTS VALLEY, CA 95066 PHONE (408) 438-8400 TELEX 172373

Inquiry 42 for End-Users. Inquiry 43 for DEALERS ONLY.

**With Dazzling Discounts!**

## BORLAND'S TURBO GAMEWORKS AND SOME OF ITS MASTER PIECES

**Chess**, the ultimate strategic game. A game so old that no one knows its exact origins. Turbo GameWorks lets you play chess at six different levels from the beginner to the sophisticated user. And you have many ways of playing with your Turbo GameWorks. Let the computer solve checkmate problems. Set the time limit for each game. And there's more.

Decide whether you or the computer "goes first." Trade places with the computer at any point in the game. It's all possible with GameWorks.

**Go-Moku**, also known as "Five-in-Line," is a very old Japanese game played on a board of squares. The first player to get five game pieces in a row—either horizontally, vertically, or diagonally—wins the game.

It's an intriguing game. But you're not limited to playing it one way. With Turbo GameWorks, you can modify it your way.

**Bridge.** Play bridge with a friend or team up against the program—you decide which hands the computer plays. You can even decide to let the program cheat! The program automatically bids and plays its own hands. And, since you can tinker with the source code, you can make "your" Bridge unlike any other.

NEW!

NEW!

## TURBO HOLIDAY JUMBO PACK

**\$245.00**

Now you get the whole Turbo Pascal family, including its newest members, at an incredible price.

- Turbo Pascal 3.0 combines an integrated programming environment with the fastest Pascal compiler in the galaxy.
- Turbo Tutor teaches you step-by-step how to use the Turbo Pascal development environment. With commented source code for all program examples on diskette.
- Turbo DataBase Toolbox gives you all the tools you need to sort and search your data and build powerful database applications.
- Turbo Graphix Toolbox™ gives you a complete library of Pascal procedures to build applications using high resolution graphics and graphics window management.
- Turbo GameWorks—Chess, Bridge, Go-Moku: Secrets and strategies of state-of-the-art computer games are revealed with complete source code.
- Turbo Editor Toolbox—the Pascal tyodules that let you build your own word processor. A full-featured WordStar-like program, MicroStar™, is included on your disk.

You're getting everything at only \$40 each. And if you already own one or several members of the Turbo family, be creative—nothing can stop you from buying the Jumbo Pack, picking out the ones you already have and giving them as holiday gifts for family or friends. At these prices you can afford to give to others and to yourself.

**Holiday Gift Packs, Turbo GameWorks™ & Turbo Editor Toolbox™**

Available at better dealers nationwide.  
To order by Credit Card call (800) 255-8008, CA (800) 742-1133.

	Quantity
* Turbo Holiday Jumbo Pack	\$245.00
* Turbo Holiday Pack	\$125.00
* Turbo New Pack	\$95.00
* Turbo Pascal	\$69.95
Pascal w/8087	\$109.90
Pascal w/BCD	\$109.90
Pascal w/8087 and BCD	\$124.95
Turbo DataBase	\$54.95
Turbo Graphix	\$34.95
Turbo Tutor	\$69.95
Turbo Editor	\$69.95
Turbo GameWorks	\$69.95

These prices include shipping to all U.S. cities. All foreign orders add \$10 per product ordered.

Amount: (CA add 6% tax) \_\_\_\_\_  
 Payment:  VISA  MC  Check  Bank Draft  
 Credit Card Expiration Date: \_\_\_\_\_  
 Card # \_\_\_\_\_

**Gift Pack Offers Last Until March 31, 1986**

NOTE: Turbo Editor Toolbox and Turbo GameWorks are available for the IBM PC and true-compatibles using Turbo Pascal 3.0 ONLY.

COD's and Purchase Orders will not be accepted by Borland International. California residents: add 6% sales tax. Outside USA: add \$10 and make payment by bank draft, payable in U.S. dollars drawn on a U.S. bank. H15

# CONTENTS

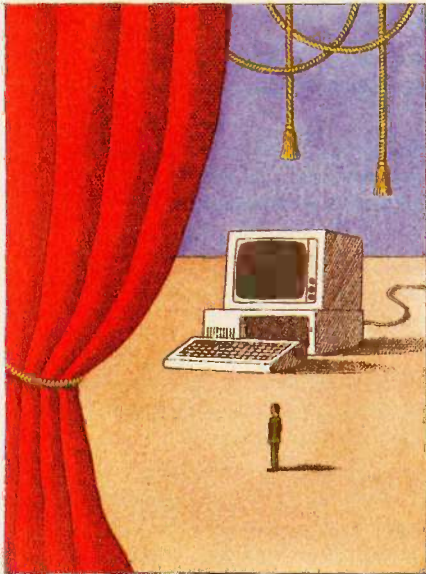

82

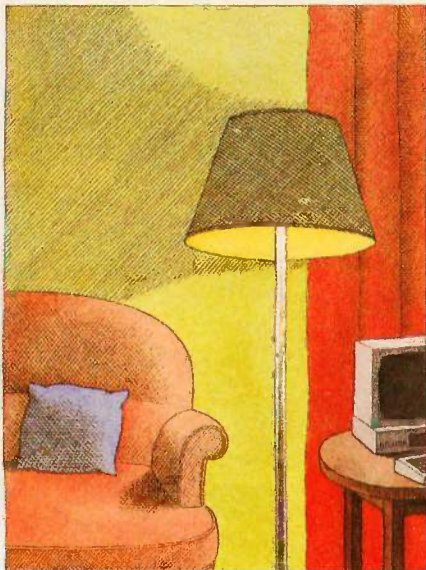

152

## FEATURES

- INTRODUCTION** ..... 82
- PRODUCT PREVIEW: THE ATARI 1040ST** by Phillip Robinson and Jon R. Edwards ..... 84  
Two BYTE editors take a look at Atari's new \$999 1-megabyte machine.
- FINDING THE TITANIC** by Marti Spalding and Ben Dawson ..... 96  
After 73 years, the wreck of the *R.M.S. Titanic* was discovered with help from the latest in image-processing equipment.
- CIARCIA'S CIRCUIT CELLAR: REAL-TIME CLOCKS: A VIEW TOWARD THE FUTURE** by Steve Ciarcia ..... 112  
Steve presents two real-time clocks, one of which also provides nonvolatile RAM.
- PROGRAMMING PROJECT: A SIMPLE WINDOWING SYSTEM, PART 1: BASIC PRINCIPLES** by Bruce Webster ..... 128  
Bruce examines the problems involved in opening a window.
- AN ANSI STANDARD FOR THE C LANGUAGE** by Steve A. Hersee and Dan Knopoff ..... 135  
ANSI has set up a standardization committee to develop a universal set of rules for this popular language.
- PROGRAMMING INSIGHT: MACINTOSH EXPLORER** by Olav Andrade ..... 145  
This disassembler, which translates machine code to human-readable mnemonics, was written in Microsoft BASIC for Apple's Macintosh.

## THEME: HOMEBOUND COMPUTING

- INTRODUCTION** ..... 152
- WORKING AT HOME WITH COMPUTERS** by Jane Morrill Tazelaar ..... 155  
For some, telecommuting is a choice; for others, it is the only option.
- USING IMAGES TO GENERATE SPEECH** by Bruce R. Baker ..... 160  
Semantic compaction lets speech-impaired people communicate quickly and effectively in a variety of environments.
- THE ELECTRONIC UNIVERSITY NETWORK** by Donna Osgood ..... 171  
Get a degree without ever leaving your computer.
- THE TECHNOLOGY OF THE KURZWEIL VOICE WRITER** by Raymond Kurzweil ..... 177  
The present office system provides a clue to future applications for the deaf.
- INCREASING INDEPENDENCE FOR THE AGING** by K. G. Engelhardt and Roger Edwards ..... 191  
Robotic aids and smart technology can help us age less dependently.
- COMPUTING FOR THE BLIND USER** by Aries Arditi and Arthur E. Gillman ..... 199  
Some special human factors must be considered in assembling a workable system.

## REVIEWS

- INTRODUCTION** ..... 212
- REVIEWER'S NOTEBOOK** by Glenn Hartwig ..... 215
- KAYPRO 2861** by Harry Krause ..... 217  
An AT clone with a lower price.

BYTE (ISSN 0360-5280) is published monthly with one extra issue per year by McGraw-Hill Inc. Founder: James H. McGraw (1860-1948). Executive editorial circulation, and advertising offices: 70 Main St., Peterborough, NH 03458, phone (603) 924-9281. Office hours: Mon-Thur 8:30 AM - 4:30 PM, Friday 8:30 AM - 1:00 PM, Eastern Time. Address subscriptions to BYTE Subscriptions, POB 590, Martinsville, NJ 08836. Postmaster: send address changes, USPS Form 3579, undeliverable copies, and fulfillment questions to BYTE Subscriptions, POB 596, Martinsville, NJ 08836. Second-class postage paid at Peterborough, NH 03458 and additional mailing offices. Postage paid at Winnipeg, Manitoba, Registration number 9321. Subscriptions are \$21 for one year, \$38 for two years, and \$55 for three years in the USA and its possessions, in Canada and Mexico, \$23 for one year, \$42 for two years, \$61 for three years, \$69 for one year air delivery to Europe, 17,100 yen for one year surface delivery to Japan, \$37 surface delivery elsewhere. Air delivery to selected areas at additional rates upon request. Single copy price is \$3.50 in the USA and its possessions, \$4.25 in Canada and Mexico, \$4.50 in Europe, and \$5 elsewhere. Foreign subscriptions and sales should be remitted in United States funds drawn on a U.S. bank. Please allow six to eight weeks for delivery of first issue. Printed in the United States of America.

# BYTE March

VOLUME 11, NUMBER 3, 1986

<b>MODULA-2 SYSTEM FOR Z80 CP/M</b> by Brian R. Anderson . . . . .	225
Hochstrasser's system supports most features as defined by Niklaus Wirth.	
<b>POCKET APL</b> by Eric H. Johnson . . . . .	237
STSC's inexpensive implementation.	
<b>ARITY/PROLOG</b> by William G. Wong . . . . .	245
A version for MS-DOS machines.	
<b>BRILLE-EDIT</b> by Henry Brugsch . . . . .	251
Raised Dot's talking word processor.	
<b>PRINTIT</b> by Henry Brugsch and Joseph J. Lazzaro . . . . .	261
A card that lets you print anything on an Apple II screen.	
<b>REVIEW FEEDBACK</b> . . . . .	265
Readers respond to previous reviews.	

## KERNEL

<b>INTRODUCTION</b> . . . . .	266
<b>COMPUTING AT CHAOS MANOR: ALL SORTS OF SOFTWARE</b> by Jerry Pournelle . . . . .	269
Jerry survives his BIX party and spends a busy month looking at new software.	
<b>CHAOS MANOR MAIL</b> conducted by Jerry Pournelle . . . . .	293
Jerry's readers write, and he replies.	
<b>APPLICATIONS ONLY: FIRST IN A SERIES</b> by Ezra Shapiro . . . . .	297
In this new column Ezra examines four software products.	
<b>ACCORDING TO WEBSTER: 68000 WARS: ROUND 1</b> by Bruce Webster . . . . .	305
Bruce begins his comparison of the three prominent 68000 computers.	
<b>BYTE JAPAN: A NEW LANGUAGE AND A LAPTOP</b> by William M. Raiké . . . . .	327
Bill looks at an all-japanese programming language called Mind and at the Fujitsu FM-16 $\pi$ .	
<b>BYTE U.K.: THE AMSTRAD PCW 8256</b> by Dick Pountain . . . . .	333
This new, completely functional, Z80-based computer and word processor from the U.K. costs less than most electric typewriters.	
<b>MATHEMATICAL RECREATIONS: DIOPHANTINE EQUATIONS</b> by Robert T. Kurosaka . . . . .	343
Who was Diophantus? Here's one way to find out.	
<b>CIRCUIT CELLAR FEEDBACK</b> conducted by Steve Ciarcia . . . . .	354
Steve answers project-related queries from readers.	

<b>EDITORIAL:</b>	
WISHES FOR SPRING: A WIDER CIRCLE . . . . .	6
<b>MICROBYTES</b> . . . . .	9
<b>LETTERS</b> . . . . .	14
<b>FIXES AND UPDATES</b> . . . . .	33
<b>WHAT'S NEW</b> . . . . .	37, 399
<b>ASK BYTE</b> . . . . .	44
<b>CLUBS AND NEWSLETTERS</b> . . . . .	54

<b>BOOK REVIEWS</b> . . . . .	57
<b>EVENT QUEUE</b> . . . . .	78
<b>DISKS AND DOWNLOADS</b> . . . . .	358
<b>BEST OF BIX</b> . . . . .	367
<b>UNCLASSIFIED ADS</b> . . . . .	461
<b>BYTE'S ONGOING MONITOR BOX:</b>	
BOMB RESULTS . . . . .	462
<b>READER SERVICE</b> . . . . .	463

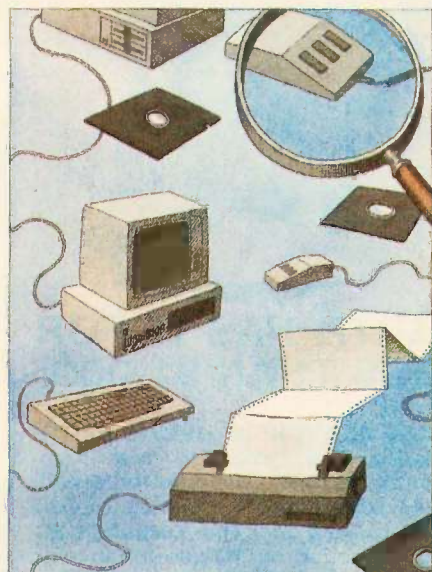

212

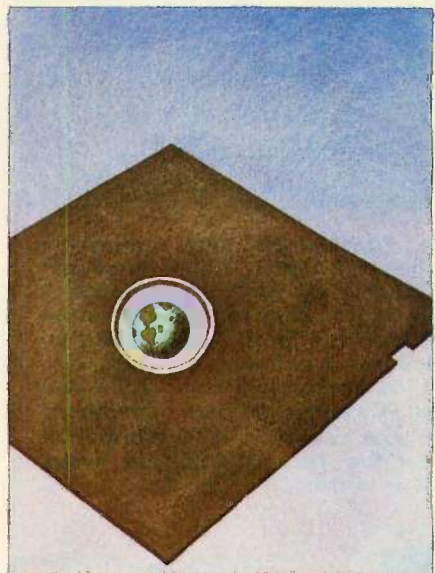

266

Address all editorial correspondence to the Editor, BYTE, POB 372, Hancock, NH 03449. Unacceptable manuscripts will be returned if accompanied by sufficient first-class postage. Not responsible for lost manuscripts or photos. Opinions expressed by the authors are not necessarily those of BYTE. Copyright © 1986 by McGraw-Hill Inc. All rights reserved. Trademark registered in the United States Patent and Trademark Office. Where necessary, permission is granted by the copyright owner for libraries and others registered with the Copyright Clearance Center (CCC) to photocopy any article herein for the flat fee of \$1.50 per copy of the article or any part thereof. Correspondence and payment should be sent directly to the CCC, 29 Congress St., Salem, MA 01970. Specially ISSN 0360-5280/83 \$1.50. Copying done for other than personal or internal reference use without the permission of McGraw-Hill Inc. is prohibited. Requests for special permission or bulk orders should be addressed to the publisher. BYTE is available in microform from University Microfilms International, 300 North Zeeb Rd., Dept. PR, Ann Arbor, MI 48106 or 18 Bedford Row, Dept. PR, London WC1R 4EJ England.



Subscription questions or problems should be addressed to: BYTE Subscriber Service, POB 328, Hancock, NH 03449

# LOOKING FOR AT PERFORMANCE FROM YOUR PC?



## EARTH HAS IT FOR LESS THAN \$1,000!

**YOUR SEARCH IS OVER!! EARTH COMPUTERS' exciting new high-speed, 80286 accelerator card, TurboACCEL-286™, is just what you've been looking for. The TurboACCEL-286 will boost your PC performance up to Five times...its completely software transparent...and its only \$995! TurboACCEL-286 will function with most operating systems and application programs (unlike other so-called accelerator boards).**



The TurboACCEL-286 features a high-speed, 8MHz, 80286 processor, 512Kbytes of RAM (expandable to 1Mbytes), a switch for 8088 operation, and facilities for an 80287 math co-processor. It occupies one expansion slot, is completely compatible with most PCs and is software transparent. End your search for AT performance. Order the TurboACCEL-286 today! Call or write:



**EARTH COMPUTERS**

P.O. Box 8067, Fountain Valley, CA 92728  
TELEX: 910 997 6120 EARTH FV

### (714) 964-5784

Ask about EARTH COMPUTERS' other fine PC and S-100 compatible products.

# BYTE

**EDITOR IN CHIEF**  
PHILIP LEMMONS  
**MANAGING EDITOR, PRINT**  
GENE SMARTE  
**MANAGING EDITOR, ELECTRONIC PUBLISHING AND COMMUNICATIONS**  
GEORGE BOND  
**CONSULTING EDITORS**  
STEVE CIARCIA  
JERRY POURNELLE  
BRUCE WEBSTER  
**SENIOR TECHNICAL EDITORS**  
G. MICHAEL VOSE, *Themes*  
GREGG WILLIAMS  
**TECHNICAL EDITORS**  
DENNIS ALLEN  
THOMAS R. CLUNE  
JON R. EDWARDS  
RICHARD GREHAN  
GLENN HARTWIG, *Reviews*  
KEN SHELDON  
JANE MORRILL, *TAZELAAR*  
TOM THOMPSON  
CHARLES D. WESTON  
EVA WHITE  
STANLEY WSZOLA

**ASSOCIATE TECHNICAL EDITORS**  
MARGARET COOK GURNEY, *Book Reviews*  
DONNA OSGOOD, *San Francisco*  
**NEWS AND TECHNOLOGY**  
EZRA SHAPIRO, *Bureau Chief, San Francisco*  
RICH MALLOY, *Senior Technical Editor, New York*  
PHILLIP ROBINSON, *Senior Technical Editor, Palo Alto*  
TONY LOCKWOOD, *Senior News Editor, Peterborough*  
**ASSOCIATE NEWS EDITORS**  
DENNIS BARKER, *Peterborough*  
CATHRYN BASKIN, *Peterborough*  
BRENDA McLAUGHLIN, *San Francisco*  
LYNNE M. NADEAU, *Peterborough*

**CONTRIBUTING EDITORS**  
JONATHAN AMSTERDAM, *programming projects*  
DAVID BETZ, *programming*  
MARK HAAS, *at large*  
RIK JADRNICKEK, *CAD, graphics, spreadsheets*  
ROBERT T. KUROSAKA, *mathematical recreations*  
PHIL LOPICCOLO, *computers in medicine*  
ALASTAIR J. W. MAYER, *software*  
ALAN MILLER, *languages and engineering*  
DICK POUNTAIN, *U.K.*  
WILLIAM M. RAIKE, *Japan*  
ROBERT STERNE, *computers and law*

**COPY EDITORS**  
BUD SADLER, *Chief*  
ELIZABETH COOPER  
FAITH HANSON  
NANCY HAYES  
CATHY KINGERY  
ANNE FISCHER LENT  
PAULA NOONAN  
JOAN VIGNEAU ROY  
WARREN WILLIAMSON

**ASSISTANTS**  
PEGGY DUNHAM, *Office Manager*  
MARTHA HICKS  
JUNE N. SHELDON  
JUDY WINKLER

**ART**  
ROSSLYN A. FRICK, *Art Director*  
NANCY RICE, *Associate Art Director*  
JAN MULLER, *Art Assistant*  
ALAN EASTON, *Drafting*

**PRODUCTION**  
DAVID R. ANDERSON, *Production Director*  
DENISE CHARTRAND  
MICHAEL I. LONSKY  
VIRGINIA REARDON

**TYPOGRAPHY**  
SHERRY MCCARTHY, *Chief Typographer*  
LEN LORETTE  
DONNA SWEENEY

**Editorial and Business Office:** 70 Main Street, Peterborough, New Hampshire 03458, (603) 924-9281.  
**West Coast Offices:** McGraw-Hill, 425 Battery St., San Francisco, CA 94111, (415) 362-4600.  
**McGraw-Hill, 1000 Ellwell Court, Palo Alto, CA 94303, (415) 964-0624.**  
**New York Editorial Office:** 1221 Avenue of the Americas, New York, NY 10020, (212) 512-2900.

**SENIOR VICE PRESIDENT/PUBLISHER**  
HARRY L. BROWN  
**PUBLISHER'S ASSISTANT**  
BEVERLY JACKSON

**PERSONNEL**  
CHERYL HURD, *Office Manager*  
PATRICIA BURKE, *Personnel Coordinator*

**CIRCULATION (800-258-5485)**  
GREGORY SPITZFADEN, *Director*  
ANDREW JACKSON, *Subscriptions Manager*  
CATHY A. RUTHERFORD, *Assistant Manager*  
LAURIE SEAMANS, *Assistant Manager*  
SUSAN BOYD  
PHIL DECHERT  
MARY EMERSON  
LOUISE MENEGUS  
AGNES E. PERRY  
JENNIFER PRICE  
JAMES BINGHAM, *Single-Copy Sales Manager*  
CLAUDETTE CARSWELL  
KAREN DESROCHES

**ADVERTISING SALES**  
DENNIS J. RILEY, *Director of Sales and Marketing*  
SANDRA FOSTER, *Administrative Assistant*  
**ADVERTISING/PRODUCTION (603-924-6448)**  
LISA WOZMAK, *Supervisor*  
ROBERT D. HANNINGS, *Senior Account Coordinator*  
MARION CARLSON  
KAREN CILLEY  
LYDA CLARK  
MICHELE JACKSON  
DENISE PROCTOR  
WAI CHIU LI, *Quality Control Manager*  
JULIE MURPHREE, *Advertising/Production Coordinator*  
**MARKETING COMMUNICATIONS**  
HORACE T. HOWLAND, *Director (603-924-3424)*  
VICKI REYNOLDS, *Marketing Production Manager*  
LISA JO STEINER, *Marketing Assistant*  
STEPHANIE WARNESEK, *Marketing Art Director*  
SHARON PRICE, *Assistant Art Director*  
DOUG WEBSTER, *Director of Public Relations (603-924-9027)*  
WILBUR S. WATSON, *Operations Manager, Exhibits*  
**RESEARCH**  
PATRICIA AKERLEY, *Research Manager*  
JULIE PERRON, *Market Research Analyst*  
CYNTHIA DAMATO SANDS, *Reader Service Coordinator*

**FINANCIAL SERVICES**  
PHILIP L. PENNY, *Director of Finance and Services*  
KENNETH A. KING, *Business Manager*  
CHRISTINE LEE, *Assistant*  
VICKI WESTON, *Accounting Manager*  
LINDA SHORT, *D/P Manager*  
EDSON WARE, *Credit*  
MARILYN HAIGH  
DIANE HENRY  
VERN ROCKWELL  
JOANN WALTER  
**PLANNING AND DEVELOPMENT**  
MICHELE P. VERVILLE, *Manager*  
FAITH KLUNTZ, *Copyrights Coordinator*

**BUILDING SERVICES/TRAFFIC**  
ANTHONY BENNETT, *Building Services Manager*  
BRIAN HIGGINS  
MARK MONKTON

**RECEPTIONIST**  
L. RYAN MCCOMBS



Officers of McGraw-Hill Information Systems Company: President: Richard B. Miller, Executive Vice Presidents: Frederick P. Jannott, Construction Information Group; Russell C. White, Computers and Communications Information Group; I. Thomas Ryan, Marketing and International. Senior Vice Presidents: Francis A. Shinal, Controller; Robert C. Violette, Manufacturing and Technology. Senior Vice Presidents and Publishers: Laurence Altman, Electronics Week; Harry L. Brown, BYTE; David J. McGrath, Construction Publications; Group Vice President: Peter B. McCuen, Communications Information; Vice President: Fred O. Jensen, Planning and Development.  
Officers of McGraw-Hill, Inc.: Harold W. McGraw, Jr., Chairman; Joseph L. Dionne, President and Chief Executive Officer; Robert N. Landes, Executive Vice President and Secretary; Walter D. Serwatka, Executive Vice President, Publishing Services; Shel F. Asen, Senior Vice President, Manufacturing; Ralph R. Schulz, Senior Vice President, Editorial; George R. Elsing, Vice President, Circulation; Ralph I. Webb, Vice President and Treasurer.

# Circuit-Board-Artwork Software for the Design Engineer in a Hurry

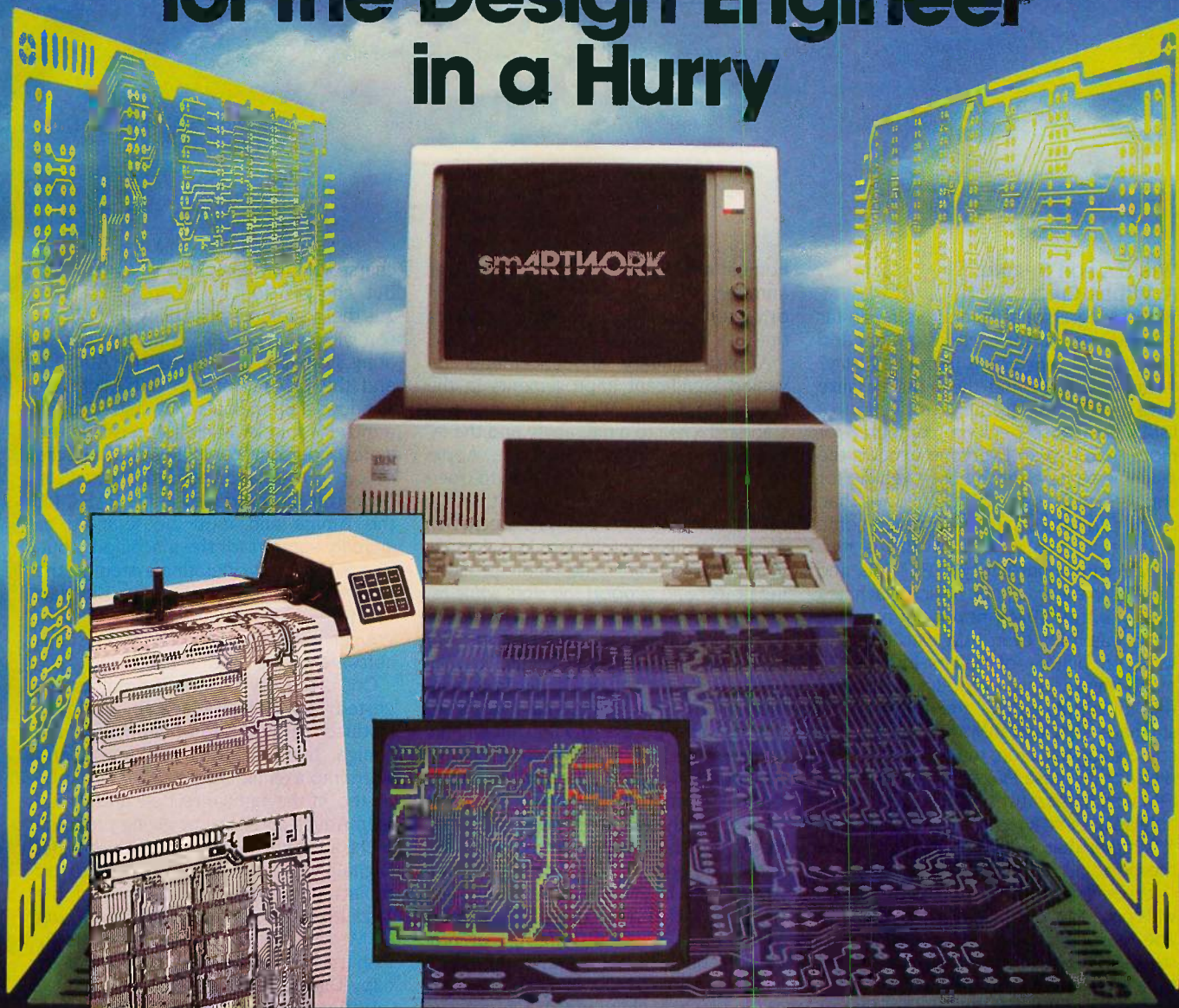

For only \$895, smARTWORK® lets the design engineer create and revise printed-circuit-board artwork on the IBM Personal Computer. You keep complete control over your circuit-board artwork — from start to finish.

Forget the tedium of taping it yourself or waiting for a technician, draftsman, or the CAD department to get to your project.

smARTWORK® is the only low-cost printed-circuit-board artwork editor with all these advantages:

- Complete interactive control over placement and routing
- Quick correction and revision
- Production-quality 2X artwork from a pen-and-ink plotter
- Prototype-quality 2X artwork from a dot-matrix printer
- Easy to learn and operate, yet capable of sophisticated layouts
- Single-sided and double-sided printed circuit boards up to 10 x 16 inches
- Multicolor or black-and-white display

#### System Requirements:

- IBM Personal Computer, XT, or AT with 256K RAM, 2 disk drives, and DOS Version 2.0 or later
- IBM Color/Graphics Adapter with RGB color or black-and-white monitor
- IBM Graphics Printer or Epson FX/MX/RX series dot-matrix printer
- Houston Instrument DMP-41 pen-and-ink plotter
- Optional Microsoft Mouse

#### The Smart Buy

At \$895, smARTWORK® is proven, convenient, fast, and a sound value. Call us today. And put it to work for yourself next week.



Wintek Corporation  
1801 South Street  
Lafayette, IN 47904-2993  
Telephone: (317) 742-8428  
Telex: 70-9079 WINTEK CORP UD

Inquiry 378

In Europe contact: RIVA Terminals Limited,  
Woking, Surrey GU21 5JY ENGLAND,  
Telephone: 04862-71001, Telex: 859502

"smARTWORK," "Wintek" and the Wintek logo are registered trademarks of Wintek Corporation.

## WISHES FOR SPRING: A WIDER CIRCLE

When will personal computers reach far beyond the current circle of owners and produce another boom in our industry? Computer users and the industry alike have been awaiting the introduction of IBM's next base personal computer for more than a year. Everyone expects the machine to be a much better vehicle for software such as Microsoft Windows than is the current PC family. However, some reliable sources insist that IBM is now caught with an inventory of PCs, XT's, and AT's well in excess of one million machines. If this is true, IBM's new base machine must wait. Not even IBM can afford to write off billions of dollars in order to make way for a new product. It appears that the IBM side of the industry will stagnate, although IBM's RT will provide some stimulus before the replacement arrives for the base PC. And when the next IBM workhorse arrives, its pricing will probably assure that it replaces existing PCs and XT's rather than extending the benefits of the personal computer to new users.

It seems more likely that a breakthrough will come on the 68000 side of the market. The Atari 1040ST is one of the great milestones in personal computing. For the first time, we can buy a 16-bit machine with 1 megabyte of RAM, 720K bytes of floppy-disk storage, a good monitor, and a mouse, all for less than \$1000. The operating system, TOS, is fully in ROM. Although screen memory and systems software make some demands on RAM, most of the megabyte really does belong to the programmer, and therefore to the user. Given its price and power, the Atari 1040ST is the first personal computer that offers programmers the hardware resources needed to make the computer accessible, responsive, and useful to millions of nontechnical people who have yet to use computers. But the software needed to take advantage of the hardware is yet to be seen. Only Tom Hudson's DEGAS paint program takes full advantage of chief designer Shiraz Shivji's hardware. (For more on the 1040ST, see the Product Preview by Phillip Robinson and Jon Edwards on page 84.) Jack Tramiel is capable of putting millions of these machines in

homes around the world. The sheer numbers and raw computing power will drive software development, but it takes time.

Apple's January announcements revealed significant improvements in the Macintosh family. With the increase in standard RAM to a megabyte and the introduction of an SCSI interface, Apple showed that it does indeed plan to open the architecture of the Macintosh. A Macintosh with slots can be expected as soon as feasible, but the required changes in systems software to add more processing power and support the slots while retaining compatibility with today's Macintosh may take time. Furthermore, the \$2495 price tag of the Macintosh Plus may prevent the Macintosh family from winning many new adherents. (We were unable to get access to a Macintosh Plus in time to prepare an article for this issue, but look for coverage in April or May.)

The Commodore Amiga is now the oldest of these three flagship 68000 machines. The Amiga's coprocessors still give it the edge in computation, but the Amiga trails both the Macintosh Plus and the Atari 1040ST in the standard configuration of RAM. Software runs on processors, but it lives in RAM. Commodore will soon have to offer an inexpensive upgrade to 1 megabyte of RAM in order to remain competitive and reduce programmers' headaches. The Amiga's open architecture should make the upgrade easy to do. We should also remember Commodore's statement when introducing the Amiga that it is the first and least powerful of a planned series of machines. Although Textcraft (with which this editorial is being written) is adequate and Electronic Arts' Deluxe Paint is spectacular, the Amiga still generally lacks software to match its hardware.

### MAKING ONE MARKET

The Atari 1040ST and the Amiga fall short of the Macintosh in both systems software and applications software. Many, many personal computer users have said they'd like to see Macintosh-quality software on Atari or Amiga hardware. Any company or group of programmers that fulfills this wish could bring about the next great

chapter of growth in personal computing. But who will do it?

Is there a remote possibility that Microsoft will put an MS-DOS-compatible operating system on the Amiga, the Atari ST, and the Macintosh, and put Microsoft Windows atop the operating system? Such a move would let Microsoft bestride the world of personal computers and unite the office, home, and education markets. Microsoft has produced a fine BASIC for the Amiga and must be tempted to simplify support for the machine by putting a Microsoft operating system in the Amiga's Writable Control Store (Kickstart RAM). But would Microsoft be bold enough to replace the ROMs and systems software of the Macintosh?

One of January's fascinating rumors suggested that Digital Research would introduce CP/M-68K and GEM for the Amiga, thereby fusing the Amiga and Atari into a single market. This would be a step in the right direction and would help Amiga and Atari by giving programmers a bigger market to write for. But Digital Research seems unlikely to try replacing the systems software of the Macintosh. The recent controversy over GEM's visual resemblance to the Macintosh user interface provides enough to occupy Digital Research's lawyers.

Lattice has taken a positive step by developing MacLibrary for the Amiga. These routines work with Lattice C on the Amiga and emulate ROM calls on the Mac. MacLibrary should help some in porting applications software from the Mac to the Amiga. Lattice C is available for the Atari ST and perhaps a version of MacLibrary will be as well. Other versions of C, including Manx C, are available for all three machines.

Let's hope someone will have the vision and the resources necessary to make one vast software market of three substantial and overlapping ones. The Atari ST, the Commodore Amiga, and the Apple Macintosh are each an important part of personal computing. Together they could form a standard second to none and attract millions of new users to personal computers.

—Phil Lemmons  
Editor in Chief



Maxell Corp. of America, 60 Oxford Drive, Moonachie, NJ 07074



**maxell**<sup>®</sup>  
FLOPPY DISKS  
THE GOLD STANDARD  
Inquiry 226

## Before you invest in a DEC\*VT240 terminal, consider the software alternative.

Stop and think about what you really need: A text terminal. Tektronix\* graphics. ReGIS\* graphics. File transfer capabilities. Communications.

Purchasing a state-of-the-art terminal may be one option, but Persoft has a smarter solution—**SmarTerm® 240**, the ultimate in terminal emulation software.

SmarTerm can do everything the state-of-the-art terminal can do—and more. That's why we call it **state-of-the-smart**.

With SmarTerm 240, the emulation is so exact you'll forget you're using a PC. It features superior text emulation, ReGIS graphics, Tektronix graphics, outstanding communications and file transfer capabilities.

You also get on-line help screens, remappable keyboard layouts and programmable softkeys which can simplify your most frequently performed tasks. You can even customize your own menus!

And because SmarTerm runs on your PC, you've always got a wealth of computing power right at your fingertips.

All SmarTerm products are backed by Persoft's strong technical support network. It's a service you expect from the industry leader in terminal emulation software.

No matter which terminal you're currently using—Data General Dasher\* D400, Tektronix 4010/4014, DEC VT100, VT125, VT220 or even the new VT240,



SmarTerm has a state-of-the-smart solution for you.

To find out more about the SmarTerm family of terminal emulation software, see your local dealer. Or contact: Persoft, Inc. 2740 Ski Lane Madison, WI 53713 (608) 273-6000 – Telex 759491

# STATE OF THE ART

# VS

# STATE OF THE SMART

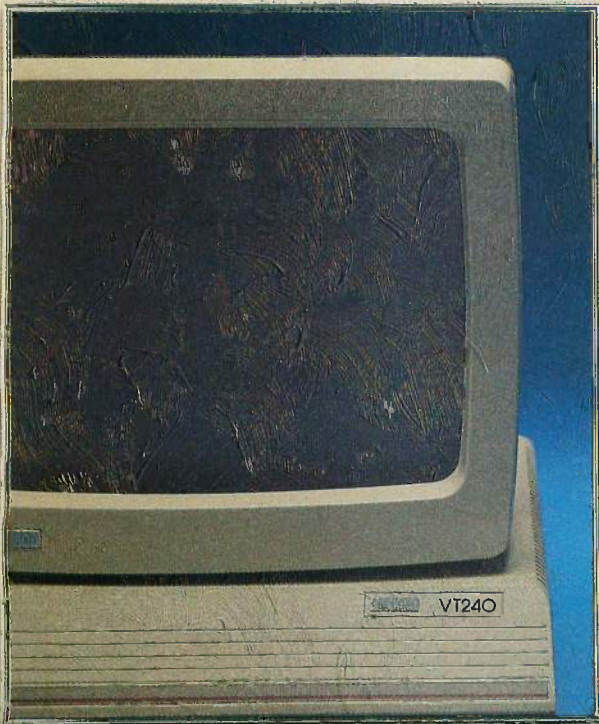

\*SmarTerm is a registered trademark of Persoft, Inc. \*DEC, VT and ReGIS, are trademarks of Digital Equipment Corp. \*DASHER is a registered trademark of Data General Corp. \*Tektronix is a registered trademark of Tektronix, Inc. © Persoft, Inc., 1986. All rights reserved.

# persoft

Inquiry 270

## **IBM Announces UNIX-based RISC-Technology Computer**

---

IBM announced the RT PC, a line of desktop and floor-standing computers that feature a 32-bit RISC (reduced instruction set computer) microprocessor. The new machines also use a proprietary 40-bit-wide memory-management chip that can access a virtual memory of 1 trillion bytes. The desktop unit is the size of the IBM PC AT, has a 1.2-megabyte floppy drive, a 40-megabyte hard-disk drive, 1 to 3 megabytes of memory, and six IBM AT-compatible expansion slots. An optional 80286 board lets the RT run AT software.

AIX, the UNIX-based operating system for the RT, is compatible with UNIX System V and includes several enhancements from Berkeley version 4.2 UNIX. AIX can accommodate up to eight users.

Also announced were three high-resolution displays for the RT. These include the Advanced Monochrome and Color Displays, both with resolutions of 720 by 512 pixels, and the Extended Monochrome Display, with a resolution of 1024 by 768 pixels.

IBM claims that the RT can perform at a rate of 1.2 to 2.4 million instructions per second. The price for the desktop model with the Advanced Monochrome Display is approximately \$13,100. The AIX operating system is an additional \$3400. Discounts of over 30 percent are available for orders of 50 units or more.

## **Dutch Engineer Discloses Method for Eavesdropping on Computer Displays**

---

In a recent issue of the journal *Computers & Security* (North-Holland), Dutch engineer Wim van Eck outlined a method whereby an ordinary television receiver can be modified to recreate the images on any nearby CRTs or computer displays. The modifications require approximately \$15 of electronic parts and a directional antenna. In one test, van Eck set up his equipment in a van parked outside an office building and was able to read classified information displayed on a computer terminal inside the building.

## **Xerox Announces Color Ink-Jet Printer and Software for Its 6085 Computer**

---

Xerox of Rochester, NY, announced a new printer for its line of personal computers and more software for its 6085 computer. The Xerox 4020 is a color ink-jet printer that reportedly prints 4000 combinations of seven primary colors at a resolution of 240 dots per inch. The printer price of \$1495 includes the GEM Desktop, WordChart, and Graph software packages.

The Xerox 6085, a low-priced relative of the Xerox Star computer, is being bundled with Xerox's 4045 Laser CP (copier/printer) and new software to form a personal publishing system called the Documenter. No price was given for this system; projected availability is in the second quarter of 1986. Xerox will also offer compilers for C, FORTRAN, and BASIC that will run on the 6085 computer. The 6085 is a large-screen, window-and-mouse-oriented computer that is available with an optional IBM PC-compatible processor.

## **High-Density 256K-bit EEPROM**

---

Xicor of Milpitas, CA, is selling samples of a 256K-bit EEPROM. The densest chip available before held 64K bits. The 256K-bit chip sits in the same package as the 64K-bit chip; for addressing, it employs two pins that were unused on the 64K-bit version. The 256K-bit EEPROM also includes new software data-protection mechanisms to guard against inadvertent writes during power-up and power-down. The 64K-bit chips cost from \$12 to \$20 apiece. The 256K-bit chip samples cost \$120 in lots of 100. Full production is expected by the middle of 1986.

(continued)

## Parallel Processing for the IBM

---

You can buy a parallel-processing add-on board for your IBM PC, XT, or AT or ITT XTRA from Compupix Technology of Boca Raton, FL. The board is based on NCR's GAPP (geometric arithmetic parallel processor) chip, which contains 72 CMOS 1-bit ALU processors. For \$4750, you get a board with 144 processors (two GAPP chips), and \$5750 buys you a board with 288 processors (four GAPP chips). Both products have an on-board sequence controller so the host computer can perform another task while the parallel processors are working.

The demonstration software that accompanies the boards was developed for both UNIX and MS-DOS environments. Compupix offers two assemblers for the board: the Macro-Meta Assembler runs under MS-DOS and costs \$1750, while a relocatable, linkable version of the Macro-Meta Assembler costs \$2150.

## Datatek Word Processor Plus Source Code for \$95

---

A \$450 word processor that was withdrawn from the market for a few months has been reissued, this time with a complete source-code listing and a price of \$95. Datatek of Oldsmar, FL, bills the new version of Datatek as a powerful, multifunction word processor and includes in the product's manual a complete listing of 30,000 lines of Pascal source code. A disk version of the source code costs \$145, and a Computer Associates/Sorcim Pascal compiler for recompiling the code will be available for less than \$100. The product runs on IBM PC, MS-DOS, and CP/M systems.

## Nanobytes

---

According to **SoftView** of Camarillo, CA, its MacInTax 1985, a \$75 program for the Macintosh, is the only tax package that can generate IRS-approved tax forms on the Apple Imagewriter printer. . . . **Epson** announced the FX-286 printer, a replacement for its FX-185 dot-matrix printer. Epson claims that the \$749 wide-carriage printer is 30 percent faster than its older relative. . . . **Omega Corp.** announced a new adapter card for its Bernoulli Box disk-cartridge system. The card lets the IBM PC boot from the Bernoulli Box. . . . **Fox & Geller** of Elmwood Park, NJ, is offering a Symphony-like database for Lotus Development's 1-2-3. Called Quickcode for 1-2-3, the program costs \$199. . . . A new multiuser version of **Fox Research's** 10-BASE database system for the IBM PC offers SQL (structured query language) features. . . . The **Toshiba** P351 dot-matrix printer can now emulate the Qume Sprint II daisy-wheel printer and the IBM Graphics Printer. Upgrades for older printers cost \$99. . . . **Panasonic** announced three dot-matrix printers: the KX-P1595 (240 cps in draft mode, Courier type fonts, \$949), the KX-P1592 (180 cps in draft, IBM Graphics Printer compatibility, \$699), and the KX-P1080 (100 cps in draft, \$319). . . . **Tiara Computer Systems** of Mountain View, CA, has acquired the Davong MultiLink local-area network and renamed it TiaraLink. The products will sell for 15 to 25 percent less. Tiara is also offering an IBM PC AT-compatible motherboard to developers for a single-quantity price of \$920. . . . The **International Computer Users Groups Association** (ICUGA) has been formed in Lexington, KY. The association is intended as a support service for users groups around the world. Contact ICUGA c/o Abshire & Abshire, Security Trust Building, Suite 100, Lexington, KY 40507. . . . **Oki Semiconductor**, Sunnyvale, CA, has developed a 5-MHz CMOS version of the 8085A microprocessor. An NMOS 8085A draws 170 milliamperes; the MSM80C85A-2 typically draws less than 20 mA. In lots of 100, each chip costs \$7.30. . . . **Aldus Corp.** of Seattle, WA, has introduced PageMaker release 1.1. This new version of the \$495 Macintosh page-design program offers the option of using the LaserWriter's bit-map smoothing, a greater variety of tab uses, and support of tabloid-size pages (11 by 17 inches). . . . **S-MOS Systems** of San Jose, CA, announced three CMOS Z80 microprocessors. The SMC 84C00AC is simply a pin-compatible CMOS Z80. The SMC 84C00AC-L adds a low-power "sleep" mode that prohibits it from supporting the Z80's on-chip dynamic-memory-refresh counter. The SMC 84C00AC-S has both the sleep mode and an on-chip oscillator. All three chips sell for approximately \$3 in quantities of 1000. . . . **Vitellic**, Santa Clara, CA, is making the V62C64, a low-power 8K-bit-by-8 CMOS static RAM chip. This new RAM has an access time of 150 nanoseconds and dissipates 175 milliwatts in operation or 10 microwatts in standby. A special low-voltage data-retention mode for battery backup lets the V62C64 retain data while dissipating only 4 microwatts from a 2-volt power source.

# TANDY... Clearly Superior™

The Tandy® 1200 Personal Computer with dual floppy disk drives edges out the IBM® PC/XT.



Another remarkable computer breakthrough that only Tandy could bring you. The new Tandy 1200 is XT-compatible, includes dual floppy disk drives and is priced at only \$1499.00—far less than IBM's XT! With the Tandy 1200, a business can expand affordably and still use virtually all of the same quality software, as well as PC expansion boards.

The Tandy 1200 (25-3001) comes with 256K RAM (expandable on-board to a total of 640K), two thinline, 360K

floppy disk drives, plus seven card slots. A parallel printer interface—an extra-cost option on the XT—is standard.

Also available is the Tandy 1200 HD (25-3000, \$1999.00). It has a built-in 10-megabyte hard disk and a 360K floppy.

You'll find everything you need—software, printers, custom forms, even furniture—at any Radio Shack Computer Center. And our support includes training, service and leasing; we have what it takes to sit down and talk business.

Available at over 1200  
Radio Shack Computer Centers and at  
participating Radio Shack stores and dealers

## Radio Shack COMPUTER CENTERS

A DIVISION OF TANDY CORPORATION

Send me a Tandy 1200 brochure.

Mail To: Radio Shack, Dept. 86-A-793  
300 One Tandy Center, Fort Worth, TX 76102

NAME \_\_\_\_\_  
COMPANY \_\_\_\_\_  
ADDRESS \_\_\_\_\_  
CITY \_\_\_\_\_  
STATE \_\_\_\_\_ ZIP \_\_\_\_\_  
PHONE \_\_\_\_\_

# Your first color good enough

**NEC** introduces the only color monitor you need. Superb resolution plus MultiSync for across-the-board compatibility with all three PC graphics boards made by IBM®, for business graphics, CAD/CAM, computer art, and text.



Now there's one high resolution color monitor that does things your way. The MultiSync™ monitor from NEC.

It gives you the best color resolution available at the price.

- Compatibility with the IBM Professional Graphics Adapter, the IBM Enhanced Graphics Adapter, and the IBM Color Graphics Adapter.



Compatibility with the IBM® Enhanced Graphics Adapter Board

- MultiSync, the NEC feature that automatically adjusts to color adapter board scanning frequencies from 15.75 KHz to 35 KHz—suggesting the possibility that the MultiSync monitor might be compatible with *all* color graphics boards that are fully compatible with the IBM PC, PC/XT, and PC/AT, now and in the future.

- Full implementation of high resolution graphics software for business and other applications, now and in the future.

- And color capability limited only by the board being used.



## See Things Our Way

Until now, you had to choose different color monitors for compatibility with all three PC color graphics boards made by IBM. With so many board and monitor configurations, folks



Compatibility with the IBM® Professional Graphics Adapter Board

didn't know which way to look.

The new MultiSync color monitor gives you unique compatibility. As well as TTL and analog color. With 7 switchable text colors. And resolution up to maximum 800 horizontal dots and maximum 560 vertical lines, on a large, 13" diagonal viewing area.

All that, priced at just \$799. All from NEC, a name respected around the world for advanced,

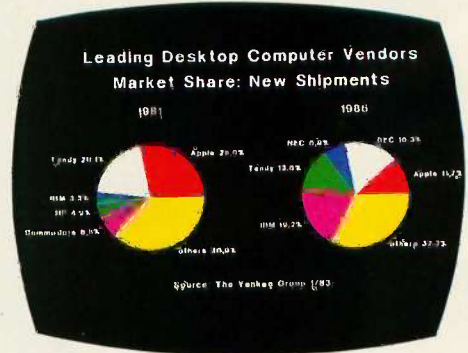

Compatibility with the IBM® Color Graphics Adapter

# monitor should be to be your last

**M U L T I S Y N C**™

The Intelligent Monitor™

reliable products  
backed by nationwide  
service.

It's the one color  
monitor that does  
everything your way.

But why talk more  
about it? Visit your

nearest dealer and see  
a graphic demonstra-  
tion of the new NEC  
MultiSync monitor's  
capabilities. Then draw  
your own conclusions.

For information dial  
**1-800-447-4700**

NEC HOME ELECTRONICS (U.S.A.) Inc.  
Personal Computer Division  
1401 Estes Avenue  
Elk Grove Village, IL 60007

# NEC

# L·E·T·T·E·R·S

## COPYRIGHTING ICONS

Your January editorial ("A Threat to Future Software," page 6) regarding Apple's stifling of software creativity was precisely to the point. Legally, I have wondered why Xerox didn't sue Apple long ago. Technically, however, I also wondered why DRI chose to slavishly copy the Mac user interface in the first place.

Take scroll bars, for example. They take up an awful lot of screen space, are difficult to use accurately, and are hardly intuitive, since you need to go *right* first to go *up*! Why not just let a function key cause the cursor to adhere to the first window border it comes to? Option would cause the contents to scroll, Command might cause the window to resize, and Shift would move the window on the screen. Need to close the window? Just move the cursor rapidly back and forth a few times anywhere in the window (a motion similar to using a pencil eraser), and it would be gone. Presto, you have a window that operates far more intuitively than a Mac window, has less screen overhead, less code overhead (no need to draw the bars and resize them), and, best of all, has little resemblance to a Macintosh! And while they are at it, the DRI people might want to throw in support for a global zoom procedure (since every computer screen is only a window on an application) and the global abort function that the Macintosh sorely needs but doesn't have.

ALEX FUNK  
Durham, NC

It is truly remarkable that Apple managed to copyright the garbage can (its primary symbol?) and the icon interface developed by Xerox.

It must be in the general interest to have a standard set of icons that express their meaning clearly and unambiguously.

Clearly, Apple is taking the necessary steps to prevent a natural development of such a standard. Is Apple trying to prevent other vendors from launching systems based on the ideas from Xerox? Do the people at Apple really think they will succeed? That is difficult to believe, as the bit map of an icon hardly is the major feature of a computer system, and more powerful machines will appear in the near

future, easily outperforming the Mac in all aspects (except the garbage can).

GÖRAN RYDQVIST  
KJELL POST  
Linköping, Sweden

When I first learned that Apple had won a decision against Digital Research for "visual copyright" infringement, I thought "Right on!" and still feel this way. A programmer should be able to protect his rights to any commercial system he develops. We would all agree that the visual aspects and appearance of any software system contribute heavily to the success of that particular system in the marketplace. Your line of reasoning to justify other persons' ignoring visual copyrights—the "incremental" theory—if carried to its logical conclusion in my mind leads us to the point where my firm could publish a new software release called Wordstar 5000, emulating the latest MicroPro screens for its fine word-processing program. As long as we could prove incremental improvements, we would be protected from (not liable to) suit by MicroPro. This is ridiculous! It is the programmer's right to release newer, incrementally improved versions of any software product he has authored. If another firm feels it has a dynamite idea for an enhancement to an existing piece of software, then isn't that what joint ventures are for?

The computer industry is far away from the ideal man-computer-man interface. Let us collectively stimulate, encourage, and suitably reward those who pursue new, untried interface techniques. As the level of computer literacy rises above thinking of the computer as a car-type tool and reaches the level where we see the computer as an extension of our brains, we will all probably want our own individualized interfaces.

MIKE CARMICHAEL  
Glasgow, KY

## COVERING ATARI'S ST MACHINES

Well, another month has come and gone, and the only mention made of the best low-priced computer on the market is a few slightly snide remarks. I can't say that I am totally surprised, since it took BYTE

a few years to figure out what every Atari owner knew—that the Atari 400/800/1200s were the best 8-bit graphics machines on the market.

Now comes a new Atari, the 520ST. It is available everywhere, right now, with software delivering now. Also available is a complete developer's software/documentation package for less than a good C compiler for the IBM PC and its look-alikes. Still, no real mention in BYTE. Methinks your biases are showing.

I will readily concede that the Amiga is probably a better machine, but at a price that is more than double that of a similarly equipped 520ST. Mr. Webster and others have said the 520ST is not expandable. Officially, that's true. But, as many owners of the Atari 400 know, the 400 wasn't expandable beyond 16K RAM, officially. I and many others have or had 400s with 48K within a year of introduction. My 520ST (remember, unexpandable) will shortly have 1 megabyte of RAM (cost: less than \$70) and an add-on 80-track 5¼-inch drive. So much for officialdom.

When I bought my machine, I received BASIC, Logo, Neochrome (graphics drawing program), and ST Writer (word processor). While the graphics and word-processing software are not up to some of the more mature applications, they are far from primitive.

In my area, the Amiga is not available yet, but it will be in "real soon now." The dealer says there is lots of software for the Amiga, but he doesn't have any in stock; again, it will be here "real soon now." I don't know about you, but in the computer world "real soon now" can often take months or years.

(continued)

LETTERS POLICY: To be considered for publication, a letter must be typed double-spaced on one side of the paper and must include your name and address. Comments and ideas should be expressed as clearly and concisely as possible. Listings and tables may be printed along with a letter if they are short and legible.

Because BYTE receives hundreds of letters each month, not all of them can be published. Letters will not be returned to authors. Generally, it takes four months from the time BYTE receives a letter until it is published.



# This Little Fella Means Business.

The Mouse by Maynard Electronics makes your favorite programs faster, easier, and smarter!

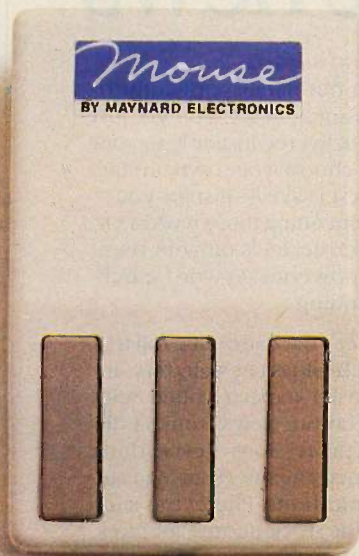

## Teach The Mouse To Type.

A single Mouse click will instantly produce the character, sentence, paragraph, or anything else you've selected. **Click:** you call up the CustomKey menu. **Click:** your file is saved. **Click:** a commonly used paragraph appears in place. No other mouse gives you such power and versatility.

At last, an "intelligent" mouse! Now you can add command power to your programs, when you want, the way you want — instantly! The Mouse by Maynard Electronics comes with our CustomKey™ software which lets you assign and reassign commands **while using your favorite programs — even those without mouse utilities.** Fly through programs like Symphony,\* Lotus 1-2-3,\* Framework,\* Multi-Mate,\* and others with undreamed of speed! And of course, it's fully compatible with all programs written for a mouse, too.

## A Tale Of Three Mice . . .

Compare our Mouse with the others running around and you'll see, there's no comparison! Here are just a few features across the board:

FEATURES	Maynard Mouse	Micro-soft	Mouse Systems
# of Button Combinations	7	3	5
Button Auto Repeat	Yes	No	No
Diagnostics	Yes	No	Yes
Dynamic Scaling	Yes	No	No
Cursor Overshoot Control	Yes	No	No
Adjustable Cursor Speed/Up, Dn (while running application)	Yes	No	No
Adjustable Cursor Speed/Rt, Lft (while running application)	Yes	No	No
Buttons-Definable (while running application)	Yes	No	No
Macro-Definable (while running application)	Yes	No	No
User-Definable Alternate Cursor Movement	Yes	No	No

## Free Drawing!

Purchase The Mouse now and receive the popular paint program Telepoint\* at no additional cost — a \$149 value!



\*Symphony and Lotus 1-2-3 are trademarks of Lotus Development Corporation. Framework is a trademark of Ashton-Tate. MultiMate is a trademark of SoftWord Systems Inc. Telepoint is a trademark of LCS/Telegraphics.

 **Maynard Electronics**  
Shaping tomorrow's technology.

460 E. Semoran, Casselberry, FL 32707 • 305/331-6402

Available at the finest computer stores. Contact your local dealer or write to us today for product information.

# Why you should ignore 95% of the news

**Because NewsNet automatically finds the 5% you need.** From our database of authoritative, up-to-date business news, you get just the stories you want, delivered instantly to your microcomputer. You choose your own, unique keywords, and NewsNet saves—just for you—every new article containing those words. Or, you can find that critical 5% on your own, with NewsNet's powerful keyword searching and text scanning.

Just what's in NewsNet's database? The full text of over 300 valuable business newsletters. In-depth news, written by experts, filled with analysis and interpretation. News from 34 different industries and professions—everything from Computers to Investments, from Management to Telecommunications. Plus extras such as wire services, online stock quotes, air fares, and business credit reports.

**Computer News: Your Specialty is our Specialty.** Here are just a few of the 25 Electronics and Computers newsletters on NewsNet:

The Artificial Intelligence Report	Mini/Micro Bulletin
The Business Computer	Personal Computers Today
The Computer Cookbook	Robotronics Age
Consumer Electronics	Newsletter
Data Base Informer	Semiconductor Industry & Business Survey
Electronic Mail News	The Seybold Report on Professional Computing
Outlook on IBM	Stanley Klein Newsletter on Computer Graphics
Japan High Tech Review	
Micro Moonlighter	

**ONLINE  
BUSINESS  
NEWS**

# NewsNet

**Call Today!**  
We'll send all you need to subscribe.

**(800)  
345-1301**

(in PA 215-527-8030)

NewsNet Inc. 945 Haverford Road, Bryn Mawr, PA 19010

As for comparing machines, we really have to compare machines that are similarly priced. With the Atari 520ST's \$1000 price tag, that leaves the Apple II. Poor Apple. When comparing compatibility, then we have to look at the IBM PC/XT/AT and the Amiga. The PC/XT/AT's saving graces are manufacture by IBM and a large base of available software. I recently saw a benchmark on the 520ST for processing (primes). Nothing that anyone will buy for home use was anywhere close to Atari's speed.

For business, I don't really believe that the Atari will penetrate the market with any great percentage. Its success will probably be along the line of the Apple Macintosh. It offers more bang for the buck than any other currently manufactured machine.

For support, Atari was always one of the better companies about supplying information and help with its machines. Also, there is a very large installed base of users that are buying up the 520STs as fast as they hit the retail store. Some public-domain software is already out there. Admittedly, it is not at the level it will be in a very short time. Also, there are two Atari-specific magazines on the market that are publishing more and more information about the machine every month.

BYTE, your prejudices are showing, and by this letter you can see that mine are showing also. Maybe it will balance out.

LLOYD PARSONS  
Herrin, IL

*Phil Lemmons replies:*  
We are not prejudiced against Atari or any other company. We were hampered in covering Atari's 520ST by the company's refusal to give us access to a machine despite repeated attempts on our part. But that problem is now past. Please note that our January, February, and March issues all contain coverage of Atari's ST machines.

### I'D KNOW THAT CHIP ANYWHERE

I don't know whether this is a coincidence or not, but a chip virtually identical to the one John Bennett has described ("Raster Operations," November 1985, page 187) was developed by myself and John Atwood at Silicon Compilers in early 1983. The chip, designed with the help of an early version of the Silicon Compilers software, has been used quite successfully in the Sun Microsystems Color Workstation. In this application, a total of eight RasterOp chips (one per bit plane) manip-

(continued)

New! Windows-Compatible In·a·Vision 1.1

FREE Microsoft Windows!  
Limited Offer  
Microsoft Windows!

# Complex Drawing Made Easy

We created In·a·Vision just for you. The engineer who needs more productive drafting support. The designer who needs versatility for alternate ideas or quick revisions. The architect who needs to manage a variety of working drawings. And the businessman who needs first-class presentation materials as well as detailed flow charts and organization charts.

## Point. Click. Draw.

Now all you do to create complex technical drawings, systems designs, blueprints, diagrams, illustrations, and proposals is point, click and draw. With In·a·Vision's mouse support, windowing, icons,

and pull-down menus, you produce drawings more quickly, accurately and efficiently than ever before. In·a·Vision's advanced technology includes many features not found on comparable systems costing thousands more. For example, you can pan around in a user-definable drawing space up to 68" x 68" and zoom in on specific areas for

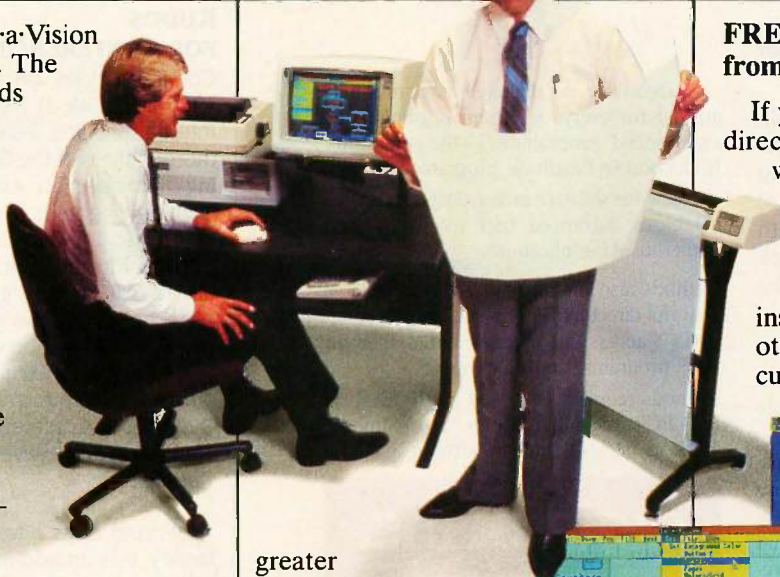

greater detail. Scale, rotate and dimension symbols, fill an area with your choices of pre-defined colors and patterns, as well as draw lines with multiple styles and widths. Other features include overlays, predefined and user-definable page sizes, rulers, grids, and templates to speed popular applications.

## Multi-tasking in a PC-based CAD system.

In·a·Vision uses multi-tasking to enable you to continue drawing while printing hard copies or edit multiple drawings simultaneously.

## FREE Microsoft® Windows from MICROGRAFX!®

If you purchase In·a·Vision directly from MICROGRAFX, we'll give you a free retail copy of Microsoft Windows so you can use In·a·Vision as part of a fully integrated working environment. Move instantly from In·a·Vision to other applications and back... cut and paste text and drawings



between applications... and more!

We're confident you'll agree — In·a·Vision will make your complex drawing tasks simple and make you more productive. Satisfaction guaranteed.

## TO ORDER CALL: 800-272-3729

As always, free demo disk\* or brochure available upon request. In Texas or for customer support, call (214) 234-1769.

MICROGRAFX, Inc., 1820 North Greenville Avenue, Richardson, Texas 75081.



# MICROGRAFX®

The Picture of Success.

(Most popular graphics cards, plotters, and printers supported.)  
Microsoft Windows-compatible. Call for specific operating environment requirements.

\* Demo requires MS Windows. Full demonstration system for users without Windows available for \$49.00.

# Escape the Programmer's Prison



Do you feel imprisoned by your IBM PC? Do you spend too much time wrestling with a rigid, unyielding programming language? Are you tired of clumsy programming tools that straight-jacket your creativity instead of liberating it?

If so, you're ready for Methods—a Smalltalk, object-oriented programming system for the IBM-PC and compatibles that sets you free from the constraints of other languages. Until you program with Methods, you don't know just how quick and creative programming can be on the IBM PC.

Methods is . . .

. . . high-performance object-oriented programming. A powerful, language-compatible subset of Smalltalk-80™.

. . . a toolkit of over 100 classes—easily-customized software building-blocks for rapid, incremental development of real-world applications.

. . . an open-ended, window environment that encourages exploration while allowing recovery from any error.

. . . extensively documented in a four-part manual for everyone from beginners to experienced programmers—the perfect introduction to Smalltalk programming.

. . . ideal for software prototyping, simulation, databases, advanced user interfaces, and numerous AI applications.

Methods also offers easy access to DOS, a powerful directory/file browser system, remote UNIX™ access, an object-oriented shell for DOS programs, and much more.

Methods requires DOS and 512K RAM on IBM PC's (including AT) or "compatibles," and can be used with or without a mouse.

**digitalk inc.**

5200 West Century Boulevard  
Los Angeles, CA 90045 (213) 645-1082

Available from Digitalk for \$250. Outside U.S. add \$15.00 for shipping and handling.

California residents add sales tax.

Educational and dealer discounts available.

Inquiry 110



IBM is a trademark of International Business Machines Corporation.  
Smalltalk-80 is a trademark of Xerox Corporation.  
UNIX is a trademark of Bell Laboratories.

## LETTERS

ulate up to 128 bits of image data in parallel for high-speed screen updating. The Sun RasterOp chip is now available commercially from VLSI Technology Inc. as part VLI6160.

ANDREAS BECHTOLSHEIM  
Sun Microsystems Inc.  
Mountain View, CA

## KUDOS FOR CONFERENCING THEME

Congratulations on the fine December 1985 issue. We at Network Technologies International Inc. were pleased to see the thoroughness of the Computer Conferencing theme section. As you know, this is an exciting segment for the computer industry, and it has tremendous growth potential in the near future. The reputation of BYTE for being on the leading edge of technology news is well deserved, as this issue focused on conferencing proves.

We were very excited by the review of our eForum product by Brock Meeks ("An Overview of Conferencing Systems," page 169). However, several points deserve clarification:

1. eForum does have an electronic mail facility. It is an add-on software package called eMemo that allows private one-to-one communications with many of the enhanced organizational features of eForum.

2. The eForum software has a migration path that cannot be matched. NETI began marketing with eForum software available on supermicro and mini systems. Beginning in February, the eForum system will be available on an MS-DOS IBM PC-compatible microcomputer. And currently, eForum on a mainframe system is available through the largest packet-switching network in the world, the General Electric Information Service. We feel this wide range of options more than adequately serves the needs of Fortune 500 companies as well as organizations of every size and need.

JEFFREY J. ELPERN  
Ann Arbor, MI

## MS-DOS DISK FORMATS

Marcus Kolod, in his article "IBM PC Disk Performance and the Interleave Factor" (*Inside the IBM PCs*, Fall 1985, page 283), goes into considerable detail to describe how PC-DOS 1.x differs from 2.x in accessing a double-sided disk. He describes DOS 1.x as accessing all of side 0 and then all of side 1, while DOS 2.x will access both sides of each cylinder on the disk before

(continued)

# For those times when 640K memory just doesn't seem to be enough.

AST introduces RAMpage!™ with up to 2 Mb of PC RAM.

Feed your byte-gobbling applications with the expanded memory of RAMpage! And stop wasting valuable time with frustrating "Memory Full" messages.

### Breaking The 640K Barrier.

RAMpage! breaks through the PC's 640K-byte barrier delivering up to 2 megabytes of parity checked memory for expanded memory applications. Up to 4 RAMpage! boards can be used in a single PC for a full 8 Mb of memory per system.

### EMS Compatibility.

RAMpage! is fully compatible with *all* applications developed for use with the Lotus®

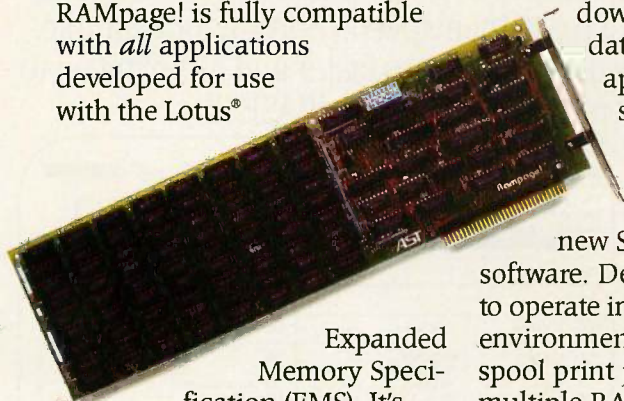

Expanded Memory Specification (EMS). It's

also supported by Enhanced EMS software—offering more versatility for even greater value and performance.

New software updates of popular applications like Symphony™, Framework™ and 1-2-3®, designed



specifically for use with EMS boards, are now becoming available. And a wide variety of other packages, including windowing, spreadsheet, database and CAD applications, will soon follow.

**A Super Bonus.** RAMpage! includes AST's new SuperPak™ utility software. Designed specifically to operate in expanded memory environments, it allows you to spool print jobs and create multiple RAM disks for added performance.

Don't let your valuable byte-hungry applications starve. Get RAMpage! today. For more information call our Customer Information Center (714) 863-1333.

Or write, AST Research, Inc., 2121 Alton Avenue, Irvine, California 92714  
TWX: 753699 ASTR UR.

### Specifications

- For use with IBM® PC, PC-XT, 3270 PC and compatibles.
- Up to 2.0 Mb expanded memory per board—8.0 Mb total per system.
- Socketed and user upgradeable with 256K DRAMS.
- Fully compatible with Lotus EMS 3.0.
- Enhanced EMS design for greater performance with enhanced EMS software.
- AST Expanded Memory Manager software standard.
- New SuperPak™ utility software standard.

## AST RESEARCH INC.

RAMpage! and SuperPak trademarks of AST Research, Inc. Lotus and 1-2-3 registered trademarks and Symphony trademark of Lotus Development Corp. Framework trademark of Ashton-Tate. IBM registered trademark of International Business Machines Corp.



# The database used now be used

Introducing dBASE III<sup>®</sup> PLUS.

The PLUS stands for all the improvements we've made to the world's number one selling database management software.

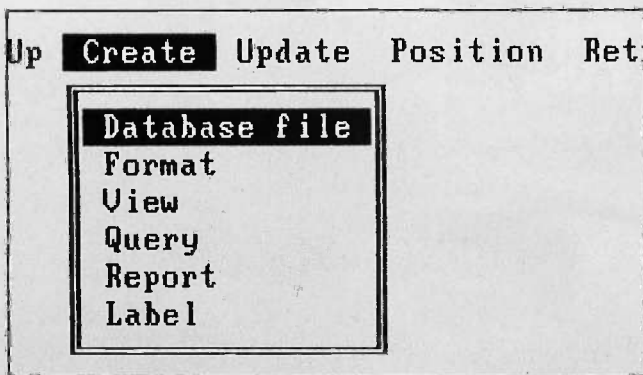

*The Assistant helps beginning users accomplish day-to-day data management tasks without programming.*

Mind you, dBASE III PLUS still has the powerful dBASE programming language, dot prompt, and all the features that have made dBASE III the standard of the industry.

We've simply raised the standard.

And just as dBASE III introduced more power to the people, our new dBASE III PLUS introduces more people to the power.

People who aren't all that crazy about programming, for example.

The Assistant feature in dBASE III PLUS now provides them with new easy-to-use pull-down menus for creating, using and modifying multiple databases.

So now anyone who can manage a simple cursor can manage day-to-day data management tasks. Without programming.

And by using our new Screen Painter,

anyone can create custom screens. Without programming.

Or using View, access related information in several databases at one time. Without programming.

With Advanced Query System, another new non-programming feature, any user can build complex queries just by selecting from the dBASE III PLUS pull-down menus.

For rapidly creating entire programs, there's even a new Applications Generator.

And for all those who wish to learn to program, the Assistant can be of further assistance. By teaching you programming commands as you go along. Without disrupting your work flow.

These are only a few of the dBASE III PLUS features that can help new users quickly get up to speed. And experienced users quickly increase their speed. (Sorting, for example, is up to two times faster and indexing up to ten times faster than dBASE III.)

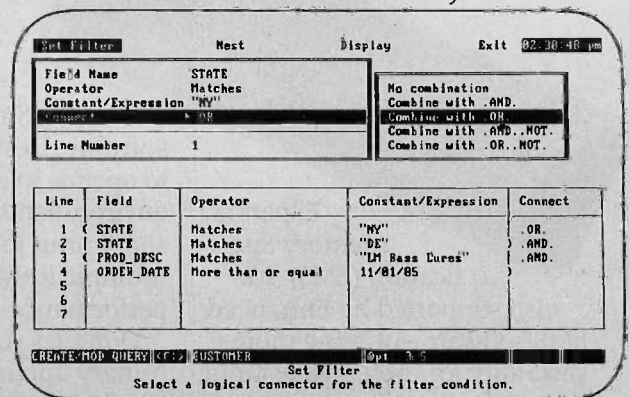

*Advanced Query System lets you set up and answer complex queries without programming.*

# by more people can by more people.

And it's the fastest way to network those users, too. Because now, local area networking capabilities are built right in.

dBASE III PLUS can also help put developers in the fast lane. With a new Data Catalog and more than 50 new commands and functions. Plus code encryption and linking, improved debugging aids, assembly language calls and much more.

To obtain a free dBASE III PLUS demo disk, call 800-437-4329, Extension 0282\* for the authorized Ashton-Tate® dealer nearest you.\*\*

And get your hands on dBASE III PLUS. It's the software more people can look forward to using.

Inquiry 383

\*In Colorado call (303) 799-4900, Extension 0282. \*\*Upgrades are available to all dBASE III owners. Requires IBM® PC or 100% compatible. Trademarks/owners: Ashton-Tate, dBASE III/Ashton-Tate; IBM/International Business Machines Corporation. ©1985 Ashton-Tate. All rights reserved.

ASHTON·TATE

## dBASE III PLUS

*The data management standard.*

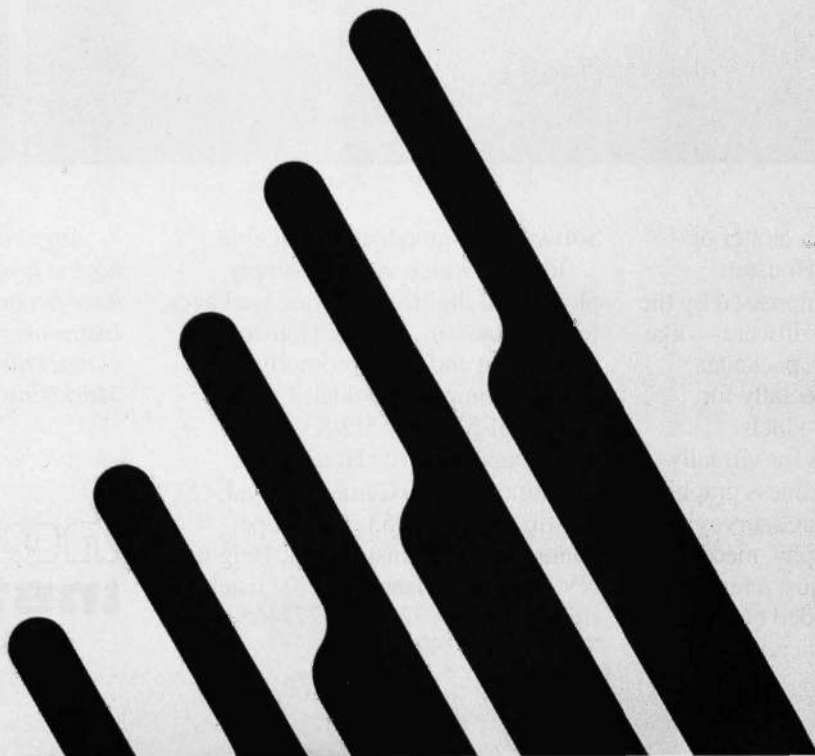

# OVER 300 WAYS TO RUN HOUSTON INSTRUMENT PLOTTERS AND DIGITIZERS

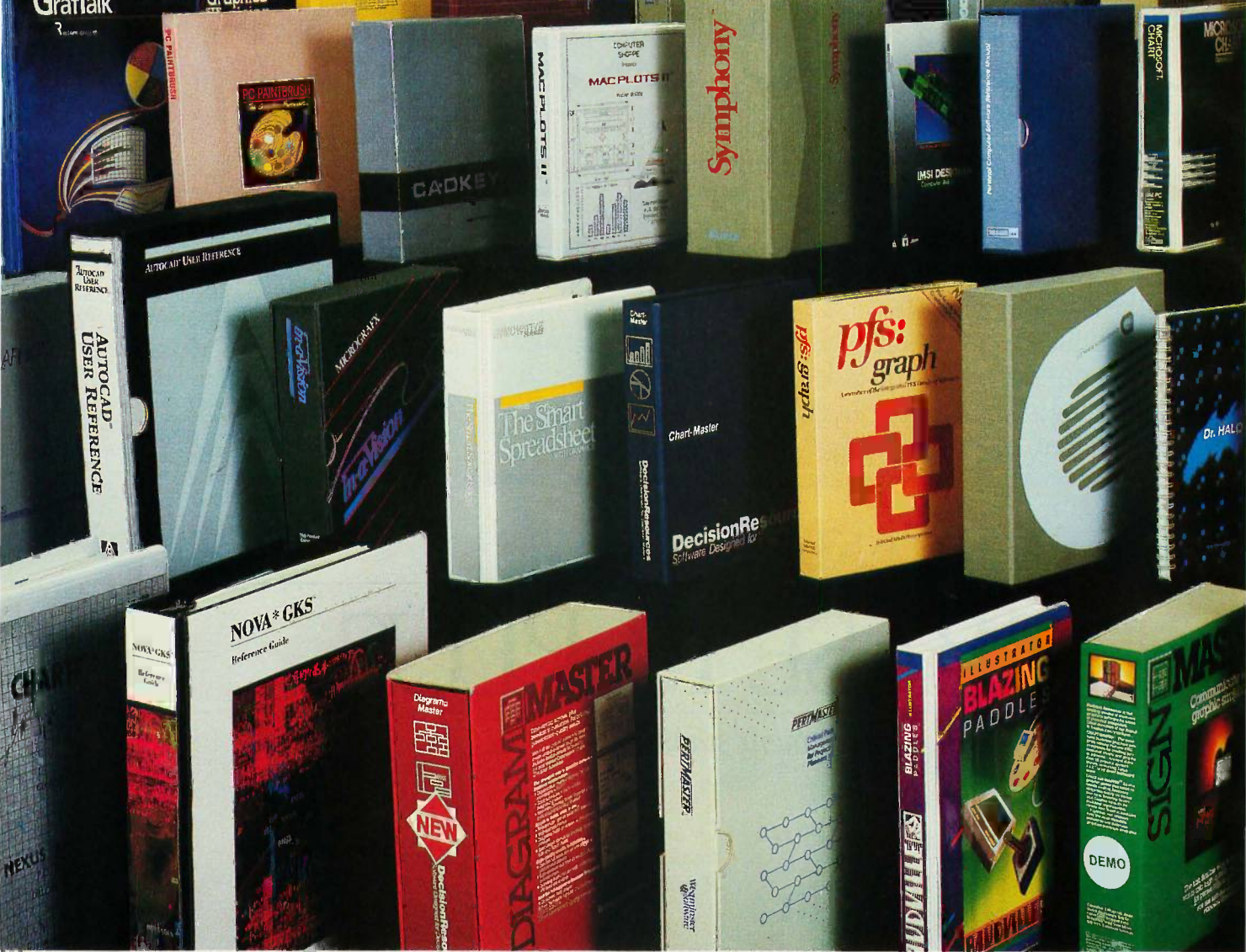

**W**hen you select a plotter or digitizer from Houston Instrument, you'll be impressed by the vast array of available software—like more than 300 graphics packages custom-configured especially for Houston Instrument products.

You'll find programs for virtually every application—business graphics, CAD/CAM, architecture, surveying, geophysics, oceanography, medical, electronics—to name just a few.

And more are being added every day. Just name your application.

Software is immediately available.

To learn which vendors supply plotter and digitizer software packages for your system, contact Houston Instrument and we'll promptly send you our complete booklet. Call 1-800-531-5205 (or 512-835-0900 if in Texas), or write Houston Instrument, 8500 Cameron Road, Austin, Texas 78753. In Europe, contact Houston Instrument, Belgium NV., Rochesterlaan 6, 8240 Gistel, Belgium. Tel.: 32-(0)59-277445. Tlx.: 846-81399.

*Attention software vendors: If you have a program you would like to have become compatible with Houston Instrument's graphics products, contact the Houston Instrument Marketing Support Group.*

## houston instrument

A Division of **AMETEK**

Inquiry 161



## LETTERS

advancing to the next cylinder. (I have dubbed the first method "surface mode" and the second method "cylinder mode.")

DOS 1.x does not access the disk this way; it uses the same cylinder mode as does DOS 2.x. In fact, I have written device drives for 17 different MS-DOS disk formats, ranging from 3½ inches to 8 inches to the AT high-density, and I've yet to see an MS-DOS surface-mode disk.

I have seen many other differences in MS-DOS floppy-disk formats, however. Several manufacturers have made changes to improve performance or to match their system design. I've seen sector sizes from 256 bytes (HP 150) to 1024 bytes (NEC APC 8-inch), cluster sizes from 512 to 4096 bytes, one boot sector (the most common) to two entire tracks (DEC Rainbow), base sector addresses of both 0 and 1, logical to physical sector mapping via a translation table (à la CP/M), and the 3½-inch 600-rpm high-speed Hewlett-Packard drive (usual speed is 300 rpm). Plus, of course, the IBM PC AT-style drive. Unfortunately, the "media descriptor byte" is not unique for each of these different formats.

I expect I will continue to see more differences in future MS-DOS disk formats; it keeps my life interesting.

GARY SANFORD  
Acton, MA

### ADDING RAM TO THE AMIGA

Thanks for printing my letter on the Amiga's RAM layout (Letters, November 1985, page 26). Thanks also to Gregg Williams for his reply, which requires further comment.

Extensive changes apparently would have been necessary to provide for future upgrades to more than 512K bytes of RAM on the Amiga motherboard, even if the upgrades were to be accomplished simply by swapping chips. As I understand it, there is a segmentation between the core 512K-byte RAM on the one hand and the larger address space available to the external bus expansion port on the other hand. The Amiga's custom processing chips apparently work only within the 512K-byte space; to expand this core RAM, the very architecture of the system apparently would have to have been rearranged. This is "rather extreme," indeed.

But after deflating my letter of its "rather extreme" atmospheres, I'm still left with the central point that caused me to write: Why is an optional cartridge necessary just to get 512K in the first place?

Including a full 512K bytes on the Amiga motherboard, using 16 standard 256K

(continued)

# Data communication problem?

## Solve it with a BayTech multiport controller

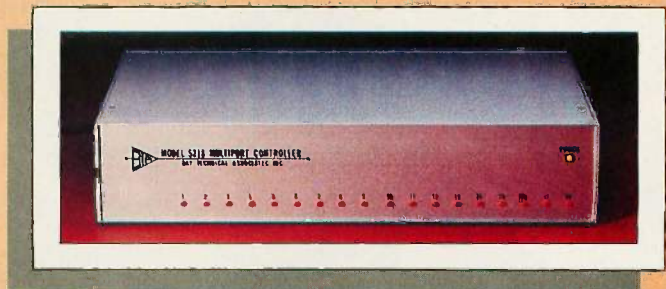

Fifty easy-to-use models for cost-effective, RS-232C serial port expansion.

- Adapt your micro to industrial control and data acquisition applications.
- Add more terminals to your existing computer system.
- Allow your computer to share or select printers.
- Enable your computers to use the same data communication lines by multiplexing.
- Simplify your network with any-device-to-any-device communication.

These intelligent multiports feature many user-programmable functions and are available in 5, 9, 12 and 18-port sizes, \$279 to \$1,795. Call or write for complete details.



**BAY TECHNICAL ASSOCIATES, INC.**  
DATA COMMUNICATIONS PRODUCTS

800/523-2702 or 601/467-8231

Highway 603, P.O. Box 387, Bay Saint Louis, Mississippi 39520  
Telex: 910-333-1618 EasyLink: 6277-1271

1-bit RAM chips, probably would have added something less than \$30 to the manufacturing cost. This would have been partly offset by the cost-reducing elimination of the optional cartridge slot, since more than 512K bytes of core RAM apparently would not have been practical, anyway.

The earlier 128K-byte prototype motherboard had 16 standard 64K by 1-bit RAM

chips, so this hypothetical upgrade to 512K bytes using 16 standard 256K by 1-bit RAM chips should have been an obvious one. The Amiga's designers must have gone out of their way to use eight nonstandard 64K by 4-bit RAM chips in order to hold standard memory down to 256K bytes and require the optional cartridge for the second 256K bytes. That was my main point, and the design choice re-

mains inexplicable to me.

I didn't want to leave the impression that I don't like the Amiga. In fact, it is precisely because I *do* like it that the memory scheme arouses my criticism; it seems to stick out like a sore thumb amidst all those wild custom processing chips. The Amiga's capabilities eat up lots of memory, and the 512K-byte core RAM should have been provided in a far more cost-effective manner. The basic Amiga should have 512K bytes of RAM, yet still be priced at \$1295 or less.

JIM HOWARD  
Project City, CA

## If lightning still scares you, you're using the wrong file manager.

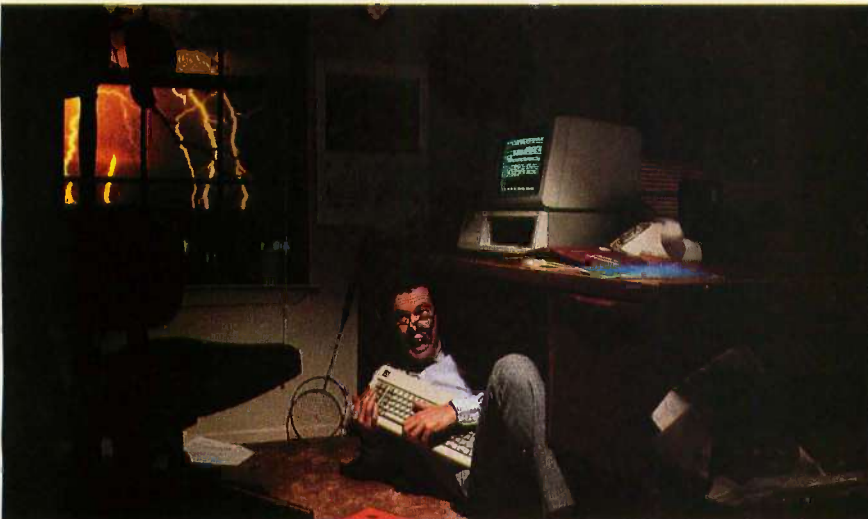

### Be sure. Btrieve.®

Lightning may strike. But it doesn't have to destroy your database.

Btrieve® file management offers automatic file recovery after a system crash. So accidents and power failures don't turn into database disasters.

Your Btrieve-based applications will come up when the lights come back on.

**Fast.** Btrieve is lightning fast, too. It's written in Assembly language especially for the IBM PC. And based on the b-tree file indexing system, with automatic balancing and electrifying access speed.

**The standard for networking.** Btrieve/N (network version) sets the standard for the industry's most popular LANs and multi-user systems.

**Fully-relational data management.** SoftCraft's entire family of products

gives you a complete, fully-relational database management system. Rtrieve™ adds report writing capabilities. Xtrieve™ speeds users through database queries with interactive menus.

**For professional programmers.** Btrieve is the fast, reliable answer for all your application development. In any development language—BASIC, Pascal, COBOL, C, FORTRAN and APL. With Btrieve, you can develop better applications faster. And know they'll be safe if lightning strikes.

**SC SoftCraft Inc.**

P.O. Box 9802 #917 Austin, Texas 78766  
(512) 346-8380 Telex 358 200

### USING THE M68000 FOR SCIENTIFIC RESEARCH

L. David Roper (Letters, October 1985, page 24) has apparently been misinformed about the M68000 family. The 68020 has 32-bit address and data buses with a 32-bit ALU and two 32-bit adders internally. It also has 32- by 32-bit multiply and 64- by 32-bit divide. The 68881 floating-point coprocessor is available in sample quantities right now and should be available for general use soon.

The 68020 is already in use. As of this date, GIMIX Inc. (in Chicago) is producing one computer with the 68020 and will soon be making a single-board computer with that chip.

I hope Mr. Roper will reconsider his decision to exclude the M68000 family from consideration in choosing a scientific computer.

CALVIN DODGE  
Wheatridge, CO

### REMOTE DIAGNOSTICS SCHEMES

Remote diagnostics offer the industry great promise, as your editorial "Service and Support" (February 1985, page 6) indicated, but their implementation is filled with "very serious problems," as a letter from Paul Pinette in the October 1985 issue (page 14) showed. The solution is not remote, however, because a carefully designed system architecture can allow us to have our bugs and eat them, too.

The old dilemma haunting the successful use of remote diagnostics occurs when the diagnostic requires the CPU, main memory, and data paths all to be operational to test a failing system. The failed system won't respond. The system can't diagnose itself for the same reason it won't respond: It's broken! There is a workable solution to this dilemma, and it is being used now. The independent multi-board architecture of the Altos 2086 and

(continued)



# The C for Microcomputers

PC-DOS, MS-DOS, CP/M-86, Macintosh, Amiga, Apple II, CP/M-80, Radio Shack, Commodore, XENIX, ROM, and Cross Development systems

## MS-DOS, PC-DOS, CP/M-86, XENIX, 8086/80x86 ROM

### Manx Aztec C86

*"A compiler that has many strengths ... quite valuable for serious work"*

Computer Language review, February 1985

**Great Code:** Manx Aztec C86 generates fast executing compact code. The benchmark results below are from a study conducted by Manx. The Dhrystone benchmark (CACM 10/84 27:10 p1018) measures performance for a systems software instruction mix. The results are without register variables. With register variables, Manx, Microsoft, and Mark Williams run proportionately faster. Lattice and Computer Innovations show no improvement.

	Execution Time	Code Size	Compile/Link Time
Dhrystone Benchmark			
Manx Aztec C86 3.3	34 secs	5,760	93 secs
Microsoft C 3.0	34 secs	7,146	119 secs
Optimized C86 2.20J	53 secs	11,009	172 secs
Mark Williams 2.0	56 secs	12,980	113 secs
Lattice 2.14	89 secs	20,404	117 secs

**Great Features:** Manx Aztec C86 is bundled with a powerful array of well documented productivity tools, library routines and features.

Optimized C compiler	Symbolic Debugger
AS86 Macro Assembler	LN86 Overlay Linker
80186/80286 Support	Librarian
8087/80287 Sensing Lib	Profiler
Extensive UNIX Library	DOS, Screen, & Graphics Lib
Large Memory Model	Intel Object Option
Z (vi) Source Editor -c	CP/M-86 Library -c
ROM Support Package -c	INTEL HEX Utility -c
Library Source Code -c	Mixed memory models -c
MAKE, DIFF, and GREP -c	Source Debugger -c
One year of updates -c	CP/M-86 Library -c

Manx offers two commercial development systems, Aztec C86-c and Aztec C86-d. Items marked -c are special features of the Aztec C86-c system.

<b>Aztec C86-c Commercial System</b>	<b>\$499</b>
<b>Aztec C86-d Developer's System</b>	<b>\$299</b>
<b>Aztec C86-p Personal System</b>	<b>\$199</b>
<b>Aztec C86-a Apprentice System</b>	<b>\$49</b>

All systems are upgradable by paying the difference in price plus \$10.

**Third Party Software:** There are a number of high quality support packages for Manx Aztec C86 for screen management, graphics, database management, and software development.

<b>C-tree \$395</b>	<b>Greenleaf \$185</b>
<b>PHACT \$250</b>	<b>PC-lint \$98</b>
<b>HALO \$250</b>	<b>Amber Windows \$59</b>
<b>PRE-C \$395</b>	<b>Windows for C \$195</b>
<b>WindScreen \$149</b>	<b>FirsTime \$295</b>
<b>SunScreen \$99</b>	<b>C Util Lib \$185</b>
<b>PANEL \$295</b>	<b>Plink-86 \$395</b>

## MACINTOSH, AMIGA, XENIX, CP/M-68K, 68k ROM

### Manx Aztec C68k

*"Library handling is very flexible ... documentation is excellent ... the shell a pleasure to work in ... blows away the competition for pure compile speed ... an excellent effort."*

Computer Language review, April 1985

Aztec C68k is the most widely used commercial C compiler for the Macintosh. Its quality, performance, and completeness place Manx Aztec C68k in a position beyond comparison. It is available in several upgradable versions.

Optimized C Macro Assembler*	Creates Clickable Applications
Overlay Linker	Mouse Enhanced SHELL
Resource Compiler	Easy Access to Mac Toolbox
Debuggers	UNIX Library Functions
Librarian	Terminal Emulator (Source)
Source Editor	Clear Detailed Documentation
MacRam Disk -c	C-Stuff Library
Library Source -c	UniTools (vi,make,diff,grep) -c
	One Year of Updates -c

Items marked -c are available only in the Manx Aztec C86-c system. Other features are in both the Aztec C86-d and Aztec C86-c systems.

<b>Aztec C68k-c Commercial System</b>	<b>\$499</b>
<b>Aztec C68d-d Developer's System</b>	<b>\$299</b>
<b>Aztec C68k-p Personal System</b>	<b>\$199</b>
<b>C-tree database (source)</b>	<b>\$399</b>
<b>AMIGA, CP/M-68k, 68k UNIX</b>	<b>call</b>

## Apple II, Commodore, 65xx, 65C02 ROM

### Manx Aztec C65

*"The AZTEC C system is one of the finest software packages I have seen"*

NIBBLE review, July 1984

A vast amount of business, consumer, and educational software is implemented in Manx Aztec C65. The quality and comprehensiveness of this system is competitive with 16 bit C systems. The system includes a full optimized C compiler, 6502 assembler, linkage editor, UNIX library, screen and graphics libraries, shell, and much more. The Apple II version runs under DOS 3.3, and ProDOS. Cross versions are available.

The Aztec C65-c/128 Commodore system runs under the C128 CP/M environment and generates programs for the C64, C128, and CP/M environments. Call for prices and availability of Apprentice, Personal and Developer versions for the Commodore 64 and 128 machines.

<b>Aztec C65-c ProDOS &amp; DOS 3.3</b>	<b>\$399</b>
<b>Aztec C65-d Apple DOS 3.3</b>	<b>\$199</b>
<b>Aztec C65-p Apple Personal system</b>	<b>\$99</b>
<b>Aztec C65-a for learning C</b>	<b>\$49</b>
<b>Aztec C65-c/128 C64, C128, CP/M</b>	<b>\$399</b>

### Distribution of Manx Aztec C

In the USA, Manx Software Systems is the sole and exclusive distributor of Aztec C. Any telephone or mail order sales other than through Manx are unauthorized.

## Manx Cross Development Systems

Cross developed programs are edited, compiled, assembled, and linked on one machine (the HOST) and transferred to another machine (the TARGET) for execution. This method is useful where the target machine is slower or more limited than the HOST, Manx cross compilers are used heavily to develop software for business, consumer, scientific, industrial, research, and educational applications.

**HOSTS:** VAX UNIX (\$3000), PDP-11 UNIX (\$2000), MS-DOS (\$750), CP/M (\$750), MACINTOSH (\$750), CP/M-68k (\$750), XENIX (\$750).

**TARGETS:** MS-DOS, CP/M-86, Macintosh, CP/M-68k, CP/M-80, TRS-80 3 & 4, Apple II, Commodore C64, 8086/80x86 ROM, 68xxx ROM, 8080/8085/Z80 ROM, 65xx ROM.

The first TARGET is included in the price of the HOST system. Additional TARGETS are \$300 to \$500 (non VAX) or \$1000 (VAX).

Call Manx for information on cross development to the 68000, 65816, Amiga, C128, CP/M-68k, VRTX, and others.

## CP/M, Radio Shack, 8080/8085/Z80 ROM

### Manx Aztec CII

*"I've had a lot of experience with different C compilers, but the Aztec C80 Compiler and Professional Development System is the best I've seen."*

80-Micro, December, 1984, John B. Harrell III

<b>Aztec C II-c (CP/M &amp; ROM)</b>	<b>\$349</b>
<b>Aztec C II-d (CP/M)</b>	<b>\$199</b>
<b>C-tree database (source)</b>	<b>\$399</b>
<b>Aztec C80-c (TRS-80 3 &amp; 4)</b>	<b>\$299</b>
<b>Aztec C80-d (TRS-80 3 &amp; 4)</b>	<b>\$199</b>

### How To Become an Aztec C User

To become an Aztec C user call 1-800-221-0440 or call 1-800-832-9273 (800-TEC WARE). In NJ or outside the USA call 201-530-7997. Orders can also be telexed to 4995812.

Payment can be by check, COD, American Express, VISA, Master Card, or Net 30 to qualified customers.

Orders can also be mailed to Manx Software Systems, Box 55, Shrewsbury, NJ 07701.

### How To Get More Information

To get more information on Manx Aztec C and related products, call 1-800-221-0440, or 201-530-7997, or write to Manx Software Systems.

### 30 Day Guarantee

Any Manx Aztec C development system can be returned within 30 days for a refund if it fails to meet your needs. The only restrictions are that the original purchase must be directly from Manx, shipped within the USA, and the package must be in resalable condition. Returned items must be received by Manx within 30 days. A small restocking fee may be required.

### Discounts

There are special discounts available to professors, students, and consultants. A discount is also available on a "trade in" basis for users of competing systems. Call for information.

Inquiry 219

# MANX

To order or for information call:

## 800-221-0440

3068 systems is designed so that even in the event of a major hardware failure, the Serial Input/Output controller (SIO PCB) is able to report status messages through a modem to the remote service center. These systems are designed so that the self-tests begin from the edge of the system (SIO PCB) and not the center (CPU). This is crucially important if the diagnostics are to function without being crippled by a failure.

If, for example, a severe hardware failure occurs in which the CPU PCB has failed, a diagnostic based on testing from the center (CPU) out will not respond. But a remote diagnostic scheme in which the tests begin at the edge (SIO) and move inward to the CPU will isolate the problem. The technician can download a wide variety of CPU diagnostics through the SIO PCB to isolate the failing component. From error messages the service center technician can devise a troubleshooting strategy. Once the CPU PCB is identified as the culprit, a new CPU can be quickly sent to the site.

In the 2086 and the 3068, each of the

key PCBs, the SIO PCB, CPU PCB, and file processor PCB, has its own independent firmware, microprocessor, and local RAM. After power-up, the Intel 8086 on the SIO PCB becomes the diagnostic controller, which is not dependent on the CPU or any other subsystem in order to execute remote diagnostics. The minimum hardware necessary for the SIO to become the diagnostic controller and start verifying the diagnostic kernel after power-up is the following: The SIO's 8086 must be able to retrieve the test program from the SIO's PROMs and store the data in the SIO's local RAMs. Only two of the ten SIO ports (one SCC integrated circuit) need to function for the SIO to be able to report status messages.

Even if the hardware necessary for the minimum diagnostic kernel fails, all is not lost. The necessary hardware for the diagnostic kernel resides on every SIO PCB. On the Altos 2086 system, there are two SIO PCBs (a master and slave). Diagnostics run from the master SIO board. So, if the failed unit does not respond to the downloaded code from the service center computer,

this indicates to the service center technician that the master SIO has failed. Now, the slave SIO can be repinned as the master SIO. Remote diagnostics can then be up and running again.

This is not a complete solution to the diagnostic dilemma that calls for failing hardware to troubleshoot itself. If the power supply of the system fails, or if the system is swallowed up by an earthquake, any remote diagnostic scheme will not work. But fortunately, most hardware failures are not catastrophic, and there is usually enough working hardware to identify the failing area. A remote diagnostic scheme designed into a system architecture of independent PCBs that self-test from the edge to the center provides the best of all possible opportunities to fix failures in the field.

CARL STRASEN  
San Jose, CA

#### CALL FOR PAPERS

*Collegiate Microcomputer*, a journal begun in February 1983, is a forum for the ex-  
(continued)

# DRIVE ENCLOSURES

## FLOPPY-WINCHESTER-TAPE

FROM \$80<sup>00</sup>

(Includes Power Supply)

FLOPPY  
8" & 5"

TAPE  
5" & 8"

WINCHESTER  
5" & 8"

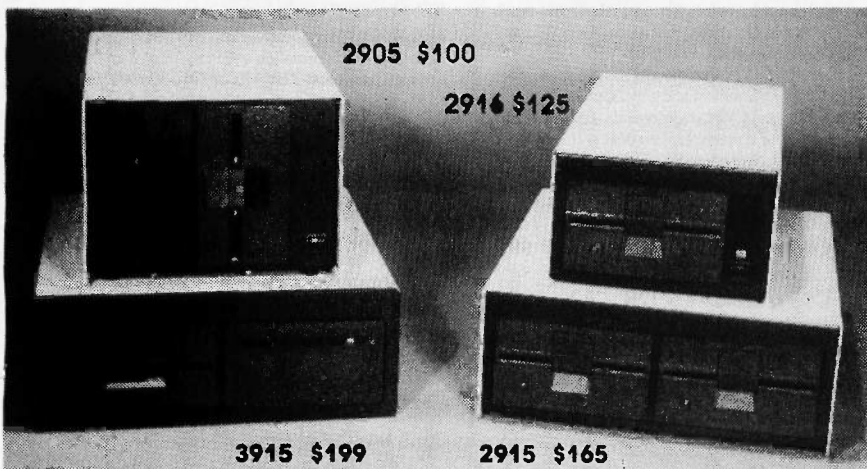

- Desktop & Rack
- Heavy Duty All Metal Cabinet
- Fan & Dust Filter\*
- Hefty Power Supplies
- Full or Slim Drives
- Power Harness From Supply To Drives
- Line Fuse, EMI Filter\*, Detachable Line Cord
- Cabinets & Supplies Available Separately

\* = Most Models (Disk drives not Included)

**INTEGRAND**

RESEARCH CORPORATION

8620 Roosevelt Ave./Visalia, CA 93291

209/651-1203

Write or call for our brochure which includes our application note:  
"Making micros, better than any ol' box computer"

32 Page Free Fakt Pakt Catalog



## *Clipper gives dBASE III™ users more time to do more. Or less.*

Clipper™ allows you to run all dBASE III™ programs 2 to 20 times faster than they do with the standard dBASE interpreter.

That frees up extra time you're wasting if you're running dBASE III programs without Clipper.

Extra time to think. To create. To produce. To use as you choose.

You see, Clipper is the first true compiler for dBASE III. Clipper eliminates the time-consuming translation which the dBASE interpreter performs line after line whenever a program is run.

With Clipper, once you've debugged your source code, it's compiled into more efficient machine code.

And Clipper compiles all your dBASE III programs. The ones you have today. The ones you'll have tomorrow. But don't wait until tomorrow to order Clipper.

Today, Clipper has already been purchased to speed up dBASE run time at 3M and Touche Ross. At Exxon and NASA. In

the Harvard Physics Department. For the State of Arizona and TRW.

And that's just a few of the installations worldwide. From Greece to Venezuela to Canada to Europe.

So stop wasting time. Call our toll-free 800 number and get Clipper.

You'll spend less time running dBASE III and more time running the rest of your life.

 **Nantucket™**

Inquiry 247 for End-Users. Inquiry 248 for DEALERS ONLY.

5995 S. Sepulveda Blvd., Culver City, CA 90230 (800)251-8438 In California (213)390-7923

dBASE III is a registered trademark of Ashton-Tate.

# When you positively custom

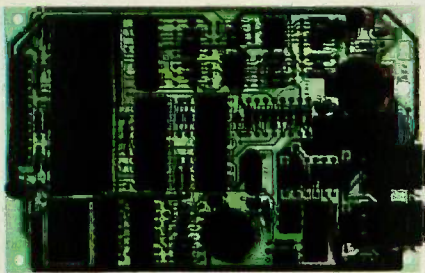

## Reliability

is your obvious first requirement in this vital link between your product and the outside world. At Ven-Tel — with 12 years experience and millions of modems designed and shipped—we don't take reliability for granted...so you can.

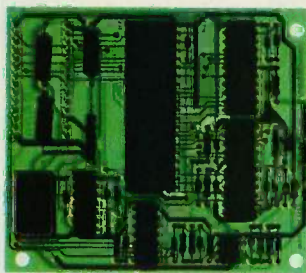

## Compatibility

with industry standards. All Ven-Tel modems utilize the industry standard "AT" command set, guaranteeing compatibility with virtually all types of software. And every Ven-Tel custom modem is fully compatible with our complete line of standard desktop and PC internal modems. We also meet Bell 212A and CCITT V.22bis standards in speeds up to 2400 baud.

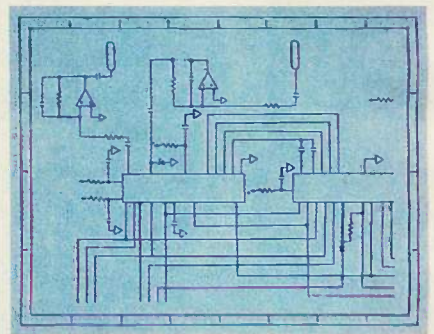

## Quick Turnaround

is more than a phrase to us. We've built a reputation for meeting product deadlines among some of the nation's largest and most demanding manufacturers. From start to finish in as little as 90 days, Ven-Tel can help you get your product to market quickly. You can even begin development using our standard modules while your design is being finalized.

# take a good

# absolutely, need reliable modems...

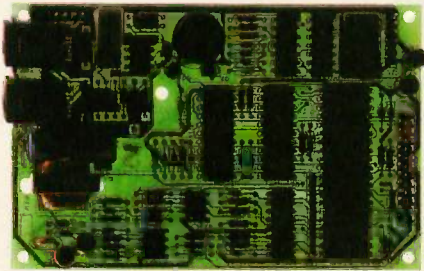

## Customizing

your modem is your choice. From our standard off-the-shelf boards, to complete custom design, to licensing our proprietary CMOS chip design (for quantities in excess of 100,000 annually), we guarantee the right modem solution based on your deadline, design and volume requirements. Custom hardware configurations and firmware give you maximum freedom for integrating the modem into your overall product design.

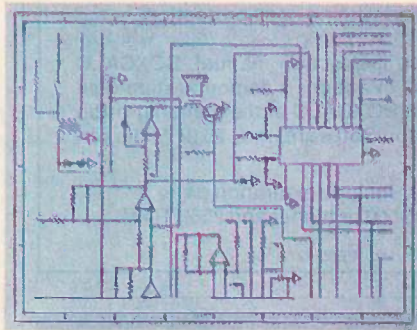

## Compact Size

is an important requirement in applications like credit check terminals, portable computers and trouble monitors. Ven-Tel modem density is state-of-the-art to provide excellent "real estate" value, with complete auto-dial/auto-answer, AT compatible, 212A modems—in as little as 12 square inches. With power requirements as low as 500mW.

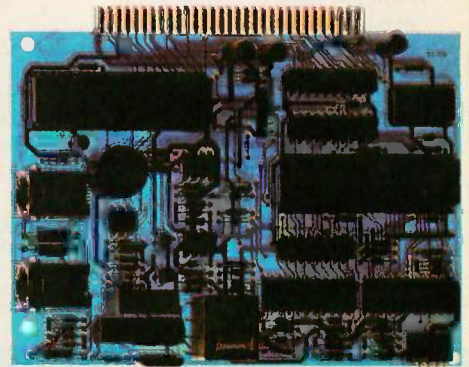

## Competitive Pricing

makes the Ven-Tel custom modem package one definitely worth looking into. For quotations based on your modem specs or a discussion with our experienced OEM sales engineers, call **800/538-5121 (outside California)**. In California, call **408/727-5721**. Or contact us for our custom modem brochure: Ven-Tel, OEM Products Division, 2342 Walsh Avenue, Santa Clara, CA 95051.

Inquiry 365

look at **Ven-Tel**

# BOXCALC™

## Not Another Spreadsheet! Not Another Word Processor!

No - BOXCALC is a new kind of calculation program that allows easy combination of figures with text. Instead of fighting pre-determined rows and columns, just type text and place calculation "boxes" anywhere on your screen at the press of a function key. This makes BOXCALC just what you need for creating cost estimates and budget reports. Even income tax forms. Any documents that used text mixed in with the figures.

- Create up to 800 calculation boxes for each BOXCALC file.
- Relocate boxes on screen under cursor control. Or move whole columns of boxes.
- BOXCALC is page oriented - files may contain up to 99 pages.
- Print any page or combination of pages (send printer control codes, too).
- Put simple or complex formula in a box to establish it's mathematical relationship to other boxes.
- Calculate boxes sequentially or in any order you specify.
- Get data from other BOXCALC files.
- Full replication features for fast, easy creation of box formulas.
- Supplied with no copy protection.

Along with 4 sample files and a comprehensive instruction manual, BOXCALC is available for \$40.00. Or, to observe BOXCALC in action, a demonstration disk and manual can be purchased for \$5.00. To order BOXCALC or the demonstration kit, send your name, address, and check to: Cotton Software, Inc., 2510 Anderson Rd., Suite #364, Covington, Ky. 41017.

(VISA/MC # accepted for BOXCALC only - include expiration date)  
Requires PC, XT or AT, color monitor, PC DOS 2.0 or higher and 256K RAM.

BOXCALC is a trademark of Cotton Software, Inc. 1-606-727-1600.

## LETTERS

change of ideas on the role of the micro-computer in all subjects and areas of college and university life. Material appearing includes uses of hardware and software, descriptions of courses, units and topics using microcomputers, results of research using microcomputers, analysis of experiments using microcomputers, student projects, suggestions and tips, write-ups of experiences as microcomputer consultants, reviews of the literature, and evaluation of microcomputer use in the office and in materials preparation for teaching and research. Subscription rates are \$28 per year and \$36 per year for non-U.S. subscriptions.

BRIAN J. WINKEL, EDITOR  
*Collegiate Microcomputer  
Rose-Hulman Institute of Technology  
Terre Haute, IN 47803*

### MAKING RS-232C CONNECTIONS UNIVERSAL

I'm afraid that the scheme proposed by Pete Klammer (Letters, October 1985, page 22) to make RS-232C connections universal will not work. To see why, let us ignore the control lines in an RS-232C setup and concentrate our attention on the two data lines, which serve as the simplest example that will demonstrate the phenomena involved.

The RS-232C standard states that the female connector shall be associated with data communications equipment (DCE); transmitted data will be on pin 2 and received data will be on pin 3.

Similarly, the male connector shall be associated with data terminal equipment (DTE). Transmitted data will still be on pin 2 and received data on pin 3.

From the point of view of the DTE, it sends data to the DCE on pin 2 and receives data from the DCE on pin 3. The DCE sends data to the DTE on pin 3 and receives data from the DTE on pin 2. This standard allows any data terminal equipment to be connected to any data communications equipment directly, maintaining compatibility of connections.

However, if all equipment were to be considered similar, and hermaphroditic connectors were used, a problem would arise. The problem would be that all units (according to Mr. Klammer's scheme) would use the same pin for a given function (let's say pin 2 to send data and pin 3 to receive). Now we could not connect any two pieces of equipment together directly, since each unit's transmit line would be connected to the other unit's transmit line, rather than to its receive line.

(continued)

## DataSaver<sup>400</sup> Standby UPS

Power protection for the most powerful micro-computer systems with peripherals is here, now, with the 400 Watt DataSaver. Protect your investment in application software and hardware with reliable, continuous power. 90 and 200 Watt capacities and international models are also available.



Cuesta Systems Corporation  
3440 Roberto Court  
San Luis Obispo, CA 93401

©1985, Made in U.S.A.

Write or call 805/541-4160  
Dealer, O.E.M. inquiries invited



# PC Paintbrush™

## Because life is too short for monochrome pie charts.

**Fun  
is the best thing  
to have.**

With PC Paintbrush, you can add color, flair, dimension and creativity to a chart, a presentation, or an otherwise dull day. From charts and graphs to serious computer art, our newest generation 3.0 PC Paintbrush will cheer you on with features no other graphics package can match.

Best of all, it's easy to use. You don't have to learn up to sixty commands, like you do with some products. If you can understand icons as simple as scissors, paintbrush, spray can and paint roller, you're ready to start using PC Paintbrush.

**The pen is mightier  
than the keyboard.**

None of history's great artists drew with a keyboard, and you shouldn't have to either. So PC Paintbrush is now available with a Summasketch MM™ Series drawing tablet, to give you complete freedom of expression. Of course, it also supports regular mice, joy-sticks, graphics tablets, and is compatible with most graphics cards.

PC Paintbrush also has a beautiful way with words. The text icon lets you write in any of eleven fonts, in nine sizes, with italics, outline, shadow and boldface variations.

What's more, with the new 3.0 PC Paintbrush, you can draw rounded boxes, rubber band curves and circles, and edit pictures many times larger than the screen.

**Are we making fun  
of 1-2-3®? Why not?**

For Lotus™ users, PC Paintbrush's new PIC

**Go on, live a little.**

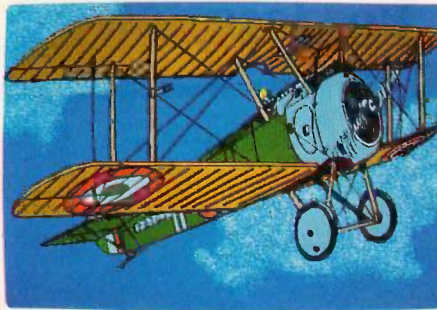
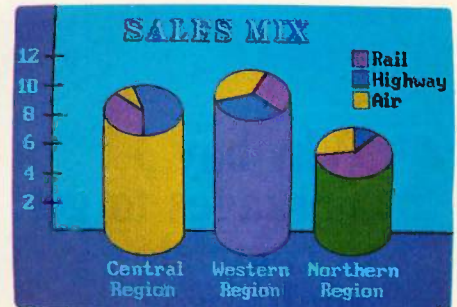
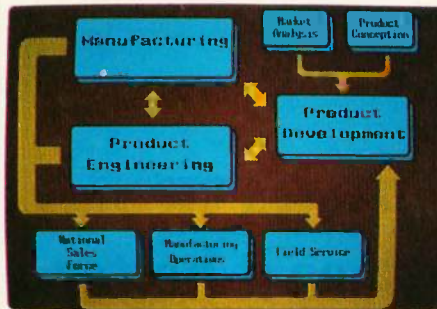

interpreter loads 1-2-3™ and Symphony™ charts and graphs at your equipment's best resolution, from an IBM EGA™ (640 X 350 X 16 colors) to a Number Nine Revolution™ (512 X 512 X 256 colors).

With our FRIEZE™ frame grabber you can pull graphics created by any program right off the screen into PC Paintbrush. So you can take your Paintbrush and palette anywhere, improving the looks of things as you go. And having a lot of fun on the way. In addition, our optional slide show package, PC PRESENTATION, allows you to program your graphics into a first class presentation with fades, zooms, quick cuts and animation.

PC Paintbrush supports 19 video graphics cards and 30 printers and plotters.

For more information on PC Paintbrush, call or write us at the address below, or ask your computer dealer for a demonstration.



**Z·SOFT**  
**PC Paintbrush**

Ask about our  
PC Paintbrush &  
Summasketch™ drawing  
tablet special

**Corporate Headquarters:**

ZSoft Corporation, 1950 Spectrum Circle, Suite A 495, Marietta, GA 30067, 404/980-1950

**West Coast Sales Office:**

160 Sir Francis Drake Blvd., San Anselmo, CA 94960, 415/456-0955

PC Paintbrush is a trademark of ZSoft Corporation. Lotus, 1-2-3, and Symphony are registered trademarks of Lotus Development Corporation. IBM and Enhance Graphics Adapter are registered trademarks of International Business Machines, Corp. Number Nine Revolution is a trademark of Number Nine Computer Corp. Summasketch is a registered trademark of Summagraphics Corp.

At the very least, a crossover connector would have to be used in all cases.

Furthermore, the use of such crossover connectors creates another, even more subtle, problem. Suppose an extension cable is needed. Since all units require crossovers and all connectors are the same, in practice all cables will contain crossovers. Then, adding an extension cable to an already existing cable will

result in *two* crossovers, which bring the same (rather than the complementary) functions together again (i.e., transmit is again connected to transmit). The fact that all cables have identical connectors at both ends would make it impossible to distinguish a straight-through extension cable from a "normal" crossover cable without making continuity checks.

With the current scheme, crossover

cables are required only when both ends have the same kind of connector (male or female); a cable with a male connector at one end and a female at the other is a straight-through extension cable.

I agree with Mr. Klammer that the current standard is not perfect; nevertheless, after considering the alternative I have come to the conclusion that it seems to be the best compromise among many conflicting factors,

HOWARD MARK  
Suffern, NY

Why buy 3 packages to get a complete multi-user dBASE\* System?

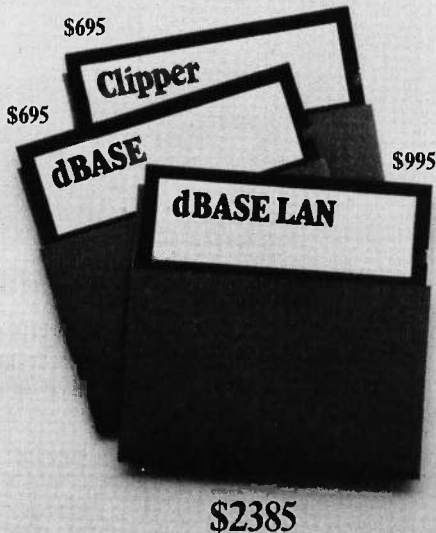

FoxBASE™  
does it better.  
For less.



for the widest variety of machines and operating systems.

In addition, FoxBASE is interactive and 100% dBASE compatible (including full macro usage). The only thing you won't get is all those annoying dBASE bugs!

Best of all, FoxBASE costs less than half the other packages.

So call (419) 874-0162 now, and ask for a copy of our comparative analysis (including benchmarks). After all...

After all, FoxBASE is a compiler, an interpreter and a multi-user dBASE system all in one. That means single vendor support and no problems with product incompatibility.

Not only that, FoxBASE actually outperforms dBASE and other dBASE compiler products: its program execution speed is far superior to the competition and its compiler runs up to 60 times faster than other compilers. And FoxBASE is available

Nothing Runs Like a Fox.

**FOXBASE™** 

Fox Software, Inc.  
27475 Holiday Lane, Perrysburg, OH 43551  
(419) 874-0162

**COMPARING THE MOTOROLA 68000 AND INTEL IAPX86**

It was intriguing to note the comparison G. Michael Vose made of the Motorola 68000 and Intel iAPX86 families ("Intel and Future IBM PCs," *Inside the IBM PCs*, Fall 1985, page 4). I agree with his first and second conclusions, especially that the "open, flexible architectures" of the M68000 family leaves more room for "innovations in software" on the part of programmers, and that such innovations do indeed "keep our industry vital." It seems to me that Mr. Vose glossed over one aspect of the comparison that, I feel, should have influenced his third conclusion.

The "rigid and formal" architectures of the iAPX86 that realize more fixed solutions in hardware also produce more standardization. While standardization may seem like a restraint to the inventive programmer, it is a boon to the commercial software producer, who must create programs that run on many machines.

I think that software standardization should be the overwhelming consideration in Mr. Vose's third conclusion about which family will dominate the "classic single-user microcomputer." It is the iAPX86 family that will likely continue to support the vast majority of standard end-user programs that "we all want on our desk or at home to play and tinker with."

Of course, that conclusion may depend on who you consider "we all." If the emphasis is on "we," i.e., computer professionals like the editors and contributors of BYTE, then the flexibility of the 68000 might be decisive. However, if the emphasis is on "all," don't forget that the vast majority of single users are not programmers but commercial program end users. I think this point is often forgotten amidst the professional enthusiasm at BYTE.

WILLIAM S. JOHNSON  
Palo Alto, CA

(continued on page 360)

\*dBase is a registered trademark of Ashton-Tate FoxBASE is a trademark of Fox Software, Inc. Clipper™ is a trademark of Nantucket



## Loud and clear.

Microsoft has been the language leader from day one. From the world's favorite BASIC to the systems languages software developers prefer. No one else has put so much programming power on so many micros.

Microsoft offers a complete set of languages. Whether you favor the elegance of C, or the power of assembly language. From data munching in COBOL to number crunching in FORTRAN, we've got the power you need.

### The advantages of leadership.

Microsoft languages have developed quite a following. They're backed by the largest collection of support libraries you've ever seen. Packages for advanced mathematics and data management. From graphics support to context-sensitive editors. All available today. So you can spend your time solving real problems, not reinventing the wheel.

Microsoft's languages—like C, FORTRAN, Pascal and Macro Assembler—have become the favorites of commercial software developers. It's not surprising. Interlanguage calling allows libraries written in one language to be

used with others. Which means your existing routines can be an investment in future projects, not lost time and effort.

Our interactive debuggers are another Microsoft edge. Now you can debug the object code using the source language. Easier debugging lets you spend more time creating.

### Pipelines to the future.

Microsoft wrote the book when it comes to operating systems. Nobody knows MS-DOS® or XENIX® better. And our languages show it. We put the latest advances within your grasp. From networking and pipes to multi-tasking, Microsoft languages have the edge you need.

### Complete support.

Only Microsoft offers language support this comprehensive. Our clear, thorough documentation, and regular product enhancements are setting new standards in the industry. Add our technical "hotline" and our highly-trained support staff, and you'll reach the same conclusion the industry has: Microsoft languages always lead from strength.



# Microsoft C

First with the pros.

*"Microsoft C is the cornerstone of all our future development projects. Not only is the code more efficient, we can really exploit the PC's architecture with Microsoft C's NEAR and FAR pointer types."*

Ray Ozzie, President of IRIS Associates and key Symphony developer.

*"The code optimization is impressive—especially the register declarations."*

Jim Bean, Peachtree Software.

When you need code that's small and fast, Microsoft® C is the language.

Our optimizing compiler lets you squeeze the maximum out of your machine with minimum effort. Tighter code runs faster. And virtually every program will run faster with Microsoft's C Compiler than with any other MS-DOS compiler.

Our advanced memory models give you unmatched flexibility. No arbitrary limits on code and data. Use large or small memory models as the application demands. Exclusive features like our NEAR and FAR pointers let you combine different models without sacrificing performance.

Our extensive math libraries are another plus. The floating point package supports 8087 operation when speed is the key. There's also floating point emulation for unendowed PCs. And the altmath package gives you an extra burst of speed when you really need it.

A bundle of other features can save you programming time. There's inter-language calling support. So you can use existing library routines. Unsurpassed XENIX compatibility. And documentation that reviewers have praised for its clarity and thoroughness.

If Microsoft C amazes you, don't be surprised. After all, our C is the choice of the leaders. Companies like Lotus® Ashton-Tate. And IBM®.

## Microsoft C Compiler Version 3.0 for MS-DOS

### Microsoft C Compiler

- Produces compact code and fast executables.
- Implements register variables.
- Small, medium and large memory model libraries.
- Can mix models with NEAR and FAR pointers.
- Transport source and object code between MS-DOS and XENIX 286 operating systems.
- Library routines implement most of UNIX™ System V C library.
- Choose from three math libraries and generate in-line 8087/80287 instructions or floating point calls:
  - Floating Point Emulator (utilizes 8087/80287 if installed).
  - 8087/80287 coprocessor support.
  - Alternate math package provides extra speed without an 8087/80287.
- Link your C routines with Microsoft FORTRAN (version 3.3 or higher), Microsoft Pascal (version 3.3 or higher) or Microsoft Macro Assembler.
- Supports MS-DOS pathnames and input/output redirection.
- File sharing, record locking and file locking are supported.
- Do source level debugging with the Symbolic Debug Utility, available separately with Microsoft Macro Assembler.

### Library Manager

- Create, organize and maintain your object module libraries created with Microsoft languages.

### Object Code Linker

- Simple overlay linker combines relocatable object modules created using Microsoft languages into a single program.
- Link very large programs (over 1 megabyte) using overlays.

### Microsoft EXE File Compression Utility

- A new utility to compress sequences of identical characters from an executable file and optimizes the relocation table.

### Microsoft EXE File Header Utility

- Display and modify EXE file header, allowing you to tune the stack size and initial memory allocation.

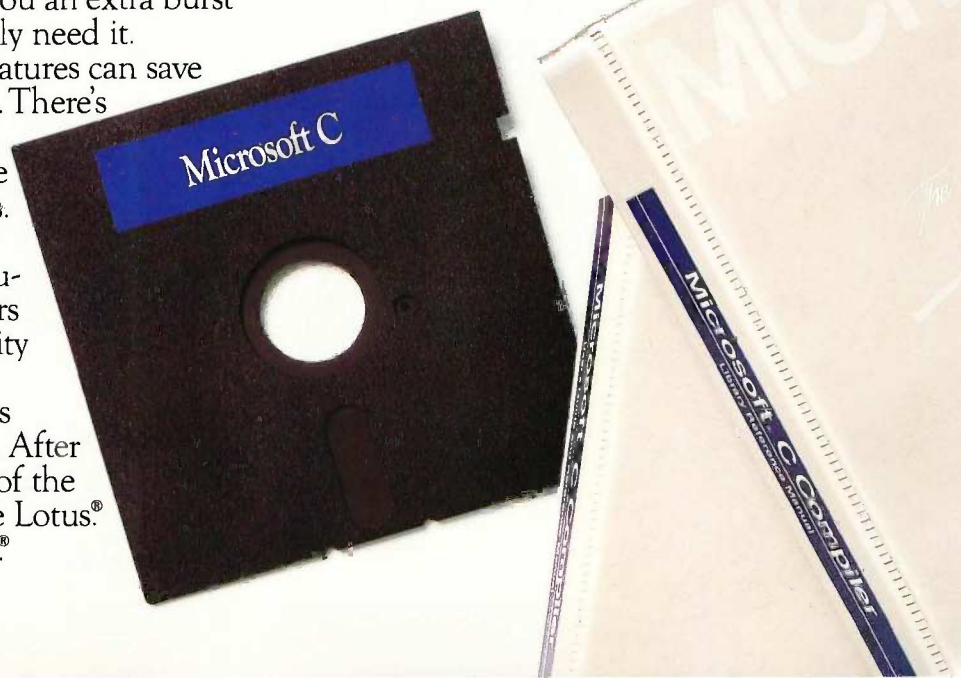

# Macro Assembler

The quickest. Bar none.

Our Macro Assembler has long been the most complete package on the market. Now it's also the fastest. Three times faster than before. And faster than anyone else. Period.

Of course, it's still the most powerful assembler on the market. It supports the standard 8086/8087 opcodes. And the new 186/286/287 instruction set. So you can make the most of the new machines.

Debugging is quicker, too. Thanks to our interactive symbolic debugger, SYMDEB. Now you can refer to variables and source code instead of getting lost in hex dumps. And this debugger also works with Microsoft languages like C, FORTRAN and Pascal. So now you can set breakpoints and trace execution—using source code for reference.

SYMDEB is just part of our complete set of utilities. Tools that make programming as fast as it should be. There are the linker and library managers you'd expect. Plus a new version of MAKE, our maintenance utility, with improvements like macro expansions and inference rules.

We've also revised the manuals. Our new Macro Assembler has a lot to offer, so we added more examples. Now our manuals are not only thorough, they're clearer than ever before.

For quick development and assembly, the choice is obvious. Microsoft. There's nobody faster.



*The Macro Assembler's symbolic debugger lets you debug Microsoft FORTRAN programs at either the source or object code level. Set break points, observe the contents of variables and expressions, and examine the contents of the stack.*

```
-v .10
10: DO 10 I = 1,8191
11: 10  FLAGS(I) = .TRUE.
12: DO 91 I=1,8191
13: IF(.NOT. FLAGS(I))
14: PRIME = I + I + 1
15: 200  FORMAT(1X, I6)
16: COUNT = COUNT + 1
17: K = I + PRIME
-bp .14 "a"
-g
13: PRIME = I + I + 1
1AEF:0069 A16240 MOV
1AEF:006C 03C0 ADD
1AEF:006E 40 INC
1AEF:006F A36440 MOV
16: COUNT = COUNT + 1
1AEF:0072 FF066040 INC
17: K = I + PRIME
-?no 4062
0001h 00000001 (1) " "
-t
16: COUNT = COUNT + 1
-
```

## Microsoft Macro Assembler Version 4.0 for MS-DOS

### Macro Assembler

- Fastest macro assembler for MS-DOS computers.
- Supports the 8086/8087/8088 and the 186/286/287.
- Define macros.

### Conditional assembly.

- Optional case sensitivity for symbols.

- 100% upward compatibility from earlier versions of both the Microsoft and IBM Macro Assemblers.

### Interactive Symbolic Debug Utility

- Source level debugger for programs written in Microsoft Macro Assembler, C Compiler, FORTRAN, and Pascal.
- Screen swapping helps debug highly visual applications.
- Set breakpoints on line numbers and symbols.
- Single step to follow program execution.

- Disassemble object code.

- Display and modify values.

- Full I/O redirection.

### Program Maintenance Utility

- Rebuilds your applications after your source files have changed.

- Similar to UNIX MAKE utility.

- Supports macro definitions and inference rules.

### Library Manager

- Create, organize and maintain your object module libraries created with Microsoft languages.

- Set page size from 16 to 32678, to create compact and granular libraries.

### Object Code Linker

- Simple overlaying linker combines relocatable object modules created using Microsoft languages into a single program.

- Load Map generation.

- Specify from 1 to 1024 segments.

### Cross-Reference Utility

- Creates a cross-reference listing of the definitions and locations of all symbols used in an assembly language program, which makes debugging programs easier.

### Microsoft EXE File Compression Utility

- Packs EXE files for smaller size on disk and faster loading at execution time.

### Microsoft EXE File Header Utility

- Display and modify EXE file header, allowing you to tune the stack size and initial memory allocation.

# FORTRAN

The overwhelming favorite.

How did Microsoft FORTRAN get so popular?

It could be the mainframe compatibility. Our compiler makes porting applications a cinch with overlays and the ANSI features you need.

It could be our support for arrays and COMMON blocks larger than 64K. So you can tackle mainframe-size problems.

It might be the shelves and shelves of third party support libraries. No other FORTRAN comes close.

It could be the extensive math support. Our collection of math libraries is simply the largest available. Tackle real problems with direct 8087 support or emulation. Use IEEE floating point or— for extra speed—the almath package.

It could be the comprehensive set of utilities. A powerful linker and library manager combination. Plus tools like EXEMOD and EXEPACK. Standard.

It could be the XENIX and MS-DOS source-level compatibility. Or the direct interlanguage calling to Microsoft C, Pascal, and Assembler. Or the ability to work with our Macro Assembler's symbolic debugger.

It could be the value. Nobody offers a FORTRAN package this complete at this low a price.

Why is Microsoft FORTRAN the most popular FORTRAN?

All the above.

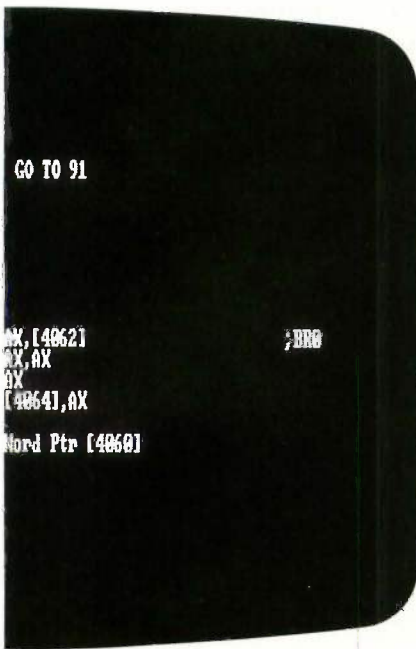

*View the FORTRAN source code. Set a break point at line #14. Run the program (g) and use the expression evaluator (?) to examine the contents of a variable. Then use the trace command (t) to observe the program flow.*

## Microsoft FORTRAN Compiler Version 3.3 for MS-DOS and XENIX 286

### Microsoft FORTRAN Compiler

- Implements most ANSI 77 standard features, plus extensions.
- Easily port mainframe/minicomputer programs with little or no modification.
- Overlay support in the compiler and linker.
- Common blocks and arrays greater than 64K.
- Supported by the largest number of third party libraries.
- Includes a full set of math libraries to select from:
  - 8087/80287 emulation.
  - 8087/80287 coprocessor support.
  - Floating Point without 8087/80287.
  - BCD Floating Point.
- Conditional compilation.
- Link your FORTRAN routines with Microsoft C Compiler (version 3.0 or higher), Microsoft Pascal (version 3.3 or higher), and Microsoft Macro Assembler.
- MS-DOS 3.1 network support and IBM local area network support.
- Source code compatible between MS-DOS and XENIX 286.
- Do source level debugging with the Symbolic Debug Utility, available separately with Microsoft Macro Assembler.

### Object Code Overlay

- Simple overlay linker combines relocatable object modules created using Microsoft languages into a single program.
- Link very large programs (over 1 megabyte) using overlays.

### Library Manager

- Create, organize and maintain your object module libraries created with Microsoft languages.

### Microsoft EXE File Compression Utility (MS-DOS only)

- A utility to pack EXE files for smaller size on disk and faster loading at execution time.

### Microsoft EXE File Header Utility (MS-DOS only)

- A utility that allows you to display and modify the fields in EXE file headers.

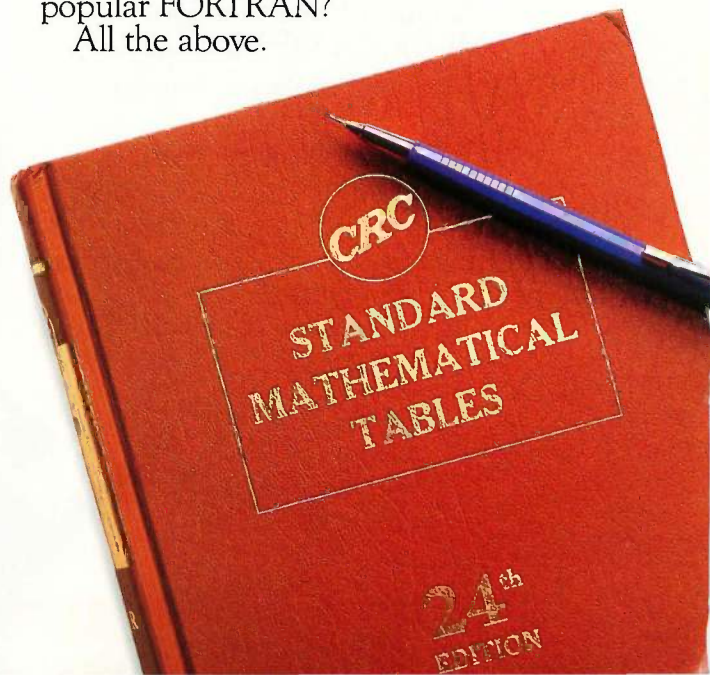

# COBOL

The interactive edge.

```
79          close transaction-file.
80
81 *         p10-read-and-process.
82           read transaction-file into work-trans-rec
83           at end move on-value to end-of-file-sw.
84
85           if transaction-status = "99"
86             perform p10-process-record
87           else if transaction-status = "10"
88             move on-value to error-sw, end-of-file-sw.

TRANSACTION-STATUS [01]
WORK-TRANS-REC [0
TOTAL-RECORD-COUNT [000009]

Breakpoint 1 Step Count 0 on Entry of P10-READ-AND-PROCESS
Breakpoint 2 Step Count 0 on line number 86

COMMAND: Breakpoint Display Find 3D Help Options
          Quit Transfer User View Window
Breakpoint 1 Step Count 0 on Entry of P10-READ-AND-PROCESS
Current line: 81 Status: Breakpoint 1 ViewCob: latest
```

Microsoft COBOL gives programs a new look. With dazzling support for interactive programs, and more. Our new COBOL Compiler brings applications to life in several ways.

Our extended screen section lets you create programs that you'd never thought could be written in COBOL. Quickly, easily.

Performance is top notch as well. Our ISAM lets your applications blaze through files. After all, our ISAM is the fastest on the micro market.

Of course, Microsoft COBOL complies with the ANSI standard. Amazing performance, without runtime license fees. No wonder our COBOL is the choice of manufacturers like IBM, AT&T, DEC, HP and Wang.

## Another breakthrough: Microsoft COBOL Tools.

Only Microsoft makes debugging this easy.

Our COBOL Tools is the perfect companion to our COBOL Compiler. A complete set of utilities. Tools that make debugging and maintenance easier than you'd thought possible.

The star of the show is ViewCOB, our

advanced interactive debugger. ViewCOB lets you control and examine programs easily. Open windows on variables and procedures while watching the source code execute. ViewCOB is simply the most advanced COBOL debugger you can get.

Microsoft COBOL and COBOL Tools. An unbeatable team.

### Microsoft COBOL Compiler Version 2.1 for MS-DOS and XENIX 286

#### Interactive extended screen section

- Cursor positioning, auto skip, and automatic data field formatting.
- ACCEPT or DISPLAY a screenful of data with a single statement.

#### Fast multi-key ISAM

- Split keys, alternate keys, duplicate keys.
- Benchmark results of 2500 reads, writes and rewrites to an ISAM file.

	Microsoft COBOL	Micro Focus native code	Ryand McFarland COBOL 2.0
Seconds	846	4073	1177

Source code compatible between MS-DOS and XENIX 286.

### Microsoft COBOL Tools for MS-DOS and XENIX 286

- Cross reference utility speeds program development.
- Menu generator allows you to use Microsoft Word style menus in your program.
- Mouse interface allows you to create programs that use the mouse (MS-DOS only).

#### Advanced interactive debugger

- Use trace, single step, and execution history to follow the program flow.
- Observe the contents of variables and memory while the program is executing.
- Set breakpoints and change the contents of variables.
- Trap fatal runtime errors.
- Use the menu driven windowing user interface with on-line help.

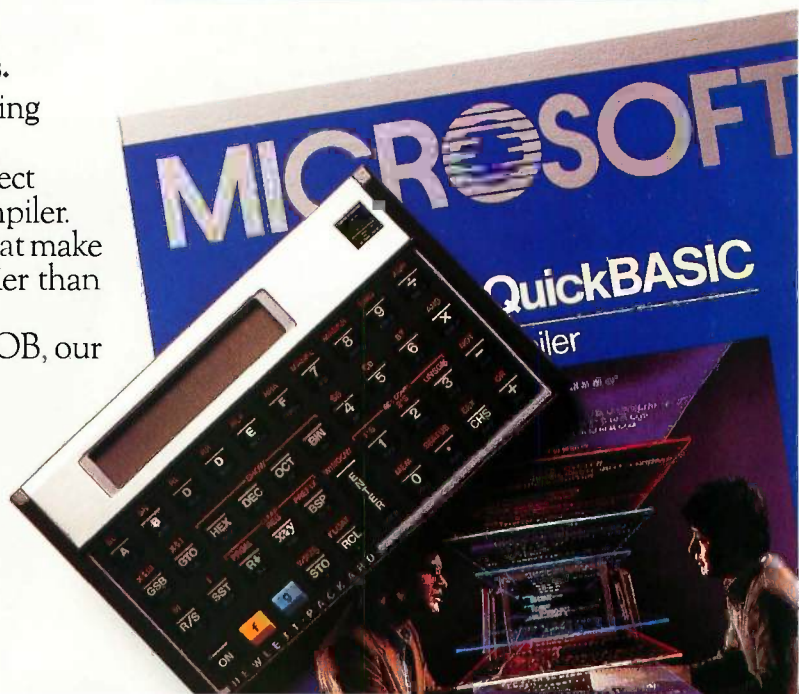



# Pascal

When you've outgrown the others.

Only Microsoft Pascal is powerful enough to push the outer limits of your PC. With more features than any other Pascal compiler.

Microsoft Pascal handles large programs with ease. No 64K boundaries — use multiple code and data segments up to a megabyte. Create your own libraries of pre-compiled Pascal modules. Separately-compiled modules can be overlaid or linked together into one file.

Our Pascal comes complete with the BCD and 8087 math libraries you'd expect. Including an IEEE floating point emulator. And Microsoft Pascal is completely compatible with IBM's Local Area Network and MS-DOS Networking. Added features without added costs.

Microsoft Pascal also supports direct interlanguage calling to modules written in Microsoft C, or Microsoft FORTRAN or assembly language. And it's compatible with our Macro Assembler's symbolic debugger. So you can track down those subtle logic errors with breakpoints instead of guesswork.

Microsoft Pascal. Nobody does it better.

## Microsoft Pascal Compiler Version 3.3 for MS-DOS and XENIX 286

### Microsoft Pascal Compiler

- Separate module compilation.
- Large program support; up to 1 megabyte code and multiple data segments.
- Overlay support.
- Contains four math libraries to choose from:
  - 8087/80287 coprocessor support.
  - Fast IEEE floating point.
  - 8087/80287 floating point emulation.
  - BCD decimal math.
- Link in your routines or third party software routines written in Microsoft FORTRAN (version 3.3 or higher), Microsoft C Compiler (version 3.0 or higher) or Microsoft Pascal (version 3.3 or higher), or Microsoft Macro Assembler.
- Source code compatible between MS-DOS and XENIX 286.
- Supports file sharing and record and file locking.
- Supports MS-DOS pathnames and input/output redirection.
- Do source level debugging with the Symbolic Debug Utility, available with the Microsoft Macro Assembler.

### Library Manager

- Create, organize and maintain object module libraries created with Microsoft languages.

### Object Code Linker

- Simple overlay linker combines relocatable object modules created using Microsoft languages into a single program.
- Link very large programs (over 1 megabyte) using overlays.

### Microsoft EXE File Compression and File Header Utility (MS-DOS only)

- Compress, modify and examine executable files and their headers.

# Microsoft QuickBASIC

BASIC just got faster.

Microsoft's new QuickBASIC Compiler gives your programs an extra burst of speed. Without sacrificing BASICA compatibility. Your compiled programs will run just like before, only faster. Three to ten times faster. With little or no modification.

QuickBASIC makes structured programming a snap. New extensions like alphanumeric labels make programming easier too. And separately compiled subprograms let you test and compile individual routines one at a time.

Microsoft QuickBASIC. All the features of a compiler, with BASICA compatibility to boot.

## Microsoft QuickBASIC Compiler Version 1.0 for IBM PC and Compatible Computers

### BASICA compatibility

- Sound statements including SOUND and PLAY.
- Graphics statements including WINDOW, VIEW, DRAW, GET, PUT, LINE, CIRCLE, LOCATE and SCREEN.

Results of the Sieve benchmark 

	BASICA	QuickBASIC
seconds per iteration	71	0.5

### Structured programming support

- Subprograms can be called by name and passed parameters. Both local and global variables are supported.
- Multi-line functions can be called by name and return a value.
- BASICA structures are supported including WHILE/WEND, IF/THEN/ELSE, FOR/NEXT, GOSUB/RETURN, and event handling.

### Alphanumeric labels

- Can be used to make your programs more readable. Line numbers are not required but are supported for BASICA compatibility.

### Modular programming support

- Separate compilation allows you to create compiled BASICA libraries to use and reuse in your programs.
- Named common gives you control of data flow between individual modules.

### Large program support

- Code can use up to available memory.
- Data can use up to 64K RAM.

# LISP

## The language of Artificial Intelligence.

What's Microsoft LISP got going for you? It runs significantly faster than the competition. And this new version adds several advanced libraries. Over 400 Common LISP functions, macros and special forms. Most implemented in machine code.

If you're putting AI on your PC, Microsoft LISP is your language.

# muMATH

## Mainframe math on your PC.

From solving equations to high precision calculations, muMATH is the ticket.

Microsoft muMATH handles tasks from algebra to calculus and vector analysis. Now your PC can do numeric analysis based on symbolic expressions. And give you exact answers.

If you crunch numbers—or equations—muMATH is just what the CPU ordered.

# Sort

## Versatility without compromise.

Microsoft Sort makes fast sorting easy.

A powerful, programmable interpreter lets you choose ASCII, EBCDIC or custom sequences. Sort handles files from any Microsoft language. Without limiting the size of your file, the number of search keys, or your record length.

Microsoft Sort. The speed and power you need. Easily.

## The leadership edge.

No other languages are backed by as massive a collection of third-party software. Here are just a few of the companies that speak our languages: **Blaise Computing, Graphic Software Systems, Greenleaf Software, Inc., IMSL, Media Cybernetics, Microrim, Numerical Analyst Group, Phoenix Software, Solution Systems, Spruce Technology, Trio Systems, and Virtual Microsystems.**

This is just a sample. For a complete list, call Microsoft at the number below.

## An added value for our readers.

We're proud of the way our family works together, so we're offering a \$25 rebate on our Macro Assembler when you purchase Microsoft C, Pascal or FORTRAN.\*

For more details, upgrade information or the name of your nearest Microsoft dealer, call toll free (800) 426-9400. In Washington State and Alaska, call (206) 828-8088. In Canada, (800) 387-6616.

Microsoft Corporation  
Bellevue, Washington USA

Microsoft GmbH  
München DEUTSCHLAND

Microsoft Canada Inc.  
Toronto CANADA

Microsoft AB  
Stockholm SWEDEN

Microsoft Pty  
Sydney NSW AUSTRALIA

Microsoft Ltd.  
Reading ENGLAND

Microsoft SARL  
Paris FRANCE

QNIX Microsoft  
Seoul KOREA

Microsoft Far East  
Tokyo JAPAN

Microsoft SpA  
Milano ITALIA

\*Rebate offer valid only in the United States.

Microsoft, MS-DOS, and XENIX are registered trademarks and The High Performance Software is a trademark of Microsoft Corporation. Microsoft Lisp and muMATH were developed by Soft Warehouse, Inc.

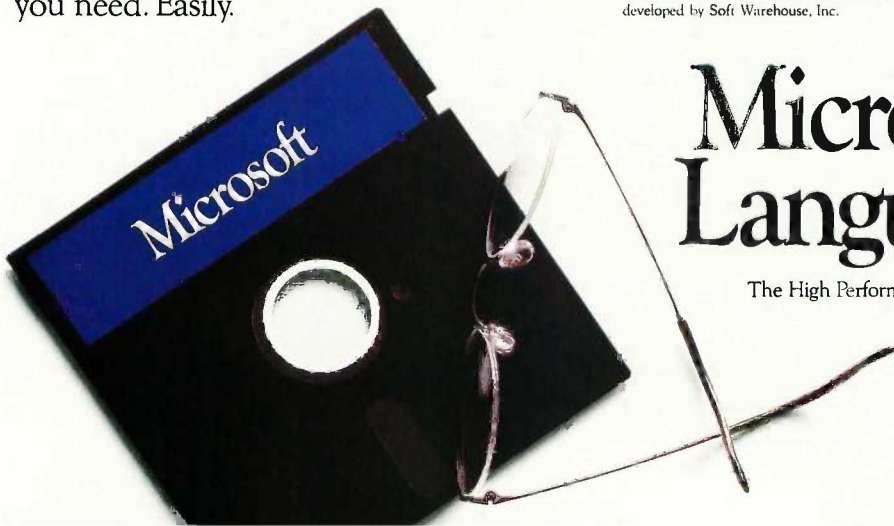

# Microsoft<sup>®</sup> Languages

The High Performance Software™

# F·I·X·E·S A·N·D U·P·D·A·T·E·S

## UPDATES

### BetterBASIC 2.0

Subsequent to Art Huston's review of Summit Software's BetterBASIC version 1.1 (October 1985, page 277), we learned of version 2.0, scheduled for shipment at the beginning of 1986 and providing the following enhancements:

**Increased IBM PC BASICA compatibility:** Random file I/O, program interrupts, assembly-language calls compatible with BASICA, error handling, dynamic strings, dynamic arrays, CHAIN with COMMON, BLOAD and BSAVE, and FIELD structure for random I/O.

The only BASICA statements not now supported by BetterBASIC are MOTOR, PEN, ON PEN, ON STRIG, STRIG, STICK, and VARPTR. A translator now allows BetterBASIC to read tokenized BASICA programs directly.

**New features:** Support for arrays to the limit of memory, support for virtual arrays to 4 gigabytes, multiple display windows, support for graphics and sound, user-programmable support for foreign-language character sets, TRACE facility for continuous or stepwise program debugging, plus the capability to set breakpoints and to continue execution of programs after modification of data or program code.

BetterBASIC version 2.0 also allows programmers to eliminate declared variables or to globally change the name of a variable in an existing program. Version 2.0 uses the IEEE format for floating-point numbers to both improve execution speed and ensure compatibility with BASICA.

Summit Software also has a new address and phone number: 106 Access Rd., Norwood, MA 02062, (617) 769-7966.

### Sold in the USA

A February What's New item (page 402) describing TDI's Modula-2/ST and UCSD Pascal for the Atari 520ST listed an address in England and prices in pounds. Soon after that page went to press, we found that both packages are available in the U.S. Each program costs \$79.95. Contact TDI Software, 10410 Markison Rd., Dallas, TX 75238, (214) 340-4942.

### PC Paintbrush

PC Paintbrush, which Robert Tinney used to create the cover of our November 1985 issue, has been released in a new edition.

ZSoft Corporation (1950 Spectrum Circle, Suite A-495, Marietta, GA 30067) says version 3.0 has 16 added features, including automatic curve drawing, variable font-stroke widths, rounded boxes, increased speed, rubber-band circles, lasso capability, editing of pictures larger than the screen, and fully adjustable palettes. The user interface and the screen remain "almost the same."

## FIXES

### Two Books One and the Same

Addison-Wesley's Marketing Coordinator has informed us of an error in "An Annotated Bibliography of Recent Books," which appeared in our 1985 special issue, *Inside the IBM PCs* (page 14). One book was listed twice: once under its correct title, once under a title it had prior to publication. The correct title is *The IBM Personal Computer from the Inside Out* (ISBN 0-201-06896). It is written by Murray Sargent III and Richard L. Shoemaker. Although *Interfacing the IBM Personal Computer to the Real World* is listed in *Bowker's Books In Print*, Addison-Wesley said it has never published that title and has no plans to do so.

### Report on Word Processors

The PC Technical Group of the Boston Computer Society has released a report covering scientific/technical word-processing and typesetting programs for the IBM PC, XT, and AT. According to the BCS, the summary represents several hundred hours of evaluation and comparison.

"IBM PC & Compatibles: Technical Word Processor Review Summary" costs \$8, which covers the cost of reproduction and mailing. For more information, contact Carl A. Hein, Dunster House, Apt. 7, Swanston Rd., Boxborough, MA 01719.

### True BASIC and the Math Coprocessor

In a review of True BASIC (May 1985, page 279), it was stated that the language can automatically sense and use the Intel 8087 coprocessor. True BASIC Inc. sent us the following information.

Version 1.0 of True BASIC for the IBM Personal Computer does not correctly detect the Intel 80287 numeric data processor. Owners of version 1.0 can get the software fixed by sending the original disk to the company's Customer Support Dept., 39 South Main St., Hanover, NH 03755. Mark "Attn: 80287 patch" on the package, and don't forget to include your return address.

### How to Access and Use BYTENet Listings

To access BYTENet Listings, call (617) 861-9764. When you get the carrier tone, enter two or three carriage returns so that our software can determine your operating parameters.

Optimum modem settings are 8 bits, 1 stop bit, and no parity at full duplex, or 7 bits, 1 stop bit, and even parity at half duplex. Acceptable operating speeds are 300 or 1200 bps. At this time, BYTENet Listings does not sup-

port 2400-bps transmissions.

The BYTENet Listings software itself is menu-driven. Programs may be downloaded using ASCII, Kermit, Tele-Link, and XMODEM protocols.

BYTE listings are also available on BIX. After connecting with the system, type join listings at the main prompt. (For more information on BIX, phone (800) 227-2983 between 8:30 a.m. and 4:30 p.m. Eastern time.)

FIXES AND UPDATES

**YOU CAN'T GET  
A GOOD FEEL  
FOR A  
SOFTWARE  
PACKAGE  
FROM AN AD.**

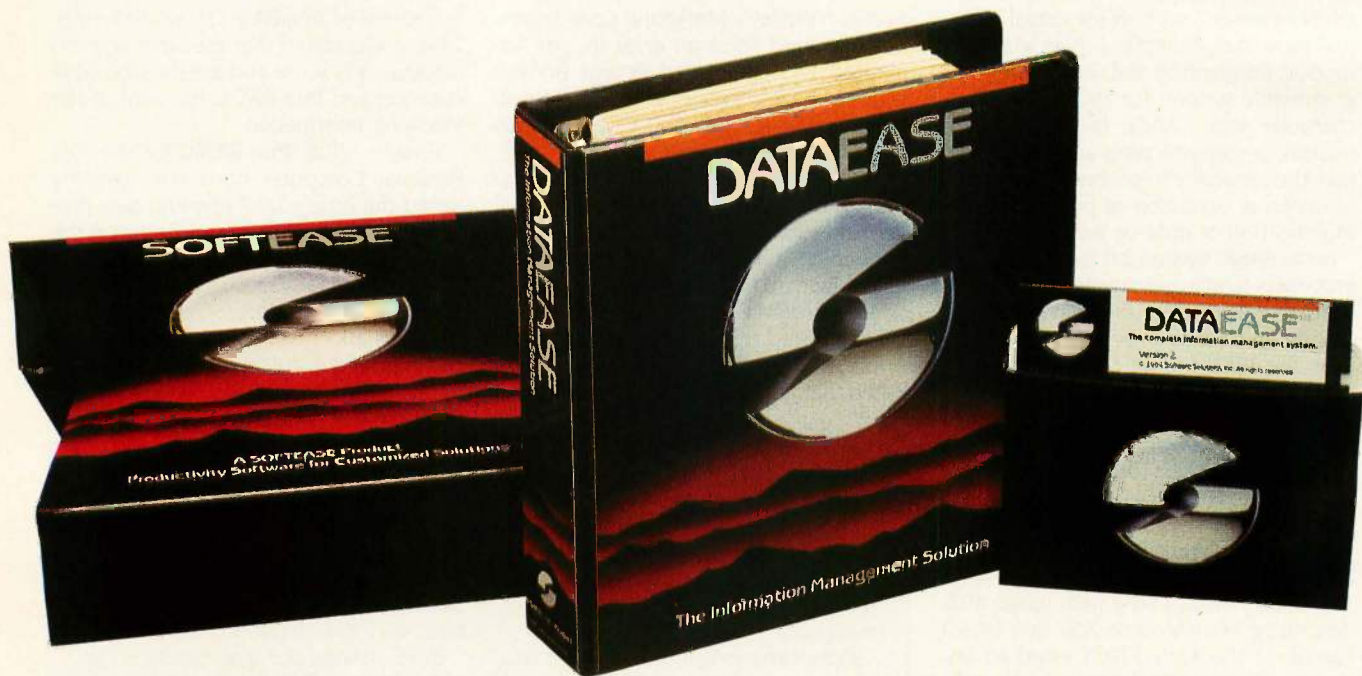

## If you're searching through the ads in this magazine for the "right" software package, good luck.

Let's say you're looking for a data base manager. You read a dozen ads. Each one offers its list of features. Each one talks about the ideal combination of power and ease of use. And each one promises to "solve your problems", "answer your needs", or both.

### Don't Believe Anybody

We could make the same claims for DATAEASE. Even before Release 2.5, tens of thousands of users made DATAEASE the corporate data base standard. We could tell you that they found DATAEASE to be an invaluable productivity tool because of its fully relational capabilities, full screen editor and unique combination of menus and commands. But don't believe us.

More than 100 reviewers from major publications agree with our productivity claims. Data Decisions called DATAEASE "perhaps the most effective blend of ease-of-use and performance available for PC users to date." But don't believe the reviewers.

Application developers, MIS/DP/IC managers, and all kinds of other users from Fortune 1000 companies throughout the country have reached strikingly similar conclusions. A user at General Instruments reports that "those same factors that

make DATAEASE preferable for non-programmers — ease of use and speed of development — make it the program of choice for many technical types, too." But don't even believe other users.

### Nobody knows what you know.

Even if all these people are absolutely right about DATAEASE, does that mean it's the right product for you?

The best way to know if DATAEASE fits your needs is to get your hands on our free sample diskette. Fifteen minutes with the sample will give you a feel for our best DATAEASE yet — Release 2.5. It has features that appeal to all users; from developers to data entry people; A complete procedural language; quick reports at the press of a button; a direct interface to Lotus 1-2-3; the ability to move rapidly from file to file on a common piece of data; and built-in scientific, mathematical, financial, date, time, and string functions.

### Productivity takes more than a good product.

It takes a good company, too. Buying a software package is the beginning of a relationship. Technical support, product upgrades, special corporate and dealer programs and informational seminars should all be part of this relationship. If the only thing you get is a product, forget about productivity. At Software Solutions, you find more than a product. You find software solutions.

### Find out for yourself.

The advances in DATAEASE's Release 2.5, and the support behind it, offer you practical advantages that leave all the other data base managers far, far behind — including R:Base 5000™ and dBase III™. But don't believe us. Call or write for information and your free sample diskette today.



**Software Solutions, Inc.**

### CALL OR WRITE FOR YOUR FREE SAMPLE DISKETTE.

Send information and a free DATAEASE sample diskette for my PC (check one):

IBM  WANG  DEC  TI

Include materials relating to:

Corporate Client  Retailer

MIS/DP/IC Professional  VAD

Other \_\_\_\_\_

Name: \_\_\_\_\_

Title: \_\_\_\_\_ Phone: \_\_\_\_\_

Company: \_\_\_\_\_

Street: \_\_\_\_\_

City: \_\_\_\_\_ State: \_\_\_\_\_ Zip: \_\_\_\_\_

Mail to: \_\_\_\_\_ BYT 3/86

Software Solutions, Inc.,  
12 Cambridge Drive,  
Trumbull, CT 06611 Telex: 703972

**Don't like samples? Then just call us. We'd be happy to talk about your information management needs and advise you.**

**800-243-5123**

©1985 Software Solutions, Inc.  
Trademarks are of their respective companies.

Scandinavia  
West Soft A/S, Alesund, Norway; (47) 71-41141

Switzerland, France  
Softsource, S&A 1222 Vesenz, Switzerland; 022-3518-55

United Kingdom  
Sapphire Systems, Essex; 01-554-0582

West Germany, Austria  
M&T Software Verlag, Munich; 089-4613-0

# MORE USERS FOR YOUR PC

*Advanced Digital's PC-Slave is the solution to your multi-user or local area network problems.*



Just plug Advanced Digital's PC-Slave board into your PC expansion slot, a connecting cable, a low-cost dumb terminal or a PC look-alike terminal and you're in business. As many as 31 low-cost workstations may be added to your IBM-PC, AT, XT, and the compatibles. Share a common data base without loss of speed or efficiency since each PC-Slave has its own 8088 CPU, 256-768K RAM dedicated to each user. Advanced Digital provides additional software which supports File & Record locking and print spooling. Advanced Digital's slave concept provides the best multi-user PC system available today! For the location of the dealer nearest you contact:

Advanced Digital Corporation  
5432 Production Drive  
Huntington Beach, CA 92649  
(714) 891-4004 / (800) 251-1801  
Telex 183210 ADVANCED HTBH

**ADVANCED  
DIGITAL  
CORPORATION**

Advanced Digital U.K. Ltd.  
27 Princes Street, Hanover Square  
London W1R8NQ-United Kingdom  
(01) 409-0077 (01) 409-3351  
TLX 265840 FINEST

Regional Distributors: In California,  
In Ontario, Canada, B&L (416) 299-7660; in Australia, Archives Computers (03) 699-8377; in New York, QuInn Data (914) 939-0002

Thomas Data Systems, Inc. (213) 214-4661;

## Drawing and Painting Program for Amiga

**E**lectronic Arts has released a graphics package for drawing and painting with the Amiga. Deluxe Paint, first in a series of arts software for the Commodore machine, has 20 drawing tools, 7 painting modes, 14 special-effects tools for brushes, 10 built-in brush shapes, and a palette of 32 colors (out of a possible 4096).

Deluxe Paint's drawing tools include magnify and zoom functions that let you split the screen into a normal image and a magnified portion of the image. As you zero in on and alter details in the magnified window, changes are reflected in the normal window. Another tool lets you customize paintbrushes. Anything you can draw can be framed, picked up, and used as a new paintbrush.

The package offers four types of brushes: circles, squares, dots, and airbrush. You can rotate any brush 360 degrees, flip it vertically or horizontally, stretch it into new shapes, or shear its angles. Shading and smearing capabilities help with texture and nuance.

You can create animation effects with what Electronic Arts calls "color cycling"—cycling a variety of colors through a static picture to concoct the illusion of motion. You can use three different color cycles and speeds per picture.

Five color controls let you handle the mix of red, green, and blue and adjust the hue and brightness of



*Images created with Deluxe Paint and an Amiga.*

each color. The software enables the Amiga to automatically generate the shades of color between any two pigments you pick.

Deluxe Paint, priced at \$79.95, is designed to work with two other programs still in the Electronic Arts workshop, Deluxe Print and Deluxe Video Construction Kit (reportedly slated for April release). It requires 256K bytes of RAM and Kickstart 1.1. Contact Elec-

tronic Arts, 1820 Gateway Dr., San Mateo, CA 94404, (415) 571-7171. Inquiry **550**.

## Video Controller Combines Popular Standards

**V**ideo-7's VEGA is an enhanced graphics adapter for the IBM PC, XT, AT, and compatible personal computers. VEGA uses surface-mounted CMOS VLSI technology, with four custom

chips and 28 integrated circuits, to provide four video-display modes, 12 graphics/text-display modes, and 256K bytes of RAM on a 4.2- by 5-inch short-slot card.

The four video-display modes offered by VEGA are the functional equivalents of the IBM Enhanced Graphics Adapter, the IBM Color Graphics Adapter, the IBM Monochrome Display Adapter, and the Hercules Graphics Card. Each mode is 100 percent compatible with the corresponding popular standard. You can move between enhanced color, color, and monochrome modes using a toggle switch on the back panel of your computer.

The board has 10 graphics and 8 alphanumeric display modes. This includes a high-resolution color display with 640 by 350 pixels and 16 colors from a 64-color palette. A RAM-based character generator allows up to four sets of 256 different characters or two sets of 512 different characters for multiple character fonts. Each character cell can be up to 32 dots high and 8 dots wide. The board also lets you split your screen horizontally when in EGA mode.

The VEGA has a DE-9 female connector, a 32-pin "feature connector," RCA phono connectors, and a 6-pin keyed light-pen connector. It will run with a monochrome display adapter or a color-graphics adapter in another slot. It

*(continued)*

sells for \$599 and is also marketed by Quadram as the QuadEGA. Contact Video-7 Inc., 550 Sycamore Dr., Milpitas, CA 95035, (408) 943-0101. Inquiry 551.

### MS-DOS Portable from Sony

**S**ony's IBM PC-compatible computer, the M35, is a 13-pound unit with a CMOS 80C88 micro-processor, 640K bytes of RAM, and two 3½-inch 720K-byte floppy-disk drives. The portable also has serial and parallel ports, composite video and analog RGB ports, and an internal 300-bps modem. Options include a 25-line LCD screen and a 5¼-inch floppy-disk drive.

Sony says its MS-DOS-based machine can be connected directly to its dedicated word processors.

The M35 will have a list price of approximately \$2695. Contact Sony Communications Products Co., Sony Dr., Park Ridge, NJ 07656, (201) 930-6432. Inquiry 552.

### Spreadsheet for the Amiga

**L**attice has developed an electronic spreadsheet for the Commodore Amiga called Unicalc. The software provides a processing area of 256 columns by 8192 rows, dual-window capability, context-sensitive help screens, floating dollar signs, negative balance indicators, and punctuated numbers. Cells can contain numeric data, algebraic formulas, or text.

Unicalc has a library of algebraic and conditional functions. Calculations can



Sony's MS-DOS portable, the M35.

be made automatically as you are entering data or later with a single command. Several sheets can be joined into one. You can customize the column widths, titles, displays, prompts, and help screens.

Lattice says its package is compatible with Lotus 1-2-3, SuperCalc, and similar software. Unicalc costs \$79.95, which also gets you a manual, telephone support, and a 30-day money-back guarantee. Contact Lattice Inc., POB 3072, Glen Ellyn, IL 60138, (312) 858-7950. Inquiry 553.

### Optical Scanner/Printer

**I**mage Communications is selling an optical scanner/printer for the IBM PC and the Apple Macintosh. Called Image Blue, it can digitize and print images (on electrostatic paper) at a resolution of 200 dots per inch. The scanner can transmit information at up to 9600 bps over its serial port or up to 2400 bps through its integral telephone jack.

Optional software (\$80) lets you load images into a PC or Mac and manipulate

the images using PC Paintbrush or MacPaint. Scanning requires about 3 minutes per page. Two scanners can be used together as a facsimile system.

Image Blue has a list price of \$1295. Contact Image Communications Inc., 640 West Putnam Ave., POB 4809, Greenwich, CT 06836-0086, (203) 661-0607. Inquiry 554.

### Polyglot Word Processor

**M**ulti-Lingual Scribe, from Gamma Productions, is a word-processing package for the IBM PC. It can type English, Russian, Greek, Hebrew, and Arabic texts and can display all those languages on a single line. The texts are shown with or without accents and vowel points and can be printed on most popular printers. The English font includes most European-language characters.

Selecting a language requires a single function-key

command. The processor includes standard word-processing features and offers block move, search and replace, headers and footers, print preview, sub- and superscripts, and unlimited document size. Its formatting commands include columns, centering, proportional spacing, boldface, underlining, mixing small and large fonts, and micro-justification. Special features such as wordwrap in both left-to-right and right-to-left modes are also part of Scribe's repertoire. Along with the software, you get keyboard layout charts and press-on keyboard labels for all four foreign languages (including both standard and mnemonic for Hebrew).

A built-in Font Generator utility lets you use on-screen graphics to customize the characters and keyboard layout or to build an entirely new set. You can compose text in either 40- or 80-column mode. The print preview feature lets you see how the text will appear when it is printed. You can also use another word processor and engage Scribe to make that software print proportionally spaced text or to add foreign characters to the files generated by that software.

Multi-Lingual Scribe 2.0 costs \$349.95 and requires an IBM PC, XT, or AT, DOS 2.0 or higher, at least 320K bytes of RAM, an IBM or Hercules color-graphics card, and one disk drive. It can print to Epson, IBM Graphics, Okidata (with Plug 'n Play IBM emulation), C. Itoh Prowriter, or NEC 8023A dot-matrix printers.

Contact Gamma Productions Inc., 710 Wilshire Blvd., Suite 609, Santa Monica, CA 90401, (213) 394-8622. Inquiry 555.

(continued)



# Using Lotus 1-2-3<sup>®</sup> without Reflex is like driving at night without lights

If you use Lotus 1-2-3 you need Reflex, the Analyst<sup>™</sup> because it shows you what 1-2-3 either hides in the dark or can't show you at all. Reflex shows you relationships and inter-relationships in your data that you can't afford to miss.

## Reflex includes the best Report Generator for Lotus 1-2-3.

Reflex includes the Report Generator that 1-2-3 should have included — but didn't. With Reflex, you can generate reports, graphs, charts and diagrams from your 1-2-3 worksheets that are impossible to generate with 1-2-3.

You can do sales reports, letters, memos, invoices and mailing labels — to name a few — and you can see a few of them on this page.

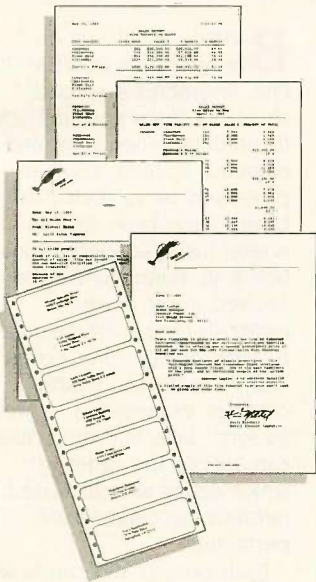

## Reflex is the best database for 1-2-3 users and it's also the easiest to use.

Reflex is the first database that separates the trees from the forest. The first database that understands that what you see depends on how you look at it.

The first database that probes relationships — then shows them to you in various graphic forms — scatter, line, bar, stacked bar and pie charts. The first database to break the bonds of traditional database management and give a dramatic visual turn to data analysis.

Reflex makes graphic leaps far beyond 1-2-3. With Reflex, when you look, you see.

## Reflex gives you five new and different views of what's hidden in your 1-2-3 worksheets.

Form View, List View, Graph View, CrossTab and Report View.

Form View lets you create your database. List View shows your data in tabular list form, just like a spreadsheet. Graph View gives you instant interactive graphic representations; CrossTab View gives you amazing "cross-referenced" pictures of the links and relationships hidden in your data. Report View allows you to use information from 1-2-3, and then print out reports in all sorts of different formats.

The commands for all five Views are consistent — so you're not stuck learning five different ways to get something done. And because Reflex uses advanced windowing techniques, you can see several views on the screen at the same time — without having to switch back and forth. You get the picture, and the pictures, all at once.

## Whether you're a 1-2-3 user or not, Reflex answers all your "What If's?" and leads you to the right conclusions.

With Reflex when you modify a number all your Views — List, Form and Graph — are immediately updated, on-screen.

Let's say you're analyzing "Traveling Expenses by Salesperson" and you ask, "What if they stayed at a Motel 5/4 instead of the Presidential Suite of the Hotel Chic?" "Show me." So Reflex shows you.

"What if they could no longer order \$100 wines, but had to stick to the stuff that matures in the truck?" "Show me." So Reflex shows you. Instant answers. Instant pictures. Instant analysis. Instant understanding.

Of course Reflex can do all of the above with or without 1-2-3. Reflex is a complete database management and analytical tool that stands on its own feet and helps you stay on yours because it's only \$99.95!

## Borland's \$99.95 Reflex could be the best business investment you'll ever make.

Buying 1-2-3 was a good idea. Reflex is an even better idea because now you can see what you're doing, what you've done, and what you need to do.

Think of Reflex as an "automatic product," a "standard" that every up-to-speed PC owner should have on hand. It's only \$99.95, and you get our 60-day money-back guarantee.

We don't believe in copy-protection, but we do believe in quality, performance and reasonable software prices. So keep driving your old 1-2-3, but get Reflex today, because then you can see where you're going.

“Everyone agrees that Reflex is the best-looking database they've ever seen

Adam B. Green,  
InfoWorld

The next generation of software has officially arrived

Peter Norton,  
PC Week

**YES!** Rush Reflex to me.

Send me \_\_\_\_\_ copies at:

**\$99.95**

This price includes shipping to all U.S. cities.

**60-DAY MONEY-BACK GUARANTEE  
NOT COPY-PROTECTED**

To order by credit card call (800) 255-8008, CA (800) 742-1133. Available at better dealers nationwide.

Name: \_\_\_\_\_

Shipping Address: \_\_\_\_\_

City: \_\_\_\_\_

State: \_\_\_\_\_ Zip: \_\_\_\_\_

Telephone: \_\_\_\_\_

Subtotal \_\_\_\_\_

Outside USA add \$10 per copy  
CA res. add \$6 tax per copy

Amount Enclosed \_\_\_\_\_

Payment: VISA MC Bank Draft Check

Credit Card Exp Date \_\_\_\_\_ / \_\_\_\_\_

Card # \_\_\_\_\_

System requirements: R15

IBM<sup>®</sup> PC, XT, AT, or compatibles. 384K RAM minimum. IBM Color Graphics Adapter<sup>®</sup>, Hercules Monochrome Graphics Card<sup>®</sup>, or equivalent. PC DOS<sup>®</sup> 2.0 or greater. Hard disk and mouse optional.

CODs and Purchase Orders WILL NOT be accepted by Borland. California residents add 6% sales tax. Outside USA add \$10 per copy and make payment by bank draft payable in US dollars drawn on a US bank.

Inquiry 46 for End-Users. Inquiry 47 for DEALERS ONLY.

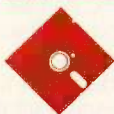

**BORLAND**  
INTERNATIONAL

*Vive la difference*

4585 SCOTT'S VALLEY DRIVE  
SCOTT'S VALLEY, CA 95066  
(408) 438-3400 TELEX: 172373

Reflex is a trademark of Borland/Analytica Inc. 1-2-3 is a registered trademark of Lotus Development Corporation. IBM and PC DOS are registered trademarks and PC, XT, AT, and Color Graphics Adapter are trademarks of International Business Machines Corporation. Hercules Graphics Card is a trademark of Hercules Computer Tech. Copyright 1986 Borland International BI-1031.

**REFLEX** THE ANALYST<sup>™</sup>  
©Copyright 1985 Licensed Material-Program property of BORLAND Analytica, Inc. 4585 Scotts Valley Drive, Scotts Valley, CA 95066. Unauthorized use, duplication or distribution is strictly prohibited by Federal Law.

## Flip Puck, Change Type

**M**etatext from Image Computer Systems converts the dotty font of a dot-matrix printer into letter-quality type. The package consists of software and what Image calls a puck; the puck is approximately the size and shape of a black-board eraser and, like a mouse, rests on the table next to the computer.

The program resides permanently in RAM. If you want letter-quality type, the software intercepts the characters sent to the printer and converts them into high-resolution plot data.

To switch between draft and letter quality, you flip the puck to the appropriately labeled side. When the "draft" side is up, output goes to the printer in the usual fashion. When the "quality" side is up, Metatext intercepts the characters.

The package works with IBM PCs and compatibles and drives most dot-matrix printers that recognize Epson control codes. No hardware or software modifications are necessary. Metatext contains six fonts and emulates the IBM Graphics Printer. It costs \$129. Contact Image Computer Systems, POB 647, Avon, CT 06001, (203) 678-8771. Inquiry 556.

## Data-Acquisition Software

**D**iscovery, from Cyborg Corp., is a menu-driven program designed for data acquisition and analysis. It can handle area-under-the-



Metatext print enhancer from Image Computer Systems.

curve calculations, FFTs and smoothing, and instrument control.

Discovery's calculation and signal-processing functions let you build a table of selected values and transfer summary data to Lotus 1-2-3 for further analysis and presentation. You can scroll through graphs of data and zoom in on regions of interest, mark points for calculation, and expand the *x*- or *y*-axis. The program also lets you store sequences of up to 10 operations for repeated use; sequences can loop and trigger from a variety of sources, including time of day, a single keystroke, and a value read from the signal source.

Other operations and functions include integration, differentiation, auto-correlation, cross-correlation, and windowing. Discovery also calculates variance, mean, standard deviation, slope, and change using the 8087 or 80287 floating-point co-processor if installed.

Discovery runs on the IBM PC, XT, and AT and requires

512K bytes of memory and a hard-disk drive. The program costs \$1190. For more information, contact Cyborg Corp., 55 Chapel St., Newton, MA 02158, (617) 964-9020. Inquiry 557.

## Apple-like Laser 128

**T**he Laser 128 is a portable computer that reportedly runs "nearly all" the software for Apple's IIe and IIc. The 12-pound machine houses 128K bytes of RAM, 32K bytes of ROM, a 5¼-inch floppy-disk drive, both a serial and a parallel printer interface, a modem port, and a 50-pin Apple-compatible expansion slot. You can also hook up an additional disk drive, a mouse or joystick, and a monitor.

Like the Apple IIc, the Laser 128 uses a 65C02 processor. The keyboard, which has 10 function keys and a numeric keypad, can be

switched between QWERTY and Dvorak layouts. The computer can produce double high-resolution graphics and has 16-color capability. Other features include a built-in speaker with volume control, 40- or 80-column text, and text in inverse or flashing mode. Data transmission can be set at seven rates, ranging from 110 to 19,200 bits per second.

The Laser 128 has a suggested retail price of \$479. Two companies are selling the machine. Contact Video Technology (U.S.) Inc., 2633 Greenleaf Ave., Elk Grove Village, IL 60007, (312) 640-1776, or Central Point Software Inc., 9700 Southwest Capitol Highway, Suite 100, Portland, OR 97219-9990, (503) 244-5782. Inquiry 558.

## Calculation Boxes

**B**oxcalc, a calculation program for the IBM PC line, resembles a spreadsheet but does not limit you to predetermined rows and columns. Instead, you can place and move "calculation boxes" anywhere on the screen (using a special function key). Formulas can be entered in the boxes to establish their mathematical relationship to other boxes. The software can handle complex expressions as well as sum, date, and time. You can specify the order in which boxes are calculated; iterative calculations are permitted.

Each Boxcalc file can hold as many as 800 boxes, and as many as 99 pages of figures and text can be created, stored on disk, and printed. Full replication features are designed to facilitate entering multiple formulas into boxes.

Boxcalc sells for \$40 and comes with an instruction manual and without copy

(continued)



HP PC Instruments  
Soft Front Panel

# See a live demonstration of HP PC Instruments... an affordable, easy way to automate testing!

Now you can perform test and measurement tasks easily, quickly and cost-effectively with affordable, rackable PC Instruments from Hewlett-Packard.

Soft front panels make HP PC Instruments easy to use. By simply touching the HP Touchscreen or using a mouse with the IBM PC, you can set functions, ranges and values, and take measurements.

You can also develop programs faster. A few easy-to-remember commands, like OUTPUT and MEASURE, control your PC Instruments from Microsoft® BASIC. And you can use the soft front panel to enter many of the instrument parameters that have been traditionally typed into a system. In addition, with optional HP Data Acquisition Software, you can be doing voltage scanning and temperature measurement in no time at all.

Add-on HP-IB libraries can also turn your PC into a versatile HP-IB instrument controller. And you can use them to control both PC Instruments and HP-IB instruments from the same BASIC program.

PC Instruments now available include:

- 4½ Digit Digital Multimeter
- 50 MHz Digital Oscilloscope
- 5 MHz Function Generator
- 100 MHz Universal Counter
- Relay Multiplexer
- 12 bit Dual Voltage Digital-to-Analog Converter
- 16 bit Digital Input/Output
- Relay Actuator



To see a live demonstration,  
or for immediate shipment  
call 1-800-523-2121 EXT. 960

Microsoft® and Microsoft BASIC® are  
U.S. registered trademarks of Microsoft Corporation.  
AD 2101552



HEWLETT  
PACKARD

protection. A demo sells for \$5. Running the program requires 256K bytes, PC-DOS 2.0 or later, and a color monitor. Contact Cotton Software Inc., 2510 Anderson Rd., Suite 364, Covington, KY 41017, (606) 727-1600. Inquiry 559.

### Define Your Digital Waveforms

**A**dtron's Data Generation System operates with IBM's PC or PC XT to produce user-defined digital waveforms. It consists of a plug-in data-generator board and a full-screen waveform editor. The hardware/software combination is designed to offer the capabilities of pattern, word, and pulse generators.

The system can serve as a signal source for these applications: laboratory data generator, communications data emulator, pseudorandom noise source, automatic test stimulus, and pulse and timing generator.

The editor, called Pulse-Ed, enables you to design, modify, store on disk, and print waveforms. Adtron says the program resembles a text editor in operation and a logic analyzer in appearance. Once you've defined a waveform, you can send it to the board for execution or transfer it to another system via disk or modem. During execution, the board does not require processor support.

Dual-channel operation offers 32,768 bits per channel, bit widths from 50 nanoseconds to 9.999 seconds, and external clock and sync inputs. The system runs on any IBM PC, XT, or compati-

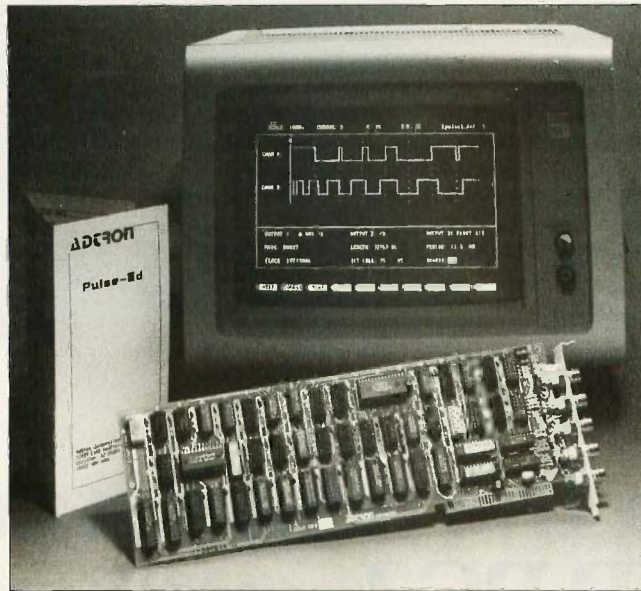

Data-generator board from Adtron's system.

ble with 128K bytes of RAM, one double-sided floppy-disk drive, and MS-DOS 2.0 or later. List price is \$2175; quantity discounts are available. Contact Adtron Corp., 11415 East Redfield Rd., Chandler, AZ 85225, (602) 926-1461. Inquiry 560.

### Calculator Kit for the Macintosh

**C**alculator Construction Set from Dubl-Click Software enables you to design your own calculators, clocks, and calendars and install them as Macintosh desk accessories. No programming is required; you drag parts onto a calculator shell and then "wire" the functions. The package contains mathematical, scientific, business, date/time, and conversion functions.

The kit's box of parts holds various-size keys, switches, LEDs, clock/calendar displays, and a resizable scrolling paper tape that prints to the Imagewriter

printer, the Mac Clipboard, or a Mac text file. You can map on-screen calculator keys to any alphanumeric keyboard or keypad (as an alternative to using a mouse).

You can customize calculator cases using MacPaint-style tools for drawing, painting, filling, stretching, and typing. Calculators can be saved as work files, accessory mover files, or self-installing calculator files.

Calculator Construction Set runs on any Macintosh and is Switcher-compatible. List price is \$99. Contact Dubl-Click Software, 18201 Gresham St., Northridge, CA 91325, (818) 349-2758. Inquiry 561.

### Utilities for dBASE Programmers

**G**ryphon Microproducts has developed a set of utilities that expand the memory capability of dBASE

from 63 variables to more than 8 million. Called dB/RA, the package consists of 22 commands that can be called directly from dBASE, letting programmers work with databases in memory in the form of arrays.

Gryphon says dB/RA takes advantage of the Lotus/Intel Extended Memory Specification. It has commands for table-lookups and range searches of as many as 100 arrays. Functions include instant screens, pop-up color windows, and Lotus-like menu operations.

The utility set costs \$200; a demo is \$20. For more information, contact Gryphon Microproducts, POB 6543, Silver Spring, MD 20906, (301) 946-2585. Inquiry 562.

### Gizmo Extends AT Memory

**T**he AT Gizmo is a card that installs between the IBM PC AT's motherboard and 80286 processor and enables PC-DOS applications to use 4.6 megabytes of extended memory. The 3- by 5-inch device remaps addresses that access memory, allowing extended memory to become addressable memory. Extended memory becomes addressable because the AT Gizmo makes all the machine's memory operate in native mode, compatible with PC-DOS. The memory usually accessed in protected mode is accessible from native mode with the card.

The AT Gizmo sells for \$295. Contact The Software Link Inc., 8601 Dunwoody Place NE, Suite 632, Atlanta, GA 30338, (404) 998-0700. Inquiry 563.

(continued on page 399)

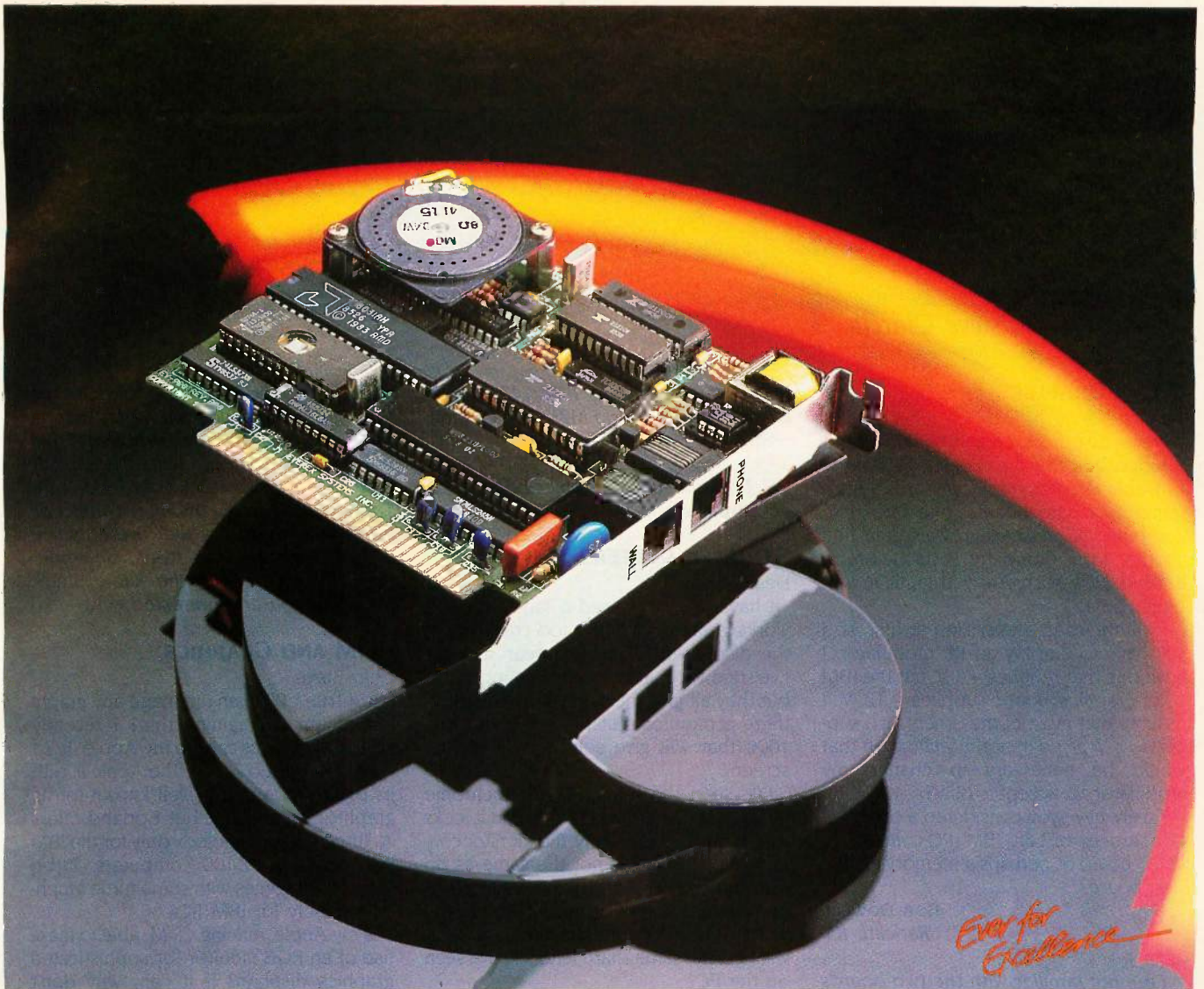

## Evercom™ ... 1200 baud, \$249

Now the EVEREX Evercom modem is available on a half-size card, perfect for the short slots in the IBM XT, Portable, and many compatibles. EVEREX has combined innovative engineering and technology to produce a quality

Hayes-compatible 1200 baud modem that out performs the competition at a lower price. EVEREX engineering is the key ingredient that delivers QUALITY and FEATURES without sacrificing PRICE.

### Demonstration -- FREE Brochure

Remember, before you buy a modem, check the features, check the price, and then call EVEREX to set up a demonstration at your local dealer.

When you call, we will also send you the total solution brochure describing EVEREX's complete line of IBM microcomputer peripherals.

**1-800-821-0806**  
in California

**1-800-821-0807**

**EVEREX**  
EVER for EXcellence

48431 Millmont Dr. Fremont CA 94539  
(415) 498-1111

### Before you buy a modem, check these features:

	EVERCOM	HAYES 1200B
• 300/1200 bps Hayes-compatible	YES	YES
• Half-size card	YES	NO
• Automatic dialing, answering, and redialing	YES	YES
• Call Progress Monitoring	YES	NO
• Configurable from COM1 - COM4	YES	NO
• Internal Speaker with software adjustable volume control	YES	NO
• Tone and pulse dialing	YES	YES
• Automatic data-to-voice transition	YES	NO
• Detects receiver off-hook	YES	NO
• Reports speed mismatch	YES	NO
• Supports 132 columns	YES	NO
• Communications software included	YES	NO
• Extended Hayes command set	YES	-
• List price	\$249	\$489

Evercom is a trademark of Everex Systems, Inc. IBM PC and XT are registered trademarks of International Business Machines Corp.

Hayes 1200B is a trademark of Hayes Microcomputer Products Inc.

Inquiry 128 for End-Users. Inquiry 129 for DEALERS ONLY.

MARCH 1986 • BYTE 43

## Conducted by Steve Ciarcia

**COLOR GRAPHICS**

Dear Steve,

I recently purchased an IBM PC without a video board. I am looking at what is available in color-graphics boards. I have found two bare boards, one from J. C. Computer Inc. in Anaheim, California, and another from Computer Parts Galore in Batavia, New York. Are you familiar with either board?

I will be using a television at first, so I will have to employ an RF modulator. I have one that requires +5 V, but the IBM color-graphics board supplies +12 V. I assume that most of the others also supply +12 V. Is it a minor modification that would be necessary to change my modulator to accept +12 V?

Finally, have you considered a construction article on an IBM PC-compatible video board or perhaps a memory-expansion board?

BOB DOWELL  
Radcliff, KY\*

*I am not familiar with the two boards you mention, but the one from Computer Parts Galore claims to be like a Persyst board and compatible with the IBM color-graphics board. This seems like a good choice, but don't forget to get the character ROM. I couldn't find J. C. Computer in recent issues of Computer Shopper, but I did find a C. J. Computers in Anaheim. They sell components to build your own PC but apparently not bare boards.*

Another source of bare boards for IBMs is Micro Mate Associates.

You can pick up the needed +5 V DC for your modulator from pin 5 of the light-pen connector on the color-graphics board.

I don't have any plans to make either an IBM-compatible graphics board or memory-expansion board. There are many of each to choose from, including the bare multifunction board from Computer Parts Galore.

Addresses of the companies mentioned above are Computer Parts Galore, 56 Harvester Ave., Batavia, NY 14020, (800) 431-9008; C. J. Computers Corporation, 2424 West Ball Rd., Suite B, Anaheim, CA 92804, (714) 821-8922; and

Micro Mate Associates, POB 742, Station B, Willowdale, Ontario M2K 2R1, Canada.  
—Steve

*P.S. I have a super graphics-board project in the works.*

**STRIATED LETTERS**

Dear Steve,

I have just purchased a Tandy 1000. It works great, but I'm not too crazy about the display—the letters appear striated. I've tried various monochrome monitors, but they all give the same striped look. Is there a monitor that I can use with the 1000 that will give solid letters on the screen?

I've seen the IBM 5151 monochrome monitor hooked to an IBM PC, and it looks wonderful. Unfortunately, the monitor connector on the PC is not the same as on the Tandy 1000. Do you know if I could make some sort of adapter to hook the 5151 to the 1000, and, having done that, will I get the same sharp letters I have seen on the PC?

DUFF KENNEDY  
Santa Barbara, CA

*The striped look you describe is typical of display systems that emulate the IBM PC color-graphics-display adapter. It comes from the 200-line vertical-resolution limit imposed by the TV-compatible scan rates combined with the noninterlace mode used to avoid jitter. This is a characteristic we learn to live with.*

The high-quality character display you see on the IBM 5151 monitor is the result of using faster horizontal sweep and slower vertical sweep to give 350 or so lines of vertical resolution, combined with wider video bandwidth (frequency response) to provide 720-line horizontal resolution. The display board also has a different character-generator ROM to take advantage of the higher resolution.

If you try to use the 5151 monitor with your Tandy 1000 graphics display driver, you not only won't get an improved character display, you will also probably burn out the monitor's power supply due to the incompatible sweep rates.

It might be possible to put a display driver like the IBM monochrome display

adapter into the Tandy 1000 and use the IBM 5151 or an equivalent monitor if you can find one that fits. The problem is that the Tandy's expansion slots are shorter than IBM's, so the IBM board won't fit. There may also be a memory conflict or other incompatibility that prevents use of both displays. This would be something to discuss with the Radio Shack people if you are interested.—Steve

**CP/M AND GRAPHICS**

Dear Steve,

Is it true CP/M can't manage any graphics, or am I imagining that? I recently added a Z80 Plus card to my Apple IIe so I could run Turbo Pascal. The Apple II, with its 6502 processor, is well known for its graphics capabilities, but Borland offers its Turbo Graphix Toolbox only for the IBM PC and Zenith Z-100 computers. Turbo Pascal itself comes with some turtle graphics but only for IBM PCs.

Is my Apple, running CP/M, able to make use of an RGB monitor for sophisticated graphics displays? If it can, why don't Borland and other companies implement these capabilities for us 8-bit CP/M users the way they do for 16-bit computers? I know that many owners of 8-bit machines running Turbo Pascal would love to have the sophisticated graphics offered to IBM owners. What's the problem?

CHAD GAGNON  
Crescent City, CA

*There is nothing specific in CP/M that prohibits graphics. Historically, however, most of the computers using CP/M had no graphics hardware, and those that did had no standard to follow. Thus, in most cases, if you want graphics, you must write the drivers yourself.*

It seems as though one could use the Apple BIOS graphics routines with the CP/M board since the 6502 still handles I/O. I haven't tried this, but you could write drivers into CP/M to send the data and graphics commands to the 6502, at least for assembly-language programming.

The probable reason Borland, Microsoft, and other language vendors don't write graphics into their CP/M languages

(continued)

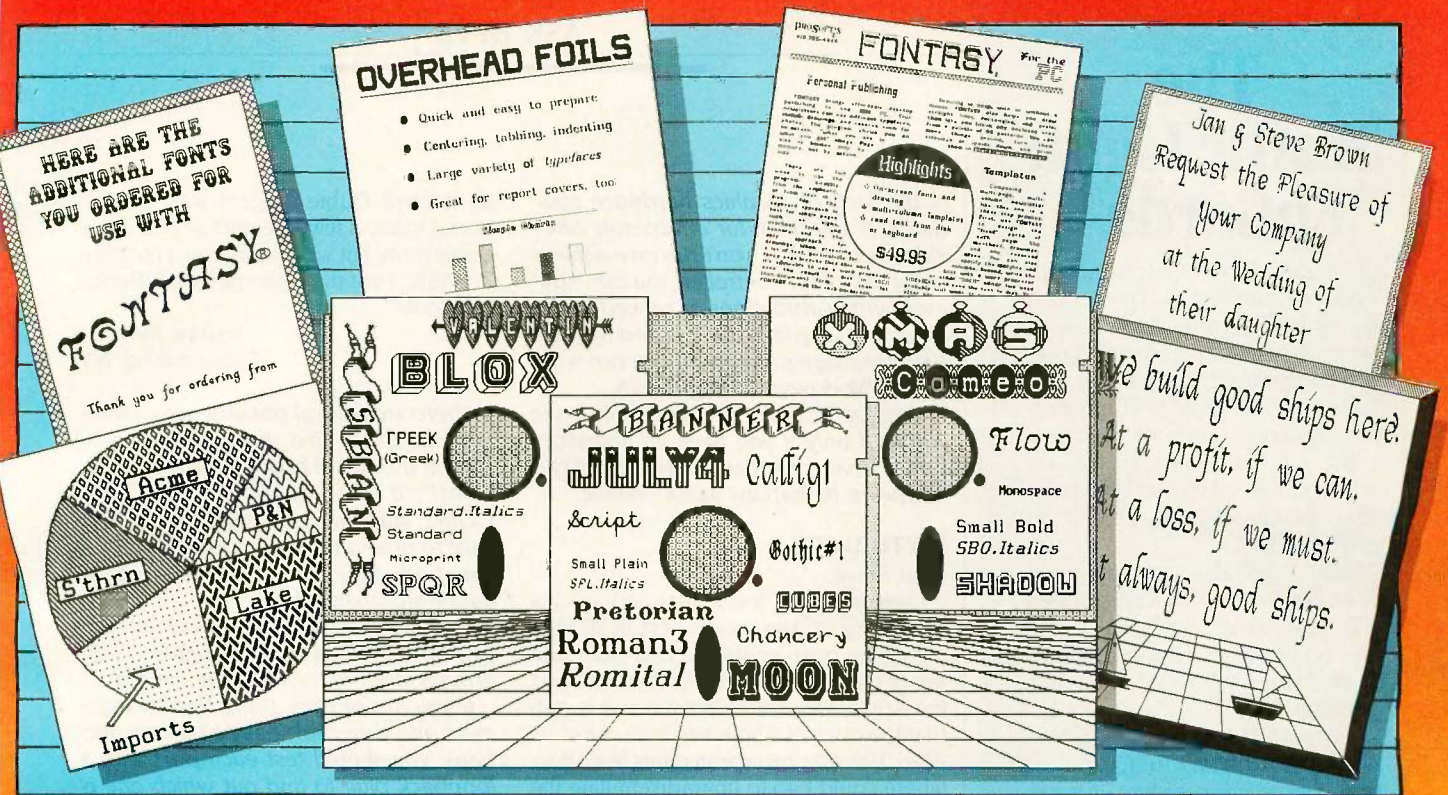

Fontasy printed all of these.

# See What You Can Do With

**P**resentations! Newsletters! Flyers! Signs! Overhead Foils! Invitations! Menus! Logos! Announcements! Banners! Layouts! When you need a goodlooking visual quickly you need FONTASY — superb typefaces and simple drawing in one easy-to-use package.

FONTASY gives you a "what-you-see-is-what-you-get" picture, as you type and draw on the graphics screen of your IBM-PC. You can create a page at a time, see a mini-picture of that page, print it, and save it on disk. Page size is limited only by memory, not by screen size.

## Features

Proportional space, justify, kern, bold-face, rearrange, magnify, black/white reversal, rotate, mirror image, lines, rectangles, ovals, draw, fill in, undo (and un-undo), on-line help, 200-page book, and easy control from keyboard or mouse. Corporate licenses available.

Fonts, fonts, and more fonts! We have over 275 typefaces in our growing library, and will be happy to send you free print samples on request.

When you deal directly with the manufacturer (that's us), you pay rock-bottom distributor prices. If you order FONTASY now, we will give you 28 fonts (a \$50 value) at no extra charge. With so many features at such a low price, FONTASY belongs in your software library even if you already have a "font" program.



**\$49.95**  
Introductory  
Price until April 30, 1986

## Equipment Needed

IBM-PC, XT, AT, or true compatible (Compaq, etc.) with IBM or Hercules graphics adapter and graphics monitor. 256K memory needed for partial pages, 448-640K recommended for full pages. Dot-matrix printer. Mouse optional. MS-DOS 2.00 or above.

FONTASY supports: IBM graphics printer, Proprinter; Epson FX, JX, LX, MX, RX, and LQ-1500; C. Itoh 8510, 1550, 1570, Pro-writer-Jr; H-P LaserJet, ThinkJet; Microline 92, 93; Gemini 10X, 15X; Radio Shack DMP 105-430, 2100; Toshiba 351, 1340-1351; Star; and most Epson-compatibles.

## Money-Back Guarantee

Fontasy is not copy-protected and has a 30-day money-back guarantee. So, take advantage of our breakthrough price and order now TOLL-FREE:

**1-800-824-7888, operator 669 (ORDERS ONLY)**

For further information and same day shipping, call: (818) 765-4444.

**PROSOFT**

7248 Bellaire Ave., Box 560  
No. Hollywood, CA 91603-0560

Name _____	Company _____
Address _____	Telephone _____
City, State, ZIP _____	Exp. Date _____
Visa/MC _____	Computer _____ Memory _____ Printer _____

Terms: M/C, Visa, checks. Please add \$3.00 shipping and handling in U.S. or Canada, \$20.00 overseas, \$2.00 for C.O.D., and sales tax in Calif.

**FONTASY \$49.95**  
Tax \_\_\_\_\_  
Shipping \_\_\_\_\_  
Total \_\_\_\_\_

# The Traffic Light: EnGarde™

EnGarde™ is the only surge suppressor with the added protection of an LED ground indicator. It warns you when an electrical outlet is improperly grounded, protecting your computer from needless and costly hardware damages.

An anti-static touch pad and a multi-peripheral master switch are also built into the total protection of EnGarde™

EnGarde™ also protects your computer from power surges caused by changes in electrical loads and other electrical disturbances. It includes a limited five-year warranty.

EnGarde™ is a product of Systems Control, manufacturer of power protection systems for the nation's utility companies.

Ask your dealer for the total protection of EnGarde™. Or call toll free 1-800-451-6866 to order (in Michigan call collect 906/774-0440). If unsatisfied, return EnGarde™ within 30 days for a full refund.



# EnGarde™

A product of Systems Control, a division of M.J. Electric, Inc.

is the lack of graphics hardware standards. If you write for a Motorola 6845 video controller, it won't run on machines using any other controller. You can, however, write subroutines or procedures in assembly language to be called by high-level-language programs if you can write the CP/M drivers to begin with.

Using an RGB monitor is possible in the Apple II only if you have an accessory board that provides that capability—hardware limitations again.—Steve

### MYTHOLOGY

Dear Steve,

I see relatively few letters and articles pertaining to Atari computers in BYTE. I thus have been unable to find out more about the similarity between the Atari and the Apple, especially since it is well known that the original Apple was built out of an Atari. Has anyone repeated this feat? If so, where could I go to upgrade/emulate the Apple with my Atari 800XL?

SUE PAOLINI  
Hoboken, NJ

Like many things that "everyone knows," this one just isn't true. Apple Computer was formed in April of 1976 to sell the original Apple kit. In June of 1977, the company ran its first ad in BYTE for the Apple II, of which today's Apple IIe is a variation. Atari announced its first computer in December of 1978, but it did not become available until late 1979.

Even though Apple and Atari use the same processor, nearly everything else (ROM, I/O, graphics, etc.) is different. Emulating an Apple on the Atari is theoretically possible but would be very difficult. I have not been able to locate any product to accomplish this.—Steve

### TNT

Dear Steve,

I have a TNT, and I've tried a few times to interface it to my IBM PC. My PC has

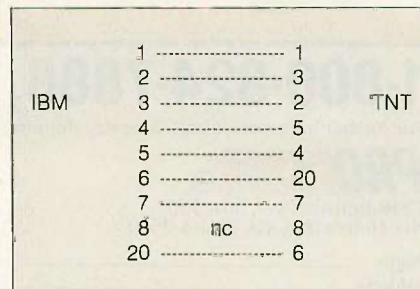

Figure 1: The diagram for construction of a null-modem cable.

an internal Qubie modem with a serial port. I made a few attempts at building a connection, but whenever I ran a program in BASIC, I got the error message "device time out."

ITSHAK MIHAELI  
Staten Island, NY

There are several possible reasons for your troubles. First, be sure the serial port in the Qubie board is connected as COM1. If it is COM2, use the OPEN COM2: statement in BASIC on the IBM side to open the serial port. Also, make sure both computers are set to the same data-transmission rate.

Next, be sure you have connected the two computers as shown in figure 1. This arrangement is called a null modem.

If you are already using this arrangement and your cable has no bad connections, you should test each port with a loopback plug to find out which one is causing the problem. A loopback plug is a DB-25 (RS-232C) connector with the following pin pairs connected together: 2 to 3, 4 to 5, and 6 to 20. This plug makes the computer send data to itself and can be used to test each computer's serial port for proper function.—Steve

### CHIPS

Dear Steve,

With the recent sharp price cuts in 256K-bit RAM chips, it seems that replacing the 4164s on the motherboard of an IBM PC or a Compaq would offer many advantages over an add-on memory board. I've heard that the 41256 chips can be substituted in some cases, but I don't know what sort of trace cuts or jumper settings might be required. Can you help?

BRIAN UNDERDAHL  
Ballwin, MO

The 256K-bit 41256 chip pin-out is identical to the 4164, except for pin 1, which is NC on the 4164 and address A8 on the 41256. This allows 9-bit row address by 9-bit column address. The IBM PC has no provision for implementing the pin 1 address, and I don't think the Compaq does either.

Changes on the board required to make this swap with jumpers would be extensive but probably not impossible. There were a couple of companies converting the early IBM 16K- to 64K-byte motherboards to use 64K-bit chips for 256K bytes total on the motherboard. Maybe someone will offer a similar service for the 256K-bit chips now that the

(continued)



# Only the Hayes® Transet 1000® can get you out of this one.

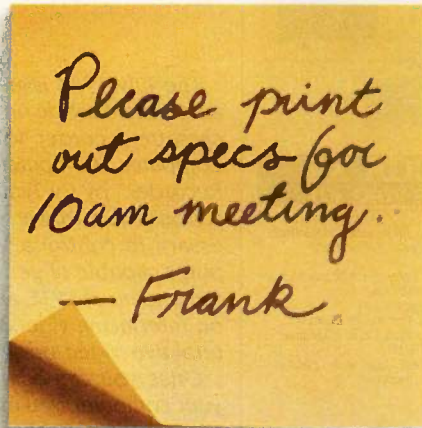

©1986 Hayes Microcomputer Products, Inc.

Now your PC can do three things at once instead of making you wait while it does one thing at once.

We call it *triple tasking*®.

It means you can work with your PC while the Transet 1000 receives your electronic mail and runs your printer for you simultaneously.

Three jobs at once. No waiting.

When you're away from your desk, or at night while your PC is turned off, Transet 1000 serves as an electronic mailbox.

Because it has its own independent 128K or 512K memory.

To get the messages that come in through the night, you can call them up on your PC. Access them through a remote modem if you're away from the office.

Or even have them waiting for you in hard copy.

By now it's dawning on you



that Transet 1000 can make your PC about three times as productive as it is now. Which is no small statement.

You've also figured out it's more than just a print buffer. More than just a communications buffer. And probably costs a lot. Right?

Wrong!

It costs only \$399\* for the 128K model which stores up to 90 pages. And only \$549\* for the 512K version with up to 360 pages of storage.

For more information and specifications, contact your authorized Hayes dealer. Or Hayes directly at (404) 441-1617.

Hayes Microcomputer Products, Inc., P.O. Box 105203, Atlanta, Georgia 30348.

## Hayes®

Say yes to the future with Hayes.

\*Manufacturer's estimated retail price.

# MEGA-16 BAR CODE READER

BAR CODE READER WITH KEYBOARD EMULATOR FOR IBM PC/XT, AT

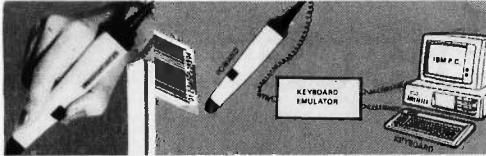

**ONLY \$395.00**

Your PC will become a BAR CODE SYSTEM by using our "MEGA-16" bar code reader. With Built-in "KEYBOARD EMULATOR" in our "MEGA-16", it can read the bar code data directly WITHOUT adding any software or hardware. All you have to do is just plug in the "MEGA-16" bar code reader to your PC instead of PC's keyboard plug.

**APPLICATIONS:**

- INVENTORY CONTROL
- ASSET MANAGEMENT
- FILE OR DOCUMENT TRACKING
- ORDER ENTRY
- WORK-IN-PROCESS RETAIL POINT-OF-SALE

**FEATURES:**

- IBM PC, PC/XT, PC/AT PLUG-IN COMPATIBLE
- WITH KEYBOARD EMULATOR, NO EXTRA SOFTWARE, OR HARDWARE IS NEEDED
- READ THE MOST OF CURRENT CODES
- BIDIRECTIONAL SCANNING
- AUDIBLE "BI" FOR CORRECT READING
- COMPACT SIZE, LIGHT WEIGHT; AND NO EXTRA POWER SUPPLY IS NEEDED
- VISIBLE INDICATOR
- EASY TO INSTALL, AND EASY TO OPERATE
- NO CARD SLOT REQUIRED/SIMPLE INTERCONNECT
- READ HIGH, MED & LOW DENSITY LABELS
- HIGH FIRST READ RATE
- SWITCH SELECTABLE OPTIONS
- SELFTEST DIAGNOSTICS
- CAN READ 6 KINDS OF BAR CODES—UPC, EAN, JAN, 2 OF 5, 3 OF 9 & CODE BAR



## "NEW" EPROM WRITER CARD: MEGA EPW-4

FOR YOUR IBM PC/XT, AT AND IBM COMPATIBLES

Our EPROM Writer Cards can be used under MS-DOS System. They are designed to be multifunctional, user-friendly, and highly reliable.

**FEATURES:**

- EPROM SIZES: 2716, 2732, 2732A, 2764, 2764A, 27128, 27128A, 27256, 27256A, 27512, 27512A
- VOLTAGE ADJUSTABLE TO 25V, 21V, 12.5V, ETC.
- CAN PROGRAM BLANK CHECK & VERIFY 4 EPROMS SIMULTANEOUSLY
- EXTREMELY HIGH SPEED - 8 TIMES FASTER THAN GENERAL EPROMS
- VERY EASY TO USE
- CAN LOAD PROGRAMMED DATA DIRECTLY FROM DISK
- CAN SAVE EPROM DATA ON DISK
- CAN DISPLAY, PRINT AND MODIFY EPROM DATA
- SOFTWARE INCLUDED

PROGRAM 4 EPROMS SIMULTANEOUSLY  
SIZE: 2716 UP TO 27256, 27512  
**ONLY \$219.00**

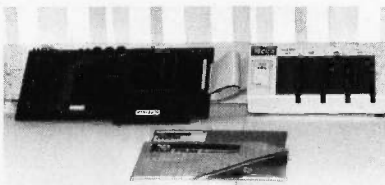

## MEGA AT BARE BONE KIT

**Including:**

- IBM AT Compatible 8 mHz Mother Board with 640K, Assembled with AT Style Case and 200W Power Supply
- One 12MB High Density Drive
- WD Hard & Floppy Drive Controller
- AT Style Keyboard
- Color Graphics Card
- Operation Manual



**ONLY \$1885.00**

## MEGA XT BARE BONE KIT

**Including:**

- Step-by-Step Assembly Instructions and User System Operations Manual
- IBM PC/XT Fully Compatible Mother Board with 640K and Bios
- Color Graphics Card
- Floppy Disk Controller Card
- One 13/30 Slim Drive (Optional, 2nd Drive \$95.00)
- Flip Top Metal Case with Speaker
- 135W Power Supply
- Keyboard



**ONLY \$795.00**

PLEASE CALL FOR AT, XT ADD-ON CARDS

### POWER SUPPLY

FOR PC/XT AND AT



**135 Watts  
XT Power Supply**



**200 Watts  
AT Power Supply**

ASK FOR OEM PRICES FOR POWER SUPPLIES IN STOCK!

### KEYBOARD

To Be Used On Both PC/XT and AT  
NO SWITCH, AUTOMATIC SELECTION!

BTC 5060 AT

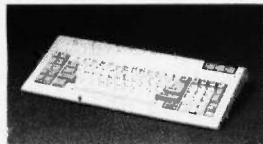

**FEATURES:**

- Solid-state capacitance low-profile key switches
- Positive tactile feedback
- Sculptured profile
- Large-scale integration encoding
- N-key rollover
- Reliable electronic shiftlock with LED indicator
- Auto repeat

OEM Prices - **Only \$69.00**  
(min. order: 10 pcs.)

### MEGA EXTERNAL SYSTEM

POWER CONTROL, HARD DISK DRIVE OR TAPE BACK-UP DRIVE.

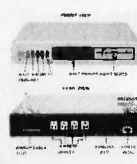

**ONLY \$175.00**

**SPECIFICATIONS:**

- DIMENSIONS: 15" x 19 1/2" x 3 1/2" (LxWxH)
- SYSTEM INPUT: 110-120V AC, 60Hz
- SYSTEM OUTPUT: 4 SWITCH SOCKETS, 110-120V AC
- OVERLOAD 15 AMP RESET CIRCUIT BREAKER
- POWER SUPPLY: +5V, +12V DC OUTPUT WITH TWO FOUR-PIN DRIVE CONNECTORS
- DRIVE SLOTS: SPACE FOR TWO HD DRIVES, HARD DISK; TAPE BACK-UP OR DISKETTE STORAGE
- CONTROL SWITCH: FIVE SWITCHES-ONE MASTER SWITCH CONTROLS THE SYSTEM, FOUR ACCESSORY SWITCHES CONTROL ONE OUTLET EACH
- COOLING FAN: DC 12V
- SURGE PROTECTOR: EMI FILTER

## ASK BYTE

prices are down.

The advantages may not be as big as they first appear, however, because almost everyone wants a battery-backed clock/calendar and one or two serial ports, etc. This being the case, it is usually economical to buy one of the multifunction expansion boards that provides these, along with 384K bytes of memory. MS-DOS won't allow easy use of more than the 640K bytes this provides.—Steve

### PC AND VCR

Dear Steve,

I plan to buy an IBM PC or a PC-compatible microcomputer. I would greatly appreciate it if you can cite any references that show how to interface it to a video-cassette recorder.

P. L. K. SASTRY  
Bombay, India

The July 1984 issue of BYTE contains an excellent article on interfacing a video-cassette recorder to the TRS-80 Color Computer. "Computer Control of a Video Recorder" by Cy Tymony (page 179) describes the hardware and software necessary to control a VCR with any computer capable of generating sound. The same issue of BYTE also contains articles on interfacing videodisc players and interactive video programming.

Once you can control your VCR from your computer, you may want to use your computer to capture and modify video images. Chorus Data Systems (6 Continental Blvd., POB 370, Merrimack, NH 03054) sells hardware and software for the IBM PC that allows you to capture video data and save it in your PC. Photo-base software from Chorus Data Systems lets you create a database containing both text and digitized video information.—Steve

### ATARI HOME CONTROL

Dear Steve,

How plausible is it to convert an Atari 2600 to a home controller, monitor, and security system? It seems to me that the 2600 has suitable graphics, I/O, and such to do so. Is it possible to do it through the ROM cartridge connector? Has anyone published specs and schematics for the machine? It seems that it would not be difficult, knowing the memory map, switches, and resident routines, to build a piece of hardware to use this machine. The firmware could be developed on another machine. I have in mind applications like laboratory monitoring, robotics, weather

(continued)



## C.J. COMPUTERS CORPORATION

(Manufacturer & Distributor)

2424 W. Ball Rd., Suite A&B, Anaheim, CA 92804

ORDER AND INQUIRY HOT LINE (714) 821-8922 (5 LINES)

TLX: 3720117 JC COMPTN

\*90 days warranty on parts and labor.

†IBM is the trademark of International Business Machines Corporation.

**IMMEDIATE DELIVERY!**

# Meet The Princeton Graphic Systems Family.

**The right monitor at the right price.** Princeton Graphic Systems offers you a complete family of high performance personal computer monitors. Monitors that deliver the compatibility, resolution, and reliability you need for any application and any budget: from word processing to sophisticated business graphics.



**HX-12E.** High resolution RGB monitor 640x350 lines noninterlaced - .28 mm dot pitch -Compatible with IBM Enhanced Graphics Adapter -Nonglare screen -**\$785**



**MAX-12.** Amber monochrome -720 x 350 lines -Enhanced to interface with IBM color or monochrome adapter card -Nonglare screen -Can display 16 shades of amber -**\$249**

**HX-12.** High resolution RGB monitor -640 x 200 lines noninterlaced -.31 mm dot pitch tube-Nonglare screen -**\$695**



**HX-9/9E.** Nine inch, high resolution RGB monitor non-interlaced -.28mm dot pitch tube -9E compatible with IBM Enhanced Graphics Adapter -Nonglare screen -Green/amber switch -Apple/IBM colors - Etched dark glass screen -**\$650/\$750 (9E)**



**SR-12P.** PGS's top of the line RGB monitor 640x480 lines noninterlaced -.26 mm dot pitch - Analog input allows for the display of 4,096 possible colors -Compatible with IBM Professional Graphics Adapter -Nonglare screen -**\$999**



**SR-12.** Super-high resolution RGB monitor -640 x 400 lines noninterlaced -.31 mm dot pitch tube - Nonglare screen - Requires interface card -**\$799**



**Princeton accessory product line.** Undergraduate tilt/swivel monitor base, ColorView card, Green/Amber switch, RGB-80 card and Scan Doubler card.

## Princeton Graphic Systems. The only real choice.

For office or home use, Princeton Graphic Systems has a monitor that's right for you. Inquire at your local computer store about our complete line of high resolution color and monochrome monitors; monitors that live up to the Princeton Graphic Systems' tradition of quality, performance, and value. **Princeton Graphic Systems.** 601 Ewing Street, Bldg. A, Princeton, N.J. 08540. (609) 683-1660 Telex: 821402PGSPRIN **(800) 221-1490.** Ext. 304.

**PRINCETON**  
GRAPHIC SYSTEMS  
AN INTELLIGENT SYSTEMS COMPANY

IBM IBM Enhanced Graphics Adapter, and IBM Professional Graphics Adapter are trademarks of International Business Machines, Inc. Compaq is a trademark of Compaq Computer Corp. Corona is a trademark of Corona Data Systems, Inc. Apple is a trademark of Apple Computer Corp. PC World is a trademark of CW Communications Inc. SR-12 screen courtesy of Mouse Systems, Inc.

# WE STOCK WHAT WE SELL!

If You Don't See It Listed Here, Call Us!!

## PERSONAL COMPUTERS

<b>ZENITH</b>	
Transportable Dual Drive 5/8 Mhz ZFA-138-42	\$1,399
Entry Level Desktop Dual Drive 5/8 Mhz ZF-148-42	\$1,169
Professional Desktop Dual Drive 5/8 Mhz ZF-158-42	\$1,799
Portable Dual Drive, Battery Operation ZFL-171-42	\$1,899
"AT" Compatible ZF-241-81	\$2,599
"AT" Compatible Winchester System ZW-241-82	\$3,699



Professional Desktop Dual Drive Monochrome 5/8 Mhz MODEL 200	\$1,749
Professional Desktop 1 Floppy, 1 20 Mg Hard Drive Monochrome 5/8 Mhz MODEL 400	\$2,844
"AT" Compatible Single Floppy Drive System PC/IT BASIC	\$2,199
"AT" Compatible 1 Floppy, 1 44 Mg Hard Drive PC/IT EXPANDED	\$3,199

## MONITORS

<b>ZENITH</b>	
ZVM-122/123	\$ 79
ZVM-1220/1230	\$ 89
ZVM-1240	\$149
ZVM-131	\$189
ZVM-1330	\$459



Video 300G	\$125
Video 300A	\$133
Video 310A	\$153
Color 300	\$244
Color 600	\$432
Color 722	\$539

Prices Quoted Reflect Cash Discount. Add 3% for Master Card or Visa. Prices and Availability Subject to Change without Notice. Add 3% for Shipping and Handling, \$5.00 minimum. 15% Restocking Charge on All Returns.

### REXWIL ADVANTAGE

- 60 Years in the Electronics Field.
- Toll Free Technical and Service Support.
- Quality Products.
- Service Facilities on Premises.

- There is No Limit and No Deposit on C.O.D. Orders.
- We accept purchase orders from qualified corporations. Subject to approval.
- Educational discounts available to qualified institutions.



Use Our Convenient Toll Free Order Line.

# 1-800-CALL-REX

Telephone Orders Only. 8:30 AM — 5:00 PM (Eastern) Mon.-Fri.



**REXWIL ELECTRONICS**

Mailing Address: REXWIL ELECTRONICS

P.O. Box 4585 • Philadelphia, PA 19131  
Dealer Inquiries Welcome

TOLL FREE 1-800-CALL-REX  
IN PA 1-800-821-1059

• P.O. Box 4585 • Philadelphia, PA 19131

## PRINTERS



SG-10	\$219
SG-15	\$399
SG-10C	\$249
SR-10	\$439
SR-15	\$589
SB-10	\$593
NB-15	\$CALL
Gemini 10X	\$169
Powertype	\$328

## LEGEND

808	\$155
880	\$199
1380	\$280
CP-VII	\$840

## Sweet's Plotters

SP100	\$215
SP600	\$818

## MODEMS



Password 1200	\$195
Password 300	\$129
Microlink 1200	\$329
Courier 2400	\$429
Microlink 2400	\$429

## MULTIFUNCTION CARDS

### STB Systems Video Cards

Chauffer	\$259
High Resolution EGA	\$399
Graphix + II	\$269
Mono +	\$159

### STB Systems Memory Cards

Big Byte 64K (384K Capacity)	\$129
Grande Byte (2M Capacity)	\$269

### dca Mainframe Links

Irma Board	\$869
Smart Alec	\$759

monitoring, security, and climate control.

I would buy your designs, but I am a medical student living on borrowed money, and the Atari 2600 is cheap.

SAM HUNTER  
Galveston, TX

There are several good reasons not to use an Atari 2600 game machine as a home controller. The RAM and I/O capabilities are limited, and a second computer would have to be used for software development. Also, specs and schematics are available only to service centers; you may have a difficult time getting them.

Why not use an Atari 400 or 800? You can often find a used machine in good condition for as little as \$25 that would provide a programming language and excellent I/O capabilities. Documentation, information, and finished products are readily available. You might want to refer to "Control Your Environment with the Atari 400/800" by David Alan Hayes (July 1983 BYTE, page 428).—Steve

## SCIENTIFIC DATABASES

Dear Steve,

I would like to know where addresses of Canadian and American scientific databases are available. Technical databases in the field of graphic arts in connection with CAD, CAE, and CAM are especially important to me. Thanks.

CLAUS STERNBERG  
Salzburg, Austria

The October 1984 issue of BYTE contains the article "Low-Cost On-Line Databases" (page 167). The author, Matthew Lesko, publishes a monthly newsletter that lists current free and low-cost databases. Contact Information USA, 4701 Willard Ave., Chevy Chase, MD 20815, (301) 657-1200.—Steve ■

IN ASK BYTE, Steve Ciarcia answers questions on any area of microcomputing. The most representative questions received each month will be answered and published. Do you have a nagging problem? Send your inquiry to

Ask BYTE  
c/o Steve Ciarcia  
POB 582  
Glastonbury, CT 06033

Due to the high volume of inquiries, personal replies cannot be given. All letters and photographs become the property of Steve Ciarcia and cannot be returned. Be sure to include "Ask BYTE" in the address.

The Ask BYTE staff includes manager Harv Weiner and researchers Larry Bregoli, Bill Curlew, Jeannette Dojan, Jon Elson, Roger James, Frank Kuechmann, Edward Nisley, Dick Sawyer, Andy Siska, and Robert Stek.

## News about the Microsoft Language Family

**Structured programming in QuickBASIC—Part 1—Subroutines**

The Microsoft® QuickBASIC Compiler provides powerful structured programming features that go far beyond BASIC's FOR/NEXT, WHILE/WEND, and GOSUB statements. True subroutines with scalar and array parameters are easy to use in QuickBASIC. All variables in subroutines are local unless they are declared as shared global variables in the current module, as shown below.

```
CALL MySort (howbig, Array())           'sort Array ()
...
SUB MySort (limit, Sieve (1)) STATIC    'Sieve is 1-dim
SHARED bubbles                          'global variable
... 'MySort subprogram body
END SUB
```

QuickBASIC modular programming with separate compilation and subroutine libraries will be covered in Part 2.

**Interlanguage calling support added to C, FORTRAN and Pascal**

The current releases of Microsoft C, FORTRAN and Pascal have been enhanced to support interlanguage calling. This was accomplished by extending the language syntax in each language and by sharing the major components of the runtime libraries—program start-up, memory models, memory allocation and floating point math support. For example, in FORTRAN these extensions allow programs to call C functions with value parameters and variable length argument lists. Under XENIX®, the interlanguage calling support allows the standard XENIX C libraries to be accessed from Microsoft FORTRAN and Pascal.

**Mixed model dynamic memory allocation in Microsoft C—Part 2**

During program start-up in Microsoft C, any memory beyond the 64K limit of the default data segment is released to MS-DOS®. (The amount returned can be increased by using the /CPARMAXALLOC switch to LINK or the EXEMOD utility.) This allows C programs to “exec” child programs. The first call to the near heap allocation routine, `_nmalloc`, creates the near heap which can use the remaining free space in the default data segment. The first call to the far heap allocation routine `_fmalloc`, creates the first far heap segment by requesting a block of memory from DOS rounded up to the nearest 8K (power of 2 equal or larger than the global variable `_amblksiz`). Subsequent `_fmalloc` calls will expand the last far heap segment up to 64K before allocating another far heap segment. When all far memory has been used, `_fmalloc` will try to allocate the memory from the near heap.

**Write to:** Microsoft Languages Newsletter  
10700 Northup Way, Box 97200  
Bellevue, WA 98009 for product and update information.  
**Or phone:**  
(800) 426-9400. In Washington State and Alaska,  
call (206) 828-8088. In Canada, call (800) 387-6616.

**Latest DOS Versions:**

Microsoft C	3.00
Microsoft COBOL	2.10
Microsoft FORTRAN	3.31
Microsoft Macro Assembler	4.00
Microsoft Pascal	3.31
Microsoft QuickBASIC	1.00

Call for latest prices.

# FREE SHIPPING

in the Continental United States via UPS Ground.

## NO SURCHARGE FOR OR

### Seagate HD □ Western Digital Controller 20 MEG Hard Disk System for PC™



**Internal \$449**  
**External \$599**

For Xebec 1220 Combined Floppy/Hard Disk Controller add \$75.

Includes Seagate Hard Disk, Western Digital Controller, Cables, Manual, Software, and Mounting Hardware.

Boots From Hard Disk 65 MS Access Time One Year Warranty

Our Hard Disk Systems are compatible with the latest versions of the following Computers: IBM PC, IBM XT, AT&T 6300, Compaq Portable, Tandy 1000, Tandy 1200, PC's Limited Turbo PC, Leading Edge PC (Both Models), Sperry PC, Wyse PC, Televideo PC, Faraday Mother Boards, Corona PC, Eagle PC, ITT PC, and most other Compatibles.

**PLEASE SPECIFY YOUR COMPUTER TYPE WHEN ORDERING.**

### Seagate

#### 20 and 30 MEG High Speed 40 MS Access Time Hard Drives for AT™

Uses Linear  
Voice Coil  
Activator.

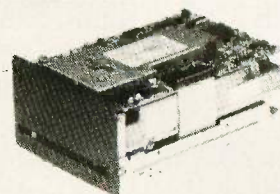

Heads park automatically  
at power down.

**20 MEG \$579**  
**30 MEG \$699**

Includes Seagate Full Height Hard Disk, Cables, Manual, and Mounting Rails. Boots from Hard Disk. One Year Warranty.

**64K RAM \$10** per set  
Set of 9 chips, 200 or 150 Nanoseconds

**256K RAM \$29** Set of 9 chips  
150 Nanoseconds

**300/1200 Baud Hayes Compatible Modem  
Fits in Short Slot**



**\$159**

### PC'S LIMITED Six Function Card

- Includes 384K
- Clock/Calendar
- Includes Software
- Parallel Port
- Serial Port
- Game Port



Two Year Warranty

**w/384K \$129**

### PC's Limited AT Multifunction Card

- Expandable To 3 Meg (1.5 on Board/1.5 on Piggy Back Board)
- Supports 64 or 256K Rams
- Parallel Port
- Serial Port (2nd Serial Optional)

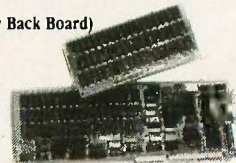

**\$199** w/OK

Piggy Back Board \$59 w/OK

### PC's Limited PC-576 RAM Board W/OK

- Expandable to 576K
- Supports 64K or 256K RAMS
- Fits in Short Slot

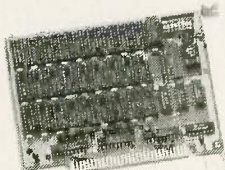

**\$69**

### SOLVE YOUR POWER PROBLEM. XT™ POWER 135W



**\$89**

Directly replaces power supply in PC.™ Fully XT™ compatible. One Year Warranty

# PRICES AND MACHINES THAT OUTRUN THE COMPETITION.

**PC'S LIMITED** TURBO  
PC™

## High Performance Competitive Price

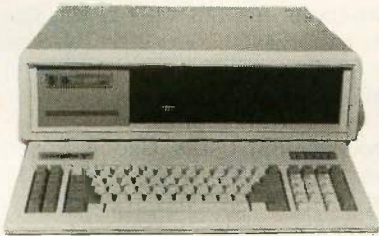

# \$795

One year warranty.\*

Includes: System Unit, 640K on Mother Board,  
360K Floppy Drive, Keyboard, 135W Power Supply.

Runs all Major Software written for the IBM PC™ and PC XT™, 40% faster, without modifications.  
(Processor) 16-bit 8088-2, 4.77 or 6.66 MHz Clock Speed. (Expansion Slots) :8; 7 are available in above configuration;  
GW Basic \$95 • IBM DOS 3.1 \$85 • 8087-2 \$149

## PC'S LIMITED AT™

### High Performance Competitive Price

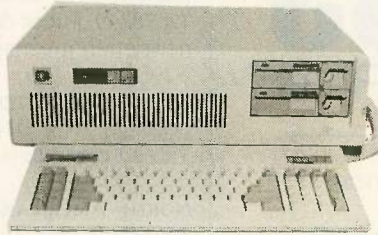

# \$1995

One Year Warranty.\*

**8MHZ Option included  
at no extra charge.**

Includes: 80286-based System Unit, 1024K on  
Mother Board, 1.2 Meg. Floppy Drive, Combined Floppy  
and Hard Disk Controller Card, AT Keyboard, 192W  
Power Supply, 2 Serials and 1 Parallel Port, and  
Clock/Calendar with Battery Backup.

Runs all Major Software written for the IBM PC™, PC XT™, and PC AT™. (Processor) Intel 80286 running at 6MHZ.  
(Expansion Slots) :8. Same Bus Configuration as IBM PC AT™.

GW Basic \$95 • IBM DOS 3.1 \$85 • 80287 \$195

### PC's Limited Mini I/O

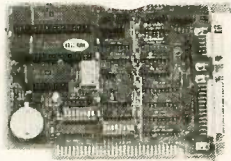

# \$99

- Serial Port
- Parallel Port
- Clock
- Software
- Fits In Short Slot

### PC's Limited Monochrome Graphics Fully Hercules Compatible

- Text Mode 80 X 25
- Graphics Mode 720 X 348 Pixels
- One Parallel Printer Port

# \$159

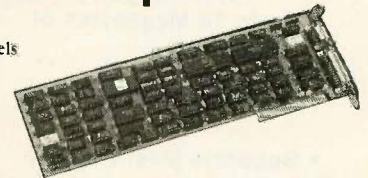

### Floppy Disk Drive

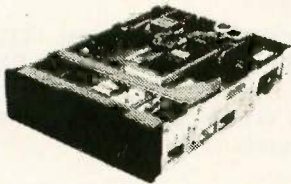

# \$109

## PANASONIC

Half-Height, DS/DD

## TEAC

55-B, Half-Height, DS/DD

Also available for AT™  
in Gray Color.

## MITSUBISHI

ELECTRONICS

Half-Height, DS/DD

### PC's Limited Universal Video Adapter



# \$259

- Replaces numerous cards, including IBM,  
Hercules, Plantronics.
- Provides 132 column text—color or mono
- Supports all parallel printers and plotters
- Emulates color software on monochrome  
monitor in 16 shades

Terms: Due to our low prices and assurance that  
all merchandise is new, unopened product, all sales  
are final. Call technical support for return  
authorization number or all warranty repairs.  
Any unauthorized return subject to a 10%  
restocking fee. Prepaid checks, money orders,  
VISA, MasterCard, American Express, or ap-  
proved company purchase orders are accepted.  
Prices reflect 3% cash, VISA and MasterCard dis-  
count. American Express not subject to discount.

Some quantities may be limited.  
PC's Limited reserves the right to  
substitute equivalent items. All  
prices are subject to change without notice.

We are an independent sales  
organization.



# PC'S LIMITED™

SALES CALLS OUTSIDE TEXAS, 1-800-426-5150

1611 Headway Circle, Building 3, Austin, Texas 78754

Sales Calls from anywhere in country, (512) 339-6962

Technical Support Calls, (512) 339-6963 Customer Service Calls, (512) 339-6964

Telex No 9103808386 PC LTD FAX (512) 339-6721

Plantronics, Teac, Seagate, Western Digital, AT&T,  
Compaq, Tandy, Leading Edge, Sperry, Wyse, Televideo,  
Parady, Corona, Eagle, and EET are registered trade-  
marks of their respective companies. IBM PC, IBM XT,  
IBM AT are trademarks of IBM Corporation.  
Leading Edge PC, Sperry PC, Wyse PC, Televideo PC,  
Corona PC, Eagle PC, AT&T 6300, Tandy 1000 and  
Tandy 3100 are trademarks of their respective  
companies.

\*Limited Warranty



Ad Number 403

**UNIX**<sup>TM</sup>**Multi-Link**<sup>TM</sup>The **BOSS**  
**BOARD**<sup>TM</sup>

High Performance

**MULTI-USER  
UPGRADE KIT**

for

**PC DOS Programs**

- IBM<sup>®</sup> PC, XT,  
AT Compatible
- Up to 16 Megabytes of  
RAM
- Unlimited Users
- Supports Most Popular  
Terminals

**Gabe Tech.**<sup>ltd.</sup>

P.O. Box 41223  
Brecksville, Ohio 44141-0223  
(216) 237-4900

Excellent VAR/ISO Programs

Full Line of Support Products  
Terminals, Cables,  
Memory Boards,  
Serial Port Boards,  
and Multi-user Application Programs.

IBM PC<sup>®</sup> & PC DOS<sup>®</sup> are trademarks of IBM Corp.  
Multi-Link<sup>®</sup> is a trademark of The Software Link, Inc.  
UNIX<sup>®</sup> is a trademark of AT & T. Bell Labs

**C·L·U·B·S A·N·D  
N·E·W·S·L·E·T·T·E·R·S**

**MACINTOSH ENTHUSIASTS OF SAN ANTONIO (MESA)**, 6134 Calderwood, San Antonio, TX 78249. Public-domain software library, newsletter, meetings. Annual fee: \$12.

**THE KEPNER LETTER**, 145 Grove St., Peterborough, NH 03458, (603) 924-9450. TRS-80 computers featured.

**NORTH AMERICAN ONE-EIGHTY GROUP (NAOG)**, POB 2781, Warminster, PA 18974, (215) 443-9031. Users group for the SB180, Steve Ciarcia's single-board computer (see September 1985 BYTE). \$15 per year includes 12 issues of newsletter.

**SANYO USER GROUP OF THE SAN FRANCISCO BAY AREA**, 1260 Westwood St., Redwood City, CA 94061, (415) 369-2034. Monthly newsletters and public-domain software library access. Annual fee: \$20.

**CASA MI AMIGA**, c/o Kinetic Designs, 1187 Dunbar Court, Orange Park, FL 32073. 24-hour BBS for Amiga owners at (904) 733-4515. Public-domain software. Send SASE.

**THE PILOT SIG**, ADCIS International Headquarters, Miller Hall Room 409, Western Washington University, Bellingham, WA 98225. Only members of Association for the Development of Computer-Based Instructional Systems eligible. Meetings, newsletter, workshops.

**STOUT MICROCOMPUTER USER GROUP (SMUG)**, John Wright, Tech Wing 248, University of Wisconsin—Stout, Menomonie, WI 54751. Student group, public-domain software library, meetings.

**MICROPUBLISHING REPORT**, 2004 Curtis Ave. #A, Redondo Beach, CA 90278, (213) 376-5724. Small computers in publishing. 12 issues: \$175.

**FREE BBS**, Marshfield Technologies Inc., Data Processing Services Dept., POB 761, 171 South Central Ave., Marshfield, WI 54449. 1200-bps BBS at (715) 387-4028.

**PANHANDLE COMPUTER SOCIETY**, POB 30545, Amarillo, TX 79120-0545. Twelve SIGs, calendar, newsletter.

**APPLE /// USERS OF NORTHERN CALIFORNIA (ATUNC)**, 220 Redwood Highway #184, Mill Valley, CA 94941. Meetings, newsletter. Annual subscription: \$20.

**COME-ADORE THE 128**, 7102 Leavitt Rd., Amherst, OH 44001, (216) 986-6114. Support for C-64 and 128, newsletter. Send SASE.

**MANASOTA IBM Users' GROUP**, Robert Moss, 111 Sunset Dr., Nokomis, FL 33555, (813) 484-1458. Meetings in Sarasota.

**COMPUTER AIDED SELLING**, The Denali Group, 1111 Third Ave., 7th Floor, Seattle, WA 98101, (206) 382-6668. News for salespeople. Annual subscription: \$87.

**THE CALGARY OSBORNE USERS GROUP**, Greg King, 24 Edgedale Way NW, Calgary, Alberta T3A 2P8, Canada. Best for 8-bit CP/M users. Meetings.

**SEATTLE CHAPTER OF THE INTERNATIONAL INTERACTIVE COMMUNICATIONS SOCIETY**, POB 31273, Seattle, WA 98103, (206) 248-4968. Interactive video applications.

**CONNECTICUT IBM PC USERS CLUB**, John McGinley, POB 291, New Canaan, CT 06840-0291, (203) 762-0229. Meetings, newsletter, public-domain software.

**SURVIVAL COMMUNICATION FORUM**, 1435 Sebastopol Rd., Suite 210, Santa Rosa, CA 95407. 300- and 1200-bps, 24-hour, free BBS at (707) 545-0746. Resources for the survivalist community.

**WOLF'S DEN BBS**, (316) 838-9456. 24-hour, 300-bps BBS with variety of features.

**SAMNA PIPELINE**, SAMNA International User's Group, 1088 Bishop St., Suite 407, Honolulu, HI 96813. Monthly newsletter on using SAMNA. ■

**CLUBS AND NEWSLETTERS** is an acknowledgment of new clubs and newsletters received at BYTE. Please allow at least four months for your club's mention to appear. Send information to BYTE, Clubs and Newsletters, POB 372, Hancock, NH 03449.



The future... a little sooner than you expected.™



**ACHIEVE THE POWER  
AND SPEED OF TOMORROW'S  
TECHNOLOGY. TODAY.**

**INTRODUCING  
THE EXEC. PARTNER™ FROM  
PANASONIC®**

The Panasonic Exec. Partner. What makes it an executive? The 7.16 MHz 8086-2 microprocessor for high-speed processing. So you can do more in less time.

What makes it your partner? Like all ambitious achievers the Panasonic Exec. Partner gets along with others. Namely, IBM hardware and software.

You'll also accomplish more with the new high-resolution plasma display. It lasts four times longer, offers clearer definition and is easier to read than an ordinary screen.

The Exec. Partner's built-in dual mode printer will help

you make a good impression. From silent, draft-quality mode to correspondence quality.

The 256K internal memory has built-in expandability to 640K. So the Exec. Partner will run the most sophisticated data base management programs. And its expansion slot allows you to fulfill the needs of specific applications like telecommunications and Local Area Networks.

Tomorrow's technology for today's executives. The new Panasonic Exec. Partner.

**Panasonic  
Industrial Company**

Get a carrying case (model FXZC751) at no charge with any Exec. Partner purchased through 3/31/86. For the location of your nearest participating dealer, call 1-800-PIC-8086.

IBM is the registered trademark of International Business Machines, Inc.

# A SIGHT FOR SORE EYES

T H O M S O N

To those of you who stare and stare—and stare at computers, blessed relief has arrived. Thomson™ monitors. We promise clearer, crisper resolution, remarkable colors and print-like text. Thomson builds a full line of monitors, from basic monochrome to high-resolution color models. All are designed to fulfill your needs today, and sophisticated enough to fulfill your needs in the future.

Thomson monitors are designed and built by Thomson, a \$6 billion international corporation. They're going to change the way America looks at computers.

Ask your local computer dealer for a Thomson monitor, or call 1-213-821-2995, ext. 34, for the Thomson dealer nearest you. Then take a stare at a Thomson monitor. It's a sight for sore eyes.™

Telex: 3720233. Thomson is a trademark of Thomson S.A.

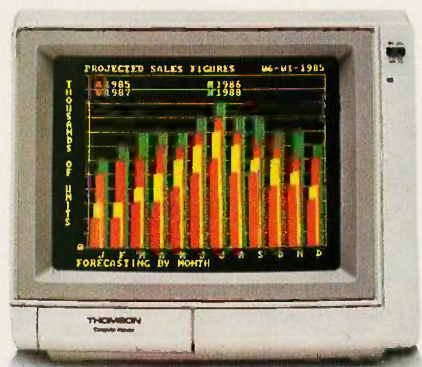

Model CM 3131SI. 12" diagonal, 31mm dot pitch RGB color monitor with text switch and non-glare tinted screen.

# THOMSON



# B·O·O·K R·E·V·I·E·W·S

THE PETER NORTON  
PROGRAMMER'S GUIDE TO  
THE IBM PC  
Peter Norton  
Microsoft Press  
Bellevue, WA: 1985  
426 pages, \$19.95

THE COMPUTER CULTURE  
Denis P. Donnelly, editor  
Fairleigh Dickinson University Press  
Cranbury, NJ: 1985  
176 pages, \$24.50

MICROSOFT MACINATIONS  
Mitchell Waite, Robert Lafore,  
Ira Lansing  
Microsoft Press  
Bellevue, WA: 1985  
497 pages, \$19.95

THE COMPUTER LAW ANNUAL 1985  
Miles R. Gilburne, Ronald L. Johnston,  
Allen R. Grogan, editors  
Harcourt Brace Jovanovich  
New York: 1985  
405 pages, \$60

---

## THE PETER NORTON PROGRAMMER'S GUIDE TO THE IBM PC

Reviewed by Donald Evan Crabb

**A**lthough the information Peter Norton provides in *The Peter Norton Programmer's Guide to the IBM PC* is not new or unique, reading it is an education. The book picks up where Norton's *Inside the IBM PC* (Robert J. Brady Co., 1983) left off. Whereas the earlier book concentrates on the hardware components of the IBM Personal Computer and how they work together, the new book is written strictly with the PC programmer in mind. Both works combined provide a comprehensive technical reference to the PC.

As you might expect, these books cover some material in common. For example, both explore the ROM BIOS of the PC. But the discussion in *The Programmer's Guide* is designed for the programmer. In fact, this book should be useful to anyone who needs to understand the technical

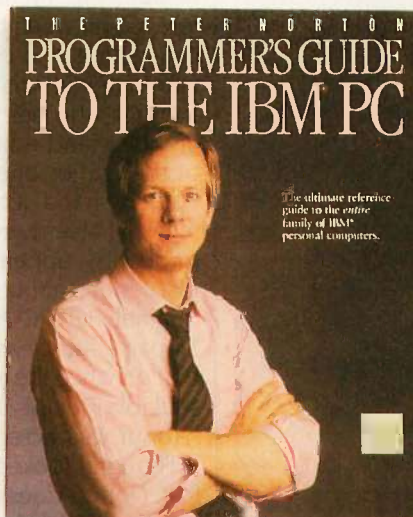

details involved in creating PC programs. Norton makes the distinction right from the start that he is providing more than just PC programming knowledge. He is trying to impart concepts about PC programming.

Norton also concerns himself with the philosophy of programming the PC. He laces the book with explanations about the design concepts that permeate the entire IBM PC line. Due to Norton's wealth of experience working with PCs, this information is synthesized so that it is more useful than the usual dry engineering discussion that you often get in books of this kind. He carefully divides the ROM information into four chapters: ROM

BIOS basics, ROM BIOS video services, ROM BIOS disk services, and ROM BIOS keyboard services.

*The Programmer's Guide* details the original PC. But keep in mind the subtitle of this book: "The ultimate reference guide to the entire family of IBM personal computers." Norton explains differences between the design, construction, and systems software of the other members of the PC family and the PC. Most of the examples and information describe the Intel 8088 microprocessor and how it's programmed through the services provided by the ROM BIOS and by DOS. Many of the programming examples use BASIC as the representative high-level language. Pascal and C-language examples also appear. Norton shows how to write 8088 assembly-language interface programs for each of these languages.

The scope of the book extends to a number of programming areas. From video and disk basics, Norton moves from how the keyboard operates in programs to all the programming aspects of DOS. The final two chapters, "Program Building" and "Programming Languages," are worth the price of admission alone. Norton covers the conceptual basics of writing, compiling and interpreting, linking, and executing programs. Especially informative are the discussions of the DOS LINK program and the logical organization of assembly-language programs.

Norton discusses both the IBM Pascal compiler and the generic Microsoft Pascal compiler. He discusses Pascal data formats on the PC and how to work with them, as

(continued)

## BREAKS THE PRICE/PERFORMANCE BARRIER



### WESTERN COMPUTER AT TURBO

#### STANDARD FEATURES:

- IBM PC/AT Compatible with 512K RAM
- Switch Selectable 6 or 8 MHz operation
- Up to 2 Megabytes of RAM on Main board
- One Parallel Port & Clock/Calendar on Main board
- Enhanced PC/AT style keyboard
- Various mass storage and video display options available
- One Year Warranty



### WESTERN COMPUTER PC/XT TURBO

#### STANDARD FEATURES:

- IBM PC/XT Compatible with 256K RAM
- Switch Selectable 4.77 or 8 MHz operation
- Up to 1 Megabyte of RAM on Main board
- Two 360K Floppy disk drives and controller
- 750 x 350 Monochrome graphics controller or IBM CGA compatible controller
- Amber or green display monochrome monitor
- Enhanced IBM PC style keyboard
- Various mass storage, I/O, and Video display option available
- One Year Warranty

**Western Computer**

1381 WARNER AVE.  
WARNER CORPORATE PARK #B, TUSIN, CA 92680  
(714) 259-7755

EUROPEAN HEAD OFFICE  
BELECTRONIC SA, RUE CENTRALE 43  
CH-1880-BEX, SWITZERLAND  
PHONE (025) 631250

TELEX 456 168 ASWERBACK BELE CH.  
IBM PC/XT/AT/CGA are trademarks of IBM corp.

Inquiry 374 for End-Users.  
Inquiry 375 for DEALERS ONLY

## BOOK REVIEWS

well as integers, strings, SETs, and floating-point numbers.

A quote about compiler compatibility illustrates the book's usefulness: "For compatibility reasons, note that version 1 of the compiler has a floating-point format compatible with BASIC, and that version 2 has formats compatible with most other languages."

### VISUAL EFFECTS

Besides the intended audience, the other noticeable difference between this book and *Inside the IBM PC* concerns the writing and editing. Norton has always had a good informational writing style, but *The Programmer's Guide* shows a writer who has improved at his craft. And the design, graphics, and editing of this book are superior to those of the earlier one. Illustrations are used to good effect. Pointing-hand icons are used to refer you to related material elsewhere in the book. Small logos and symbols frequently appear in a second color and differentiate discussions about the different members of the PC family: original PC, PC XT, PCjr, Portable PC, and PC AT. The 14-page index eases specific research. Three appendixes that enhance the already relevant material are entitled "Installable Device Drivers," "Hexadecimal Arithmetic," and "About Characters."

Though I looked for them, I couldn't find any errors of fact. Norton does point out some errors, however, in IBM's own technical documentation.

*The Peter Norton Programmer's Guide* deals primarily with the PC and the PC XT but also discusses some of the hardware and programming concerns of owners of the PCjr, the PC AT, and the IBM Portable PC.

I recommend this guide to PC programmers and to those people who need the technical information. While the prices of technically oriented softcovers have risen, the \$19.95 price of Norton's guide is reasonable considering all the information that's packed into its 400-plus pages. Norton traces his selected territory well, providing helpful references to other PC publications. If you plan on some serious programming using an IBM Personal Computer, this book will be a good companion to ease you through the rough spots.

*Donald Evan Crabb is director of instruction and laboratories at the University of Chicago (Department of Computer Science, Ryerson Hall 163, 1100 East 58th St., Chicago, IL 60637). He is on the review board of InfoWorld.*

### THE COMPUTER CULTURE

Reviewed by Hugh Kenner

The six talks in this book were delivered by six speakers at a symposium that Siena College staged in 1981, and aging for five years has not improved them. University presses have a natural abhorrence of symposia—some won't consider symposium proceedings at all—and once

(continued)

# MARK WILLIAMS' CSD SOURCE DEBUGGER

Those who insist on C compiler performance  
are very big on Mark Williams.

And the compiler is just part of our total C Programming System.

## NEW 3.0 ENHANCEMENTS

These and other powerful utilities now *included* in the C Programming System:

- make: compiles only what's necessary from multiple modules, a powerful programming discipline
- diff: identifies differences between two files
- m4: macroprocessor expression editing and substitution
- egrep: extended pattern search
- MicroEMACS: full screen editor with source

## COMPILER FEATURES

- Runs under MS-DOS
- Full Kernighan & Ritchie C with recent extensions including void and enum
- Register variables for fast, compact code
- Full UNIX™ compatibility and complete libraries
- Large and small memory models
- MS-DOS linker compatibility
- 8087 Support
- One-step compiling
- English error messages
- ROMable code
- Linker, assembler, archiver
- Extensive third party library support

## csd C SOURCE DEBUGGER

- Debugs at C source level without assembly language
- Separate evaluation, source, program and history windows
- Can execute any C expression
- Capabilities of a C interpreter, but runs in real time
- Set trace points on any statement or variable

Mark Williams' C compiler has earned a place in some very big companies for some very good reasons: it proves the benchmarks right with the speed, code density, consistent performance and expert support required in professional development environments.

But a total development tool shouldn't stop with compiling. Or go on and on with extras that add up and up.

Only Mark Williams' C Programming Systems *includes* the csd C Source Debugger with true source level debugging to speed your programming job.

And only Mark Williams' new 3.0 version *includes* utilities like "make" to make quick work of even the largest projects.

From source code to final product, only one takes you all the way: Mark Williams' C Programming System.

All for only \$495. Ask about our 60-day money back guarantee when you call

**1-800-692-1700 to order today.\***

You'll be big on the total C Programming system from Mark Williams, too.



1430 West Wrightwood  
Chicago, Illinois 60614

# Absolutely the Best IBM™ Compatibles!

## Starter System . . . \$395

Case, 135 Watt Power Supply, Enhanced Keyboard, Motherboard, 8 Slots

## Basic System . . . \$795

All the Above PLUS 256K RAM, 1 DS/DD 360K Disk Drive, 1 Serial, 1 Parallel, 1 Game Port and Floppy Disk Controller

## Business System . . . \$995

All the above PLUS RAM expanded to 640K and a second DS/DD 360K Floppy Disk Drive

## Pro System . . . \$1575

All the above PLUS 20 Meg Hard Drive with Controller Card

Ask about other configurations of these fine compatibles. Both of these machines run all major software written for the IBM. All have been thoroughly checked by our techs and have been burned-in for at least 48 hours. Both come with FREE Word Processing Software and limited use Phone Directory Software.



## AT Starter System . \$1875

Case, 190 Watt Power Supply, AT Style Keyboard, 640K Motherboard, 8 Slots, Combination Disk Controller

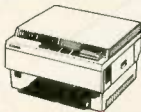

## Laser Beam Printer

Many Advantages over HP, No additional Cost, Quantity Discounts

## IBM Parallel Interface

It can THINK! It's a Diablo 630

4 Resident Fonts  
Downloadable Fonts  
Choose number of copies from keyboard or software  
Best Price . . . \$1995



## A-40 Impact Dot Matrix Printer

Near letter quality 23 x 18 matrix, 140 cps, 3 kinds of Graphic Image, IBM Printer Compatible, Selectable Linfeed, Push Feed Adjustable Tractor, Fanfold Single Sheet & Multipart Copy Paper Usable  
Many More Features . . . Only \$259  
A-50 . . . \$399 A-55 . . . \$550

### New on the Market Exclusive From AB

Now there is no need to lose thousands of dollars trading in your PC or XT to get a faster machine. Many programs run as fast as the AT!!! PLUS - WE BUY YOUR OLD MOTHERBOARD!!!  
KIT A - \$399 KIT B - \$499 KIT C - \$1099

### Attention - PC Owners! DON'T Trade in Your PC or XT TURBO-IZE!!!

Controls 2 Floppy Disk Drives and 2 Hard Disk Drives on a 1/2 card!!! Great for all portable, Tandy, IBM and Compaq owners who need to use a half slot card to maximize their machine capability. USE THAT 1/2 SLOT TO DO TWO JOBS - NO!!!  
1 - \$199 5 - \$189 10 & up - \$180

### CLOSEOUTS

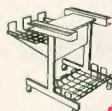

**Universal Printer Stand**  
Less than 200 lbs  
Reg. \$169 **\$99<sup>99</sup>**

**USI Monitor**  
Less than 1000 lbs  
1-19 \$70  
20 & up . \$60

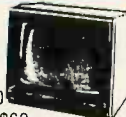

**Famous Manufacturer Daisy Wheel Printer**  
22 cps Uses Diablo Hi-Type Ribbon and Wheel only \$349  
Tractor . . . \$69  
Sheet Feeder . . . \$169



### BUILD YOUR OWN PC

**135 W Power Supply**  
• 4 Drives Power Plugs  
• Side Switch Model like IBM  
1 - \$109 2-3 \$105  
4-10 \$100



**PC Case with Hinged Top**  
Easy, Quick Access, Fits IBM PC/XT Mother Board, Hardware for Mounting 2 - 4 Drives - Quality Case, All Metal  
1 - \$69 2-3 \$68 4-10 \$65

### PC-XT Mother Board IBM™ Fully Compatible

8088 Micro-Processor with 8087 Math Pros Socket, 8 I/O Slots, 256K on Board Memory Assembled & Tested Board & All Components  
1 - \$229 3-4 \$219 4-10 \$200  
Over 10 Call

### Enhanced Keyboard for IBM PC Fully IBM Compatible

Enlarged Return Key & Shift Key LED Indicators on Cap's Lock & Number Keys  
1 - \$89 2-3 \$85  
4-10 \$80



### Add-Ons for IBM™ PC & Compatibles

- Disk Controller Card . . . 59
- Disk I/O Card (2 Ser, Par, Clock & Game) . . . 139
- Parallel Printer Card . . . 35
- Hi-Res Mono Card . . . 79
- Serial Card . . . 35
- Color Graphics Card . . . 89
- Color Card/Parallel Port . . . 119
- Mono Graphic Card/Printer Port . . . 119
- Speaker . . . 4.00
- I/O Plus Card . . . 89
- Game Adapter . . . 25

### ZENITH data systems

#### 2 DS/DD 360K Disk Drive

384 RAM Memory, Am Jer 20 MHz Monitor P13 Built in ROM Diagnostics, 1 Expansion Slot  
CZF-148-42BU . . . **1,350**

#### One Plus 7 Expansion Slots

CZF-158-42BU . . . **1,850**

#### One Plus Hard Disk System,

20 Meg Winning 1/DS/DD 360K 384 RAM Memory, 8 MHz with 7 Expansion Slots  
CZW-158-42BU . . . **2,429**

#### Trans Portable 128K RAM 24.2 lbs.

2 DD 360K Drives  
CZF-138-21 . . . **Call**

### New Advance Technology PC IBM PC/AT Compatible

Single DS/DD 1.2 Meg Disk Drive 512K RAM, Serial Parallel Amber 20 MHz Monitor (P13) Expandability for up to 12 simultaneous users  
CZF-241-81 . . . **Call**

#### Four Plus Hard Disk System

Same as above including 40 Meg Hard Disk  
CZW-241-82BU . . . **Call**

#### Portables 14.3 lbs. 250K RAM

2 Standard DS/DD/360K Drives  
CZ171-42 . . . **Call**

LEASES AVAILABLE! Call for quote; ask for Mr. Morphus.



Use our Toll-Free Order Line,

Mon.-Fri. 9 am - 6 pm EST

**800-822-1211**

In Pennsylvania: 215-822-7727  
252 Bethlehem Pike, Colmar, Penn 18915

## BOOK REVIEWS

*Some pages in The Computer Culture, like the ones covering on-line conferencing, are so archaic they give off an odor of lavender.*

they do decide to move, their production speed can be an order of magnitude slower than the computer culture requires. I'm willing to guess that someone at Fairleigh Dickinson University Press saw "social issues" seeming to be addressed and finally gave a green light on the principle that social issues evolve less quickly than hardware.

The symposium was "part of Siena College's integrated humanities program" (translation: nothing too technical here), and the editor, Denis P. Donnelly, dithers mightily to persuade us that the jargon of social science, of which he is far from being a native speaker, can confer humane generality on something as rinky-dink as "the transistor switch."

Here's a sample: "When changes effect quantitative displacements, they also become agents of qualitative change in a given environment whether one is logging in a forest or waging war on a battlefield, for example." If prose, like Pascal, required writers to declare their variables, a sentence like that would detonate error messages. What it's trying to say is probably something like, "The transistor by its sheer speed has changed everything; so grab your hat and read on."

Like most of the introductory matter, what it's also saying is, "These big themes require big ponderous sentences. We address major issues here. The world we all grew up in slips from our grasp. Accredited themes for worry are well known: big machines, big changes, Big Brother. We'll all be worrying along."

Let me get most of this out of the way quickly. Some pages, like the ones covering a discussion of on-line conferencing, are so archaic they give off an odor of lavender. Elsewhere familiar worries are reinforced. While the computer can model fearfully complex interrelationships, we must beware of assumptions that get built into the model; "We are never free from the potential for misuse." That is something we'd all heard before we came in. Likewise, "We need computer systems and the information they produce, but somehow their limitations must be recognized." Somehow! You could glean as much from any op-ed page.

The first half of the book is about "Artificial Intelligence;" the second half about "Computer Influences in Modern Culture." The former is unexpectedly rich; I'll come to it. The latter does contain one chunk of meat: Alan F. Westin's discussion of privacy, technology, and regulation.

The market, Westin reminds us, "deserves our continued respect" because "much of what could be done by com-

(continued)

# Mark Williams

Now the biggest name  
in C compilers comes in a size  
everybody can afford.

Let's C.™  
\$75

Introducing Mark Williams' \$75 C compiler. Want to explore C programming for the first time? Or just on your own time? Now you can do it in a big way without spending that way. With Let's C.

This is no little beginner's model. Let's C is a powerful programming tool, packed with all the essentials of the famous Mark Williams C Programming System. The one chosen by Intel, DEC, Wang and thousands of professional programmers. The one that wins the benchmarks and the reviewers' praise:

#### Mark Williams Let's C

- For the IBM-PC and MS-DOS
- Fast compact code plus register variables
- Full Kernighan & Ritchie C and extensions
- Full UNIX™ compatibility and complete libraries
- Small memory model
- Many powerful utilities including linker, assembler, archiver, cc one-step compiling, egrep, pr, tail, wc
- MicroEMACS full screen editor with source
- Supported by dozens of third party libraries
- Upgradeable to C Programming System for large scale applications development

Let's C Benchmark Done on an IBM-PC/XT, no 8087.  
Program: Floating Point from BYTE, August, 1983.

#### Exec Time in Seconds

Let's C	134.20
MS 3.0	347.45

*"(This compiler) has the most professional feel of any package we tested..."—BYTE*  
*"Of all the compilers reviewed, (it) would be my first choice for product development."—David W. Smith, PC WORLD*

And now for more big news. Get our revolutionary csd C Source Debugger for just \$75, too. You can breeze through debugging at the C source level ignoring clunky assembler code.

Affordable, powerful, debuggable. Mark Williams Let's C is the big name C compiler at a price you can handle. Get your hands on it now.

Use this coupon or charge by calling toll-free:  
1-800-MWC-1700. In Ill. call 312-472-6659.

**ORDER NOW! 60-DAY MONEY BACK GUARANTEE!**

#### Mark Williams Let's C

Please send me:

\_\_\_\_\_ copies of Let's C and \_\_\_\_\_ copies of csd (C Source Debugger) at \$75 each. (Ill. residents add 7% sales tax.)

Check    Money Order    Visa, MasterCard or American Express

Name \_\_\_\_\_

Address \_\_\_\_\_

City \_\_\_\_\_ State \_\_\_\_\_ Zip \_\_\_\_\_

Card # \_\_\_\_\_ Exp. Date \_\_\_\_\_

Signature \_\_\_\_\_



**Mark  
Williams  
Company**

1430 West Wrightwood Chicago, Illinois 60614 Inquiry 221

# Turbo Pascal Programmers:

## Turbo-Task will make your program resident just like Sidekick!

You only need to add two lines to your source code. One declares Turbo-Task as an external procedure and the other is a call to Turbo-Task. There is only one parameter to pass, the numerical value of the key that will invoke your program. When you call Turbo-Task your program is installed in memory and can then be invoked at any time by pressing the "invoke key." The user can pop in and out of your software at will without disturbing any program in operation. Up to 16 programs can use Turbo-Task at the same time, each with its own invoke key and independent window. Turbo-Task does not interfere with SIDEKICK. Works with TURBO EDITOR and GAMEWORKS.

## Ram-Page changes the Display Buffer Address

Hard to believe, right? But it works. Ram-Page pulls a fast one on Turbo Pascal and changes the value of the display buffer segment. This allows you to make a text page in the heap and then use any of Turbo's text handling procedures just as if you were writing to the screen. Write, Writeln, Clrscr, InLine, DelLine, Gotoxy will be redirected to work on the text page. Ram-View allows you to display any portion of the text page on the screen. This "window" is automatically updated as writes are made to the text page. Ram-Page handles up to 16 pages of any size. 256k of heap can be allocated as 80 chars by 1600 lines! The statement "Gotoxy (1, 1600)" is now a reality.

## Turbo-Linker breaks the 64k Code Segment Barrier

Turbo-Linker performs two important functions: it allows your program to grow beyond 64k, and it eliminates the need to continually recompile debugged routines. Turbo-Linker will convert a set of your procedures into a module that can be loaded into the heap at run time. These procedures will operate in the heap thus freeing space in the code segment for the main program. In effect, it is using the heap for overlays, except these "overlay" modules can be shared by any number of programs. Once you create a module, you never have to recompile it. You can maintain a library of modules of your frequently used procedures. You can load up to 16 modules into a program, each with up to 64 procedures or functions.

All these utilities—ONLY \$70

# Tangent Technologies

180 North Wacker Drive • Suite 350 • Chicago, IL 60606 • (312) 263-0024  
MC/VISA Supports version 3.0 for PC-DOS and MS-DOS  
Turbo Pascal, Turbo Editor, Gameworks and Sidekick are trademarks of Borland Intl.

**NEW LOWER \$**  
**the X-16 gives you**  
**Out of This World Performance**

## PLUS PC COMPATABILITY!

### Features:

- 8 MHz 80186 microprocessor with true 16-bit data bus.
- True PC compatibility with our own custom ROM BIOS and PC cardslots for the video of your choice.
- Standard 512K zero wait DRAM, 640K or 1M options:
- 8087 numeric coprocessor port.
- On-board floppy disk controller for up to four 5 1/4" drives.
- On-board SCSI hard disk controller port.

### Kits

- Not So Bare Board ..... \$250
- Quick Kit ..... \$625
- Full Kit ..... \$795
- Assembled and Tested... \$895
- 128K Add-On ..... \$ 90
- 1/2 MEG Add-On ..... \$240
- XT Style, Flip Top Enclosure ..... \$ 85
- 150 Watt Power Supply .. \$135
- 5 1/4" 48 TPI DS 1/2 Height Floppy Disk Drive ..... \$125

**NEW LOWER PRICES**

**NEW**  
**Total Solutions:**

- Assembled and Tested Systems**
- Mono-Chrome System .. \$1,865  
Includes: 640K, Power Supply, Enclosure, Keyboard, Monitor, Two Drives, and Printer Port.
  - Color System ..... Call
  - Quantity Discounts Upon Request
  - Call For Info on Add-Ons, Hard Disks, Etc.

FOR MORE INFORMATION CONTACT:

**PC TECH**  
P.O. Box 128  
904 North 6th Street  
Lake City, MN 55041  
(612) 345-4555

## BOOK REVIEWS

puters will be done on a large scale in the United States only if someone can make a great deal of money from it or if the government is willing to pay for it." Most of the Big Brother talk we've heard implies "awesomely expensive" implementation, and "Information is a power resource that nobody gives freely."

In fact, "We can . . . often give greater protection to information in a computer system than in the highly decentralized, leaky manual-record era." No, Westin's not sanguine, but "as long as we keep on struggling, pointing out the potential abuses . . . we will not be caught unaware." He discerns "an interesting marriage between the liberal political and the strong conservative viewpoints on limiting information abuse" and he's right.

That is one rewarding stretch in this book, and the other is the AI section. MIT's Marvin Minsky and Yale's Roger C. Schank set up a discussion that never gets off the ground because on page 79, "Influences in Modern Culture" drearily takes over. I don't downplay Minsky if I call Schank especially interesting. Minsky's format didn't allow him to canvass particulars the way Schank's did, and Schank gives as lucid an account of his script-recognition work as you'll find anywhere.

How does a program work its way through a story so effectively it can answer questions the story leaves implicit? By translating downward into a more general language with, for instance, just 11 "verbs." "Eleven primitive actions can express *all* human activities that there are in the world." A fascinating claim, and we're shown the list.

Schank is saying that if we stay inside a system of words we can hope to generate whatever additional words may be required to pass Turing's test. (Turing's test implied that a machine might as well be called "intelligent" if a questioner couldn't tell it wasn't.) In a "Postscript" the Siena audience apparently never heard, Skidmore's Warren Hockenos denies that radically. You cannot, he implies, reduce "meaning" by altering strings of tokens to other strings of tokens; "meaning" implies an intending intelligence. When I say "horse" I assert my perception of a horse, "real" perhaps or hallucinatory perhaps, but somehow perceived, by me, and that matters.

How it matters we might have learned if Schank had answered, but as far as I can tell they never heard each other. That's the major botched opportunity in a botched book.

*Hugh Kenner is a professor of English at Johns Hopkins University (Baltimore, MD 21218).*

## MICROSOFT MACINATIONS

Reviewed by Scott L. Norman

**M**icrosoft *Macinations* is an excellent self-teaching guide to Microsoft BASIC as implemented on the Macintosh. Mitchell Waite, Robert Lafore, and Ira Lansing have

(continued)



**\$14.95**  
SUGGESTED  
RETAIL PRICE

A NEW SOLUTION from  
MicroComputer Accessories, Inc.

# OPEN AND SHUT CASE.



## LOCKING 50 DISK + 4 FILE

Holmes, it's criminal—these "sloppy disks" all over the desk! How can we keep them secure and dust-free and still have access to the active ones?

Mystery solved, Watson. This new 50 + 4 Locking Disk File provides a locking, smoked plastic enclosure for up to 50 5¼" diskettes, *plus* an open, up-front, instant access, swap-rack for 4 diskettes. Let me call your attention to the built-in handle, and the adjustable dividers with adhesive labels. Note the rear storage pocket for extra labels.

By Jove, Holmes, open and shut simultaneously! It's perfect for those powerful integrated, multi-disks systems—and no one's thought of it before! Holmes, you never cease to amaze me.

Elementary, my dear Watson.

MicroComputer Accessories, Inc. 



Open—swap-rack for 4

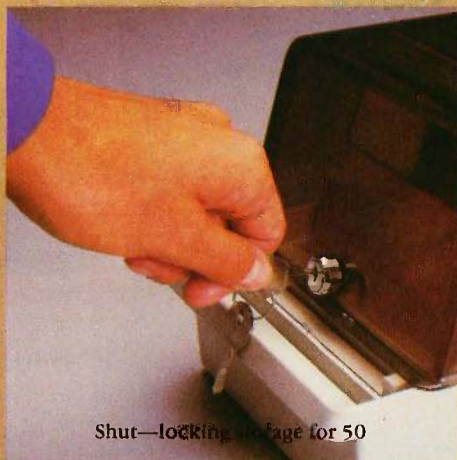

Shut—locking storage for 50



Built-in carry handle

USA: P.O. Box 3725, Culver City, CA 90231. Telephone 213/641-1800. EUROPE: Rue de Florence 37, 1050 Bruxelles, Belgique. Telephone 02/538.61.73.

Inquiry 235 for End-Users. Inquiry 236 for DEALERS ONLY.

MARCH 1986 • BYTE 63

# VIP SERVICE



If you're a serious PC user, you know that even the finest personal computer products can develop problems. When that happens, Micro Mart customers know they can trust us to get them on-line again.

We have the largest in-house service department in the Southeast. Our experienced

technicians offer the fast, reliable service that business needs. Plus expert advice and information to help you select the right PC options from our \$15 million inventory.

Micro Mart service and support. For some very important people. Our customers. Call us today.

## COMPUTERS

AT&T Color and Mono Systems in stock Start at \$1795

## MULTIFUNCTION BOARDS

We have a complete line of Multi-function Boards compatible with the Portable, XT/AT.  
**SIX PAK 64-384K**, multifunc. \_\_\_\_\_  
**1/0 MINNIE 1/0** shortboard for Portable & AT New low Price!  
**ADVANTAGE 128K-3Mb**, expansion for AT \_\_\_\_\_  
**RAMPAGE 64K-2Mb** NEW!  
**QUADRAM QUADBOARD** Loaded, 384K CALL!  
**QUADRAM GOLDBOARD**, 384K \$459  
**TECMAR CAPTAIN 0-384K**, multifunc \$175  
**TALLTREE J-RAM II** CALL!

## GRAPHIC CARDS

**HERCULES Mono & Color** Graphics cards New Low Price!  
**TECMAR Graphics Master, HiRes Color & Mono** supports Lotus \$449  
**QUADRAM Quadcolor I & II** color cards \_\_\_\_\_  
**PARADISE Multi-display** or modular graphics cards From \$199  
**STB Chauffeur & EGA Plus** From \$289  
**SIGMA Color 400** for PGS SR-12 New Low Price!

## FLOPPY DISK DRIVES

**TANDON TM 100-2, DD/DS, 360K** New low, low price!  
**1/2 HEIGHT Disk Drives** from Shugart, Mitsubishi, TEAC and Toshiba.  
**PC, XT & AT Compatible** From \$99  
**BEST SUPPLY ON EAST COAST**

## HARD DISCS

**IRWIN/TANDBERG Tape back-up systems** From \$495  
**SEAGATE Fast 10, 20, 30, and 75 Meg.** for PC & AT CALL!  
**RODIME Hard Discs in Stock** CALL!  
**SYSGEN Complete line** Call for our special Sysgen pricing!  
**BERNOULLI TECHNOLOGY Hard disc Subsystems** From \$2875  
**PRIAM Superfast 40 & 60 Meg.** for AT Call!  
**INTERDYNE 10 mg.** Reel to Reel Tape Back-up \$439  
**Best availability of voice coil and stepper motor hard drives** with highest quality controllers From \$495

## SOFTWARE

### ACCOUNTING, SPREADSHEETS & INTEGRATED PACKAGES

**SORCIM/IUS Complete line** including Windows From \$295/each  
**SORCIM SuperCalc 3**, vers. 2.0 New Low Price!

### ENHANCEMENTS & UTILITIES

**FOX & GELLER Complete line** for dBase II/III, RBase 4000  
**NORTON Utilities 3.0** \$69  
**ROSESOFT ProKey 3.0** \$89  
**CENTRAL POINT SOFTWARE Copy II PC** \$35  
**SOFTSTYLE Set FX+** and Printworks, printer control  
**SIDEWAYS Inverts printout** \$51  
**BORLAND SideKick** and SuperKey From \$40  
**BORLAND Lightning** and Reflex New! Call!

### COMPILERS & LANGUAGE TOOLS

**LATTICE C-Compilers** \$279  
**MICROSOFT Complete line** \_\_\_\_\_  
**MICROSOFT QuickBasic** New Low price!  
**BORLAND Turbo Pascal, Turbo Toolbox & more** From \$35/each

### GRAPHICS

**Z-SOFT PC Paintbrush**, mouse graphics \$95  
**DECISION RESOURCES ChartMaster** Latest Version, CALL!  
**MICROSOFT Chart** CALL!  
**MICROSOFT Windows** CALL!

### COMMUNICATIONS

**MICROSTUF Crosstalk XVI**, Latest version \$99  
**HAYES Smartcom II** \$85

### WORD PROCESSING

**MULTIMATE w/spelling checker & tutorial** New Low Price!  
**SAMNA+** \$369  
**MICROSOFT Word**, New version New Low Price!  
**LIFETREE Volkswriter Deluxe** \$169  
**SSI WordPerfect**, version 4.1 New Low Price, CALL!  
**MICROPRO WordStar Professional series** New Low Price!

### OFFICE & PROJECT PLANNING

**HARVARD Total Project Manager** \$339  
**SORCIM/IUS Super Project** \$199  
**MICROSOFT Project** \$175

### DATA BASE MANAGERS

Call for unadvertised Data Base Managers  
**MICRORIM 5000**, Report Writer & Clout New Low Price!  
**WARNER SOFTWARE The Desk Organizer** \$145  
**MICROSTUF Infoscope** \$99

## NETWORKING/ PROTOCOL CONVERSION

**SNA & BISYNC 3780, 5251, Mod 11 & 12, 3274, 3278**  
**PC TURBO 186/187 board, 128K, 8087 Serial Board attached** \$875  
**IRMA Complete line** From \$849

## PRINTERS

We have thousands in stock.  
**DOT MATRIX**  
**EPSON FX85/286** NEW!  
**EPSON LQ1500/LQ800/LQ1000** New Prices!  
**OKIDATA 192 & 193, ML84, Pacemark 2410**  
**TOSHIBA P-341, P-351 & 1340** New Low Prices!  
**NEC New P-5, P-6 & P-7** Low Price!

### LETTER QUALITY

**NEC Spinwriters 2050, 3550, 8850** New Low Prices!  
**EPSON DX20 & DX35** New Letter Quality Printers!

### CHIPS

All our chips are tested and priced for quick sale. Call us!  
**INTEL 8087, 80287**, high speed coproc Call for Market Price.  
**64K-256K RAMCHIPS** Call for Market Price.  
**128K Piggy-back chips** for your AT Call for Market Price.

## MODEMS

**HAYES Smartmodem 300, 1200, 1200B & 2400**. We have the best stock in the USA Call!  
**VEN-TEL 1200 Baud Half Card w/Crosstalk** \$399  
**PEACHTREE TECHNOLOGIES P-1200 ext.** \$279

## MISCELLANEOUS

**MAXELL Diskettes** \$25  
**DYSAN Diskettes** at the lowest price in the USA Call!  
**MOUSE SYSTEMS PC Mouse**, optical w/software \$139  
**MICROSOFT Mouse**, bus or serial mechanical New model in stock!  
**KEYTRONICS 5151** keyboards CALL!  
**KEYTRONICS 5153 Keyboard** with mouse NEW!  
**KENSINGTON MICROWARE MasterPiece** \$99  
**CURTIS Accessories, Pedestals, cables, etc.** \_\_\_\_\_  
**GRAVIS Joysticks** \$45  
**QUADRAM Microfazer print buffer 8-128K** From \$129  
**TRIPPELITE ISOBAR surge protectors, 4 & 8 plug** From \$49  
**POLAROID Palette** \$1245

## MONITORS AND CRTS

**PGS Max12 (E), HX12, HX12(E), & SR-12** New Low Prices!  
**AMDEK Color 600** CALL!  
**AMDEK 722**, New alternative to IBM enhanced monitor \$569  
**AMDEK 300A/300G/310A** \$129/\$119/\$165

© Copyright 1986, Micro Mart, Inc. Technology Corporate Campus 3159 Campus Drive Norcross, Georgia 30071

Prices are subject to change without notice and are similar, but may vary at over 20 Micro Mart Retail Stores.

Leasing and financing options are available. MasterCard/VISA or ask for Micro Mart Blue Chip Credit.



(404) 449-8089

Orders only

1-800-241-8149

BT 3/86



America's PC Specialist

**CALL BTE COMPUTERS, INC. CALL**

SUPER DISCOUNT WHOLESALER

IBM XT 512K FLOPPY	\$1988	ZENITH 148	\$1098
IBM XT 512K 20 MEG HD	\$2488	ZENITH 158	\$1598
IBM AT 512K FLOPPY	\$3288	ZENITH 177	\$1988
IBM AT 512K FLOPPY 20 MEG HD	\$3788	ZENITH 200 AT	\$1888
512K (0K) MEMORY CARD	\$ 48	20 MEG SEAGATE HD	\$ 488
384K (0K) XT MLTIFCT CARD	\$ 98	10 MEG IRWIN TAPE	
COLOR GRAPHICS CARD	\$ 78	BACK-UP	\$ 468

MONITORS		PRINTERS	
AMDEK COLOR 600	\$388	CITIZEN MSP10	\$248
SONY IBM HI RES COLOR	\$488	EPSON FX85	\$368
TAXAN IBM HI RES COLOR	\$395	OKIDATA 182	\$216
ZENITH AMBER TTL	\$159	IBM PRINTER CABLE (HI QUALITY)	\$ 15
RF MODULATOR IBM OR APPLE	\$9.99	APPLE 2i or 2e CABLE	\$ 15
OTHER PRICES	CALL	OTHER PRICES	CALL

**INTRODUCING THE NEW SUPER SPC XT PORTABLE**  
 FITS ANY IBM PC, XT or APPLE II+, IIE or AT  
 COMPATIBLE MOTHER BOARDS

- KIT INCLUDES:**
- TTL or COMPOSITE (AMBER GREEN)
  - 3 DISK DRIVE SLOTS
  - HARDWARE RESET
  - POWER ON INDICATOR
  - KEYED POWER SWITCH
  - AUTOMATIC BRIGHTNESS CONTROL
  - EASY TO ASSEMBLE
- INCLUDES:**
- 9" HIGH RES MONITOR
  - 135 W SWITCHING POWER SUPPLY
  - KEYBOARD
  - ABS CASE, ACCESSORIES, MOUNTING HARDWARE, ASSEMBLY MANUAL
  - UP TO 6 EXPANSION SLOTS

- ASSEMBLED AND TESTED**
- SPC XT 256K FLOPPY MONO ..... \$ 999
  - SPC XT 256K FLOPPY
  - 10 MEG HD ..... \$1499
  - SPC XT 256K FLOPPY 10 MEG HD
  - 10 MEG TAPE BACK-UP ..... \$1999

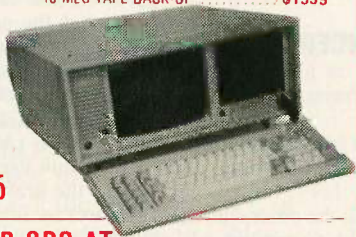

ONLY **\$695**

**SUPER SPC AT**  
**TOTALLY IBM AT HARDWARE & SOFTWARE COMPATIBLE**

- |                              |       |
|------------------------------|-------|
| MOTHER BOARD                 |       |
| 80286 MICROPROCESSOR         | \$ 89 |
| 80287 COPROCESSOR (OPTIONAL) | \$ 89 |
| 512K STANDARD MEMORY         |       |
| 8 I/O EXPANSION SLOTS (OK)   |       |
| ONLY                         | \$999 |
- SUPER AT KEYBOARD ..... \$ 89
  - SUPER AT CASE ..... \$ 89
  - SUPER AT 200 WATT POWER SUPPLY ..... \$149
  - 2.5M MULTI-FUNCTION CARD (OK) ..... \$229

**SUPER COMPATIBLE PC/XT MOTHERBOARD**  
 HARDWARE & SOFTWARE

- 256K TOTALLY IBM XT COMPATIBLE
- ONLY ..... \$149
- MONOCHROME GRAPHIC PRINTER CARD ..... \$ 88
- MULTI-I/O CARD ..... \$128
- PARALLEL PRINTER CARD ..... \$ 28
- SERIAL CARD ..... \$ 28
- GAME PORT ADAPTER ..... \$ 28
- EPROM WRITER CARD ..... \$109



**NEW SHORT COLOR & MONOCHROME GRAPHICS CARD**

COMPOSITE OUTPUT PORT TTL OUTPUT PORT MONOCHROME GRAPHICS TO COLOR GRAPHICS COLOR GRAPHICS TO MONOCHROME GRAPHICS - 1'S PROCESSOR MANUAL AND SOFTWARE INCLUDED

**\$158**

**APPLE COMPATIBLE PRODUCTS**

- |  |       |                                      |       |
|--|-------|--------------------------------------|-------|
| APPLE IIe COMPATIBLE MOTHER BOARD        | \$238 | EPROM WRITER CARD                    | \$58  |
| APPLE IIe COMPATIBLE 90 COLUMN CARD      | \$48  | 2 1/2" CP/M CARD                     | \$38  |
| APPLE IIe REPLACEMENT NUMERICAL KEYBOARD | \$58  | GRAPHIC COMPATIBLE PRINTER CARD      | \$39  |
| APPLE IIe REPLACEMENT NUMERICAL CASE     | \$58  | PRINTER CABLES                       | \$13  |
| POWER SUPPLY REPLACEMENT (IIe or IIx)    | \$39  | 80 COLUMN CARD FOR IIe               | \$42  |
| APPLE IIe DETACHABLE KEYBOARD            | \$99  | DISK CONTROLLER CARD                 | \$29  |
| W/KEYPAD                                 | \$189 | 16K MEMORY LANGUAGE CARD             | \$29  |
| APPLE IIe COMPATIBLE MOTHER BOARD        | \$38  | EPSON TYPE PRINTER CARD              | \$19  |
| APPLE IIe REPLACEMENT CASE               | \$48  | JOYSTICK                             | \$19  |
| APPLE IIe REPLACEMENT KEYBOARD           | \$59  | FANCY JOYSTICK                       | \$19  |
| APPLE IIe FUNCTION & NUM KEYBOARD        | \$79  | HALF HEIGHT DISK DRIVES (IIe or IIx) | \$110 |
| APPLE IIe DETACHABLE KEYBOARD            |       | HC DRIVES                            | \$138 |
|  |       | SUPER FANS FOR APPLE IIe or IIx      | \$27  |

- 70 DISK FLOPPY FILE W/LOCK ..... \$8.88
- 85 DISK FLOPPY FILE W/LOCK ..... \$9.99

**2e EXTERNAL KEYBOARD**

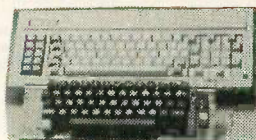

**2e INTERNAL KEYBOARD**

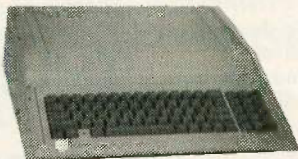

**2e W/KEYPAD**

MAIL TO BTE, Inc.

P.O. BOX 30705C • PHOENIX, AZ 85046-0705 • PHONE (602) 867-8962

MASTER CHARGE, VISA, ARE WELCOME. \$5.00 MINIMUM SHIPPING & HANDLING. NOT RESPONSIBLE FOR TYPOGRAPHICAL ERRORS. ALL PRODUCTS SUBJECT TO AVAILABILITY OR STOCK ON HAND. ALL PRICES ARE SUBJECT TO CHANGE WITHOUT NOTICE! ALL SALES ARE CASH DISCOUNT PRICES! REFUNDS ARE CREDITED ONLY.

BOOK REVIEWS

*The authors use a simple program fragment to introduce a major topic, then build upon it by describing how to add more polished options.*

the reader with code that can be used to add menus to BASIC programs. Like the commercial variety, user-written menus can include such niceties as check marks to indicate the last selection made and dimmed lettering for selections that are unavailable at a particular point.

The step-by-step approach is characteristic of this part of the book. The authors use a simple program fragment to introduce a major topic, then build upon it by describing how to add more polished options. The attentive reader can wind up with the beginnings of a nice library of core routines for civilized programming.

The book then covers video "buttons" activated with a mouse click. There are three types: push buttons, which make things happen immediately, and radio buttons and check boxes, both of which can be used to make selections that will influence some subsequent action. The DIALOG function is introduced as the means of determining which button, if any, has been "clicked."

Windows, dialog boxes, and edit fields (like the filename box in the "Save As..." window) are covered at length. The versatile DIALOG gets a major workout here. The reader can learn how to set up dialog boxes that will accept either the clicking of a "Save" button or the pressing of the Enter key on the Mac's keyboard to record data in an edit field; another example of using built-in routines to add polish to your own code.

**QUICKDRAW**

The most publicized of the Mac's ROM resources is probably the QuickDraw family of graphics routines, reached from BASIC with a CALL statement. The authors contrast QuickDraw with LINE, CIRCLE, and similar functions of other Microsoft BASICs.

The concept of QuickDraw's pen metaphor for drawing leads to other topics: functions for drawing lines and changing the size and pattern of the pen itself. This in turn brings up the idea of representing an 8 by 8 arrangement of pixels (the pen pattern) as an array of hexadecimal numbers for storage in the Mac's memory. There is even a BASIC program, Pattern Editor, with which you can create a pattern in a FatBits-like window; the program then generates the associated integers. In one of the book's few miscues, the backslash symbol for integer division is used in this program without ever being defined in the text.

The final topics in the chapter include the PENMODE

(continued)

# Finally!

# File Names That Make Sense!



**PCEASY**™ Organizes Your Files, Simplifies DOS, and Speeds Up Your PC

Every time you face the maze of 8 character file names in your computer you probably wonder why there isn't a better way. At TranSec Systems we felt the same way. So we developed a better file management program for our own use and after using this new program we knew every PC should have it.

**The Heart of PCEasy.** The heart of the PCEasy system is its expanded 32 character capability to name your files. Thus you can use easily remembered names, plain words, -- even dates -- to name your files. You can also name file "folders" to place reports, letters, spreadsheets, programs or whatever in their own logical, easy to find place.

With PCEasy you can forget those half forgotten or cryptic file names. And to keep it easy, you don't have to type the name again and again to access the file. All you have to do is select the file you want and PCEasy finds it for you -- fast!

PCEasy file names work with most of the popular application programs such as Lotus 1-2-3™, Symphony™, dBase III™, and Framework™. In fact, PCEasy works with nearly any program because it translates PCEasy file names to standard DOS file names for your program application -- automatically!

PCEasy makes your work easier in other ways, too. PCEasy features quick, easy menu access to your application programs and DOS operating commands. You just select the function you want and PCEasy does the rest for you.

**PCEasy Makes Your Computer Work Faster Too.** We've added some other features we think you'll like. Commands are performed faster and DOS runs faster and more efficiently. We've even added an expanded "type ahead" buffer to keep the system speedy.

**PCEasy Makes Your Work Easier, and is Easy To Use.** You can use PCEasy without learning a lot of new, complicated commands and extra keystrokes. PCEasy actually prompts you through DOS commands and on-line help is always available.

PCEasy works with any IBM PC, XT, AT or compatible computers. DOS 2.1 or higher and 256K or larger is required.

Not Copy Protected



STANDARD DOS SCREEN

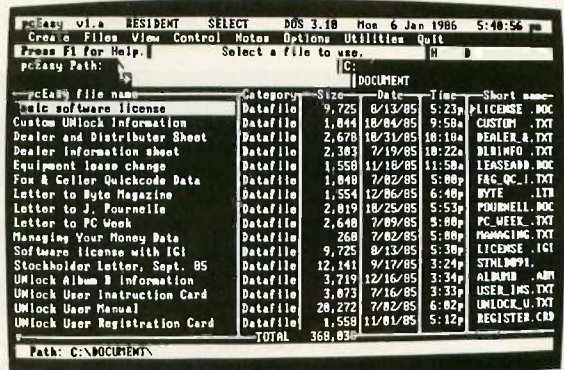

PC EASY FILES MENU



PC EASY PROGRAM MENU

The company that brought you UnLock™ to remove copy protection



TranSec Systems, Inc.  
1802-200 North University Drive  
Plantation, FL 33322  
**DEALER AND VAR INQUIRIES INVITED**  
Trademarks are the sole property of their respective owners

**Special Introductory Offer!**

Save 15% Off the Regular Price  
of \$74.95 for **PCEASY**™

**Call Today to Order Your Copy**  
**(305) 474-7548**

Only \$63.50 (For a Limited Time Only)

Please Add \$5.00 Shipping and Handling  
(Foreign Orders \$15.00)

Use your or



# So you can't get Toshiba Printer Accessories, Bunkie?

Any time (24 hours) grab your VISA or MasterCard  
**JUST CALL 800/854-0561 EXT 837**  
 IN CALIFORNIA CALL 800/432-7257 EXT 837

### Type Font Cartridge: P351, P341, P321

### Type Font Disks (Downloadable)

- T/FC011 \$69  
**Bold Face Letter Gothic**
- T/FC012 \$69  
**Elite Italic Gothic 15**
- T/FC013 \$69  
**Greek/Math I** Α Ω Ψ Φ Θ Λ Π Σ Ξ Ω Α Π Ι
- T/FC014 \$69  
**Greek/Math II** ! " # \$ % & A B Γ Δ Ε Ζ Ζ
- Sci Pi I 0 + \* - / { } ( ) [ ] < > =
- T/FC015 \$69  
**ORATOR1 Orator2**
- T/FC016 \$69  
**OutLine1 Script**
- T/FC017 \$69  
**Theme Litalic**
- T/FC018 \$69  
**Bitatitcl OCR-B**

- G/FD051 \$50: Sci 4, Sci 5, Sci 124, Sci 125
- G/FD052 \$25: Miniset
- G/FD053 \$30: Maxiset
- T/FD016 \$69: T Origin 2, L Gothic 2, B Italic 1, Gothic 15, E Italic 1
- T/FD011 \$49: T Origin 2, L Gothic 2, B Italic 1
- T/FD014 \$49: Orator 1, Orator 2, Outline 1
- T/FD015 \$49: Theme, Script, L Italic
- T/FD013 \$69: Greek/Math 1, Greek Math II: APL 1, Sci Pi 1
- T/FD021 \$49: Micro 1, Italic 1, Italic 2
- T/FD031 \$35: Courier, Graph 10, Elite, Graph 12
- F/FD001 \$95: Micro 1, Copper 1, Italic 1, Italic 2, Zip 1, Micro 20, Science 1
- F/FD002 \$95: Boss 1, D Gothic 1, C Italic 1, G Italic 1, Fathead 1, Gothic 15, Greek 1
- F/FD003 \$95: Courier 1, L Gothic 1, Orator 1, Script 1, Italic 17, Symbol 12, Hebrew 1
- F/FD004 \$95: Roman 1, Elite Italic, OCR-A, OCR-B, Prestige Pica, Greek 2, Micro 15

### P351 Dual Emulation Kit

T/DE 351 \$99: Upgrade early model P351 to add IBM Graphics Printer emulation.

Upgrade your early model P351 printer to add IBM Graphics Printer emulation. Complete instructions included.

### Ribbon for 3-in-One Printers

T/RO01 \$12: Ribbon for 3-in-One Printers

### Start-Up Kit

T/SK \$99: Sample kit containing Type Font Cartridge, Type Font Disk, Printer Ribbon, Data Disk and much, much more.

### PRINTER ACCESSORIES

\$4.75 shipping and handling will be added to each order. 6% sales tax added to California orders. Send for free catalog of accessories, manuals, printer enclosures and much more.

**DIRECT INC. / P.O. BOX 19608-347, IRVINE, CA 92713/714-832-7312**

## Anyone mastering all this material could possibly write a BASIC version of MacPaint.

statement and the ways in which its eight modes affect the relationship between the pixels of the pen and pattern and the background, and the use of QuickDraw's built-in routines for drawing rectangles, round-corner rectangles, and ovals. Anyone mastering all this material could possibly write a BASIC version of MacPaint as a final exercise.

Microsoft Macinations returns to more conventional topics with a discussion of sequential and random-access disk files. First, the reader is gently led through the commands for opening, closing, writing to, and reading from a sequential file. Next come the useful Mac-specific functions FILE\$(0) and FILE\$(1). The former sets up a dialog box for saving a file, complete with prompting message and push buttons. FILE\$(1), on the other hand, allows you to select the name of an existing disk file from a scrolling dialog box. There is a brief discussion of file-type identifiers and their use in restricting the names that appear in the box.

The coverage of sequential files ends with a little program that creates a simple employee file and calculates total pay from pay rate and hours worked. The same topic is used as an example in the discussion of random-access files. This portion of the book includes a nice treatment of the necessary conversion of numeric variables to character strings before they can be written to a random-access file. The use of index tables for finding your way around a file is touched upon; no sample programs are developed, however.

The last two chapters cover animation and multivoice sound—possibly as rewards for mastering the material on files. The GET and PUT statements, which together with PSET and PRESET form the basics of animation, are introduced. The authors present a convenient form of the equation for computing the size of the one-dimensional array needed to store image points. They also explain the use of a two-dimensional array for storing multiple images for animation. The final topic in the animation chapter is interfacing with MacPaint—that is, importing images through the Clipboard. That is as close as the book comes to discussing the Mac's generalized device I/O.

Multivoice sound depends on two commands: SOUND and WAVE. The final chapter of Microsoft Macinations deals with them. Here you can find the details of how to set up a data array to simulate the equal-tempered scale. There are numerous routines for adding sound effects to games, programming music chords, and experimenting with nonsinusoidal waveforms. The last program is a rather elaborate waveform tester that allows you to experiment

(continued)

**OEM DESIGN/DEALERS WELCOME!! ALPHA CONCORD**

**99% Hayes compatible 300/1200 MODEM**

- Auto dial, auto answer (tone or pulse)
- 8 status indicators & switch selectable
- Auto speed selection (0-300, 1200 bps)
- Speaker with volume control
- Aluminum case, w/adaptor

**7 Days Money Back Guarantee (except handling \$15)**

**6 MONTH WARRANTY** ONLY★ **\$139**

**SEMI-ASSEMBLED** Modern board completely assembled, & guaranteed. 5 minutes assembly.

**MODEM KIT ★★ \$110** **103/212A \$129**



**PC/XT 1200 bps INTERNAL MODEM \$125**

Add 5% Shipping Charge

**NEW!! Make PC/XT/Compatible run 30% to 50% faster 4.77/6.77 Mhz switchable. Easy to install. \$29.95**

**BUILD YOUR PORTABLE XT/AT XT PORTABLE \$399**

(Price includes only case, full size keyboard, 9" monitor, 130 watt power supply.) (Fit mega/XT/AT m-board & standard cards.)



Add 10% Shipping

Size, weight & look like Compaq.

**CONCORD Technology Ltd.**  
 47 W. Broadway, Van., B.C. Canada V5Y 1P1  
 Ph. (604) 879-3555 or (604) 879-7419

Replacement & 99% Compatible  
**AT COMPATIBLE MOTHERBOARD**



**\$750**  
Bareboard \$Call

**XT or APPL IIe MOTHERBOARD \$155 each**

tested guaranteed 99% compatible

Color card \$70  
Control card \$45

**FACTORY PRICES ON AT/XT or IIe cases, cards, keyboards (minimum 25) \$Call**

# THE PROFESSIONAL'S CHOICE

<b>NEW</b> Lotus 1-2-3 <b>\$319</b>	<b>NEW</b> Lotus Symphony <b>\$439</b>	dBase III <b>\$369</b>	FrameWork II <b>\$369</b>	MultiMate <b>\$219</b>	<b>NEW</b> Word Perfect 4.1 <b>\$209</b>
--	---	---------------------------	------------------------------	---------------------------	---

## Software

<b>Word Processing Editors</b> FANCY FONT \$139 FINAL WORD \$179 MICROSOFT WORD \$219 MULTIMATE \$219 ADVANTAGE \$269 OFFICE WRITER/ SPELLER \$239 PFS: WRITE \$ 89 SAMNA WORD III \$259 VOLKSWRITER DELUXE \$159 VOLKSWRITER SCIENTIFIC \$269 WORD PERFECT 4.1 \$209 WORDSTAR \$189 WORDSTAR 2000 \$249 WORDSTAR 2000+ \$259 XYWRITE II- \$189  <b>Database Systems</b> ALPHA DATA BASE MANAGER II \$179 CLIPPER \$389 CLOUT V 2.0 \$139 CONDO III \$329 CORNERSTONE \$279 DBASE III \$369 KNOWLEDGEMAN 2 \$329 PARADOX \$Call PC FOCUS \$1139 PFS: FILE/PFS: REPORT \$169 POWERBASE \$219 QUICKCODE III \$159 QUICKREPORT \$159 R BASE 5000 \$359 REFLEX \$ 79 REVELATION \$629  <b>Spreadsheets/Integrated Packages</b> ELECTRIC DESK \$209 ENABLE \$349 FRAMEWORK II \$389 JAZZ \$399 LOTUS 1-2-3 \$319 MULTIPLAN \$135 OPEN ACCESS \$359 SMART SYSTEM \$529 SPREADSHEET AUDITOR \$109 SUPERCALC 3 \$209 SYMPHONY \$439	<b>Graphics</b> BPS BUSINESS GRAPHICS \$229 CHARTMASTER \$219 CHARTSTAR \$169 DIAGRAM MASTER \$215 EXECUVISION \$249 ENERGRAPHICS \$189 FREELANCE \$239 GEM DRAW \$ 95 GRAPHWRITER COMBO \$339 IN-A-VISION \$319 MS CHART-NEW \$189 OVERHEAD EXPRESS \$109 PC DRAW \$249 PC PAINTBRUSH \$ 89 PFS: GRAPH \$ 89 SIGNMASTER \$159  <b>Project Management</b> HARVARD TOTAL PROJECT MANAGER \$279 MICROSOFT PROJECT-NEW \$249 PROJECT SCHEDULER NETWORK \$339 SUPERPROJECT \$209 TIMELINE 2.0 \$289  <b>Desktop Environments</b> DESK ORGANIZER \$ 69 GEM DESKTOP \$ 39 SIDEKICK \$ 38  <b>Communications/Productivity Tools</b> CROSSTALK \$ 99 CROSSTALK MKIV \$149 PROKEY \$ 89 KEYWORKS \$ 59 RELAY GOLD \$Call REMOTE \$119 SMARTERM \$Call SMARTCOM II \$ 99 SUPERKEY \$ 55  <b>Statistics</b> SPSS/PC \$685 STATPAK-NWA \$329 STAPAC-WALONICK \$349 SYSTAT \$419  <b>Professional Development</b> LIGHTYEAR \$319 THINK TANK \$109	<b>Languages/Utilities</b> CONCURRENT DOS \$189 C86 C COMPILER \$289 DR FORTRAN 77 \$219 FASTBACK \$119 LATTICE C COMPILER \$289 MARK WILLIAMS C \$319 MICROSOFT C COMPILER \$249 MS BASIC COMPILER \$249 MS FORTRAN \$229 NORTON UTILITIES \$ 59 QUICK BASIC \$ 79 TURBO PASCAL \$ 49 XENIX \$Call  <b>Accounting</b> BPI \$299 GREAT PLAINS \$479 IUS EASYBUSINESS \$319 ONE WRITE PLUS \$179 OPEN SYSTEMS \$359 PEACHTREE \$289 REAL WORLD \$369 STAR ACCOUNTING PARTNER \$249 STAR ACCOUNTING PARTNER II \$529	<b>Multifunction Boards</b> AST ADVANTAGE \$389 AST 6 PAK PLUS (64K) \$229 AST 6 PAK PLUS (384K) \$249 GOLD QUADBOARD (OK) \$419 ORCHID BLOSSOM (OK) \$199 ORCHID BLOSSOM (384K) \$249 ORCHID PC TURBO (256K) \$699 PERSYST TIME SPECTRUM (OK) \$199 PERSYST TIME SPECTRUM (384K) \$249 QUADBOARD (OK) \$189 QUADBOARD (384K) \$219 SILVER QUADBOARD (OK) \$219 TECMAR CAPTAIN (OK) \$189 TECMAR CAPTAIN (384K) \$229 TECMAR JR CAPTAIN (128K) \$289 TECMAR WAVE (64K) \$209  <b>Emulation Boards</b> AST 5251-11 \$599 AST 5251-12 \$549 AST 85C \$489 AST 85A \$599 CXI 3278/9 Plus \$959 IRMA \$799 IRMALINE \$989  <b>Networks</b> AST PC NET \$Call CORVUS NET \$Call ORCHID PC NET \$Call 3 COM \$Call  <b>Mass Storage/Backup</b> EXCEL STREAM 60 TAPE (INT) \$699 IOMEGA BERNOULLI BOX-NEW! \$2445 IRWIN 310A 10MB TAPE (EXT) \$850 IRWIN 110D 10MB TAPE (INT) \$499 MAYNSTREAM 60MB TAPE (INT) \$1199 MOUNTAIN DRIVECARD 10MB \$789 TALLGRASS \$Call TECMAR QIC-60AT TAPE (INT) \$1199	<b>Monitors</b> AMDEK 310A \$169 AMDEK 300/500 \$249/349 AMDEK 600/710 \$449/489 PRINCETON HX-12 \$459 PRINCETON MAX-12E \$179 PRINCETON SR-12 \$579 PRINCETON HX-12E \$559 PRINCETON HX-9 \$529 TAXAN 122 AMBER \$159 TAXAN 630/640 \$469/539  <b>Modems</b> AST REACH 1200 \$389 HAYES 1200 \$389 HAYES 1200B \$349 HAYES 2400 \$579 TRANSNET 1000 \$299 VENTEL 1200 HALF CARD \$369 WATSON \$489  <b>Printers/Plotters</b> BROTHER TWINWRITER \$939 DIABLO \$Call EPSON FX-85 \$369 EPSON FX-185 \$499 EPSON LQ-1500 \$999 HP 7475A \$Call JUKI 6300 \$699 NEC ELF 350 \$439 NEC 3550 \$1139 OKIDATA 183 \$539 QUME SPRINT 1155 \$1569 SWEET P 600 \$839 TI 855 \$799 TOSHIBA P351 \$1129  <b>Input Devices</b> KEYTRONIC 5151 \$179 KOALA \$109 MICROSOFT MOUSE \$129 PC MOUSE W PAINTBRUSH \$129  <b>Accessories</b> CURTIS SURGE PROTECTORS \$Call DATASHIELD BACKUP POWER \$Call GILTRONIX SWITCHES \$Call MASTERPIECE PLUS \$135 MICROFAZER INLINE (64K) \$219 TRIPLETE BACKUP POWER \$Call 256K RAM SET \$ 39 8087 MATH CHIP \$135
---	--	--	--	--

## Hardware\*

Helcules Graphics Card <b>\$299</b>	Mountain Drivecard 10 <b>\$789</b>	Quadboard 384K <b>\$219</b>	Six Pak Plus 384K <b>\$249</b>	Smartmodem 1200B <b>\$349</b>	Smartmodem 2400 <b>\$579</b>
--	---------------------------------------	--------------------------------	-----------------------------------	----------------------------------	---------------------------------

\*CALL FOR SHIPPING COSTS

**FREE SHIPPING**  
on all credit card or prepaid orders and all orders over \$1000.

**LOWEST PRICE GUARANTEE!!**  
We will match current nationally advertised prices on most products. Call and compare.

*free!*  
Diskette Library Case with your order

**1-800-221-1260**  
In New York State call (718) 438-6057

TERMS:  
Checks—allow 14 days to clear. Credit processing—add 3%. COD orders—cash, M.O or certified check—add \$5.00. Shipping and handling UPS surface—add \$3.00 per item (UPS Blue \$8.00 per item). NY State Residents—add applicable sales tax. All prices subject to change.

MasterCard VISA  
MON.-THURS. 9:00 AM-8:00 PM  
SUN. & FRI. 9:00 AM-4:00 PM

**Softline**  
Softline Corporation  
P.O. Box 729, Brooklyn, N.Y. 11230  
TELEX: 421047 ATLN UI  
FAX: 718-972-8346

# The right prices. The right

IBM HARDWARE		
AST	List	Ours
SixPak Plus 64K	\$395	\$239
SixPak Plus, 384K, S/P/CC	\$895	\$269
Advantage Multif Brd for AT	\$595	\$425
CENTRAL POINT		
PC Option Board	\$ 95	\$ 81
COMX		
130 Watt Power Supply	\$179	\$ 93
CORE Hard Disks for AT		
ATplus 20 meg for AT	\$1595	\$1395
ATplus 30 meg for AT	\$1995	\$1695
ATplus 56 meg for AT	\$3595	\$3195
EVEREX		
The Edge, Color/Mono Board	\$399	\$269
HAUPPAGE (HCW)		
8087 Chip	\$175	\$125
8087-2 Chip	\$225	\$175
80287 Fast-5 Chip	\$295	\$229
HERCULES		
Color Card with Parallel Port	\$245	\$165
Mono Graphics Card	\$499	\$319
INTEL		
Above Board 64K for PC	\$395	\$299
Above Board 128K for AT	\$595	\$449
KENSINGTON		
Masterpiece Plus	\$180	\$129
KEYTRONIC Keyboards		
KB5151 or KB5151 Jr	\$255	\$189
MICROSOFT		
Mouse	\$195	\$125
128K Booster with Mouse (Jr)	\$295	\$195
MOUNTAIN		
20 meg Drive Card	\$1195	\$945
MOUSE SYSTEMS		
PC Mouse with Paint	\$220	\$145
Mouse with Software (Jr)	\$220	\$138
PERSYST		
PC Mono Board w/Par Port	\$250	\$159
Color Board	\$210	\$139
QUADRAM		
Quadboard no RAM to 384K	\$295	\$195
Quadboard 384K S/P/CC/G	\$595	\$279
Quadcolor I Board 4 colors	\$295	\$175
RACORE		
Expansion Chassis Plus (Jr)	\$675	\$459
256K Expansion Board (Jr)	\$275	\$179
TALLTREE		
JRAM II board	\$219	\$159
JRAM III 256K Board	\$399	\$309
TITAN		
PC Accelerator 128K	\$795	\$595
VIDEO 7		
Mono Graphics Card	\$250	\$179
MGC with Parallel Port	\$300	\$215
VEGA Board IBM EGA Comp	\$599	\$429

IBM SOFTWARE		
ASHTON-TATE		
Framework II	\$695	\$389
dBase III+	\$695	\$395
dBase II (req. PC DOS & 128K)	\$495	\$305
BORLAND		
Traveling Sidekick	\$ 70	\$ 39
Editor Toolbox or GameWorks	\$ 65	\$ 40
Turbo New Pack	\$ 95	\$ 50
Traveling Combo	\$125	\$ 65
Superkey/Sidekick Package	\$125	\$ 65
Turbo Holiday Pack	\$125	\$ 69
Turbo Jumbo Pack	\$245	\$130
Reflex: The Analyst	\$ 99	\$ 59
BOURBAKI		
1 dir	\$ 95	\$ 62
BPI		
Gen. Acctg. AR, AP, or PR	\$595	\$365
CENTRAL POINT		
Copy II PC	\$ 40	\$ 22
PC Tools	\$ 40	\$ 22

DIGITAL RESEARCH		
CP/M 86	List \$100	Ours \$ 64
Gem Draw	\$150	\$ 95
DOW JONES		
Market Analyzer	\$349	\$229
FUNK SOFTWARE		
Sideways NEW VERSION!	\$ 60	\$ 42
HARVARD		
Total Project Manager	\$495	\$295
HOWARD SOFT		
1986 Tax Preparer	\$295	\$199
HUMAN EDGE		
Mind Prober	\$ 50	\$ 29
LIFETREE		
Volkswriter Deluxe	\$295	\$159
LIVING VIDEOTEXT		
Think Tank	\$195	\$109
LOTUS		
1-2-3 NEW VERSION	\$495	\$329
Symphony	\$695	\$449
MAGNUM COMPUTER		
Fastrak, RAMdisk & Print Spooler	\$ 50	\$ 39
MICROPRO		
Easy	\$150	\$ 99
WordStar	\$350	\$189
WordStar 2000 Plus	\$595	\$295
MICRORIM		
R:Base 5000	\$695	\$385
R:Base Clout	\$249	\$133
MICROSOFT		
QuickBASIC	\$ 99	\$ 69
Windows	\$ 95	\$ 69
Macro Assembler	\$150	\$ 99
Access	\$250	\$169
Word	\$375	\$239
MICROSTUF		
Crosstalk XVI	\$190	\$110
MULTIMATE		
Multimate	\$495	\$229
Advantage requires 384K	\$595	\$295
PETER NORTON		
Norton Utilities	\$100	\$ 56
POLYTRON		
Polywindows	\$ 85	\$ 45
ROSESOFT		
Prokey	\$130	\$ 80
SATELLITE (SSI)		
WordPerfect NEW VERSION!	\$495	\$229
SOFTWARE PUBLISHING		
PFS: Write, File or Graph	\$140	\$ 84

DISKETTES		
CONROY-LAPOINTE DISKETTES™		
10 ea SS/SD 35 trk (Apple)	\$ 13	
100/1000 ea SS/SD, 35 trk	\$ 99/669	
10 ea SS/DD 3.5" (Mac)	\$ 25	
50/100 ea SS/DD 3.5"	\$115/235	
10 ea DS/DD 40 trk (IBM)	\$ 16	
100/1000 ea DS/DD 40 trk	\$119/799	
10 ea DS/HD 96 TPI (IBM-AT)	\$ 29	
100 ea DS/HD 96 TPI (IBM-AT)	\$269	
GENERIK		
10/100 SS/SD 35 TRK (Apple)	\$ 8 / 75	
10/100 DS/DD 40 trk (IBM)	\$ 10 / 79	
10/100 DS/HD 96 TPI (AT)	\$ 27/249	

MODEMS		
HAYES		
Micromodem IIe (Apple)	\$199	\$149
Transit 1000 Comm. Buffer	\$399	\$309
Smartmodem 1200B (IBM Int.)	\$549	\$379
Smartmodem 1200 (External)	\$599	\$419
2400 Modem (External)	\$899	\$619
PROMETHEUS		
ProModem 1200A (Apple)	\$449	\$329
VENTILE		
PC Halfcard (IBM Internal)	\$549	\$389

APPLE HARDWARE		
CCS	List	Ours
7711 or 7710-A Ser. Card	\$115	\$ 95
CPS/EASTSIDE		
Wild Card II Copier	\$140	\$ 79
COMX		
16K RAM Card (1 Yr Ltd Wty)	\$119	\$ 39
KENSINGTON		
System Saver Fan	\$ 90	\$ 65
KOALA		
Muppet Keys	\$ 80	\$ 44
Touch Tablet	\$130	\$ 75
MICRO-SCI		
80 Col.+64K Card Ile	\$179	\$ 79
Full or Half Ht Drive II+.e	\$269	\$139
MICROSOFT		
Z80 Softcard II, 64K	\$425	\$295
ORANGE MICRO		
Grappier Plus (Par.Card)	\$145	\$ 72
Hot Link S-P Cable I/c	\$ 70	\$ 44
TEAC		
T40 Half Ht Disk Drive	\$249	\$149
TITAN		
Accelerator IIe	\$319	\$229
128K RAM Card	\$329	\$149
VIDEO 7		
V Color I/c	\$130	\$ 89
V Color IIe	\$250	\$169

APPLE SOFTWARE		
ADVANCED LOGIC SYS. (ALS)		
Word or List Handler	\$ 80	\$ 36
ASHTON-TATE		
dBase II (req. CP/M)	\$495	\$305
BEAGLE BROTHERS		
Big U or D Code	\$ 40	\$ 25
Fat Cat or Pro Byter	\$ 50	\$ 27
BORLAND		
Turbo Pascal (req. CP/M)	\$ 70	\$ 36
Turbo Toolbox	\$ 55	\$ 30
BPI		
AR, AP, PR, or INV	\$395	\$240
BRODERBUND		
Karateka	\$ 35	\$ 25
The Print Shop	\$ 50	\$ 31
Print Shop w/Refill	\$ 65	\$ 39
CENTRAL POINT		
Copy II Plus	\$ 40	\$ 22
FUNK		
Sideways	\$ 60	\$ 37
INFOCOM		
Zork I, II, or III	\$ 40	\$ 29
LIVING VIDEOTEXT		
Think Tank	\$145	\$ 89
MICROPRO		
WordStar w/Starcard	\$495	\$265
WordStar Professional	\$495	\$265
MICROSOFT		
Typing Tutor II	\$ 25	\$ 17
MICROSTUF		
Crosstalk	\$195	\$109
MONOGRAM		
Dollars & Sense II+.e	\$100	\$ 59
Dollars & Sense 128K	\$120	\$ 69
ORIGIN		
Ultima III	\$ 60	\$ 39
Ultima IV	\$ 64	\$ 44

SATELLITE (SSI)		
WordPerfect NEW!	List \$179	Ours \$115
SIMON & SCHUSTER		
Typing Tutor III	\$ 50	\$ 33
SOFTWARE PUBLISHING PFS Series		
File, Write, Graph or Report	\$125	\$ 79
SPECTRUM HOLOBYTE		
GATO (req. 128K)	\$ 40	\$ 25
SUBLOGIC		
Flight Simulator II	\$ 50	\$ 30
TIMEWORKS		
Swiftax	\$ 70	\$ 49

MACINTOSH		
AEGIS		
Challenger or Pyramid	\$ 50	\$ 37
ASSIMILATION		
Numeric Turbo	CALL	
Mac Port Adaptor	\$ 79	\$ 59
BORLAND		
Sidekick (copiable)	\$ 85	\$ 45
CENTRAL POINT		
Copy II Mac	\$ 40	\$ 22
HABA SYSTEMS		
800K DS/DD Disk Drive	\$599	\$299
LIVING VIDEOTEXT		
Think Tank	\$145	\$ 92
LOTUS		
Jazz	\$595	\$389
MICROSOFT		
Multipan, Word or File	\$195	\$125
Fortran	\$295	\$199
Excel	\$395	\$259
Business Pak	\$595	\$395

PRINTERS		
BROTHER		
HR25 Daisywheel	\$695	\$555
EPSON		
LX80 100 cps, 16 cps NLQ	\$299	\$249
FX286 200 cps, 40 NLQ	\$749	\$609
LQ800 180 cps, 60 LQ	\$799	\$649
LQ1000 180 cps, 60 LQ, 15"	\$995	\$795
LQ1500 200 cps, 67 LQ, 15"	\$1295	\$995
OKIDATA		
Okimate 20, 182, 84	LOW	
92, 192, 193, 2410 Pacemark	PRICES	
PANASONIC		
P1092 180 cps	\$599	\$349
P1093 180 cps 15"	\$699	\$469
P3151 22 cps Daisywheel	\$659	\$439
STAR MICRONICS		
SG10 120 cps, 30 cps NLQ	\$299	\$249
SD10 120 cps, 40 cps NLQ, 10"	\$449	\$379

MONITORS		
AMDEK		
300G 12" Green Composite	\$179	\$119
300A 12" Amber Composite	\$199	\$129
310A 12" Amber TTL (IBM)	\$230	\$159
PRINCETON		
MAX-12 12" Amber TTL (IBM)	\$249	\$179
HX-12 12" Color RGB	\$795	\$445
HX-12e RGB for IBM-EGA	\$785	\$545
ZENITH		
ZVM-1220 12" Amber Comp.	\$159	\$109
ZVM-1230 12" Green Comp.	\$159	\$109
ZVM-1240 & ZVM-135	SAVE	

We carry thousands more products than are listed here. If you don't see what you are looking for, call!



**ORDERING INFORMATION & TERMS**  
 Mail to: 12060 S. W. Garden Place, Portland OR 97223 • Include telephone number • We immediately honor cashiers checks, money orders, Fortune 1000, and Government checks • Personal and other company checks allow 20 days to clear • Advertised prices reflect a 3% discount for cash, so add 3% for credit card purchases • We ship Federal Express Standard Air • U.S. and Puerto Rico add 3% (\$5 minimum) • Canada add 12% (\$15 min) • Foreign add 18% (\$25 min) • APO, FPO other U.S. Territories add 6% (\$10 min) • All prices, availability and specifications subject to change without notice • All sales final • We do not guarantee compatibility • You must call for R. A. number to return defective goods.



**CONROY-LAPOINTE COMPUTER STORES 3 Locations. Retail Sales Only. Store Prices May Vary.**  
 San Francisco, CA • 415-982-6212 • Across From The Pyramid On Washington St. Near Montgomery  
 Portland, OR • 503-620-5595 • Business Park 217 In Tigard, At Intersection of Hwys 217 & 99W  
 Seattle, WA • 206-455-0206 • Belgate Plaza In Bellevue, 2 Blocks North Of Bellevue Square

"We'll give you the best service anywhere"



# products. The right choice.

B36

## Internal Hard Drives



**10 meg** List \$745 **\$389**  
with controller

**20 meg** List \$895 **\$489**  
with controller

Fast access time beats the standard IBM drive by 30%. 90 day limited warranty.

**64K RAM** 100+ sets **\$ 9**  
9 each, 4164 200 ns chips 1-99 sets \$11

**256K RAM** 100+ sets **\$32**  
9 each, 4256 150 ns chips 1-99 sets \$34

**128K RAM** 100+ sets **\$37**  
9 each, 4128 150 ns chips 1-99 sets \$39

All prices subject to change without notice. 90 day limited warranty.

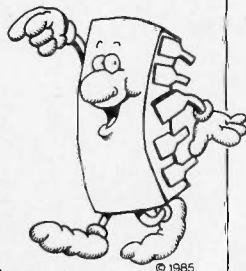

## CDC 360K Floppy Drives

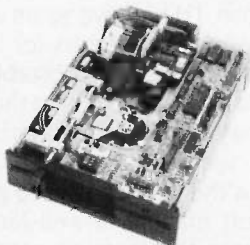

**Half Ht.** List \$195 **\$ 75**

**Full Ht.** List \$195 **\$119**

Half-Height for AT \$95 Call for quantity prices. 30 day limited warranty.

## MAGNUM EconoRAM

- Full 384K of RAM
- Short Board
- Fastrak Printer Spooler & RAMdisk Software
- Snap-In Installation
- 1 Year Limited Warranty

**384K** List \$99 **\$89**

For IBM PC, XT and compatibles. with 256K of installed memory.

## MAGNUM PCMasterCard™

### More Features Than SixPak or Quadboard

- Expandable to 1.5 MB
- 1 Serial RS-232C Port
- Parallel Printer Port
- Clock/Calendar & Battery
- Game Port
- SiliconBullet Software: Printer Spooler, RAMdisk, and Bank Switching Driver
- 1 Year Limited Warranty

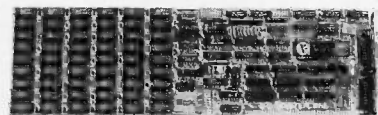

**384 KB** List \$199 **\$179**

**1.5 MB** List \$399 **\$329**

For IBM PC, PCXT or Compatibles.

## COMX/IRWIN Tape Backup

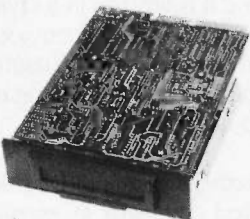

**10 meg** List \$795 **\$495**

**Kit** List \$895 **\$549**

with Tape, Cable & Software  
90 day limited warranty.

## MAGNUM

## Get Magnum In Your Corner

**Only \$895**

System A  
128K, 1 360K Floppy drive

### XT Mark 2

- Fully IBM PC/XT Compatible
- Dual Speed 4.77 and 8 MHz 8088-2
- RAM Expandable to 640K On Motherboard
- 360K Floppy Disk Drives
- 135 Watt Power Supply
- IBM Selectric AT Style Keyboard (84 Keys)
- 5 Expansion Slots
- 2 Serial RS-232C Ports Built-In
- Parallel Printer Interface Built-In
- Clock/Calendar Built-In
- Floppy Disk Controller Built-In
- Tape Backup Interface Built-In
- MS-DOS Operating System
- Complete User Operating Manual
- Reset Button Switch Built-In
- 8087-2 Co-Processor (optional)
- RAMdisk & Printer Spooler
- 90 Day Limited Warranty

### Systems

B. 640K, 2 360K Floppy Drives	<b>\$ 995</b>
C. 640K, 1 Floppy, 10 MB Hard Drive	<b>\$ 1595</b>
D. System C plus Tape Backup	<b>\$2295</b>
J. 640K, 1 Floppy, 20 MB Hard Drive	<b>\$ 1795</b>

Other systems available, please call.  
Above prices exclude video card and monitor.



### Our References

- First Interstate Bank (503) 643-4678
- Portland Chamber of Commerce (503) 228-9411
- Direct Marketing Association
- Dun and Bradstreet
- Others On Request



**1•800•547•1289**

Oregon Toll Free 1•800•451•5151 Telex 910 380 3980  
Foreign, Local (503) 620-9878 hours 6-6 (Pacific) Mon-Fri, 8-4 Sat  
Customer Service (503) 620-9877 hours 8-5 (Pacific) Mon-Fri

# Conroy•LaPointe

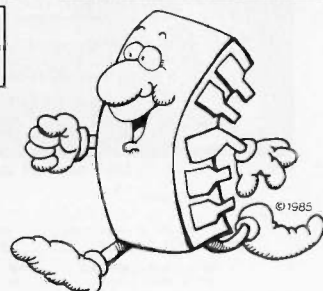

**THE BYTEK SYSTEM 125**

- A GANG PROGRAMMER,
- A SET PROGRAMMER,
- A UNIVERSAL PROGRAMMER,

**ALL IN ONE**

PLUS FEATURES LIKE THESE:

- SUPPORTS ALL TECHNOLOGIES
- UP TO 1 MEGA BYTE OF RAM
- CENTRONIC PARALLEL PRINTER PORT
- 16 x 2 LIQUID CRYSTAL DISPLAY AND MUCH, MUCH MORE.
- HIGHEST PERFORMANCE/COST RATIO AVAILABLE TODAY
- OTHER MODELS AVAILABLE
- PRICES START AT \$995
- UV ERASERS FROM \$67
- AVAILABLE FROM STOCK

**CALL NOW TO ORDER**  
**(305) 994-3520**

**BYTEK** Corporation  
Instrument Systems Division

1021 South Rogers Circle, Boca Raton, FL 33431  
(305) 994-3520, Telex 4310073 MEVBTC

**JAPANESE QUALITY AT INCREDIBLE LOW PRICES**



Fast delivery — We manufacture and control every stage of design and production. Many outstanding and unique products never shown before.



We are willing to take care of small orders, too.

**INQUIRE TODAY**  
**EAST DIGITAL CO., LTD.**  
2nd Fl., No. 432 Kuang-Fu S. Rd. Tel : 703-2243, 703-2371  
Taipei, Taiwan, R.O.C. Tlx : 10531 GEEMING, 20630 EDCLTD

**HONG KONG OFFICE** Tel : 5-893-3201, 5-893-0888  
ATTN: MRS. CHEN Tlx : 61253 ITCOY

**BOOK REVIEWS**

with changing the shapes of the waves in two different voices. You can choose from sine, square, or sawtooth waveforms, or you can design your own by drawing with the mouse. The whole thing is also a good review of BASIC's menu and button commands.

**LASTING IMPRESSIONS**

By the time I acquired Microsoft BASIC for my own Macintosh, I'd had five years of experience with the same company's interpreters for the Radio Shack Color Computer and Model 100 portable. As a result, I anticipated little trouble in picking up the details of the new package. That may have been optimistic; the process seemed to take longer than it should have. While I still think it possible for the veteran user to get by with nothing but the Microsoft manual, a well-illustrated and less terse book can make the learning process a lot easier.

*Microsoft Macinations* is one of the best such books. It is well paced (with the exception of the very early pages), and it is written in a style that avoids Mac-cutesiness. The book's emphasis on special features of the user interface, combined with the useful program components, leads me to believe that I will be referring to my copy for some time to come.

Scott L. Norman (8 Doris Rd., Framingham, MA 01701) is a frequent contributor to computer magazines.

**THE COMPUTER LAW ANNUAL 1985**

Reviewed by David A. Price

Few industries have created as many difficult legal issues in as short a time as the computer industry. Although some lawyers have developed specialized expertise in "computer law," as it is now called, the industry is far too large and the issues too pervasive to be left to specialists. Miles R. Gilburne, Ronald L. Johnston, and Allen R. Grogan, the editors of *The Computer Law Annual 1985*, have performed a valuable service by assembling an excellent group of articles about the legal problems that computer businesses often face.

Its 20 articles are from a legal journal, *The Computer Lawyer*. They cover a wide variety of issues, most of them pertinent to computer businesses of all sizes. Not surprisingly, the topic receiving the most coverage is that of protecting proprietary rights to software. Instead of giving only a recitation of the legal doctrines governing copyright and trade-secret protection, the articles go further by tackling some difficult questions. To what extent can a firm permissibly "reverse-engineer" a copyrighted software product by disassembling it? When should a firm require a license agreement for the sale of software and when should it just rely on copyright? When does a programmer own the copyright to a software product that he or she wrote as an employee? How can a firm enlist the help

(continued)

# STATISTICAL PACKAGES

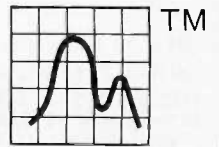

data-analysis software from: **StatSoft**  
**unbeatable power and flexibility for unbeatable prices!**

We developed complete,  
 high-performance  
 statistical packages  
 for all computers:

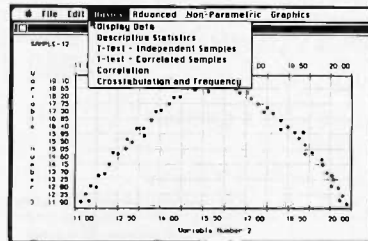

1. **STATS-2™** (release 2.0): Statistical supplement for Lotus 1-2-3™ and other spreadsheet programs. Can also be used as a stand-alone statistical package, runs on IBM™ and compatibles, 256k, 2dd, 8087 support . . . . **\$149**
2. **STATFAST™** (release 2.0): The most powerful statistical package developed for the Macintosh™ 128k or 512k, 1dd . . . . . **\$119**
3. **APP-STAT™**: A complete statistical package for the Apple II™ family of computers, 1dd . . . . . **\$99**
4. **PSYCHOSTAT-3™**: A complete statistical package, available for Kaypro™ and all CP/M™ computers, 1dd . . . . . **\$99**

Ask for our statistical packages for other computers.

All of these statistical packages are user friendly and super-easy to use. They include the full range of basic statistical analyses (descriptive statistics, t-tests, correlations, crosstabulations, nonparametric statistics, and more) and advanced multivariate statistics (multiple regression, multifactor analysis of variance and covariance, repeated measures, contrasts, unbalanced designs, and more). All packages can handle **data files of unlimited size**, include flexible Data Editors, and can access data files from spreadsheets, data-bases, and mainframes.

**TO ORDER:** Send check, credit card number, or money order (plus \$5 shipping and handling) to:



**StatSoft™**

2832 EAST 10TH STREET, SUITE 4, TULSA, OK 74104  
 (918) 583-4149



To order by phone (Visa, MasterCard, C.O.D. orders accepted) or talk to our technical staff for more information, call (918) 583-4149.

STATSOFT, STATSOFT logo, STATS-2, STATFAST, APP-STAT, PSYCHOSTAT-3, LOTUS 1-2-3, Symphony, IBM, Macintosh, Apple II, Kaypro, and CP/M are registered trademarks of respective companies.

# THE PRICE LEADERS!!!

## BUILD YOUR OWN PC!

IBM COMPATIBLE

COMPLETE SYSTEM



IBM PC-XT TYPE CASE .....	\$ 39.00
150 WATT POWER SUPPLY .....	\$ 79.00
5150 IBM-TYPE KEY BOARD .....	\$ 49.00
MOTHER BOARD EXPANDABLE TO 640K WITH 128K INSTALLED .....	\$135.00
MONOCHROME GRAPHIC PRINTER BOARD .....	\$ 85.00
FLOPPY CONTROLLER BOARD .....	\$ 35.00
2-FLOPPY DISC DRIVES @\$85 EACH .....	\$170.00
12" TTL HIGH RESOLUTION MONITOR .....	\$ 97.00
COMPLETE WITH INSTRUCTION & ASSEMBLY MANUALS .....	
<b>YOUR COST .....</b>	<b>\$689.00</b>

OPTIONAL:	
ASSEMBLED & TESTED WITH MS DOS & GW BASIC .....	\$127.00
RAM CHIPS TO EXPAND TO 640K .....	\$ 75.00
Any of these components may be purchased separately.	\$891.00

All boards guaranteed for 1 year. IBM, PC/XT are trademarks of International Business Machines, Inc.

### SmarTeam Modem



103/212A -  
Operates at 300  
Baud & 1200 Baud  
• Hayes  
Compatible  
• Auto Answer,  
Dial & Redial

Uses RS 232-C Connector

#91990 ..... \$165.00

### Messenger Modem



Has all the features of the SmarTeam  
Modem, so why pay more?

#97900 ..... \$148.00

### Key Boards



5151 IBM Type Key Board  
Caps and Num Lock

#5151 ..... \$79.00

5050L XT Key Board—looks like AT,  
has big return key & LED indicators.  
#5050L ..... \$59.00

### Brother® Printer



Dot Matrix Printer

#DM5 ..... \$75.00

### ADD ON BOARDS IBM COMPATIBLE

#### Monochrome Graphic Printer Board

- Built in Parallel Printer Port
- Text: 25 line x 80 column
- Graphics: 720 x 348 resolution
- TTL High Resolution Output

#92270 ..... \$85.00

#### Multifunction Board

- Expandable to 384K RAM
- Serial Port, Game Port
- Parallel Printer Port
- Clock Calendar w/ Battery Backup
- Software, Manuals and Cables

#92290 ..... \$89.00

#### Color Graphics Board

- RGB and Composite Port
- Light Pen Interface
- Graphics: 320 x 200(color);  
640 x 200(BW)
- Text: 25 x 80

#92280 ..... \$72.00

#### 384K RAM Expansion Board

- Fully buffered

#92305 ..... \$35.00

#### 512K RAM Expansion Board

- Fully buffered

#92300 ..... \$49.00

#### RS 232 Serial Board

- 1 Serial Port
- 2nd Port optional

#92310 ..... \$29.00

#### Parallel Printer Card

- Also may be used as I/O Port

#92700 ..... \$29.00

#### Floppy Disk Controller

- Drives 2 internal drives
- Includes cable
- IBM PC compatible

#92260 ..... \$35.00

Plus A Huge Selection of Cables & Accessories!

## THE WHOLESALE OUTLET

Dept BY, 1 Interstate Avenue, Albany, NY 12205. To order call  
1-800-344-4387 (NoH-NYS Res.) or 518-459-7883 (NYS Res.)

Personal and company checks accepted (on mail-in orders.) Customer pays  
freight & handling FOB Albany, NY. Non-credit card order shipped UPS. C.O.D.  
Minimum order \$25. Dealer and large quantity  
orders call 518-459-7883. Ask for Computer Dept.



## BOOK REVIEWS

of the U.S. Customs Service to prevent the importation of an infringing product?

The book also discusses such diverse topics as avoiding antitrust liability, drafting warranties, securing access to a vendor's proprietary information in case the vendor becomes bankrupt, obtaining start-up capital, compensating employees, and reducing taxes. Because the annual is intended for practicing lawyers, its emphasis is on solving real problems rather than on academic theorizing. To help a lawyer investigate a question further, the book gives citations where appropriate to legal references such as case reporters, which contain the published decisions of courts; the U.S. Code, which contains federal statutory law; and the Code of Federal Regulations, which contains the regulations issued by federal agencies.

The contributors display an unusual command of the technical aspects of the field. For example, in two articles that examine copyright issues in writing a BIOS compatible with the IBM Personal Computer, the contributors freely discuss the use of software interrupts—a topic beyond the grasp of most lawyers and more than a few programmers. That level of technical understanding is necessary, however, for an intelligent analysis of the question involved. To avoid infringing IBM's copyright, is it enough simply to avoid copying exact sequences of IBM's code? Must you also avoid copying IBM's algorithms, which happen to be available from a source listing in an IBM manual? Must you avoid copying IBM's device-dependent timing loops? Can IBM claim protection for its interrupt scheme?

Despite its astute handling of technical matters, the book maintains its focus primarily on lawyers. Nonlawyers would have difficulty following some of the articles; unexplained legal terms appear throughout. An article about contract negotiation, for instance, refers to "liquidated damages" and "choice of law and forum provisions" with the assumption that these phrases need no explanation.

One slightly disappointing aspect is that the contributors rarely make arguments about policy. They describe the directions in which the legal rules are forming, but they say little about what kinds of rules are desirable. One of the articles about antitrust is a refreshing exception. After showing how the operation of the Robinson-Patman Act frequently thwarts its own stated purpose of increasing competition, the article concludes that the Act "is difficult to defend." Equally blunt arguments about other areas of computer law would be enlightening.

This omission is understandable, however, because the purpose of the book is to inform rather than persuade. For lawyers who have computer firms as clients, and for managers who are willing to wade through some legal jargon, *The Computer Law Annual 1985* is first-rate. It discusses the nuts and bolts of computer law with precision and authority. ■

David A. Price (57 Roseland St. #2, Somerville, MA 02143) is a third-year law student at Harvard University.

# Powerful MS-DOS Software.

For the IBM®-PC, XT, AT & others with generic MS-DOS/PC-DOS 2.0 or higher.

Not copy  
protected!

Only **\$39.95** Each!

## UTAH COBOL™

Whether student, teacher or professional programmer, this is the one you've heard so much about.

- It's easy to use. Compiles 5000 statements on a 128K machine.
- 170 clear error messages, i.e. DATA-NAME IS MISSING OR MISPELLED.
- Distribute your object code programs royalty free.
- Small object code programs conserve disk space.
- Fast compile times to increase programmer productivity. Over 25 times faster than one compiler costing \$995!
- You get a diskette and 213-page manual with lots of examples and 16 complete COBOL source code programs. **\$39.95.**

Also available: COBOL Application Packages, Book 1 **\$9.95.**

## UTAH PASCAL™

- 14-digit precision, BCD math, no round-off errors with decimal arithmetic for business and floating point + 63 - 64 for scientific.
- A very nice TRACE style debugging.
- Arrays up to 8 dimensions and 64K strings.
- External procedures and functions with dynamic auto-loading.
- One-step compile, no assembly or link required.
- You get a 132-page manual and diskette. **\$39.95**

## UTAH PILOT™

- Perfect for industrial training, office training, drill and testing, virtually all programmed instruction, word puzzle games, and data entry facilitated by prompts.
- John Starkweather, Ph.D., the inventor of the PILOT language, has added a built-in full-screen text editor, and much more.
- Meets all PILOT-73 standards for full compatibility with older versions.
- You get a diskette, 125-page manual and ten useful sample programs. **\$39.95.**

Also still available for 8-bit machines with CP/M® is our world famous Nevada Software Series used by 50,000 customers in 40 countries. These include Nevada COBOL, Nevada FORTRAN, Nevada PASCAL, Nevada PILOT, Nevada BASIC and Nevada EDIT. **\$39.95** each.

Satisfaction guaranteed. If for any reason you're not completely satisfied, just return the package within 15 days in good condition, and we'll refund your money.

IBM is a registered trademark of International Business Machines Corp. CP/M is a registered trademark of Digital Research. MS is a trademark of Microsoft Corp. © 1985 Ellis Computing, Inc.

## UTAH FORTRAN™

- FORTRAN IV based upon ANSI-66 standards.
- Very fast compile times and easy to use.
- IF . . THEN . . ELSE constructs.
- Chaining with blank and named common.
- Copy statement.
- ENCODE and DECODE.
- Free-format input and output.
- A very nice TRACE style debugging.
- 150 English language error messages.
- You get a diskette, and 223-page manual. **\$39.95**

## UTAH EDIT™

- A character-oriented full-screen video display text editor designed specifically to create COBOL, FORTRAN and PASCAL programs.
- Only requires 15K disk space so it can fit on the same disk as your compilers.
- Completely customizable tab stops, default file type, keyboard control key layout and CRT by menu selection.
- Diskette comes with easy to read 58-page manual. **\$39.95.**

## UTAH BASIC™

- This interpreter has a built-in full-screen editor.
- Single- and Multi-line user definable functions.
- BCD Math- no round-off errors.
- Full Matrix operations.
- You get 220-page manual and diskette. **\$39.95.**



Handling/Shipping: No shipping charge within US. Overseas add \$10 for first package, \$5 each additional. Checks must be in US Dollars, drawn on a US bank.

Utah Software requires 128K RAM and PC-DOS or MS-DOS 2.0 or higher.

HOW TO ORDER. Send check or money order to Ellis Computing, Inc. with VISA or MASTERCARD order by phone. Sorry no COD's.



Ellis Computing, Inc.  
5655 Riggins Court, Suite 10  
Reno, Nevada 89502  
Phone (702) 827-3030

SINCE 1977  

**ELLIS COMPUTING™**

# E·V·E·N·T Q·U·E·U·E

## March 1986

**DISCOVERY III: TRAINING AND TECHNOLOGY FOR THE DISABLED**, Milwaukee, WI. Office of Continuing Education and Summer Session, University of Wisconsin-Stout, Menomonie, WI 54751, (800) 457-8688; in Wisconsin, (800) 227-8688. *March 3-5*

**SEVENTH ANNUAL COMPUTER GRAPHICS CONFERENCE: EMERGING FROM THE CHAOS**, Hollywood, FL. Carol Every, Frost & Sullivan Inc., 106 Fulton St., New York, NY 10038, (212) 233-1080. *March 5-7*

**EFFECTIVE ANALYSIS AND DESIGN OF INFORMATION SYSTEMS**, Worcester, MA. Office of Continuing Education, Worcester Polytechnic Institute, Higgins House, Worcester, MA 01609, (617) 793-5517. *March 10-12*

**1986 EASTERN SIMULATION CONFERENCES**, Norfolk, VA. The Society for Computer Simulation, POB 17900, San Diego, CA 92117-7900, (619) 277-3888. *March 10-12*

**CIMTECH '86**, Boston, MA. Cheri Willetts, Society of Manufacturing Engineers, One SME Drive, POB 930, Dearborn, MI 48121, (313) 271-1500, ext. 374. *March 10-13*

**FOURTH ANNUAL TECHNOLOGY IN TRAINING AND EDUCATION CONFERENCE (1986 TITE)**, Montgomery, AL. Thomas S. Allman, HQ AU/XPZ, Maxwell AFB, AL 36112, (205) 293-6160. *March 10-13*

**ETHICS AND EXCELLENCE IN COMPUTER EDUCATION:**

**CHOICE OR MANDATE**, Tempe, AZ. Gary Bitter, College of Education, Payne 216, Arizona State University, Tempe, AZ 85287, (602) 965-7363. *March 12-14*

**HANNOVER FAIRE: CEBIT '86**, Hannover Fairgrounds, West Germany. Hannover Fairs USA Inc., POB 7066, 103 Carnegie Center, Princeton, NJ 08540, (609) 987-1202. *March 12-19*

**1986 IEEE WORK STATION TECHNOLOGY & SYSTEMS CONFERENCE**, Atlantic City, NJ. Helen Yonan, IEEE Office, Moore School of Electrical Engineering, University of Pennsylvania, Philadelphia, PA 19104, (215) 898-8106. *March 17-20*

**NUMERICAL METHODS AND DIGITAL COMPUTER TECHNIQUES FOR ENGINEERS AND SCIENTISTS**, Los Angeles, CA. Short Course Program Office, UCLA Extension, 10995 Le Conte Ave., Los Angeles, CA 90024, (213) 825-1295. *March 17-21*

**1986 IEEE VLSI TEST WORKSHOP—MICROSYSTEMS: NEW TEST CHALLENGES**, Atlantic City, NJ. Wesley C. Radcliffe, IBM Corp., East Fishkill Facility, Dept. 277, Building 321-5E1, Hopewell Junction, NY 12533. *March 18-19*

**INFOMART**, Dallas, TX. International Information Processing Market Center, 1950 Stemmons Freeway, Dallas,

TX 75207, (214) 746-3500. *March 18-20*

**1986 SOFTWARE & COMPUTER CONFERENCE FOR INFORMATION MANAGERS & LIBRARIANS**, Atlanta, GA. Meckler Publishing, 11 Ferry Lane West, Westport, CT 06880, (203) 226-6967. *March 18-20*

**SOUTHCON/86**, Orlando, FL. Electronic Conventions Management, 8110 Airport Blvd., Los Angeles, CA 90045. *March 18-20*

**PERSONAL COMPUTER INTERFACING FOR SCIENTIFIC INSTRUMENT AUTOMATION**, Blacksburg, VA. Dr. Linda Leffel, C.E.C., Virginia Polytechnic Institute and State University, Blacksburg, VA 24061, (703) 961-4848. *March 19-21*

**THIRD ANNUAL PHYSICIANS AND COMPUTERS: APPLICATIONS IN PATIENT CARE**, Las Vegas, NV. Beverly J. Johnson, University of Southern California School of Medicine, Postgraduate Division, 2025 Zonal Ave., KAM 318, Los Angeles, CA 90033, (213) 224-7051. *March 19-23*

**WESTERN EDUCATIONAL COMPUTING WORKSHOPS**, Orange Coast College, Costa Mesa, CA. Alexia Devlin, California Educational Computing Consortium, San Francisco State University, Accounting Data, NADM-358, 1600 Holloway Ave., San Francisco, CA 94132. *March 21-22*

**OAC '86—INTEGRATED SYSTEMS: MERGING ISLANDS OF TECHNOLOGY**, Houston, TX. OAC '86, American Federation of Information Processing Societies Inc., 1899 Preston White Drive, Reston, VA 22091, (800) 622-1986. *March 24-26*

**ARTIFICIAL INTELLIGENCE '86 CONFERENCE**, Singapore. John Tagler, Elsevier Science Publishers, 52 Vanderbilt Ave., New York, NY 10017. *March 24-27*

**COMTEL '86**, Dallas, TX. International Conference Management Inc., 15851 Dallas Parkway, Suite 1155, Dallas, TX 75248, (214) 458-7011. *March 24-27*

**INTERFACE '86 CONFERENCE AND EXPOSITION**, Atlanta, GA. The Interface Group Inc., 300 First Ave., Needham, MA 02194, (617) 449-6600. *March 24-27*

**1986 SPRING NATIONAL DESIGN ENGINEERING SHOW AND CONFERENCE**, Chicago, IL. Show Manager, Spring National Design Engineering Show, 999 Summer St., Stamford, CT 06905, (203) 964-0000. *March 24-27*

**COMPUTER-AIDED DRAFTING AND DESIGN (CADD)**, Austin, TX. College of Engineering, The University of Texas at Austin, Austin, TX 78712, (512) 471-3506. *March 24-28*

**INFO (EUROPEAN INFORMATION TECHNOLOGY AND OFFICE AUTOMATION EXHIBITION)**, Olympia, London, England. British Information Services, 845 Third Ave., New York, NY 10022, (212) 752-8400. *March 25-27* ■

*IF YOU WANT your organization's public activities listed in BYTE's Event Queue, we need to know about them at least four months in advance. Send information about computer conferences, seminars, workshops, and courses to BYTE, Event Queue, POB 372, Hancock, NH 03449.*

# PC NETWORK GOES TO THE

# ORIENT

# DIRECT

How do you suppose most manufacturers of personal computer products get started?

They go to the Orient... taking either their designs or simply their ideas to one or more of the major electronics manufacturing concerns, getting bids for making these devices under contract to the creators. Multifunction Cards, Video Cards, Disk Controllers, Modems and I/O Boards all begin their life in this way.

This relationship between the manufacturing capabilities of the East and the design and marketing talents of the U.S. has resulted in the incredible selection of enhancement products for the IBM and Apple computer markets.

Well, with 100,000 members and growing strong, The Network sent its buyers east to visit some of these manufacturing

concerns to check out the feasibility of directly importing these products in the necessary volumes to *save our members money!* What they came back with was astounding.

Now, we always figured that there were some pretty substantial markups as these boards came into the country and got fancy boxes and marketing promotions under any one of a number of well known brand names in the peripheral add-on markets *but we had no idea they were so large!*

To prove our point, consider what they brought back. Each board is constructed to the same precise specifications, on exactly the same machinery as their name-brand duplicates. The difference? *As a Network member, you pay only 8% over our unusually low wholesale price... and you get our full 1 year warranty!*

## Hercules™ Smarter Brother

A Monochrome Graphics Card with Printer Port...100% compatible with Hercules™ product...

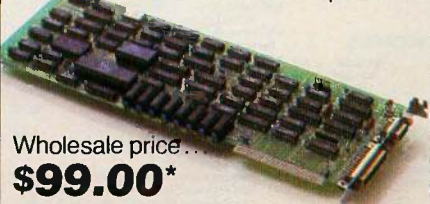

Wholesale price...  
**\$99.00\***

## Graphics Printer Interface

If all you want is a printer, this is the card for you. Supports all text and graphics printer features.

Wholesale price... **\$29.00\***

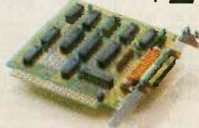

## The Multi-384 Board

A clone of the AST's SixPakPlus™ includes up to 384Kb of expansion memory, 1 serial, 1 parallel, 1 game port, a clock/calendar and software standard.

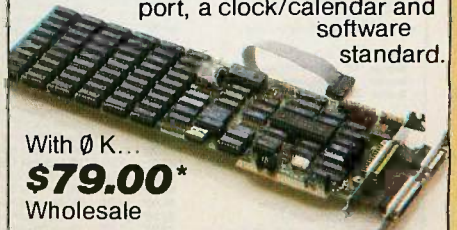

With 0 K...  
**\$79.00\***  
Wholesale

## IBM Color Card

100% compatible with the IBM offering. The wholesale price?

A mere **\$69.00\***

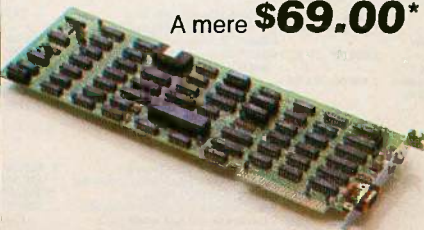

## I/O Multifunction Card

Identical I/O board to the AST's I/O+™ with 2 serial, (1 standard) 1 parallel, 1 game port and clock/calendar with software.



Wholesale price...  
**\$65.00\***

## 512 K Memory

The least expensive way to add memory to your current system. With 0 K installed.



Wholesale priced at only...  
**\$59.00\***

™Six Pak, I/O Plus and AST are all registered trademarks of AST Research Inc. Hercules is a registered trademark of Hercules Computer Technology Inc.

\*PC NETWORK Members pay just 8% above this wholesale price, plus shipping. All prices reflect a 3% cash discount. Minimum shipping \$2.50 per order. International orders call for shipping & handling charges. Personal checks: please allow 10 working days to clear.

**CALL TOLL-FREE 1-800-621-SAVE** In Illinois Call (312) 280-0002

# PC NETWORK

GET THE NETWORK ADVANTAGE!!!

# PC NETWORK

## BUY HARDWARE AND SOFTWARE AT WHOLESALE + 8%, AND GET 14-30 DAY SOFTWARE RENTALS†...

Listed below are just a few of the over 30,000 products available at our EVERYDAY LOW PRICES! The Network carries products for Apple, IBM, CP/M and most other popular computer families.

### GAMES & EDUCATIONAL SOFTWARE FOR YOUR APPLE II & MACINTOSH

(Please add \$1 shipping and handling for each title ordered from below.)

Wholesale	Wholesale
Arma, ...me Accountant-Mac Only \$65.00*	Miles Computing Mac Attack-Mac Only* \$23.00*
Axon Art Portfolio & Card Shop 31.00*	Palair Mac Type-Mac Only 23.50*
Bluechip Baron! Millionaire or Tycoon 26.00*	Penguin Graphics Magician 28.97*
Broderbund Loadrunner 19.75*	Penguin Pensate or Xyphus 20.00*
Broderbund Chopfiles 19.00*	Penguin Transylvania-Mac Only 20.00*
Broderbund Print Shop 28.75*	Professional Software Trivia Fever 19.00*
Broderbund Dazzle Draw 31.97*	Priority Software Forbidden Quest 21.00*
CBS Mastering the GRE 53.50*	Scarborough Master Type 26.50*
CBS Murder by the Dozen 20.97*	Scarborough Run for Your Money 26.00*
CBS Goron Bridge Made Easy 45.00*	Simon & Schuster's Tutoring III 28.25*
Counterpoint: The Newsroom 24.75*	Sir-Tech Wizardry 25.97*
Davidson Speed Reader II 36.50*	Sir-Tech Knight of Diamonds 18.97*
Davidson Math Blaster 26.50*	Sir-Tech Rescue Raiders 18.97*
Davidson Word Attack 26.50*	Sublogic Night Mission Pinball 20.00*
1st Byte Smooth Talker-Mac Only 47.00*	Sublogic Flight Simulator II 27.25*
Hayden Deluxe House/Interior/Landscapes 24.75*	*Spinmaker Alphabet Zoo, Face Maker, Kinder Camp, Hey Diddle Diddle, Rhymes & Riddles, Story Machine
Hayden Sargon III 25.75*	*Spinmaker The Most Amazing Thing 20.77*
Infocom Deadline or Suspended 24.00*	*Spinmaker Delta Drawing 25.00*
Infocom Enchanter, Planetfall 20.00*	*T-Maker Click Art-Mac Only 25.00*
Cuthroths, Witness or Zork I 20.00*	Warner Desk Organizer 65.00*
Infocom Hitchhiker's Guide to Outer Space 22.00*	Vindex Fun Pack-Mac Only 19.77*
Infocom Suspect, Sorcerer or Inland 22.00*	Vindex Mac Checkers & Reversi 25.17*
Infocom Zork II or III 22.00*	Virtual Combinatics Micro Cookbook 21.00*
Layered Fun Desk-Mac Only 65.00*	
Mirage Concepts Trivia 11.00*	

### BUSINESS SOFTWARE FOR YOUR APPLE II & MACINTOSH

(Please add \$2.50 shipping and handling for each title ordered from below.)

Wholesale	Wholesale
*Apple Apple Works \$160.00*	*Microsoft Word for Macintosh \$102.00*
Borland International Turbo Pascal 30.00*	*Microsoft File for Macintosh 102.00*
BPI GL, AP, AR, PR, or INV 205.00*	*Microsoft Multiplan for Macintosh 102.00*
Broderbund Bank Street Writer 40.00*	Microsoft Basic for Macintosh 79.00*
Central Point Copy II Plus or Copy II Mac 20.00*	Microsoft Chart for Macintosh 69.00*
Funk Software Sideways 32.00*	Monogram Dollars & Sense for Apple IIc 55.00*
Funsoft Macasam 60.00*	Monogram Dollars & Sense for Macintosh 70.00*
Haba Habadex 40.00*	Odeata Hell for Macintosh Reg's \$12K 200.00*
Haba Quartet 97.00*	Provue Overview-Mac Only 135.00*
Harvard Mac Manager 29.95*	Sensible Software Sensible Speller IV 67.50*
Human Edge Mind Prober 24.95*	Softcraft Fancy Fonts 125.00*
Human Edge Sales Edge 110.00*	Softech Microsystems UCSD Pascal 37.00*
Human Edge Education Edge 98.00*	Software Arts TK Solver for Mac 134.00*
Living Videotext Think-Thank-Mac Tool 65.00*	Software Publishing PFS: File, Write, or Graph 68.00*
Main Street Filter-Mac Only 87.00*	Stonerware DB Master-Mac Tool 95.00*
MEGA Managing your Money 87.50*	Teles Television for Mac 87.50*

### HARDWARE FOR YOUR APPLE II & MACINTOSH

(Please add shipping and handling charges found in italics next to price.)

#### DISK DRIVES

Alopa AP-100A Dual Apple Drives in One Case \$309.00* (7.00)	Apple MAC 400KB External Drive 349.95* (7.50)	Corvus 5.25MB Hard Drive 938.00* (20.28)	Omiga Macintosh 5MB Removable Drive for Macintosh 1,250.00* (27.00)	Micro Sci. A2 1.4MB Drive 150.00* (5.00)	Just like Apple's Own 55.00* (2.50)	Micro Sci. Floppy Controller 750.00* (16.20)	Paradise Mac 20MB Hard Drive Subsystem 950.00* (20.52)	Paradise Mac 10MB Hard Drive 95.00* (2.50)	Rana Elite II 163K Drive 225.00* (5.00)	Teclar 5MB Removable Drive for MAC 999.00* (21.58)	Teclar 10MB MAC Drive 999.00* (21.58)	Teclar 5MB MAC Drive Upgrade 1,235.00* (26.68)
--	---	--	---	--	-------------------------------------	--	--	--	---	--	---------------------------------------	--

#### BOARDS AND BUFFERS

ALS Z-Engine \$115.00* (2.50)	AST* Multi I/O - 2 Serial Clock 155.00* (2.50)	Microsoft Premium SoftCard IIe 243.87* (2.50)	Microtek Dumping/CX 55.00* (2.50)	Orange Micro Grappler+ 66.00* (2.50)	Orange Micro Serial Grappler 66.00* (2.50)	PC Network Z80 Card 35.00* (2.50)	Quadram APIC/G Graphics Interface 62.00* (2.50)	Quadram RAM-80 88.00* (2.50)	Quadram Multitrac - 1 Parallel/1 Serial/1 Clock Expandable to 256K 140.00* (2.50)	Thunderware Thunderclock 104.00* (2.50)
-------------------------------	--	---	-----------------------------------	--------------------------------------	--	-----------------------------------	---	------------------------------	---	---

#### MODEMS

Hayes Micromodem IIe w/Smartcom \$125.00* (2.50)	Novation Apple Cat II 174.45* (3.50)	Prometheus 1200 A 276.00* (6.00)	Low Cost 1200 Baud Internal Modem for Apple II. 299.00* (6.00)	Prometheus Promodem 1200 w/Mac Pack 95.00* (2.50)	Z8000 Modem IIe 95.00* (2.50)	Micromodem Compatible-Free Dow Jones 8.25* (1.50)
--	--------------------------------------	----------------------------------	--	---	-------------------------------	---

#### ACCESSORIES

Apple Macintosh Carrying Case \$69.00* (1.49)	Apple Macintosh Security Kit 29.00* (1.50)	Apple Macintosh Numeric Keypad 69.00* (2.50)	Hayes Mac II Joystick 31.00* (1.50)	w/Free Button for IIc 8.25* (1.50)	Kensington Dust Cover for MAC or imagewriter 54.00* (3.00)	Kensington Surge Protector 33.47* (2.50)	Kensington System Saver Fan 56.97* (1.50)	Koala MacVison 158.00* (3.00)	Koala Keypad Touch Tablet 78.00* (1.50)	M&R Sup-R-Mod RF Modulation 44.00* (1.50)	PC Network Cooling Fan with Surge Protector & Dual Outlets 25.00* (2.50)	PC Network SS/DD Disks (Box of 10) 7.95* (1.50)	PC Network Macintosh Disks (Box of 10) 15.95* (1.50)	These Disks are Guaranteed for Life! No Generics! Sony MAC Disks (Box of 10) 19.00* (1.50)
---	--	--	-------------------------------------	------------------------------------	--	--	---	-------------------------------	---	---	--	---	--	--

### GAMES & EDUCATIONAL SOFTWARE FOR YOUR IBM

(Please add \$1 shipping and handling for each title ordered from below.)

Wholesale	Wholesale
ATI Intro to PC DOS Vol. I & II \$23.00*	Infocom Deadline, or Suspended 25.00*
ATI Intro to BASIC 23.00*	Microsoft Flight Simulator 27.00*
Blubbush Chess (Your Toughest Opponent) 34.00*	Mouse Systems PC Pain! - Turn your PC into a Color Macintosh! 59.95*
Bluechip Millionaire Oil Bar or Tycoon 28.25*	Scarborough MasterType 26.50*
Broderbund Love Runner 19.75*	Sierra On-Line King's Quest II 25.00*
CBS Goren-BrIDGE Made Easy 40.00*	Spectrum Holobyte GATO 18.00*
CBS Mastering the SAT 50.00*	*Spinaker Alphabet Zoo, Kinder Comp, Story Straching, Face Maker, Hey Diddle, Diddle, Rhymes & Riddles 15.97*
CDEX Training for Word Star 37.25*	*Spinaker Delta Drawing 24.97*
Comprehensive Intro to Personal Computing 32.00*	*Spinaker Most Amazing Thing 20.77*
Davidson Math Blaster, Word Attack! 28.50*	Sublogic Night Mission Pinball 20.00*
Davidson Speed Reader II 36.50*	Virtual Combinatics Micro Cookbook 21.00*
Hayden Sargon III 25.75*	
Individual Professor DOS 32.50*	
Individual The Instructor 24.50*	
Infocom Zork I or Witness 20.00*	

### BUSINESS SOFTWARE FOR YOUR IBM

(Please add \$2.50 shipping and handling for each title ordered from below.)

Ashion-Tate DBase II \$65.00*	MicroPro Wordstar 2000 \$219.00*
Ashion-Tate Framework II 365.00*	MicroPro Wordstar 2001+ 282.00*
Borland Turbo Pascal 25.75*	MicroRim RBase 5000 300.00*
Borland Sidekick (Protected) 26.00*	Microsoft C Compiler 220.00*
Borland Superkey 32.00*	Microsoft Word - Latest Version 2.0 202.00*
BPI GL, A/R or A/P 305.00*	Microsoft Multiplan 101.00*
BPI Java 265.00*	Microsoft Mouse 107.00*
BPI Personal Accounting 48.00*	Monogram Dollars & Sense 95.00*
Breakthrough Timeline 230.00*	Multimate Multimate (Latest Version) 190.00*
Central Point Copy II PC 20.00*	Norton Norton Utilities 3.0 46.00*
Conceptual Instruments Desk Organizer 157.00*	Oracle The Word Plus 75.00*
Digital Research DR Logo 75.00*	Open Systems P/S A/R INV G/L A/P 275.00*
Digital Research Gem Desktop 25.00*	Team Wax 107.00*
Digital Research Gem Draw 73.00*	Real World G/L A/P A/R or OE/INV 197.00*
Energetics Energraphics 155.00*	Roseport ProKey Version 3 65.00*
Funk Software Sideways 32.00*	Ryan McFarland RM COBOL (Dev. System) 520.00*
Harvard Harvard Project Manager 175.00*	Sanna Samra II Word Processor 227.00*
Harvard Total Project Manager 225.00*	*Semna Word 320.00*
Human Edge The Management Edge 137.50*	*Satellite Software Word Perfect 190.00*
Human Edge The Sales Edge 110.00*	Softcraft Fancy Fonts 125.00*
Human Edge Mind Prober 24.00*	Software Arts TK Solver 200.00*
Infocom Conversion 242.00*	Software Publishing PFS: File, Write, Graph 68.00*
Lilfreed Mailwriter III 135.00*	Software Publishing PFS: Report 169.00*
Lotus Development Lotus 1-2-3 285.00*	Sorcim SuperCalc III 169.00*
MDS KnowledgeGen 2 295.00*	Xanaro Ability 247.50*

### HARDWARE FOR YOUR IBM

(Please add shipping and handling charges found in italics next to price.)

Wholesale	Wholesale
Omiga Bernoulli Box \$2,149.00* (46.12)	Everex Evercom II 1200 BPS Short Slot 120.00* (2.50)
Dual 10MB Drives 330.00* (7.13)	Everex Evercom II 1200 BPS Short Slot 120.00* (2.50)
PC Network 10MB INTERNAL Height 330.00* (7.13)	Compatible Modem 312.00* (2.50)
Autoboot Drive: New lower price Drives by Shugart or Tandem 395.00* (8.94)	Hayes Smartmodem 1200B with New Smartcom II V1700 Emulator 225.00* (2.50)
PC Network 10MB Tape Backup Same unit used in Compaq's DeskPro 1,155.00* (24.95)	Prometheus Promodem 1200B Internal 225.00* (2.50)
PC Network AT 42MB Internal Hard Disk 35MS Access Time - Comes Complete 495.00* (10.69)	Quadram Quadmodem II 1200 Baud Hard Card w/CrossTalk XVI 275.00* (2.50)
PC Network 20MB Tape Backup Half Height Internal w/Controller 95.00* (2.27)	
PC Network Half Height DS/DD Drives 93.00* (2.20)	
Tandon TM 100-2 Full Height DS/DD Drives 2,250.00* (48.60)	
Talagross 25MB External Hard Disk with 60MB Tape Backup	

#### MULTIFUNCTION CARDS

Apparat AT Ram Expansion Card \$139.00* (2.50)	Hercules Color Card w/Parallel Port \$142.00* (2.50)
AST* SixPakPlus™ With 64K 195.00* (2.50)	Hercules Monochrome Graphics Card 263.00* (2.50)
AST* I/O Plus II™ 120.00* (2.50)	Paradise Modular Graphics Card 219.00* (2.50)
AST* Advantage for AT™ 355.00* (2.50)	PC Network Hercules Mono Card Clone 99.00* (2.50)
Everex Magic Card/Kit 160.00* (2.50)	100% Hercules Compatible 69.00* (2.50)
PC Network 32K Memory Board w/OK 59.00* (2.50)	PC Network Color Card 299.00* (2.50)
PC Network The Multi-384 Board 79.00* (1.10)	Persyst Bob Card Ultra High Res Color 199.00* (2.50)
A clone of the AST's™ SixPakPlus™ includes up to 384Kb of expansion memory, 1 serial, 1 parallel, 1 game clock/calendar, and software standard.	*STB Graphix Plus II (Simultaneous on Graphics & Color) 99.00* (2.50)
PC Network I/O Plus II Clone 65.00* (2.50)	
Seri/Par Game/Clock standard 170.00* (2.50)	
Quadram Improved Quadboard w/OK 146.00* (2.50)	
Teclar Captain Multifunction Card w/OK	

#### VIDEO CARDS

Hercules Color Card w/Parallel Port \$142.00* (2.50)	Hercules Monochrome Graphics Card 263.00* (2.50)
Paradise Modular Graphics Card 219.00* (2.50)	PC Network Hercules Mono Card Clone 99.00* (2.50)
100% Hercules Compatible 69.00* (2.50)	PC Network Color Card 299.00* (2.50)
Persyst Bob Card Ultra High Res Color 199.00* (2.50)	*STB Graphix Plus II (Simultaneous on Graphics & Color) 99.00* (2.50)

#### ACCESSORIES

Brand Name DS/DD Disks Guaranteed for Life! No Generics! \$8.95* (1.00)	DS/DD Bulk Rate Special 59.95*
Package in 50 with sleeves and labels. Guaranteed for Life!	
PC Network Replacement 130 Watt IBM PC Power Supply - Gives your PC the same Capacity as an XT. Good for add in tape Drives (without need for a piggyback unit) and large capacity disk drives.	70.00* (2.70)
SMA PC Document-Keybord Templates for Lotus/DBase/Multimate and others (Each)	9.99* (1.00)

### MEMORY CHIPS

(All Memory Chips Guaranteed for Life!)

64K Memory Upgrade Kits (9 Chips) Quantity Discounts Available! \$7.55* (1.00)	64K Dynamic Ram Chips (Each) .85* (1.00)	256K Dynamic Ram Chips (Each) 2.25* (1.00)	128K IBM AT Piggyback Chips (Each) 5.50* (1.00)
--	--	--	---

### EXTERNAL MODEMS

Anchor Signalman Express \$205.00* (5.00)	Hayes Smartmodem 300 125.00* (5.00)	Hayes Smartmodem 1200 340.00* (5.00)	Hayes Smartmodem 1200B with new Smartcom II V1700 Emulator 315.00* (2.50)	Hayes Smartmodem 1200B Alone 355.00* (5.00)	Hayes Smartmodem 2400 275.00* (6.00)	Prometheus Promodem 1200 275.00* (6.00)	U.S. Robotics Courier 2400BPS Modem 395.00* (5.00)	U.S. Robotics Password 195.00* (4.00)
---	-------------------------------------	--------------------------------------	---	---	--------------------------------------	---	--	---------------------------------------

### LOWEST PRICE! 1200BPS Modem!

### MONITORS

Amdek Video 300A Composite Green \$110.00* (3.00)	Amdek Video 300G Composite Amber 120.00* (3.00)	Amdek Video 310A IBM Type Amber 130.00* (3.00)	Amdek Color 300 NEW Composite 215.00* (4.64)	Amdek Color 600 NEW High Res RGB 365.00* (7.88)	Amdek Color 700 NEW Ultra High Res 455.00* (8.83)	Amdek Color 710 NEW 700 w/Non Glass Long Phosphor 475.00* (10.48)	Princeton HK 12 RGB Monitor 399.00* (8.62)	Princeton MA-A Tpe 156.00* (5.00)	Work with Color or Mono Card! 289.00* (6.24)	Quadram Quadchrome II New! 640X200 RGB w/14" Screen! Black, Phosphor Mask/IBM Case 85.00* (5.00)	*Samsung 12" TTL IBM Type Amber A great looking/performing monochrome from the manufacturer of IBM's own color monitor. 85.00* (5.00)	Taxan 640 Super Hi Res RGB Currently available works with Persyst Bob Card 495.00* (10.69)	Zenith ZVM 1230A Green Hi Res! Non Glare 81.00* (1.75)
---	---	--	--	---	---	---	--	-----------------------------------	--	--	---	--	--

### TERMS & CONDITIONS

PC NETWORK - Members pay just 8% above the wholesale price, plus shipping. All prices reflect a 3% cash discount. Minimum shipping \$2.50 per order. International orders call for shipping & handling charges. Money Orders, personal and company checks please allow 10 working days to clear. All prices subject to change without notice.  
 †RENT BEFORE YOU BUY - Members are eligible to join The Network's Business and Game software Rental Libraries and evaluate products for a full 14 (Regular) or 30 (VIP) days to see if it meets your needs. And The Network's rental charges are far less than other software rental services - Just 20% OF THE MEMBER WHOLESALE PRICE. Rental titles available in IBM/Apple/MAC and CP/M Formats. Hardware prices highlighted by \* reflect recent major price reductions.

### COMPLETE SYSTEMS

Apple Macintosh Base Systems CALL	Compaq Hard Disk Portable 10MB Hard Disk/Floppy/256K IBM PC Base System 205DD/FDCI/256K 1,325.00* (30.78)
AT AT 6300 PC CPU2 \$1,575.00* (34.02)	IBM PC Professional Hard Disk 1,685.00* (36.91)
AT AT 7300 Unix PC 3,699.00* (79.90)	IBM PC AT Base System - 1.2MB Floppy/256K 2,795.00* (60.37)
10MB Hard Disk I/Floppy/512K CO/MS-DOS/20MB Tape Backup System 2,446.00* (63.70)	IBM AT Professional System 1.2MB Floppy/20MB Hard Disk I Ser I Par/512K CALL

### PRINTERS

Citizen MSP-10 NEW! 160CPS/80COL/Fric + Trae \$265.00* (5.72)	NEC 3530 33CPS LQ Letter Quality Pmntor \$ 888.00* (19.18)
Citizen MSP-120C/Fric + Trac 350.00* (7.56)	NEC 3550 33CPS Letter Quality Pmntor 820.00* (17.87)
Citizen MSP-20 NEW! 160CPS/132COL/Fric + Trac 350.00* (7.56)	NEC 8050 58CPS Printer 1,330.00* (28.73)
Citizen MSP-25 NEW! 200CPS/80COL/Fric + Trac 499.00* (10.76)	NEC 9000 New Color Dot Matrix 599.00* (12.93)
Citizen Premier 35 NEW! 35CPS Daisley/Intel/132COL/Fric + Trac 385.00* (8.32)	Okidata ML 182 New 120CPS/LQ Model/Fric/IBM Graphics + more 1,685.00* (36.91)
Epson LX-80 100CPS 80COL LQ Mode New Model!! 199.00* (4.30)	Okidata ML 192 New Sleek Design! 160CPS/LQ Model/Fric/IBM Graphics CALL
Epson FX-85 299.00* (6.48)	Okidata OK 200CPS/LQ + more Colors/LQ Model/IBM Graphics + more (Requires Interface) CALL
Epson FX-286 NEW! 450.00* (9.91)	Okidata IBM Interface for Okidata C-20 2.00*
Epson LO1000 NEW! 180 CPS/60 CPS NLO 599.00* (12.94)	Okidata ML 84P 200CPS 132COL CALL
Epson SQ2000 NEW! Inkjet Printer 1,399.00* (29.35)	Okidata ML 93P 160CPS Wide Platen CALL
106CPS LQ Model I/Floppy/132COL 569.00* (12.29)	Okidata 2410P Pacemaker 350C/LQ CALL
Epson DX-35 35CPS Letter Quality Printer 605.00* (13.00)	Quime Sprint 1140 40CPS Letter Quality 1,155.00* (24.00)
NEC 2030 20CPS LQ Parallel 605.00* (13.00)	Star Micros Power type 16CPS 300.00* (6.48)
NEC 2050 20CPS Letter Quality Printer 605.00* (13.00)	Toshiba P1340 80COL/140CPS 430.00* (9.29)
	Toshiba P341 New! 210CPS/132COL 699.00* (15.09)
	Toshiba P351 New! 288CPS/132COL 975.00* (21.06)



# COMPLETE SYSTEMS

(Optional local warranty service available in most major metro areas)

## IBM PC BASE SYSTEM

IBM PC w/256K  
Floppy Drive Controller  
2 Double Sided Double  
Density Disk Drives  
Mix and Match with  
your Favorite Monitor  
and Printer!

**\$1,325.00\***

CALL FOR  
LATEST IBM  
ANNOUNCEMENTS

New Lower Prices!



## IBM PC HARD DISK SYSTEM

IBM PC w/256K  
Floppy Drive Controller  
1 Double Sided Double  
Density Disk Drive  
Half Height 10MB  
Disk Subsystem

**\$1,685.00\***

CUSTOM  
CONFIGURATIONS  
WELCOME

# COMPAQ™

## PORTABLE HARD DISK SYSTEM

w/256K/1 Floppy/ 10MB Hard Disk



**\$2,269.00\*** w/20MB  
Call for 10MB

## DESKPRO SYSTEM WITH TAPE BACKUP

640K CPU/1 Floppy/10MB Hard Disk  
10MB Tape Drive/Monitor



**\$2,446.00\*** w/10MB  
**\$2,596.00\*** w/20MB

## APPLE IIc



## APPLE IIe



## MACINTOSH SYSTEMS



## 64K IBM PC MEMORY EXPANSION KITS

Quantity Discounts Available.  
Guaranteed for Life!



Set of 9 Chips **\$6.21\***

## DISKETTES

Guaranteed for Life!  
Brand name diskettes  
available in boxes of 10  
or in bulk packs of 50

**5 1/4" DS/DD**  
**\$8.95\***  
Bx. 10 Bx. 50  
ea. **.59\***

**5 1/4" SS/DD**  
**\$7.95\***  
Bx. 10 Bx. 50  
ea. **.47\***

**3 1/2" SS/DD**  
Bx. 10  
**\$15.95\***  
Free Flip  
& File Case

## 1/2 HEIGHT DS/DD DISK DRIVES



The Network buys direct  
and makes fantastic deals  
with manufacturers like MPI/  
Tandon/CDC/Shugart/Qume/  
TEAC and others to bring you  
fantastic prices on Name  
Brand drives for your PC/AT/  
XT/ir/Compatible.

**\$59.00\***  
Quantity Discounts Available

## INTERNAL PC HARD DISK

Low Power/Automatic Boot. Works on standard PC's  
and Compatibles. Includes drive/controller/cables/  
mounting hardware and instructions.

Full one year warranty!



**10MB**  
**\$330.00\***  
**20MB**  
**\$410.00\***  
Quantity Discount Available



**\$285.00\***

## Word Perfect

**\$190.00\*** ea.  
**Multimate™**

\*Members pay 8% above this wholesale price plus shipping.

CALL TOLL FREE 1-800-621-S-A-V-E (orders and memberships)

In Illinois call (312) 280-0002 Validation code: B336

Customer Service and Order Status (312) 280-1567

TM & R—Registered trademarks of IBM/COMPAQ/APPLE/AST Research/LOTUS/Multimate Int./IOWEGA. Inquiry 264

# PC NETWORK

GET THE NETWORK ADVANTAGE!!!

SEE WHY OVER 100,000 HAVE JOINED  
MAKING US THE NATION'S #1 SOURCE  
FOR EVERYTHING IN COMPUTING...

- **Our 600 Page Wholesale Catalog**  
Over 30,000 products priced at Wholesale + 8%. Anything you will ever need at a Consistent low price...
- **Quarterly Catalog Updates**  
Your Catalog is never obsolete! Keep on top of the newest products and latest price changes.
- **The Printout**  
Our newsletter gives you fantastic specials along with unbiased analysis of new products and industry trends.
- **10 Day Returns on any Hardware!!**  
If you don't like any hardware product—for any reason—return it for a refund.
- **1000 + Title Rental Library**  
14 to 30 day rentals on over 1000 different titles. Try before you buy!!
- **Size-Strength and Stability**  
The Network has over 100 employees, 40,000 square feet of office and warehouse, inventory valued in excess of \$15,000,000 and is ranked the largest computer product supplier in the Nation!! Our commitment is to serve our customers and our 90% repeat business rate is proof!!

## CALL TOLL FREE 1-800-621-S-A-V-E

(Orders—Membership and Advice!)

In Illinois call (312) 280-0002

Your Membership Validation Number **B336**

You can validate your membership number and, if you wish, place your first money-saving order over the phone by using your VISA, MASTERCARD or AMERICAN EXPRESS. Our knowledgeable sales consultants are on duty Mon.-Fri. 8:00 AM to 7:00 PM, SAT. 9:00 AM to 5:00 PM CST.



**PERSONAL COMPUTER NETWORK**  
320 West Ohio  
Chicago, Illinois 60610

Call now...Join the PC NETWORK and start saving today!  
Customer Service and Order Status (312) 280-1567  
8:30 AM to 4:30 PM, Mon.-Fri. CST



## PC NETWORK • MEMBERSHIP APPLICATION

**YES!** Please enroll me as a member in the PC NETWORK™ and rush my catalog featuring thousands of computer products, all at just 8% above DEALER WHOLESAL PRICES. I will also periodically receive "THE PRINTOUT", a special up-date on merchandise at prices BELOW even those in my wholesale catalog, and all the other exclusive, money-saving services available to Members.

**B336**

I am under no obligation to buy anything. My complete satisfaction is guaranteed. Please check (✓) all boxes that apply:

### Basic Membership With 14 Days Rental

- One-year membership for \$8
- Two-year membership for \$15 (SAVE \$1)
- Business Software Rental Library for \$25 add'l. per year—with 14 day rentals
- Games Software Rental Library for \$10 add'l. per year

### Special V.I.P. Membership With 30 Days Rental.

- One-year membership for \$15
- Two-year membership for \$25 (SAVE \$5)
- BOTH Business and Game Software Rental Libraries for \$30 add'l. per year—with 30 day rentals
- \*VIP members receive advance notice on limited quantity merchandise specials

Bill my credit card:  VISA  MasterCard  American Express

Account Number:

Exp. Date: \_\_\_\_\_  
mo. year

Check or money order enclosed for \$ \_\_\_\_\_

Name: \_\_\_\_\_

Address: \_\_\_\_\_ Apt. No. \_\_\_\_\_

City: \_\_\_\_\_ State: \_\_\_\_\_ Zip: \_\_\_\_\_

Telephone ( ) \_\_\_\_\_

My computer(s) is:  IBM PC  IBM-XT  IBM-AT  Apple II  
 Macintosh  Other \_\_\_\_\_

Signature: \_\_\_\_\_  
(Signature required to validate membership)

Copyright © 1985, PC NETWORK INC.

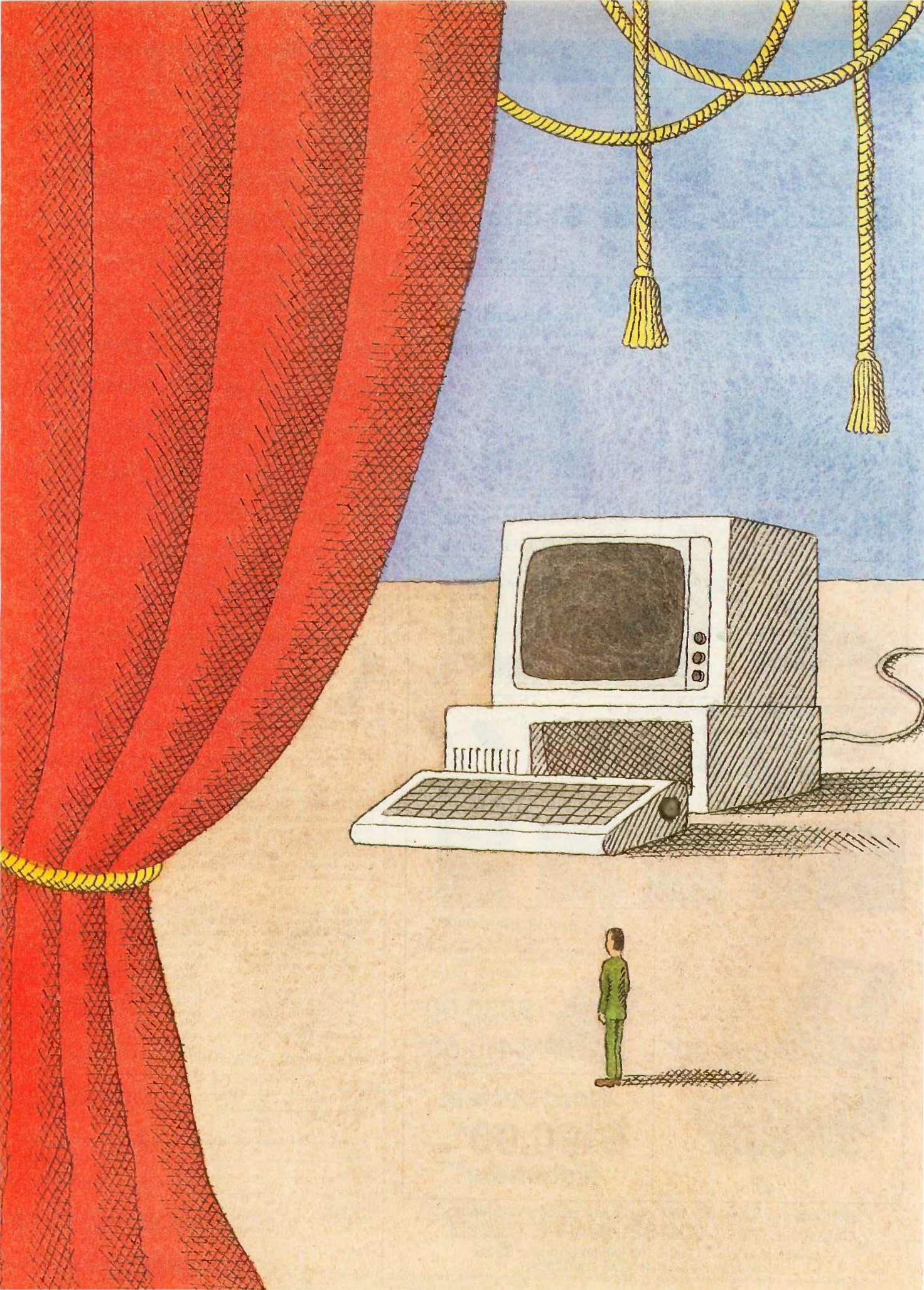

# Features

---

<b>PRODUCT PREVIEW: THE ATARI 1040ST</b> <i>by Phillip Robinson and Jon R. Edwards . . . .</i>	<b>84</b>
<b>FINDING THE TITANIC</b> <i>by Marti Spalding and Ben Dawson . . . . .</i>	<b>96</b>
<b>CIARCIA'S CIRCUIT CELLAR:</b>	
<b>REAL-TIME CLOCKS:</b>	
<b>A VIEW TOWARD THE FUTURE</b> <i>by Steve Ciarcia . . . . .</i>	<b>112</b>
<b>PROGRAMMING PROJECT:</b>	
<b>A SIMPLE WINDOWING SYSTEM,</b>	
<b>PART I: BASIC PRINCIPLES</b> <i>by Bruce Webster . . . . .</i>	<b>128</b>
<b>AN ANSI STANDARD</b>	
<b>FOR THE C LANGUAGE</b> <i>by Steve A. Hersee and Dan Knopoff . . . . .</i>	<b>135</b>
<b>PROGRAMMING INSIGHT:</b>	
<b>MACINTOSH EXPLORER</b> <i>by Olav Andrade . . . . .</i>	<b>145</b>

---

THIS MONTH, BYTE PRESENTS a preview of Atari's new \$999 1-megabyte machine—the 1040ST. Although the system is similar to Atari's 520ST, it has twice the memory capability, an internal double-sided disk drive, an empty socket for a graphics coprocessor, and it is the first computer to begin its retail life at a cost of less than one dollar per kilobyte. The article also includes an interview with Shiraz Shivji, Atari's vice president of research and development, who discusses the company's plans for the future.

In "Finding the Titanic," Marti Spalding and Ben Dawson take a look at the state-of-the-art image-processing equipment used in the underwater exploration that located the sunken *Titanic*. The ship was lost in the Atlantic for 73 years until teams of French and American researchers, with millions of dollars worth of equipment, were able to pinpoint the wreck.

In Ciarcia's Circuit Cellar, Steve offers us a choice of real-time clocks. The first one uses a CMOS chip that you attach to the computer through parallel ports. This conventional approach appeals to those who want a quick resolution of a problem. The second clock uses a unique concept that Steve believes will prevail long into the future. It uses a new clock "socket" that requires no independent interfacing and merely plugs in with a static-RAM chip.

The Programming Project is the first of a two-part article by Bruce Webster. Bruce mentions that windowing systems can be and have been implemented on most of the more "mundane" computers. The goal of his article is to show you how to do this. In Part I, Bruce covers basic principles and examines the problems involved in opening a window.

As C has become more popular among developers and programmers, it has become necessary to establish a standard to keep C programmers working with the same language. "An ANSI Standard for the C Language," by Steve A. Hersee and Dan Knopoff, describes the standard that has been proposed by the ANSI Standardization Committee and invites participation in establishing the standard.

This month's Programming Insight describes a disassembler program. In "Macintosh Explorer," Olav Andrade explains that when using a Macintosh he discovered that the Toolbox/Operating System routines would be vital to his applications. His problem was that he needed to know how the Toolbox calls were made and Macintosh Explorer was his solution. It is written in Microsoft BASIC for the Macintosh.

# THE ATARI 1040ST

## A megabyte of memory for \$999

*Editor's note: The following is a BYTE product preview. It is not a review. We provide an advance look at this product because we feel that it is significant. A complete review will follow in a subsequent issue.*

**A**tari's new \$999 1-megabyte 1040ST (see photo 1) establishes a price break reminiscent of the Commodore 64's. And, as table 1 shows, the 1040ST will be the first computer to begin its retail life at a price that represents less than one dollar per kilobyte. The 1040ST is clearly a bargain, with over 1 megabyte of RAM (random-access read/write memory), its operating system in ROM (read-only memory), an internal 720K-byte double-sided drive, an internal power supply, and the same features and functionality that already make the Atari 520ST an attractive purchase. [Editor's note: See "The Atari 520ST" by Jon R. Edwards, Phillip Robinson, and Brenda McLaughlin, January BYTE, page 84.]

### SYSTEM DESCRIPTION

Our coverage of the 520ST adequately describes most of the features of the 1040ST (see also the "In Brief" box on page 86). The new computer has the same keyboard, the same ports (although these are now in new locations, see photo 2), and the same architecture. We remain uncomfortable with the keyboard, but the keytops are removable. We suspect that

some speedy entrepreneur will provide alternative tapered keys for the ST machines.

The most obvious changes are cosmetic: The keyboard/computer unit is 2 inches deeper and 4½ pounds heavier than the 520ST, and the keyboard provides a much more substantial feel. The mouse/joystick ports are now located under the bottom right front of the unit, a significant improvement for left-handed users.

A number of changes are more than cosmetic. The internal power supply eliminates two of the external power supplies needed by the 520ST (wire haters rejoice). We left the unit on for five days and experienced no difficulties with overheating. There is no internal fan, but the unit appears to adequately dissipate heat. The internal disk drive supports both single- and double-sided disks. An RF (radio frequency) modulator will allow you to hook up the 1040ST to a television set; you might, therefore, obtain the high-resolution monochrome system for word processing and programming without sacrificing the use of low- and medium-resolution color. However, we received a preproduction unit lacking the RF modulator that will accompany the final product; therefore, we were unable to test the television quality of the computer's output.

The megabyte of RAM in the 1040ST isn't crammed into the case. The 520ST uses a custom Memory Controller chip to handle its sixteen 256K-byte dynamic RAM chips. The 1040ST uses the same Memory Controller. Because the controller can handle 32 RAM chips at a time, the

Atari engineers simply had to find room for 16 more 256K-byte dynamic RAMs on the 1040ST circuit board to pump RAM capacity to a full megabyte (see photo 3). In fact, the Memory Controller can also govern 1-megabit dynamic RAM chips. Atari should have little difficulty designing an ST with 4 megabytes of memory.

Undoubtedly, the most interesting addition to this computer, apart from the extra memory, will be an empty socket for a graphics coprocessor. Our preproduction unit also did not include the socket, and it may not be offered with the first releases of the 1040ST. Phil Robinson discussed this and Atari's future plans with Shiraz Shivji, vice president of research and development for the company (see the text box "An Interview with Shiraz Shivji" on page 90).

### TOS IN ROM

With TOS (the operating system for both the 520ST and the 1040ST) in ROM, the 1040ST boots more quickly than the 520ST. [Editor's note: Atari is currently supplying the ROM chips to 520ST developers and will be making the chips available through users groups.] Booting with a nonsystem disk takes less than 6 seconds, down from 37

(continued)

Phillip Robinson is a senior technical editor, and Jon R. Edwards is a technical editor for BYTE. They can be contacted at BYTE, POB 372, Hancock, NH 03449.



Photo 1: *The Atari 1040ST.*

**IN BRIEF****Name**

Atari 1040ST

**Company**

Atari Corp.  
1196 Borregas Ave.  
Sunnyvale, CA 94086  
(408) 745-2000

**Price**

With monochrome monitor, \$999  
With color monitor, \$1199

**Microprocessor**

Motorola 68000, a 32-/16-bit microprocessor (32-bit internal architecture with 24-bit, nonsegmented, external data bus) running at 8 MHz

**Main Memory**

1024K bytes of dynamic RAM

**ROM**

192K-byte TOS in ROM, not including the desktop accessories

**Graphics**

Three modes: 640- by 400-pixel monochrome, 320 by 200 with 16 colors, and 640 by 200 with 4 colors

**Sound**

Three independent sound channels from 30 Hz to 125 kHz

**Floppy-Disk Drive**

Internal 3½-inch double-sided double-density drive with capacity of 720K bytes. System supports maximum of two floppy-disk drives.

**Keyboard**

94-key Selectric-style QWERTY keyboard with numeric keypad, cursor controls, and rhomboid function keys

**Interfaces**

MIDI in and MIDI out ports  
Monitor port (supports RGB analog, high-resolution monochrome)  
RF modulator  
Centronics parallel printer port (supports Epson-compatible printers)  
RS-232C serial port  
Floppy-disk port  
Hard-disk port (10-megabit-per-second DMA transfer rate)  
128K-byte ROM cartridge port  
Ports for mouse or two joysticks

**Bundled Software**

Atari Logo  
ST BASIC

**Optional Peripherals**

SF354 single-sided drive  
SF314 double-sided drive

**Planned Expansion**

Graphics coprocessor, SMM801 dot-matrix printer, SDM121 daisy-wheel printer, 10-megabyte fixed disk, 8-slot expansion interface, CD-ROM, local-area network for MIDI port

seconds on the 520ST. After booting, the color system displays blue and yellow crossbars instead of the multicolor display shown on the 520ST. The desktop icon also appears in much brighter green on the 1040ST, which Neil Harris of Atari explains is more effective on color television screens for those who will make use of the RF modulator.

Although it increases the time to 17 seconds, you may prefer to boot with a nonsystem disk that includes the desktop accessories. By so doing, you can maintain access to the Control Panel (to change the background color, for example), the RS-232 Port Configuration, and the Install Printer facilities. You also have the option of placing the operating system (38 seconds), and presumably any alternative operating system, into RAM.

The ROM TOS appears to be functionally identical to the first release of TOS in RAM, but there have been some additions. In the interest of supporting business applications, the ROM TOS raises the limit on open files from 30 to 100. A new dialog box informs you if you have insufficient memory to run an application. The earlier versions of TOS simply return you to the desktop. Two new GEM functions, `form__button` and `form__keyboard`, will allow developers to bring up dialog boxes without freezing the current application. You could, for example, postpone your response until you finish a task.

Most of the other changes involved crunching the code from over 200K bytes to 192K bytes (Landon Dyer, software design engineer for Atari, reports that the production ROMs are a mere 14 bytes short of 192K bytes), but there have also been a number of modifications and corrections, many in response to the experiences of ST developers. Early versions of TOS did not allow you to print from the desktop if you set your printer to the serial port. Now you can. Full type-ahead buffers will no longer eat characters. And icon grabbers can take comfort in the fact that rapid movements of icons into the

menu bar can no longer crash the system.

**A SAMPLE SESSION**

We obtained similar results on BYTE's standard benchmark tests for both the 520ST and the 1040ST. Using ST BASIC (see photo 4), both machines ran the Sieve of Eratosthenes in 85 seconds and the Calculations benchmark of 10,000 multiplication and 10,000 division operations in 32 seconds. Both formatted single-sided disks (357,376 available bytes) in 54 seconds. The 1040ST took 102 seconds to format a double-sided disk (726,016 available bytes). It took 16 seconds with the 520ST to transfer a 40K-byte file from one single-sided

drive to another. It took 17 seconds to transfer the same file from the 1040ST's internal drive to an external single-sided drive.

In conducting the tests, we had two small problems. First, when we connected an external single-sided drive and took a directory of the internal drive, the 1040ST appeared to poll both drives. We got the directory we requested, but the fact that the internal drive is so quiet made it seem that we had inadvertently addressed the external drive. The whirring of the external drive was a continual annoyance.

Second, Atari's ST BASIC reserves approximately 160K bytes to buffer graphics, store arrays, and so on. On

the 1040ST, with TOS in ROM and when booting with the desk accessories, you still obtain a workspace in excess of 700K bytes. On the 520ST, with TOS in RAM, we obtained a workspace of only 5K bytes. To run the Sieve, which dimensions an array to 7000 elements, we had to boot without the desk accessories (a savings of about 30K bytes), eliminate graphics buffering (an additional savings of 32K bytes), and dimension the array as an integer array. Using a real array, the 1040ST ran the Sieve in 90 seconds.

**SOFTWARE**

The earliest critics of the 520ST bemoaned the lack of software, but the

*(continued)*

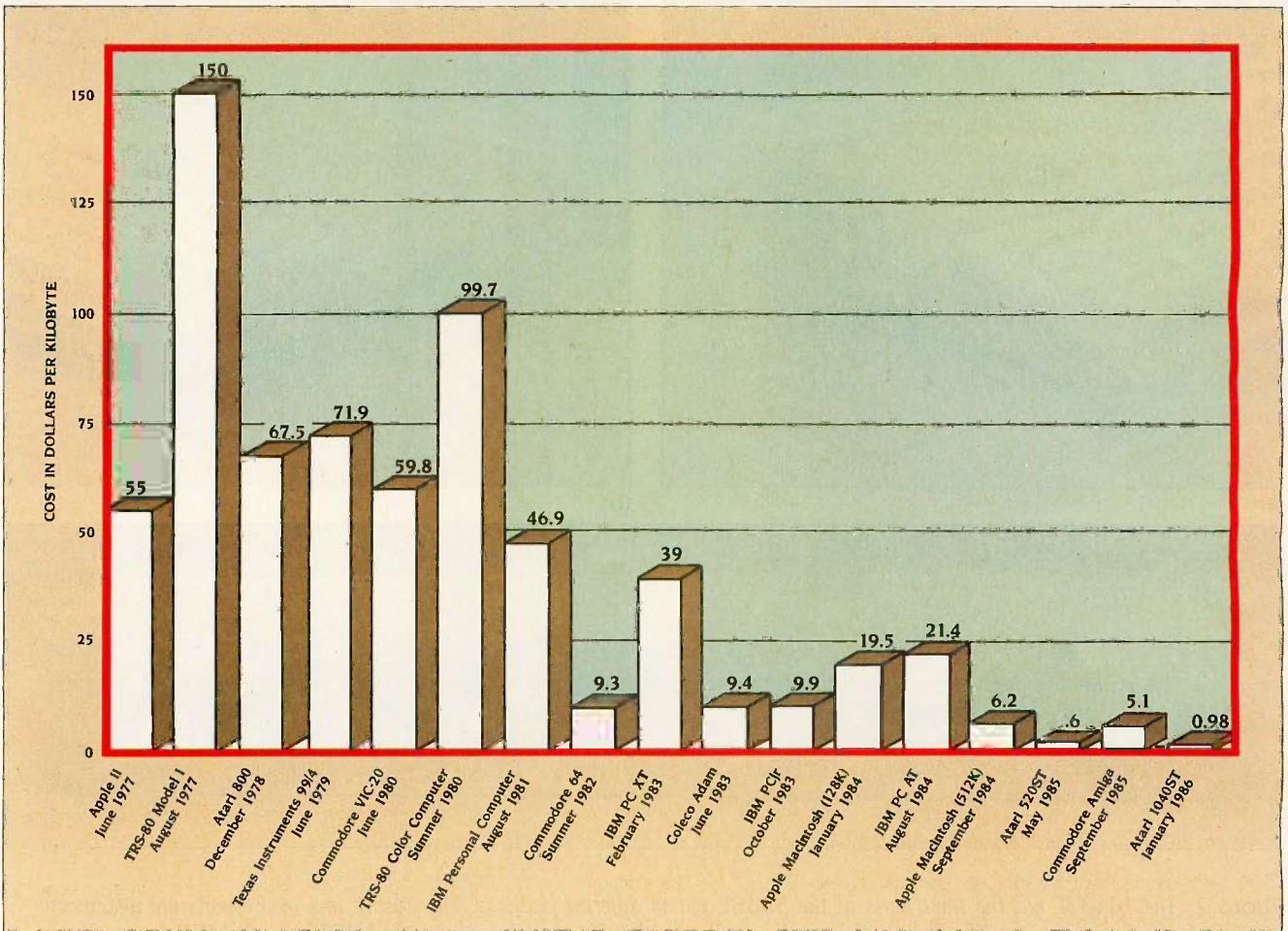

Table 1: The Atari 1040ST is the first computer with an original list price that represents less than a dollar per kilobyte. The price-per-kilobyte figures were determined by using the original list price for each system on the chart. Prices reflect those for the original system configurations; many but not all of the systems were originally bundled with disk drives and monitors.

list of available packages has grown and is still growing. The major criticism left is that most of the early products are ports that don't take advantage of the ST's full capabilities. A significant exception is DEGAS from Batteries Included, a full-featured paint package that makes the color monitor worth having (see photo 5).

For those of you who are anxious for information about available software: Michtron has a variety of utilities for the ST machines, including a printer spooler, a RAM disk, and terminal software. SST Systems has Chat, version 1.2, a terminal program with support for XMODEM. A variety of word processors are available, including Mince and Final Word from

*For some time, the  
Atari 1040ST will be  
the clear leader  
in price/performance.*

Mark of the Unicorn, Express from Mirage Concepts, Haba Writer from Haba Systems, Regent Word from Regent Software, and both 1st Word and ST Writer from Atari. The last of these is in the public domain. DB-Master One from Atari, Hippo Simple from Hippopotamus Software, and Zoomracks from Quickview Systems

are database managers. Regent Software also offers a spelling checker with full GEM features. VIP Systems offers The Professional, a Lotus-like spreadsheet. And XLENT software offers Typesetter ST, which supports DEGAS and Neo formats and Pro-writer, NEC, and Epson printers.

#### CONCLUSION

The 1040ST has a remarkable price, and for some time it will be the clear leader in price/performance. Moreover, the graphics coprocessor chip may convince skeptics to take a second look at the ST. Some of our criticisms of the Atari 520ST remain: The desktop is less effective than the

*(continued)*



(a)



(b)

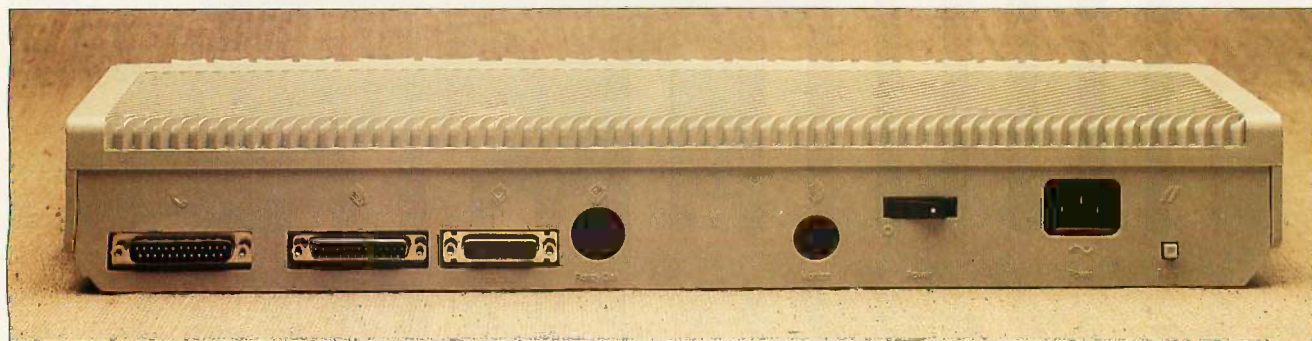

(c)

Photo 2: The 1040ST has the same ports as the 520ST, but in different locations. The joystick and mouse ports are underneath the right front of the unit. (a) The disk drive is on the right side. (b) On the left side are the MIDI out and MIDI in and the 128K-byte ROM cartridge port. (c) From left to right on the back panel are the RS-232C serial port, the 25-pin Centronics parallel printer port, the DMA (hard-disk) port, the floppy-disk port, the monitor port, the on/off switch, the AC power connector, and the reset button.



# ATARI 1040ST

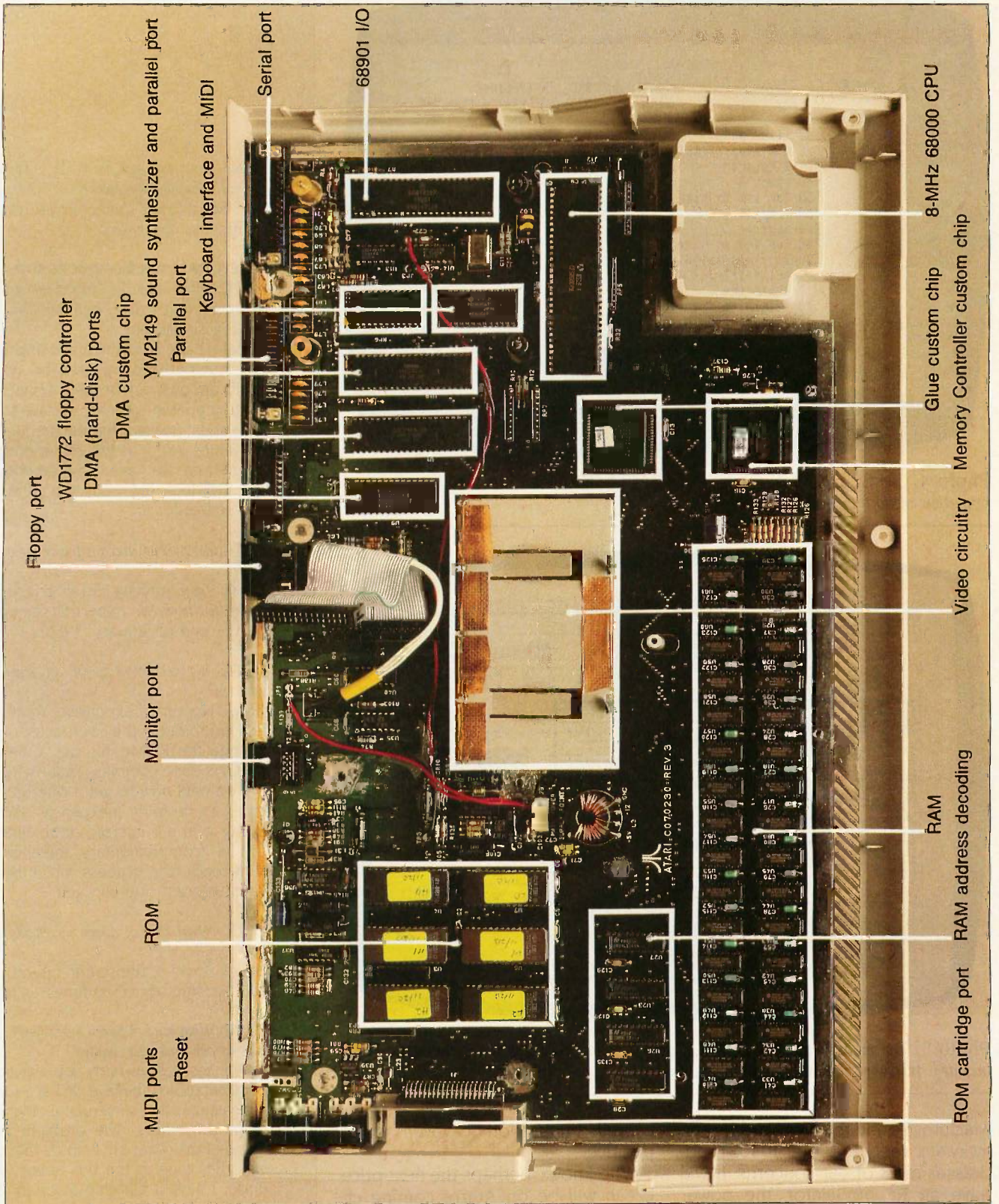

Photo 3: The 1040ST motherboard.

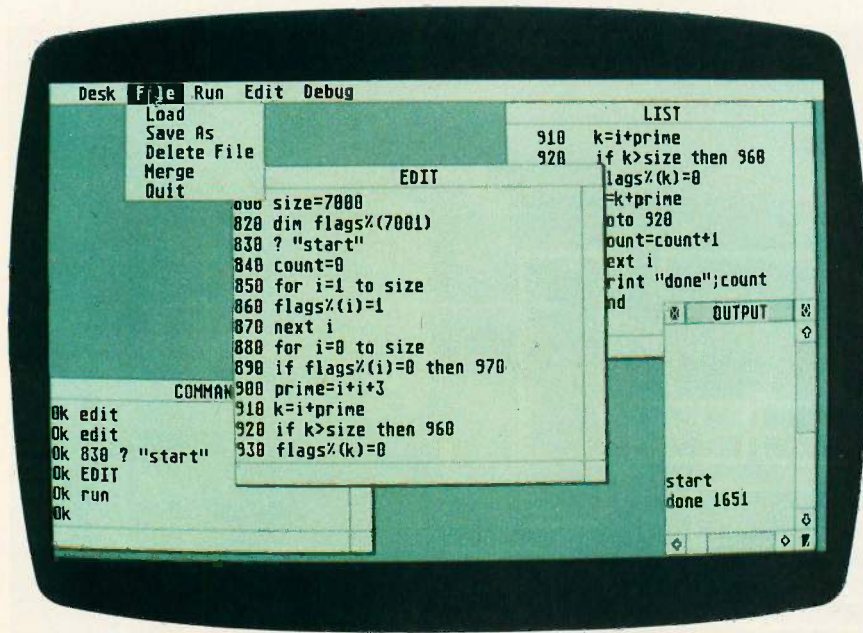

Photo 4: The Sieve of Eratosthenes in ST BASIC. The screen shows the high-resolution monochrome display.

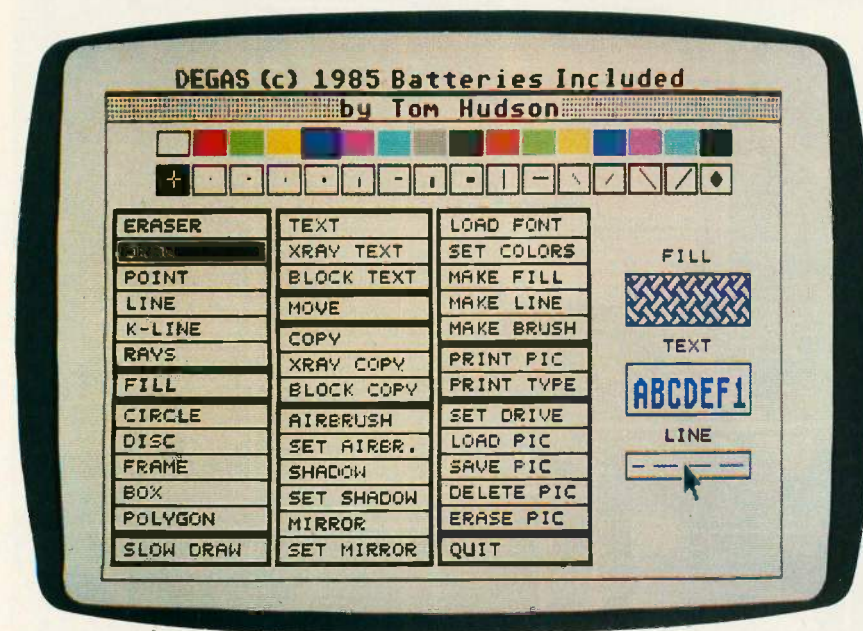

Photo 5: The main menu of DEGAS, a deluxe paint package from Batteries Included, in low-resolution color graphics.

Macintosh's and the keyboard has an awkward feel. But the 1040ST addresses most of our concerns. It will have an RF modulator, the power supply is internal, and TOS is in ROM. And given the outstanding price, our

overall impression is even more positive.

Who knows, perhaps the next price break will be on Atari's coming efforts: 2- and 4-megabyte machines and 640- by 592-pixel graphics.

*Editor's note: This text box contains portions of Phil Robinson's December 1985 interview with Shiraz Shivji, Atari's vice president of research and development.*

**THE GRAPHICS COPROCESSOR**

**BYTE:** Tell us about the graphics coprocessor. When will there actually be a socket waiting for it in the machine?

**Shivji:** That's up to the marketing people, but perhaps by April or May. I really am pushing for the machines to be upgradable—at least to have sockets—and it may not happen in the first machines. As far as the engineering is concerned, we have some artwork in the 1040 footprint ready to go that has the socket for it.

**BYTE:** How far advanced is the design of the chip?

**Shivji:** We're running checks on the layout right now. We expect to see parts by the end of January [1986].

**BYTE:** It's not going to be an expensive addition?

**Shivji:** No, very inexpensive. You'll only need to put in the coprocessor and change the ROMs. It's not a simple part, it's quite complex. That's why we waited until now to get it out. But it's going to be fairly inexpensive. We're doing it in a 2-micron, double-metal CMOS [complementary metal-oxide semiconductor] process, which is the latest process you can get.

**BYTE:** What kind of power will it add and how?

**Shivji:** Some of the screen operations will become about 20 times as fast.

**BYTE:** What kind of screen operations? Like blitting one area over another?

**Shivji:** Yes, it does fairly sophisticated blit operations. I believe we have some nice features that some of the other blit chips don't have. The problem with some of the other blit chips is that the way they glue to the bus is not very good. I have a blit chip from an outside vendor right now that has just

## AN INTERVIEW WITH SHIRAZ SHIVJI

CONDUCTED BY PHILLIP ROBINSON

come out, but the chip needs a lot of glue around it; in fact, it needs external counters and so on. I would say we do as much as what's in the Amiga chip, and we have some things in it that make it nice in the way it fits on the bus. The cleanliness of the architecture is very important to us. It's a 68-pin PLCC [plastic leaded chip carrier] part. It sits on the bus. It's benign unless it's activated, and then it comes over and takes the bus. But again, a lot of the things like the DMAs [direct memory accesses] are not affected because the DMA will preempt the chip; it has the same priority as the processor.

**BYTE:** *How does it share time with the processor?*

Shivji: It takes over stuff from the processor, but it doesn't hog it completely. We allow the processor to have a few cycles.

**BYTE:** *How many gates? Is it a gate array or will it be a fully custom-designed chip?*

Shivji: It will be a fully custom chip. As far as complexity is concerned, I would say it's around 20,000 transistors, so it's medium complexity. One of the things that is important in any design is how you partition things. I feel we have the best partitioning, as good as you can get. And again, it's like the early days of computers where things were hard-wired and the concept of having sub-routines came along. That was a tremendous breakthrough—to be able to modularize stuff. This is what I feel we've done on the ST. We are modular. For example, the blit is completely coordinate-free. We will use the same part in the new version of the ST, which is high-resolution. So, it's nice the way we can do those kinds of things and not have it tied to the machine.

### EMULATING THE IBM PC

**BYTE:** *The V20 board that's in the lab for emulating the IBM Personal Computer—is that experimental?*

Shivji: No. We will actually show it at an upcoming CES [Consumer Elec-

tronics Show]. In fact, we can either run an 8088 or a V20. We're running it at 8 MHz, and we're going through the DMA channel to get the speed for the display.

**BYTE:** *You're going through the DMA channel, so this is going to be an external board in a little box?*

Shivji: It's a self-contained box with its own power supply. It will have quite a bit of its own memory. It has the 8088. It also has an 8253 because a lot of people go directly to the timers in the IBM PC. But the problem in any kind of an emulation is the speed of scrolling things on the screen because you have to effectively reproduce what is being done in the PC environment into something else, and it's very slow. We don't think it will be that slow in the case of the ST. Our graphics modes are a superset of the IBM PC's anyway.

**BYTE:** *Are you using some BIOS [basic input/output system] from an outside source?*

Shivji: Actually, we have the work done on a machine that provides IBM PC compatibility with the 800XL. Initially there was an Atari project that was compatible with the IBM PC, the Apple II, and the 800XL. They eventually abandoned the Apple II compatibility, but they made it compatible with the 800XL. We're essentially following from that effort; we're using a lot of software from that era.

### FUTURE MACHINES

**BYTE:** *Will the next machine be 2 or 4 megabytes?*

Shivji: We are using the base architecture for future machines. We will have a 2-megabyte version out fairly soon, perhaps in the same case. As you know, the chip is designed to handle 1-megabit parts. If 1-megabit parts are in sufficient quantities, then today we can use sixteen 1-megabit parts; that's a 2-megabyte machine. And if you use 32 parts, which the chip is designed to handle. . . .

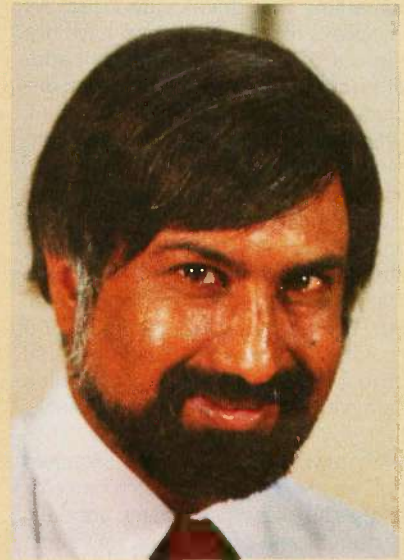

**BYTE:** *You'd just need to have a new board layout, drill new holes.*

Shivji: Yes. And as a matter of fact, it would be easy to upgrade a 1040. . . . 1-megabit parts are 18-pin parts. It would not be that difficult to upgrade your 1040 to make it a 4-megabyte machine by using 1-megabit parts.

**BYTE:** *How would you do that?*

Shivji: You have two banks, you'd have to remove the chips, but you could do it because it's not that difficult. In fact, we have built a prototype with 1-megabit parts.

### CHOICE OF THE 68000

**BYTE:** *About the 68010 and the 68020. You were saying that the 68010 didn't improve ST performance that much.*

Shivji: Not as much. We designed the ST in part as a front end for a compute engine through the DMA channel. That's where we're going to put our compute engine, whatever it is. The people that have bought STs and are buying STs in the future will have the capability of expanding painlessly and using their existing peripherals and everything and get on to a full 32-bit machine such as a 68020.

*(continued)*

**BYTE:** *So you're thinking more in terms of a box out back with a 68020 in it and not of an internal 68020.*

**Shivji:** Yes. We now know how to do a good job in putting a 68000 as part of something that drives video displays in various modes. In fact, we have not run out of steam yet as far as bandwidth of data is concerned for even displays that are 1024 by 1024. We think 1987 is approximately when we might have another generation of machines where the base I/O [input/output] driving the video, and so on, may not be enough, especially if you're talking about 4 to 8 planes of 1024 by 1024. Then you need something like a 68020. But even that is not enough. You couldn't run just raw 32-bits. You would probably have 64- and 128-bit-wide data paths to take care of all the planes that you're talking about.

We have the architecture sketched out; we are doing the custom parts for it. By the way, these parts are fully custom. Some of the chips we've met are really huge. You wouldn't be able to do it even with semicustom. You certainly could not use gate arrays; there's no gate array built at the moment that can handle one of the chips we're talking about. It would be the equivalent of about 25,000 gates. It's also very high speed. We're looking, in some cases, to run things at about 100 MHz.

**BYTE:** *Do you have to go to bipolar then in the custom chips?*

**Shivji:** We will actually have custom chips at 2-micron, double-metal CMOS. But then there's going to be an interface chip to drive external things. The reason we can go to high speeds is because the structures we're using are very regular. There's no loading. Supposing you run a shift register. There's no loading in between cells. All you're doing with a flip-flop cell is driving another cell, and so on. You can get quite a bit of performance if you use such a structure, and we're using a similar structure.

**BYTE:** *And when you're at 2-micron, too.*

**Shivji:** Yeah, 2-micron double-metal is quite fast. So we can run close to 100 MHz, but only on a small section of the chip. Everything is not running at that speed.

## CD-ROMS AND FLOPPIES

**BYTE:** *What about the disk memories? the CD-ROM?*

**Shivji:** We're waiting for audio. The first version of the CD-ROM players was a small unit; the power supply was a separate box. The second batch has a built-in power supply. Now Sony has a third batch, starting around April, which has audio as well as digital. That's the one that we're waiting for. We feel that if a customer spends \$600, he might as well have audio, too.

**BYTE:** *What about the floppies? Is there going to be a change at some point, going to higher densities, 1.2 megabytes?*

**Shivji:** Two megs is almost here. The thing that's going to be important is the media, because it is special media that can handle 2 megs. Some of our Japanese friends who are drive manufacturers are working on a 10-megabyte floppy in the 3.5 format. They think that sometime around mid to late 1986 there will be 10-megabyte drives.

## MULTITASKING

**BYTE:** *What about multitasking? When will that be coming as an option, or do you see that as necessary at all?*

**Shivji:** To get useful multitasking you have to have things like protection, which is not the case in many existing machines. Although we have protected space, as you've noticed, it's not very much. The architecture is there to provide more protection, and in future versions of the machine we may provide a lot more protection.

**BYTE:** *That's why you're looking at the memory-management chips and such?*

**Shivji:** Yes, we're looking at memory-management chips, but doing logical-to physical-address translation is perhaps not as important as the protection feature for multitasking. So we're looking closely into protection. Again, the future versions of the ST architecture could have more; we have only 2K bytes at the moment, and we could probably protect about half a megabyte. And then that would make it a lot easier to run a protected kernel and then multitask.

**BYTE:** *What about UNIX System V?*

**Shivji:** We're looking at System V now.

We're constantly looking at multitasking, and we're constantly getting proposals for a multitasking environment. As a matter of fact, I think it has become a bit of a buzzword. But it is something that people now are looking forward to having in their machines. So with the amount of memory the 1040 has, it will not be out of place to have a multitasking operating system that could run, coexist with TOS perhaps, by at least the third quarter of 1986.

**BYTE:** *What about peripherals? Is Atari going to get in the business of printers and modems and the like?*

**Shivji:** Yes, we have printers. We are working on a modem. We feel that a 1200-baud modem should be inexpensive. There have been a lot of advances in technology (such as the modem chips from Sierra Semiconductor). We hope that around the middle of 1986 we will have something to show.

**BYTE:** *What about higher-end printers? With Atari leading this price/performance curve now, what about laser printers?*

**Shivji:** We started talking to the people, around the time that the laser printers came out from Apple and Hewlett Packard. We have talked to a lot of the manufacturers. We're looking at something that costs about \$1200 retail, but we don't feel that it's really a mass item. Although imagine an ST in an engineering environment where you can get prints.

Yes, we were looking at it. As a matter of fact, the interesting thing is that the cost of building the ST board is so low that we were thinking of using the ST board as a driver for the printer. At 300 dots per inch, if you want to have a full page in the unit, you've got to have about one and a half meg of RAM. And we actually can support more than that. It's something that's in the pipeline. We unfortunately don't have control over the manufacturers. We actually looked at the LCS technology—the liquid-crystal shutter—which is similar to that. Casio uses that. It wasn't quite as good. Nowadays people are also pushing the LEDs [light-emitting diodes]. The company that is farthest along the line of good printers in LEDs is NEC. They have a really nice

## ATARI 1040ST

one. We've been talking to them about getting their engine for quite a while. But right now it's too expensive. We could probably get it down to about \$1500 right now. We're looking more toward \$1200 and then under \$1000.

**BYTE:** *What about sound capabilities?*

**Shivji:** We had a project here started during Alan Kay's tenure—a chip called Amy. And the ST was designed to have the Amy. But the Amy did not happen. We had silicon, the first pass, in October or November, and we had severe problems with it. It was kind of an orphan project. There were a lot of people who had worked on it. And if you have a chip that has six or eight people who have worked on it at different times, chances of the chip working are slim. But it's a good design.

**BYTE:** *What does it do? What's so special about it?*

**Shivji:** The approach of others is that during horizontal-refresh time you go out to some place and put some memory out automatically, and that goes through a DAC [digital-to-analog converter] and you have sound. Essentially you're sampling at 15.75 kHz, which is the typical frequency. So it's like a digital tape recorder. You have a digitized sound and you're just putting it out. And it needs enormous amounts of memory. The key is: How do you encode sound? From an information-theoretic point of view, there are two problems with this approach. One is it's an enormous waste of memory. Because you could encode whatever sound you're going to play, as far as data is concerned in a sound piece, the data rate is extremely low. And doing it in the digital tape recorder way, you're wasting an awful lot of bandwidth and a lot of memory. The second problem with other implementations is that you only have 8 bits and it's not really that good. Especially with CDs coming out.

Amy was a chip that had 16 bits of information coming out. So you could have 96 decibels of range. What you could hear! Amy was a complete digital sound chip. It's called an additive-digital synthesizer. It had an adder and 64 independent oscillators. It has a model for sound and you feed it the

parameters. But if you do that you have to do an awful lot of preprocessing. We had hired a lot of people. We had a VAX 780 devoted to it. We had equipment, fast floating-point array processors, and so on, to analyze notes. We would get a tape of piano playing and then the VAX would analyze it and would take the Amy model and give the parameters. To play anything you only needed to have parameter tables and feed it to the chip.

**BYTE:** *Is it still a possibility then?*

**Shivji:** It is still a possibility. We were going to have the Amy, and then it didn't happen. Then we said, look, we want to have a base machine that's a good machine. Everybody doesn't really care about great sound, right? So let's not penalize people that don't care. Let's put something that will allow people who really care about sound to be able to play things. That's how the MIDI came in. And so if you get Amy, we could even have it out as a MIDI device. It's a great chip. Essentially all you do is you load it up. Off line you're doing an analysis of all the different things, and then you have it in table form. And you can play it any time you want. And you're not using up the bus that much.

**BYTE:** *If it has that kind of processing capability, it could probably build models for voice, too.*

**Shivji:** Exactly. We actually could reproduce opera sound. As a matter of fact, we had a sound lab. The type of sound that you could hear from that chip was just incredible. Again, 16-bit. Actually, the chip could even give you 17 bits if you wanted it to. The two problems are it needs too much memory and it hogs the bandwidth. The bandwidth you could probably get around. However, that's not the whole thing. You still have to move all that data around. Of course you don't get the data at the right place for free. For example, you have to move it somehow from a disk drive.

**BYTE:** *So the Yamaha chip is in there just to give it the basic sound?*

**Shivji:** Yes, just the basic sounds you need. Though, of course, the ports are very useful. ■



# STOP SOFTWARE PIRACY . . .

. . . with one of our new sophisticated copy prevention products.

## NEW

### For Hard Disk Protection

- Fixed Disk Locker

### For Disk Security

High Level Security

- PADLOCK II DISK
- SAFEGUARD DISKS
- COUPON DISKS

Low Level Security

User Installable Protection

- PC-PADLOCK

Why should your valuable data or useful software program become available in the Public Domain?

Call or write for more information.

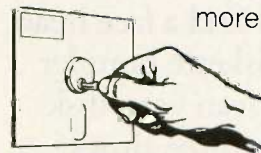

## GLENCO ENGINEERING INC.

3920 Ridge / Arlington Hts., IL 60004

(312) 392-2492

# Don't let debris wo through

In every specially marked box of ten 5¼" 3M diskettes you'll find a free head cleaning diskette sampler kit that'll clean your disk drive heads three times.

Plus a coupon good for a \$2.00 rebate from 3M on your next head cleaning

diskette kit purchase.

Why are we doing this? We've done everything but chant and burn incense to take the worry out of diskettes by making the most reliable, worry-free product possible.

But there's one thing we

can't protect you from. Yourself.

If you let your recording heads collect dust and debris without cleaning them, you have to be prepared for the possibility of data loss or errors.

But not to worry.

# dust and rries run your head.

Our free  
head cleaning  
kit will help  
get you in  
the habit of  
cleaning your  
heads.

So the most  
reliable floppy in

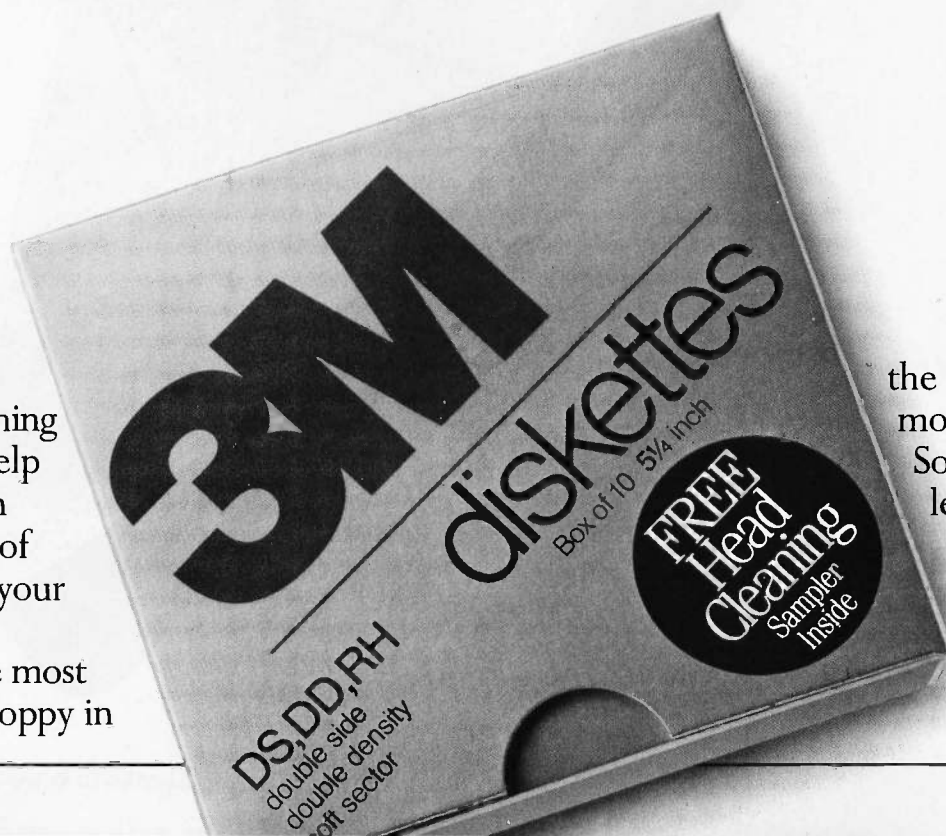

the world can be even  
more reliable.

So you can worry even  
less about the floppy  
you didn't have to  
worry about anyway.

One less thing to  
worry about.™

Inquiry 348

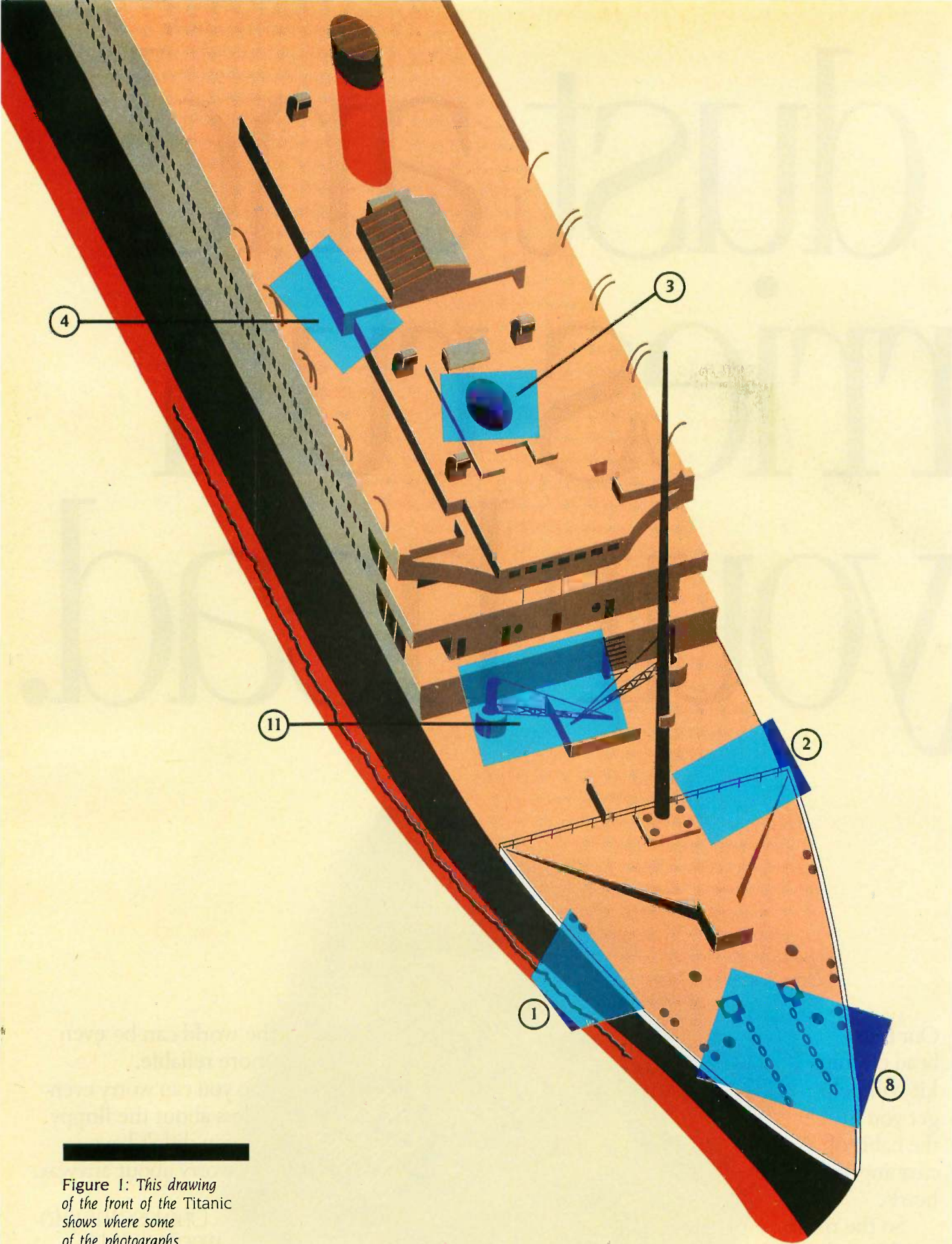

Figure 1: This drawing of the front of the Titanic shows where some of the photographs in this article were taken.



# FINDING THE TITANIC

*Image processing helped locate the historic wreck*

**O**n April 14, 1912, the "unsinkable" *Titanic* sank when it collided with an iceberg in the North Atlantic, taking with it more than 1500 of its 2000 passengers. When the *Titanic* slid into its grave, the technology of the day could indicate only that it sank somewhere in a 150-square-mile area of the Atlantic Ocean. The combination of such a large search area and the tremendous depth of the water frustrated attempts to find the ship.

Then, after 73 years of being lost in the vast and frigid waters of the Atlantic, the *Titanic* was located 370 miles south of Newfoundland on September 1, 1985, at 13,000 feet (more than 2 miles) below sea level. The team that found her consisted of 13 researchers aboard the U.S. Navy vessel *Knorr*, a group of French scientists from the vessel *Le Suroit*, and millions of dollars worth of equipment. The success of this expedition was due largely to advances in deep-sea exploration and image-processing technology.

## **HOW DO YOU FIND A SUNKEN SHIP?**

The French ship *Le Suroit* was equipped with an advanced remote-acoustic system (SAR) that was originally developed for finding valuable manganese nodules on the ocean floor. As the ship moves, the SAR side scans kilometer-wide strips of the ocean floor. The system synthesizes these high-resolution strip images to

provide a continuous two-dimensional image.

Using the SAR, the French examined most of the 150-square-mile search area but missed finding the *Titanic* by 300 yards.

*Le Suroit* certainly *could* have located the *Titanic* or its debris but might have had trouble making a positive identification. Because SAR images are two-dimensional, they do not allow you to determine the height of an object on the ocean floor unless the object casts a shadow. As with an optical shadow, you can estimate the height if you know the viewing angle and distances. If the *Titanic* were not intact or viewed from the proper angle, identification might have been difficult even if the SAR had located it.

Meanwhile, the Americans explored using the *Argo*, named for the ship sailed by the Greek hero Jason in his search for the Golden Fleece. The *Argo* is a 15-foot-long unmanned vehicle developed at the Woods Hole Oceanographic Institution in Massachusetts as part of a system for ocean-bottom research. It acquires wide-angle television pictures while "flying" 120 feet above the sea floor and zooming in for close-up shots.

With only a few days remaining in

*(continued)*

Marti Spalding (*Imaging Technology*, 600 West Cummings Park, Woburn, MA 01801) has a B.A. in education and is a senior technical writer for *Imaging Technology*. Ben Dawson (E10-120 MIT, 79 Amherst St., Cambridge, MA 02139) is a research scientist at MIT.

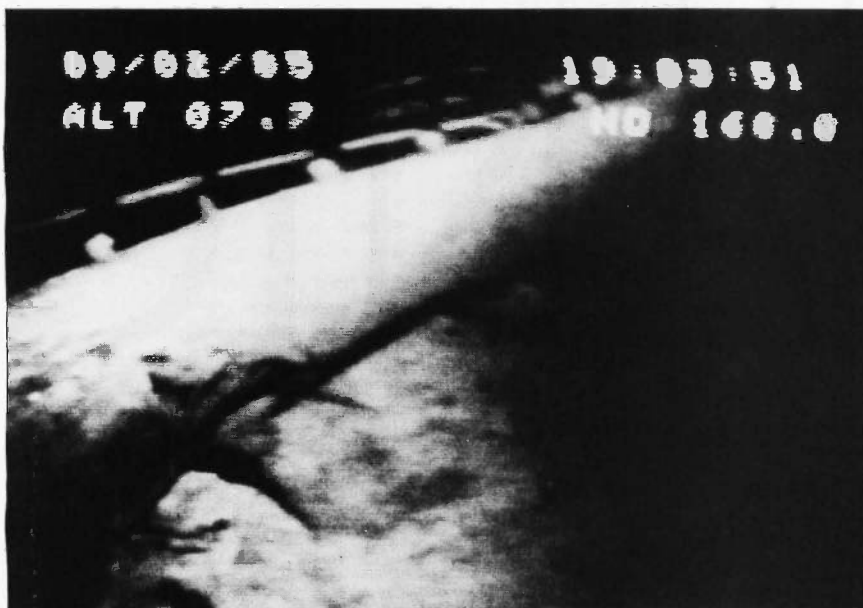

Photo 1: One of the first views of the Titanic seen since it sank into the frigid waters of the North Atlantic almost three-quarters of a century ago. This video image was taken by the Argo from approximately 25 feet above the wreck and shows the gash in the bow area where the iceberg struck. The time-code numbers along the top of the image are blurred due to the averaging process. (All photos and figures courtesy of the Woods Hole Oceanographic Institution.)

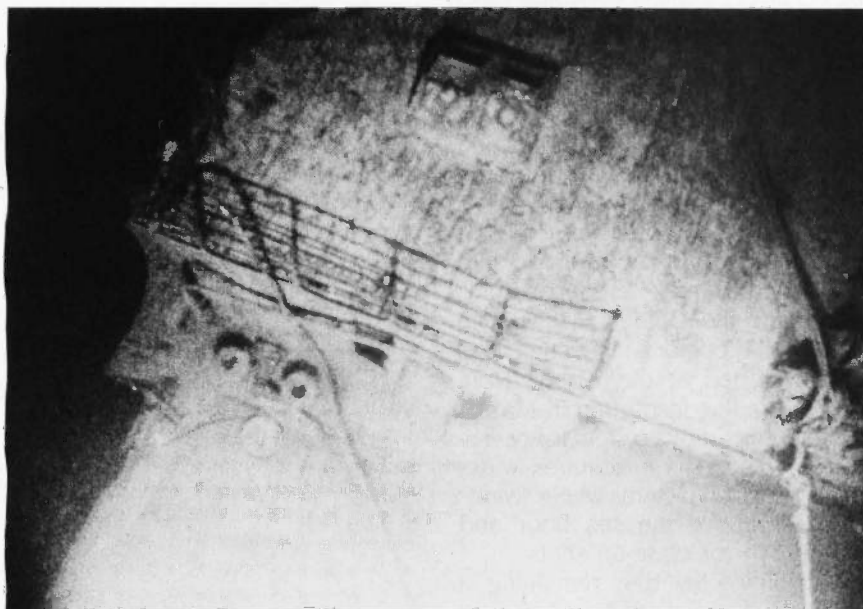

Photo 2: This view clearly shows the teakwood deck and railing of the Titanic. Photos 2 through 6 are 35mm photographs taken by the ANGUS. Although they are of much higher quality than the video images used to locate the Titanic, the 35mm images are somewhat cloudy due to light scatter from particles in the water.

the expedition, the Argo started sending back video images of the debris from the *Titanic*. Within hours the researchers had found and identified the wreck of the *Titanic* itself (see photo 1).

Because the video images provided by the Argo were of relatively poor quality, the researchers dispatched a second towed vehicle, the ANGUS (acoustically navigated geological underwater survey), which zoomed in and took high-quality 35mm photographs. The ANGUS was designed primarily to work in rugged volcanic terrains to depths of 20,000 feet. The ANGUS's depth is controlled by the amount of tow cable let out and typically flies 25 to 35 feet above the ocean floor. Its heavy-duty steel frame must be capable of withstanding jarring head-on collisions with rock outcrops, because it sends no visual information back to the surface ship.

Within the ANGUS's frame are three large-capacity 35mm color cameras, each containing 400 feet of film (3200 photos) and capable of photographing a swath of sea floor about 200 feet wide. These cameras take photographs at 20-second intervals, using strobe lights to illuminate the ocean bottom. At the speed at which the ANGUS travels, this rate provides a generous photo overlap. (Photos 2 through 6 were taken by the ANGUS. Figure 1 shows the approximate site of the photographs in this article.) The ANGUS must be pulled up on board the *Knorr* and the film processed before the images can be viewed.

#### GETTING PICTURES FROM THE ABYSS

The Argo (see photo 7), with its ability to send real-time video images to the *Knorr*, was the key to finding the *Titanic*. Even after the French had explored and eliminated 80 percent of the search area, a large area remained. Real-time video imaging allowed the researchers to do a rapid search of the ocean floor and obtain a positive identification of the wreck, which could not have been done with the delays inherent in processing film from the ANGUS.

The Argo carries three video cameras, strobe lights and floodlights, a sonar system, and a variety of electronics (see figure 2). One camera looks forward while the other two look down. A video switcher selects a camera signal for transmission up the tow cable to the *Knorr* where video images are then processed, monitored, and recorded. The sonar system on the Argo is similar to the French SAR system but has lower resolution and is used to augment the video capabilities. The Argo's depth is controlled by changing the length of the tow cable.

The Argo uses two modes of operation. In snapshot mode, the strobe lights fire every 10 seconds to survey a wide area of ocean floor. The Argo is towed at a speed of 0.6 to 2.4 miles per hour (0.5 to 2 knots) so that successive video snapshot images overlap. When the researchers locate something of interest, they lower the Argo and use a continuous mode of operation. In this mode, two 250-watt floodlights illuminate a smaller section of the ocean floor, as the cameras send continuous video images back to the *Knorr*.

In shallow water, the design for an Argo-like vehicle would be simple: Attach TV cameras and lights to a frame, and send the video pictures back through a coaxial cable to the surface ship. With a deep submersible vehicle, however, two factors—the ocean environment and the tow cable—make this design a formidable problem.

The environment at great ocean depths is in some ways more hostile than the vacuum of space. The water is completely dark and its pressure crushes any unprotected equipment. In addition, the conductive and corrosive properties of salt water destroy equipment or quickly make it unreliable. Solutions to these problems included enclosing the electronic equipment in heavy-pressure housings and connecting equipment with pressure-compensated oil-filled cables. The small size of the housings and the cost of this protection constrained the amount of electronics that could be



Photo 3: The gaping hole left by the collapse of the Titanic's first (forward) smokestack. The huge liner had four smokestacks.



Photo 4: An area of major damage between the first and second smokestacks.

placed aboard the Argo.

Ocean water contains a large amount of suspended particles (such as dirt and silt) that reflect illuminating light and partially blind the cameras. The problem is similar to using headlights in fog. The designers of the

Argo reduced these reflections by mounting its lights and cameras as far apart as possible. In a similar way, fog lights on a car are usually mounted as far below the driver's eyes as possible.

(continued)

## TITANIC

At these tremendous ocean depths, the design of the tow cable is a major problem; let's consider what the cable must do. It must support thousands of pounds of equipment, operate under tremendous water pressure,

and provide an electronic path for all power delivered to the Argo and the control, telemetry, and video signals sent between the Argo and the *Knorr*. In shallow water, you could use multiple cables for these functions. At any

great depth, however, multiple cables are unmanageable. The design of the Argo required that all the support, power, and signal functions be built into a single coaxial tow cable.

The tow cable consists of a single center conductor surrounded by a coaxial shield and a waterproof barrier wrapped in two layers of steel armor. The steel armor prevents the cable from being crushed by the water pressure. The cable is 0.68 inches in diameter and 20,000 feet long, and it weighs over seven tons.

The cable's weight becomes a major problem when handling and testing it—the cable spool literally sinks into pavement or floors. The cable can support 40,000 pounds of properly terminated load, a substantial portion of which is its own weight. Because the cable is unwound from a spool, all electrical connections must be made through rotating contacts. A single coaxial cable can withstand repeated flexures and other abuse better than a multiconductor cable and makes the design of the rotating contacts simple and reliable.

Power for the Argo's equipment is transmitted down the tow cable using 440 volts AC. At the same time, control signals are sent down the cable and telemetry signals are sent up the cable (including one channel for the video information). Frequency-division multiplexing allows the power and signals to travel on a single cable. That is, the power and each of the control and telemetry signals occupy a different frequency band in a 5-MHz total bandwidth. Modulators shift signals to appropriate bands, and demodulators recover the signals at the receiving end.

The problems with this scheme include limited power transmission, noise, and limited bandwidth for signals. The limited amount of power that can be sent down the cable means that in snapshot mode, the strobe lights have to charge for several seconds before they can fire; in continuous mode, only 500 watts of illumination is available.

The researchers on the *Knorr* made

*(continued)*



Photo 5: Some of the debris surrounding the Titanic. The serving tray is about 3 feet across. The black lumps are coal. The ocean bottom at these depths is usually featureless.



Photo 6: This twisted machinery is the base of the aft crane. Surprisingly, some items (the serving tray and wine bottles) were gently deposited on the ocean floor, while others were ripped off the ship and destroyed.

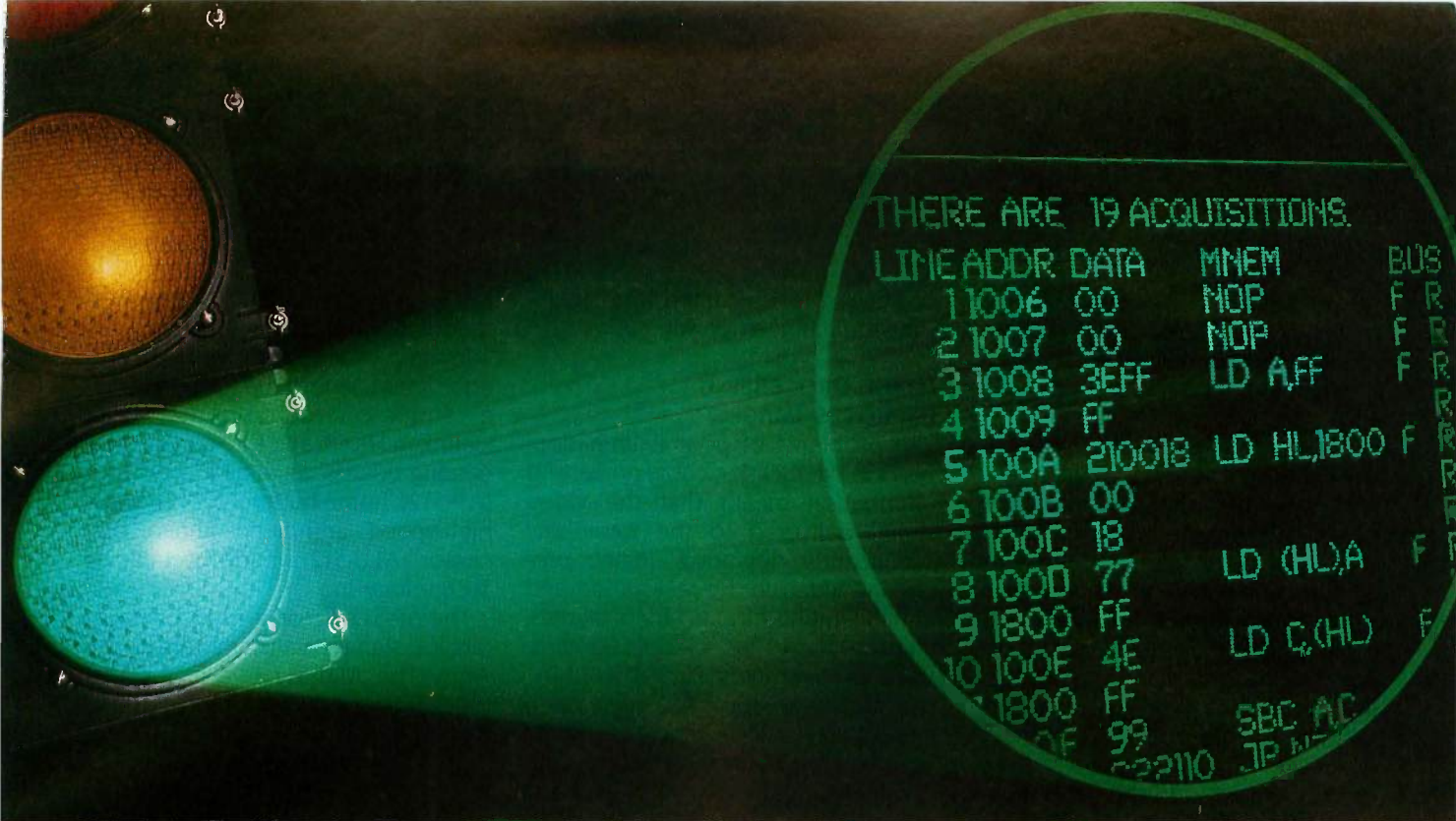

```

THERE ARE 19 ACQUISITIONS.
LINE ADDR DATA MNEM BUS
1 1006 00 NOP F R
2 1007 00 NOP F R
3 1008 3EFF LD A,FF F R
4 1009 FF F R
5 100A 210018 LD HL,1800 F R
6 100B 00 F R
7 100C 18 LD (HL),A F R
8 100D 77 LD C,(HL) F R
9 1800 FF LD C,(HL) F R
10 100E 4E SBC A,C
1800 FF JP HL
022110
  
```

# GO WITH THE BEST LOW COST 8-BIT SUPPORT.

**Tektronix introduces TekMate, powerful 8-bit support with many more features than you'd expect to find in a low cost development system.** Emulation is non-stop, transparent and real time. A content-selectable 1024-line bus trace buffer simplifies prototype evaluation—while your program runs without interrupting execution.

**Tek's eight years of emulation experience brings the user unmatched reliability in this low-cost system.** Every feature of TekMate helps keep you on schedule, within budget, and in control. For instance, you can select any of 16 break points for specific address values and ranges. Rapidly detect errors with the aid of full symbolic debug that lets you use an unlimited number of symbols—even define new ones. Versatile and flexible, TekMate provides software analysis and debug at every

stage from initial concept to final integration.

**Remarkably easy to use, TekMate supports Z80, 8085 and 6809—plus the 68HC11 micro-controller.** Host computers include IBM PC™, VAX/VMS™, MicroVAX™ and Tek 8560—and TekMate is integrated via emulation control

software and language support tools, such as struc-

ured analysis and structured design tools, plus source editing, C, Pascal, assembler and debug tools.

To save you time, Tek's own Colorkey+ and Softkey user-interface packages give you simple, single keystroke access to the entire command set.

**TekMate—the most powerful emulation system in its price range—is an integral component of Tek's Computer Aided Software Engineering (CASE) program.** This growing toolset cluster from Tek's Software Development Products Division demonstrates Tek's commitment to software technology. For product or ordering information, please contact your Tek representative.

Or call today:  
**1-800-342-5548.**

**CASE: From concept to code, Tek's tools take you all the way.**



**Tektronix®**  
COMMITTED TO EXCELLENCE

Inquiry 343

the best use of the Argo's limited power by switching between the two modes. In snapshot mode, the Argo briefly illuminated a large area to allow a survey, while for close-up viewing it continuously illuminated a smaller area. To maximize the limited light available, the system utilized highly sensitive Silicon Intensified Target (SIT) video cameras. While the comparison between film and video is not exact, the approximate sensitivity of these cameras is 200,000 ASA (an ISO [International Organization for Standardization] film-speed rating).

The video signals returned from the Argo are degraded by cable noise and bandwidth limitations. Imagine the kind of noise problems that arise from running 440 volts AC on the same line as a video signal! Again, the bandwidth of the cable is only 5 MHz, so to transmit all the power and signals the video signal had to be modulated at 5 MHz. Half the video signal occupied the frequency band between 5 and 10 MHz, which was well past the bandwidth of the cable. Thus, at 5-MHz frequency, the cable attenuated the video signal by 80

decibels, which resulted in a significant reduction in power.

### IMAGE PROCESSING IMPROVES IMAGES

The problems of poor illumination, particle backscatter, cable noise, and attenuation meant that the video signal delivered to the Knorr was significantly degraded. Image processing aided in the restoration and enhancement of the video signals. Figure 3 shows the specialized hardware configuration used to capture, transmit, and process the video images obtained from the Argo. Some common image-processing terms are explained in the glossary on page 110.

Depending on the mode of operation, the Argo sends the output from its cameras directly up the tow cable to an analog video preprocessor or temporarily stores it in a *frame store* located aboard the Argo. This frame store is a modular 5½-inch-high unit (manufactured by Toko Inc.) that is small enough to fit into a pressure housing. On the Knorr, the analog video preprocessor reinserts synchronization signals to correct for

losses caused by the frequency-modulation telemetry system.

Image processing and control equipment aboard the Knorr includes a single-board computer, the Heurikon HK68, and three image-processing boards: an analog processor (AP-512), frame buffer (FB-512), and a high-speed arithmetic image processor (ALU-512), made by Imaging Technology Inc.

The AP-512 *digitizes* the video images (analog signals) transmitted from the Argo. The ALU-512 is a high-speed pipelined processor that supports real-time full-frame arithmetic and logical operations (such as add, subtract, AND, and OR) on video images in real time (1/30th second per frame). Output from the ALU is routed to the FB-512 frame buffer for storage.

The FB-512 is a general-purpose frame buffer that stores the resulting digitized image in its 256K bytes of RAM (random-access read/write memory) as 512- by 512-bytes by 8 bits (RS-170 specification results in the image being acquired and displayed as 480 lines). This module stores and outputs a digitized image in real time, at a rate of 30 frames per second.

The image-processing system was controlled by the HK68 68000-based computer running VRTX (Versatile Real-Time Executive), a real-time multi-tasking operating system. This board has 1 megabyte of memory and allows DMA (direct memory access) transfer of images between CPU (central processing unit) memory and the FB-512 frame buffer. A second Heurikon HK68 system on the Knorr was used for modifying this software while the ship was at sea.

VRTX manages the assignment of memory and the input/output of data in a real-time system environment. As such, it functions somewhat like a switchboard operator, making sure that priority calls are handled immediately and that other calls are answered as soon as possible without allowing any call to fail to get answered. VRTX helps direct data transmission between the Argo and the Knorr, helps control the Argo and

(continued)

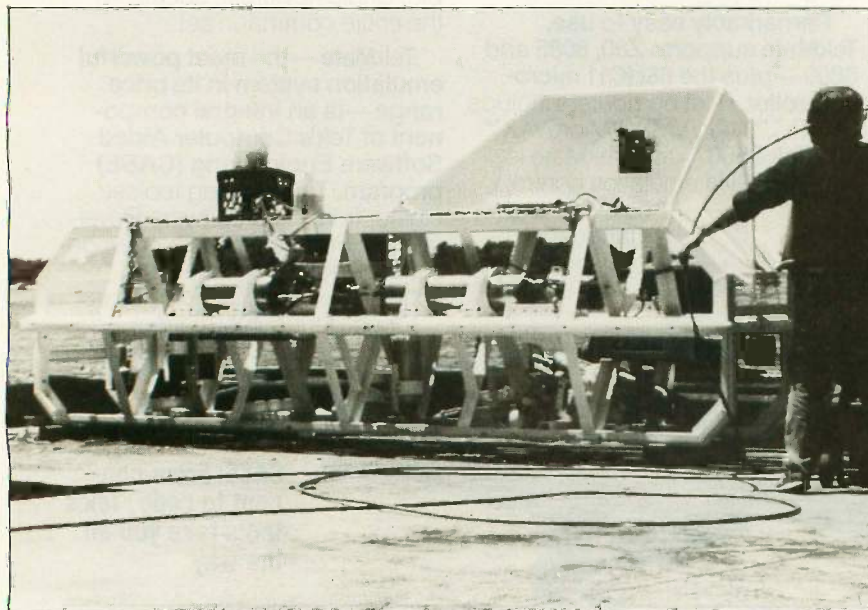
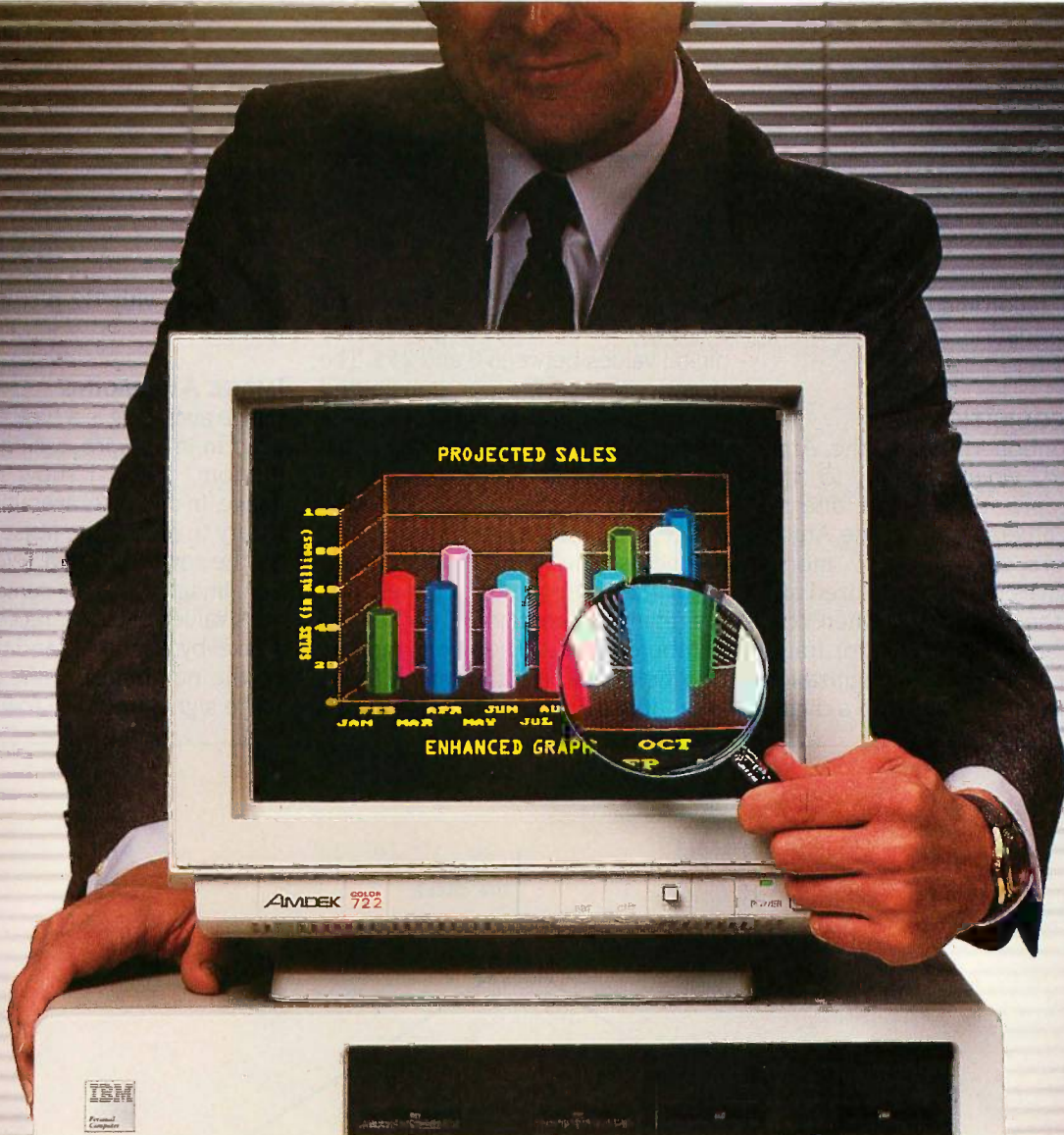

Photo 7: The Argo remote vehicle. This vehicle was towed near the ocean bottom and sent back video images of the Titanic. The cylindrical pressure housings hold cameras, strobe lights, and other electronics.



## Amdek challenges you to read between the lines.

Not all monitors are created equal. And no monitor in this price range can equal the new Amdek Color 722.

What makes the 722 RGB monitor so distinctive? For one, a dual frequency output that is capable of supporting IBM's Enhanced Graphics Adaptor. The result is 350 lines of resolution, assuring you of a sharper, crisper image that makes your graphs and charts look more like a work of art, and less like a rough sketch. For another, the fact that the 722 is made by Amdek — where monitors are our only line, not just a sideline.

The high performance 722 features an etched glass, non-glare screen that's easy on the eyes, plus front-mounted controls that are easy on the operator. This means less eye fatigue and greater productivity.

### All 350 of 'em.

What's more, the 3-position text switch enables you to choose green, amber or full-color type — up to 80 characters in width x 25 lines of text. There's even an optional tilt/swivel stand that allows you to select a viewing angle that's most comfortable for you.

It all adds up to more monitor for the money, and is backed by more warranty for your peace of mind. Amdek's warranty protects your investment for three full years on the CRT, and two years on all other parts and labor. No other monitor warranty offers you more.

For high resolution performance, see the new Amdek Color 722. We know you'll be impressed. After all, everytime an Amdek monitor is sold, we know that we are putting our image on the line.

# AMDEK

Inquiry 18

*Clearly the finest in monitors.*

the data recording, and displays status information on an operator console.

## IMAGE ACQUISITION

As we mentioned earlier, the Argo transmitted video signals to the analog preprocessor either directly from the cameras or from the Argo's frame store. In snapshot mode, camera signals were first digitized and stored in the frame store, then converted to an analog signal for transmission up the tow cable. Digitization converts an analog signal to a digital

code, where 0 represents black and 255 white, with values of gray having digital values between 0 and 255. The stored video image was transmitted continuously up the cable and processed, as explained below, to improve its quality.

In video terminology, one video image is called a frame. A frame has two fields; one of the fields contains all of the even-numbered lines, and the other field contains all of the odd-numbered lines. The even and the odd fields are *interlaced* into a frame with approximately 480 horizontal

lines, each with 512 picture elements (pixels).

## IMAGE AVERAGING

Image averaging is a typical operation used in image processing to remove random noise ("snow") from an image. In this case, averaging was necessary to reduce the noise introduced by the tow cable and telemetry system. Image averaging sums the brightness values of two or more frames on a pixel-by-pixel basis and then divides by the number of frames summed.

The signal from the tow cable con-

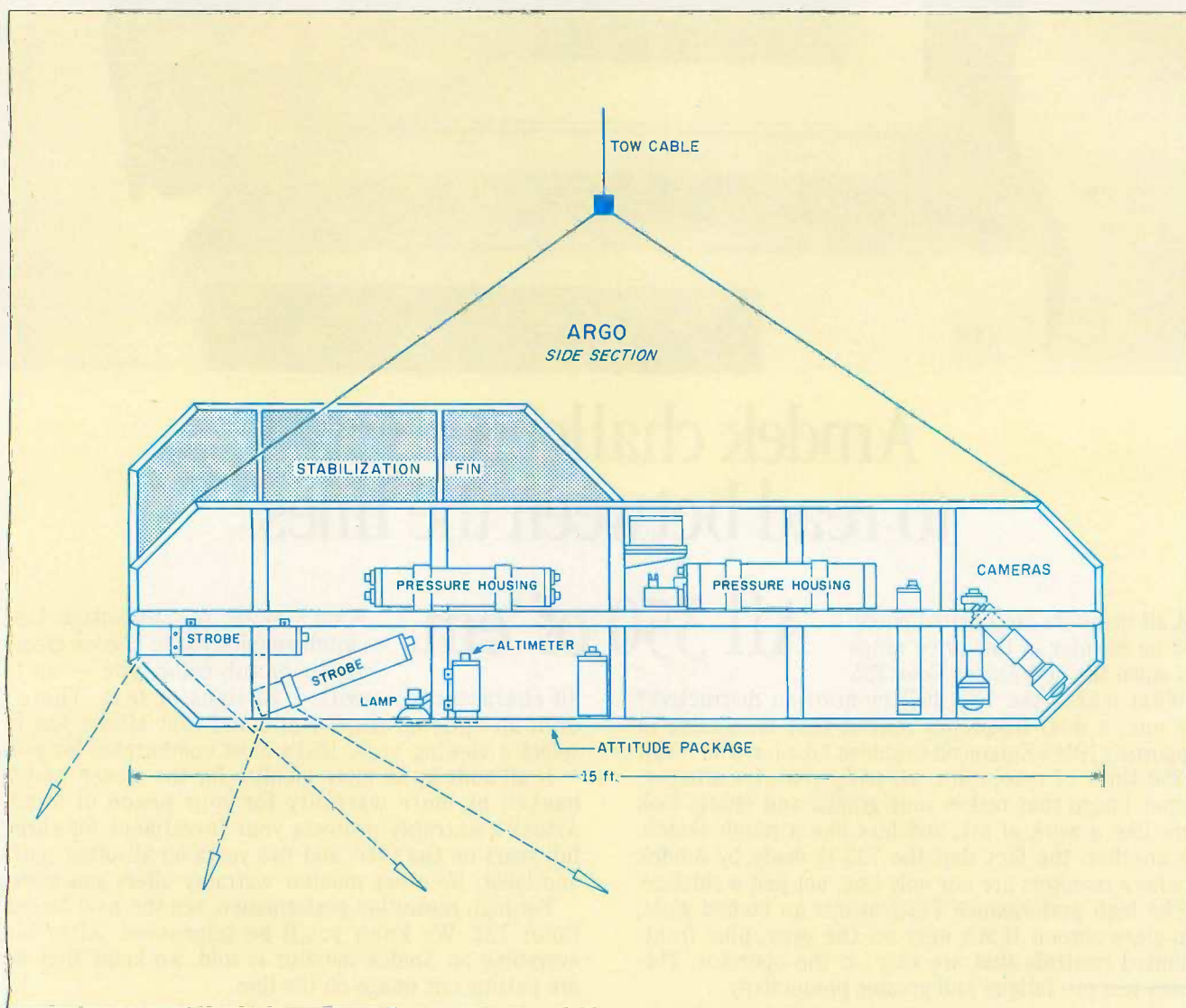

Figure 2: This drawing of the Argo shows the tow cable, pressure housings, cameras, and lights. Other housings hold the altimeter, attitude package (depth, heading, heave, etc.), and control and communication electronics.



sists of the desired video signal plus the added random noise. These random-noise values may either increase or decrease the digital value of the desired video signal and appear in different spatial positions from frame to frame. When the system sums the tow cable signal values, the random-noise values tend to cancel but the desired video signal increases. The final division scales the sum back to a range that can be displayed on a television monitor. The actual increase in the signal-to-noise ratio is proportional to the square root of the

number of images averaged if the noise is completely random. The result of averaging two or more frames of the same noisy image is a much clearer picture.

Consider the values of a single pixel in a sequence of eight frames. Suppose that the correct signal value for this pixel should be 5, but noise values of -2, 0, and 2 are being randomly added to the signal. A typical sequence of frame values for this pixel might be

5 7 3 3 7 5 7 5

The sum of the pixel values is 42 and when divided by 8 the average is 5.25. This estimate is very close to the correct signal value of 5. The limited range of numbers represented in the frame buffer truncates the fractional value to 5.

From a hardware standpoint, the video signal was digitized by the AP-512 analog processor and summed with existing values contained in the FB-512 frame buffer by the ALU-512 arithmetic logic unit. These summed values were returned

(continued)

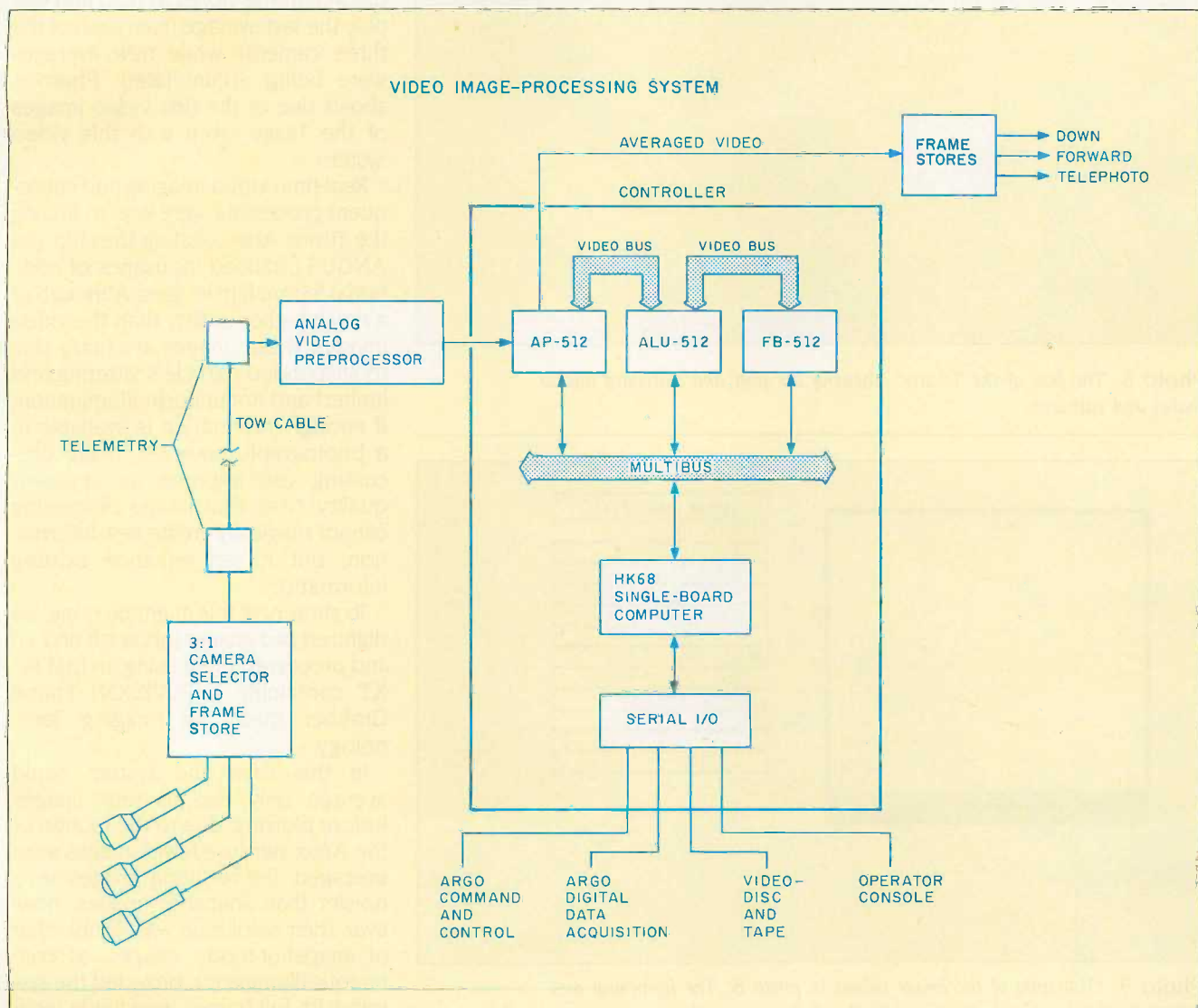

Figure 3: The video image-processing system on the Argo and Knorr. The cameras and frame stores on the Argo are shown on the left and the processing and display hardware on the Knorr to the right.

to the FB-512. Since a separate sum is kept for each of the more than 250,000 points (512 by 512 bytes) in the image and is updated 30 times per second, the ALU-512 performs over 7,000,000 sums, multiplies, and shifts (divisions) per second. A last

pass through the ALU-512 divides the final sum to produce the average.

It should be noted that if the image changes, this averaging process results in a blurred image. The human eye performs a similar averaging, so that fast-moving objects appear

blurred. To avoid this problem, the Argo sent the same stored image repeatedly while in snapshot mode and used fewer images while in continuous mode.

The illumination provided by the strobe light in snapshot mode was very brief. Because the SIT camera has a nonlinear signal decay, the video image transmitted was so degraded that only one field of information was used. Thus, in snapshot mode, the spatial resolution of the image was 240 by 512 pixels.

In both modes, the system used additional frame stores to hold and display the last average from each of the three cameras while new averages were being accumulated. Photo 1 shows one of the first video images of the *Titanic* taken with this video system.

Real-time video imaging and subsequent processing were keys to finding the *Titanic*. After locating the ship, the ANGUS provided thousands of additional 35mm film images. Although of a much higher quality than the video images, these images are fuzzy due to suspended particle scattering and limited and nonuniform illumination. If enough information is available in a photograph, however, image processing can improve its apparent quality. Note that image processing cannot magically create new information, but it can enhance existing information.

To show how this might be done, we digitized two images (photos 8 and 11) and processed them using an IBM PC XT containing a PCVISION Frame Grabber made by Imaging Technology.

In this case, the system could average only two to four images before blurring, due to the motion of the Argo. Because fewer images were averaged, the resulting images were noisier than snapshot images; however, their resolution was double that of snapshot-mode images, as continuous illumination provided the system with full frames (two fields totaling 480 by 512 pixels) for averaging rather than the single field (240 by 512 pixels) of snapshot mode.

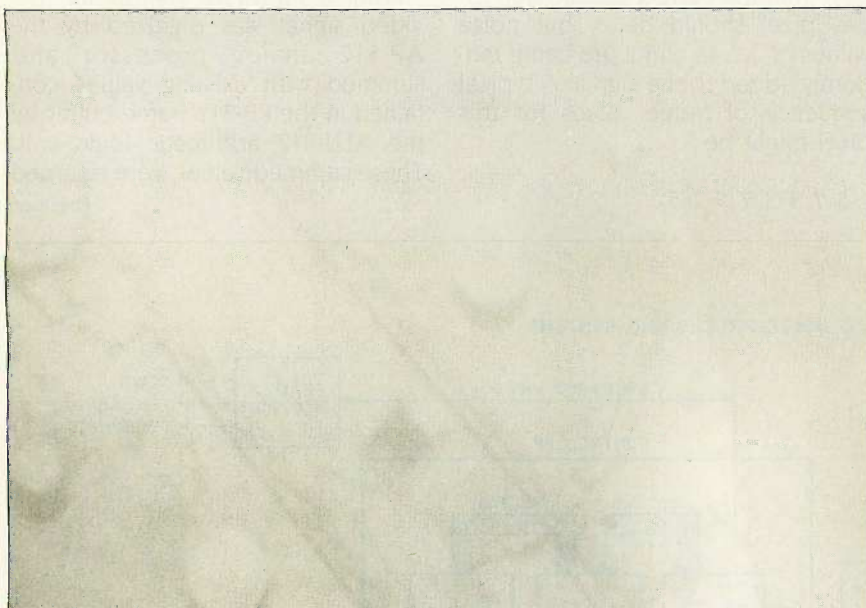

Photo 8: The bow of the *Titanic*, showing the port and starboard anchor chains and capstans.

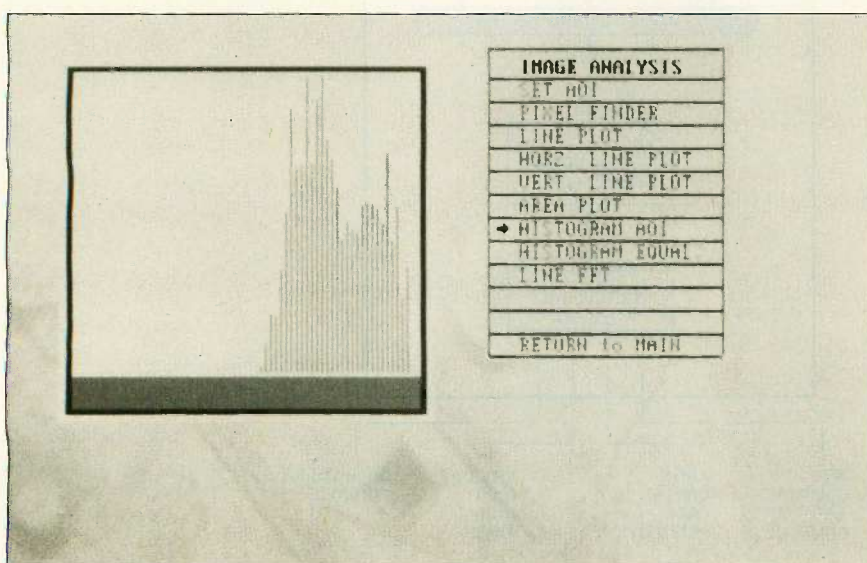

Photo 9: Histogram of the image values in photo 8. The horizontal axis represents the gray level and the vertical axis represents the number of pixels that have that gray level. The menu shown is part of the Image Action software package made by Imaging Technology.

**CONTRAST ENHANCEMENT**

One class of image-processing operations modifies the intensity values at each image point to enhance the apparent contrast of the image. Because these operations work only on a single image point, they are known as point processes. For example, if the intensity values in an image range from 0 to 100, the apparent contrast of the image may be increased by multiplying the value of each image point by 2.

The range of intensity values can be determined by a histogram operation, that is, by counting the number of pixels of each intensity. The histogram of photo 8, for example (photo 9), shows that the intensity values range from 130 to 255.

The contrast of this photo can be improved by transforming each pixel point by the following equation:

$$\text{transformed pixel value} = M * (\text{original pixel value} - K)$$

where K=130 and M=2.

This results in "sliding" the value of all pixels down the gray scale by 130, followed by a linear "stretch" of the values by 2.

In essence, this makes the lightest pixels white, the darkest pixels black, and linearly arranges the intermediate intensities to span the range of 0 to 255. This transformation can be done by lookup tables (LUTs) on the frame grabber. To understand the action of an LUT, consider that the LUT is a small block of memory that receives an 8-bit address as an input and outputs the 8-bit data stored at that address. The input addresses are pixel values and the values stored at these addresses are the transformed values that are output. Thus, rather than doing the transform on each and every pixel, the system checks the LUT to find the precalculated value. This saves time since, for example, every pixel with an intensity value of 200 will have a transformed value of 140.

Any arbitrary intensity transform can be generated and loaded into the LUT. We programmed the transform

shown above into the LUT and the resulting enhancement and contrast of photo 8 is shown in photo 10.

**EDGE ENHANCEMENT**

Another class of image-processing operations uses the information from

the area surrounding each pixel to change the spatial contrast of the image. When an area operation is used to sharpen or enhance the edges in an image, it is called an edge enhancement. Edge enhancements

*(continued)*

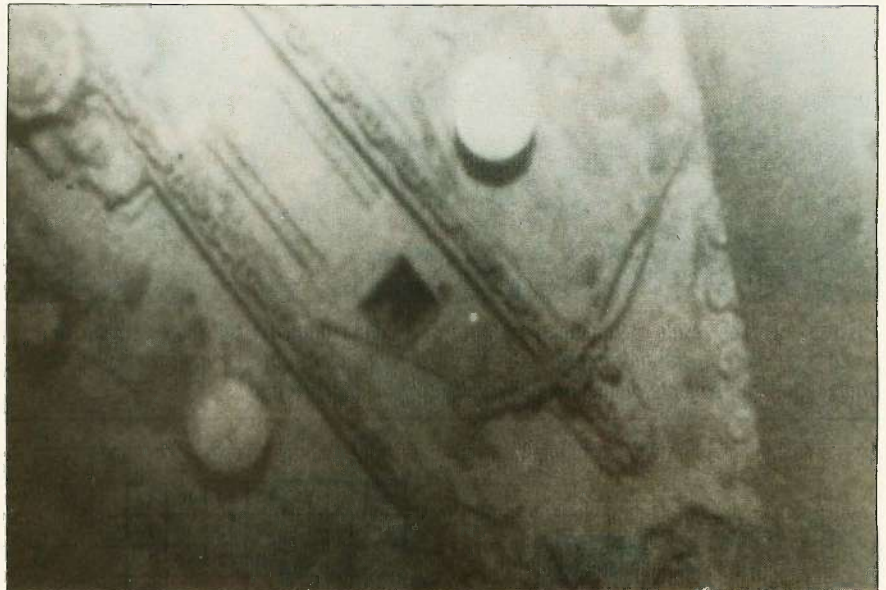

Photo 10: The result of contrast-enhancing the image shown in photo 8. The process adds no new information to the image but adjusts the pixel values to improve the contrast.

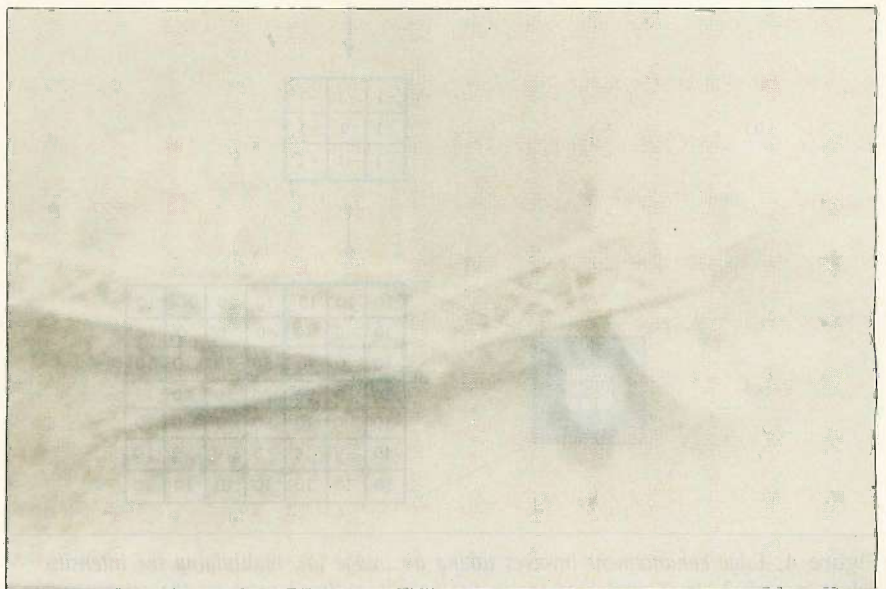

Photo 11: Digitization of a photo taken by the ANGUS. This image shows the foredeck of the Titanic directly in front of the bridge, with the entire starboard crane, the boom of the port crane, part of the mast, and an open hold.

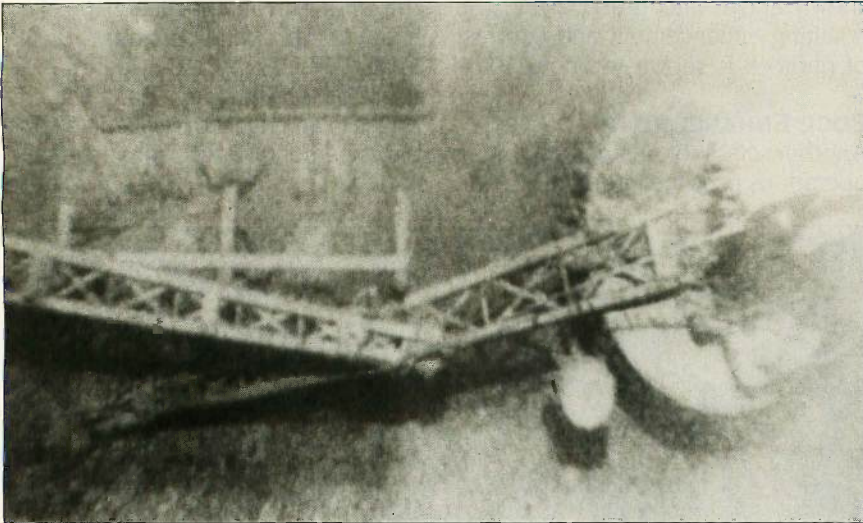

Photo 12: The result of contrast-stretching and edge-enhancing the image shown in photo 11. These operations improve the contrast and accentuate the high-frequency information components of the image, resulting in a sharper image.

can use convolution to implement a spatial filter that accentuates high frequencies.

The convolution operation consists of multiplying pixels in the "neighborhood" of a given pixel by constants, summing and scaling, and replacing the center pixel by the result. The constants used for the multiplication are called the *kernel* of the convolution.

If the neighborhood is 3 pixels horizontally by 3 pixels vertically and the center pixel is at location  $(x,y)$ , the convolutions operation can be represented by the following formula:

$$O(x,y) = M_1[I(x-1,y-1)] + M_2[I(x,y-1)] + M_3[I(x+1,y-1)] + M_4[I(x-1,y)] + M_5[I(x,y)] + M_6[I(x+1,y)] + M_7[I(x-1,y+1)] + M_8[I(x,y+1)] + M_9[I(x+1,y+1)]$$

You can extract the kernel values ( $M_1$  to  $M_9$ ) and represent them as a single table. For an edge enhancement kernel, you can use the following kernel table:

-1	-1	-1
-1	9	-1
-1	-1	-1

To see how this accentuates edges (changes) in an image, imagine one area of an image with intensity values as shown in figure 4a. If you overlay the kernel table (see figure 4b) on each 3- by 3-pixel section of the image, multiply the corresponding numbers, add all the products, and place the result in the center pixel, the resulting image is shown in figure 4c.

The effect of the convolution is to enhance spatial changes in intensity. In this example, the brighter square (with the original value of 20) is accentuated by decreasing the surrounding values to 0 and increasing the edge values to 70 at the corners and 50 in between. Note that areas that do not have any spatial change in intensity are left unchanged—the area surrounding the center square is still of intensity 10, and the center of the square is left at intensity 20.

Some of the resulting values of the convolution operator are negative numbers. Because negative intensity

(continued)

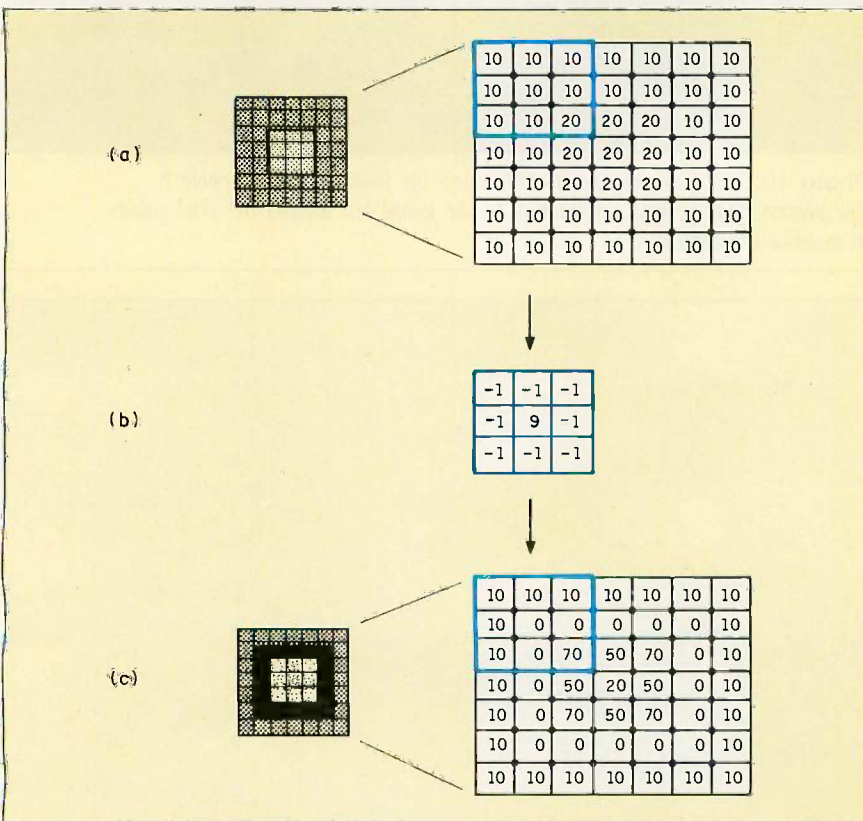

Figure 4: Edge enhancement involves taking an image (a), multiplying the intensity values in each 3- by 3-pixel area (as in the heavily outlined area) by the corresponding values in a preset kernel (b), summing the products, and placing the results in the center pixel. The result of performing this process on (a) is shown in (c). Note how edge enhancement makes the dim inner square of (a) easier to view in (c).

# IBM's AT forgot The Answer!

Every time IBM builds an AT computer, it forgets to put in a Serial/Parallel adapter and a *full* memory. That's a problem. Because without the adapter, the AT can't communicate with a printer (or anything else).

The answer to the problem is *The Answer!*<sup>TM</sup>

*The Answer!* is an easy to install multi-function board. It has just what the AT can use with PC DOS—without making you pay extra for options it *can't* use.

There's a parallel printer port. Two 50 to 19.2K baud serial ports for communications or serial printer hookup. An optional game port. Plus 128K of RAM to bring the 512K AT up to its 640K PC DOS limit. Plus all necessary cables of course.

*The Answer!* is fully assembled. Fully tested. And backed by our 3-year "No Sweat" Warranty. Which is 3 times longer than the warranty on the AT itself.

So when you get an IBM AT, make sure you get *The Answer!* And you won't have a problem.

For complete details, ask your dealer, circle the Reader Service Number, or contact: SMT, Inc., 1145 Linda Vista Dr., San Marcos, CA 92069. 619/744-3590. **The Answer!**<sup>TM</sup>

IBM AT is a registered trademark of IBM Corp.  
The Answer is a registered trademark of SMT.

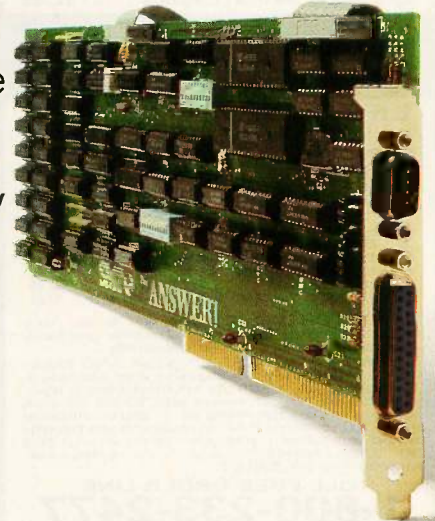

## SMT

SYSTEMS MANUFACTURING TECHNOLOGY, INC.

# Color Diskettes BY **TYCE** CENTECH

The Colorful Solution to Data Organization™

**TIMELESS WARRANTY**  
 SS-DD QTY. 100 DS-DD  
 \* **69¢** Color Bulk **89¢** \*  
 \* **85¢** Color Boxed **\$1.05** \*  
 \* \* **99¢** Color Bulk 96 TPI **\$1.19** \* \*  
 \* \* **\$1.98** \* \*  
 IBM PC-AT Compatible Color Bulk DS-HD

100% error-free beyond 75% clipping level. Available in 12 useful assorted colors. Custom Labeling/Branding available.  
 \* Color Bulk w/Tyvek sleeves add 6c. Label Kits 2c.  
 \* Pre-packaged in Plastic Library Case/12. A \$4.95 value case for 20c/disk extra. DISKS ARE "OPAQUE"



**\*FREE! Headcleaning**  
 Diskette plus **\$2.00/box**  
 rebate on H/C

**LIFETIME WARRANTY**  
 SS-DD QTY. 5 BOXES DS-DD  
 \* **99¢** w/FREE H/C Kit **\$1.39** \*  
 \$1.29 ← w/Flip 'n' File/15 → \$1.69  
 \$1.97 ← .96 TPI → \$2.45  
 \$1.89 ← 3.5"/135 TPI → \$2.59  
 \$2.09 3.5"/135 TPI w/Flip 'n' File \$2.89 \*  
 DS-HD 96 TPI w/Free Headcleaning Kit \$2.89  
 DS-HD 96 TPI w/Flip 'n' File/15 \$3.19  
 3M Headcleaning Kit \$5.99  
 (After \$2.00 rebate with purchase of regular 3M disk)

**3M Data Cartridges**

	QTY. 5	QTY. 10
DC-100A	\$12.15	\$12.10
DC-1000	\$14.34	\$12.42
DC-300XLP	\$21.54	\$19.08
DC-600A	\$21.82	\$20.29

## Nashua "Boxed" Diskettes

**LIFETIME WARRANTY**  
 SS-DD QTY. 10 BOXES DS-DD  
**75¢** **85¢**  
 \$1.95 **\$2.65**  
 3.5"/35 TPI



Factory fresh in boxes of 10 with sleeves, user ID labels, write-protect tabs and reinforced hub ring.  
 High Density for IBM PC-AT Compatible \$2.59

100% Error-Free **BULK** By Leading American Media Manufacturer one of the top 2

**LIFETIME WARRANTY**  
 SS-DD QTY. 100 DS-DD  
**55¢** w/hub ring **65¢**

TYPEK ENVELOPES	6¢ ea.	Labels	2¢ ea.
Printer Ribbons		DISK STORAGE	
Epson MX 70/80	\$2.68	Amray Media Male	
Epson MX-100	\$4.06	50	\$7.99
Okidata 80, 82, 83, 92, 93	\$1.36	Disk Minder II-75	\$8.99
Okidata 84	\$2.95	Micro Disk Minder-36	\$7.75

**PRICE PROMISE:** We will better any lower delivered price on the same products and quantities advertised nationally.  
**TERMS:** FREE USE OF VISA AND MASTERCARD. American Express also accepted.  
**Shipping:** Add \$3.00 per 100 diskettes or fraction thereof. Other items add \$3.00 for disk storage or headcleaning kit or dozer ribbons or C.O.D. orders. P.O. accepted from recognized institutions and schools on 2% - 10 Net 30. Utah residents add 5% sales tax. Minimum order \$30.00.

**TOLL FREE ORDER LINE:**  
**1-800-233-2477**  
**INFORMATION AND INQUIRIES:**  
**1-801-942-6717**

**Computer Affairs, Inc.**  
 2028 E. FT. UNION BLVD., 105  
 SALT LAKE CITY, UTAH 84121  
 CALL: 1-800-AFFAIRS  
 HOURS: 9AM-6PM M-F (Mtn. Time)

## TITANIC

# GLOSSARY

**ARITHMETIC LOGIC UNIT (ALU):** Hardware that performs arithmetic functions such as add or subtract and logical functions such as AND or OR.

**DIGITIZE:** The process of converting an analog (in this case, video) signal's amplitude to digital values.

**DISPLAY:** The device in which an image is converted from electrical to optical signals; typically, a television monitor.

**FIELD:** In an interlaced scanning system, the set of even or odd lines into which a frame is divided.

**FILTER:** In image processing, an operation that changes the spatial and intensity characteristics of an image.

**FRAME:** The total number of lines of scan that represent an image.

**FRAME BUFFER:** A high-speed memory designed to store a single image and allow simultaneous video display. ALU processing, and CPU (central processing unit) access.

**FRAME MEMORY:** Any area in memory (host-computer memory or frame-buffer memory) that is used to store an image.

**FRAME STORE:** A high-speed memory designed to temporarily store a single image.

**IMAGE PROCESSING:** The alteration and analysis of a picture for such purposes as enhancement and recognition.

**INTENSITY:** The strength of light at a particular point in an image. Pixels represent intensity values that are perceived by the eye as brightness.

**INTERLACE:** The means by which an image is scanned in standard video format, where the odd and even fields are displayed alternately.

**LOOKUP TABLE (LUT):** Hardware that provides map values for transforming or modifying pixels. Each pixel in the frame buffer has a value ranging from 0 to 255. LUTs allow you to modify these values for purposes of enhancing the image.

**PIXEL:** The smallest unit of storage in a digital image, addressed by that unit's horizontal and vertical coordinate or location within an image.

**REAL TIME:** In image processing, an operation or a function that is completed in one frame time is said to be performed in real time. For standard television (RS-170) equipment, a frame time is 1/30 of a second.

**RESOLUTION:** In image processing, the number of bits of accuracy or number of gray levels that can be represented in a pixel; for example, 8 bits = 256 levels, 6 bits = 64 levels.

**SPATIAL RESOLUTION:** In image processing, the number of pixels into which an image is divided, indicating the precision or accuracy horizontally and vertically. For example, a spatial resolution of 480 by 512 pixels means that the image has 480 lines, with 512 pixels each (for a total of 245,760 pixels).

is meaningless, we have changed these values to 0.

The image shown in photo 11, two cranes on the foredeck of the *Titanic*, was enhanced using the LUTs and convolved with an edge-enhancing kernel (see photo 12).

### CONCLUSION

Deep-sea exploration is just one of the many applications in which image processing is being used. For example, image processing is used in medical imaging for digital radiography, microscopy, X-ray averaging and recording, and in factory inspection

for robotic vision, quality control on production lines, and X-ray inspection. Finding the *Titanic* is certainly a spectacular example of the processes that scientists and technicians in a variety of fields are using to coax useful information from two-dimensional images. ■

### ACKNOWLEDGMENT

We thank Robert Squires and Stewart Harris of the Woods Hole Institution Deep Submergence Laboratory for information and assistance in preparing this article. Bob and Stu are part of a team of scientists and engineers on the *Titanic* expedition and under the direction of Dr. Robert Ballard, who designed and built the *Argo*.

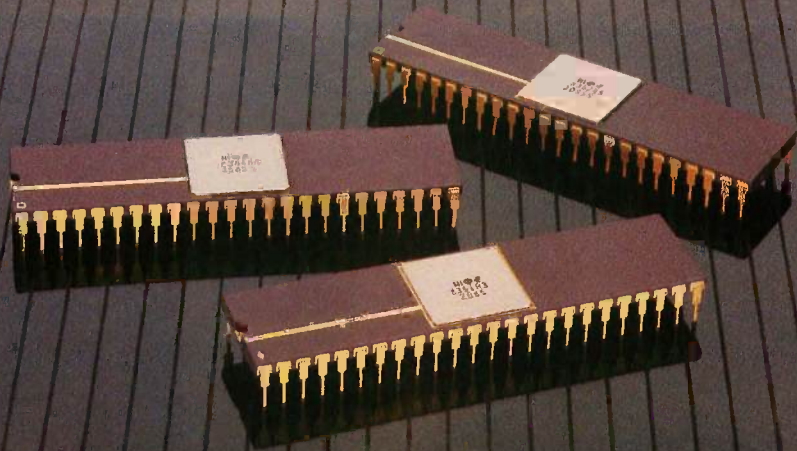

YOU'RE LOOKING AT  
4,096 COLORS  
4-CHANNEL STEREO  
32 INSTRUMENTS  
8 SPRITES  
3-D ANIMATION  
25 DMA CHANNELS  
A BIT BLITTER  
AND  
A MALE AND FEMALE VOICE.

## ONLY AMIGA GIVES YOU ALL THIS AND A 68000 PROCESSOR, TOO.

Three custom VLSI chips working in combination with the main processor give Amiga™ graphic dazzle, incredible musical ability and animation skill.

And they make Amiga the only computer with a multi-tasking operating system built into hardware.

All these capabilities are easy to tap because Amiga's open architecture provides you with access to the 68000 main bus in addition to the serial, parallel and floppy disk connectors. Complete technical manuals enable you to take full



advantage of the custom chips and the software support routines in the writable control store on the Kickstart™ disk that comes with every Amiga computer.

You can access these resources in a number of development languages, including Amiga Macro Assembler™, Amiga C, Amiga Basic (Microsoft®—Basic for the Amiga), Amiga Pascal and even Amiga LISP.

So Amiga not only gives you more creativity, it gives you creative new ways to use it.

*Amiga by Commodore.*

GIVES YOU A CREATIVE EDGE.

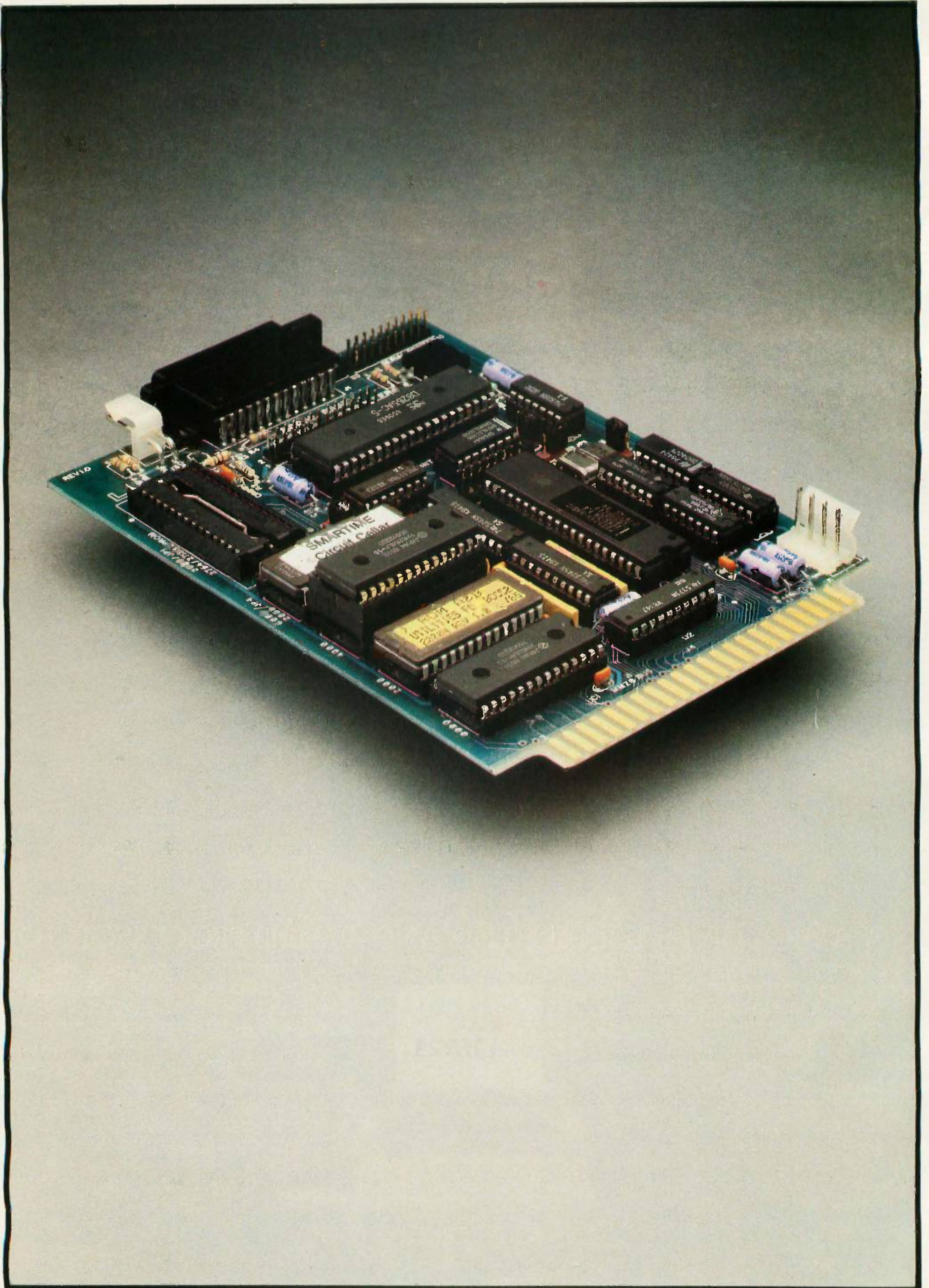



## REAL-TIME CLOCKS: A VIEW TOWARD THE FUTURE

BY STEVE CIARCIA

*One of these clocks also  
provides nonvolatile RAM*



Ever have one of those occasions when everything is progressing smoothly and then you hit a big snag? Here I was, standing on a 6-foot ladder with screwdrivers in my back pockets, electric drill in my right hand, hammer in my belt, mouth full of screws, a pencil over my ear, and the audio/video multiplexer that I described last month balanced in my left hand. A precarious climb if ever there was one. I assure you.

I had solved the ever-present do-it-yourself problem of forgetting some needed tool by dragging everything along with me up the ladder. I cursed as I banged my head on an overhead heating duct and swore that the next time I set aside an area to mount all this home-control junk, I'd know everything I was going to put on it in advance and leave plenty of room. Instead of a convenient shoulder-high location where life would be easy, I was halfway up under the floor joists sniffing concrete dust and soot. (Installing this stuff is getting about as pleasurable as writing software for me these days. Back when all I had was 48-instruction processors and lots of empty wall space, everything was copacetic.)

The only saving grace to this temporary agony was that it would soon be relieved

by the enhanced automatic living afforded through the intelligent audio/video multiplexer (AVMUX). Using the BCC-52 computer and a smart terminal board from a couple of previous Circuit Cellar projects, the AVMUX would take inputs from a variety of audio and video sources and channel them to any of a number of specific outputs. My intention was to enhance my present level of automatic living to include programmed light, sound, and music.

I wiped my brow after turning the last mounting screw for the AVMUX and instinctively dodged another floor joist as I looked down at the card cage containing the computer that I still had to mount. I had included all the necessary cabling and mounting hardware between it, the multiplexer, and the Home Run Control System (HCS) already in operation. My control program was already written and saved in EPROM (erasable programmable read-only memory) so that it would automatically start when I powered up the system. Depending upon the day, time, direct signals from the HCS, and a yet-to-be-designed remote-

*(continued)*

*Steve Ciarcia (pronounced "see-ARE-see-ah") is an electronics engineer and computer consultant with experience in process control, digital design, nuclear instrumentation, and product development. He is the author of several books about electronics. You can write to him at POB 582, Glastonbury, CT 06033.*

control interface, specific or dynamically variable I/O (input/output) configurations would be mapped into the AVMUX. By retaining the different I/O maps in RAM (random-access read/write memory), the controller could switch among different command situations easily and rapidly.

Time? Memory maps? Uh-oh. It's terrible getting revelations on a ladder. Instead of the normal reaction—stand up, slam my hand on the desk, and yell "That's it!"—I had to be cognizant of the limited headroom and the dust I would raise by yelling.

In actuality, I had discovered

nothing—nothing except a realization that what I had remembered was what I had forgotten to incorporate in my controller design. While the BCC-52 had a real-time clock/calendar within BASIC, it lacked the capability of retaining the I/O maps in RAM or the time if a power failure occurred.

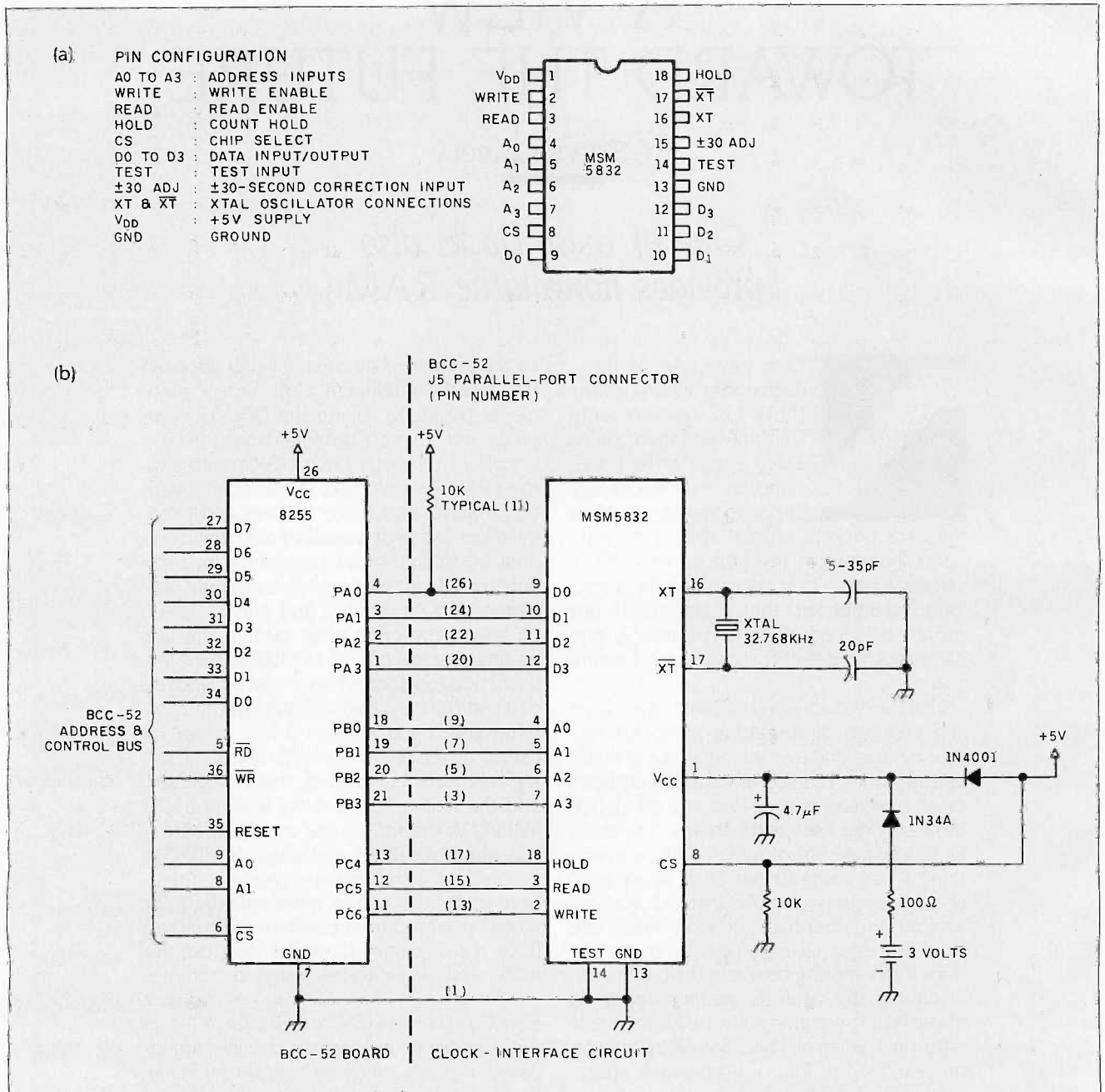

Figure 1: (a) Pin-out of the Oki MSM5832 clock chip. (b) Schematic diagram of a real-time clock circuit using the chip from (a) and an 8255 PIA (already on the BCC-52).

The EPROM-resident control program was self-initiating and would not be destroyed. But it would start up with a time and date of zero and RAM cleared.

My first reaction was to consider a UPS (uninterruptible power supply) or backup battery power for the whole computer. Either option was expensive and would consume a lot of circuit-board real estate that I didn't have. Even if successful, what good is powering the whole computer system unless all the peripherals that it controls are operational as well? In reality, all I needed to power was less than 1K byte of RAM and whatever component or system functions as the real-time clock/calendar. Of course, powering the whole computer would indeed provide nonvolatile memory and an uninterruptible clock/calendar.

Another trek up this ladder to mount a half-dozen rechargeable batteries didn't appeal to me. I needed a self-contained, battery-backed real-time clock that operated independently of the BCC-52 yet could be interrogated periodically regarding the time. Along the way, I'd look into making some portion of RAM nonvolatile.

Within seconds, I was down the ladder and shuffling through my junk box: piles of unopened news releases and an eyebrow-high pile of trade publications. The dimensions of this pile are usually affected only by an earthquake or a desperate search for some new technical idea around article time. Fortunately, my search was rewarded, and I came upon two solutions. One of them uses conventional technology; the other one is rather innovative.

This month, I'll describe two real-time clock/calendars and let you be the judge of which one you want to implement in your application. While both circuits are applicable to any computer, I was specifically looking to attach a clock and nonvolatile RAM to the BCC-52. Also, since I have covered the basics of real-time clocks and the specific attributes of the BCC-52 computer in previous Circuit Cellar articles, I refer you to them for additional information: "Everyone

Can Know the Real Time" (May 1982, page 34) and "Build the BASIC-52 Computer/Controller" (August 1985, page 104).

The first device uses a CMOS (complementary metal-oxide semiconductor) clock/calendar chip that attaches to the computer through paral-

lel ports. Easy to exercise in software but consumptive of I/O, this conventional approach appeals to many of us who simply want a quick resolution of a problem and are not concerned about the I/O costs or having to manufacture thousands of them. The

(continued)

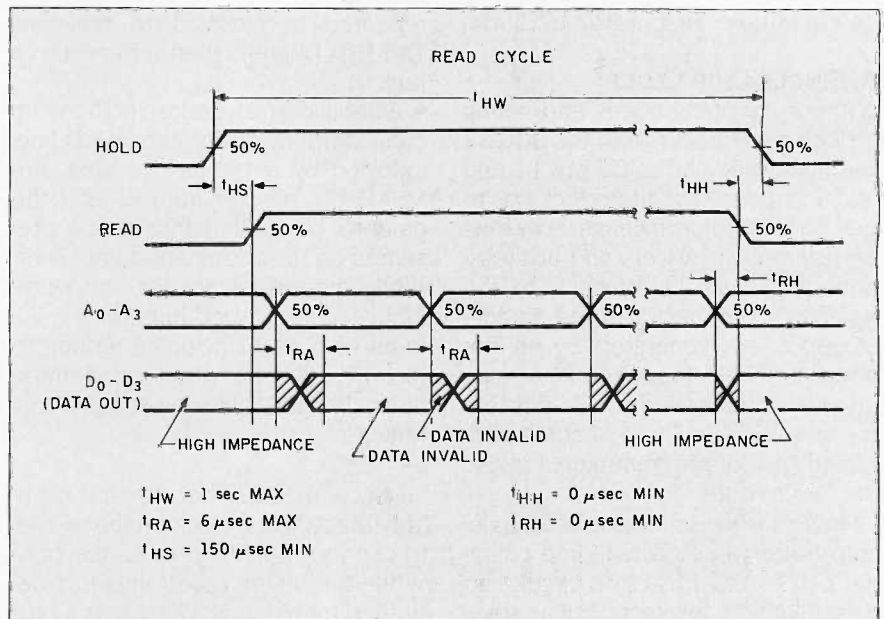

Figure 2: The read-cycle timing diagram for the MSM5832.

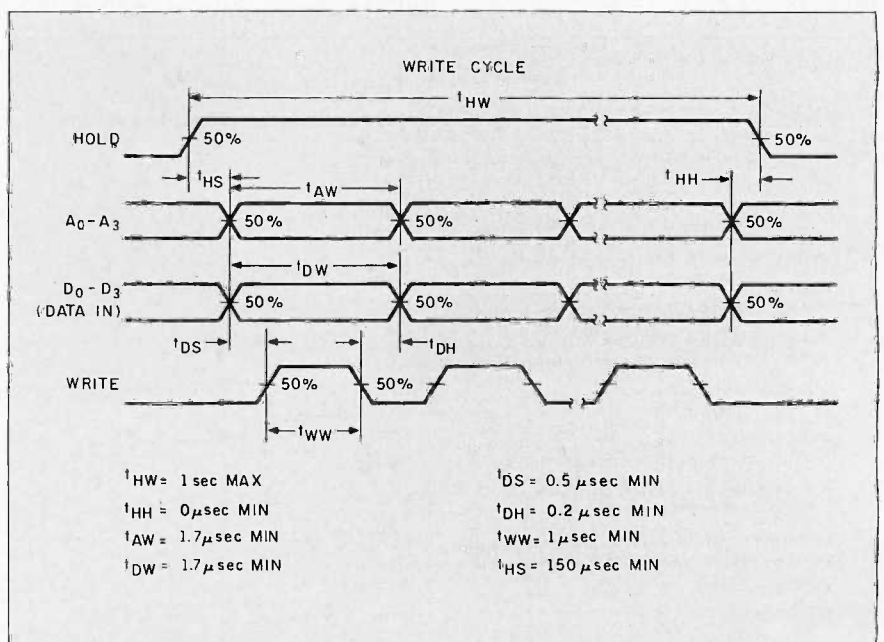

Figure 3: The write-cycle timing diagram for the MSM5832.

second approach uses a new clock "socket" from Dallas Semiconductor that requires no independent interfacing and merely plugs in with a static-RAM chip that might already be resident in the computer system. While software-intensive compared to the conventional clock chips, the concept is unique and will surely prevail long into the future. First, a little tradition.

### A SINGLE-CHIP CLOCK

Without chopping traces and gluing a clock chip directly onto the BCC-52 bus lines, the only logical way I could add a hardware real-time clock was to build another interface card (with its associated bus drivers and address-decoding logic) or attach it to the parallel I/O connector (three parallel I/O ports are generated by an on-board 8255 PIA [peripheral interface adapter] and attached to a 26-pin connector designated as J5). For simplicity and ease of programming, I chose the latter route.

Figure 1 is the schematic of a single-chip battery-backed real-time calendar clock. As far as clock circuits go it is relatively low-tech, but it does work and was easy to build. It uses an Oki MSM5832 clock chip that functions as follows:

- Read cycle (see figure 2): The HOLD line goes high first, followed by the 150-microsecond hold setup time ( $t_{HS}$ ). After this, READ is set high, and the specific MSM5832 registers are sequentially (or randomly) addressed. There is a 6- $\mu$ s read-access time delay ( $t_{RA}$ ) between setting the address and reading the data. This procedure is repeated to read all 16 registers. The HOLD line is then returned to a logic 0.

- Write cycle (see figure 3): The write cycle starts by raising the HOLD line, followed by a 150- $\mu$ s  $t_{HS}$ . Next, the MSM5832 register address and the data to be loaded into it are presented on the address and data lines. While these lines are set, the write-input line is strobed high for a minimum of 6  $\mu$ s. Concluding writing to the 13 counter/registers and three flags, the HOLD line is set again to a logic 0.

I chose the 5832 because it is probably the simplest clock on the market to use in a parallel-port connection. While the timing constraints just described make the 5832's use as a bus-connected clock chip a more difficult connection, they are of little consequence when using it with a PIA.

especially one operated in BASIC. Many clock chips are available to match the speeds of today's processors. By connecting them through a PIA, however, this increased speed is filtered by the PIA and is of no extra value. Specific bits on the PIA function to simulate the computer bus, but the range of control is greater, and bus timing constraints are eliminated.

The 5832 functions by counting pulses from a 32-kilohertz crystal. These counters can be individually preset (setting the time) or read (reading the time) under program control. The chip is CMOS, and while it operates on 5 volts, it retains its status and continues keeping time with a power supply of only 2.2 V. Two hearing-aid batteries (1.5-V alkaline) are soldered together to produce 3 V. (While lithium batteries are preferred, all the lithium batteries I had were larger than I cared to use on this clock.) When the computer is powered, 5 V is applied to  $V_{CC}$  and the clock chip-select line, enabling all I/O and programming functions. With the absence of power, the chip continues to function on 2.8 V supplied through a germanium diode, but I/O and programming functions are inhibited because the chip-select line will be at logic 0.

Five volts is not normally available on the J5 parallel I/O connector, so I had to add a jumper to the back of the board. Rather than try to reroute the circuit connections of J5, I wired +5 V to pin 10 of the J2 serial-printer header and attached a jumper wire with a 2-pin header to connect this power to the prototype board. This pin is not normally used on a serial printer and will not obstruct its use. If you want both the real-time clock and a printer to function together, however, you'll have to make an alternate connection point.

The entire clock is constructed on a 3-square-inch piece of prototyping board that piggybacks on the BCC-52 and plugs directly into the J5 parallel-port connector. Four bits of port A (on the 8255) function as the clock chip's bidirectional data bus; 4 bits of port B serve as the address bus. Three ad-

Function	MSM5832 Hex Address	Hex Entry Range
X1 Seconds	00	0-9
X10 Seconds	01	0-5
X1 Minutes	02	0-9
X10 Minutes	03	0-5
X1 Hours	04	0-4
X10 Hours	05	0-11
Bit 0 and Bit 1 — X10 Hours		
Bit 3 — AM(0)/PM(1)		
Bit 4 — 12(0)/24(1) Hours Format		
Day of Week	06	1-7
X1 Day of Month	07	0-9
X10 Day of Month	08	0-7
Bit 0 and Bit 1 — X10 Days		
Bit 2 — 28(0)/29(1) Day Leap Year		
Bit 3 — N/C		
X1 Month of Year	09	0-9
X10 Month of Year	0A	0-1
X1 Years	0B	0-9
X10 Years	0C	0-9

Figure 4: A map of the MSM5832's registers.

ditional bits of port C provide control signals that gate data into and out of the clock chip. The addresses and functions of these clock registers are shown in figure 4.

As listing 1 demonstrates, the 5832 is easy to set and read in BASIC. To set the time, the three ports are all configured as outputs by loading 80 hexadecimal into the 8255's control register (P4). Since I was writing the program (and you know how I feel about programming), I didn't get too fancy with PRINT statements in the clock-setting routines. Considering that the clock should have to be set only once forever, I think you can do a little hand calculation on the bit configurations and enter each of the presets with a simple prompt of which register is being loaded. If it's August 8th, for example, I expect that you could translate that into an 8 for register 9 and a 0 for register 10. As each entry is made, the port C (P3) control lines are activated in this sequence—hold on, write on, write off, hold off—thus functioning as a simple write strobe.

Reading the device is much simpler. Port A is set as input; ports B and C are set as outputs by loading 20 hexadecimal into the 8255's control register. The 13 clock registers are read by sequentially setting an address on port B and storing the value presented to port A. Because we are doing this all in BASIC, timing is non-critical. Even the hold command, normally enabled whenever the 5832 is read or set, can be ignored if counter-update ripple-through is not critical. After reading all the registers, the values are multiplied by the appropriate constants and added. My software is bare bones, and 24-hour timing was chosen for simplicity. (I realize I could have done it with 11 bits on only two ports—and probably never have finished the software.)

#### A REAL-TIME CLOCK WITH NO INTERFACE REQUIRED

As I wrote the above subhead, I tried to imagine how you would interpret it. Would the skeptical among you say, "Who's he trying to kid?" Or would

Listing 1: A BASIC program to set and read the MSM5832 real-time clock chip.

```

100 DIM N(200) : DIM M(200)
110 REM
120 REM REV 1.5 11/8/85
130 REM 5832 REAL TIME CLOCK FOR BCC-52 I/O PORT
140 REM
150 P1=51200 : P2=51201 : P3=51202 : P4=51203
155 REM SET 8255 PORT A AS INPUT AND B&C AS OUTPUT
160 XBY(P4)=90H
170 REM PORT B IS ADDRESS AND PORT C IS CONTROL BUS
180 PRINT "ENTER 0 TO SET TIME OR 1 TO READ TIME",
: INPUT A
190 ON A GOSUB 350,220
200 GOTO 180
210 GOTO 145
220 REM READ 13 5832 REGISTERS
230 XBY(P3)=20H : REM SET READ MODE
240 FOR A=0 TO 12
250 XBY(P2)=A : N(A)=XBY(P1)
260 NEXT A
270 REM DISPLAY CONTENTS
280 PRINT "DATE ",
290 PRINT N(10)*10+N(9),"/",N(8)*10+N(7),"/",N(12)
:10+N(11)
300 PRINT "TIME ",
310 IF N(5)>=8 THEN N(5)=N(5)-8
320 PRINT (N(5)*10)+N(4)," : ",(N(3)*10)+N(2)," : ",
(N(1)*10)+N(0)
330 PRINT
340 RETURN
350 REM SET TIME
360 XBY(P4)=80H : REM SET PORTS A,B,&C AS OUTPUT
370 REM MSB OF REG 5 12(0)/24(1) HRS & MSB-1 AM(0)/PM(1)
380 FOR A=0 TO 12
390 PRINT "REGISTER",A, : INPUT X
400 XBY(P2)=A : XBY(P1)=X
405 REM WRITE STROBE
410 XBY(P3)=10H : XBY(P3)=50H : XBY(P3)=10H : XBY(P3)=00H
420 NEXT A
430 XBY(P4)=90H : REM RESTORE READ PORT SETTINGS
440 PRINT
450 RETURN

```

you take it on faith that I've had the answer up my sleeve all along?

While the previous circuit works very well, and many of you no doubt will build it, it is I/O-intensive. The value of a single-board computer like the BCC-52 is that it is often desirable to implement it as a single-board control solution. As such, the parallel ports might be needed for the application and not be available for the clock interface I've described.

Not using the PIA means that the clock chip must be connected to the bus and addressed as memory or additional I/O. Short of using one of the already-decoded 8K-byte memory-

block address strobes and building the clock to plug it in in place of a memory chip, it would appear that the only alternative is to attach the clock circuit through the external expansion-bus connector. That, however, would be the traditional answer to the problem.

Using one of the RAM-chip locations sounds like the most logical approach, until you realize that you are sacrificing 25 percent of the available on-board RAM (the BCC-52 holds 32K bytes of RAM in four 8K-byte chips on board) for less than 10 bytes of clock data. It would be much better if both

(continued)

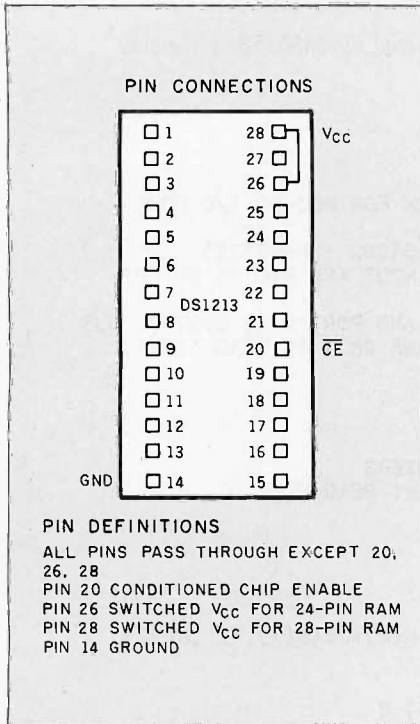

Figure 5: A pin-out diagram of the SmartSocket.

the clock and the RAM could share the memory-block address and any locations not those of the clock could be RAM. Better yet, why not keep all the RAM and attach the clock as a phantom interface that is there only when you need it?

Just as I was cleaning off the soldering iron to build the ultimate real-time clock, I discovered that such a device was just introduced by Dallas Semiconductor (4350 Beltwood Parkway South, Dallas, TX 75244, (214) 450-0470). Called SmartWatch, it does everything I had hoped in a single package and has some startling side benefits, like 8K bytes of nonvolatile memory. This latter revelation necessitates starting at the beginning and discussing a few additional Dallas Semiconductor products that are incorporated in the SmartWatch. The most notable of these is the DS1213 SmartSocket.

**NONVOLATILE RAM**

The DS1213 is a 28-pin 0.6-inch-wide DIP (dual in-line package) socket with

a built-in CMOS controller circuit and lithium battery (see figure 5). It accepts either a 28-pin 8K by 8 or 24-pin 2K by 8 lower-justified JEDEC (Joint Electronic Device Engineering Council) byte-wide CMOS static RAM. When the socket is mated with a CMOS RAM, it makes the RAM contents nonvolatile by automatically switching the RAM to battery operation and write-protecting it upon any occurrence of power interruption.

The SmartSocket performs five circuit functions necessary for implementing battery backup on a CMOS memory. First, a switch is provided to direct power from the battery or V<sub>CC</sub> supply, depending on which is greater. This switch has a voltage drop of less than 0.2 V. The second function is power-fail detection at input voltages less than 4.75 V. The DS1213 constantly monitors the V<sub>CC</sub> supply. When V<sub>CC</sub> falls below 4.75 V, a precision comparator detects the condition and inhibits enabling of the RAM chip.

The third function accomplishes write protection by holding the chip-

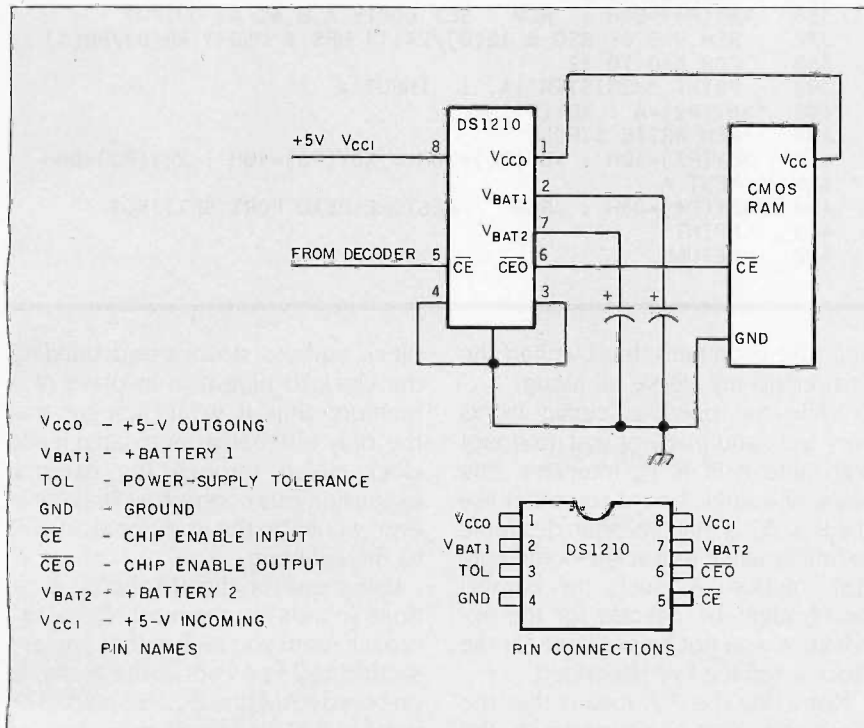

Figure 6: The pin-out and functional diagram for the DS1210 nonvolatile-RAM controller.

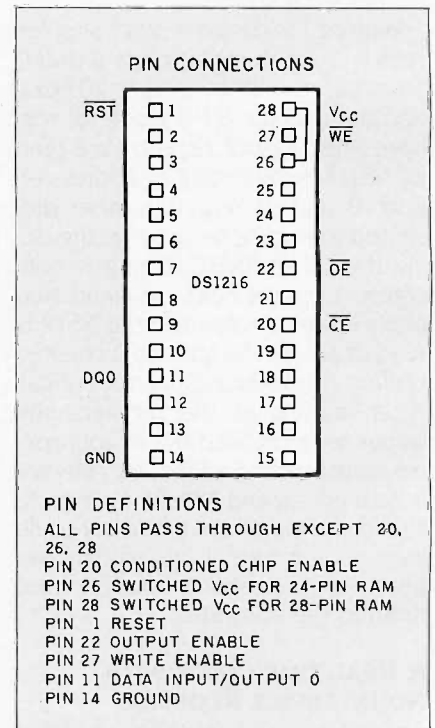

Figure 7: A pin-out for the DS1216 SmartWatch.

enable signal to the memory to within 0.2 V of  $V_{cc}$  or battery supply. If the chip-enable signal is active at the time power-fail detection occurs, write protection is delayed until after the memory cycle is complete to avoid corruption of data. During nominal power-supply conditions, the memory chip-enable signal will be passed through to the socket receptacle with a maximum propagation delay of 20 nanoseconds.

The SmartSocket's fourth function is to check battery status and warn of potential data loss. Each time that  $V_{cc}$  power is restored to the SmartSocket, the battery voltage is checked with a precision comparator. If the battery supply is less than 2.0 V, the second memory cycle is inhibited. Battery status can, therefore, be determined by performing a read cycle after power-up to any location in the memory, recording the contents of that memory location. A subsequent write cycle can then be executed to the same memory location, altering the data. If the next read cycle fails to verify the written data, the contents of the memory are questionable because the battery may not have retained it.

The fifth function is battery redundancy. In many applications, data integrity is paramount. The DS1213 SmartSocket has two internal batteries. During battery-backup time, the battery with the highest voltage is selected for use. If one battery fails, the other automatically takes over. The switch between batteries is transparent to the user. A battery status warning occurs only if both batteries are less than 2.0 V. Each of the two lithium cells contains 35 milliampere/hour capacity, making the total 70 mA/hr.

If you are contemplating a new design and want the benefits of non-volatile static memory, the essential ingredients of the SmartSocket are available in chip form. Designated as DS1210, DS1224, and DS1212, they coordinate and perform the above described backup and write-protect functions for banks of 1, 4, or 16 in-

(continued)

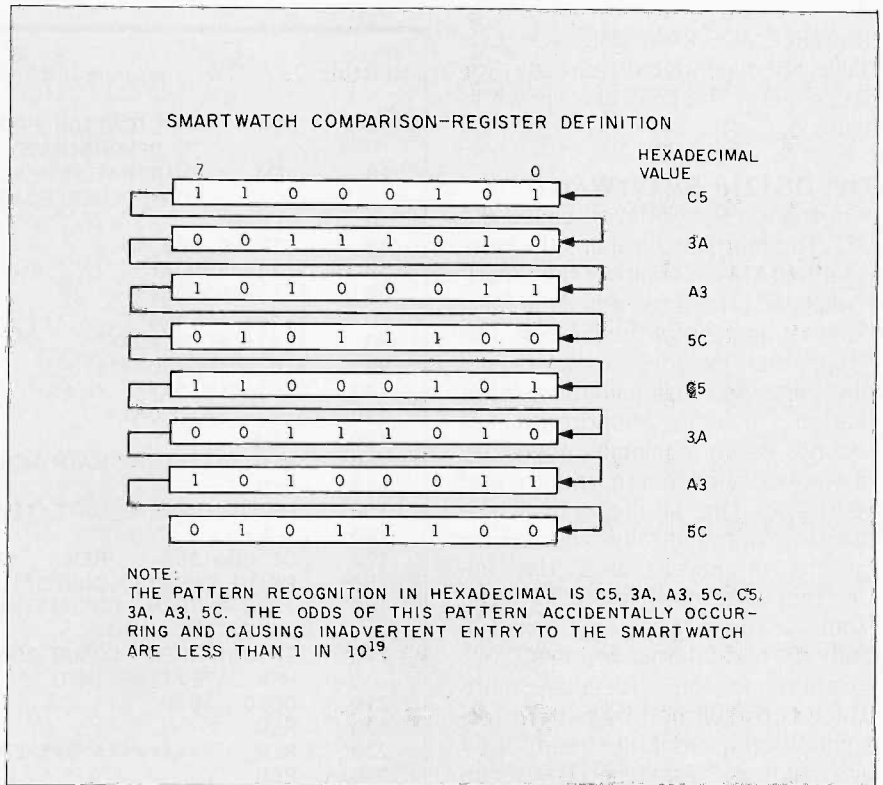

Figure 8: The SmartWatch's comparison bit pattern.

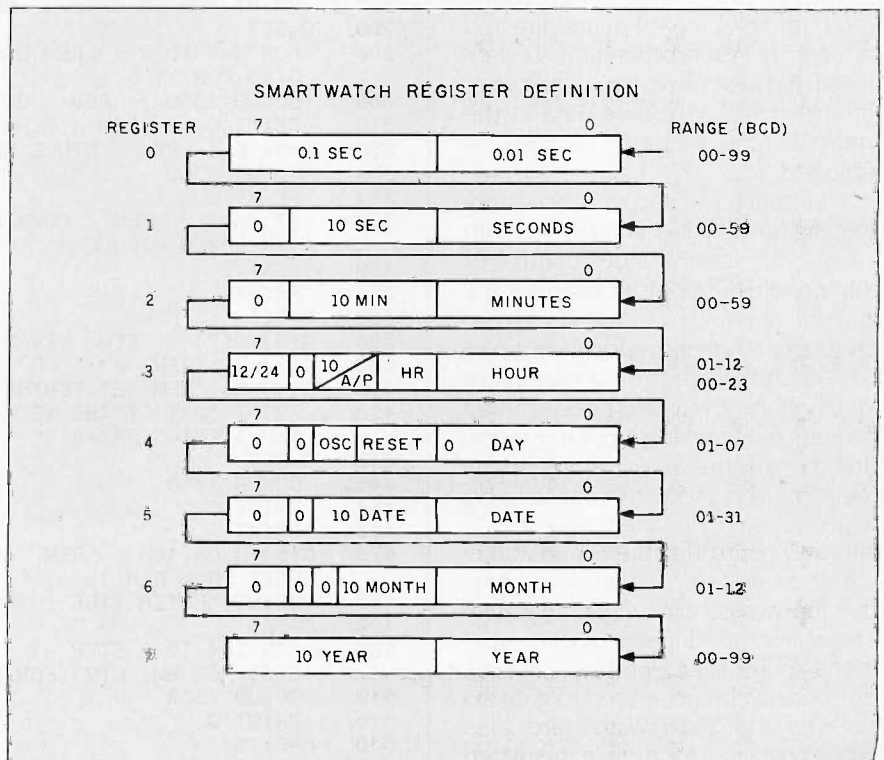

Figure 9: The SmartWatch's registers.

dividual CMOS RAM chips. (Contact Dallas Semiconductor directly for data sheets.) The DS1210 is shown in figure 6.

### THE DS1216 SMARTWATCH

A new socket-style device called the DS1216 SmartWatch retains the non-volatile-RAM capability of the SmartSocket and adds a calendar time function (see figure 7 for the pin-out). The SmartWatch includes its own crystal time base and maintains time information, including hundredths of seconds, seconds, minutes, hours, day of week, day of month, month, and year. The date at the end of the month is automatically adjusted for months with fewer than 31 days, including correction for leap year. Hours of the day can be tracked in both 12- and 24-hour formats.

Communication with the SmartWatch is established by pattern recognition on a serial bit stream of 64 bits that must be matched by executing 64 consecutive write cycles containing the proper data on DQ0. All accesses that occur prior to recognition of the 64-bit pattern are directed to memory. After recognition is established, the next 64 read or write cycles either extract or update data in the SmartWatch; memory access is inhibited.

Data transfer to and from the time-keeping function is accomplished with a serial bit stream under control of chip enable ( $\overline{CE}$ ), output enable ( $\overline{OE}$ ), and write enable ( $\overline{WE}$ ). Initially, a read cycle to any memory location using the  $\overline{CE}$  and  $\overline{OE}$  control of the SmartWatch starts the pattern-recognition sequence by moving a pointer to the first bit of the 64-bit comparison register. The next 64 consecutive write cycles are executed using the  $\overline{CE}$  and  $\overline{WE}$  control of the SmartWatch. These 64 write cycles are used only to gain access to the SmartWatch. Therefore, any address to the memory in the socket is acceptable. However, the write cycles generated to gain access to the SmartWatch are also writing data to a location in the mated RAM. The preferred way to manage this requirement is to set aside one

Listing 2: A BASIC program that sets and reads the SmartWatch.

```

10  REM      APPLICATION PROGRAM USING ONLY BASIC
      TO DEMONSTRATE
20  REM      SMARTWATCH REAL TIME CLOCK ON BCC52 COMPUTER
      CONTROLLER BOARD

30  CLEAR
40  STRING 200,15
50  $(1)="SUNDAY"
60  $(2)="MONDAY"
70  $(3)="TUESDAY"
80  $(4)="WEDNESDAY"
90  $(5)="THURSDAY"
100 $(6)="FRIDAY"
110 $(7)="SATURDAY"
120 REM
130 REM ***** MAIN MENU *****
140 REM
150 PRINT "0=READ DATE/TIME  1=ENTER NEW DATE/TIME ?"
160 G=GET
170 GOSUB 1350 : REM  GET NUMBER 0-9
180 PRINT CHR(18),CHR(27),"Y" : REM CLR & HOME TERMITE
190 IF G=0 THEN GOSUB 790 : REM READ & DISPLAY
      DATE/TIME INFO
200 IF G=1 THEN GOSUB 250 : REM GATHER & SAVE
      NEW DATE/TIME INFO
210 GOTO 150
220 REM
230 REM ***** GATHER $ SAVE NEW DATE/TIME INFO
240 REM
250 J=XBY(4000H) : REM SAVE BYTE LOCATED IN 4000H
      TO REPLACE WHEN DONE
260 GOSUB 1420 : REM SEND PATTERN RECOGNITION CODES
270 PRINT "ENTER DATE  MMDDYY"
280 G=GET
290 FOR Z=6 TO 8 : REM USE G(6) FOR MM, G(7) FOR DD,
      G(8) FOR YY
300 GOSUB 1350 : REM  GET NUMBER 0-9
310 PRINT G, : REM  ECHO NUMBER 0-9
320 H=G*16 : REM  STORE NUMBER IN UPPER NIBBLE
330 GOSUB 1350
340 PRINT G,
350 G(Z)=H+G : REM  COMBINE NUMBERS 1 IN UPPER NIBBLE,
      1 IN LOWER NIBBLE
360 NEXT Z
370 PRINT
380 G=G(6) : REM
390 G(6)=G(7) : REM  SWAP 6 & 7, NOW 6,7,8 IN DD/MM/YY
400 G(7)=G : REM
410 G(1)=0 : REM SET TENTHS & HUNDREDTHS OF A SECOND = 0
420 PRINT "DAY OF THE WEEK SUN=0 MON=1 TUE=2 WED=3
      THU=4 FRI=5 SAT=6 ?"
430 G=GET
440 GOSUB 1350
450 PRINT G
460 PRINT
470 G(5)=G.OR.10H : REM  OR BIT4 TO IGNORE
      RESET FROM PIN 1
480 PRINT "ENTER TIME  HHMMSS"
490 G=GET
500 FOR Z=4 TO 2 STEP -1 : REM  USE G(4) FOR HH,
      G(3) FOR MM, G(2) FOR SS
510 GOSUB 1350
520 PRINT G,
530 H=G*16
540 GOSUB 1350
550 PRINT G,

```



```

560 G(Z)=H+G
570 NEXT Z
580 PRINT
590 PRINT "IS THE TIME IN 0=24 HOUR FORMAT
1=12 HOUR FORMAT ?"
600 G=GET
610 GOSUB 1350
620 IF G<>1 THEN 680 : REM IF NOT 1 THEN JUMP
630 G(4)=(G(4).OR.80H) : REM OR BIT7 TO
INDICATE 12 HOUR FORMAT
640 PRINT "IS IT 0=AM 1=PM ?"
650 G=GET
660 GOSUB 1350
670 IF G=1 THEN G(4)=(G(4).OR.20H) : REM OR
BIT5 TO INDICATE PM
680 REM HOLD FOR TIME SYNCHRONIZATION
690 PRINT "HIT '0' TO GO SET THE NEW DATE/TIME"
700 GOSUB 1350
710 IF G<>0 THEN 700
720 GOSUB 1530 : REM STORE DATE/TIME INFO TO SMARTWATCH
730 XBY(4000H)=J : REM REPLACE BYTE TO 4000H
740 G=0
750 RETURN
760 REM
770 REM ***** READ & DISPLAY DATE/TIME
780 REM
790 J=XBY(4000H)
800 GOSUB 1420 : REM SEND PATTERN RECOGNITION CODES
810 GOSUB 1230 : REM READ SMARTWATCH REGISTERS
820 PRINT "TODAY IS ",$(G(5).AND.7H)+1 :
REM STRIP OFF DAY OF WEEK
830 $(8)=" / / " : REM INITIALIZE DATE STRING
840 Z=7 : REM USE G(7) MM REGISTER
850 X=1 : REM PLUG CHARACTERS INTO STRING STARTING
AT POSITION 1
860 GOSUB 1630 : REM GET 2 CHARACTERS FROM G(Z)
AND PLUG INTO STRING $(8)
870 Z=6
880 X=4
890 GOSUB 1630
900 Z=8
910 X=7
920 GOSUB 1630
930 $(9)=$(8) : REM SAVE IT IN $(9) FOR ANY FUTURE USE
940 PRINT $(9)
950 $(8)=" " : REM INITIALIZE TIME STRING
960 G(9)=G(4)
970 IF (G(4).AND.80H)=0 THEN 1020 :
REM IF BIT7=0 THEN 24 HR FORMAT, JUMP
980 IF (G(4).AND.20H)=0 THEN ASC$(8),13)=41H :
REM IF BIT5 = 0, PLUG A
990 IF (G(4).AND.20H)=20H THEN ASC$(8),13)=50H :
REM IF BIT5 SET, PLUG P
1000 ASC$(8),14)=4DH : REM PLUG M
1010 G(9)=(G(4).AND.1FH) :
REM STRIP OFF FORMAT FROM HOUR REGISTER
1020 Z=9
1030 X=1
1040 GOSUB 1630
1050 ASC$(8),3)=3AH : REM PLUG IN THE CHARACTER FOR COLON
1060 Z=3
1070 X=4
1080 GOSUB 1630

```

(continued)

address location in RAM as a Smart-Watch scratchpad.

When the first write cycle is executed, it is compared to bit 1 of the 64-bit comparison register. If a match is found, the pointer increments to the next location of the comparison register and awaits the next write cycle. If a match is not found, the pointer does not advance, and all subsequent write cycles are ignored. If a read cycle occurs at any time during pattern recognition, the present sequence is aborted, and the comparison-register pointer is reset.

Pattern recognition continues for a total of 64 write cycles until all the bits in the comparison register have been matched (this bit pattern is shown in figure 8). With a correct match for 64 bits, the SmartWatch is enabled, and data transfer to or from the timekeeping registers can proceed. The next 64 cycles will cause the SmartWatch to either receive or transmit data on  $\overline{DQ0}$ , depending on the level of the  $\overline{OE}$  pin or the  $\overline{WE}$  pin. Cycles to other locations outside the memory block can be interleaved with  $\overline{CE}$  cycles without interrupting the pattern-recognition sequence or data-transfer sequence to the SmartWatch.

The SmartWatch information is contained in eight registers of 8 bits each, which are sequentially accessed a bit at a time after the 64-bit pattern-recognition sequence has been completed. When updating the Smart-Watch registers, each must be handled in groups of 8 bits. These read/write registers are defined in figure 9.

Data contained in the SmartWatch registers is in BCD (binary-coded decimal) format. Reading and writing the registers are always accomplished by stepping through all eight registers, starting with bit 0 of register 0 and ending with bit 7 of register 7. A few of the significant bits are the following:

- AM-PM/12/24 mode: Bit 7 of the hours register is defined as the 12- or 24-hour mode select bit. When high, the 12-hour mode is selected. In the

(continued)

```

1090 ASC$(8),6)=3AH
1100 Z=2
1110 X=7
1120 GOSUB 1630
1130 Z=1
1140 X=10
1150 GOSUB 1630
1160 PRINT $(8)
1170 XBY(4000H)=J
1180 G=0
1190 RETURN
1200 REM
1210 REM ***** READ SMARTWATCH REGISTERS
1220 REM
1230 FOR Z=1 TO 8
1240 G(Z)=0
1250 FOR X=1 TO 8
1260 G=(XBY(4000H).AND.1) : REM G = BIT0
1270 IF G=0 THEN 1290 :
  REM BIT = 0, DON'T ADD ANYTHING TO REGISTER BYTE
1280 G(Z)=G(Z)+(2**(X-1)) :
  REM BUILD REGISTER BYTE FROM BITS RECEIVED
1290 NEXT X
1300 NEXT Z
1310 RETURN
1320 REM
1330 REM ***** GET NUMBER 0-9
1340 REM
1350 G=GET
1360 IF G<48.OR.G>57 THEN 1350
1370 G=G-48 : REM ASC TO 0-9
1380 RETURN
1390 REM
1400 REM ***** INITIALIZE PATTERN RECOGNITION CODES
1410 REM
1420 G(1)=0C5H
1430 G(2)=3AH
1440 G(3)=0A3H
1450 G(4)=5CH
1460 G(5)=0C5H
1470 G(6)=3AH
1480 G(7)=0A3H
1490 G(8)=5CH
1500 REM
1510 REM ***** SEND REGISTERS TO SMARTWATCH
1520 REM
1530 FOR Z=1 TO 8
1540 FOR X=1 TO 8
1550 IF (G(Z).AND.(2**(X-1)))<>0 THEN G=1 ELSE G=0 :
  REM STRIP OFF BIT
1560 XBY(4000H)=G : REM SEND BIT TO SMARTWATCH
1570 NEXT X
1580 NEXT Z
1590 RETURN
1600 REM
1610 REM ***** GET 2 CHARACTERS FROM G(Z) REGISTER
1620 REM ***** PLUG $(8) @ X
1630 G=INT(G(Z)/16)
1640 ASC$(8),X)=G+48
1650 ASC$(8),X+1)=G(Z)-(G*16)+48
1660 RETURN
1670 REM
1680 REM ***** END

```

12-hour mode, bit 5 is the AM/PM bit with logic high being PM. In the 24-hour mode, bit 5 is the second 10-hour bit (20-23 hours).

- Oscillator and reset bits: Bits 4 and 5 of the day register are used to control the reset and oscillator function. Bit 4 controls the reset pin (pin 1). When the reset bit is set to logic 1, the reset input pin is ignored. When the reset bit is set to logic 0, a low input on the reset pin will cause the SmartWatch to abort data transfer without changing data in the watch registers. Bit 5 controls the oscillator. This bit is shipped from Dallas Semiconductor set to logic 1, which turns the oscillator off. When set to logic 0, the oscillator turns on, and the watch becomes operational.

- Zero bits: Registers 1, 2, 3, 4, 5, and 6 contain one or more bits that always read logic 0. When writing these locations, either a logic 1 or 0 is acceptable.

### READING AND SETTING SMARTWATCH IN BASIC

While it is ultimately smarter to exercise the SmartWatch through an assembly-language routine, the universality of BASIC suggests that it would be a better tool for demonstrating the intricacies of communicating with SmartWatch. Listing 2 is a BASIC program that sets and reads a SmartWatch installed at 4000 hexadecimal on a BCC-52 computer/controller board. This program is more involved than the 5832 clock-chip program described earlier, primarily because it has more reporting features and communicates with the operator through menus. Embedded among all the REM and PRINT statements are the essential time-setting and read routines that you can translate from BASIC-52 to any other BASIC.

### AN ASSEMBLY-LANGUAGE FIRMWARE UTILITY

The assembly-language interface to the SmartWatch is also done on the bit level. The device requires that a particular pattern of 64 consecutive bits be written to data bit 0 in order to access the time and date registers

of the SmartWatch. Then, 64 more consecutive reads or writes are required to examine or set the watch.

The firmware EPROM consists of a set of routines that take care of manipulating the SmartWatch and conversion of the SmartWatch data from BCD to binary format (I call this firmware SmarTime). This allows the use of BASIC to directly read the data in memory with no conversion code necessary in the BASIC-52 program. Year, month, date, day of week, hours, minutes, seconds, and hundredths of seconds are made available in the BCC-52 data memory for reading by the user program. SmarTime uses 24-hour military time (00:00-23:59) in order to eliminate the need for an AM/PM indicator. If AM/PM time is required, you can convert it to the more standard format in BASIC.

The SmarTime system is contained within an EPROM at location 6000 hexadecimal (for this demonstration) and occupies 300 (hexadecimal) bytes of memory (the SmarTime routines can be reassembled to run in any available 300 [hexadecimal]-byte EPROM space on the board). The rest can be used by your application if desired, but be careful to put your data into the EPROM from the top down.

SmarTime stores its register save and load areas and date/time information in the area directly above BASIC-52's current MTOP pointer. Because of this, the MTOP address must be adjusted down by 30 bytes prior to calling the initialization routine at location 6000 hexadecimal. A memory map appears in figure 10.

Three basic functions are found in SmarTime (figures 11-14 outline the logic flow of these programs). The first is a routine that sets up the memory environment for SmarTime to use. This routine, executed with a CALL 6000H, creates a load table of information in the memory above MTOP. The table contains the base address of the SmartWatch device, as well as a pointer to where the time information is stored.

A second routine, invoked with a CALL 6003H, uses the binary data

stored in the time and date fields to set the SmartWatch. The required control bits for establishing 24-hour time and for turning on the SmartWatch internal oscillator are added to the data prior to its being written to the SmartWatch device. The routine also does the binary-to-BCD conversion.

The third function of the software is a routine for reading out the SmartWatch date and time information, converting it from BCD to binary format, and storing it in the memory area above MTOP. It is executed with a CALL 6006H.

Using the SmartWatch with SmarTime is easy. With the DS1216 installed at address 4000 hexadecimal and SmarTime at 6000 hexadecimal, simply enter and run the program

### *SmarTime uses*

## *24-hour military time to eliminate the need for an AM/PM indicator.*

shown in listing 3.

Finally, we are back to simple BASIC programs with the help of a little firmware tucked away in an EPROM. As this program runs, you should see the seconds location of the clock/calendar printed out once per second. If it is correctly incrementing, the EPROM is installed properly at location 6000 hexadecimal and the Smart-

*(continued)*

Program Memory	6000H-6300H	SmarTime EPROM-resident software	
External Data Memory	Offset Above MTOP Value	Function	
	DEC	HEX.	
	24	18	YEARS (00-99)
	23	17	MONTHS (01-12)
	22	16	DATE (01-31)
	21	15	DAY (01-07)
	20	14	HOURS (00-23)
	19	13	MINS. (00-59)
	18	12	SECS. (00-59)
	17	11	HUNDREDTHS of SECS (0.00-0.99)
	16	10	BANK 3 REG 7 LOAD (RESERVED)
	15	0F	BANK 3 REG 6 LOAD (RESERVED)
	14	0E	BANK 3 REG 5 LOAD (RESERVED)
	13	0D	BANK 3 REG 4 LOAD (RESERVED)
	12	0C	BANK 3 REG 3 LOAD (TIME AREA LOW)
	11	0B	BANK 3 REG 2 LOAD (TIME AREA HIGH)
	10	0A	BANK 3 REG 1 LOAD (RESERVED)
	09	09	BANK 3 REG 0 LOAD (WATCH BASE)
	08	08	BANK 3 REG 7 SAVE AREA
	07	07	BANK 3 REG 6 SAVE AREA
	06	06	BANK 3 REG 5 SAVE AREA
	05	05	BANK 3 REG 4 SAVE AREA
	04	04	BANK 3 REG 3 SAVE AREA
	03	03	BANK 3 REG 2 SAVE AREA
	02	02	BANK 3 REG 1 SAVE AREA
MTOP += >	01	01	BANK 3 REG 0 SAVE AREA

Figure 10: The SmarTime firmware memory map.

Watch at location 4000 hexadecimal. You can now write your own BASIC-52 programs to use SmartTime.

**IN CONCLUSION**

Either real-time clock I've presented is applicable and valuable in control applications. Which you use depends primarily upon the application. It took

only a few hours to build and test the 5832 circuit, and it proved an immediate success for a one-shot problem. In the long run, however, the SmartTime system incorporating the SmartWatch and nonvolatile RAM is a more useful BCC-52 peripheral that can be easily duplicated, especially now that the software is written.

Speaking of software, the BASIC listings and a file of the SmartTime executable code (to run at 6000 hexadecimal) discussed in this article are available for downloading from BYTE-net Listings at (617) 861-9764 and the Circuit Cellar BBS at (203) 871-1988. They are also available from BYTE on disk (see page 358).

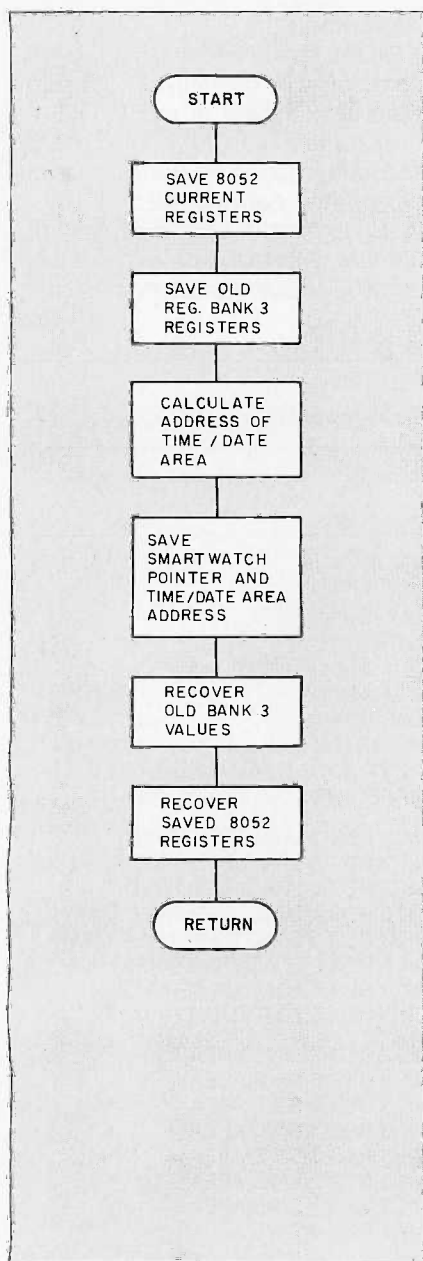

Figure 11: The SmartTime firmware flowchart—the initialization routine.

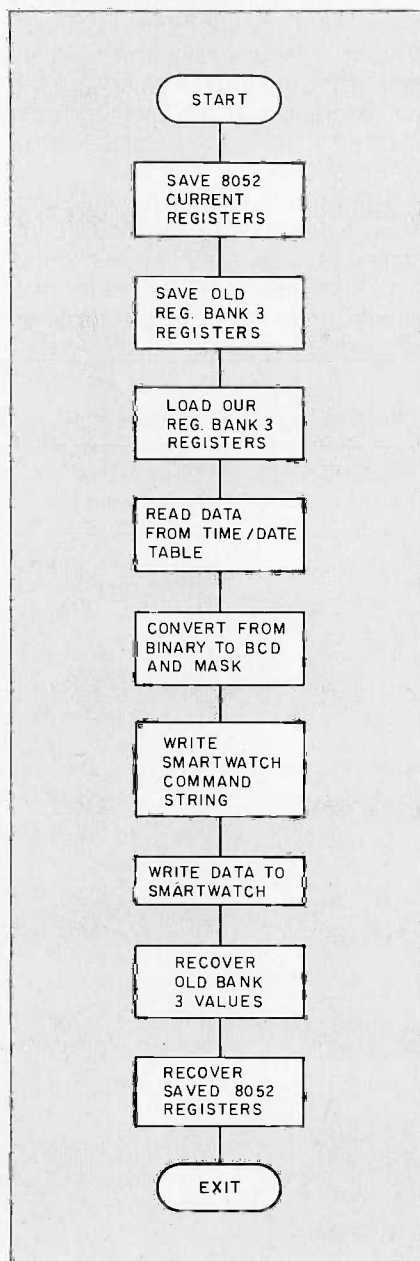

Figure 12: The SmartTime firmware flowchart—a routine to set the SmartWatch.

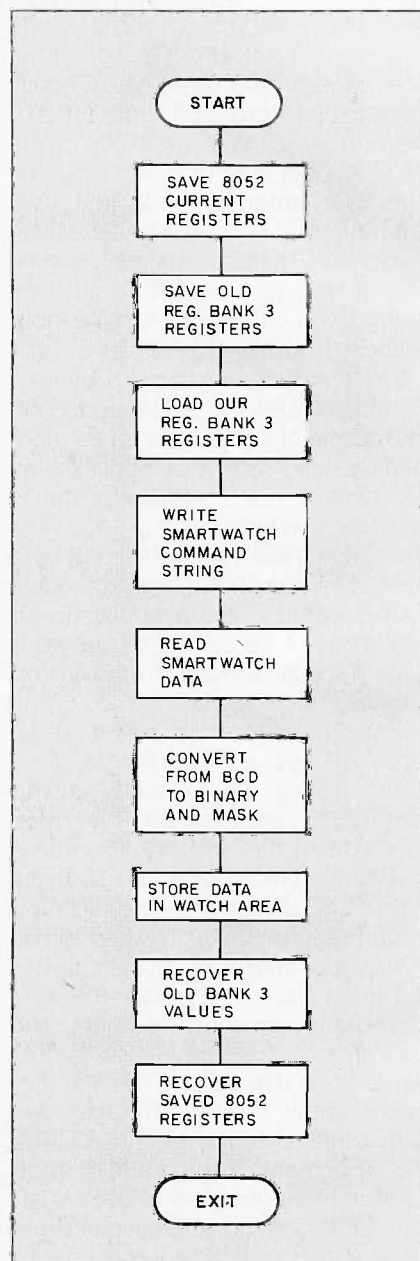

Figure 13: The SmartTime firmware flowchart—a routine to read the SmartWatch.

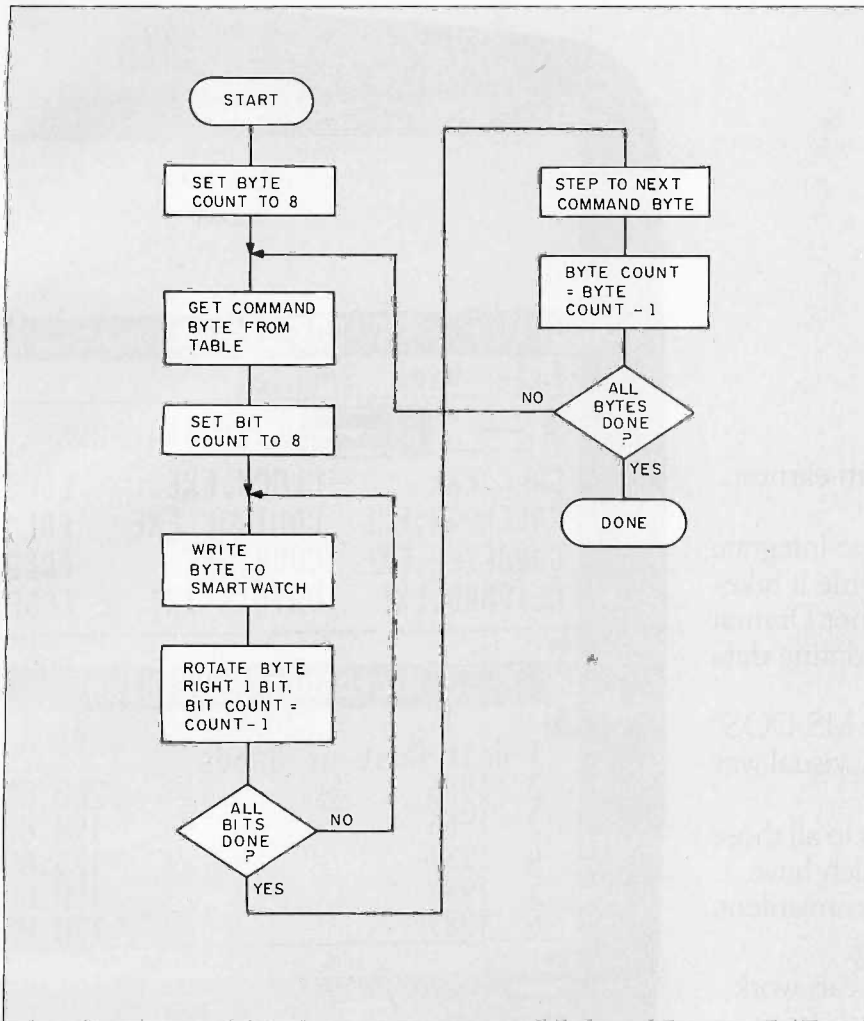

Figure 14: The SmartTime firmware flowchart—a routine to write a command string or data to the SmartWatch.

**CIRCUIT CELLAR FEEDBACK**

This month's feedback is on page 354.

**NEXT MONTH**

Beating your own security system: a personal experience. ■

Special thanks to Jeff Bachiochi and Bill Curlew for their software expertise.

Diagrams pertaining to Dallas Semiconductor components and Oki are reprinted by permission.

The following items are available from

The Micromint Inc.  
 25 Terrace Dr.  
 Vernon, CT 06066  
 (800) 635-3355 for orders  
 (203) 871-6170 for information

The BCC-52 SmartTime system consists of a DS1216 SmartWatch and a SmartTime firmware EPROM (ROM C) written in 8052 assembly language. The EPROM contains the assembled executable code (address 7D00 hexadecimal) and the power I/O system as described in the December 1984 Circuit Cellar. Using the assembler provided in the optional expansion utilities ROMs A and B, the SmartTime routine can be reassembled to execute anywhere in memory. The SmartTime manual contains the source file of the SmartTime utility.

1. SmartTime firmware EPROM with SmartWatch module.  
 BCC-52 clock and SmartROM C . . . \$69
2. SmartTime firmware EPROM with SmartWatch module and 8K-byte RAM chip.  
 BCC-52 8K clock and SmartROM C . \$79
3. DS1216 SmartWatch clock module separately.  
 DS1216 . . . . . \$39
4. BCC-52 computer/controller board with manuals.  
 BCC-52 . . . . . \$239

Please include \$5 for UPS shipping and handling in the continental United States, \$12 for ground or \$18 for air shipment elsewhere. Connecticut residents please include 7.5 percent sales tax.

Editor's Note: Steve often refers to previous Circuit Cellar articles. Most of these past articles are available in book form from BYTE Books, McGraw-Hill Book Company, POB 400, Hightstown, NJ 08250.

Ciarcia's Circuit Cellar, Volume I covers articles in BYTE from September 1977 through November 1978. Volume II covers December 1978 through June 1980. Volume III covers July 1980 through December 1981. Volume IV covers January 1982 through June 1983.

Listing 3: This BASIC program uses the SmartTime firmware to update a seconds counter on screen. Note that comments in parentheses next to the code should not be entered as part of the program.

```

10 MTOP = MTOP - 30 (RESET MTOP POINTER)
20 DBY(18H)=040H (ASSUME SMARTWATCH AT 4000H)
30 CALL 6000H (INITIALIZE THE SYSTEM)
40 REM NOW SET SMARTWATCH TIME
50 FOR X=MTOP+24 TO MTOP+17 STEP -1
60 READ C
70 XBY(X)=C
80 NEXT X
85 REM ZZ/01/85 14:25:00.00
90 DATA 85,11,01,05,14,25,00,00
100 CALL 6003H (WRITE THE VALUES)
110 CALL 6006H (READ THE VALUES)
120 PRINT MTOP+18 (SECONDS COUNTER)
130 GOTO 110
    
```

# Introducing PC

Microsoft® Windows has arrived.

For anyone who uses a computer in earnest, that is extremely good news.

Windows gives you a practical way to integrate programs. It radically decreases the time it takes to move from one application to another. Dramatically simplifies the means of consolidating data from many different programs.

And as a graphical extension of the MS-DOS® operating system, it gives you a highly visual way to work and to organize your work.

In short, Windows brings efficiency to all those processes of personal computing which have till now been awkward, unwieldy, inconvenient.

## The joys of job hopping.

With the advent of Windows, you can work with multiple applications. And switch from program to program with ease.

Start up with one application, then another, and another. Leap back and forth between applications as your work routine dictates. Then pick up right where you left off.

The ability of Windows to change quickly from program to program logically and naturally magnifies the utility and productivity of the personal computer. And is a recognition of the way people who exploit the power of PCs really do their jobs.

## Breaking the 640K barrier.

Just like you, Microsoft Windows can handle several projects at the same time. Juggle assignments. Deal with frequent interruptions.

And Windows will ignore the 640K limit of the PC, especially if you have a hard disk, the Intel® Above™ Board, or expanded memory. It will execute the rather neat trick of working with more programs than

memory can hold at one time.

## Spreading knowledge.

Another significant service Windows performs is accelerating the movement of information from one program to another.

Collecting and combining that information is as simple as taking a "snapshot" of data in one program. Editing it. Then consolidating it with data from other programs.

With Windows, you can enjoy the advantages of conventional integrated programs without their compromises. Because Windows lets you put together the applications that you know, and that get a job

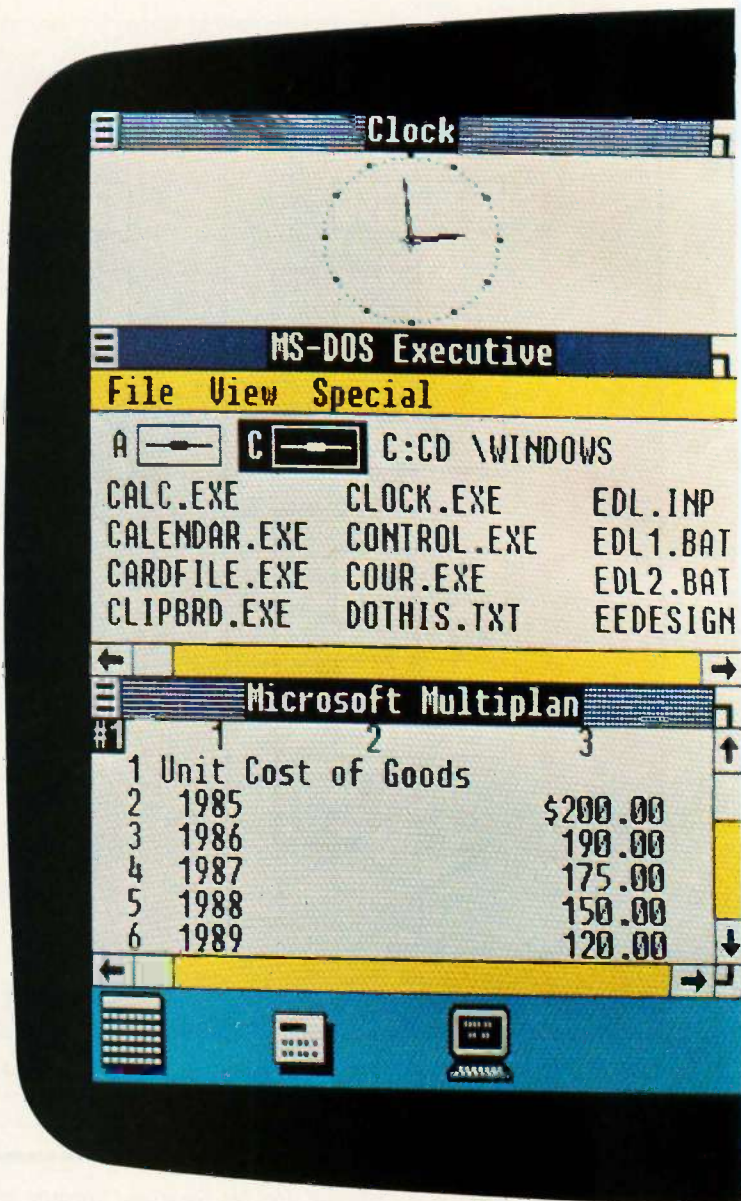

# Power Windows.

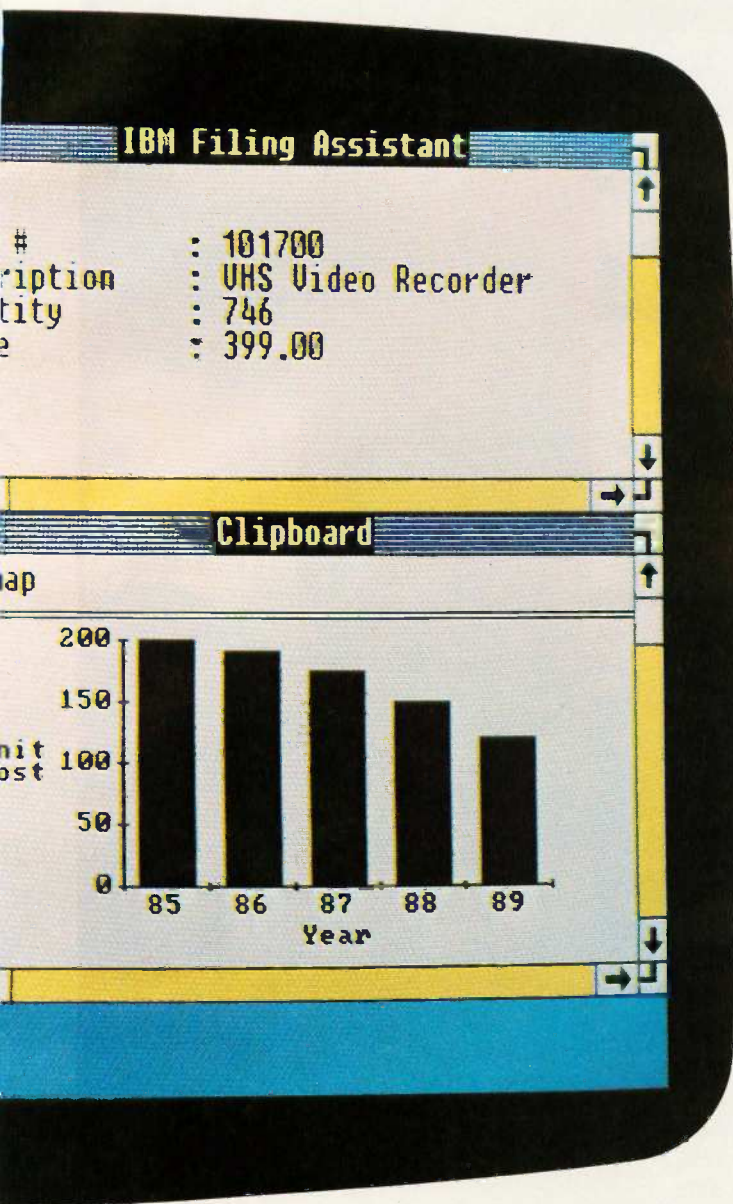

done for you.

Choose your best word processor, spreadsheet, database—you name it. They're all there for you at a keystroke.

## Common ground.

Finally, Windows is not only an immensely powerful tool for today, it's also a solid base for a new generation of Windows Applications.

As an introductory offer, two of these—Microsoft Windows Write and Windows Paint—are included in the Windows package. Along with more than a dozen other Windows desktop applications. Including a DOS file management program, calendar,

cardfile, notepad, calculator, and a telecommunications program.

In Windows Applications you have a common interface which includes drop-down menus, dialog boxes, icons. Along with a richer environment that allows you to mix pictures and text. And to summon different type faces and styles at a keystroke.

Windows is a bridge between today's applications and the graphics based software now evolving. A way to work interchangeably with today's programs. And tomorrow's.

**Of course, all this is going to cost you: \$99.**

A price that makes Windows the most startling value ever offered in software. A comparable collection of programs—a switching program, a graphic interface, desktop applications, a word processor, a drawing program—could easily cost hundreds of dollars more.

If you're someone who uses personal computing as a natural part of your work life, who capitalizes on the productive powers of sophisticated applications, look into Windows.

It offers a new vision of what a computer can do.

## Microsoft® Windows

The High Performance Software™

For the name of your nearest Microsoft dealer, call (800) 426-9400. In Washington State and Alaska, (206) 828-8088. In Canada, call (800) 387-6616.

Note: Photo shows color and resolution obtained on an IBM® PC equipped with IBM Enhanced Graphics Adapter. Monochrome display is generated when an IBM Color Graphics Adapter or compatible graphics adapter card is used.

Microsoft and MS-DOS are registered trademarks and The High Performance Software is a trademark of Microsoft Corporation. Intel is a registered trademark and Above is a trademark of Intel Corporation. IBM is a registered trademark of International Business Machines Corporation.

System Requirements: IBM or COMPAQ Personal Computer (or 100% compatibles) 256K memory, two double-sided, double-density disk drives (512K and a hard disk recommended, when using multiple applications or DOS 3.0 or higher). Graphics adapter card (IBM Color Graphic Monitor Adapter, IBM Enhanced Graphics Adapter, Hercules Graphics Card, or compatible).





# A SIMPLE WINDOWING SYSTEM

## PART 1: BASIC PRINCIPLES

BY BRUCE WEBSTER

---

*Windows can be implemented on almost any system  
with a memory-mapped display*

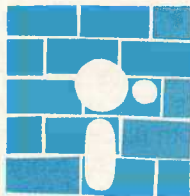

The use of windows for user interfaces is not new; the Xerox Palo Alto Research Center has been developing window-based systems for years. But it wasn't until Apple released the Macintosh two years ago that windows became popular. Now, just about every major microcomputer has a window-based user interface available (if not actually bundled), and a wide range of software, from databases to games, uses windows as well.

Though windows are most often associated with high-powered bit-mapped computers, they can be implemented—and implemented well—on nearly any system with a memory-mapped display, be it graphics or text. There is nothing magic or secret about windows; the underlying concepts are easy to understand and usually easy to implement. Windowing systems can be and have been implemented on most of the more “mundane” computers; the goal of this article is to show you how. I will assume that you are using some existing set of graphics or text routines. Only a few routines are essential: a viewport or screen bounds command, to restrict writing or drawing to the current window; a clear screen or fill screen command, to erase the portion of the screen where the window will

appear; a cursor-positioning command for text displays, to draw (if desired) a border of characters; and a line-drawing command for graphics displays, also to draw a border.

This month's installment will cover the basic principles of windows and then examine the problems involved in opening a window. Next month, I will look at how to close a window, develop a pseudocode implementation of a windowing system, and show an actual implementation on a specific computer.

### UNDERSTANDING WINDOWS

A window is simply a small screen that appears within a larger screen (your computer's display). Its function is to let you perform some task within it, then disappear when it is no longer needed. Often, two or more windows are created, each with its own purpose, and you can then select which window to use. Figure 1 shows an example of multiple windows in use on the Macintosh.

When a window is created—or opened—it hides whatever is behind it, including portions of other windows that it might overlap. Usually, a border is drawn around the window to visually set it apart from everything

*(continued)*

Bruce Webster is a consulting editor for BYTE. He can be contacted c/o BYTE, POB 1910, Orem, UT 84057.

else on the screen: a title is sometimes placed at the top as well. Having opened the window, you can then do things within it: write text, draw

pictures, or whatever your software allows you to do. Attempts to write or draw outside of the window should be ignored. This is usually done by using

a viewport or screen bounds command.

You can write or draw in a window as long as it is active. If windows overlap, the one on top—that is, the one that is not overlapped by any other window—is the active one. If you have two or more nonoverlapping windows, only one is active at any given point in the program; for the sake of simplicity, I will always use the most recently opened window. Of course, by constantly switching between windows, you can give the illusion of multiple windows being active simultaneously. (It is even possible—though difficult, or at least tedious—to have partially obscured windows be active. Such a technique is beyond the scope of this article; you'll have to work it out on your own.)

Often, you will want to close a window, that is, make it go away and restore the display underneath it. You can use a few different approaches to deal with this problem. Digital Research's GEM and the Macintosh Toolbox both place the burden upon the programmer to redraw the now-exposed portion of the screen. This is done for two reasons. First, it saves memory, since nothing needs to be saved when the window first appears. Second, it makes it easy to reorder overlapping windows, that is, to bring a partially hidden window to the "top." The drawback is that your program must know how to redraw that portion of the screen and then take the time to do so.

The other approach is to save what is underneath a window when it is opened, then restore that to the screen when the window is closed. This uses up memory and/or disk space, since that screen data has to be stored somewhere. It also enforces a last-opened/first-closed restriction for overlapping windows. Suppose you open window A, then window B (which overlaps A), then window C (which also overlaps A), and finally window D (which overlaps B). You must close window D before you can close B, and you must close both B and C before you can close A. If two windows do not overlap (such as B

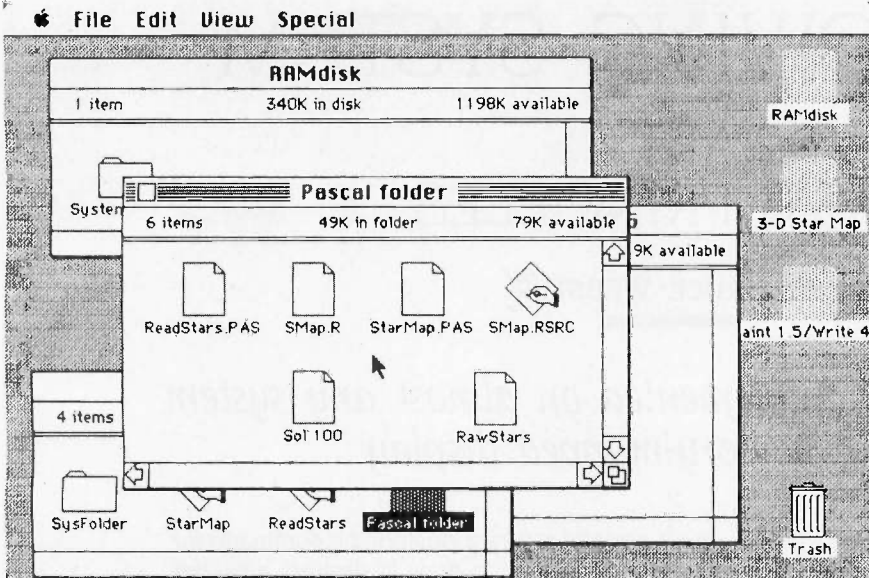

Figure 1: An example of multiple overlapping windows on a Macintosh screen.

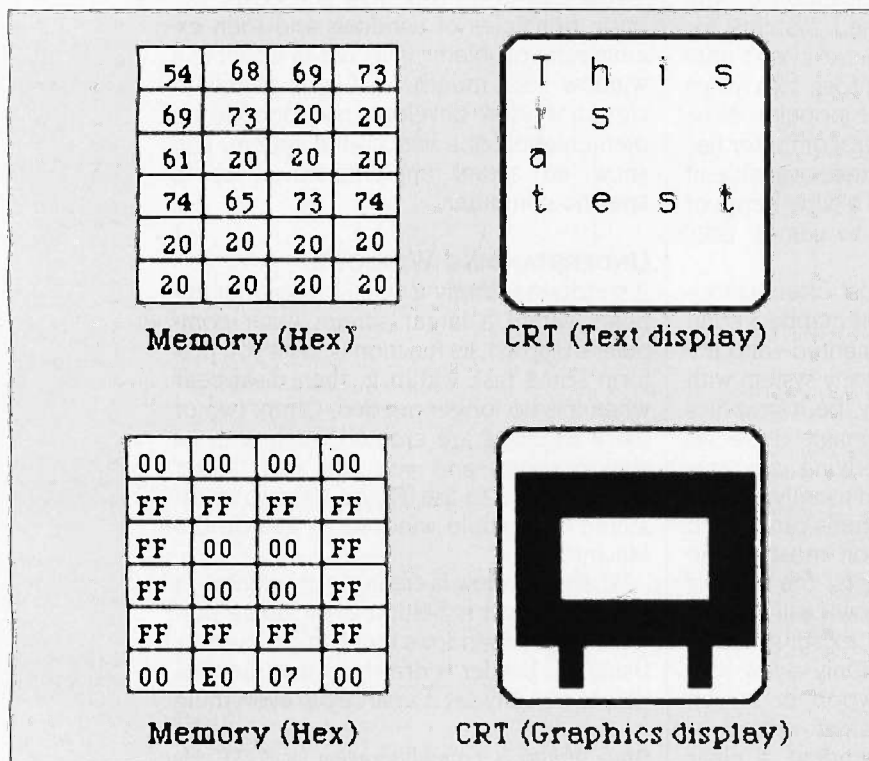

Figure 2: A simple example of a memory-mapped text display (top row) and a memory-mapped graphics display (bottom row).

and C), you can close either one independent of the other. The advantages of this method are that your program doesn't need to remember how to redraw anything, it can be very fast (if properly written), and it's simple. This is the approach that I will use in this article.

**OPENING A WINDOW**

Your first task is to open a window on the screen. You need to specify the location of the window (say, the upper left corner), the size of the window (width and height), and the address to save what is under the window.

In addition, you need to decide if the window will have a border and/or a title and (if so) how they will be drawn. I'll defer discussion of the borders and titles for a little while and concentrate on creating the window itself.

Notice that I've been vague as to whether your display is text (that is, a character-only ASCII display) or graphics (bit-mapped). The fact is, it doesn't really matter, as long as the display is memory-mapped and you can read from and write to that memory. Memory-mapped means that there is some area in RAM (random-access read/write memory) that corresponds to your display; anything written there appears on the screen in some form. In a memory-mapped text display, each byte usually represents a single character; the value of the byte is the ASCII value of the character being displayed. Memory-mapped graphics displays have more variety, depending upon the computer. One or more bits correspond to each dot on the screen; sometimes those bits are next to each other, sometimes they are quite a distance apart. See figure 2 for examples of memory-mapped displays.

The Apple II and the IBM Personal Computer have both memory-mapped text and graphics, while the Macintosh has only memory-mapped graphics. The main difference between the two kinds of displays is that the text display takes up less memory. For example, the 80-character by 25-line text-mode display on the IBM

PC Color Graphics Adapter takes up 4000 bytes—2000 bytes for the 80 by 25 text itself and another 2000 bytes for attributes (bold, underline, etc.) for each character—whereas the graphics-mode display takes up 16,000 bytes (high resolution: 640 by 200 pixels, 1 bit/pixel; medium resolution: 320 by 200 pixels, 4 bits/pixel).

The amount of memory required by a graphics display increases proportionally to the resolution and/or the number of colors per pixel. One of the highest resolutions for a micro-computer display is that of the Amiga: 640 by 400 pixels, with 16 colors (4 bits) per pixel. A full screen at that

*(continued)*

# ONE-STOP ARCnet™ LAN SOLUTIONS

Now you can get all the tools you need to build industry standard **TOKEN-PASSING** networks from one source.

InterContinental Micro.

Our networking packages let you configure any combination of nodes (PC's and compatibles, ATs, XTs, Jrs., Z-100's) to a common Fileserver in just a few minutes with our menu-driven installation program.

Active and passive hubs allow you to integrate up to 255 users on a single network with *increased efficiency* as the network grows.

In addition, our stand-alone ARCnet™ Workstation/Fileserver and complete line of S-100 Bus products (single board computers, slaves and controllers) give you and your customers even more options.

We're also compatible with other industry-leading ARCnet PC™ and S-100 products, and our PC networking boards include an optional 256K of system RAM.

All with InterContinental Micro's reputation for outstanding reliability, exceptional service, and highly competitive pricing.

Call InterContinental Micro today, or circle the bingo number below for ARCnet™ LAN solutions.



4015 Leaverton Court, Anaheim, CA  
92807; Phone: (714) 630-0964  
Telex: 821375 SUPPORT UD; Easylink: 62562040.

ARCnet is a trademark of Datapoint Corporation.



resolution requires 128,000 bytes (640 × 400 × 4/8). By contrast, the original text display on the Apple II—40 by 24—requires only 960 bytes of RAM.

To keep this windowing system simple, you can assume that all windows start and end on byte boundaries. This means you won't split up any bytes, that a window will always be so many bytes wide. For text displays you have no choice, since each character takes up a byte. For graphics displays, however, you could try to work on the bit level, starting a window partway through a byte. But for most purposes this is unnecessary. Restricting the *x* coordinates of the window to byte boundaries makes your system easier and faster because your code doesn't have to do the shifting and masking that bit-level boundaries would require.

You need to specify the location of the window. Most of the popular microcomputers use the upper left corner of the screen as the starting point, or origin, for text or graphics. The first location in the memory map for the display corresponds to that corner; each successive location moves across to the end of the line, then to the start of another line (though, as Apple II programmers can tell you, not necessarily the next line down). By specifying the upper left corner of the window, you simplify the

task of copying the underlying display memory to some other location. Since you're sticking to byte boundaries, you'll define the upper left corner as (*x,y*), where *x* is the left byte and *y* is the top line. You'll also define the upper left corner of the entire screen as (0,0); that is, the topmost line is 0, and the leftmost byte of each line is 0.

You now need to specify the width and height of the window. Two choices present themselves, each with its strengths and weaknesses. First, you could specify the coordinates of the lower right corner, (*x2,y2*). This would make it easier to avoid accidentally creating a window that extends beyond the screen boundaries, since you would have to deliberately specify illegal (out-of-range) coordinates. Second, you could give the width (in bytes) and height (in lines) of the window. This makes it clearer how big the window actually is. Arguments can be made for either method, and it is simple to implement either one. For now, let's go with the second, naming the parameters (width,height). You can then calculate (*x2,y2*), since  $x2 = (x + \text{width} - 1)$  and  $y2 = (y + \text{height} - 1)$ .

Finally, you need to specify the address of the buffer, that is, the area where the underlying screen data will be saved. You will need at least width × height bytes of storage; "at

least," because you may also want to store the information describing the position of the window (*x,y,width,height*) in the buffer, to make restoration of the screen data easier. Assuming you use 2 bytes for each of those values, you'll need a total of (width × height + 8) bytes.

You now need to make some decisions concerning error checking. The following cases must be handled somehow:

1. The coordinate *x* and/or *y* is out of range; i.e., it is less than 0 or greater than the maximum allowable value.
2. Width and/or height is too large; i.e., *x2* and/or *y2* is out of range.
3. The buffer isn't big enough to save the screen data.

You can take two general approaches. First, you can try to make things "fit." For example, if *x* is negative, you can set it to 0 and proceed anyway; likewise, if the window boundaries extend below the bottom edge of the screen, you can chop off the excess. This is dangerous, however, since the calling program will get something other than it requested. The alternative is to return an error code, informing the calling routine that the window was not opened and the reasons why. The program can then take whatever steps are necessary to adjust its request. This second approach is safer, and we'll take it.

You now need to deal with the issue of memory management. Two separate problems present themselves. First, you must decide how much memory to give to the window buffer or buffers. A simple solution is to find and set aside a chunk of memory (a "window buffer") equal in size to the largest window that you'll let be opened. Ideally, this would be the same size as the actual display, so that you could open up a window filling the entire screen. This is feasible for a 40 by 24 text display on the Apple II—but it might not be feasible for the 280 by 192 graphics display on that same Apple II, especially if you have 64K bytes (or less) of total memory. If you don't have enough free RAM, you'll need to set aside some lesser

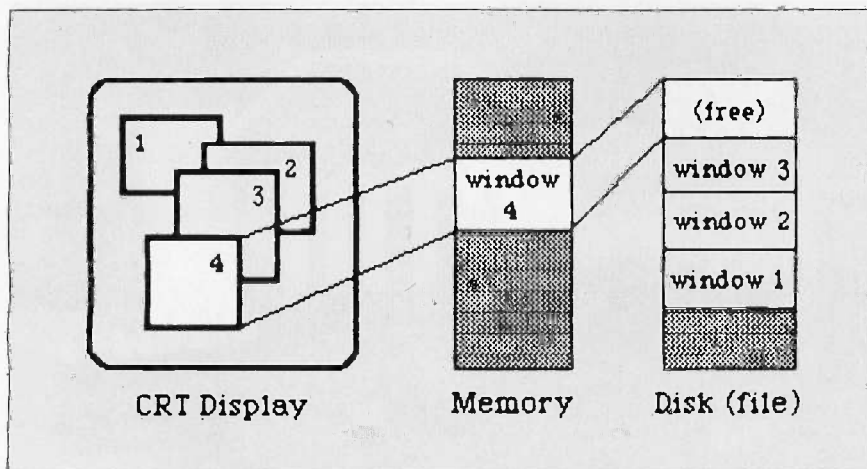

Figure 3: If you run out of RAM for storing window buffers, you can save some of those buffers to disk.

## PROGRAMMING PROJECT

amount and let the open-window routine know what that amount is. It can then compare that size to the value ( $\text{width} \times \text{height} + 8$ ) and return the appropriate error code if it's not large enough. For now, assume that you've set aside as much RAM as you can spare, and that the address and size of that buffer are known to the open-window routine. (If your language lets you dynamically allocate memory, you may want to use that to create the buffer as needed.)

The second problem occurs when you run out of available RAM for storing window buffers. You can, of course, just refuse to open the window. But that might be too much of a limitation, especially if you have only enough memory for a single buffer (and, therefore, a single window). One alternative is to write the buffer out to disk, then reuse the buffer for the new window. This involves more record keeping, as well as a check to be sure you have sufficient room on the disk. Again, the simplest solution here is to set aside an area on the disk big enough to hold some fixed number of fixed-size buffers. Each time you open a new window, you write the current contents of the buffer out to the next free slot on the disk (see figure 3). Once the disk area is full, you return the "too many windows" error message on any further attempts to open a window.

The final decision is how to handle borders and titles. Let's drop titles but keep borders. For text displays, this is simple. You can draw the border using any special characters provided (like the IBM graphics characters or the MouseText characters on the Apple IIc and enhanced IIe) or by adapting some regular characters, like dashes, exclamation points (or vertical bars, if your display supports them), and plus signs. But you'll need to decide whether the border is inside or outside the window. The border itself will eat up two lines (top and bottom) and two columns of bytes (left and right).

If you put the border inside the window, the display area within the window itself will be smaller; for example, if you create a window that's 20

bytes wide and 10 lines high, the actual "screen" within the window will be only 18 bytes wide and 8 lines high. If the border is outside the window, you have to handle the cases where the window is flush against one or two sides of the screen, such as a window whose upper left corner is at (0,0). You'll also have to be sure to save the areas covered by the borders, so your actual buffer size may be as great as  $(\text{width} + 2) * (\text{height} + 2)$  bytes. For this article, I'll assume that the border is within the window; you may want to design your own routines otherwise.

For graphics windows, the problems are similar. Drawing a border is quite simple: a line across the top and bottom lines and along the left and right sides. Given the previous decision to limit windows to byte boundaries, there is no real "inside/outside" choice, unless you want to pad the left and right sides by a full byte (which may represent several pixels of "empty" space on each side). Again, I'll assume that the border is within the graphics window; again, you may decide otherwise for your own implementation.

The final thing you must do is set the viewport (or active screen) to the "screen" within the border, if possible. The graphics or text routines you're using may allow you to define those limits; if so, you want to set them at  $(x+1, y+1, x2-1, y2-1)$ . On a graphics display, you may want to leave a little gap between the border and the drawings within the window. You may also want to set the  $x$  values on a bit boundary rather than a byte boundary, if you can, to avoid too large a gap on either side.

### INTERMISSION

You should now have a good idea of what you must consider in opening a window: how to specify it, where to save the screen data, what to do when errors occur. Next month, you'll learn how to close the window again. You'll also see a pseudocode implementation of the system I've developed here, as well as a partial translation for an Apple II. ■

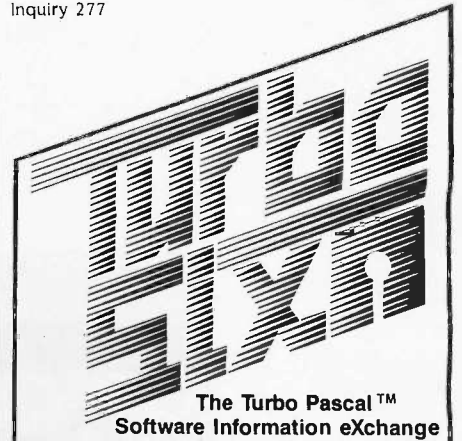

The Turbo Pascal™  
Software Information eXchange

Megabytes of Turbo Pascal code, including many commercial quality programs, are now available from a single source for the low price of

**\$6 per diskette\***

\*non-member price is \$7.50 per disk

Each diskette is packed with programs and/or routines organized to offer solutions in a selected area of interest. You will save countless hours and learn from the work of your fellow Turbo programmers.

Some of the selections currently available are:

- 106. DOS Functions (MS-DOS & CP/M)
- 504. Telecommunications Programs
- 402. Business Financial Analysis
- 301. Home Financial Management
- 206. Source Code Processing
- 702. Astronomy Programs w/Graphics
- 603. Turbo Games
- 212. Screen Design Tools

Many more selections available with new titles added regularly. For a complete list send for the TURBO S.I.X. catalog or better yet join TURBO S.I.X. As a member you will enjoy the following benefits:

- Get your first selection for 5¢!
- \$1.50 discount on every disk!
- A MONTHLY newsletter covering what's new in Turbo software, programming tips and other topics of interest to the Turbo Pascal user. Edited by Steve Wood, author of *Using Turbo Pascal*. (Osborne/McGraw-Hill)

**Your one year membership is  
ONLY \$19.95**

Add just 5¢ for your first diskette. It can be one of the selections mentioned above, or you can wait and choose from the catalog you get FREE with your paid membership. The catalog is available separately for \$1.95. Texas residents add 5% sales tax.



TURBO S.I.X.



2012 Lake Air, Dept. B1

Waco, Texas 76710

(817) 753-2182 • (817) 776-3103

AD SERIES #1

# Cermetek Talks Family

If you're looking to purchase a quality modem for your business applications look no further than Cermetek.

Take for example our Security Modem. Not just an add-on device, it incorporates one of the safest and most cost efficient methods of protecting your business files from unauthorized access. It's called barrier security. Available in 1200 and 2400 bps, both include a variety of sophisticated security features.



Security Modem - A Hayes™ compatible unit available in 1200 or 2400 bps that provides Barrier Security for your important computer files.



1200 SPC Modem - The 1200 SPC Modem provides Hayes™ compatibility - designed for the short slot in the IBM™ PC/XT/AT or clone.



1200 Modem - A Hayes™ compatible unit featuring call progress tone detection, voice/data switching, built-in diagnostics, and more.



2400 Modem - A Hayes™ compatible 2400 bps modem with intelligent features and built-in diagnostics. MNP error control is available on the 2400 EP Modem.

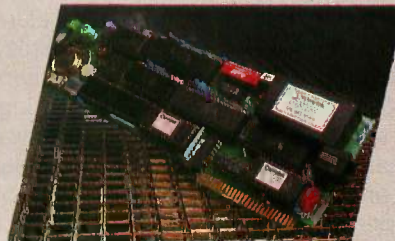

AppleMate 1200 Modem - A Hayes™ compatible internal modem card designed for the Apple™ II, II+, IIe with intelligent features and built-in diagnostics.

**Cermetek**  
microelectronics

Inquiry 62

**Cermetek Microelectronics, Inc.** 1308 Borregas Avenue Sunnyvale, CA 94088-3565 408/752-5000

Hayes is a registered trademark of Hayes Microcomputer Products, Inc. IBM is a registered trademark of International Business Machines Corp. Apple II, II+, IIe are registered trademarks of Apple Computer

# AN ANSI STANDARD FOR THE C LANGUAGE

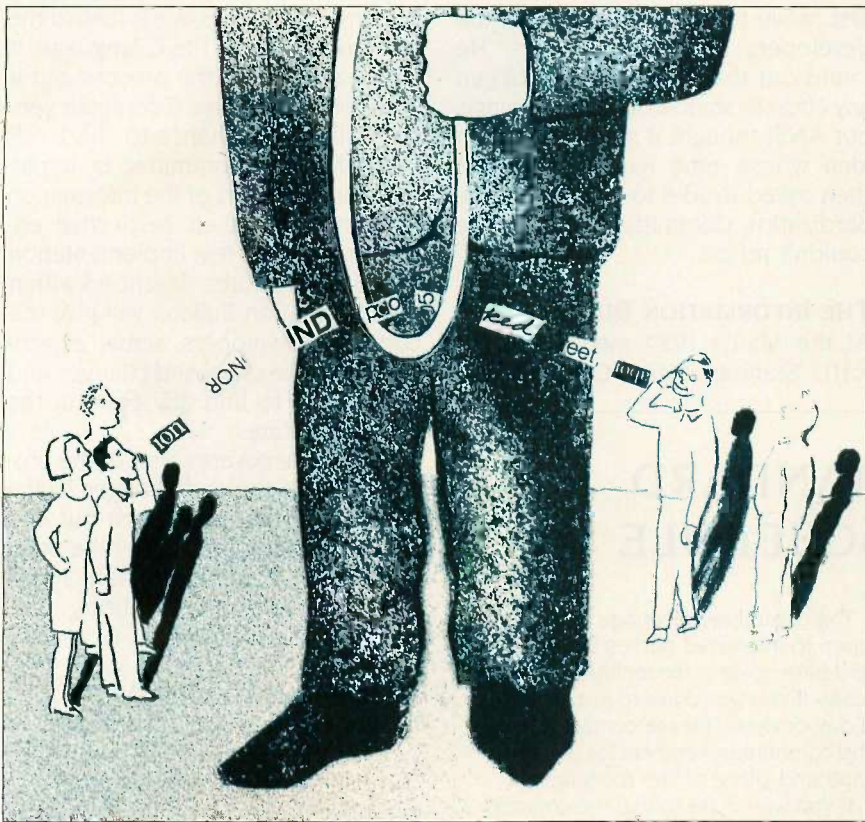

## *A description of the standard proposed in the X3J11 committee's Information Bulletin*

**I**n *The C Programming Language* (Prentice-Hall Inc., 1978) Brian W. Kernighan and Dennis M. Ritchie defined C as "a general-purpose programming language which features economy of ex-

pression, modern control flow and data structures, and a rich set of operators." The C language was first developed for use on the UNIX operating system; however, C is now widely accepted in the personal computer arena, and it is no longer just the god-child of UNIX developers. There is now enough interest and investment in C to develop an American National Standards Institute (ANSI) standard for C. The process is currently underway and entrusted to the X3J11 Standardization Committee.

### **WHY DEVELOP A STANDARD?**

As more developers and users become dependent on C, a universal set of rules is necessary to keep C programmers working with the same language. The challenge then is to establish a nonpartisan keeper of the "standard."

At first, the choice appears to be easy. Why not let the compiler implementors and developers (such as AT&T, Whitesmiths, or Lattice) hammer out their own language definition? But could any of these organizations actually claim that changes and additions would be implemented to serve the public good?

The C language already has a de facto standard taken from Kernighan

*(continued)*

Steve A. Hersee is one of three founders of Lattice Inc. He has a B.S. in electrical engineering and computer science from the University of Illinois and is the International Representative of the X3J11 Standardization Committee. Dan Knopoff is the production manager at Lattice Inc. He has a B.A. in English from Northeastern Illinois University. They can be reached at Lattice Inc., POB 3072, Glen Ellyn, IL 60138.

and Ritchie's book (known as K&R). K&R was published in 1978 as both a tutorial and an "official" statement of the syntax and semantics of C. However, due to ambiguities in the text, UNIX references, and recent extensions to C (such as the portable C compiler), K&R is not always the most viable alternative for a compiler writer to follow. In fact, a C compiler author has almost too many choices. Should an author of a C compiler provide the C described by the K&R standard or should the UNIX version 7 be used? Or how about UNIX System III? Or Whitesmiths (the oldest commercial compiler)?

The standardization of C will allow C to move into more environments. Since the standard addresses just the C language, the variations between operating systems can be filtered out (they are never really eliminated), and C can move away from its original UNIX roots. In fact, two-thirds of the

Standardization Committee's members represent companies offering C for non-UNIX environments.

An ANSI standard for the C language will allow C to grow in an orderly way, without the problems that many other languages have had. The standard will also allow C to "grow up" without being controlled by a single compiler implementor or operating system.

Jim Brodie of Motorola made the first move to wrest C away from the developers and implementors. He found out that ANSI had not begun any effort to standardize the language, but ANSI thought it sounded like an idea whose time had come. ANSI then asked Brodie to chair the Standardization Committee—an offer he couldn't refuse.

#### THE INFORMATION BULLETIN

At the March 1984 meeting of the X3J11 Standardization Committee in

Chapel Hill, North Carolina, the Committee voted to publish the current draft of the ANSI C Language Standard as an ANSI Information Bulletin. (This draft is published by the Computer & Business Equipment Manufacturers Association [CBEMA].) See the text box "ANSI C Standard Meeting Schedule" for the address and information about the Standardization Committee.

The Information Bulletin is only one step in a multistep process toward the standardization of the C language. It is an early step in the process, but it is important because C compiler vendors will have a chance to check out the work of the committee by implementing all or part of the Information Bulletin within their respective environments. The test implementation of the new features described within the Information Bulletin will give the compiler developers actual experience with the proposed changes and allow them to find any flaws in the present features.

This article covers some of the proposed additions and changes to the C language that have been put into the Information Bulletin by the Standardization Committee. Table 1 lists the standard function library proposed in the Information Bulletin.

#### EXTENSIONS TO UNSIGNED

In K&R, the keyword `unsigned` is a type of integer or `int`. In many later compilers the keyword `unsigned` was extended to be a modifier as well as an integer. As an extension to K&R, the committee added `unsigned char`, `unsigned short`, `unsigned int`, and `unsigned long` to the normal use of `unsigned`. This modification is considered to be an easy extension to K&R, as it will not break any existing programs.

#### UNIQUE MEMBER NAMES

The standard proposed allows unique member names within structures and unions. C programmers will then be able to use the member name "Name," for example, in many different structures without having to

(continued)

## ANSI C STANDARD MEETING SCHEDULE

If you are interested in participating in the C standardization, call or write

Jim Brodie  
Chairman  
X3J11 Standardization Committee  
Motorola Microsystems  
2900 South Diablo Way  
Tempe, AZ 85282  
(602) 438-3456

or

Tom Plum  
Vice Chairman  
X3J11 Standardization Committee  
Plum Hall  
1 Spruce Ave.  
Cardiff, NJ 08232  
(609) 927-3770

The 1986 schedule for meetings is

March 3-7, Palo Alto, CA  
June 2-6, Philadelphia, PA  
September 8-12, Chicago, IL  
December 8-12, Cary, NC

The committee meetings have been open to interested parties to observe and participate in the technical discussions. If you would like to just sit in for a day or more, please contact one of the committee members for the exact time and place of the meeting.

If you would like to join the committee, there is a \$150 per year fee payable to

ANSI  
Computer & Business Equipment  
Manufacturers Association  
X3 Secretariat CBEMA  
311 1st Street NW, Suite 500  
Washington, DC 20001

The committee meets for one week every three months. All participants are volunteers and are responsible for their own expenses. Besides the meeting, committee members are required to prepare papers for presentation to the committee and to contact other members about the issues before the next meeting.



Table 1: *The ANSI C standard library.*

assert(int expression)	fgetc(FILE *stream)
isalnum(int c)	fgets(char *s, int n, FILE *stream)
isalpha(int c)	fputc(int c, FILE *stream)
iscntrl(int c)	fputs(const char *s, FILE *stream)
isdigit(int c)	getc(FILE *stream)
isgraph(int c)	getchar(void)
islower(int c)	gets(char *s)
isprint(int c)	putc(int c FILE *stream)
ispunct(int c)	putchar(int c)
isspace(int c)	puts(const char *s)
isupper(int c)	ungetc(int c, FILE *stream)
isxdigit(int c)	fread(void *ptr, size_t size, int num, FILE *stream)
tolower(int c)	fwrite(const void *ptr, size_t size, int num, FILE *stream)
toupper(int c)	fseek( FILE *stream, long offset, int ptrname)
acos(double x)	ftell(FILE *stream)
asin(double x)	rewind(FILE *stream)
atan(double x)	clearerr(FILE *stream)
atan2(double x)	feof(FILE *stream)
cos(double x)	ferror(FILE *stream)
sin(double x)	perror(const char *s)
tan(double x)	
cosh(double x)	atof(const char *buffer)
sinh(double x)	atoi(const char *buffer)
tanh(double x)	atol(const char *buffer)
exp(double x)	strtod(const char *buffer, char ** endbuffer)
frexp(double value, int *exp)	strtol(const char *buffer, char ** endbuffer, int base)
ldexp(double value, int exp)	rand(void)
log(double x)	srand(unsigned int seed)
log10(double x)	calloc(unsigned int num, size_t elsize)
modf(double value, double *iptr)	free(void *ptr)
pow(double x, double y)	malloc(size_t size)
sqrt(double x)	realloc(void * ptr, size_t size)
abs(int i)	
ceil(double x)	abort(void)
fabs(double x)	exit(int status)
floor(double x)	getenv(const char *name)
fmod(double x, double y)	onexit(onexit_t func)
	system(const char *string)
setjmp(jmp_buf env)	memcpy(void *toadd, const void *fromadd, size_t length)
longjmp(jmp_buf env, int val)	memset(void *s, int initchar, size_t n)
signal(int sig, void (*func)())	strcpy(char *to, const char *from)
kill(int pid, int sig)	strncpy(char *to, const char *from, size_t n)
va_start(va_list ap, parmN)	strcat(char *to, const char *from)
va_arg(va_list ap, type)	strncat(char *to, const char *from, size_t n)
va_end(va_list ap)	memcmp(const void *s1, const void *s2, size_t n)
remove(const char *pathname)	strcmp(const char *s1, const char *s2)
rename(const char *old, const char *new)	strlen(const char *s1)
tmpfile(void)	strncmp(const char *s1, const char *s2, size_t n)
tmpnam(char *s)	memchr(const void *s, int c, size_t n)
fclose(FILE *stream)	strchr(const char *s1, int c)
fflush(FILE *stream)	strcspn(const char *s1, const char *s2)
fopen(const char *filename, const char *type)	strpbrk(const char *s1, const char *s2)
freopen(const char *filename, const char *type, FILE *stream)	strrchr(const char *s int c)
setbuf(FILE *stream, char *buf)	strspn(const char *s1, const char *s2)
fprintf(FILE *stream, const char *format, ...)	strtok(char *s1, const char *s2)
printf(const char *format, ...)	
scanf(const char *format, ...)	clock(void)
fscanf(FILE *stream, const char *format, ...)	time(time_t *timer)
sprintf(char *s, const char *format, ...)	asctime(const struct tm *timeptr)
sscanf(char *s, const char *format, ...)	ctime(const struct tm *timer)
vfprintf(FILE *stream, const char *format, va_list arg)	difftime(time_t time2, time_t time1)
vprintf(const char *format, va_list arg)	gmtime(const time_t *timer)
vsprintf(char *s, const char *format, va_list arg)	localtime(const time_t *timer)

worry that it must be the same displacement in each structure. All structures and unions have their own name space, and the compiler will keep track of the valid member names for each. This may cause trouble for programmers with old code that defined structures or unions and then used the member names as a general value to be added to wherever they wanted.

**PASSING AND ASSIGNING STRUCTURES**

The committee has incorporated the use of passing and assigning structures (as currently available within UNIX System V) into the Information Bulletin. This means that programmers will be able to assign one structure to another, to pass an entire structure as an argument on the stack, and to have a function return a value to its caller that is an entire structure. These features allow functions to work on structures that are copies of the original structure and then allow an assignment to update the original structure when all of the changes are complete.

**THE BELL CHARACTER**

Programmers will now be able to send the ASCII Bell character as an alert to the end user by including a `\a` as an output string literal. Additional terminal support was considered, but the number of hardware choices and the constraints necessary to keep the committee focused on the language left the `\a` option the only hardware-related feature included within the Information Bulletin.

**INTERNATIONAL TRIGRAPH CHARACTER OPERATORS**

The C language has "used up" the ASCII character set. This is not a problem for programmers in the U.S., but it is a problem for programmers in other countries. It seems that some

of the characters used as C operators are known as alphabetic extenders and are required in German, Spanish, French, and other foreign languages.

To make C easier to use internationally and to promote a wider use of C as an international language, the committee chose to address the problem of the "overused" ASCII character set within the Information Bulletin by defining a group of trigraph character sequences to act as operator equivalents. The trigraphs allow characters to be defined that are not in the ISO (International Organization for Standardization) 646 Invariant Code Set (see table 2), a subset of the 7-bit ASCII code set.

As part of the trigraph feature, the character sequence of `\?` has been defined as a `?` to provide an escape for the sequence when a program is printing out a trigraph.

**KEYWORD CHANGES**

The committee has brought five keywords into the proposed ANSI C language described in the Information Bulletin. Keywords were added with caution because programs being updated to the ANSI C language may have to be changed if a keyword were used for some other function. The five new keywords are `void`, `enum`, `const`, `signed`, and `volatile`.

The keyword `void` has been added to the Information Bulletin from UNIX System V to allow the programmer to define a function that returns no value. For example, the program segment

```
extern void exit();
```

tells the compiler that no meaningful value is expected from the return of the function `exit`. This allows the compiler to flag the following expression as an error:

```
a = b + exit();
```

The type `enum` has been added to the Information Bulletin exactly as it is used in UNIX System V. The type `enum` is similar to an enumeration type in Pascal but implemented in the spirit of the C language.

The keyword `const` is already in use by internal AT&T C compilers. The keyword `const` is a type specifier that defines an object that is either not to be modified or is resident in ROM (read-only memory). A `const` type object cannot be assigned to, incremented, or decremented. There are two major benefits of the `const` type: Data can now be identified that is not to be altered either in a module or in the entire program, and data to be placed into ROM can be identified as a specific group. After identifying data as `const`, the data can be checked by the compiler to flag an error if the programmer tries to alter the data of type `const`.

The C language as defined within K&R allows compiler implementors to choose whether they wish the type `char` to be a signed value or an unsigned value. This allows the compiler implementor to obtain the maximum possible speed for code generation in working with items of type `char`. This means that when the programmer adds the type modifier `unsigned` to `char`, the value is unsigned. But what about signed values? The keyword `signed` has been included within the Information Bulletin to allow signed values to be generated.

Adding the keyword `signed` to C also eliminates the problem where the natural `char` is unsigned and the programmer cannot receive a signed `char` value between `-128` and `+127`. With the addition of the keyword `signed` the programmer has full control over whether the `char` is signed, unsigned, or chosen by the compiler.

The type modifier `signed` can be used anywhere that the type modifier `unsigned` is allowed. This allows the programmer to be very specific in the declaration of a variable to help the program's readability and performance.

The keyword `volatile` can be used by

(continued)

Table 2: The trigraphs and the operators they define.

Trigraph	??=	??(	??/	??)	??'	??<	??!	??>	??-
Character Defined	#	[	\	]	~	{		}	~

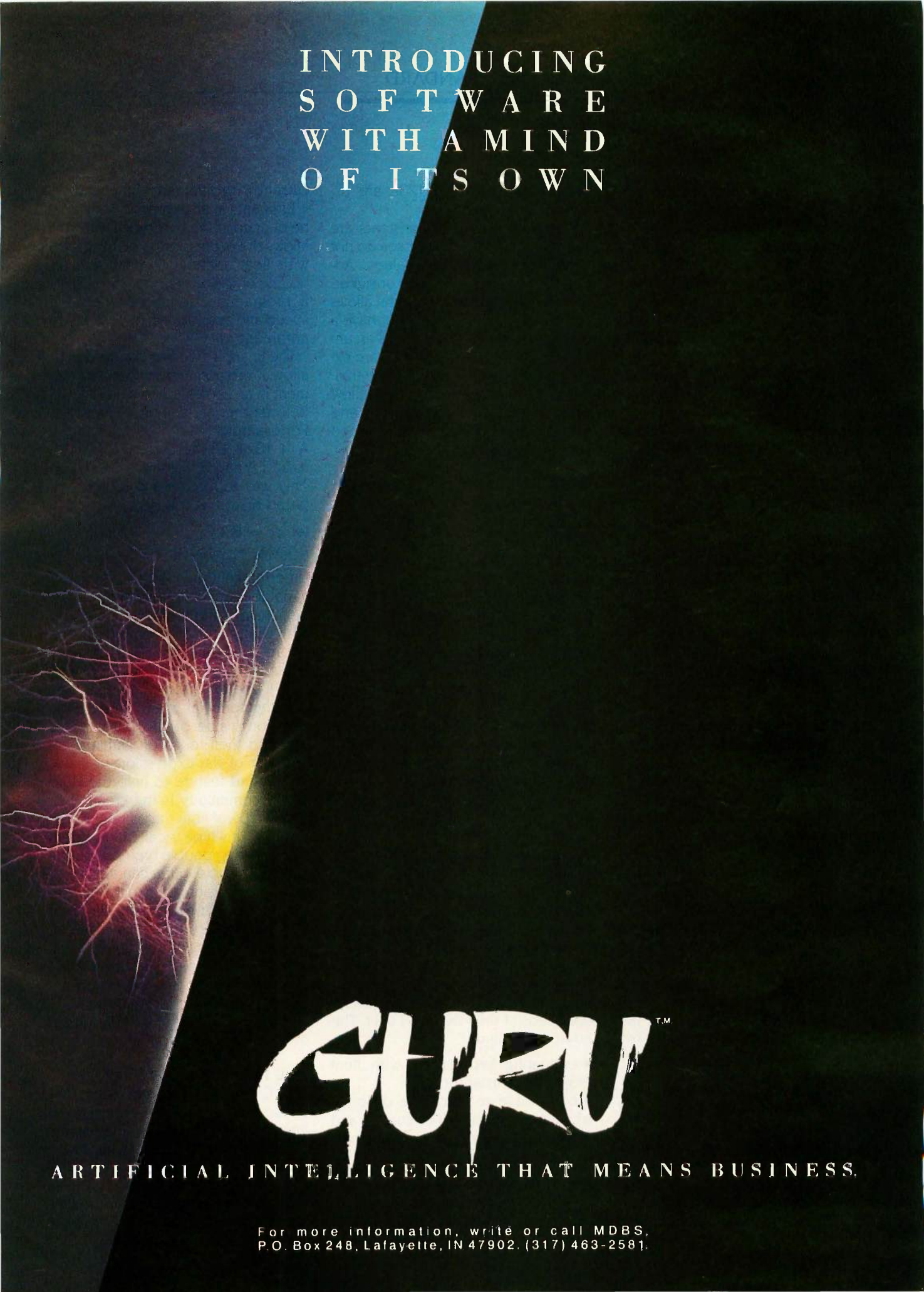

INTRODUCING  
SOFTWARE  
WITH A MIND  
OF ITS OWN

**GURU**<sup>TM</sup>

ARTIFICIAL INTELLIGENCE THAT MEANS BUSINESS.

For more information, write or call MDS,  
P.O. Box 248, Lafayette, IN 47902. (317) 463-2581.

the programmer to describe the compiler's environment. Currently, after a compiler loads a value into a register (if a programmer does nothing to that value through the program), the value in the register is the same as the location in memory that was used to load the register in the first place. There are some pitfalls with this, however. For instance, what if the memory location is a memory-mapped I/O location such as a communication port? Or what if the location is a shared memory location that can be modified by another process? The value loaded into the register at one time will not be the same after time has passed or some event has occurred.

There is a real conflict between the basic compiler assumption that once a value is loaded into a register, there is no reason to reload that particular value if there has been no action to modify the memory location. The basic model of memory and the compiler in K&R did not allow the programmer to describe the condition where a memory location can be altered by events outside of the knowledge of the compiler. This is most evident in a multiprocessing environment like UNIX. If there is an area of shared memory, the location that the compiler is operating on may have changed since the last time the compiler looked at it.

The real plus with the keyword `volatile` is that the quality of compiler optimization can be improved, as the programmer will be better able to describe the underlying compiler environment. This allows greater optimization on normal variables and the proper handling of special data areas in various machines.

The keyword entry was dropped because it does not have a use in K&R.

### LONG AND UNSIGNED INTS

In the C language, a constant (123, for example) is considered to be an int. As an int, it is a signed value of a known size that can be used in expressions with other ints. When a constant appears in an expression that also includes long types, the constant can be followed with the letter `l` to

mean long (123l and 123L are examples of long ints).

This works fine until constants are used as addresses. Addresses do not make sense as signed values. Addresses make sense only as unsigned values. The Information Bulletin allows constants to be specified that have a trailing `u` to define the value as an unsigned value (123u and 123U are examples of unsigned values). The trailing `u` for unsigned values will allow programmers to force address and other expressions to be performed with unsigned arithmetic.

### SHORT, INT, AND LONG LENGTHS

Compilers based on K&R use the keywords `short` or `long` as synonyms for an int. Normally on 16- and 32-bit machines a `short` and an `int` are both 16 bits, while a `long` is 32 bits. In the ANSI C language proposed by the Information Bulletin, all three types may be different lengths. For example, a large machine could have a `short` that is 16 bits, an `int` that is 32 bits, and a `long` that is 64 bits. Allowing `short`, `int`, and `long` to be different lengths may prove most useful on some of the larger machines. However, it is not a requirement to have three different sizes, so that the actual sizes can be specified by the compiler implementor.

### ADDITIONS TO C FOR THE FORTRAN COMMUNITY

Since the C language has become popular, many FORTRAN programmers have been considering changing to C. To encourage the changeover, the committee implemented three additions to the proposed ANSI C language to make C more adaptable to the needs of the FORTRAN user. The additions include

- evaluating expressions with float (floating-point) arithmetic;
- being able to force the order in which expressions are evaluated; and
- creating a new type of float larger than double.

The Standardization Committee was careful to address these issues to allow implementation without forcing

current C programs to be changed.

Elements in an expression can now be defined at the float type level. This allows the expression to be evaluated with float arithmetic rather than in double precision, which in turn allows a programmer to choose between speed and accuracy when performing arithmetic.

The unary `+` operator was added to allow a programmer to force an element in an expression to be evaluated before other parts of the expression. For example, if a programmer writes `A + (B + C)` the C compiler is free to add `A` and `B` first and then `C`. The only way to force `B + C` to be computed first is as follows:

```
temp = B + C;
Answer = temp + A;
```

Unfortunately, the use of a temporary variable requires the programmer to declare an additional variable and may change the style of coding. The Information Bulletin allows the expression to be written as `A + +(B + C)`. The extra, or unary, plus sign tells the compiler to evaluate the expression inside of the parentheses first and then to go on with the remainder of the expression.

The third feature to help the FORTRAN community is the creation of a new type of float that is larger than double. This type is called long double. The long double type can be the same as double, but it can also be of greater precision than double. The long double type allows the writer of the math library functions to use a precision that is greater than normal. Intel uses this same idea with its 8087 math chip, where the data in and out of the chip is 64 bits while the 8087 chip does its internal calculations in 80 bits.

### THE PREPROCESSOR

The C language preprocessor is a strange and wondrous beast open to interpretation by the compiler writer to determine just exactly what to do with the preprocessor phase of the compiler.

The preprocessor, as described by

(continued)

# M P S

In this confusing new world of music software someone has finally created a computer program that is so powerful that it allows musicians to forget about learning computerese and get back to what they like doing best—music. Only now with more control and creative potential than ever before. Behind this program is the same company responsible for some of the music industry's greatest achievements. The company, of course, is Roland. And the product is called MPS. It stands for the Music Processing System. **What** if a musician could harness the same computer power to create music that writers use in word processing? That's exactly what MPS does. It gives you the creative freedom to develop, edit and shape your ideas into a complete piece of music, all under computer control, totally at your direction. Working together with Roland's MPU-401 intelligent interface, any IBM PC (or compatible) computer and your MIDI instruments, MPS takes you every step of the way from first inspiration to a beautifully realized printed score. **The** MPS system's power is unleashed in its three operating

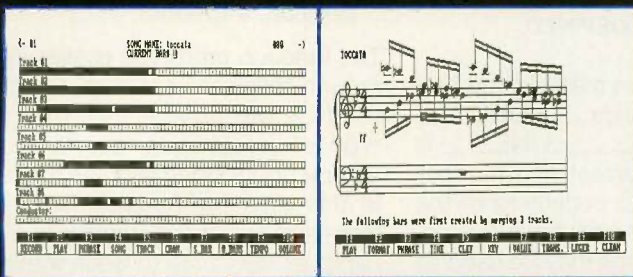

Song Mode, Arrange Page      Score Mode, Analysis Page

modes: Song, Score and Print. All modes are totally interactive, so that any change made in one is automatically made in the others. In the Song Mode, you assemble musical phrases into complete compositions. Use any MIDI instrument as an input device. Once phrases are entered, they can be altered, edited, combined and recombined at will. MPS Software gives you eight tracks to fill with music. Each track can be assigned to any of 16 MIDI channels and used to drive any MIDI instrument. Merge tracks or phrases as needed and reassign MIDI channels to check out how a passage sounds on different instruments. A clear, concise

on-screen display keeps you up to date on track status on a measure-to-measure basis. **The** process continues as you move on to the Score Mode. Here, the music you've created becomes a graphic score, which can be further polished and perfected. You define keys, clefs and time signatures, transpose octaves, assign accidentals and rests...even change the direction of note flags and stems for a highly legible, musically correct score. There are three different areas on the staff to spell out song lyrics, verbal cues and instructions—everything you want to put into words. **When** you've finished perfecting your score, you're ready for the MPS Print Mode. Everything you've put into your on-screen score can be transformed into an attractive hardcopy printout via the MPS Hi-Resolution Print Mode. As always with MPS software, *you're* in control. "Cut and paste" your score to meet your own specific needs. You can print out single parts for individual players or a complete score representing your entire composition. Print copies on your computer's standard printer with or without song lyrics or in any quantity you desire. Break into the future of electronic music production—harness the power of Music Processing with the MPS—the Roland of Music Software. For more information contact: Roland Corp US, 7200 Dominion Circle, Los Angeles, CA 90040 (213) 685-5141. **Hardware** Required: IBM-PC or full compatible (256K minimum, up to 640K), 2 disk drives recommended, IBM color graphics card and CRT monitor, Roland MIF-IPC interface card, Roland MPU-401 MIDI Processing Unit, Any MIDI-equipped Instrument(s), Optional dot matrix graphics printer (IBM compatible).  Roland



Roland Music Software Software  
**MPS**  
Music Processing System  
Version No. 1.0

*Roland Music Software*

the Information Bulletin, adds two new operators to the preprocessor. The first is the # (sharp sign), and second is the ## (double sharp sign). These two extensions allow the preprocessor to do two things that have been available in some (but not all) C compilers. Both of the tokens have to do with strings and macros. Many programmers like to have a macro to construct a value that is later used as a string or as a new token such as a variable name. These may sound like simple needs at first, but there are a number of problems that current programming solutions do not address. Maybe the best way to describe this is through the example included within the Information Bulletin:

```
#define debug(s,t) printf("x" # s
    " = %d, x" # t " = %s",x##s,x##t)
debug(1,2)
```

results in

```
printf("x" "1" " = %d, x" "2"
    " = %s",x1,x2)
```

which, after concatenation of the adjacent strings, results in

```
printf("x1 = %d, x2 = %s",x1,x2)
```

The #, when followed by a formal parameter of a macro, is replaced by the corresponding macro argument and is enclosed in quotes. This is shown above when, #s become "1." This allows the easy creation of string literals from macros. The ## is the token concatenation operator. In a macro expansion after all replacements have taken place, each ## is removed and the tokens preceding and following each ## operator are concatenated.

### EXPANDED STRING LENGTH

The above examples contain another proposed change to current C usage. The proposed ANSI C language allows strings to be longer than those in current use. The programmer can construct a string from more than one line when the lines appear as adjacent strings within a C program. The lines are logically concatenated into one string. This means that the following two examples are equivalent:

Example 1:

```
printf("this is a single string with the
    numbers one, two, and three \ ");
```

Example 2:

```
printf("this is a " " single string"
    " with the "
    "numbers "
    "one,"
    " two and three");
```

### CHANGE TO PREDEFINED MACRO VALUES

A change has been made to the predefined macro values `__LINE__` and `__FILE__`. `__LINE__` is defined as the current line number and `__FILE__` is defined as the current source and/or #include filename. These macros may be used as references to print out information concerning the current file and line number.

### ADDITION OF #PRAGMA

The #pragma preprocessor directive has been added to the proposed C language to allow compiler writers to get additional information to their compiler without having to invent a new set of implementation keywords. The #pragma macro acts as a general escape mechanism to make any environment/feature/extension information truly portable between compilers. Any information appearing on the #pragma line that is not recognized by the compiler and/or is not specific to the environment is ignored and is not flagged as an error.

### FUNCTION PROTOTYPES

Function prototypes are a major addition defined within the Information Bulletin. A function prototype is an expansion of the old extern function() syntax. The new syntax still enables the old syntax to work and also allows the programmer and library writer to give the reader and compiler additional information on the compilation process.

A common problem that involves function calls can be demonstrated by the function lseek. The function lseek has three arguments, and it returns a long value. In usage, the function

is given as

```
extern long lseek();
```

This form is still viable and will continue to work in existing programs. The proposed ANSI C language defined within the Information Bulletin allows the addition of the function prototype:

```
extern long lseek(int file, long
    position, int mode);
```

The function prototype passes information to the compiler that can be used by the programmer. The first type of information describes the arguments included with the function. In this case, the function lseek has three and only three arguments. If the compiler sees a call to lseek with anything other than three arguments, that lseek call is an error. The function prototype also converts the value to the type specified when the second argument is not a long value. The conversion is performed as if it were being assigned across an equals sign.

This type checking for function calls is a very large part of the UNIX utility lint. Function prototype checking is more powerful than lint, however, because it is performed at compilation time by the compiler rather than as a separate utility after the program is compiled. Also, as all of the standard library header files have the library function prototypes in them, the programmer is notified of both the argument count and improper type errors when the program is compiled, not at some later time during a debugging session or a lint pass.

The names in the function prototypes are optional for readability. They allow the person documenting the function to place the name in the function prototype to describe how it is used by the function. Many of the compilers that are providing the function prototype feature also allow the compiler to output a prototype definition file as part of the compilation process. This allows the automatic generation of function prototypes to be included in any other modules that use the functions.

(continued)



## MAKE THE CONNECTION . . .

Our **Connection** systems will solve your problem of trying to read and write diskettes or tapes from almost any computer system using your PC.

The **Diskette Connection** is a hardware system that enables the IBM PC or compatible to read and write most 8 inch, 5¼ inch, or 3½ inch diskettes.

With our **File Connection** software programs you can transfer data files between most computer systems, including CP/M, DEC, Honeywell, Univac, IBM 3740, S/1, S/3, S/23, S/32, S/34, S/36, and S/38.

Our **Word and Typesetting Connection** programs use IBM standard Document Content Architecture (DCA-RFT) to transfer document files between most word processing and typesetting systems, including Compugraphic MCS, CPT, Displaywriter, OS/6, Multiset, NBI, Quadex, Xerox, and Wang.

Our **Tape Connection** system will read and write IBM or ANSI standard ½ inch 1600 BPI magnetic tape. A full size 2400 foot tape can store a 45 MByte file and be written in 6 minutes.

Since 1982, we have supplied thousands of systems to customers around the world, including IBM, NASA, AT&T, Kodak, and General Motors.

Our specialty is conversion systems and we can provide a solution to your problem. Call us today to discuss your requirements.

*This ad is one of a series featuring NASA missions. For a free poster, send us your written request.*

**Box 1970 Flagstaff, AZ 86002**  
**(602) 774-5187 Telex 705609**

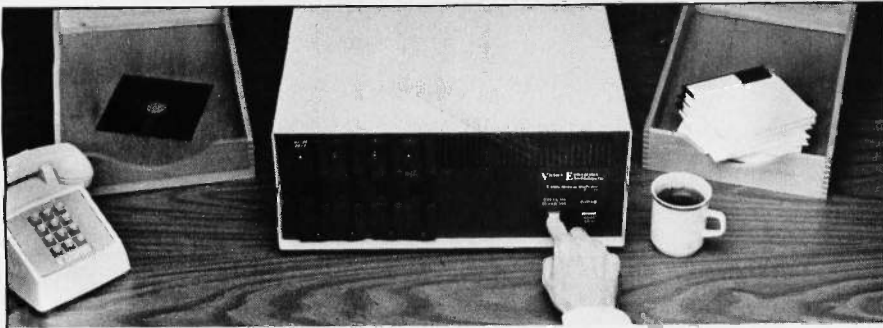

## Copying diskettes will never be easier than pushing one button.

While your computer is busy doing other things, your Victory Duplicator can be making as many as eight copies of a diskette at once—producing up to 360 copies in an hour. DualMaster™ models can even make multiple copies of two different diskettes simultaneously. Just insert the diskettes and press one button.

### Copy different formats, flawlessly.

An automatic format analysis program makes it possible for the Victory Duplicator to

copy virtually any 5¼, 3½ or 8-inch diskette. The system tests for quality and accuracy at every stage of the process.

### It practically services itself.

Each drive has a separate controller to maximize up-time. Simple diagnostics to verify drive alignment and industry standard drives allow you to maintain your system without waiting for outside service.

### All at an attractive price.

Victory Duplicators offer fast copying, serialization,

copy protection, a communications port, a four-month warranty and much more—all for one low price.

### Call 1-800-421-0103.

Call today for more information. (In Texas, call 512-450-0801.)



## VICTORY ENTERPRISES

Technology, Inc.

8910 Research Blvd., Suite B2  
Austin, Texas 78758

©1986 Victory Enterprises Technology, Inc.

## ANSI STANDARD

## The committee has come up against some tough issues.

When using function prototypes, the programmer is no longer forced to have all arguments automatically widened to doubles and ints. When a prototype is present in both the definition and in the file where the function is to be used, the arguments may be specified to be float, char, or even register. This allows greater optimization by the compiler writer and greater control over how information is passed to the function, which is the basic unit in C.

### THE TOUGH ISSUES

Over the last year and a half, the Standardization Committee has come up against some tough issues. Various solutions were presented, reports were prepared to educate the members on the pitfalls and plaudits of the solutions, and decisions were made and added to the Information Bulletin. Legwork and elbow grease helped the committee resolve issues such as

- whether the functionality of the enum should be extended;
- what the length of external items should be;
- whether external names can appear in a single case or in both upper- and lowercase;
- how the C language should expand or widen values when evaluating an expression that involves many types;
- how much checking should the compiler do to detect an attempt to change an item declared as type const; and
- whether external items must have a single definition or if they can have many definitions when they are initialized to the same values.

The solutions were arrived at peacefully in an attempt to make the ANSI C language described within the Information Bulletin as usable as possible by the largest set of users. ■

## Verbatim Datalife

Preserving your data is vitally important. Lose it and you've lost both time and money. That's why Verbatim Datalife Diskettes have 6 data-shielding improvements for greater disk durability and longer life. They come standard with a lifetime warranty that establishes the industry standard—it guarantees trouble-free recording, storage, and retrieval. And to help introduce you to the Verbatim quality standard we're running a special offer on many of their products, including—Datalife Diskettes, Cleaning Kits, and Disk Drive Analyzers.

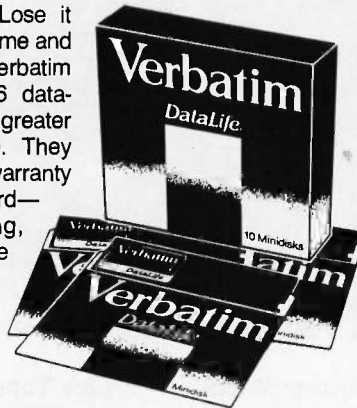

What separates us from our competition? Simply a combination of the best service in the industry, highly competitive pricing, and an ever widening range of products. Above all we care about our reputation and we are willing to work on a lower margin while delivering what others only claim—and we do it all on a day-in day-out basis.

Early in 1986 every subscriber to **Byte Magazine** will receive our New 1986 First Edition Catalog with 16 additional pages and dramatically lower pricing. We want to be your source for computer supplies & accessories.

## Lyben Computer Systems

WATCH FOR OUR NEW 1986 CATALOG

1050 E. MAPLE RD. • TROY, MI 48083  
(313) 589-3440



# THE DIRECT BENEFITS OF BUYING SOFTWARE & HARDWARE DIRECT FROM LOGICSOFT.

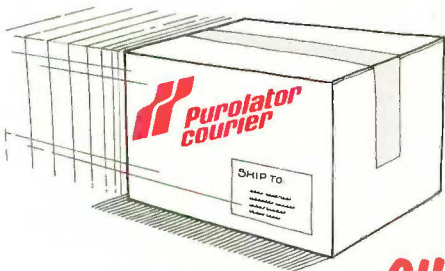

## FREE OVERNIGHT DELIVERY.

Buy it today . . . use it tomorrow! At Logicsoft, we know you want your new product as fast as possible. That's why only Logicsoft ships your order the same day via Purolator Overnight Courier\* . . . at no additional cost to you! You not only save money, you save valuable time, too.

## OUR LOWEST PRICE GUARANTEE.

We're so confident about our low prices that if you can find a lower price we'll beat it by \$10!† This offer includes any legitimate advertised price or quote on any of the hundreds of products we stock. And we stock only the latest versions. All factory sealed with the manufacturer's warranty. Our Corporate Accounts Program also offers attractive volume discounts. And we accept purchase orders from qualified institutions.

They're two more reasons why Logicsoft has become the major supplier of hardware and software to more than 50,000 companies worldwide, including over 90% of the Fortune 1000.



## TOLL-FREE CUSTOMER SERVICE.

Customer service and technical support is only a toll-free call away before *and* after the sale. Our customer service representatives can instantly recall your ordering information from our on-line terminals. So they can answer your questions quickly and efficiently. Our technical people are standing by to help answer questions on any product we carry. Logicsoft gives you much more than great prices and fast delivery. We give you peace of mind as well.

\*Applies to order totaling over \$100. Shipped UPS—free if under \$100 (within Cont. U.S.). Due to weight restrictions, systems, printers and monitors are also shipped UPS—free. †This offer does not apply to items under \$100, American Express or Terms orders. In these instances, we will meet any lower price. (Subject to discretion of sales agent.)

To order or receive technical assistance, call our National Hotline: **1-800-645-3491** NY State: **1-800-23 LOGIC** (235-6442)  
Customer Service: 1-800-431-9037

Circle #400 on reader service card.

# FREE 90-DAY, ON-SITE SERVICE ON ALL SYSTEMS.

On all systems listed below, Logisoft offers something no other direct distributor does: a free-90 day, on-site system hardware service contract. If a problem arises with your system, SORBUS®, a Bell Atlantic™ company, provides your free service AT YOUR FACILITY in most metropolitan areas. SORBUS® is one of the nation's largest and most respected independent computer maintenance firms, servicing over 315,000 computer systems. With SORBUS®, expert computer maintenance is only a phone call away.

## IBM-PC DELUXE—\$2,229

- 256Kb Ram Memory • Two DSDD 360K Floppy Disk Drives • Half Height 10Mb Internal Hard Disk • Hard Disk Controller • Five Expansion Slots • IBM-PC Keyboard • 90-Day, On-Site Sorbus Service Contract • Color Or Monochrome Monitor Available As Option

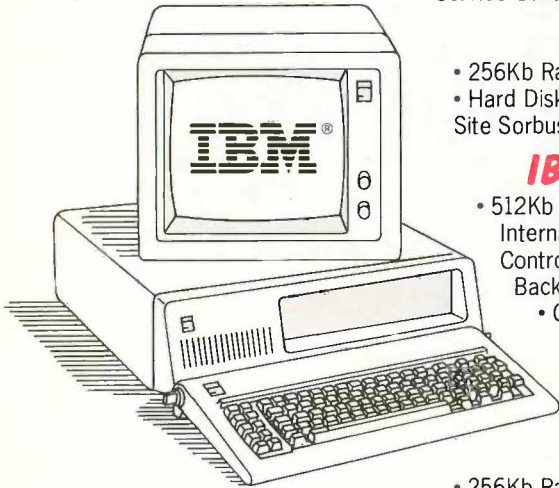

## IBM PC/XT—\$2,349

- 256Kb Ram Memory • DSDD 360K Floppy Disk Drive • 10Mb Internal Hard Disk • Hard Disk Controller • Eight Expansion Slots • IBM PC/XT Keyboard • 90-Day, On-Site Sorbus Service Contract • Color Or Monochrome Monitor Available As Option

## IBM PC/AT ENHANCED—\$3,895

- 512Kb Ram Memory (Exp. to 3Mb) • 1.2Mb Floppy Disk Drive • 20Mb Internal Hard Disk (Optional 30Mb) • Eight Expansion Slots • Hard Disk Controller • IBM 84 Key AT Keyboard • Optional 20Mb Stream Tape Back-up • 90-Day, On-Site Sorbus Service Contract • Color Or Monochrome Monitor Available As Option

## COMPAQ PORTABLE HARD DISK SYSTEM—\$2,495

- 256Kb Ram Memory • DSDD 360Kb Floppy Disk Drive • 10Mb Internal Hard Disk • Hard Disk Controller • 90-Day, On-Site Sorbus Service Contract • 9" Text/Graphics Monitor Included

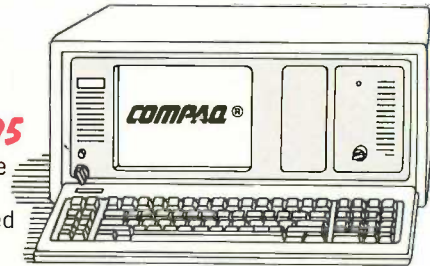

## COMPAQ PORTABLE 286 MODEL 2—\$4,249

- 640K Ram Memory • 1.2Mb Floppy Disk Drive • 20Mb Internal Hard Disk Drive • 80286 Based CPU • 9" Text/Graphics Monitor Included • 90-Day, On-Site Sorbus Service Contract

## COMPAQ PORTABLE DUAL DISK SYSTEMS—\$2,239

- 256Kb Ram Memory • Two DSDD 360Kb Floppy Disk Drives • 9" High Resolution Text/Graphics Monitor Included • 90-Day, On-Site Sorbus Service Contract

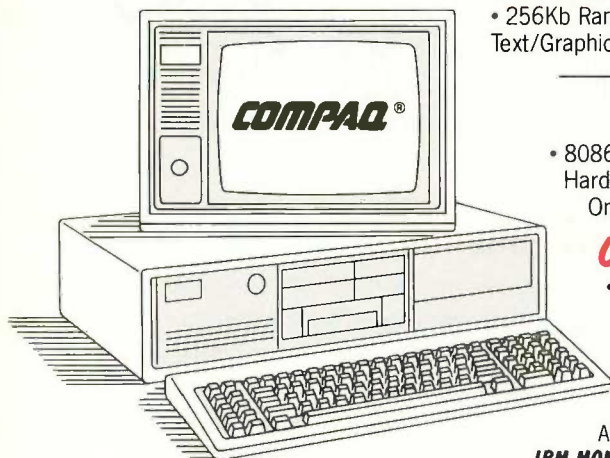

## COMPAQ DESKPRO—\$2,549

- 8086 Board CPU • 256K Ram Memory • 360K Floppy Disk Drive • 10 Mb Hard Disk • Hard Disk Controller • COMPAQ Dual Mode Monitor • 90-Day, On-Site Sorbus Service Contract

## COMPAQ 286 DESKPRO—\$4,349

- 80286 Based CPU • 640K Ram Memory • 1.2 Ms Floppy Disk Drive • 20 Mb Hard Disk • Hard Disk Controller • COMPAQ Dual Mode Monitor • 90-Day, On-Site Sorbus Service Contract

**IBM MONOCHROME OPTION 1—\$249** Monochrome Graphics Display Card. AMDEK 310A Monitor. Parallel Port.

**IBM MONOCHROME OPTION 2—\$349** Monochrome Graphics Display Card. IBM Monochrome Monitor. Parallel Port.

**IBM COLOR OPTION 1—\$559** Color Graphics Display Card. Princeton RGB HX-12 Monitor. Parallel Port.

**IBM COLOR OPTION 2—\$659** Color Graphics Card. IBM Color Monitor. Parallel Port.

**AT&T 6300 SERIES AVAILABLE.**



• No surcharge for MasterCard, VISA, American Express. C.O.D., money order or check • P.O.s accepted . . . no surcharge (please call for price verification)  
 • No sales tax on orders shipped outside N.Y. State • Please add 2% for insurance and handling (Int'l orders add'l) • We do not bill until we ship.  
 All products covered by mfg's warranty. Defective merchandise may be returned for repair or exchange only. We do not guarantee compatibility. Any goods returned for credit are subject to a 15% restocking charge.

IBM PC™, AT™, and PC/XT™ are trademarks and IBM® is a registered trademark of International Business Machines Corporation. COMPAQ® is a registered trademark of Compaq Computer Corporation.

Circle #400 on reader service card.

# SOFTWARE FOR VIRTUALLY EVERY IBM-PC APPLICATION.

**FREE OVERNIGHT DELIVERY. LOWEST PRICE GUARANTEE. TOLL-FREE CUSTOMER SERVICE.**

**WORD PROCESSING**

Wordstar	\$205
Wordstar 2000	259
<b>WORDSTAR 2000 PLUS</b>	<b>305</b>
Wordstar Pro Pac	255
<b>WORD PERFECT</b>	
(New Release)	219
Microsoft Word	249
Multimate	245
<b>MULTIMATE ADVANTAGE</b>	<b>275</b>
Volkswriter III	159
Easywriter II/Speller/ Mailer	199
<b>EASY</b>	<b>99</b>
Finalword	209
Samna III	279
Xy Write II Plus	239
Think Tank	119
Pfs: Write	85

**DATA BASE MANAGEMENT**

<b>KNOWLEDGEMAN/2</b>	<b>\$329</b>
<b>CORNERSTONE</b>	<b>275</b>
Tim IV	199
d Base II	295
<b>R:BASE 5000</b>	<b>355</b>
<b>R: BASE 5000 (Runtime)</b>	<b>255</b>
<b>d BASE III PLUS</b>	<b>415</b>
<b>CLIPPER</b> (d Base III Compiler)	<b>385</b>
Data Base Manager II (alpha)	169
Friday	179

pfs: file & pfs: report	165
<b>REVELATION</b>	<b>655</b>
Revelation Network (1-4)	1,195
Powerbase	199
<b>PARADOX</b>	<b>529</b>
Reflex	59

**INTEGRATED/SPREADSHEETS**

<b>LOTUS 1-2-3 (v2.0)</b>	<b>\$319</b>
Enable (New Version)	355
Ability	315
<b>FRAMEWORK II</b>	<b>415</b>
Electric Desk	209
<b>SYMPHONY</b>	<b>439</b>
Supercalc 3	185
Multiplan	129
pfs: plan	85

**FINANCIAL**

Dollars And Sense	\$115
<b>MANAGING YOUR MONEY</b>	<b>115</b>
Howard Tax Preparer '86	Low Price—Call!

**GRAPHICS**

<b>CHARTMASTER</b>	<b>\$239</b>
Signmaster	185
pfs: graph	85
<b>GRAPHWRITER COMBO PAK</b>	<b>305</b>
<b>DIAGRAM MASTER</b>	<b>195</b>
Microsoft Chart	179

**ENERGRAPHICS** \$239

PC Draw	219
Gem Draw (incl. Desk Top)	95

**PROJECT SCHEDULERS**

**MICROSOFT PROJECT** \$229

SuperProject Plus

**Low Price—Call!**

**HARVARD TOTAL PROJECT MGR.** 285

Project Scheduler 5000 (Scitor)	289
Project Scheduler Network	395
Timeline	275

**LANGUAGES/UTILITIES**

**CONCURRENT PC DOS** (w/windows) \$185

PL/1-(DR) 489

**LATTICE C. COMPILER** 275

**TURBO PASCAL** 39

Pascal Compiler (MS)	199
C Compiler (MS)	265
Cobol Compiler (MS)	399
Business Basic (MS)	309

**FORTRAN COMPILER (MS)** 239

C86 C Compiler (Computer Innovations) 309

Microsoft Macro Assembler 105

P-Mate 189

P-Link 86 319

**JUNIOR CORNER**

Lotus 1-2-3 Junior	\$319
--------------------	-------

**MISC. UTILITIES**

**FANCY FONT** \$145

Wordplus (Oasis)	119
pfs: proof	65
Punctuation & Style	99
Quickcode III	149
Quick Report	159
D Graph III	149
D Util III	65

**SPREADSHEET AUDITOR** 109

K Graph	175
K Paint	85
K Text	109
Clout 2	149
Extended Report Writer	119
Sideways	45
<b>PROKEY 4.0</b>	<b>89</b>
Norton Utilities (New Release)	59
<b>SIDEKICK</b> (unprotected)	<b>55</b>
<b>CROSSTALK XVI</b> (New Release)	<b>109</b>
Remote	109
Turbo Lightning	59
Smartcom II	109
Easy Plus	75
<b>SUPERKEY</b>	<b>39</b>
Copy II PC	39
<b>DESK ORGANIZER</b>	<b>65</b>

**ACCOUNTING SYSTEMS**

	Computer Associates (Formerly IUS)	Open Systems	Great Plains	Versa Business	State of The Art	Realworld (MBSI)	BPI
Accounts Payable	\$299	\$359	\$459	\$79	\$479	\$359	\$345
Accounts Receivable	299	359	459	79	479	359	345
Fixed Assets	—	359	—	—	—	—	—
General Ledger	299	359	459	119	479	359	345
Inventory	299	359	459	79	479	359	345
Job Costing	—	359	459	—	—	—	345
Timekeeping/Billing	845	—	—	—	679	—	—
Order Entry/Processing	299	359	—	—	479	359	—
Payroll	365	359	459	79	479	359	345
Report Writer	—	359	—	—	—	—	—
Sales Invoicing	—	359	—	—	479	—	—
Purchase Order Entry	—	359	—	—	—	—	—
TCS Client Ledger System	\$1195	—	—	—	—	—	—
GNP CPA + (Requires 1 2 3)	\$379	—	—	—	—	—	—

All prices and policies subject to change without notice.

**CAN'T FIND IT? ASK FOR OUR SPECIAL ORDER DEPT.**

If you can't find the product you want here or you think it's not available through the mail, ask for our Special Order Department. There's a good chance we do carry the product (we're adding new ones every day). Or, we can get it for you from one of our suppliers—still at our low direct-to-you prices.



110 Bi-County Blvd., Dept. 543  
Farmingdale, NY 11735  
CANADA: 416-283-2354  
Domestic/Int'l Telex  
286905 SoftUR

To order or receive technical assistance, call our National Hotline:

**1-800-645-3491**

NY STATE: 1-800-23 LOGIC (235-6442)  
Customer Service: 1-800-431-9037

EUROPE: 020-83.48.64  
Telex: 10759 Logic NL  
Mail orders to:  
LOGICSOFT EUROPE BV  
pb 9460, 1006 AL Amsterdam, Holland

Circle #400 on reader service card.

# PERIPHERALS TO EXPAND YOUR SYSTEMS & CAPABILITIES.

**FREE OVERNIGHT DELIVERY. LOWEST PRICE GUARANTEE. TOLL-FREE CUSTOMER SERVICE.**

PRINTERS*		MULTI-FUNCTION BOARDS		QUADRAM		CORVUS	
<b>EPSON</b>		<b>AST RESEARCH</b>		Quadmodem Series . . . . .		The Bank 100 Mb . . . . .	\$1,729
LQ1500**	\$879	Six Pak Plus (384k) . . . . .	\$259	<b>Low Price—Call!</b>		<b>EVEREX</b>	
LQ1500 Sheet Feeder (Cut)	395	Six Pak Plus (64k) . . . . .	239	<b>RACAL-VADIC</b>		Excel Stream 20 Mb Int. . . . .	\$639
JX-80 . . . . .	499	Mega Plus II (64k) . . . . .	275	2400 PC . . . . .	\$635	Excel Stream 60 Mb Int. . . . .	929
LX-80 . . . . .	229	Mega Pak (256k) . . . . .	369	<b>VEN-TEL</b>		Excel Stream 60 Mb Ext. . . . .	989
LX-80 Tractor/Feeder . . . . .	30	Advantage (128k) . . . . .	409	PC Modem Half Card . . . . .	\$375	<b>IRWIN</b>	
RX-100 . . . . .	399	I/O Plus II . . . . .	129	1200 Plus . . . . .	399	Irwin 110 10 Mb Int. . . . .	\$595
FX-85 . . . . .	349	<b>EVEREX</b>		<b>MOUSE INPUT DEVICES</b>		<b>KAMMERMAN LABS</b>	
FX-286 . . . . .	Low Price—Call!	Magic Card II (64k) . . . . .	\$175	<b>MOUSE SYSTEMS</b>		The Flight Tape Series	
<b>JUKI</b>		<b>STB</b>		PC Mouse w/DR Halo II . . . . .	\$135	60 Mb . . . . .	\$1,675
6100 . . . . .	\$365	Chauffeur . . . . .	\$255	<b>MICROSOFT</b>		The Flight Tape Series	
6300 . . . . .	689	<b>TECMAR</b>		Microsoft Mouse (Serial) . . . . .	\$135	10 Mb . . . . .	1,195
<b>NEC</b>		Captain (64k) . . . . .	\$189	Microsoft Mouse (Buss) . . . . .	135	<b>MAYNARD ELECTRONICS</b>	
8850 . . . . .	\$1,459	Captain (384k) . . . . .	199	<b>SURGE PROTECTORS</b>		Maynstream 20 Ext. . . . .	\$1,139
Pinwriter P2 . . . . .	559	<b>QUADRAM</b>		<b>KENSINGTON MICROWAVE</b>		Maynstream At-20 Int. . . . .	949
Pinwriter P3 . . . . .	895	Quadboard (384K) . . . . .	\$255	Masterpiece . . . . .	\$95	<b>SYSGEN</b>	
<b>MANNESMAN TALLY</b>		Goldboard . . . . .	Low Price—Call!	<b>CURTIS</b>		External 10 Mb . . . . .	\$845
MT-86 . . . . .	Low Price—Call!	Silverboard . . . . .	Low Price—Call!	Diamond . . . . .	\$39	<b>TALLGRASS TECHNOLOGIES</b>	
<b>OKIDATA</b>		<b>COMMUNICATIONS BOARDS</b>		Emerald . . . . .	49	Tg 4060 w/controller	
182 Plug & Play . . . . .	\$219	<b>AST</b>		Sapphire . . . . .	59	card . . . . .	\$1,495
192 Plug & Play . . . . .	349	AST-5251-11 . . . . .	\$695	Ruby . . . . .	69	<b>TECMAR</b>	
193 Plug & Play . . . . .	555	<b>DCA</b>		<b>KEYBOARDS</b>		Qic 60 At . . . . .	\$1,275
241 O Plug & Play . . . . .	1,749	IRMA Board . . . . .	\$839	<b>KEYTRONIC</b>		<b>HARD DISK TAPE BACK-UP SUBSYSTEM</b>	
<b>SILVER REED</b>		<b>QUADRAM</b>		5150 . . . . .	\$159	<b>ALLOY</b>	
770 . . . . .	\$699	Quadlink . . . . .	\$339	5151 (Deluxe) . . . . .	169	PC Qicstor 30/60 . . . . .	\$3,495
<b>PANASONIC</b>		<b>GRAPHICS BOARDS</b>		<b>JUNIOR CORNER</b>		Microstor 20/20 . . . . .	2,275
KX 1091 . . . . .	\$265	<b>AST</b>		Keytronic 5149 . . . . .	\$49	<b>KAMMERMAN LABS</b>	
<b>TOSHIBA</b>		Monograph plus . . . . .	\$425	Keytronic Junior 5151 . . . . .	169	Masterflight 10/10 . . . . .	\$1,795
P351 Tractor . . . . .	\$175	Preview . . . . .	249	<b>MEMORY STORAGE</b>		Masterflight 60/60 . . . . .	3,849
P351 . . . . .	999	<b>EVEREX</b>		<b>IOMEGA</b>		<b>SIGMA</b>	
1340 . . . . .	459	Graphics Edge . . . . .	\$269	Bernoulli Box (20mb) . . . . .	\$2,389	Stand Alone Winchester:	
<b>CITIZEN</b>		The Edge . . . . .	249	<b>HARD DISK DRIVES</b>		Tape 20/45 . . . . .	\$2,675
MSP10 . . . . .	\$279	<b>HERCULES</b>		<b>EVEREX</b>		<b>SYSGEN INDUSTRIES</b>	
MSP15 . . . . .	385	Graphics Card . . . . .	\$299	Everdisk 10 Mb Int. . . . .	\$525	Sysgen Plus . . . . .	\$2,875
MSP25 . . . . .	519	Color Card . . . . .	155	Everdisk 20 Mb Int. . . . .	575	<b>LOGICSOFT PRODUCTS</b>	
<b>MONITORS*</b>		<b>PARADISE SYSTEMS</b>		<b>MAYNARD ELECTRONICS</b>		Logicboard (six pak &	
<b>AMDEK</b>		Multi-Display Card . . . . .	\$209	Pci 10 Mb Int. . . . .	\$539	equiv.) . . . . .	\$129
Color 300 . . . . .	\$219	Modular Graphics Card . . . . .	255	Ati 20 Mb Int. . . . .	775	Logicboard AT (Advantage	
Color 600 . . . . .	389	<b>QUADRAM</b>		<b>MICROSCIENCE</b>		equiv.) . . . . .	\$279
Color 710 . . . . .	559	Quadcolor I . . . . .	\$195	10 Mb Int. . . . .	\$495	Logicmodem 1200B (Hayes	
12" Green 300G . . . . .	119	<b>SIGMA</b>		20 Mb Int. . . . .	525	equiv.) . . . . .	\$195
12" Amber 300A . . . . .	129	Color 400 (Princeton) . . . . .	\$499	<b>MOUNTAIN COMPUTER CORP.</b>		<b>FLOPPY DISK DRIVES</b>	
12" Amber 310A . . . . .	149	<b>STB</b>		Dynamic Disk 10 Mb Ext. . . . .	\$1,475	Tandon TM-100 360 K . . . . .	\$109
<b>PRINCETON GRAPHICS</b>		Graphics Plus II . . . . .	\$259	<b>PRIAM CORP.</b>		Toshiba 360 K 1/2 Ht. . . . .	109
RGB HX-12 . . . . .	\$429	<b>TECMAR</b>		Innerspace 1d 40 Ext. . . . .	\$1,250	CDC 360 K 1/2 Ht . . . . .	109
RGB SR-12 . . . . .	569	Graphics Master . . . . .	\$445	<b>SIGMA</b>		<b>BACK UP POWER SUPPLIES</b>	
Scan Doubler Board		<b>MODEMS</b>		Hard Disk Kit 10 Mb Int. . . . .	\$725	<b>DATA SHIELD</b>	
(for SR-12) . . . . .	185	<b>HAYES</b>		<b>TALLGRASS TECHNOLOGY</b>		200 Wt. (PC) . . . . .	\$249
Amber Max-12E . . . . .	159	Smartmodem 300 . . . . .	\$145	Tc 5525i 25 Mb Int. . . . .	\$849	300 Wt. (XT) . . . . .	359
<b>QUADRAM</b>		Smartmodem 1200 . . . . .	389	<b>SEAGATE</b>		500 Wt. (AT) . . . . .	559
Amberchrome 12" . . . . .	155	Smartmodem 1200B		10 Mb 1/2 Ht. Int. . . . .	\$475	<b>GRIZZLY</b>	
<b>TAXAN</b>		w/Smartcom II . . . . .	359	20 Mb 1/2 Ht. Int. . . . .	495	200 Wt. (PC) . . . . .	\$475
122 . . . . .	139	Smartmodem 2400 . . . . .	609	<b>CARTRIDGE TAPE BACK-UP</b>		300 Wt. (XT) . . . . .	495
620 . . . . .	Call for Price	<b>PROMETHEUS</b>		<b>ALLOY</b>		500 Wt. (AT) . . . . .	695
640 . . . . .	Call for Price	Pro-modem 1200 . . . . .	\$299	PC Qictape Ext. 70 Mb . . . . .	\$1,749	<b>LOGICSOFT EUROPE BV</b>	
		Pro-Modem 1200B . . . . .	259	PC Back Up Ext. 20 Mb . . . . .	1,649	pb 9460, 1006 AL Amsterdam, Holland	

\*Due to weight restrictions, Printers and Monitors are shipped UPS—free.

\*\*Parallel Interface req. . . . . Ask sales agent.

All prices and policies subject to change without notice.

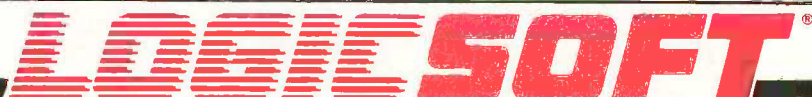

To order or receive technical assistance, call our National Hotline:

**1-800-645-3491**

NY STATE: 1-800-23 LOGIC (235-6442)

Customer Service: 1-800-431-9037

Circle #400 on reader service card.

EUROPE: 020-83.48.64  
Telex: 10759 Logic NL

Mail orders to:

LOGICSOFT EUROPE BV

pb 9460, 1006 AL Amsterdam, Holland

110 Bi-County Blvd., Dept. 543  
Farmingdale, NY 11735

CANADA: 416-283-2354

Domestic/Int'l Telex

286905 SoftUR

# MACINTOSH EXPLORER

BY OLAV ANDRADE

*A disassembler written in BASIC  
that lets you investigate your Mac*

AN EXCELLENT WAY to learn how to use a processor's instruction set is to see how things have already been done. The function of a disassembler is to translate machine code to human-readable assembler mnemonics. I know that a disassembler can't aid you in writing good documentation for your own assembler programs, structured code, or any of the aesthetics that a good programmer would consider in writing a program. But if you need to know what is involved in rewriting a particular function for your tastes, or even for a different target machine, a disassembler can help. However, you'll have to keep your wits about you: The reconstituted assembler source is never enough to immediately understand the code; without comments you may find the code's purpose completely obscure.

The target for the disassembler I will describe is Motorola's 68000 microprocessor. I wrote the actual disassembler in Microsoft BASIC for Apple's Macintosh. When I decided that I needed a disassembler, there were no facilities for native compilation on the Mac, but I realized that the many Macintosh Toolbox and operat-

ing-system routines (supplied by Apple in ROM) would be a major part of any application. Hence I had to understand how Toolbox calls were made: "How are parameters handled?" for instance. (When I wrote this disassembler, Apple's publication *Inside Macintosh*, which describes these calls, was not available in its final form.) Also, my disassembler didn't need to be fast, since I wouldn't be using it too often; an interpreted language would be fine.

## IMPLEMENTATION

A disassembler, as it turns out, doesn't behave too differently from a microcoded processor (such as the 68000). Microcode is a program inside the processor itself that tells the processor what each instruction code should do. In the 68000, the fetched instruction is decoded by a programmed logic array (PLA) to yield a start address in the microcode. You can think of this PLA as a multiway branch in any programming language. In my disassembler, the PLA function is split into two distinct operations: isolating those bits that are important to the decoding (done by performing a bitwise AND to the instruction word

using a mask value); and then executing a GOSUB to the appropriate routine. As it turns out, only 30 or so distinct routines are needed to disassemble the entire instruction set of the 68000 processor.

The four data structures needed to implement this scheme are an opcode table and, for each op code in the table, a mask, a match word, and a subroutine identification number. The data for the table itself is pre-sorted according to the number of bits required to uniquely identify the op code. Since those instructions that have no operands (such as nop) have a mask with all bits on (i.e., \$FFFF since the 68000 uses a 16-bit op code), they occur first in the table; more flexible instructions occur later in the table (e.g., move.w uses only the first nybble to specify the op code, so the mask is \$F000). [Editor's note: Dollar signs preceding numbers denote hexadecimal notation.] The scheme employed by the disassembler is to sequentially compare entries in the table with the op

*(continued)*

Olav Andrade (13 Bromley Crescent, Bramalea, Ontario L6T 1Z2, Canada) holds a B.S. from the University of Toronto. He is currently developing Macintosh software.

code until a match is found. (This sequential comparison is the reason for presorting the table by the number of bits in the mask.) A match is indicated when the masked op code is the same as the match word of a particular table entry.

Figure 1 shows the bit encoding,

mask word, and match word for the instruction LEA EffectiveAddress,An. If you wanted to decode the word \$4BD3, you would perform a bitwise logical AND between the masks in the op-code table and \$4BD3 until the result equaled the match word for that op code. In this case, \$4BD3 AND

\$F1C0 = \$41C0, where the \$F1C0 is the mask for the LEA instruction; \$41C0 equals the match word for the LEA instruction. You would therefore deduce that the op code is an LEA instruction and pass it to the subroutine that breaks out its operands. From there it's just a matter of vectoring to the appropriate subroutine by using the subroutine identification number for that table entry.

Another subroutine is used to return a string version of the address mode for those instructions that have flexible addressing modes. Since not all instructions encode the address mode in the same bit positions, this subroutine's caller must break out the addressing mode information and pass it along. This routine also handles the offsets that may follow the op-code word. In double address instructions, as many as four extension words may be required to resolve the address; in any given invocation of this subroutine, only two extension words may be used—and these are passed in as parameters. Boolean variables (actually, BASIC doesn't have any, but they're used that way) indicate whether the extension was used or not. The caller needs to know this so that the next instruction can begin on the correct word, or, for a double address, so that the correct extension words are passed in on the second invocation of this subroutine.

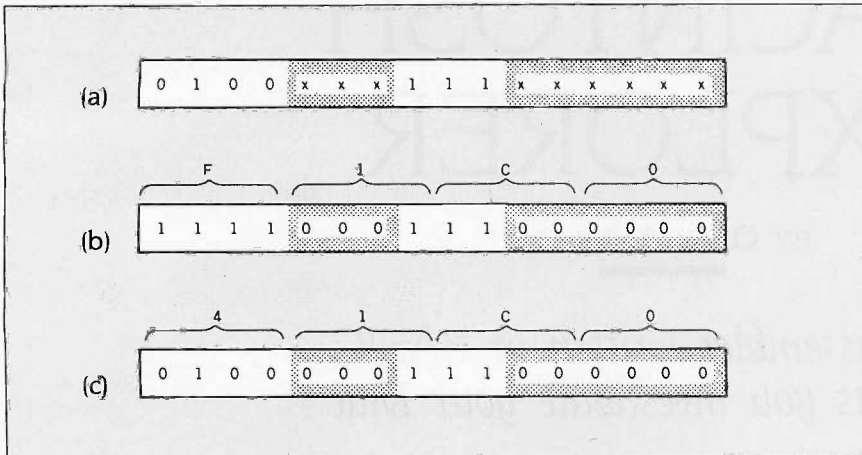

Figure 1: (a) Bit encoding of LEA effectiveAddress,An instruction. The Xs represent "don't care" bits. For an LEA instruction they are used to encode the operands; they may be ignored in determining which instruction is represented. (b) The mask word for the above instruction is formed by filling the word with 1s, except for "don't care" bits in the op code, which are set to 0s. (c) The match word for this instruction is formed by a bitwise AND between the op code encoding (with Xs treated as 0s) and the mask word.

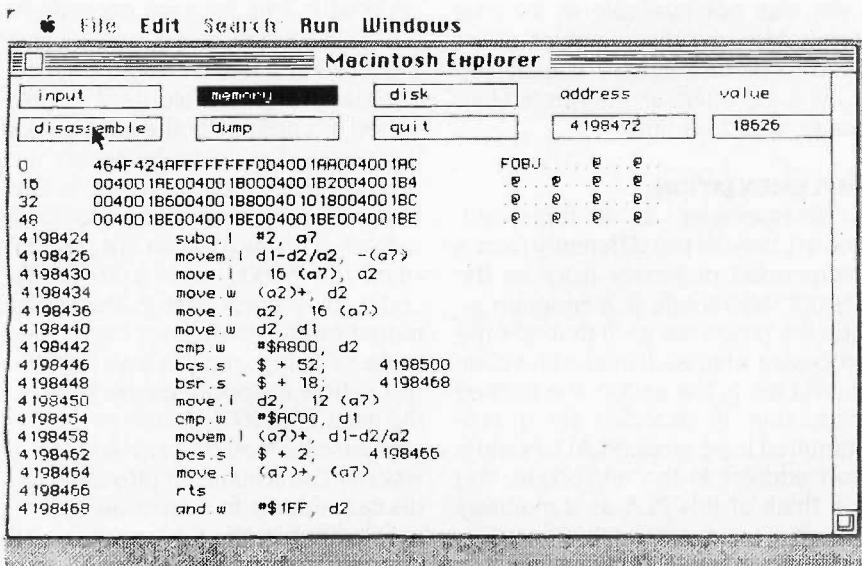

Figure 2: Shown is the screen of the Macintosh Explorer. Note that the memory path is in reverse video, indicating that it is active. You can see a dump of the beginning of memory and a disassembly starting at address 4198424.

### USER INTERFACE

The Macintosh is renowned for its user interface, and this program tries to take as much advantage of that interface as possible. Consequently, a great deal of code is concerned with the state of the mouse. There are three paths of information available to the disassembler, indicated in the top row of boxes: Input, Memory, and Disk (see figure 2). This grouping is intentional and useful because it visually indicates the connection between them. The active path is shown by highlighting its associated box. You change the active path by clicking the mouse button on the desired box. Since it's uncomfortable to change

(continued)



## Networking Raised to a Greater Power

Advanced Technology. With it, IBM tripled the speed of the PC and increased its memory capacity five-fold. Nowhere is this increase in computing power more important than in networking situations. If the AT's technological advances have prompted you to look into a multi-user network, you owe it to yourself to take a closer look at MultiLink Advanced™ . . . a unique multi-tasking, multi-user networking system that runs programs under PC-DOS 3.0.

**Eight Workstations for the Price of an AT.** MultiLink Advanced™ represents the next generation in networking systems for IBM microcomputers. The system enables terminals, connected to a single AT, to emulate IBM-PC's having up to 448K of RAM (The PC-Shadow™ terminal, shown above, even has a PC look-alike, as well as work-alike keyboard and display).

This means that instead of spending \$3,000 per workstation for a PC with a Kilobuck "Network Interface Board," you can use inexpensive terminals . . . eight of which cost less than an IBM AT. Even if you need only one workstation connected to your AT, you'll realize significant savings.

**MultiLink Advanced™ . . . Instant Access to All of Your Resources.** Central to most multi-user situations is the need to coordinate a variety of printers. With what's been described by *PC-Tech Journal* as ". . . by far, the best print spooler for the IBM PC," MultiLink Advanced™ gives users the option to print either at their workstations, or at a central location. In addition, programs and files can be shared by multiple users locally or through use of a modem. Just think of it . . . having remote access to an AT with a lightweight terminal/modem.

Although designed to take advantage of the AT, MultiLink Advanced™ runs on all versions of PC-DOS, except 1.0, and certain implementations of MS-DOS. A wide range of leading programs are supported which include WordStar, dBASE III, Multimate, and Lotus 1-2-3.

**Get the Advanced Story Today.** Call The Software Link Today for complete details and the dealer nearest you. MultiLink Advanced™ is immediately available at the suggested retail price of \$495 and comes with a money-back guarantee. VISA, MC, AMEX accepted.

# MultiLink™

## ADVANCED



THE SOFTWARE LINK, INC.

8601 Dunwoody Place, Suite 632, Atlanta, GA 30338 Telex 4996147 SWLINK

CALL: 404/998-0700

Dealer Inquiries Invited

IBM PC, AT, & PC-DOS are trademarks of IBM Corp. MS-DOS, WordStar, dBase III, Lotus 1-2-3, and Multimate are trademarks of Microsoft Corp., MicroPro, Ashton-Tate, Lotus Development Corp., & Multimate International, respectively.

THE SOFTWARE LINK, INC./CANADA  
409 Esna Park Drive, Suite 18  
Toronto (Markham), Ont. L3R 3K2  
CALL: 416/477-5480

MultiLink Advanced™ & PC-Shadow™ are trademarks of The Software Link, Inc.

# DeSmet C

8086/8088  
Development  
Package **\$109**

## FULL DEVELOPMENT PACKAGE

- Full K&R C Compiler
- Assembler, Linker & Librarian
- Full-Screen Editor
- Execution Profiler
- Complete **STDIO** Library (>120 Func)

## Automatic DOS 1.X/2.X SUPPORT

**BOTH 8087 AND S/W FLOATING POINT  
OVERLAYS**

## OUTSTANDING PERFORMANCE

- First and Second in AUG '83 BYTE benchmarks

**SYMBOLIC DEBUGGER** **\$50**

- Examine & change variables by name using C expressions
- Flip between debug and display screen
- Display C source during execution
- Set multiple breakpoints by function or line number

**DOS LINK SUPPORT** **\$35**

- Uses DOS .OBJ Format
- LINKs with DOS ASM
- Uses Lattice® naming conventions

Check:  Dev. Pkg (109)  
 Debugger (50)  
 DOS Link Supt (35)

SHIP TO: \_\_\_\_\_

\_\_\_\_\_ ZIP \_\_\_\_\_

**CW A R E**  
CORPORATION

P.O. BOX C  
Sunnyvale, CA 94087  
(408) 720-9696

All orders shipped UPS surface on IBM format disks. Shipping included in price. California residents add sales tax. Canada shipping add \$5, elsewhere add \$15. Checks must be on US Bank and in US Dollars. Call 9 a.m. - 1 p.m. to CHARGE by VISA/MC/AMEX.

Street Address: 505 W. Olive, #767, (94086)

## MACINTOSH EXPLORER

### *A disassembler behaves much like the microprocessor itself.*

from the keyboard to the mouse, I've tried to minimize the keyboard input. The address and value box are the only places where keyboard input is required. The address field is for specifying the address where you want to begin the dump or disassembly; the value field is only for use with the Input path active (I'll discuss the value field later).

Both the address and value fields allow either decimal or hexadecimal numbers. The value field is restricted to 16-bit numbers, although you don't get an error message if the field overflows.

The bottom row of boxes is grouped to show commands: Disassemble, Dump, and Quit. Clicking the mouse on one of these will execute the command. Disassemble and Dump each generate one line of output. (Holding the mouse button down generates multiple lines.) The Quit command returns to the system that Macintosh users know as "the Finder." Perhaps this action is a bit drastic, since it may involve an unintentional exit, but I haven't found it to be a problem.

To the user the three paths appear to operate on linear arrays (indexed by the address field). This is done to present a consistent model of the machine—although it means more work for the programmer since the program must take care of details like mapping the disk address to a block address. Also, each path's address "sticks to it." By this I mean that changing the path from memory to disk will change the address (and display that change) to the address last used to read the disk. This allows users to flip between the paths and resume disassembling or dumping from where they left off. This strategy is meant to further reduce the use of the keyboard.

To many readers the Input path will be the mysterious part of this program. It is meant to be used for pre-assembled code such as that which is made available to BASIC through an array (like that used to perform the disk-sector Read function in this program). By clicking on the Input path and then specifying the address, you will be able to enter the preassembled code through the value box. You can then disassemble or dump it, as you would with the Memory or Disk paths.

The presence of the Input path is the only reason that the value field exists or accepts input. Both the Disk and Memory paths ignore values entered in the value field. Although it would be easy to extend its function to allow editing of memory and disk locations, it is not necessarily useful. The program's central purpose is to present information, not to potentially corrupt the system's integrity.

## CONCLUSION

Because a disassembler behaves much like the processor itself (i.e., fetching data that is treated as code), the structure of the disassembler can be used to emulate the processor in a different environment. This means that with some work, the Macintosh Explorer can be used as a debugger for the Motorola 68000 processor—and because the program is in BASIC, you don't need that processor itself. So if your plans stray into the area of building a 68000 system, you could use this program on an existing computer to debug the bootstrap routines. Though much of the program is dedicated to making the disassembler almost entirely mouse-driven, it shouldn't be too difficult to use it on any system by replacing the user interface and disk-sector Read subroutines. ■

[Editor's note: The source code for the Macintosh Explorer is written in Microsoft BASIC 2.0 for the Macintosh and is available for downloading from BYTEnet Listings at (617) 861-9764 and is also available on disk. See page 358 for details.]



# Directions for converting a PC to an XT.

# Insert tab A into slot B.

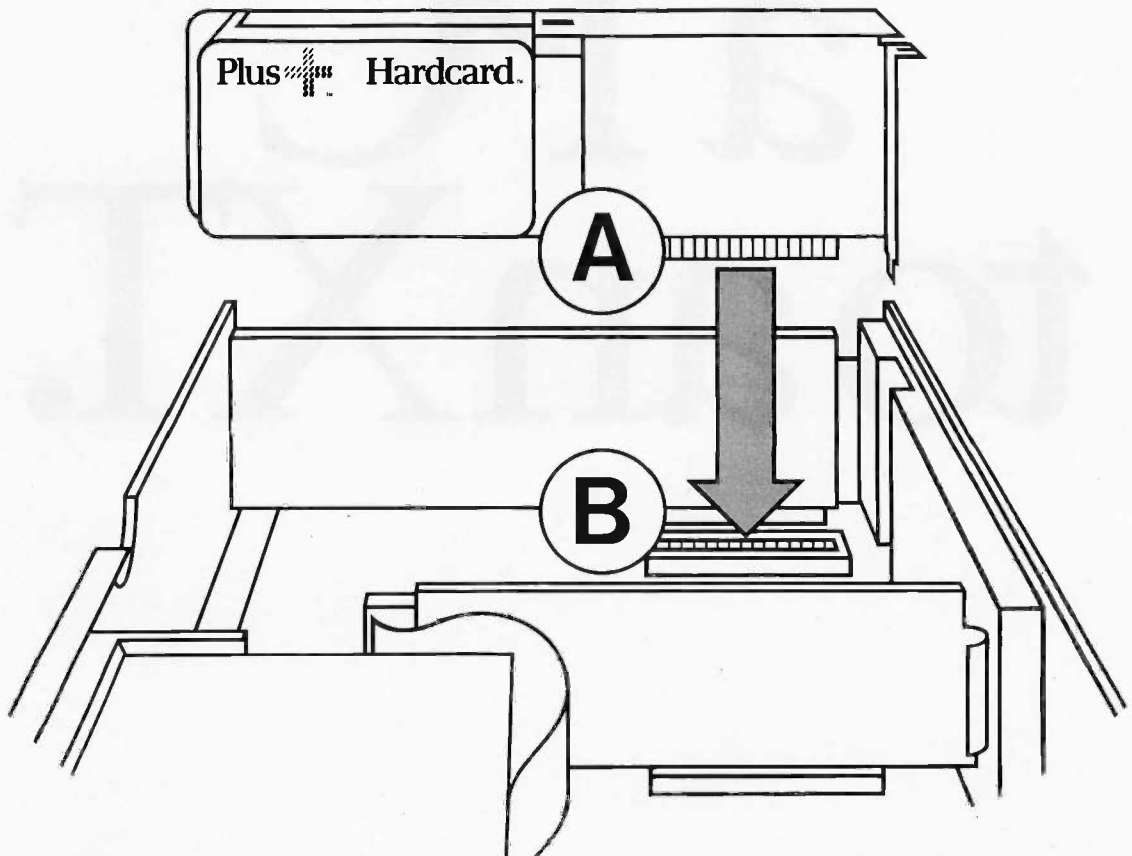

First you have to remove Hardcard™ from its box.

An operation that's about as simple as installing it in your PC.\*

Using thumb and forefinger, lift the flap of the box. Now reach inside and grasp Hardcard. Slowly pull it out, making sure that your warranty information doesn't fall unnoticed to the floor.

And that's it. You're over the hump.

You've got 10 megabytes of hard disk storage in your hand. Everything—the drive, the controller, the electronics—is compressed onto a single card.

Allow yourself a moment to marvel at its size and weight. Just over 2 lbs. Measuring only 13 x 4 x 1 inches. With no connector cables. No additional power supply required. No adapter card to buy.

Now slip it into a single expansion slot inside your PC and forget it. Odds are you'll never have to fuss with it again.

Because it's so remarkably reliable. More than twice as reliable as the XT's built-in drive. Since Hardcard has fewer parts, there are fewer things that can go wrong.

On top of that, Hardcard is even faster than the XT's drive.

And it maintains PC compatibility with the most popular software programs. In fact, our special compatibility task force has spent many man-years making sure that Hardcard runs popular software trouble-free.

Hardcard also lets you keep both your floppies up and running. Which is something no other add-in drive can do.

All of which means that your PC can now be saved.

And that friendly, intelligent little machine can have its useful life extended.

You won't have to go to the expense of replacing it with an XT.

Or suffer the shortcomings of bulky, conventional hard disks. Which take hours or even days to install.

And when it comes to installing DOS, Hardcard is just as easy. Its special installation program loads your operating system and gets you ready to install your software in minutes.

And Hardcard's Directory Program lets you access those programs at the touch of a key.

Finally, since Hardcard is so much more reliable, we can give you a warranty that goes well beyond the usual 90 days.

We give you a full year.

Still, it's nice to know that if anything ever should go wrong, you can pick up a replacement Hardcard at your nearby authorized service center.

Hardcard is available now at major retailers nationwide. For the name of the one nearest you, call Plus at (408) 946-3700. Or write Plus Development Corporation, 1778 McCarthy Blvd., Milpitas, CA 95035.

And we'll give you all the directions you need to save your PC.

\* Hardcard is compatible with IBM PC, IBM PC XT, Compaq Portable, Compaq Plus, AT&T PC 6300.

Plus and Hardcard are trademarks of Plus Development Corporation. IBM, IBM PC and IBM PC XT are trademarks of International Business Machines Corporation. Compaq Portable and Compaq Plus are trademarks of Compaq Computer Corp. AT&T PC 6300 is a registered trademark of AT&T Information Systems, Inc. © Plus Development Corporation. All rights reserved.

# Hardcard™

from Plus™

Inquiry 273



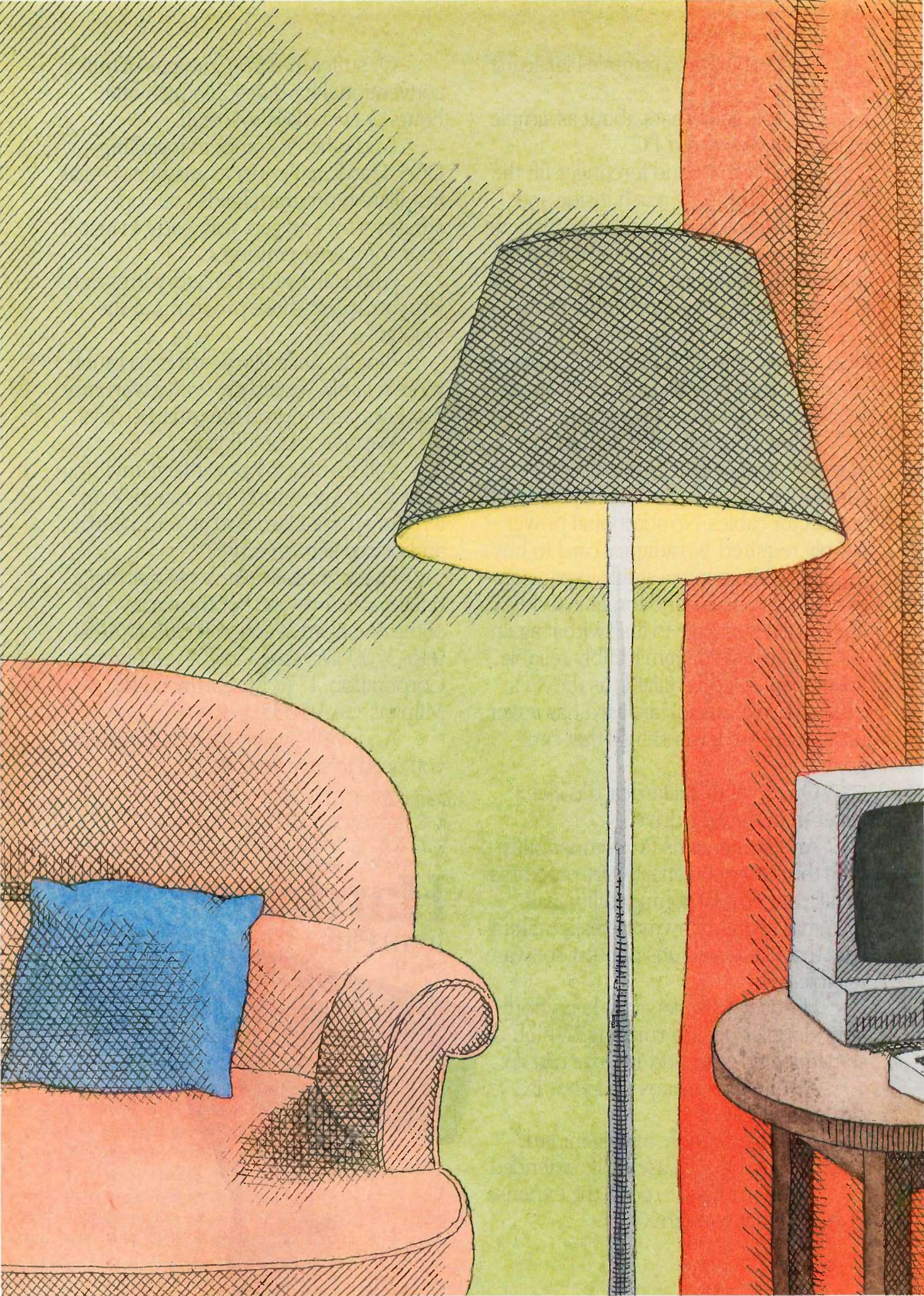

# Homebound Computing

---

<b>WORKING AT HOME WITH COMPUTERS</b> <i>by Jane Morrill Tazelaar</i> . . . . .	155
<b>USING IMAGES TO GENERATE SPEECH</b> <i>by Bruce R. Baker</i> . . . . .	160
<b>THE ELECTRONIC UNIVERSITY NETWORK</b> <i>by Donna Osgood</i> . . . . .	171
<b>THE TECHNOLOGY OF THE KURZWEIL VOICE WRITER</b> <i>by Raymond Kurzweil</i> . . . . .	177
<b>INCREASING INDEPENDENCE FOR THE AGING</b> <i>by K. G. Engelhardt and Roger Edwards</i> . . . . .	191
<b>COMPUTING FOR THE BLIND USER</b> <i>by Aries Arditi and Arthur E. Gillman</i> . . . . .	199

---

THE WORD HOMEBOUND means exactly that—bound to the home. We have used this word intentionally. This issue is not restricted to computing for the disabled. There are various ways in which a person can be homebound. If you are severely disabled or require special care or equipment, you are considered homebound. If you are elderly, you may also be essentially homebound, although you would not necessarily be considered disabled. If you are the care-giving parent of a small or disabled child, you are homebound a great deal of the time. If you live in a geographically remote or economically depressed area, you also qualify as homebound in your current environment. Finally, if you are bound to your home by choice rather than necessity, that is, if you choose to work at home instead of in an office, you are also considered homebound by our definition.

In this issue of *BYTE* we have tried to present articles of interest to each of these groups—hopefully, something for everyone. "Working at Home with Computers" discusses various things to consider before you make the choice—if indeed it is a choice and not a necessity—to work at home. Bruce Baker's "Using Images to Generate Speech" presents a fascinating concept borrowed from ancient Egypt; in practical application the article is about a concept keyboard for the speech-impaired that uses images with different meanings in different contexts to generate environment-specific sentences. "The Electronic University Network" by Donna Osgood deals with earning a college degree at home with the help of a microcomputer, not from a correspondence course, but from a fully accredited university. Raymond Kurzweil discusses "The Technology of the Kurzweil Voice Writer," a machine with significant implications for future applications for the hearing-impaired. "Increasing Independence for the Aging" by K. G. Engelhardt and Roger Edwards focuses on the future of robotic aids for the aged and for other persons who are motion-impaired, whether by birth, accident, or disease. While our readership does not include a large number of aged persons, who among us does not one day hope to reach that stage? Finally, Aries Arditi and Arthur Gillman talk about the human factors that must be considered in creating "Computing for the Blind User."

For some of us, being homebound is a fact of life; for others it is a dream. Either way, computer technology provides opportunities and aids that were unavailable a few short years ago. The future can only expand the horizons of those of us who are homebound.

—Jane Morrill Tazelaar, Technical Editor

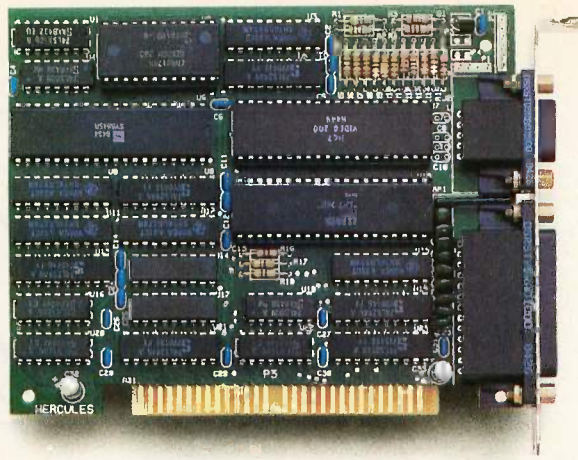

**NOW  
COMES  
WITH FREE  
PRINTER CABLE!**

## Why the Hercules Color Card is better for your XT than IBM's.

Did you know that there's a color graphics card specially designed for the XT™? It's called the Hercules™ Color Card. We think that it's better for your XT than the IBM® Color Graphics Adapter. Here's why.

The XT comes with an empty short slot. IBM's card is too long to fit in it, so you're forced to sacrifice a valuable long slot, while your XT's short slot goes unused.

The Hercules Color Card is designed to fit in this short slot. It's the smartest way to maximize the usable slots in an XT and provide for your future expansion needs.

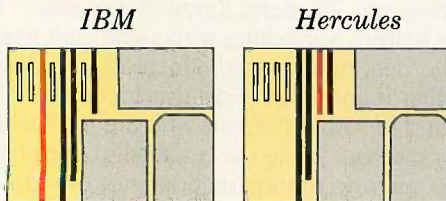

*Notice how much more efficiently Hercules makes use of the XT's slots.*

Our efficient use of an XT's slots is not the only reason to buy a Hercules Color Card instead of IBM's. We give you a parallel printer port at no extra cost. (IBM charges extra and takes up another slot.)

A lot of people wonder how Hercules can do everything that IBM can in a card less than half the size. We do it by designing our own graphics microchips. Just one of our chips packs the punch of dozens of IBM's, reducing by more than 50% the number of components that can fail.

And we'll do just about anything to make our products the most reliable you can buy.



*Hercules*



*IBM*

Of course, you *will* have to give up something when you buy a Hercules Color Card. You'll have to give up software incompatibility. With Hercules, there is none. Every program that runs on the IBM color card will run on the Hercules Color Card.

You'll have to give up IBM's ninety day warranty. Ours is two years.

		<i>Compare warranties</i>
<i>IBM</i>	■ 3 months	
<i>Hercules</i>	■ 2 years	

And you'll have to give up a dollar. The Hercules Color Card is \$245—IBM's is \$244.

Look into the Hercules Color Card for the XT, PC or AT™. Find out why the readers of *PC World* voted the Hercules Color Card 1985's best color graphics card—ahead of IBM's. Call 1 800 532-0600 Ext.432 for the name of the dealer nearest you and we'll rush you our free info kit.

# Hercules.

**We're strong on graphics.**

Inquiry 152

# WORKING AT HOME WITH COMPUTERS

BY JANE MORRILL TAZELAAR

*For some, telecommuting is a choice;  
for others, it is the only option*

THERE ARE MANY REASONS for wanting to work at home. Some of them involve disabilities that make it impossible or impractical to work in an office. For many disabled persons, the alternative to working at home is no alternative at all; it is the only work they can do, the only way they can become productive members of the work force. Some people work at home because of priorities such as being available to young children, especially during the preschool years. Many parents of small children must choose between sending them to day-care centers or babysitters and earning a reasonable living. Other reasons involve the lack of local work opportunities in economically depressed or geographically remote areas. And for some people, working at home is a simple matter of choice. The electronic cottage, the flexiplace, telecommuting, worksteading, or whatever you wish to call it could be the answer to all these problems.

## **STARTING YOUR OWN BUSINESS**

Starting your own business seems to be the answer for many people. There

is a certain romance in the very word entrepreneur, and there is a great deal of information available to help you get started if the idea of being one appeals to you. The various organizations associated with the cottage industry movement—the Association of Electronic Cottagers, the National Association for the Cottage Industry, and the National Alliance of Home-based Businesswomen—offer good and helpful information for the aspiring entrepreneur. (See the text box "Sources Mentioned" on page 156 for addresses and phone numbers.) They also offer countless references, contacts, and, possibly most important, support groups.

Two subjects seemed to jump out at me from all the literature I have seen on starting your own business: selling and networking. First, if you don't want to sell, you probably don't want your own business. Most business ventures involve direct selling. Whether you provide a product or a service, you need to sell it. Even if you have salespeople working for you, you have to sell the idea to some financial institution to get funds to get

started and to the people you hire to get them to work for you. Then, long after the basics are in place and you are operational, you'd better be prepared to talk about your product or service, explain its value, and convince a prospective buyer that he or she ought to do business with your company instead of someone else's—in other words, sell.

Networking is a way to increase your contacts. Whether people are business contacts or social contacts or both, they can add significantly to the success of your business. The people you know either personally or electronically are sources that can provide you with future customers, business partners, financiers, good tax accountants, awareness of your competition, discounts on computing equipment, the inside story on future technology, and so on.

Starting your own business is a very rewarding venture for some and a complete disaster for others. At the

*(continued)*

Jane Morrill Tazelaar is a technical editor for BYTE. She can be reached at BYTE, POB 372, Hancock, NH 03449.

very least, you should make sure you enjoy what you are going to be doing before you enter the world of the entrepreneur, because you will probably be doing a great deal more of it than you think.

Then consider the advice of some successful trailblazers who have done the dirty work and found out what is necessary the hard way. It is nearly impossible to foresee at the outset all the complications involved in having your own business. *Working from Home* by Paul and Sarah Edwards (Jeremy P. Tarcher Inc., 1985) is a good book that covers the many steps involved in setting up a business and arranging your life to handle it. *Women Working Home* by Marion Behr and Wendy Lazar (WWH Press, 1983) contains a number of examples of home-based businesses (not all computer-related) and provides a sizable directory of contacts organized on a state-by-state basis. There are many more sources available. The various cottage industry groups can lead you in the right direction.

**WORKING AT HOME FOR SOMEONE ELSE**

As exciting as starting your own business sounds to some, it is not for everyone. The difference between starting your own business and working for someone else is not a question of talent, intelligence, or personality. It is rather one of desire, time, and priorities. Working at home for someone else doesn't inspire the volumes of written material that entrepreneurship does. The romance doesn't extend to the worker; however, *finding* such home employment is easily as creative a project.

Where do you look? Whom do you contact? Will personnel officers think you're crazy even asking? What kinds of positions exist? Can you convince your current employer to try it? It's not an easy task, and if you are disabled or caring for small children, it can be even more difficult. There is help, however. The various cottage industry associations, while they do not stress this area, do offer some resources. In particular, the National Association

**SOURCES MENTIONED**

**THE ASSOCIATION OF ELECTRONIC COTTAGERS**  
677 Canyon Crest Dr.  
Sierra Madre, CA 91024  
(818) 355-0800

**BIX**  
BYTE Magazine  
70 Main St.  
Peterborough, NH 03458  
(603) 924-9281, ext. 131

**COMPU SERVE INFORMATION SERVICES**  
5000 Arlington Centre Boulevard  
Columbus, OH 45220  
(800) 848-8990

**GIL GORDON ASSOCIATES**  
10 Donner Court  
Monmouth Junction, NJ 08852  
(201) 329-2266

**THE NATIONAL ALLIANCE OF HOME-BASED BUSINESSWOMEN**  
POB 237  
Norwood, NJ 07648

**THE NATIONAL ASSOCIATION FOR THE COTTAGE INDUSTRY**  
POB 14460  
Chicago, IL 60614  
(312) 472-8116

**THE SOURCE**  
1616 Anderson Rd.  
McLean, VA 22102  
(800) 336-3366

for the Cottage Industry provides a list of 49 companies currently using telecommuters. Many of these are national companies, and while only those locations mentioned on this list are currently involved, I would assume other local offices of those companies would be good possibilities.

Another contact is Gil Gordon of Gil Gordon Associates. His consulting firm specializes in working with companies to set up telecommuting programs. He has general information on telecommuting and publishes a news-

letter on the subject. He does not, however, maintain lists of companies. Gil sells an audiocassette entitled "How to Get a Job Working from Home: Telecommuting and Other Options." The Association of Electronic Cottagers describes it as outlining "how to keep your paycheck while working from home, including the best industries to approach, what companies are hiring at-home workers and how to convince your boss to let you work at home."

Electronic networking can be as important to the home-based employee as to the entrepreneur. You need to keep yourself up to date on new developments in the industry, and what better way than to tap in electronically to a whole community of people involved in your field? Bulletin-board systems provide this opportunity. For the at-home worker more than others, this contact can provide the kind of interaction, both business and social, that occurs on coffee breaks and casual lunches for the office worker. It can also provide a support group of other people who share the problems and pleasures of working at home. One such electronic support group is the Work-at-Home Special Interest Group on CompuServe. (You locate it by entering GO HOM 146.) The Source and BIX also provide good electronic contacts.

**THE CURRENT DEBATE**

There are two sides to the telecommuting issue. The AFL/CIO is definitely opposed to the current trend toward working at home with computers. This is not a matter to be taken lightly. The AFL/CIO, a powerful organization, has asked the U.S. Labor Department for a ruling against doing computer work at home (see reference 1). The organization raises some important issues: assuring the payment of at least minimum wage, protecting employee fringe benefits, and guaranteeing the right to organize in order to deal with unreasonable employer demands.

Undoubtedly, we all have our own biases: for or against working at

(continued)



# INTRODUCING THE FUJITSU DL2400

# THE ONE PRINTER THAT DOES IT ALL

Thanks to advanced 24-wire technology, the DL2400 is much more than a dot matrix printer. It can also do the work of daisywheel printers, laser printers and plotters. It prints fast drafts and spreadsheets at 216 cps. Letter quality at 72 cps. And plots presentation-quality graphics on overhead transparencies in black and white, or seven brilliant colors.

You'll find the built-in, bi-directional tractor greatly simplifies paper handling. Just flick a switch to go from continuous forms to single-sheet feeding without having to remove the tractor paper. Push a button and it automatically reloads.

The DL2400 comes with an industry-leading reliability rating of 6000 hours MTBF and a full one-year warranty.

The front panel LCD display makes this highly sophisticated machine

incredibly simple to operate. Just touch a button to set every function from print mode to font style. No more hard-to-use dip switches. And it operates quietly too—at under 55 dBA.

To top it off, the DL2400 sets a new productivity point for measuring printers. You no longer have to buy different printers to do different jobs, when the new Fujitsu DL2400 does it all.

Call Fujitsu America, Peripheral Products Division, at 800-626-4686.

**WE'RE DEVELOPING TECHNOLOGY FOR YOU.**



Inquiry 138

**FUJITSU**

**FUJITSU AMERICA**



MEMO

To: the art department  
From: The boss  
Re: New business presentation  
I know the new Fujitsu DL2400 is great fun, but try not to get carried away. Please narrow it down to two or three of these colors for the presentation. O.K.?

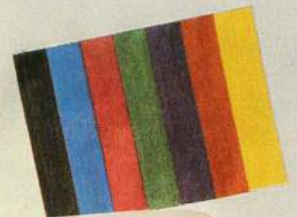

Illustrations by the  
Fujitsu DL2400



Hat Of The Month Club

J. Guttenberg  
Major Company  
Dear Mr. Guttenberg:  
You'll never guess how I printed this letter. No, it wasn't with a daisywheel printer, or a laser printer.  
Believe it or not, this letter was done with a dot matrix printer.  
Now you, it's an ordinary printer. It's the new Fujitsu DL2400. And I can use it for a lot of things besides letters. I like printing out new designs. Doing my accounting and even making transparencies for presentations.  
I can use the Fujitsu DL2400 to do all my printing. But now, the variable type I ordered came. It'll be great for memorandum files.

Charlie

# Tight Wad.



The next time you travel, bring along a cheap friend, the AT&T Card. It's the most inexpensive way around to make AT&T Long Distance Service calls from a public phone. Cheaper than coins for out-of-state calls. Cheaper than calling collect. The AT&T Card—a tight wad you could learn to love.

**Apply today. Dial 1 800 CALL ATT Ext. 4585**



**AT&T**

The right choice.

## WORKING AT HOME

home, for or against the union argument, for or against federal intervention in that portion of our lives. But the fact remains that there are valid points on both sides. If the legal outcome of this issue favors working at home, some protective provisions will have to be made so that telecommuters will not be exploited. If the outcome favors the union argument, some exceptions will have to be made to allow severely disabled persons (and perhaps other individuals) to support themselves by working at home.

### STATE AND LOCAL REGULATIONS

Many states have laws on their books that relate in one way or another to working at home. Most of these regulations are left over from a pre-electronic era. In fact, a January 1985 report on these state regulations by Electronic Services Unlimited notes, "ESU found *no current state regulations directly prohibiting company employees from working at home as teleworkers* . . . . In fact, five states [Iowa, Virginia, Delaware, Kansas, and Minnesota] have passed resolutions *endorsing* work-at-home, and a sixth, New Jersey, has introduced such a resolution." (See reference 2.) However, there is at least one reported instance of a zoning department using zoning restrictions on operating a business in a residential area to prohibit working at home on a home computer (see reference 3). Farfetched? Maybe, but true.

ESU goes on to say, "If there is any reason to be concerned with [current] state regulations. . . it stems from the possibility that unions, lobbying against telework as a potential modern equivalent of the sweatshop, may attempt on a state-by-state basis to extend the traditional laws to include prohibitions against telecommuting. It is certainly easier to attempt to extend current laws than to try to establish an entirely new set of anti-computer laws." (See reference 2.)

The legal argument is still in its infancy. Some states have dealt with telecommuting on a legislative level, but the question is far from answered. Many of us aren't even sure what the

*Many states have laws that relate to working at home.*

question is. For instance, if you earn your living at home on your computer or on a workstation electronically connected to your employer's computer, we could probably agree that you would be affected by laws related to working at home. However, if you work with computers in an office and use your home computer to connect to a bulletin-board or conferencing system on which you discuss various computer-related subjects, would work-at-home laws apply to you? Most of us would probably say no. However, this question may not be left to us to decide.

**CONCLUSION**

The availability of considerable computing power in home computers has opened the door for new groups of people to enter the work force. Many of these people would have been unable to support themselves in another time. Many of these minds would have gone untapped in an earlier age. Freedoms once embraced are hard to give up, and telecommuters and those who dream of being telecommuters will not relinquish the freedom to work at home easily. Perhaps a compromise will be reached that will allow those who need or wish to work at home to do so while maintaining the worker protections so hard won by the labor movement. ■

**REFERENCES**

1. "AFL/CIO Seeks to Blow Down Electronic Cottage." *The Electronic Cottage News*. South Pasadena, CA: The Association of Electronic Cottagers, September 1985, vol. 1, no. 1, page 4.
2. "State Regulations on Work at Home." *Telecommuting Research Program Memorandum #2*. New York: Electronic Services Unlimited, January 1985, pages i-ii.
3. "Computer Shock! City Calls Home-Work Illegal." *The Chicago Sun-Times*. August 28, 1983, page 2.

# Fast Forward.



When you use your AT&T Card at a public phone, you don't have to hang up after each call. Just hit this button after your first conversation, and dial the number of your next long distance call. The phone automatically remembers your AT&T Card number. So you have more time to take care of business.



**AT&T**

The right choice.

# USING IMAGES TO GENERATE SPEECH

BY BRUCE R. BAKER

*Semantic compaction lets speech-impaired people quickly and effectively communicate in a variety of environments*

Using graphic images to express meaning is a very old idea; the first writing systems of which we have any extensive knowledge were pictorial in origin. Recently, graphic images have been used to represent certain concepts on computer systems. However, these images are not used as hieroglyphics were—that is, linked together to make sense in sequence. For instance, the Egyptian hieroglyph in figure 1 means "scribe" and contains a combined palette, water bowl, and brush holder beside a seated man. The Egyptians selected these images from a "lexicon" of standard symbols and combined them to form a single idea.

Another difference between ancient and modern iconic graphics is that

*Bruce R. Baker is the president of Minspeak Corporation (840 Rolling Rock Rd., Pittsburgh, PA 15234). He invented the concept keyboard. Bruce did his undergraduate and graduate work in classical languages and linguistics and is currently a consulting linguist for Prentke Romich Company and the Westinghouse Electric Corporation.*

modern computer icons have used a unique image to represent each unique meaning while ancient writing systems used one image to represent different ideas in different contexts. For instance, the Maya hieroglyph for "shark" in figure 2 also represented "sea." That same glyph in another place meant "green" (because the Maya thought of the sea as green). Since the image indicated "green," it could also mean "jade" when the context was appropriate.

## **MULTIPLE MEANINGS**

The multiplicity of meanings employed in ancient writing systems should not surprise us. Spoken language has always behaved in this way. No one ever confuses "blue" and "blew" in speech. They sound the same, but their meanings are obvious in context. Using this concept of multiple meanings, early writing systems could express a large number of specific ideas without resorting to thousands of ideographs.

I explored this natural tendency toward polysemy (multiple meanings) while working on improving the com-

munication rate of people with severe neurological damage. More than a million people in the United States alone cannot speak or use handsigns. Strokes, cerebral palsy, and Lou Gehrig's disease are common causes. Many of these people have full minds; they are just physically unable to express themselves. Spelling and abbreviation systems had been set up to help them communicate, but most of the systems were ineffective because the disabled user had to make a dozen or more inputs to output a single sentence. Complicated number and letter codes also existed, but it was often difficult to remember what had been encoded and how it should be retrieved.

Speech-impaired people need a more powerful information-transfer technique. In an effort to meet that need, I developed a concept keyboard that, while it uses a limited number of images, has the capacity to define whole sentences in five or fewer keystrokes through a technique called *semantic compaction*. The system is commercially implemented with a speech-synthesis device to provide

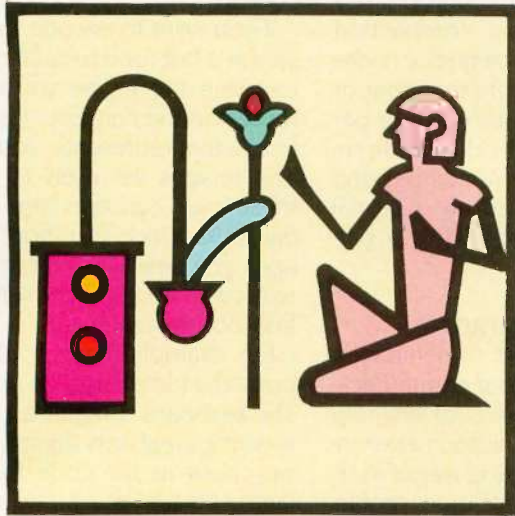

Figure 1:  
An Egyptian hieroglyph  
meaning "scribe."



Figure 2:  
A Maya hieroglyph of multiple meanings  
including "shark," "sea," "green," and "jade."

voice output. (For examples of the technique in use, see the text box "In Practical Application" on page 166.)

The system does not use any particular set of graphics; rather, it provides a method for using graphics in a multiple-meanings setting. Naturally, some types of icons are more appropriate to the technique than others.

While the original work has been applied to the development of a disability aid to facilitate communication for the speech-impaired, the system lends itself to other applications as well. One is a hand-held language translator; another is a smart front end for expert systems and databases.

#### USING SEMANTIC COMPACTION

If you want to set up a semantic-compaction system for a specific use, you should first make a list of those topics or semantic features that you want to be able to express. A semantic feature is a concept underlying the meaning of a word. Sometimes a single word can represent different semantic features. For example, the word "new" can express at least two

semantic features depending upon your intent. If you said, "He has a new car," you could mean either that the car was factory-fresh or that it was recently purchased.

In order to represent natural language for the disability aid, I drew up a list of some 250 semantic features and general topics. With the help of some people who were actually going to use the disability aid, 50 central semantic features and topics were selected to be represented by an illustration of an everyday object or action. For example, we chose to represent the semantic feature "insufficiency" with an umbrella to illustrate "under;" a concept linked to that feature for English speakers. The list was examined for at least five other meanings that could easily be associated with that image without further illustration. Weather was one; need was another; protection, a third; and so on.

When we had represented 50 concepts by various common images taken from daily life, we found that 200 other features and topics were also well represented. It is not difficult

to encode sentences with only 50 images, but it does take a certain frame of mind. You cannot be afraid of puns, and you have to approach the task with a certain eclectic abandon. You write a wide range of sentences that express the routine needs and thoughts of your day-to-day living. This kind of list has hundreds of items but is not as extensive as you might think. You need to be careful to include only those sentences that you would actually need or use in real life and not add those you might use in a purely hypothetical circumstance.

If you are designing a list for (and with) someone who hasn't been taught how to spell, that skill should not be required for them to use the disability aid to communicate. First, you generate a sentence in your mind and then type it, letter by letter, into the communication aid's keyboard, where one of your images has been superimposed on each number and letter. Then you select from one to several images from the keyboard to summarize the sentence (as concisely as possible). After you have en-

(continued)

## USING IMAGES

coded the sentence, you need to strike only the designated code (or sequence) to output the whole sentence.

There is always a trade-off between specificity and fluency. Your group of encoded sentences would probably not contain the sentence "I don't like broccoli and mushroom casseroles," but you would want "I'm sorry, I don't like that." The art of choosing what to encode often lies in minimizing specificity to maximize fluency. Often, you can do this by making sentences applicable to a variety of verbal and physical contexts. "That is not what I meant" is a more widely usable sentence than "That is not what I meant to order." You can use the first sentence to deal with any misunderstanding, while the second sentence applies only to one in a place of business.

A sentence vocabulary of 700 to 1000 entries can go a long way toward enabling a speech-impaired person to

communicate, provided those sentences are quickly and appropriately accessible. Semantic compaction allows this because its sentence codes are very short—no more than four or five images (and therefore keys) per sentence—and its individual code sequences are easy to remember and generate because they are pictorial reminders that are logical to a particular user.

### ENVIRONMENTAL IMPACT

To compose your list of sentences, you need to divide your communication needs into a series of environments. These communication environments provide a practical way of looking at your communication profile. The code or codes you establish to define a communication environment are the initial element or elements in a sentence sequence, and you can use a special power key to lock in the initializing environmental code. Each sentence you initiate while an environ-

ment is locked in is interpreted in that context.

If you want to encode things to be said in a fast-food restaurant, you can combine the image you choose to represent the concept "fast" with an image that represents "food" to you. The images we used to represent these two concepts are shown in figure 3a. Once you input these images, you view all the other images as related to things you might say in a fast-food restaurant.

For example, how would you express the idea "large" in this context? The keyboard contains an illustration showing elephants (figure 3b), which we chose as the code for "Make it large, please." If you were to look across the entire keyboard with all the available images, dozens of sentences would now suggest themselves; in fact, you could incorporate the menu of any restaurant into the semantic map. You can encode "I would like a Coke, please" by adding the icon in

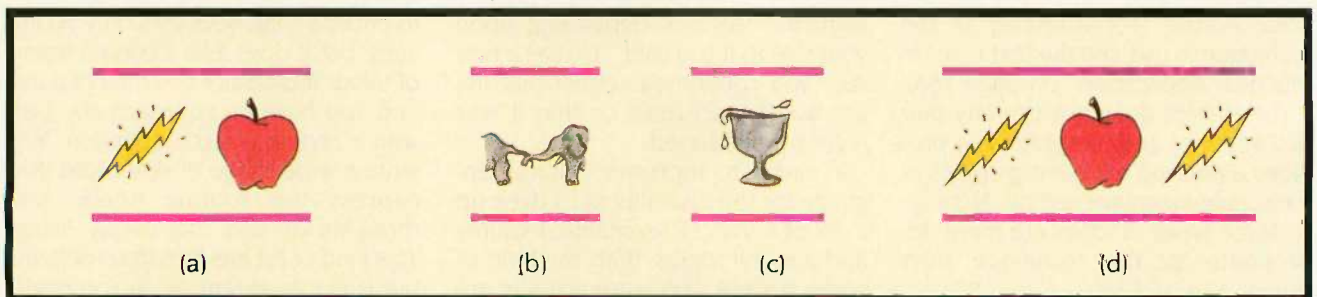

Figure 3: Possible concept codes for a fast-food restaurant: (a) represents one possible environment-code sequence appropriate for that environment, (b) could mean "large," and (c) could be used to order a Coke. The computer sequence shown in (d) could be used to order french fries in a fast-food restaurant; it consists of the environment code followed by a code you might choose for french fries.

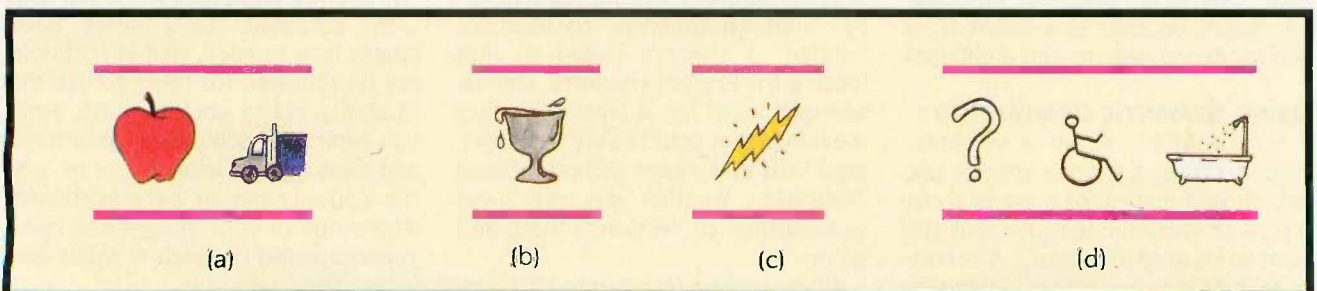

Figure 4: Possible concept codes for a service station: (a) could represent the environment code, while (b) might mean "Fill it up" within that environment, (c) might mean "Please check the battery," and (d) could be used to ask the question, "Is your bathroom wheelchair-accessible?"

USING IMAGES

figure 3c to the initializing environment code (figure 3a).

What would you choose to represent a desire for french fries? To many people, the yellow lightning bolt already used as part of the fast-food environment code also resembles a french fry. Thus, figure 3d forms a sequence that could represent "I would like some french fries."

A service station is another common communication environment. For the environment code, you might choose the apple for food or fuel and the truck for transportation (see figure 4a). Now each symbol on the keyboard relates to something you might say in a service station. What could the cup running over in figure 4b symbolize? "Fill it up" is the choice of many people. The lightning bolt in figure 4c could be used for "Check the battery, please." Just as for the fast-food environment, all the images on the keyboard now relate to the central theme or environment: things to be said in a service station. What might figure 4d mean in this environment? For many users, this sequence means "Is your bathroom wheelchair-accessible?"

You can select as many different communication environments as you wish or need. A college student might want to have a set of sentences describing religious or political views. Figure 5 could be the environmental lock-in code for discussions about scholarship money. The topics, or environments, are limited only by your imagination and, practically speaking, your communication needs.

**AN ASSOCIATION OF ONE**

The technique is an associational one, and no one but you need understand the meaning of the sequence. Different sets of images meet the needs of people of different ages and in various states of cognitive development. You, as the system user, select those codes that are appropriate to you for the sentences that are also appropriate to you. If necessary, a therapist or family member can enter the sentences and codes you choose

(continued)

**TAKE COMMAND of Your Keyboard**

Place your most often used software commands where they belong—at your fingertips—on top of the keys. End fumbling and searching through manuals. Touch-down™ Key Overlays will greatly reduce instructional needs and learning time, reduce operator fatigue and increase productivity.

These Overlays are made of a non-glare rigid plastic material with the same look and feel as the original keytop, precisely die-cut to the exact size of your keytops. Printing is on the underside to prevent the print from ever wearing off. The back is laminated with a strong non-slip adhesive for permanent adherence to the keytop, although they can be removed without permanent damage to the keytops if desired.

Instructions for easy installation are included with the kit.

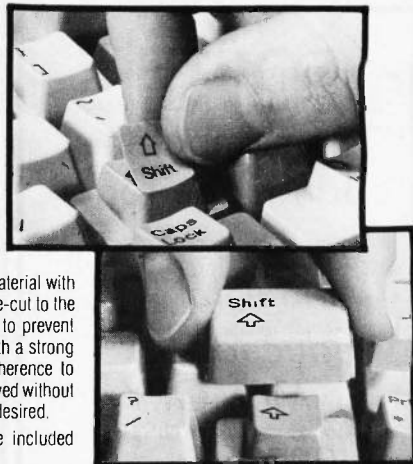

**CUSTOM KEY OVERLAYS** can be made to your exact specs at a much lower cost than engraving.  
**P. O. Box 201, Dept. B, Cornville, AZ 86325 (602) 634-7517**

**KEY OVERLAYS**

Qty.	Price
5250/5251 (48 keytops/ fronts)	\$21.95
5520 (101 keytops)	29.95
3270 (30 key fronts)	18.95
DisplayWrite 2 (36 keytops)	21.95
DisplayWrite 3 (38 keytops)	21.95
Dvorak (43 keytops)	26.95
Wordstar (29 keytops)	26.95
Control Key English (5 keytops)	6.95
Blank Overlays (99 keytops)	21.95
Do-it-yourself Kit (200 + pieces)	29.95

Qty.	Price
MultiMate (44 keytops)	\$29.95
EasyWriter II (22 keytops/ 7 key fronts/Handy Card)	29.95
Lotus 1-2-3 (24 keytops/Handy Card)	29.95
WordPerfect (32 keytops/Handy Card)	29.95
WordPerfect 3.2 (32 keytops/ 10 key fronts/Handy Card)	29.95
WordPerfect 4.0 (24 keytops/ 11 key fronts/Handy Card)	29.95

**KEYTOP EXPANDERS**

Qty.	Price
IBM PC, PC/XT, PC Port (12 keys)	\$21.95
IBM 5291 Display Station (13 keys)	21.95
Compaq, Columbia (10 keys)	21.95
Corona, Eagle Spirit, Cubie, Keytronic (10 keys)	21.95
IBM 3270 PC "Enter" (1 keytop)	3.95
Individual Expanders	2.75

Name \_\_\_\_\_  
 Address \_\_\_\_\_  
 City \_\_\_\_\_ State \_\_\_\_\_ Zip \_\_\_\_\_  
 Visa  MC Exp. Date \_\_\_\_\_ Card # \_\_\_\_\_

Visa or MC orders phone **602 634-7517**

Your satisfaction guaranteed or your money refunded.

TOTAL (Min. order \$10.00) \$ \_\_\_\_\_  
 Prices include first class postage.  
 (Orders shipped within 24 hours.)  
 Arizona residents add 5% tax  
**TOTAL ENCLOSED \$ \_\_\_\_\_**

**Helpful Hints**  
**High speed modems zip big batches of data at low cost.**

If you need to exchange data routinely, you'll save both time and money with a "high speed" modem. Lets you move ahead fast. They save time by transmitting and receiving data as fast as 9600 bps. And a high speed dial-up modem can save your phone bills in half. Since you won't have to wait for slower modems to complete transmission, you'll get more work done in less time than ever before.

You'll improve the effectiveness of your department and increase growth. EasyWriter II handles two or more terminals onto a single line, thus saving you the speed you need to handle the high volume input efficiently. Inmac now offers three high speed modems. Each meets a specific need. The chart below will show you which one is most cost-effective for you.

**Get An Expert's Advice ... First.**

Go straight to the Inmac catalog for helpful hints and advice from our engineers. Also ... for 2,400 computer supplies and accessories. All are prominently displayed and described in depth. All have our exclusive 45-day trial use and minimum 1 year guarantee.



**FREE**  
**1-800-547-5444**

**inmac™** 2465 Augustine Drive  
 Santa Clara, CA 95054  
 Yes... I'd like to get an expert's advice first.

NAME \_\_\_\_\_  
 COMPANY \_\_\_\_\_  
 ADDRESS \_\_\_\_\_  
 CITY \_\_\_\_\_ STATE \_\_\_\_\_ ZIP \_\_\_\_\_  
 PHONE ( ) \_\_\_\_\_

# FORTH

The computer language for increased...

EFFICIENCY reduced.....

MEMORY higher.....

SPEED

Largest selection of FORTH...

Books

Manuals

Source Listings

Software

Development

Systems

Expert Systems

MVP-FORTH Programmer's Kit for IBM, Apple, CP/M, MS DOS, Amiga, Macintosh and others. Includes source, disks, books and manual.

Specify computer.

\$175.

Phone Order Numbers:

800-321-4103

In California:

800-468-4103

Send for your

FREE

FORTH

CATALOG

MOUNTAIN VIEW

PRESS

PO BOX 4656

Mountain View, CA 94040

## USING IMAGES

into the system. Anything that you associate with the pictorial or ideographic aspects of an image is fair game. The code is established as a communication between you and the machine, not between you and someone to whom you wish to speak.

This technique would be purely mnemonic if memory were the only mental facility involved. However, this technique relies on association as well. What you associate with a given image today, you are likely to associate with that image tomorrow. This principle is frequently the basis

of psychological tests. You do not so much remember the sequences of images as you reassociate them.

It is not enough to be able to remember how you encoded a sentence; you have to know that you have such and such a sentence at hand. As your eyes scan the various images on the keyboard, you perceive a gestalt. If you are thinking in terms of fast food, each image serves as a prompt to remind you of what you have stored in that environment. Another gestalt occurs as you scan for the environments you programmed. If you set up "money" and "house" (see figure 6) to mean a bank, your mind is alerted that this environmental code sets up certain sentences.

In the examples shown, the codes themselves have been brief. Owing to the special power key used to lock in the environment code, you can express fairly long and often quite specific sentences with a single key. Polysemy is the generating linchpin of a usable concept keyboard. In this article alone, the lightning bolt has been used to mean fast, french fries, and a car battery. Without polysemy the number of symbols you would need to represent all the ideas and topics about which you would want to communicate becomes too large.

The two salient characteristics of semantic compaction are, first, a limited number of graphic images and, second, very short codes to represent the unique items held in the database. Semantic compaction achieves these economies by using the human mind's ability to understand context, a feat as yet fairly difficult for machine intelligence.

### INDIVIDUAL WORDS

The most efficient way to use semantic compaction is to have it output whole sentences, but you can use the technique to output words as well. Even in this, semantic compaction is more efficient than abbreviation systems that rely on spelling, and it develops better syntax for the developmentally disadvantaged while giving you a real opportunity to com-

(continued)

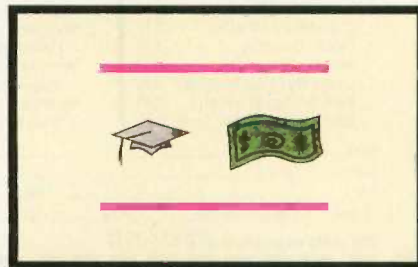

Figure 5: A possible environment sequence for discussions of scholarship money.

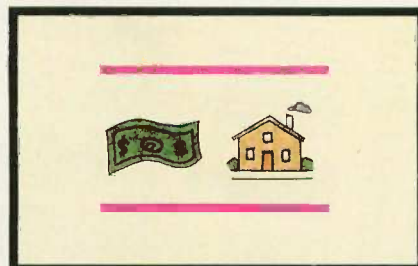

Figure 6: An environment sequence that might represent a bank.



Figure 7: If you use semantic compaction to produce individual words instead of sentences, this image of a telescope might be used to generate the word "look."



# Get the speed and brains of a \$5000 AT for only \$595.

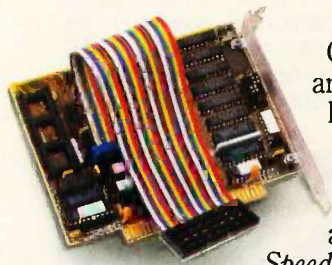

Give your PC the power of an 80286 without paying a huge price for it. And, protect your PC investment at the same time.

Introducing the new and incredible Victor *SpeedPac 286*.™

Available at the introductory price of only \$595, the *SpeedPac 286* is today's newest generation turboboard. The *SpeedPac 286*'s microprocessor is an 8 MHz 80286, a faster version than the AT's 80286. That's right. Even faster than the AT. Which means that it can make your IBM PC, PC/XT and Victor VPC function over 600% faster.

## The Ultimate Productivity Enhancer

The *SpeedPac 286* works with your existing PC software. Your software library is protected. And, the *SpeedPac 286* is an absolute breeze to install. Measuring just 5" in length, it's the only turboboard that fits into a half slot. An impressive advantage since it frees your long slots for other add-on cards.

## 60-Day Money-Back Guarantee

We're so sure you'll love the *SpeedPac 286*, we're offering you a 60-day money-back guarantee. Plus,

IBM PC, PC/XT and PC-AT are registered trademarks of International Business Machines Corporation.

a one-year warranty. Our introductory price of \$595 is good only until March 31, 1986. So, act now. After that, it will be priced at \$795.

For your nearest Victor dealer, or to order please call toll-free:

**1-800-248-5252**

Or simply mail in the coupon.

Victor Technologies Inc., 380 El Pueblo Road, Scotts Valley, CA 95066  
Attn: Order Processing  
I'd like to order the *SpeedPac 286* for my PC, PC/XT or Victor VPC.  
I enclose payment of \$595\* plus \$5.00 shipping and handling. I understand that if I'm dissatisfied at any time within 60 days, you'll refund my money in full. Please call for details about quantity purchases.

Name \_\_\_\_\_

Address \_\_\_\_\_

City \_\_\_\_\_ State \_\_\_\_\_ Zip \_\_\_\_\_

Telephone ( ) \_\_\_\_\_

Method of Payment: Check  Money Order  MasterCard  Visa

Card # \_\_\_\_\_ Exp. Date \_\_\_\_\_

Signature \_\_\_\_\_

\*Add applicable sales tax to the following states: California, Georgia, Illinois, New Jersey, New York and Ohio.

**VICTOR** 

BM

pose your own sentences with word elements that you can readily learn to manipulate.

The system works by assigning a

single word meaning to each symbol on the keyboard. For instance, you might choose to assign the symbol of a telescope shown in figure 7 to the

word "look." To do this, you assign to a key at the top of the keyboard the meaning "Verb" or "Action." The adjoining key bears "Verb+s" or

## IN PRACTICAL APPLICATION

Jenny Lowe is pictured using Minspeak (a commercial product using the semantic-compaction technique) in a device called Light Talker by Prentke Romich (see photo A), which was prescribed by her speech pathologists at the Pioneer School in Pittsburgh. (Prentke Romich has leased the exclusive use of the Minspeak patent protections for the disability industry until 1989.) This device became available in the summer of 1985. It is called Light Talker because its front panel exhibits 128 LEDs (light-emitting diodes), each of which emits a beam of infrared light that is read by the optical wand worn by Ms. Lowe. When the wand is in optical rapport with a specific diode for a user-specific amount of time, the device reads it as a keystroke. The panel can have as many as 128 such keys or as few as 8. You make your key selections either directly or indirectly by scanning if your disability makes it difficult for you to point with your head, hand, or foot. Many people with Lou Gehrig's disease, cerebral palsy, or head injuries can operate only single switches or joysticks with ease and accuracy.

Consequently, you can access the Light Talker with a variety of switch interfaces including the optical headpointer, brow-wrinkle switch, rocking-lever switch, pneumatic switch (sip-puff breath switch), air cushion, joystick, and arm-slot control. The selection of the desired operating mode is simple: You depress the Light Talker's On button for 10 seconds, then a menu of possible operating modes appears, one mode at a time, on the two-line LCD (liquid-crystal display) each time you depress the On button. There are 25 different entry modes possible. Among them are 128- and 32-key row-column scanning, 8-key count scanning, two- and three-switch-entry Morse code, and five-switch directional scanning. Speech pathologists, occupational and

physical therapists, and psychiatric medical doctors can all have input into the appropriate mode and switch selection for an individual. When the optimal mode and switch have been determined—often through trial and error—you can connect the desired specialized switch to the Light Talker through a standard RS-232C interface.

Prentke Romich's Touch Talker (see photo B) is another realization of the Minspeak technique. It is somewhat smaller than the Light Talker, weighs about five pounds, and uses touch to activate 128 membrane switches embedded on the front panel. Specially attached front panels can configure the system with only 32 or as few as 8 touch-sensitive areas. Photo C shows a Touch Talker being used by Tony Miralles, M.S.W., one of United Cerebral

Palsy's professional staff members in Pittsburgh, who has cerebral palsy. In this photograph the Touch Talker interfaces to a printer for use not as a voice communicator but as a means of lowering the number of keystrokes required to write a social history of a client. You can mix grammatically oriented labels with the multimeaning icons to generate texts that require radically fewer key selections per word.

Both devices use Street Electronics' Echo II speech synthesizers and store up to 1526 sentences averaging 25 characters each. They come supplied with a set of 100 symbols that have proved helpful to users in developing their communicative systems in the past. Blank overlays are also furnished, as are instructions and materials for designing your own symbol set.

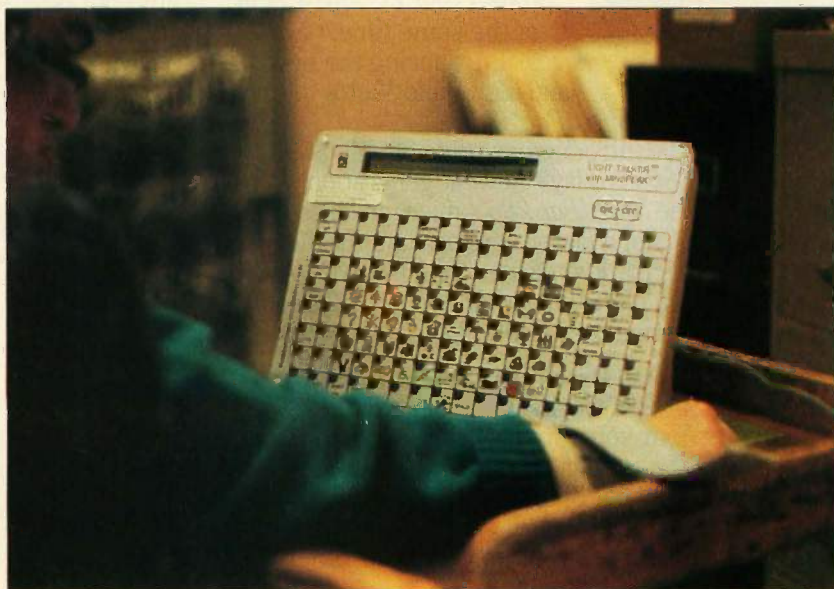

Photo A: Jenny Lowe using the Light Talker keyboard. Note the optical wand Ms. Lowe is wearing and the lighted diode on the keyboard. When light contact has been sustained for a user-definable length of time, the keyboard interprets the contact as a keystroke. (Photo by Robin Schwartzmiller.)

## USING IMAGES

"Action+s." The next key is inscribed with "-ing." The sequence of "Verb" followed by the telescope image outputs "look," while that of "Verb+s"

and the telescope outputs "looks," and the sequence of "-ing" plus the telescope outputs "looking." An ac-  
(continued)



Photo B: The Touch Talker keyboard. Note the keyguard to prevent those with motor-coordination difficulties from activating the wrong key. This device also requires a pressure of 4½ ounces to initiate a keystroke, enabling those who have problems controlling fine movements to select only the key they really want. (Photo by Robin Schwartzmiller.)

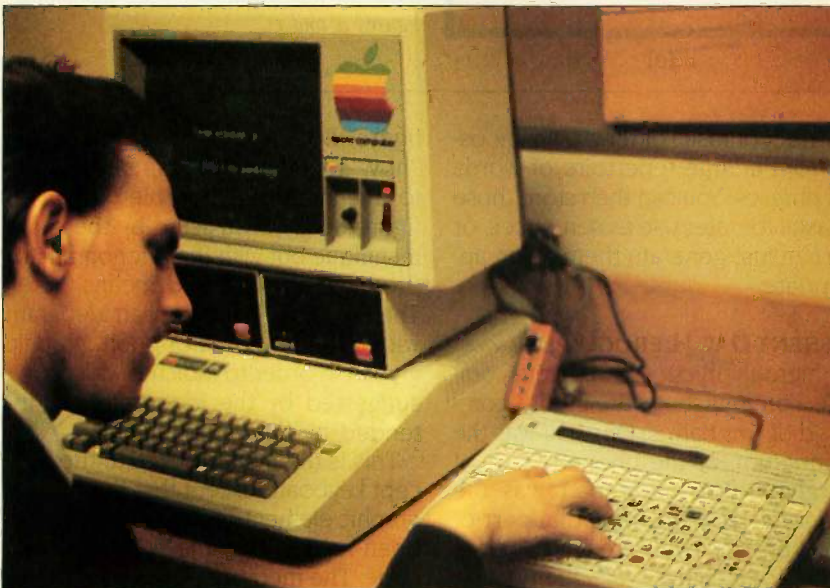

Photo C: Tony Miralles using Touch Talker. In this case the keyboard is not being used to generate speech; it interfaces with the computer to lower the number of keystrokes required to enter information. (Photo by Robin Schwartzmiller.)



## GPIB ↔ PC

### Hardware Flexibility

- Low cost for instrument control
  - 300K bytes per second
  - \$395 complete with software
- High performance data links
  - Maximum speed of GPIB
  - On-board buffering

### Software

- Over \$1,000,000 in software development
- Easy to use, yet handles any GPIB application
- Works with Lotus 1-2-3
- UNIX, DOS and over 12 languages

### Applications Support

- Applications Library with sample programs & TIPS for all major instruments
- Full staff of Applications Engineers dedicated to support your specific needs

### Other IEEE-488 Products

- Interfaces & Software for
  - Multibus VMEbus
  - DEC Q-bus & UNIBUS
  - STD & S-100 bus
- General GPIB Products
  - GPIB Bus Testers
  - GPIB Bus Extenders
  - Stand-Alone Controllers



12109 Technology Boulevard  
Austin, TX 78727  
1.(800) 531-GPIB  
In Texas (800) IEEE-488  
Telex: 756737 NAT INST AUS

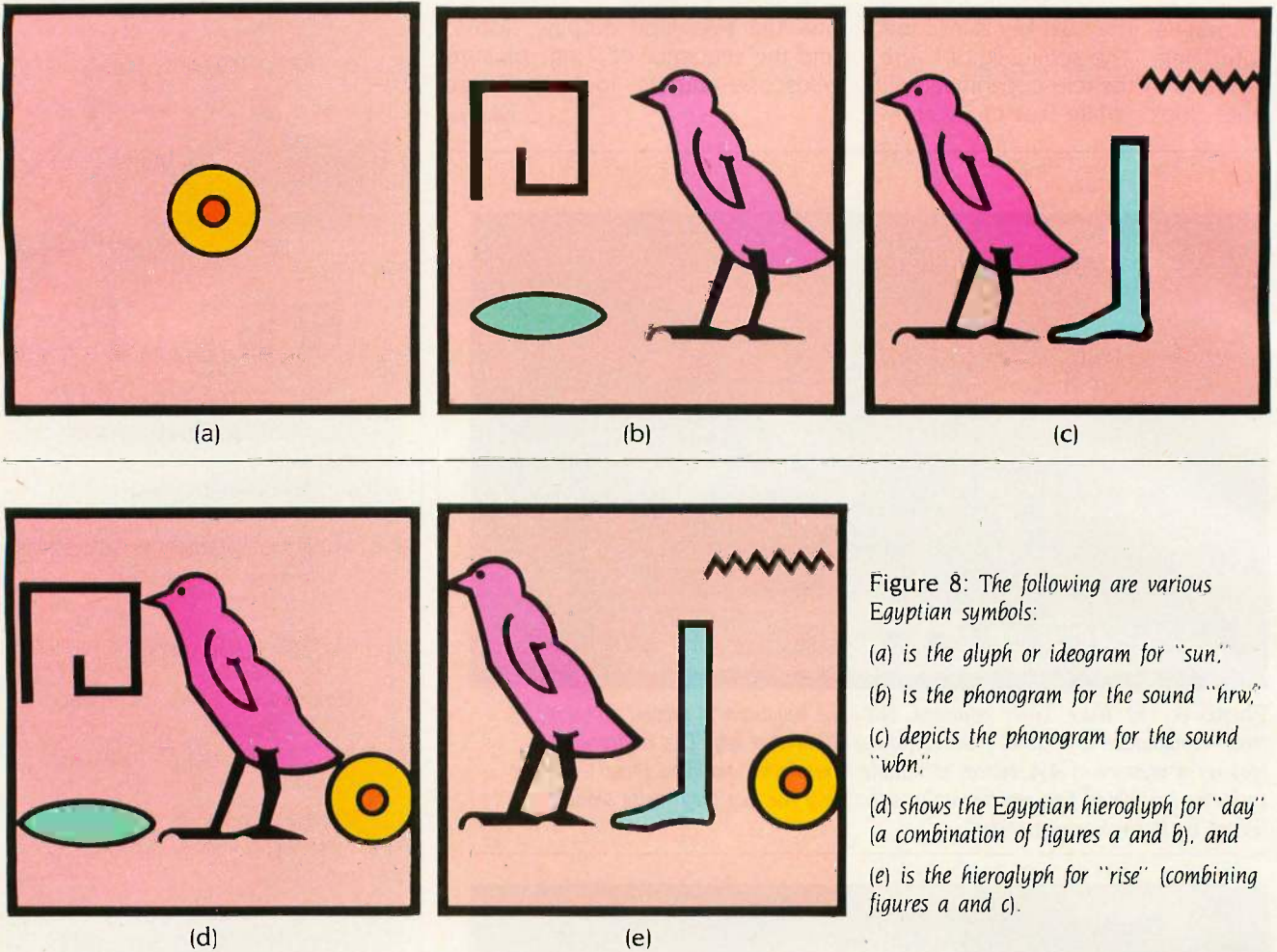

Figure 8: The following are various Egyptian symbols:

- (a) is the glyph or ideogram for "sun."
- (b) is the phonogram for the sound "hrw."
- (c) depicts the phonogram for the sound "wbn."
- (d) shows the Egyptian hieroglyph for "day" (a combination of figures a and b), and
- (e) is the hieroglyph for "rise" (combining figures a and c).

tion word that can readily be associated with each image on a concept keyboard is coordinated with simple grammar keys. This gives you 50 or more action words—in their correct form—at only two strokes per word.

The next step is to assign a key at the top of the keyboard the value "Noun" or "Thing." Another key is labeled "Noun Pl." or "Thing Pl." Then you assign to each image the meaning most appropriate for it. This gives you 50 nouns you can use in sentence composition.

You can repeat the foregoing steps for as many parts of speech as you desire. If you exploit the system to its fullest potential, you can represent many hundreds of words on the keyboard. By this process, even nonreading users can assemble grammatical-

ly correct phrases of their own choosing from a large repertoire of words and phrases. You can then store those phrases for later use as sentences, or you can just generate them when appropriate.

#### PRESENT-DAY HIEROGLYPHS

The hieroglyphics of Egypt were composed of units that were in turn composed of two halves. One half was the phonogram, or the phonetic part of the glyph. The other part was the ideogram, or the conceptual part of the glyph. The two were combined in order to achieve specificity and economy. For instance, the glyph for "sun" in figure 8a suggests various ideas to the mind. Figures 8b and 8c are phonograms that represent the Egyptian sounds "hrw" and "wbn," respectively. Thus, the hieroglyph in

figure 8d combines the Egyptian "hrw" sound with the "sun" ideogram to mean "day." The hieroglyph in figure 8e is constructed by the same technique but with the phonogram for the "wbn" sound and means "rise." The Egyptians combined an ideogram with different sound or phonographic glyphs in order to indicate which idea suggested by the ideogram was intended by the writer.

This is the method used in the concept keyboard except that the phonographic element of the hieroglyph has been replaced by the environmental code. The memory of semiconductor technology allows this. Since the computer remembers the details, we can discard the more exacting and inefficient phonetic components and enter into a totally ideographic man-to-machine interface. ■



# We don't care which computer you own. We'll help you get the most out of it.

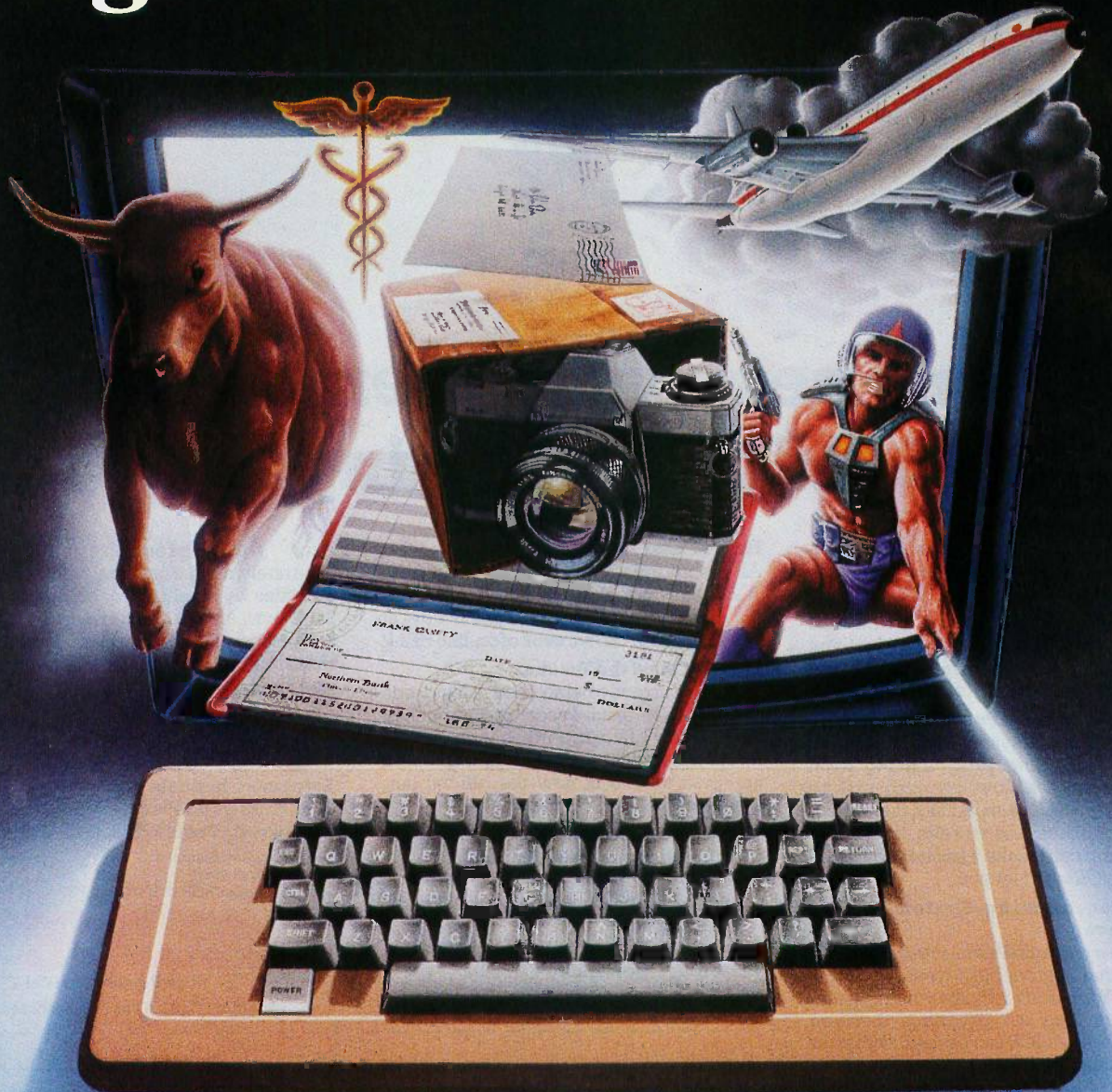

## CompuServe puts a world of information, communications, and entertainment at your fingertips.

CompuServe is the world's largest information service designed for the personal computer user and managed by the communications professionals who provide business information services to over one quarter of the FORTUNE 500 companies.

Subscribers get a wealth of useful, profitable or just plain interesting information like national news wires, home

shopping and banking, travel and sophisticated financial data. Plus electronic mail, national bulletin boards, forums (special interest groups), and a multi-channel CB simulator.

You get games and entertainment, too. Board, parlor, sports, space and educational games. Trivia and the first online TV-style game show played for real prizes.

To buy a CompuServe Subscription Kit,

see your nearest computer dealer. To receive our informative brochure or to order direct call or write:

## CompuServe®

Consumer Information Service, P. O. Box 20212  
5000 Arlington Centre Blvd., Columbus, OH 43220  
**800-848-8199** In Ohio Call 614-457-0802

An H&R Block Company Inquiry 76

# THE ELECTRONIC UNIVERSITY NETWORK

BY DONNA OSGOOD

*Get a degree without ever leaving your computer*

UNTIL RECENTLY, education at home meant correspondence courses. Taking courses through the mail is a slow, cumbersome way to learn, and for many people it means missing out on a vital part of the education experience: contact with a human instructor. Without that, you can easily lose interest in the course and drop out.

Meanwhile, as the baby boom generation passes, colleges faced with declining enrollments are looking for ways to reach a wider range of potential students. They need to reach people who would not ordinarily be willing or able to matriculate in the traditional way.

TeleLearning's Electronic University Network addresses both problems. Through the Network, universities offer accredited courses to students who enroll, participate in "class," interact with instructors and other students, and take tests on the material they have studied, all without leaving their microcomputers. Since classes are small (usually 10 students per instructor) and feedback on each assignment comes within a day or so, students taking courses from colleges

through the Electronic University Network get much more individual attention than they would in a large class on campus. Some of the other benefits of telecommunication apply here as well: An instructor can judge a student only on the basis of his or her work, without interference from preconceived notions and biases based on how the student looks, speaks, or acts.

Founded in 1983, TeleLearning began offering accredited courses in March of 1984. In January 1985 it established full-fledged degree programs, and it now offers two associate degrees, two bachelor's degrees, three MBAs, and specialized professional certificates. The degrees are awarded by fully accredited colleges (Thomas A. Edison State College in Trenton, New Jersey, City University in Bellevue, Washington, and John F. Kennedy University in Orinda, California). The Electronic University itself offers no credit, acting solely as a coordinating medium and resource center for students. About 17,000 students have enrolled.

Courses available through the Elec-

tronic University Network include noncredit courses for personal improvement (writing, computer literacy, drawing, and wine appreciation, for example), business and professional skill classes (time management, accounting, and business math, among others), and tutoring programs for children (reading, math, and computer literacy). Courses for credit span the humanities, natural sciences, mathematics, social sciences, and business at undergraduate and graduate levels.

## HOW IT WORKS

You enter the Electronic University by buying an enrollment package for \$150. This one-time fee covers operating software, communications software, and lifetime enrollment in the Electronic University for your entire family. Tuition for individual classes is handled separately. The admissions questionnaire and class registration

*(continued)*

Donna Osgood is an associate technical editor for BYTE. She can be contacted at McGraw-Hill, 425 Battery St., San Francisco, CA 94111.

# Decade II

the odyssey continues . . .

**APRIL 3-6, 1986  
MOSCONE CENTER  
SAN FRANCISCO**

**Don't miss the best show  
of '86!**

The biggest, most important, most exciting, public computer event on the West Coast will take place at the **11th West Coast Computer Faire**. People who are vitally interested in computers will be there. Join us at the show that makes the difference!

**See thousands** of computer products exhibited by hundreds of leading and innovative companies.

**Touch the future** with hands-on demonstrations.

**Learn from the experts.** The comprehensive conference program attracts industry

speakers and computer users from business, education, government and scientific, engineering and research communities.

**Take advantage** of low cost Professional Development Seminars.

**Get FREE** one-on-one consulting help.

**Save money** with incredible "special show pricing" on all kinds of products.

Produced by



The World's Leading Producers of Computer & Communication Conferences & Expositions

## ELECTRONIC UNIVERSITY

can be completed on line. When you sign up for a class, the University mails you a textbook, study guide, and course disk.

Currently, undergraduate tuition is \$180 per course, while graduate courses are \$200. Connect time is included in course fees.

### **HARDWARE**

TeleLearning software is available for the IBM Personal Computer and PCjr, Apple II series, and Commodore 64. According to Ron Gordon, president of TeleLearning, 35 percent of the Electronic University's students did not own a microcomputer before but bought one in order to take classes. Any student who doesn't already have a modem can buy one from TeleLearning.

### **COUNSELING**

If you choose to pursue a degree program through the Electronic University, you consult one of TeleLearning's counselors. The counseling services go beyond those of a traditional admissions counselor. Counselors help students pick a school suited to their needs and design appropriate curricula, incorporating courses from participating colleges, classes taken on campus, and proficiency exams. The TeleLearning counselor who helps you choose courses or design a degree program also follows through with periodic progress checks and is always available to answer questions and offer guidance. In fact, the counselor will keep tabs on your progress in a particular course ("Have you finished lesson 4 yet?"), but only if you request that sort of hand-holding.

### **TAKING A CLASS**

A typical lesson in a credit course begins when you boot up the course disk and receive an assignment, perhaps chapters in a text to read and workbook sections to complete. After doing this work you go back to the disk to work through the exercises that accompany the lesson. This may include an overview of the sections

*(continued)*

Send in for more information:

Please send me information on attendee preregistration discounts.

Name \_\_\_\_\_

Company \_\_\_\_\_

Street \_\_\_\_\_

City \_\_\_\_\_ State \_\_\_\_\_ Zip \_\_\_\_\_

I would like to  Attend  Exhibit

Send this coupon to:

**The Interface Group, Registration Dept.**

**300 First Avenue, Needham, MA 02194**

You can call us at **(617) 449-6600**





# Multi-User 10 Times Faster Half the Cost of LANs ALLOY'S PC-PLUS

## Here's how to get the job done — faster and cheaper

Alloy's PC-PLUS is the perfect solution for sharing data among users. Faster, easier to install and maintain, and cheaper than LANs. Begin with a PC-SLAVE/16 expansion card containing an 8 MHz microprocessor which operates at over two times the speed of an IBM® PC's processor. PC-SLAVE/16 lets you read or write hard disk data up to 10 times faster than most LANs at half the cost of LANs!

## How PC-PLUS expands your PC's capabilities

Plug a PC-SLAVE/16 into your PC. Add a terminal and Alloy's Network Executive software. You

have the power of TWO PCs! Sharing data, peripherals and printers. Add more PC-SLAVE/16 cards and terminals as you need to grow. And by adding Alloy's PC-XBUS and PC-QICSTOR, up to 31 users can communicate with the PC host and with each other. That's total utilization of your PC's capabilities and your investment in software, hardware and valuable time and data.

## Speaking of investments

Because the workstations you add are inexpensive terminals, the cost of increasing your computing capability is much less with PC-PLUS than with the next best thing. When you consider how much more productive your office would be if you added another PC, choose PC-PLUS instead.

## Alloy — your PC Productivity Company

Alloy brings you more than networking. It brings you a complete family of personal computer expansion products — from software to hard disks. All to make your PC more than a Personal Computer. With PC-PLUS, you get a Productivity Center plus all the benefits of a Personal Computer.

Call (617) 875-6100 today — for more information — or to see PC-PLUS in action.

# ALLOY

Computer Products, Inc.

100 Pennsylvania Avenue, Framingham, Massachusetts 01701. (617) 875-6100, TWX: 710-346-0394  
In Europe: Alloy Computer Products (Europe) Ltd., Cirencester, Gloucestershire, England. Tel: 0285-69571, Tlx: 43340

Inquiry 13 for More Information.  
Inquiry 14 for Sales person or demonstration.

IBM is a registered trademark of International Business Machines®.

MARCH 1986 • BYTE 173

you've just read, with a series of exercises designed to make you think about the lesson in as many ways as possible. Some of the ideas presented in the reading may be covered in more depth at this point.

The lessons are designed to make learning active, to avoid the electronic page turning that has blighted com-

puter-aided instruction (CAI). According to one student, "The lessons are never dull and are not predictable. Just when you think you've got the professor figured out, something changes. That keeps it interesting."

A particular lesson may contain several sections that you complete locally, working through a problem

and finding the answer in the next section. Some sections are to be completed and sent to the instructor. You leave the assignment in the instructor's electronic mailbox. The instructor reads the material and responds within a day or so.

At this point the advantage to the TeleLearning system becomes apparent. The instructor can respond quickly and can customize that response based on knowledge of your ability, interests, and goals. The instructor spends 15 to 30 minutes on each student's lesson, using prepared responses where appropriate but adapting them to each student's needs. It is this human contact, the student's feeling that someone has a personal interest in his or her progress, that distinguishes Electronic University Network courses from correspondence courses or computer-aided instruction.

You can "meet" with the instructor during electronic "office hours" and exchange messages in real time. TeleLearning is presently working to set up bulletin boards where students can exchange messages with other class members and where class "discussion groups" can meet. The goal is to simulate the feeling of community and the interaction that develops naturally when students meet on campus. This can be an important part of the learning process. Perhaps a computer conference is the next best thing to being there.

**TESTS**

If you are enrolled in a degree program, the college involved is responsible for administering the final exam. For students taking individual credit courses, the CLEP (College Level Examination Program) test often serves as the exam. Tests are proctored, administered at a college or library close to the student.

**THE LIBRARY**

The Electronic University has, of course, an electronic library. Students have access to extensive on-line database facilities, including abstract ser-

(continued)

**Why your next generation of products should use our 5th generation tools.**

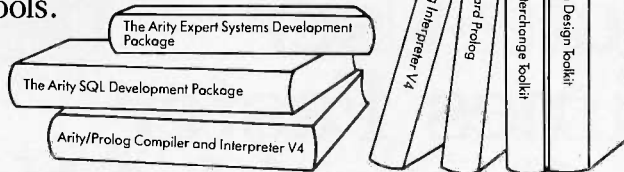

Arity's integrated family of programming tools allows you to combine software written in Arity/Prolog, the best of the fifth generation languages, with Arity SQL, the best of the fourth generation languages, and with conventional third generation languages such as C or assembly language to build your smarter application.

You can use Arity/Prolog to build expert systems using the Arity Expert Systems Development Package. Or to build natural language frontends. Or to build intelligent information management systems. Arity/Prolog lets you build advanced technology into your vertical applications package.

**And more...**

That's not the whole story. Arity's products are all designed to be fast, powerful, serious. Each of our products contains unexpected bonuses. Such as a one gigabyte virtual database integrated into Arity/Prolog. The most powerful of its kind on a PC.

**Quality first. Then price.**

In order to be the best, we had to prove it to our customers. Our tradition of quality software design is reflected in every product we sell. Quality first. Then price. And we always provide the best in customer support.

Our products are not copy protected. We do not charge royalties. We offer generous educational and quantity discounts. And we have a 30 day money back guarantee.

Try us to know that we keep our promise on commitment to quality and reliability. Try us by using our electronic bulletin board at 617-369-5622 or call us by telephone—you can reach us at 617-371-2422.

Or fill in this coupon. Whether you order today or not, let us send you full descriptions of our integrated family of Arity products.



We design and distribute high quality, serious application software for the IBM PC, XT, AT and all MS-DOS compatibles.

Please complete this form to place your order and/or request detailed information.		Quantity	Info only
Arity/Prolog Compiler and Interpreter V4 .....	\$795.00	_____	_____
Arity/Prolog Interpreter V4 .....	\$350.00	_____	_____
Arity Standard Prolog .....	\$ 95.00	_____	_____
Arity SQL Development Package .....	\$295.00	_____	_____
Arity Expert System Development Package .....	\$295.00	_____	_____
Arity Screen Design Toolkit .....	\$ 49.95	_____	_____
Arity File Interchange Toolkit .....	\$ 49.95	_____	_____
TOTAL AMOUNT (MA residents add 5% sales tax) (These prices include shipping to all U.S. cities)	\$ _____	_____	_____

NAME \_\_\_\_\_  
 SHIPPING ADDRESS \_\_\_\_\_  
 CITY/STATE/ZIP \_\_\_\_\_  
 TELEPHONE \_\_\_\_\_  
 Payment:  Check  PO  AMEX  VISA  MC  
 Card # \_\_\_\_\_ Exp. date \_\_\_\_\_  
 Signature \_\_\_\_\_

ARITY CORPORATION • 358 BAKER AVENUE • CONCORD, MA 01742



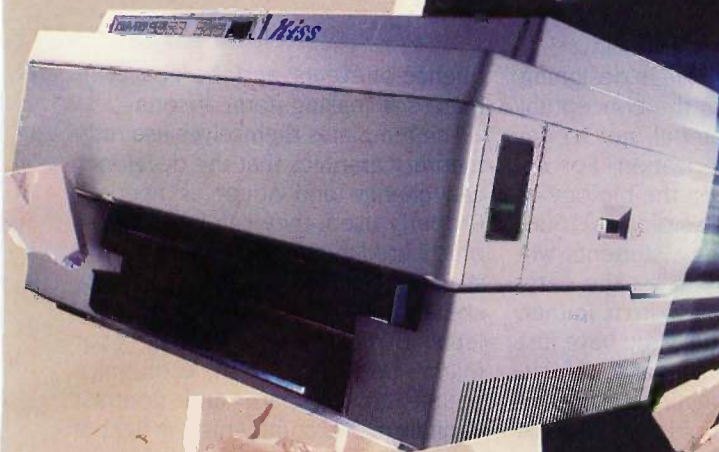

## Now There's A Laser Printer That Blasts Through The Price Barrier.

QMS introduces the KISS.™ The first laser printer at the never-before-heard-of price of \$1,995.\* KISS keeps it smart and simple. It's the perfect mate to any PC.

It's so sophisticated, you'll want to kiss your old daisywheel and dot matrix printers good-bye. KISS is ten times faster. And it's very quiet. It produces crisp, near typeset-quality output at up to 400 characters per second. And it has its own cut-sheet feeder.

With nine resident fonts, you get quality, style and flair. Mix them all on a page—even on one line. Imagine all that power on your desk.

Plus, KISS is smarter than your old printer. It works with WordStar®, Lotus®, and any other software that will print to a Diablo 630®, Epson FX 80® and QUME Sprint®. At up to 6ppm, KISS is unmatched in efficiency and versatility.

Can you imagine your present printer performing like that? We can't.

QMS is meeting today's needs with proven technology. Like the KISS. It's inexpensive. Dependable. Exciting.

Let us give you a KISS.

Call toll free, 1-800-523-2696 for more information.

**QMS**®

Print Systems With Imagination.™

- Send me more information about the KISS.  
 Please contact me to arrange a demonstration.

Name \_\_\_\_\_

Title \_\_\_\_\_

Company \_\_\_\_\_

Address \_\_\_\_\_

City \_\_\_\_\_ State/Zip \_\_\_\_\_

Phone ( ) \_\_\_\_\_

Type of system you are now using \_\_\_\_\_

Number of print workstations you are considering \_\_\_\_\_

Prime application for printer \_\_\_\_\_

WordStar is a registered trademark of Micropro International. Lotus is a registered trademark of Lotus Development Corporation. Diablo is a registered trademark of Xerox Corp. Epson is a registered trademark of Epson America, Inc. QUME is a registered trademark of QUME Corp.

\* This price good in domestic United States only.  
Inquiry 287

P.O. Box 81250. Mobile, AL 36689  
©1986 QMS® Inc.

BY 3/86

## *Participating colleges handle course design, consulting with TeleLearning to translate courses to the new medium.*

vices, an encyclopedia, and databases for business, education, science, medicine, social science, and humanities. News services, stock market reports, and the *Official Airline Guide* are also available. Students who use the library pay a communication fee ranging from about \$10 to \$20 an hour (nonbusiness hours).

### **COURSE DESIGN**

In general, the participating colleges handle course design, consulting with TeleLearning staff and using tools provided by TeleLearning to translate their courses to the new medium. The college can choose its top professor in a field to design a course, then recruit graduate students and associate professors to serve as instructors. Instructors are interviewed and monitored by TeleLearning staff and must have graduate degrees and classroom teaching experience.

Dr. Philip Zimbardo is one of the "master teachers" designing a course for the Electronic University. His Psychology 001, the best-attended class offered at Stanford, draws hundreds of students to the lecture hall. Zimbardo sees the TeleLearning course reaching a new audience, a more diverse group of people than he would find within the confines of a traditional university setting, including many of his favorite sort of student: adults who are not in class for a grade, who simply want to learn what he has to teach and who get excited about the ideas he presents.

Zimbardo believes that students in large lecture sections "develop pas-

sive learning habits." He is designing his lessons to stress the conceptual meaning of the material, not to encourage rote memorization. For example, in a section on the biology of behavior and the physiological foundations of psychology, students will not be asked simply to list the parts of the human nervous system. Rather, the problem might be: "You have just been hired as a consultant to a high-tech firm that is designing a perfectly programmed humanoid. On the basis of what you now know, you are to design its nervous system. What aspects of the human nervous system would you include, what would you improve, and what kinds of modifications would you make?"

Early, noncredit TeleLearning courses were based on standard CAI and drill-and-practice models. Dr. James Milojkovic, vice president of Educational Research and Development, explains that this sort of electronic page turning is not appropriate for college-level courses, which should put an emphasis on critical thinking and higher-order cognitive processes. "We went back to square one, thinking from an educational rather than a technical point of view," Milojkovic says. "We asked, 'What does a master teacher do?' We looked at the best teachers and the best textbooks to extract the educational principles involved, then we built the technology around that."

Since the people best qualified to develop courses often have no expertise with computers, TeleLearning provides developers with "knowledge templates," predesigned generic structures that they can adapt to each course. Dozens of knowledge templates are available to course developers, and using them can cut the time it takes to create a set of lessons.

Some examples of template structures are the tree-diagram template, which can illustrate any sort of hierarchical structure; a matrix template with which the student can organize material, compare items using appropriate criteria, or visualize relationships among a set of elements; the timeline template, to illustrate any se-

quence of events; and the T-bar template, for making comparisons.

The templates themselves use rudimentary graphics that the developer can change and adapt as needed. Properly used, they can become sophisticated heuristic tools if the instructor fleshes out the template skeleton with thought-provoking problems. For example, the basic T-bar might be used in an economics course to compare and contrast capitalism and communism in light of issues brought up in the lesson.

In TeleLearning courses, the computer is used only when it is most effective, for interactive study and telecommunication. Milojkovic says, "We don't make the fatal mistake of trying to put everything onto the computer. 'A textbook is a perfectly good, portable, random-access information display device, and there's no advantage to dumping the entire textbook and study guide on the computer.'"

### **ELECTRONIC UNIVERSITY'S FUTURE**

One of TeleLearning's goals right now is to make the student's experience in the Electronic University as rich as possible in terms of human interaction. A real sense of community can develop around people who know each other only electronically. TeleLearning hopes to give as much of an on-campus feeling as possible to the Electronic University.

Other plans include an emphasis on work-related courses in the office. Some companies are already offering tuition and fee reimbursements to employees who take Electronic University courses, and some even provide a workstation in the office.

The Electronic University offers new options to the student who prefers to study at home in a nonthreatening but highly personalized medium. "Many people talk about lifelong learning," says Milojkovic. "We're making it real." ■

*Editor's note: To reach TeleLearning, write to 505 Beach St., San Francisco, CA 94133, or call (800) 22LEARN; in California, call (800) 44LEARN or (415) 928-2800.*

# Compatibility without Compromise!!

Big Savings

Reliable Support

Full Documentation



## STANDARD BRAND PRODUCTS

## PC/XT

- Intel 8088-3 (4.77 MHz)
- Half-Height Floppy Disk Drive
- 640K Ram
- 135 Watt Power Supply
- 8 Total Slots
- Keyboard



# \$649

*Includes 1 Year Warranty!*

Don't Compromise Your Price Savings With Poor Quality Or Incomplete Documentation. We Offer IBM® Compatibility At A Reduced Price In A Complete Package.

- ✓ Non-Infringing BIOS Copyright
- ✓ Extended Burn-In Testing
- ✓ 100 Page Illustrated Users Guide

*"Runs All Major Software Written For The IBM® PC & XT"*

# PC SOURCE

12303-G Technology  
Austin, TX. 78727

Call Toll Free 1-800-626-4027  
Within Texas 512-331-6700

# Setting The Import Standard

**Our Factory-Direct Volume Buying Saves You Money...Quality Assured With Our STANDARD 2 Year Warranty**

**STANDARD**  
BRAND PRODUCTS

Enhancement Products For  
The IBM PC Market.

## STANDARD MFC w/384K

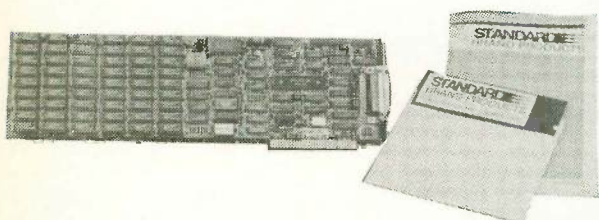

- 384K Ram
- Clock/Calendar
- Serial Port
- Parallel Port
- Game Port
- Software

**\$129**

## Memory

64K .....	\$10
256K .....	\$29
<b>intel</b> Math Co-Processor	
8087 .....	\$119
80287 .....	\$219

**Standard Monographic Card**  
Hercules Compatible Monochrome  
Graphics Card With Parallel Port

**\$119**

**Standard I/O Card**  
Includes Serial Port, Parallel  
Port and Clock Calendar

**\$89**

**Standard AT-MFC**  
Multifunction Memory  
Expansion for IBM AT w/384K

**\$189**

## FDC



Controls Up to 4 Floppy  
Disk. Includes Internal Cables.

**\$49**

## 5151 Keyboard



**\$99**

## MonoCard

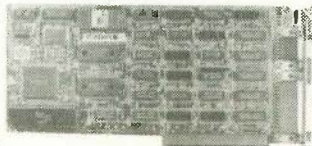

Monochrome Display Card  
w/Parallel Port

**\$99**

## 150 Watt

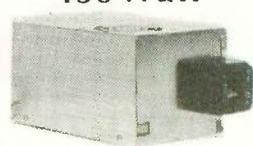

Replacement Power Supply

**\$85**

## Brand Name Products At Bargain Prices...



Smartmodems

1200(external) .....	<b>\$389</b>
1200B (internal, w/Smartcom II) .....	<b>\$359</b>

## AST SixPakPlus

w/384K



- Serial Port
- Parallel Port
- Clock / Calendar
- Memory Expansion
- Sidekick Software
- 2 Year Warranty

**\$249**



**HEWLETT  
PACKARD**  
Plotters

7475 Six Pen Size A&B	<b>\$1395</b>
7440 ColorPor 8 Pen, Size A	<b>\$999</b>

No Charge For UPS Ground  
Shipping. No Surcharge For  
MasterCard or VISA. Fortune 1000  
Purchase Order Welcome. All  
Warranty Work Must Have A  
Return Authorization Number.  
IBM Hercules is a registered trade mark of  
Hercules Computer Technology, Inc.

**PC  
SOURCE**

12303-G Technology Austin, TX. 78727

Outside Texas  
**800-626-4027**

Inside Texas  
**512-331-6700**

# THE TECHNOLOGY OF THE KURZWEIL VOICE WRITER

BY RAYMOND KURZWEIL

*The present office system provides a clue  
to future applications for the deaf*

*Editor's note: This article is not a review of the KVV; it is a look at a technology that may be available on personal computers in the future.*

THE KURZWEIL VOICE WRITER (KVV) is a voice-activated word processor with a relatively unrestricted user-specific vocabulary. The system starts with a vocabulary of at least 5000 frequently used words in the English language. It subsequently adds the words you use that are not part of its initial vocabulary and eventually deletes those words that you never use. Total vocabulary, depending on the KVM model, will be in the 7500- to 20,000-word range.

Voice is our most effective and rapid means of communication, and the ability to interact with computerized information services and devices by voice, without the restrictions of artificial vocabularies or syntax, is expected to be of major benefit. The primary application of the KVV is to automate the creation of written text, which is a fundamental activity in the office. Combining large-vocabulary ASR (automatic speech recognition)

with natural-language understanding would also enable professionals and executives to make inquiries of database-management systems or management information systems verbally in natural language instead of through a keyboard.

One planned application of this technology is to create a speaker-independent version of the KVV to serve as a display telephone for the deaf. This would enable a deaf person to hold a phone conversation without being restricted to speaking to other deaf people who have compatible TDDs (telecommunications device for the deaf). It is not yet available but the technology that will be used in its creation is described in essence in this article.

The KVV as it currently exists requires only that you can speak and that you can see. Motion and hearing impairments are not obstacles in its operation. The current version of the KVV is for the business community, but it fills a need for many disabled persons as well. The initial KVM model, which can be shared by multiple users (one at a time) is expected

to be introduced this year at a price under \$20,000. Future models of both single-user and multiuser systems are expected to be in the \$4000 to \$10,000 range. While this is beyond the price range of most individuals, the technology is the clue to future, more individually affordable solutions.

## **LARGE-VOCABULARY ASR**

There are two difficulties involved in creating large-vocabulary ASR. First, you must create a set of linguistic and speech-recognition algorithms that provide the requisite recognition power and that are capable of resolving the fine distinctions and ambiguities that are inevitable when you deal with a large natural vocabulary. The incidence of "perplex clusters" (words that differ by only one phonetic feature) is much higher for

*(continued)*

*Raymond Kurzweil is the founder and chairman of Kurzweil Computer Products, Kurzweil Music Systems Inc., and Kurzweil Applied Intelligence Inc. He received a B.S. degree from MIT and an honorary Ph.D. from Hofstra University. He can be reached at 411 Waverly Oaks Rd., Waltham, MA 02154.*

# Switches to make your PCs powerful.

Reliable and affordable port expansion without memorizing complicated software commands. Switch your PC between peripherals with the push of a button. Is MFJ good? Joe Campbell in his book, *The RS-232 Solution* said, "Switch boxes are sold by many suppliers, but by far the two best values are from MFJ Enterprises." Below are just some of those values.

When you need to switch between two peripherals ... or you need to have two computers share the same peripheral... MFJ-1240/\$79.95

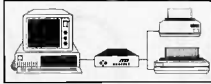

The 1240 has a built-in transmit/receive switch that allows 2-way information flow. LEDs monitor data lines while built-in surge protectors guard them. Can be used as a null modem. MFJ's No. 1 seller!



When you need 1-to-4 computers to share one peripheral or 1-to-4 peripherals to share a common computer... MFJ-1243/\$119.95

The perfect office switch. Save money. Don't buy extra printers or modems.

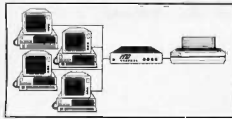

Connect 1-to-4 computers to a single printer or let a PC share up to four peripherals. LEDs monitor data lines; surge protectors guard them. Two way communication is allowed.



When you need to interconnect four computers and four peripherals at one time! The MFJ-1294 gives you a computer system...

With the MFJ-1294 you can create a mini-network of computers and peripherals. All eight devices can be working simultaneously! Think of the production you'll get with the MFJ-1294's 16 possible combinations.

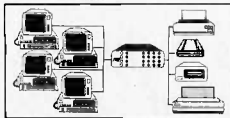

Seven additional models to choose from including MFJ's IBM and Centronics Parallel Switches. All RS-232 switches have RS-232 connectors, LEDs to monitor data lines, MOV surge protectors and transmit/receive buttons that allow 2-way communication.

# And Power Strips to make them safe.

Your fine computer and peripheral equipment can be damaged by electrical surges much smaller than you've been led to believe. Save them and your valuable data with an MFJ Power Center. Multi-filters isolate equipment, eliminating noise/hash/inter-  
action. MOVs suppress spikes and surges. These are heavy-duty, commercial quality Power Strips.

MFJ-1107 - 8 sockets, 2 unswitched. \$79.95

MFJ-1108 - 7 sockets, 1 unswitched. Drop-out relay prevents disk drive head from bouncing. \$99.95

MFJ-1109 - like 1107 but intelligent (switch on the device that's plugged into the control socket and everything else comes on). \$129.95

There are other Switches, Power Centers and Computer Peripheral Products available from MFJ. Call and talk with us about all your computing needs. When you do, ask for our latest catalog. Both the call and catalog are free.

1-800-647-1800

For technical/repair information, or in Mississippi or outside the Continental United States, please telephone...

1-(601) 323-5869 or telex 53-4590 MFJSTKV

All MFJ products come with a double guarantee we think is unmatched. Order from MFJ and try any product for 30 days. If it doesn't satisfy your needs, just return it for a full refund less shipping. If you keep it you can be assured of continued service and our One Year Unconditional Guarantee.

Call toll-free 1-800-647-1800 and charge the products you need to your VISA or MasterCard, or send a check or money order, plus \$5.00 shipping, and our shipping department will promptly have your computer peripheral on its way to you.



MFJ Enterprises, Inc.  
921 Louisville Road  
Starkville, MS 39759

## VOICE WRITER

a natural vocabulary than for an artificially created command vocabulary. Indeed, many words do not differ in sound at all (homonyms), but can be differentiated only by context. For example, if you want to recognize "To be or not to be, that is the question," you must deal with the first six words, each of which represents a perplex homonym set: (to, too, two, 2); (be, bee, b); (or, oar); (not, knot); (to, too, two, 2); (be, bee, b). Of the 576 possible phrases, all are acoustically correct, but only one is linguistically correct.

Second, you must provide the necessary computing power. Running the algorithms for the KVV on a sequential computer of Motorola 68000 power requires over an hour per word. One reason that the algorithms require this amount of computation is to provide the very high degree of precision needed to deal with the perplexity of a large natural vocabulary. Significant computation is also required to perform the transformations and property-extraction algorithms required to deal with the numerous sources of speech variance that such a system is subject to. Parallel processing provides the speed improvement of several thousandfold necessary to achieve a real-time response time of 250 milliseconds.

The KVV architecture incorporates multiple microprocessors and uses dedicated implementations of specific algorithms in custom VLSI (very-large-scale integration) and discrete circuits. This significantly increases the effective computation throughput levels. A current industry trend finds parallel arrays of dedicated implementations of algorithms in custom VLSI replacing the conventional architecture of a single programmable processor with its one memory space, software, and appropriate peripherals.

### VOCABULARY

One type of information that adapts as you use the KVV is the active vocabulary. The system starts out with a vocabulary of at least 5000 common words in the English language. The first time you use a particular

word that is not in this starting vocabulary, the system won't be able to recognize it, and you will have to either type it in or verbally spell it in. This process is required only the first time you use a new word; the system will add the word to the active vocabulary and should subsequently be able to recognize it when you use it again.

Words continue to be added until the vocabulary reaches its maximum size, which will vary depending on the model. (The vocabulary size required will vary from user to user. It is expected that user-specific vocabularies in the 7500- to 20,000-word range will ultimately be provided.) After this, new words continue to be added, but the system must drop words from the original set that you have never used. The final result is a vocabulary that should cover the vast majority of words that you use.

### MULTIPLE EXPERTS

Rather than select a single technique such as Markov modeling, dynamic time warping, robust feature analysis, or high-level feature extraction, the KVV technology incorporates multiple experts, each of which uses a somewhat different approach to the problem of large-vocabulary speech recognition. Different approaches to a complex pattern-recognition task such as ASR have different strengths and weaknesses, and a system that incorporates a variety of techniques is likely to provide better performance than a system that relies on a single method.

Some of the experts run in real time on conventional 68000 microprocessors, while others require specialized parallel circuitry to provide real-time performance. In this specialized circuitry, 68000 microprocessors provide function control and sequencing, while the circuitry acts like peripherals to them. The resulting architecture consists of multiple 68000s, each with its own RAM (random-access read/write memory) space, plus specialized circuitry incorporating additional RAM spaces.

(continued)



# MICRO CAP and MICRO LOGIC put your engineers on line... not in line.



## MY OWN WORKSTATION

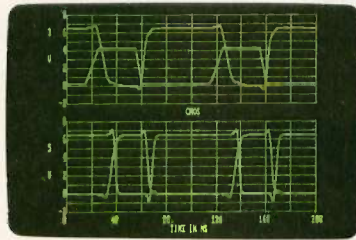

"Typical MICROCAP Transient Analysis"

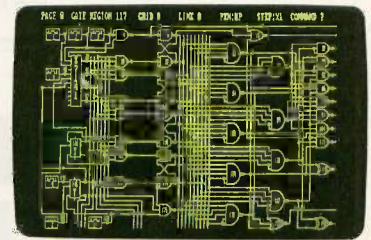

"Typical MICROLOGIC Diagram"

How many long unproductive hours have you spent "in line" for your simulation? Well, no more. MICROCAP and MICROLOGIC can put you on line by turning your PC into a productive and cost-effective engineering workstation.

Both of these sophisticated engineering tools provide you with quick and efficient solutions to your simulation problems. And here's how.

## MICROCAP: Your Analog Solution

MICROCAP is an interactive analog circuit drawing and simulation system. It allows you to sketch a circuit diagram right on the CRT screen, then run an AC, DC, or Transient analysis. While providing you with libraries for defined models of bipolar and MOS devices, Opamps, transformers, diodes, and much more, MICROCAP also includes features not even found in SPICE.

MICROCAP II lets you be even more productive. As an advanced version, it employs sparse matrix techniques for faster simulation speed and larger net-

works. In addition, you get even more advanced device models, worst case capabilities, temperature stepping, Fourier analysis, and macro capability.

## MICROLOGIC: Your Digital Solution

MICROLOGIC provides you with a similar interactive drawing and analysis environment for digital work. Using standard PC hardware, you can create logic diagrams of up to 9 pages with each containing up to 200 gates. The system automatically creates the netlist required for a timing simulation and will handle networks of up to 1800 gates. It provides you with libraries for 36 user-defined basic gate types, 36 data channels of 256 bits each, 10 user-defined clock waveforms, and up to 50 macros in each network. MICROLOGIC produces high-resolution timing diagrams showing selected waveforms and associated delays, glitches, and spikes—just like the real thing.

## Reviewers Love These Solutions

Regarding MICROCAP... "A highly recommended analog design program" (PC Tech Journal 3/84). "A valuable tool for circuit designers" (Personal Software Magazine 11/83).

Regarding MICROLOGIC... "An efficient design system that does what it is supposed to do at a reasonable price" (Byte 4/84).

MICROCAP and MICROLOGIC are available for the Apple II (64k), IBM PC (128k), and HP-150 computers and priced at \$475 and \$450 respectively. Demo versions are available for \$75.

MICROCAP II is available for the Macintosh, IBM PC (256k), and HP-150 systems and is priced at \$895. Demo versions are available for \$100.

Demo prices are credited to the purchase price of the actual system.

Now, to get on line, call or write today!

## Spectrum Software

1021 S. Wolfe Road, Dept. B  
Sunnyvale, CA 94087  
(408) 738-4387

Inquiry 325

# DS-RJ11/45...

**NEW!**



**\$42.00\***  
ea.

**A Telephone Type Connector Serial Data Switch for Increasing Computer System Productivity.**

No computer system should be without a Via West Data Switch. At the touch of a button (or key), you can connect your computer to the peripheral device you want to use.

Over 16 types are available to fit either serial or parallel systems. This includes

both AB and X-type switches designed to fit and work with all types of computer systems. Now you can put an end to recabling, once and for all. See your local computer dealer or call today for a factory-direct shipment.

**DS-RJ11/45 DATA SWITCH**

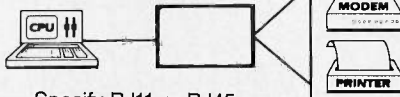

Specify RJ11 or RJ45

534 North Stone Ave.  
Tucson, Arizona 85705  
602-623-5716

**VIA WEST**  
"The Interface Company"

\*Add \$4 per product for shipping. Quantity discounts available. Visa, MasterCard & COD orders accepted. AZ residents add 7%. Contention Adapters, Port Contenders, Serial to Parallel and RS232 to RS422 devices available. Money Back Guarantee.

## VOICE WRITER

To take maximum advantage of a multiple-expert strategy, you must combine the results from each expert in a way that recognizes its unique strengths and weaknesses. In general, the system can quickly and accurately resolve each recognition within a small perplex set of words. After this initial cut of the vocabulary to a small set (ranging from one word to a few dozen), the expert-management techniques depend to a great extent on the nature of the resulting perplex set. Some of the expert-management techniques are knowledge-based. For example, the handling of homonym sets is done through a single expert that is capable of differentiating between homonyms based on context. Other techniques involve probability: the methods of combining the probabilities from each expert are controlled by statistics on how the various experts have performed for different types of perplex sets. Some of these parameters are derived from statistics gathered during a particular user's time on the system and thus form part of the overall user-adaptation process.

### LANGUAGE EXPERTS

A number of experts try to predict the likelihood of different words occurring at a particular lexical entry point based entirely on context. These experts use a variety of information-theory as well as sentence-parsing techniques.

The sentence-parsing expert is similar to the type of parser used in some natural-language understanding programs in that a tree-like structure is generated showing the part of speech of each word and its relationship to other words in the sentence. One significant difference is that the KVV parser is able to generate parses on incomplete sentences. At a particular point in a dictated sentence, we have only the "left" part of the sentence (from the beginning up through and not including the current word). Based on each parse of the incomplete sentences as they come in, the parsing expert is able to assign probabilities to different parts of

(continued)

# OUR PLUG-IN CARD GIVES YOU PLUG-IN CONTROL.

**PC 488** allows your IBM PC/XT/AT or compatible to control IEEE-488 instruments.

With **PC 488**, you can:

- Plug-in to BASIC, C, FORTRAN, or Turbo Pascal™
- Emulate hp controllers,
- Use Tek Standard Codes and Formats,
- Run IBM's IEEE-488 software, and much more.

Just \$395 for the complete hardware and software interface.



Capital Equipment Corporation  
10 Evergreen Avenue  
Burlington, MA 01803  
Call today (617) 273-1818

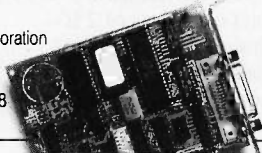

Turbo Pascal is a trademark of Borland International

You would think when IBM needs EPROM Programmers they would choose the best and the most expensive. They don't. They only choose the best. GTEK.

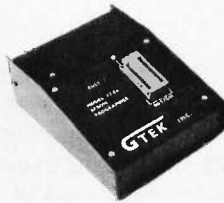

MODEL 7956 (w/RS-232 option) . . . . \$1099  
 MODEL 7956 (stand alone) . . . . . \$ 979

GTEK's outstanding Gang Programmer with intelligent algorithm can copy 8 EPROMS at a time! Use the 7956 in a production environment when you need to program a large number of chips. Programs all popular chips through the 27512 EPROMS; supports CMOS EPROMS through the 27C256; supports EEPROMS through the X2864A; supports Intel's 2764A & 27128A chips. The 7956 will also program single chip processors.

MODEL 7228 . . . . . \$ 599

GTEK's 7228 has all the features of the 7128, plus Intelligent Programming Algorithms! It supports the newest devices available through 512K bits. The 7228 programs 6 times as fast as standard algorithms. It programs the 2764 in one minute! Supports CMOS EPROMS through the 27C256; supports EEPROMS through the X2864A; supports Intel's 2764A & 27128A chips. Supports Tektronics, Intel, Motorola and other formats.

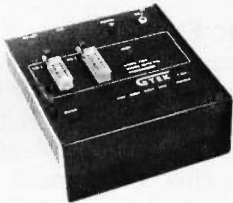

MODEL 7324 . . . . . \$1499

The 7324 has a built-in compiler. It programs all MMI, National and TI 20 & 24 pin PALS. It has non-volatile memory and operates stand-alone or via RS-232.

MODEL 7128 . . . . . \$ 429

The 7128 has the highest performance-to-cost-ratio of any unit. It supports the newest devices available through 256Kbits.

MODEL 7322 . . . . . \$1249  
 Same as Model 7324 but operates only via RS-232.

MODEL 7316 . . . . . \$ 749

This PAL PROGRAMMER programs Series 20 PALS. It has a built-in PALASM compiler.

MODEL 705 . . . . . \$ 299

68705V3, U3, P3 PROGRAMMER.

### EPROM, PROM & PAL PROGRAMMERS

— These features are standard from GTEK —

Compatible with all RS-232 serial interface ports • Auto select baud rate • With or without hand-shaking • Bidirectional Xon/Xoff • CTS/DTR supported • Read pin compatible ROMS • No personality modules • Intel, Motorola, MCS86 Hex formats • Split facility for 16 bit data paths • Read program, formatted list commands • Interrupt driven—program and verify real time while sending data • Program single byte block or whole EPROM • Intelligent diagnostics discern bad and/or unerased EPROM • Verify erasure and compare commands • Busy light • Complete with Textool zero insertion force socket and integral 120 VAC power (240 VAC/50Hz available) •

### UTILITY PACKAGES

GTEK's PGX Utility Packages will allow you to specify a range of addresses to send to the programmer, verify erasure and/or set the EPROM type. The PGX Utility Package includes GHGX, a utility used to generate an Intel HEX file.

PALX Utility Package—for use with GTEK's Pal Programmers—allows transfer of PALASM® source file or ASCII HEX object code file.

Both utility packages are available for CPM®, MS-DOS®, PC-DOS®, ISIS® and TRSDOS® operating systems. Call for pricing.

### CROSS ASSEMBLERS

These assemblers are available to handle the 8748, 8751, Z8, 6502, 68X and other microprocessors. They are available for CPM and MS-DOS computers. When ordering, please specify processor and computer types.

### ACCESSORIES

Model 7128-L1,L2, L2A (OEM Quantity) \$259.	Erasers . . . . . DE4 \$80; PE14T \$129 C25 \$349; C50 \$599
Model 7128-24 . . . . . \$329.	U/V Eraser DE-4 . . . . . \$ 80.
Cross Assemblers CPM-80 . . . . . \$200.	Cables: Serial or Parallel . . . . . \$ 30.
MSDOS, CPM 86 . . . . . \$250.	8751 Adapter . . . . . \$174.
PGX Utilities . . . . . Call for pricing	8755 Adapter . . . . . \$135.
PALX . . . . . Call for pricing	48 Family Adapter . . . . . \$ 98.

RUN CPM SOFTWARE ON YOUR IBM OR IBM COMPATIBLE

If you are a CPM user who wanted to convert to MS-DOS or PC-DOS but didn't because you wouldn't abandon or rewrite your CPM programs, now you can convert without losing or rewriting a single CPM program!

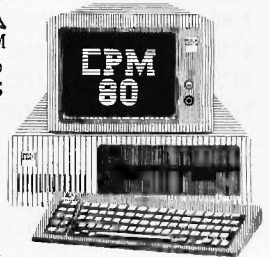

GTEK's CPEmulator emulates Z-80 code and Televideo or Lear-Seigler terminals. The CPEmulator copies to and from 54 CPM disks and the serial port.

Now all the work you accomplished in CPM is still as valuable with your change to MS-DOS or PC-DOS. And you won't see any difference when you run your CPM programs on your IBM or IBM compatible!

GTEK's incredible CPEmulator is just \$199! JUST RELEASED!!! Need more speed? With GTEK's SPEED KIT you can run your CPM programs much faster. The Speed Kit includes NEC V20 or V30 processors. With your CPEmulator, just \$99.00!

Call GTEK's CPM Hotline . . .  
 1-601-467-9019

### NEW PRODUCT FROM GTEK! MODEL 8014 PROGRAMMABLE PARALLEL PRINTER SWITCH



Finally, for everyone using multiple parallel printers, GTEK makes available a reliable and affordable programmable parallel printer switch. With it's programmable printer port, you can connect your IBM PC or other computer with a

single parallel port, to from one to four printers at one time.

Each port is selectable by sending GTEK's 8014 a simple escape sequence. The 8014's microprocessor allows Epson-type graphics codes to pass unchanged. By cascading 8014s, you can access as many printers as you need!

The 8014 will prove invaluable to you . . . use one computer to print invoices, serial number labels, disk labels, and plain paper . . . without changing the form each time. There are hundreds of applications for GTEK's 8014 Programmable Parallel Printer Switch.

And with the Model 8014-32k or 8014-128k, you can spool and switch your printer output.

Model 8014 (switch only) \$279.00; Model 8014-32k (32k buffer) \$339.00; Model 8014-128k (128k buffer) \$399.00.



Development Hardware/Software  
 P.O. Box 289, Waveland, MS 39576  
 601/467-8048; telex 315-814 (GTEK UD)  
 , INC.

GTEK, PALASM, CPM, MS-DOS, PC-DOS, ISIS, TRSDOS, & CPEmulator are registered trademarks.

speech. Rather than the eight or nine basic parts of speech that grade school children are familiar with (noun, verb, adjective, etc.), the KVV parser uses approximately 200 types representing subcategories of the basic parts of speech. This degree of specificity enables the parsing expert to increase the value of its predictions.

Using a lexicon of approximately 50,000 words that indicates the likelihood of different parts of speech for each word, the parsing expert is able to assess the likelihood of different words. In particular, the parsing expert is good at eliminating choices that are syntactically unlikely.

There is a fortunate orthogonality

between the strengths of the acoustic experts and those of the language experts. For example, most homonyms represent significantly different syntactic types that can be determined from context. "Two," "to," and "too" represent very different grammatical categories with readily identifiable word contexts. Also, short function words, which tend to be more difficult for an acoustic recognizer, are actually easier for the language model to make predictions for.

**ACOUSTIC EXPERTS**

The acoustic experts share an acoustic front-end processor that includes a high-resolution digitization (over 96-decibel dynamic range) and a robust filter bank made up of several hundred two-pole filter elements with 24-bit accuracy. The resulting spectral data is subsequently processed through a series of normalizations and other transformations to reduce variability and preserve feature invariance. Some of the transformations are based on an auditory model similar in many ways to the human ear's auditory front-end processing.

The acoustic experts utilize a RAM storage of word models, which are updated after each utterance. The acoustic experts are capable of evaluating the likelihood of every word model for a given test token, although the expert manager may request that a particular acoustic expert evaluate only a subset of the models based on the results of earlier experts.

**PARALLEL-PROCESSING ARCHITECTURE**

One area that uses extensive parallel processing is the front-end filtering. In order to make the fine distinctions necessary to handle the perplexity of a large vocabulary, a great deal of accuracy and resolution is needed in the number of filter channels and the accuracy of both the sample stream and the filters. Filtering is handled by the KSC2408 filter chip (from Kurzweil Semiconductor, a division of Kurzweil Applied Intelligence Inc.) with several

(continued)

**FLAMINGO**  
M I C R O

America's leading discounter  
of micro computers and their associated hard- and software.

*Our prices are laid back  
a Day Back*

**IBM®** hardware available upon request; call for current pricing. Volume discounts are given.

**IBM®** AT clone, 1 meg Ram, 2 360 K floppies, 192 watt power supply, keyboard \$1795.

**IBM®** XT clone 256 K, 360 K floppy, 135 watt power supply, keyboard \$600.

Internal 300 / 1200 baud, Hayes compatible modem. \$189.

Hard disk, 20 megabyte sub-system \$469.

Herdon printer letter quality daisy wheel, 18 cps, warranted by Qume for one year. Regular retail \$599, now just \$275.

Add \$50 for 640 K.

5151 Style keyboard available for AT or XT - Add \$25.

ABOVE PRICES AT 3% CASH DISCOUNT

Call Toll Free 1-800-231-1214  
In Florida 904-837-3995

Write for catalogue: P.O. Box 1491 Destin, Florida 32541-1491  
Prices subject to change without notice

SERIGRAPHIA

# Picture the advantages.



## Capture TV-quality images on your personal computer for a very affordable price.

### Amazing, but true.

Only AT&T Truevision™ lets you capture and display pictures with such clarity and full-color intensity so economically. Using only a single-slot graphics board.

### True versatility.

Now your personal computer can grab and store true-to-life images from any standard video source. Modify, enhance, merge and manipulate them. Superimpose text and graphics. And even send them to other locations via ordinary phone lines.

Now you can store photo files. Create electronic slide shows. And display your images in vivid color.

All with Truevision.

### True economy.

All you need is the AT&T Truevision

Image Capture Board. Suggested retail price only \$1,295. For even higher resolution, AT&T offers the Truevision Advanced Raster Graphics Adapter (TARGA) series. Four separate models address the spectrum of your continuous-tone imaging needs. Suggested retail prices range from \$2,295 to \$4,995.

For applications requiring display-only capability, the AT&T Truevision Video Display Adapter offers the same image quality at a suggested retail price of \$695.

All products can be used with the AT&T PC 6300, IBM or plug compatible PC's. All occupy a single slot in your PC.

AT&T offers software packages, too. The AT&T Truevision Image Processing Software lets you enhance and manipulate digitized video im-

ages or create your own. The Truevision PC Carousel Presentation Software lets you pre-time and pre-arrange your TV-quality images in a sophisticated electronic slide presentation.

AT&T Truevision Still-Frame Teleconferencing Software lets you transmit your electronic photos from here to there over ordinary phone lines, and even lets you annotate screens at both sites simultaneously if you desire.

### True advantages.

Picture all the ways you can use TV-quality graphics to increase productivity and heighten communications efficiency. For more information, or to place an order, write to: AT&T Electronic Photography and Imaging Center, 2002 Wellesley Blvd., Indianapolis, IN 46219, or call **1-800-858-TRUE.**



**AT&T**

The right choice.

## VOICE WRITER

two-pole filters used for each filter channel. Implementing the 2408's filter algorithm (for a single two-pole filter) on a 68000 requires five seconds to process one second of speech, or five times real time. Each KSC2408 chip includes eight such filters (which operate in real time) and is thus equivalent to forty 68000 microprocessors (for the 2408 filter algorithm). The current model 1 KVW uses 25 KSC2408 chips, which is equivalent to using a thousand 68000 microprocessors for the filtering operation.

The equivalent of several thousand additional 68000 microprocessors (for certain dedicated algorithms, not for general-purpose computation) is provided by other special circuits used in the acoustic-matching process. The language experts and elements of the acoustic-recognition process such as normalization and other

transformations are handled by multiple conventional microprocessors.

### USING THE KVW

In dictation mode, you simply speak your text in a rapid, discrete manner, with brief pauses between words. The pause required between words is adjustable and should be set just long enough to reduce or eliminate the ambiguity between word pauses and stopgaps within a word. In general, this figure ranges from 100 to 250 milliseconds. The system responds within 500 ms after the end of each word by displaying the recognized word on the screen. A special status line displays any alternate word choices. In trials of the KVW, when the system has chosen the wrong word, the correct word has usually been the first or second alternate given.

The basic mode of operation is to speak into the system and watch the

text appear. You don't need to be aware of what is in the active vocabulary. You simply speak and let the vocabulary-adaptation process proceed automatically.

You can also enter commands by voice. To distinguish commands from text, you enter a command mode either by depressing a function key or by speaking an appropriate unique verbal "Enter command mode" instruction (for example, "blix"). Once you enter command mode, you can switch among different types of commands to go, for example, from application-program commands to operating-system commands.

The primary mode of integrating the KVW's capabilities with an application program is through "transparent" integration. In this mode, the KVW simulates the keyboard. Recognized text and commands are converted

*(continued)*

## HOW CAN YOU REFUSE THIS OFFER, IF YOU ARE SHOPPING FOR IBM CLONE!

Special Sale for IBM PC/XT Compatible Computer System

 **pinecom**™

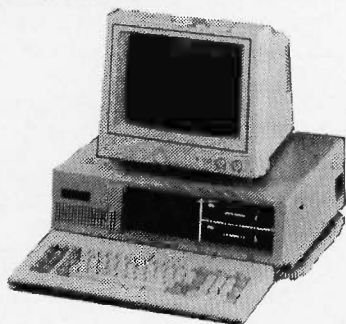

- Fully IBM PC/XT compatible
- 640K on board memories
- 8 IBM PC/XT standard I/O slots
- 8087 coprocessor ready socket
- Standard 4.77 MHz clock speed
- Flip-top type metal cabinet
- 83 key full function key board (enlarged return key and led indicators)
- Color graphic adapter with composit out (RES. 640 x 320)
- One parallel port for printer
- One RS-232 serial port
- One game port for joystick
- Real time clock with calendar (5 years battery back up on board)
- 135 watts hard disk ready power supply
- 2 halfheight 360K floppy drives
- 12" monochrome monitor included
- Fully assembled and tested
- 6 months parts and labor warranty

#### OPTIONAL ADD ON :

- A. For 5151 100 keys keyboard add \$40.00
- B. For 3way RGB color monitor 13" add \$285.00
- C. For 10 MGB internal hard disk with controller add \$499.00
- D. For 22 MGB internal hard disk with controller add \$599.00
- E. For Monochrome graphic adapter with printer port and TTL Monochrome 12" Hi-RES monitor add \$60.00

**SHIPPING CHARGES :** 5% for C.O.D., 2% for prepaid orders inside Continental U.S. No Personal Checks Accepted.

**DEALERS INQUIRIES INVITED.** Inquiry 272  
● IBM is registered trade mark of IBM Corp.

## IBM PERIPHERALS

- PC/XT 640K MOTHER BOARD, LOADED W/BIOS \$250.00
- COLOR GRAPHIC CARD W/RGB & COMPOSIT VIDEO OUT PUT (640x 400 RES) \$ 88.00
- MONOCHROME GRAPHIC CARD W/PRINTER PORT (720x348 RES) \$120.00
- FLOPPY DISK CONTROLLER CARD W/CABLE \$ 49.00
- O/384K MULTIFUNCTION CARD W/PARALLEL PORT; SERIAL PORT; GAME PORT; CALANDER, CLOCK (BATTERY BACK UP) AND 384K RAM SLOTS \$119.00
- DISK I/O CARD W/PARALLEL PORT; SERIAL PORT; GAME PORT; CALANDER, CLOCK (BATTERY BACK UP) AND FLOPPY DISK CONTROLLER W/CABLES \$135.00
- PARALLEL PRINTER CARD \$ 25.00
- SERIAL PRINTER CARD (RS-232) \$ 53.00
- DUAL SERIAL CARD (RS-232) (COM-1, COM-2) \$ 75.00
- O/512K RAM EXPANSION CARD \$ 52.00
- MOUSE SYSTEM (MICRO-SOFT COMPATIBLE) (3 BUTTONS) \$ 95.00
- EXTERNAL MODEM 300/1200 BULD (HAYS COMPATIBLE) \$250.00
- 135 WATT POWER SUPPLY 110/220V SIDE SWITCH \$ 95.00
- KEYBOARD : PC/XT LOOK ALIKE 84 KEY (5150) \$ 78.00
- KEYBOARD : SELECTIC-II LOOK ALIKE, LARGE RT KEY \$ 78.00
- KEYBOARD : ADVANCE 100 KEY MODEL : 5151 \$109.00
- KEYBOARD : AT LOOK ALIKE, LARGE RT KEY \$ 98.00
- PARALLEL PRINTER CABLE (6 FT.) \$ 14.00
- SERIAL PRINTER CABLE (6 FT.) \$ 14.00
- JOY STICK (SELF CENTERING W/2 FIRE BUTTON) \$ 25.00
- 360K HALF HEIGHT DISK DRIVE (PANASONIC OR TEAL) \$ 95.00
- SURGE SUPPRESSED POWER STRIP (6 OUTLETS) \$ 18.00

**SPECIAL OFFER: \$949**

**PINE COMPUTER INC.**

1455 MONTEREY PASS RD., SUITE 103  
MONTEREY PARK, CA 91754

**PHONE : (213) 269-1103**

**STORE HOURS : Mon. - Sat. 9 A.M. - 6 P.M.**

# A CROSSTALK<sup>®</sup>

## Klone FOR \$49<sup>95</sup>

The Closer You Look, the Better We Look!



**FEATURING**  
**Foreground/Background Communications**

**MIRROR** is the mirror image of Crosstalk XVI V3.6, the industry standard in data communications software for small business computers. **MIRROR**'s design closely reflects Crosstalk XVI's menus, commands and features. In fact, if you have used Crosstalk XVI before, you will feel right at home with **MIRROR**. The one thing you will not find reflected in **MIRROR** is Crosstalk XVI's \$195.00 price. Because we control the reflection, **MIRROR** costs only \$49.95.

If you are new to data communications, it makes sense to go with the industry standard in data communications software, but why pay the industry standard price. **MIRROR** lets you have the industry standard at 1/4 the price. If you or your company have already standardized on Crosstalk XVI, then consider **MIRROR** for future purchases and upgrades, you'll realize significant savings, without sacrificing on quality, standardization or features.

## MIRROR™ WILLOB

**THE RIGHT DATA COMMUNICATIONS  
 CHOICE FOR ANY USER!**

Inquiry 312



1210 East Park Avenue  
 Tallahassee, Florida 32301  
 For Information Call:  
 1-904-878-8564  
 TLX: 6714280 KLON

**\$49.95**

Site Licensing Available  
 60-Day Money-back Guarantee  
 Not Copy Protected

To Order Call Toll-Free:



National:  
**1-800-538-8157**  
 Ext. 848

California:  
**1-800-672-3470**  
 Ext. 848

**\$49.95**, plus \$5.00 postage/handling  
 (\$8.00 for COD orders) ea.

Florida residents must add 5% sales tax  
 Overseas orders: Add \$18.00 for shipping.

MIRROR is available for the IBM PC/XT/AT and compatibles and requires MS-DOS 2.0 or higher.

MIRROR, KloneWare and SoftKlone are trademarks of SoftKlone Distributing Corporation. Crosstalk XVI and Microstuf are registered trademarks of Microstuf, Inc. HAYES is a registered trademark of Hayes Microcomputer Products, Inc., Wordstar is a registered trademark of Micropro International.

**DISTRIBUTED IN CANADA BY:**  
 Saraguay Software Distributors  
 121 Avenue Road, Suite 202  
 Toronto, Ontario, M5R 2G3  
 Ph: (416) 923-1500

### For New Users, **MIRROR Provides:**

- Menu/Command Driven
- Complete Crosstalk XVI V3.6 Compatibility
- New User Script File (Enables you to sign-on to your favorite online service in minutes)
- Auto-dial/Auto-answer
- Alphabetized Help-Command Summary
- Money Saving Offers From Online Information Services

### For Experienced Data Communications Users, **MIRROR Provides:**

- Complete Background Operation (concurrent operation/memory resident)
- Programmable Script/Command Language (Crosstalk XVI V3.6 compatible with extensions)
- Extended Error-checking Protocol Support (XMODEM-single, XMODEM-multi-file, Crosstalk, HAYES and KERMIT)
- Integrated Wordstar-like Text Editor
- Multiple Terminal Emulations (VT-100/52, IBM 3101, Televideo 912C/920/925, TI 940, ADDS Viewpoint, ADM-3A)
- Enhanced Individualized Password Protection

into appropriate character strings and transmitted to the operating system as if they came from the keyboard. The character strings come in through a special serial line and an appropriate driver intercepts them and presents them to the operating system as having come from the keyboard.

## USER INTERFACE

One user interface that has been proposed for ease of use includes a pointing device (such as a mouse) to control the cursor, which is not easily manipulated by either keystrokes or verbal commands. The mouse would have two buttons, one to toggle between text and command mode and the second to correct errors. Again, you would have the choice of using these two buttons or using verbal commands. You would have relatively little use for the keyboard. Being able to correct most errors, go back and forth between text and commands, and control the location of the cursor would provide most of the control necessary aside from the actual verbal dictation of the text and commands.

To take this concept one step further, you could combine a flat-panel display with a touch-sensitive surface to provide a "pad" that you would hold in your lap or on your desk. As you speak to the pad, words would appear on its surface display. To control the cursor for insertion, deletion, or replacement operations, you would simply point to the screen. The two basic functions of error correction and toggle-to-command mode would be provided by either displayed "buttons," real buttons, or voice command (at your option). For the occasional requirement to type in a new vocabulary word, a QWERTY keyboard could be displayed on the screen.

## PHYSICAL CONFIGURATION

The KVV consists of an approximately 100-megabyte Winchester disk, four circuit boards, and a power supply in a standard rack-mountable cabinet. While it would be possible to sit the KVV server next to the work-

station it serves, it is generally found in a separate location. Thus, you interact only with your workstation and a microphone. The microphone can be either head-mounted, worn on your lapel, or desk-mounted. It is connected to a small box that digitizes the signal and transmits it on a high-speed serial line.

## FUTURE DIRECTIONS

Future applications of the KVV technology include integration with natural-language-understanding systems, domain-specific expert systems, text-to-speech synthesizers, and a variety of application packages to provide executive assistants that are powerful and easy to use. Such systems will have access to the internal databases and MIS (management information system) information of the user's own organization as well as public, semipublic, and restricted-access databases accessed by telecommunications. Professionals, executives, students, and others will be able to converse with such systems to conduct rapid research and inquiry into a variety of questions of interest. Such questions might involve information retrieval ("How did the sales in our Western region for the past quarter compare to those of our three largest competitors?") as well as substantive analysis ("Which financing option for the proposed capital acquisition is best supported by our current balance sheet?"). Questions would be asked by voice in natural language. The questions would be clarified through two-way voice communication (or display), and final answers would be provided by either voice, display, or printout, as appropriate.

The acoustic experts in the KVV are adaptable to continuous speech input. The computation requirements must be increased to handle connected speech, as must the recognition power requirements to handle the additional perplexity of word segmentation, interword coarticulation, and function word reduction. It is expected that economically viable systems that can handle continuous

speech will follow discrete-word KVV within a few years.

The KVV techniques are also adaptable to European languages. The acoustic experts require very little change. The principal changes necessary to the language experts are (1) to provide the appropriate grammar rules to the parsing expert (although the parsing-expert algorithms themselves don't require substantial change) and (2) to train the language experts on appropriate foreign-language text. Foreign-language KVV will probably follow the English KVV within a few years.

Handling Japanese requires more work than do European languages such as French or German. While Japanese has only about 120 syllables (compared to around 10,000 in English), the syllable set is a perplex one, with many syllable pairs being distinguished only by the duration of the vowel. Also, the differences in Japanese syntax require modifying more than just the parsing expert's grammar rules. Most of the KVV's techniques are, however, appropriate to the language, and a Japanese machine is feasible.

A number of configurations of a speech-to-display sensory aid for the deaf using the KVV technology have been proposed, which the company plans to pursue. Alternatives range from a speaker-independent version of the KVV (with an increased error rate) to a system that displays phonetic transcriptions rather than words. Such a phonetic transcription would contain some insertion, deletion, and substitution errors but could be understood by the user with appropriate training.

## CONCLUSION

The introduction of large-vocabulary ASR is expected to provide dramatic productivity gains in creating written text, an optimal mode of communication between persons and intelligent computerized devices and services for information retrieval and analysis, as well as improved understanding and communication for the deaf population. ■



# FORTRAN PROGRAMMERS

## LOOK FAMILIAR?



## F77L GETS YOU OUT OF THESE SITUATIONS

### 1. PROGRESS IMPOSSIBLE

You've tried other PC FORTRANS, but none of them allow you to complete your project. It could be the lack of key features, the overwhelming bugs, being stuck with a subset, or the inability to run large programs.

The answer to your problems is F77L. With F77L you not only get the full ANSI(X3.9—1978) Standard but additional features for flexibility in programming. We have done more than simply design a product to run all your programs, we implemented a system that allows users to reach their full programming potential. At LCS, we have been specializing in FORTRAN for over 16 years, and we believe that our commitment and dedication to FORTRAN has resulted in the finest language system available.

*"Judging by Lahey's corporate history, they've got lots of experience writing FORTRAN compilers. Judging by my experience with their product, I would agree wholeheartedly."*

IEEE Software, November 1985

### 2. THE ENDLESS COMPILE

Your valuable time is spent waiting endlessly for your programs to compile.

We have not only developed an unbelievably fast compiler but we did it without sacrificing features, diagnostics, or the speed of execution.

This uncompromising attitude is evident in the quality and performance of F77L. Whether you are downloading from mainframes or developing on the personal computer, you can appreciate the importance of compiler speed.

*"F77L compiled the five files in a total of 12 minutes, which was 4 times as fast as MS FORTRAN and an astounding 6 times as fast as Pro FORTRAN."*

PC Magazine, Dec. 24, 1985

### 3. MYSTERY MESSAGES

The messages your FORTRAN is giving don't make any sense.

F77L eliminates the confusion by explicitly diagnosing errors. The compiler and run time messages describe, in plain English, the nature and location of the error. For logical program errors, we provide our unique Source On-Line Debugger (SOLD). SOLD allows you to interface with your program at the FORTRAN level and doesn't require re-compiling or re-linking. If you happen to run into an especially tough problem, you can call our technical staff for assistance.

*"The manual that comes with this compiler is well put together. The messages are clearly explained, the compiler's unique features are well documented... All in all, F77L is a fine, well supported product that we think will do very well in the marketplace."*

Computer Language, January 1986

Isn't it time to say good-bye to all the shortcomings of your old FORTRAN system, and get back to enjoying programming.

## F77L

### "THE PROGRAMMER'S FORTRAN"



*"Lahey's F77L FORTRAN is the compiler of choice."*

PC magazine

**\$477**

Requires: PC/MS-DOS, 256K, 8087/80287

**TO ORDER OR FOR MORE INFORMATION**

**(213) 541-1200**

**LCS** Lahey  
Computer  
Systems, Inc.

31244 Palos Verdes Dr. W., Suite #243  
Rancho Palos Verdes, CA 90274

MS FORTRAN is a trademark of Microsoft Corporation  
Professional FORTRAN is a trademark of International Business Machines

**VERSION 2.0 NOW AVAILABLE**

# COMPUTER MAIL ORDER

## THE CMO ADVANTAGE

- ✓ THE BEST PRICES!
- ✓ Next day shipping on all in stock items.
- ✓ Free easy access order inquiry.
- ✓ Orders from outside Pennsylvania save state sales tax.
- ✓ Free technical support with our factory trained technical staff.
- ✓ There is no limit and no deposit on C.O.D. orders.
- ✓ There's no extra charge for using your MasterCard or Visa. Your card is not charged until we ship.
- ✓ No waiting period for cashiers checks.
- ✓ We accept purchase orders from qualified corporations. Subject to approval.
- ✓ Educational discounts available to qualified institutions.
- ✓ FREE CATALOG MEMBERSHIP

### ORDER LINE

CALL TOLL-FREE  
**1-800-233-8950**

Educational Institutions  
Call Toll-Free

**1-800-221-4283**  
**CUSTOMER SERVICE & TECH SUPPORT**  
1-717-327-1450  
Dept. A103

### MAILING ADDRESS

Computer Mail Order  
Dept. A103  
477 East Third Street  
Williamsport, PA 17701



MEMBER DIRECT MARKETING ASSOCIATION

### CREDIT CARDS



Inquiry 84



### SHIPPING

Add 3%, minimum \$7.00 shipping and handling on all orders. Larger shipments may require additional charges.

All items subject to availability and price change.

Returned shipments may be subject to a restocking fee.

### CANADIAN ORDERS

**1-800-268-3974**  
Ontario/Quebec

**1-800-268-4559**  
Other Provinces

**1-416-828-0866**  
In Toronto

**TELEX: 06-218960**

2505 Dunwin Drive,  
Mississauga, Ontario  
Canada L5L1T1

All prices shown are for U.S.A. orders.  
Call The Canadian Office for Canadian prices.

## HOME COMPUTERS

### ATARI

<b>130XE (128K)</b> .....CALL
<b>520ST (512K)</b> .....CALL
800XL 64K.....CALL
1010 Recorder.....\$49.99
1050 Disk Drive.....CALL
1020 Printer.....\$29.99
1027 Letter Quality Printer.....\$129.00
1030 Direct Connect Modem.....\$59.99

### Commodore

<b>C128 Computer</b> .....\$269.00
<b>C1571 (Disk Drive for C128)</b> .....\$249.00
<b>C1902 (RGB 13" Monitor for C128)</b> .....\$289.00
<b>C1670 (Modem for C128)</b> .....\$179.00
C64 Computer.....CALL
C1541 Disk Drive.....\$189.00
C1530 Datasette.....\$39.99
M-801 Dot Matrix Printer.....\$149.00
MCS 803 Dot Matrix Printer.....\$179.00
C1802 Color Monitor.....\$189.00
C1660 Auto Modem.....\$59.99
DPS 1101 Daisy Printer.....\$339.00
Comrex 220 (C64 Interface).....\$79.99

### Professional Software

Fleet System II w/Spell.....C64/128\$49.99
Trivia Fever.....\$29.99
Info Pro.....\$179.00

### APPLE

APPLE IIe.....CALL
APPLE IIc.....CALL
MacINTOSH.....CALL
IIc LCD Display.....CALL

### GRAPHICS

#### Polaroid

Palette.....\$1299.00
Power Processor.....\$229.00
Illuminated Slide Mounter.....\$39.99
Polacolor 2 Pack film.....\$18.99

## PORTABLE COMPUTERS

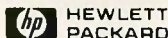

41CV.....\$189.99
41CX.....\$249.99
HP 11C.....\$62.99
HP 12C.....\$89.99
HP 15C.....\$89.99
HP 16C.....\$89.99
HPIL Module.....\$98.99
HPIL Cassette or Printer.....\$359.99
Card Reader.....\$143.99
Extended Function Module.....\$63.99
Time Module.....\$63.99

We stock the full line of  
HP calculator products

### NEC

PC-8401 LS.....CALL
PC-8201 Portable Computer.....\$319.00
PC-8231 Disk Drive.....\$599.00
PC-8221A Thermal Printers.....\$149.00
PC-8281A Data Recorder.....\$99.99
PC-8201-06 8K RAM.....\$79.99

### SHARP

PC-1350.....\$149.00
PC-1261.....\$149.00
PC-1500A.....\$169.00
PC-1250A.....\$89.99
CE-125 Printer/Cassette.....\$129.00
CE-150 Color Printer Cassette.....\$149.00
CE-161 16K RAM.....\$129.00

### Software Specials

8036 Atari Writer.....\$24.99
Star Raiders.....\$4.99
Missile Command.....\$4.99
Defender.....\$4.99
Galaxian.....\$4.99
Asteroids.....\$4.99
Centipede.....\$4.99
Miner 2049'er.....\$4.99
Eastern Front.....\$4.99
VisiCalc.....\$39.99
Arcade Champ.....\$9.99

### BRODERBUND

The Print Shop.....\$28.99
Music Shop.....\$28.99
Graphics Library.....\$17.99
Graphics Library II.....\$17.99
Graphics Library III.....\$17.99
Bank Street Writer.....\$32.99



File (C64).....\$39.99
------------------------

BATTERIES INCLUDED

PaperClip w/Spell Pack.....\$49.99
The Consultant DBMS.....\$37.99
Home Pak.....\$29.99
Bus Card II.....\$119.00
80 Col Display.....\$99.99

## ACCESSORIES

### CURTIS

Diamond SP-1.....\$32.99
Emerald SP-2.....\$39.99
Sapphire SPF-1.....\$52.99
Ruby SPF-2.....\$62.99
Safe Strfp SP-3.....\$19.99

### KENSINGTON

MasterPiece.....\$99.99
MasterPiece Plus.....\$119.00

## DISKETTES

### maxell

3 1/2" SS/DD (10).....\$24.99
3 1/2" DS/DD (10).....\$34.99
5 1/4" MD-1 w/Hardcases (10).....\$12.99
5 1/4" MD-2 w/Hardcases (10).....\$18.99
5 1/4" MD-2-HD for AT (10).....\$39.99
3 1/2" 5 pack SS/DD.....\$13.99

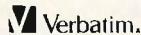

5 1/4" SS/DD.....\$19.99
5 1/4" DS/DD.....\$24.99
Disk Analyzer.....\$24.99

### Dennison

Elephant 3 1/2" SS/DD.....\$29.99
Elephant 5 1/4" SS/DD.....\$13.99
Elephant 5 1/4" SS/DD.....\$14.99
Elephant 5 1/4" DS/DD.....\$16.99
Elephant Premium DS/DD(50).....\$79.99



5 1/4" DS/DD floppy disks (Box of 10).....\$26.99
--

## DISK HOLDERS

### INNOVATIVE CONCEPTS

Flip'n File 10.....\$2.99
Flip'n File 50.....\$17.99
Flip'n File 50 w/lock.....\$24.99
Flip'n File 100.....\$24.99
Flip'n File Data Case.....\$9.99

### AMARAY

50 Disk Tub 5 1/4".....\$9.99
30 Disk Tub 3 1/2".....\$9.99

## MODEMS



Volksmodem.....\$59.99
Volksmodem 300/1200.....\$189.99
Signalman Express.....\$259.00
Lightning 2400 Baud.....\$399.00
Expressi.....\$199.00
6470 (64/128) 300/1200 Baud.....\$139.00

### DIGITAL DEVICES

AT300 - 300 Baud (Atari).....\$99.99
--------------------------------------



Smartmodem 300.....\$139.00
Smartmodem 1200.....\$389.00
Smartmodem 1200B.....\$359.00
Smartmodem 2400.....\$599.00
Micromodem IIe.....\$149.00
Smart Com II.....\$89.99
Chronograph.....\$199.00
Transet 1000.....\$309.00



Reach 1200 Baud Half Card.....\$399.00
--

### MPP MICROBITS

MPP-1064 AD/AA (C-64).....\$69.99
-----------------------------------



Smart Cat Plus.....\$299.00
J-Cat.....\$99.99
Novation 2400.....\$549.00
Apple Cat II.....\$229.00
212 Apple Cat II.....\$379.00
Apple Cat 212 Upgrade.....\$229.00
Macmodem.....\$279.00



Quadmodem II
300/1200.....\$339.00
300/1200/2400.....\$499.00

### EVEREX

1200 Baud Internal (IBM/PC).....\$199.00
--

## DRIVES

### HARD

#### I-MEGA

10 meg Bernoulli Box.....\$1899.00
20 meg Bernoulli Box.....\$2599.00



25, 35, 50, 80 meg (PC)
.....from \$1299.00

### IRWIN

Tape Backup.....CALL
----------------------



60 Meg Internal Backup System.....\$799.00
--

### U-SCI

10 meg Internal IBM.....\$399.00
20 meg Internal IBM.....\$549.00

### CORE

AT20-AT72MB.....CALL
----------------------

### PRIAM

40, 60 MB (PC, XT, AT).....CALL
---------------------------------



Atari GT.....\$219.00
C-64 GT.....\$219.00



SD1 C-64 Single.....\$219.00
SD2 C-64 Dual.....\$469.00



320K 5 1/4" (PC).....\$119.00
-------------------------------

### TEAC

320K 5 1/4".....\$119.00
--------------------------

Dept. A103

# CALL TOLL-FREE

**MONITORS**

**PRINTERS**

**PC COMPATIBLES**

Inquiry 84

**COMPUTER MAIL ORDER**

**AMDEK**

Video 300 Green.....	\$129.00
Video 300A Amber.....	\$139.00
Video 310A Amber TTL.....	\$169.00
Color 300 Composite.....	\$169.00
Color 500 Composite/RGB.....	\$289.00
Color 600 Hi-Res. RGB.....	\$399.00
Color 710 Ultra Hi-Res.....	\$439.00
Color 722 Dual Mode.....	\$529.00

**NEC**

JB1201 G/1205A.....(ea.)	\$79.99
JB1270G/1275A.....(ea.)	\$99.99
JB1280G TTL.....	\$129.00
JB1285A TTL.....	\$129.00
JC1460 RGB.....	\$249.00
JC1225 Composite.....	\$179.00
JC1401 Multi Sync RGB.....	\$549.00

**PRINCETON**

MAX-12E Amber.....	\$179.00
HX-9 9" RGB.....	\$469.00
HX-9E Enhanced.....	\$519.00
HX-12 12" RGB.....	\$469.00
HX-12E Enhanced.....	\$559.00
SR-12 Hi-Res.....	\$599.00
SR-12P Professional.....	\$699.00

**TAXAN**

115 12" Green.....	\$119.00
116 12" Amber.....	\$129.00
121 TTL Green.....	\$139.00
122 TTL Amber.....	\$149.00
610 510x200 RGB.....	\$NEW
620 640x200 RGB.....	\$NEW
630 640x200 RGB.....	\$NEW
640 720x400 RGB.....	\$NEW

**QUADRAM**

8400 Quadchrome I.....	\$499.00
8410 Quadchrome II.....	\$339.00
8420 Amberchrome.....	\$179.00
8500 Quad Screen.....	\$1449.00

**ZENITH**

ZVM 1220/1230.....(ea.)	\$99.99
ZVM 1240 IBM Amber.....	\$149.00
ZVM 130 Color.....	\$269.00
ZVM 131 Color.....	\$249.00
ZVM 133 RGB.....	\$429.00
ZVM 135 RGB/Color.....	\$459.00
ZVM 136 RGB/Color.....	\$599.00

**INTERFACES**

**AST**

Multi I/O (Apple II).....	\$159.00
---------------------------	----------

**PRACTICAL PERIPHERALS**

Graphcard.....	\$79.99
Serial Card.....	\$99.99
Microbuffer II +.....	\$169.00
Microbuffer 32K.....	\$189.00

**QUADRAM**

Microfazer.....	from \$139.00
Efazer (Epson).....	from \$79.99

**Orange Micro**

Grappler CD (C64).....	\$89.99
Grappler + (Apple).....	\$89.99
Grappler 16K + (Apple).....	\$159.00

**DIGITAL DEVICES**

Ape Face (Atari).....	\$4.99
U-Print A (Atari).....	\$54.99
U-A16/Buffer (Atari).....	\$74.99
U-Call Interface (Atari).....	\$39.99
U-Print C (C64).....	\$49.99
P-16 Print Buffer.....	\$74.99
U-Print 16 apple Iic.....	\$89.99

**Canon**

A40.....	CALL
LBP-8A1 Laser.....	CALL

**CITIZEN**

MSP-10 (80 col.).....	\$279.00
MSP-15 (132 col.).....	\$389.00
MSP-20 (80 col.).....	\$349.00
MSP-25 (132 col.).....	\$509.00

**C. ITOH**

Prowriter 7500.....	\$179.00
Prowriter 1550P.....	\$349.00
Starwriter 10-30.....	\$399.00

**corona**

Lazer LP-300.....	\$2799.00
-------------------	-----------

**DIABLO**

D25 Daisywheel.....	\$549.00
635 Daisywheel.....	\$899.00
D80IF Daisywheel.....	CALL

**daisywriter**

2000.....	\$749.00
-----------	----------

**EPSON**

Homewriter 10, LX-80, LX-90.....	CALL
FX-85, FX-286, RX-100, JX-80.....	CALL
DX-10, DX-20, DX-35.....	CALL
SQ-2000, Hi-80, HS-80, AP-80.....	CALL
LQ-800, LQ-1000, LQ-1500.....	CALL

**JIUKI**

6000 Letter Quality.....	CALL
6100 Letter Quality.....	CALL
6200 Letter Quality.....	CALL
6300 Letter Quality.....	CALL
5510 Dot Matrix.....	CALL

**LEGEND**

808 Dot Matrix 100 cps.....	\$179.00
1080 Dot Matrix 100 cps.....	\$259.00
1380 Dot Matrix 130 cps.....	\$289.00
1385 Dot Matrix 165 cps.....	\$339.00

**NEC**

3000 Series.....	\$999.00
8000 Series.....	\$1399.00
ELF 360.....	\$449.00
Pinwriter 560.....	\$999.00

**OKIDATA**

182, 183, 192, 193, 2410, 84.....	CALL
Okimate 10 (Specify C64/Atari).....	\$189.00
Okimate 20 (IBM).....	CALL

**Panasonic**

KX1080.....	\$NEW
KX1091.....	\$259.00
KX1092.....	\$389.00
KX1093.....	\$479.00

**QUADRAM**

Quadjet.....	\$399.00
Quad Laser.....	CALL

**SILVER-REED**

500 Letter Quality.....	\$279.00
550 Letter Quality.....	\$419.00
770 Letter Quality.....	\$759.00

**Star**

SG-10C (C64 Interface).....	CALL
SB/SD/SG/SR Series.....	CALL
Powertype Letter Quality.....	CALL

**Texas Instruments**

Ti850.....	\$529.00
Ti855.....	\$639.00
Ti865.....	\$799.00

**TOSHIBA**

1340 (80 column).....	\$469.00
P341 (132 column).....	\$949.00
P351 (132 column).....	\$1099.00

**IBM PC SYSTEMS**  
Configured to your specification.  
Call for Best Price!  
IBM-PC, IBM-PC II, IBM-XT, IBM-AT

**KAYPRO**

KP-2000 Portable.....	CALL
Kaypro PC.....	CALL

**SOFTWARE FOR IBM**

**ANSA Software**

Paradox.....	\$549.00
--------------	----------

**ASHTON-TATE**

Framework II.....	\$399.00
dBase III Plus.....	CALL

**BORLAND**

Lightening.....	\$59.99
Sidekick (unprotected).....	\$59.99
Reflex.....	\$59.99
Newspack.....	\$59.99

**CENTRAL POINT**

Copy II PC-Backup.....	\$29.99
------------------------	---------

**DECISION RESOURCES**

Chartmaster.....	\$229.00
Signmaster.....	\$169.00
Diagram Master.....	\$219.00

**FOX & GELLER**

Quickcode III.....	\$169.00
--------------------	----------

**FUNK SOFTWARE**

Sideways.....	\$39.99
---------------	---------

**HARVARD SOFTWARE**

Total Project Manager.....	\$269.00
----------------------------	----------

**INFOCOM**

Cornerstone.....	\$279.00
------------------	----------

**LIFETREE**

Volkswriter 3.....	\$159.00
--------------------	----------

**LIVING VIDEOTEK**

Think Tank.....	\$109.00
Ready.....	\$64.99

**LOTUS**

Symphony.....	CALL
1-2-3.....	CALL

**MECA SOFTWARE**

Managing Your Money 2.0.....	\$99.99
------------------------------	---------

**MICROSTUF SOFTWARE**

Crosstalk XVI.....	\$89.99
Crosstalk Mark IV.....	\$149.00
Remote.....	\$89.99

**MICRORIM SOFTWARE**

R:Base 4000.....	\$249.00
R:Base 5000.....	\$389.00
Clout 2.0.....	\$129.00

**MICROPRO**

WordStar 2000.....	\$249.00
WordStar 2000 +.....	\$299.00
WordStar Professional.....	\$199.00
Easy.....	\$99.99

**MICROSOFT**

Word.....	\$229.00
Mouse.....	\$139.00
Flight Simulator.....	\$39.99
MultiPlan.....	\$129.00

**MULTIMATE**

Advantage.....	\$289.00
Multi Mate Word Proc.....	\$219.00
On File.....	\$89.99
Just Write.....	\$89.99

**NOUEMENON**

Intuit.....	\$69.99
-------------	---------

**NORTON**

Norton Utilities 3.1.....	\$59.99
---------------------------	---------

**ONE STEP**

Golf's Best.....	\$39.99
------------------	---------

**PFS:IBM**

First Success W/F/P.....	\$199.00
File/Graph.....(ea.)	\$79.99
Report.....	\$74.99
Write/Proof Combo.....	\$79.99

**PROFESSIONAL SOFTWARE**

Wordplus-PC w/Boss.....	\$249.00
-------------------------	----------

**THE SOFTWARE GROUP**

Enable.....	\$259.00
-------------	----------

**SATELLITE SYSTEMS**

Word Perfect 4.1.....	\$219.00
-----------------------	----------

**SORCIMI/UIS**

Accounting AP/AR/GL/INV/OE.....(ea.)	\$299.00
SuperCalc III.....	\$199.00
EasyWriter II System.....	\$199.00
Super Project.....	\$199.00

**SPI SOFTWARE**

Open Access.....	\$379.00
------------------	----------

**SUBLOGIC**

Jet.....	\$39.99
----------	---------

**5th GENERATION**

Fast Back.....	\$109.00
----------------	----------

**ZENITH**

PC-138 Series.....	CALL
PC-148 Series.....	CALL
PC-158 Series.....	CALL
PC-160 Series.....	CALL
PC-171 Series.....	CALL
AT-200 Series.....	CALL

**SANYO**

MBC 550-2 Single Drive.....	\$649.00
MBC 555-2 Dual Drive.....	\$949.00
MBC 675 Portable.....	CALL
MBC775.....	\$1699.00
MBC 880 Desktop.....	CALL

**AT&T**

Safari (7300).....	CALL
6300.....	CALL

**corona**

PPC400 Dual Portable.....	\$1289.00
PPCXT 10 meg Portable.....	\$1989.00
PC40022 Dual Desktop.....	\$1389.00
PC400-HD2 10 meg.....	\$1989.00

**ITT**

ITT X-TRA 256K, 2 Drive System.....	CALL
256K, 10 meg Hard Drive System.....	CALL
XP5, 20 meg.....	CALL

**SPERRY**

Sperry-AT.....	as low as \$1749.00
Sperry-IT.....	as low as \$2699.00
Call for Specific Configuration!	
All Models.....	CALL

**MULTIFUNCTION CARDS**

**AST**

Rampage.....	\$379.00
Six Pack Plus.....	\$229.00
I/O Plus II.....	\$139.00
Advantage-AT.....	\$399.00
Graph Pak/64K.....	\$599.00
MonoGraph Plus.....	\$399.00
Preview Mono.....	\$299.00
PC Net Cards.....	\$379.00
\$251/11 On-line.....	\$669.00
\$251/12 Remote.....	\$579.00

**dca**

IRMA 3270.....	\$879.00
IRMA Print.....	\$999.00
IRMA Smart Alec.....	\$779.00

**EVEREX**

Edge Card.....	\$259.00
Graphics Edge.....	\$259.00
Magic Card II.....	\$169.00

**HERCULES**

Graphics.....	\$299.00
Color.....	\$159.00

**IDEA Associates**

IDEA 5251.....	\$589.00
----------------	----------

**MYLEX**

The Chairman.....	\$469.00
-------------------	----------

**PARADISE**

Color/Mono Card.....	\$149.00
Modular Graphics Card.....	\$259.00
Multi Display Card.....	\$219.00
Five Pack C, S.....	\$129.00

**PERSYST**

Bob Board.....	\$359.00
----------------	----------

**TEGMAR**

Captain - 64.....	\$199.00
Captain Jr. 128K.....	\$199.00
Graphics Master.....	\$469.00

**QUADRAM**

Quadport-AT.....	\$119.00
Liberty-AT (128K).....	\$349.00
The Gold Quadboard.....	\$449.00
The Silver Quadboard.....	\$239.00
Expanded Quadboard.....	\$209.00
Liberty.....	\$309.00
QuadPrint.....	\$499.00
QuadLink.....	\$399.00
QuadColor.....	\$199.00
QuadJr. Expansion Chassis.....	\$419.00
Expansion Chassis Memory.....	\$199.00
Chronograph.....	\$79.99
Parallel Interface Board.....	\$64.99

**INTEL**

PCNC8087 5MHz.....	CALL
PCNC8087-2 8 MHz.....	FOR
PCNC80287 6 MHz.....	YOUR
1010 PC-Above Board.....	PC
1110 PS-Above Board.....	
2010 AT-Above Board.....	

**1-800-233-8950**

**Dept. A103**

# DRIVE PLUS

**Performance**  
**Reliability**  
**Economy**

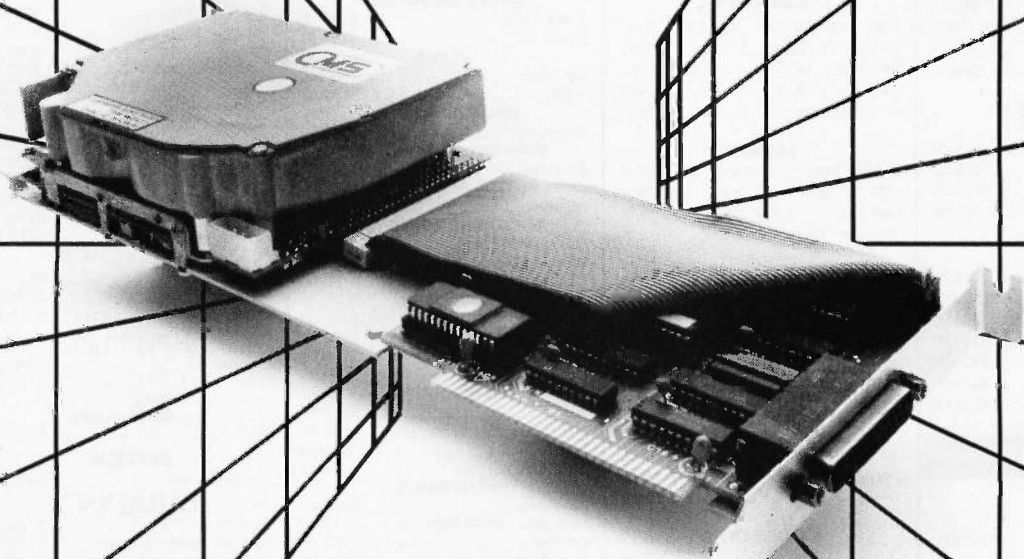

## **20 MB Hard Disk Expansion Card Family**

**DRIVE PLUS SCSI**

SCSI interface. 7.5 Mbit/sec transfer rate

**DRIVE PLUS HI-REL**

Automatic head lifters never allow heads to touch media.

**DRIVE PLUS ECONOMY**

Unbeatable low price for a hard disk card.



**Best Price · Best Performance**

401 W. Dyer Road, Santa Ana, CA 92707 (714) 549-9111

# INCREASING INDEPENDENCE FOR THE AGING

BY K. G. ENGELHARDT AND ROGER EDWARDS

*Robotic aids and smart technology  
can help us age less dependently*

FOR THE FIRST time in history, a significant portion of our population is living to be senior citizens, and we have no experience in caring for large numbers of healthy, literate, articulate older persons, many of whom are highly educated. As our society grays, we need more ways to help increase the independence of those with chronic and multiple disabilities. Rapid advances in microprocessor-based technologies are providing us with many new possibilities. Their miniaturization, flexibility, modularity, and ever-decreasing costs now make it possible to realistically address human problems that we could not just 10 years ago.

The need to control our environment and our lives in order to reduce dependence is critical to human development. Loss of personal independence is costly, not only in actual dollars spent on institutional and long-term care, but also in emotional and psychological terms. The need to reduce premature and unnecessary institutionalization of our elderly citizens is critical. We need more devices that will increase the in-

dependence and the sphere of control of individuals with disabilities and to augment the care givers' tasks with state-of-the-art tools to help them provide better care.

This article discusses potential applications of microprocessor-based technology for increasing independence in those with declining abilities. From panic buttons to smart houses, from stationary telemanipulators to self-navigating robots, from memory-aid devices to expert systems for daily living, microprocessor-based technology can assist the functionally dependent older person.

## APPLICATIONS

An applications team was formed during the winter of 1984 to investigate potential uses for robots and robotic-related technologies. The team identified 54 subgroups of tasks and divided them into 12 major categories: patient transport-lift-transfer, housekeeping, ambulation (walking patients to help prevent bedsores), physical therapy, depuddler (urine cleaner), surveillance (to help with wandering patients), physician assis-

tant, nurse assistant, patient assistant, vital-signs monitor, mental stimulation, and one miscellaneous group. Let's look at some possible robotic applications in a few of these groups. **LIFTING AND TRANSFERRING:** The challenge of lifting and transferring individuals with partial or total paralysis, extensive weakness, or increased fragility due to age is significant. One robotic solution could be a track-mounted robot arm that glides along the ceiling until it reaches the room to which it has been summoned. The care giver or the older person could then direct the arm to assist in lifting or transferring the individual from bed to chair or wheelchair to bath, for example. This assistance could also help

*(continued)*

K. G. Engelhardt is a senior research scientist and codirector of the Health and Human Services Robotics Laboratory at the Robotics Institute of Carnegie-Mellon University.

Roger Edwards is a research scientist in the H.H.S. Robotics Laboratory at the Robotics Institute of Carnegie-Mellon University. They can be reached at the Robotics Institute, Carnegie-Mellon University, Schenley Park, Pittsburgh, PA 15213.

## *An expert system could aid in keeping people independent and in their homes.*

reduce back injuries and increase job satisfaction for health-care workers and offer increased independence for the older person.

**AMBULATION:** This same ceiling-mounted robotic arm could offer an "elbow" to people who need exercise but are a bit shaky, or it could help by pushing a wheelchair along the arm's track corridor. Another solution could be comfortable parachute-like harnesses to safely support weakened individuals in standing positions. These "people walkers" would be programmed to move at varying speeds (under computer control) depending on the individual's prescribed exercise needs. Currently, patients are rarely walked individually on a daily basis because there is not enough free staff time to assist them. Regularly prescribed exercises might affect an older person's quality of life, health, and sleeping patterns.

**PATIENT ASSISTANT:** Robotic aids can also perform manipulation tasks in an older person's physical environment. Our research has shown that older people are capable of using a robotic aid, and it has identified a range of health and independence-related applications from stationary, sensoryless, bedside-mounted manipulators to problem-solving, self-navigating vehicles with robotic arms that work in coordination. A low-cost manipulator could be mounted on a bedside table, hospital bed, or wall track and perform pick-and-place tasks for a bedbound person. A stationary system with some sensory capabilities, such as force and tactile sensors, could help with some personal grooming and feeding tasks. A mobile, guided vehicle could deliver food trays or perform simple fetch-and-carry tasks. A self-navigating

robot wheelchair could transport the individual and have a robotic arm attached to perform manipulation tasks.

### **DAILY-LIVING EXPERT SYSTEMS**

Expert systems that offer cognitive assistance are another possibility. Such a system could help someone with physical or cognitive limitations to make the decisions required in everyday living. An expert system could aid in keeping people independent and in their own homes for a longer time. It could help remind older individuals to perform certain tasks. It could also alert a care giver elsewhere should a change of status signal an emergency situation.

Development of a memory aid or "mind jogger" for specific activities is the first step in creating an expert system for daily living. Such aids are needed for a wide spectrum of people with short-term memory deficiencies. Work on this problem is underway at the University of Michigan (see reference 1). Development of an effective memory aid for those with declining cognitive abilities depends on the system's ability to communicate reminders to its user and on the user's ability to comprehend those messages. Both the quality and content of the information conveyed are important considerations.

What is the best way for a reminding aid to present information so it is most likely to be understood? We know virtually nothing about how much and what kinds of information are needed for various use groups. There is a range of choices that vary depending on the intended user. Whether we use visual or auditory reminders or both depends on the user's "cognitive perceptual and motor demands." Voorhees (see reference 2) has demonstrated the importance of careful integration of multimodal information systems in designing airline cockpits. This analogy is not as farfetched as it may seem, since automated feedback in both instances serves a reminding function. In both cases, we must consider specific characteristics associated with visual and voice output. Our goal, as in Voorhees's

cockpit design, is to deliver the "maximum amount of information transfer under conditions of minimum cognitive effort" (see reference 2, page 54). Determining the requirements for devices that improve independence requires examining the functional capabilities of older users. Their cognitive statuses, hearing losses, and visual abilities are three main factors in designing input control schemes and effective verbal or visual feedback.

Lawton's concept of "centers of control" that older people create in their environments (see reference 3) can be a starting point for considering technology's capability for increasing independence. He observes that older people with decreased mobility generally have a favorite easy chair surrounded by those objects that they consider essential, including tables, television, medicines, water and pitcher, pictures, and other personal memorabilia. They usually face an entrance so they know who is entering and leaving. Since elderly individuals often spend increasing amounts of time in their own homes, control over their home environments becomes increasingly important to their sense of independence.

In an airplane, the cockpit is the organized center for controlling an aircraft. Its design allows the pilot to maximize the interactive workspace. Work with disabled persons, whose wheelchairs serve as their primary interactive lifespaces, has brought a new meaning to this concept of "centers of control."

### **VOICE I/O**

For older people, voice technology offers a more natural approach to controlling objects and devices within their personal space. They need a natural-language interface that enables them to communicate with the system in everyday English as opposed to computerese.

Environmental and remote control of televisions, appliances, stereos, doors, windows, and locks under voice control already exist. Voice operation of entertainment items is

*(continued)*

# Turbocharged AT ? Turbocharge *Your* Office.

Introducing  
the ARC 286 *turbo*.  
An AT compatible  
personal computer.



## We're ARC.

OEM and Distributor Sales:  
Please contact Debra, (818) 289-8742.

National Accounts:  
Please contact Djohan, (818) 289-8744.

American Research Corporation  
2001 West Chestnut Street  
Alhambra, CA 91803

**Reliability.** We design it in, we build it in, we test it in. With two separate R&D staffs. With the highest quality components and board. With 72 hour burn in. And we guarantee it for two years.

**Technology.** We produced the first guaranteed compatible XT "turbo" system. The first V-20 based system designed to run at 2.8 times XT speed. The first XT dimensioned AT upgrade.

**Value.** It's not an outdated concept at ARC. Whether your company is small or big, the value we provide makes a difference to your business. At ARC, providing value is our job.

XT and AT are trademark of International Business Machines Corp.

**ARC** American  
Research  
Corporation  
**Reliability. Technology. Value.**

Inquiry 392 for End-Users. Inquiry 393 for DEALERS ONLY.

# NO OTHER PRINTERS CAN PRINT THIS STATEMENT.

I AM SO RELIABLE, I AM COVERED BY PANASONIC'S 2-YEAR LIMITED WARRANTY.

Panasonic KX-P1092 Multi-Mode Printer

Panasonic. That name already says a lot about the kind of reliability you expect from a computer printer.

But we don't just let our name speak for itself. Every Panasonic printer is backed by Panasonic's exclusive 2-year warranty. How many printers do you know of that can make that statement?

And speaking of strong statements, consider these, as well:

All Panasonic printers, whether dot matrix or daisy wheel, are compatible with today's most popular business computers.

All of them offer a variety of sophisticated advances you'd expect from a company like Panasonic. Like astonishingly legible compressed-letter styles available for easy-to-read spreadsheets on any of our dot matrix printers. Or an impressive array of word processing embellishments like boldface, shadow, underline and more on our daisy wheel printers.

All of them have Panasonic's seamless, endless, continually self re-inking ribbon so you can print clean and fast from the first character to the last.

And speaking of fast, you'll be able to print your documents at velocities of up to 240 characters per second.

Most printers feature time-saving bi-directional printing and logic-seeking. Some even have a built-in print mode or font selectable switch that allows you to change printing styles directly on the printer rather than through your computer.

But what really says the most about Panasonic printers is how well we back them: two full years, double the standard in the industry. See it at your dealer.

Need we say more?

(Oh, yes...for the dealer near you, call toll free: 1-800-PIC-8086.)



KX-P1080 Dot Matrix 100 CPS



KX-P1091 Dot Matrix 120 CPS

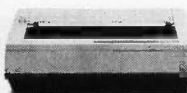

KX-P1092 Dot Matrix 180 CPS



KX-P1592 Dot Matrix 180 CPS



KX-P1595 Dot Matrix 240 CPS



KX-P3131 Daisy Wheel 17 CPS



KX-P3151 Daisy Wheel 22 CPS

## Panasonic Industrial Company



important also. Security can be enhanced by voice-activated door locks and by using smoke detectors that have feedback designed for "aged ears."

Voice technology might play an important role in functions such as reminding older people to take their medicines. A buzzer or bell gives only one level of communication: sound without content. Voice messages act as a more effective memory jogger by reminding people *what* they need to do.

We can apply principles already operating in natural-language database interfaces to this area. Several age-related considerations could be important in voice input and output and in a natural query language for older users. The jargon or slang of relevant decades could be stored and used to optimize a specific person's ability to communicate by using

familiar terms. For example, if you want to ask whether an older person wants to listen to the stereo, you might use words such as "record player" or "phonograph" to improve that person's understanding of the question.

Voice output could also be used interactively with human input to help maximize functional well-being. For instance, a smart system might ask its user, "Can you hear this?" and, based on the response (or nonresponse), adjust volume levels of various output devices. The system could also decrease or increase its speech output *rate* in order to increase intelligibility. In this way, it could temporarily or permanently adapt to changing user or environmental characteristics. Redundancy and repetition may also play important roles in successful use. In one research situation where we worked with older persons with

cognitive deficits, the guide rule was "everything in triplicate"—we repeated all instructions three times.

**CREATING A SAFER SMART ENVIRONMENT**

Another potential application for the aging or disabled person is the *smart card*—one or more microelectronic chips mounted in a piece of plastic the size of a credit card" (see reference 4)—which can contain a complete medical history and other relevant information and may provide an easy, secure way of interfacing with intelligent machines. If paramedics had card-reading machines, they could obtain vital health information very quickly in an emergency situation. Devices that can read such cards also have sufficient information about an individual to adapt its feedback, pace, and overall interaction to that person's

(continued)





**COMPUTEX TAIPEI '86**

Visit Computex and obtain a complete overview of the latest developments in Taiwan's dynamic computer industry. This year's show, to be held in the newly opened Exhibition Hall of the Taipei World Trade Center, will be the biggest and best Computex yet. Contact the organizer for full information.



**June 2-8, 1986  
Exhibition Hall,  
Taipei World Trade Center**

Organizer:  
 **China external trade development council**  
201, Tun Hwa N. Rd., Taipei, Taiwan, R.O.C. Telex: 21676 CETRA. Tel: (02) 7151515.  
Sponsor:  
 **Taipei World Trade Center**  
5 Hsin Yi Rd., Sec. 5, Taipei, Taiwan, R.O.C. Telex: 28094 TPEWTC. Tel: (02) 7251111.  
Branch Offices:  
**FETS Branch Office in Chicago**  
Telex: 253726 FAREAST TR CGO. Tel: (312) 321-9338.  
**CETDC, Inc.**  
Telex: 426299 CETDC NY. Tel: (212) 532-7055.  
**FETS Branch Office in San Francisco**  
Telex: 171521 FETS SF. Tel: (415) 788-4304-5.

Please Send Me More Information About The  
**Computex Taipei '86**  
Please tick:  I'm interested in exhibiting.  
 I'm interested in visiting.  
Name: \_\_\_\_\_  
Company: \_\_\_\_\_  
Address: \_\_\_\_\_  
Telex: \_\_\_\_\_  
Tel: \_\_\_\_\_

*People need support  
without isolation  
as well as the tools  
to help protect  
dignity and privacy.*

capabilities. For example, an automatic-teller machine could adjust its speech rate or volume when it detects a particular code on a smart card.

Smart-card technology could also be used to pay for home-delivered groceries ordered through a computerized television catalog. A nutritionist, as part of a home-care team, could maintain a minimum recurring order that the older person could add to. The smart card could pay for and inventory the groceries when they were delivered. In this way, a forgetful older person could obtain and pay for groceries and not have to worry about cash transactions or remembering to buy necessary foods and supplies. Such applications could help delay removing older people from their own homes, from independent living.

Emergency-alert systems provide an individual with immediate access to a health-care affiliate and enable a distressed individual to contact or signal neighbors, family, or professional help. In one European country, the personnel at the midway answering point have met the older users so that the person who responds to the call for help is not an unknown. This blending of a personalized approach with telecommunications technology offers security without isolation for many older people.

Electronic instrumentation enables us to monitor babies during birth, unstable heart patients, and other severely traumatized individuals in order to determine the well-being of a person "at risk." The capabilities of this technology have also been extended to include remote monitoring

of well individuals in potentially hazardous situations, for example, astronauts. By combining remote vital-signs monitoring with panic buttons, we can achieve an interactive biotelemetry that provides a chronically but not critically ill person with the physical and psychological security to remain in a home setting. Individuals who are unable to call for help are assured that "someone" will know when they are not functioning properly and will initiate assistance. We need to provide support without isolation as well as the tools to help protect dignity and privacy.

Ultimately, a total living environment that is smart enough to help maximize functional security and capability for a disabled, elderly person may be the best way to care for our growing over-85 population. The first steps to creating a smart, forgiving environment could incorporate current distributed-intelligence capabilities such as appliances (e.g., irons) that turn themselves off when they are not in use, stoves that buzz or speak to you (like the seat-belt reminder to buckle up), and programmed thermostats that help conserve energy.

Brody claims that the first integrated smart house will be built in 1986-87 (see reference 5) and will include appliances that can communicate with each other and with the occupants, environmental and appliance operation from a single TV-like remote-control device or through voice commands, energy-consumption management, and security through various sensing devices. Subsequent efforts could incorporate technological capabilities already utilized in the space program to monitor the health and well-being of a homebound older person.

#### CONCLUSION

While we as a nation have conquered many of the challenges of land, air, undersea, and space travel, we have not conquered the frontiers of our own aging bodies and minds. One of the first steps we need to take is functional rehabilitation. If we can provide

the assistance that will enable people of all ages and abilities to function at their highest level of performance, we will be taking giant steps forward. Using technology to serve human needs is not a novel idea. However, using evolving electronic innovations in this service role is still an exciting new field to be explored as we begin to understand our older citizens and their roles.

A new era of technology demands a new era of attitudes. The use of technology to augment human independence and dignity is a critical concern for each of us as we also age. Today's elderly have witnessed more rapid technological change during their lives than has any prior generation. Many of these people rode in horse-drawn buggies as children, drove family automobiles in their middle years, and now fly to visit their grandchildren. It is up to us to consider what technologies we want developed and available to us as our abilities also decline, so that we can live longer, more independent lives. ■

#### REFERENCES

1. Levine, S. P., N. L. Kirsch, M. Fellon-Krueger, and L. A. Jaros. "The Microcomputer as an 'Orthotic' Device for Cognitive Disorders." *Proceedings of the Second International Conference on Rehabilitation Engineering*, page 130. Ottawa, Canada: 1984; Washington, DC: RESNA.
2. Voorhees, James W. "The Integration of Voice and Visual Displays for Aviation Systems." *Journal of the American Voice Input/Output Society*, vol. 1, no. 1, June 1984, page 48.
3. Lawton, M. P. *Technology and Aging Conference*, Palo Alto, CA: March 1985.
4. McIvor, R. "Smart Cards." *Scientific American*, vol. 253, no. 5, November 1985, page 152.
5. Brody, H. "The Smartest House on the Block." *High Technology*, vol. 5, no. 5, May 1985, page 60.

#### ACKNOWLEDGMENTS

We would like to thank Margaret Gianinni, director of the Rehabilitation Research and Development Service of the Veterans Administration in Washington, D.C. for her support. We would also like to thank the staff and patients who have participated in our research at the VA Nursing Home Care Unit in Menlo Park, California and colleagues at PAVAMC.

# WE'RE TEACHING COMPUTERS AND VIDEO NEW TRICKS!

## INTRODUCING TELECOMP COMPUTER/VIDEO COMBINERS

Now, Add Full Color Video From Any Video Source To Your Micro-Computer Display. . .

### VIRTUALLY NO LIMIT TO THE APPLICATIONS

With just a few simple cable connections, TELEcomp lets you interface almost any micro-computer with virtually all video equipment without limitation. Imagine the new horizons your micro-computer can attain with the added power of video. Simulations become real! Demonstrations come alive! Instruction and training can be combined with data displays. Computer graphics and animations mixed with video take on a new dimension. Research and development groups, scientists, doctors, and trainers, to name a few, can generate computer data and make real-time video observations all on a single monitor screen.

### RECORD THE COMBINED OUTPUT ON VIDEO TAPE OR DISC

And with the TELEcomp 2000 Series, you can project the signal using any composite or RGB video projector. In fact, you can broadcast the signal or even transmit it by satellite for applications such as teleconferencing, because the TELEcomp 2000 returns an NTSC standard video signal, equal to the quality of the video input — with the computer output combined!

### USE WITH MOST MICRO-COMPUTERS. . . NO SOFTWARE REQUIRED

TELEcomp has been engineered to provide you with the maximum in benefits and versatility. TELEcomp interfaces with virtually all computers with TTL or composite video output. This includes IBM PC/XT/AT and compatibles, Apple, Commodore and countless others. Since TELEcomp does all the work, no software is required. Your computer remains free to run the software you want and to perform the jobs you need. TELEcomp's external peripheral design doesn't use up your computer's valuable board slots or memory.

### ADD, COMBINE, MIX OR SUPERIMPOSE VIDEO AND COMPUTER

TELEcomp incorporates full window control which permits you to place the video or computer image anywhere on the screen — from a dot to a full screen image (4 dials control the horizontal/vertical window image size). Overlay and source selector switches let you view either computer, video or combined image and then choose which source (computer, video or mix) is dominant. For more flexibility there's even an overlay intensity control. TELEcomp 2000 Series converts your TTL signal to composite video and provides 2 amplified video outputs along with analog RGB output. It even includes a built-in video sync generator in case you want to record, display or project your micro-computer's output when no other video source is present.

### MORE VALUE AND A LOT MORE FEATURES STARTING AT UNDER \$400.00

Order the TELEcomp you need. TELEcomp-1000 lets you combine genlockable B+W camera video with computers that have composite video output for only \$399.95. Choose the TELEcomp-2000M to combine monochrome computer output with any color video source for \$995.00. If your needs require color computer output combined with any color video source, order the TELEcomp-2000C for only \$1595.00.

### SPECIAL LIMITED TIME OFFER

Order a TELEcomp-1000 with our hi-res. B+W genlockable video camera. Get both for only \$599.00. Save over \$250.00.

### ORDER NOW. . . AT THESE INCREDIBLE BREAKTHROUGH PRICES!

All of the capabilities of the remarkable TELECOMP product are available now. With our 10 DAY RISK FREE TRIAL, you can order knowing that TELEcomp will perform to your satisfaction or we'll return your money! Don't delay, order now — call toll free 800-631-0867 and have your Visa, MasterCard or American Express card ready. Or order by writing to the address listed below, enclosing your check or money order with your purchase order. (Prices include shipping/handling; NJ customers add 6% sales tax).

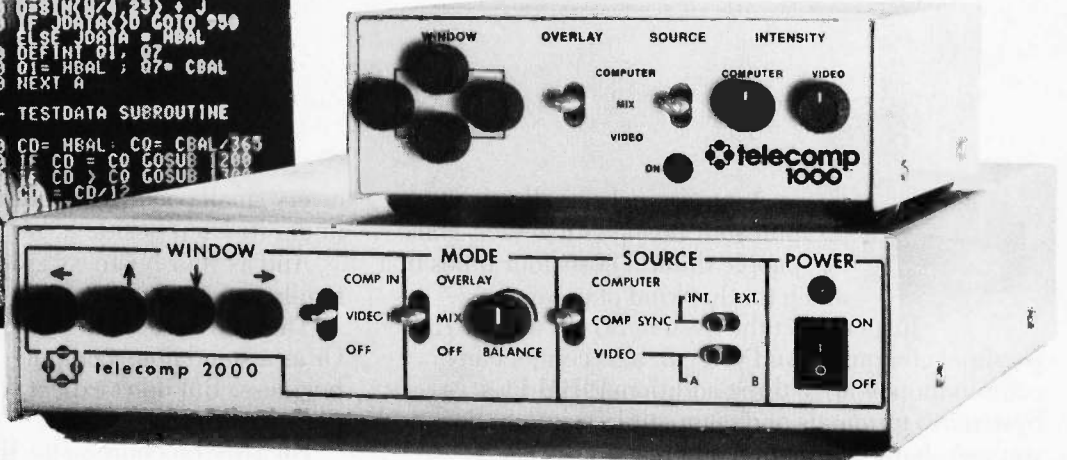
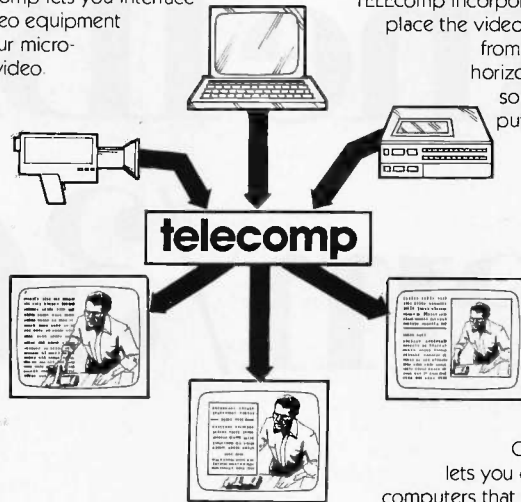

valiant:  
**universal  
micro**

195 Bonhomme Street, P.O. Box 488  
Hackensack, NJ, USA, 07602.  
International telex 919-804  
NJ call 201-487-6340  
Toll-Free 800-631-0867

**telecomp**  
COMPUTER/VIDEO COMBINERS™

Dealer, distributor and OEM inquiries are encouraged.

Inquiry 364

MARCH 1986 • BYTE 197

# A big feature of the IBM System/36 PC

\$5995\*



A surprisingly small price to pull your business together. Some people think it costs four times that much for this kind of power.

Just connect the System/36 PC to your IBM personal computer. And you can also connect any combination of up to three additional IBM PCs, System/36 terminals and compatible printers. So you can share information and resources.

Now you can work with the most popular PC software. And with thousands of business applications written for the System/36 family.

Another big feature: All this power comes in

a very small package. Place it on your desk. Or under it. Even beside it.

And as your business grows, the System/36 family can grow to fit your needs.

The IBM System/36 PC. Use it in a department. Or as a standalone computer for a small business. But don't expect your business to stay that size forever.

For a free brochure on the IBM System/36 PC or for information on product availability from participating Authorized IBM PC Dealers, Value Added Dealers or IBM Product Centers, call 1 800 IBM-2468, ext. 104/YY. Or call your IBM marketing representative.

\*Suggested Retail Price for a 256K, 40MB System/36 Processor.

# COMPUTING FOR THE BLIND USER

BY ARIES ARDITI AND ARTHUR E. GILLMAN

*Some special human factors must be considered  
in assembling a workable system*

INEXPENSIVE COMPUTERS and non-visual communications hardware have, in theory, made personal computing as accessible to blind as to sighted persons. But in practice, personal computing has its own special set of problems for the blind user. In this article we'll present some of the human-factors issues specific to non-visual personal computing. Our concern is to make computers more accessible and efficient for blind and visually impaired persons. We hope our suggestions will be useful to individuals and to designers of hardware and software. Many of the improvements we discuss below can be implemented in several ways, often in more than one component of the system. They are intended to illustrate human-factors issues rather than to critique specific products.

The system we use as a basis for this discussion is a popular one for blind and visually impaired users and is inexpensive enough for home use as well as employment settings. It consists of an Apple IIe microcomputer operating under DOS 3.3, a Votrax Personal Speech System for voice out-

put, and Raised Dot Computing's Braille-Edit program version 2.44a.

[*Editor's note: There is a more recent version of Braille-Edit with a number of new features and enhancements. See Henry Brugsch's review, "Braille-Edit," on page 251. Also, for an address list for manufacturers of products mentioned in this article, turn to page 208.*]

Most blind users have a printer for producing sighted (conventional) hard copy. Another useful peripheral is a braille printer, since braille hard copy is easier to proofread than voice output. While we will not specifically discuss braille hard copy, many of the human-factors issues discussed here are relevant to the design of braille printers.

Braille-Edit is an integrated software package designed to satisfy most blind users' needs to process documents. It is intended for use with a low-cost artificial-voice system such as the Votrax Personal Speech System or Street Electronics' Echo series (including the Echo+ speech synthesizer) and various other peripherals. Braille-Edit is not intended to (and does not) make all programs that run on the Apple accessible to the

blind user, nor is it particularly useful in programming the computer. But it has a number of desirable utilities for the blind user, such as a translator of text to and from grade II braille (a commonly used coding system similar to Speedwriting shorthand) that makes impressively few errors and a copy facility for copying files to and from a paperless braille such as the Versabraile from Telesensory Systems Inc. (TSI).

The hardware and software designed to make a system accessible to the blind user can be viewed as an in-

*(continued)*

*Aries Arditi, Ph.D., is a vision scientist and experimental psychologist in the Department of Research at the New York Association for the Blind (111 East 59th St., New York, NY 10022) and an adjunct associate professor in New York University's Department of Psychology.*

*Arthur E. Gillman, M.D., is a practicing psychiatrist and past director of research at the New York Association for the Blind. He is now clinical director of Central Westchester Community Services, Rockland Children's Psychiatric Center. He can be contacted at 34 Pryer Manor Rd., Larchmont, NY 10538.*

---

*Our concern is  
with the accuracy,  
speed, and generality  
of the blind-user  
interface.*

---

terface between the user and hardware or software that presumes that the user is sighted. Our concern is with the accuracy, speed, and generality of the blind-user interface. Accuracy and speed are areas in which data transmission to and from the computer can be improved by better design of the individual components of the interface or by the coordination or compatibility of the components. Speed and accuracy need to be balanced to produce the greatest levels of efficiency. Generality has to do with the scope of programs not specifically written for blind users that can be run by the blind user as a result of interface design.

#### **ACCURACY**

Inaccuracies in data interchange between the blind user and the computer arise from imperfect translations of normal input and output into the special modes of the blind user. The normal text output of the screen must not merely be redirected to a voice device but must also be translated into speech that effectively conveys all of the information on the screen. Similarly, if you type in braille, the braille text input must be accurately translated to standard computer text prior to processing.

One of the main functions of any voice-based software interface is to send the text that would normally go to the screen to the voice-output device. The fact that text data is not essentially visual is what makes the accessibility of computers to blind people possible in the first place. The voice peripheral receives streams of characters and pronounces either full

words or individual characters. Full-word pronunciation breaks up each word into likely phoneme or allophone strings based on its spelling. Even though there may be errors in pronunciation resulting from exceptions to these pronunciation rules, this scheme has the advantage of an unlimited vocabulary of pronounceable words. An excellent and readable discussion of issues relating to text-to-speech conversion can be found in reference 1.

Full-word pronunciation is desirable when the computer is prompting the blind user or conveying the results of its operations. For example, it is quicker and more natural for the system to pronounce "Enter selection" than to spell it out. Full-word pronunciation is also useful in editing documents, primarily as a means of finding your place in a document. But you cannot rely on artificial full-word text for other aspects of editing because text-to-speech conversion pronounces neither nonprinting characters such as space or tab characters nor punctuation symbols that are embedded in a text file. Typographical errors are also difficult to detect since they may result in only subtle if detectable pronunciation errors. For example, a voice device would pronounce "really" the same way it would pronounce "reelly" because it would analyze the two character strings into the same component phonemes (or allophones).

Spelled-pronunciation mode is the only viable way to know precisely which text characters have been typed and is therefore preferred for most editing and all proofreading. But even with spelled-pronunciation mode it may be difficult to distinguish between similar sounding letters such as "m" and "n" or "t" and "p."

The particular voice device you choose determines both the intelligibility of the artificial speech and usually the quality of the text-to-speech (full-word pronunciation) conversion. The "voice synthesizer" chip within the device is responsible for generating the sounds corresponding to each phoneme or allophone ele-

ment, and the discriminability of such sounds is largely determined by this chip. A microprocessor and memory, also parts of the voice device, typically perform the text-to-speech conversion. The time and memory taken by the algorithm that implements the conversion are important factors influencing the accuracy of the conversion. Although most speech devices allow you to control a number of speech parameters, such as speech rate, inflection, and pitch, through special commands or controls, none of the less-expensive speech devices has as yet incorporated these parameters into their text-to-speech algorithm. This would excessively reduce the speed and/or increase the complexity of the algorithm. The result is a usually intelligible but monotonous parade of pronounced phoneme strings separated by short pauses for word separation. The near future will undoubtedly bring us more natural sounding artificial speech at low cost.

Thus far, we have discussed problems translating text to voice. Translating braille to text poses additional accuracy problems. One way for a blind user to enter text into the computer is with a braille keypad or keyboard. The braille keypad can be simulated with an ordinary keyboard by using the space bar and the six keys on the lower tier of the keyboard. These six keys correspond to the dots of a braille character cell. With Braille-Edit you can choose to have whatever is typed show up on the screen as ordinary print-style text (through braille-to-ASCII conversion) or as visual braille, which is of some use to the sighted transcriber.

However, the lack of a one-to-one correspondence between ASCII codes and braille symbols causes significant problems. If the software doesn't take this into account, you will get garbage on the screen and gibberish through the voice device. For example, the "dot 6" character in braille signifies that the next character should be interpreted as uppercase. To have the text spoken out properly, the software that takes input

*(continued)*



*Software*

**"Your Money's Worth"**

**WORD  
PROCESSOR  
WITH MAIL-MERGE  
for the IBM-PC**

**\$89.95**

**Includes Spelling Checker**

**FILE RECOVERY  
SYSTEM**

**\$69.95**

**YES YOU CAN RECOVER  
ERASED FILES**

Even \*.\*. With Brown Bag™ Software's File Recovery System for the IBM-PC and compatibles, no programming experience required. If you can erase a file, you can restore it.

**MENU-DRIVEN and  
"FOOL-PROOF..."**

Do you have "one-of-those" in your office...we do too! That's precisely why we developed Brown Bag™ Software's File Recovery System for the IBM-PC and compatibles! Our menu-driven system is a snap.

**FIX A DAMAGED FILE TOO!**

Sometimes files can get "glitched," by a power spike? bumping into the hard disk, dropping the computer on the floor, etc. We understand. That's why we've included a full screen editor to repair any spot in any file, hidden or otherwise.

**IS IT HARD OR FLOPPY?**

We don't care. We work with floppy disk, most hard disks, and most IBM-PC compatible computers. And we are not copy protected.

**HELP IS ONLINE TOO!**

We know that most people don't read manuals. (But we include a comprehensive one anyway.) And when you erase a file and need it recovered NOW, you're not in any frame of mind to pour through any manual. We understand. That's why we've put hand-holding online. Just hit the ? key and the help appropriate to where you are and what you want to do is immediately available. The only thing better would be two aspirin!

**OTHER HANDY TOOLS...HELP:  
WHERE'D THE FILE GO?**

We provide menu-driven tools to change a file's attributes, change disk labels, modify screen color, locate a lost file that you know is somewhere on the disk, but it's lost in a maze of sub-directories (you forgot which).

To Order: CALL NOW

**408-395-9568**

**24 Hours A Day, 7 Days A Week  
Have Your Credit Card Handy**

**Brown Bag™ Software  
15100 El Camino Grande  
Saratoga, CA 95070**

**WE DO WINDOWS**

Brown Bag™ Software's Word Processor for the IBM-PC and compatibles allows you to edit two documents at the same time or edit two parts of the same document at the same time. You can choose the window size of your choice.

**FREE MAIL MERGE**

Brown Bag™ Software's Word Processor for the IBM-PC and compatibles comes with Mail Merge built-in, not an expensive add-on! This allows you to send out "form letters" that insert data, names and addresses from your favorite database.

**KEYBOARD MACROS INCLUDED**

Brown Bag™ Software's Word Processor for the IBM-PC and compatibles includes a built-in Macro Processor. This feature allows you to re-assign almost any key on the keyboard to a more favored one, or to assign commonly used text, boiler-plate, signature blocks, etc., to a keystroke. Save keystrokes, eliminate errors, increase productivity!

**POWERFUL EDITING FEATURES**

Like right and/or left justification, global search and replace including wildcards, un-replace, un-do, block moves, block copy and/or delete, word wrap, temporary and permanent margins, footnotes, headers, trailers (multi-line), mixed right and left pages, page numbering option, on-screen page breaks and more more more!

**PRINTERS AND FONTS GALORE!**

Brown Bag™ Software's Word Processor for the IBM-PC and compatibles includes drivers for 47 types of printers, including the new laser! Multiple fonts are standard too, including draft printing (high speed) options. Speaking of printing, we can print any document continuously (until you either run out of paper or terminate), a specified number of times or just once.

**GREAT DOCUMENTATION AND  
FREE TELEPHONE SUPPORT**

Brown Bag™ Software's Word Processor for the IBM-PC and compatibles comes with a 175+ page manual which includes a table of contents, index and tutorial. For those "Techie Types," we've also included a complete technical section. A limited amount of free telephone support is included for registered owners of this package, only. Additional telephone support is available at a time-based charge. This additional support is charged to Visa or Mastercards. Support is available Monday through Friday, 9 A.M. through 5 P.M. Pacific Time, normal business holidays excluded.

**COMPATIBILITY**

IBM-PC and most compatibles including XT, AT, JR, Compaq, Tandy PC's, Eagle, etc. 128K of memory is preferred. Monochrome display, single color, or multi-color mode, pick your own colors, or use our defaults, 24 editing lines. Use your existing word processor files, too! Requires 1 double-sided floppy disk drive. It runs on hard disks, and will use DOS 2.0 or greater sub-directory commands and path names.

---

*Rates of information exchange between the user and the machine will be inherently worse for a blind user.*

---

from braille-keypad mode and sends it to the screen or speech synthesizer must delete dot 6 characters and capitalize the first character of the subsequent word. This is fine for final copies of documents, but since this translation takes time, it is not really practical for writing and editing. To make the braille-keypad mode usable for editing documents, the voice-output device must be made to say "dot 6" or "capital" at the moment a dot 6 is encountered. This can either be done within programs like Braille-Edit, or it can be incorporated into intelligent voice-output-device firmware, whereby they can be made to run in braille mode, filtering out all special braille characters and making appropriate translations when the text is received.

A specific difficulty for systems using braille input resulting from the lack of one-to-one character correspondence is that if you are using the braille-keypad mode, two different systems for coding numbers may have to be remembered. Standard braille uses the convention of coding numbers as strings of characters whose ordinal position in the alphabet (for "a" through "i") is equal to the value of each digit in the number; each such string is preceded by a braille "#" character. For example, the two-character string "34" corresponds to the braille symbols for "#cd," a three-character string, and the print and braille translation facilities assume that numbers have been typed in the latter format.

But user commands that include numerical arguments (e.g., the command for "advance the cursor 34

characters") are best entered as Nemeth code, a system of braille used for mathematics, in which braille numbers are represented by a string of characters just as in ordinary braille. However, in Nemeth code, the number is not preceded by "#"; instead, each character in the number is shifted down one row in the braille cell matrix to distinguish the character as a digit. Because Nemeth code omits the "#," a Nemeth number requires the same number of characters to represent as a print-style digit string and therefore is much more easily translated into a string of ASCII digits.

These translation problems should not necessarily be solved with software. It would not be difficult, for example, to design a braille keyboard that emulates and could replace a standard keyboard. Likewise, a voice device could easily have a braille-to-voice conversion mode built into its firmware.

Another solution to braille-to-text translation problems is for the blind user to learn to type with a standard computer keyboard as Braille-Edit users do. This circumvents the lack of one-to-one correspondence between braille and ASCII codes entirely. By using spelled-pronunciation mode, you get immediate feedback as to which keys you have pressed. (Incidentally, small raised dots on the D and K keys of the Apple keyboard aid in finding the home keys.)

### **SPEED**

Rates of information exchange between the user and the machine will be inherently worse for a blind user than a sighted user because vision conveys text information more quickly than other sense modalities. The sighted user viewing a display screen can receive a screenful of information all at once, whereas the blind user working with artificial-voice output or a braille computer terminal receives information from the computer in serial fashion only and much more slowly than the sighted user. Because of this, increasing speed is especially important for the blind user.

A general design issue that greatly affects the speed of the blind-user interface is the choice of driving the program by menus or by command language. A menu lists on the screen all the options currently available and prompts you to select one. This has the advantage that commands need not be memorized, and thus the user does not need experience to run the program. In contrast, a command language generally provides only a prompting character such as "\*" to signal that the program is ready to receive a command. It takes time to learn a command language, but once you learn it, you can specify desired actions more tersely and more quickly than with a menu.

For the blind user, the menu format is especially slow because the menu must be listened to rather than seen. Also, since it is easy to forget options listed early in the menu, lengthy menus must often be repeated. For these reasons, we think command-language format is better for the blind user. Command languages often provide help-command supplements as teaching and mnemonic aids. The command language with help facilities combines the advantages of a menu with those of the command language because you can use a help menu while learning the program and avoid it when it would otherwise be unnecessary clutter.

Another bottleneck that reduces the speed of the blind-user interface is the difficulty in translating screen format to voice format. Redirection of the screen contents to the artificial-voice device makes the primary output of the computer intelligible, but a good deal more effort must go into making the output easily accessible to the blind user. Since so much software is screen-oriented, it is desirable to buffer the output to a "virtual screen." This virtual screen is an area of memory that contains one or more screens full of text and a virtual "voice" cursor. The virtual cursor may be moved about the virtual screen without affecting the contents of the ordinary terminal cursor. With key-

*(continued)*



# The big news in Toshiba 3-in-One™ technology is small.



## Introducing the compact version of P351 technology.

Meet Toshiba's P321 printer. It packs the power of 3-in-One technology into a compact new size. At an even more compact price.

### Three for all.

What is 3-in-One technology? It's the ability to offer the three things everybody wants in one narrow-carriage printer: speed, letter-quality type and crisp graphics.

It all comes from our Toshiba-designed 24-pin print-head. One that prints at a blazing 216 characters per second, has superb graphics ability and combines those with type that looks like a daisy wheel's.

So one P321 can actually replace three ordinary machines.

### Just like the big boys.

The P321 comes with downloadable type fonts,

optional IBM graphics printer emulation, plus year-in, year-out Toshiba reliability. In fact, the P321 gives you almost every office capability the giant machines do. Even spreadsheets.

Not bad for a printer with a footprint about two-thirds the usual size.

### Free font cartridge.

With the P321, you have an incredible array of font cartridges to choose from. A face for every occasion.

And while we're introducing the P321, you get a font cartridge FREE with each P321 you decide to buy.\*

Which should be an easy decision. It's the only compact printer that competes with larger machines on features. While it competes with lesser machines on price.

Call 1-800-457-7777, Operator 32 for your nearest Toshiba dealer.

\* Offer good through May 31, 1986

In Touch with Tomorrow

## TOSHIBA

TOSHIBA AMERICA, INC., Information Systems Division

Inquiry 356

stroke commands such as "Speak phrase at cursor;" the blind person can quickly read text anywhere on the screen. This feature has been incorporated in several "talking terminals;" in TSI's VERT, and in other recent software packages for the IBM PC.

It is important for the user to know the locations of both the actual and the virtual cursors, and there should be a command serving this function. Locations should be spoken out as line and column number rather than serial character position because it is easier to imagine location in two dimensions than in one. For example, it is of limited use to know that you are 323 characters into a page, especially when that page may contain 100 space characters.

Speed of use also depends greatly on the user's ability to adjust voice parameters of the system. Because intelligibility depends on many factors, including speech rate and sound-frequency content (or "pitch"), such controls should be accessible to the user in some way, whether by command or by knobs on the voice device itself. Your ability to understand the artificial voice improves the more you listen to it, and you can maximize efficiency by using the fastest speech you can understand.

There should also be some simple way to interrupt the voice device. A problem with our example system is that during output of long menus, the only way to terminate voice output is to turn off the power switch on the voice unit. Otherwise, you must listen to boring, lengthy menus you have memorized so thoroughly that it is irritating to have to wait for them to finish. Turning off the power on the voice device to clear its buffer and force it to silence also resets the unit. Then commands to set parameters such as speech rate must be sent all over again. A special key or button on the voice device could be dedicated to the "Abort voice output" function.

The choice of word processors versus text-file processors also affects user speed. These are two fundamentally different approaches in programs designed to aid document writing.

With what we call the "text-file processor" approach, you create a text file with commands embedded within the text to be executed later by the text-file-processor program. These commands do nothing to the text on the screen during an editing session but give the text a more pleasing spatial layout later, when the chapter is printed through the text-file processor. The embedded commands are, of course, filtered out and do not appear in the output.

A more popular approach with personal microcomputers is that of the word processor, in which editing and formatting the page are combined in the same process. Writing with a word processor makes the screen appear similar to the printed page that will eventually be printed out. As you type, the words are automatically arranged on the "page" to fit within the margins with the currently selected line spacing, etc. Commands such as "Center next line" are performed on the screen as soon as you issue them. For example, whereas the file to be formatted with a text-file processor might contain only \$\$\$ to signal that the next line should be centered when formatted, the word processor would insert the number of spaces needed for the line to be centered during the editing session.

Each approach has its advantages. Files to be text-formatted are much shorter because blank spaces and lines are added only when the file is processed. Also, you can make sweeping changes to the entire file with single commands such as "Set double spacing." For the blind user working with voice output, blank space and lines are abbreviated as commands such as \$a20 rather than being counted one by one as the voice device repeats "space, space, space, . . ." A disadvantage of text-file processors is that it is more difficult to imagine how the page will appear when printed out. Although this might not seem to be a drawback for blind users, in fact most blind people make use of spatial imagery in similar ways as sighted people (reference 2) and *do* imagine the spatial structure of

the printed page. Another disadvantage is that the command strings may be somewhat distracting when spoken out by the voice device in full-word pronunciation mode.

Advantages to the word processor are that the text need not be cluttered with the embedded commands, and you see the page in a form that is more similar to its printed appearance. A disadvantage is that since the text is being rearranged continuously during editing, words move about more. It may be difficult for the blind user to find words, since they rely more on the constancy of word positions in each line. Most word processors, however, allow you to enable and disable the automatic formatting facilities at will.

The choice of word processor or text-file processor generally depends on how the location of the cursor is represented and on how the voice system represents blank space. If cursor location is represented in character units, then the text-file processor is preferred because it is difficult to interpret a cursor location number due to the possibility of significant amounts of blank space. However, if line and column representation is used, and blank space can be spoken out in abbreviated form such as "20 spaces" or as nonspeech sounds representing spaces or linefeeds, then word-processor format is preferred because it is easier to imagine the final output.

### GENERALITY

Finally, generality must be considered in designing a system for the blind user. Although a system designed from the bottom up to serve only blind users would have obvious advantages for the blind person, a more realistic goal, and one that fosters better communication with sighted users and produces more employment opportunities, is to design a system that gives the blind user access to all general-audience software that is not intrinsically visual.

A flexible and general system should allow the user to customize

(continued)

# SOMETIMES GOOD IS JUST NOT GOOD ENOUGH.

*Frankly, there's a lot of good development software on the market today. But when your programming project is on the line, good isn't good enough. You need the best.*

*Because we're an independent publisher and distributor, we can pick and choose. We've been selling to microcomputer programmers since 1976, so we know quality when we see it.*

*Lifeboat offers each of the following popular software development tools and more... When we offer a product, you know it is the very best in its class.*

## LATTICE® C COMPILER

The best selling C compiler!

Additional 100 functions in the library. These include functions as simple as system time to complex functions such as critical error handling.

- Conforms to the proposed ANSI standards: enumerated types, void types, unsigned as modifier.
- Code is faster and smaller with 3.0.
- Inline 8087/80287 support.
- Fully compatible with current libraries.
- Support for 80186/80286.

In addition to the new features of 3.0, the *Lattice C Compiler* still provides the widest selection of C support tools, offers four memory models for optimum efficiency, is compatible with the C implementation established by Kernighan and Ritchie and gives you superbly written documentation.

*Lattice C Compiler 3.0* adds more reasons to the list of why software developers continue to choose *Lattice C*, the industry standard.

## RUN/C—THE C INTERPRETER™

Learn C the natural way with the *RUN/C* introductory package. Over 100 sample programs are included on the disk to coincide with the thorough and professionally written C reference manual. *RUN/C*'s user interface is similar to that of the BASIC interpreter with easy familiar commands such as LOAD, LIST, SAVE, EDIT, and RUN. Debug with TRON, TRACE, and PRON. Try your hand at graphics with easy-to-learn functions like PUT, GET, CIRCLE, LINE, SCREEN, and DRAW. Lighten up on the time it takes to learn C with *RUN/C*.

## RUN/C PROFESSIONAL™

New!

All of *RUN/C Lite*'s features, plus powerful enhancements for program development. LOAD and RUN, your favorite library functions from within your *RUN/C*™ interpreted code. Polish program modules before compiling. New source code debugging facilities allow you to set multiple breakpoints, single step through a program, and view and change variables during execution.

## GREENLEAF FUNCTIONS AND COMMUNICATIONS LIBRARY

New Versions!

*The Greenleaf Functions* are more than 200 powerful routines for the PC, AT and close compatibles, including DOS and BIOS capabilities. *The Greenleaf Functions* has string handling, color text capabilities and much more. Many functions are coded in assembler for speed and compactness. *The Greenleaf Communications Library* gives your programs asynchronous communications capability. Allows multiple simultaneous file transfers through an arbitrary number of ports at up to 9600 baud. Also supports XMODEM protocol and Hayes-compatible commands.

## GSS™ PRODUCTS

New!

Industry leading graphics software based on a commitment to standardization. Device independence and source code portability are assured with these powerful software tools.

**GSS DRIVERS™**—Provide a standard VDI interface between your PC and a wide variety of peripherals.

**GSS™ BINDINGS**—Provide an interface between the language source and the VDI. Bindings to Lattice C and the following MicroSoft languages are available: Fortran, Assembler, Pascal, Basic Compiler.

**GSS-TOOLKITS™**:

**Kernel System**—Subroutine library provides quality graphics for computer aided design and engineering. This toolkit adheres to standards described in Level 2b and the ANSI Graphical Kernel System (GKS) specifications.

**Plotting System**—Device independent subroutine library of two-dimensional plotting functions for creating programmer-specified charts efficiently and easily.

**Metafile Interpreter**—Converts any standard metafile to graphic output commands

## PANEL®

A powerful and flexible tool for interactive screen design. *Panel* simplifies the tedious screen design process enabling you to create and modify screens interactively from your keyboard.

*Panel* automatically generates source code describing the data-entry screen, including subroutines which dynamically load the screen at run-time.

With *Panel* you determine the content, position, size and attributes of screen and data fields at any point in the program's design or execution.

*Panel* handles the details of interfacing a wide variety of terminals, without changes in your program.

For immediate delivery or more information call:

**1-800-847-7078**

In NY:

**212-860-0300**

or write: **LIFEBOAT™ ASSOCIATES**

1651 Third Avenue  
New York, NY 10128



**"The Source For Programming Software With Full Support"**

the workings of the blind-user interface. You should be able to set all parameters of that interface while an applications program is running. Generally, this involves having either a separate keypad or switches on the voice device, or a special switch or command that redirects normal keyboard input to the voice device. This

approach would avoid the possible conflicts between keys (e.g., function keys) that are used both to operate the applications program and to control the voice device.

Some voice devices now allow considerable flexibility in speech style, including options such as whether numbers ought to be pronounced by

individual digits or as full words, how to handle abbreviations and acronyms, whether or not to signal punctuation symbols, etc. Some allow you to redefine pronunciations of words and thus correct deficiencies of the text-to-speech algorithm. Such options can be useful, but they must be easily accessible through hard controls or software. Our Votrax speech synthesizer, for example, has codes to set the speech rate and to abort speech, but Braille-Edit has no facility to send such commands. If the Votrax had separate knobs or buttons to control them, the system would be completely software-independent in regard to these functions.

Another important feature of the virtual screen with the virtual cursor described above is that it allows blind users to read portions of the screen that they would not be able to read with an ordinary cursor. An ordinary cursor is generally prohibited from moving into certain areas of the screen (protected fields, e.g., an area that displays current margin settings, tabs, etc.) where information is displayed constantly rather than being pushed off the screen (from scrolling) after the screen is full. With the ordinary cursor, the blind user has constant access only to those portions of the screen that have been explicitly directed by the program to voice output. But a virtual cursor can move within the protected fields, and you can read what would otherwise be hidden without affecting the actual cursor that must obey the boundaries set by the applications program.

Perhaps the major disadvantage of our example system is that it is not possible for us to run any applications programs that are not specifically designed for the blind user. Braille-Edit is a useful program that performs all the functions featured on its menus and probably makes the Apple II computers more accessible to blind people than any other system, but greater flexibility can be achieved by systems that modify or extend the operating-system facilities.

Most applications programs send

(continued)

# You already own a computer that can talk. Now let it.

Now you can upgrade almost any personal computer and make it more powerful than ever, by giving it the power of speech.

The Votrax Personal Speech System is the least expensive sophisticated voice synthesizer available today. The PSS's text-to-speech vocabulary is virtually unlimited, and you can define an exception word table and customize your translations. So the PSS can say just about anything!

## It's a speech and sound specialist.

The PSS can also mix speech and sound effects or speech and music. It contains its own speaker, a programmable master clock, 256 programmable frequencies, a programmable speech rate for a more natural rhythm, and 16 programmable amplitude levels for incredible control of word emphasis. You can control the volume. Plus, it doesn't use any of your computer's valuable memory.

## It's computer friendly.

The PSS is unbelievably easy to use. It doesn't need an interface card for most computers. It comes with standard serial and parallel ports. Speech, music, and sound effects are as simple as printing out a document.

## What do you do with a talking computer?

There are countless practical applications. Businesses may want the PSS for spoken transmission of information, narration of displays, and product demonstrations. It makes verification of data input possible for the blind. It can be part of a burglar alarm system. Children can use the PSS as a study aid. And it helps games come alive, speaking while you play.

Whatever your computer can do, the PSS can help it do it better, at a cost that makes it all worthwhile: only \$395.\* Call (313) 583-9884 to hear an actual voice demonstration of the PSS.

## There's also the Type 'N Talk.

If you want a less sophisticated unit and want to spend a little less, consider the Votrax Type 'N Talk (TNT). Its vocabulary is also limited only by what you can type. It doesn't use any computer memory, it's compatible with most computers, and it's only \$249.\* Just plug it in to your own speaker and go!

For more information about the Personal Speech System or the Type 'N Talk, see your local computer retailer, call toll-free or write:

**votrax**

1394 Rankin  
Troy, Michigan 48063  
1-800-521-1350  
(In Michigan, call collect  
313-588-0341)

GIVE YOUR  
COMPUTER  
THE POWER OF  
SPEECH.



\*Suggested retail price

# It's not just that COMPAQ 286 Computers are getting rave reviews...

## It's why.

Since we introduced the COMPAQ DESKPRO 286® and COMPAQ PORTABLE 286®, the accolades haven't stopped:

*InfoWorld:* "(COMPAQ DESKPRO 286 is) a superb performer. It races through its tasks with efficient competence and heartwarming speed. Most IBM PC programs worked much faster than on the PC or XT. Wordstar's speed is a joy. Lotus' 1-2-3 zips along... this machine will outperform the AT."

*PC Week:* "...the machines IBM should have built." "...significant user advantages over IBM's machine... a standard dual-mode monitor, reliable tape backup, ... better construction than IBM's, an impressively fast drive and other little extras—at a price below similarly configured IBM's."

*Popular Computing:* "...genuine enhancements, such as higher CPU speed, greater RAM capacity, portability, ... greater hard-disk capacity, and an optional tape backup unit."

Why are the COMPAQ® 286 computers getting such rave reviews? They simply work better.

For a free brochure or the location of your nearest Authorized COMPAQ Computer Dealer, call toll-free 1-800-231-0900 and ask for Operator 13.

©1985 COMPAQ Computer Corporation. All rights reserved.



**COMPAQ®**

It simply works better.

output and receive input through these facilities. Almost all, for example, request the operating system to type characters on the screen rather than writing a new section of program to perform this task. They do this both because it is easier and because it maintains the generality of the program; i.e., the program will run on all machines that use the same operating system. If the operating system is modified so that all screen output also automatically goes to a voice synthesizer, then virtually any program that is run will send whatever ordinarily goes to the screen to the voice output as well. Operating-system modifications would have the generality that allows programs not written for blind users to be accessible to them nevertheless. In this way, blind and sighted users can work together, using the same software. Braille-Edit is not this kind of modification—it is simply a good applications program written for the blind user. The alternative to operating-system modification is that each commercial program that is devel-

oped will require parallel development of a blind-users version of that program.

In recent months several new systems have been offered commercially that do work by these principles. One is TSI's Professional VERT, a voice-output hardware and software configuration for the IBM PC that we have not evaluated. Another is an operating-system modification and addition called The Enhanced PC Talking Program (from Computer Conversations). This program also runs on the IBM PC and will work with most inexpensive voice-output peripherals, although the Votrax Type-'N-Talk is recommended. Another similar, more recent package for the IBM PC from Computer Aids Corporation is called Screen Talk. Both VERT (with an additional plug-in board) and The Enhanced PC Talking Program can emulate several popular computer terminals, making them especially attractive in employment settings. Finally, Maryland Computer Services' Total Talk PC system is a talking version of the Hewlett-Packard HP 150 Touch-

screen personal computer. Yet another system, a passive screen reader card for the IBM PC, currently being developed by Tim Cranmer and others at the National Federation of the Blind, will not modify or add onto the operating system but will receive and interpret all data sent to the video screen buffer, so that even programs that bypass operating-system calls to write to the screen can be run.

The rapid introduction of so many new systems illustrates how rapidly the field of making computers accessible to blind persons is growing and becoming more competitive. Undoubtedly the capabilities of computer hardware and software designed for blind users will continue to grow in parallel with the capabilities of systems designed for sighted users.

For a microcomputer to be as accessible as possible to blind people, designers must interface the system to the blind user at as primitive a level as possible. If the computer's operating system "thinks" it is receiving standard keyboard input but is in fact receiving braille that is translated before it is received by the operating-system software, then any program that uses the keyboard ought to be able to use braille entry as well. Similarly, if the operating system "thinks" it is sending output to a screen but actually sends it to a buffer that holds as much as a screenful or more, the blind user can peruse desired sections of it much the same way as a sighted person, for whom the program was originally designed. We hope that our observations have provided some structure to the various problems in designing a blind-user interface. We feel that solutions to the problems we have described will contribute to the more efficient and broader use of computers by blind people. ■

REFERENCES

1. Stoffel, David. "Talking Terminals." *BYTE*, September 1982, page 218.
2. Kennedy, J. M. "Haptic Pictures." *Tactual Perception*, W. Schiff and E. Foulke, eds. New Rochelle, NY: Cambridge University Press, 1982.

PRODUCTS MENTIONED

SCREEN TALK

Computer Aids Corp.  
124 West Washington, Lower Arcade  
Fort Wayne, IN 46802  
(219) 422-2424

THE ENHANCED PC TALKING PROGRAM

Computer Conversations  
2350 North Fourth St.  
Columbus, OH 43202  
(614) 263-4324

TOTAL TALK PC

Maryland Computer Services  
2010 Rock Spring Rd.  
Forest Hill, MD 21050  
(301) 879-3366

BRaille-EDIT

Raised Dot Computing Inc.  
408 South Baldwin St.  
Madison, WI 53703  
(608) 257-9595

ECHO+

Street Electronics Corp.  
1140 Mark Ave.  
Carpinteria, CA 93013  
(805) 684-4593

VERT

VERSABRAILLE  
Telesensory Systems Inc.  
455 North Bernardo Ave.  
Mountain View, CA 94043  
(415) 960-0920

PERSONAL SPEECH SYSTEM

TYPE-'N-TALK  
Votrax Inc.  
1394 Rankin Dr.  
Troy, MI 48083  
(313) 588-2050



# A FRIEND INDEED.

Face it. Everybody needs somebody some-time. And even the best PC occasionally needs help with faulty power.

So give your hard disc or critical-use system LINE 2<sup>®</sup> power conditioning. And eliminate those nagging problems that your PC can't prevent. Like voltage sags and surges. Brownouts. Spikes.

LINE 2 Power Conditioners are designed

specifically with your PC in mind. High inrush currents don't affect them. Neither do power problems. And they're amazingly economical.

A LINE 2 Power Conditioner can be your PC's best friend. And a friend in need is a friend indeed. Call us today at (619) 279-0831, or contact your local Square D distributor.

**TOPAZ**<sup>®</sup>  
SQUARE D COMPANY

# Have It Your Way

## IBM PC/XT SYSTEMS



**MAINSTREET  
ENHANCED  
XT \$2284**  
with 20 MB Hard Disk

Same System with  
32 MB Hard Disk

**\$2504**

Monitor sold separately

- 360kb Tandon Floppy
- 20 MEG ADEPT Hard Disk
- 256K RAM
- All Cables, Manual
- 1 Year Warranty

Many Options Available

## IBM PC/AT SYSTEMS



**MAINSTREET  
AT PLUS  
\$3988**

**20 MB System  
Includes:**

- 1.2 MB Floppy
- 360 KB Floppy
- 512K RAM
- 20 MB Hard Disk
- Serial/Parallel/Clock
- All Cables, Manual

Same System with  
32 MB Hard Disk

**\$4211**

Monitor sold separately

### MORE IBM SYSTEMS FROM MAINSTREET

**SUPER XT  
\$2873**

- 256K RAM
- 360K Floppy
- 20 MEG
- Tape Drive
- 135 Watt

**Slot Saver  
\$2566**

- 20 MB Hard Disk
- Persyst Video Combo
- 3 Slots Available
- 2.360K Floppies

**SUPER XT+  
\$3107**

- 640K RAM
- 2 Floppy
- 20 MEG HARD
- Tape Backup
- Quick Six
- 135 Watt Power

**PC 2/20  
\$2135**

- 256K RAM
- 2.360K Floppies
- 20MB Hard Disk

**AST**

- Sixpack Plus with 384K ... \$245
- Advantage ..... \$399
- Rampage ..... \$349
- I/O Plus ..... \$129
- Mega Plus II ... \$294

Call for latest RAM prices.



### Printers

EPSON FX-85 CALL \$929	TOSHIBA 341 \$939
EPSON LQ-1500 \$529	NEC E•L•F \$449
EPSON FX-185 \$529	CITIZEN MSP-10 \$299
EPSON LX-80 \$229	OKIDATA 182 \$239
TOSHIBA 1340 \$569	OKIDATA 192 \$349
TOSHIBA 351 \$839	OKIDATA 193 \$549
TOSHIBA 1351 \$999	OKIDATA 84 \$759

**BACK-UP  
POWER  
ADEPT™**

- DataShield AT 800 ... \$689
- Back up power 800 Watts
- DataShield XT300 ... \$369
- DataShield PC200 ... \$285
- DataShield AT500 ... \$559

**SURGE  
Protection**

- DataShield S100 ..... \$59
- DataShield S85 ..... \$49
- DataShield S75 ..... \$36
- Kensington Masterpiece ..... \$95
- Computer Accessories



**COMPAQ  
DESKPRO™**

**20 MB System  
\$2931**

- FAST 8086 Processor
- 640K RAM
- 20 MB Hard Disk
- 2 - 360kb Floppy
- High Resolution Monitor
- All Cables, Manual
- 1 Year Warranty

**Tape Back Up  
10 MB \$525  
20 MB  
\$739**

TO PLACE YOUR ORDER CALL  
**1-800-426-MAIN**

**MAINSTREET  
COMPUTER CORPORATION**  
1025 Main St. Bastrop, Texas 78602 512-321-4406  
ORDERS: 800-426-6246, 800-252-3404 (Texas) M-F 9-6 Sat 9-3

**Desk Pro 286**  
■ 256K Ram  
■ 1.2 MB Floppy  
■ 20 MB Hard Disk  
■ Monitor  
**\$4878**

**COMPAQ**

**COMPAQ Portable  
\$2466**

256K, 360KB Floppy,  
10MB Hard Disk

**\$2709**  
with 20 MB  
Hard Disk

**ORDERING INFO:** All Mail: 1025 Main St., Bastrop TX 78602. We accept personal and corporate checks. No delay if driver's license and expiration included. Shipping is free on prepaid orders via UPS Ground. Air is extra. We accept VISA, MC, (Am. Exp. and Diner's Club = 3% surcharge.) We double manufacturer's warranty on all hardware. Software is not returnable. All goods are new.  
TELEX 5106007038-MAINSTREET-UQ 8386



# At Mainstreet Computer

## ADEPT™ PC SYSTEMS



# \$749

### ADEPT™ Personal Computer

- 640K RAM
- 360Kb Floppy
- "Touch Type" Keyboard
- 1 Year Warranty
- Runs IBM™ Software

Same System with  
20MB Hard Disk

# \$1228

30 Day Trial / 100% Credit  
Towards IBM PC

Monitor sold separately

**ADEPT**  
SYSTEMS

## ADEPT™ AT SYSTEMS

# \$1975

### ADEPT™ AT

- 80286 Microprocessor
- 1.2 MEG Floppy Drive
- Hard Disk Controller
- "Touch Type AT" Keyboard
- Runs IBM PC, XT, AT Software
- 8 Full-Size Expansion Slots
- 1 Year Warranty



Add 20MB Hard Disk  
For Only **\$329**

Monitor sold separately

### "Our #1 Seller" Quick-Six Multifunction Board **\$139**

- Serial Port
- Parallel
- 384K RAM
- Clock/Calendar
- RAM Disk Software
- Print Spooler

For A Limited Time

Includes Homebase  
\$49.95 Value FREE



### AT E•X•P BOARD

- 128K - 3MB RAM Capacity
- Serial Port
- Parallel Port
- For IBM or ADEPT AT

# \$289

128K

### MONO/COLOR GRAPHICS BALANCE II

# \$259

- | GRAPHICS                  | TEXT             |
|---------------------------|------------------|
| • 720 x 348 Mono          | • 80 x 25 Mono   |
| • 640 x 200 Color         | • 132 x 44 Mono  |
| • Color Emulation On Mono | • 80 x 25 Color  |
| • Plantronics Compatible  | • 132 x 25 Color |

MONO/GRAPHICS  
BALANCE I — **\$199**

### HIGH SPEED TAPE BACK-UP

# \$739

20MB

Backs up 20 MB in  
less than 10 minutes

60 MB

# \$899

Similar to TECMAR  
QIC-60

### HARD DISKS by ADEPT™

# 20MB \$479



- Half-Height
- Complete System
- Easy to Install
- Mounts Internally
- 1 Year Warranty
- Works In Most IBMPC Compatibles

32MB - **\$695**

For really FAST access, call our  
hard drive specialist — 800-426-6246

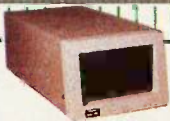

### ADEPT™

20 and 32MB... From **\$684**  
20 MB

#### Combination Systems

HARD DRIVE	TAPE	PRICE
20 MEG	20 MEG	\$1379
20 MEG	60 MEG	\$1654
32 MEG	60 MEG	\$1870

A perfect match! Colors and casing to conform with your IBM or ADEPT PC. In two convenient models to suit your space requirements. Add hard drives in 20, 32 or 40 megabytes. Cartridge tape backup in 20, or 60 megabytes. Combine hard drive and tape backup for complete storage solutions. All units come with power supply, cables, software and manual.

### EXTERNAL STORAGE



20 and 32MB... From **\$724**  
20 MB

#### Combination Systems

HARD DRIVE	TAPE	PRICE
20 MEG	20 MEG	\$1419
20 MEG	60 MEG	\$1694
32 MEG	60 MEG	\$1915

IBM, XT and AT are trademarks of International Business Machines Corporation. Compaq is a trademark of the Compaq Corporation. All brands are registered trademarks. Prices are subject to change without notice.

24 Hour  
Bulletin  
Board  
Service  
UPLOAD  
SIGS  
MAIL  
DOWNLOAD  
ORDERING  
12-321-7317  
All Non-  
Order Calls  
12-321-4406

**ORDERS**  
800 426-6246  
In Texas  
800 252-3404

Mainstreet Computer  
1025 Main St.  
Bastrop, TX 78602

Hours:  
Mon-Fri: 9 am-6 pm  
Saturday: 9 am-3 pm

**SOFTWARE**—Many titles available 800 426-6246

Lowest Inquiry 218 Call for Latest Version and Price  
Examples— Borland Superkey \$35 Copy II PC \$25  
Multimate \$238 Norton Utilities \$49



# Reviews

---

<b>REVIEWER'S NOTEBOOK</b>	
<i>by Glenn Hartwig</i> . . . . .	<b>215</b>
<b>KAYPRO 286i</b>	
<i>by Harry Krause</i> . . . . .	<b>217</b>
<b>MODULA-2 SYSTEM FOR Z80 CP/M</b>	
<i>by Brian R. Anderson</i> . . . . .	<b>225</b>
<b>POCKET APL</b>	
<i>by Eric H. Johnson</i> . . . . .	<b>237</b>
<b>ARITY/PROLOG</b>	
<i>by William G. Wong</i> . . . . .	<b>245</b>
<b>BRILLE-EDIT</b>	
<i>by Henry Brugsch</i> . . . . .	<b>251</b>
<b>PRINTIT</b>	
<i>by Henry Brugsch and Joseph J. Lazzaro</i> . . .	<b>261</b>
<b>REVIEW FEEDBACK</b> . . . . .	<b>265</b>

---

THIS MONTH'S SECTION starts with an in-depth look at one of the proliferating generation of machines based on the 80286 processor, the Kaypro 286i. A fact about the machine, which is either a benefit or a defect depending on how you view the IBM PC AT, is that the two machines are so close as to be nearly indistinguishable. On the other hand, there is a wide gulf between the prices that our reviewer, Harry Krause, found advertised for the IBM PC AT and the Kaypro 286i.

Reviewer Brian R. Anderson looks at a Modula-2 compiler system for Z80 CP/M from Hochstrasser Computing AG. Mr. Anderson begins by noting that the close association between the authors of the compiler and the author of the language led him to expect a high-quality product. He reports that his expectations were fulfilled.

Eric H. Johnson begins his review of Pocket APL by noting that its cost and special hardware requirements have hampered the spread of a generally popular language outside academic or corporate environments. Now comes a new version of the language that runs in as little as 128K bytes of memory and requires no special hardware. On top of that, it's a complete implementation of the language. Drawbacks? Some. Are they serious? Not if you use the language as a learning tool or to write fairly small programs.

Arity/Prolog is an implementation of Prolog for MS-DOS systems and, says reviewer William G. Wong, one that matches implementations found on a number of mainframes. Given the fact that this version of Prolog is not cheap (you can pay from \$495 for the base version Prolog interpreter to a whopping \$1950 for a native-code compiler with the interpreter), you would expect it to have something going for it. In Mr. Wong's view, it does indeed.

Braille-Edit from Raised Dot Computing is a word processor that utilizes just about every kind of input and output not dependent on sight. For example, you can print to braille or print to paperless braille (storing braille characters on magnetic tape), you can run it on a variety of speech devices, and you can write files in braille using dedicated keys on the computer keyboard. One of the things blind computer users have long complained about is that products for them were simply shoddy, that they didn't represent a large enough "market segment" for vendors to take seriously. Reviewer Henry Brugsch gives careful consideration to the overall quality of this talking word processor and delivers his judgment on how well Braille-Edit conforms to or rebels against that trend.

In our final review, we hear again from Henry Brugsch, this time collaborating with Joseph J. Lazzaro on a discussion of Printit—a card that lets you print anything you can get up on your Apple II's screen. Printit can also send any nongraphic data to a speech-output device. If you want your software package to "talk," and it won't do so in any other way, Printit will let you hear any text you can get on the screen.

# TODAY PROGRAMMING BECAME A THREE LETTER WORD



The Artek Ada compiler is the most advanced implementation of Ada available for personal computers. Fast and efficient, the compiler increases programming productivity and cuts costs.

## Ada is here to stay

Ada is the most powerful general purpose language available today. It was designed for the largest user of computer hardware and software in the world (a nonprofit organization commonly referred to as the U.S. Department of Defense). Billions of dollars have already been invested in Ada projects, and there is more to come. Ada is unquestionably the computer language of the future. It will be used to program everything from spreadsheets to space stations.

## Artek Ada: A new standard in software engineering

Ada provides you with powerful facilities for modular programming and separate compilation. Reusable components (generics) save costly code re-writes. Software reliability is ensured through Ada's inbuilt error handling. System programming features provide low-level access to hardware while the language's standardization guarantees portability.

## Artek Ada: The most advanced Ada compiler for personal computers

Artek Ada implements the DoD's 1983 Ada standard, including

generics, derived types, overloading, packages, separate compilation, dynamic arrays, standard I/O, string handling, array and record aggregates and much more. The only major Ada feature not implemented is tasking. Minimum hardware requirements are: IBM PC or a compatible computer running MS-DOS or PC-DOS (2.0 or later versions) with 384 Kb RAM and one double sided floppy-disk drive. Artek Ada works with the IBM PC network. For further information see our information kit.

## Artek Ada is available now

You can order the Artek Ada compiler now for only \$ 895.00 including a debugger and a screen editor. Outside the U.S.A. add \$ 20.00. A demo diskette is also available for \$ 29.95 (including p&p anywhere in the world). Ask for our free information brochure. For orders or information call toll free 1-800-PC-ARTEK, in New Jersey or outside the continental U.S.A. call (201)-867-2900, or write to our address. VISA, MC and AMEX accepted.

New Jersey residents: Add 6% sales tax. Please pay with credit card or a bank draft, payable in U.S. dollars drawn on a U.S. bank.

Dealer and distributor inquiries welcome.

**A** r t e k

Inquiry 29

Artek Corporation 100 Seaview Drive Secaucus  
NJ 07094

Artek is a trademark of Artek Corporation.  
Ada is a trademark of the U.S. Department of Defense, AJPO.  
IBM and PC-DOS are registered trademarks of International Business Machines Corporation.  
MS-DOS is a registered trademark of Microsoft Corp.

# REVIEWER'S NOTEBOOK

We've been concerned by what we thought were electrical power problems, so when we saw a power-line monitor designed to work with micros, we felt that this was something we ought to explore. It's called the Powertrac and it comes from Vertex Systems Inc. in Los Angeles. It consists of a power-line interface that plugs into your computer's serial port. From there, a connection leads to an Atari plug-in power supply that you slip into a wall socket. So much for setup. The software is a disk with programs for collecting data on power-line conditions. It'll function as a background data logger if you want to leave it on and running while you go about your normal tasks. When you decide you've sampled an interval long enough, you pull a report. You can also use it as a real-time monitor with a graphics display that simulates a strip recorder. Another graphics display shows up as a crude oscilloscope to help you point out voltage spikes and high-frequency noise. The version we got is for use with the IBM PC, but there's also one that works with the entire Apple II series. The company notes, however, that the background data logger only works on the IBM PC version.

Powertrac generally seems to work pretty well. It's actually kind of fascinating to watch it redraw the graphs every minute or so. Major problems tend to be spectacular enough that we're not really interested in calm, rational responses. But in the normal course of things, you could probably use the Powertrac to make a case for calling in the electrician or asking your next-door neighbor to shut off the arc welder. The Powertrac would probably be a handy thing to have if you moved your computer around a lot and wanted to be sure you weren't deal-

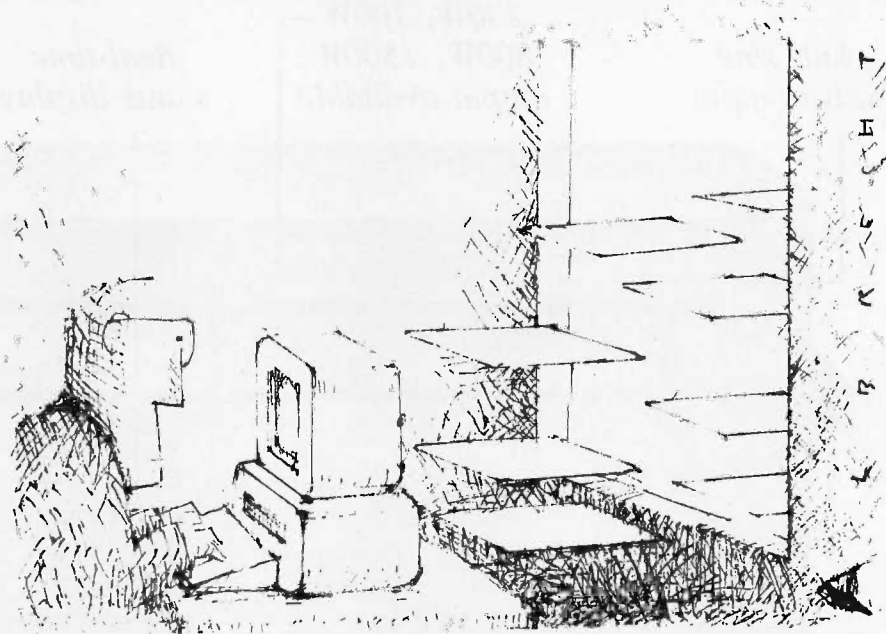

ing with a flaky electrical system before you got too deeply involved in an important application.

Super Utility, from Powersoft Products in Dallas, is a repair kit for damaged data files. You use it, first and foremost, to unerase files that you've accidentally gotten rid of. Beyond that, however, it has functions to edit, verify, or modify sectors, copy sectors to files, do sector diagnostics, map file-allocation tables for individual files or whole drives, edit directories and subdirectories, rename files, set their attributes, and do string searches.

This is the same company that makes the popular disk utility program of almost the same name (Super Utility Plus) for the TRS-80. They put a notice in their sales flyer that Super Utility PC is not SU+ "ported over" from the Tandy line. Fair enough, but if you're already familiar with SU+ you'll be on more familiar ground.

I think one of the nicer aspects of Super Utility is the fact that it's very simple and straightforward. The company seems to have remembered that someone who's just erased a file or a disk is not going to be in the mood for lighthearted banter that gets in the way of quickly and faultlessly restoring all that lost work. The directions in the little documentation pamphlet

are clear and to the point.

Once you call the program by typing `su`, you get a screen with a copyright notice, and it also tells you to hit the escape key if you're having a hard time reading the screen. It does this because it's normally set to work with a color monitor and can be unreadable with some monochrome units at first. Once you tell it, in effect, what kind of monitor you have, you go right to a menu that asks you what you want to do and it lets you do it.

When you want to unerase a file, the program shows you a DOS directory of your disk. Those that have been erased—but not yet overwritten—will flash and are printed on the screen with the first letter of the filename missing. You supply the missing letter and the program gives you a screen full of data, asks you if it looks like the data you're trying to restore, and tells you to press the return key if it is. It samples each cluster of likely data and you restore the file, or program, in increments.

Powersoft says you can use Super Utility with the IBM PC, XT or AT and such compatible computers as the Compaq, AT&T 6300, and Tandy 1000, 1200, and 2000. It's being introduced at \$89.95 and looks like something that would be a comfort to have around.

Glenn Hartwig  
Technical Editor, Reviews

# “Power Protection”

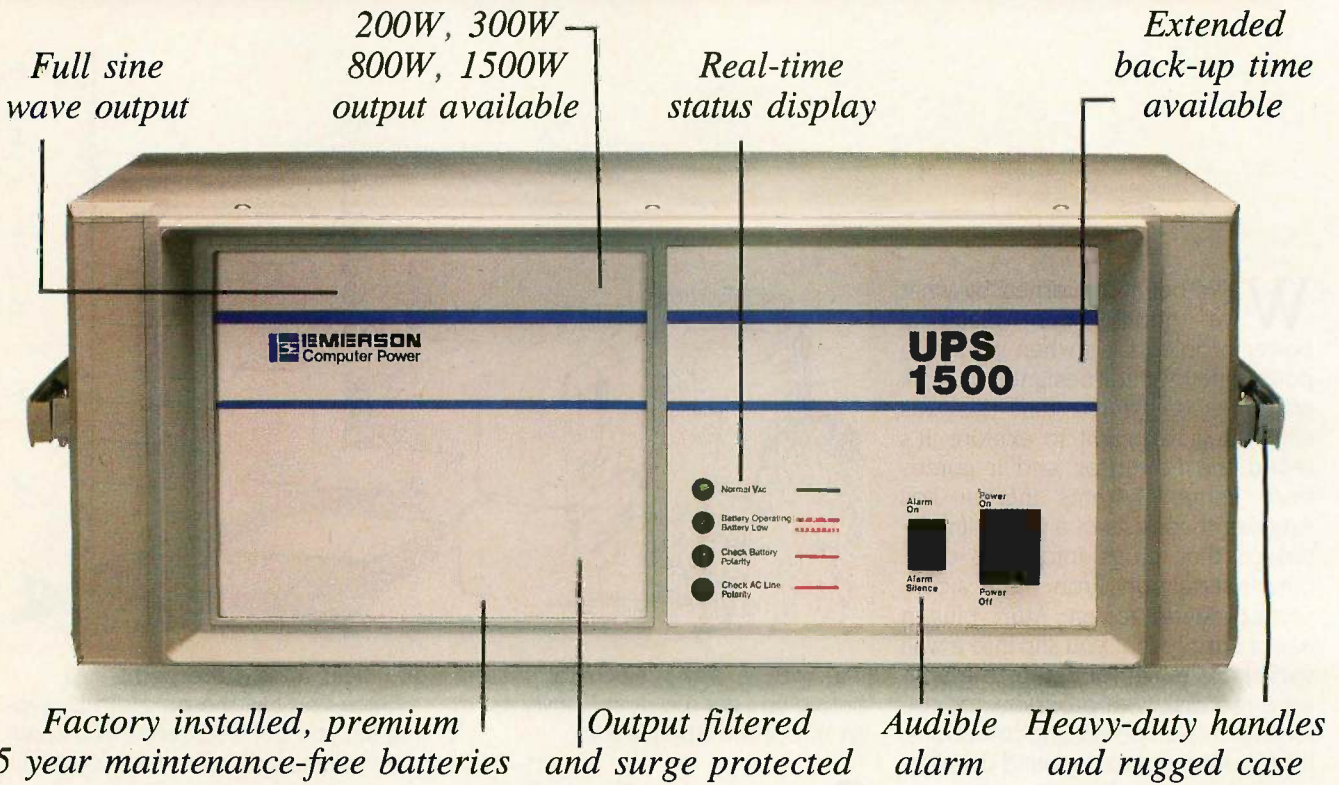

## Announcing: AP1000 Series UPS Full sine wave UPS for low power applications from Emerson, the Technology and Price Leader in Uninterruptible Power Systems

Your electronic equipment depends upon clean uninterrupted power. If that power is disturbed by “Black-outs”, “Brown-outs”, Spikes or Surges, your equipment could be damaged and memory lost. Your valuable system becomes worthless.

### Do you have these?

P.C.'s, office computers, ATM's, PBX's, Point of Sale Terminals, Security Systems, or Test Equipment. They could be vulnerable to power-line disturbances.

Now they can be economically protected with the new Emerson AP1000 Series UPS with power ratings from 200-1500 watts and starting at \$379. From 200VA to 4,000 KVA, Emerson has you covered.

For a free Technical Brochure and the Distributor/Dealer nearest you, call toll free 1-800-BACK-UPS. Emerson Computer Power, 3300 S. Standard St., Santa Ana, California 92702.

CALL  
1-800-BACK-UPS  
For Your Free  
Technical  
Brochure



**EMERSON**  
Computer Power



# Kaypro 286i

An AT clone  
at a good  
price

BY HARRY KRAUSE

**T**he Kaypro 286i, a well-designed and well-manufactured clone of the IBM PC AT, is widely available from retail dealers at what appear to be bargain-basement prices.

The \$4450 list price (about \$1000 less than a similarly equipped IBM PC AT) includes 512K bytes of RAM (random-access read/write memory), two 1.2-megabyte floppy-disk drives, a built-in battery-backed clock and calendar, a color-graphics driver board, two built-in parallel ports and a nine-pin serial port, an RGB (red-green-blue) monitor, and a large assortment of software. However, you can obtain the computer far below the list price; local Kaypro dealers in the Washington, DC, metropolitan area advertise the basic system for \$3000, or about \$2500 less than a similar IBM product. One dealer offered the machine with a 20-megabyte hard disk for \$3295.

Like the IBM PC AT, the 286i uses the Intel 80286 microprocessor running at the same 6-MHz clock speed. The main board of the evaluation unit had 512K bytes of 150-nanosecond RAM chips. Two rows of nine 256K-bit chips each (the extra chip is for parity checking) provide 512K bytes. IBM took a different approach on the AT, using piggy-backed 64K-bit chips. The Kaypro solution is more elegant.

Two additional rows of empty memory-chip sockets are next to the 256K-bit chips, and you might assume that you can fill the empty sockets with additional 256K-bit chips (for a total of 1024K bytes of RAM on the motherboard). However, the Kaypro documentation indicates that the empty sockets are for 64K-bit RAM chips only, limiting the motherboard to no more than 640K bytes of RAM, the limit of memory directly addressable by current versions of MS-DOS. If Microsoft raises the 640K-byte memory limitation, you might try installing the additional 256K-bit RAM chips. The machine's design and the capabilities of the 80286 CPU (central processing unit) allow up to 15 megabytes of system RAM.

The rest of the Kaypro's guts resemble an IBM PC AT, with generic chips, boards, drives, and sockets. The 286i's motherboard has a socket for Intel's 80287 math coprocessor chip, but the evaluation unit did not have one. The disk-controller card looks just like the one in a PC AT and can handle two hard disks and two floppy disks.

Kaypro shipped its first 286i machines with two floppy drives and later announced the availability of hard disks. The evaluation unit had two 1.2-megabyte floppy drives; you can purchase your unit with a 1.2-megabyte floppy and a 360K-byte floppy or just one floppy drive. The Kaypro dealership I contacted was getting different hard disks for the 286i from three different manufacturers. The dealership installed the drives, a fairly trivial task that takes no more than half an hour and a couple of common hand tools. Compatible 20-megabyte hard disks are available for under \$1000.

If you buy your own hard disk, make sure it comes with adequate instructions; you won't find much help in Kaypro's manuals. The bundled software includes voluminous documentation, but the hardware manual is an inadequate 32-page booklet. In fact, it might be a good idea to buy an IBM PC AT technical manual.

Kaypro did not include an operating system with its early production of the 286i. According to the documentation, the computer requires either PC-DOS 3.x or MS-DOS 3.x. Therefore, you will need to buy Microsoft's MS-DOS 3.x operating system separately, perhaps from an IBM PC dealer if Kaypro has not yet released its version. Kaypro does bundle GW-BASIC, which runs most programs written for BASICA.

Kaypro is also bundling WordStar Professional, MailMerge, PolyWindows, and MITE (for telecommunications), but if you are already using good applications software, you may not want to switch from your programs. I had no trouble running any software written for the PC AT. I could not run soft-

(continued)

Harry Krause (10214 Forest Lake Dr., Great Falls, VA 22066) is a marketing consultant whose interests include microcomputers, writing, and sailing.

# SmarTEAM

## Smart move.

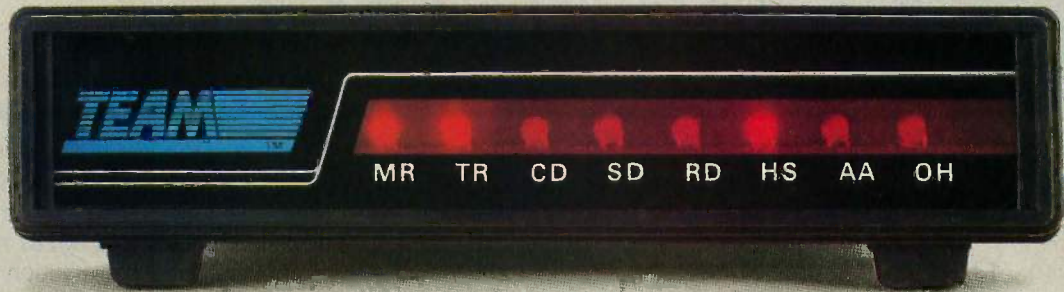

### SmarTEAM 2400

- \* Bell 103/212A, CCITT V.22, V.22 bis
- \* Auto speed selection (300, 1200 or 2400)
- \* Auto answer, auto dial (tone or pulse)
- \* Hayes compatible
- \* Call progress detection (dial tone, ringing, busy)
- \* Speaker with volume control
- \* 8 LED status indicators
- \* 6 self test modes
- \* 2 YEAR WARRANTY

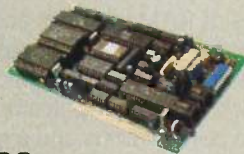

**\$599**

#### SmarTEAM 2400B

Short card for IBM PC, XT, AT and compatibles software included



**\$299**

#### SmarTEAM 1200AT

100% compatible with Hayes 1200

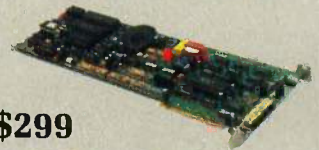

**\$299**

#### SmarTEAM 1200B

Full card for IBM PC, XT, AT and compatibles MITE software included



**\$299**

#### SmarTEAM V.21/22 (CCITT)

300, 1200bps full duplex  
Hayes commands compatible.



**\$249**

#### SmarTEAM V.21/23 (CCITT)

1200/75/5 bps - Hayes compatible



**\$599**

### OEM designs:

Send us your specifications. We will deliver a prototype in 30 days.

Inquiry 340



HEAD OFFICE:  
**TEAM TECHNOLOGY INC.**  
10F, 270, NANKING E. RD., SEC. 3, TAIPEI  
TAIWAN, R.O.C.  
TLX: 19725 PETRCHEN ATTN TEAM  
TEL: (02)7414270, FAX: (02) 771-2985

U.S.A.  
**MORRISON & DEMPSEY COMMUNICATIONS**  
19209 PARTHENIA ST., SUITE D  
NORTHRIDGE, CA 91324  
TEL: (818) 993-0195

- \* Hayes is a registered trademark of Hayes Microcomputer Products, Inc.
- \* IBM PC, XT, AT are registered trademarks of International Business Machines Corp.
- \* MITE is a registered trademark of MYCROFT LABS INC.

CANADA  
**BUDGETRON INC.**  
1320 Showan Drive, Unit 1  
Mississauga, Ontario  
Canada L4W 1C3  
TEL: (416)6737800  
TLX: 06-968080



See us at  
**COMDEX Winter '86**  
April 1-3, 1986  
Los Angeles Convention Center  
Los Angeles, CA  
Booth #1523



## AT A GLANCE

### Name

Kaypro 286i

### Company

Kaypro Corp.  
533 Stevens Ave.  
Solano Beach, CA 92075  
(619) 481-4300

### Size

21 by 16½ by 5½ inches  
System unit (without hard  
disk) and keyboard:  
40 pounds

### Components

Processor: 6-MHz Intel 80286

Memory: 512K bytes of  
150-nanosecond 256K-bit

RAM chips standard,  
expandable to 640K bytes  
Display: Kaypro 14-inch RGB  
monitor, 80 characters by 25  
lines

Keyboard: Detached with 84-  
key QWERTY layout including  
10 function keys, numeric  
keypad, Caps Lock, Num  
Lock, Scroll Lock, and  
indicator lights

Expansion: Eight expansion  
slots

I/O interfaces: Two parallel  
ports, serial port, RGB  
monitor port

### Software

GW-BASIC, WordStar  
Professional, MailMerge,  
PolyWindows, and MITE

### Documentation

32-page user's manual for  
computer, voluminous  
manuals for software

### Price

Dual 1.2-megabyte  
floppy-disk system \$4450

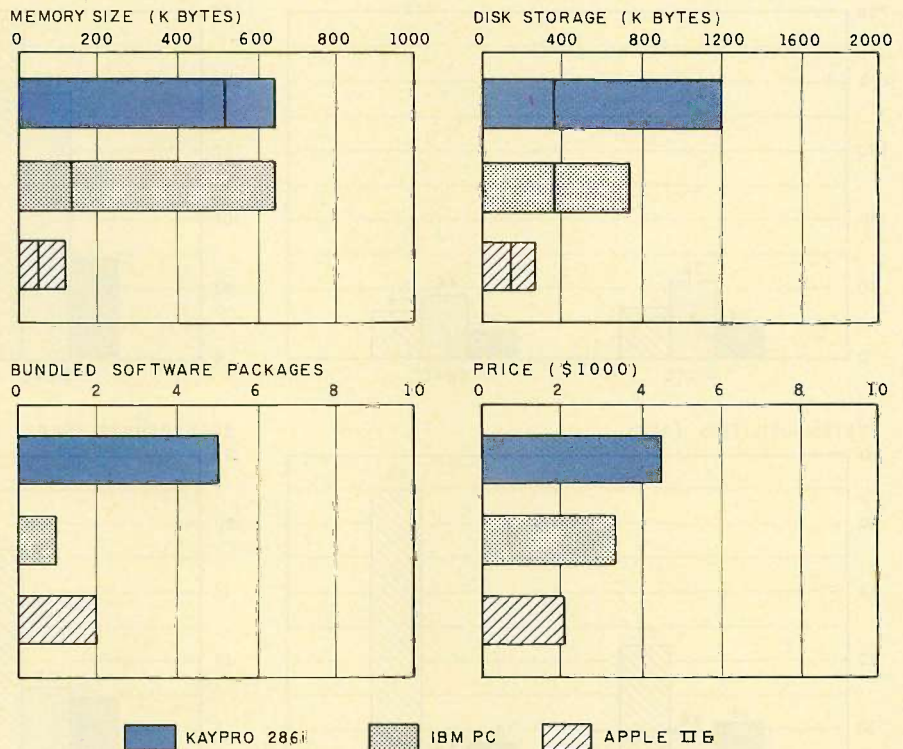

The Memory Size graph shows the standard and optional memory available for the computers under comparison. The Disk Storage graph shows the highest capacity for a single floppy-disk drive and the maximum standard capacity for each system. The Bundled Software graph shows the number of software packages included with each system. The Price graph shows the list price of a system con-

figured with two drives, a monochrome monitor, graphics and color display capability, a printer port and a serial port, 256K bytes of memory (64K bytes for 8-bit systems), the standard operating system for the computers under comparison, and the standard BASIC interpreter. Note that the price of the Kaypro 286i is for the dual floppy-disk-drive system and does not include the cost of the operating system.



The back panel of the Kaypro 286i.

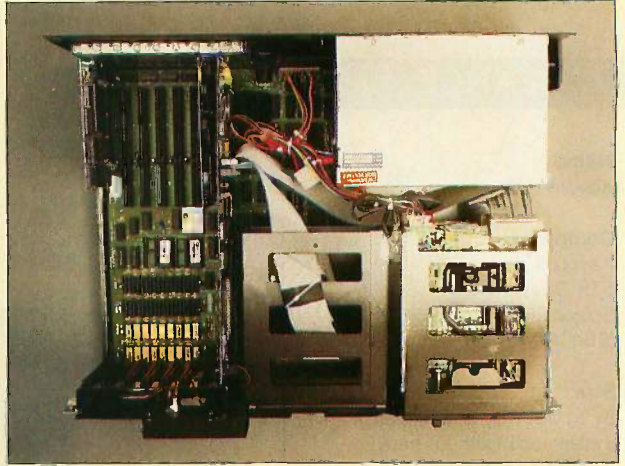

Inside the Kaypro 286i: six slots appear on the left. The review unit included two floppy-disk drives.

DISK ACCESS IN BASIC (SEC)

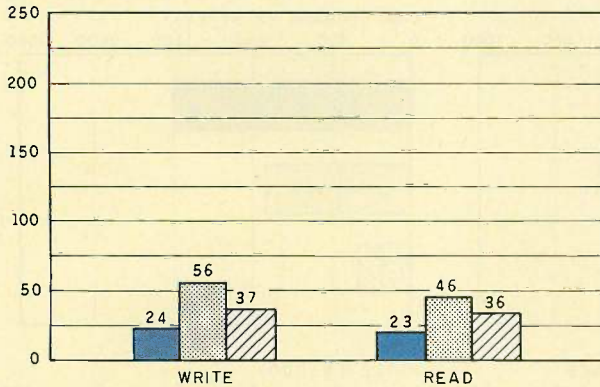

BASIC PERFORMANCE (SEC)

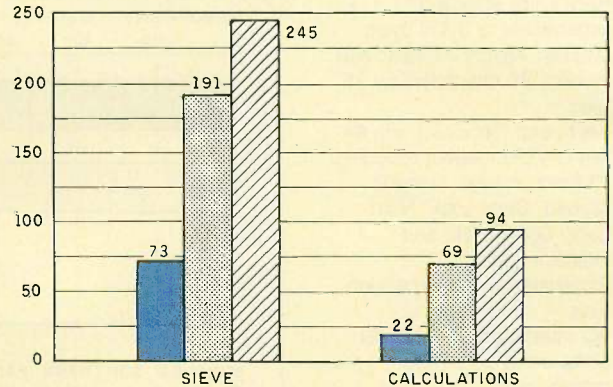

SYSTEM UTILITIES (SEC)

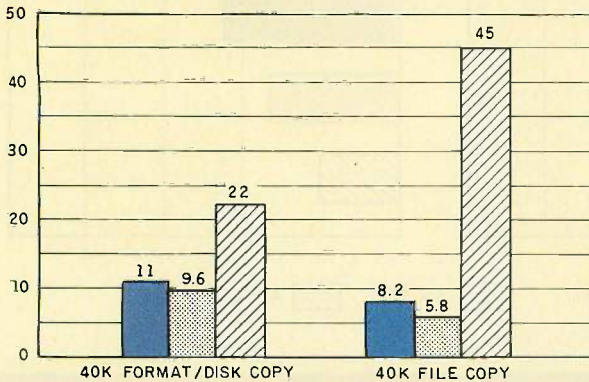

SPREADSHEET (SEC)

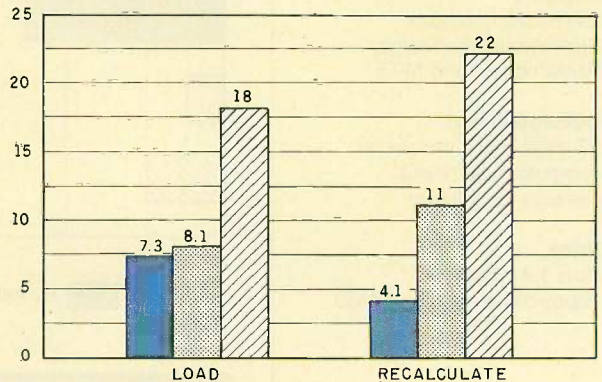

■ KAYPRO 286i    ▨ IBM PC    ▩ APPLE IIe

The graphs for Disk Access in BASIC show how long it took to write and to read a 64K-byte sequential text file to a blank floppy disk. (For the program listings, see BYTE's Fall 1985 special issue, *Inside the IBM PCs*, page 195.) The Sieve graph shows how long it took to run one iteration of the Sieve of Eratosthenes prime-number benchmark. The Calculations graph shows how long it took to do 10,000 multiplication and 10,000 division operations using single-precision

numbers. The System Utilities graphs show how long it took to format and copy a disk (adjusted time for 40K bytes of disk data) and to transfer a 40K-byte file using the system utilities. The Kaypro was tested using the drives in double-density mode. The Spreadsheet graph shows how long it took to load and recalculate a 25- by 25-cell spreadsheet where each cell equals 1.001 times the cell to its left. The spreadsheet used was Microsoft Multiplan.

# SEIZE POWER.

## LOGIMOUSE<sup>®</sup> C7

Become twice as productive with half the effort and three times the fun. Whether you're using AutoCAD, Lotus 1-2-3, PC Paintbrush or Reflex. LOGIMOUSE is the productivity demon that gets you there faster.

### At a powerful \$99 price.

**HARDWARE SUPERIOR** LOGIMOUSE has always been hardware superior. Which is why it's the consistent choice of professional users.

- HIGH resolution—twice as high as most other mice
- NO pad, NO external power supply—FREE of the optical mouse jumble of pads, wires, and plugs
- IBM PC, XT, AT compatible directly into any serial port

**SOFTWARE SUPERIOR** LOGIMOUSE software is still a generation ahead in bringing the mouse to its full power within your application.

- Fully compatible with AutoCAD, GEM, Lotus 1-2-3, MS Windows, all Microsoft compatible programs, PC Paintbrush, Reflex and many, many more
- LOGIMOUSE Software Disk FREE with every mouse, including:
  - Universal Mouse Driver with easy Mouse Setting File TAG, the Text-And-Graphics editor
  - LOGIMOUSE INTERFACE for 1-2-3

### LOGIMOUSE INTERFACE FOR LOTUS **FREE**

The all new LOGIMOUSE INTERFACE for Lotus 1-2-3 sets a new industry standard for making 1-2-3 work faster and easier. LOGIMOUSE is not just a replacement for keyboard key-strokes. It's a 1-2-3 liberator that makes Lotus more fun to use.

OFFERED FREE for a limited time  
on every LOGIMOUSE Software Disk.

### LOGIPAINT SET **\$149**

LOGIMOUSE C7 plus PC Paintbrush 3.0 is the most advanced paint set available for the PC. Use LOGIPAINT for designing a logo, creating a cartoon, or drawing a picture of a product you're developing. You won't believe its power with either free hand drawing or graphics.

To place a credit card order  
call our special toll free number:

**800-231-7717**

In California:

**800-552-8885**

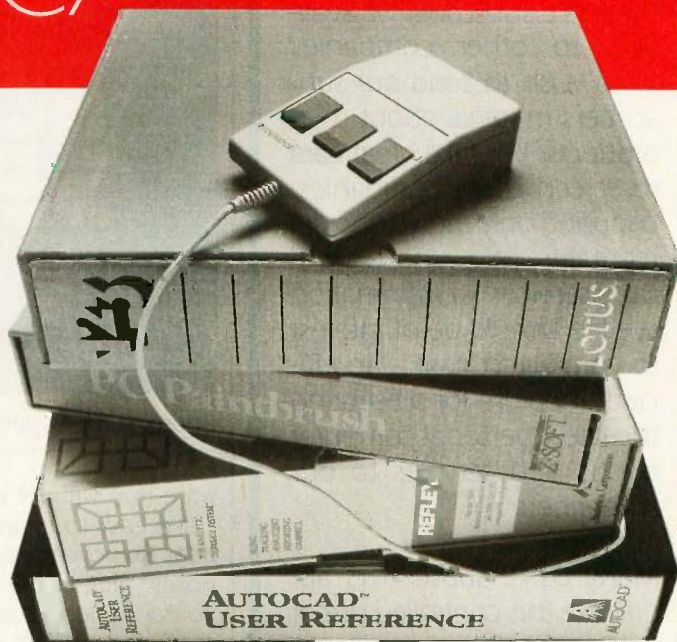

**YES!** I want to seize the LOGIMOUSE Power!  
Please send me:

- LOGIMOUSE C7 with the Universal Mouse Driver, TAG and the LOGIMOUSE INTERFACE for 1-2-3. **\$99\***
- LOGIPAINT SET—LOGIMOUSE C7 with the Universal Mouse Driver, TAG, the LOGIMOUSE INTERFACE for 1-2-3, PLUS PC Paintbrush 3.0. **\$149\***

\*Add \$5 for shipping and handling.

- VISA     MASTERCARD     CHECK ENCLOSED

Card Number \_\_\_\_\_ Expiration Date \_\_\_\_\_

SIGNATURE \_\_\_\_\_

NAME \_\_\_\_\_

ADDRESS \_\_\_\_\_

CITY, STATE \_\_\_\_\_

ZIP \_\_\_\_\_ PHONE \_\_\_\_\_



LOGITECH, Inc.  
805 Veterans Blvd., Redwood City, CA 94063, USA  
Telephone: (415) 365-9852

LOGIMOUSE is a registered trademark of LOGITECH Inc. AutoCAD is a trademark of Autodesk Inc. GEM is a trademark of Digital Research Inc. Lotus and 1-2-3 are trademarks of Lotus Development Corp. MS Windows is a trademark of Microsoft. PC Paintbrush is a trademark of ZSoft Corp. Reflex is a trademark of Borland/Analytica Corp.

## a message to our subscribers

From time to time we make the **BYTE** subscriber list available to other companies who wish to send our subscribers material about their products. We take great care to screen these companies, choosing only those who are reputable, and whose products, services, or information we feel would be of interest to you. Direct mail is an efficient medium for presenting the latest personal computer goods and services to our subscribers.

Many **BYTE** subscribers appreciate this controlled use of our mailing list, and look forward to finding information of interest to them in the mail. Used are our subscribers' names and addresses only (no other information we may have is ever given).

While we believe the distribution of this information is of benefit to our subscribers, we firmly respect the wishes of any subscriber who does not want to receive such promotional literature. Should you wish to restrict the use of your name, simply send your request to the following address.

**BYTE Magazine**  
Attn: Circulation  
Department  
70 Main St  
Peterborough NH  
03458



## REVIEW: KAYPRO 286i



Photo 1: The Kaypro 286i keyboard uses the IBM PC AT layout.

ware that will not run on the PC AT.

It is easy to unpack and set up the 286i. Remove the equipment from its boxes, plug in the monitor and keyboard cables, plug in the electrical cord, and turn on the machine. Like the PC AT, the Kaypro includes a small barrel key that fits into a lock on the front panel and switches the keyboard on and off. If you leave the lock in the Ready position, you won't have a problem when you lose the key. Fortunately, Kaypro supplies two keys.

It is easy to hook up a printer to the parallel port at the back of the 286i; Kaypro uses the IBM PC adaptation of the Centronics standard. Unfortunately, the serial port follows the IBM PC AT standard. It is a nine-pin male plug, virtually useless without an extra-cost adapter (\$40 retail) that turns it into a standard PC serial port. IBM reportedly used the smaller serial plug so that a serial and parallel port could be placed on the same card. Kaypro picked up the PC AT's bad features along with the good.

The Kaypro's keyboard (see photo 1) uses the same layout as the PC AT, but the Enter key and right-hand Shift keys are a little larger. The PC AT's keyboard has the feel of an IBM PC keyboard, requiring firm pressure on the keytops to enter data. It is also noisy. The Kaypro keyboard requires a softer touch and is much quieter.

The 14-inch RGB monitor, bundled with the system or available separate-

ly for \$595, is barely adequate for a machine with the 286i's capabilities. The retail price is high for a monitor with a shadow-mask aperture of only 0.4 millimeters. Characters closely resemble those produced by the IBM graphics adapter/monitor combination, but the letters are coarse; extended use would probably give you eyestrain. Color graphics are adequate, but there are many more reasonably priced RGB displays on the market that will produce better results with characters and graphics than the Kaypro monitor. The monitor has a built-in tilt stand, a minor convenience.

If you're intrigued by the Kaypro 286i as an alternate to the IBM PC AT, I don't think you'll go wrong. I couldn't uncover any hardware incompatibilities. IBM's Enhanced Graphics Adapter and Enhanced Graphics Monitor worked perfectly. And, like the AT, the Kaypro is very fast. When running the System Information routine from The Norton Utilities, the 286i's CPU processes data approximately 5.7 times faster than the Intel 8088-based IBM PC, the same rating as the IBM PC AT. The Kaypro's results on the BYTE benchmarks were similar to the IBM PC AT (see page 220).

The Kaypro 286i is a true compatible with a list price substantially lower than the IBM machine. A careful shopper can save close to \$3000 by buying the Kaypro instead of the IBM. ■

# New from Logitech.

## MODULA-2/86 VERSION 2.0

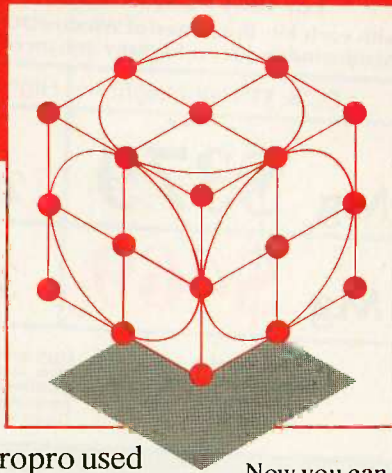

### Professional Modula-2 for \$89.

Now the same powerful tools Micropro used to develop its latest word processing system is available to you at a new \$89.00 price.

**Building Blocks for Tomorrow's Technology**  
Universities are switching to LOGITECH MODULA-2. Innovative programmers now develop applications and products with LOGITECH MODULA-2. The most productive teams at major companies depend on LOGITECH MODULA-2.  
Now you can create your professional software development system using the proven technical sophistication of LOGITECH MODULA-2/86.

#### Systems to Fit Your Needs.

- Base Language System** \$89
  - Compiler and Linker
  - Module Library
- Base Language System/8087** \$129
  - Inline 8087 code.
- Base Language System/512K** \$189
  - Full 8087 support.
  - Uses RAM to increase speed by 40 to 50 percent.
  - 80186 and 80286 support.
- Run-Time Debugger** \$69
  - Monitors the execution of a program with user-defined breakpoints or by stepping through the program.
  - Symbolically displays the source code, data, procedure call chain, and raw memory.
- MODULA-2 Editor** \$59
  - Fast on-line Modula-2 syntax check.
  - Can run compiler and linker from the editor.
  - User definable templates for Modula-2 syntax constructs.
- Utilities Package** \$49
  - Decoders: Disassemble link and load files.
  - Version: Administrate different versions of one program.
  - Post-Mortem Debugger: Debugs a program after abnormal termination.
  - Cross Reference: Produces a cross-reference listing of a Modula-2 program.
- Sources** \$179
  - Sources to customize your system.
  - Run-Time System sources.
  - Some library module sources.

Not Copy Protected

#### INTRODUCTORY OFFER:

Through the end of March you get the new MODULA-2 Editor for free with any purchase of the Base Language System.

To place an order call our special toll free number:

**800-231-7717**

In California:

**800-552-8885**

**YES**, I want to create my professional software development system. Please send me the following building blocks:

- BLS \$89    BLS/8087 \$129    BLS/512K \$189
- RTD \$69\*    EDITOR \$59\*
- UTILITIES \$49\*    SOURCES \$179\*

\*\$10 less with the purchase of any Base Language System. Please add \$5 for shipping and handling.

- VISA    MASTERCARD    CHECK ENCLOSED

CARD NUMBER \_\_\_\_\_

EXPIRATION DATE \_\_\_\_\_

SIGNATURE \_\_\_\_\_

NAME \_\_\_\_\_

ADDRESS \_\_\_\_\_

CITY \_\_\_\_\_

STATE \_\_\_\_\_

ZIP \_\_\_\_\_

PHONE (\_\_\_\_) \_\_\_\_\_



# LOGITECH

LOGITECH, Inc.

805 Veterans Blvd., Redwood City, CA 94063, USA

Telephone: (415) 365-9852

LOGITECH SA

Box 32, CH-1143 Apples, Switzerland

Telephone: 41 (21) 774545

**FREE**  
Software Bonus  
With Each Drive Kit

### HARD DISK SYSTEMS

For IBM PC's, XT's and Compatibles.

FREE with each kit: the powerful WindowDOS Resident Utility Software giving instant-window access to many enhanced DOS functions. A \$50 value.

	PC & XT Half Height.	High Performance. Full Height.
<b>External Cabinets</b> \$149  Easily converts drive kits into external drives.	10 Mg <b>\$379</b>	20 Mg <b>\$749</b>
	20 Mg <b>\$469</b>	30 Mg <b>\$895</b>

Seagate 13 month warranty

Kits include drive, controller, cables, hardware, & easy instructions. Systems backed by our warranties of 13 or more months. Bootable from hard disk.

For combo floppy/hard drive controller add \$75

High performance drive kits include full height drive, controller, cables & instructions. Outstanding voice coil technology provides quality performance and 40 ms average access time. Drives require 135 watt power supply.

- We have lowest prices. Compare.
- No surcharge on VISA, MC.
- Prompt shipping. Free on many items. Call!
- Finest service! Your full satisfaction is our goal!

**\$795**

### The New High Performance TCS TURBO PC



- ❑ 2 speed motherboard with keyboard selectable 4.77 MHz regular and 8 MHz Turbo modes.
- ❑ 640K on motherboard.
- ❑ 8 expansion slots.
- ❑ 135 watt power supply.
- ❑ One 360K half height floppy drive.
- ❑ Floppy drive controller.
- ❑ Beautiful cabinet with LED lights that indicate running speed for PC or Turbo.
- ❑ 5150 style keyboard. 5151 style optional.

**8 MHz of Turbo Speed!**

2nd floppy for \$100 extra.

Blaze along with up to 70% increase in processor speed over normal 4.77 MHz PC's, and faster than most other Turbo PC's. Runs all major IBM compatible software. One year warranty. An outstanding value.

### CARDS FOR IBM PC AND COMPATIBLES

- MULTIFUNCTION CARD** ..... \$129
  - 384K Memory • Clock/Calendar with battery backup
  - Parallel, serial & game ports.
- Without memory** ..... \$99
- MONOCHROME CARD** ..... \$119
  - Emulates IBM mono card
  - Hercules compatible
  - Printer port.
- COLOR CARD** ..... \$119
  - Fits 5 inch slot
  - Emulates IBM RGB card.
- EVEREX GRAPHICS EDGE** ..... \$299
- EVEREX EDGE** ..... \$279
  - Color and monochrome, Do-everything graphics card.
- EVEREX INT. MODEM** ..... \$225
- I/O CLOCK CARD** ..... \$99
  - 2 serial ports, 1 parallel port, 1 game port (no memory).

### TAPE BACK-UP SYSTEMS

INTERNAL	
10 mg .....	\$399
20 mg .....	\$699
60 mg .....	\$888
EXTERNAL	
20 mg .....	\$749
25 mg .....	\$849
60 mg .....	\$1095

### EMERGENCY POWER

200 watts from .....	\$269
1000 watts .....	\$899

### MONITORS

RGB Ultra Hi Res .....	\$399
13", .31 dot pitch, anti-glare.	
RGB Hi Res .....	\$349
13" .43 dot pitch, anti glare.	
Green Screen TTL .....	\$129
12" Looks and works like IBM monochrome monitor.	

### PC POWER SUPPLIES

135 watt .....	\$89
150 watt .....	\$119

### PRINTERS

FUJITSU DotMax 9 .....	\$349
DotMax 24 .....	\$1295
PANASONIC 1080 .....	\$225
1092 .....	\$359
1093 .....	\$420
3151 (DW) .....	\$412
JUKI 6100 .....	\$359
6300 .....	\$679
Star SG-10/15 .....	\$219/\$379
Olympia NP .....	\$245
RO (Daisywheel) .....	\$289

We do not guarantee compatibility for all systems. Brand names listed are registered trademarks. Sales are final. Returns for repair require authorization. Prices, specifications and availability are subject to change without notice.

- All merchandise is new, with manufacturer's warranty.
- We accept cashier's checks, money orders, VISA, MC, C.O.D. and approved corporate PO's. For American Express, add 3%.
- \$100 minimum purchase required.

# Modula-2 System for Z80 CP/M

Hochstrasser's  
package  
supports  
most features  
as defined  
by Wirth

BY BRIAN R.  
ANDERSON

**T**he Modula-2 System for Z80 CP/M produced by Hochstrasser Computing AG was written in Zurich, Switzerland, by four graduates of ETH (Federal Institute of Technology), where Niklaus Wirth developed both Pascal and Modula-2. Because of the close association between the author of the language and the authors of this compiler, I had every expectation of a high-quality product that adhered closely to Wirth's definition of Modula-2.

I was not disappointed. This is a full-featured system with extensive library support and a very smooth user interface. Everything seems to be well engineered and relatively bug-free. The system supports virtually all features as defined by Wirth, lacking only processes and monitors. Version control is currently disabled. All features are expected sometime in the future and will be available to registered users at a nominal charge for media and printing. This review refers to version 2.0 of the compiler. The release date was March 28, 1985.

The library modules (most with commented source code) include three separate file systems—two sequential, one random-access; a program chaining system that allows data sharing; full access to both BDOS (basic disk operating system) and BIOS (basic input/output system) calls; math functions (transcendentals); and many others.

## HARDWARE

A Z80 CP/M system with at least 52K bytes of RAM (random-access read/write memory) and two disk drives is required. The compiler uses about 170K bytes of disk space. The linker and all its support files (that is, library and utility modules and excluding the source files) take up about 120K bytes. Since the compiler and linker don't have to be present on the system at the same time, it would be possible to work with disk drives as small as 170K bytes. However, to work comfortably, it would be

better to have larger drives; Hochstrasser recommends at least 300K bytes each. The Z80 is a must; the compiler will not work with an 8080 or 8085.

My computer system consists of an S-100 single-board computer made by Intercontinental Micro Systems, using a 4-MHz Z80 operating under CP/M 2.2. All tests were done with an 8-inch single-sided single-density (SS/SD) disk as the data disk. The system disk was an 8-inch double-sided double-density (DS/DD) disk.

The documentation that comes with the compiler is quite good. The manual, *Modula-2 System for Z80 CP/M*, is organized so that the first-time user can get up and running quickly.

The first section of the manual explains system requirements and guides you through configuration and a sample compile session (several sample programs are on the disks).

The manual's introduction to Modula-2 provides a good insight into the differences between Modula-2 and Pascal. It is not a replacement for *Programming in Modula-2* by Niklaus Wirth (Springer-Verlag, 2nd edition, 1983), but this introduction is a worthwhile companion to it.

The implementation section explains the use of the compiler in detail and describes the library modules. The description of the compiler is excellent. Although the library description is adequate for most purposes, it is at times sketchy and vague; keep Wirth's book handy. (Another useful companion is *Modula-2 for Pascal Programmers* by Richard Gleaves [Springer-Verlag, 1984]. It is based on the MS-DOS implementation of Modula-2 by Volition Systems, and it describes the library modules in some detail—along with example programs. The Volition and Hochstrasser implementations are very similar, and virtually everything in Gleaves's book applies equally to the Hochstrasser Modula-2.)

Also in the system manual is an advanced

(continued)

Brian R. Anderson (2977 East 56th Ave., Vancouver, British Columbia V5S 2A2, Canada) is a certified engineering technician with experience in communications and industrial control. He works as an instructor at Vancouver Community College. His interests include motorcycling and playing the guitar.

programming guide that has tips and techniques to improve efficiency, interface to assembly-language modules, and other useful information.

Finally, there is a set of appendixes, including an explanation of the linker format, an EBNF (Extended Backus-Naur Form) language definition, and a list of error messages used by the compiler and linker.

### EVALUATION

The method I chose to evaluate this compiler was to develop several benchmark programs, each testing a specific feature. Compile time is important to everyone, so all compile times (using automated batch processing) are tabulated for the test programs. Different features are significant depending on your application; therefore, I have evaluated four separate areas for execution speed: integer math, floating-point math, screen output, and file I/O (input/output).

As a concession to tradition, I also include the Sieve of Eratosthenes among the test programs. The Sieve tests the ability to perform loops, but little else.

### COMPARISON LANGUAGES

For comparison, I compiled and ran similar programs in Pascal (using Borland International's Turbo Pascal) and in C (using Aztec C). Choice of comparison languages was dictated mostly by what I had available. However, I'll try to justify my choices on technical grounds, too. Since I know of no other Z80 compiler system for Modula-2 (and I've looked), there was no option but to compare with compilers of other languages.

Pascal is closely related to Modula-2, so it seems natural to compare these two. Turbo Pascal is an excellent product, known particularly for its compilation and execution speed.

Both C and Modula-2 are considered to be "systems" languages (that is, useful for writing operating systems). Both have separated scope (visibility) and lifetime (existence) for variables. Both use modules. (C how-

ever, does not formalize this; C's independent compilation units are similar to Modula 2's modules—instead of the import/export lists, C uses the extern concept.) Since C and Modula-2 seem to be vying for the same space, it does not seem unreasonable to compare them. Aztec C has received consistent high marks in

reviews comparing it to other implementations of the language.

### THE BENCHMARKS

The math benchmarks are simple. The programs execute one operation repeatedly; I timed the operation and then divided the total time by the number of repetitions. The result is

Listing 1: Benchmark to evaluate integer operations.

```

MODULE MTIMEI;

  FROM Terminal IMPORT (* standard module as
    defined by Wirth *)
    Write, WriteLn, WriteString;

  FROM ASCII IMPORT
    bel;

  VAR
    x, y, z : INTEGER;
    i : CARDINAL;

  PROCEDURE Delay (x : CARDINAL); (*
    variable Delay, x in milliseconds *)

    VAR
      i, j : CARDINAL;

    BEGIN
      FOR i := 1 TO x DO
        FOR j := 1 TO 18 DO
          END;
        END;
      END Delay;

BEGIN
  x := 11;  y := 2;

  WriteString ('Blank');  WriteLn;
  Delay (500);
  Write (bel);
  i := 1;
  REPEAT
    z := y;
    i := i + 1;
  UNTIL i = 10000;
  Write (bel);
  Delay (4000);

  WriteString ('Addition');  WriteLn;
  Delay (500);

  Write (bel);
  i := 1;
  REPEAT
    z := x + y;
    i := i + 1;
  UNTIL i = 10000;
  Write (bel);
  Delay (4000);

```



## REVIEW: Z80 MODULA-2

the time taken to perform that operation once. To factor out overhead for the loop and assignment portion of the operation, I also included a blank loop in the tests. I subtracted the time for this blank loop from the other times before calculating time per operation. See listing 1 (Integer) and listing 2 (Floating Point). [Editor's note:

All programs shown here are available for downloading from BYTEnet Listings, (617) 861-9764, or on disk (see page 358 for details.)

This compiler implements floating-point math in a single-precision format, which is similar to that proposed by IEEE (Task 754, 1981), and pro-

(continued)

```

WriteString ('Subtraction');  WriteLn;
Delay (500);
Write (bel);
i := 1;
REPEAT
  z := x - y;
  i := i + 1;
UNTIL i = 10000;
Write (bel);
Delay (4000);

WriteString ('Multiplication');  WriteLn;
Delay (500);
Write (bel);
i := 1;
REPEAT
  z := x * y;
  i := i + 1;
UNTIL i = 10000;
Write (bel);
Delay (4000);

WriteString ('Division');  WriteLn;
Delay (500);
Write (bel);
i := 1;
REPEAT
  z := x DIV y;
  i := i + 1;
UNTIL i = 10000;
Write (bel);
Delay (4000);

WriteString ('Modulus');  WriteLn;
Delay (500);

Write (bel);
i := 1;
REPEAT
  z := x MOD y;
  i := i + 1;
UNTIL i = 10000;
Write (bel);
Delay (4000);

WriteString ('Good-bye...');  WriteLn;
END MTIMEI.

```

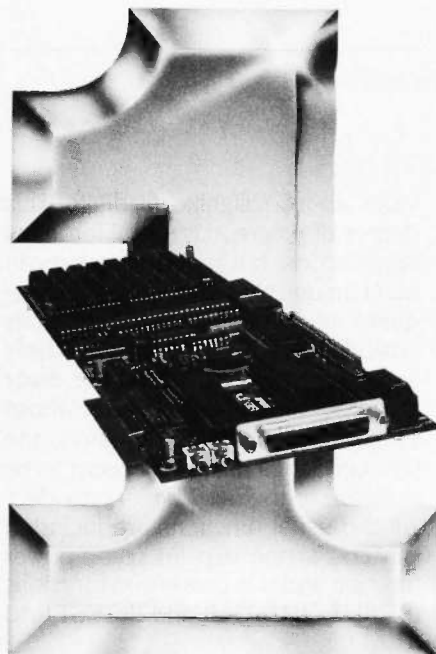

**Number One  
in Performance**  
**68010/68000  
Coprocessor for  
IBM/AT/XT/PC-**  
**8/10/12.5mz No Wait States**  
**\$1295<sup>00</sup> Qty. 1**

## FEATURES

- 1-2 MB RAM (1MB Standard)
- 16K-64K EPROM
- 2-8 Serial Ports  
  Async/Sync/Bisync Communications
- Battery-backed Real Time Clock
- Battery-backed 2K-8K RAM
- 2 Parallel Ports
- 68881 Math Coprocessor
- Memory-mapped Dual-port BUS
- 3-9 Users Per Board (3 Standard)
- Up To 16 Boards Per AT/XT/PC
- Can Operate As Standalone Processor

## SOFTWARE

- OS9 (Powerful UNIX-like Multi-user OS)
- CPM/68K
- Software selectable OS including concurrent PC DOS/OS-9 or CPM/68K operation
- Support Module for IBM Graphics
- High-speed Local/Global Disk Caching
- Basic, Pascal, Fortran, C, and COBOL

IBM is a registered trademark of International Business Machines  
OS is a registered trademark of Microsoft System Corp. CPM/68K is a registered trademark of Digital Research Corp.  
MS-DOS/MS-DOS 2.0 are registered trademarks of Microsoft. UNIX is a registered trademark of AT&T.



West: 4704 W. Jennifer, Suite 105, Fresno, CA 93711, 209/276-2345  
East: 67 Grandview, Pleasantville, NY 10570, 914/747-1450  
Distributor: Telemarketing Services, Inc.  
1897 Garden Ave., Eugene, OR 97403, 800/874-2288

vides about 7 significant digits. This degree of precision is useful for many applications, but round-off error can build up quickly if your application requires much iteration. As an example, I calculated factorials (both recursively and iteratively) and found the error could become excessive after about 11 iterations. With no iteration, the transcendental functions appear to be accurate to the full 7 digits provided. All the usual functions are included (sin, cos, arctan, exp, ln), plus a power function and two conversion functions (REAL to INTEGER and INTEGER to REAL).

Note that both Turbo Pascal and Aztec C implement their floating-point operations in double-precision.

The third benchmark tests console screen output speed—specifically the time taken to completely rewrite the screen with "The quick brown fox . . ." Rapid screen update is particularly important for writing programs such as text editors or anything that makes extensive use of console I/O. In all cases, the console was operating at 19,200 bits per second. The screen output program is shown in listing 3.

The final benchmark involved disk file I/O (listing 4); it's a simple file-copy program, ostensibly to create a backup file. The text file copied was 100 lines of "The quick brown fox . . ."—7K bytes in total.

Listing 5 shows the Sieve program as implemented in this review.

Statistical results for the mathematical benchmarks are given in table 1. All other benchmark statistics are given in table 2.

I did not encounter any bugs in the compiler or linker, although some were reported at the beta test sites and have been corrected with release of version 2.0. I did come across two errors in the library/utility modules; these also have been corrected in the latest release.

As the tables show, Modula-2 fared quite well in most benchmark categories. Although compile times were much slower than for Turbo Pascal, they were similar to those of Aztec C.

(continued)

Listing 2: Benchmark to evaluate floating-point operations.

```

MODULE MTIMEF; (* times floating point
operations *)

  FROM Terminal IMPORT
    Write, WriteLn, WriteString;

  FROM MathLib IMPORT
    sin, cos, arctan, ln, exp;

  FROM ASCII IMPORT
    bel;

  VAR
    x, y, z : REAL;
    i : CARDINAL;

  PROCEDURE Delay (x : CARDINAL); (*
variable delay, x in milliseconds *)

    VAR
      i, j : CARDINAL;

    BEGIN
      FOR i := 1 TO x DO
        FOR j := 1 TO 18 DO
          END;
        END;
      END Delay;

BEGIN
  x := 12.5; y := 0.5;

  WriteString ('Blank'); WriteLn;
  Delay (500);
  Write (bel);
  i := 1;
  REPEAT
    z := y;
    i := i + 1;
  UNTIL i = 10000;
  Write (bel);
  Delay (4000);

  WriteString ('Addition'); WriteLn;
  Delay (500);
  Write (bel);
  i := 1;
  REPEAT
    z := x + y;
    i := i + 1;
  UNTIL i = 10000;
  Write (bel);
  Delay (4000);

  WriteString ('Subtraction'); WriteLn;
  Delay (500);
  Write (bel);
  i := 1;
  REPEAT
    z := x - y;
    i := i + 1;
  UNTIL i = 10000;
  Write (bel);
  Delay (4000);

```

## REVIEW: Z80 MODULA-2

```

WriteString ('Multiplication');  WriteLn;
Delay (500);
Write (bel);
i := 1;
REPEAT
  z := x * y;
  i := i + 1;
UNTIL i = 10000;
Write (bel);
Delay (4000);

WriteString ('Division');  WriteLn;
Delay (500);
Write (bel);
i := 1;
REPEAT
  z := x / y;
  i := i + 1;
UNTIL i = 10000;
Write (bel);
Delay (4000);

WriteString ('Sine');  WriteLn;
Delay (500);
Write (bel);
i := 1;
REPEAT
  z := sin (y);
  i := i + 1;
UNTIL i = 1000;
Write (bel);
Delay (4000);

WriteString ('Cosine');  WriteLn;
Delay (500);
Write (bel);
i := 1;
REPEAT
  z := cos (y);
  i := i + 1;
UNTIL i = 1000;
Write (bel);
Delay (4000);

WriteString ('Arctangent');  WriteLn;
Delay (500);
Write (bel);
i := 1;
REPEAT
  z := arctan (x);
  i := i + 1;
UNTIL i = 1000;
Write (bel);
Delay (4000);

WriteString ('Natural Log');  WriteLn;
Delay (500);
Write (bel);
i := 1;
REPEAT
  z := ln (x);
  i := i + 1;
UNTIL i = 1000;
Write (bel);
Delay (4000);

```

(continued)



## Number One In Performance

## Hard Disk Intelligent VCR Backup for AT/XT/PC

### FEATURES

- High speed microprocessor controlled backup (68000)
- Two channel interface
- Built in LAN channel
- Software control of most VCR functions including Fast Forward, Rewind, and auto backup using VCR timer capabilities
- Economical VHS or Beta formats



West: 4704 W. Jennifer, Suite 105, Fresno, CA 93711, 209/276-2345  
 East: 67 Grandview, Pleasantville, NY 10570, 914/747-1450  
 Distributor: Telemarketing Services, Inc.  
 1897 Garden Ave., Eugene, OR 97403, 800/874-2288

Code size is where Modula-2 really excelled, at times bettering the competition by a ratio of 5 to 1. Execution times were similar throughout, with a slight edge going to Modula-2, on average.

### EASE OF USE

In most ways, Modula-2 for Z80 CP/M runs smoothly and is exceedingly easy to use. The system consists of a four-pass compiler and a two-pass linker. The multipass design results in tight, efficient code and acceptable compile speed, considering the results. Several useful compile switches are provided (for example, assembly output or listing-file output), but not so many that they are hard to remember.

The compiler has two methods of handling errors. The default mode automatically creates a listing file (complete with page breaks, headers, and line numbers), with error messages embedded. A "star bar" flags the line where an error occurs, while a pointer shows the position within the line. A compiler switch allows *errors to be handled* in a simpler manner: The lines and positions of errors are output to the console. Errors are tagged with uncanny accuracy, and I seldom got an error message that did not make sense.

Errors are noted by numbers, which you must look up in the system manual. I did manage to invoke an error that is not listed in the manual—Error 332 was caused by trying to EXIT from a WHILE statement. This error should have been Error 151 according to the manual. In Modula-2, EXIT is allowed only from a LOOP statement. I guess I've been tainted by C, where you can break (as C calls it) from nearly anything.

The compiler and linker have an excellent system that allows them to find their respective source files no matter what drive they are located on. You can easily customize the search path at installation. With the module concept, such a path search is nearly essential, since you are certain to have modules on more than one disk (sys-

(continued)

```
WriteString ('Natural Antilog'); WriteLn;
Delay (500);
Write (bel);
i := 1;
REPEAT
  z := exp (y);
  i := i + 1;
UNTIL i = 1000;
Write (bel);
Delay (4000);
END MTIMEF.
```

Listing 3: Benchmark to test screen I/O execution.

```
MODULE MSCREEN;

  FROM TERM1 IMPORT (* nonstandard terminal
module *)
  Write, WriteCard, WriteString, WriteLn;

  FROM ASCII IMPORT
  bel, sub;

  VAR
  i : CARDINAL;

BEGIN
  Write (sub); (* Clear Console Screen *)
  Write (bel);

  FOR i := 1 TO 100 DO
    WriteCard (i, 3);
    WriteString (' The quick brown fox jumped
over the lazy dogs back. ');
    WriteString ('1234567890'); WriteLn;
  END;

  Write (bel);
END MSCREEN.
```

Listing 4: Benchmark to test disk I/O.

```
MODULE MFILECPY;

  FROM SeqIO IMPORT
  FILE, FileState, Open, Create, Close,
Read, Write, EOF;

  FROM Terminal IMPORT
  ReadString, WriteLn, WriteString;

  FROM Strings IMPORT
  STRING;

  VAR
  inFile, outFile : FILE;
  name, BAKname : STRING; (* filenames *)
  c : CHAR;
```

REVIEW: Z80 MODULA-2

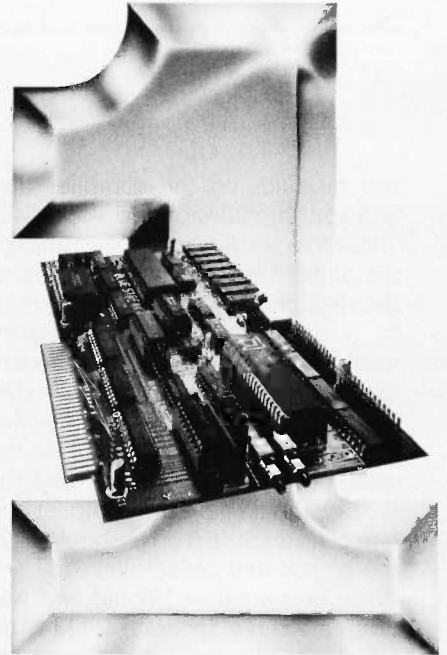

**Number One  
in Performance**

**Z80H  
BLUESTREAK™**

**IBM/AT/XT/PC- 8mz  
No Wait States**

**FEATURES**

- 64K-256K RAM
- 2K-8K EPROM/Static Ram
- 2 Serial Ports
- Async/Sync/Bisync Communications
- Real Time Clock
- Memory-mapped Dual-port BUS
- On-board/Remote Reset NMI capability
- Up To 32 Boards Per AT/XT/PC
- Can Operate As Standalone Processor
- Less Than Full Size Board  
(will fit other compatibles.)

**SOFTWARE**

- ZP/M™ CP/M Emulation Software  
(Supports Most CP/M Software)
- Multiuser Capability If Used As A  
Slave Processor

IBM is a registered trademark of International Business Machines.  
CP/M is a registered trademark of Digital Research Corp.



West: 4704 W. Jennifer, Suite 105, Fresno, CA 93711, 209/276-2345  
East: 67 Grandview, Pleasantville, NY 10570, 914/747-1450  
Distributor: Telemarketing Services, Inc.  
1897 Garden Ave., Eugene, OR 97403, 800/874-2288

```

PROCEDURE MakeBAK (in : STRING; VAR out :
STRING; tag : STRING);
  VAR
    i, j : CARDINAL;
  BEGIN
    i := 0;
    WHILE (in[i] # 0C) AND (in[i] # '.')
DO
      out[i] := in[i];
      INC (i);
    END;

    j := 0;
    WHILE tag[j] # 0C DO
      out[i] := tag[j];
      INC (i); INC (j);
    END;

    out[i] := 0C; (*add NULL terminator*)
  END MakeBAK;

BEGIN
  WriteString ('File Backup Utility');
  WriteLn; WriteLn;
  WriteString ('Enter filename: ');
  ReadString (name); WriteLn;
  MakeBAK (name, BAKname, '.bak');

  IF Create (outFILE, BAKname) = FileOK THEN
    IF Open (inFILE, name) = FileOK THEN
      WHILE NOT EOF (inFILE) DO
        Read (inFILE, c);
        Write (outFILE, c);
      END;

      IF (Close (inFILE) <> FileOK) OR
(Close (outFILE) <> FileOK) THEN
        WriteString ('Error closing
files...'); WriteLn;
      ELSE
        WriteString (BAKname);
        WriteString (' completed.');
```

tem modules on the compiler disk and your modules on the work disk).

Due to a small quirk in the compiler, the object files are always written to the default drive (usually the system or A drive). A great improvement would result if the object files were written (or could be redirected) to the disk where the main source file was found. Maybe it's me that has the quirk, but you be the judge. I think the A drive should have the compiler system on it, and the B drive should have the source and object files.

The best solution I could find was to create three separate CP/M SUBMIT files; one to compile program modules (on the B drive), one to compile definition and implementation modules on the B drive, and one to

compile definition and implementation modules on the A drive. Shown below are the three SUBMIT files, along with an explanation of each. Contents of file modula.sub are

```
MC $1 /V /X
ML $1 /V /O:B:$1
ERA $1.MRL
```

MC invokes the compiler in the verbose mode (/V) and terminates batch processing (/X) if there are any compile errors. As usual with CP/M SUBMIT files, \$1 specifies the first command-line argument (in this case the source filename, without the file type).

ML invokes the linker (also in the verbose mode), with the object file redirected to the B drive (/O). The /O

*Due to a small quirk in the compiler, the object files are always written to the default drive (usually the system or A drive).*

option allows you to specify the object filename of the linker. Here, the filename itself is the same as the source filename, with the drive specifier forced to B. Linker output is a .COM file.

ERA erases the relocatable file (.MRL) output by the compiler. This file is used by the linker and is then no longer needed (at least in the case of stand-alone programs). This prevents .MRL files from cluttering up the system disk.

File Deflmp/B.SUB contains

```
MC $1.DEF /V /X
MC $1.MOD /V /X
PIP B:=A:$1.*
ERA $1.MSY
ERA $1.MRL
```

Definition and implementation modules are compiled separately. The PIP command moves the .MSY (Modula symbol) and .MRL (Modula relocatable) files to the B drive before the unwanted copies on drive A are erased.

File Deflmp/A.SUB contains

```
MC $1.DEF /V /X
MC $1.MOD /V
```

When compiling to the system disk (for example, compiling library modules), definition and implementation modules are compiled separately and left on A. Two examples follow. To compile the program module sieve.mod, all that is required is

```
A>submit modula sieve <CR>
```

To compile definition and implemen-

*(continued)*

Listing 5: Sieve of Eratosthenes benchmark written in Modula-2.

```
MODULE MSIEVE;

  FROM TERM1 IMPORT
    WriteString, WriteCard, WriteLn;

  CONST
    Size = 8190;           (* size of
array *)
    Iterations = 10;      (* minimum 1 *)

  VAR
    count, i, iter, k, prime : CARDINAL;
    flags : ARRAY [0..Size] OF BOOLEAN;

  BEGIN
    WriteString ('10 Iterations'); WriteLn;
    FOR iter := 1 TO Iterations DO
      count := 0;

      FOR j := 0 TO Size DO
        flags[j] := TRUE;
      END;

      FOR i := 0 TO Size DO
        IF flags[i] THEN
          prime := i + i + 3;
          k := i + prime;
          WHILE k <= Size DO
            flags[k] := FALSE;
            INC (k, prime);
          END;
          INC (count);
        END;
      END; (* FOR *)
    END; (* FOR *)

    WriteString ('There were ');
    WriteCard (count, 0); WriteString ('
primes. ');
  END MSIEVE.
```

# PERFORMANCE

## THAT IS OUT OF THIS WORLD...



**\$389<sup>00</sup>**

**MODEL 2000 20MHz  
DUAL TRACE**

**\$549<sup>00</sup>**

**MODEL 3500 35MHz  
DUAL TRACE DELAYED SWEEP**

## ...AT A DOWN TO EARTH PRICE

At last! Truly affordable test equipment with no compromise in design, and features you would expect to find only on oscilloscopes costing hundreds of dollars more! JDR Instruments presents two, new, high-performance models backed by a two year warranty and technical support which is only a phone call away. Perfect for the technician or advanced hobbyist, both models feature Dual Trace capability and a variety of operating and triggering modes, including CH-B Subtract and X-Y operation.

MODEL 2000 has a 20 MHz bandwidth and 20 calibrated sweeps ranging from .2s to .2 $\mu$ s. A convenient built-in component tester provides additional diagnostic power.



INCLUDES TWO HIGH QUALITY  
1x, 10x TEST PROBES

MODEL 3500 features a 35 MHz bandwidth and exceptional 1mV/DIV sensitivity. Delayed sweep and variable holdoff allow stable viewing of complex waveforms.

**ORDER TOLL FREE**  
**800-538-5000**  
**800-662-6279 (CA)**



**JDR INSTRUMENTS**  
1224 South Bascom Avenue  
San Jose, California 95128 (408) 995-5430

## AT A GLANCE

### Name

Modula-2 System for Z80 CP/M

### Company

Hochstrasser Computing AG  
 Chratzstrasse 14  
 8954 Geroldswil  
 Switzerland

### Format

Three SS/SD 8-inch distribution disks;  
 not copy-protected

### Computer

Z80-based CP/M system with 52K bytes of  
 RAM required, two floppy-disk drives  
 holding at least 300K bytes each  
 recommended

### Documentation

User's manual, 240 pages with index

### Price

\$160

tation modules for NEWMOD to the  
 B drive.

A>submit Deflmp/B newmod  
 <CR>

## CONCLUSIONS

These lads from Zurich have done an excellent job of implementing Modula-2 on a Z80. All features operated extremely well. The documentation is good and quite complete. I have no hesitation in recommending this system to anyone interested in working with Modula-2. I stress *working*—this is not a toy compiler. Because of the small code size, this system would be suitable even for small control applications. The compiler produces native Z80 code that is ROMable and reentrant. Because of the program chaining facilities, very large applications greater than 64K bytes can also be easily developed. At this time, Modula-2 System for Z80 CP/M is available only on standard 8-inch SS/SD (IBM 3740) disks. Other formats reportedly are coming soon. ■

Table 1: Results of math benchmarks. Execution times are in milliseconds. Compile times are in minutes:seconds. For the floating-point benchmarks, Modula-2 uses 7 significant digits, Turbo uses 10, and Aztec C uses 14.

### Integer Operations

Test	Modula-2	C	Pascal
+	.007	.04	.01
-	.011	.05	.01
*	.06	.27	.14
DIV	.36	.55	.43
MOD	.32	.54	.41
Compile time (TIMEI)	1:38	1:44	0:08
.COM file	2K bytes	9K bytes	8K bytes

### Floating-Point Operations

Test	Modula-2	C	Pascal
+	.29	.42	.34
-	.33	.50	.38
*	.76	11.60	1.60
/	1.20	18.10	2.20
sin	9.50	162.00	22.00
cos	9.30	196.00	23.00
atn	7.20	190.00	19.00
ln	9.30	184.00	26.00
exp	10.70	149.00	23.00
Compile time (TIMEF)	2:01	2:18	0:07
.COM file	6K bytes	15K bytes	9K bytes

Table 2: Results of I/O and Sieve benchmarks. Execution times are in milliseconds. Compile times are in minutes:seconds.

### Screen Update

	Modula-2	C	Pascal
Execute	1.1	2.1	1.1
Compile time (SCREEN)	1:25	1:27	0:06
.COM file	2K bytes	11K bytes	8K bytes

### File Copy

	Modula-2	C	Pascal
Execute	15.2	14.7	25.1
Compile time (FILECPY)	1:52	1:46	0:08
.COM file	8K bytes	12K bytes	8K bytes

(Note: PIP copied the same file in 10.2 seconds.)

### Sieve of Eratosthenes

	Modula-2	C	Pascal
Execute	18.4	23.2	22.1
Compile time (SIEVE)	1:25	1:12	0:06
.COM file	2K bytes	8K bytes	8K bytes





# Now You Can Trade-In Your **USED** IBM\* PC/XT\* or AT\* Keyboard!



Easy to Read Regular Key Legends Rather than Symbols.

Easy to Identify Status Lights are on "Lock" Keys.

Easy to Use "Shift" & "Return" Keys are in familiar Typewriter locations.

Easy to Edit Separate Cursor and Editing Keys.

Easy for Numbers Separate Numeric Keys.

Easy to Enter Convenient Enter Key.

## Buy a Key Tronic KB 5151 and Receive \$25.

Buy a Key Tronic KB 5151, send in your new or USED IBM\* PC, XT\* or AT\* keyboard and Key Tronic will send you \$25. It's that simple!

Type on the KB 5151 keyboard and feel the difference for yourself. It's the Key Tronic touch!

Look at the layout of the KB 5151. It was designed to increase operator speed and comfort. No wonder it's the choice of professionals.

Ask a Key Tronic customer about our products. You will learn about our reputation for manufacturing durable professional products.

Key Tronic is the world's largest independent manufacturer of full travel keyboards and offers a complete line of integrated input devices.

See your local dealer or call 1-800-262-6006 for more information. (7 am - 3 pm Pacific Time) In Washington State call (509) 928-8000.

*"Feel the Key Tronic Touch"*

**key tronic**  
The Responsive Input Company

P. O. Box 14687 • Spokane, WA 99214 • USA

The Key Tronic KB 5150 and KB 5151 keyboards are also eligible for trade-in under the terms of this rebate program. Trade-in offer also applies to purchases of other Key Tronic keyboard products.

\*IBM, XT and AT are registered trademarks of IBM Corporation.

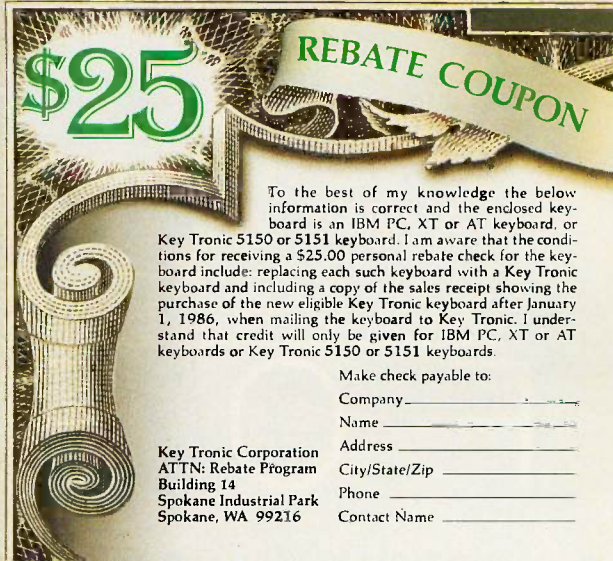

To the best of my knowledge the below information is correct and the enclosed keyboard is an IBM PC, XT or AT keyboard, or Key Tronic 5150 or 5151 keyboard. I am aware that the conditions for receiving a \$25.00 personal rebate check for the keyboard include: replacing each such keyboard with a Key Tronic keyboard and including a copy of the sales receipt showing the purchase of the new eligible Key Tronic keyboard after January 1, 1986, when mailing the keyboard to Key Tronic. I understand that credit will only be given for IBM PC, XT or AT keyboards or Key Tronic 5150 or 5151 keyboards.

Make check payable to:  
Company \_\_\_\_\_  
Name \_\_\_\_\_  
Address \_\_\_\_\_  
City/State/Zip \_\_\_\_\_  
Phone \_\_\_\_\_  
Contact Name \_\_\_\_\_

Key Tronic Corporation  
ATTN: Rebate Program  
Building 14  
Spokane Industrial Park  
Spokane, WA 99216



**BASF**  
2 HD high density  
two sided  
sectors soft  
FlexyDisk® 5.25

Now that you can  
store twice as much  
on one disk, you  
had better be sure  
of that one disk.

 **BASF**

BASF QUALIMETRIC™ 1.2 MB FLEXYDISKS® CERTIFIED 100% ERROR-FREE AND WARRANTED...

FOR EVER

# Pocket APL

An  
inexpensive  
yet complete  
version of  
the language

BY ERIC H. JOHNSON

**D**espite the great popularity that APL has gained in recent years, it has remained out of the reach of many microcomputer owners because implementations have been too costly and often required special hardware (such as an 8087 numeric coprocessor) and a special character ROM (read-only memory). Now, however, STSC Inc. has released a reasonably priced, very friendly package for the IBM Personal Computer that runs with as little as 128K bytes of memory and requires no special hardware. Aptly named Pocket APL, it is a complete implementation of APL that incorporates extended system and file functions, a comprehensive on-line help facility, and sample workspaces all on a single disk—and with plenty of room to spare. The introductory tutorial that comes with the package is superb, and there are adequate reference materials, including a user's manual and placards containing the keyboard layout as well as keyword and symbol references.

Pocket APL is aimed at programmers who are beginning to learn APL or who intend to write only small applications. Its only serious disadvantage is that its workspace area is limited to 64K bytes, regardless of how much memory you have. If you require a more powerful APL system, STSC's APL\* PLUS/PC offers complete memory utilization, full-screen editing, graphics, and many more features, but for a considerably higher price. On the other hand, if for now you are interested in learning APL but aren't sure about making the investment in a more robust package, then Pocket APL is definitely the way to go. It is by no means a professional package, but you will be surprised at some of its capabilities nonetheless.

Pocket APL comes with some full-screen editing capabilities. However, the insert and delete functions are extremely sluggish, especially with the color/graphics adapter, and there is no "true" insert mode; you must hit the insert key once for every character that you want to put in a line. For

editing user-defined functions, you can use the screen editor along with the "del" editor, a version of the editor found on most APL systems. Its operation is quite straightforward, but when used with the screen editor, it is helpful only for line insertion and deletion. As primitive as it is, the screen editor is much more effective for in-line editing.

Pocket APL supports the use of both APL component files and regular DOS files. APL component files are a powerful tool: They allow entire matrices (either numeric or character) to be stored as easily as if they were single elements, relieving you of the burden of having to restructure data. Components may be accessed randomly, and components may be of both numeric and character type within the same file. Unfortunately, Pocket APL imposes a severe restriction on the size of component files; I could not create one greater than about 10K bytes in size. (This was for an entire file, not just one component of a file.)

File operations are performed through special system functions, and there are many more system functions and commands to control the Pocket APL environment in general. These make for a versatile system, but they can be confusing for a first-time user, especially with their unusual (but very consistent) syntax. The syntax of system functions is the same as the syntax of APL's other functions, with the exception that system functions are designated by an English keyword preceded by a "quad box" symbol.

When you enter APL from DOS, the system asks you whether you would like to use APL symbols or their equivalent keywords, and you may switch between the two at any time during your session. The keywords can be used with either the monochrome or the color/graphics adapter card, but I only recommend you use the symbols if you have the latter. For monochrome boards, the standard PC character set is shuffled

(continued)

Eric H. Johnson is a teaching assistant and undergraduate in the computer science department at Michigan State University. He can be contacted c/o Lyman Briggs School, Michigan State University, East Lansing, MI 48824.

around a bit in a good attempt to reproduce the APL symbols, but many of them aren't there. If just starting out in APL, you may want to use the keywords, but this feature is rather awkwardly implemented. The keywords can interfere with user-defined functions, and they are case-sensitive; as you get bogged down in their use, the brevity of the symbols looks much more attractive. If you come to like APL and are not bothered by Pocket APL's limited environment, then you may want to install an APL character ROM, available from STSC for \$35. The APL symbols do not interfere with standard ASCII characters, as

only some of the more obscure foreign-language characters are displaced. It is available for the Hercules monochrome board as well as IBM's standard.

Pocket APL comes with a keyboard reference placard that you can lean up against your monitor or system unit. This is fine if you are a touch-typist, because all you have to do is glance at the placard and touch the key where you see the symbol. However, if you are a hacker type (such as myself) who never took typing classes, you have to look at the placard and then at the keyboard to locate the key. I would prefer little decals that stick

on the keys, as I am used to the full APL keyboards found on the terminals of large mainframe systems.

**BENCHMARKS**

Although Pocket APL does not have the mind-numbing speed of APL implementations with 8087 numeric coprocessors, it does a good job of holding its own against other interpreted languages. To test the performance of Pocket APL, I ran benchmark tests between it and another popular language, IBM's BASICA 2.00. (It is difficult to compare APL with any other language, so I chose the language that I felt was the best known among PC owners.) Where APL could be applied appropriately, the functions were much shorter than the BASIC programs to perform the same task. The benchmarks were run under DOS 2.1 on an IBM PC (see table 1).

First, let's consider some basic operations. The summation of the integers 1 to 10,000, while a bit simple-minded for a benchmark comparison, will allow me to point out the major differences between the way APL and BASIC perform their operations and allocate memory. The BASIC program for this task is simple enough; it is essentially a FOR-NEXT loop, taking five statements. The APL version, however, is far more concise (see listing 1) and yields the answer more quickly. This was not as surprising as one other difference: Pocket APL responded with a clean 50005000, but BASIC came back with an inexact 5.00029E+07. Using double precision in BASIC gave the correct answer, but it took a full 8 seconds more than with single precision, chugging through in 47.3 seconds. In APL, all floating-point numbers are double precision by default.

In listing 2, I compare some elementary APL array operations with the same operations in BASIC. As you can see, not only are the APL versions of these operations much more succinct, but they execute much faster, due to the much lower interpreter overhead. One of the most powerful operators in APL is the "upgrade," used in sorting numeric arrays. Curiously enough,

**Table 1:** Benchmark times for Pocket APL and IBM BASICA 2.00. The Disk Read and Write benchmarks were shortened to account for Pocket APL's limited file capabilities. For benchmarks involving real numbers, both Pocket APL and BASIC used double precision unless otherwise noted. (Times are in minutes:seconds.)

Test	Pocket APL	BASICA
Integer summation, 1 to 10,000	0:25.4	0:39.2 (single precision)
Create 10,000-element array of random integers	0:3.6	0:1:13.0
Find largest element of 10,000-element integer array	0:19.8	0:52.0
Sort 100-element integer array in ascending order	0:0.1	0:59.0
Disk Write (shortened)	0:4.1	0:12.0
Disk Read (shortened)	0:1.3	0:10.0
Sieve of Eratosthenes	3:34.0	3:27.0
Calculations	7:18.0	4:14.0
Summation of sin function values (1-360 degrees)	0:12.1	0:19.0

**Listing 1:** Summation of the integers 1 to 10,000 in (a) APL and (b) BASIC.

(a)

```
+// 110000
```

(b)

```
5 REM Summation of integers 1 to 10000
10 SUM=0
20 FOR I=1 TO 10000
30     SUM=SUM+I
40 NEXT I
50 PRINT "Done. Sum= ";SUM
60 END
```

it took much less time to sort a 10,000-element array than it did to find its greatest element. The sort program written in BASIC is a form of the selection sort, a common algorithm that requires, for an array of  $n$  elements,  $n^2/2$  iterations to complete. More efficient algorithms (particularly those involving recursion) cannot be implemented in BASIC without a great deal of complication, so I had to choose something less powerful. For direct comparison I used an array of size 100. (I had attempted using an array of size 10,000, which Pocket APL still handled very well. The BASIC program, on the other hand, got hopelessly bogged down in the selection sort and I finally stopped the program after about 17 minutes, at which point the variable  $I$  of the outer FOR loop had only reached a value of 13.)

These examples show one of the advantages of using APL, in terms of time, accuracy, and the generality of solutions (also see the text box "APL's Flexibility" on page 243). But APL also has a dark side. While the BASIC program and variables for the first example occupied only 132 bytes of memory, Pocket APL hogged nearly 20K bytes to do the same job. This was the consequence of APL's not having to construct a loop to perform the summation; it had to generate a 10,000-element array containing the numeric sequence and then perform the summation over the array. (In this case, the memory occupied by the array was released back into the workspace because I did not create a variable with it.) This is why Pocket APL's small workspace is such a disadvantage. APL can be so memory-intensive that in a small system, even simple array operations can take up all available memory if the arrays are large enough.

This memory restriction made itself emphatically clear when I tried to run some of the standard benchmarks required of BYTE reviews; the arrays generated by the operations quickly inundated the small workspace, and in each case, all I received for my pro-

(continued)

Listing 2: Elementary array operations in APL: (a) generates a 10,000-element random integer array, (b) finds the largest element of the array, and (c) sorts it in ascending order. The associated code fragments in BASIC are shown in (d), (e), and (f).

(a)

```
A ← ? 10000 ⍴ 10000
```

(b)

```
⍒ / A
```

(c)

```
A ← A [ ⍋ A ]
```

(d)

```
5 REM Generate a 10,000-element array
  of random integers.
10 DIM AX(10000)
20 FOR I=1 TO 10000
30   AX(I)=1+10000*RND
40 NEXT I
50 END
```

(e)

```
5 REM Find the largest element
  of an array.
6 REM Assume existence of 10,000-element
  array AX.
100 XX=AX(1)
110 FOR I=2 TO 10000
120   IF XX<AX(I) THEN XX=AX(I)
130 NEXT I
140 PRINT "Done. Largest element=" ;XX
150 END
```

(f)

```
5 REM Array sort using selection algorithm.
6 REM Assume existence of 100-element
  array AX.
100 FOR I=1 TO 100
110   FOR J=1 TO 100
120     IF AX(J)<AX(I) THEN T=AX(I):
      AX(I)=AX(J):AX(J)=T
130   NEXT J
140 NEXT I
150 PRINT "Done."
160 END
```

## AT A GLANCE

**Name**

Pocket APL

**Type**

Language

**Company**

STSC Inc.  
2115 East Jefferson St.  
Rockville, MD 20852  
(301) 984-5123

**Computer**

IBM PC, IBM PCjr, and some PC-compatibles equipped with PC-DOS or MS-DOS; requires at least 128K bytes of memory; IBM PC graphics board required for APL soft character set

**Documentation**

*APL is Easy!*, a 173-page tutorial; 22-page reference manual; keyword reference card; APL keyboard placard

**Price**

\$95 (\$5 shipping)

programming efforts was an unceremonious WS FULL (workspace full) message. To avoid this, I either had to "scale down" the benchmark programs or formulate iterative solutions, which I found to be quite frustrating. Another problem was with the component files (for the reasons I mentioned earlier).

The standard benchmarks used were Disk Read and Disk Write, Calculations, and the ubiquitous Sieve of Eratosthenes (see listing 3). The results summary indicates that in cases where APL could be used most appropriately, it was appreciatively

faster than BASIC. However, where APL had to be applied iteratively, as in the Sieve and Calculations benchmarks, BASIC gave it a hard time. In fact, if you compare the code for each case, you will see that as the degree of iteration increases, the slower APL performs. While in the Sieve function some degree of parallelism could be maintained, there were no parallel operations whatsoever in the Calculations function, where APL did the worst, although it did return an error of zero. To further test the precision of APL's floating-point operations, I

*(continued)*

Listing 3: *The standard benchmarks in APL: (a) is the Disk Write benchmark, (b) is the Disk Read benchmark, (c) is the Sieve benchmark, and (d) is the Calculations benchmark. Note that programs (a) and (b) had to be modified to fit Pocket APL's file-size limitations (see text). For the BASIC versions of these programs, see the June 1984 BYTE, page 327, and October 1984, page 33.*

(a)

```

▽DISKWRITE[0]▽
[0] DISKWRITE;A;B
[1] A Diskwrite benchmark
[2] A
[3] A Create A, an 8 element character vector
[4] A←'12345678'
[5] A Create B, a 96 by 96 element character matrix
[6] B← 96 96 ρA
[7] A Create file 'TEST', with tie number 1
[8] 'TEST' OFCREATE 1
[9] A Write B to the first component of TEST
[10] B OFAPPEND 1
[11] A Close file TEST
[12] OFUNTIE 1
    
```

(b)

```

▽DISKREAD[0]▽
[0] DISKREAD
[1] A Diskread benchmark
[2] A
[3] A Open file TEST with tie number 1
[4] 'TEST' OFTIE 1
[5] A Read B from first component of TEST
[6] B←OFREAD 1 1
[7] A Close file TEST
[8] OFUNTIE 1
    
```

```

(c)
  ▽SIEVE[0]▽
[0] Z←SIEVE N;FLAGS;I;ILIMIT;PRIME;K;SETZERO
[1] A Perform first iteration of Sieve of Eratosthenes.
[2] A
[3] A Set Index Origin to zero
[4]   0I←0
[5] A Initialize flag array
[6]   FLAGS←(N+1)⍉1
[7] A Initialize looping parameters
[8]   ILIMIT←LN÷3
[9]   I←0
[10] A FOR I←1 TO ILIMIT
[11] FOR:K←I+PRIME←I+I+3
[12] A IF FLAGSC[I]=0 THEN NEXT I
[13]   →(0=FLAGSC[I])/NEXT
[14] A Generate indices to set elements of FLAG to zero.
[15]   SETZERO←+K,(1+I(N-I)÷PRIME)⍉PRIME
[16] A Set FLAG elements to zero
[17]   FLAGSC[SETZERO]←0
[18] A NEXT I
[19] NEXT:→(ILIMIT2I←I+1)/FOR
[20] A
[21] A Number of primes is equal to number of 1's
      left in FLAG
[22] Z←+/FLAGS

```

```

(d)
  ▽CALC[0]▽
[0] CALC;A;B;C;I
[1] A Calculation benchmark
[2] A
[3] A←+1 A A←Natural log base e
[4] B←01 A B←Pi
[5] C←1
[6] A Initialize looping parameter
[7]   I←1
[8] A FOR I←1 TO 5000
[9] FOR:
[10] C←C×A
[11] C←C×B
[12] C←C÷A
[13] C←C÷B
[14] A NEXT I
[15] NEXT:→(50002I←I+1)/FOR
[16] A
[17] 'DONE'
[18] 'ERROR='
[19] C-1

```

# CopyWrite

## BACKS UP IBM PC SOFTWARE

Hundreds of the most popular copy-protected programs are copied readily. CopyWrite needs no complicated parameters. It needs an IBM Personal Computer, or an XT or an AT, 128k bytes of memory, and one diskette drive. CopyWrite will run faster with more memory or another drive.

CopyWrite is revised monthly to keep up with the latest in copy-protection. You may get a new edition at any time for a \$15 trade in fee.

CopyWrite makes back up copies to protect you against accidental loss of your software. It is not for producing copies for sale or trade, or for any other use that deprives the author of payment for his work.

To order CopyWrite, send a check for \$50 U.S., or call us with your credit card. We will ship the software within a day.



**Quaid Software Limited**

45 Charles Street East  
Third Floor  
Toronto, Ontario M4Y 1S2  
(416) 961-8243

Ask about ZeroDisk to run copy-protected software from a hard disk without floppies.

Listing 4: An illustration of the order of operations in APL. This example calculates a summation over the values of  $\sin(x)$ , where  $x$  ranges from 1 to 360 degrees.

```

+/10(=180)×0.360
+/ 1 0 (=180) × 0 1360
-----
+/ 1 0 (=180) × 0 1360
-----
+/ 1 0 (=180) × 0 1360
-----
+/ 1 0 (=180) × 0 1360
-----
+/ 1 0 (=180) × 0 1360
-----
1.193489751E-15
    
```

Generate integers 1 through 360  
 multiply each by Pi  
 divide result by 180  
 take the sine of each element of the result  
 finally, take the sum of the whole.

← Answer printed directly by system.

either document them very well or enjoy solving computational puzzles later on when you've forgotten what you wrote them for.

**DOCUMENTATION**

The introductory tutorial that comes with the package deserves more than the passing mention I gave it earlier; it is truly excellent. *APL is Easy!* by Jerry R. Turner offers newcomers a straightforward introduction to the language. Its only flaw is that it assumes you are at once familiar with the APL keyboard, which for new users can be terribly confusing. A general overview of each chapter is given in the introduction, and the format of the tutorial is clearly explained. There are exercises at the end of each chapter (with solutions in the back of the book) and examples galore. The sample programs in the book are even on the system disk so you don't have to type them in. *APL is Easy!* will not teach you everything there is to know about APL, but it will give you an excellent working knowledge and a very solid base upon which you can further develop your skills.

In addition to the tutorial is a 22-page reference guide containing summaries of APL and system features. Like the tutorial, it is well

made it perform the summation of the sines of the angles 1 through 360, which should yield a null result. (Besides, I could do it noniteratively so as not to offend my sense of purism.) The expression is in listing 4;

it is reminiscent of the gloriously undecipherable "one-liners" that are the experienced APL programmer's claim to fame. These are fun once in a while, but I don't recommend that you adopt them generally unless you

**EPROM PRODUCTION EFFICIENCY: \$995.00**

**14 DAY FREE TRIAL OFFER**

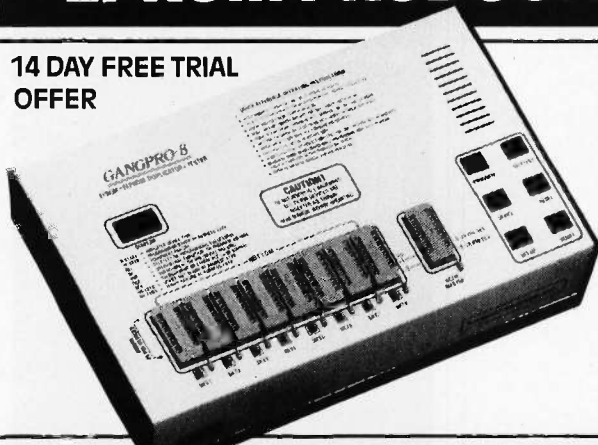

GANGPRO-8 – meets time-critical production needs. This upgraded unit simultaneously programs eight EE/EPROMs with speed, reliability, and accuracy. Non-technical personnel can efficiently learn to operate GANGPRO-8 within 30 minutes.

- Programs 2716-27512, 27513 (incl. A versions), 68764 & 87C64/128
- Verifies at 4.75, 5.00, and 5.25 VCC margins
- Isolates and displays the location of any failures

- Fast, intelligent algorithms
  - RS232 option for up/download to any computer/ includes IBM PC software
- Compare features, compare price; then make the Logical choice.

**IT'S LOGICAL**

For details, write or call:  
 1321 NW 65th Place  
 Fort Lauderdale, FL 33309;  
 (305) 974-0967;  
 toll free 800-331-PROM  
 TELEX 383142

**LOGICAL DEVICES INC.**



## APL'S FLEXIBILITY

Array operations in APL can be extended to arrays of any dimension. For a one-dimensional array, called a vector, we can find the summation of its elements with the expression  $+ / A$ , where A is the name of the vector. The number of elements in the vector is of no concern to the programmer; the parameters for controlling the summation are taken care of internally. In BASIC, the summation would have to be handled this way:

```
10 Sum = 0
20 For I = 1 to MaxI
30   Sum = Sum + A(I)
40 Next I
```

If the length of A were to change, the value of MaxI would have to be changed, too. What's worse, if the number of dimensions of A were to

change, then more code would have to be added:

```
10 Sum = 0
20 For I = 1 to MaxI
25   For J = 1 to MaxJ
30     Sum = Sum + A(I,J)
35   Next J
40 Next I
```

and so on as the number of dimensions were increased. The values of MaxI and MaxJ (the number of elements along each respective dimension) might have to be changed as well.

In APL, to perform the summation of any numeric array, the expression is  $+ / A$ . The comma between the slash and the A acts on the array A by "raveling" it, or taking all its elements and forming a vector for the purpose of the summation.

organized and its format is explained in the introduction.

If you require assistance with APL on line, the system help facility is very useful. The panic button is F6; when you press it, the screen clears and is filled with the names of the various topics (there are 35 of them). To see information on a topic, just move the

cursor to where you see it listed and hit the enter key; the screen for that topic then appears, and there are often subtopics to choose from.

### CONCLUSION

Although Pocket APL has some maddening limitations, STSC should be applauded for creating an APL pack-

age that is intended for the general PC user. It's terrific for quick-and-dirty calculations, and the fact that it runs on an unmodified PC makes it even more attractive. If, however, you are an experienced APL user, you will be disappointed. Many features found in more advanced APL systems are missing, such as groups, shared variables, and auxiliary processors.

The most disappointing part of reviewing Pocket APL was the fact that, since the standard benchmarks could not be implemented in the most appropriate way, it performed very poorly on them. I tell people unfamiliar with APL that it has power and elegance, especially in its handling of arrays.

If nothing else, Pocket APL is a means of exploring an entirely different kind of programming language, one that will make you think about programming in a new and broader sense. Naturally, it is much slower than professional APL packages, particularly for floating-point operations. But since both the workspace size and file capacity are so limited, you will not find yourself using it for serious applications to begin with. You may find that it works well for small numerical applications, but don't push it too hard. ■

## STAND-ALONE EPROM PROGRAMMER: \$395.00

14 DAY FREE  
TRIAL  
OFFER

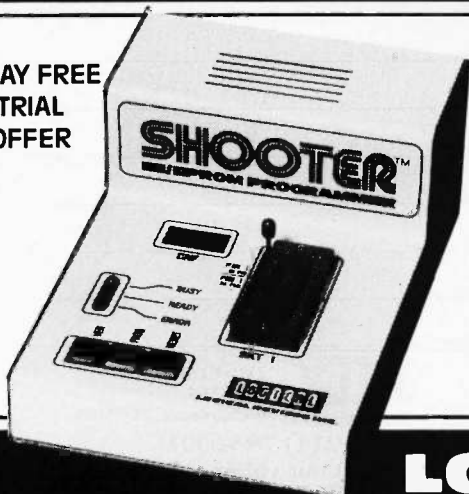

SHOOTER – Aim low in cost and high in quality with this stand-alone EPROM programmer containing 128 k-bits of internal RAM. Program all popular single voltage EPROMs 2716-27256 including CMOS and "A" versions.

- Ideal for light use and personal projects; field service too!
- Stand-alone copy and verify
- Fast intelligent algorithm
- Built in debug firmware for RAM editing via terminal/PC
- RS232 port: to 2400 baud

- Communication software available directly from Logical Devices
  - Up/download INTEL/ Motorola type file formats and ASCII/Hex/ Binary type file formats
- Compare features, compare price; then make the Logical choice.

### IT'S LOGICAL

For details, write or call:  
1321 NW 65th Place,  
Fort Lauderdale, FL 33309;  
(305) 974-0967; toll free  
800-331-PROM TELEX 383142

# LOGICAL DEVICES INC.

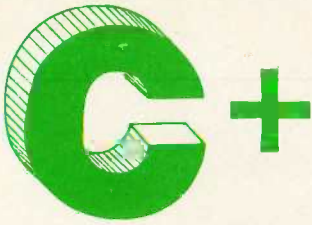

# The Best C Book A Powerful C Compiler

## One Great C Value \$39.95

A good C book just isn't complete without a good C compiler to go with it. That's why we give you both. You get a comprehensive 450 page book and a full feature standard K&R C compiler with the Unix V7 Extensions. The Book is loaded with examples that teach you how to program in C. And our fast one pass C compiler comes with an equally fast

linker so you don't waste a lot of time watching your disk drives spin. You also get a Unix compatible function library that contains more than 150 functions (C source code included). And if all that isn't enough, we offer you a 30 day money back guarantee. So what are you waiting for? The exciting world of C is just one free phone call away.

### Language Features

- Data Types: char, short, int, unsigned, long, float, double
- Data Classes: auto, extern, static, register
- Typedef, Struct, Union, Bit Fields, Enumerations
- Structure Assignment, Passing/Returning Structures

abs  
asm  
asmx  
atan  
atof  
atoi  
atol  
bdos  
bdosx  
bios  
biosx  
calloc  
ceil  
cfree  
chain  
character  
chdir  
chmod  
clearerr  
close  
clrscrn  
cmpstr

conbuf  
conc  
cos  
cpyst  
creat  
curshlk  
curslin  
curscol  
cursrow  
cursoff  
curson  
delete  
drand  
exec  
execl  
execv  
exit  
exitmsg  
exp  
fabs  
fclose  
fdopen

feof  
ferror  
fflush  
fgets  
fileno  
filetrap  
find  
floor  
fopen  
fprintf  
fputs  
fread  
free  
freopen  
fscanf  
fseek  
fiell  
fwrite  
getc  
getch  
putc  
getchar

### Functions

getcseg  
getdseg  
getd  
putd  
getdate  
gettime  
geti  
puti  
getkey  
getmode  
setmode  
gets  
getw  
heapsiz  
heaptrap  
hypot  
index  
inp  
insert  
iofilter  
isalnum  
isalpha

iscntrl  
isdigit  
islower  
isprint  
ispunct  
isspace  
isupper  
itoa  
keypress  
left\$  
len  
log  
log10  
longjmp  
lseek  
malloc  
mathtrap  
alloc  
mid\$  
mkdir  
modf

movmem  
open  
outp  
peek  
perror  
poke  
poscurs  
pow  
printf  
putc  
puts  
putw  
rand  
read  
readatr  
reach  
writech  
readdot  
writedot  
realloc  
rename

replace  
repmem  
rewind  
right\$  
rmdir  
rmdir  
scanf  
setbufs  
setcolor  
setdate  
settime  
setjmp  
setmem  
sin  
sound  
sprintf  
sqrt  
strand  
scanf  
stacksiz  
str\$

strcat  
strcmp  
strcpy  
strlen  
strcat  
strncmp  
strncpy  
strsave  
system  
tolower  
toupper  
ungetc  
ungetch  
unlink  
write  
writechs  
xmembeg  
xmemend  
xmemget  
xmemput  
xmovmem  
\_exit

## MIX Editor \$29.95

When you're programming in a high level language you need a high powered editor. That's why we created a programmable full/split screen text processor. It lets you split the screen horizontally or vertically and edit two files at once. You can move text back and forth between two windows. You can also create your own macro commands from an assortment of over

100 predefined commands. The editor comes configured so that it works just like Wordstar but you can change it if you prefer a different keyboard layout. The editor is a great companion to our C compiler. Because they work so well together we want you to have both. To make sure you do, we're offering the editor for just \$15 when purchased with the C compiler.

## ASM Utility \$10

The ASM utility disk allows you to link object files created by Microsoft's MASM or M80 assemblers. Lots of useful assembly language functions are included as examples.

**ORDERS ONLY**  
**1-800-523-9520**  
IN TEXAS  
**1-800-622-4070**

Canadian Distributor  
Saragosa Software: 416-923-1500

NOT COPY PROTECTED

Editor \$ \_\_\_\_\_ (29.95)

C \$ \_\_\_\_\_ (39.95)

C & Editor \$ \_\_\_\_\_ (54.95)

ASM Utility \$ \_\_\_\_\_ (10.00)

TX Residents \$ \_\_\_\_\_ (6.125% sales tax)

Shipping \$ \_\_\_\_\_ (see below)

Total \$ \_\_\_\_\_

Check  Money Order

MC/Visa\* \_\_\_\_\_ Exp \_\_\_\_\_

Shipping Charges: (No charge for ASM Utility)

USA: \$5/Order

Canada: \$10/Order

Overseas: \$10/Editor • \$20/C • \$30/C & Editor

PCDOS/MSDOS (2.0 or later)

IBM PC Single Side

IBM PC Double Side

Tandy 2000

8 Inch

Other \_\_\_\_\_

CPM 80 (2.2 or later)

8 Inch

Kaypro II

Kaypro 4

Apple (Z80)

Osborne I SD

Osborne I DD

Morrow MD II

Other \_\_\_\_\_

Name \_\_\_\_\_

Street \_\_\_\_\_

City \_\_\_\_\_

State \_\_\_\_\_

Zip \_\_\_\_\_

Country \_\_\_\_\_

Phone \_\_\_\_\_



2116 E. Arapaho  
Suite 363  
Richardson, TX 75081

(214) 783-6001

Ask about our volume discounts.

B1

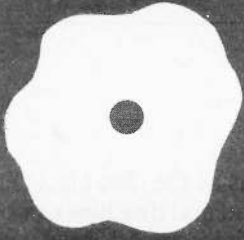

# Arity/Prolog

An  
excellent  
microcomputer  
version of  
Prolog

BY WILLIAM G. WONG

**A** rity/Prolog is an implementation of Prolog for MS-DOS systems, one that matches implementations found on a number of mainframes.

The base version of Arity/Prolog includes the Prolog interpreter and is available for \$350. You can purchase a native-code compiler with the interpreter for \$795. (I reviewed version 3.2; see the text box "Arity/Prolog 4.0" on page 247 for a look at the recently announced version.) The compiler can generate code for stand-alone programs or code that you can use with the interpreter. There are no license fees for stand-alone programs. Compiled Prolog code has all the advantages of conventionally compiled code, including faster execution.

## COPY PROTECTION

Arity/Prolog is a great product, as the rest of this article will show. However, it has what I consider one major problem: copy protection using a key-disk system. This only applies to the interpreter and compiler. Stand-alone programs do not have copy protection.

You must have the key disk in drive A when you initially run the programs, even on a hard-disk system. Also, you get only one key disk and nothing runs without it. I would hate to have the key disk fail in the middle of important research or writing.

## DOCUMENTATION

Arity/Prolog comes in a nice vinyl binder with two books entitled *The Programming Language* and *The Programming Environment*. Arity Corporation expects to have new documentation in the near future. The existing documents are good and include appendixes and an index.

*The Programming Language* describes the implementations of Arity/Prolog, including all functions built into the system. This book contains a number of good examples but is not intended to be a tutorial. The only item not covered in enough detail is the tail-recursion optimization.

*The Programming Environment* describes how to use the interpreter, compiler, and utility programs. It also describes the assembly-language and Lattice C interface and has a detailed presentation of the Prolog internals. The organization and examples are excellent.

## DATA TYPES

Arity/Prolog has a number of different basic data types, including 16-bit integers, floating-point numbers, strings, lists, variables, atoms, and structures. It lets you manipulate integers and floating-point numbers using normal arithmetics, logical bit operators, and logarithmic and trigonometric functions. The language uses an 8087 numeric coprocessor for floating-point manipulation if it is resident.

Strings and lists have the usual set of manipulation functions found in languages such as C and BASIC. Strings are character-based vectors, while lists can contain any data type. A string is written with dollar signs as delimiters; double-quote delimiters are reserved for a list of characters. This is different from other languages but does provide the required differentiation. See table 1 for examples of the two types.

Although lists have the advantage of holding an item of any type, the string usually holds text more efficiently. You will often use lists to hold a list of atoms that can be searched quickly. However, Arity/Prolog also provides the `string__search` function, which allows quick examination of strings for tokens. Multiple occurrences of a string can be found using `string__search` because it supports backtracking. For example,

```
string__search($xyz$, $xyz abc xyz$, X)
```

would succeed twice with X being instantiated to 0 and 8.

Prolog variables start with a capital letter or an underscore. An underscore alone is the anonymous variable. Atoms are constants and start with a lowercase letter or

(continued)

William G. Wong (Logic Fusion Inc., 1333 Moon Dr., Yardley, PA 19067) is president of Logic Fusion Inc. and a developer of systems and applications software.

are enclosed in single quotes. See table 2 for a list of valid variables and atoms.

Unfortunately, all variables are converted into internal names when they are placed into the database. Internal variable names have an underscore and a hexadecimal number, as in `__1CD8`. This is an inconvenience only when you use the interpreter because

```
likes( X, some__fruit ) :-
    likes( X, apples ),
    likes( X, oranges ).
```

gets converted to

```
likes( __0123, some__fruit ) :-
    likes( __0123, apples ),
    likes( __0123, oranges ).
```

Structures provide a general-purpose mechanism for describing relationships between terms. The name of a structure, called a *functor*, must be a constant. A structure can have a number of terms listed between parentheses and separated by commas. The functor can be listed by itself if it includes no terms, as in

```
functor__with__no__terms
likes( john, apples )
plural( apple, apples )
kind__of( apple, fruit )
```

The only quirk is that the left parenthesis must be adjacent to the functor. Any intervening spaces indicate

that the functor has no terms associated with it. In addition, infix operator precedence can be specified so the previous examples could appear as

```
john likes apples
apple plural apples
apple kind__of fruit
```

### DATABASE SUPPORT

Arity/Prolog uses a single database containing clauses that are structures. Clauses can be hidden in a modular fashion only if you use the compiler. A complete set of operators is provided for adding and deleting clauses. Any interpreted clauses can be listed to the screen or to a file. This capability is somewhat limited, but you can easily extend it.

In addition, you can save the entire database or restore it from a file very quickly. The save option allows incremental backup. The restore option lets you resume a session in the same condition as it was saved. This process is much faster than reading Prolog text, since information is already placed into the database.

### I/O SUPPORT

Arity/Prolog supports a wide variety of I/O (input/output) functions for character devices and disk files. You access character devices, such as the console and the printer, by using the

same functions as the disk file. I/O is stream-oriented and disk files can be randomly addressed. All input and output uses character-, string-, or structure-based operations. The language currently has no formatting options similar to PRINT USING in BASIC or format strings in C. However, you can convert numbers to strings by using a limited formatting capability, and then you can print them.

The I/O operators can use the standard input and output files or specific file handles. For example,

```
get0(Character)
get0(Handle, Character)
```

shows the use of the character-input operator with the standard input file and a specified file handle. I/O redirection is possible and is described in the documentation. You can perform redirection of the standard input and output files permanently or for the duration of a Prolog goal search.

Arity/Prolog supports the DOS 2.x subdirectories and a search-path facility for data files similar to the DOS PATH command. Directory-maintenance operations and subdirectory creation and deletion are also supported.

You can access the screen directly, including cursor-positioning control and character-attribute manipulation. This makes menu presentation much easier. You can also retrieve screen contents, which makes programming menu windows a snap.

Arity/Prolog includes direct access to the I/O ports accessible to the 8088/8086. This lets you create communications or process-control programs in Prolog without using assembly-language functions.

In general, the I/O support is adequate for most AI (artificial intelligence) applications but is limited for general applications that require formatted output. You can access binary files, but this is difficult using the existing operators.

### SYSTEM ACCESS

Direct access to the DOS for non-file-related functions is limited to time functions and invocation of the DOS

Table 1: Examples of lists and strings in Arity/Prolog.

Example	Description
[ a, b ]	Two-element list
.( a, .( b, nil ) )	Same as [ a, b ]
\$This is a string.\$	Normal string
\$A dollar sign\$\$.\$	String with embedded \$ sign
'abc'	Same as [ 97, 98, 99 ]

Table 2: Arity/Prolog's valid variables and atoms

Variables	Atoms
—	anonymous
X	x
__0394	'France'
Sack_of__items	box_of__apples

Command program. The latter lets you run other programs directly from Prolog.

You can directly access the current time and date. Also, the format of the time-stamp structure is the same as that used by the directory-manipulation functions.

Access to DOS interrupts and other system-related functions is possible if you include assembly-language or C functions.

### ERROR HANDLING AND TRACING

Arity/Prolog error handling is adequate but different from most languages. It lets you change error messages and turn the error messages for syntax and file I/O on and off. Arithmetic errors cause the evaluation to fail, and any variables involved are bound to the atom `err`. This is a nice feature when you are dealing with mathematical proofs. All other operations cause the goal to fail.

Only fatal errors, such as insufficient space, will cause the program to abort. This is unfortunate, since the state of the database is lost. Aborting current computation and returning to the top-level prompt or some specified clause would have been preferable.

The trace facility is very good. It includes a single-step-mode option with a number of other options. You can monitor a clause when it is called, when it exits, when it fails, or when backtracking occurs.

The only type of operation not supported by Arity/Prolog is a LISP-style CATCH/THROW including an UNWIND\_\_PROTECT. This would let a computation return a single result without your explicitly declaring such a possibility within a database. It also would provide a better error-handling facility for both fatal system and program-induced errors.

### VIRTUAL MEMORY

Virtual-memory support is built into Arity/Prolog, both interpreted and compiled. The Prolog database is automatically moved between a file and main memory as the program re-

## ARITY/PROLOG 4.0

I received some preliminary documentation for version 4.0 just before this article was to be published. Although I could not review the actual software, the documentation gives a glimpse of things to come.

The first change is a cleaner "cut" operation called a "snip." A snip looks like a list with cut symbols added, as in

```
[! snippet !]
```

where snippet can be any clause. The snip prevents backtracking through the snippet if it succeeds. This allows more control over the backtracking than a cut, which prevents backtracking to any prior point in a body. For example,

```
test :- a, [! b, c !], d.
test :- a, b, c, !, d.
```

The first allows backtracking on a if b and c succeed but d fails, whereas the second causes test to fail if d fails.

Version 4.0 also adds support for multiple "worlds." A world is a partition within the database (there is still only one). Separate "code" and "data" worlds are possible, with a current and

default set being accessible at one time. The structure is not hierarchical nor automatic for any set larger than the current and default worlds.

Multiple worlds let you partition information for ease of use. It also increases efficiency, since the virtual-memory system works on world boundaries. Access to data within a particular world is faster because information in other worlds does not have to be examined.

Two other major additions are support for B-trees and hash tables. These are structures within the database and not file-oriented support modules. However, they do provide faster access to large amounts of information, even faster than using different worlds. Multiple-key support is described in the documentation but is not built in.

If all goes as planned, the new version of Arity/Prolog should be a powerful superset of the existing product. Sophisticated applications seem appropriate for this implementation, especially if you have a large hard disk and extended memory support.

quires. Obviously, faster file access leads to faster program execution. Virtual-memory files are impractical on floppy disks, acceptable on hard disks, and very nice with RAM (random-access read/write memory) disks.

Arity supplies a menu-driven environment-definition program to control the operation of the virtual-memory system and a number of other system parameters.

### COMPATIBILITY

Arity/Prolog is an extended version of Prolog as found on many mainframes. A recommended Prolog text is *Programming in Prolog* by W. F. Clocksin and C. S. Mellish, which matches Arity/Prolog very well.

Arity/Prolog supports some sophisticated Prolog features, such as infix notation with operator precedence and definite clause grammars (DCGs).

This module is very useful for building natural-language parsers.

### COMPILER AND ASSEMBLY-LANGUAGE INTERFACE

The compiler is available at additional cost and provides a number of major benefits. You can compile any interpreted program unless it contains string or floating-point constants. However, you can achieve the desired effect by placing these constants in compiled code as atoms along with atom-conversion operators. Even so, this limitation can cause major problems. Additional mechanisms provide a method of defining modules that let you hide internal definitions from other modules. You can reduce name conflicts by using this feature.

Compiled code runs faster than interpreted code. The speed increase is

(continued)

**AT A GLANCE**

**Name**

Arity/Prolog 3.2

**Company**

Arity Corp.  
358 Baker Ave.  
Concord, MA 01742  
(617) 371-2422

**Computer**

IBM PC, XT, AT, or compatible  
PC-DOS/MS-DOS 2.0 or later  
256K-byte minimum (640K bytes  
recommended)  
One floppy-disk drive (hard disk  
recommended)

**Compatible Software**

Microsoft MASM assembler and linker  
Lattice C

**Documentation**

*The Programming Language*  
*The Programming Environment*

**Price**

Demo disk	\$19.95
Interpreter	\$350
Compiler/interpreter	\$795

highly dependent upon the application. Computationally bound algorithms that do not allocate new objects might be up to 20 times faster, while other operations might be only two or three times faster. Disk operations might be only 10 to 20 percent faster.

Running the compiler is easy; it prompts for all information. Unfortunately, these parameters cannot be on the command line, which makes batch files less useful. The compiler generates object files compatible with the Microsoft linker normally supplied with MS-DOS. You can use compiled code with stand-alone programs. The code can also be included with the interpreter, in which case the compiled operators are available interactively.

You can also use assembly code and functions written in Lattice C in the same fashion as compiled code. C code can handle only those arguments that are integers, atoms, strings, and floating-point numbers. The documentation gives a number of examples and describes the interface mechanism in detail.

**BENCHMARKS**

I performed a few of the standard BYTE benchmarks, using an IBM PC XT with PC-DOS 2.1, 640K bytes of RAM, a 320K-byte floppy disk, a 20-megabyte hard disk, and no 8087 numeric coprocessor.

As you can see from table 3, the Write and Read benchmark operations are slightly faster than interpreted BASIC and change little between interpreted and compiled code, indicating the hardware limitation of the floppy disk. In general, screen-

based I/O will speed up when compiled, but disk-based code will have limited speed benefits.

The floating-point calculation example is significantly slower than interpreted BASIC. However, BASIC is using a single-precision floating-point number, while Arity/Prolog uses double-precision. Arity/Prolog is slower for another reason: Unlike integers, floating-point numbers are allocated like strings. This uses additional overhead. Even so, floating-point operations are acceptable, and using an 8087 can speed up calculations.

The Loop benchmark (which tests the speed of an empty loop) and Append benchmark (which tests the speed of list manipulation) show the greatest change in elapsed time due to compilation. This marked improvement is more typical of AI-based applications where a good deal of unification is performed along with integer and list manipulation.

I did not do a benchmark for the Sieve of Eratosthenes prime-number program, because Arity/Prolog lacks arrays, which the Sieve algorithm uses. Using Prolog lists would significantly degrade the indexing operations in the algorithm. Modification of the algorithm to suit Prolog would make the algorithm very different from one written in BASIC or C. Comparisons would be difficult at best. Arity/Prolog works well with computation-based operations but not with arrays.

**SUMMARY**

Arity/Prolog is an excellent product. It provides a complete set of operators, including random file access and screen support. The virtual-memory facility can handle very large applications; it works well with a hard disk and is even better with a RAM disk. The new expanded memory boards should really make the system hum.

The only major items that need changing are the addition of a resident editor, removal of the copy protection, and better window support. However, Arity/Prolog provides a suitable environment for major AI work, especially on a PC AT with a large RAM disk and hard disk. ■

Table 3: A comparison of performance times in seconds for interpreted and compiled versions of standard BYTE benchmark programs (writing, reading, and calculations) and two additional programs (loop and append), written in Arity/Prolog.

Benchmark Name	Interpreted Time	Compiled Time
Write	31.5	29.9
Read	32.3	28.7
Calculate	362	153
Loop	15.5	0.9
Append	25.3	1.2



# NUMBER SMASHER™

**Triple your PC speed for only \$799!**

## 8087 Upgrades™

MicroWay is the world leader in 8087 support. Our 8087 development software has been in use since 1982. By 1984 we had become Intel's 97th largest OEM account. When you buy from us, you can be confident that you will receive the 8087 chip designed for your PC and that our unique diagnostics will instantly verify that your processor works correctly as installed. Call for current prices.

## 287Turbo™

This card plugs into the 80287 socket on your AT or COMPAQ, doubling the 80287 clock from 4 to 8 Mhz. It does not change the 80286 clock speed or affect your warranty. The card comes with an 8 Mhz 80287 and has provisions for faster crystals as better 80287s become available. It also has a reset button and circuit that provide a hardware alternative to CNTRL-ALT-DEL. 287Turbo with Diagnostics and Reset . . . . . **\$395**

## Number Smasher™

Number Smasher gives you AT speed and 100% compatibility with all PC software and hardware. It comes with a 10 Mhz 8086 and 512K of no wait state RAM. Most are shipped with an optional matched 10 Mhz 8087 and 128K daughterboard. The card runs programs a factor of 2.5 to 4.0 faster than the PC, XT or compatibles it runs in. Other features include FASTROM, a Ram Disk, Print Spooler and Disk Cache. Revision 2 of the Smasher is designed and manufactured by MicroWay in the U.S.A. and has the best service and support of any accelerator card.

## MegaPage™

MicroWay's "Lotus/Intel" extended memory card has all the features of the others plus one: it uses low power, cool running CMOS DRAM. Ask for our pamphlet "Extended vs Expanded Memory" and learn why MegaPage is the right card for you. MegaPage with 2 Megabytes CMOS . . . . . **\$549**



*The World Leader in 8087 Support*

P.O. Box 79, Kingston, Mass. 02364 USA (617) 746-7341  
Tempo House, London, U.K. call 01-223-7662

Number Smasher, MegaPage and 287Turbo are trademarks of MicroWay, Inc. MicroWay is a registered trademark of MicroWay, Inc.

# COMPUTER WAREHOUSE

CALL TOLL FREE **1-800-528-1054**

**FREE** **FEDERAL EXPRESS**

**Air Express Shipping**

See Details Below

**HARDWARE**

**NOW**

**BEST PRICES**

**No Charge for Bank Cards**

## PRINTERS

Anadex All Models	Call
Brother All Models	Call
Cannon Laser Printer	\$2099
Citizen MSP-10	\$255
MSP-15	\$349
MSP-20	\$319
MSP-25	\$485
Datasouth All Printer Models	Call
Diablo D-25	\$549
635	\$1079
Other Printer Models	Call

### EPSON

All Printer Models	Call
Juki 6000	\$169
6100	\$349
6300	\$679
NEC 2010, 2015, 2050	\$629
3510, 3550, 3515, 3530	\$749
8810, 8830, 8850	\$1079
P2, P3	Call
Eii 360	\$399
Eii 370	\$389

### OKIDATA

All Printer Models	Call
Panasonic 1091	\$235
1092	\$309
1093	\$419
KXP3151	\$399

### STAR MICRONICS

All Printer Models	Call
Silver Reed	
EXP400 Parallel	\$205
EXP500 Parallel or Serial	\$279
EXP550 Parallel or Serial	\$389
EXP770 Parallel or Serial	\$699

Toshiba 321	Call
P351 Parallel	\$969

### DISKETTES

Maxell MD-2 Plastic Box (Qty 100)	\$125
Sony MD/2 (Qty 100)	\$120

### MONITORS

Amdex All Monitors	Call
NEC All Monitors	Call
Princeton Graphics	Call
Texan All Models	Call
Zenith All Models	Call

### VIDEO TERMINALS

IBM 3161 & 3163 Series	Call
Qume QVT Green 101	\$299
QVT Amber 101	\$314
Wyse 30	\$299
50	\$419
75	\$559
Wyse 85	\$439
Wyse 350	\$659
Zenith Z-22	\$455
Z-29	\$559
Z-49	Call

### MODEMS

AT&T	
4000 External	\$309
Anchor Automation	
Anchor Express	\$229

### HAYES

All Modems	Call
Prometheus All Models	Call
US Robotics Courier 2400	\$389
Password 1200	\$189
Microlink 2400	\$389

## COMPUTERS

Compaq All Models	Call
-------------------	------

### Zenith Computer Products

**SAVE Up to 50%**

Z-158 All Models	Call
Z-138 All Models	Call
Z-148 All Models	Call
Z-171	Call
Z-200	Call

### DISK DRIVES

Alpha Omega Turbo 10	\$529
Turbo 20	\$529
Turbo 30	\$729
Haba Macintosh 800K	\$409
Iomega	
Bernoulli Boxes for IBM	Call
Bernoulli Boxes for Macintosh	Call
Paradise Macintosh Hard Disk	Call

## BOARDS

AST Advantage	\$389
Six Pack Plus	\$219
Everex Boards	Call
Hercules Color Card	\$149
Graphic Card	\$299
Intel	
Above Boards	Call
Paradise Modular Graphic 06-1	\$259
Five Pak	\$119
Quadram	
Quadlink	\$325
Tec Mar Graphics Master	\$445
Captain No Memory	\$155

## PLOTTERS

Enter Sweet-P600	\$749
Epson Hi-80	Call

## KEYBOARDS

Keytronics 5151	\$159
-----------------	-------

## COPIERS

### Canon PC

Canon PC-10	\$509
Canon PC-14	\$649
Canon PC-20	\$719
Canon PC-25	\$939

### XEROX

1020 w/Toner	\$1099
--------------	--------

### SANYO

SFT 600	Call
---------	------



## SOFTWARE

Gem Collection	\$115
Gem Desktop	\$29
Gem Draw	Call

### LANGUAGES

C Compiler (Microsoft)	\$235
Fortran Compiler (Microsoft)	\$209
Macro Assembler	\$89
Pascal Compiler (Microsoft)	\$178
Turbo Pascal 3.0	\$35
Lattice C Compiler	\$229
Run C Interpreter	\$85
Quick Basic	\$59
Turbo Tool Box	\$28

### PROJECT MANAGEMENT

Harvard Total Project Manager	\$269
Microsoft Project	Call
Super Project	\$182
Timeline 2.0	\$249

### COMMUNICATIONS

CompuServe Starter Kit	\$19
Crosstalk XVI	\$94
PFS Access	\$78
Remote	\$94

## IBM PC and 100% Compatibles

### INTEGRATIVE SOFTWARE

Enable 1.1	\$329
Framework II	Call
Smart Software System	Call
Symphony	Call

### TRAINING

Flight Simulator	\$30
Typing Instructor	\$29
Typing Tutor III	\$29

### GRAPHICS

Chartmaster	\$206
Turbo Graphix Tool Box	\$28
Diagram Master	\$190
Energraphics	\$165
Energraphics w/ Plotter Option	\$214
Microsoft Chart	\$175
PC Draw	\$203
PC Draw Light Pen	\$104
PC Paint w/ Mouse	\$123
PC Mouse w/ Dr. Halo II	\$107
PFS Graph	\$78
Printmaster	\$30
Signmaster	\$135

### WORD PROCESSORS

Lightening	\$52
Leading Edge Word Processor	\$50
Leading Edge W/P with Spell & Mail	\$105
Microsoft Word 2.01	\$229
Multimate 3.3	\$206
PFS:Write	\$78
Wordstar w/Tutor	\$169
Wordstar Pro Pack	\$239

Word Perfect (Ver.4.1)	\$199
Wordstar 2000	\$239
Wordstar 2000 Plus	\$285

### UTILITIES

1 DIR	\$48
Copy II PC	\$19
Norton Utilities 3.1	\$49
Sidekick	\$28
Sidekick (Unprotected)	\$43
Sideways	\$36
Superkey	\$35
Printworks	\$36
Sidekick—Superkey (Bundle)	\$65

### SPREADSHEETS

Lotus 1-2-3	Call
Multiplan	\$114
Spreadsheet Auditor 2.0	\$83

Supercalc 3 (Ver.2.1)	Call
-----------------------	------

### MONEY MANAGEMENT

Dollars & Sense w/Forecast	\$95
Tobias Managing Your Money	\$95

### DATA BASE MANAGEMENT

Cornerstone	\$255
dBase II	Call
dBase III	Call
Nutshell	\$50
PFS:File	\$78
PFS:Report	\$70
Quickcode	\$139
QuickReport	\$139
Extended Report Writer	\$80
Think Tank	\$93
Clipper	\$355
KnowledgeMan II	\$299
KnowledgeMan Upgrade Kit	\$152
Relflex	\$52

R:Base 5000	\$335
-------------	-------

Many other titles available.

We do not guarantee computer compatibility.

Inquiry 88 for MS DOS Products. Inquiry 89 for all others.

# COMPUTER WAREHOUSE

Order Line: 1-800-528-1054  
 Order Processing: 602-224-9345  
 2222 E. Indian School Rd.  
 Phoenix, Arizona 85016  
 602-954-6109

Store Hours: Mon-Fri 10-5:30  
 Saturday 9-1  
 Order Line Hours: Mon-Fri 7-5:30  
 Saturday 9-1  
 Order Processing Hours: Mon-Fri 10-3

Product shipped in factory cartons with manufacturer's warranty. Please add \$6.00 per order for UPS ground shipping on orders up to 10 lbs. Orders 10 lbs. and under you pay for ground service, receive air service at no extra charge. Available on orders 11-30 lbs. \$17 for air service. Prices & availability subject to change without notice. Send cashier's check or money order...all other checks will delay shipping two weeks.



CWF-185



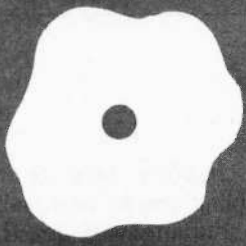

# Braille-Edit

## Raised Dot's talking word processor

BY HENRY BRUGSCH

**T**he revolution begun by the printing press and the linotype machine has created a barrier for the blind. The printed word is another reminder that we are unable to read or write without verification. The development of the typewriter brought us the capability of generating text, but we had to type and handle print without being able to read it or verify what we had typed. This meant that we had to be able to type flawlessly and accurately or that we had to have a proofreader on hand. In the last few years, with the advent of the micro-computer and breakthroughs in speech technology, a word processor for the visually impaired has become a reality.

Braille-Edit from Raised Dot Computing performs general word processing and translates printed material into braille and back (via a braille input device). You can write files in braille using dedicated keys on the computer keyboard, and you can move from Braille-Edit's file format to generating text files or other word-processing files.

To use the program, you need to install a speech synthesizer. Braille-Edit runs well with a variety of speech devices, including Intex Talker, Type-'N-Talk, and Street Electronics' Echo General Purpose Speech Synthesizer. But the most successful synthesizer for this program, the one on which it is based, is the Echo II (also from Street Electronics), now supplanted by the Echo+. This slot-mounted device requires 16K bytes of RAM (random-access read/write memory) to support its speech algorithms, which are built into the Braille-Edit program.

When you purchase Braille-Edit, you get a print-interface guide, either a print manual or a braille manual (your choice), or cassette versions of both. You also receive the double-sided disk-based software for the Apple II, Apple II+, and Apple IIc along with a year's subscription to *Raised Dot News Letter*. The Echo training disk is an option. Speech devices and attendant software are available from the appropriate manufacturers or directly from Raised Dot Comput-

ing. Braille-Edit is written in Applesoft BASIC and is licensed to run on Pronto-DOS, a variant of DOS 3.3.

Version 2.50 of Braille-Edit features these formats: print to braille, print to paperless braille (storing braille characters on magnetic tape), braille to print, Braille-Edit to text file, and text file to Braille-Edit. The program lets you copy unprotected disks and initialize blank ones. It also lets you construct files in the Bank Street format.

### GETTING STARTED

You are first confronted with the double-sided disk and a fairly formidable manual. For a first-time user, the "boot before reading" approach is not recommended. The first time you run Braille-Edit, it asks you for a configuration. You can run one of four default configurations, which assume certain basic equipment conditions, or you can set up your own configuration (by hitting the asterisk key). To choose a default configuration, you key \*2 for two-drive machines or \*1 for one-drive machines. If you want speech synthesis, you key in \*E followed by the number of drives on your machine to activate the on-board speech synthesizer. From the configuration prompt, \*E enables you to enter your configuration through speech, following the appropriate prompts.

Once you have set up a configuration appropriate to your equipment, you are ready to use Braille-Edit. The program tells you the title of the menu you are using. In the first menu the words "STARTING MENU, ENTER COMMAND" are either displayed on the screen or spoken if you have a speech synthesizer. The starting menu lets you copy disks, initialize them, list their directories, etc. As the program is currently written, you get to the main menu by turning the disk over and pressing the space bar.

From the main menu you can execute basic editing operations or print docu-

(continued)

Henry Brugsch (32 Morgan Ave., Medford, MA 02155) is a professional piano tuner who recently became interested in computers. He has a B.A. from Tufts University. His other interests include amateur radio and steam-locomotive preservation.

**AT A GLANCE**

**Name**  
Braille-Edit

**Type**  
Talking word processor for the visually impaired

**Company**  
Raised Dot Computing Inc.  
408 South Baldwin St.  
Madison, WI 53703  
(608) 257-9595

**Computer**  
Apple II, IIe, IIc, and compatibles

**Documentation**  
Choice of print or braille manual and print-interface guide, or cassette versions of each

**Price**  
\$300  
(\$275 prepaid)

ments; you can translate chapters (files) into grade 2 braille and back again (grade 2 applies to general generic braille); you can access a number of braille devices and interface to them; you can also load a file from another computer with a modem. You can initiate most Braille-Edit commands with a logical mnemonic. If you can't think of it, however, help is available. Either a return or a ? will give you a command reference to jog your memory.

From the main menu you can also access two other menus. Entering an S takes you to the secondary menu, which lets you process chapters. (The help functions are available here also.) From this menu you can manipulate chapters by changing their names or deleting, splitting, or merging material. Typing a Z at either the main menu or the secondary menu provides entry to the page menu, which

lets you treat chapters one page at a time. By enabling you to reorganize a chapter by shuffling its pages, this page-manipulation ability gives the program a text-handling capability not available in many word processors.

**THE EDITOR**

Braille-Edit is a chapter- and page-oriented word processor. The editor creates a chapter from which you can create pages of text. A page can hold up to 4096 characters, the limit of allocated buffer memory. When one page is full, you can select and write the next page. You assign a chapter name and fill pages with your text. As you write and manipulate text, you can move pages about and alter their sizes. You can leave one chapter's environment and pull pages to another one. You can call in pages from other chapters and merge them with the

(continued)

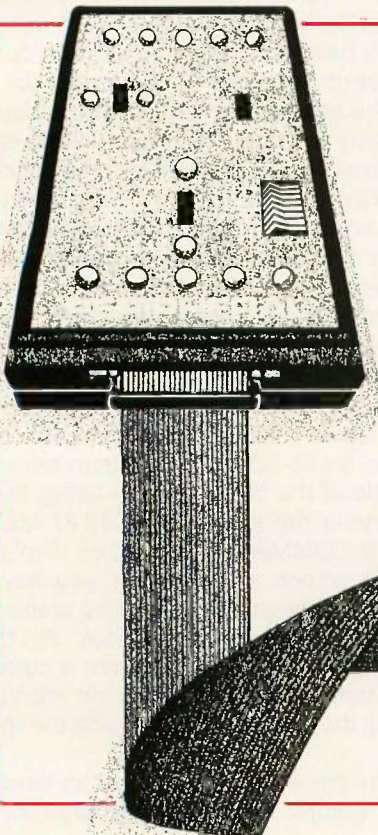

**SMART CABLE**

**Universal RS-232 connections — Just \$149.95!  
Just arrived from I.Q. Technologies Inc.**

**The SC821 Plus**

- Only 30 sec. from hook up, to communication, to pin configuration display.
- Instantly interfaces all RS 232 Serial asynchronous equipment.
- Displays the correct configuration of the equipment being interfaced.
- Reconfigures for each RS 232 application needed.
- Comes with 2 cables with male and female DB 25 connections on each end.
- Eliminates the need for breakout boxes.
- Cable making has never been easier.

Just \$149.95, plus shipping

CALL **SEATTLE DATA SYSTEMS**  
1-800-232-0817 MASTER CARD, VISA ACCEPTED  
IN EUROPE, CALL (31)-(0) 2280-16049

# FARSIGHT "SHOCKS" THE INDUSTRY WITH \$1000 WORTH OF SOFTWARE FOR \$99.95. DON'T BELIEVE US?



## JUST ASK THE FRANKLINS.

**SPREADSHEET, WORD PROCESSOR, WINDOWS: \$99.95.** Introducing Farsight. The first truly integrated spreadsheet, word processor and window manager priced to put a jolt into the competition. Because \$99.95 delivers a 1-2-3® like spreadsheet, a high-end/full-featured word-processing system and an expandable window manager. Systems that purchased separately would easily cost \$1,000.00.

**LIKE 1-2-3. ONLY BETTER.** Farsight's Spreadsheet is everything you've loved about 1-2-3 plus some new high-voltage features. And you can move up to Farsight today without any down-time. Your existing 1-2-3 data files are read directly, plus keyboard and menu-driven macros are fully supported. You won't even have to re-learn your commands. So your investment in 1-2-3 data and procedures is not lost. Easy enough.

**WORD PROCESSING + SPREADSHEET. TOGETHER AT LAST.** Farsight's Word Processor combines all the features contained in the leading high-end products with the ease of use typically found in entry-

level systems. But the real spark in your word processing productivity comes from Farsight's multiple user-defined windows. You can virtually open as many document or spreadsheet windows as you wish and cut 'n paste text from one to another. With as little as six keystrokes.

**BANK SOME BENS WITH FARSIGHT.** Ben Franklins, that is. About nine of them. And that's just the value built into Farsight. Feature-rich software that's going to change the way the industry conjures up its inflated prices. So order today. We'll ship you Farsight and our 500-page manual within three days of your phone order. And if you don't agree that Farsight is the best value on the market, we'll send you your money back.

**NON COPY-PROTECTED.  
MONEY-BACK GUARANTEE.**

**FARSIGHT**

from Interface Technologies Corp.  
3336 Richmond, Suite 200, Houston, TX 77098

**1-800-922-9049**

(In Texas, call 713/523-8422) Telex: 322127  
In Europe, call ITC in Switzerland at (01) 700-3037

IBM is a registered trademark of International Business Machines Corporation. 1-2-3 is a registered trademark of Lotus Development Corp.

Not available through dealers. Hardware requirements: IBM PC family or 100% compatible, dual-floppy or hard disk, PC/DOS 2.0 or higher.

### PARTIAL FEATURES LIST

#### Farsight's Spreadsheet/Data Manager

- All spreadsheet/data manager features of 1-2-3 Rel. 1A
- 1-2-3 macros, templates fully supported
- 1-2-3 data file read directly, no tedious importing
- Speeds comparable to or better than 1-2-3 Rel. 1A
- Pop-down menu user interface
- Sparse matrix technology like 1-2-3 Rel. 2.0
- Can search for values and labels
- 2048 rows by 256 columns

#### Farsight's Word Processor

- Full editing with insert or strikeover modes
- Multiple ruler layouts within a document
- Decimal tabs
- Search and replace backward or forward—case insensitive optional
- Continuous reformatting, underlining, boldfacing, italics, page breaks indicated on screen
- Proportional and micro-spacing supported
- Undo feature restores text deletions
- Can move columns
- Multiline headers and footers
- Soft hyphenation

#### Farsight's Window Manager

- Allows any combination of spreadsheet and word processor windows with full cut 'n paste integration
- On-line context sensitive help
- Filer supports subdirectories, file copy, move, rename, delete and search
- Supports over 40 popular printers
- Background printing
- Can have multiple printers on one machine
- Can add new Farsight applications as they become available
- User assignable keys for all applications
- Can record macros from the keyboard

Yes, rush me \_\_\_\_\_ copies of Farsight. I've enclosed \$99.95 for each copy plus \$7.00 shipping and handling. In Texas, add \$6.13 sales tax. U.S. prices only. No purchase orders accepted.

Check  Money Order

AMEX  VISA  MASTERCARD

Credit Card # \_\_\_\_\_

Expiration Date \_\_\_\_\_

Signature \_\_\_\_\_

Name  
please print \_\_\_\_\_

Shipping Address \_\_\_\_\_

City \_\_\_\_\_

State/Zip \_\_\_\_\_

Day Phone \_\_\_\_\_

International orders add \$30 shipping/handling. If paying by check, check or draft must be in U.S. dollars drawn on a U.S. bank.

INTERFACE TECHNOLOGIES CORPORATION  
3336 Richmond, Suite 200, Houston, TX 77098  
(713) 523-8422

BYT

original work. Only the size of your disk limits you.

Many of Braille-Edit's functions are chapter-oriented; others, however, are limited to page orientation. For example, the search feature can only be done one page at a time. If you wish to create a braille chapter, you run your completed text through the braille translator. You can also translate a braille chapter into print.

When you move from page 1 to page 2, Braille-Edit saves the text from page 1. Each time you change the page you're working on, the editor saves the previous page. This process is ongoing as you write and fill pages. Quitting the editor also saves your text.

The editor holds up to six screens of text in memory at a time. Control characters let you move about the document. The Apple II's arrow keys control up and down line movements

as well as back and forward space movements. Control-F takes you forward to the next screen, while Control-B moves you back. If you are using the speech capabilities, there are five additional characters plus the arrow keys for working with screens.

Braille-Edit provides a global-replace function, available from the secondary menu; it lets you replace all occurrences of one given character or group of characters with another. This is done by means of a Braille-Edit chapter. You are limited to two pages of changes, or 8192 characters. The grade 2 translator is based on one of these transformation chapters.

Braille-Edit incorporates sound cues to help the blind user more readily access the features of the program. If you enter a control function in the editor, the program beeps to let you know when the function has finished execution. There are no sound cues

for moving forward in text, but there is a quick buzz to tell you when the voice synthesizer has finished reciting the menu help screens. This is particularly useful during long chapter transcription runs. These buzzes can keep you informed of program status if you have silenced speech with a Control-X.

### SCREEN FORMATTING

Braille-Edit formats screens by embedding special commands based on the dollar sign; for example, \$P indicates a paragraph, \$F initiates a form feed, \$\$H centers and underlines, and \$L tells the program to issue a carriage return. So does Control-M, but for certain braille functions, this is not recommended. Tabs are based on real line spacing; they are not influenced by current margins. There are other \$ commands that ma-

(continued)

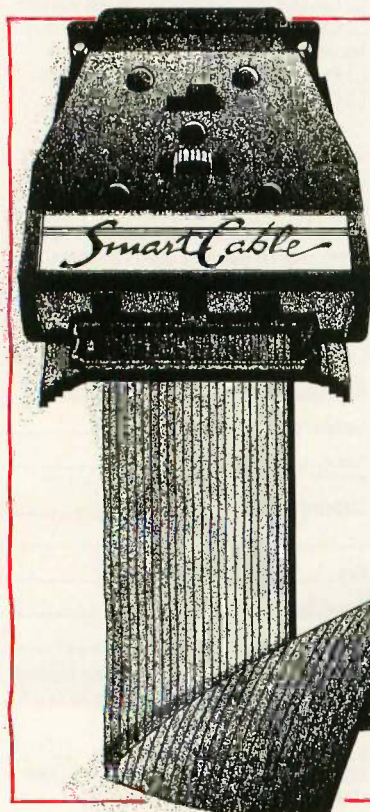

# SMART CABLE

Universal RS-232 connections — Just \$49.95!

Here's the one cable to connect virtually any computer to nearly any serial peripheral. No more custom cables. It's easy! It's the Smart Cable SC 817 from IQ Technologies. Just plug it in, flip a switch, and its ingenious electronics do the rest. Instantly. Automatically.

"Another heaven-sent accessory." —PC Week  
 "A marvel of ingenuity."  
 —Microcomputing Magazine

"The answer to a costly problem."  
 —PC Magazine

Just \$49.95, plus shipping

### InfoWorld Report Card

#### Smart Cable

	Poor	Fair	Good	Excellent
Setup				✓
Ease of use				✓
Performance				✓
Serviceability				✓

CALL SEATTLE DATA SYSTEMS

1-800-232-0817 MASTER CARD, VISA ACCEPTED

IN EUROPE, CALL (31)-(0) 2280-16049

# ECCELL: Your Insurance Card



**ECCELL**  
Multifunction Card with  
Error Correction Code

This Card Signifies ECCELL'S  
**PARITY ERROR PROTECTION PLAN**

Give Your:

**IBM AT OR COMPATIBLE  
MULTIFUNCTION & EMS**

*Would any other card  
keep running with a bad  
or missing RAM chip?*

## ECCELL: Don't Use Your AT without it. Because You Never Know When You'll Need Protection.

IBM AT owners beware—the AT can hold 25 times more memory than the PC. That's 25 times more chance for a parity error. You know what that means: your work is lost and your computer freezes with the message.

### PARITY CHECK 2

Orchid's ECCELL is your "insurance card"—a multifunction card that guards against parity errors. It has serial & parallel ports, Productivity Software to make your whole system run better, and ultra-simple Switchless Installation. It holds up to 3 megabytes of memory, including Lotus Expanded Memory, to break the 640K DOS limit (EMS).

But ECCELL has *more*: it is the only multifunction card for the IBM AT with Error Correction Code. It continuously checks memory and corrects single-bit errors *before* they do any harm. Parity errors don't stop you; they don't even slow you down.

ECCELL is like having a PARITY ERROR PROTECTION PLAN. It protects you by *preventing* disaster in the first place. The beneficiary is anyone who uses an IBM AT or compatible equipped with ECCELL. It pays the best benefit of all—the peace of mind that comes from parity-error protection.

### Features:

- Up to 3 Mb of RAM
- DOS, Extended, and EMS Memory (all three modes simultaneously)
- Switchless Installation gets you up and running in minutes
- Error Correction Code (ECC)
- Includes: RAM Disk  
Disk Caching  
Print Spooling
- Serial/Parallel Ports or 2 Serial Ports
- Adds EMS to ATs that *already* have multifunction cards

\*Orchid's Limited Warranty is included with each ECCELL.

ECCELL is a trademark of Orchid Technology. Other products named in this document are trademarks of their manufacturer.



47790 Westinghouse Dr.  
Fremont, CA 94539  
(415) 490-8586  
Telex 709289

nipulate margins and page numbering, and you can enter these characters with a space on either side where appropriate in your text.

How do you *see* what you have typed? The main menu has a printer option where you can format the screen as you call the print routine. When the program asks for a specific printer option, you key an S to see your text on the screen in print format. The Echo II speech synthesizer can analyze a 40-column line while suppressing the dollar signs. This tells you if your formatting is correct and whether you have neglected to place spaces between the commands.

When you are satisfied with your screen presentation, you can print your text. Since Braille-Edit isn't configured for any particular type of printer, it makes some basic assumptions that might need changing. For instance, you may have to insert printer commands to obtain a desired type font.

### PROBLEMS

As functional as Braille-Edit is, I found a few rough edges. The manual covers most contingencies very well. In section 26, the author explains what to do during an editor crash, which occurs far too frequently. In the event of a crash, you press Reset and then enter RUN 999. This saves whatever text is left in the editor in a chapter called Save. Then you go to the secondary menu, use the F option to "fix" the Save chapter, and create a new Braille-Edit chapter. Then you can append the new page to your article.

All this takes some time. On a few occasions, I found a lot of random rubbish (control characters and the like) that I had to manually strip from the text. One time my system crashed while formatting a list I was trying to create. When the editor died, the usual panic stations and alarm bells went off. I spent the next hour manually cleaning house. There was a lot of garbage, which proved a bit of a problem for the speech synthesizer. Indeed, until I got rid of the garbage, the editor crashed every time I loaded the tainted file. Obviously,

the garbage in the file contributed to the program crash. (However, later versions of Braille-Edit seem to have fixed some of the problems with editor crashes.)

As it turns out, there is an easier solution. On the program disk is a transformation chapter called TXVB, which prepares text for formatting on a special braille device. It can also do double duty as a housecleaning aid. It strips all control and formatting characters from the text, and where double carriage returns exist, the program inserts a \$P to make the paragraph acceptable to Versabraille, a cassette recorder from Telesensory Systems that delivers braille instead of music.

Another problem with Braille-Edit occurs with the command WRITE CHAPTER TO TEXTFILE. If you write an unformatted chapter to a text file without specifying a formatting command anywhere in the file, you get an unformatted text file with no carriage returns. As an early user of version 2.44a, which created a *formatted* text file whenever the WRITE CHAPTER TO TEXTFILE program was run, that's what I expected to find. The old version placed carriage returns at appropriate intervals (designated by the user) in the text. The transition to an unformatted text file in the later versions of Braille-Edit, 2.45 and up, was quite a jolt. After a number of phone calls to the author, I got the explanation that you have to insert certain formatting commands into the text to be converted. If you specify the width of a line by embedding a \$W followed by the appropriate number, you will get a carriage return at the column width you specify. If, on the other hand, you wish to leave your carriage returns as you previously entered them, you will lose them unless you specify a line delimiter that tells the program to leave all existing carriage returns alone.

### A FEATURE LOST

The older version of Braille-Edit, 2.44a, contained a program called Text Print that would display your text file on the screen. You could see

whether the text file you created still ran true to form. This program doesn't exist in versions 2.45 and up; you must find your own means of reading your text files.

Another minor irritation is the search command. Since it is not a global search, you must comb several pages of text to locate a specific entry. This command is extremely effective, but its utility is lost to some degree by having to individually scan pages. Since each page has a finite limit of 4096 characters, that is the largest single amount of text that you can store in memory.

### COMMENTS

#### ON BRAILLE TRANSLATION

Although I cannot evaluate the braille output of the program at this time, I can summarize the braille features available. The configuration menu contains a number of profiles for different braille output options. Braille-Edit supports Versabraille. It also supports the Kranmer Braille, an adaptation of the mechanical Perkins Braille Writer. The Kranmer Braille was designed to be a stand-alone terminal and to interface with other machines. Braille-Edit also works with the braille embossers built by Triformations. Another braille output variant is the Dipner Dot system, which enables a standard letter-quality printer to produce braille. Braille-Edit can offer grade 2 braille output with any of these devices.

### OVERALL IMPRESSIONS

I have been using Braille-Edit for the last nine months and have mixed feelings. It is a highly developed program with a great number of useful features, but it has a few failings and suffers from excessive construction. Since it now encompasses two sides of an Apple disk, Braille-Edit is somewhat cumbersome and involves frequent disk movements. It is not an easy program to use and has never been offered as such. With practice, you can get used to the numerous menus and disk accesses. As a diversified word processor and braille

(continued)

LOMAS DATA PRODUCTS LETS YOU:

# RAM IT

## Introducing Megasram.

MEGASRAM is the highest density static RAM board available for the S100 bus today. A full MEGABYTE of high speed, low power STATIC RAM on a single height S100 board without a daughter board. MEGASRAM offers the power and density required by today's high speed 16 bit microprocessors. With this board and our 8Mhz 80286 you can run WITHOUT WAITSTATES. NO ONE can offer any better performance on the S100 bus. In addition to the high speed MEGASRAM can be provided with an optional battery backup option to provide non-volatile operation. The standard MEGASRAM offers 150Ns operation, fast enough to run with an 8Mhz 80286 with no waitstates. Faster versions are available at extra cost providing as fast as 100Ns maximum access times. All our access times are quoted as board access times, not chip access times.

Prices starting at . . . . . \$395.00

### IBM COMPATIBLE S100 BUS COLOR GRAPHICS

LOMAS DATA PRODUCTS presents COLOR MAGIC, the most complete compatibility solution for S100 bus computer products. COLOR MAGIC includes three major hardware sub-functions which allow it to emulate the IBM-PC: An entirely compatible video function, an IBM-PC keyboard interface and an IBM-PC compatible timer interface including IBM-PC sound compatibility. HOW COMPATIBLE IS IT? Currently we are running MICROSOFT's FLIGHT SIMULATOR recognized as one of the severest tests of compatibility. We can also directly boot PC-DOS for the IBM-PC with no alterations. Other programs which have been tested and function without problems are: LOTUS 1-2-3, DBASE III, WORDSTAR and VOLKSWRITER. **COLOR MAGIC (16K byte version) . . \$595.00**

■ **THUNDER 186** single board computer provides a high performance 16 bit computer all on one board. It is an ideal companion to the COLOR MAGIC to provide a low cost, high performance IBM-PC compatible system. The 8Mhz 80186 offers 10Mhz 8086 performance. THUNDER 186 provides all the components necessary to form a complete system including: 256K bytes of no wait-state RAM, 2 serial ports, a parallel printer port, high performance floppy disk controller controls both 5 1/4" and 8" drives simultaneously, full IEEE 696 (S100) bus for system expansion. The COLOR MAGIC

and THUNDER 186 combine to provide performance you won't find in other compatibles. The price includes the powerful Concurrent DOS operating system. **THUNDER 186 . . . \$1195.00**

■ **NV-DISK** is a solid state memory with software to emulate a disk drive under MS-DOS, Concurrent DOS, and CP/M-86. NV-DISK is entirely COMPUPRO software compatible allowing COMPUPRO users to take advantage of the lower cost and battery protection support offered by NV-DISK. It offers the advantage of high speed access and no moving parts. It can be battery protected to allow data to stay even while powered down. The board is available in either 512K or 2 Megabyte configurations and multiple boards may be used to create disk drives with up to 16 Megabytes of storage. **NV-DISK 512K, \$595.00 2 MBYTE, \$1695.00**

■ **MEGARAM** is a high density, high performance dynamic RAM board with up to two Megabytes of storage. Megaram offers no wait state performance in 8086 systems with up to 10 Mhz processors at a fraction of the cost of comparable performance static RAM. **MEGARAM . . . . . 1/4 MBYTE, \$475.00 1/2 MBYTE, \$595.00 . . . . . 1 MBYTE, \$795.00 2 MBYTE, \$1095.00**

### IBM-PC COMPATIBLE S100-BUS SYSTEM

LOMAS DATA PRODUCTS offers IBM-PC compatible systems with performance far ex-

ceeding that available from IBM. You can purchase systems offering performance of an eight Mhz 8086 or up the performance of an 8Mhz 80286. Each system is capable of supporting 8Mhz math coprocessors. Our 8Mhz 80286 system offers IBM-PC compatibility while offering up to 2 times the performance of the IBM-PC-AT. For applications where PC compatibility is desirable but higher performance is a benefit or requirement LDP offers the only viable solution.

### WHO IS LOMAS DATA PRODUCTS . . .

LOMAS DATA PRODUCTS has been shipping 16 bit microprocessor S100 bus products for five years. We have earned a strong reputation for reliability and performance over these five years. We were running MS-DOS (SCP-DOS/PC-DOS) before IBM knew the operating system existed. We offer a wide range of 16 bit operating systems including MS-DOS, CP/M-86, CONCURRENT CP/M-86 and CONCURRENT DOS. All our products are backed by a one year guarantee. We offer no 8 bit products and concentrate entirely on high performance 16 bit systems. *If you are looking for the highest performance possible on the S100 bus, you can be sure LOMAS DATA PRODUCTS offers it.*

The S100 Bus Experts.



Dealer inquiries invited.

MS-DOS, trademark of Microsoft  
PC-DOS, trademark of IBM  
Concurrent CP/M-86, concurrent DOS, trademark of Digital Research

## LOMAS DATA PRODUCTS, INC.

182 CEDAR HILL STREET, MARLBORO, MASSACHUSETTS 01752 □ TELEPHONE: (617) 460-0333 □ TELEX: 4996272

For orders outside the U.S., contact our exclusive dealers: □ Australia - LAMRON PTY. LTD., (02) 808-3666 □ Malaysia - EXA COMPUTER (M) SENDIRIAN BERHAD, 795284 □ England - RATIONAL SYSTEMS, 0908-613209 or 0908-611349; SHARP BORN LTD., 018764559.

translator, it currently has no equal, but there is always room for improvement.

Although I had used the program before getting the chance to review it, I requested a braille manual from Raised Dot Computing for this article. When the package arrived, it contained both braille and print manuals, as well as the cassette versions. The braille manual was on thick fanfold braille paper. Before I could read the manual, I had to remove all the tractor-feed edges and tear apart the pages. Since the manual contains 94 of these fanfold sheets, this was quite an undertaking. Would a commercial program for sighted users survive if you had to tear apart and organize your own manual? The disks arrived in two pieces of cardboard stapled together. The cassettes were wrapped in a piece of paper.

Version 2.50 of Braille-Edit experiences too many crashes. The time gained by the improvements in the editor are offset by the time lost recovering from editor crashes. In trying to deal with this problem, I approached several other Braille-Edit users to see what their experiences have been. One has experienced frequent crashes in the editor, while another has never had a problem.

Phone calls to the people at Raised Dot Computing indicate that they know about the problem; they suggested I install a line-surge protector. I have done this and grounded all the equipment in the circuit. The crashes still occur.

Braille-Edit has been highly useful during the nine months I have had it. As improvements have come out and changes have been made, the features have multiplied. But as it has grown in complexity, it has also grown in size—from one side of a floppy disk and two menus to two sides of a floppy disk and four menus.

If you like, you can bypass Braille-Edit's menus. Once you are familiar with the program, you can move through the different functions by typing in the desired command. You won't see the menus until you enter a return or a ? at the prompt.

I have performed some timing tests on the program. You should realize that these tests were performed with Echo speech invoked. The times would be shorter without the audio clues. The scrolling function required between 10 and 12 seconds per page; the character count per page varied from 3077 to 3328. On top of this, each disk access requires 10 seconds, and each page requires one disk ac-

cess. The search function was much quicker, needing only 1 second per page. However, you must add the constant of 10 seconds of disk access per page to this number as well.

#### SUMMARY

Braille-Edit has moved from a strong, reliable word processor in its earlier versions to a form that is taking some steps backward in version 2.50. The program has had to use more disk space and generate more disk accesses in order to preserve memory continuity. This means that as you proceed from the main menu to the secondary menu and then to the page menu with approximately 10 seconds for each disk access, you spend a fair amount of time waiting. This doesn't take into account the boot-up procedure.

Except for the editor crashes, Braille-Edit functions reliably. I haven't had any irretrievable situations, but sometimes it is frustratingly slow to get the program going again. However, at the time I write this, it is still the best talking word processor available (there are indications of other programs of this type to come). In fact, this article would have been impossible without Braille-Edit because I am visually impaired. ■

# TURBO PASCAL PROGRAMMERS

## TURBO PROFESSIONAL 2.0 is available now!!!

- Safe, resident programs
- Virtual windows
- Service interrupts (no assembly)
- DOS program execution
- Change file modes
- Directory searches
- Read & write disk sectors
- Access hidden files
- DOS memory allocation
- Read strings from screen
- Background printing (DOS3)
- Keyboard macro processor
- Many example programs
- Source code included
- Royalty free applications

Expertly crafted Pascal and Assembler, TURBO PROFESSIONAL will take your programs to new heights. Optimized for speed and minimum code size, these routines offer capabilities previously not available. Ever tried writing safe, resident applications which can actually use DOS? Will they work with Sidekick, DOS's PRINT, mouse software, and a RAM disk? They will if you write them with TURBO PROFESSIONAL. In fact, we believe that TURBO PROFESSIONAL offers the most advanced systems level routines available for any language. So, while the other guys are playing catchup, we're not playing at all.

\$69.95 + 5.00 Shipping and Handling, VISA and Mastercard welcome.

**ORDER LINE**  
**(206) 367-0650**

Requires Turbo 2 or 3 for compatibles. DOS 2.0 - 3.1  
Sidekick & Turbo Pascal trademark Borland Intl.

**Sunny Hill**  
**Software**



13732 Midvale North Suite 206  
Seattle, Washington 98133



We have over 1000 Software and hardware items in stock. Shipments on almost all items within 24 hours!



**FREE SOFTWARE!**  
With over \$100 purchase you will receive a free diskette for your IBM PC with label maker, checker game and banner programs.

Call for programs not listed

Technical & Other Info. (602) 246-2222

# TOLL-FREE ORDER LINE 1-800-421-3135

## SOFTWARE ---DATA BASE MANAGERS---

Clipper	3345
Clout 2	129
Condor III	299
Fox and Geller Quickcode	145
Fox and Geller Quickreport	145
Knowledgeman	225
Knowledgeman II	299
K Paint	60
K Graph	135
K Text	105
K Report	135
Nutshell	55
PFS: File	78
Power Base 2.1	199
RBase 5000	Call
Think Tank	93
Tim IV	169

## ---WORD-PROCESSING---

Easy (Micro Pro)	89
Leading Edge w/Merge/Spell	130
Microsoft Word 2.01	230
Multimate 3.31	205
Multimate Advantage	255
Oasis Word Plus	85
Peachtext 5000	145
PFS: Write	78
Random House Spell Checker	36
Samna III 3.0	265
Volkswriter 3	139
Word Perfect 4.1	199
Wordstar	170
Wordstar Propac	238
Wordstar 2000	238
Wordstar 2000+	285

## ---SPREADSHEETS---

Microsoft Multiplan	115
PFS: Plan	78
Supercalc II	145
Supercalc III 2.1	Call
Twin	79

## ---ACCOUNTING---

BPI Accounts Payable	299
BPI Account Receivable	299
BPI General Accounting	299
BPI Payroll	299
Cyma	Call
Dollars and Sense	95
MBSI	Call
Tobias Managing Your Money	94

**TCS. Big Four equivalent of Peachtree Series 4** - Specially augmented and customized for your IBM PC Terminal and Printer - GL, AR, PA, AP, CP/M-80, CP/M-86 for PC XT, DOS 1.1, 2.0.  
Each Module \$65 For All Four \$249

## ---INTEGRATED---

Enable	Call
Smart Software	Call

## ---TRANSFER PROGRAMS---

Crosstalk XVI	89
Hayes Smartcom II	88
Microsoft Access	149
Move-It	79
Remote	89

## ---GRAPHICS---

Chartmaster	215
Dr. Halo II	99
Energraphics w/o Plotter	170
Energraphics w/Plotter	220
Fontrix	99
Freelance	199
Graphwriter/Combo	310
Microsoft Flight Simulator	30
PC Paint Brush	62

PFS Graph	78
Signmaster	135

**INCREDIBLE VALUE!**

Nationally advertised boards for IBM PC and compatibles at giveaway prices.

**1 year warranty**

5151 Equivalent Keyboards ..... \$89

Monochrome Board w/Printer

Port... \$79 Hercules Graphic Board Equivalent

Expansion Board 0 to 576 K... \$59

AST Six Pack Equivalent with game port ..... \$99

Four Drive Floppy Controller... \$45

Color Card without printer port. \$79

Color Card with printer port... \$95

**IBM PC CLONE**  
256K, 2 drives 7" expansion slots ..... \$695

## ---LANGUAGES---

Concurrent PC/Dos	Call
Fortran 77	208
Lattice C Compiler 3.0	Call
Run C Professional	169
Microsoft C Compiler	239
Microsoft Fortran	209
Microsoft Macro Assembler	89
Microsoft Pascal Compiler	178
Microsoft Quick Basic	65
Multi Halo	140

## ---UTILITIES---

Copy II PC	19
Copy II PC Board	79
Copywright	45
Norton Utilities 3.1	52
PC Tools	22
Prokey 4.0	75
Superkey	35

## ---PROJECT MANAGEMENT---

Harvard Project Manager	199
Microsoft Project	Call
Super Project	165

## HARDWARE

### ---HARD DRIVES---

Bernoulli 20 MB 1/2 ht.	2439
Seagate 20 MB Internal w/Controller	499
Turbo 10 internal	529

### ---MODEMS---

Anchor Express	235
Hayes 1200	Call
Hayes 1200B w/Software	Call
Hayes 2400	599
U.S. Robotics Courier 2400	Call
U.S. Robotics Password 1200	Call

### ---RAM---

64K 150NS Chips (Japan - Set of 9)	9.50
256K Ram Chips (Set of 9)	27

### ---BOARDS---

AST Advantage	359
---------------	-----

## HARDWARE

AST Sixpack (384K)	259
Hercules Color Card	145
Hercules Graphics Card	289
J RAM III	Call
Paradise Five Pak	119
Paradise Modular Graphics Card	249
Quadram Board with Par/Ser and Game Port	199
Quadcolor I	185
Sigma Maximizer Multifunction	149
STB Chauffeur Board	249
STB Mono Board	155
AB Parallel Print Switch w/cables	75
Mini Micro Parallel Print Buffer	69

## ---COMPUTERS---

Corona PC	Call
-----------	------

Sperry PC Mono 256K Dual Drive Serial Port, Clock, MS/DOS 2.11 ..... \$1650

IBM PC-AT	Call
-----------	------

ITT Computers PC Compatible 256K Dual Drive, Mono, MS/DOS	1395
---	------

ITT XP 80286 IBM/PC Compatible, 512K, 10 MB Winchester, 3 times faster than an XT. 30% faster than an AT. .... \$2650

Zenith 171	Call
------------	------

## ---PRINTERS---

### FREE! PRINTER SET SOFTWARE

Purchase an Okidata, Epson, Gemini, Citizen or Toshiba printer and receive at no charge a menu driven program to set print characteristics or to make your computer function as a correcting typewriter. Retail value \$35. Available for most disk formats.

## CITIZEN

MSP-10	255
MSP-15	355
MSP-20	329
Citizen 120D	169
Premiere 35 Daisywheel	415

**EPSON** - Call on all models

## JUKI

Juki 6100	349
Juki 6300	685

## NEC

3550	989
8850	1349
P5 Parallel	995
Elf 360	398

**OKIDATA** - Call on all models

## PANASONIC

1091	239
1092	320
1093	429
KXP3151	410

**STAR MICRONICS** - Call for prices

## TOSHIBA

1340	460
P351	1049
P341	875

## ---MONITORS---

AMDEK	Call for price
Monochrome TTL Monitors	
Amber or green	\$65
Taxan 610	319
Taxan 121 Green	125
Taxan 122 Amber	134
Princeton Max 12	169

**TERMS:** Prices include 3% cash discount. Add 3% for charge and C.O.D. orders. Shipping on most software is \$5.00. AZ orders +6% sales tax. Personal check - allow ten (10) days to clear. Prices are subject to change. We accept purchase orders.

TOLL-FREE ORDER LINE 1-800-421-3135

## WAREHOUSE DATA PRODUCTS

2701 West Glendale Ave. • Phoenix, AZ 85051

inquiry 372



# PC AT PERFORMANCE FOR A FRACTION OF THE COST. GUARANTEED.

10MHz 8086  
processor with  
full 16-bit  
data path

10MHz 8087 math  
co-processor  
(optional)

Print spooling,  
RAM disk and disk  
caching software included

Comes standard  
with 512K RAM,  
expandable to 640K

300% performance  
increase

Compatible with  
IBM Basica programs

Normal IBM speed  
emulation switch

That's right, guaranteed performance. The Univation Turbocharger will triple the processing speed of your IBM PC, PC/XT, or 100% compatible.

Just think, the data processing speed and performance of a PC/AT without the expense. Plug it in, and your PC will do everything it did before, only 300% faster.

Best of all, the Univation Turbocharger works with all

your existing PC software automatically. Nothing to learn, nothing to change. Speed spreadsheets, databases, graphics, even IBM Basica programs. The Turbocharger will spark each and every program you use.

To ensure complete reliability, our Turbocharger is extensively tested. It's available for immediate delivery. And, best of all, it's guaranteed. Guaranteed to work exactly as promised

and to provide all the processing power you'll ever need.

So why not make your life a little easier and do your work a lot quicker with the Univation Turbocharger.

See it at your local computer dealer today. For the dealer in your area call: (408) 745-0180.



**UNIVATION**

YOUR EXPANSION COMPAN

1037 North Fair Oaks Ave.  
Sunnyvale, CA 94089  
(408) 745-0180

Dealer and distributor inquiries invited.

IBM PC, PC/XT and PC/AT are trademarks of International Business Machines Corp.

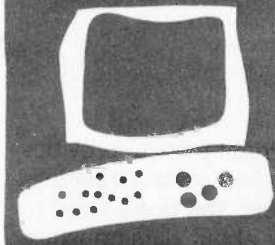

## Printit

**A card that lets you print anything that's on an Apple II screen**

BY HENRY BRUGSCH  
AND JOSEPH J. LAZZARO

**H**ow many times has protected software prevented you from printing text or graphics displayed on your Apple II's screen? Here is a printer interface card that lets you send text or graphics to your printer under any software circumstances.

Printit is a combination serial/parallel printer interface card made especially for Apple and Franklin computers. The purpose of Printit is to dump the contents of the screen to any standard serial or parallel printer, independent of whatever software you are running. This is significant since most software marketed today takes a heavy-handed approach: total domination of your computer. If a programmer decides that you should not have a printer routine in your new software package, then you are forced to live within those limits.

Printit changes all that. You can print anything on your screen automatically with a full set of print options: ordinary text, low-resolution graphics, high-resolution and double high-resolution graphics, 80- or 40-column text, side-by-side pages, inverse images, rotated images, double-size images, mixed graphics and text, black-and-white or color images, and emphasized print. With Printit's Control-I command, you can even send format commands to your printer. You can also use multiple options (for example, print a double-size black-on-white image). The combinations are many and useful. Printit is also not limited to just driving printers. The external device can be a plotter, another computer, or even a speech synthesizer.

Installing the Printit board is simple: Plug it into any Apple expansion slot and connect it to a printer with the supplied cables. (Be sure you get the right cables when you order your Printit.)

Push the activation button on the card and then hit a carriage return with any program in memory to get a full screen dump. Printit stops the software dead in its tracks. When the printing is finished, the program

restarts where it left off, totally unaware that it was interrupted.

Suppose you have a graphics screen you would like to preserve and you can't initialize your printer card because the software is protected. Press the Printit button and a carriage return and you will get an immediate dump of your screen to your printer.

You can print anything that appears on your screen, even if it doesn't want you to. If you wish to change your printer's configuration during a program run, simply press the Printit button to halt the program. Then press Control-I (ASCII value 9). This tells Printit to send control codes to the printer. You can then reconfigure the printer with its own set of commands.

### PRINTIT AND SPEECH SYNTHESIZERS

Printit can send nongraphic data to a speech device. This can be very useful to those people dependent on speech synthesis as their sole output medium. Printit works with the Votrax Personal Speech System, the Intex-Talker, or the Street Electronics Echo General Purpose speech synthesizers. The Votrax and Intex-Talker are both serial/parallel synthesizers; they will work with Printit configured either as a serial or a parallel device. With an Echo GP, you can use only the serial configuration.

Think of Printit used in this way as a brute-force speech dump. It is not a user-friendly way for a blind computer user to access his or her software, but if you cannot get a software package to "talk" by any other means, Printit is one solution.

### A STANDARD INTERFACE CARD

Printit functions just like an ordinary serial or parallel printer interface card. You do not need to press Printit's button to make your printer print. Printit can be driven in the normal way by most software packages. For example, if your Printit is in slot one and you want to set up your printer for 80-column

(continued)

Henry Brugsch attended Perkins School for the Blind and is a graduate of Tufts University. He is a self-employed piano technician and can be contacted at 32 Morgan Ave., Medford, MA 02155.

Joseph J. Lazzaro is a freelance writer and consultant (Talking Computer Systems, POB 524, Revere, MA 02151, (617) 289-3828). He specializes in voice I/O systems.

## AT A GLANCE

**Name**

Printit

**Type**

Serial/parallel printer interface card

**Company**

Texprint  
220 Reservoir St.  
Needham Heights, MA 02194  
(617) 449-5808

**Hardware Needed**

Apple II or Franklin computer with either dot-matrix or letter-quality printer

**Software**

ROM-based firmware requires no external software drivers

**Features**

Prints any screen when activation button is pressed; drives serial and parallel printers

**Documentation**

24-page manual

**Options**

Serial interface cable, parallel interface cable

**Price**

\$199

print, do the following: push Printit's button, press Control-I, then type 80N. You can even issue these commands from within a BASIC program:

```
10 PRINT CHR$(4)"PR#1"
20 PRINT CHR$(9)"80N"
30 END
```

As far as a word processor is concerned, it is talking to a standard Apple parallel interface card. All text formatting is accomplished in the normal manner, and all printer control setup codes are the same.

**COMPATIBILITY**

Printit is totally Apple-compatible. It runs on any Apple II computer (except for the IIc) and Franklin Apple II clones. The Franklin 80-column card, which resembles the Videx, will not work with Printit in certain configurations.

If you have a Microsoft CP/M coprocessor card in your system, you may encounter problems. When you press Printit's button, it may not be able to halt the coprocessor card.

**PRINTIT WITH PRINTERS**

We tested Printit on the Star Micronics Gemini-10X and the Okidata MU-92

printers. The Printit manual provides an easy-to-use chart of switch settings for most printers. You don't need to know anything about data-transmission rates or data formats, since the chart is indexed by printer type. We were able to get good-quality screen dumps from popular software packages at the press of a button.

We were also able to double the size of the image by pressing Printit's button, typing D, and hitting a carriage return. You can print a double-size emphasized version of the screen by entering ED and a carriage return. It is easy to mix multiple command options; you can even get an emphasized, doubled, inverted, white-on-black image. See table 1 for a complete list of printer options.

**CONCLUSION**

Printit is worth its price, especially when you consider that this board has built-in serial and parallel compatibility. Its one drawback is its inability to handle two-way telecommunications traffic, like the Apple Super Serial Card. If you need a flexible printer interface card with the power to punch through protected software, give this board a close look. ■

Table 1: Printit's commands and their functions. Commands can be passed to Printit either through software or the keyboard after you press Printit's button.

Command	Function
1	Display page #1
2	Display page #2
4	40-column print
8	80-column print
P	Print graphics only
M	Print mixed graphics and text
V	Double high-resolution or low-resolution graphics
C	Normal high-resolution or low-resolution graphics
S	Print pages #1 and #2 side by side
D	Print double-size image
R	Rotate image 90 degrees
I	Print inverse image (white on black)
W	Print black and white
L	Left-justify image
E	Print emphasized image
Control/I	Send commands to external device

IN ADDITION TO PRINTING TEXT AT 40, 100 OR 200 CPS, THE IBM PROPRINTER CAN PRINT ALL-POINTS-ADDRESSABLE GRAPHICS. →

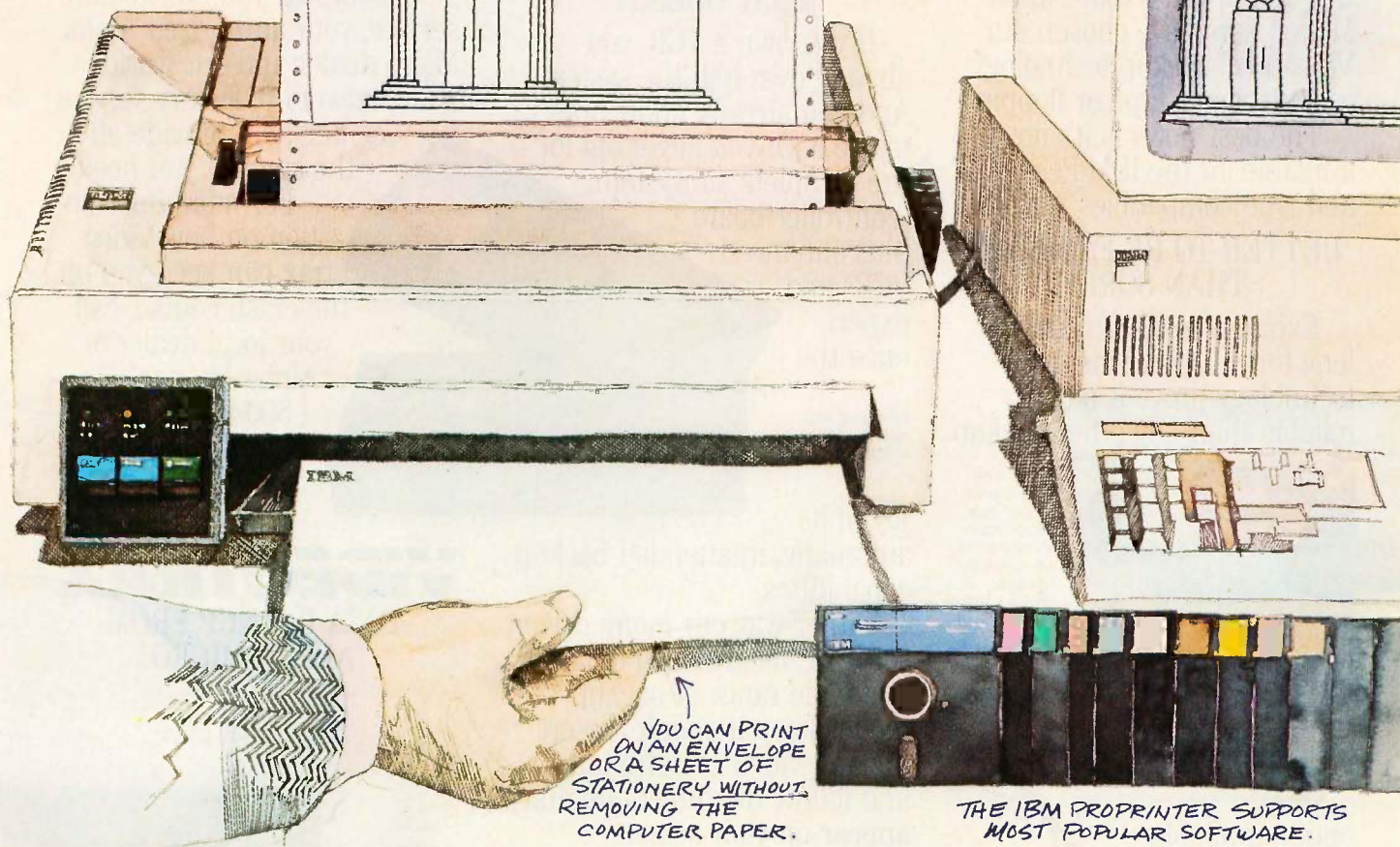

YOU CAN PRINT ON AN ENVELOPE OR A SHEET OF STATIONERY WITHOUT REMOVING THE COMPUTER PAPER.

THE IBM PROPRINTER SUPPORTS MOST POPULAR SOFTWARE.

## Built to take it. Priced to take it with you. The Proprinter from IBM.

There's just one thing that's as remarkable as the rugged reliability of our most versatile personal printer—and that's its price. Under \$550.

The Proprinter is built by IBM to last. And simplicity of design is what makes it so reliable.

Yet the IBM Proprinter is a full-featured machine. It has three printing speeds to give you everything from fast first drafts to sharp, near-letter-quality correspondence. It takes perforated

computer paper for long jobs and—without removing the paper—will easily print on a sheet of stationery or an envelope, thanks to a handy slot in front.

With its all-points-addressable graphics and its comprehensive character set, the IBM Proprinter supports most popular software.

The Proprinter attaches to every IBM PC and to other leading personal computers. And it's just part of our growing family of personal printers. All are

designed to serve a single purpose: To give everything you do the finishing touch.

For the authorized IBM dealer or the IBM Product Center nearest you—or for free literature—call 1 800 IBM-2468, Ext. 104/LH. Or contact your IBM marketing representative.



IBM Personal Printers...The Finishing Touch

# 15,000 SAVED FROM CRASH.

No hysteria. No panic. No reports of data loss. No wonder more than 15,000 Alpha Micro users have chosen our Videotrax™ backup technology over streamer tape or floppies.

The best news is it's now available for the IBM PC-AT, XT and true compatibles.

## BETTER TO BE FAIL-SAFE THAN SORRY.

Exhaustive testing and long term use of Videotrax technology prove it more reliable than any other backup

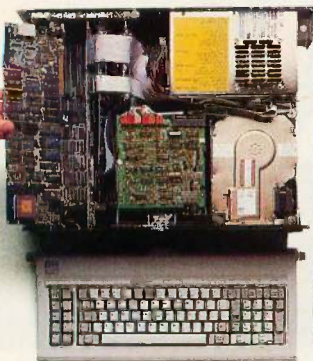

*High-tech. Open your PC and slide the controller board into any expansion slot. Low-tech. Hook up VCR to computer with standard connector cables.*

option available. Even more reliable than the hard disk you're backing up.

At the heart of the system is a patented video tape controller board that employs a standard video cassette recorder for copying data. Which means Videotrax offers the sophisticated technology of today's VCRs. And the depend-

ability of a durable consumer good.

## EASY DOES IT.

If you own a VCR, you already own half the system. And you already know how to use it. Or you might opt for the complete subsystem (controller board plus enhanced VCR) and experience the

*Your basic video cassettes. Reliable, cheap, easy to find.*



joy of its automatic, unattended backup capabilities.

Either way, our menu driven software, clear documentation and wide range of backup modes keep it simple: Insert a blank video cassette tape and follow the directions that appear on your screen.

You can copy or restore your entire hard disk, specific files, or only files modified since the last backup, while the system busily self-monitors for proper functioning.

And for the price of taping your favorite TV shows, you can record your most valued computer data. Up to 80MB can be stored on a single cas-

sette at less than a third of the cost of streamer tape.

Of course, if you ever require service, your authorized Alpha Micro dealer and our worldwide network of factory service centers will provide all the support you need.

For more information on how Videotrax can keep you off the crash course, call your local dealer or Alpha Micro at 1-800-992-9779 (in California call 1-800-821-0612).

## VIDEOTRAX™ DATA BACKUP FROM ALPHA MICRO.



Corporate Headquarters: 3501 Sunflower, P.O. Box 25059, Santa Ana, CA 92799 © Alpha Microsystems 1986

# R·E·V·I·E·W F·E·E·D·B·A·C·K

## ENABLE

I have been an Enable user for ten months. The following is my review of your review of Enable (January, page 331).

Steve King concluded the review with the statement "Although I've heard version 1.1 is better, I found Enable 1.0 not quite ready and able..." It seems unprofessional to publish a review of a product that is not the current version. The review mentioned but a fraction of Enable's features. One of these was so misunderstood by both Rich Malloy and King that it was singled out as a major drawback, namely the fact that Enable's menu and command sequences were dissimilar and therefore (so you thought) confusing.

On the contrary, this is in fact an asset, once you understand that the menu selection is for those who prefer to use the arrow keys to move the block cursor and/or type single initials to match the displayed choices of the menu. In this case your review was a disservice to both prospective Enable buyers and to the Software Group, producers of Enable. The update 1.1 version was first shipped three months before the January date of BYTE.

I realize the publishing predicament of soliciting a review then finding it is out of date at the time of publication. The only fair course in this case is a new in-depth review of Enable 1.1, rather than trying to redeem the time-expired review with a hasty half-page text box about the new version.

REV. FRANCIS G. McCLOSKEY  
Albany, NY

Steve King's review of Enable was right on target, making it obvious that he has used the program.

King is absolutely right that version 1.0 was unusable. My version of 1.1, with some October 1985 changes, is a vast improvement. (I mention the date of my latest changes because they are continuing to make minor changes. An earlier release of 1.1 is clearly different.)

Some may wonder what Enable is good for. Enable is the only integrated program I've seen with adequate help screens and prompts. No keyboard overlay is necessary, and the commands, if sometimes awkward, are at least usually consistent.

I have found Enable to be well suited to odd multifunction jobs, especially where there are involved computations to be done in a relational database (exponentials and trigonometric functions, etc.), and the results are to be included in a mail-merge letter. Billing for leased equipment where there is a variable interest rate is a good example of its capabilities. If the new release has as many improvements as were made in version 1.1, it should be a winner.

CARTER HARISON  
Beaverton, OR

## AT&T PC 6300

I am writing in response to Bob Troiano's review of the AT&T PC 6300 (December 1985, page 294). I am very familiar with the IBM PC XT and I think the AT&T is by far the better of the two, especially if you use Lotus 1-2-3!

PC 6300 readers should take note of the suggestion for adding 512K bytes of memory to the motherboard. This will save the PC 6300 owner a lot of money. I paid an estimated \$550 less than if I ordered from AT&T, and \$450 less than if I acquired AST's SixPakPlus with 384K bytes of memory, a memory-expansion board, and a 128K-byte expansion kit. I had already installed the 256K memory chips, but I could not get anyone to give me the appropriate DIP switch settings. Mr. Troiano's article gave me most of the information I needed.

One caution about the setting of DIP switch 1 (aka bank 1): The switch should not be adjusted unless the PC 6300 user wishes to reconfigure the unit's disk drives. For example, the setting that Mr. Troiano recommends configures the system with a floppy-disk drive and a hard-disk drive designated as drive C. Settings are different if you have two floppy drives or if you designate the hard disk as drive C, as shown below:

Troiano recommendation: 00110011  
Two floppies: 00000110  
One floppy and the hard disk designated as C: 00110100

In addition, I'd like to offer advice to potential PC 6300 buyers: Many dealers sell the PC 6300 equipped with 128K or

256K bytes at very similar prices. If you select a unit with 256K, you will be forced to purchase a memory-expansion board as well as chip sets to increase the PC's memory to 640K. I recommend that potential buyers order the 128K unit, install eighteen 256K chips, and set switch 0 as recommended.

As far as software is concerned, AT&T has released an update disk for MS-DOS 2.11 and GW-BASIC. This disk includes some new programs.

MICHAEL J. SOBOTA  
Schaumburg, IL

I purchased an AT&T PC 6300 in August 1985 and really do like it; however, it has also caused hours of frustration.

I agree with Bob Troiano's comments on the machine's speed, operability, and compatibility. I have upgraded to 640K bytes of memory and have added virtual-disk capability with 360K bytes. Uploading my operating software to drive C really makes the machine faster than any I've seen. I imported the virtual-disk operating software from PC-DOS 3.0, as the AT&T user's manuals do not discuss virtual disks. All common IBM software runs fine on my machine. As the review pointed out, however, the GW-BASIC provided with the unit does not directly interface to BASICA. As a matter of fact, I have several programs waiting for patches to get them running.

On the other hand, I don't agree with Troiano's speculation on AT&T's product support. I have had my machine in the shop three times for a total of over seven weeks. It has gone through three power supplies, two disk drives, two keyboards, and three motherboards. The longest delays I experienced were because motherboards were out of stock. If indeed motherboards are scarce, I would caution potential customers against buying the machine until the problem is corrected.

AL SARGEANT  
San Diego, CA ■

REVIEW FEEDBACK is a column of readers' letters. We welcome responses that support or challenge BYTE reviews. Send letters to Review Feedback, BYTE Publications, POB 372, Hancock, NH 03449. Name and address must be on all letters.





# Kernel

---

<b>COMPUTING AT CHAOS MANOR: ALL SORTS OF SOFTWARE</b> <i>by Jerry Pournelle</i> .....	269
<b>CHAOS MANOR MAIL</b> <i>conducted by Jerry Pournelle</i> .....	293
<b>APPLICATIONS ONLY: FIRST IN A SERIES</b> <i>by Ezra Shapiro</i> .....	297
<b>ACCORDING TO WEBSTER: 68000 WARS: ROUND 1</b> <i>by Bruce Webster</i> .....	305
<b>BYTE JAPAN: A NEW LANGUAGE AND A LAPTOP</b> <i>by William M. Raike</i> .....	327
<b>BYTE U.K.: THE AMSTRAD PCW 8256</b> <i>by Dick Pountain</i> .....	333
<b>MATHEMATICAL RECREATIONS: DIOPHANTINE EQUATIONS</b> <i>by Robert T. Kurosaka</i> .....	343
<b>CIRCUIT CELLAR FEEDBACK</b> <i>conducted by Steve Ciarcia</i> .....	354

---

ONE COMMON THREAD that seems to weave itself through many of Jerry's columns is his attendance at parties. We all realize that this is a nasty job, but Jerry knows full well that somebody has to do it. This month's column finds him hosting a BIX party at Chaos Manor. Fortunately, he is able to survive the party and forge ahead. Much of the column deals with a wide variety of software. One of the products that he is quite impressed with is an integrated package known as Q&A.

BYTE presents a new column this month—Applications Only, written by Ezra Shapiro. The column is intended to provide a quick look at various applications software packages. This time, Ezra reviews four new products—Turbo Editor Toolbox, Ready!, Balance of Power, and Easy.

The Macintosh from Apple, the Atari 520ST, and Commodore's Amiga are the three prominent 68000 machines that are causing a stir in microcomputer circles. Now having all three of these computers, Bruce Webster begins his comparison of them in this month's According to Webster. He takes a number of different areas and ranks the machines in each of them. Bruce's observations show him that each machine has both strengths and weaknesses and that there is no clear winner.

In BYTE Japan, Bill Raike looks at a new language called Mind, which he believes is the first programming language created in Japan. All of Mind's reserved words are written in Japanese kanji characters, and the statement syntax resembles that of the Japanese language. Bill also describes his new laptop—the Fujitsu FM-16 $\pi$ .

The Amstrad PCW 8256 is a Z80-based computer and word processor from Amsoft of Essex, England. At £399, it is actually a dedicated word-processing system for less than the price of many electric typewriters. So far, these new Amstrads have been popular in their homeland, and Dick speculates that they may soon be available in the U.S.

The subject covered by Bob Kurosaka in Mathematical Recreations is the Diophantine equation. A number of methods are available for solving this type of equation, but this month's column looks for a method of solution based on general principles of mathematics. There is also a section on mail received from readers of previous columns.

# FORTRAN, C, and BASIC Programmers...

## Programming just got easier with Scientific Subroutine Libraries from Wiley Professional Software.

You need to quickly generate dependable, accurate and error-free code. Whatever language you use, Wiley Professional Software has a powerful Scientific Subroutine Library that can save you considerable programming time and development money.

Each library consists of more than 100 pretested and precompiled mathematical and statistical subroutines, supplied on disk as a linkable library and as source code. Each package includes 400-plus pages of documentation, providing you with extensive reference material, a listing of the subroutine's source code, complete test programs and the results of running each test. The Subroutines cover formulas for:

- ◆ General statistics
- ◆ Probability
- ◆ Analysis of variance
- ◆ Regressions
- ◆ Matrices
- ◆ Interpolations
- ◆ Fourier analysis
- ◆ Cross tabulations
- ◆ Differential equations
- ◆ Roots of biquadratic equations
- ◆ Function evaluations
- ◆ Systems of equations
- ◆ Solution of equations
- ◆ Times series analysis
- ◆ and more

### Just out, Professional FORTRAN! Coming Soon, MORE FORTRAN!

And now all the subroutines are available to those of you programming in Professional FORTRAN. All that's required is IBM Professional FORTRAN or Ryan McFarland FORTRAN.

On the way is MORE FORTRAN, which includes subroutines covering such areas as:

Analytical Geometry ◆ Vector Algebra ◆ Utility (including complex matrix manipulation) ◆ Numerical Analysis (including fast Fourier transforms, and solution to systems of non-linear equations) ◆ Assembler Service Routines—FORTRAN CALLS

LIBRARY	PRICE	REQUIREMENTS
FORTRAN Library	\$175	Microsoft FORTRAN ver. 3.13 or later, or IBM 2.0
C Language Library	\$175	Lattice C Compiler ver. 2.12 or later
BASICA Library	\$125	BASICA
Professional FORTRAN Library	\$175	IBM Professional FORTRAN: Ryan McFarland FORTRAN
MORE FORTRAN Library	Call for Price	Microsoft FORTRAN ver. 3.2 or later: IBM Professional FORTRAN: PC DOS 2.0 or better

Developed by Peerless Engineering Service

**To order, or for free literature, call: 212-850-6788**

**Or write:** Wiley Professional Software  
John Wiley & Sons, Inc.  
Leslie Bixel,  
605 Third Avenue, New York, NY 10158



**Dealer Inquiries Invited.**  
**Educational site licenses available.**

**wiley**<sup>TM</sup>  
PROFESSIONAL  
SOFTWARE

THE TECHNICAL SOFTWARE SOURCE

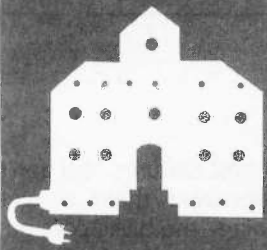

# C·O·M·P·U·T·I·N·G A·T C·H·A·O·S M·A·N·O·R

## All Sorts of Software

The Big Party

BIX

Crosstalk

Printer Optimizer

Q&A

XyWrite

Ready!

Logimouse

Alien Names

Beyond Compare

PC Calculator

Quick BASIC

Heath/Zenith Show

BY JERRY POURNELLE

**W**ell, we survived the big party. About half the civilized world, and a third of the barbarians, seem to have wandered through Chaos Manor at one time or another during the evening. My neighbor's yard was so littered with champagne corks the next morning that I had to send the boys out with trash bags. Half a dozen Black Forest and San Honore cakes, a gallon of Athol Broz, three gallons of chili, and 12 feet of stevedore sandwich disappeared without a trace. We had two separate computer systems connected to BIX (BYTE Information Exchange) so that those on the network could share in the festivities. And a good time was had by all. Mrs. Pournelle, who thinks computers are boring and computer parties more so, had fled to San Jose for the evening and returned with some trepidation; but amazingly nothing was broken. In fact, thanks to honorary hostesses Pamela Clark and Barbara Clifford, things were in such good shape that the housekeeper gave no more than a token look of disapproval.

### COMMUNICATING

One of the people I met at my party was Connie Kageyama. It happened this way: when we got Philippe Kahn of Borland International on BIX, he was somewhat unhappy with the speed of the mail system. (It was pretty slow, but that's been fixed.)

"It takes too long. You're on line too much," Philippe said.

"True, but what can I do?"

"Talk to Connie Kageyama," said Philippe, which turned out to be good advice. Connie is a system operator for CompuServe's IBM Special Interest Group and calls himself a computer hobbyist; but he knows more about computer communications than most professionals I've met. He says he isn't creative, which may be, but he's one heck of a problem solver. After a couple of weeks playing with BIX, he had some suggestions, including some programs he wanted to bring over; it seemed natural enough to in-

vite him to the party.

The result is a series of command scripts for the Crosstalk communications program. I can use these to log on to BIX, get my mail and the conference materials I want to read, and log off the system. All this happens while I go for coffee. Then I can read the stuff at my leisure.

I also have a program furnished by one of the Bixen—inhabitants of the BIX network—that is said to parse headers and sort the conference messages. I confess I haven't used it yet because I'm told an improved version is in the works. What I really need, though, is a program that will do even more: sort through the messages, assigning some to a priority file and others to the bit bucket depending on subject matter and origin; then let me, still off line, answer the messages using a good full-screen editor with a spelling checker; then go back on line and squirt the answers into the various conferences in which they belong.

I don't have such a program, but I'm working on it. "Working on it" doesn't mean I'm going to write it, because I have neither the time nor the expertise to do it. What I have done is tell every computer genius I know that a real integrated communications package making use of current artificial intelligence concepts is likely to make a lot of money. It seems a natural: more and more people are involved in computer communications whether they like it or not, and most of them are going nuts.

### BURNOUT?

There's a lot of literature on computer conferencing. Most experts in the field describe a pattern: a new user discovers computer-mediated conferencing; it's wonderful—the best thing that's happened in years; the user becomes addicted. Then the trouble starts.

A recent letter described the problem exactly: whereas an open computer conference begins with a small number of well-informed and highly interested participants,

(continued)

*Jerry Pournelle holds a doctorate in psychology and is a science-fiction writer who also earns a comfortable living writing about computers present and future.*

it soon attracts others. That's all right; it's supposed to attract others. Where else would you get new ideas? But soon it attracts too many, far too many, and some of them are not only uninformed but aggressively *misinformed*. Dilution takes place. Arguments replace discussions. Tempers are frayed.

The result is that while computer conferencing began by saving time, it starts to eat up all the time it saved and more. Communications come from dozens of sources. Much of it is redundant. Some of it is stupid. The user spends more and more time dealing with irrelevancies. One day, the user wakes up, decides the initial euphoria was spurious, and logs off, never to return. This is known as burnout, and it's apparently quite common.

Certainly something like that happened to me; but as it happened I noticed something: most of the irrita-

tion came from a handful of people, sometimes only one or two. If I could only ignore them, the computer conferences were still valuable. Alas, it's not always easy to do; temperament and emotion work against overlooking some of the dreadful things people say, while good manners (and in my case, residual memories of being a teacher) dictate that you pay some attention to the sincere but confused. Easy or not, you must restrict your interactions, especially on a system with thousands of users, or burnout is inevitable. I can't do that alone, but the next generation of communications software should help me accomplish it. I can hardly wait.

**CROSSTALK**

In addition to the scripts, Connie Kageyama brought over a copy of the latest revision of Crosstalk. Crosstalk scripts—command files—are one of

the program's best features. You don't need to understand them to get Crosstalk running—the basic communications package is easy to implement—but given some work and experience, you can really customize Crosstalk.

The program is also full of undocumented, or poorly documented, features. For example, I installed the new Crosstalk by copying it into the XTALK subdirectory of the Kaypro 286i's hard disk, then invoking it. All my old scripts and communications files worked fine—as they were supposed to—except that now, instead of white letters on a black screen, I had green letters.

I don't much like green on black. The newest version of Crosstalk has needed features, such as the Kermit system for sending long files, so I didn't want to go back to the old one; but I also didn't want those green letters. Surely there's a way to change back to white on black, I thought.

Clearly it was time to open the manual. First things first. Start with the index and look up "color." No. Try "screen." No index entry for that either, and none for any other word I thought relevant. Eventually I gave up on the index.

Next step: the old version didn't change screen colors. This is a new revision. Look at the pages specific to this revision. Aha! A new command, VIdeo (all Crosstalk commands can be invoked by their first two letters). Surely that will do it—but of course it didn't. I tried other approaches, but eventually I gave up and called Microstuf, Crosstalk's publisher. After a couple of minutes, I was connected with Bob Strong, who with Les Fried founded Microstuf back in the hobbyist 1970s.

I'm glad I called. Strong is one of Crosstalk's designers, and he knew all about its undocumented features. "There are two ways to change the screen color," he said. "You can patch the EEKS file [that's how he pronounced it; I presume that means the EXE file, although I never got around to asking]—there's one byte for the

(continued)

**XT WINCHESTER WITH TAPE.**

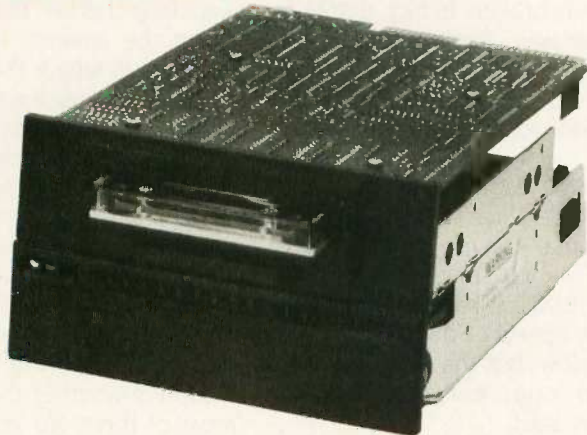

Interface gives you enhanced IBM PC-XT storage plus data security with its new DoubleBarrel<sup>®</sup> combination drives. These are internally-mounted units that are simple to install and give you 10, 22, or 33 megabytes on a half-height Winchester disk drive plus a half-height cartridge tape. Now, you have enhanced Winchester storage plus tape backup in a single package that mounts simply

in the "B" drive location using a single slot.

Interface provides a full range of IBM PC and PC-compatible storage products that are recognized for their performance and quality. Since 1978, Interface has been providing quality peripheral subsystems for personal computers along with complete service and technical support.



21101 Osborne Street  
Canoga Park, CA 91304  
(818) 341-7914 Telex 662949 CNPK

In Canada Santronic Sales, Ltd. (604) 589-4454

IBM is a registered trademark of IBM Corporation  
DoubleBarrel is a copyright of © Interface, Inc.

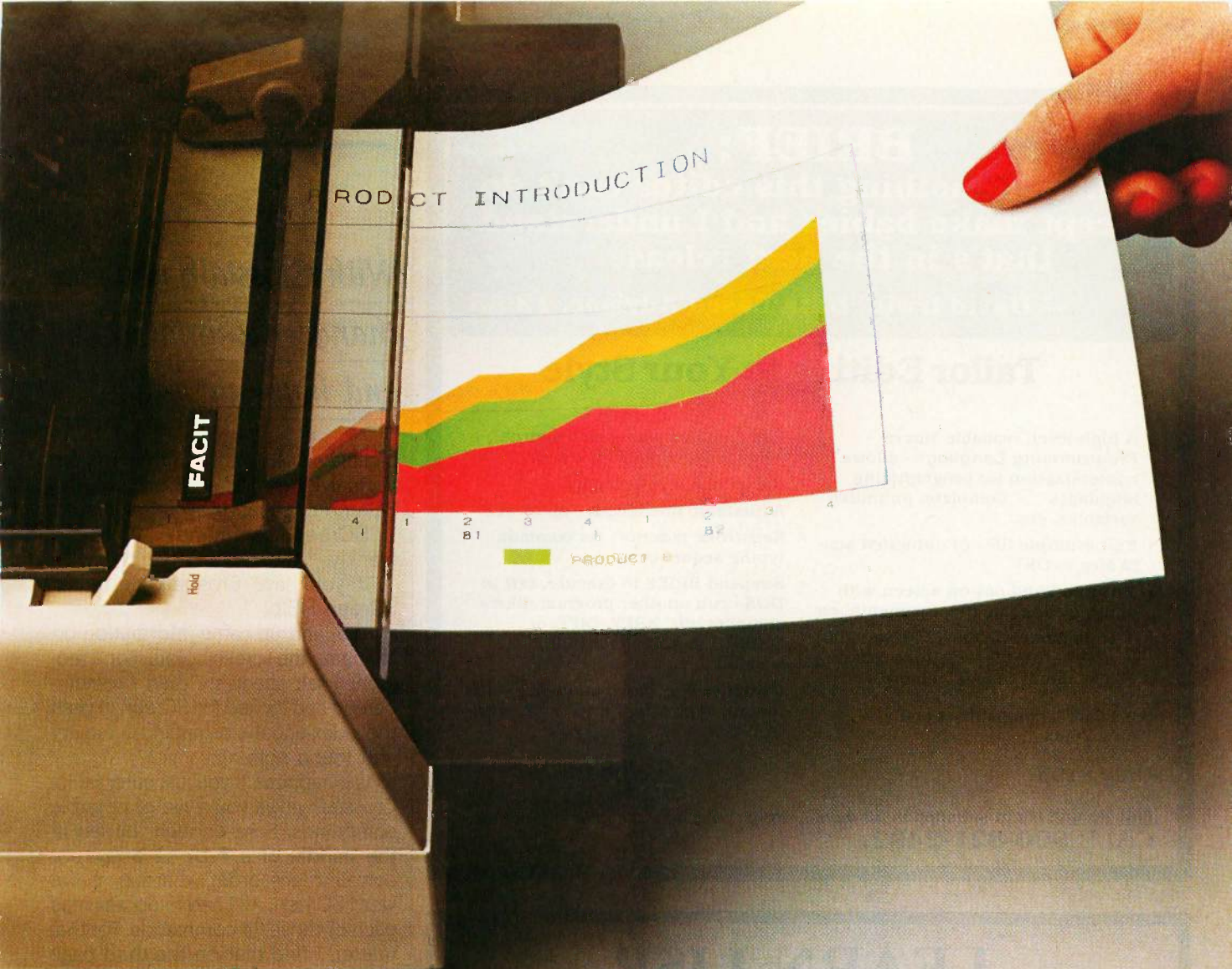

# GET THE PICTURE WITH FACIT 6-PEN PLOTTERS

Multicolour graphics on paper and overhead transparency film are now a reality at a price every computer owner can afford – with the new Facit 4550 and Facit 4551 Pen Plotters.

The 6-pen cassette design provides instant colour changes with a multitude of colour set-ups. Longlife ballpoint for paper, oil-based fiber-tip for transparencies and water-based ceramic pens for high-quality CAD drawings are available with 8 to 12 different colours. Two pen-cassettes can be stored in pockets on top of the casing. The pens are securely sealed to prevent drying.

Business graphics, CAD, CAE, science and engineering plottings are handled with a character resolution as high as 10×10 elements per character. Facit 4550 accepts media sizes ISO A4 or 8 1/2 × 11", while Facit 4551 takes media up to ISO A3 or 11 × 17".

## FRIENDS WITH ALL MAJOR COMPUTERS

With HP-Graphic Language emulation and serial/parallel interfaces, the plotters easily make friends with all major computer models on the market. Software packages include Lotus 1–2–3,

Symphony, Fast Graphs, DR Draw/Graph, BPS, etc.

Got the picture? Get it at your nearest Facit representative!

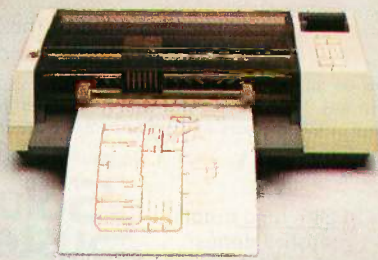

# FACIT

Inquiry 131

## BRIEF:

**"There is nothing this editor can't do except make babies and I understand that's in the next release."**

— David Irwin, Data Based Advisor, 12/85

### Tailor Editing to Your Style

- A high-level, readable *Macro Programming Language* - allows customization for programming languages . . . Complete, unlimited variables, etc.
- Edit *multiple files of unlimited size* (2 Meg is OK)
- Multiple *Windows* on screen with different or same file, fragments, etc.
- A bona-fide *UNDO* stack (up to 300) of all operations: deletions, reading files, search, translate, more.
- Full "regular expression search" - wild cards, complex patterns
- Reconfigurable keyboard
- Adjustable line length - up to 512.
- *Keystroke macros* - for common typing sequences
- Suspend BRIEF to execute, exit to DOS - run another program (like a compiler, dir, XREF, DIFF, or DEBUG) then resume BRIEF session
- *Compiler-specific support* like auto indent, syntax check, compile within BRIEF

For PC, AT, compatibles and Tandy 2000.

Only \$195

Full Refund if not satisfied in 30 days.  
CALL 800-821-2492.



335-B, Washington St., Norwell, MA 02061  
617-659-1571

## LEARN LISP

Interactively and Write "Realistic" Programs with TransLISP for Only \$75

A "COMMON LISP" compatible Tutorial, Interpreter, Debugging, and Pretty Printer plus a Fast, Full Screen Editor, Samples and Help

- Start Easily and Quickly:**  
A complete, modular tutorial helps you learn LISP at your own pace. An integrated, interactive environment provides all of the elements needed to enter, modify, analyze and debug programs.
- Write Realistic Programs:**  
Short examples and substantial programs of about 10 pages in length help you learn by modifying, studying and using the key concepts needed to write programs of 1000 lines or more.
- Natural Language, Expert Systems and Mailing List:**  
Natural Language concepts are illustrated by a phone number retrieval program. Choose the best word processing program for you with the Expert System. File handling and typical data processing work are demonstrated by a Mailing List program.
- The "COMMON LISP" Standard:**  
TransLISP includes a 230+ function subset of the "COMMON LISP" Standard. Use extras like the MSDOS interface and graphics. Or use "strict compatibility" to make programs written in TransLISP, with no changes, work with other COMMON LISP systems like VAX LISP, GC/LISP or LISP Machine LISP.

Use and Modify the Mailing List program to learn how to handle "normal" programming in LISP.

Runs on any MSDOS or PC DOS Systems: Not copy-protected. TransLISP is available in just about any 3", 5" or 8" format. PC compatibles can run TransLISP with no installation procedure. 192K memory and 1 floppy drive are the minimums required.

ONLY \$75 For Beginners and Experienced Programmers

Full refund if not satisfied during first 30 days.



335-B Washington St.  
Norwell, Mass. 02061  
617-659-1571  
800-821-2492

## CHAOS MANOR

*With Crosstalk you can change background and highlight colors.*

highlight color and another for the normal letters—or you can use the SScreen command."

"SScreen command?" I asked blankly.

"If you have Crosstalk up, enter SScreen HELP."

I did, and up came information on changing the screen colors. For a moment I felt sheepish, then I remembered I had looked for SScreen in both the index and the command summary and found nothing.

As it happens, if you just enter HELP, Crosstalk gives you a list of possible commands. Sure enough, buried in the middle of a 7 by 12 array, not sorted in any order whatever, is the word SScreen. All I had to do was read each of those 84 commands. For that matter, I find that on the third page of the table of contents, the seventeenth entry for Chapter 6 (Terminal Features) is "Changing the Screen Colors."

Indeed you can, given close reading of the manual, change both background and highlight colors; you can make the letters pale blue on a bright blue screen with yellow highlighting (rather pleasing, actually; just enter SC N Cb) or almost anything else. You can put screen colors into your various communications files so that, for example, you can use one set of colors for BIX, another for Dow Jones Information Retrieval, and yet another for communicating with your friendly neighborhood hobbyist bulletin board and have those colors come up automatically. Of course, you'll first have to find the proper commands.

Even then you want to be careful. The example they give of using the SScreen command is "SCREEN A FB, where A specifies the type of characters you want to set (N for normal, H for highlighted, or L for status line),

(continued)

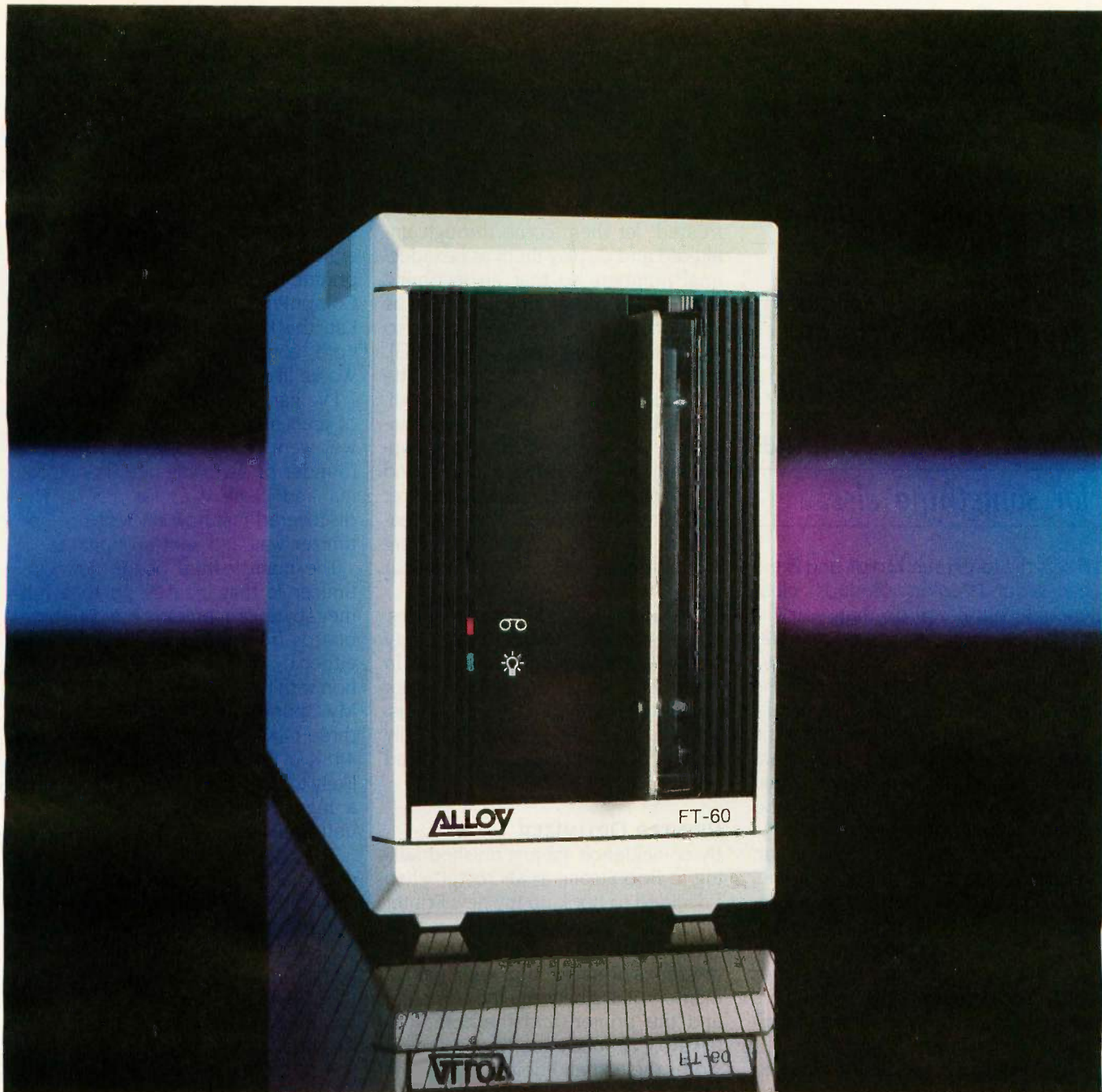

## Alloy's Streamliner Series. The best protection for your company's past, present, and future.

The best protection for your personal computer data storage needs is available today. From Alloy. Choose tape only. Or combined disk and tape. Either way, the Streamliner Series provides the performance you expect from the leader. At a remarkably affordable price.

Alloy's FT-60 streaming tape backup subsystem gives you up to 60Mb storage capacity and high-speed data transfer. The SL-60 models give you the same high quality tape unit *plus* integral hard disk. And you can choose 20Mb or 41Mb formatted data capacities.

With Alloy's Streamliner Series, you'll get the best protection for your company's past, present, and future. So call Alloy today at (617) 875-6100.

**ALLOY**  
Computer Products, Inc.

100 Pennsylvania Avenue, Framingham, MA 01701 (617) 875-6100, TWX 710-346-0394

In Europe: ALLOY Computer Products (Europe) Ltd., Cirencester, Gloucestershire, England. Tel.: 0285 69571 Telex: 43340

Inquiry 15 for More Information. Inquiry 16 for Sales person or demonstration.

MARCH 1986 • B Y T E 273

*The Printer Optimizer  
stores text and doles  
it out to the printer  
as needed; meanwhile,  
you can use the computer  
for something else.*

F sets the foreground color, and B the background color." Sounds clear enough, but if you do that, you will get a blinking background that drives you mad. It turns out that you must use a *lowercase* letter to specify the background, else it blinks. The manual never tells you that. I suspect that the only reason they don't get more frantic phone calls is that so few people find the instructions to change the screen colors in the first place.

Incidentally, it turns out that you can *change the color of the status line*, meaning that you can, if you like, blank it out entirely by putting black letters on a black background. Of course, if you do that, you'd better remember how to get it back again, or you'll have to give all your commands by memory.

I do like Crosstalk. I can't claim to be an expert on communications programs, but I have used several of them, and I now use Crosstalk for all my conferencing and telecommunications, meaning that I prefer it to anything else I've tried. I also like Microstuf's upgrade policy: if you have bought the program in the last year or so, the upgrade is free, and if you have an ancient copy that requires a new manual, the cost is still nominal.

I like Crosstalk, but that manual has real problems. Of course, it is a dilemma. The Microstuf people don't want to overwhelm you with hundreds of pages that you must read before you can use the program; on the other hand, they keep adding features.

For example, there's a DEbug command. With DEbug you can set the

way incoming control characters are treated: let them come through unaltered and display them as hexadecimal numbers so that an incoming Control-Z is shown on your screen as [1A], display as ASCII mnemonics so that the Control-Z is shown as [SUB], or show the Control-Z as ^Z. The really nifty feature of DEbug, though, is the RS232 command: when you invoke it, you see precisely what's happening with pins 2, 3, 4, 5, 6, 7, 8, and 20 of your serial communications line. Bob Strong says he added that feature because he got tired of having the batteries burn out in his breakout box.

There are tons of other features, some well-documented, some pretty obscure. Documenting them all in great detail would scare off users; not documenting them drives us nuts. What to do? The problem is hardly unique, and there is a solution. Read on.

#### PRINTER OPTIMIZER

By coincidence, I'd just finished talking to Bob Strong at Microstuf when I decided to hook up my new Printer Optimizer from Applied Creative Technology (ACT). The Printer Optimizer is a smart box with lots of memory. It sits between the computer and the printer, and the computer talks to it at 9600 baud. The Optimizer stores the text and doles it out to the printer as needed; meanwhile, you can use the computer for something else.

That's worth something, but actually the Optimizer does a lot more. It's programmable, so you can take text formatted for one printer and translate it into the format for another one. You can store a huge bunch of text in the Optimizer and print it later. You can stop printing, bring in more text, print that, and go back to the original job. You can use the Optimizer to dial up special features for your laser printer. You can even use the Optimizer as an adapter to let your Macintosh drive a non-Apple laser printer.

Finally, the Optimizer is pretty smart: you can have two computers

and two printers hooked up to it and use it as a switching device so that either computer can drive either printer. In my case I have Zeke II, the CompuPro Z80 I write with, and Big Kat, the Kaypro 286i AT-compatible, both connected to the Optimizer. Works like a charm.

I've had an Optimizer for a couple of years now. Last summer, just before we went to Europe, Tim Wylde, founder of ACT, was here in California and came over for a visit. He discovered just how ancient my Optimizer was and sent an upgrade.

The main feature of the new Optimizer is that it takes up to a full megabyte of memory. The 64K-byte boards from the old one also work, either by themselves or in combination with the newer 256K-byte boards. My Optimizer has one 256K-byte and three 64K-byte boards, for a total of 448K bytes, which is as much as I'm likely to need. (Well, *Footfall* was almost a megabyte long, but that was an unusual case.)

The Optimizer comes with lots of documents. It has to, since it's designed to work with a variety of computers and printers. Unlike Crosstalk's documents, these make no attempt to conceal the machine's features: just the opposite. Begin reading, and you're soon plunged into the mysteries of character substitution, how an RS-232C port works, and like that. It's all written in plain language and is very useful.

However, I didn't need an introduction to the RS-232C port. I didn't even need the discourse on switch and cable settings because all I had to do was copy the switch setting from the old Optimizer into the new one. Indeed, when I compared the two, I found that the new switch had already been set up like the old one. Good, I thought. One less thing to worry about. Just plug in the cables and send over a test file—which I did.

The Optimizer displays the amount of free memory; as text is pumped into it, the number on its screen decrements. Sure enough, 448 went down to 447, then 446, at which point

*(continued)*



# THE PROGRAMMER'S SHOP™

helps save time, money and cut frustrations. Compare, evaluate, and find products.

## SERVICES

- Programmer's Referral List
- Compare Products
- Help find a Publisher
- Evaluation Literature FREE
- BULLETIN BOARD - 7PM to 7AM 617-826-4086
- Dealer's Inquire
- Newsletter
- Rush Order
- Over 700 products

## AI - Expert System Dev't

- AritySystem - incorporate w/C. PC \$295
- ExpertEASE - Develop by describing examples of how you decide. Call
- EXSYS - All RAM, Probability. Why. Trees, Solid, files, popular. PC \$359
- 1st Class - by example, interfaces \$250
- Insight I - Probabilities, required thresholds, menus, fast (\$79). 2 adds backward, forward, partitions, dB2, lang, access. PC \$399
- Others: APES (\$359), Advisor (\$949), ES Construction (\$100), ESP (\$845), Experteach (\$399), Expert Choice (\$449)

## AI - LISP

- List Our
- GC LISP - "Common", rich. Interpreter - Interactive Tutorial \$495 Call
- LARGE Model - 2 to 15 meg. Compiler and Interp. \$1190 Call
- TLCLISP - "LISP-Machine" - like, all RAM, classes, turtle graphics, 8087, compiler. CPM-86, MS \$225
- WALTZ LISP - "FRANZ LISP" - like, big nums, debug. CPM-80 MS \$149
- Others: IQ LISP (\$155), BYSO (\$125), MuLISP-86 (\$199)

## AI - PROLOG

- ARITY Standard - full, 4 Meg \$ 95
- Interpreter - debug, C, ASM \$ 350
- COMPILER/Interpreter - EXE \$ 795
- With Exp Sys, Screen - KIT \$1250
- MicroProlog - enhanced \$ 229
- MProlog - Improved. Faster PC \$ 725
- Professional MicroProlog MS \$ 359
- TransPROLOG - Learn Fast, Standard, tutorials, samples MS Call
- Others: Prolog-1 (\$359), Prolog-2 (\$1895)

## Editors for Programming

- BRIEF Programmer's Editor - undo, windows, reconfigure PC Call
- C Screen with source 80/86 \$ 75
- EMACS by UniPress - powerful, multifile, windows, DOS, MLISP, programming. Source: \$949 \$299
- Entry Systems for C PC \$325
- Epsilon - like EMACS, PC \$169
- FirsTime by Spruce - Improve productivity. Syntax directed for Turbo (\$69), Pascal (\$229), or C (\$239)
- Kedit - like XEDIT PC \$115
- PMATE - power, multitask 80/86 \$159
- VEDIT - well liked, macros, buffers, CPM-80-86. MS PC \$119
- XTC - multitasking PC \$ 95

## FEATURE

- TransLisp - "Common subset, tutorial, editor, PP, trace. Best to learn. All MS Only \$ 75

## Free Literature - Compare Products

Evaluate products. Compare competitors. Learn about new alternatives. One free call brings information on just about any programming need. Ask for any "Packet" or Addon Packet  AI  ADA. Modula  BASIC  C  COBOL  Editors  FORTH  FORTRAN  PASCAL  UNIX/PC or  Debuggers, Linkers

## C Support - Systems

- Basic C Library by C Source \$139
- C Debug - Source debuggers - by Complete Soft (\$269), MSD (\$149).
- C Sharp - well supported, Source, realtime, tasks \$600
- C ToolSet - DIFF, xref, source \$135
- Lattice Text Utilities \$105
- The HAMMER by OES Systems \$179
- H.E.L.P. By Everest Solutions \$329

## Fortran & Supporting

- Forlib+ by Alpha - graph, comm. \$ 59
- Fortran >> C - FORTRIX creates maintainable translations. \$995
- MACFortran by Microsoft - full '77 \$239
- MS Fortran \$239
- No Limit - Fortran Scientific \$129
- PolyFortran - xref, pp, screen \$149
- Prospero - '66, recentrant \$390
- RM Fortran - enhanced "IBM Ftn" \$429
- Scientific Subroutines - Matrix \$149
- Statistician by Alpha \$269
- Strings and Things - registers, shell \$ 59

## TURBO PASCAL and SUPPORT

- BORLAND: Turbo 3.0 \$ 49
- 3.0 with 8087 or BCD \$ 79
- 3.0 with 8087 and BCD \$ 85
- Turbo Graphix - graphs, windows \$ 39
- Turbo Toolbox or Editor \$ 55
- Turbo Tutor \$ 29
- TURBO... Asynch by Blaise, full \$ 89
- MetaWindow by Metagraphics \$ 49
- Power Tools by Blaise - library \$ 89
- Power Utilities - profiler, pp \$ 89
- Professional - interrupts, macros, \$ 70
- OTHERS: Screen Sculptor (\$99), Pascal Pac (\$100), Tidy (\$45), Multi Halo (\$89).

## OTHER PRODUCTS

- Btrieve/N (\$469), single user \$199
- CPRINT - by ENSCO \$ 50
- DoubleDOS - concurrent \$ 85
- Faster C - scrap your linker \$ 95
- HTest/HFormat - thorough XT Fix \$119
- Microsoft Windows \$ 75
- Opt Tech Sort - sort, merge \$ 85
- Panel - Screens, windows \$239

Ask about ATARI ST, Amiga

Call for a catalog, literature, and solid value

# 800-421-8006

THE PROGRAMMER'S SHOP™

128-M Rockland Street, Hanover, MA 02339

Mass: 800-442-8070 or 617-826-7531 186

## RECENT DISCOVERY

- Dan Bricklin's Demo Program - Prototype quickly, with realism. User feedback without programming. All 250 ASC characters plus attributes. Subsetting, building blocks, macros, thorough. PC \$ 75

## C Language - Compilers

- BDS C - solid value, fast CPM80 \$125
- C86 by CI - 8087, reliable MS Call
- Consular Mac C w/toolkit MAC \$299
- ECO C/88 MS \$ 59
- Lattice C - from Lifeboat MS \$289
- Lattice C - from Lattice MS \$339
- Mark Williams - debugger MS \$379
- Megamax - tight full ATARI/ST \$179
- Microsoft C 3.0 - new, MS \$259
- Q/C 88 by Code Works - Compiler source, decent code, cross/native MS \$295
- Wizard C - Lattice C compatible, full sys. III, lint, fast. MS \$379

## C Language - Interpreters

- C-terp by Gimpel - full K & R., OBJ and ASM, large progs. MS \$249
- INSTANT C - Source debug, Edit to Run-3 seconds MS \$399
- Interactive C by IMPACC Associates. Interpreter, editor, source debugger, profiler. PC \$395
- Introducing C - Interactive C to learn fast, tutorial PC \$115
- Professional Run/C has C plus ability to create add-in libraries, (Lattice C compatible) and load/unload them. MS \$199
- Run/C - improved MS \$109

## C Libraries - General

- Blaise C Tools I (\$109), C Tools 2 \$ 89
- C Food by Lattice - ask for source \$119
- C\*LIB by Vance \$129
- C Utilities by Essential - Comprehensive screen graphics, strings, file handling, memory mgmt. Source. MS \$139
- Entelekon C Function Library \$119
- Entelekon C Windows \$119
- Entelekon Superfonts for C \$ 45
- Greenleaf Functions - portable, ASM \$139
- Polytron - for Lattice, ASM source \$ 99
- Software Horizons - Pack 1 \$129

## C Libraries - Communications

- Asynch by Blaise \$149
- Greenleaf - full, fast \$139
- Software Horizons - pack 3 \$119

## C Libraries - Files

- FILES: C Index by Trio - full B + Tree, vary length field, multi compiler /File is object only \$ 89
- /Pro is partial source \$179
- /Plus is full source \$349
- CBTREE - multiuser record locking, sequential, source, no royalties \$99

Zeke indicated that as far as he was concerned, the file was all printed. The printer, however, remained silent. (Laser printers take about 25 seconds for the first page, then print about eight pages a minute.) I waited—

Still nothing. Clearly the Optimizer wasn't giving instructions to the printer. Back to the manual. Aha!

Here's a hands-on tutorial for getting started—only it tells me how to do command substitutions. Nothing about making the thing print. Try another page. And another. Hmm. Here's an interesting note. "If any problem takes you more than 10 minutes, call Applied Creative Technology." Right.

I called. It turns out that the Optimizer by default wants to send the text out through its parallel port, which is port 1. To change to the serial port, you press the P, the 2, and the Exe buttons on the Optimizer's little control pad. It took the ACT people about 10 seconds to tell me that, and once it was done, printing began immediately. Nothing to it—except that I couldn't find that instruction, although I'm sure it's buried somewhere in the manual. Everything else is.

"Be sure to tell them we're revising the manuals. Also that we're real helpful on the phone," said the ACT people; and indeed it's all true. More than that: the Optimizer's documents have some of the best material on the mysteries of the RS-232C port that I have seen. The Optimizer includes a little built-in breakout board, and the appendixes on how to use it to hook the Optimizer to different printers are outstanding for their simplicity and clarity. They explain complicated stuff very well; it's the obvious they've overlooked. It's not an unusual situation.

I have a remedy. Both the Printer Optimizer and Crosstalk documents need examples. Here's what you do, and here's the result. Put in a dozen or so of those, and most users will be able to figure out what's going on. Moreover, documents should start with the simplest possible applications. I've always recommended that every computer language document should begin with that language's equivalent of PROGRAM 'Hello', which does nothing but print "Hello" on the screen. Similarly, every hardware and software document should have a section showing precisely how you go about getting the most elementary feature to work.

Pournelle's law of documentation: "You can't have too many examples."

#### OUT OF MEMORY

It was inevitable. It began with SideKick, the indispensable—to me at any rate—memory-resident utility from Borland International. Then

(continued)

# Lattice® Works

## VERSION 3 OF THE LATTICE MS-DOS C COMPILER IS NOW AVAILABLE.

This is a major upgrade of the product and is available to registered users for a \$45 update fee. Non-registered \$60. The list price remains \$500.

New compiler features include:

- *ANSI language constructs...*
  - "unsigned" as a modifier
  - "void" data type
  - "enum" data type
  - structure assignments, arguments, and returns
  - argument type checking
- *Inline code 8087/80287 80186/80286*
- *Code generation*

The compiler also contains numerous improvements such as better aliasing algorithms, more efficient code generation, and more flexible segmentation. The library includes more than 200 new functions in the following categories:

- *ANSI/UNIX/XENIX compatibility*
- *Extended support for MS-DOS*
- *Extended support for networking, including file sharing, file locking, and I/O redirection*
- *Flexible error handling via user traps and exits*

The Library has also been re-engineered to produce much smaller executables.

## LATTICE ANNOUNCES NEW DATA ENCRYPTION SOFTWARE

Now you can keep your confidential data confidential. Thanks to new SecretDisk, a new data encryption system for IBM PC, XT, AT and compatibles.

Utilizing the NBS Data Encryption Standard, SecretDisk provides complete security for salaries, customer lists, or other sensitive information stored on a floppy or hard disk. SecretDisk is loaded as a disk driver by MS-DOS. It creates new DOS drives (like D:) on floppy or hard disks where all data and programs are always fully encrypted.

SecretDisk is extremely easy to use. A password is entered when the system is booted, and protection can be switched on and off with a single password controlled command line. However, without the password, there is no way to access the encrypted files. \$59.95.

## LATTICE CREATES C COMPILER FOR COMMODORE AMIGA

Amiga C, produced by Lattice for the Commodore Amiga, supports the Amiga's 68000 microprocessor and offers the same high speed and extensive capabilities of the MS-DOS Lattice C compiler currently used by more than 30,000 software developers worldwide. Available from both Commodore and Lattice. \$149.95.

In addition, Lattice also offers cross compilers that allow you to develop Amiga programs on MS-DOS. Native and Cross \$250.

Contact Lattice, to discuss your programming needs. Lattice provides C compilers and cross compilers for many environments including Tandy, Sony, Hewlett-Packard, Tandem, and IBM Mainframe. Corporate license agreements available.



**Lattice**

(312) 858-7950 TWX 910-291-2190  
 INTERNATIONAL SALES OFFICES:  
 Benelux: De Vooght. (32) 2-720-91-28.  
 Japan: Lifeboat Inc. (03) 293-4711  
 England: Roundhill. (0672) 54675  
 France: SFL. (1) 46-66-11-55



Top  
Quality  
Programming  
Tools  
from the  
Developers  
of the  
TurboPower  
Utilities

**NEW!**

# Turbo EXTENDER<sup>™</sup>

Tired of fighting 64K Code and Data Segments?  
Bored while waiting for your 10,000 liner to Compile?  
Want to optimize those sluggish Overlays?

## LARGE CODE MODEL

Write Turbo Pascal programs using all 640K of MSDOS memory, based on any number of separately compiled modules. Provides complete parameter passing using normal Pascal syntax. Heap and Data Segment are shared between all modules. No memory-resident kludges or unnatural parameter passing schemes. Comes with a utility which automatically converts your existing applications.

## LARGE DATA ARRAYS

Transparently access 1 and 2 dimensional arrays of any conceivable size and type. Four models support Normal RAM to 640K, Expanded memory (EMS) to 2Meg, Virtual (Disk-based) to 30Meg, and sparse arrays like the most advanced spreadsheets. Comes with a fast full-screen array browser.

## MAKE FACILITY

A Unix-like MAKE program that is optimized for the Turbo EXTENDER large code model. Rebuild multi-module programs with no wasted effort.

## OVERLAY ANALYST

Perform Static and Dynamic analysis of overlaid Turbo programs. Determine sizes of all procedures in each overlay group. Monitor the running program to find the number of overlay reads, procedure calls, and the load address of all procedures.

## AND EVEN MORE!

DISK CACHE can be incorporated in your program to speed up disk reads for data bases, overlays, et al. Multi-file full screen BROWSE works on any text file. Pascal ENCRYPTOR makes your source safe from prying eyes, improves compile speed 15-30% and leaves the code 100% functional. SHELL generator creates fast compiling shells of unexercised code.

Two DSDD disks with complete Source Code, 100 page printed manual, 30 day guarantee!

Requires Turbo Pascal 3.0 and DOS 2.X or 3.X. Runs on IBM PC/XT/AT and compatibles. Call for generic MSDOS support.

**\$85**  
complete

Also get the TurboPower Utilities

with the acclaimed Pascal Structure Analyzer  
Includes a Pretty Printer, Execution Profiler, and powerful Text and Command Automation Tools.

With full source \$95, executable only \$55.

Credit Card Orders only call Toll-free 7 days per week  
(US)800-538-8157x830 (CA)800-672-3470x830  
PO, COD, Dealers, Questions, Brochures, call or write:



478 W. Hamilton #196  
Campbell, CA 95008  
ph. 408-378-3672  
M-F 9AM-5PM PST

*The Turbo Lightning  
memory-resident  
on-line thesaurus  
is a wonderful tool  
for editing text. It  
beeps at you if  
you misspell a word.*

came Borland's SuperKey macro program, which isn't quite as indispensable as SideKick but darned useful. I use SuperKey to define a whole bunch of convenient BIX commands; for example, Alt-down-arrow is Skip to last, which in BIX jumps to the last message in a conference, while Alt-F9 does a long and complicated routine of some 20 keystrokes to prepare previously edited text to be sent out on BIX. I could live without those, but I wouldn't want to.

Then came Borland's Turbo Lightning memory-resident on-line thesaurus. It's a wonderful tool for editing text. Lightning beeps at you if you misspell a word while writing. This is sufficiently annoying that I generally turn off that feature until I have the draft composed; then it's simple and convenient to switch Lightning back on and have it check the spelling; and meanwhile the thesaurus has been instantly ready for use at all times. I guarantee that writers who get used to an on-line thesaurus won't give it up lightly.

For that matter, the continuous spelling checker with its beep can be useful when writing letters, composing quick answers to questions in an on-line conference, or anytime you're in a hurry and aren't trying to be creative. It's something else you can get pretty accustomed to having around.

SideKick, Lightning, and SuperKey among them use up a lot of memory, but they do work together.

The trouble started with Gordon Eubanks. Gordon is a former Navy submarine driver. He's been in the microcomputer revolution since the beginning. He wrote the first compiled BASIC—public-domain E-BASIC—while a professor at the U.S. Navy Postgraduate School in Monterey, California. After retiring from the Navy, he turned E-BASIC into CBASIC, which, despite my enthusiasm for Modula-2, is still the language I've used for all my large and important programs. Eventually, Gordon's company was sold to Digital Research, and Gordon became Digital Research's vice president in charge of languages. About a year ago, he left to run a new outfit known as Symantec.

Symantec is seriously trying to apply artificial intelligence (AI) principles to business programs. The first result is an integrated package known as Q&A (see the Product Preview in the January BYTE, page 120), and just before my monster party, Gordon wanted to come down and show it to me.

I don't usually let software publishers find out what city Chaos Manor is located in, much less invite them to my house. But Gordon isn't a publisher, he's a hacker from the early days, and Lord knows back in those days I bent his ear enough about problems I'd found and features I wanted in CBASIC. So the day before the big party, Gordon Eubanks showed up with a colleague, Brett Walter.

Walter's business card gave his title as Product Marketing Director, which was a bit frightening. In fact, Brett turns out to be a hacker and former philosophy student, and it didn't take long before we began talking about some of the AI theory in Q&A, including intercensal references. Somewhere in the conversation—I can't believe I said it—came the word "disambiguation." This caused Eubanks to say, "leez, we work for years to make this thing user-friendly, and all these Ph.D.s want to complicate things. You're not going to talk about that, are you?"

Meanwhile, Gordon and Brett were

(continued)

# "The C86 C Compiler is Great...

## Computer Innovations' Support is Even GREATER"

DALE HILLMAN,  
PRESIDENT, XOR CORPORATION  
CREATOR OF "NFL CHALLENGE"

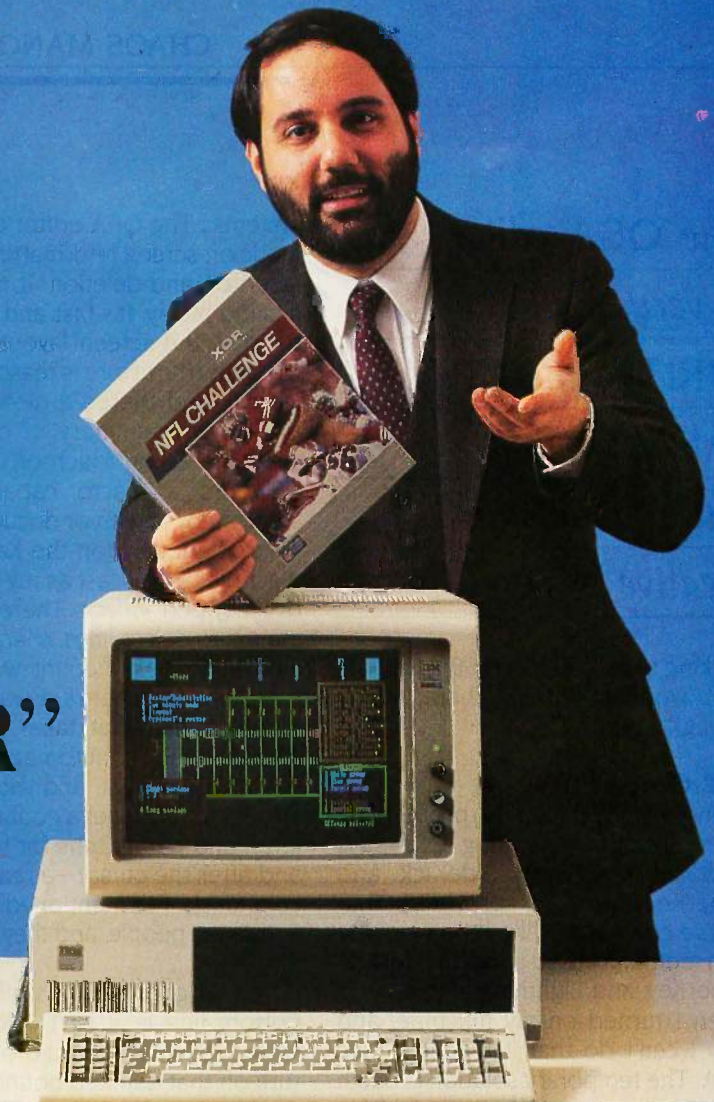

When Dale Hillman decided to create the most exciting football simulation game ever, he knew he needed good language support. The portability and maintainability of C made it a natural choice. **Which** C compiler to choose was another matter entirely.

"Of the many C compilers available, choosing the best one for the job was not easy. Comparing benchmarks, most compilers were strong in one or two categories, yet decidedly weak in others.

Computer Innovations' C86 was the exception. I found the C86 Compiler consistently strong in all categories.

"C86 had a reputation for being a solid, reliable, high-performance compiler. 8087 math support, source level debugging — it had it all. BEST of all was Computer Innovations' incredible technical support. Their highly knowledgeable support team was always available. Their assistance helped cut development

time substantially. And since NFL CHALLENGE took 12 1/2 man-years to create — every little bit helped. It was a service you just can't place a dollar value on. . ."

If you're working on the next great program, call Computer Innovations. We'll show you why you'll never have to look any further than C86.

**For Further Details  
Call Toll-Free:  
800-922-0169**

**Behind Innovative Programs —  
Computer Innovations**

**COMPUTER  
INNOVATIONS, INC.**

980 Shrewsbury Avenue,  
Tinton Falls, NJ 07724 USA (201) 542-5920

EUROPEAN DISTRIBUTOR  
Boston Micro, Inc., TELEX: 6712477 BMI USA

©1986 Computer Innovations, Inc.  
™ NFL Challenge is a trademark of NFL Properties

*The Q&A editor  
is very similar to  
WRITE, the CP/M  
text editor that  
I use for all my  
creative work.*

working to install Q&A on Big Kat; on-ly it wouldn't install. There wasn't enough memory.

#### THE Q&A EDITOR

Eventually we solved the problem by killing off Turbo Lightning. Q&A says it works with both SideKick and SuperKey installed, provided that you've completely filled the machine with memory. I used to have SideKick, SuperKey, and Lightning all come up when I turned on my machine, and now I can't do that if I want to use Q&A. The temporary solution is batch files: I rename my AUTOEXEC.BAT file to HOLD.BAT and rename QA.BAT to AUTOEXEC.BAT. Then I reset the machine, and it comes up in Q&A with SideKick and SuperKey installed. On exiting Q&A, I invoke yet another batch file, RESTORE.BAT, which puts everything back the way it was so that on reset I'm in my normal mode. That works, but it's hardly convenient.

On the other hand, Q&A has such a nice text editor that I'd seriously consider using it as my primary writing tool. It does have its problems, including the inevitable status line at the bottom with the little blob moving along it every time I type a letter. The Q&A editor is very similar to WRITE, the CP/M text editor I use for all my creative work. (Confusingly, Symantec calls its editor Write also; I don't see how they can get away with that, since WRITE was trademarked by Tony Pietsch, but I'm not a lawyer. Anyway, to avoid confusion here, when I refer to WRITE, I'm speaking of Tony's editor that works on CP/M

systems.) The Q&A editor does automatic on-screen reformatting on both insertion and deletion. It moves text around nicely. It's fast and clean and handles the screen layout well. The command structure is reasonable and logical, and there's a nicely laid-out one-screen summary of commands available at the touch of the F1 key.

There's a macro capability and scrolling by screen or document page or continuously (on the Kaypro 286i it scrolls fast, as fast as my Z80 memory-mapped video). There are commands to delete lines, characters, and words. It doesn't count words automatically, but there's a way to get a word count. (That takes seven keystrokes. WRITE automatically gives you a word count, and with two keystrokes you can get a count of words, lines, and paragraphs for text before and after the cursor—a real boon for columnists. I've mentioned that to the Symantec people, and they're looking into it.)

I could go on for a while, but the bottom line is, it isn't WRITE. However, if Symantec would only let me turn off that damned bouncing ball at the bottom of the screen, I'd seriously consider writing books with the Q&A editor—especially if I could figure out some way to use both it and the Turbo Lightning thesaurus. I keep hoping Symantec will be able to work something out.

#### INTELLIGENT ASSISTANT

Of course, Q&A is more than a text editor. It integrates your text editor, file manager, database, and report generator. Now let me confess immediately that I am no expert on databases and file managers. I don't even use the darned things much. I should, of course. There are lots of ways a good computerized database could help run my life. For a start, I could get all my royalty statements entered and thus keep track of which publishers have paid and which are overdue, which books have foreign editions, what printing each book is in, and a whole raft of stuff that I now painfully dig out of paper records.

The reason I haven't done it is that

each time I need the information it's easier to dig out by hand than to put it all in a database; and so far I haven't seen a database and file manager that I could use to design my entry fields, then hand the whole mess over to an assistant to fill in the data. Not only are most databases hard to learn, but sure as anything, my form design is going to lack something. For example, suppose I put in fields for nearly everything, but when we're entering the data, we discover that *The Mote in God's Eye* has been translated into Finnish, and I haven't included a Finnish rights category. Where do we enter that revenue? Miscellaneous might be an obvious answer in this case, but then we discover Malay translation rights, and after a while the miscellaneous category gets filled with all kinds of stuff.

Q&A solves that problem. You can add new fields at any time. You can also rearrange them. The data-entry fields are designed with the Q&A text editor and can be as complex as you like: keyword fields, numerical data, Boolean data types, labels, you name it—and Q&A seems able to handle it. Simple to learn, easy to use.

All well and good, but that's not what makes Q&A different from other database programs. The real reason I'd like to adopt Q&A is the Intelligent Assistant, an AI program that takes plain English instructions and uses them to control the Q&A database. Intelligent Assistant—IA, and I suspect the similarity to AI is no coincidence—can make up quick-and-dirty reports, find information, sort information, do calculations, answer questions about the database, and, while it's at it, learn a lot about how you operate. It has a synonym dictionary, so if you don't like the built-in commands Q&A uses, you can substitute your own.

For example, IA can do things like "Find me all the books that have revenue from Danish and Finnish rights." It needs to know that "Finnish rights" is the same as "Finnish translation rights," but that turns out to be a simple thing to teach it. Indeed, you begin by giving the Intelligent Assis-

(continued)

# Doors Open When You Know C

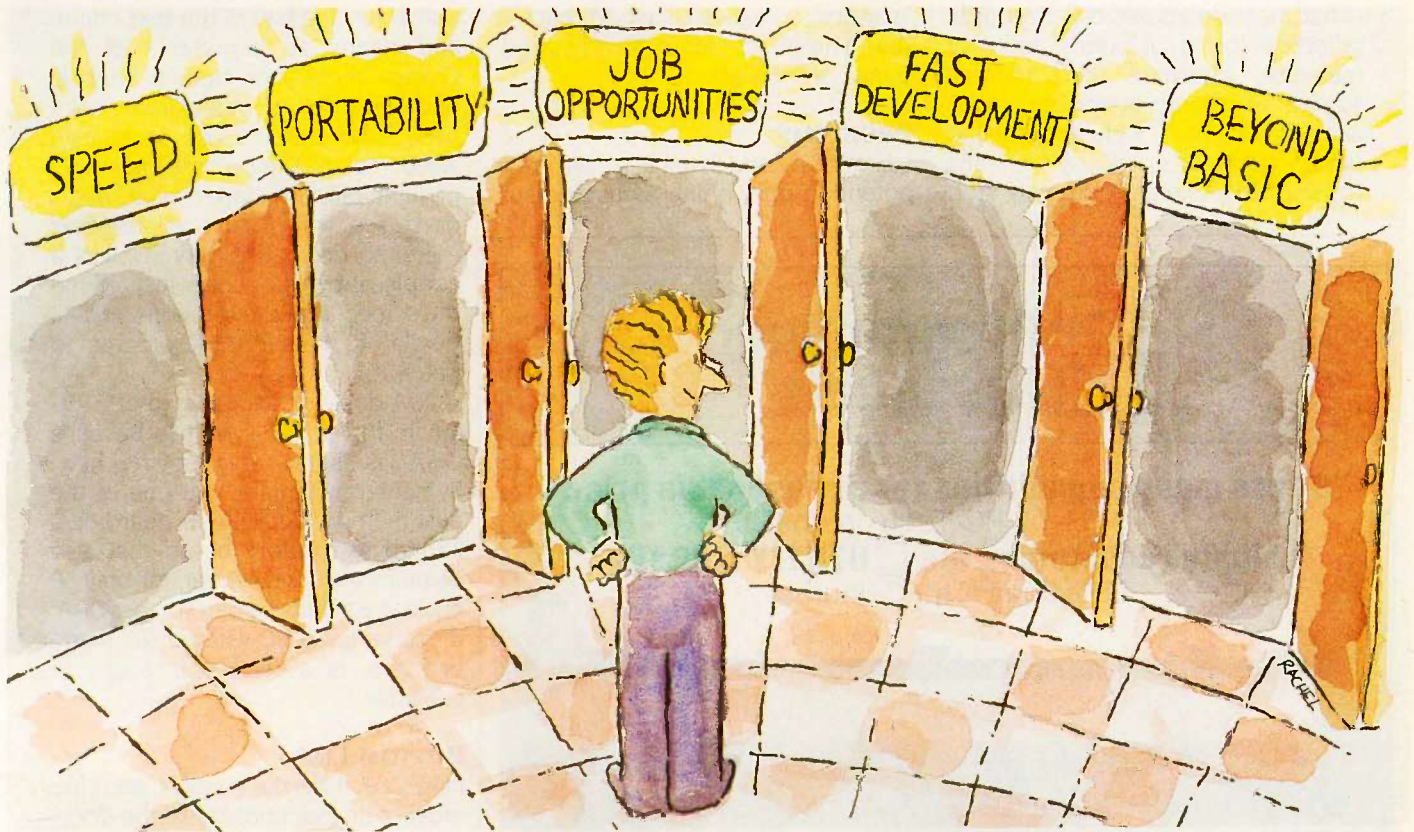

## Unlock Them With *Introducing* C

The growth of the C language is nothing short of phenomenal. Over the past five years, it has emerged as the language of choice for most major PC applications. Why? Speed, portability, and compactness of code are a few of the reasons. But more important, its structured approach vastly reduces the time involved in ANY programming task. It's a big step beyond BASIC.

Now, Computer Innovations makes learning C fast and easy with *Introducing C*. A unique, interactive learning system, *Introducing C* combines a thorough, self-paced manual with a C INTERPRETER for fast results. *Introducing C* provides a solid background in standard C functions, operators, and data types including structures, unions, arrays, and pointers. Plus the

package includes a screen text editor, extensive error diagnostics, and sample programs.

**"...one of the best C training systems I have seen..."** INFOWORLD, 9/85

*Introducing C* is so effective, many corporations have made it their standard C training system. Make it your personal one!

**Introducing C: The Key To Your Future**

**ONLY \$125** Not Copy Protected  
**CALL 800-922-0169**

 **COMPUTER  
INNOVATIONS, INC.**

980 Shrewsbury Avenue, Tinton Falls, NJ 07724 (201) 542-5920  
EUROPEAN DISTRIBUTOR  
Boston Micro, Inc., TELEX: 671-2477 BMI USA

Prices And Specifications Are Subject To Change Without Notice.

© 1986 COMPUTER INNOVATIONS, INC.

tant lessons: what the database is all about; what fields identify a form (what most databases call a record); adjective forms of nouns; units of measure; alternate field names; strange verb forms (associate "paid" as well as "pay" with a particular field); adjectives ("lousy" means royalties of less than 8 percent); stuff

like that. Interestingly, IA already knew that "royalties" was the plural of "royalty," so I didn't have to teach it that. There's lots more, mostly good. Some isn't so good.

**PROBLEMS**

I like Q&A, and I think it has great potential; but I think Symantec still

has some work to do. Some problems are cosmetic: I want them to kill that bouncing ball in the text editor, and nearly as important, let me change the cursor from a blinking underline to a transparent solid blob. And I would like to change screen colors. I've become enamored of light blue on darker blue, and I don't see why I can't tell the text editor to do that; it only involves a couple of bytes of code. Just tell me the screen-attribute locations, and I'll be glad to write a BASIC program to patch it.

Q&A does use a lot of memory; too much for some systems. Because Q&A is such a memory hog, Symantec will make you one of the best memory deals I ever heard of: a 256K-byte memory board that also contains a clock/calendar, for only 50 bucks if you buy it when you get Q&A. If you've got a PC without full memory, this is a deal you ought to consider.

**BOTTOM LINE**

I like Q&A. I like the concept, and I like most of its execution. I like the documents, which are clear and explicit. I'm fond of the Intelligent Assistant. The database looks like the easiest one to use that I've yet encountered, and indeed I'm rather eager to get my troops to work using it to enter all my books. I'd love to be able to ask a database, "Who owes me royalties in November?" and get a sensible answer, and Q&A looks well able to do that. While I have some quibbles about the text editor, by and large it's as good as anything I've seen for an MS-DOS system.

On the other hand, while Q&A has great features, giving up all memory-resident programs seems a pretty high price to pay in order to use it. True, the industry is moving rapidly. Pretty soon we ought to have the hardware and software to give PC AT users megabytes to play with. When that happens, integrated programs like Q&A will come into their own. Until then, much as I like Q&A, I'll probably do without or use some-

(continued)



## Programmer Essentials

**"Offers many capabilities for a reasonable price"**  
W. Hunt, PC Tech Journal

**"I highly recommend the C UTILITY LIBRARY"**  
D. Deloria, The C Journal

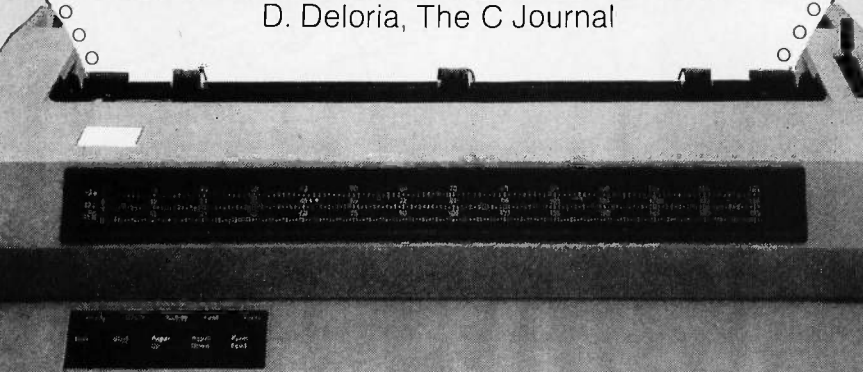

**CESSENTIALS**

200 functions: video, strings, keyboard, directories, files, time/date and more. Source code is 95% C. Comprehensive manual with plenty of examples. Demo programs on diskette. Upgrade to THE C UTILITY LIBRARY for \$95.

**THE C UTILITY LIBRARY**

Thousands in use world wide. 300 functions for serious software developers. The C ESSENTIALS plus "pop-up" windows, business graphics, data entry, DOS command and program execution, polled async communications, sound and more.

**ESSENTIAL GRAPHICS**

Fast, powerful, and easy to use. Draw a pie or bar chart with one function. Animation (GET and PUT), filling (PAINT) and user definable patterns. IBM color, IBM EGA and Hercules supported (more soon). NO ROYALTIES. Save \$50 when purchased with above libraries. Available February, 1986.

**Compatible** with Microsoft Ver. 3, Lattice, Aztec, Mark Williams, CI-C86, DeSmet, and Wizard C Compilers. IBM PC/XT/AT and true compatibles.

**C Compiler Packages:** Microsoft C - 319, Lattice or CI-C86 compilers \$329. Save \$40 - \$50 when purchasing compiler and library combinations. Specify C compiler and version number when ordering. Add \$4 for UPS or \$7 for UPS 2-day. NJ residents add 6% sales tax. Visa, MC, Checks, PO's.

**\$100**

**\$185**

**\$250**



**ESSENTIAL SOFTWARE, INC**  
P.O. Box 1003 Maplewood, NJ 07040 914/762-6605



LIFE-TIME  
WARRANTY

Your Most  
Important  
Connection

# THE ULTIMATE CABLE ASSEMBLY™

DATA SPEC®, a quality name in computer support products, has spent years of extensive research and development in designing the Ultimate Cable Assembly. No other cable looks or works quite like the Ultimate Cable Assembly. It not only visually enhances your computer environment, but provides superior quality inside and out. With the DATA SPEC® cable assemblies, you have purchased the highest quality cable available for connecting your valuable equipment.

## The Ultimate Cable Assembly by DATA SPEC® features:

- Full shielding exceeding the F.C.C. EMI/RFI emission requirements.
- Positive strain relief.
- Exclusive Polyvinyl Doping Technique (P.D.T.), which insures maximum strength and durability under the most adverse conditions.
- Gold-plated pins.
- Individually soldered (not crimped) conductors which are PVC jacketed and color coded.
- Full Aluminex shielding.
- Large convenient thumbscrews. (No screwdrivers are needed.)

**DATA SPEC® produces Ultimate Cable Assemblies to fit any of your interface needs: RS232, parallel (Centronics), printers, modems, disk drives, and monitors. DATA SPEC® also has a full line of high integrity computer support products.**

**DATA SPEC®**  
The Ultimate in Computer Accessories

20120 Plummer Street  
Chatsworth, CA 91311 • 1-818-993-1202

©Copyright 1986 Alliance Research Corporation

Inquiry 401 for End-Users. Inquiry 402 for DEALERS ONLY.

In Japan Contact Data Spec Japan LTD., No. 3-17-5 Minami Otsuka, Toshima-Ku Tokyo, Tel (03) 985-9425, FAX (03) 980-2651, TLX 2723374

thing else, something that I may not like as much but that will give me back my SideKick, SuperKey, and Lightning thesaurus.

Last-minute update: I just got a new spelling checker and thesaurus program from Wayne Holder, whose The Word Plus is still my favorite CP/M spelling checker. Holder's new pro-

grams are designed to work with Q&A and will be bundled with future editions of the program. There went one of my objections.

I am also told that Symantec is working furiously on a version of Q&A that can make use of the extended memory boards manufactured by Intel and others for the PC AT. When

they get that done, I'll be able to use Q&A, SideKick, SuperKey, Turbo Lightning, and so forth. I can hardly wait. Symantec has a winner with this program.

**XYWRITE RECONSIDERED**

The one unforgivable sin for a text editor is losing text. XyWrite managed to do that the other day. Somehow the program created too many temporary files, filled a floppy, and gave up, trashing about 90K bytes of text that my assistant, Don Hawthorne, had painstakingly entered. In fairness, Don had pretty well filled the disk and ought to have been more careful; but the program ought to have warned him.

Fortunately, Barry Workman was able to use one of his disk utilities to go onto the disk and pull off the information file by file, so we lost nothing important; but we have retired XyWrite until we know that bug is fixed.

Late addition: XyWrite III fixes many bugs, including that one; we've been unable to lose text with III, and I tried fairly hard. I'm told that an even later edition of XyWrite III will allow the program to be used with SideKick, SuperKey, Turbo Lightning, and other memory-resident programs. I'm eagerly awaiting that one.

**READY!**

As if SideKick, Turbo Lightning, and SuperKey didn't use up enough memory, now comes Ready! from Living Videotext, the people who brought you ThinkTank. Ready! is also a memory-resident program and a darned good one at that.

Ready! is an outline processor; it's a bit hard to describe how outline processors work to someone who hasn't used one. I first heard of ThinkTank a year or so ago when my friend and editor Jim Baen called to rave about it. "You've got to try it," Jim said. "I was just mucking about learning to use it, and I wrote one of my best editorials. It really lets you get thoughts down as you think them and organize as you go."

(continued)

# UNLOCK™ Removes Copy Protection

## RUNS YOUR SOFTWARE ON ANY HARD DISK

Currently supports only programs listed below:

**UNlock ALBUM "A"**  
**\$49.95** Plus \$4 ship/handling

- LOTUS 1-2-3™ (1.A, 1.A\*, 2.0)
- dBASE III™ (1.0, 1.1 & 1.2)
- FRAMEWORK™ (1.0, 1.1, II)
- SYSTAT™ (1.3 & 2.0)
- SPOTLIGHT™ (1.0 & 1.1)
- GRAPHWRITER™ (4.3 & 4.31)
- REALIA COBOL™ (1.2, 2.0)

**UNlock ALBUM "B"**  
**\$49.95** Plus \$4 ship/handling

- SYMPHONY™ (1.0 & 1.1)
- CLIPPER™ (Winter 84, Summer 85)
- ELECTRIC DESK™ (1.04)
- DOUBLEDOS™
- MANAGING YOUR MONEY™ (1.5 & 1.51)
- smARTWORK™ (1.0 REV 8, REV 9)
- DATA BASE MANAGER II™ (2.0, 2.02)

**UNlock ALBUM "C"**  
**\$49.95** Plus \$4 ship/handling

- MICROSOFT WORD™ (1.5, 2.0, 2.01)
- MULTILINK ADVANCE™ (3.02)
- IBM WRITING ASSISTANT™ (1.01)
- LOTUS 1-2-3 REPORT WRITER™ (1.0)
- PARADOX™ (1.0)
- PFS ACCESS™ (1984 Edition)
- THINKTANK™ (2.0)

- Produce non-protected DOS copies from popular software programs.
- For IBM® PC, XT, AT, compatibles

TranSec UNlock is a unique software copying disk that removes copy protection, providing standard non-protected DOS copies. UNlock runs on IBM® PC, XT, AT, and compatibles with 256K or more, DOS 2.0 or higher.

**BACKUP COPIES.** UNlock safely and easily makes backup copies.

**RUN ON HARD DISK.** Programs load faster, use less disk space and work with any hard disk, including Bernoulli Boxes. No longer do you need the original in drive "A".

**RUN ON RAM DISK.** UNlock is the only software that can run copy protected software on a RAM disk or micro-floppy.

**EASY TO USE.** 1) Type UNlock. 2) Select program destination. 3) Insert program disk.

**SAFE ORIGINAL.** UNlock does not alter your original distribution disk. UNlock works by creating a copy of your distribution disk on a hard or floppy disk. It then removes copy protection from the copy!

Recommended by the editors of:

**PERSONAL COMPUTING**

"The Best Software Utilities For Under \$100"

ORDER TODAY BY TELEPHONE!

**1-305-474-7548**

**TRANSEC™**



TranSec Systems, Inc., 1802-200 North University Drive, Plantation, FL 33322  
 Trademarks are the sole property of their respective owners. • UNlock is For Use Only to Improve the Useability of Legally Acquired and Operated Software.

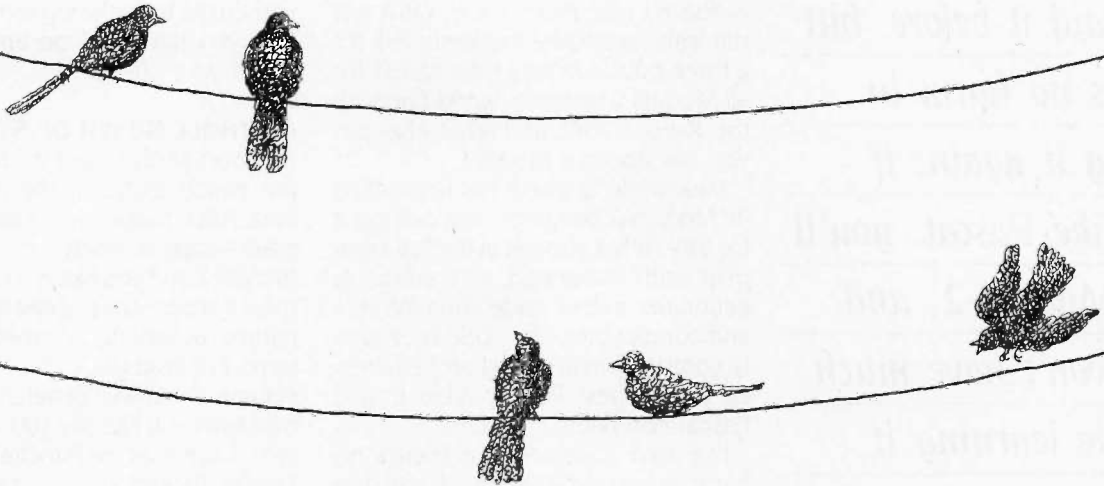

**In the next seventeen seconds, the AT&T Model 4000 Modem will send 12 call reports, last week's sales figures and this month's inventory projections from one PC to another.**

AT&T's telephone wires have always served us well. Now they also serve to transmit large volumes of data from a personal computer, say, in Philadelphia to one in Fresno.

In a matter of seconds.

This phenomenal achievement is made possible by the AT&T Model 4000 Modem and SoftCall™ Communications Software. A communications system that's not only a link between PCs, but one that can also access an increasingly large number of sophisticated data bases.

And since the use of SoftCall Software doesn't require any technical expertise, it offers you the unique advantage of accessing and transmitting that data with remarkable ease.

Whether you're

working on a PC from AT&T, IBM\* or any other standard asynchronous terminal, the AT&T Model 4000 Modem will establish lines of communication.

All things considered, what better name to have on your modem than AT&T? The company with high-performance computers and integrated communications tools.

Which proves that AT&T is not merely the right choice. It's the obvious one.

For more information on the AT&T Model 4000 Modem, call 1 800 247-1212, Ext. 240, for your nearest authorized AT&T Dealer.

Then you can begin to send data regardless of where you're perched.

© 1986 AT&T Information Systems.

\*IBM is a registered trademark of International Business Machines Corp.



**The AT&T  
Model  
4000  
Modem**



**AT&T**

The right choice.

*I've said it before, but there's no harm in saying it again: if you like Pascal, you'll like Modula-2, and you won't have much trouble learning it.*

All of this is true. ThinkTank was great; and if you liked ThinkTank, you'll like Ready!. More: if you're a professional writer using a PCompatible and you're not using either ThinkTank or Ready!, you're working too hard.

Ready! doesn't use as much memory as Q&A, and it works fine with all the Borland utilities in place. You can invoke Turbo Lightning's thesaurus and spelling checker while doing outlines. I've got mine installed on Big Kat, and it works fine with SideKick, SuperKey, and Lightning. I've been using Ready! pretty constantly for the past six weeks, and there's been nary a glitch. It's the kind of thing you can get to depend on pretty fast.

Ready! is available in a version that isn't copy-protected, installs easily on a hard disk, and can be brought in with an AUTOEXEC.BAT file. It is one of the first programs to be designed to make use of the extended memory boards; used that way, Ready! takes up almost no space in memory. Even without extended memory, Ready! works with Symantec's Q&A. If you work with words and ideas, you can't afford to be without Ready!. Highly recommended.

#### OF MICE AND MODULA

Logitech has a new mouse and new prices for the Modula-2 compiler. Both are good buys.

The Logimouse connects to your PCompatible through the 9-pin connector, and its software installs painlessly in the AUTOEXEC.BAT start-up.

It doesn't take much room: Q&A will run with Logimouse implemented. It's a three-button mouse ("standard" for all Modula-2 systems), works fine with the Kaypro 286i, and what else can you say about a mouse?

Meanwhile, Logitech has unbundled its Modula-2 compiler; you can get it for \$89. What you get is the full compiler with integrated text editor. It generates native code for IBM PCs and compatibles. The code is certainly comparable in speed and efficiency to the best PCompatible C and Pascal compilers I've seen.

I've said it before, but there's no harm in saying it again: if you like Pascal, you'll like Modula-2, and, moreover, you won't have much trouble learning it. Most Pascal source code can be translated into Modula-2 by means of programs written in Modula-2.

The main advantage of Modula-2 over Pascal—and darned near any other language—is the total independence of the modules. In Modula-2, no matter what *it* is, if you didn't explicitly import it, it can't affect what's going on inside the module; and if you don't export it, it can't affect anything else. The result is that you can build up library after library of small modules and never have to worry about variable names. (Who cares if you have 400 different counting variables called *i*? They can't affect each other if they're in separate modules.) You can also hand someone else the definition module describing what your code does, let that person write code to mate with yours, and be secure in the knowledge that nothing your partner does can have side effects inside your own modules.

Flash: Workman and Associates have a CP/M Z80 Modula-2 compiler they call FTL Modula. It's less than \$100, fast, and you get the source code to its integral editor.

Modula-2 has been getting theoretical applause for years; what it has needed was a good low-cost compiler for a popular machine. Logitech has remedied that defect and is to be congratulated. If you hack, try Modula-2. Even if you don't like the language,

you ought to know something about it. If you haven't done any hacking, here's your chance.

#### A WHOLE BUNCH OF STUFF

It's short-shrift time: I've dipped into the peach crates in the storeroom. First, Alien Names is a shareware program—copy it freely and give it to friends, but if you like it, recompense the author—that generates odd names according to specified patterns. For example, CVVCVC (C = consonant, V = vowel) generates as many names as you like, say 100, in that pattern. Examples are Puocek, Seathol, Doafid, Baudet, Daulab; it's up to you to pick the good ones. It can give you many different vowel-consonant patterns.

It also generates alien insults. Take that, yukky dozam! Alien Names does its job well. Of course, there aren't too many BYTE readers who need alien names and insults. . . .

There's a new version of Beyond Compare, which is quite the best text-comparison program for PClones I've seen. The newest version has features for copy editors. Professional writers working with PCompatibles simply can't afford to be without this program.

Sammamish Data Systems (13730 Northeast 20th St., Bellevue, WA 98033) has programs and libraries that draw U.S. maps by census tract or zip code and can include various graphical information you supply. This program and its libraries—or something else that does the same job, only I haven't seen anything else—would be indispensable to people conducting market analyses and extremely useful to anyone trying to display census information, poll results, etc.

Keymate Systems (9225 Mira Mesa Blvd., Suite 212, San Diego, CA 92126) has a kit to convert your IBM PC keyboard into something not merely tolerable but pretty snazzy. The kit has five new keys and software with documentation. They move the offending Squiggle key so it's not in the way of the Return, make the Return

(continued)

NOW  
COMES  
WITH FREE  
PRINTER CABLE!

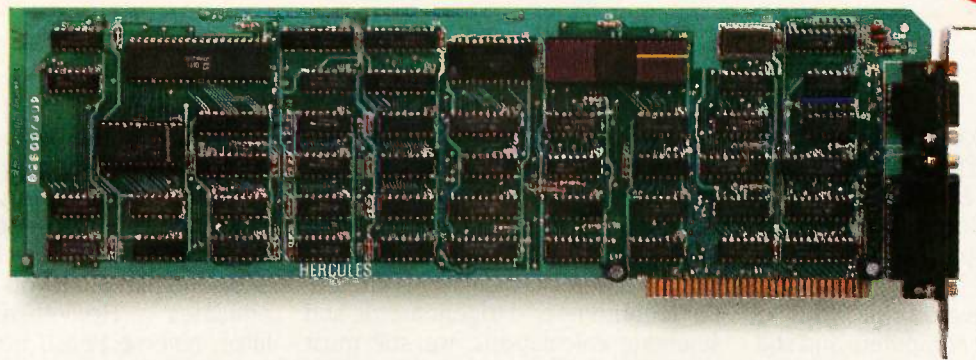

## The world's best selling monochrome graphics card for the IBM PC.

There are more Hercules<sup>™</sup> Graphics Cards in more IBM<sup>®</sup> PCs, XT<sup>s</sup> and AT<sup>s</sup> than any other monochrome graphics card in the world.

Over a quarter of a million demanding users around the world use a Hercules Graphics Card to improve the performance of their software.

### The Lotus<sup>®</sup> 1-2-3<sup>®</sup> Booster.

Consider Lotus 1-2-3. Hercules gives an off-the-shelf



copy of 1-2-3 the highest resolution possible on an IBM

PC, XT or AT. More 1-2-3 users choose the Hercules Graphics Card to get crisper text and sharper graphics than any other monochrome graphics card.

And we bring the same performance to other integrated programs like Symphony<sup>™</sup>, Framework<sup>™</sup>, and SuperCalc<sup>®</sup>3.

But we don't stop there. The Hercules Graphics Card

improves all kinds of software.

Like Microsoft<sup>®</sup> Word, a word processor that enables you to display text with subscripts, superscripts and italics.

Or pfs: Graph, an easy-to-use business graphics program that converts your data into presentation quality graphs.

Or Microsoft<sup>®</sup> Flight Simulator, the high flying game for the overworked executive.

Or our own Graph X<sup>™</sup>, a library of graphics sub-routines that eases graphics programming.

Or AutoCAD<sup>™</sup>, a computer aided design program that offers features normally associated with expensive CAD systems.

And we supply free software with each card to do hi-res graphics using the PC's BASIC interpreter.

### State-Of-The-Art Hardware.

The Hercules Graphics Card gives you graphics resolution of 720h x 348v and a

parallel printer port. Our unique static RAM buffer provides sharp 9 x 14 characters and flicker-free scrolling. Our exclusive safety features help



prevent damage to your monitor.

State-of-the-art custom IC technology delivers unsurpassed reliability. Ordinary graphics cards use up to 30 ICs to do what one Hercules IC does. By using fewer parts, we reduce the possibility of component failure.

Which is one reason we warranty the Hercules Graphics Card for two years.

Unbeatable reliability. Advanced technology. Proven by over a quarter of a million users. Why settle for anything less than Hercules?

Call 1-800-532-0600 Ext 408 for the name of a Hercules dealer nearest you and we'll rush you our free info kit.

**Hercules.**  
We're strong on graphics.

key bigger, and deal properly with the Shift keys. When it's finished, it's very much like an IBM Selectric keyboard. If you like the feel of the PC keyboard but hate the layout, this is probably the kit to get.

It has always seemed ridiculous to have three or four computers and still keep a desk calculator, but I've no-

ticed that most people do. It's convenient. One remedy for that is SideKick, which has a good programmer's calculator (it does hexadecimal and binary as well as decimal arithmetic); but the SideKick calculator is limited. For logarithms and trigonometric and scientific calculations, we still must either write a BASIC program or, more

likely, turn to the desk calculator.

No more. Comes now a shareware program from Mitchell Schoenbrun called PC Calculator—send him \$25 for a copy or get a copy from a friend and send him \$10 if you like it—which emulates a Hewlett-Packard calculator, reverse Polish notation (RPN) and all. PC Calculator has logs and trig, e and pi, and financial calculations; it's also programmable—hardly surprising given that it's really a program for a computer! If you often find problems that the SideKick calculator can't handle and you're tired of keeping a calculator next to your computer, this is a good remedy—provided you can remember RPN.

I wish I had room to say a lot more about Microsoft's Quick BASIC; they've improved it yet again, removing some bugs and problems detected in beta test; experienced users of Microsoft BASIC and BASCOM are very excited. If you program in BASIC, be sure to look Quick BASIC over; I think you'll like it. More on that another time.

#### HEATH/ZENITH SHOW

The regional Heath/Zenith User Group show was held at the Disneyland Hotel this weekend, and I went down for a day. Fascinating: that show still retains the excitement and general atmosphere of the old days before computers became such big business.

The best news is that there are now two different boards that make your Zenith Z-100 about 99 percent PC-compatible (plays Flight Simulator, for example). Considering that the Z-100 also runs CP/M 2.2 programs, including WRITE and CP/M-86, and now all PC programs, and that the Z-100 can handle a RAM (random-access read/write memory) disk, hard disk, and 8-inch disk drives all at once, it's arguable that a Z-100 may be the best computer buy in the industry. More on that another time: it will take most of a column to describe all the nice things they've done with the Z-100, and it's worth doing.

Meanwhile, Barry Watzman (560 Sunset Rd., Benton Harbor, MI

(continued)



## One Star Always Shines Brightest.

Display Telecommunications Corporation announces a complete family of IBM® compatibles.

#### MEGA-BOARD-AT™

80286 CPU • Our own Mega-BIOS-AT™ • Full megabyte RAM motherboard

#### MEGA-NET™

Token-passing ring LAN • IBM NETBIOS Compatible • Uses existing twisted pair telephone wire

#### MEGA-BOARD-XT™

Our industry standard board with Mega-BIOS

#### New OEM pricing. XT-AT BIOS licensing.

"...masterpiece of IBM imitation...minor masterpiece of the circuit designer's art."  
Winn L. Rosch, Cloning Your Own PC, PC Magazine, July 10, 1984.



"The most compatible IBM clone I've ever worked with."  
Lee Konowe, American Software Club, Ridgefield, Ct.

IBM is a registered trademark of International Business Machines Corporation.

8445 Freeport Parkway • Suite 445 • Irving, TX 75063  
1-800-227-8383 • For Technical Calls Only: 1-214-607-1382  
TELEX 5106000176 DTC UD

**We've Earned Our Reputation. Let Us Help You Earn Yours.**

# GoldStar



## Another Futuristic Leap From Goldstar's Long Line of Electronics—5 1/4" & 3 1/2" Floppy Disks

Goldstar is determined to keep pace with the new frontiers in this electronic age. So, we now market both 5 1/4" Floppy Disks and 3 1/2" Micro Floppy Disks for all of your computer consumers.

All of Goldstar's pioneering experience, research, and demand for excellence has been channelled into this surge for technology. Therefore, you can be sure of our reliability, as Korea's electronic history-maker.

Our self-imposed demands match yours exactly—nothing less than perfection; and we're even trying to improve that, as we keep on top of the latest developments in computers and peripherals. Both lines of disks, the 5 1/4" and 3 1/2", are manufactured with the most advanced technology.

All Goldstar disks are individually certified 100% error-free at all levels, equal to or above ANSI, DIN, ECMA, ISO and JIS standards.

Goldstar Floppy Disks are engineered to the highest possible quality precision for the maximum in long archival life, accuracy, data integrity, and reliability.

So, for superiority and reliability—  
CHOOSE GOLDSTAR FLOPPY DISKS, either 5 1/4" or 3 1/2".

### LINE-UP

Item	Type	Tracks/Inch	Bits/Inch	Capacity
5 1/4"	M-1S	48	2768	125 KB
	M-1D	48	5536	250 KB
	M-2D	48	5876	500 KB
	M-2DD	96	5922	1 MB
3 1/2"	MF-1D	67.5	8128	250 KB
	MF-2D	67.5	8650	500 KB
	MF-1DD	135	8190	500 KB
	MF-2DD	135	8720	1 MB

(Unformatted)



## LUCKY-GOLDSTAR INTERNATIONAL CORP.

Magnetech Group: C.P.O. Box 1899, Seoul, Korea; Tel. (02)756-9090; Tlx. LGINTL K29579.

 LUCKY-GOLDSTAR

•New York Office: 2nd Floor 1050, Wall Street West, Lyndhurst, New Jersey 07071, U.S.A.; Tel. (201) 460-8010; Tlx. LGI UR 219108; Fax. (201) 935-5686 •Los Angeles Office: 13013 East 166th Street, Cerritos, Calif. 90701, U.S.A.; Tel. (213) 404-2626/9; Tlx. LGI LA (910) 583-5719; Fax. (213) 926-0849 •London Office: Tel. (01) 840-7111; Tlx. 21765 LGI UK •Frankfurt Office: Tel. 069-6664083/5; Tlx. 4185337 LGIF •Paris Office: Tel. 734-52-06; Tlx. LGIPAR 201877.

## ITEMS DISCUSSED

ALIEN NAMES (shareware) from Roberts .....\$15 from a user .....\$10 Ralph Roberts POB 8549 Asheville, NC 28814	CROSTALK .....\$195 Microstuf Inc. 1000 Holcomb Woods Parkway Suite 440 Roswell, GA 30076 (404) 998-3998	Q&A (for IBM PC & compatibles) unbundled .....\$299 bundled with 256K-byte board .....\$349 Symantec 10201 Torre Ave. Cupertino, CA 95014 (408) 253-9600
THE ANCIENT ART OF WAR for IBM PC, PCjr, & Macintosh .....\$44.95 for Apple II, IIC, & IIE .....\$39.95 Brøderbund Software 17 Paul Dr. San Rafael, CA 94903 (415) 479-1170	LOGIMOUSE .....\$99 MODULA-2/IBM PC .....\$89 Logitech Inc. 805 Veterans Blvd. Redwood City, CA 94063 (415) 365-9852	READY! (for IBM PC) .....\$99.95 Living Videotext Inc. 2432 Charleston Rd. Mountain View, CA 94043 (415) 964-6300
BEYOND COMPARE .....\$30 General Transformation Company POB 10083 Berkeley, CA 94709 (415) 644-0702	PC CALCULATOR (shareware) from Schoenbrun .....\$25 from a user .....\$10 Mitchell Schoenbrun 1133 Guerrero St. San Francisco, CA 94110	WIZARDRY I for Apple II .....\$49.95 for Mac, PC, PCjr, & monochrome .....\$59.95 SirTech POB 245 323 Washington St. Ogdensburg, NY 13669 (315) 393-6633
BIX (BYTE INFORMATION EXCHANGE) for BYTE subscribers .....\$25 for non-BYTE subscribers .....\$39 BYTE Magazine BIX Business Office 70 Main St. Peterborough, NH 03458 (603) 924-9281 ext. 131	PRINTER OPTIMIZER...starts at \$459 Applied Creative Technology Inc. 2156 West Northwest Highway Suite 303 Dallas, TX 75220 (214) 556-2916	XYWRITE III .....\$395 XyQuest Inc. POB 372 Bedford, MA 01730 (617) 275-4439

49022), who was the principal system architect for the Z-100, has Perks, a SideKick-like desktop utility that includes scratchpad and calculator. Z-100 users who don't have it will probably want it. He can also furnish enhancements to CP/M-86 or CP/M+ for the Z-100. Write for his catalog. More on new Zenith stuff later.

### WINDING DOWN

Once again I'm out of space and time. There are two games of the month, both for the Macintosh: Brøderbund's *The Ancient Art of War*, a game of military strategy that I have yet to actually win (although my boys have managed to defeat the PC version), and Wizardry I. I don't know what the fascination of Wizardry I is; if I describe it in objective terms, it seems boring—which it certainly is not, as witness the time it has eaten this

month. I've penetrated deeper into the dungeon and found the office where I get a pass to the private elevator. . .

The book of the month is *Cities and the Wealth of Nations* by Jane Jacobs (Random House, 1964). She has a rather startling theory of economics that makes more sense than just about anything else I've seen; and she writes so well it's a joy to read her work. I've long been one of her admirers. Her book *The Economy of Cities* was the economic inspiration for *Oath of Fealty* by Niven and Pournelle.

There's a plethora of computer books this month. Que has some excellent new books on C. Microsoft has brought out a new edition of Van Wolverton's *MSDOS* (1985), which doesn't have enough examples and the index isn't complete, but it is the best MS-DOS user's book I've come

across. There's also a new edition of Cary Lu's book on the Macintosh (*The Apple Macintosh Book*, Microsoft, 1985). It's much improved over the first edition, and the first edition was the best Macintosh book around. If you have a Mac or are curious about them, this is the book to have.

And now I really am out of space. I have a luncheon speech next week to the U.S. Space Federation; they tell me three senators and the Secretary of Defense will be there. Something tells me I'd better work on that talk. ■

*Jerry Pournelle welcomes readers' comments and opinions. Send a self-addressed, stamped envelope to Jerry Pournelle, c/o BYTE Publications, POB 372, Hancock, NH 03449. Please put your address on the letter as well as on the envelope. Due to the high volume of letters, Jerry cannot guarantee a personal reply.*



Hi, Honey!

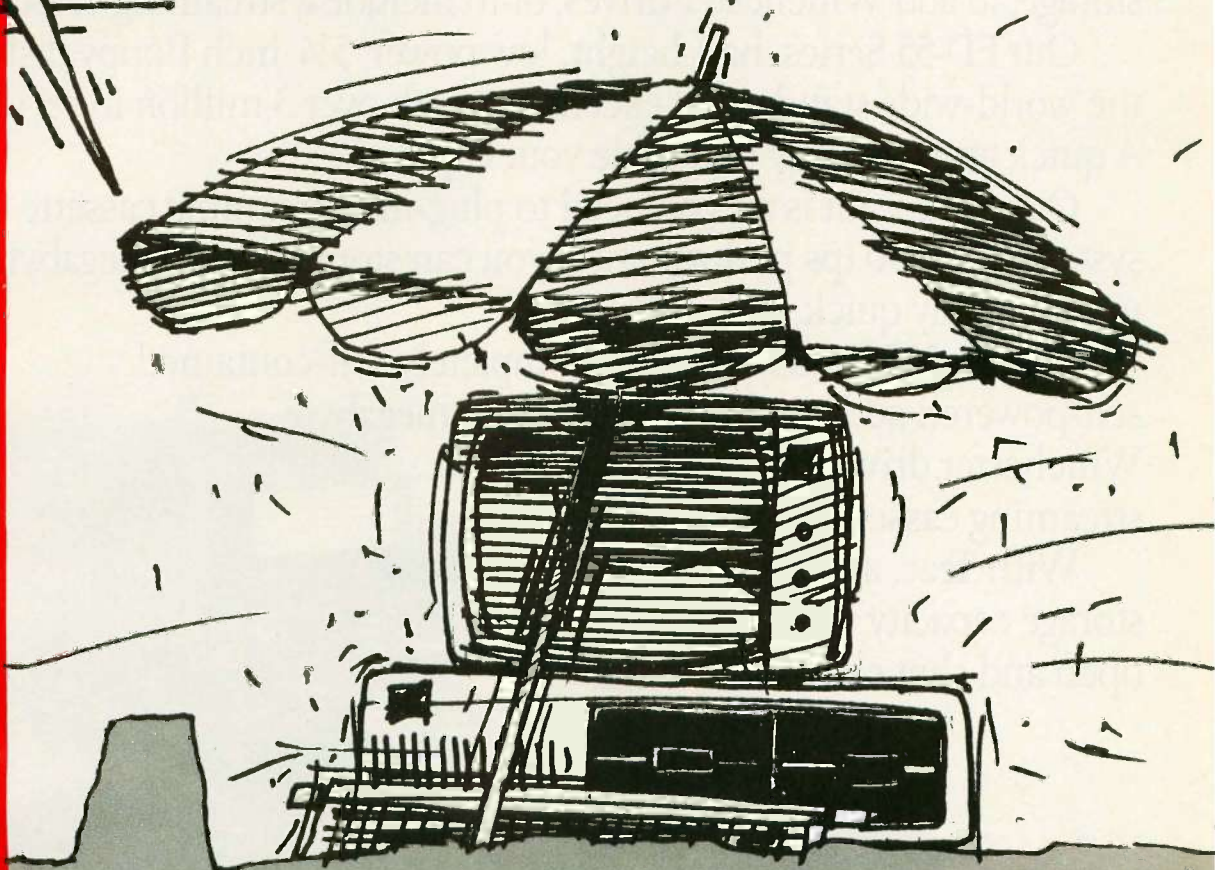

**H**ONEYWELL VIP  
emulation using standard  
IBM hardware. Synchronous  
and asynchronous.  
CALL USING possible.  
File transfer as  
standard FTF and ASCII.

Compatible with TopView  
and IBM PC Network

**TDT**

Rivergate Plaza  
444 Brickell Avenue  
Miami, FL 33131  
1-800/826-7439 or 305/372-9332

Connections IBM PC-Honeywell DPS4 DPS6 DPS7 DPS8

# Look at what we're plugging now.

## Plug-in Teacs.

We offer a full line of PC compatible components to increase your floppy storage, to add Winchester drives, or to include a streaming cassette back-up.

Our FD-55 Series, half-height, low power, 5¼-inch floppy disk drives are the world-wide standard of excellence with over 3 million in service to date. A quick and easy way to double your capacity.

Our MT-2st Kit is all you need to plug-in a streaming cassette back-up system. With 90 ips performance, you can store up to 20 megabytes of back-up incredibly quick.

Our PS-5250 subsystem is a completely self-contained, self-powered add-on that includes a 20 megabyte Winchester drive and a 20 megabyte streaming cassette back-up.

With Teac, adding on more storage capacity is an open and shut case.

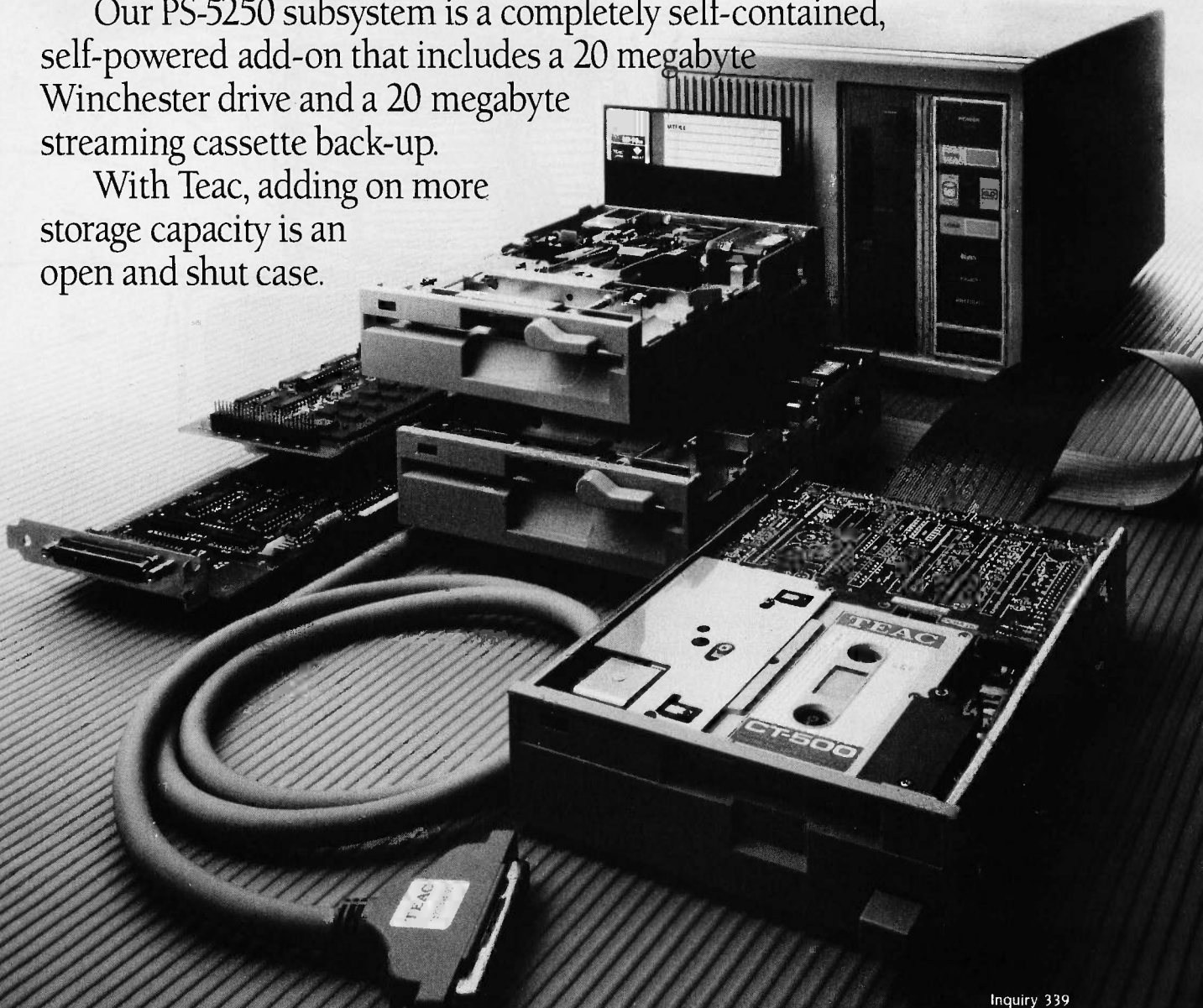

Inquiry 339

Built To Fanatical Standards. **TEAC**

INSTRUMENTATION AND COMPUTER PRODUCTS DIVISION, 7733 TELEGRAPH ROAD, MONTEBELLO, CA 90640

East (617) 475-7311

South/Midwest (312) 351-9124

Rocky Mountain (602) 242-4025 (303) 337-6329 (801) 532-2111

Northwest (408) 727-1427

Southern California (213) 726-0303

©1985

## LANGUAGE

Dear Jerry,

As you mentioned in your column in July of 1985, rigid, top-down programming design is at least sometimes not the way successful programmers actually carry on their skills. One can find, as you did, convenient analogies with the writing of fiction.

While strict, top-down, and modular design may prove (*has proven*) beneficial in some circumstances some of the time, it seems to me that these circumstances and times are not *initial* circumstances; that is, they are not *beginnings*. In the first stages of creating anything, one might well have a structure in mind. But even so, only the most rigid of souls (and by that I suppose I mean "uncreative") could avoid the spontaneity that the act of creation urges upon us in those moments of insight and inspiration.

This is because ideas do not usually jump, full-blown, to the conscious mind. They have to be groped for, culled, begged, prodded, and bribed into being, and that is not always done by mere thought. Often it is the very *doing* that brings forth a framework, structure, or purpose for the doing itself. Sometimes a writer simply writes words or phrases, as though they were mnemonics or special incantations that will call forth what really is to be said. Musicians will tinker with notes and chords in order to allow a melody to gather together under their fingers. An artist may sketch almost idly in order to discover not only what is to be drawn but how something should be drawn.

We do not expect a baby to remain silent until it can speak in complete sentences. That cannot be done without a great deal of practice with sentence components, yet such practice must nevertheless be practice in *speaking*. For this reason, I believe that Pascal is not a good teaching language, because it is difficult to practice with bits and pieces. And even as adults—as experienced users—most of our conversations are partially acts of discovery: We may have the gist of what we want to say already in mind, but the words and phrases actually used are discovered

by us as we are in the process of uttering them.

And at the ends of things, too, adjustments need to be made. The last part of our melody requires a change in the first part; and the ending of our novel now tells us something new about the beginning, which we did not know at the time, and we find ourselves revising what seemed for so long to be fundamental; and the creation of certain routines in a programming project forces us to revise or discard earlier ones. This is one reason why a person in charge of a team programming project ought to be good at facilitating communications—that is, a dialogue of creation—among the team's various members.

Remember that language has a motive power all its own. We make a serious mistake if we start to believe that language is a static tool that we may pick up for various purposes at will or set down when it no longer suits our needs, as though our purposes and our needs could be determined in the absence of using that very language.

This is one of the important ways in which artificial "languages," such as programming languages, are like natural languages: Their use encourages the flow of thoughts in certain ways (and discourages certain other ways). Because there is such a high degree of ceremony in ALGOL-like programming notations, it is hard to get to the heart of the matter until fairly strict preparations have been made. (And even then, all that ceremony sometimes stands in the way. I find it difficult to begin scanning a Pascal program without thinking, "Damn it! Get to the point!") But the coding of a program, like the performance of a play, is not achieved without rehearsals. When we make rehearsing easier, we tend to have a final product more to our liking.

DAVID B. SUITS  
Rochester, NY

*Your letter is an excellent one; and indeed, it's thoughtful feedback like this that makes writing this column so much fun.*

Thanks.—Jerry

## TRUE BASIC

*I have received a great deal of mail, much of it thoughtful, regarding my views on True BASIC that were given last September. The following things seem clear:*

1. *I had a broken copy. Certain operations everyone else can perform simply will not work with the copy that was sent to me.*
2. *I was probably hasty in my reaction. In my own defense, I will point out that I did write the ANSI committee in question, and my letter was neither acknowledged nor answered; and I have yet to meet anyone from the micro community who was invited to submit inputs to that committee. I do not believe they much listened to micro users when they devised this "standard."*
3. *I have written to Addison-Wesley requesting a new and unbroken copy. So far they have not replied. When and if I get a new copy, I will take another look, paying due attention to the mail I've received and the fact that some of True BASIC's features are described only in the Reference Guide rather than the User's Manual.*
4. *I am still inclined to the view that compilers should compile and interpreters should interpret. I freely admit that I wouldn't be much interested in Microsoft BASIC if it didn't have the BASCOM (now renamed Quick BASIC) compiler to turn loose on the code.*

*My own practice has been to do quick-and-dirty programs—filters, file transformers, things that will be run once or twice to get a job done and then thrown away—in Microsoft BASIC; larger and more permanent programs in Compiling CBASIC (which, especially if augmented with the Minnow Bear CBC Tools, is still one heck of a well-structured language); and think hard about transforming all this stuff to Modula-2, where I can build up a basic toolbox.*

*It may be that there's a real place for True BASIC; in any event, I have enough letters from people I respect to convince me I need to give it a second chance.*

—Jerry ■

# It's amazing what you can reveal when you strip.

Introducing a shape that's about to turn on an entire industry.

The Softstrip™ data strip. From Cauzin.

This new technology allows text, graphics, and data to be encoded on a strip of paper, then easily entered into

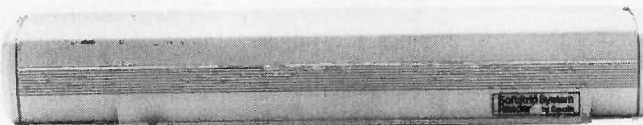

The Cauzin Softstrip System Reader replaces tedious typing by scanning the strip and reading it into your computer.

your computer using a scanning device called the Cauzin Softstrip™ System Reader.

Creating a simple, reliable and cost efficient way to distribute and retrieve information.

Softstrip data strips, like those you see here, can contain anything that can be put on magnetic disks.

Facts. Figures. Software programs.

Video games. Product demonstrations.

Sheet music.



The Cauzin Softstrip System Reader is now compatible with the IBM PC, Apple II and Macintosh.

A single strip can hold up to 5500 bytes of encoded data.

It can stand up to wrinkles, scratches, ink marks, even coffee stains.

And it can be entered into your computer with a higher degree of reliability than most magnetic media.

Simply by plugging the Cauzin Reader into your serial or cassette port and placing it over the strip.

The reader scans the strip, converts it to computer code, and feeds it into any standard communication interface.

Because strips are so easy to generate, most of your favorite magazines and books will soon be using them in addition to long lists of program code.

And you'll be able to enter programs without typing a single line.

There is also software for you to generate your own strips.

Letting you send everything from correspondence to business information using our new technology.

Find out how much you can reveal by stripping. Just take this ad to your computer dealer for a demonstration of the Cauzin Softstrip System Reader.

Or for more information and the name of the dealer nearest you, call Cauzin at 1-800-533-7323. In Connecticut, call 573-0150.

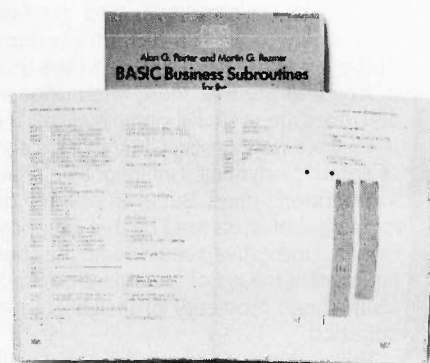

Soon everyone will be stripping as data strips appear in popular magazines, computer books and text books.



Cauzin Systems, Inc.  
835 South Main St., Waterbury, CT 06706

Apple® and Macintosh® are registered trademarks of Apple Computer Inc., Apple® is a registered trademark of Apple Records, Inc., Softstrip® and the Softstrip® System Reader are trademarks of Cauzin Systems, Inc., IBM® is a registered trademark of IBM, Inc.

# HYPER FACTORING

Recently, there has been a revival of interest in factoring large numbers. The interest is due to the growth in popularity of public-key ciphers for security.

In its simplest form, a public-key cipher is a larger number (N) that has two prime-number factors (p and q). The number (N) is so large that it is impractical to factor it.

In the March, 1985 issue of BYTE Magazine, (Page 396), Richard B. Leining took up the challenge and wrote HYPER, a program that quickly factors large numbers.

Read the data strips on the right into your computer and then enter BASIC to RUN the program. LOAD and RUN the program called HYPER.REV. It is menu-driven.

IBM is a registered trademark of International Business Machines Corporation. Reprinted with permission of Richard B. Leining and BYTE magazine, a publication of McGraw-Hill

# ACCURATE CALCULATIONS

What if you asked your 10-year-old to square your Social Security number? After extensive pencil chewing you would get your answer. Your computer will do the same and give you an answer that might look something like this:

```
302,325,885x302,325,855
9.140092260148103D+16
```

Actually the correct answer is 91,400,922,601,481,025. The reason for the slight inaccuracy is that all computer assign a specific amount of space for storing integers.

The concept is fascinating and anyone working with large-number transactions will demand software that can accurately calculate to the penny.

These data strips contain the program ARITHMETIC by Peter Rice, reprinted from BYTE Magazine (March 1985, p.119). Read the strips into your computer and enter BASIC to RUN the program. The screen will ask for a number up to 200 digits in length. From that point on the program is menu-driven.

IBM is a registered trademark of International Business Machines Corporation. Reprinted with permission of Peter Rice and BYTE magazine, a publication of McGraw-Hill.

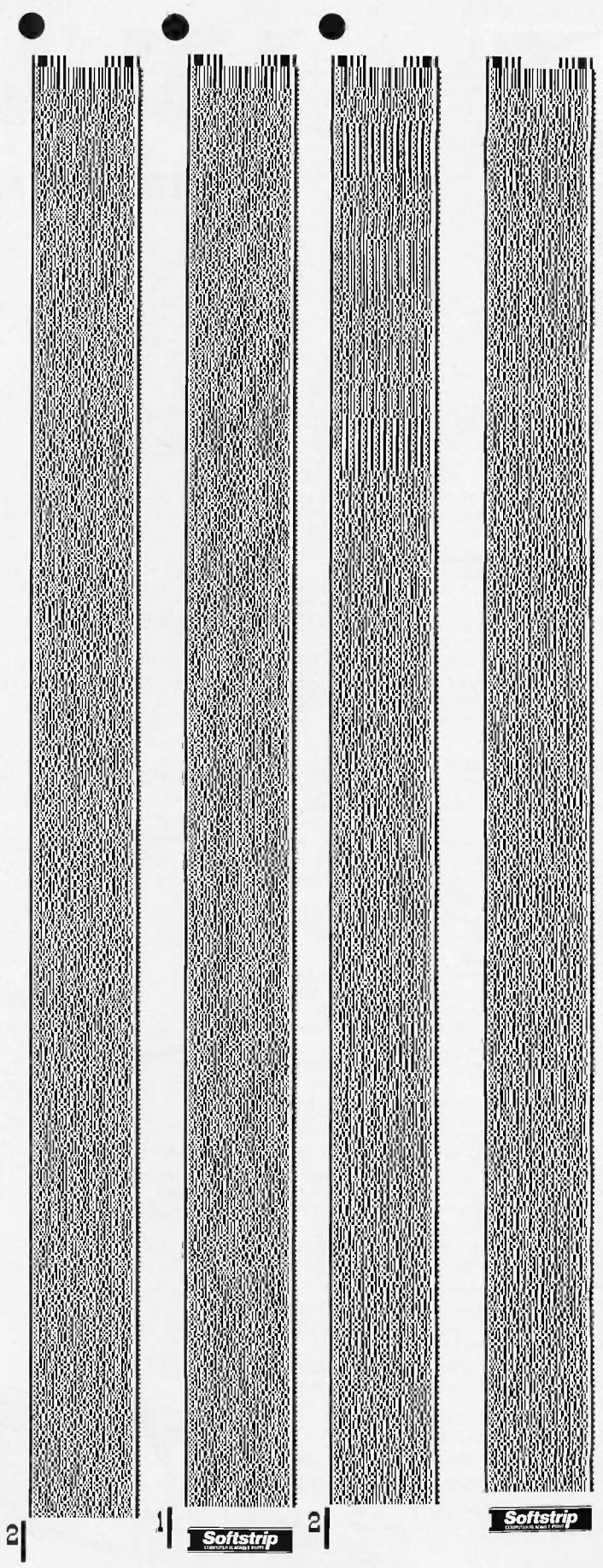



Leonardo Da Vinci was not only a great artist, he was also a great engineer and architect. His innovative designs which blended art, science and technology stressed efficiency and detail and were years ahead of their time.

Today, Da Vinci's spirit lives on in QDP Computer Systems' new and exciting graphics card... VIVA!

VIVA was designed for PC graphics software developers by providing graphics primitives in hardware, increasing productivity and reducing application development time.

VIVA was designed for graphics software users by providing compatibility with existing PC/AT software packages, ultra high resolution color and vastly increased drawing speed over standard graphics cards.

VIVA, like Da Vinci, is now the new standard by which all other graphics cards must be measured. This is VIVA.

- **Compatible with IBM, PC/XT, PC/AT and clones.**
- **On-board video multiplexer**  
*Allows a single monitor to be used for both normal text and graphics. Simply plug the output of your standard color graphics card into VIVA's input port. The display selection is controlled through software.*
- **On-board 16 bit graphics coprocessor**  
*Performs all screen drawing and display functions at high speed leaving your computer's CPU free to perform other tasks.*
- **Use with standard IBM color TTL RGB monitors.**
- **Supports analog RGB monitors on the basic card.**  
*(You get ultra high resolution color that is normally only available on mini and main-frame computers.)*
- **Standard resolution of 640 by 400, 16 colors with 128K of video ram on the Silver Card.**
- **Maximum resolution of 1024 by 1024, 16 colors with 512K of video ram on the Gold Card.**
- **Expansion connector:**  
*Allows upgrades which extend and enhance the features of the basic card—no more obsolete hardware. Planned extensions include:*
  - 256 colors (8 bits/pixel) displayable from a palette of 262,144 colors.
  - 512 colors (9 bits/pixel) displayable from a palette of 16,777,216 colors.
- **Display characteristics are fully programmable**
  - Interlaced mode allows use of low cost monitors.
  - Non-interlaced mode for flicker-free display
  - Display size up to 1024 by 1024 (40MHz bandwidth.)
- **Flash hardware enable/disable on 4 colors (Layers) allows any of 4 specified layers to be temporarily "disabled" i.e., erased, then later can be "enabled", i.e., put back on the screen without being redrawn. This greatly increases speed of use.**
- **Light pen input port.** (Permits a light pen to be used as a pointing or pick device)
- **Hardware pan and zoom support.** (Allows smooth panning, and zoom up to 16 times magnification)
- **Compatible with existing software including AutoCAD, p-cad, VERSACAD, MasterCAD, etc.**
- **Software support.** Planned software includes Tektronix emulation, Graphics support library.

# VIVA DaVINCI!

QDP PRESENTS  
THE ULTIMATE IN GRAPHICS CARDS

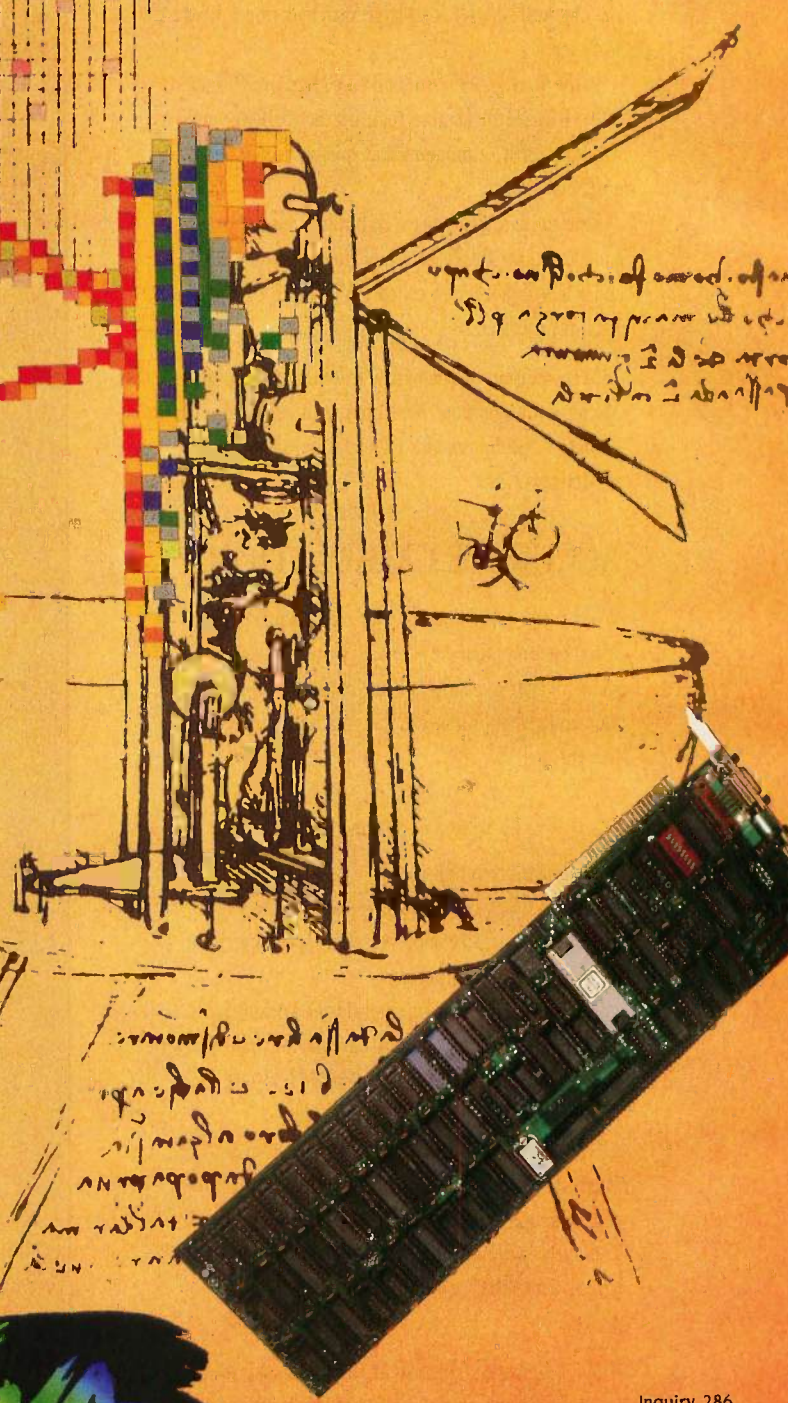

Get VIVA and bring your PC to life! VIVA is versatile, state of the art quality at a price you can afford. Call today and we'll be there—QDP! VIVA Da VINCI!



This card accepted by over 3 million PCs nationally.

Inquiry 286



QDP Computer Systems, Inc.  
10330 Brecksville Road  
Cleveland, Ohio 44141  
(216) 526-0838 Telex 241596  
Cable: Quasdata, Brecksville

## First in a Series

Turbo Editor Toolbox

Ready!

Balance of Power

Easy

BY EZRA SHAPIRO

**W**hy this column? Software. Lots of software. Software in boxes. Software in stacks. Software filling bookcases, filing cabinets, entire rooms. Software in battered binders and shrink-wrapped slipcases. Software all over the place.

The problem is quantity. And time. Organizing a fishing expedition in this sea of products is no mean feat; you go for minnows and wind up with sharks; you go for sharks and wind up with whales.

Applications Only is a shortcut, a quick glance at applications software—word processors, database managers, spreadsheets, communications packages, utilities, etc. Pournelle and Webster look at machines, compilers, operating systems; I don't. This is the slick, commercial stuff—the (shudder) "productivity tools" and (sigh) "software solutions."

In format, Applications Only is something between review and opinion. Prejudices stated up front. Intended to pick out winners, losers, and occasional oddities, but no guarantees. And monthly, so you can learn my biases and figure out if it makes more sense to follow my recommendations or avoid them.

### OPENING SALVO

Turbo Editor Toolbox (Borland, \$69.95) struck me as a nifty way to kill two birds with, well, two stones. The Toolbox is a wonderful idea—source code in Turbo Pascal for a complete editor, a thorough well-written manual, and no royalties to pay if you use the routines in your own programs.

This was my plan: Turbo Pascal costs \$69.95; the Editor Toolbox costs \$69.95. Buy both, compile the code, and you get a word processor *and* a Pascal compiler for under a hundred and forty bucks. Not bad! Or so it seemed.

How does the Toolbox stack up as an editor? The cover of the Toolbox manual is pretty convincing. "Features that word pro-

cessors selling for several hundred dollars can't begin to match," it trumpets. "Create your own word processor. We provide all the editing routines. You plug in the features you want. You could build a WordStar-like editor with pull-down menus like Microsoft's Word, and make it work as fast as WordPerfect." Borland has even gone so far as to name the editor "MicroStar." What would *you* think you were getting?

And the list of features is impressive, as far as it goes. A WordStar command set. Multiple windows. Multitasking. Undelete. Memory-mapped screen handling. An interface to Turbo Lightning for spelling checking as you type. Block operations. Search and replace. And you get the source, so you can change anything you don't particularly like.

I have to admit that the folks at Borland never actually say you're buying the code for an improved version of WordStar; they just make it very easy to leap to that conclusion.

However, a little something is missing. There are no facilities—none—for any kind of output formatting. No page breaks. No page numbers. No headers. No footers. No dot commands. No mail merge. No printer font changes. No proportional spacing. No pausing to insert single sheets of paper. None of that stuff.

What Borland has produced is a great gift to programmers and an excellent product, but it's not a substitute for a true word processor. Turning it into one is a big project. So, if you want to spend a lot of time programming, buy the Editor Toolbox. If you want WordStar, buy WordStar.

### BETTER NEWS

Ready! (Living Videotext, \$99.95) is one of those nice programs that's difficult to write about because it does exactly what its publishers claim, and it does it well. It's a memory-resident outline processor that closely resembles ThinkTank, Living Video-

(continued)

Ezra Shapiro is BYTE's West Coast bureau chief. He can be contacted c/o BYTE, McGraw-Hill, 425 Battery St., San Francisco, CA 94111.

# Now! Tek quality and expert advice are just a free phone call away!

**The industry standard in CRT performance.** Crisp, easy-to-read, bright CRT; 14kV accelerating potential, provides high writing rate and small spot size. Full size 8x10 cm display for measurement accuracy.

**Display controls are flexible and easy to use.** Separate intensity controls reduce blooming in alternate sweep mode. Focus tracking minimizes control adjustment and BEAM FIND eliminates confusion.

**Vertical system provides measurement assurance.** Flat transient response and high accuracy ensures true reproduction of your signals. Fast risetime and high bandwidth is well suited for a variety of measurement.

**Perform delayed sweep measurements accurately and easily.** Both sweeps can be displayed alternately making differential measurements easy and accurate (1%). An interlocking SEC/DIV control simplifies set-up.

**Stable hands-off triggering.** P-P AUTO detects signal peaks, then sets the trigger level for you. Display asynchronous signals using VERT MODE triggering. Independent TV field and line selection.

**Front panel laid out by function for ease of use.** Color coding aids the user in operation. Functions and modes are placed logically. All nomenclature is clearly labeled, and protected behind a scratchless Lexan surface.

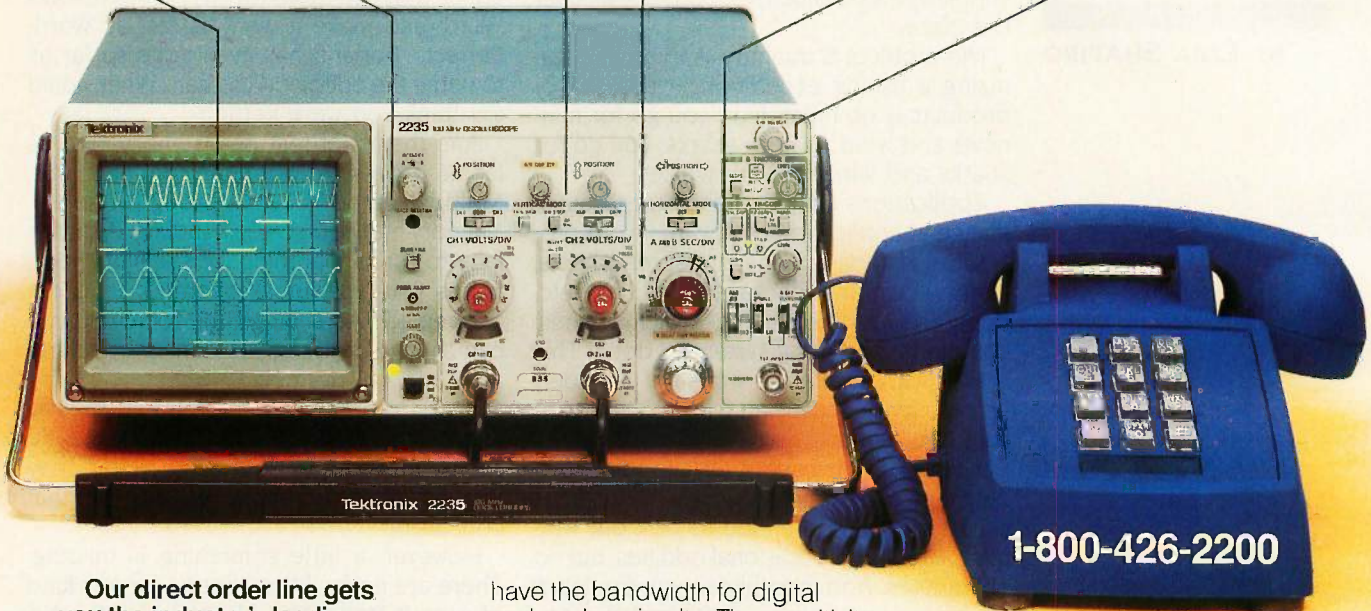

**1-800-426-2200**

**Our direct order line gets you the industry's leading price/performance portables... and fast answers from experts!** The 60 MHz single time base delay 2213A, the 60 MHz dual time base 2215A and the 100 MHz dual time base 2235 offer unprecedented reliability and affordability, plus the industry's first 3-year warranty\* on labor and parts, CRT included.

**The cost: just \$1275 for the 2213A, \$1525 for the 2215A, \$1750 for the 2235.**† Even at these low prices, there's no scrimping on performance. You

have the bandwidth for digital and analog circuits. The sensitivity for low signal measurements. The sweep speeds for fast logic families. And delayed sweep for fast, accurate timing measurements. All scopes are UL Listed and CSA approved.

**You can order, or obtain literature, through the Tek National Marketing Center.** Technical personnel, expert in scope applications, will answer your questions and expedite delivery. Direct orders include comprehensive 3-year warranty\*, operator's

manual, two 10X probes, 15-day return policy and worldwide service backup.

**Order toll free: 1-800-426-2200, Ask for Rick.**

In Oregon, call collect: (503) 627-9000. Or write Tektronix, Inc. P.O. Box 1700 Beaverton, OR 97075

**Tektronix®**  
COMMITTED TO EXCELLENCE



text's full-scale outliner. Ready! lacks some of the sophisticated word-processing features of ThinkTank, but because it lives in RAM it's faster and, of course, it's designed for other purposes.

The program takes a short amount of time to learn. You use cursor keys and function keys to create an indented outline. You can insert, delete, alphabetize, or reorganize items with little hassle. Not much to it.

Ready!'s chief distinction is its ability to transmit outlines into other applications programs. With one keystroke, you can drop a Ready! outline into a word-processor file and then proceed to edit it there as raw text. The program comes with 27 different output configurations for popular products, of which you can have 10 loaded at any one time. Why that many? Ask the people who developed other software. Word processors usually—but not always—like lines ended with carriage returns; spreadsheets use arrow keys. No standardization.

Living Videotext suggests that Ready! can be used for generating spreadsheet labels and database forms, storing keyboard macros, and suchlike, as well as developing textual outlines. I use it for keeping various lists that often have nothing to do with the material on screen in my primary application.

Other reviewers have compared Ready! to Borland's SideKick, differentiating between the two by noting that Ready! builds outlines while SideKick produces flat text files. That's missing the point.

Let me coin some terms here. I see SideKick as an *inbound* utility, and Ready! as an *outbound* one. What do I mean by that? SideKick can pick up on-screen data and let you massage it: it's handy for collecting chunks of data from other programs and organizing a new document file. It outputs to disk or printer, not directly into another program. Ready! can't capture material from other sources; you use it to originate data, which you can then send to disk, to a printer, or into an open applications file. I use Side-

Kick for *manipulating* and Ready! for *creating*. The two programs are not merely different approaches to taking notes; if anything, they're complementary.

My only complaint is that Ready!, when configured to hold a 32K-byte outline file, chews up 127K bytes of memory. That reduces my 640K-byte computer system to 512K bytes. I liked having that memory pad, since I prefer RAM-based editors and databases. Oh, well. You have to make sacrifices, I guess.

Anyway, Ready! gets high marks from me. It's more than worth its modest price.

**TOUR DE FORCE**

Webster's Dictionary defines "transcendent" as "exceeding usual limits . . . extending or lying beyond the limits of ordinary experience. . . ." It's the best word I can find to

describe **Balance of Power** (Mind-scape, \$49.95). Ostensibly a game for the Macintosh, this simulation is one of the finest programs—of any type—that I've seen on a microcomputer.

Subtitled "Geopolitics in the Nuclear Age," the game is an exploration of superpower diplomacy played on a world map. You choose to be either the U.S. or the U.S.S.R. (In a one-player game, the computer takes the other side. You can also play against a friend.) In brief, you decide whether to support or undermine the governments of each of 60 countries; you can send economic or military aid to either government or rebel forces, conduct covert operations to destabilize unfriendly regimes, apply diplomatic pressure, sign treaties, station troops. The object is to increase your sphere of influence and international prestige—at your opponent's

(continued)

**SMD/SCSI And More For . . .**

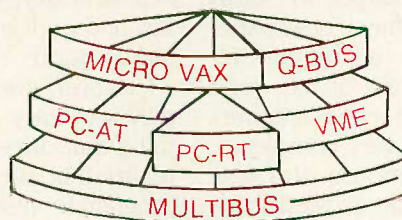

**COMPLETE, COMPATIBLE, SMD DISK/TAPE MEMORY SYSTEMS WITH . . .**

**SMD/SCSI** or Pertec, and 8 inch Winchester technology intelligently adapted to meet your needs in **leading system environments**.

Data rates up to 2.4 MB/SEC, access times of 15ms-20ms.

**Disk storage/systems** of 84MB, 168MB, 335MB, 474MB, 689MB, and up. Compatible with major networks. . . **designed for performance**.

**Industry standard** nine-track 1/2 inch, and 1/4 inch **tape back up** systems.

**Multifunction single board controller** for PC-AT, PC-RT, Unibus, and Q-Bus.

**Tower, desk top** and **rack mount** configurations are optional.

**Laser optical disk technology** and systems too!



SMD/SCSI multifunction for PC-AT/RT



Desk Top/Rack Mount Disk/Tape Systems

TWX 9103866006  
TELEX 821892 NMS UD  
LIVERMORE, CA 94550

National  
Memory  
Systems  
CORPORATION



**415-443-1669**

---WE ARE HERE FOR YOU---

expense—while avoiding nuclear war, in which both sides lose. The dynamics of the game consist of challenging your opponent's moves; at every step the other side takes you can choose to send a diplomatic protest, which can expand into a full-scale crisis. Your opponent has the same opportunity. It's a grand global game of "chicken," played for the highest stakes possible.

I don't have the space to get much further into a discussion of how the game is played. It's an intriguing adult simulation, provocative as well as entertaining. A carefully thought-out game could take days, and, as an educational tool, I could see Balance of Power as a month-long project for a high school social science class.

But what strikes me most forcefully about the game is how beautifully it uses the Macintosh's resources. You can display vast amounts of political, social, economic, and military data about the world, ranked in several ways, on cross-hatched maps. Every "event" triggers changes in status reports, maps, and mock newspaper displays. And the algorithms for analyzing the progress of the world situation over the course of a game's eight-year span are very complex.

Limitations? My mouse arm gets tired. I wish the Mac allowed more keyboard shortcuts. And I suppose someone with a Ph.D. in political science could take issue with the

game's content. But as Chris Crawford, the game's designer, points out in the comprehensive manual, as long as you're asking questions about the realism of Balance of Power, it still has something to teach you.

If I gave out little stars or little disks for computer programs, this one would get the highest rating. This is what computers should do.

**PARTING SHOT**

I wanted to like Easy (MicroPro, \$150). I really did. I've got a certain amount of residual loyalty because (even though I've tried to find a replacement) I've been using WordStar as my "serious" word processor for about three and a half years. Easy files are compatible with WordStar files; you don't need any annoying export/import utilities. And on paper, Easy seems to have a lot of desirable features lacking in WordStar—pull-down menus, automatic paragraph reformatting, support for a massive list of printers (including my neglected Manesmann Tally), a simplified command set, and undelete. Plus it's cheap. So far, so good.

However, every time I sit down to play with Easy, I stumble onto something that drives me to distraction. I realize that MicroPro has geared the program for first-time users, so I'm not the typical customer. However, if you've used any other text editor or word processor, Easy is a letdown.

To begin with, it's slow, particularly with the auto-reformatting. It feels like I'm typing through molasses. I haven't timed the response with a stopwatch, but it's not great.

Next, if you move your cursor beyond the end of a line and type a character, Easy automatically fills the dead area with spaces. This might be considered a useful feature by some, but it means that you can't move from the end of one line to the beginning of the next by leaning on the cursor key; you must use Ctrl-right-arrow.

Then three bothersome things happen when you're inserting text into a preexisting block. First, the automatic paragraph reformatting becomes visually annoying. If you add enough characters to force the last word on a line to the line below, Easy drops the word to a brand new line with nothing else on it. The program thinks for a second, then brings the remaining text up to where it should be. So you have a constant flashing effect as Easy opens a gap and then closes it, and this happens every time you push a word to the next line.

Second, if you want to break a line in the middle, you've got to hit Ctrl-enter. Hitting the enter key merely drops you to the line below. This gets irritating when you're trying to reformat material to shorter line lengths.

Finally, if you move to the next character position beyond the end of a line, Easy will not let you add a space. If you try to type a space followed by more text, Easy will remove the space and run the words together. If you teach yourself to get to the end of a line using the Ctrl-arrow combinations, you'll discover a soft space at the end of every line; use those combinations and you can add text just fine.

Conclusion: If you've never used a computer word processor before, get a demonstration of Easy before you buy it. See if you can live with the slowness and flashing-on-reform. If you have used other text-handling programs, note that you'll have to learn unfamiliar ways to move around the screen. As a second word processor, Easy is tough. ■

**ITEMS DISCUSSED**

**TURBO EDITOR TOOLBOX** . . . . . \$69.95  
 Environment: MS-DOS  
 Borland International Inc.  
 4585 Scotts Valley Dr.  
 Scotts Valley, CA 95066  
 (408) 438-8400  
 For orders: (800) 255-8008  
 In California: (800) 742-1133

**READY!** . . . . . \$99.95  
 Environment: MS-DOS  
 Living Videotext Inc.  
 2432 Charleston Rd.  
 Mountain View, CA 94043  
 (415) 964-6300

**BALANCE OF POWER** . . . . . \$49.95  
 Environment: Macintosh  
 Mindscape Inc.  
 3444 Dundee Rd.  
 Northbrook, IL 60062  
 (800) 221-9884  
 In Illinois: (800) 942-7315

**EASY** . . . . . \$150  
 Environment: MS-DOS  
 MicroPro International Corp.  
 33 San Pablo Ave.  
 San Rafael, CA 94903  
 (415) 499-1200

# Connections 2780/3780 RJE IBM PC HOST

## Possible Connections

- PC to PC
- PC to any other computer using one of these protocols:
  - Standard IBM BSCA V24 interface RS232
  - Modem: synchronous; leased or public line; half duplex; 9600 baud maximum speed
  - Direct connections need RX/TX clocks

## Characteristics

- Remote control possible
- Automatic error correction
- Operation log per file
- CALL USING from local program
- Multi file
- Multi record per block
- Maximum block size 512 bytes
- RJE support
- Automatic ASCII EBCDIC translation
- Transparent mode with translation option for ASCII on receive
- Space compression
- Record size definition
- Adding and deleting of characters such as CR/LF for each record
- Record separator as ITB or IRS
- Translation table modification ASCII/EBCDIC/ASCII
- The PC can work as the host
- Installable on hard drive
- Manual or automatic execution
- The parameters (per file) can be introduced from the keyboard or from the parameter file
- Minimum configuration: IBM PC with 128K and IBM BSC ASM card

**PRICE \$149**

1-800-826-7439



**K** eep your file transfers on the track. Using standard IBM hardware, PC3780 lets you transfer files between any sites using 2740/3740/3741/2780/3780. 100% error free.

**TDT**

Inquiry 338

Rivergate Plaza, 444 Brickell Avenue, Miami, FL 33131, 305/372-9332

HOW TO  
MAKE A  
GREAT  
IMPRESSION  
AT THE  
OFFICE

# With the Hewlett-Packard LaserJet Printer.

Page 2  
1985-86 Marketing Report

indicating a lower overall risk than had originally been projected.

## Market Penetration

Since introduction in 1976, the product has experienced tremendous growth in all geographical areas. In fact, the only quarter-to-quarter exception occurred Q1-Q2 1980, when the rate of penetration stalled as a result of the \$.35 coupon offered by the leading competitor (*See Fig. 2a*).

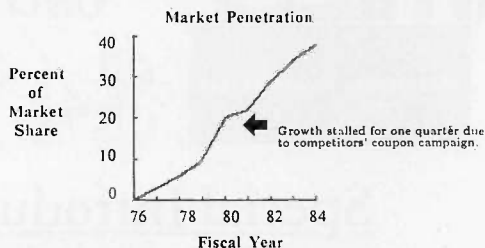

Figure 2a. Market Penetration (all geographic areas)

All regions are contributing to this growth, especially the Southern Region, which is experiencing a growth in market penetration far greater than the industry average. In the last three quarters, the Southern Region has increased at a rate twice that of the same period in the previous year. *Figure 2b* compares Southern Region and overall company performance with industry growth rates.

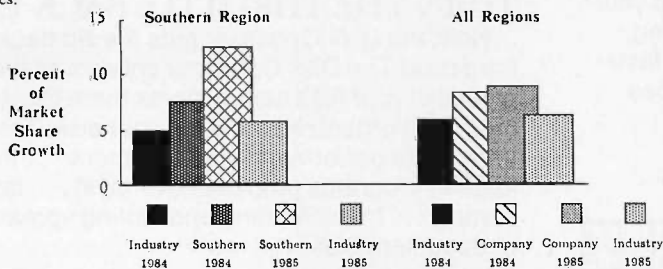

Figure 2b. Market Growth Rate Comparison

This would indicate that the increased effort directed at the dealers in the South has proved successful. No other elements were altered.

## Impact on Profitability

After expenses for the new dealer program, profits have increased 29% in the Southern Region. In the other regions, profits have held steady. This indicates that the ROI for dollars allocated

No matter what business you're in, the impressions you make on paper have a lot to do with the impressions you make on people.

And nothing makes a better impression than Hewlett-Packard's LaserJet Printer.

Super sharp, publication-quality printing. The blackest blacks. A wide variety of graphics. All printed in resounding silence. Eight times faster than a daisy wheel for a standard page of text. And completely compatible with all leading PCs and software.

The HP LaserJet Printer will even make a good impression on your ledger sheet. Just \$2995\* For new enhanced graphics: LaserJet PLUS, \$3995\*

Call (800) FOR-HPPC, Dept. 710 G, for the Hewlett-Packard dealer nearest you and see an impressive demonstration.



**HEWLETT  
PACKARD**

Inquiry 157

Print sample printed on an HP LaserJet Printer using Polaris PrintMerge. Polaris Software, San Diego, California. (619) 471-0922.

\*U.S. List Price

# SHIFT YOUR HARD DISK BACK INTO HIGH GEAR

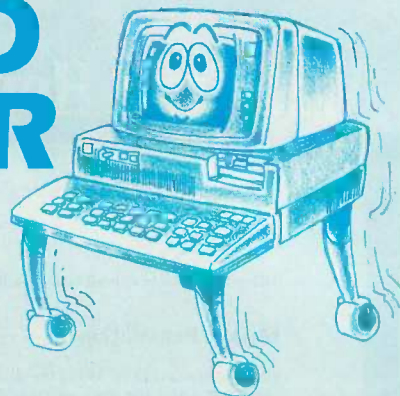
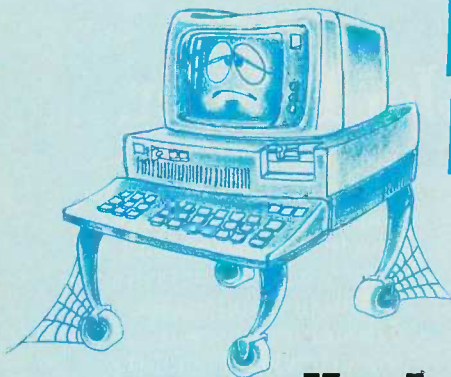

with

## disk optimizer



ONLY

# \$49.95\*

Special Introductory Price

## Tunes Your Disk Files For Highest Performance

The Disk Optimizer organizes your disk to make your PC run faster. You'll discover faster program loading, faster file loading and sorting, faster file creation, faster backups to diskette. And the disk Optimizer reduces the chances of error during your disk I/O.

A	CC	AA	DDD	D	E	BB	F	F	GG	AAA	H	BB	JJ	JJJ	AAA	BBBB
A	CC	AA	DDD	D	E	BB	F	F	GG	AAA	H	BB	JJ	JJJ	AAA	BBBB

AAAAAAAA	BBBBBBBB	CC	DDDD	E	FFF	GG	H	JJJJ
AAAAAAAA	BBBBBBBB	CC	DDDD	E	FFF	GG	H	JJJJ

### DOS IS SLOWING YOU DOWN!

Whether you realize it or not, the more you use your hard disk, the slower it is likely to react. This is because the operating system (PC-DOS/MS-DOS) stores things (programs, overlays, batches, etc.) randomly, wherever unused disk space is available. Your operating system doesn't keep pieces of the same file together. This means slower access time. Lost speed. Lost productivity.

### TURN THE THROTTLE BACK UP!

Now, the Disk Optimizer puts the zip back into your hard disk! The Disk Optimizer collects all the scattered pieces of your files and re-stores them together in neat, well-organized areas on your disk. The result: immediate performance improvement . . . faster loading programs (and their overlays) . . . faster sorting . . . faster loading and storing spreadsheets or document files.

### BONUS EXTRAS — at no extra cost

- ✓ **DISK ANALYZER**  
Displays a visual performance analysis . . . shown in percentages . . . for any disk or diskette.
- ✓ **PERSONAL FILE SECURITY**  
Password protect any file or program.
- ✓ **FILE PEEKER**  
Now you can visually examine any file on your system!

# \$49.95\*

\*Plus \$5.00 Shipping & Handling

**Order Toll-Free:**  
**1-800-272-9900**



## SOFTLOGIC SOLUTIONS

Inquiry 313

Creators of DoubleDOS

530 Chestnut Street, Manchester, NH 03101  
1-800-272-9900. In NH, call 627-9900  
Disk Optimizer works with IBM PC's and true compatibles.

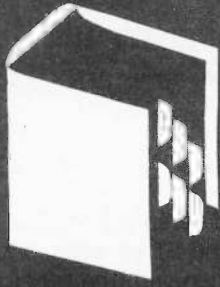

# A·C·C·O·R·D·I·N·G T·O W·E·B·S·T·E·R

## 68000 Wars: Round 1

Macintosh

Atari 520ST

Amiga

BY BRUCE WEBSTER

**I**t is late November—almost Thanksgiving—as I finish writing this, and the editors back in Peterborough are screaming for my column. It's nice to be wanted, eh? However, if I don't wrap this up and upload it posthaste, I may be wanted in two or three states. Worse yet, a certain managing editor may end up being wanted for manslaughter, though I doubt if any reasonable jury would convict him. I must type faster. . . .

I now have all three of the prominent 68000 machines: Apple's Macintosh, the Atari 520ST, and Commodore's Amiga 1000. I've had the Mac for nearly two years and the ST and Amiga for less than two months. And the single most common question I get these days is, "What do you think of the [one of the above] as compared to [one or two of the others above]?" Also, a lot of claims and counterclaims have been floating around concerning the relative merits of and problems with the three machines. In this column and the next few, I hope to sort out fact from fantasy and present some well-supported—if not completely objective—opinions. (Note: "Objective opinion" is an oxymoron, that is, a self-contradictory phrase, like "intelligent idiot" or "deliverable vaporware.")

### MAC VERSUS ST VERSUS AMIGA

The format of this column is simple. I'll take a number of different areas, one by one, and give my opinion on how the three machines stack up—who wins, who places, who shows. Where possible, this is based on direct experience. However, since I am not all-seeing or all-knowing, I have asked questions of those with more experience or knowledge, and I've done my best to acknowledge them at the end of the column.

### APPEARANCE AND PHYSICAL SETUP

The Macintosh wins this category easily. My 2-megabyte Mac has a 20-megabyte hard disk (MacBottom) and two disk drives (in-

ternal and external). The design is clean, attractive, professional, and unique. Better yet, the system takes up less than one square foot (9½ by 9½ inches) for the main unit and another 6 by 13 inches for the detachable keyboard, which can be easily moved 3 to 4 feet from the main unit. The Mac itself needs only one power outlet, though the hard disk requires its own as well. It definitely looks good in an executive suite and won't eat up all your desk space.

The Amiga comes in second, resembling the IBM PC (though, in my opinion, it looks nicer). The main unit is 17½ by 13 inches, covering more than twice as much desk space as the Mac. The monitor stacks nicely on top of the main unit, but a second (external) disk drive must sit to one side and takes up an 8- by 6-inch area. The detachable keyboard (6 by 16 inches) is larger than the Mac's, but it slides nicely under the main unit when not in use, and it can be moved almost as far as the Mac's. One warning, though: Since the expansion bus is on the right side of the Amiga, adding hardware is going to cause the Amiga to grow wider. The basic system (with two drives and monitor) needs two power outlets.

The ST comes in last, for reasons grouched about last month. The main unit is 18½ by 9½ inches. It therefore takes up less space than the Amiga, but neither the monitor nor the external disk drives can stack on it, so a complete system takes up much more desk space than either the Mac or the Amiga: A conservative estimate is about 21 by 21 inches. The keyboard is built into the main unit, so you don't have the additional space requirements for that, but you also don't have the flexibility of a detachable keyboard. The ST has a nice design but looks much like a home computer (which it is). Most unfortunate are the thick cables and external power supplies—one for the main unit and one for each disk drive. A basic system with monitor and two disk

(continued)

Bruce Webster is a consulting editor for BYTE. He can be contacted c/o BYTE, POB 1910, Orem, UT 84057, or on BIX as bwebster.

# The Same Only Better

The PC AT  
layout  
for the  
PC

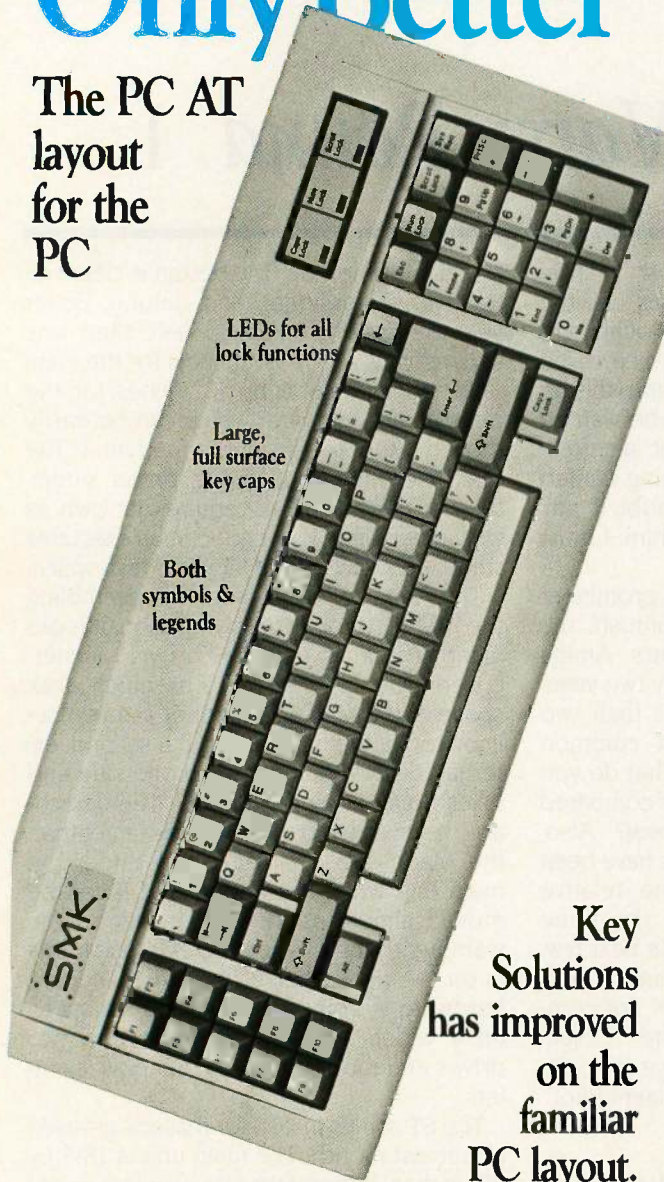

Key  
Solutions  
has improved  
on the  
familiar  
PC layout.

Plug Compatible Models:

KS 8300 AT/PC · PC/XT™ code

KS 8300 AT/AT · PC AT™ code

Introductory special only \$99

Normally priced at \$125

Call for volume discounts · Dealers inquiries invited

Call 612 - 435 - 2720

## KEY SOLUTIONS™

An SIMIK Company

1294 West County Road 42  
Burnsville, MN 55337



PC and PC AT are trademarks of International Business Machines Corporation.

Inquiry 196 for End-Users.

Inquiry 197 for DEALERS ONLY.

ACCORDING TO WEBSTER

drives uses four power outlets and seven cables. One last problem: With the main unit of the ST so wide, finding room for the mouse is tougher than with the other two systems.

### MONITORS

For a monochrome display, the Mac barely noses out the ST, mostly due to cleaner-looking text and icons, as well as the monitor's size (i.e., built in, doesn't eat up desk space). However, if you are using the Atari monochrome monitor, you'll find it just about as crisp as the Mac, and the display itself is larger, both physically (12 inches versus 9 inches) and in terms of pixels displayed (640 by 400 versus 512 by 342). Both also have a true 1:1 aspect ratio. If you have an Atari color monitor, you can choose medium-resolution mode, which is 640 by 400 pixels with two colors; however, the aspect ratio is not quite 1:1, so icons and text look a little elongated. The Amiga doesn't have a monochrome mode or a monochrome monitor. You can set up a display using only two colors, but it doesn't look nearly as crisp as on the Macintosh or the 520ST.

For a color display, I think the Atari RGB (red-green-blue) monitor produces crisper, more brilliant colors than the Amiga RGB monitor (Model 1070). The Atari display has a cleaner look, while the Amiga display tends to look a little mushy. I'd like to swap monitors between the Atari and Amiga to determine where the real praise or blame for the display quality should go, but the Atari hardware uses a rare round 13-pin DIN connector that makes it hard to hook up other monitors to the ST or the Atari monitor to other computers. The Mac, of course, isn't even in the running for color display—yet.

While the ST is the overall winner for display clarity, the Amiga completely blows the other two away for display versatility, i.e., video-signal options. The Mac has no external video output. The ST has both color (analog RGB) and monochrome coming out of a single port, but—as mentioned—it is hard to hook up anything but an Atari monitor. If you want both crisp monochrome and color graphics, you have to have both monitors, eating up more money and desk space. Also, a number of ST software packages will run only with the color monitor—I don't know of any that will run only with a monochrome monitor—so that complicates things even more.

The Amiga, however, presents you with multiple options. You have RF (radio frequency)-modulated video and audio, for hooking up the Amiga to older TV sets. You have high-quality NTSC (National Television System Committee) composite video for newer TV sets as well as color monitors you might have lying around from other computer systems. You have both analog and digital RGB output for RGB monitors and top-of-the-line TV sets. And Commodore has a genlock board that lets you take an external video source (laser disk, VCR, camera, TV) and mix it with your graphics display. The external video then

(continued)



# O'HANLON DELIVERS THE BOTTOM LINE: PROFIT.

In any business, profit is the bottom line. In application development, profit not only depends on quick development cycles. It also depends on the ability to maintain your software cost effectively and implement modifications swiftly.

O'Hanlon's SENSIBLE SOLUTION DataBase Language delivers the bottom line.

Ask Dick and Judy Buffo, publishers of the highly successful Terra/Pac Agricultural system.

Hundreds of state-of-the-art applications have been developed using the Sensible Solution DataBase Language by itself or in conjunction with the Sensible Solution Management Series accounting applications. Discover a new dimension in application development.

**datasphere**  
Computer Systems, Inc.

**The SENSIBLE SOLUTION DataBase Language**

- Syntax-free, Self-Prompting Source Code Editor
- Screen and Report Format Printing
- High-Speed Compiler
- Complete Application Transportability
- Data Dictionary
- B+ Tree File Indexing
- Run-Time Module

**The SENSIBLE SOLUTION Management Series available with source code**

- General Accounting
  - General Ledger
  - Accounts Receivable
  - Accounts Payable
- Wholesale Distribution
  - Sales Order Entry
  - Purchase Order Entry
  - Inventory Tracking
- Law Office Management
  - General Ledger
  - Accounts Payable
  - Law Office Management & Billing

The Sensible Solution product line is more than just a series of powerful development tools. It is a completely new concept in application development. O'Hanlon has combined a versatile development language, with proven accounting applications and high level technical support to create a profitable environment for application developers. Combining the power of the Sensible Solution language, and O'Hanlon's pre-packaged accounting applications we created our Terra/Pac system in a fraction of the time normally associated with traditional techniques. This efficiency meant our products reached the market months sooner. Because market demands change, applications can not remain static. The Sensible Solution allows us to easily enhance our product and stay ahead of the competition. Terra/Pac's market is expanded because applications developed in the SENSIBLE SOLUTION are completely transportable across a wide range of single, multi-user and network operating systems.

Inquiry 255 for End-Users. Inquiry 256 for DEALERS ONLY.

Call or write today! Or better yet, send for a 30-day evaluation package and redeem this coupon for 10% off your first SENSIBLE SOLUTION system.



**O'HANLON**  
COMPUTER SYSTEMS

11058 MAIN STREET SUITE 110  
BELLEVUE, WASHINGTON 98004 (206) 454-5350 Ext. 379  
Development Software for Computer Professionals.....

- Yes I'm interested, please have a representative call me.
- Yes I'm interested, please send full descriptive literature.
- Yes I'm interested, please send a 30-day evaluation in the following format:  
Single-user \_\_\_ Multi-user \_\_\_ 8" \_\_\_ 5 1/4 \_\_\_  
DOS \_\_\_ MP/M \_\_\_ CP/M \_\_\_ Other \_\_\_\_\_

NAME \_\_\_\_\_  
 TITLE \_\_\_\_\_  
 COMPANY \_\_\_\_\_  
 ADDRESS \_\_\_\_\_  
 CITY \_\_\_\_\_ STATE \_\_\_\_\_  
 ZIP \_\_\_\_\_ PHONE \_\_\_\_\_ PHONE EXT \_\_\_\_\_

Tell us about yourself:  
 VAR \_\_\_ OEM \_\_\_ MIS \_\_\_ Dealer \_\_\_ Distributor \_\_\_ End-user \_\_\_

# TOTAL CONTROL

with **LMI FORTH™**



## For Programming Professionals: an expanding family of compatible, high-performance, Forth-83 Standard compilers for microcomputers

### For Development:

#### Interactive Forth-83 Interpreter/Compilers

- 16-bit and 32-bit implementations
- Full screen editor and assembler
- Uses standard operating system files
- 400 page manual written in plain English
- Options include software floating point, arithmetic coprocessor support, symbolic debugger, native code compilers, and graphics support

### For Applications: Forth-83 Metacompiler

- Unique table-driven multi-pass Forth compiler
- Compiles compact ROMable or disk-based applications
- Excellent error handling
- Produces headerless code, compiles from intermediate states, and performs conditional compilation
- Cross-compiles to 8080, Z-80, 8086, 68000, and 6502
- No license fee or royalty for compiled applications

### Support Services for registered users:

- Technical Assistance Hotline
- Periodic newsletters and low-cost updates
- Bulletin Board System

**Call or write for detailed product information and prices. Consulting and Educational Services available by special arrangement.**

**LMI** Laboratory Microsystems Incorporated  
Post Office Box 10430, Marina del Rey, CA 90295  
Phone credit card orders to: (213) 306-7412

#### Overseas Distributors.

Germany: Forth-Systeme Angelika Flesch, D-7820 Tübingen-Neustadt  
UK: System Science Ltd., London EC1A 9JX  
France: Micro-Sigma S.A.R.L., 75008 Paris  
Japan: Southern Pacific Ltd., Yokohama 220  
Australia: Wave-onic Associates, 6107 Wilson, W.A.

## ACCORDING TO WEBSTER

becomes the background "color" (color 0), with all other colors appearing on top of it.

### GRAPHICS

While the ST and the Mac beat the Amiga in display quality, the Amiga breezes ahead of both in terms of graphics speed and variety. I'll have an extensive set of graphics benchmarks in next month's column, but here's the basic information about each machine.

The Mac has a single graphics resolution: 512 by 342 pixels, monochrome. Video RAM (random-access read/write memory) is a single 21K-byte block of memory; each bit represents exactly one pixel. There is no hardware support for the graphics, so every pixel that appears on the screen is put there by the 68000 processor. Extensive and sophisticated software support is provided via QuickDraw and other ROM (read-only memory) routines.

The ST has three graphics resolutions: 320 by 200 pixels, 16 colors; 640 by 200, 4 colors; and 640 by 400 (noninterlaced), monochrome. All colors are taken from a palette of 512 (3 bits each of red, green, and blue). A special mode lets you redefine the palette on each scan line; however, when invoked, you have to handle it for every scan line. Video RAM is a 32K-byte block of memory. An interlaced bit-plane approach is used. If you have four bit planes (16 colors), every four consecutive words represent one word from each of the four planes. Again, the 68000 processor has to draw each and every pixel on the screen. Software support is provided via GEM (from Digital Research), which has some limitations compared to the Mac routines. However, overall graphics performance on the ST seems to be better than on the Mac.

The Amiga has four basic resolutions: 320 by 200 pixels, 32 colors; 320 by 400 (interlaced), 32 colors; 640 by 200, 16 colors; and 640 by 400 (interlaced), 16 colors. You choose from a palette of 4096 colors (4 bits each, RGB). Bit planes are truly separate, can be located anywhere in the lower 512K bytes of RAM, can be larger or smaller than the display screen, and can be allocated as needed. For example, if you want a 320 by 200 display with 4 colors, you need to set aside only 16K bytes of RAM (8K bytes for each bit plane). Special graphics modes include half-bright (which lets you have up to 64 colors in the 320-resolution modes), dual playfield (which sets up two independent graphics displays, one "in front of" the other, with color 0 for the front display being "transparent" and letting the back display show through), and hold-and-modify (which lets you have up to 4096 colors on the screen simultaneously). You can change resolution (320 versus 640) and palettes at will while moving down the screen, and you can scroll both vertically and horizontally merely by changing some register values.

Most of the grunt work is done by custom graphics hardware, leaving the processor free to do other work (more on this in a minute). And I haven't mentioned hardware and virtual sprites, object animation, hardware collision

(continued)

# MACH 1 PAD 4th Generation Productivity ... Under \$1000!

(Cincinnati, Ohio) January, Tominy, Inc. announced the immediate availability of a single-user version of their Mach 1 System Generation Facility on the IBM PC.

## Professional Applications Developer on the IBM PC

The Mach 1 Professional Application Developer (PAD) provides the micro computer system developer with an advanced set of System Generation tools to develop applications that run on MACH 1's micro, mini and mainframe multi-user environments.

At the core of all Tominy systems is a powerful Data Base Management System, used worldwide since the 1970's in business and commercial applications.

## Logical Data Base, Program Generator, and Query/Report Generator

The Logical Data Base Structure of the Tominy products provide unlimited record sizes, multiple file keys, data independence, record locking and free space management. The Logical Data Base's flexible design supports Relational, Hierarchical, and Network Data Views.

Programs to maintain the Data Base can be completely generated by MACH 1. A MACH 1 Generated Program allows users to inquire on the Data Base and add, update, or delete Data Base information.

Ad hoc data analysis or reports are addressed by the MACH 1 Query/Report Generator. The simple "English-like" Query statements allow data to be selected, sorted, summarized, displayed and printed.

To allow for more complex transaction processing and reporting, MACH 1 contains the fourth-generation procedural language "LOGIC."

## Fourth-Generation LOGIC Language

The LOGIC language provides the command structure to manipulate data; perform data base, screen and print I/O; control program flow; manipulate tables and arrays; log system messages; and perform mathematical calculations.

A standardized approach to program development is ensured using the "program framing" concept of the MACH 1 products. MACH 1 "frames" the LOGIC code by "writing" the complete data variable section, and including various LOGIC modules.

This approach to application development ensures a consistent structure while still providing the flexibility required by the serious application developer.

The LOGIC programs are tested on-line using the Interactive Program Tester which steps through the execution of the LOGIC code and permits immediate changes to the program statements, variable values, and the test data base.

## Screen Designer, Automatic Editing, and Simplified Print Logic

To facilitate LOGIC program development, MACH 1 includes a full screen designer. Screens for applications and menus are easily created and maintained by entering prompts and data entry fields on the screen itself.

MACH 1 has the capability to automatically edit each data entry field for date format, numeric data, and required field length. In addition, MACH 1 will perform data validation against existing File Keys, or Table Entries.

The Report Design tools of MACH 1 removes report handling (headings, form control, and print queues) from the

program, reducing print logic to a simplicity not found with other programming languages.

## Menus, Help Screens, and Full System Security

The MACH 1 is a menu driven package. It is simple and easy to use. Full-screen text editors are included for entering the LOGIC code, Job control statements, and Data Base Descriptions.

On-line HELP screens are provided to guide the developer through the numerous utilities provided with MACH 1. In addition, the MACH 1 manuals walk the owner through designing, developing, testing, packaging, and maintaining their Application System.

And all this is offered with system security. Security codes will be validated upon entry to MACH 1, and whenever a program function is executed.

## Full Application and Development Portability

Applications developed using MACH 1 PAD run on micro, mini and mainframe multi-user systems using MACH 1. IBM, DEC and Data General are current MACH 1 environments.

The MACH 1 PAD requires

- IBM PC/XT/AT or Compatible
- PC DOS 2.1 or up
- 128 KB Memory
- 8 MB on-line storage

Discover the power and performance of MACH 1 PAD. Now, just \$129.95 (regular retail \$199.95) when you order by April 31, 1986. **Save \$70.00!** Mail the coupon or call Tominy *toll free* at 1-800-543-8628. In Ohio call 1-800-445-1737.

SAVE \$70 on **mach1Pad**<sup>TM</sup> only \$129.95

Please send me MACH 1 PAD, the complete development package for single-user environments...

Check Enclosed  Money Order Enclosed

MasterCard  Visa

Account Number

Expires

Single-user Environment @ \$129.95

Shipping & Handling \*5 (\*10 foreign)

Sales Tax, Ohio residents: 5 1/2 %

Total Amount of Order \$

(Offer expires April 31, 1986)

\_\_\_\_\_  
(PLEASE PRINT)

Name \_\_\_\_\_ Signature \_\_\_\_\_

Address \_\_\_\_\_ Phone \_\_\_\_\_

City, State, Zip \_\_\_\_\_

Please send me information about the unlimited version of MACH 1  
for:  Main Frame,  Mini,  Multi User Micro Systems

MACH 1 and MACH 1 PAD are registered  
Trademarks of TOMINY, Inc.

Send to: TOMINY, Inc. • MACH 1 PAD Division • P.O. Box 160 • Cincinnati, Ohio 45242

# Expansion Chassis/ Sub-System

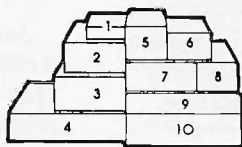
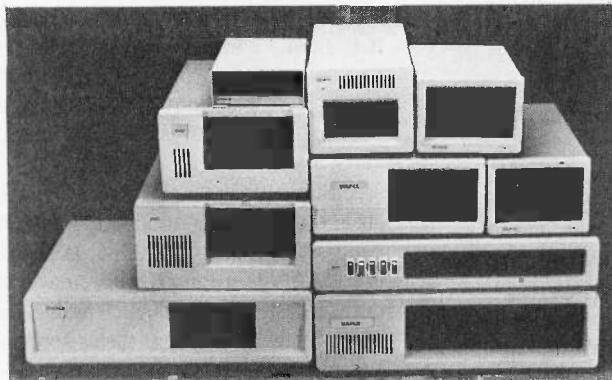

## Specification

Model No.	No. of Slot	Half Height Drive	Power Supply	Dimension D x W x H (cm)	Price
M-1*	0	1	A or B	30 x 15 x 6.5	\$149
M-2	3	3	C	42 x 25 x 16	\$299
M-3	5	3	C	39 x 30 x 15	\$259
M-4	12	2	D	40 x 39 x 14	\$299
M-5	0	2	E	39 x 18 x 15	\$149
M-6	0	1	A or B	26.5 x 18 x 13.5	\$169
M-7	5	2	C	38.5 x 30 x 13.5	\$299
M-8	0	2	E	39.5 x 18 x 13.5	\$149
M-9	0	2	F	38.5 x 49 x 9	\$249
M-10	8	4	G or H	43 x 49 x 14	\$259

\* Extra space for a stand alone controller

## EXT and RCV Adapters

- Connecting master expansion chassis to PC, XT or AT
- Fully buffered address, data and control signals.
- 3 feet shielded flat cable.

Price \$159

## Power Supply

	Watt	+5V	+12V	-12V	-5V
A	50	5.0	2.5		
B	50	1.8	3.5		
C	100	8.0	5.0	0.3	
D	100	10	3.5	0.5	0.5
E	45	4.0	2.0		
F	60	5.0	3.0		
G	135	15	4.2	0.3	0.3
H	150	15	6.0	0.3	0.3

**ORDER TOLL FREE: (800) 826-0267**  
**In California Call (415) 651-3355**

DEALER INQUIRIES INVITED

**SOURCE ELECTRONICS CORP.**

45277 Fremont Blvd., Unit 6

Fremont, CA 94538

Telex: 279366

FAX: (415) 791-0935

## ACCORDING TO WEBSTER

detection, multiple screens and windows, display list processing by the Copper (graphics coprocessor), minterm processing by the Blitter, and so on. Software support exists on three levels: direct access of the custom chips, low-level graphics routines, and high-level graphics routines. The routines are not as complete or polished as the Mac's but still have some significant capabilities not found in the other two machines.

## A DIGRESSION

I want to make some comments here about the custom chips on the Amiga, mostly in response to some misleading and distorted comments floating around on the bit stream. The internal bus of the Amiga runs at 14.2 megahertz, twice the clock rate of the 68000 processor. Alternate cycles are given to the 68000 and the DMA (direct memory access) channels, so that the 68000 is usually running at full speed. However, two different situations can occur to cause the 68000 to run slower.

First, if the 68000 is running code located in the lowest 512K bytes of RAM (the Amiga's internal memory, known as chip RAM), contention may—but does not necessarily—occur between the 68000 and the DMA channels. You can, for example, run a four-plane low-resolution (320 by 200 by 16) display (or a two-plane high-resolution display), with all four audio channels, all eight sprites, and be accessing the disk as well—and the 68000 will still be going full tilt. However, if you have a six-plane low-resolution display, the 68000 will slow down by 50 percent during the video update cycles, due to bus contention, if and only if the 68000 is accessing chip RAM. (Note, though, that the 68000 still has no contention during horizontal and vertical blanking.) However, if you've expanded the Amiga beyond 512K bytes, and your code is running in the external memory (known as fast RAM), there is no contention at all, and the 68000 continues to run at full tilt, regardless of the current screen resolution.

The second situation in which the Amiga's 68000 loses cycles is when the Copper or the Blitter is running. Both will steal cycles to accomplish their work; however, since both can accomplish in a few cycles what would take the 68000 many cycles, the net effect is significantly greater performance than either the Mac or the ST, both of which rely upon their 68000s to draw every pixel.

## SOUND

The Amiga is the winner in the area of sound. It has four audio channels, each with its own 8-bit D/A (digital-to-analog) converter and DMA channel. Left and right audio outputs on the back (standard RCA jacks) let you hook up the Amiga to your RGB monitor (you'll need a Y-adaptor) or your stereo system; two channels are assigned to each output. (By the way, both outputs also go out through the TV video port, though the current RF modulator combines them to produce monaural sound.) Because the audio channels are DMA-driven, they can run

(continued)



# For thousands of years, man used personal computers without decent tape backup. Enough.

Personal computers have come a long way. Unfortunately, tape backup systems have not. Their functions are primitive, they're frightening to install and truculent to use.

Genoa's Galaxy™ Systems are more highly evolved. So not only do they outperform competitive systems, but using them is actually something that can be done by an ordinary human.

## The simpler. The better.

Our software is what makes the difference between our systems and everybody else's. And it's designed to help you use the system easily in either of two modes. Namely, menu-driven or batch file.

The menu mode operates true to its name, with menus showing all the commands you have to choose from. And there isn't a thing you can't do from the menu mode because it's comprehensive.

You'll want to use the batch mode for routine operations though, because it allows you to create a "file"

to contain those operations and run them automatically, just by hitting a few keys.

But probably the best example of just how downright civil the Galaxy systems can be is our auto backup. You just preset the time and the desired function, and the system does the rest. Automatically.

No other tape backup systems, by the way, operate this simply.

## The features all tape backups should have. But don't.

Before you make your first backup — which is the right time to do this — our installation software checks your disk configuration to make sure your tape drive will run at top speed. And it checks the entire system to guarantee it will perform as promised. No competitive system offers anything like it.

Another thing you can do is abort any command at any time. So you don't have to sit through a 20-minute

file-by-file restore just because you hit the wrong key.

You can also do a file-by-file restore from an image backup. So you can get back the one file you need rather than all the files you don't.

But whether it's a couple of files or a complete image, you'll be pleased to know you can restore to any storage device, thanks to Galaxy's interchangeability feature.

Multiple backups on the same tape — even from multiple sources like a floppy or another hard disk — aren't a problem either. The system simply starts recording where the last backup ended.

Or you can use multiple tapes to back up very large files. The system will just let you know when it needs a new tape.

We also perform crc error checking constantly. We can back up a 20 Mb disk in just over 4 minutes. And we're network compatible.

## What price progress?

Surprisingly, the Galaxies cost somewhat less than tape backup systems that offer less. Which includes all of them.

For the Genoa Galaxy dealer near you or complete specs, call 408-945-9720. Or write Genoa Systems Corporation, 73 E. Trimble Road, San Jose, CA 95131.

The Genoa Galaxy Systems. The most civilized tape backup in history.



*The IBM®-compatible Genoa Galaxies are available as internal or external versions of 1/4" streaming tape or cassette models. (External cassette not shown.)*

**GENOA**  
We make PCs better.

**NOVAS** **PC/XT/AT**  
**IN TURBO**  
**TOP OF THE LINE IBM PC**  
**COMPATIBLE COMPUTER**  
**MOTHERBOARD**

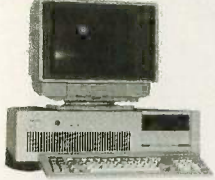

<p><b>NOVA'S PC/XT TURBO ON BOARD UP TO</b> 640K DUAL SPEED (4.77 MHZ, 8 MHZ), keyboard software selectable, 8 slots, external reset <b>\$125.00</b> (in large OEM quantity)</p>	<p><b>NOVA'S AT 286 DUAL SPEED (6 MHZ, 8 MHZ)</b> keyboard software selectable, battery on board and memory expandable up to 1 MB, 8 slots, external reset switch power good detection circuit which guarantees that the power supply and reset is working properly. (optional on board: 2 serial / 1 parallel) includes legal ROM BIOS <b>\$595.00</b> w/SET UP DISKETTE (in large OEM quantity)</p>
<b>SYSTEM</b>	
<p><b>NOVA'S PC/XT BARE BONE</b> 64K includes keyboard, 130W power supply, 8 slots, up to 640K on mother board and case <b>\$510.00</b></p>	<p><b>NOVA'S PC/XT 2 DRIVE SYSTEM</b> 8 slot mother board w/256K, 130W power supply and two half ht. TEAC floppy drives and case <b>\$795.00</b></p>
<p><b>NOVAS AT 286 BARE BONE</b> 1 MB RAM memory, 1.2 M drive, keyboard, 195W power supply, case, HD/FD controller <b>\$1,985.00</b></p>	<p><b>NOVAS AT 286 ENHANCED MODEL</b> 1 MB RAM memory, 1.2 M drive, 20 MB hard disk, 195W power supply, HD/FD controller, S/P card <b>\$2,795.00</b></p>
<p>100% hardware and software compatible ENHANCED GRAPHIC ADAPTER \$450.00 640 x 350 enhanced color mode, 16 color in 640 x 200 resolution 720 x 350 in monochrome mode, total of 256K bytes of memory Plus Printer Port (can select LPT1 to LPT3) Build in Printer Port Jumper for LPT1 to LPT3</p>	
<p><b>OEM, WHOLESALE, RETAILER, END USER ARE WELCOME</b> <small>*IBM IS TRADEMARK OF INTERNATIONAL BUSINESS MACHINES CORP.</small></p>	
<p><b>COMPUTRADE COMPANY</b> 780 Trimble Road, Suite 605, San Jose, CA 95131 Tel: (408) 946-2442 Telex: 171605 Fax: (408) 435-5458</p>	

MAX IBM® AT COMPATIBILITY

SHUTTLE-AT BOARD

- 80286 CPU at 6, 8, 10 MHZ
- Upgradable to 1 megabyte
- 1 parallel, 4 serial ports on board
- 4 models (S-286, TS-286, C-286, TC-286)
- Legal and true compatible BIOS

**OEM QUANTITY PRICE**  
**\$595.00**

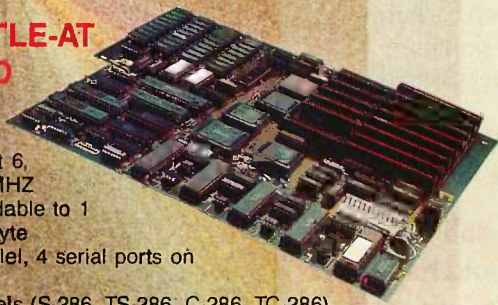

EGA BOARD

- 256K on board
- Parallel port on board
- Adapts to EGA, Monochrome, RGB monitors
- 640 x 350 pels (64 colors)
- Less than half the cost for IBM® EGA

**from \$295.00**



BIOS CONTRACT AT, XT, PC, EGA available to manufacturers

IBM, AT are trademarks of International Business Machines Corporation



**IBS Corporation—professional quality and support**  
2700 E. Imperial Hwy., Bldg. A., Brea, CA 92621  
To order an evaluation call: (714) 579-0680, 579-0691,  
579-0692, TLX: 753197, & FAX (714) 579-0695.

ACCORDING TO WEBSTER

with little processor overhead. You can also combine channels to do frequency and amplitude modulation. The Amiga's software support of sound is also excellent, including standard routines to play back digitized sound and to do speech synthesis.

The ST takes a different approach to sound. It has no D/A converters or audio outputs. Instead, it uses a standard three-voice sound chip, which was designed primarily for music synthesis and arcade sound effects and has previously shown up in machines like Mattel's Intellivision. Again, use of this chip helps to relieve any burden on the processor; however, you do not have the same ability to play back digitized sound found in the Amiga (or, with some work, in the Mac). This audio signal is then fed to the monitor via the cable. However, what excites a lot of music enthusiasts about the ST are the standard MIDI (musical instrument digital interface) in and MIDI out ports on the back. This makes it easy to use the ST to control synthesizers and other audio exotica, with some impressive results. Software support for both the sound chip and the MIDI ports seems to be minimal, though; all I could find in the technical documentation were a couple of BIOS (basic input/output system) calls, and I found no information at all as to how the hardware worked.

The Macintosh has a four-voice synthesizer using a single 8-bit D/A converter. Only a little overhead is involved with a single voice, but if you're running all four voices, you place a significant load on the 68000. It is possible to play back digitized sound, but it requires custom software; the ROM routines do not directly handle it.

**SYSTEM SOFTWARE**

The Mac wins here. For all the grousing that I and others have done about the Mac's Finder, OS (operating system), and even its Toolbox, they are still perhaps the finest system software put on a microcomputer, and they really shine when viewed next to the ST and the Amiga. Of course, Apple has had longer to polish them, but I think the Mac at its release still had far better stuff than either of the others, especially since it had to run on a 128K-byte machine.

It is hard to come up with a clear winner between the ST and the Amiga in the area of system software, but I'll go with the ST, mostly because of GEM and GEM Desktop. Even though they have some limitations and often lack intelligence and flexibility, they are still more polished than their counterparts on the Amiga. And because of the accepted limitations, GEM can often outperform both the Mac and the Amiga in standard system functions (opening windows, etc.). Atari was smart to go with a system to which someone else had already devoted a lot of resources, leaving Atari with more time to concentrate on the hardware.

Commodore, on the other hand, has done everything in-house and just hasn't done the job on the Amiga system software that it should—probably due to too few peo-

*(continued)*



Dr. Martin Alpert is pleased to re-introduce his "state of the art" products now marketed by his new subsidiary - Scientific Solutions.

## IBM PC® Data Acquisition and Control for Laboratory and Industry.

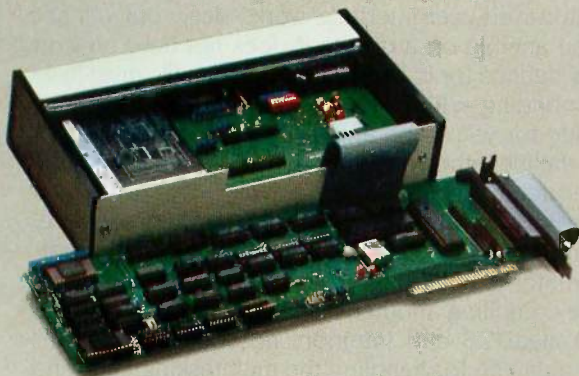

### Lab Master™

- Resolution - 12, 14 or 16 bit
  - Speed - to 80 KHz
  - Channels - to 256
  - Remote A/D for maximum signal clarity
  - Timer counter with 1 microsecond resolution
- Plus much more!**

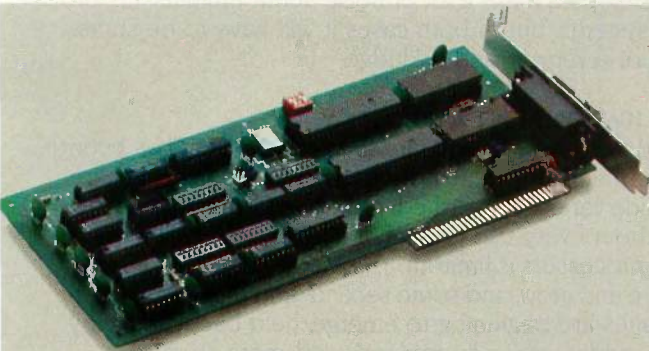

### IEEE488 Interface™

- 3 different addressing modes
- Operates as talker, listener or controller
- DMA controlled transfers
- Control up to 15 instruments

Scientific Solutions' Lab Master and IEEE488 Interface are used by more scientists and engineers worldwide than any other brands!

**Don't forget the other top-selling products now sold through Scientific Solutions:**

- Lab Tender™ - Economical 8 bit A/D - D/A
- DADIO™ - High speed 12 bit D/A
- Base Board™ - 96 I/O lines with opto options
- Stepper Motor Controller™ - Control 1-2 steppers

**And more!**

**For the location of your nearest Scientific Solutions dealer, call 216-349-4030.**

S C I E N T I F I C



S O L U T I O N S

Scientific Solutions, Inc., 6225 Cochran Road, Solon, Ohio 44139, 216-349-4030. Telex: 510,100,9900  
Scientific Solutions International, Inc., Chaussee de la Hulpe 181, 1170 Brussels, Belgium. Telex: 20256

## COMPETITIVE EDGE

631 S. Main Street, Plymouth, MI 48170 — 313-451-0665  
**Compupro®, LOMAS, EARTH, TELETEK**

### S-100 CIRCUIT BOARDS

Compupro 286 CPU	\$671	Lomas 286 8MHz	\$821	Color Magic 32K	\$556
Compupro SPU Z™ 8MHz	296	Lomas 8086	420	Lomas 10MHz 8086	520
Compupro 8085/88™	263	Lomas Octaport™ 8 Serial	320	Lomas 4 serial	200
Compupro Disk 1A™	371	Lomas LDP™ 72	206	Lomas Color Magic™ 16K	476
Compupro Disk 3™	446	Lomas 256K Dram	358	Lomas MSDOS™ 2.11	200
Compupro Ram 22™	446	Lomas 512K Dram	448	Compupro MDrive H™ 512K	446
Compupro Ram 23™	188	Lomas Ram 67™	599	Compupro I/O 3 8 port	371
Compupro Ram 23 128	263	Lomas Hazil™	244	Teletek SBC 16MHz 128	375
Compupro CPU Z™	189	Thunder 186™	895	TurbodOS™ for Teletek	650
Compupro CCP/M™ 816*	300	Lomas CCP/M™ 86™	280	Lomas 2 Megabyte	
System Support One™	263	Compupro I/O 4	263	Ram (2048K)	just \$821
Teletek HD/	375	Systemmaster II*	795	Earth Turbomaster	\$795
Teletek Systemmaster*	495			I.T. 1024x1024 Bdr	\$995

**Illuminated Technology 1024x1024 Board for Autocad™ \$995.**

**Earth Computer TURBO SLAVE 18MHz 128K \$395.**  
 Turbo Slave I runs with Teletek, North Star Horizon, Advanced Digital and Others under Turbodos™

### SYSTEMS

Compupro 85/88, 256K CDOS, SS1, I/O 4, 2.96TPI DRS, 15 Slot	\$3095
Compupro 85/88, 256K CDOS, SS1, I/O 4, 1.96TPI, 20MB, 15 Slot	\$4295
Compupro 286, SPUZ, 40MB, SS1, I, 3, CDOS, 15 Slot, 30 amp P/S	\$6995
286, 1024K, 20MB, AutoCad 2 System — Ready to Run	\$8395
Lomas 286, 1024K, 20MB HD, 1-5", CDOS, 6 SERIAL, 2 Par, 15 Slot	\$4995
Lomas Thunder 186, 256K, 20 MB HD, 1-5", CDOS, 4 Slot	\$2895
Teletek 8MHz Master, 4-8MHz 128K SLVS, 1-5", 20 MB HD, TDOS	\$4995
AT CLONE 286, FAST 20 MB HD, enhanced 512K	\$2995
AT CLONE, 10MHz 286, 1024K, FAST ZOMB, mono card	\$3695

### UPGRADE YOUR IBM® PC™ III

MONITORS	GRAPHIC BOARDS	HARD DRIVE KITS
Amitek 310A	Everax Elite	PC 10MB PC
Princeton Max 12 Amber	Hercules™ Color Card	PC 21MB PC
Princeton Color HR-12	Tecmar Graphics Master	AT 21MB AT/FAST
Princeton Color SR-12	Enhanced Graphics Clone, 256K	AT 36MB AT
<b>286 ACCELERATOR</b>	PBS Color Card w/parallel	AT 70MB AT
Turbo Accel-286 8MHz	Hercules Compatible MONO	AT 80MB AT
<b>MULTI-FUNCTION BOARDS</b>	<b>FLOPPY DRIVES</b>	AT 119MB AT
PC-PBS 7 Pack 8K	Mitsubishi 485A-AT	PC Floppy Controller
PC-PBS 7 Pack 384K	Mitsubishi 96 TPI	AT SER/POR
ATMF3000 DVS, 3MB V/OK	5" 2DD50 Color Diskettes	

### ALL PRICES SUBJECT TO CHANGE AND STOCK ON HAND

Compupro is a Registered Trademark of Viasyn, CPU Z, Disk 1A, Disk 3, Interfacer 3, Interfacer 4, CPU 286, CPU 8085/88, System Support 1, MDRIVE-H, Ram 22, Ram 23 are trademarks or registered trademarks of Viasyn. CPM 2.2, CCP/M, are registered trademarks of Digital Research Inc. MSDOS is a registered trademark of Microsoft. Systemmaster & Systemmaster II are registered trademarks of Teletek Enterprises. Turbodos is a registered trademark of Software 2000. Hercules is a trademark of Hercules. IBM & AT are trademarks or registered trademarks of International Business Machines. AutoCad 2 is a registered trademark of AutoDesk, Inc.

## ACCORDING TO WEBSTER

ple and too little money. The Amiga is a complex piece of hardware; writing ROM and OS routines to take advantage of that complexity isn't easy, and the gaps often show. I do not like AmigaDOS, which is a modified version of Tripos, a 68000-based OS developed in England (see the February BYTE U.K., page 321). It is nonstandard, ignoring common microcomputer conventions like Control-O/Control-S, wild cards, and so on. The command-line interpreter is simply a little routine to execute programs, so that even common commands like DIR (show directory) and CD (change directory) require it to go back to the boot disk to load in a DIR or CD program. Intuition, a window-based user interface, works nicely but will not show you any file on a disk that does not have an icon explicitly defined for it; in other words, each file must have a corresponding <filename>.INFO with the icon definition inside for you to be able to open, move, delete, or execute the file; otherwise, you have to use the command-line interpreter.

If there is a bright point to the Amiga's system software, it is the multitasking Kernel, which makes everything you do inherently multitasking; you can, for example, edit a file while compiling another one. Since the Kernel exists below AmigaDOS and Intuition, no special provisions need to be made for handling the multitasking. Mac and ST developers make a lot of noise about multitasking on their systems, but in both cases it will have to be something of a retrofit and a kludge.

### APPLICATION SOFTWARE

The Mac has the advantage, simply because it has been out so much longer than the other two machines. There is a wide variety of polished, professional applications for just about every use (though, curiously, the selection of word processors is limited). The Mac market continues to mature and grow, and some second- and third-generation packages are beginning to emerge, held back mostly by the previous limits on memory and mass storage.

The ST has an impressive number of titles available right now, as demonstrated by the large and crowded Atari booth at COMDEX, probably more so than the Mac had four months after its release. Most though, are geared toward development, entertainment, and personal productivity; few slick, powerful programs have come forth, simply because they take longer to write and because the ST's memory is being eaten up by TOS/GEM, which is not yet in ROM. Also, I suspect that most business software houses don't see the ST as a business machine, so they haven't put any effort into developing programs for it.

Few titles are currently (November) shipping for the Amiga. This is so for a couple of reasons. First, the Kernel and system software have been changing continually all year, and many developers have had to do significant rewrites to accommodate each change. Version 1.1 of the system software is due to be released within a few days, and a number of firms plan to start shipping titles as soon

(continued)

# Bluestreak™

Quality Communication Software  
 for the IBM and Compatibles

**NOW! — VERSION 1.1 with more features.**

- **TWO TERMINALS IN ONE** — Bluestreak supports simultaneous independent terminal sessions over COM1 and COM2.
- **EMULATES MOST POPULAR TERMINALS** — Emulations include IBM 3101, VT100, VT52, FREEDOM 100, ADDS REGENT 25, ADDS VIEWPOINT, HAZELTINE 1500, TELEVIDEO 920, ADM 3A, DG DASHER 6053 AND MIME 340, BLOCK MODE EMULATIONS — IBM 3101 and Televideo 925. Special requests considered.
- **CHARACTER TRANSLATION** — Set up a user table or use the built in ASCII/EBCDIC table.
- **EXTENSIVE SETUP FACILITIES AND OPERATIVES** — Hardware and software flow control, Baud rates to 9600, file receive and file send control utilities, XMODEM, keyboard definition, character filtering.
- **TELECOMMUNICATION SUPPORT** — Modem functions using the AT command set with Phone directory.
- **DOS ACCESS** — Enter DOS with a single keystroke. Return with terminal session still intact on COM1, COM2 or BOTH.

#### BLUESTREAK PLUS — \$89.95

All of Bluestreak plus a Trigger function to command operation from the remote computer. Also "HOOKS" to run user programs within the Bluestreak environment. Source examples in C, Turbo Pascal and Basic included.

#### DATA EXTRACTION MODULE — \$149.95

A standalone program which extracts data items from captured files based on user selected criteria. The data is placed in DIF, WKS, WRK or SDF files.

#### BLUESTREAK 3101 AND 925 — \$89.95

Full BLOCK MODE emulations.

**BLUESTREAK — STILL ONLY \$52.95 Postpaid**

ORDERS OR INFORMATION, CALL TOLL FREE

**(800) 541-2255, AT THE TONE PRESS 677-1539**

MasterCharge, Visa, Check or Money Order  
**30 DAY MONEY BACK GUARANTEE**

**LANG-ALLAN, INC.**

2431 ALOMA AVENUE, SUITE 103  
 P.O. BOX 1341, WINTER PARK, FL 32790  
 (305) 677-1539



**ORDER  
LINE  
800-354-7330**

**LOWEST PRICES**

**NO SURCHARGE  
ON BANK CARDS**

**SILICON SPECIALTIES**

**HARDWARE**

**PRINTERS**

Anadex All Models	Save
Brother All Models	Save
Cannon Laser Printer	\$2099
Citizen MSP-10	\$255
MSP-15 or MSP-20	\$349
MSP-20	\$319
MSP-25	\$485
Datsouth All Printer Models	Save
Diablo D-25	\$549
635	\$1079
Other Printer Models	Save
Epson All Printer Models	Save
Juki 6000	\$169
6100	\$349
6300	\$679
NEC 2010, 2015, 2050	\$629
3510, 3550, 3515, 3530	\$749
8810, 8830, 8850	\$1079
P2, P3	Save
Elit 360	\$399
Elit 370	\$389
Okidata All Printer Models	Save
Panasonic 1091	\$235
1092	\$309
1093	\$419
KXP3151	\$399
Star Micronics	Save
All Printer Models	Save
Silver Reed	Save
EXP400 Parallel	\$205
EXP500 Parallel or Serial	\$279
EXP550 Parallel or Serial	\$389
EXP770 Parallel or Serial	\$699

**BOARDS**

AST Advantage	\$389
Six Pack Plus	\$219
Everex Boards	Save
Hercules Color Card	\$149
Graphic Card	\$299
Intel	Save
Above Boards	Save
Paradise Modular Graphic 06-1	\$259
Five Pak	\$119
Quadram	Save
Quadlink	\$325
Tec Mar Graphics Master	\$445
Captain No Memory	\$155

**COMPUTERS**

Compaq All Models	Save
Zenith	Save
Z-158 All Models	Save
Z-138 All Models	Save
Z-148 All Models	Save
Z-171	Save
Z-200	Save

**VIDEO TERMINALS**

IBM 3161 & 3163 Series	Save
Qume QVT Green 101	\$299
QVT Amber 101	\$314
Wyse 30	\$299
50	\$419
75	\$559
Wyse 85	\$439
Wyse 350	\$859
Zenith Z-22	\$455
Z-29	\$559
Z-49	Save

**DISK DRIVES**

Alpha Omega Turbo 10	\$529
Turbo 20	\$529
Turbo 30	\$729
Haba	Save
Macintosh 800K	\$409
Iomega	Save
Bernoulli Boxes for IBM	Save
Bernoulli Boxes for Macintosh	Save
Paradise Macintosh Hard Disk	Save

**MODEMS**

AT&T	Save
4000 External	\$309
Anchor Automation	Save
Anchor Express	\$229
Mark XII	\$229
Hayes Smartmodem 300 Baud	Save
Smartmodem 1200 Baud	Save
Smartmodem 1200B (IBM)	Save
Smartmodem 2400 Baud	Save
Micromodem 11E (Apple)	Save
Prometheus All Models	Save
US Robotics Courier 2400	\$389
Password 1200	\$189
Microlink 2400	\$389

**KEYBOARDS**

Keytronics 5151	\$159
-----------------	-------

**DISKETTES**

Maxell MD-2 Plastic Box (Qty 100)	\$125
MD-20 Plastic Box (Qty 100)	\$158
Sony MD/2 (Qty 100)	\$120

**PLOTTERS**

Enter Sweet-P600	\$749
Epson Hi-80	Save

**SOFTWARE**

**IBM PC and 100% Compatibles**

**WORD PROCESSORS**

Lightening	\$52
Leading Edge Word Processor	\$50
Leading Edge W/P with Spell & Mail	\$105
Microsoft Word 2.01	\$229
Multimate 3.3	\$206
PFS-Write	\$78
Wordstar w/Tutor	\$169
Wordstar Pro Pack	\$239

Word Perfect (Ver.4.1)	\$199
Wordstar 2000	\$239
Wordstar 2000 Plus	\$285

**GRAPHICS**

Chromaster	\$206
Turbo Graphics Tool Box	\$28
Diagram Master	\$190
Energraphics	\$165
Energraphics w/Platter Option	\$214
Microsoft Chart	\$175
PC Draw	\$203
PC Draw Light Pen	\$104
PC Point w/Mouse	\$123
PC Mouse w/Dr. Halo II	\$107
PFS Graph	\$78
Printmaster	\$30
Signmaster	\$135

**LANGUAGES**

C Compiler (Microsoft)	\$235
Fortran Compiler (Microsoft)	\$209
Macro Assembler	\$89
Pascal Compiler (Microsoft)	\$178
Turbo Pascal 3.0	\$35
Lattice C Compiler	\$229
Run C Interpreter	\$85
Quick Basic	\$59
Turbo Tool Box	\$28

**UTILITIES**

1 DIR	\$48
Cajoy II PC	\$19
Norton Utilities 3.1	\$49
Sidekick	\$28
Sidekick (Unprotected)	\$43
Sidekicks	\$36
Superkey	\$35
Printworks	\$36
Sidekick - Superkey (Bundle)	\$65

**TRAINING**

Flight Simulator	\$30
Typing Instructor	\$29
Typing Tutor III	\$29

**MONEY MANAGEMENT**

Dollars & Sense w/Forecast	\$95
Tobias Managing Your Money	\$95

Gem Collection	\$115
Gem Desktop	\$29
Gem Draw	Save

**PROJECT MANAGEMENT**

Harvard Total Project Manager	\$269
Microsoft Project	Save
Super Project	\$182
Timeline 2.0	\$249

**COMMUNICATIONS**

CampusServe Starter Kit	\$19
Crosstalk XVI	\$94
PFS Access	\$78
Remote	\$94

**INTEGRATIVE SOFTWARE**

Enable 1.1	\$329
Framework II	Save
Smart Software System	Save
Symphony	Save

**SPREADSHEETS**

Lotus 1-2-3	Save
Multiplan	\$114
Spreadsheet Auditor 2.0	\$83

Supercalc 3 (Ver.2.1)	SAVE
-----------------------	------

**DATA BASE MANAGEMENT**

Cornerstone	\$255
dBase II	Save
dBase III	Save
Nutshell	\$50
PFS:File	\$78
PFS:Report	\$70
Quickcode	\$139
QuickReport	\$139
Extended Report Writer	\$80
Think Tank	\$93
Clipper	\$355
Knowledgegen II	\$299
Knowledgegen Upgrade Kit	\$152
Powerbase	Save
(New Ver. Reb. 320K)	\$205
Rellex	\$52

**R:Base 5000. \$335**

**TOSHIBA  
PRINTERS  
SPECIAL**

321 Parallel	SAVE
321 Serial	SAVE
341 Parallel	\$829
341 Serial & Parallel	\$879
351 Serial & Parallel	\$985

**MONITORS**

Amdex All Monitors	Save
NEC All Monitors	Save
Princeton Graphics	Save
Taxan All Models	Save
Zenith All Models	Save

Inquiry 308 for MS DOS Products. Inquiry 309 for all others.

Prices reflect 3% to 5% cash discount. Product shipped in factory cartons with manufacturer's warranty. Please add \$10.00 per order for UPS shipping. Prices & availability subject to change without notice. Send cashier's check or money order...all other checks will delay shipping two weeks.



**SILICON SPECIALTIES**  
2034 WEST SOUTHERN  
MESA, ARIZONA 85202  
602-969-0909

CV35-186



# BetterBASIC, Version 2.0

## Runs Existing BASIC Programs

*"I write a lot of complicated mathematical models for air pollution control. I have used FORTRAN for its speed, and BASIC for its text handling and graphics, but now I use BetterBASIC for all three. Most of the programs require dozens of different parameters, and BetterBASIC's modular structure allows me to have common routines resident while designing the input forms.*

*"I have recommended BetterBASIC to my coworkers, and I recommend it to you."*

Phil A. Lawless, Ph.D. • Research Triangle Park, NC

### ACCESS FULL MEMORY—

BetterBASIC accesses the full memory of the computer enabling you to overcome Microsoft's 64K barrier.

### INTERACTIVE

**COMPILER**—BetterBASIC compiles to an intermediate code giving you five to six times the speed of traditional BASICs. There is immediate feedback on line entry.

**COMPATIBLE**—Version 2.0 of BetterBASIC is GW-BASIC, PC-BASICA compatible when running on IBM

PCs. BetterBASIC is easy to learn because the syntax is the same.

**STRUCTURE**—Create well-organized programs using procedures and functions that are easily identified and understood.

**NOT COPY PROTECTED**—Install BetterBASIC on your hard disk. BetterBASIC is licensed to the programmer, so you can compute at work and at home using the same copy of BetterBASIC.

**USER DEFINED KEYWORDS**—The BetterBASIC language can be extended by adding your own procedures and functions to the language as keywords.

**RUNTIME SYSTEM**—Creates stand-alone EXE. files. Developers can distribute their programs written in BetterBASIC without royalties.

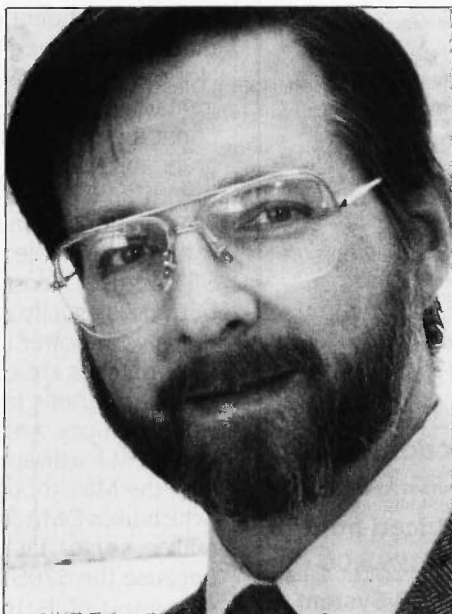

**SAMPLE DISK**—Contains a tutorial, a demo, and allows you to use an abbreviated form of BetterBASIC. It also contains a 60 page on-line mini manual.

**AND MORE**—Such as DOS and BIOS ROM calls, Chaining, Overlays, Local and Global Variables, Recursion—Graphics and Windows—You can define up to five windows. Optional 8087/80287 Math Chip Support.

**LIBRARIES**—Write reusable code.

**TECHNICAL SUPPORT**—

Available to all registered users.

**BetterBASIC** Runs on IBM PC, XT, AT and all IBM-compatibles. Ask your local dealer for BetterBASIC or call 1-800-225-5800.

In Canada call 416-469-5244. Also available for the Tandy 1000, 1200 and 3000 at Tandy/Radio Shack stores.

### PRICES:

Better BASIC	\$199
8087/80287 Math Module	\$99
Runtime System	\$250
Sample Disk with Tutorial	\$10

*Better*  
**BASIC.**

**Because It's The Best.**

**Summit Software Technology, Inc.™**

Inquiry 329

106 Access Road, Norwood, MA 02062

MasterCard, Visa, Checks, Money Order, C.O.D. accepted and P.O. on approval.

BetterBASIC is a registered trademark of Summit Software Technology Inc.

IBM PC, XT, AT, are registered trademarks of International Business Machines Corp. Tandy is a registered trademark of Tandy Corp.

(If you're using BetterBASIC and would like to be featured in one of our ads, please write to the Director of Advertising at Summit.)

# Little Board™/186.... \$495

High Performance, Low Cost PC-DOS Engine

Boots IBM PC-DOS  
(not included)

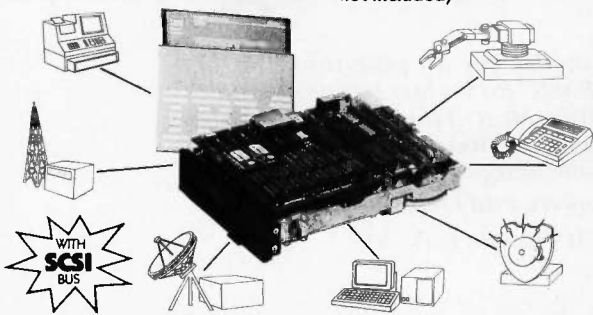

- Three times the COMPUTING POWER of a PC
- Data and File Compatible with IBM PC, runs "MS-DOS generic" programs
- 8 MHz 80186 CPU, DMA, Counter/Timers, 128/512K RAM zero wait states, 16-128K EPROM
- Mini/Micro Floppy Controller (1-4 Drives, Single/Double Density, 1-2 sided, 40/80 track)
- 2 RS232C Serial Ports (50 -38,400 baud), 1 Centronics Printer Port
- Only 5.75 x 7.75 inches, mounts directly to a 5-1/4" disk drive
- Power Requirement: +5VDC at 1.25A, +12VDC at .05A; On board -12V converter
- SCSI/PLUS™ multi-master I/O expansion bus
- Software Included:
  - PC-DOS compatible ROM-BIOS boots DOS 2.x and 3.x
  - Hard Disk support
- OPTIONS:
  - Expansion board with:
    - 128 or 512K additional RAM
    - 2 Sync/Async RS232C/422 serial ports
    - Battery backed Real Time Clock
    - 8087 Math Co-Processor
    - Buffered I/O Bus
  - STD Bus Adapter
  - Utilities source code
  - TurboDOS / Networking

## BOOKSHELF™ Series 200

Fast, compact, high quality, versatile PC-DOS system

Three times the COMPUTING POWER of a PC

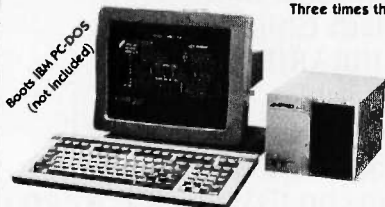

Priced from  
**\$1295.00**  
**10MB System**  
**Only \$1945.00**

- Data and File compatible with IBM PC-DOS 2.x and 3.x
- Runs "MS-DOS generic" programs (Dbase II, Multiplan, Wordstar, Supercalc 2, Turbo Pascal, Fortran 77, Microsoft C, Lattice C, IBM Macro Assembler, Intel compilers & tools, GW Basic, etc.....)
- Works with any RS232C ASCII terminal (not included)
- Compact 7.3 x 6.5 x 10.5 inches, 12.5 pounds, all metal construction
- Based on Little Board/186
  - 512K RAM, no wait states
  - Two RS232C serial ports
  - One Centronics printer port
- One or two 360 Kb floppy drives
- 10MB internal hard disk drive option

- Software Included:
- PC-DOS Compatible ROM-BIOS boots DOS 2.x and 3.x
  - Hard Disk Support
  - T/Maker III — Word processing, spreadsheet, relational database, spelling checker, and data encrypt/decrypt

- Expandable:
- Floppy expansion to four drives
  - Hard disk and tape expansion
  - SCSI/PLUS™ multi-master I/O expansion bus

### DISTRIBUTORS

ARGENTINA: FACTORIAL, S.A., (1) 41-0018, TLX 22408 BELGIUM: CENTRE ELECTRONIQUE LEMPEREUR, (041) 23-4541, TLX 42621 CANADA: DYNACOMP COMPUTER SYSTEMS LTD., (604) 872-7737 ENGLAND: QUANT SYSTEMS, (011) 253-8423, TLX 946240 REF: 19003131 FRANCE: EGAL\*, (1) 502-1800, TLX 620893 SPAIN: XENIOS INFORMATICA, 593-0822, TLX 50364 AUSTRALIA: ASP

MICROCOMPUTERS, (613) 500-0628 BRAZIL: CNC-DATA LEADER LTDA., (41) 262-2262, TLX 041-6364 DENMARK: DANBIT, (03) 66-20-20, TLX 43558 FINLAND: SYMMETRIC OY, (0) 585-322, TLX 121394 ISRAEL: ALPHA TERMINALS, LTD., (3) 49-16-95, TLX 341667 SWEDEN: AB AKTA, (08) 54-20-20, TLX 13702 USA: CONTACT AMPRO COMPUTERS INC., TEL.: (415) 962-0230 TELEX: 4940302

IBM®, IBM Corp.; 80186®, Intel, Corp.; TurboDOS®, Software 2000, Inc.; Dbase II®, Ashton-Tate; Wordstar®, Micropro, Inc.; Supercalc 2®, Sorcim, Inc.; Turbo Pascal®, Borland, Intl., Inc.; Microsoft C®, GW Basic®, Multiplan®, Microsoft, Inc.; Lattice C®, Lattice, Inc.

**AMPRO**  
COMPUTERS, INCORPORATED

67 East Evelyn Ave. • Mountain View, CA 94041 • (415) 962-0230 • TELEX 4940302

## ACCORDING TO WEBSTER

aside for expansion hardware, so that if developers follow the protocol given, the system will configure itself when booted, avoiding the need for DIP (dual in-line package) switches and so on.

One of the best examples of the Amiga's open architecture comes from Computer System Associates, a firm that makes a board for 68000 development systems. The board, which plugs into the 68000's socket, has a 68020 processor and a 68881 floating-point processor. Vic Wintriss, the president of CSA, bought an Amiga, opened the machine, removed the 68000, and plugged in his board. Not only did the Amiga work fine, but Vic says he got an immediate 70 percent increase in speed, which doesn't count the floating-point hardware. Similar attempts to upgrade the Mac have failed; I don't know if anyone has tried it with an ST.

As mentioned, neither the Mac nor the ST is designed to be expandable: the Mac, because of philosophy; the ST, because of cost. It is possible to expand RAM in both, but this is usually at the cost of your warranty and sometimes your power supply. ROM changes and system-software patches are often required as well, and some application programs may not work or may not recognize the extra memory. And neither is really set up for significant non-RAM hardware expansion. The ST does have an edge over the Mac, though, because of both the hard-disk port (which uses DMA for speed) and the cartridge port (which makes some data and address lines available). Also, because the 520ST is not designed for hardware expansion, most of its 16-megabyte address space is available for RAM, while the current Mac is pretty much limited to 4 megabytes.

## TECHNICAL MANUALS

The Amiga wins here easily. The seven technical manuals—more than 2000 pages, all professionally printed and bound—are the best I've seen for a new computer and may well be the best I've ever seen for any computer. They are well written, well organized, and amazingly complete, covering hardware, Kernel routines, AmigaDOS, and Intuition. Addison-Wesley is bringing out mass-market versions of the manuals; the ones I have were put together by Commodore, which makes the feat even more impressive.

*Inside Macintosh* is, well, the manual we all know and love. And hate. It is a large collection of technical notes about various aspects of the Mac's system software, with almost no mention of, nor significant information about, the hardware. There is little overall organization to the manual; however, most sections follow a consistent format that makes it easy (once you've found the right section) to dig out what you need. However, as Kathe Spracklen (coauthor of *Sargon II*) once observed, each section (there are 30 or so) requires that you understand all the others, which can make your initial exposure to *Inside Macintosh* a challenging experience in intellectual bootstrapping. I have

(continued)

# SOLVE PROGRAMMING PROBLEMS THE WAY YOU THINK. PURE AND SYMBOL.

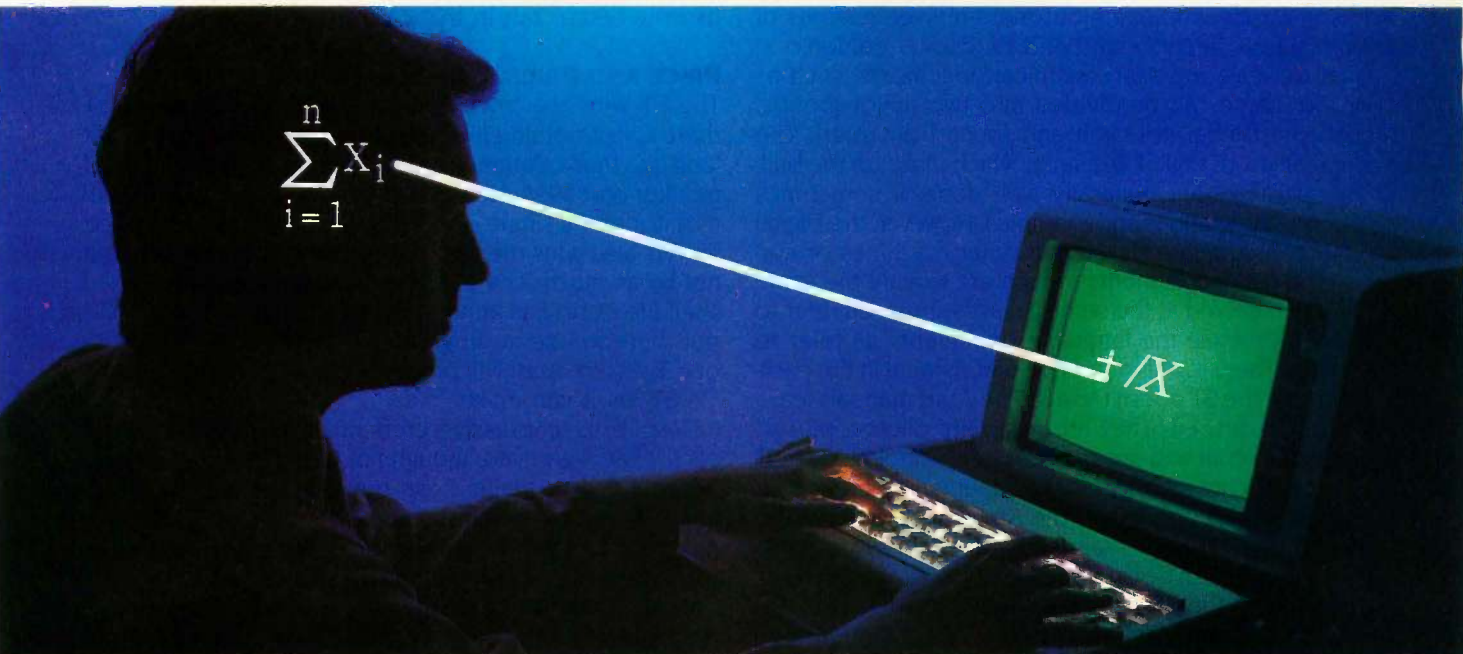

## *Introducing the new APL★PLUS® PC System, Release 5.0*

The shortest distance between two points is a straight line. But unfortunately, that's not the case in programming.

Most languages require you to go through an enormous number of steps before an idea becomes reality.

That's why the APL★PLUS PC System is such a dramatic and exciting software tool for serious PC programmers and application developers.

Instead of requiring you to learn—and write—long-winded and complicated programs, APL is based on your instinctive ability to deal in symbols. And once you begin using APL's quick notations, you'll find it the ideal programming

environment for all your application needs.

The incredible shortcuts you get with APL will let you spend less time on drudgery and more time creating. Intricate calculations and modeling on PC's are a snap.

The Release 5.0 version features:

- multi-window, full-screen editing
- graphics primitives, now with EGA support
- spreadsheet-like numeric editing
- fast Assembler library
- built-in terminal mode
- and report formatting.

Plus concise notation for programs like sorting, matrix inversions, string searching,

and more. And the complete package price is just \$595 with major credit cards accepted.

Act now, and we'll send you a free Convincer Kit. Contact your local dealer, or call 800-592-0050 (in Maryland, call 301-984-5123) to order your system, or for more information about our other APL★PLUS products—from our UNIX™ version to the new streamlined Pocket APL™.

Or write STSC, Inc., Software Publishing Group, 2115 East Jefferson St., Rockville, MD 20852.

You'll see how symbol PLUS★WARE products are to use, the very first time you use them.



### **Problem-solving at the speed of thought.™**

**STSC**  
A Contel Company

APL★PLUS PC System requires 256K and DOS 2.0 or later. A soft character set can be used for computers with IBM compatible graphics board. A character generator ROM or software is included for the IBM PC or selected compatibles.  
PLUS★WARE and Pocket APL are trademarks of STSC, Inc. APL★PLUS is a registered trademark of STSC, Inc. UNIX is a trademark of AT&T Bell Laboratories.

both the original loose-leaf and the phone book editions. Addison-Wesley is bringing out mass-market versions of *Inside Macintosh* in softbound and hardcover editions.

Then we have the Atari technical documents, such as they are. These can be divided into two major groups: those from Digital Research and those from Atari. The documents from Digital Research, which make up the bulk of the package, are generally well done, if sometimes sparse on explanations and examples. However, the Digital Research documents all refer to other machines or systems. The GEM documents—which are exactly the same as those I received at the seminar last spring—all refer to the IBM PC, while the language documents all refer to CP/M-68K. There is, in fact, a CP/M-68K manual in the package, though the ST doesn't use it. The Atari manuals leave much to be desired. They are generally photocopies of dot-matrix output and are sparse and incomplete. The ST hardware documents, including schematics, are about 15–20 pages; by comparison, the Amiga hardware manual is more than 300 pages (and, of course, the Mac hardware manual doesn't exist). The DOS, BIOS, and "Line A" documents for the ST are better than its hardware documents but still represent less than 300 pages (more than 400, if you include the BIOS listing), while the Amiga ROM

Kernel manual alone is 1500 pages long. More isn't necessarily better, but in this case it definitely is.

**PRICE AND PRICE/PERFORMANCE**

The ST wins the price comparison by a wide margin—there is just nothing like it for less than \$1000. It was not long ago that a Commodore 64 with a disk drive and color monitor cost \$995. Now you can buy a 520ST with an RGB monitor and a single-sided disk drive for the same price. The ST also wins the price/performance comparison, but not by as much. The 520ST is a closed box with a fixed shelf life; Atari has announced its successor, the 1040ST, but there will be no upgrade path to it, at least no easy one. Even so, Atari will probably continue to sell as many 520STs as it can make.

Despite its impressive credentials, the Amiga is still somewhat overpriced, though not (in my opinion) as badly as most people claim. I can buy a \$1295 Amiga—which has 256K bytes of memory and a double-sided disk drive holding 876K bytes—take it home, hook it up to my TV set or a spare color monitor (using RF, composite, or RGB), boot up BASIC, and have more than 40K bytes of memory available. To do the same with a 520ST, I would have to

(continued)

**IBM PC AT performance!  
PCjr price!**

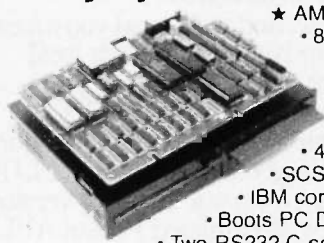

- ★ AMPRO Little Board/186 \$419
  - 8 Mhz 16 Bit 80186 CPU
  - 128 512K RAM; 1 MB w add-on board
  - 128K EPROM – 2 Byte Wide sockets
  - 4 Drive floppy disk controller
  - SCSI (SASI) hard disk interface
  - IBM compatible ROM-BIOS
  - Boots PC DOS 2.x. 3.x
  - Two RS232 C serial ports

- Parallel printer port
- Expansion board w 512K RAM. 8087-2. Clock. 2 serial ports. RS422 port

- ★ AMPRO Little Board Plus \$289
- Same as Little Board 186 except 4 Mhz Z80A (8 Bit) CPU 64K RAM, 4 – 16K EPROM; w/ CP/M 2.2, ZCPR3

- ★ AMPRO Little Board (the original) \$239
- Same as Little Board Plus except no SCSI, 4K EPROM; w/ CP/M 2.2, ZCPR3

- ☆ 25 different enclosures w/power supplies, cables, etc. from \$99
- ☆ Floppy/Winchester drives from \$89
- ☆ XEBEC 4000 OWL 1/2 Ht 10Mb drive w/ integral controller \$595
- ☆ Terminals: Wyse, Qume, Kimtron from \$395
- ☆ Power supplies, cables, connectors in stock

Complete technical support. Assembled systems available. Write or call for free catalog. Most orders shipped same day.

VISA, MasterCard, Money Order, C.O.D. Checks allow two weeks. Purchase orders and bids welcome. Prices F.O.B. Prairie View, IL.

IBM PC AT, PCjr, PC DOS are trademarks of International Business Machines Corporation. XEBEC OWL is a trademark of XEBEC, Inc.

**DISKS PLUS** INC  
15945 West Pope Blvd.  
Prairie View, IL 60069  
(312) 537-7888

**ONE STOP CABLE SOURCE**  
Our cables are custom manufactured with the highest quality materials and are guaranteed to the original buyer for life!

CABLE DESCRIPTION:	ORDER #	PRICE
• IBM-PC & Compatibles Shielded Parallel Printer Cable	1103-8MM 1103-12MM	\$16.95 \$21.95
• Centronics 36 Pin Parallel Cable W/Bail Lock Connectors.	3036-6MM 3036-10MM	\$22.95 \$26.95
Extension Type	{ 3036-6MF 3036-10MF	\$23.95 \$27.95
• RS-232 Type-DB-25 Cable W/Screw Lock Connectors.	3025-6MM 3025-10MM	\$18.95 \$22.95
Extension Type	{ 3025-6MF 3025-10MF	\$19.95 \$26.95
• Commodore Serial 6 Pin DIN Connector	3006-5MM 3006-8MM	\$ 9.95 \$12.95
Extension Type	{ 3006-5MF 3006-8MF	\$10.95 \$13.95
• AMIGA-Parallel Printer Cable	3040-6MM 3040-10MM	\$17.95 \$21.95

IMPORTANT: — 6MM designates a 6 ft. male to male type  
— 10MF designates a 10 ft. male to female type, etc.  
Order only the exact numbers above—we do not stock others.

**INTERFACES:**

• APPLE II, IIe, II + Parallel Printer Interface "PC Ware" W/O Graphics	1104	\$76.00
• APPLE IIc "Printer Jack" Parallel Printer	1109	\$79.00
• C-64 & C-128 Printer Interface-"G-WIZ"	1105	\$46.95

**AB SWITCHES:**

• ABC-3 to 1 Centronics Switch	4036	\$65.95
• ABC-3 to 1 RS232 (DB-25) Switch	4025	\$60.95

2 Week Money Back Guarantee — 1 Year Warranty  
Send Order to:

APROTEK 1071-A Avenida Acaso, Camarillo, CA 93010

TECHNICAL INFO: 1- (805) 987-2454

OR CALL OUR TOLL FREE ORDER LINES TODAY:

1- (800) 962-5800 USA or 1- (800) 962-3800 CALIF.

Add: \$3.00 Shipping. Listed are cash prices. VS & MC add 3%.

# High technology doesn't get any higher!

From the minds of MASTERVOICE. Introducing Butler-In-A-Box. The world's first environmental control system that *responds to voice commands*. The first with A.I.R. (Artificial Intelligent Recognizer); a futuristic software program which makes it a reality.

## Replace pushbutton control with voice activated magic!

Butler-In-A-Box replaces old-fashioned pushbutton control systems making them obsolete. At the sound of your voice, he carries out your tasks. All you have to do is ASK! From the comfort of your favorite easy chair, up to twenty feet away.

## Control all of your electronic devices at the sound of your voice.

Butler-In-A-Box puts all of your electronic devices, high tech or not, under your voice control. He will dial your phone and answer incoming calls without ever touching him. He turns your TV, stereo, heating systems and other electronic devices on and off, even dims lights. All of this instantly or at the predetermined times you desire.

## Computerized protection against intruders.

Butler-In-A-Box has a unique, built-in infrared sensor and *intrusion detection* system that guards your home and alerts you to uninvited guests. When he detects intruders, he will *speak*, and *ask* them to identify themselves. Only you can verbally command him to turn off his intrusion detection system, because he is trained to recognize only your voice. He is also capable of interfacing with your existing home security system, so it can be activated by your voice.

## Speaks and understands any language.

Your Butler-In-A-Box is smart enough to call you by name and answer "intelligently" with a variety of random responses — in any language you wish! Even with an *accent*.

## Easy to install and use.

Your Butler has been designed with you in mind. He's so simple to install and use you won't believe it. Complete with instructional audio cassette and easy to follow written instructions. And, *no special wiring* of your home is required.

Experience the technology of tomorrow, today! Put Butler-In-A-Box to work for you.

Order direct or send for our free brochure by just lifting a finger, (possibly for the last time), and dialing our toll-free hot-line: 1-800-O-BUTLER. (In California) 1-(714) 952-7056. Or write:

Future Systems Marketing  
5067 Cumberland Drive  
Cypress, CA 90630



**MASTERVOICE**  
BUTLER IN A BOX

**Future Systems Marketing** — Tomorrows dreams, today's reality.

Inquiry 223 for End-Users. Inquiry 224 for DEALERS ONLY.

© 1985 Mastervoice, Ltd.



# RS-422 CONVERTER TO/FROM RS-232

- Up to 100 kilobaud at 4000 feet
- Up to 3 miles at 1200 baud
- Supports eight signals
- Doubles as a high speed short haul modem
- All handshake signals and clock
- Write or call to order or for more information

## TELEBYTE

A PUBLIC COMPANY

Remark Division • Telebyte Technology, Inc. • 270 E. Pulaski Rd.  
Greenlawn, NY 11740 • (516) 423-3232 800-835-3298

### ACCORDING TO WEBSTER

*There is no clear winner.*

*Each machine has its*

*strengths and its weaknesses.*

spend \$1095, which would get me the nice Atari RGB monitor (since the ST can't use a TV set or a composite color monitor), a double-sided drive (holding only 709K bytes, or about 81 percent of the Amiga's drive), and 512K bytes, of which only about 256K bytes is available since GEM/TOS is not in ROM yet. (However, I have just had late word that Atari has started shipping EPROMs with GEM/TOS to developers and that ROMs for end users should be available shortly. That will make a big difference in the amount of memory available for applications.) And while I would like to see the Amiga down at, say, \$995, Commodore has little incentive right now to lower the price since—like Atari—it's selling all it can make.

I'm not sure what the Mac's official list price is, but the street price right now for a 512K-byte single-drive (400K bytes) Mac is slightly less than \$2000. The Mac, therefore, comes in a distant third in both price and price/performance. Since the Mac still has a tremendous advantage in terms of software, support, and company stability, the price isn't likely to come down too far or too fast.

### WRAP-UP OF ROUND 1

Based on the observations above, there is no clear winner. Each machine has its strengths and its weaknesses. The Mac is an established machine, with lots of software and hardware available, a large installed base, and sound financial backing (at least in comparison to Atari and Commodore). The 520ST is an amazing bargain, much more a computer "for the rest of us" than the Mac ever was, and it should sell well. The Amiga is slow coming out and is in a precarious position in terms of price, software, and financial backing. But if it (and Commodore) can survive the next six months, the Amiga could easily be around for 5 to 10 years, long after 520STs are gathering dust on closet shelves.

### IN THE QUEUE

Next month will feature round 2 of the 68000 wars. I'll have a number of tables comparing system features and showing the results of various benchmarks. I hope to squeeze in comments on some of the software that is piling up, especially those packages for the 520ST and the Amiga. Until then, I'll see you on the bit stream. ■

*Many thanks to the following people for technical information and corrections: Eric Zocher of Silicon Beach Software; Bob Pariseau of Commodore; Neil Harris of Atari; Jez San of Argonaut Software Ltd.; Scott Turner of L5 Computing; Charlie Heath of MicroSmiths; the Amiga crowd on BIX; and the SIG ATARI crowd on CompuServe.*

**Special Purchase**  
**LAP COMPUTER**  
**FULL FACTORY WARRANTY**

**BUILT IN 300 BAUD MODEM**  
Built in spread sheet, similar to Lotus Terminal Emulator to Communicate with Personal or Mainframe Computers.

**IT'S A HANDS FREE PHONE**  
Comes with Rechargeable Batteries and Charger. Options Available: Serial or Parallel Port, Workstate Printer

**workstate**  
BY CONVERGENT TECHNOLOGIES

**THE MOST PORTABLE TERMINAL**

OUR BEST PRICE EVER **\$295.00** ORIGINALLY \$1195.00

**INCLUDES FREE SOFTWARE WORTH \$88.00**  
Information and Consultant Services Software.

**OTHER SOFTWARE PACKAGES - WITH PURCHASE ONLY**

Project Manager	\$15.00	Finance Analyzer	\$15.00
Cost Management	\$15.00	Real Estate	\$15.00
Inventory Management	\$15.00	Electronic Mail	\$25.00
Marketing Management	\$15.00	Installation Services	\$15.00
Sales Reporter	\$15.00	Loan Analysis	\$15.00
Travel	\$15.00	Portfolio Analysis	\$15.00

This state of the art computer comes with two instructional cassettes that talk you through the learning process. This means a human voice tells you which keys to press as you are learning to manipulate information on the screen. This computer also has built-in hardware that lets you hook in to services like Dow Jones/News Retrieval. The Source: MCI Mail, and many other services, including thousands of electronic bulletin boards. • Dimensions: 8 1/2" x 11 1/2" x 1 1/2". • 3 lbs. • Display: LCD, 46 characters per line, 16 lines. • Power: NiCad keys. • Typewriter-style keyboard and calculator pad. • Power: NiCad rechargeable battery. AC adaptor/recharger or 4AA alkaline batteries. • Software: Built-in handles worksheets for Financial analysis, phone, calendar and communications management. Internal Memory up to 12 8 1/2" x 11" pages. Microcassettes store up to 10 worksheets or 45 minutes of audio information.

**15 Day Money Back Guarantee**

**CEC**

1745 Adrian Road, No. 1  
Burlingame, CA 94010  
415/342-4058  
800/228-3411



# If you need easy access to your IBM mainframe, our Emulation Adapters are just the tickets.

With the IBM Enhanced 5250 Emulation Adapter or the IBM 3278/79 Emulation Adapter, you can quickly convert your IBM Personal Computer into an online terminal. Thereby gaining easy access to mainframe data without leaving your desk. And making the transfer of data between PC and mainframe simple.

What's more, you can access programs at the host and run PC programs simultaneously. Switching from one to the other with a simple keystroke sequence.

You can even pick your own printer in most cases: the host's high-speed printer or your own PC's printer.

**Put the power of our most popular mainframes on your desk.**

The enhanced 5250 emulation card allows you to access the IBM System/34, 36 or 38 with your PC, PC XT, PC AT or *Portable* PC. (Remote access is available on the System /36 and 38 using appropriate hardware and software.)

And the 3278/79 card lets you and your IBM PC, PC XT or PC AT interact with the IBM 4300, 3081, 3083 or 3090, either local or remote.

**You'll thank us for the memory.**

The 3278/79 card's emulation

control program requires only 23K of memory.

Which means, with our 3278/79 card, you've got more memory left for application programs. And less tied up with housekeeping functions.

**The key to keyboard familiarity.**

The enhanced 5250 card's emulation program lets you define keyboard functions. Default definitions make it easy to map the PC, PC XT, PC AT or *Portable* PC keyboards to the 5291 keyboard. You can also define your own personal keyboard layout and play back predefined strings of keys.

**The 3278/79 Emulation Adapter is now available through your dealer.**

The 5250 card is carried by selected dealers. Both Emulation Adapters are available at IBM Product Centers and through your IBM marketing representative. You'll be pleasantly surprised by the cost of either card.

So if you'd like to put the power of your company's mainframe to work for you, put in one of our Emulation Adapters. And you'll find out why our cards are the hottest tickets in town.

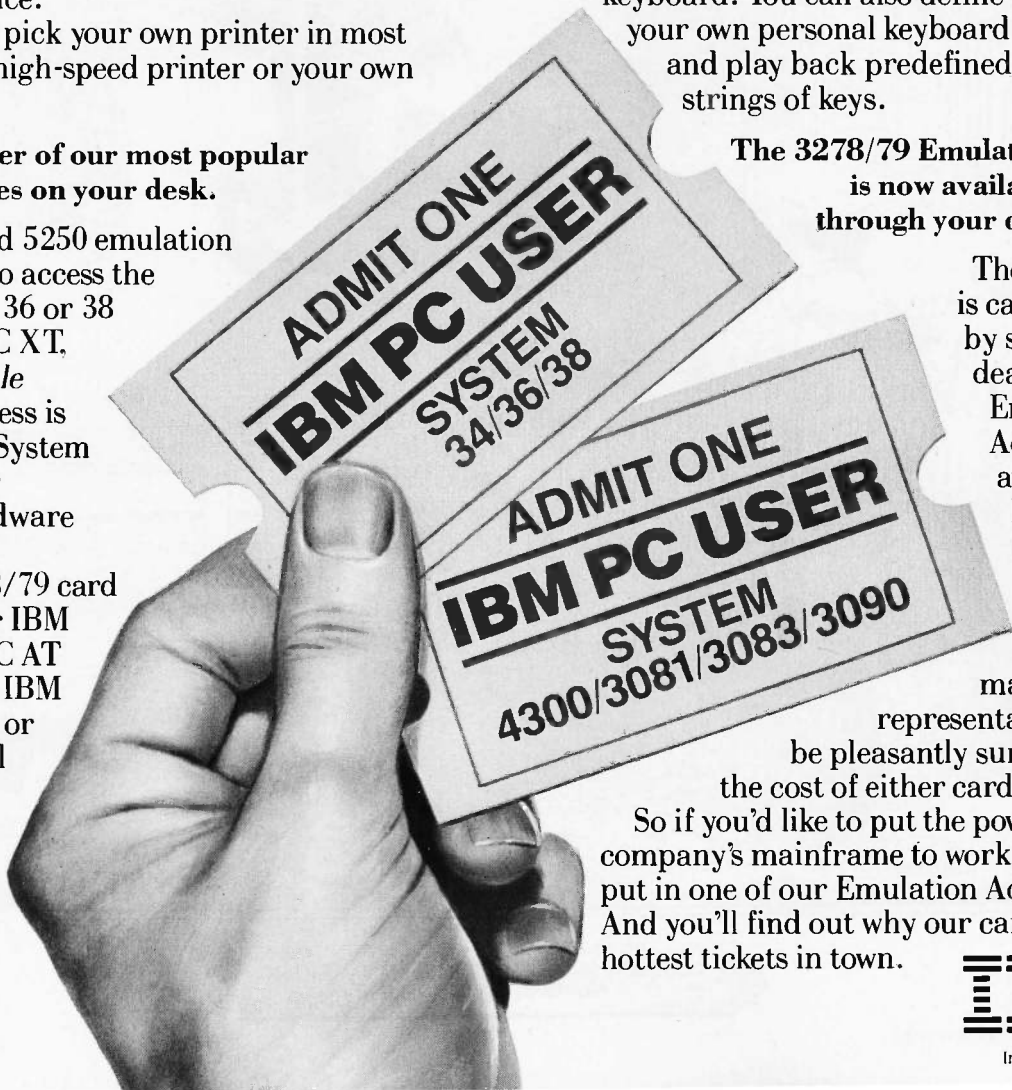

**IBM**

Inquiry 165

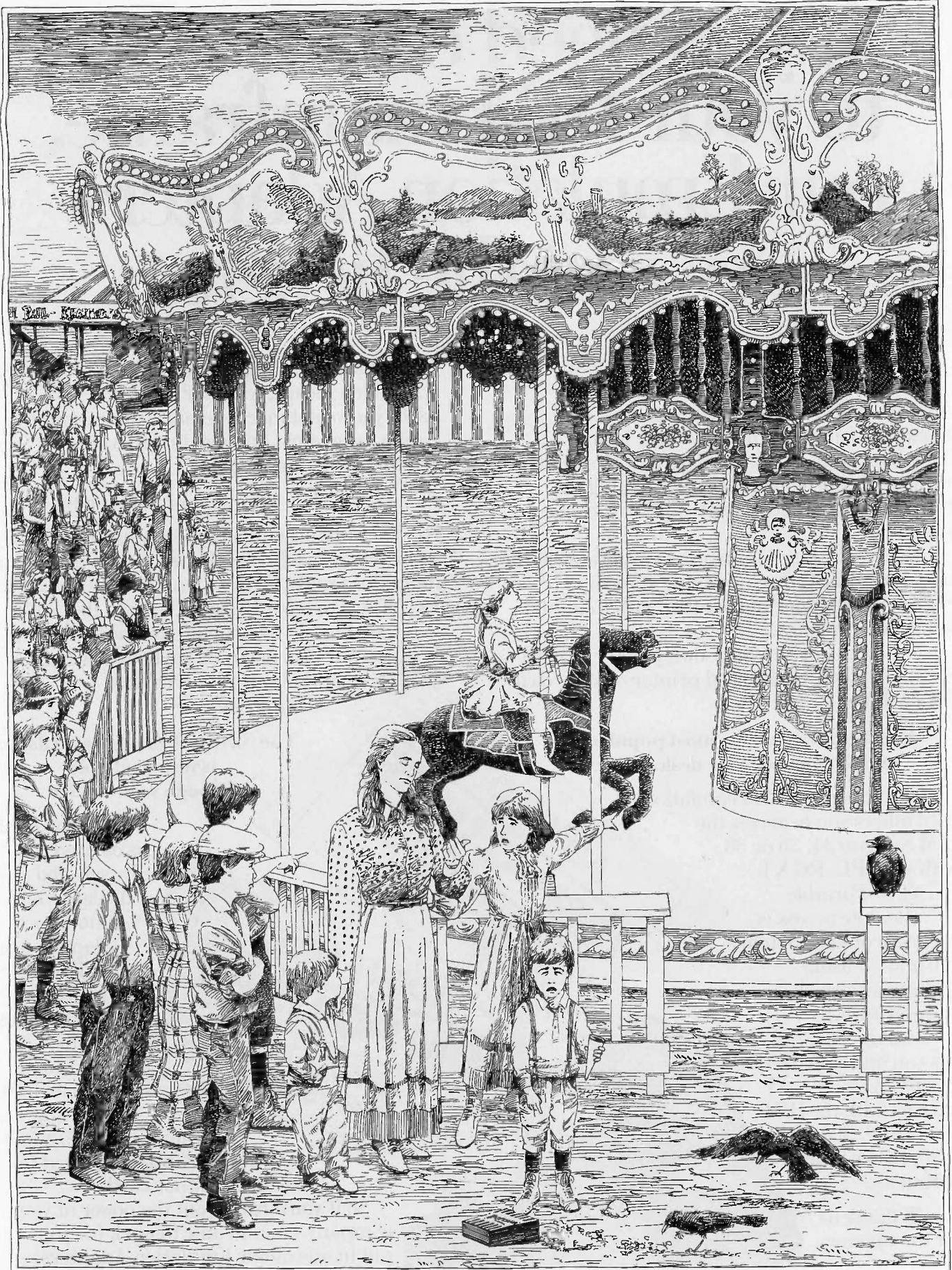

COMMON SENSE IN DATABASE MANAGEMENT  
NUMBER FIVE IN A SERIES

# SOME THINGS CAN NEVER BE SHARED. OTHER THINGS SHOULD BE.

**T**he people who make database software have some strange logic. They tell you information is the most valuable thing in the world. And then they design their products for single-user systems. Which means that every time different people actually need to use your data, they have to stand in line for it.

## INTRODUCING R:BASE™ 5000 MULTI-USER.

At Microrim, we have a much better idea of the way offices work. So we've developed a multi-user version of R:base 5000 that lets users update their database while other people analyze it. And we've made this new version fully compatible with our single-user version. Which means any application you develop on the single-user version today can be run on our multi-user version tomorrow.

## DATAPRO RANKS R:BASE 5000 #1.

Of course, we gave the multi-user version all the features that convinced the Datapro Research Corporation to rate our single-user version as the best DBMS on the market. But we've also designed it to make optimum use of all the extra capabilities offered by the IBM PC Network (IBM PC DOS 3.1). To optimize data sharing, R:base 5000 Multi-User takes full advantage of the front end processing power of the PC. As

a result, multiple users will be able to work with the same database at the same time.

While editing, data integrity is protected by a locking mechanism that operates at the item level. This important feature lets the other users work with columns and rows of the same table. Instead of making them wait around for the other guy to finish his editing job.

## SEE FOR YOURSELF: 1-800-547-4000.

The full price is \$1500, complete with three sets of documentation. But if you believe in common sense as much as we do, you won't make a decision this big till you get your hands on a copy and see for yourself. And that's just what we'd like you to do. For only \$50, we'll send you a copy of the program that has all the features, one set of documentation, and all the functionality of the full product, except for limitations on the numbers of rows, columns and tables.

Just call 1-800-547-4000 and ask for Dept. 906. From Oregon, or outside the U.S., call 1-503-684-3000, Dept. 906. Or head straight for a leading software store or computer dealer.

And see how nice it is to take advantage of information. Instead of taking turns at it.

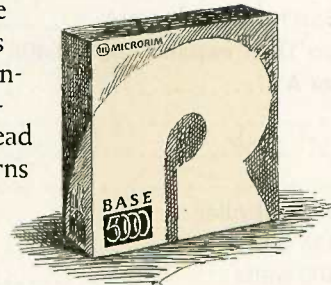

# R:BASE 5000 MULTI-USER FROM MICRORIM

IT ALL COMES DOWN TO COMMON SENSE.

**AMT 286 IBM PC<sup>®</sup> AT COMPATIBLE \$1499.<sup>①</sup>**

**XT-PLUS IBM XT COMPATIBLE \$399.<sup>①</sup>**

**AT jr 8MHz COMPATIBLE AT SPEED \$699.<sup>①</sup>**



**AMT 286**

IBM PC AT compatible computer, 6MHz clock, 640K memory, keyboard, FD/HD Controller, 1.2MB Floppy . . . **\$1499.<sup>①</sup>**

**AMT 286-e**

IBM PC AT compatible computer, 8MHz clock, (enhanced version), 640 memory expandable to 1MB, Keyboard, FD/HD Controller, 1.2MB Drive, 20MB Hard Disk . . . **\$1999.**

"O" wait state Option . . . extra **\$ 300.**

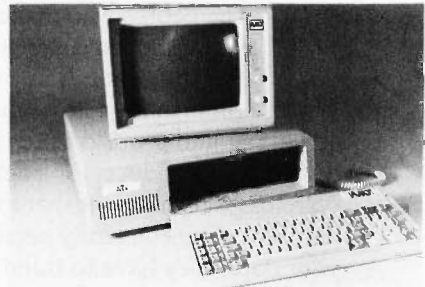

**AT jr**

IBM PC XT compatible, 300% faster than IBM PC XT, 8 MHz Clock (dual speed, hardware or software switch), 640K on Mother Board, using V-20 chip, Keyboard, Floppy Disc Controller, two 360KB Drives - Runs Lotus 123, Wordstar, dBase III, Flight Simulator and more...all for . . . **\$699.<sup>①</sup>**



**XT-PLUS**

IBM PC XT compatible, 4.77 MHz Clock, 640K on Mother Board, 8088 Intel Chip, Keyboard, 135 watts Power Supply; all for . . . **\$399.<sup>①</sup>**

① Prices for quantity purchases only  
② Registered trademark of IBM Corporation

**DEALER & OEM SPECIAL**

(25 or more unit purchase price)

Floppy Disc Controller . . . . .	\$ 29.
Monochrome Graphics Card/PP . . . . .	79.
Disk I/O Card FDC, PP/SP, Game, Battery Clock . . . . .	79.
1200 Baud Modem . . . . .	139.
1200 Baud Modem for AT (1/2 size) . . . . .	199.
XT-Mother Board "O" K expandable to 640K . . . . .	99.
Mother Board for AT . . . . .	650.
Keyboard 5150 . . . . .	49.
Keyboard 5151 . . . . .	79.
Keyboard AT . . . . .	79.
20MB Drive with Controller . . . . .	425.
Power Supply 135 watts . . . . .	69.
Power Supply 200 watts . . . . .	129.
XT Chassis . . . . .	31.
AT Chassis . . . . .	99.
Hi-Res Color Graphics Card (640x400) . . . . .	399.
Hi-Res Color Monitor . . . . .	499.
8MHz IBM PC XT Compatible Mother Board "O" K . . . . .	199.
30MB Drive with Controller . . . . .	650.

**AMT AMERICAN MICRO TECHNOLOGY**  
1322 E. EDINGER SANTA ANA, CA 92705

**(714) 972-2945**  
TWX 5106003265

**\* ASK FOR FREE CATALOG \* DEALERS WANTED**

Prices and Availability subject to change without notice

## A New Language and a Laptop

Mind and  
the Fujitsu FM-16 $\pi$

BY WILLIAM M. RAIKE

**I**n last month's BYTE Japan I lamented the fact that so few interesting Japanese software products appeared at last October's Software Show. Almost immediately after I wrote that column, one of the local computer journals carried ads for two new software products that I think are worth mentioning. One is an all-Japanese programming language called Mind, and the other is EM/3+, a unified operating environment that supports all three of the most widespread microcomputer operating systems in Japan. This month, I'll talk about Mind.

### THE MIND COMPILER

Mind was developed jointly by Rigi Corporation and Microsoft Associates (which, by the way, is not related to Microsoft Inc.). I haven't been able to do a hands-on evaluation because Mind is available only for NEC personal computers and I own a Fujitsu machine, but I still think it's worth mentioning for several reasons. As far as I can determine, this is the first programming language created in Japan. Although its overall structure seems similar to a kind of structured BASIC, all of the reserved words are written in Japanese kanji characters, and the statement syntax has some patterns that resemble the Japanese language. The language has control, arithmetic, string, graphics, input/output, and file-processing features that seem to be about on a par with recent versions of BASIC in terms of power and flexibility. Mind is compiled rather than interpreted, and programs can be compiled and then linked with separately compiled object libraries using the linkage editor. The language includes a screen editor, and the whole package comes with a fairly extensive collection of source libraries, including graphics, mouse, and communications libraries, and program-maintenance utilities, including a Japanese-language dictionary maintenance utility.

Mind runs under MS-DOS on the NEC PC-9801 series of personal computers (ex-

cept for the top-of-the-line 80286-based PC-98XA machine). It costs only about \$200, a real bargain compared to the cost of most other compilers here, which usually range from \$400 to \$1500 or more. Those prices are for products that sell for one-fourth to one-half as much in the U.S. (One exception is Turbo Pascal, which is almost as much of a bargain in Japan as it is in the U.S.)

I don't forecast a particularly bright future for Mind, since it seems to offer little that isn't available with other compilers and languages. On the other hand, it could (but probably won't) be used for teaching purposes. The only other language I know of that handles source programs written in Japanese characters (other than for character string constants and comments) is Fifth-86 (a successor to FORTH-86).

For programmers who are familiar with conventional programming languages, Mind will be somewhat slow and cumbersome to use because it takes longer to type Japanese characters than alphanumeric or katakana characters. The screen editor supplied with Mind may help to overcome that drawback; I can't be sure until I see it in action.

### RESISTANCE TO WORD PROCESSING

One popular weekly Japanese magazine, *Shukan Bunsho* (October 1985), recently carried an article on whether word processors are a boon or a bane to creative writing. The issues are a little different here than in the U.S. and other Western countries. As I've mentioned before in this column, Japanese typewriters have never been popular or widespread, even in the business world. Japan is now in midleap—jumping straight from handwriting into word processing. Since authors writing in English have long been accustomed to typing their manuscripts, the switch to word processors, while not altogether without trauma, has by and large been welcomed eagerly.

(continued)

William M. Raïke, who has a Ph.D. in applied mathematics from Northwestern University, has taught operations research and computer science in Austin, Texas, and Monterey, California. He holds a patent on a voice scrambler and was formerly an officer of Cryptext Corporation in the United States. In 1980, he went to Japan looking for 64K-bit RAMs. He has been there ever since as a technical translator and a software developer. He can be contacted c/o BYTE, POB 372, Hancock, NH 03449.

Besides the numerous word-processing programs you can buy for every Japanese personal computer, Japanese consumers now have a choice of dozens of models of dedicated word processors, at prices that start at about \$300 for the simplest portable electronic typewriter. These machines offer various levels of

sophistication and flexibility in the way they convert phonetic characters (katakana, hiragana, and in some cases the Roman alphabet) into Japanese kanji characters, as well as in how they perform common editing functions like insertion and deletion, cut-and-paste, formatting, and so forth. (Among other things, Japanese can be

written either conventionally from left to right or vertically from top to bottom starting at the upper right corner of the page. Some word processors rotate each character 90 degrees and then print them horizontally on a page inserted sideways into the printer.) Different machines offer larger or smaller kanji dictionaries, depending on the price.

Here are 79 reasons to buy at Elek-Tek, not to mention the fastest delivery anywhere.

**MEGA**  
BERNOULLI BOX

1. 10 meg 1/2 height Drive for IBM-PC/XT/AT & compatibles . . . . . \$ 1675
2. 20 meg 1/2 height Drive for IBM-PC/XT/AT & compatibles . . . . . 2335
3. Non-Bootable Interface Card . . . . . 104
4. Bootable Interface Card . . . . . 234
5. 10 meg cartridges for above (3 pak special) . . . . . 125

**Save 30% to 43% off Manufacturer Suggested Ret. prices on America's most wanted Printers**

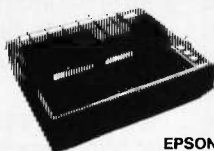

- EPSON®**  
FX 85
6. LX 80 . . . . . \$ 215
  7. RX 100+ . . . . . 299
  8. FX 85 . . . . . 340
  9. FX 286 . . . . . CALL
  10. LQ 1500 parallel . . . . . CALL
  11. DX10 Daisy Wheel 10CPS . . . . . 230
  12. DX20 Daisy Wheel 20CPS . . . . . 320
  13. DX35 Daisy Wheel 35CPS . . . . . 590

**Huge Discount on TOSHIBA OKIDATA STAR**

**UNBELIEVABLE! XEROX/DIABLO D-36 DaisyWheel 35CPS**  
Mfr. Sugg. Ret. \$1495  
**Elek-Tek Price \$450**

**P-38 Dot Matrix 400CPS**  
Mfr. Sugg. Ret. \$1995  
**Elek-Tek Price \$600**

**PRODUCTS FOR IBM-PC**

- |   |  |   |
|---|--|---|
| <ol style="list-style-type: none"> <li>14. Amdek 310A Amber Monitor . . . . . \$ 150</li> <li>15. Generic Multi Multifunction Board, 64K . . . . . 135</li> <li>16. Generic Multi 384K Multifunction Board, 384K . . . . . 175</li> <li>17. AST Six Pak + Multifunction Board, 64K . . . . . 225</li> <li>18. AST Six Pak + (loaded) Multifunction Board, 384K . . . . . 290</li> <li>19. Quadram Quadboard Multifunction Board, 0K . . . . . 195</li> <li>20. Multi Board, 64K/384K . . . . . 210/267</li> <li>21. Orchid Tech. PC Turbo 186 . . . . . 570</li> <li>22. ECCELL 0K . . . . . 399</li> </ol> | <ol style="list-style-type: none"> <li>23. ECCELL Daughterboard . . . . . 135</li> <li>24. ECCELL I/O Board . . . . . 99</li> <li>25. Hercules Monochrome Card . . . . . 299</li> <li>26. Hercules Color Color Graphic Card . . . . . 155</li> <li>27. Novation 4905921 1200B Int. No Software . . . . . 150 with MITE Software . . . . . 165</li> <li>28. Novation 490605-1 2400BPS inc. Mite Software . . . . . 620</li> <li>29. Novation 490603 1/2 Card Modem 2400 BPS No software . . . . . 425</li> <li>30. Novation 490603-1 As above inc. MS-DOS Software . . . . . 490</li> </ol> | <ol style="list-style-type: none"> <li>31. Hayes 1200 External modem . . . . . 380</li> <li>32. Hayes 1200B Internal modem w/software . . . . . 359</li> <li>33. Hayes 2400 External modem . . . . . 599</li> <li>34. Hayes 2400B Internal modem w/software . . . . . 525</li> <li>35. AT&amp;T 4000 300/1200 Ext. Modem . . . . . 335</li> <li>36. US Robotics Courier 2400 Ext. 2400B Smart Modem . . . . . 460</li> <li>37. Toshiba HND 04DT 1/2 ht. DSDD Disk Drive . . . . . 90</li> </ol> |
|---|--|---|

**38. Dyan Internal H.D. Subsystem**  
20 Megabyte . . . . . \$500

**39. I BAR 8-15**  
8 Outlet Surge Protector . . . \$50

**40. XIDEX Precision DS/DD Diskette 10pk/\$7.00**  
5 boxes minimum

**DISKETTES**

	Dyan	maxell	3M	MEMOREX	IBM
3 1/2" SSDD	20.00	20.00	23.00	—	—
DSDD	27.00	26.00	29.00	—	—
5 1/4" SSDD	15.00	13.00	12.00	11.50	11.00
DSDD	19.00	15.00	15.00	14.00	12.00
SSDD96TPI	24.00	24.00	24.00	—	—
DSDD96TPI	33.00	29.00	29.00	—	—
5 1/4" DSDHD (For IBM AT)	33.00	28.00	30.00	—	24.00
8" SSDD**	22.00	29.00	25.00	—	—
8" DSDD**	26.00	32.00	29.00	—	—

Call for Quantity pricing for 10 boxes or more.

**3M DATA CARTRIDGES**

73. DC100A . . . . . \$ 13.50
74. DC300A . . . . . 17.50
75. DC300XL . . . . . 20.50
76. DC300XL/P . . . . . 21.50
77. DC600A . . . . . 23.00
78. DC1000 . . . . . 14.50
79. DC2000 . . . . . 19.50

Call for quantity pricing for 10 cartridges or more.

CALL TOLL FREE 800-621-1280 EXCEPT Illinois, Alaska

CANADIAN TOLL FREE 800-458-9133

Comp. Accts. Inv. 10% Int. Ord. \$15.00 Visa or MasterCard by Mail or Phone. Mail Cashier's Check, Mon. Ord., Personal Check (2 wks. to clear) Add \$4.00 Int. Item. (AK, HI, P.R., Canada add \$10.00 first item) \$1.00 ea. add'l shipg. & hand. Shipments to IL address add 7% tax. Prices sub. to change. WRITE for free catalog. RETURN POLICY: Defective Only; Most products replaced within 30 days of purchase with identical merchandise only. Computer and large peripherals replaced only when defective on arrival (within 3 work days of delivery). Other problems covered by mfr. warranty. ALL ELEK-TEK MERCHANDISE IS BRAND NEW, FIRST QUALITY AND COMPLETE. Delivery subject to availability. 800-621-1280

**ELEK-TEK, inc.**

6557 N. Lincoln Ave., Chicago, IL 60645  
(312) 631 7800 (312) 677 7660

**A VARIETY OF CONCERNS**

Popular acceptance of the new technology has never been in question, but some authors are putting up resistance, claiming they are forgetting how to write some kanji. One author of science fiction, Motoko Arai, told *Shukan Bunsho* that she was embarrassed when she couldn't remember how to write people's names. Shintaro Ishihara, a novelist who's also a politician, writes some of his copy by hand and uses a word processor for the rest; he says his handwriting is terrible but claims the word processor results in a stiff writing style. One poet believes it's impossible to compose poetry at the keyboard, claiming that the concentration involved in calligraphy is essential to his art. On the other hand, novelist Masahiro Mita scorns such attitudes; he feels that the brain's creation is the central issue and that the medium used to capture it is irrelevant. And novelist Ayako Sono uses her word processor all the time but has modified the kanji conversion system to have the machine select particular characters she wants to use.

For foreigners living in Japan, myself included, word processors provide a shortcut to writing Japanese. I'm lazy, and it's much easier to learn to recognize a character when you see it than it is to write it. Most people, Japanese included, can read many more characters than they can write. With a word processor, you type in the phonetic reading of a character, word, or phrase, and then step through a selection of the possible characters with that pronunciation until you find the desired one. In effect, you can write (or type) as soon

(continued)

In the tradition of Samuel Morse's telegraph, we've created an easier way to dash off messages on your computer.

In 1844 Morse tapped out a series of dots and dashes on his new telegraph, and the message "What hath God wrought?" traveled instantly between Washington D.C. and Baltimore. Telecommunications was born. Today, we've teamed our new 1200 bps modem with Microsoft's Access software, and telecommunications has come of age.

Making information easier to send and receive was the reason we designed the Kyocera modem for the IBM PC, AT, XT\* and compatibles. That's why we gave it 8K of intelligence for a variety of time and money-saving functions. Like unattended operation, busy and dial tone detection, 11 result codes, and help menus.

Then we teamed it with today's most advanced communications software. Access by Microsoft.

Access is the communications program with X.PC, the amazing protocol that allows you to open 15 live connections over a single line while actually viewing 8 of them simultaneously through "windows" on your screen. At the same time, it automatically checks for data errors during transmission. In addition, Access has built-in interfaces for the information services you need, like CompuServe® and Dow Jones News/Retrieval®. And the Access Learn command turns long command sequences into one-stroke functions that quickly get you on your way to solving problems and doing business.

So get the communications package that makes it easier to get the business information you need. The bundle includes modem, Access software, all accessories, and even the RS-232C cable (for IBM PC, XT and compatibles).

It's a system even Sam Morse would be proud of.

 **KYOCERA Modems**  
A tradition of innovation.

For your nearest Kyocera dealer, call toll-free (800) 235-1222 or (408) 257-8000.

© 1985 Kyocera International, Inc., Valley Park, 10050 N. Wolfe Rd., Suite 266, Cupertino, CA 95014. Microsoft is a registered trademark of Microsoft Corporation. CompuServe is a registered trademark of CompuServe, Inc. Dow Jones News/Retrieval is a registered trademark of Dow Jones, Inc. IBM PC, AT, XT are registered trademarks of IBM Corporation.

Inquiry 199 for End-Users. Inquiry 200 for DEALERS ONLY.

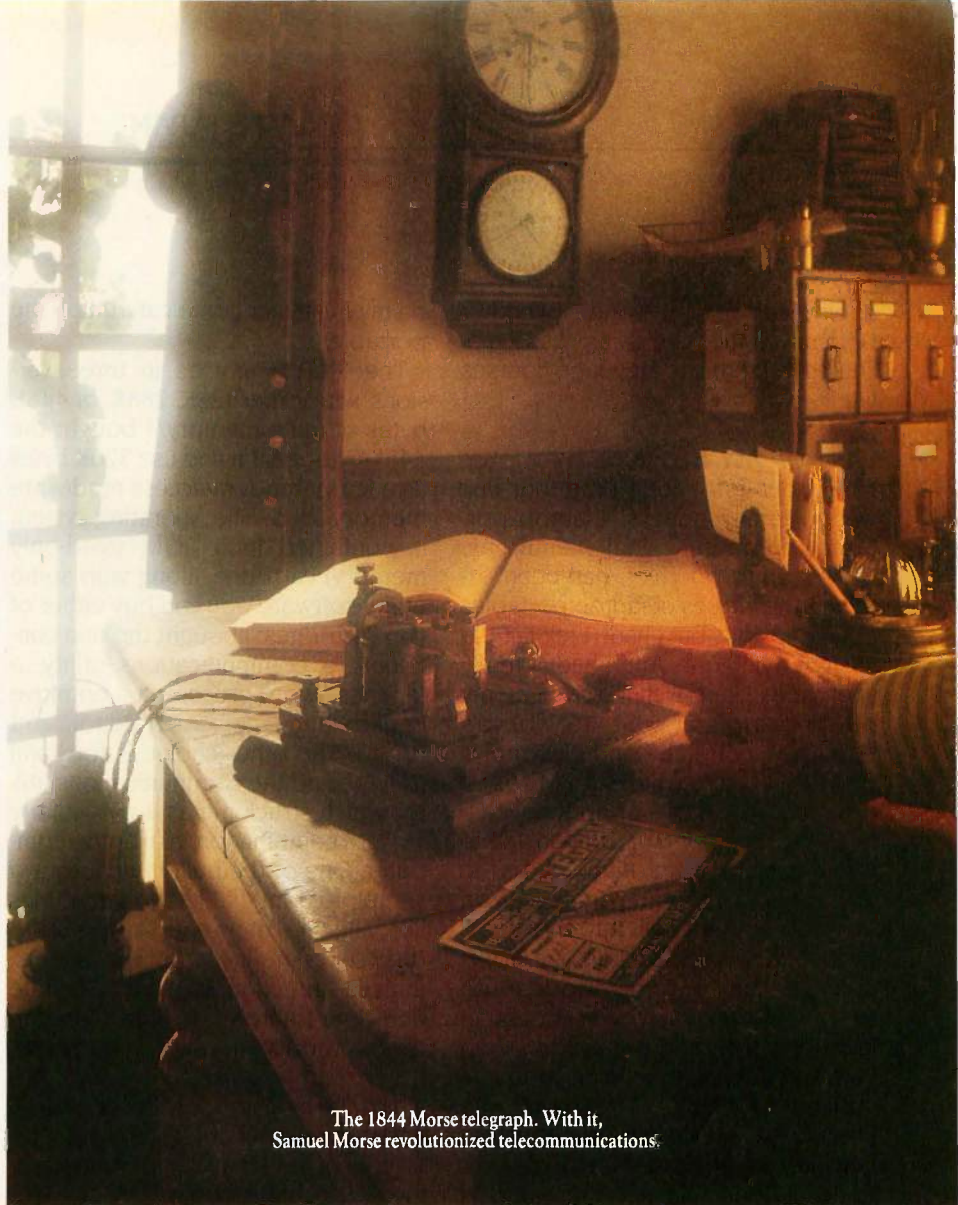

The 1844 Morse telegraph. With it, Samuel Morse revolutionized telecommunications.



Microsoft Access with X.PC allows multiple live connections.



THE INTELLIGENT STAND ALONE MODEM WITH MICROSOFT SOFTWARE

as you can read. I wonder whether U.S. universities are using these machines in Japanese language courses yet.

### LAST ON MY BLOCK

I held out for a long time, but last week I finally bought a laptop portable computer. Phil Lemmons, BYTE's editor in chief, has been extolling the virtues of laptop portables for a long time, but I hadn't felt I could justify buying one. And I hadn't really seen one I liked. Well, I overcame my objections and went to Tokyo's Akihabara computer and electronics district to buy a Fujitsu FM-16 $\pi$ . I described this Fujitsu portable briefly in the January BYTE Japan (page 381). My chief complaint then was the awkward design of the space bar on the keyboard: It's split into three sections, and only the middle one works as a space bar; the other two are used to control Japanese word-processing functions. It turned out not to be so hard to get used to after all, and just about everything else about the FM-16 $\pi$  is a delight. The whole machine weighs just over 6 pounds, stands about 2 inches high, and is exactly the size of a sheet of stationery. It uses an internal rechargeable battery plus a separate memory-backup battery and comes with an AC adapter/charger.

Two features convinced me to buy this computer. One was the excellent readability and visibility of the liquid-crystal display. It's an 80- by 25-character (640- by 200-dot) panel, with adjustable contrast, and it has the best readability I've yet seen in this size display—far better, for example, than the Data General/One (which is double the price of the Fujitsu) and as good or better than the Datavue 25. When displaying Japanese characters it can display 11 lines of 40 characters in a very clear 16- by 16-dot font. The other strong incentive was the type of microprocessor used in the FM-16 $\pi$ ; it's a CMOS (complementary metal-oxide semiconductor) version of the 8086 (the MBL8086L) running at 5 MHz. The machine runs under CP/M-86, so most of the software I run

on my Fujitsu at home can run on the portable, too.

The FM-16 $\pi$  comes in three versions, with either 128K, 288K, or 448K bytes of main memory. I bought the 448K-byte version and use 320K bytes as a RAM (random-access read/write memory) disk. The operating system is contained in a ROM (read-only memory) cartridge, along with some utility software. You can buy either of two cartridges; I bought the one containing a communications utility, a Japanese word processor, a primitive English-language screen editor, and BASIC. The other choice is for Kanji COBOL and the communications utility, which struck me as a particularly useless combination in a laptop computer. One of the built-in utilities is a setup program that lets you do things like allocate memory for the RAM disk, set communication parameters, initialize function keys, set the date and time (there's a built-in calendar/clock), choose an auto-power-on sequence, and choose the interval after which the machine powers itself down when no key has been pressed.

I connected my main computer and the new portable by cable and had no trouble downloading both text or program files at speeds from 300 to 9600 bps (bits per second). Both WordStar and Turbo Pascal work just fine, along with my own all-purpose communications program (it's more convenient than the one supplied in ROM), a spreadsheet program, and other homegrown software. They all fit in the RAM disk (drive A) with plenty of room to spare.

The FM-16 $\pi$  has no built-in floppy-disk drive, although you can buy a separate 3½-inch dual microfloppy-disk drive for about \$425. I felt I didn't need it because I'll be able to either upload files to my main computer at home using an RS-232C cable or, if I'm traveling, send them to The Source or elsewhere by telephone. There is a microcassette drive built into the machine, but it's slow (about 200 characters per second), so I doubt I'll use it very often.

Regrettably, while the built-in RS-232C interface works just fine for

communications, the FM-16 $\pi$  doesn't have an internal modem, which forces me to use my Epson portable acoustic coupler instead. It's inconvenient, but the lack of a modem is understandable here in Japan, since it's only been a few months since it became feasible to attach a direct-connect modem to phone lines in Japan. In fact, as I write this, there is only one model of 1200-bps full-duplex modem generally available to personal computer owners here, and it's a single-speed device that doesn't work at 300 bps. That situation is certain to change in the very near future, as personal computer communications continues to grow rapidly. Importing the popular U.S. personal computer modems hasn't been a solution, since the Japanese phone system (along with most of the rest of the world) uses different telephone standards (the CCITT, or International Telephone and Telegraph Consultative Committee, standards), with different signaling frequencies, than the Bell 103 and 212A standards. (I did recently discover, though, that many people have found that the American modems work all right at 1200 bps, since the frequencies are apparently close enough.)

### COMPUTING EN ROUTE

Since I normally send the copy for this column back to BYTE headquarters in Peterborough, New Hampshire, via The Source, I plan to take my new Fujitsu portable along with me on an upcoming visit to the U.S. Then if BYTE's monthly manuscript deadline falls on the dates that I'm away, I'll be able to file my next column from the nearest telephone. [Editor's note: Because Bill Raikes is traveling, gathering material for upcoming columns, BYTE Japan will not appear in the April issue of BYTE but will reappear in the May issue.] Since Turbo Pascal works so well, I may even get a chance to finish some small software projects. And here at home I can take the computer along with me and work at the local coffee shop. I think the convenience of the FM-16 $\pi$  is worth the investment of \$1400 or so. ■



# YOU BE THE JUDGE!



## THEY'RE EVEN LOOK ALIKES!

- 512K on Mother Board
- 8 Slots and 192 Watt P.S.
- 20mb. H.D., and 1.2 mgb. Floppy
- AT Keyboard (monitor not included)

## AND THE DIFFERENCE... A \$2000 SAVING!

**ROBYTE PC** with 2/360K floppy drives on XT mother board and keyboard **\$775**  
IBM Compatible

**ROBYTE XT** with 10mb. hard disk drive and 1 floppy with keyboard **\$1475**  
IBM Compatible

**ROBYTE**  
40-60M  
**Tape Back Up**  
Int. or Ext.  
(For all IBM compatibles)  
**\$595 to \$795**

**ROBYTE**  
**1200 BAUD**  
Hayes compatible  
External Modem  
**\$229**

**ROBYTE**  
**COLOR**  
**MONITOR**  
640 x 200 res.  
**\$395**

Call for special prices on limited supply of T.I. closeouts

**ROBYTE**  
Super Quality Boards, Multi-Ply & Socketed  
One year guarantee  
**MULTIFUNCTION CARD**  
Serial and parallel ports, 384K expandable, clock/calendar, game  
OPTION PORT \$139.00  
SERIAL CARD \$59.00  
PARALLEL CARD \$39.00  
COLOR GRAPHICS CARD \$74.00  
MONO GRAPHICS CARD \$99.00  
I/O MULTIFUNCTION CARD \$119.00  
AT MULTIFUNCTION CARD, EXPANDABLE TO 3M, includes piggyback \$349.00

**IBM SPECIAL**  
IBM, 1-320K DS, DD Disk Drive 10 Meg. Hard Drive, Amber or Green Monitor, 256K, Par Port PFS. Write and File  
**\$2350.00**

Call for special prices on all variety CABLES. 50% and more off!

**NEW!**  
**POWER SURGE PROTECTOR**  
with Monitor Swivel Attached  
6 outlets  
A \$175 VALUE **\$89**

**COMPAQ**  
**"286"**  
Desktop Model "2"  
full configuration  
**\$4395**  
Regular Use Also

**WESTERN ELECTRIC**  
Touch-Tone Modem  
Telephones  
**\$29**  
Reg. Use Also

SOFTWARE	MONITORS	PRINTERS
<b>WORD PROCESSING</b>	<b>PRINCETON GRAPHICS</b>	<b>EPSON</b>
WORDSTAR 2000 PLUS \$315.00	HX-12 HI RES \$545.00	FX-286 \$559.00
WORDSTAR EASY \$99.00	SR-12 W/DOUBLER \$714.00	FX-85 \$372.00
WORDPERFECT \$250.00		LO-1500 \$967.00
W/SPELLER \$240.00	<b>AMDEK</b>	<b>STAR MICRONICS</b>
MICROSOFT WORD \$211.00	COLOR 300 RGB \$359.00	SG 10 \$206.00
	COLOR 600 \$439.00	SD 10 \$279.00
<b>SPREADSHEETS &amp; DATABASES</b>	COLOR 710 HI-RES \$499.00	SR 10 \$394.00
LOTUS 1-2-3 \$327.00		<b>BROTHER</b>
SYMPHONY \$459.00	<b>IBM</b>	HR-25 \$554.00
DBASE III PLUS \$417.00	PROF. GRAPHICS MON \$969.00	HR-35 \$796.00
FRAMEWORK II \$417.00	ENHANCED GRAPHICS MON \$649.00	TWINWRITER 5 \$973.00
SUPERCALC \$211.00		<b>HEWLETT PACKARD</b>
MULTIPLAN \$117.00	<b>DISK DRIVES</b>	LASERJET \$2316.00
	<b>SEAGATE</b>	6-PEN PLOTTER \$1466.00
<b>FINANCIAL SOFTWARE</b>	SEAGATE 20 MG W/CONT \$595.00	THINKJET \$349.95
HOME ACCOUNTANT \$89.00	SEAGATE 30 MG W/CONT \$895.00	LASERJET PLUS \$3089.95
MONOGRAM DOLLARS & SENSE \$108.00	SEAGATE 42 MG W/O CONT (37 M.S.) \$1250.00	
	<b>MODEMS</b>	<b>GRAPHICS CARDS</b>
<b>HAYES</b>	SMARTMODEM 300 \$145.00	<b>HERCULES</b>
SMARTMODEM 1200B \$399.00	SMARTMODEM 2400 \$655.00	GRAPHIC CARDS \$289.00
	<b>DISKS</b>	COLOR CARD \$145.00
MAXELL HI-DEN \$42.95	MAXELL DS-DD \$19.95	<b>PARADISE</b>
MAXELL DS-DD \$21.95	VERBATIM DS-DD \$21.95	GRAPHICS CARD \$272.00
	<b>HARDWARE</b>	MULTIDISPLAY CD \$197.00
	<b>AST</b>	<b>ZOOM MODEM FOR IIE \$90.00</b>
	SIX PACK PLUS \$242.00	<b>DIABLO</b>
	AT ADVANTAGE CARD \$381.00	RIBBON CARTRIDGES <b>\$2.95</b>

ORDER LINE 1-800-334-8989 IN CALIF. CALL 1-818-341-9193

OPEN 6 DAYS/WEEK, MON.-SAT. 6 AM - 6 PM Pacific Std. Time

IBM is a registered trademark of International Business Machines Co. Shipping & handling charges, 3%. Cal. residents only, 6.5% tax. All prices and availability subject to change without notice. For fast delivery, send cashier's check, certified check or money order. MC and Visa at discount prices above. American Express add 4%. Defective merchandise replaced with same item only. Returns require authorization number. Allow 3 weeks for personal or company checks to clear. Government, quasi-government, or educational institutions on Net 15 terms. Refused shipments subject to 25% charge (\$50 minimum). No returns on software.

Inquiry 278

Price-Line  
Computers, Inc.

9710 Topanga Canyon Place, Chatsworth, CA 91311

# NEW RELEASE

## Ecosoft's Eco-C88 Rel. 3.0 C Compiler



\$59<sup>95</sup>

Release 3.0 has new features at an unbelievably low price. ECO-C88 now has:

- Prototyping (the new type-checking enhancement)
- enum and void data types
- structure passing and assignment
- All operators and data types (except bit fields)
- A standard library with more than 200 functions (many of which are System V compatible for greater code portability)
- cc and mini-make that all but automates the compile process
- 8087 support (we sense the 8087 at runtime - no dual libraries)
- ASM or OBJ output for use with MSDOS linker
- Tiered error messages - enable-disable lint-like error checking
- Fast compiles and executing code
- Expanded user's manual
- Enhanced CED program editor (limited time offer)

We also offer the following support products for Eco-C88.

### CED Program Editor

\$29<sup>95</sup>

CED now supports on-line function help.

If you've forgotten how to use a standard library function, just type in the name of the function and CED gives you a brief summary, including function arguments. CED is a full screen editor with auto-flagging of source code errors, multiple windows, macros, and is fully configurable to suit your needs. You can edit, compile, link, and execute DOS commands from within the editor. Perfect for use with Eco-C88. For IBM PC, AT and look alikes.



### C Programming Guide \$20

After reading the 1st edition, Jerry Pournelle (BYTE Magazine) said: "I recommend this book... Read it *before* trying to tackle Kernighan and Ritchie." The second edition expands this best seller and walks you through the C language in an easy-to-understand manner. Many of the error messages include references to this book making it a perfect companion to Eco-C88 for those just starting out with C.

### C Source for Standard Library

\$10

Contains all of the source code for the library functions that are distributed with Eco-C88, excluding the transcendentals and functions written in assembler.

(\$20 if not with order)

### Developer's Library

\$25

Contains the source code for all library functions, including the transcendentals and those written in assembler. Perfect for the developer that wish to write their own custom functions or learn how we implemented the Eco-C88 library.

(\$50 if not with order)

### ISAM Library

\$15

Contains the code from the C Programmer's Library in relocatable format (i.e., .OBJ) including the delete code for the ISAM file handler.

(\$30 if not with order)



### C Self-Study Guide \$17

(Purdum, Que Corp.). Designed for those learning C on their own. The book is filled with questions-answers designed to illustrate many of the tips, traps, and techniques of the C language. Although written to complement the Guide, it may be used with any introductory text on C.



### C Programmer's Library \$20

(Purdum, Leslie, Stegemoller, Que Corp.). This best seller is an intermediate text designed to teach you how to write library functions in a generalized fashion. The book covers many advanced C topics and contains many useful additions to your library including a complete ISAM file handler.

Eco-C88 C compiler requires an IBM PC, XT, or AT (or compatible) with 256K of memory, 2 disk drives and MSDOS 2.1 or later. Call today:

1-800-952-0472 (for orders)

or

1-317-255-6476 (tech. info.)



Ecosoft, Inc.  
6413 N. College Ave. • Indianapolis, IN 46220



TRADEMARKS: ECO-C88, ECOSOFT

# The Amstrad PCW 8256

A complete  
word  
processor  
and  
computer  
that costs  
less than  
many electric  
typewriters

BY DICK POUNTAIN

**P**rogress in the computing business is a more subtle phenomenon than is commonly appreciated. At first glance, it appears to be a steep upward curve: more bits on the data bus, more MIPS (million instructions per second) in the central processor, more memory, more pixels on the screen, more bugs in a bigger operating system—in fact, more of everything.

But in the real world, an apparent step backward can represent progress. Amstrad (Amsoft, Brentwood House, 169 Kings Road, Brentwood, Essex CM 14 4EF, England) recently loaned me its new PCW 8256 (see photo 1), a Z80-based personal computer and word processor that runs the "old" CP/M Plus operating system. So where is the progress in that? In the price. The PCW 8256 retails for £399 in the U.K. This price buys a complete system including a 90- by 32-character green-screen monitor, a near-letter-quality printer, and software. Moreover, the PCW emulates a dedicated word processor with a keyboard full of special keys. For the first time you can buy a completely functional, ready-to-go word-processing system for less than the price of a modest electric typewriter.

The effect on the market here appears to be quite galvanizing. Suddenly, writer friends of mine who have resisted buying a computer for years are asking, "How good is that new Amstrad?" or even, "I'm getting one of those new Amstrads!" It seems as if £500 represents the magic psychological pricing barrier for self-employed professionals, just as £200 has become the barrier for home games players, at least in this country.

I wrote about Amstrad's debut machine, the CPC 464, in fairly positive terms in the January 1985 BYTE U.K. (page 401). Since then, Amstrad boss Alan Sugar has led the company to become the only U.K. personal computer manufacturer to increase profits and stock price amidst the general financial gloom. His formula looks very much like a

hardware version of Borland International's road to success—decent products at prices people can afford.

## THE HARDWARE

The PCW 8256 is a 4-MHz (megahertz) Z80-based computer with 256K bytes of RAM (random-access read/write memory). Since the Z80 can only directly address 64K bytes, the RAM is bank-switched under the CP/M Plus (sometimes called CP/M 3.0) operating system. This provides for a 61K-byte TPA (transient program area), and all the spare memory (normally more than 100K bytes) is automatically configured as a RAM disk called drive M. The video buffer occupies its own memory bank and can only be accessed by CP/M calls.

Physically, the PCW consists of three units. The monitor unit, which looks very much like a portable television set, sits on a small pedestal and contains the power supply and all the computer components (there is no separate system unit). The detached keyboard plugs into the side of the monitor. A dot-matrix printer takes its power from a 24-volt socket on the back of the monitor, so the whole system can be fed by a single power cord.

In the top right corner of the monitor there is a 3-inch disk drive with a space below it (covered by the maker's name plate) for an optional second drive. Amstrad made the controversial decision some time ago to run with Hitachi's 3-inch microfloppies rather than Sony's 3½-inch standard that Apple, Hewlett-Packard, and Apricot have adopted. When pressed on this point, Amstrad cheerfully claims to have sold enough computers (450,000) to establish its own standard. Right now, though, the decision creates headaches in transporting old CP/M software to the new format.

The 3-inch disk looks quite similar to the now well-known 3½-inch disk, although it is rectangular rather than square. It is fully enclosed in a plastic case with an automat-

(continued)

Dick Pountain is a technical author and software consultant living in London, England. He can be contacted c/o BYTE, POB 372, Hancock, NH 03449.

ically retracting metal shutter to protect the recording surface. Amstrad uses the disks in single-headed drives with 180K bytes on each side of the disk. Each unit is therefore treated as two separate disks—it must be flipped over to access the other side—and each side needs to be formatted independently.

The green-screen monitor is unorthodox in that it can display 90 columns by 32 rows rather than the CP/M (and MS-DOS) standard of 80 columns by 24 rows. This enables you to see a lot more text on screen than usual. A utility program that comes with the system switches it to 80 columns by 24 rows for use with standard CP/M software, while another utility switches from green-on-black to black-on-green display for those (like myself) who prefer it. The monitor emulates a Zenith Z-19 terminal when installing standard CP/M software.

The display's definition is respectable, if not outstanding. It's similar to that of a decent serial terminal. The display character set is also quite good with true descenders and serifs. It uses a full 8-bit character repre-

sentation allowing 256 symbols; the extras are used as on the IBM Personal Computer to support math symbols and European language characters.

The screen is capable of dot graphics at a resolution of 720 by 248 pixels, and Digital Research's GSX (Graphics System Extension) software is bundled with the machine. In fact, as on previous Amstrad machines, video handling is completely "soft," with no distinction between text and graphics modes; all characters are bit-mapped and could be redefined by a competent system programmer. Despite this, the CP/M applications programmer sees conventional character-based output, as CP/M Plus handles all the underlying trickery.

The keyboard unit has proper keys with sculpted tops and full travel. The feel is not as good as an IBM PC's, but it is much better than the typical home computer. The keys make a hollow "boxy" sound rather like the Macintosh's. I found the spacing cramped, with no gap between the main keyboard and the special-keys pad. The keyboard has no less than

six special keys level with the space bar (i.e., below the shift keys), which also takes some getting used to. The whole keyboard is software-redefinable using a CP/M utility SETKEYS and a file of new key assignments.

The dot-matrix printer has a normal-size 80-column carriage but is very small in the fore-and-aft dimension (around half the depth of an Epson FX-80). The printer comes with a detachable tractor feed and can accept either single sheets or continuous paper.

For me the most heartbreaking feature of this printer is that its high-quality-mode output is as good as anything I can get from my Epson FX-80, which cost me almost as much as a whole PCW system. While not quite daisy-wheel quality, the text is as good as that from a portable electric typewriter, with no dots discernible. High-quality mode gives 960- by 1368-dot resolution at 20 characters per second—faster than cheap daisy-wheel units—while draft mode runs at 90 cps. The printer supports underlining (word or continuous), bold, italic, true subscripts and superscripts, and five font sizes (10, 12, 15, and 17 pitch, and proportionally spaced).

Amstrad has chosen to fully integrate the printer into the hardware and software. The disadvantage is that it is difficult to fit alternative printers. The advantage is that software control of the printer is superb. You can press a dedicated Ptr key at any time to bring up a menu from which you can control all of the printer's functions, including linefeeds, form feeds, and switching from single sheet to continuous paper. The software can even detect when the paper-bail bar is retracted and prompt you to close it. In direct print (i.e., typewriter) mode, you can control the print-head position using the cursor keys; this provides sufficient accuracy so that you are able to fill in complicated forms.

Given the outstanding price, I think that Amstrad's decision to integrate the printer was the right one. The PCW is being sold as a complete writ-

(continued)

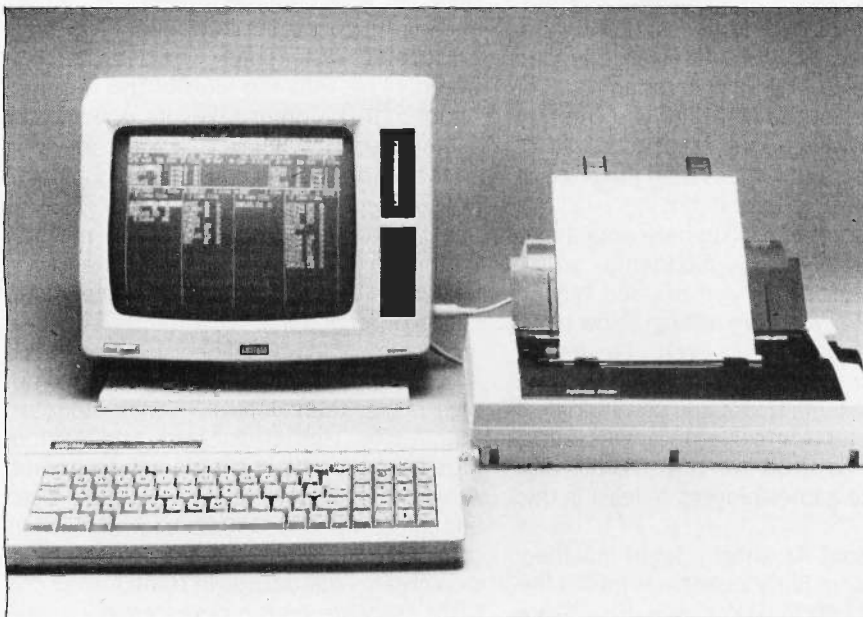

Photo 1: The new Amstrad PCW 8256 personal computer and word processor. This 256K-byte CP/M Plus computer comes complete with built-in disk drive, keyboard, monitor, letter-quality printer, and word-processing software for a price of £399 inclusive. It also can take a second built-in disk drive.



# Pick A Racehorse, A Workhorse, Or Your Choice Of Saddles

**Trying To Rope** in a pure bred PC or AT compatible computer system? Basic Time has the system you've been looking for. With more than 10 years as a computer manufacturer and distributor, Basic Time systems have the breeding it takes to be real reliable performers. That experience has created systems with carefully selected and integrated components, providing top notch performance at a surprisingly low price.

## Run With Our Racehorse-The BT/AT.

This 80286 computer with fast access drives of 20, 40, or 70Mb capacity, running at selectable 6 or 8 Mhz clock rates will run circles around the IBM™ AT. Its new system board comes standard with a full 640K of RAM and can still be expanded to 2Mb on the system board, with up to 15.5Mb directly addressable by the system. Also standard are two serial ports and a parallel port on the Basic Time system board, keeping precious I/O slots available for future expansion.

Standard features include an 84-key keyboard, 1.2Mb/360K floppy, MS-DOS and GW-BASIC. Rounding out the system is a Hercules compatible monochrome monitor (color or EGA compatible color optional). All this and more at the lowest price available for an AT compatible\*.

## Try Our Workhorse-The BT/XT.

A new standard in price/performance for an 8088 computer. 8 slots, 256k RAM, AT type keyboard, Hercules compatible monochrome monitor and adapter, 20 Meg hard disk, floppy drive, 135 Watt power supply, MS-DOS, and full PC compatibility.

## Your Choice Of Saddles.

Either horse you choose, we can outfit you completely. Our HR series monitors support monochrome, color, or EGA adapters. Communication is easy with Basic Time internal or external modems. Hard disk storage is simple and reliable with our 20Mb systems for PC's and BT44 and BT70Mb drives for AT's. Tape backup systems are available to secure your data too. Need more memory and I/O ports? The BT6Plus and AT4x4Plus multifunction boards give you unrivaled bang for your buck.

**For Information** on where to purchase Basic Time products, call or write:

**Basic Time**  
Department B  
3350 Scott Blvd.,  
Bldg. 52  
Santa Clara, Ca. 95054

(408) 727-0877

**basic time**

\*Infoworld Sept. 2, 1985, Page 1.

ing tool, and if you wish to use alternative printers, you probably should buy something else (of course, then you'll end up spending a lot more money).

There are no standard I/O (input/output) ports provided on the basic Amstrad PCW 8256. Amstrad supplies an extension unit that adds both

RS-232C serial and Centronics parallel ports.

**THE WORD PROCESSOR**

As with the original Amstrad CPC 464, software development for the PCW was done by Locomotive Software. In particular, Locomotive put up an extended version of its BASIC (called

Mallard BASIC) and the dedicated word-processing program Locoscript.

Locoscript does not run *under* CP/M Plus, but it is a turnkey program that runs straight on the machine, all disk-management activities being performed from within its own menu system. One drawback is that although Locoscript uses the CP/M physical disk format (and can read CP/M directories), it does not use standard CP/M files, so it cannot be used as the system editor.

The initial disk-manager screen displays the directories not only of the floppy and RAM drives but of the separate "groups" on each device. Groups are really CP/M-user partitions, but Locomotive has doctored the software to manage them in a more transparent and intuitive way (more like Macintosh folders). Each device can have up to eight groups on it, and each group contains the same kind of document. The group contains a file defining a template for that group (e.g., letters, memos, reports) and also a file of keyboard macros called "phrases." These utility files are automatically copied to the RAM disk when the system is booted up, although you must deliberately copy your document files to the RAM disk. The directories of all the groups are displayed in vertical columns, and the screen smooth-scrolls sideways to view them all. There is no command line. All file activities are selected by moving a reverse-video cursor block to the filename.

One useful feature is that deleted files are put into limbo; on request you may see a menu of limbo files and call them back if desired. Limbo files are eventually written over as the disk fills up, but this feature provides good insurance against disaster for the neophyte.

The large number of dedicated editing keys on the keyboard simplifies the use of Locoscript. There are keys to move through text by character, word, paragraph, page, or user-defined "unit," and to move to either end of a line. Find and Replace functions have a special key. Cut, Paste,

(continued)

# ATRON BUGBUSTERS GREASE BORLAND LIGHTNING

"If I were starting a software company again, from scratch, Atron's AT PROBE™ would be among my very first investments. Without Atron's hardware-assisted, software debugging technology, the flash of Turbo Lightning™ would be a light-year away!"

*Philippe Kahn, President, Borland*

**HOW BORLAND DOES SO MUCH, SO WELL, SO FAST**

We asked Borland International president Philippe Kahn to share his secrets for rapidly taking a good idea and turning it into rock-solid reality. How does the Borland team do so much, so well, so fast?

He begins, "I remember when Atron used the June 24, 1985 *Wall Street Journal* chart of top-selling software in an ad." [Note: At that time, seven of the top ten software packages were created by Atron customers; it's now now nine out of ten.] "Side-Kick was number four, and I let Atron quote me in saying that there wouldn't have been a SideKick without Atron's hardware-assisted debuggers.

"You might say lightning has literally struck again. Turbo Lightning made number four on *SoftSel's Hotlist* within weeks of its introduction! And again, I say we couldn't have done it without Atron debugging technology.

"Cleverly written code is, by definition tight, recursive, and terribly complex," he continues. "Without the ability to externally track the execution of this code, competent debugging becomes very nearly impossible."

Concludes Philippe, "And after Turbo Lightning was solid and reliable, Atron tuning software turned our Probes into performance analyzers. How do you think we greased our lightning?"

Philippe, along with a couple million or so of your satisfied customers, we say congratulations on yet another best-selling product. We can't wait to see what awesomely useful technology will come shooting out of Borland International next.

**HOW BUGBUSTERS KEEP YOU FROM GETTING SLIMED**

The AT PROBE is a circuit board that plugs into your PC/AT. It has an umbilical which plugs into the 80287 socket and monitors all 80286 activity.

Since AT PROBE can trace program execution in real time, and display the last 2048 memory cycles in symbolic or source-code form, you can easily answer the questions: "How did I get here?" and "What are those silly interrupts doing?"

It can solve *spooky* debugging problems. Like finding where your program overwrites memory or I/O - impossible with software debuggers.

You can even do source-level debugging in your favorite language, like C, Pascal or assembler. And after your application is debugged, the AT PROBE's performance measurement software can isolate performance bottlenecks.

Finally, the AT PROBE has its own 1-MByte of memory. Hidden and write-protected. How else could you develop that really large program, where the symbol table would otherwise take up most of memory.

**LOOK AT IT THIS WAY.**

History shows that non-Atron customers don't stand a very good chance of making the Top Ten list. Lightning really does have a way of striking twice!

The PC PROBE™ is \$1595 and the AT PROBE is \$2495. So call Atron today. You can be busting some really scary bugs tomorrow. And maybe, just like Borland, you can also bust some records.



20665 Fourth Street • Saratoga, CA 95070 • 408/741-5900

Copyright © 1985 by Atron Corp. PC PROBE™ and AT PROBE™ Atron, SideKick™ and Turbo Lightning™ Borland International, Inc. Ad: by TRUA, 408-258-2708.

# GET THE KNOW-HOW TO REPAIR EVERY COMPUTER ON THIS PAGE.

## Learn the Basics the NRI Way—and Earn Good Money Troubleshooting Any Brand of Computer

The biggest growth in jobs between now and 1995, according to Department of Labor estimates, will occur in the computer service and repair business, where demand for trained technicians will actually *double*.

You can cash in on this opportunity—either as a fulltime corporate technician or an independent serviceperson—once you've learned all the basics of computers the NRI way. NRI's practical combination of "reason-why" theory and "hands-on" building skills starts you with the fundamentals of electronics, then guides you through advanced electronic circuitry and on into computer electronics. You also learn to program in BASIC and machine language, the essential languages for troubleshooting and repair.

## You Build—and Keep—a Sanyo MBC-550-2

The vital core of your training is the step-by-step building of the 16-bit Sanyo MBC-550-2 computer. Once you've mastered the details of this state-of-the-art machine, you'll be qualified to service and repair virtually every major brand of computer, plus many popular peripheral and accessory devices.

With NRI training, you learn at your own convenience, in your own home. You set the pace—without classroom pressures, rigid night-school schedules, or wasted time. You build the Sanyo MBC-550-2 from the keyboard up, with your own personal



IBM is a Registered Trademark of International Business Machine Corporation.

Epson is a Registered Trademark of Epson America, Inc.

Apple and the Apple logo are Registered Trademarks of Apple Computer, Inc.

Compaq is a Registered Trademark of COMPAQ Computer Corporation.

© 1984 AT&T Technologies, Inc.

using machine language. You'll also prepare the interfaces for future peripherals such as printers and joysticks.

## 100-Page Free Catalog Tells More

Send the postage-paid reply card today for NRI's big 100-page color catalog on NRI's electronics training, which gives you all the facts about NRI

courses in Micro-computers, Robotics, Data Communications, TV/

Video/Audio Servicing, and other growing high-tech career fields. If the reply card is missing, write to the address below.

# AND MORE.

NRI instructor and the complete NRI technical staff ready to answer your questions or give you guidance and special help whenever you need it.

Praised by critics as the "most intriguing" of all the IBM-PC compatible computers, the new Sanyo uses the same 8088 microprocessor as the IBM-PC and features the MS/DOS operating system. As a result, you'll have a choice of thousands of off-the-shelf software programs to run on your completed Sanyo.

Your NRI course includes installation and troubleshooting of the "intelligent" keyboard, power supply, and disk drive, plus you'll check out the 8088 microprocessor functions,



Your NRI course includes the Sanyo MBC-550-2 Computer with 128K RAM, monitor, disk drive, and "intelligent" keyboard; the NRI Discovery Lab®, teaching circuit design and operations; a Digital Multimeter; Bundled Spread Sheet and Word Processing Software worth \$1500 at retail—and more.

**NRI** SCHOOLS  
McGraw-Hill Continuing Education Center  
3939 Wisconsin Avenue, NW  
Washington, DC 20016

We'll Give You Tomorrow.

and Copy keys let you rearrange the text, and there are two delete keys, Del> and <Del. These make word processing seem rather blissful after years of struggling with nonstandard backspace and delete key actions.

This excellent keyboard is not without its drawbacks for experienced computer users. The escape key is called Exit, the control key is called Alt, and Return and Enter are separate keys. The large Return key performs a typewriter-style carriage return, but you must use the Enter key to execute commands; I'll guarantee that it will take weeks for an experienced computer user's reflexes to adapt. For a first-time user, though, the arrangement is far less mysterious than the curious hodgepodge we have come to accept as the "standard" keyboard. The Exit key is used consistently to terminate operations, while a different key, Can (for cancel), will

countermand a mistaken selection.

Commands in Locoscript are selected from pull-down menus activated by function keys F1 through F8. A master menu of the current function-key assignments always appears at the top of the screen. You make menu selections either by entering the initial letter of an item or by moving the cursor, Macintosh-style. When you have gained some familiarity with the commands, you can bypass the menus by hitting the special Select and Deselect keys on either side of the space bar, followed by any recognizable abbreviation for the command. If your abbreviation is too short to be unique (e.g., R could stand for reverse or right-justify), then a shortened menu containing only those options that could fit will be displayed—very smart indeed.

Locoscript has great formatting capabilities. You can introduce new

formats, called layouts, at any point in the text, and they take effect on all the text below them until they are overridden by another new layout. A layout includes the margin and tab settings, type pitch and style, and line spacing and justification parameters. You can create a new layout by editing on screen from a pull-down menu; this layout is then assigned a number and stored in memory. Henceforth, you can insert that layout like any other attribute by entering a single code into the text.

If you modify an existing layout, the changes you make automatically take effect everywhere you have used that format; the layouts used are automatically saved with the document. As the cursor enters the zone of a new layout, the layout number is displayed along with other status information at the top of the screen. I found this feature more powerful and easier to use than Microsoft Word's style sheets.

The Show menu controls whether attribute codes, layout ruler lines, and other nontext items are visible. You can have spaces visible as dots, Wang-writer-style, and carriage returns shown as bent arrows. The attribute codes are words rather than cryptic control codes. For example, boldface is indicated by + Bold to select and - Bold to deselect, and a layout might appear as + Layout3. Only underlining is shown as such on the screen.

Locoscript is an inserting editor with wordwrap and it features semiautomatic reformatting. The text is reformatted from the cursor position onward whenever you issue a movement command, so the screen always reflects the current state of the document.

The down side of the story lies in the speed of some of its functions. I ran the BYTE word-processing benchmarks on Locoscript using a standard 23K-byte document with the results shown in table 1.

The times for Document Save and Search are excruciatingly slow, while the times for Document Load and Scroll compare well with WordStar

(continued)

**SUNDAY 10-5**

**PROMPT DELIVERY**

**COMPUTERS, PRINTERS, DISK DRIVES, MODEMS, MONITORS, ACCESSORIES, FURNITURE & EXPERIENCE**

**GUARANTEED LOWEST PRICES**

**COMPUTER: 1-800-874-1235**

**VIDEO: 1-800-223-6779**

**COMPUTER: (718) 237-2828**

**S'nW ELECTRONICS & APPLIANCES**

**633 Bedford Ave, Bklyn, NY 11211**

**TOLL FREE OUT OF N.Y.**

**IN N.Y. CALL (718) 237-2828**

**HOURS: Mon.-Thurs. 9-6**

**Fri. 9-2, Sun. 10-5, Sat. Closed**

**C.D.D. Accepted**

**Credit Card Accounts charged at time of order**

**Add Ship. Hand. Fees**

**Prices Subject to change without notice**

**Qty. Limited**

**Not responsible for typographical errors**





# IBM COMPATIBILITY

...at a not so IBM price

## TECH TURBO PC/AT \$2399

### PRICE INCLUDES:

- 6 TO 8 MHZ 80286 CPU
- 512K
- ONE, 1.2 MB FLOPPY DRIVE
- 8 EXPANSION SLOTS
- 195 WATT POWER SUPPLY
- COMPLETE MS DOS, PC DOS, XENIX COMPATIBILITY
- RUNS LOTUS 123, DBASE III FRAMEWORK AND ALL OTHER POPULAR AT SOFTWARE
- ONE YEAR WARRANTY!!

### OPTIONS:

TECH TURBO PC/AT WITH 20MB HARD DISK **\$2825**

TECH TURBO PC/AT WITH 20MB HARD DISK, MONOCHROME MONITOR, HERCULES® COMPATIBLE MONO/GRAPHICS CARD **\$2999**

ALSO AVAILABLE WITH TAPE BACKUPS, MODEMS, LARGER HARD DISKS, AND NETWORKING SYSTEMS.

## TECH PC/AT \$1999

### PRICE INCLUDES:

- 6MHZ 80286 CPU
- 512K
- ONE, 1.2 MB FLOPPY DRIVE
- 8 EXPANSION SLOTS
- 195 WATT POWER SUPPLY
- COMPLETE MS DOS, PC DOS, XENIX COMPATIBILITY
- RUNS LOTUS 123, DBASE III FRAMEWORK AND ALL OTHER POPULAR AT SOFTWARE.
- ONE YEAR WARRANTY!!

### OPTIONS:

TECH PC/AT WITH 20 MB HARD DISK **\$2499**

TECH PC/AT WITH 20MB HARD DISK, MONOCHROME MONITOR, HERCULES® COMPATIBLE MONO/GRAPHICS CARD **\$2699**

ALSO AVAILABLE WITH TAPE BACKUPS, MODEMS, LARGER HARD DISKS, AND NETWORKING SYSTEMS.

## TECH TURBO PC/XT \$1099

### PRICE INCLUDES:

- 4 TO 7 MHZ SOFTWARE SWITCHABLE CPU
- 640K
- TWO 360K DS/DD FLOPPY DISK DRIVES
- 8 EXPANSION SLOTS
- 135 WATT POWER SUPPLY
- ONE YEAR WARRANTY!!

### OPTIONS:

TECH TURBO PC/XT WITH 20MB HARD DISK **\$1699**

TECH TURBO PC/XT WITH 20MB HARD DISK, MONOCHROME MONITOR AND HERCULES COMPATIBLE MONO/GRAPHICS CARD **\$1950**

ALSO AVAILABLE WITH TAPE BACKUPS, MODEMS, LARGER HARD DISKS, AND NETWORKING SYSTEMS.

## TECH PC/XT \$799

### PRICE INCLUDES:

- 4.77 MHZ CPU
- 256K
- TWO, 360K DS/DD FLOPPY DRIVES
- 8 EXPANSION SLOTS
- 135 WATT POWER SUPPLY
- ONE YEAR WARRANTY!!

### OPTIONS:

TECH PC/XT WITH 20MB HARD DISK **\$1449**

TECH PC/XT WITH 20MB HARD DISK, MONOCHROME MONITOR, HERCULES COMPATIBLE MONO/GRAPHICS CARD **\$1649**

ALSO AVAILABLE WITH TAPE BACKUPS, MODEMS, LARGER HARD DISKS, AND NETWORKING SYSTEMS.

HI-TEK PGS AVT TAXAN IBM AMDEK HERCULES GENOA PARADISE TEAC TOSHIBA HARDWARE/SOFTWARE NETWORKING HAYS AST JRAM HI-TEK PGS AVT TAXAN AMDEK HERCULES GENOA PARADISE TEAC TOSHIBA  
PLEASE ALLOW ONE WEEK FOR SHIPPING VISA, MASTERCHARGE  
TELEX: 272006 Answer Back-TECH FAX: 714/556-8325

# TECH PC

TECH PERSONAL COMPUTERS  
2131 South Hathaway, Santa Ana, California 92705

## 714/754-1170

©1985 TECH PC \*IBM, IBM PC, XT, and AT are registered trademarks of International Business Machines Corp. \*Hercules is a registered trademark of Hercules Computer Technology

Inquiry 341 for End-Users. Inquiry 342 for DEALERS ONLY.

and other programs. Slow saving is particularly dangerous, as it discourages frequent safety backups. The small difference between RAM drive and floppy timings indicates that the problem lies in the program itself and is not significantly I/O-bound. The PCW's disk system can physically copy a 23K-byte file in 9 seconds. The root cause of the speed problem is the internal representation used to hold text, which involves traversing a linked list, and it is the price you pay for great flexibility of layout and formatting. In practice it means that LocoScript is usable for letters and short documents up to 5K bytes, but not really for books or theses. You could run WordStar as an alternative, but that would be a shame, since LocoScript is so superior in every other way.

**SYSTEM SOFTWARE**

CP/M Plus is the latest version of the famous 8-bit operating system that many of us grew up with. It fixes most of what was wrong with CP/M 2.2 and adds features that make it feel more like MS-DOS. For example, you no longer need to hit Control-C after changing a disk, you can edit command lines, and the error trapping is almost civilized. CP/M Plus came along just as the IBM PC was transforming the personal computer market, and very few implementations became available. The Amstrad might draw some new attention to CP/M Plus. It is certainly a grown-up operating system, and there are lots of serious programs available that will be able to run under it—just about any-

thing that will run under CP/M 2.2—when the disk-format problem is cracked. I tried out Caxton Software's (10 Bedford St., London W1, England) range of programs, including Cardbox and Brainstorm and the SmartKey keyboard enhancer, and they all ran immediately.

The PCW version of CP/M Plus includes the GSX software and a bunch of programmer tools, including the RMAC macro assembler, SID debugger, XREF cross-referencer, and loads of utilities. You also get Mallard BASIC and Digital Research's Dr. Logo bundled in for your £399. The latter is a first-class implementation of Logo that looks particularly nice on the PCW's high-resolution graphics screen.

Mallard BASIC is business-oriented and differs from earlier Amstrad BASICs that were home-computer-oriented with lots of color and sound commands. (Incidentally, the name Mallard refers to a famous British railway locomotive that held the world speed record.) Mallard is a large superset of MBASIC version 5.2, and its claim to fame lies in a keyed file-management extension called Jetsam. Jetsam provides indexed sequential and random file accesses with file and record locking. You can use the keyed file-management extension to write multiuser database programs, although you can't use it under the single-user CP/M Plus.

To get some impression of its speed—Mallard is, after all, an illustrious name to live up to—I ran the BYTE BASIC benchmarks. The results that I obtained were consistently 25 percent

faster than the results of BASICA on an IBM PC.

**CONCLUSION**

The Amstrad PCW 8256 is a first-rate CP/M computer, regardless of price. Once you consider the price and the included software, it becomes an astonishing bargain. Amstrad has blown the whistle on the pricing policies and the profit margins of other manufacturers.

The PCW should appeal to two completely different groups of users. A large number of first-time users will be attracted by the price and will consider using the PCW as an alternative to an electric typewriter. These first-time users will find LocoScript easy to use and the printer capable of excellent-quality output. Users who are writers intending to use the Amstrad to write books may want to consider an alternative CP/M editor such as WordStar, Perfect Writer, or Final Word.

On the other hand, computer enthusiasts who wish to upgrade from a home computer to a serious machine will find that the PCW can meet almost any of their needs. Also, impoverished scientific and technical users will find the PCW to be a capable machine.

The hardware and CP/M Plus operating system provide plenty of scope for adventurous programming, and you can have the total system for less than the price of upgrading a Commodore 64 to a by-no-means-equivalent specification. Put Turbo Pascal on it and you have serious computing at a sensible price.

As 32-bit processors and multi-megabyte memories crowd into the marketplace, it is easy to forget that a machine like the Amstrad has all the computing power that many single users will ever need, plus a software base that includes compilers and applications that were state-of-the-art only a couple of years ago.

Amstrad is keeping quiet about transatlantic plans at present, but by the time this column is published, I wouldn't be surprised to see the PCW announced in the U.S. ■

*Table 1: The results of LocoScript on the BYTE word-processing benchmarks using a standard 23K-byte document. The results of WordStar on an IBM PC is shown for comparison.*

	LOCOSCRIPT		WORDSTAR
	Floppy Drive	RAM Drive	IBM PC Floppy
Document Load	11 seconds	9 seconds	10 seconds
Document Save	143 seconds	119 seconds	25 seconds
Search	292 seconds	265 seconds	11 seconds
Scroll	65 seconds	62 seconds	41 seconds

# Princeton Graphic Systems Number One Again

Sharp resolution, full compatibility, and rugged reliability. That's what you get in every Princeton Graphic Systems monitor. That's why Princeton Graphic Systems is number one in the minds of more and more personal computer owners every year.

Only Princeton Graphic Systems offers a complete family of quality personal computer

displays. Our color and monochrome monitors outperform the competition every time. That's why, for the second year in a row, our HX-12 high resolution color monitor has been voted best in the world.\*

So for the very best in personal computer monitors, pick the company that's number one. Princeton Graphic Systems.

\*PC WORLD Magazine's 1985 World Class Survey.

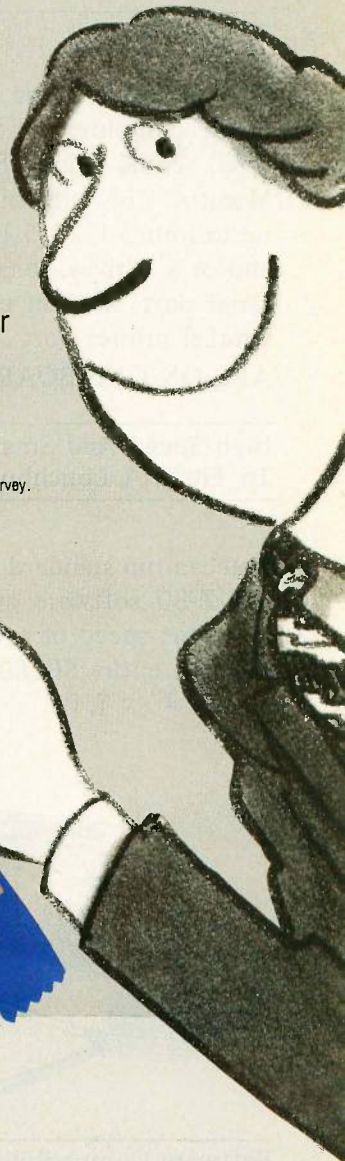

## PRINCETON®

GRAPHIC SYSTEMS  
AN INTELLIGENT SYSTEMS COMPANY

601 Ewing Street, Bldg. A, Princeton, NJ 08540, (609) 683-1660, Telex: 821402 PGSPRIN, (800) 221-1490 Ext. 704

# The SB180 Computer Reasserts 8-Bit Computing In A 16-Bit World

**Y**ou're one of the few heroes left. The stalwart CP/M user who's held the fort despite all the odds against you – a slow, bulky system that can't seem to compete against today's 16-bit computers. Well, help has finally arrived.

**IT'S THE SB180 COMPUTER.**

The SB180 is a true single-board computer: A CMOS CPU, 256K Ram, 8K ROM Monitor, disk controller for up to four 3 1/2", 5 1/4" and/or 8" drives, console serial port, modem port parallel printer port . . .  
**ALL ON ONE BOARD**

## High Speed And Small Enough To Fit In A Lunchbox

You can run standard 8080/8085 and Z-80 software at up to twice the speed of a 4MHz Z-80. And the entire SB180 package is only 4" x 7 1/2".

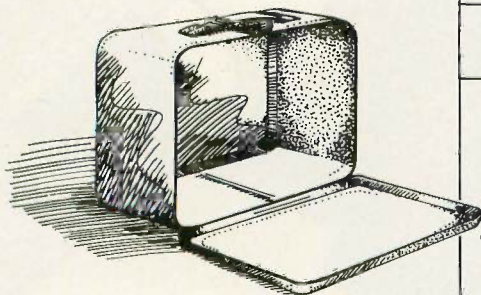

## Software Compatibility With The World

Any of the thousands of application programs, languages or utilities which run under CP/M will also run on the SB180.

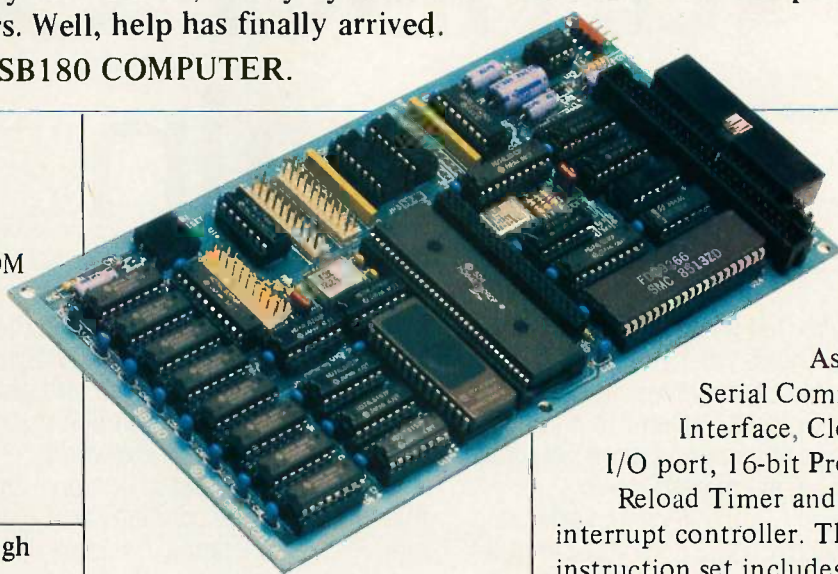

Asynchronous Serial Communications Interface, Clocked Serial I/O port, 16-bit Programmable Reload Timer and a 12 source interrupt controller. The expanded instruction set includes hardware multiply and a sleep instruction for low power standby operation.

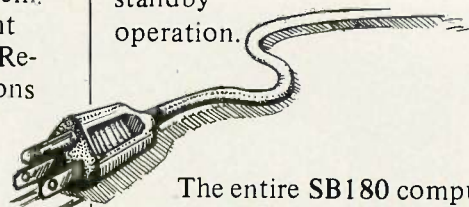

The SB180's Z-System is an enhanced 8-bit operating system. It is a complete replacement for CP/M 2.2 from Digital Research, yet provides functions and facilities similar to MS-DOS and UNIX.

## Reduced System Cost And Low Power Operation

The SB180 uses the most powerful of the new generation 8-bit CPU's – the Hitachi HD64180.

The chip is based on a micro-coded execution unit and advanced CMOS manufacturing technology.

System costs are reduced because many key functions have been included on-chip: Memory Management Unit, Direct Memory Access Controller, wait state generator, dynamic RAM refresh,

The entire SB180 computer with 256K bytes RAM and the 8K ROM monitor is only \$369.00. If you want ZCPR3, ZRDOS, ROM and BIOS sources, the whole package comes to \$499.00.

Quantity discounts are also available. Dial toll free 1-800-635-3355 to order the SB180. For technical information write us at 25 Terrace Drive, Vernon, CT 06066 or call 1-203-871-6170. (Telex: 643331)

So call now, and say you're a CP/M user who's ready for reinforcements.





# M·A·T·H·E·M·A·T·I·C·A·L R·E·C·R·E·A·T·I·O·N·S

## Diophantine Equations

### Finding whole-number solutions to equations

BY ROBERT T.  
KUROSAKA

**A** man buys some  $x$ 's at \$154 each and some  $y$ 's at \$69 each. If he spends a total of \$5000, how many of each did he buy?

Although this problem appears to be from a first-year algebra text, we find that the techniques required are not usually found in a "mainstream" course in mathematics. The equation  $154x + 69y = 5000$  has infinitely many solutions. However, assuming the man bought whole-number quantities, we want *integral* solutions  $(x,y)$  for the equation, and now we need a method for solving such equations.

#### DIOPHANTINE EQUATIONS

Equations of the form  $ax + by = c$ , for integral  $a$ ,  $b$ , and  $c$  and integral solutions  $(x,y)$ , are called Diophantine equations. No one is certain when or where Diophantus of Alexandria was born. Sources vary from "born about A.D. 50" to "flourished about A.D. 250." He is called "the father of algebra," having promoted algebraic notation and algebraic treatment of mathematical problems. Previously, such work was done by "rhetorical algebra" or geometric proofs.

A variety of methods are available for solving Diophantine equations. One of these is modulo arithmetic, a powerful and fascinating concept that I may explore more closely in a future column.

A very simple method of solving our original problem comes to mind. Since the equation is equivalent to  $y = (5000 - 154x)/69$ , we can simply try consecutive values of  $x$  (from 1 to 32 only) until we get an integral value for  $y$ .

Since we are mathematically inclined, such an inelegant approach may not sit well with us. Rather, we may prefer to look for a method of solution based on general principles of mathematics. What can we say in general about integral solutions for an equation of the form  $ax + by = c$ ?

First, we can readily see under what conditions the equation would have no solu-

tion. Consider the greatest common denominator (GCD) of  $a$  and  $b$ . We will call it  $d$ . If  $d$  is not a factor of  $c$ , the equation will have no integral solutions. Why? Since  $ald$  is, by hypothesis, an integer and  $b/d$  is also one, the value  $(ald)x + (b/d)y$  will be an integer if  $x$  and  $y$  are integers. That is, the integers are *closed* under addition and multiplication. Thus, if  $c/d$  is not an integer, either  $x$  or  $y$  must not be an integer.

#### DIOPHANTUS MEETS EUCLID

This leads us to Euclid's algorithm, which was the subject of my last column in January (page 397). If we employ Euclid's algorithm to determine the GCD of  $a$  and  $b$ , we can immediately determine whether there are integer solutions to the Diophantine equation by dividing the GCD into  $c$ . But we can use Euclid's algorithm for much more than that. To see how, let us reexamine the algorithm with an eye toward solving Diophantine equations. Figure 1 outlines the way the Euclidean algorithm finds the GCD of 154 and 69. Their GCD is 1, meaning that the two numbers are relatively prime. Now, to begin our examination of the way to solve Diophantine equations, let's modify our original equation to  $154x' + 69y' = 1$ . That is, we will begin with the case where  $c$  is equal to the GCD.

In figure 2, I have rewritten the divisions of figure 1 as equations. In order to find integer values of  $x'$  and  $y'$  that solve the equation  $154x' + 69y' = 1$ , all I need to do is substitute  $154 - 2(69)$  for 16 in equations 2 and 3 and  $69 - 4(154 - 2(69))$  for 5 in equation 3. After collecting terms, I find that  $1 = 13(154) - 29(69)$ . Thus,  $x' = 13$ ,  $y' = -29$  will satisfy the equation  $154x' + 69y' = 1$ . We will call  $(13, -29)$  the *basic solution* to  $154x' + 69y' = 1$ . Is it the *only* solution?

Let us write our equation in the general form again:  $ax + by = c$ . Now, let  $n$  be any integer and  $d$  be the GCD of  $a$  and  $b$ . If we add 0 to the left-hand side of the equation, we haven't changed it, so  $ax + by + (nabd -$

(continued)

Robert T. Kurosaka teaches mathematics in the Massachusetts State College system. He invites your correspondence to BYTE, POB 372, Hancock, NH 03449.

$nabd) = c$ . Rearranging,  $ax + nabd + by - nabd = c$ . Collecting terms,  $a(x + nbd) + b(y - nbd) = c$ . So, once we have the basic solution for  $x$  and  $y$ , we can generate an infinite number of  $x$ 's and  $y$ 's that satisfy the equation by selecting any integer  $n$ , multiplying it by  $bd$ , and adding it to the basic solution value of  $x$  while we multiply  $n$  by  $ad$  and subtract it from the basic solution  $y$ . In the case of  $154x' + 69y' = 1$ , where the basic value of  $x'$  is 13, the

basic value of  $y'$  is  $-29$ , and  $d$  is 1, any set of numbers  $(x', y')$  such that  $x' = 13 + n(69)$  and  $y' = -29 - n(154)$  will satisfy the equation.

So far, I have shown two things. First, if  $c$  is not a multiple of the GCD of  $a$  and  $b$ , there is no solution to the Diophantine equation. Second, if  $c$  equals the GCD of  $a$  and  $b$ , the Euclidean algorithm will provide a path for finding all integer solutions of  $x$  and  $y$ . But what if  $c$  is a multiple of the

GCD of  $a$  and  $b$ ?

We have let  $d$  equal the GCD of  $a$  and  $b$ . We will now introduce one last letter,  $e$ , such that  $e = cd$ . Then,  $c = de$ . Since  $ax' + by' = d$  and  $c = de$ ,  $e(ax' + by') = de = c$ . Thus,  $x = x'e$ ,  $y = y'e$ , and  $a(x'e) + b(y'e) = c$ . That is, to solve the equation  $ax + by = c$ , we solve the equation  $ax' + by' = d$ , find  $e$  such that  $e = cd$ , and multiply  $x'$  by  $e$  and  $y'$  by  $e$  to find the basic solution of  $ax + by = c$ . Listing 1 (available for downloading from BYTenet Listings at (617) 861-9764 or on disk [see page 358]) provides a BASIC program that prompts you to enter the Diophantine equation, checks to make sure that there are integer solutions, and then prints out the basic solutions for  $x$  and  $y$ , the GCD of  $a$  and  $b$ , and the parametric equations for obtaining all integer solutions to the Diophantine equation (see figure 3). Other than the Euclidean algorithm that was discussed last time, the program is just a lot of bookkeeping, so I won't bother discussing it here.

### LESS IS MORE

What's that? The man in our starting problem didn't buy a negative number of  $x$ 's or  $y$ 's? Okay, we're almost done. For  $154x + 69y = 5000$ ,  $a = 154$ ,  $b = 69$ ,  $c = 5000$ ,  $d = 1$ ,  $e = 5000$ ,  $x' = 13$ , and  $y' = -29$ . Thus,  $x = 13(5000)$ , or 65,000, and  $y = -29(5000)$ , or  $-145,000$ . The parametric equation for all  $x$  solutions is  $x = 65,000 + 69n$ ; for  $y$ ,  $y = -145,000 - 154n$ . Since both  $x$  and  $y$  must be greater than 0, we can write  $0 < 65,000 + 69n$  for  $x$  and  $0 < -145,000 - 154n$  for  $y$ . Thus,  $n < -65,000/69$  and  $n < 145,000/(-154)$ . Combining and simplifying,  $-941.56 > n > -942.03$ . Therefore,  $n = -942$  and  $x = 65,000 - 69(942)$ , or 2, and  $y = -145,000 + 154(942)$ , or 68. Writing a program to handle inequalities is kind of a pain, so I'll leave that as an exercise for you (don't you wish you were a columnist?).

### MAIL CALL

I have been receiving a lot of interesting mail recently. Professor Gernot

(continued)

To find the GCD of 154 and 69 by the Euclidean algorithm:

1. Divide 154 by 69.
 

2
69
┌
154
├
138
└
16
2. Divide the divisor by the remainder.
 

4
16
┌
69
├
64
└
5
3. Repeat step 2 until the remainder is 0.
 

3
5
┌
16
├
15
└
1
4. The GCD is the last nonzero remainder, or 1.
 

5
1
┌
5
├
5
└
0

Figure 1: The Euclidean algorithm is illustrated with the numbers 154 and 69.

Rewrite the divisions of figure 1 as equations:

1.  $16 = 154 - 2(69)$
2.  $5 = 69 - 4(16)$
3.  $1 = 16 - 3(5)$

Substitute  $154 - 2(69)$  for 16:

2.  $5 = 69 - 4(154 - 2(69))$
3.  $1 = 154 - 2(69) - 3(5)$

Substitute  $69 - 4(154 - 2(69))$  for 5:

3.  $1 = 154 - 2(69) - 3(69 - 4(154 - 2(69)))$

Collect terms to find the basic solution to  $154x + 69y = 1$ :

3.  $1 = 13(154) - 29(69)$

Figure 2: How to use the Euclidean algorithm to find basic solutions to Diophantine equations.

# We've gone to great widths to make you look good.

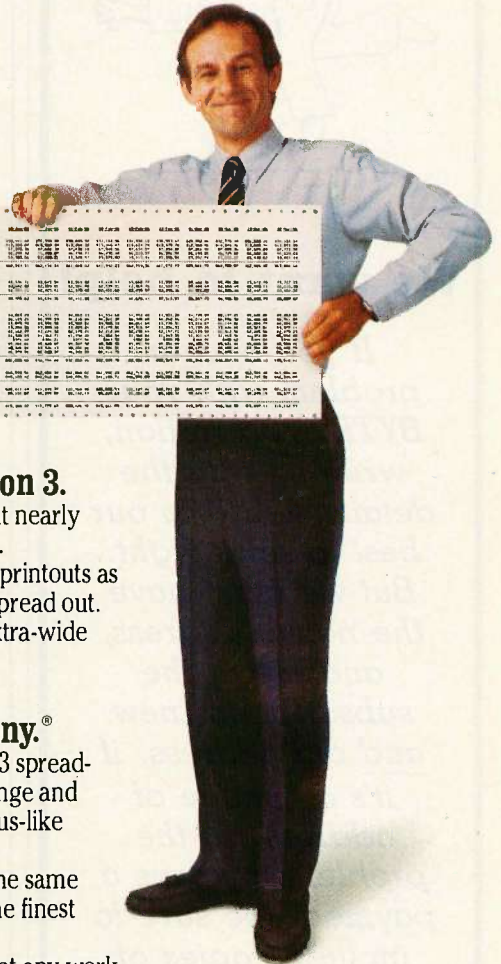

## Introducing New SIDEWAYS™ Version 3.

Sideways has always been the favorite way to print nearly everything that's too wide for a printer. Not surprising.

It's quick. It's easy. And it makes clean, one-piece printouts as wide as you like. So you get spreadsheets that really spread out. Pert charts that peer far into the future. All kinds of extra-wide reports without staples, glue or tape.

But now Sideways Version 3 goes even further.

## Especially for 1-2-3™ and Symphony.®

Now you can make short work of those wide 1-2-3 spreadsheets. No need to make print files. Just highlight a range and print right from your worksheet file using familiar Lotus-like menus.

Mix bold, underlined and expanded type, all on the same page. Print through or skip over perforations. Make the finest extra-wide printouts this side of typesetting.

Using Symphony? Sideways chimes right in to print any worksheet you've loaded without ever leaving your Symphony session.

## No matter what software you use.

Spreadsheets, databases, word processors, project planners. Whatever you use, you'll get more out of new Sideways.

Choose from nine different type sizes, from "minuscule" to "mammoth." Print bold, underlined or expanded - whatever your software can create. Even foreign language and line-drawing characters. Plus, there are so many ways to adjust margins, spacing and page size, it stretches the imagination.

Sideways Version 3 for the IBM® PC and all popular dot-matrix printers. Available now at computer dealers nationwide. Or directly from Funk Software with your check, Visa or Mastercard.

At just \$69.95 a copy, you'll never want for width again.



Funk Software, 222 Third Street, Cambridge, MA 02142. Phone (617) 497-6339.

Copyright 1985, Funk Software, Inc. Sideways is a trademark of Funk Software. Lotus, 1-2-3 and Symphony are registered trademarks of Lotus Development Corp.

# Subscription Problems?



## We want to help!

*If you have a problem with your BYTE subscription, write us with the details. We'll do our best to set it right. But we must have the name, address, and zip of the subscription (new and old address, if it's a change of address). If the problem involves a payment, be sure to include copies of the credit card statement, or front and back of cancelled checks. Include a "business hours" phone number if possible. We'll respond A.S.A.P.*

**BYTE**

Subscriber Service  
P.O. Box 328  
Hancock, NH 03449



## INTEGRAL SOLUTIONS

Listing 1: A BASIC program to solve Diophantine equations.

```

10 *****
20 **          DIOPHANTINE EQUATION SOLVER          *
30 **          BY BOB KUROSAKA                      *
40 *****
50 CLS
60 PRINT "This program solves equations of the form AX + BY = C,"
70 PRINT "where A, B, C, X, and Y are all integer values."
80 PRINT :PRINT "Enter your equation as shown in the general form."
90 PRINT "For example, enter 154X + 69Y = 5000 or 154X - 69Y = 5000."
100 PRINT "Do not enter negative coefficients with parentheses."
110 PRINT "That is, do NOT enter 154X + (-69Y) = 5000."
120 PRINT :PRINT "The program will not work properly for the degenerate case"
130 PRINT "where either A or B is 0."
140 PRINT :INPUT "Enter equation";EQUATION$:A$=EQUATION$
150 REM DEFINE A READABLE FUNCTION FOR DISCARDING LEFTMOST
    CHARACTERS.
160 DEF FNDROP.LEFT$(A$)=RIGHT$(A$,LEN(A$)-1)
170 REM PARSING ROUTINE
180 A=VAL(A$)
190 IF A=0 THEN A=1:IF LEFT$(A$,1)="-" THEN A=-1
200 A$=FNDROP.LEFT$(A$)
210 DISCARD$=LEFT$(A$,1)
220 WHILE DISCARD$<>"+" AND DISCARD$<>"-"
230     A$=FNDROP.LEFT$(A$)
240     DISCARD$=LEFT$(A$,1)
250 WEND
260 B=VAL(A$)
270 IF B=0 THEN B=1:IF DISCARD$="-" THEN B=-1
280 WHILE DISCARD$<>"="
290     A$=FNDROP.LEFT$(A$)
300     DISCARD$=LEFT$(A$,1)
310 WEND
320 A$=FNDROP.LEFT$(A$)
330 C=VAL(A$)
340 IF A<>INT(A) OR B<>INT(B) OR C<>INT(C) THEN PRINT "NOT A
    DIOPHANTINE EQUATION":GOTO 760

350 REM END OF PARSING ROUTINE
360 REM EUCLIDEAN ALGORITHM FOR FINDING GCD.
370 REM FIRST, INITIALIZE THE TERMS FOR THE ALGORITHM
380 IF ABS(A)>=ABS(B) THEN DIVIDEND=A:DIVISOR=B
390 IF ABS(A)<ABS(B) THEN DIVISOR=A:DIVIDEND=B:SWAP.XY$="YES"
400 REM USE 'FIX' INSTEAD OF 'INT' TO TRUNCATE RATHER THAN ROUND
    NEGATIVE #s.
410 QUOTIENT=FIX(DIVIDEND/DIVISOR)
420 REMAINDER=DIVIDEND-DIVISOR*QUOTIENT
430 REM X1=ONGOING COUNT OF X', Y1=ONGOING COUNT OF Y'. YOU
    CAN KEEP TRACK OF ALL ONGOING COUNTS BY USING ONLY THE
    PREVIOUS TWO VALUES FOR X' AND Y', SO WE NEED ONLY X1, X2, X3,
    AND Y1, Y2, Y3.
440 X1=1:Y1=-QUOTIENT
450 REM IF EITHER A OR B IS AN EVEN MULTIPLE OF THE OTHER, THEN
    EITHER X' OR Y' WILL EQUAL 1 WHILE THE OTHER EQUALS 0.
460 IF REMAINDER=0 THEN X2=0:Y2=1:GOTO 620
470 DIVIDEND=DIVISOR:DIVISOR=REMAINDER
480 QUOTIENT=FIX(DIVIDEND/DIVISOR)
490 REMAINDER=DIVIDEND-DIVISOR*QUOTIENT
500 X2=-QUOTIENT*X1:Y2=1-QUOTIENT*Y1
510 REM IF A GCD IS FOUND ON THE SECOND ITERATION OF THE
    EUCLIDEAN ALGORITHM, THEN X'=X1, Y'=Y1. IN ALL
    SUBSEQUENT CASES, X'=X2, Y'=Y2.
520 IF REMAINDER=0 THEN X2=X1:Y2=Y1:GOTO 620

```

(continued)



# "NOW IN OUR 8TH YEAR"

## THE WORLD OF PC UPGRADES

### FREE

5 Mega Bytes Of software with the purchase of any P.C. hard disk

PC HARD DISK



10 Mbyte  
IS10 \$495

PC HARD DISK



20 Mbyte  
IS20 \$545

PC HARD DISK



30 Mbyte  
IS30 \$895

TANDY 1000  
MULTI-FUNC BOARD



TMF-1 \$255

CASH ASSIST



SPEEDS  
DISK  
ACCESS

\$49.95

DIRECT ASSIST  
SIMPLIFIES  
DOS  
OPERATIONS



\$49.95

COMMAND ASSIST



DOS  
MANUAL  
ON  
DISK

\$49.95

INTERNAL  
TAPE BACKUP



10 Mbyte  
MT10 \$385

PORTABLE  
TAPE BACKUP



10 Mbyte  
MT10P \$525

INTERNAL  
TAPE BACKUP

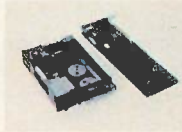

60 Mbyte  
MT60 \$895

DESK TOP  
TAPE BACKUP

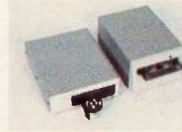

MT10E \$575  
MT60E \$995

AT HARD DISK



20 Mbyte  
AT20 \$545

AT HARD DISK



33 Mbyte  
AT33 \$750

AT HARD DISK



70 Mbyte  
AT70 CALL

PC/AT HARD DISK

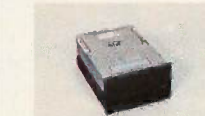

120 Mbyte  
AT120 \$4,995

ORDER LINE **800-228-0891**  
**305-677-8333**



## Micro Design International Inc.

6566 University Boulevard, Winter Park, Florida 32792 (305) 677-8333 TELEX 332559 MDII QRL UD

1 YEAR WARRANTY, 30 DAY MONEY BACK GUARANTEE ON ALL OUR PRODUCTS

```

530 REM THE FIRST TWO ITERATIONS ARE THE ONLY ONES THAT DO NOT
    FOLLOW THE PATTERN: X(N)=X(N-2)-QUOTIENT*X(N-1),
    Y(N)=Y(N-2)-QUOTIENT*Y(N-1).
540 WHILE REMAINDER<>0
550   DIVIDEND=DIVISOR:DIVISOR=REMAINDER
560   QUOTIENT=FIX(DIVIDEND/DIVISOR)
570   REMAINDER=DIVIDEND-DIVISOR*QUOTIENT
580   IF REMAINDER=0 THEN GOTO 610
590   X3=X1-QUOTIENT*X2:Y3=Y1-QUOTIENT*Y2
600   X1=X2:X2=X3:Y1=Y2:Y2=Y3
610 WEND
620 REM CALCULATE BASIC SOLUTION FOR AX + BY = C FROM GCD
    RESULTS, WHICH HAVE PROVIDED AX' + BY' = D BASIC
    SOLUTION.
630 D=DIVISOR:E=C/D
640 IF C/D<>INT(C/D) THEN PRINT "NO INTEGER SOLUTIONS.":GOTO 760
650 IF SWAP.XY$="YES" THEN SWAP X2,Y2
660 PRINT "The basic solution to the Diophantine equation,"
670 PRINT EQUATIONS$," is:"
680 PRINT "X = ";X2*E:PRINT "Y = ";Y2*E
690 PRINT "The GCD of ";A;" and ";B;" is:";ABS(D)
700 PRINT "The parametric equations for all integer answers is:"
710 PRINT "X = ";X2*E;":IF B/D>0 THEN PRINT " + ";
720 PRINT B/D;"N, and"
730 PRINT "Y = ";Y2*E;":IF A/D<0 THEN PRINT " + "; ELSE PRINT " - ";
740 PRINT ABS(A/D);"N"
750 PRINT "for all integer values N."
760 END
    
```

This program solves equations of the form  $ax + by = c$ , where  $a$ ,  $b$ ,  $c$ ,  $x$ , and  $y$  are all integer values.

Enter your equation as shown in the general form. For example, enter  $154x + 69y = 5000$  or  $154x - 69y = 5000$ . Do not enter negative coefficients with parentheses. That is, do *not* enter  $154x + (-69y) = 5000$ .

The program will not work properly for the degenerate case where either  $a$  or  $b$  is 0.

```

Enter equation? 74x+85y=1
The basic solution to the Diophantine equation,
74x+85y=1 is
x = -31
y = 27
The GCD of 74 and 85 is 1.
The parametric equations for all integer answers are
x = -31 + 85n and
y = 27 - 74n
for all integer values n.
    
```

Figure 3: A screen dump of the program in listing 1 solving a Diophantine equation.

Metze of the University of Illinois at Urbana-Champaign stunned me with this concept: Use  $\phi$ , the Golden Mean, as a number base. (I will wait while you catch your breath.)

The system uses the digits 0 and 1 and is based on the identity  $\phi^2 = \phi$

+ 1. In order to get a feel for what he has to say, we should take a brief excursion into another way of using the Euclidean algorithm: representing numbers as continued fractions. Figure 4a shows how to represent  $154/69$  as a continued fraction. You

One interesting

letter suggested

using the Golden

Mean as a number

base by employing

the identity

$$\phi^2 = \phi + 1.$$

just collect all the quotients from the Euclidean algorithm (2, 4, 3, 5) and stack them as shown in the figure. Any rational number can be expressed as a finite continued fraction. Now,  $\phi = (1 + \sqrt{5})/2$ , and  $\sqrt{5}$  is irrational. Its continued fraction will be infinite but regular (see figure 4b). When we "add" the continued fractions for  $1/2$  and  $\sqrt{5}/2$ , we get the continued fraction for  $\phi$  in figure 4c.  $\phi$  turns out to be the simplest continued fraction,  $(\bar{1})$ . Back to Professor Metze.

The identity  $\phi^2 = \phi + 1$  means that "100" = "011" in the  $\phi$ -nary system, and these two patterns can be interchanged anywhere in a  $\phi$ -nary number. For example,  $10011 = 10100$  (the rightmost "011" becomes "100"), and  $1110 = 10010$  (the leftmost "011" becomes "100"). That is, the final representation need not contain consecutive 1s.

You may want to try to construct an addition table in base  $\phi$ , but some mental agility is required. Our first snag is "1 + 1." How do we "carry" in this system? Since  $1 = 1.00 = 0.11$  (remember the pattern switch?), we can proceed:  $1 + 1 = 1.00 + 1.00 = 1.00 + 0.11 = 1.11$ , which can be rewritten as  $10.01$ , and we have found "2"! You may wish to verify that  $10.01 = 2$ , that is, that  $\phi + \phi^{-2} = 2$ . Similarly,

we find "3" with  $10.01 + 1.00 = 11.01 = 100.01$ , and so on. The representations grow rapidly in both directions.

There was a large and enthusiastic response to the "π, e, and All That"

(continued)

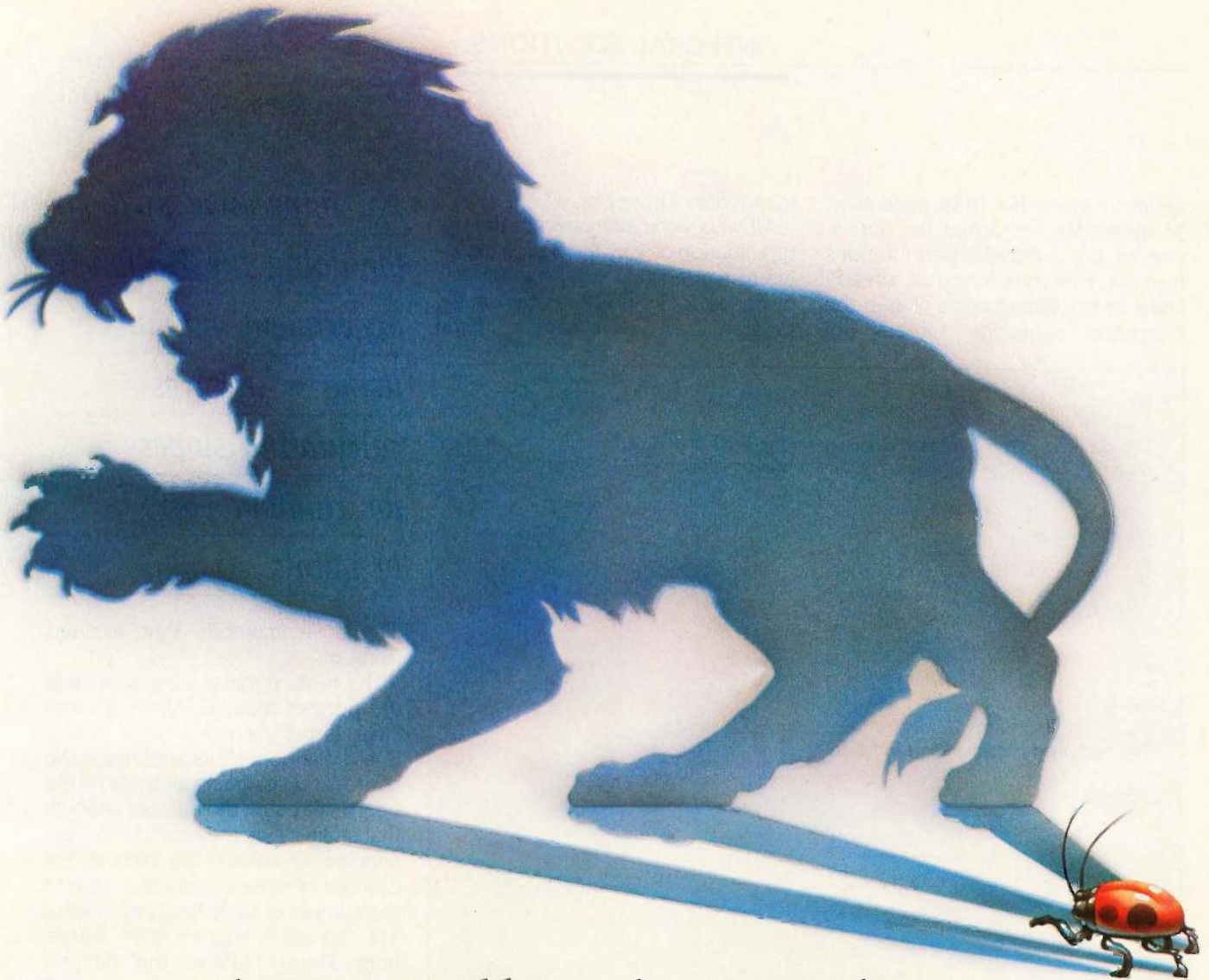

## Even the smallest bug is big game.

There are no insignificant bugs. They're often ferocious... and elusive!

That's why we built the better "bug hunter." The UDL (Universal Development Laboratory). It's actually an:

- **Advanced 48-channel bus state analyzer**
- **8/16 bit in-circuit emulator**
- **EPROM programmer**
- **Input stimulus generator**

All packed into one, compact box for only **\$2995**.

UDL turns almost any PC/MS-DOS and CP/M™ computer into a powerful, integrated workstation for hardware/software debugging. UDL's unique,

real-time emulation lets you track bugs of 46 different target microprocessor "species," without buying expensive hardware adapters.

Access all four instruments through the same control program. Handle single-step debugging with the emulator. And quickly define a complex trigger spec, so the built-in logic analyzer can find those nasty, subtle bugs.

When your tested program is bug-free, plug a PROM into the socket. And with one command, simply write your program from emulation memory directly into the PROM.

Let our UDL simplify the hunt, and keep you quick on the trigger. If you're serious about bug hunting, find out how to qualify for a no-obligation, 10-day "safari" with UDL. Call: **800/245-8500** (or 415/361-8883 in California). Or write: 702 Marshall Street, 6th Floor, Redwood City, CA 94063.



**ORION**  
Instruments

Become a Professional Bug Hunter.

column (September 1985, page 409). Many readers requested the derivation of the complete permutations formula. Everyone found or already knew of the hiding place of  $\phi$  in the Fibonacci sequence. Others de-

manded to know why  $e^{i\pi} = -1$ .

All who were interested in the approximation of  $\pi$  by the Buffon experiment agreed that my program was dishonest for its inclusion of  $\pi/2$  in the program itself. Several readers offered

*An impressive method for doing the Buffon experiment without using  $\pi$  involves calculating slopes for random pairs of points.*

alternative methods that avoided using  $\pi$ .

The most popular suggestion was the potshot method. There is a circular target inscribed on a square board. Random shots are fired at the board, and, assuming all shots hit the board, we count the number of shots that strike inside the circle. For longer and longer volleys, the ratio of the number of strikes inside the circle to the number of shots fired approaches  $\pi/4$ . Donald S. Higgins of St. Petersburg, Florida, offered the miniprogram in listing 2.

It turns out that I was lucky not to have adopted his method because the April 1985 *Scientific American* described it (among other simulations) in the "Computer Recreations" column by A. K. Dewdney.

Ellis Golub of Bryn Mawr, Pennsylvania, offered an impressive method. Select four random decimals and use them to form two random points:  $(x_1, y_1)$  and  $(x_2, y_2)$ . Consider the slope of the line through these two points:  $SLOPE = (y_2 - y_1)/(x_2 - x_1)$ . Then let  $PROJ = .25/SQR(SLOPE^2 + 1)$ , which is equivalent to my  $.25 * COS(ANGLE)$  but completely eliminates the use of trig functions and any mention of  $\pi$ . He also had a 25 percent reduction in running time.

In the next column, I will examine Pellian equations, which are of the form  $x^2 - ny^2 = 1$ , where  $n$  is a non-square integer and the solutions  $(x, y)$  are integral. Until then, keep those cards and letters coming. ■

(a)

The quotients of the Euclidean algorithm for the GCD of 154 and 69 are (2,4,3,5). The continued fractional representation of 154/69 is

$$154/69 = 2 + \frac{1}{4 + \frac{1}{3 + \frac{1}{5}}}$$

(b)

The continued fractional representation of  $\sqrt{5}$  is

$$\sqrt{5} = 2 + \frac{1}{4 + \frac{1}{4 + \frac{1}{\dots}}}$$

(c)

The continued fractional representation of  $\phi = (1 + \sqrt{5})/2$  is

$$\phi = 1 + \frac{1}{1 + \frac{1}{1 + \frac{1}{\dots}}}$$

Figure 4: The way of representing numbers as continuing fractions. (a) 154/69 as a continuing fraction; (b) the infinite continuing fraction for  $\sqrt{5}$ ; (c) the simplest infinite continuing fraction,  $\phi$ .

Listing 2: Donald Higgins's program to approximate  $\pi$  by the potshot method.

```
5 REM Program to approximate pi by Donald S. Higgins, St. Petersburg, FL.
10 INPUT "TRIALS"; N
20 FOR I= 1 TO N
30     X = RND(0)
40     Y = RND(0)
50     IF X*X+Y*Y < 1 THEN C = C + 1
60 NEXT I
70 PRINT "ESTIMATE OF PI =" ; 4*C/N
```

# Turbo, who?

Do you have to give up power and advanced potential to get ease of use and affordability? Not anymore. Because now, you can have *UCSD Pascal* for only \$79.95!

If you're making your move into programming, there's no better way to go than Pascal. And starting now, you *don't* have to settle for a stripped-down version of Pascal in order to get a price that's right. Instead, you can choose UCSD Pascal—the recognized Pascal programming standard in colleges and universities throughout the country—at the incredibly low introductory price of \$79.95 for your PC-DOS, MS-DOS, or other popular computer.

### Start with the standard

With an *entry-level* system, you spend a lot of valuable time learning a *non-standard* form of Pascal. And you don't get all the capabilities a true Pascal system is supposed to deliver—unless you buy a lot of add-on utilities—which can send the cost of your system sky-high! Worst of all, when you're ready to tackle anything more than short, simple programs—you have no choice but to move up to a more sophisticated system (like UCSD Pascal). And at that point, you also have to *relearn* standard Pascal.

### UCSD Pascal has everything you need

With UCSD Pascal, you get a

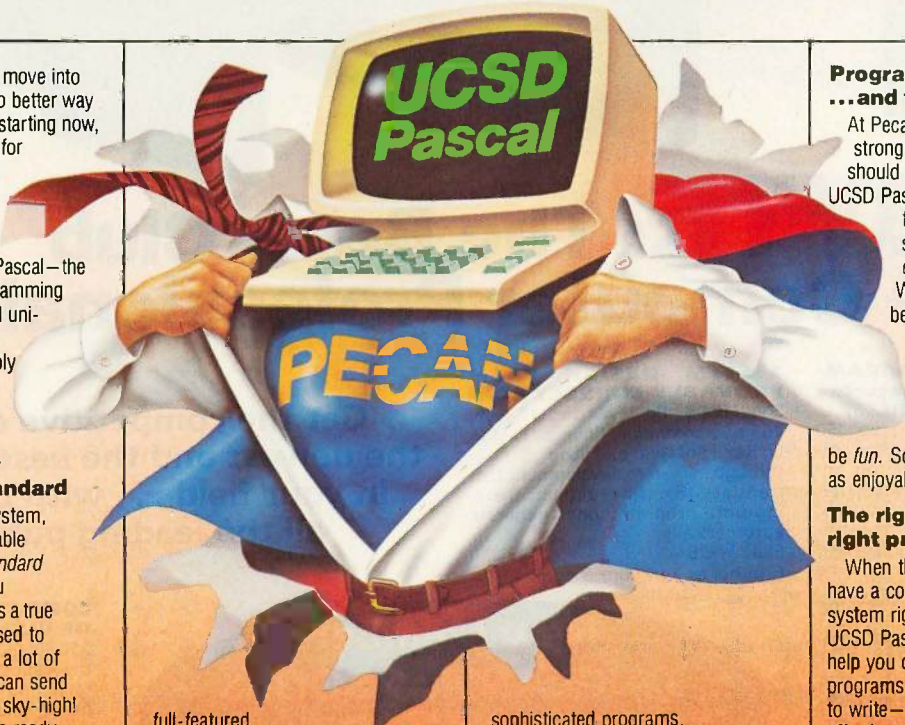

full-featured, professional programming tool that's being used right now in the development of major scientific and business applications. The system comes with an outstanding text editor, a complete on-line tutorial, 8087 math coprocessor support and BCD (decimal arithmetic) included in the package at no extra cost. In fact, UCSD Pascal contains virtually everything you need—as standard equipment—for developing the simplest to the most

sophisticated programs.

UCSD Pascal is available for MS-DOS, PC-DOS, UNIX, VMS, MSX and many other operating systems. You can use UCSD Pascal to write programs of any size on virtually any computer, and port them to any other computer. And if speed is what you're after, the latest native code version of UCSD Pascal actually benchmarks favorably with Turbo Pascal® in execution time!

### Programming that's easy ...and fun!

At Pecan Software Systems, we strongly believe programming should be as easy as possible. UCSD Pascal was originally designed for teaching programming skills, so it's extremely easy to learn and to use. With UCSD Pascal, you'll be developing programs right from the start that are easy to write, easy to understand, and easy to maintain. We also believe that programming should be *fun*. So we've made UCSD Pascal as enjoyable to use as it is powerful.

### The right tool at the right price

When the fun gets serious, you'll have a comprehensive programming system right at your fingertips with UCSD Pascal—a system that will help you develop those big-league programs you may eventually want to write—at a price you can readily afford.

Put UCSD Pascal programming power on your PC now for only \$79.95! Order by mail today or phone now 1-800-63-PECAN. UCSD Pascal—the original standard of Pascal programming excellence. The new leader in Pascal price/performance.

# PECAN™

The UCSD Pascal Company  
Pecan Software Systems, Inc.  
1410 39th Street, Brooklyn, NY 11218  
718-851-3100

# UCSD Pascal™

UCSD Pascal \$79.95 (for PC-DOS, MS-DOS, AMIGA, APPLE, ATARI 520, MACINTOSH, RAINBOW, TANDY, as well as most popular 8/16/32-bit systems).  
Price includes 8087 support and BCD.  
Please send me \_\_\_\_\_ copies of UCSD Pascal for my \_\_\_\_\_ (Operating system) which runs under \_\_\_\_\_

(Name and model of computer) \_\_\_\_\_  
My disk size is 3 1/2" \_\_\_\_\_ 5 1/4" \_\_\_\_\_ 8" \_\_\_\_\_  
Total amount (NYS add appropriate tax) \_\_\_\_\_  
Payment by  VISA  MC  US Bank Check  Bank Draft  
Card Number: \_\_\_\_\_  
Credit Card Expiration Date: \_\_\_\_\_

Mail to: Pecan Software Systems, Inc.  
1410 39th Street  
Brooklyn, NY 11218  
ITT Telex No. 494 8910  
CompuServe Code 76703, 500

Name \_\_\_\_\_ State \_\_\_\_\_ Zip \_\_\_\_\_  
Shipping Address \_\_\_\_\_  
City \_\_\_\_\_  
Telephone \_\_\_\_\_

Call or write for UNIX, VAX or other UCSD Pascal versions—and ask about our powerful Pascal add-ons, too. **SCHOOLS:** Contact us for our special educational discounts!  
Call toll-free or enclose a check with this coupon to place an order. Please add \$2.50 for shipping within the US. Foreign orders add \$10 and make payment by bank draft payable in US dollars on US bank. New York State residents add appropriate sales tax.

**UCSD Pascal**  
Not copy protected  
60-day money-back guarantee

CREDIT CARD ORDERS  
CALL TOLL-FREE  
1-800-63-PECAN  
(NYS) 1-800-45-PECAN

AMIGA is a trademark of Commodore Electronics LTD.  
APPLE & MACINTOSH are trademarks of Apple Computer.  
ATARI 520 is a trademark of Atari Corporation.  
RAINBOW is a trademark of Digital Equipment Corporation.  
TANDY is a trademark of Radio Shack.  
Turbo Pascal is a registered trademark of Borland International.

UCSD Pascal is a registered trademark of The Regents of University of California

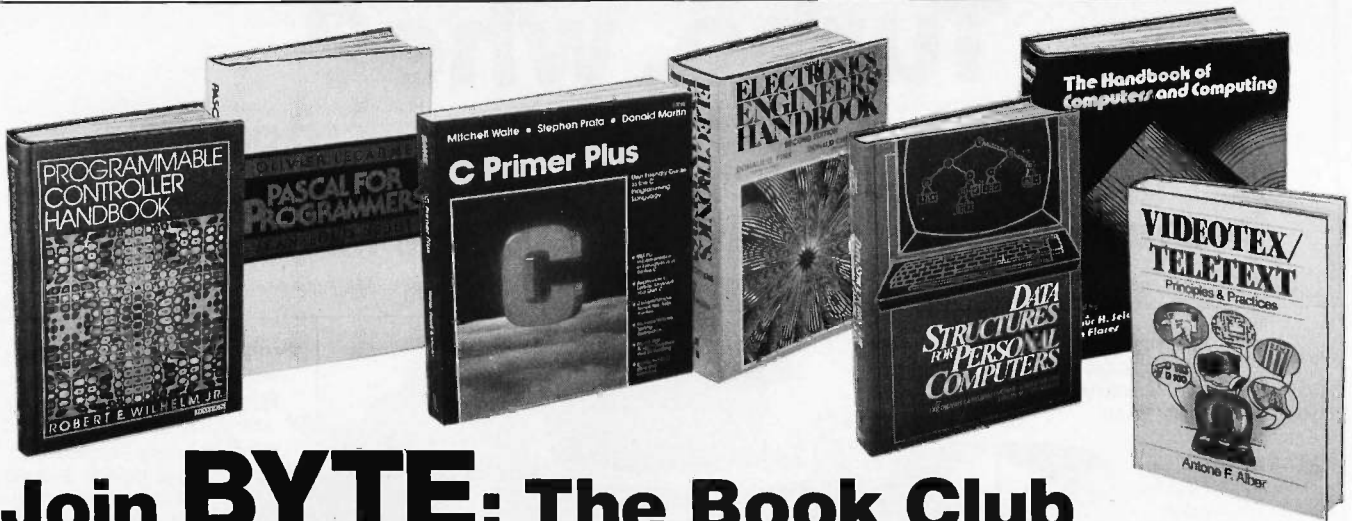

# Join **BYTE**: The Book Club for the Computer Professional

**ADVANCED PROGRAMMER'S GUIDE Featuring dBase II and dBase III.** By L. Castro, J. Hanson and T. Rettig. 450 pp., illus. *softbound*. Most complete guide now available on advanced dBase. Covers the latest debugging techniques, subroutines, structured programming and system design and documentation. Thorough coverage included on the implementation process. 583149-XB \$28.95 (Counts as 2 of your 3 books)

**THE ENCYCLOPEDIA OF ELECTRONIC CIRCUITS.** By R. F. Graf. 760 pp., 1,256 illus. Delivers 1256, fully illustrated circuits, each accompanied by explanatory circuit notes for your convenience. Covers the full gamut from filters to sensors and controllers to pulse generators and converters. Fully indexed this unique compendium has broken these proven circuits into 98 categories. 583265-8A \$50.00 (Counts as 3 of your 3 books)

**HANDBOOK OF SOFTWARE ENGINEERING.** Edited by C. Vick and C. Ramamoorthy. 683 pp., 332 illus. and tables. Emphasizing quality assurance, this first-ever guide shows you how to design, implement, test and maintain virtually any type of software. Ranging from graphic theoretic modeling to software development you see how to apply the latest software engineering techniques in each stage of development. 583204-6A \$62.50 (Counts as 3 of your 3 books)

**SINGLE-CHIP MICROCOMPUTERS.** Edited by P. Lister. 231 pp., 102 illus., 25 tables. Comprehensive coverage of the single-chip micros now available, their characteristics and application range. Separate chapters cover Motorola's M6801 & M6805 families, TI's TMS 1000 & TMS 7000 devices, Zilog's Z80, National Semiconductors COP8 400 and Mostek's 16-bit MK 682000. 308/309B \$39.50 (Counts as 2 of your 3 books)

**SYSTEM DESIGN FROM PROVABLY CORRECT CONSTRUCTS.** By J. Martin. 392 pp., 155 two-color illus. Covers "Higher Order Software," the breakthrough in system development that translates & refines human thinking until program codes generate automatically. 582259-3B \$37.50 (Counts as 2 of your 3 books)

Get the competitive edge with the *newest* and the *best* information in your field . . . with books from all the leading publishers.

**New Members**  
**TAKE ANY 3 BOOKS**  
**FOR ONLY \$1.00 EACH\***  
**Values up to \$83.50**

**THE HANDBOOK OF COMPUTERS AND COMPUTING.** Edited by A. Seidman and I. Flores. 874 pp., illus. This monumental handbook, aimed specifically at computer professionals, covers everything from microprogramming, online systems and programming ergonomics to software engineering and computer security. Features the first intensive exploration of ATE to appear in print. 583138-4A \$77.50 (Counts as 3 of your 3 books)

**DATA STRUCTURES FOR PERSONAL COMPUTERS.** By Y. Langsam, M. Augenstein and A. Tenenbaum. 560 pp., 116 illus. Gives you a solid grounding in high-level programming techniques by combining the elementary concepts of data structures with guidance on structured programming in BASIC. 583186-4B \$29.95 (Counts as 2 of your 3 books)

**COMPARING AND ASSESSING PROGRAMMING LANGUAGES: ADA • C • Pascal.** Edited by A. Feuer and N. Behani. 271 pp., *softbound*. Enhances your understanding of these languages by comparing their strengths and weaknesses. Contrasts and assesses each so you can choose the best for your application. 583262-3 \$16.95

**PROGRAMMING ASSEMBLER LANGUAGE.** By P. Abel. 2nd Ed., 581 pp., 154 illus. and listings. Updated and expanded this carefully detailed study of the 370 mainframe and Assembler covers the essentials of Assembler coding, binary operations, and external storage. Also discusses debugging, floating point operations, macro writing and operating systems. 583088-4B \$26.95 (Counts as 2 of your 3 books)

**MULTIPLE PROCESSOR SYSTEMS FOR REAL-TIME APPLICATIONS.** By B. Liebowitz and J. Carson. 383 pp., 150 illus. This definitive guide for the practicing professional covers each of the MPS's major building components, design tools and techniques and implementation methodology. Case histories from both government and industry are included. 583237-2B \$36.95 (Counts as 2 of your 3 books)

**ART AND THE COMPUTER.** By M. Prueitt; intro. by CARL SAGAN. 256 pp., 277 full-color illus. First comprehensive survey of today's extraordinary computer graphics. Describes and illustrates, in full color, the principles and techniques behind this revolutionary new art form. 508/941B \$39.95 (Counts as 2 of your 3 books)

**COMPUTATIONAL ASPECTS OF VLSI.** By J. Ullman. 495 pp., 252 illus. Coverage ranges from the theoretical to current VLSI design tools and the algorithms that underlie them. Includes specific algorithms for circuit extraction, rule checking, switch-level simulation and automatic routing. 582990-8B \$44.95 (Counts as 2 of your 3 books)

**SUCCESSFUL DATA PROCESSING SYSTEM ANALYSIS, 2/e.** By T. Gildersleeve. 369 pp., 117 illus. This completely revised, updated and expanded guide covers the whole process of system analysis. In clear, professional language it covers identifying the problem and developing a cost-benefit analysis to testing the system for acceptability. 583311-5B \$30.95 (Counts as 2 of your 3 books)

**PROGRAMMABLE CONTROLLER HANDBOOK.** By R. Wilhelm, Jr. 718 pp., 341 illus. First comprehensive reference on these special-purpose computers that are now the standard solution to most industrial control applications. Special attention is given to the many functions and operations not possible to perform with industrial control relays. 583244-5B \$49.95 (Counts as 2 of your 3 books)

**DATA COMMUNICATIONS, NETWORKS AND SYSTEMS.** T. Bartee, Editor-in-Chief. 359 pp., 196 illus. Brings you up-to-date pm digital system design. Shows how they operate and the trade-offs they entail. Covers basic system approaches, network security, error control techniques and common carrier regulations. 583276-3B \$39.95 (Counts as 2 of your 3 books)



**DESIGN AND ANALYSIS OF DISTRIBUTED REAL-TIME SYSTEMS.** By P. Fortier

216/193B \$36.95  
(Counts as 2 of your 3 books)

**HOW TO BE A SUCCESSFUL COMPUTER CONSULTANT.** By A. Simon

572/968 \$16.95

**THE THEORY & PRACTICE OF COMPUTER WRITING.** By J. Tremblay & P. Sorenson

651/612B \$39.95  
(Counts as 2 of your 3 books)

**INTRODUCING PC-DOS & MS-DOS.** By T. Sheldon

565/597 \$18.95

**68,000 MICROPROCESSOR.** By W. Triebel & A. Singh

583613-0B \$34.95  
(Counts as 2 of your 3 books)

**PROGRAMMING WITH TURBO PASCAL.** By D. Carroll

852908-5B \$34.95  
(Counts as 2 of your 3 books)

**COMPUTER ARCHITECTURE, 3/e.** By C. Foster & T. Iherall

583278-XB \$38.95  
(Counts as 2 of your 3 books)

**MICROPROCESSOR SYSTEM DESIGN CONCEPTS.** By N. Alexandridis

583313-1B \$32.95  
(Counts as 2 of your 3 books)

**CREATING COMPUTER SOFTWARE USER GUIDES.** By D. Houghton-Alico

304/718 \$17.95

**FUNDAMENTALS OF PROGRAMMING LANGUAGES, 2/e.** By E. Horowitz

583303-4B \$29.95  
(Counts as 2 of your 3 books)

**MICROCOMPUTER ASSEMBLY LANGUAGE PROGRAMMING.** By G. Elfving

583190-2B \$29.95  
(Counts as 2 of your 3 books)

**CICS: MASTERING COMMAND LEVEL CODING USING COBOL.** By W. Bruno & L. Bosland

583216-X \$24.95

**STEVE CIARCIA'S ASK BYTE.** By S. Ciarcia

881200-3 \$14.95

**MATHEMATICS FOR THE ANALYSIS OF ALGORITHMS.** By D. H. Greene & D. E. Knuth

582707-7 \$14.95

**THE MASTER HANDBOOK OF HIGH-LEVEL MICROCOMPUTER LANGUAGES.** By C. Taylor

583096-5 \$21.95



\* 3 books for only \$1.00 each . . . if you join now for a trial period and agree to purchase three more books—during your first year of membership. (Publishers' prices shown)

**VIDEOTEX/TELETEXT.** By A. Alber

009/570B \$32.95  
(Counts as 2 of your 3 books)

**CIARCIA'S CIRCUIT CELLAR VOLUME V.** By S. Ciarcia

109/697 \$19.95

**COMPUTER PERIPHERALS FOR MINICOMPUTERS, MICROPROCESSORS, AND PERSONAL COMPUTERS.** By C. L. Hohenstein

294/518B \$36.50  
(Counts as 2 of your 3 books)

**PROGRAMMING WITH ADA: An Introduction By Means of Graduated Examples.** By P. Wegner

789/24XB \$25.00  
(Counts as 2 of your 3 books)

**REAL-TIME COMPUTING: With Applications to Data Acquisition and Control.** Edited by D. A. Mellichamp

582844-8B \$44.50  
(Counts as 2 of your 3 books)

**ASSEMBLERS, COMPILERS, AND PROGRAM TRANSLATION.** By P. Calingaert

582110-9B \$27.50  
(Counts as 2 of your 3 books)

**PASCAL FOR PROGRAMMERS.** By O. LeCarme & J. Nebut

369/585B \$25.00  
(Counts as 2 of your 3 books)

**DISCRETE MATHEMATICS.** By M. Marcus

582987-8 \$19.95

**More Books to Choose from**

**LEARNING WITH LOGO.** By D. H. Watt

685/703 \$22.95

**MICROCOMPUTER AND MICROPROCESSOR INTERFACING.** By J. C. Cluley

582585-6B \$27.50  
(Counts as 2 of your 3 books)

**MICROPROCESSOR AND MICROCOMPUTER DATA DIGEST.** By W. H. Buchsbaum & G. Weissenberg

582835-9B \$29.95  
(Counts as 2 of your 3 books)

**MICROPROCESSOR DATA BOOK.** By S. A. Money

427/062B \$35.00  
(Counts as 2 of your 3 books)

**BUILD YOUR OWN Z-80 COMPUTER.** By S. Ciarcia

109/621 \$22.95

**MICROCOMPUTER INTERFACING.** By B. Artwick

789/436B \$28.00  
(Counts as 2 of your 3 books)

**PRINCIPLES OF INTERACTIVE COMPUTER GRAPHICS, 2/e.** By W. M. Newman & R. Sproull

463/387B \$41.95  
(Counts as 2 of your 3 books)

**MICROCOMPUTER OPERATING SYSTEMS.** By M. Dahmke

150/710 \$18.95

**ELECTRONIC ENGINEERS' HANDBOOK, 2/e.** By D. G. Fink & D. Christiansen

209/812A \$83.50  
(Counts as 3 of your 3 books)

**Z80 USERS MANUAL.** By J. Carr

582336-5 \$16.95

**INTRODUCING THE UNIX SYSTEM.** By H. McGilton & R. Morgan

450/013 \$24.95

**HANDS-ON BASIC For the IBM® Personal Computer.** By H. Peckham

491/78X \$23.95

**Why YOU should join the Byte Book Club™ now!**

- **Best and newest books from ALL publishers!** Books are selected from a wide range of publishers by expert editors and consultants to give you continuing access to the best and latest books in your field.
- **Big savings!** Build your library and save money too! Savings range up to 30% or more off publishers' list prices—usually 20% to 25%.
- **Bonus books!** You will immediately begin to participate in our Bonus Book Plan that allows you savings up to 70% off the publishers' prices of many professional and general interest books!
- **Convenience!** 14-16 times a year (about once every 3-4 weeks) you receive the Club Bulletin FREE. It fully describes the Main Selection

and alternate selections. A dated Reply Card is included. If you want the Main Selection, you simply do nothing—it will be shipped automatically. If you want an alternate selection—or no book at all—you simply indicate it on the Reply Card and return it by the date specified. You will have at least 10 days to decide. If, because of late delivery of the Bulletin you receive a Main Selection you do not want, you may return it for credit at the Club's expense.

As a Club member you agree only to the purchase of three additional books during your first year of membership. Membership may be discontinued by either you or the Club at any time after you have purchased the three additional books.

Fill out the card and mail today! If the card is missing, write to:  
**BYTE BOOK CLUB™**, P.O. Box 582, Hightstown, New Jersey 08520-9959

## Conducted by Steve Ciarcia

### SB180 QUESTIONS

Dear Steve,

After reading about the SB180 in the September 1985 BYTE, I have a couple of questions and observations.

Last year, I sold my old computer and a TeleVideo 925 terminal, and I now have an IBM PC. I did some of the beta testing for the Trump Card, and it seems that the ideas behind it and the SB180 aren't too remote from one another. Would it be possible to somehow use the IBM's power supply and disk drives for the SB180 as well as interfacing the IBM PC to act as a terminal?

I'm a big fan of the Oasis operating system, and I still help maintain a friend's computer using Oasis. If I were to return to 8 bits, I would like to take advantage of all the experience I've had using Oasis. Do you know if it can be implemented on the SB180? A 512K-byte memory disk (or maybe even a 10-megabyte hard disk) would be a great addition to such a system.

Now for the observations: One thing that really appeals to me is the possibility of the SB180's portability. However, I keep running into the same problem—no one makes a readable screen for a portable. Mostly, it seems that this is because people want a battery-operated system. Thus, the portable must rely on the limited power that batteries can supply. I am rarely far from a plug and would much prefer a system that has a highly readable screen. Any thoughts on this?

MICHAEL CASEY  
Highland Park, IL

*You can certainly use the IBM PC's case, power supply, and disk drives with the SB180. The SB180 draws little current, so it wouldn't be much of a drain on the PC's power supply. At least one of the disk drives must be a double-sided double-density unit in order to boot up the Z-System; otherwise, the drives will be fine. It would even be possible to have a dual-processor system and use the PC as a terminal into the SB180. You could mount four half-height drives in the PC: two for use by the PC itself, and two for use by the SB180. When you wished to use the SB180, you could boot up a terminal-emulation program (Crosstalk, PC-Talk), which would actually be connected to the console input of the SB180. Then, Z-System would be loaded from the other two drives.*

*You should have little trouble implementing such a system since no major modifications are needed to either computer. Most of the work would be in making mechanical/electrical connections, so a minimum of technical know-how would be required. If you do attempt this project, please send me a write-up.*

*As far as I know, no one has brought up Oasis on the SB180 yet. The BIOS source code that comes with the software for the SB180 would be invaluable. If you have ever ported Oasis to a different machine, getting it on the SB180 should be no different. I agree that a hard disk is a near necessity. In December 1985, I presented a combination 300/1200-bps modem and SCSI hard-disk expansion board for the SB180. I also plan*

*a more sophisticated presentation in May 1986.*

*As soon as I find an economical portable display, I'll be looking for a way to incorporate it into an article—perhaps with a revision of my Term-Mite board.*  
—Steve

### DVORAK KEYBOARD

Dear Steve,

I have a question about your Term-Mite design (January and February 1984). I am particularly interested in implementing a Dvorak simplified keyboard, and the Term-Mite offers some possibilities in that direction. According to your description of the keyboard-scanning routine, it would be necessary only to substitute the desired ASCII values in the lookup table that the routine uses to assign values to the keystrokes. Where is that table located?

R. F. WHITE  
Ft. Worth, TX

*You are correct about changing the keyboard-scanning table to implement a Dvorak keyboard. The table is in the EPROM, beginning at location 278 hexadecimal. The current table contains the ASCII code for each key in 1 byte. You need only substitute the bytes in this table for the new key encodings for the Dvorak layout. See table 1.*

*Code resumes at location 2CF hexadecimal. When you change the EPROM code, you must set switch sw1, position 6, closed to enable the EPROM. One problem may be that the punctuation above the numbers will not be separately controlled by these changes, because they are generated from the character codes themselves. The source code for the Term-Mite is available for \$20 from*

*The Micromint Inc.  
25 Terrace Dr.  
Vernon, CT 06066*

*To understand it, get "NS455-Series Terminal Management Processor (TMP)" from National Semiconductor. It has a complete description of the chip and a description of the instruction set of the processor.—Steve ■*

Table 1: The new key codes needed for the Dvorak layout.

278	esc	ctl/s	ctl/l	LF	VT	null	tab	ctl/n
280	BS	ctl/p	ctl/q	ctl/r	ctl/o	7	8	9
288	2	3	4	6	5	7	8	8
290	\	9	.	0	=	null	null	null
298	W	E	R	Y	T	U	Q	I
2A0	underbar	O	[	P	]	4	5	6
2A8	S	D	F	H	G	J	A	K
2B0	CR	L	:	:	\	1	2	3
2B8	X	C	V	N	B	M	Z	
2C0	rubout	null	/	.	null	0	null	
2C8	null	null	null	null	null	null	space	



# There's a Familiar Face Behind the New Name



**NANAO MONITORS.** The name is new to the American market. That's because for the first time in history, a huge new line of computer monitors is available to the U.S.—factory direct. 26 different models offered in three series, bringing you a range of features broader than any other. Color resolution from 480 dots x 200 lines up to 720 dots x 480 lines. And Eh scanning from 15.75 to 24.75 KHz. But the truth is that Nanao has been around for a long time. For over a decade we've supplied OEM's worldwide, designing and manufacturing monitors recognized for their outstanding performance and reliability. Now that same quality, selection and value is yours—right from the source. Nanao. The old standby with a new name.

Inquiry 245 for End-Users. Inquiry 246 for DEALERS ONLY.

## NANAO

**NANAO USA CORPORATION**

373 G. Vintage Park Drive  
Foster City, California 94404  
Phone (415) 341-7055

Distributor Inquiries Welcomed

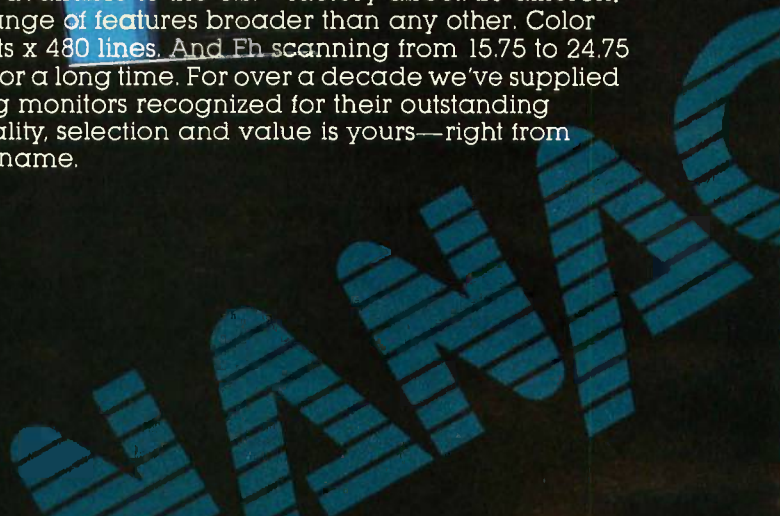

# BYTE Invites You to Join **BIX**

BYTE is the world's leading high-tech microcomputer magazine. Its readers collectively possess more information about personal computers and related topics than any other group in the world. BIX is BYTE's brand-new electronic information exchange, a computer conferencing system that puts you in touch with BYTE readers and other computer enthusiasts on a daily basis.

---

## YOU AND BIX

BIX goes far beyond electronic bulletin boards to give you all the advanced features of true computer conferencing. It's the first major system dedicated to microcomputer information. Check these features:

- You can join ongoing discussions about your favorite computers, programming languages, operating systems, and applications programs, exchange information, ask questions, and offer opinions.
- You can read what others have already entered, add your own thoughts, and download information.
- You can participate when it's convenient for you, from home or office or while you're traveling.
- You also get electronic mail with BIX, putting you in direct, private contact with BYTE editors and BIX users everywhere.

## CUSTOMIZE BIX TO MEET YOUR NEEDS

As a BIX user, you select only the conferences and topics that are of real interest to you. You may join a new conference or leave an old one anytime you want. Each time you log on to BIX, you're immediately notified of any electronic mail messages waiting for you, and you see which of the conferences you've joined have had new activity since the last time you logged on. BIX keeps track of your interests.

With BIX, you're an active participant in a giant microcomputer information exchange.

## WHAT BIX COSTS. . . HOW YOU PAY

ONE-TIME REGISTRATION FEE:	
BYTE Subscriber . . . . .	\$25
Nonsubscriber . . . . .	\$39

BIX HOURLY USAGE FEES (All times are local):	
Off Peak (6 p.m.-7 a.m. plus weekends and holidays) . . . . .	\$9
Peak (7 a.m.-6 p.m. weekdays) . . . . .	\$12

## TELECOMMUNICATIONS CHARGES:

BIX is available via Tymnet from anywhere in the United States.

TYMNET (Continental U.S.):	
Off Peak . . . . .	\$2/hr.
Peak . . . . .	\$6/hr.

## PAYMENT:

BIX and Tymnet charges are billed through either VISA or MasterCard. No cash, checks, or money orders.

## START USING BIX NOW!

With our easy on-line registration, you can start using BIX in the next few minutes. No lengthy waiting for your registration to be processed by mail. (Step-by-step instructions on how to log on to BIX follow. Reading this material before you log on will speed you through the registration process.)

## LOG-ON INSTRUCTIONS AND REGISTRATION INFORMATION

### BEFORE YOU CALL BIX:

Having your credit card handy (VISA/MasterCard) before you log on will speed you through BIX registration. *You will not be billed for the time you spend on line registering for BIX. If at any time during the on-line process you decide not to register for BIX, just hang up.*

### HOW TO LOG ON TO BIX:

Step 1: Set your computer's telecommunications program for full duplex using 8-bit words, no parity,

and 1 stop bit, or 7-bit words, even parity, and 1 stop bit. You may call at either 300 or 1200 baud.

Step 2: To reach BIX via Tymnet.

- Call your local Tymnet number and log on.
- Tymnet will ask you for a "terminal identifier." Type the letter "a."
- Tymnet will ask you to log on. Type "byteneti" and a carriage return.
- Tymnet will ask you for a password. Type "mgh" and a carriage return.
- You will then be at the BIX computer. At the next prompt, type "bix" and a carriage return. You're now on line with BIX.

*BIX is accessible from anywhere in the country through local Tymnet numbers. Call Tymnet's 24-hour customer service number, (800) 336-0149, for local Tymnet numbers and for assistance in setting your computer's communications program properly. This is also the number to use to report problems with the Tymnet system. (There is a premium charge for Tymnet, but you still reach BIX for much less than regular long distance.)*

Step 3: Once on BIX, you will be asked to enter your name. Since this will be your first time on the system, enter "new" and a carriage return. This will take you to a special section where you enter the information we need to register you as a BIX user. Follow the on-line prompts and supply the infor-

mation requested. BIX lets you reenter data if you make a mistake.

When you've completed your registration, BIX will automatically take you to a special "Learn" conference where you'll get a quick tutorial on how to use the system. (Typing "help" or "?" at any prompt while you are on BIX will give you an immediate review of available commands.)

**Problems:** If you follow these instructions but still are unable to log on to BIX, call the BIX Customer Service Line for assistance at (800) 227-2983 from 8:30 a.m. to 11:00 p.m. eastern time weekdays.

In New Hampshire, call 924-9281.

### **ACCESSING BIX FROM FOREIGN COUNTRIES**

BIX is accessible from most foreign countries via the Tymnet network in the United States. Once you reach Tymnet, follow the log-on instructions listed here.

If you do not know how to reach Tymnet from your country, call or write us for more detailed information.

### **USERS GROUPS, TRADE AND MEMBERSHIP ORGANIZATIONS**

To learn how the members of your organization can qualify for BIX registration discounts, send us the name and address of your group on official letterhead.



*We'll Send You a BIX User's Manual and Subscriber Agreement As Soon As We've Processed Your Registration*

**BYTE INFORMATION EXCHANGE  
70 MAIN STREET  
PETERBOROUGH, NH 03458  
(603) 924-9281**

# D·I·S·K·S   A·N·D   D·O·W·N·L·O·A·D·S

---

## ORDERING DISKS OF BYTE LISTINGS

Source-code listings in the form of text files of programs that accompany BYTE articles are now available from BYTE on disk. To order a disk of these listings for noncommercial purposes, indicate the issue (the first available is December 1985) and the kind of disk on the form below. Enclose a check or money order in the correct amount made out to BYTE Listings. All prices include postage. Send requests to BYTE Listings, 70 Main St., Peterborough, NH 03458.

BYTE issue: \_\_\_\_\_

## COMMON 5¼-INCH FORMATS

(all cost \$5 per disk in North America, \$6 in Europe and South America, \$7 in Asia, Africa, and Australia)

- Apple II 5¼-inch DOS 3.3
- Apple II 5¼-inch ProDOS
- Atari
- Commodore 64
- Hewlett-Packard 125
- IBM PC
- Kaypro 2 CP/M
- Texas Instruments Professional
- TRS-80 Model III
- TRS-80 Model 4
- Zenith Z-100

## COMMON 3½-INCH FORMATS

(all cost \$6 per disk in North America, \$7 in Europe and South America, \$8 in Asia, Africa, and Australia)

- Apple Macintosh
- Atari 520ST
- Commodore Amiga
- Data General/One
- Hewlett-Packard 150

## CP/M STANDARD 8-INCH FORMAT

(\$6 per disk in North America, \$7 in Europe and South America, \$8 in Asia, Africa, and Australia)

- Single-sided single-density

## OTHER FORMATS

(all cost \$6 per disk in North America, \$7 in Europe and South America, \$8 in Asia, Africa, and Australia)

Size	Machine
<input type="checkbox"/> 8-inch	_____
<input type="checkbox"/> 5¼-inch	_____
<input type="checkbox"/> 3½-inch	_____

## SEND DISK TO:

Name \_\_\_\_\_

Street \_\_\_\_\_

City \_\_\_\_\_ State or Province \_\_\_\_\_

Postal Code \_\_\_\_\_ Country \_\_\_\_\_

Check or money order enclosed for \$ \_\_\_\_\_

## BULLETIN BOARDS IN CANADA

Listed below are some computer bulletin boards that carry program listings from BYTE. Programs are for noncommercial use in connection with BYTE articles only. Some BBSs may charge an annual maintenance fee, and you must pay your own telephone charges.

Western Canadian Distribution Center (101 1112 101st St., Edmonton, Alberta T5G 2A2) will be supplying listings to its member bulletin-board systems. Edmonton, Alberta, (403) 454-6093

Meadowlark, Alberta, (403) 435-6579

Montreal, Quebec, PComm Systems, (514) 989-9450

Prince George, British Columbia, (604) 562-9519

Regina, Saskatchewan, (306) 586-5585

Toronto, Ontario, Canadian Remote Systems, (416) 231-9202

Toronto, Ontario, Epson Club of Toronto (EPCOT), (416) 635-9600

Winnipeg, Manitoba, (204) 452-5529

In addition, arrangements for BYTEnet Listings have been made with one or more system operators in the following nations: Australia, Denmark, Italy, Japan, The Netherlands, Norway, Singapore, Sweden, Switzerland, and United Kingdom. Contact us at (603) 924-9281 for an up-to-date list.

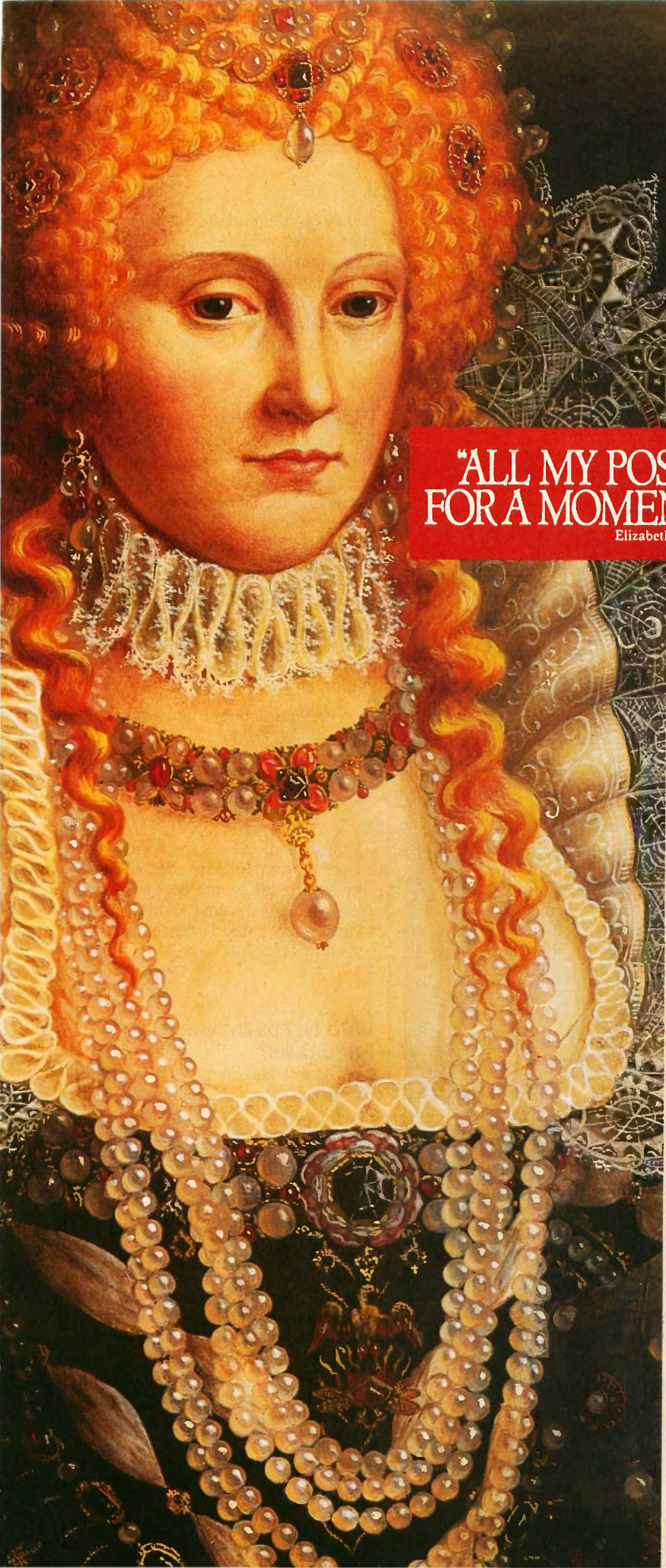

**"ALL MY POSSESSIONS  
FOR A MOMENT OF TIME."**

Elizabeth I



The ITT XTRA XP desktop personal computer

**You can't buy time.**

Long before Queen Elizabeth I, man began his quest to hoard that most precious and elusive of commodities. Time.

He can only make better use of the few hours he already has.

Hence, the development of today's business computer.

**The ITT XTRA™ XP. Our crowning achievement.**

By matching memory to the muscle of the Intel 80286 microprocessor, we're able to achieve "no wait states."

Processing never pauses for slower memory.

Making the ITT XTRA XP thirty percent faster than the IBM AT. And fully XT-compatible.

Giving you speed and flexibility.

Because, being a corporation of many businesses, we're in a unique position to better understand what you need to grow.

Today, as well as tomorrow.

	ITT XTRA XP	COMPAQ 286	IBM PC/AT
Lotus 1-2-3	11sec	13sec	15sec
dBase	36sec	52sec	56sec
FormSort	52sec	1min 5sec	1min 10sec

All comparisons are for purposes of illustration only. User's application performance is dependent on application.

**A moment's investment today can pay off royally tomorrow.**

Call (800) 321-7661. In California, (800) 368-7300.

And call quickly. Every moment wasted is a potentially profitable moment you'll never possess again.



**BECAUSE TIME IS THE  
ULTIMATE BOTTOM LINE.**

© 1986, ITT Information Systems. IBM, PC/AT and PC/XT are registered trademarks of International Business Machines. Intel 80286 is a registered trademark of Intel Corporation. Compaq 286 is a registered trademark of Compaq Computer Corporation. Lotus and 1-2-3 are registered trademarks of Lotus Development Corporation. dBase is a registered trademark of Ashton-Tite.

Inquiry 181 for End-Users. Inquiry 182 for DEALERS ONLY.

(continued from page 32)

## ANOTHER SOFTWARE-ONLY SPEECH SYNTHESIZER

I am writing about a letter from Gary W. Odom of Melbourne, Florida, entitled "Long Live the Macintosh" (Letters, October 1985, page 30). In his letter he said, "The four-voice sound generator produces astounding computer music, so good that

the Macintosh has the only software-only speech synthesizer available on a computer of any size."

I would like to correct his error. I have an Atari 400 and 800XL, and both have four-voice music with the ability to synthesize speech using S.A.M. by Don't Ask Software. S.A.M. produces speech and allows the user to vary both pitch and speed.

I may be overreacting, but it bothers me when someone makes an all-encompassing statement, as in Mr. Odom's letter. Some degree of responsibility must be assumed by anyone making such a statement. Without this responsibility, a letter becomes pure conjecture and opinion.

ROGER N. ASCH  
Fishkill, NY

## VLSI: NOT VERY

So many of your articles use the acronym VLSI (very-large-scale integration) when indeed LSI would be the correct term. For instance, in the January issue, "The Acorn RISC Machine" by Dick Pountain (page 387) stated that the ARM chip contains 25,000 transistors. Surprise! This meager amount of devices constitutes LSI, not VLSI, and there is a vast difference in complexity.

Here is a table for your reference showing the relationship between level of integration and device count.

Device Count	Integration
1,000,000	ULSI
100,000	VLSI
10,000	LSI
1,000	MSI
100	SSI

Examples of LSI are the 68000 microprocessor and 16K dynamic RAMs. Examples of VLSI are the 80286 microprocessor and 64K dynamic RAMs. Please try to apply some standard meaning for integration acronyms.

DANIEL J. PAYNE  
Santa Cruz, CA

## WHO NEEDS INTEGRATED PROGRAMS?

Jerry Pournelle's comments in the 10th anniversary issue (Computing at Chaos Manor, September 1985, page 347) just confirmed my feeling that integration is becoming a much less important term in computerdom. In fact, I think the integrated products have reached their zenith and it will all be downhill. AppleWorks notwithstanding.

As a journalist and a computer user since 1980, I've been using Apple PIE for word processing and pfs:File and dBASE II for database applications. Until recently, I had no use for a spreadsheet. When I did start using a sheet, I went to my own library, shook the dust off an early version of VisiCalc, and starting using it.

The reason I haven't changed my main programs is comfort. I know all four programs backward and forward, well enough

(continued)

# Tools for the Programmer from Blaise Computing

Save Up To \$130 On These Special Offers!

## TOOLS & TOOLS 2

For C or Pascal

For a limited time, pick up both packages and save \$50 off our regular list price. The C version comes with libraries for the Lattice, Computer Innovations and Microsoft (version 2.03 and

3.00) compilers. The Pascal version supports IBM and Microsoft Pascal. **\$175.**

## VIEW MANAGER With Source

All libraries are included. Please specify C or Pascal. Regular \$425. Save \$130. **\$295**

Blaise Computing provides a broad range of fine programming tools for Pascal and C programmers, with libraries designed and engineered for the serious software developer. You get clearly written code that's fully commented so that it can serve both as a model and also be easily modified to grow with your changing needs. Our packages are shipped to you complete with comprehensive manuals, sample programs and source code. None of the programs are copy-protected.

### FOR C AND PASCAL PROGRAMMERS:

#### TOOLS ♦ \$125

Extensive string and screen handling, graphics interface and easy creation of program interfaces. Includes all source code.

#### TOOLS 2 ♦ \$100

Memory management, general program control and DOS file support. Interrupt service routine support. Includes all source code.

#### VIEW MANAGER ♦ \$275

General screen management. Create data entry screens that can be easily manipulated from your application program. Block mode data entry and retrieval with last screen access.

#### VIEW LIBRARY Source ♦ \$150

Source code to the VIEW MANAGER library functions.

#### ASYNCH MANAGER ♦ \$175

Powerful asynchronous communications library providing interrupt driven support for the COM ports. All source code included.

### FOR THE TURBO PASCAL PROGRAMMER:

#### Turbo POWER TOOLS ♦ \$99.95

Extensive string support, extended screen and window management, interrupt service routines, program control and memory management, interrupt filters. All source code included.

#### Turbo ASYNCH ♦ \$99.95

Interrupt driven asynchronous communication support callable from Turbo Pascal. ASYNCH is written in assembler and Turbo Pascal with all source code included.

### PACKAGES FOR ALL PROGRAMMERS:

#### EXEC ♦ \$95

Program chaining executive. Chain one program from another even if the programs are in different languages. Common data area can be specified. Source code included if you're a registered C TOOLS and C TOOLS 2 user.

#### SPARKY ♦ \$75

Run-time resident (or stand-alone) scientific, fully programmable, reverse polish notation calculator. No limit on stack size, variables or tape. Includes all standard scientific functions and different base arithmetic.

**TO ORDER, call Blaise Computing Inc. at (415) 540-5441**

♦ 2034 Blake Street ♦ Berkeley, CA 94704 ♦ (415) 540-5441

**BLAISE** *watch us!*  
BLAISE COMPUTING INC.

# THE PC'S LIMITED AT™ —\$1995. THE PC'S LIMITED TURBO PC™ —\$795.



At these prices, it's no wonder  
we're burning up the marketplace.

Yes, you can believe it. Since we ran our first advertisement for the PC's Limited AT™ and Turbo PC™, the calls we've received mostly start with comments like "Is this for real?" And "How can that be?" But now that our machines are in the hands of influential buyers, the questions tend to concern quantity discounts for further purchases. (Which are available.) You see, the PC's Limited machines are assembled from components bought worldwide with our strong buying power. Then they are offered directly to you—with no middleman markups. So light a match to your old budgets. With the savings we're providing, you'll have money to burn.

## PC'S LIMITED AT™

- 80286-based System Unit running at 6MHZ. (8MHZ option included at no charge.)
- 1024K on Mother Board
- 1.2 Meg Floppy Drive
- Combined Floppy/Hard Disk Controller Card
- AT Keyboard
- 192W Power Supply
- 2 Serials and 1 Parallel Port
- Clock/Calendar with Battery Backup

Runs all Major Software written for the IBM PC™, PCXT™, and PC AT™. Unit has 8 Expansion Slots. Same Bus Configuration as IBM PC AT™. One year limited warranty.

GW Basic \$95 • DOS 3.1 \$85 • 80287 \$195

## PC'S LIMITED TURBO PC™

- 16-bit 8088-2 System Unit (running at 4.77 or 6.66 MHZ)
- 640K on Mother Board
- 360K Floppy Drive
- Keyboard
- 135W Power Supply

Runs all Major Software written for the IBM PC™ and PCXT™, 40% faster, without modifications. Unit has 8 Expansion Slots, with 7 available in above configuration. One year limited warranty.

GW Basic \$95 • IBM DOS 3.1 \$85 • 8087-2 \$149

IBM™ is a registered trademark of International Business Machines Corporation. IBM PC, PC XT, and PC AT™ are trademarks of International Business Machines Corporation.



## PC'S LIMITED™

SALES CALLS OUTSIDE TEXAS, 1-800-426-5150

1611 Headway Circle, Building 3, Austin, Texas 78754

Sales Calls from anywhere in country, (512) 339-6962

Technical Support Calls, (512) 339-6963 Customer Service Calls, (512) 339-6964

Telex No. 9103808386 PC LTD

Ad Number 403/86

# THE SMARTEST BUY YOU'LL EVER MAKE: 20 MBYTES OF *AUTOMATIC* TAPE BACK-UP FOR JUST \$795.



## ONLY FROM SYSGEN.™

**The Sysgen Smart Image.™**  
**More capacity. More features. More value.**  
The best-selling tape back-up system for the IBM® and compatibles gets even better!

Now the Sysgen Smart Image delivers *double* the storage capacity: 20 Mbytes on a high density cassette. It backs your data up *automatically*. And it comes in two convenient versions: The internal model, for just \$795—or the slim, half-height external chassis for \$895.

**Only Sysgen gives you *unattended* back-up.** Set the Smart Image once, like a VCR, and it will back up your data up to twice daily, seven days a week. And, if you're using your system, the Smart

Image will wait until you're through, then back up your files automatically. *That's smart.*

**You can't pass up a buy like this.**

You won't find a smarter solution—or a better price. Sysgen's entire disk and smart tape family offers an unbeatable combination of capacity and value. Our systems are IBM® standard compatible, and run all software written for current versions of PC DOS®. Compare for yourself:

For a Sysgen dealer near you, call 1-800-821-2151, Dept. 30



Trademarks: Sysgen, Smart Image—Sysgen, Inc. Registered Trademarks: IBM, PC DOS—International Business Machines Corporation.  
47853 Warm Springs Blvd., Fremont, CA 94539  
(415) 490-6770, Telex 4990843

**SYSGEN**  
INCORPORATED



to tutor other people in their use. I have no desire for an "integrated" program. The degree of program improvement and data interchangeability simply doesn't merit tackling a new learning curve.

Furthermore, until I needed a spreadsheet, none of the integrated programs on the market would have met my needs. However, I will admit to looking at AppleWorks very closely, since I have need for all of its functions. Throw in the upcoming Jeeves and the system appeals to me greatly.

As a sometime consultant, I've also had occasion to computerize a friend, an internationally known sculpture. His son left him a Zenith while he went gallivanting off to other parts of the world, and he's decided to get more serious about computers.

He asked me about Symphony, the supposed king of integration.

I asked him, "Have any complaints about WordStar?" He shook his head.

"Got any major problems with dBASE II?" Another shake of the head.

"Multiplan does just about everything

else you want, right?" An affirmative shake of the head.

"In other words, you feel comfortable with what you're using."

My friend laughed and abandoned plans to become integrated.

I think the main problem with integrated programs is that they are *too* powerful. I cheerfully admit that my "regulars" don't have as much power as I would like. But they fill the bill 95 percent of the time.

As a result, I don't get my computer loaded up with RAM-consuming modules that slow down the modules that I do want.

Something like Switcher for the Macintosh is an important idea. It allows the user to cobble together the integrated system of his or her choice. Two years ago, I would have put PIE together with pfs:File (if there had been an Apple II analogy of Switcher back then) and would have been as happy as a clam. Then, when I found the need for a spreadsheet, I would have reconstructed my system to include VisiCalc.

Notice I've never found a need for a

graphing program, and I am happy I'm not wasting RAM to have one at the press of a button.

I don't think I stand out all that much. Very few business users actually end up using all the various modules of integrated programs. Many businessmen make use of spreadsheet and graphing programs, with occasional access to the database. The word processing is left to secretaries, who rarely have any reason to do spreadsheeting.

That is not an all-encompassing statement. Many businessmen, and many secretaries, do use all the various modules. But many don't. And of the many that do, how many can't afford the time to quit a program and load another one, instead of going from module to module?

No, if I were a programmer right now, I'd be working on Switcher-like programs, the kind of Chinese-menu programs that will allow people to do their own integration.

GARY MACPHERSON MUGFORD  
Bramalea, Ontario, Canada ■

## New Quark®/PC SBC

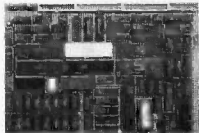

Base model 5" x 8"

Only \$ **495.**

Quantity discounts available

- IBM PC-XT® compatible single board computer mounts to 5 1/4" drive
- Includes Floppy Disk & Color Graphics CRT Controllers plus more

**Also includes:** Legal BIOS • Boots MSDOS® • Printer Port • 2 Serial Ports • 256K RAM • Clock Speed at 4.77 MHz • Alphanumeric and Graphics Modes for Color Video Controller.

**Options include:** 512K RAM • Motherboard with IBM PC® Bus Expansion Slots • XT - Compatible Hard Disk Controller • Real Time Clock with battery-back-up • Clock speed of 9.5 MHz (twice as fast as a PC)

The Megatel Quark/PC is for the OEM designer or systems integrator who wants reliable PC compatibility in an easy-to-use SBC. The Quark/PC BIOS will run most IBM PC® software including Flight Simulator and Lotus®. To meet your specifications a set of options let you add memory, speed and an XT-compatible hard disk controller. Not only does it quickly mount to a 5 1/4" drive, it also comes with floppy disk and CRT color graphics controllers — all for just \$495.

To order or enquire call us today. Dealer enquiries welcome. Megatel Computer Technologies (416) 745-7214 150 Turbine Drive, Weston, Ontario M9L 2S2 Telex: 065-27453 U.S. Address: 1051 Clinton St., Buffalo N.Y. 14206 Distributors: NCS Electronics — Varese, Italy • SES Electronics — Nordlingen, Germany • Perdix Microtronics — Biggin Hill, U.K. • Microcomputing — Ghent, Belgium.

Quark is a registered trademark of F and K MFG CO. LTD. IBM, IBM PC and IBM XT are registered trademarks of International Business Machines Corp. Lotus is a registered trademark of Lotus Development Corp. MSDOS is a registered trademark of Microsoft Corp.

**megatel**

# DISKETTES

Ask about our monthly "SPECIAL"

<b>Dysan</b> 5 1/4" Disks S-SIDE 13.95 D-DEN. 18.95 S-SIDE 23.95 D-SIDE 29.95 HIGH DEN. 39.95 3 1/2" Disk S-SIDE 24.95 8" Disks S-SIDE 20.95 D-DEN. 22.95 D-SIDE 27.50	<b>maxell</b> 5 1/4" Disks S-SIDE 9.85 D-SIDE 14.75 S-SIDE 19.95 D-SIDE 24.50 HIGH DEN. 28.75 3 1/2" Disks S-SIDE 18.40 8" Disks S-SIDE 26.95 D-DEN. 24.95 D-SIDE 26.95	<b>SONY</b> 3 1/2" Disks S-SIDE 18.95 D-SIDE 28.95 <b>ATHANA</b> MINI 6.95 per box 5 1/4" 5.50 7.95 per box D-SIDE <b>BULK PACK</b> 50 DISK \$29.50 \$34.50 Media Mate \$8.95 ea +2.00 Shipping	<b>3M</b> 5 1/4" Disks S-SIDE 10.95 D-DEN. 15.25 S-SIDE 19.95 D-SIDE 24.50 HIGH DEN. 30.95 3 1/2" Disks S-SIDE 19.95 D-SIDE 27.95 8" Disks S-SIDE 19.95 D-DEN. 23.95 D-SIDE 27.95	<b>Verbatim</b> 5 1/4" Disks S-SIDE 11.75 D-DEN. 14.95 S-SIDE 19.95 D-SIDE 24.50 HIGH DEN. 29.95 3 1/2" Disk S-SIDE 18.95 8" Disks S-SIDE 19.95 D-DEN. 21.95 D-SIDE 24.95
--	---	--	--	---

Old Reliable **\*Delaware 1-800-451-1849**  
P.O. Box 10247 Wilmington, DE 19850  
**\*Oklahoma 1-800-654-4058**  
P.O. Box 1674 Bethany, OK 73008  
**\*Nevada 1-800-621-6221**  
P.O. Box 1213 Boulder City, NV 89005

**DISKETTE CONNECTION™**

**TERMS:** Minimum 20 disks or \$35.00 — VISA or MasterCard accepted  
C.O.D. orders add 2.00 for special handling. **SHIPPING:** 3 1/2" & 5 1/4" Diskettes; Add 3.00 for every 100 Diskettes or any fraction thereof. 8" Diskettes; Add 4.00 for every 100 Diskettes or any fraction thereof. We ship UPS; orders requiring other delivery methods add shipping, plus 2% of total order.



## When the World Sells Micros,

Have you considered your international prospects already? Good. Then you know that capturing this market will have a tremendous impact on your business. Now is the time to plant the seeds of recognition—the international micro industry is taking off. In fact, in Europe alone, annual micro sales are in the billions of dollars.

So how are you going to do it? Let BYTE offer you a solution: in addition to the 1.9 million BYTE readers in the U.S., we have over 177,000 readers (80% in

Europe) outside the North American continent—all of whom comprise the most select audience for your advertising investment. BYTE is the micro medium that communicates your sales message in a language understood all over the world. And BYTE is the only U.S.-based micro publication to earn the reputation as *the* international standard.

BYTE also offers a special International Advertising Section (IAS) which allows you to advertise your products only to BYTE readers outside the North



For subscription information in Europe, call  
Margaret Wootten in England: 011-44-628-23431



# the Common Language is BYTE.

American continent at reduced rates.  
Call your regional sales representative to  
find out how BYTE can speak for  
you...all over the world.

**BYTE. The Official Translator  
of the Micro World.**

For advertising information, call:

Austria, Vienna	Hans Csokor	222 75 76 84
France, Paris	Alain Faure	(1) 47-20-33-42
Hong Kong	Seavex, Ltd.	5-260149
Israel, Bat Yam	Gurit Gepner	3 866 561 321 39
Italy, Milan	Savio Pesavento	02 86 90 617
Japan, Tokyo	Hiro Morita	3 581 9811
Singapore	Seavex, Ltd.	734-9790
Spain, Madrid	Maria Sarmiento	1 45 52 891
Sweden, Nacka	Andrew Karnig	8-44 0005
U.K., London	Arthur Scheffer	01 493 1451
W. Germany, Frankfurt	Fritz Krusebecker	69 72 01 81

# BYTE

THE SMALL SYSTEMS JOURNAL

70 Main Street  
Peterborough, NH 03458  
(603) 924-9281



# BETTER SONY THAN SORRY.

The bomb's up. The system's down. You've lost all your data to disk error because you made a very basic human error. You didn't use Sony floppy disks.

Next time, go with the industry standard, the company who invented the 3.5" disk drive system, and a floppy disk that comes 100% certified error free. Sony.

Only Sony 3.5" micro floppy disks contain such error suppressing materials as patented Vivax™ magnetic particles and a high-molecular DDL™ binder system. This protects your micro floppy disk, and the information on it, for its lifetime; and assures data retrieval in the order you choose. Guaranteed.

So use Sony 3.5" or 5.25" floppy disks, and avoid disk error. If you use somebody else's, you could be sorry.

**SONY**  
THE ONE AND ONLY®



© 1986 Sony Corporation of America. Sony is a registered trademark of the Sony Corporation. Vivax and DDL are trademarks of the Sony Corporation. "The One and Only" is a registered trademark of Sony Corporation of America.

# AMIGA

Topics this month include notes on compiling programs for the Amiga, recovery of inadvertently zapped disks, and posting source code to the BIX network. The Software Bugs and Fixes section contains a workaround for a disk font system bug. Users of both Amigas and Macintoshes compare notes on disks, windows, and menus.

Alastair J. W. Mayer, author of BIX's CoSy software, presents a comparison of precision versus resolution with regard to computer graphics systems, there is discussion of Electronic Arts' IFF graphics protocol for message exchange, and Bob Pariseau of Amiga reveals the secret of Amiga's bouncing-ball demo.

## COMPILING AMIGA PROGRAMS

amiga/main #733, from crunch [John Draper]

The Amiga BBS in Los Gatos has a demo program called "toydemo.c" which is supposed to use the Amiga's speech system. Unfortunately, I cannot get it to compile. Has anyone else had the same problem? Would anyone from Amiga care to comment on it? The program was written by Dave Lucas in Los Gatos. I think it is supposed to show a person talking with lips moving and speaking.

I sure would prefer the programs on the Amiga that support BBSs to compile on the native compiler without modification. I get the "system error" request. The program is rather long. I tried for several days to break it up into two smaller pieces. Then I broke off the gadget, menu, and other structure definitions into a separate header file.

I was very frustrated because I was curious what the program looks like.

amiga/main #740, from mikez [Michael Zarembski]:  
a comment to 733

If you are referring to the speechtoy.demo.c, I had the same problems till I reset the stack to 30,000 (by doing a "stack 30000"), and then it compiled just fine. It appears that phase 1 of the Lattice C compiler was overwriting the system stack and the system would go out to lunch (Lattice claims V3.03 will do stack checking).

The program is neat for checking out the speech variables interactively using the mouse.

amiga/main #743, from crunch:  
a comment to 740

Please tell me where I'm supposed to type the stack 30000? Do I type it into CLI or "INCLUDE" it in the source?

amiga/main #748, from mikez:  
a comment to 743

At the CLI prompt ( > ), type "stack 30000," or you can do what I did and put the stack command in s/startup-sequence so that it will automatically reset the stack for me.

amiga/tutorial #208, from pariseau [Bob Pariseau, Commodore-Amiga]

TITLE: Up That Stack!

There have been several reports from folks saying that they get system crashes or other strange results when they try to compile or link large programs on the Amiga.

These failures are *almost always* due to insufficient stack space for the compiler. The default stack setting in a new CLI is 4000. As a mat-

ter of course, I bump mine up to 20,000 when I'm doing compiling.

If you have modified your s/startup-sequence file to leave your CLI around when you boot, I would recommend that you put the command stack 20000 in that file as well.

If you get to your CLI from the Workbench icon, either remember to reset the stack when you start or, for those of us with short memories, put the stack 20000 command in the front of your Make script. That way you're assured of having a sufficiently large stack whenever you compile. Note that the commands are not "cumulative" in any sense; thus you can issue and reissue stack commands to your heart's content.

In particularly complicated programs, a stack of 20,000 may not even be enough. If your system crashes while compiling, *double the size of your stack*.

## USING A PASCAL COMPILER WITH A SINGLE DISK DRIVE

amiga/softw.devlpmt #476, from jmeyer [Jim Meyer]

TITLE: Pascal and Single Drive?

Some of the members of my users group, who don't yet access the BBSs, can't get their Pascal to work with a single-drive system. The Pascal manual seems to indicate that a second drive is required. Is it possible to simply create a RAM disk and assign it to df1? (I'd give it a shot, but I'm W.P.—Without Pascal.)

amiga/softw.devlpmt #477, from jdow [Joanne Dow]:  
a comment to 476

You might have to use two disks with Pascal compiler and INCLUDE files on one disk and the linker on the other. If the Pascal is anything like the C, you will find you can shove some of the files off into the RAM: (Simply "copy source file to RAM:.")

The linker seems to take enough memory that it will not run for me if there is very much else working in the 512K RAM I have. Hence, it might have to be on its own disk with the libraries.

## TRASHED DISK RECOVERY

amiga/tech.talk #152, from sdb [Scott Ballantyne]

TITLE: Help with Garbaged Disks!

I have had a lot of fun reading the messages here, and I'm sorry to leave this one as my first, but, HELP!

I made a small change to my start-up script, and BOOM!, the disk became unreadable when I wrote it out.

Has anyone figured out the disk format and DiskEd enough to help me recover it?

PS.: Do I have the honor of being the first to trash a disk on the Amiga?

amiga/tech.talk #155, from cheath [Charlie Heath, MicroSmiths]:  
a comment to 152

You're not the first, unfortunately.

It is possible to recover zapped disks with a tool called DiskEd, which is included in the developer's kit. It is not fun.

## SOFTWARE BUGS AND FIXES

amiga/softw.devlpmt #473, from pariseau

TITLE: Disk Font System Bug!

There is a bug in the V1.0 and V1.1 diskfont.library code that can cause the system to crash when memory gets low. A workaround is presented below.

Disk-based system resources such as fonts and device drivers are

(continued)

brought into memory when they are first opened. They remain in memory thereafter until some task asks for more memory than is available in the system "Free Memory Pool." At that point the Exec function AllocMem() "expunges" (removes from memory) any resources that currently have zero openers. This design means that resources tend to hang around in memory so that if they are frequently opened and closed there is no time lost reloading them from the disk.

Many applications periodically use the trick of attempting to "AllocMem()" more memory than can possibly be in the system, to flush any unused resources from memory. Note that if AllocMem() finds any resources to expunge, then the number returned by AvailMem() after the call to AllocMem() will be [larger] than before the call (presuming, of course, that the AllocMem() does not, in fact, return a newly allocated chunk of memory to you).

The bug is that when a disk-based font is expunged from memory, the expunge code in diskfont.library does not properly remove the font descriptor from the list of fonts known to be in memory. Thereafter, whenever a font is looked up, there is a chance that the system will crash since the font node now points at memory that has been returned to the system "Free Pool."

The workaround involves manually removing the font from the font list before you close it. The workaround, as presented, provides maximum protection for the system at the expense of possibly having multiple copies of the font temporarily exist in memory together. If you know that *all* font users in the system are using the workaround, then only the last closer of the font need do the Remove() function.

Note that version 1.1 of Notepad (for instance) does *not* implement this workaround.

The workaround for the diskfont.library bug is, whenever closing a font:

1. Forbid();
2. Check the font flags to see if it is a disk font.
3. *If a disk font*, check that this font is in a list by ensuring that the predecessor's and successor's nodes point to it.
4. If the font is in a list, "Remove(0, font)" it.
5. Permit();
6. CloseFont();

Note that the first argument to Remove(), the 0, is a dummy argument present for historical purposes. The TextFont structure is described in the include file text.h (or text.i if you speak assembly). Note that the "Accessors" field contains the opener count for a font.

If you are not concerned with reclaiming the memory space taken up by your unused fonts, it is sufficient, as an alternate workaround, simply to never close your fonts. This will ensure that AllocMem() never tries to expunge the font.

Note that this would keep the font from *ever* going away—even after your program terminates. If Notepad, or another program, has opened and closed disk fonts prior to the running of your program, the font list has the potential of being messed up the next time AllocMem() goes to expunge resources.

If such an expunge has already occurred, there is no recovery other than to reboot the system. On the other hand, if an expunge has *not* yet occurred, you can protect yourself by emptying the font list before you first trigger an expunge. To empty the font list, traverse it starting from the TextFonts pointer found in the structure GfxBase. Do a Remove() on each disk-based font in the list.

(Warning! Only Remove() disk-based fonts.) The elements of the list are structures of the type TextFont. Note that you *must* do this cleanup prior to triggering your first expunge (i.e., before calling AllocMem() with a large value). This cleanup should be done while tasking is disabled (i.e., between a Forbid() and a Permit()).

This bug will be fixed in the V1.2 system software. Any application implementing the above workaround will continue to work under the new system software.

## POSTING SOURCE CODE ON BIX

amiga/main #704, from crunch

TITLE: Amiga Source

I have some Amiga source code to post on BIX. It is quite long and was written by a friend of mine who asked me to post it. Would anyone please BIX-mail me instructions on what procedures I need to follow to post it?

amiga/main #707, from jadow:  
a comment to 704

If you are uploading to this conference (source less than perhaps 50K bytes to 70K bytes), there is a reasonably successful procedure. For longer files, find the Amiga section in the Listings conference and upload there.

1. If logged on through Tymnet, make sure flow control (XON/XOFF) is disabled (i.e., do not send a Ctrl-X and/or Ctrl-R during log-in). Set up your terminal program to generate a local echo of your typing; then set Tymnet to half-duplex by typing a backspace during the typing of the "bytenet" prompt.
2. To set up for XMODEM transfer mode, type "opt up xmodem down xmodem q."
3. Have a clear scratchpad—uploading clears out what is currently stored in your scratchpad to start out fresh. This way you won't be surprised upon finding something valuable was deleted from your scratchpad area.
4. At any "R:" prompt type "UP." You'll get several lines of "UMODEM ready for upload" messages.
5. When the messages stop, proceed to engage your XMODEM program and send the file.
6. Pray (or prey, depending on your proclivities).

I hope this helps.

Oh, yes. This may fail if your XMODEM program time-outs are too short.

amiga/main #737, from greggw [Gregg Williams, Senior Technical Editor, BYTE]:  
a comment to 707

The "upload" and "download" commands will eventually disappear from BIX; they are not all that useful and they're hard to use. I know this is placing software outside of a conference, but *please* put listings, executable programs, and long text documents in the Listings conference. Type "join listings" to get there, then "?" for help. There is a separate "Amiga" file area.

Crunch [John Draper] has posted a set of C files there. Items in the Listings conference are tagged with a description, keywords, and the contributor's name.

If you have any questions, please let me know.

## PRECISION VERSUS RESOLUTION

amiga/tech.talk #153, from al [Alastair J. W. Mayer, University of Guelph]

TITLE: Precision versus Resolution

I'm not sure the best single place to put this, so I'm going to copy it to a few other places. Apologies to those who read it twice.

(continued)

AT&T presents maxims for better international communication.

# Sometimes, it's better to put all your eggs in one basket.



**AT&T International Services offer the strongest, sturdiest basket for your telecommunications needs.**

Because AT&T has a long history of making international connections and developing international services.

AT&T offers a wide range of international services for your company, whether you're involved in manufacturing, distribution, marketing or any other function. AT&T International Long Distance Service, for example, helps your company build better business relationships. AT&T International 800 Service encourages the steady flow of contact between customers, salespersons and suppliers, so you can maintain a competitive edge.

But how do you choose the services that are right for you? It's simple. Just contact your Account Executive or Sales Specialist at AT&T. They're experts in a wide range of businesses, and they can offer you our entire basket to accommodate your needs. Together you and your AT&T representative can tailor services and applications that work for you.

To learn more about AT&T's state-of-the-art telecommunications and the applications they have for your business, please contact your Account Executive at AT&T Communications now. Or call a Sales Specialist at the toll-free number below.

**1 800 222-0400 Ext. 515**



**AT&T**

The right choice.

The title, "Precision versus Resolution," refers to two computer graphics terms whose meanings seem to have become confused in the wave of advertising hype for new micros, including the Atari 520ST and the Commodore Amiga.

"Precision" refers to how finely the coordinates of a given pixel can be specified, which boils down to the number of addressable points along each axis of an image. "Resolution" refers to the number of distinct dots that can be displayed in a given area of the screen.

Thus, saying the 520ST or Amiga has a resolution of 640 by 200 is totally meaningless. They may have a *precision* of 640 by 200 (in one particular graphic mode—different in other modes), but the *resolution* is entirely dependent upon the display device.

For example, no matter what graphic mode I'm in, there is no way I am going to get much better than about 300 by 200 (if that) resolution on a normal color TV. Why do I bring this up? In part, just for the sake of clarity of language. But also because I believe that, while the *precision* of the 520ST and Amiga is comparable (and indeed, the Amiga has higher precision in some graphic modes), the *resolution*—which visually is more important—differs between the Atari monitor and the Amiga monitor.

I have seen both (I am comparing the 640 by 200 color modes here), and my impression is that the image on the Atari monitor is much sharper and crisper (i.e., at higher resolution) than the image on the Amiga monitor. Indeed, the "feel" is that the resolution of the Amiga monitor is just barely adequate for the precision, while the Atari monitor has resolution to spare.

In all honesty, I have not had the opportunity to compare the two side by side. But I have used both for several hours and on several occasions, over the space of a week or so. It may be that my perception of the resolution of these monitors (and I've seen more than one of each, so discount individual variation) is affected by optical illusions because of the different diagonal screen size (Atari is smaller), or color choices, or text font.

But there *is* a difference between precision and resolution, and even with displays at the same precision, the visual effect is that the Amiga monitor has lower resolution.

What I'm interested to know is

1. Does anyone agree or disagree with my subjective feelings about these two monitors in particular?
2. And how about some comparisons with these machines using other (e.g., Sony, Hitachi, etc.) RGB monitors? (The point behind the latter is I am wondering about the quality of the signal put out by the Atari and Amiga—whether the fault lies in the monitor or the video circuits of the computer—if indeed there is a "fault.")

Comments?

(N.B.—I'm not trying to start a war here; I'm just (a) clarifying terminology and (b) looking for info.)

amiga/tech.talk #154, from jsan [Jez San, Argonaut Software]:  
a comment to 153

AI—I disagree with your definitions of "precision" versus "resolution." We live in the *real world* here, and not some textbook definition.

People in the *real world* talk about the graphic resolution of a computer as its *x* and *y* addressable pixel range. Maybe in a textbook world you are right, but don't think for a second that people are going to start saying "precision" instead of "resolution"!

amiga/tech.talk #156, from al:  
a comment to 154

And in the real world, I can't display the 640 by 400 pixels of the

Amiga on a color TV in any way that a human being can *resolve* them as distinct.

Resolution is display-dependent, not computer-dependent. By the same token, displaying C-64 output on a Sony monitor will give you fantastic resolution, but no more than 320 by 200 precision (but you'll be able to resolve those pixels easily).

### IFF GRAPHICS PROTOCOL

amiga/softw.devlpmt #157, from gregr [Gregg Riker, Electronic Arts]

TITLE: IFF (Information Format Files) Is Available!

I mentioned that I used IFF files with the SlideShow. Allow me to elaborate.

Electronic Arts has a general interest in promoting standards, so we knocked heads with some people at Commodore-Amiga and came up with IFF.

IFF is intended to be used by any and all interested developers. It offers a convenient way of allowing programs to exchange data with one another.

For example, Graphicraft will be able to exchange files with Deluxe Paint and other EA products. The design is extensible, in that you may add your own types to the standard. There are programs available in C (public domain!) that will read and write graphic images in IFF format.

If you're interested in a copy of the spec, please contact Rob Peck at Commodore-Amiga. He can supply you with a copy. If you have any problems or need more information, please contact Jerry Morrison at Electronic Arts, (415) 571-7171.

P.S.: IFF covers graphics, audio, and text and is expandable!

amiga/softw.devlpmt #164, from patiseau:  
a comment to 157

IFF documentation will be included with the standard V1.1 release package. Commodore-Amiga has decided to adopt IFF as our standard interchange format. In the short term, this will affect graphics files produced by the paint packages (Graphicraft and EA's Deluxe Paint) as well as the format for text and graphics clips through the clipboard device.

amiga/softw.devlpmt #218, from al:  
a comment to 157

Is IFF NAPLPS-compatible? If not, why not?

A plea: Anyone out there doing any kind of software development that involves the software creating pictures: give it a NAPLPS option!

Either creating NAPLPS files describing the pictures, or interpreting NAPLPS and drawing the pictures. Or both. (NAPLPS includes text, too.) This will allow the exchange of such images and text with many other such systems—including via BIX.

amiga/main #381, from cheath

Let's all study IFF and NAPLPS real carefully. I hope we don't get a split camp on this. I suspect most *fast* graphics programs will want to use IFF. Where is the NAPLPS spec? Let's get IFF up here!

amiga/main #399:  
a comment to 381

Another BIX subscriber said that NAPLPS is a good protocol for transmitting images over communication lines but not ideal for local graphics storage. He further stated that bit maps were best stored in IFF format and converted to NAPLPS format for transmission.

(continued)



# How to get all the ATs you want.

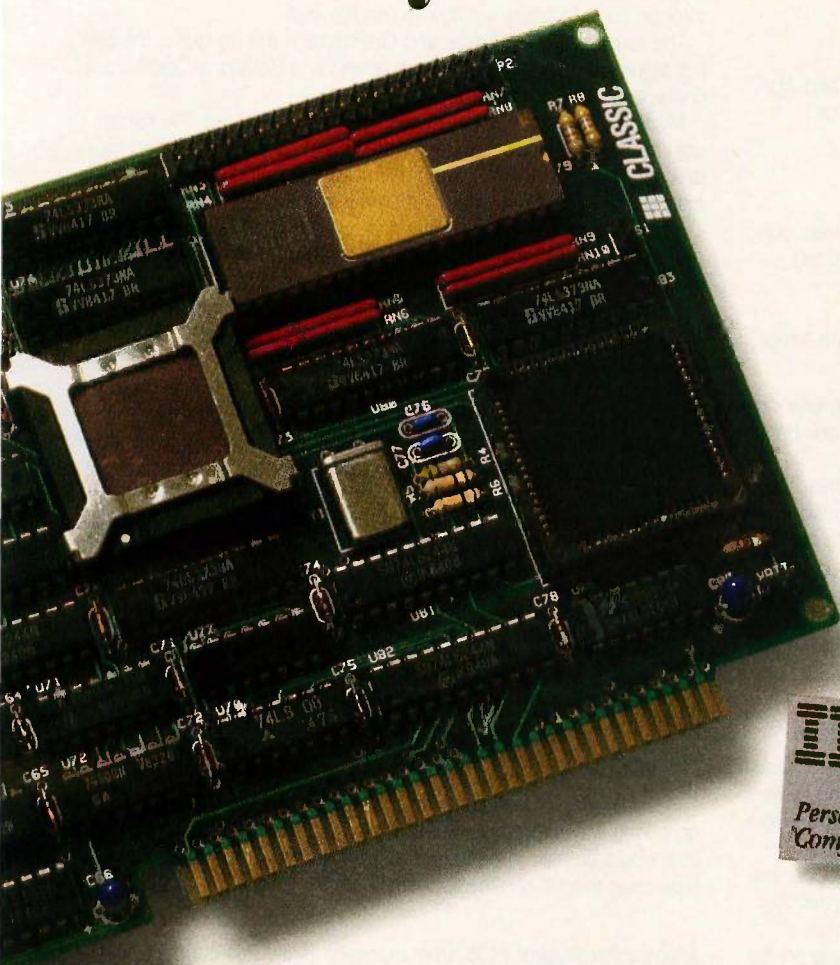

A number of products promise to "make your PC perform like an AT."

Unfortunately, the resulting "AT" all too often lacks one or more important characteristics.

Like compatibility with PC and AT software. Like IBM serviceability. Like support for multitasking.

And like the ability to manage large, AT-size spreadsheets and databases.

Classic's 286 Speed Pak performs 33% faster than an AT—without damage to your PC, with no BIOS problems, and with no service problems. It's completely

hardware—and software-compatible.

And it's the only board you can upgrade to let your PC or XT perform multiple tasks simultaneously. For example, you could compile a new program, run a spreadsheet and print a large document all at once. Just add our TaskMaster multitasking software and 2.5Mb memory adapter.

- DOS 3.0 and 3.1 compatible
- 100% I/O emulation of the 8088 (no timing problems)
- 8088 native mode
- 512K or 1 Mb memory
- Can address up to 16 megabytes of memory on add-in expansion

- boards
- Optional 80287 math co-processor
- 16-bit BIOS
- Full 16-bit data path.

For more information about the 286 Speed Pak and the name of your nearest dealer, phone 408/434-9333. Because if you're not with Classic, you're not where it's really AT.

**CLASSIC**  
Everything you always wanted from IBM.

Classic Technology Corporation  
2090 Concourse Drive, San Jose,  
CA 95131 • 408 434-9333

amiga/softw.devlpmt #230, from cheath:  
a comment to 229

Is IFF being limited to Amiga? We are developing on Amiga and Atari. It would be nice to be able to use the same data format, for us.

amiga/softw.devlpmt #231, from gregr:  
a comment to 230

IFF is *absolutely* designed to be used with other systems. Please consider yourself invited to use IFF on the Amiga. Contact me by telephone so that we can arrange your receipt of the spec.

amiga/softw.devlpmt #232, from rjm [R. J. Mical, Commodore-Amiga]

IFF is great. It has everything that we currently need.

I arrogantly stated once, when asked about standards, that "one can't standardize that which hasn't been dreamed yet. Standards look backward; I want to look forward."

The IFF standard looks forward. It is extendable in many unique and flexible ways. This extendability costs a little bit (bulk in overhead, processing), but it will be worth it, especially if IFF is still a viable standard three years from now.

We at Amiga give it our stamp of approval, and we intend on supporting it completely. Congrats to the folks at Electronic Arts for dreaming it up and polishing it until it shines (we helped just a little, and just at the end).

amiga/main #390, from tenney [Glen Tenney, Fantasia Systems]

IFF is really a very good standard for Interchange Format Files, meaning that it is intended for any and all processors and operating systems as a means to interchange as many different kinds of data as possible. IFF is very open-ended, allowing new data types to be defined.

I am not certain, but I believe that, aside from example C code, real code is in use on the Amiga, IBM PC, and Mac (I think). My recollection of NAPLPS is based more on Telidon, so pardon my errors. NAPLPS seemed too slow and cumbersome for interactive use on the computer actually sitting in front of you. I remember it as being more suited as a file transfer and don't think I'd like to sit there with a 68000 and a hard disk waiting for a picture to be processed.

amiga/tutorial #182, from cheath

Duck, I'd be upward-compatible if I knew how. I'm just using the documentation I have available, which is for V1.0. Don't the IFF routines make the same assumptions?

amiga/tutorial #184, from duck [Dale Luck, Commodore-Amiga]:  
a comment to 182

The IFF data format actually specifies 8 bits per color. This is the encoding on the file and must be converted to the actual hardware/software abilities, like SetRGB4, so that the Amiga's 1000 colors 0-F map to 00-FF on the IFF (0=black, ff=full bright).

I do not claim to know all there is to know about graphics, compatibility, upward portability. If any of you have suggestions, by all means make them; they may make it in the next release, but not 1.1—the window for enhancements is closed on this version.

amiga/softw.devlpmt #378, from cheath

TITLE: IFF Report

I set up the IFF graphics file load/save, using the C files sent by Electronic Arts. I used their packaged routine, which is designed to save a full-screen 320- by 200-pixel scene. It took a bit of wading

through code to figure out how to use the stuff.

The routines are PutPicture and GetPicture in the file exiff.c; the calling arguments are fairly simple: an open file, a BitMap, a ColorMap, a character buffer, and bufsize.

My only problems came with setting up the ColorMap. You *cannot* use the ViewPort color map, and I also had trouble using a map allocated by the call GetColorMap. Finally, I allocated and initialized a map explicitly, and Rah smiled upon my efforts.

The performance was a bit sluggish. Before I had been using a simple "save 32000 bytes," which would take about 3 or 4 seconds for a load or save operation. With the IFF, loads take from 4–6 seconds, and saves take about 10 seconds. The routines added about 8K bytes to my execute file. Some of this can probably be reclaimed by removing unused routines.

The good news, aside from compatibility, was that the files averaged about 10K bytes versus the 32K that would result from a simple bit-map save. It is possible to store the images more compactly, but this is a reasonable balance between speed, simplicity, and compaction.

We are hoping to use the IFF standard for saving Atari 520ST graphics files. It looks like a fair amount of work to replace the Amiga data structures, but that only needs to be done once. We would be interested in hearing from anyone else interested in this.

Bugs:

1. Symbol "OFFSET\_\_BEGINNING" (iffrc, iff.w.c) should be OFFSET\_\_BEGINING. (Spelling is correct!)
2. Unable to write files on RAM: device. Files could be read from RAM: but not written to it.

Suggestions:

1. A set of simple, well-documented routines for screen dumps would go a long way to promote widespread acceptance.
2. It would be nice to be able to pass a RastPort rather than a BitMap. How does this tie in with clipboard?

amiga/softw.devlpmt #406, from mposehn [Mike Posehn]:  
a comment to 378

About IFF

1. I'm not sure what you mean about not using the color map directly. Here's how I read a three-plane picture and set the colors:

```
/* Set default colors in case this picture doesn't have them */
for(n=0;n<8;n++) colorMap[n] = GetRGB4(vport ->ColorMap,n+8);
/* Read the picture and color map */
success = GetPicture(file, bm, colorMap, tmpr.as.RasPtr,tmpr.as.Size);
if (success)
{
    /* Ok, set the colors */
    for(n=0;n<8;n++)
        SetRGB4(vport,n+8,(colorMap[n] << 8) & 0xf,
                (colorMap[n] >> 4) & 0xf,
                colorMap[n] & 0xf);
}
```

2. The IFF reading and writing speed is greatly improved in the version being released now. I upgraded to it today—you'll like it a lot more.
3. As you know it's OFFSET\_\_BEGINNING in the dos.h file. Some people can't put up with a little spelling error and insist on redefining it with a "#define OFFSET\_\_BEGINNING OFFSET\_\_BEGINING".
4. As far as passing a RastPort instead of a BitMap—I'm glad it's a bit map. Many months ago it seemed like every ROM routine wanted a RastPort and I was continually wasting code making fake RastPorts for

(continued)

# COMPUPRO OPENS THE DOOR TO THE WORLD OF IBM® PC SOFTWARE

Now owners of S-100 systems can have the best of both worlds—a multi-user, multi-tasking environment and the business applications that go with it—*plus* limited access to the world of IBM PC software and its personal productivity tools. And you can do it all with one system by adding our **PC VIDEO™** board and **Concurrent DOS 816™ Version 4.1\*** operating system.

The PC VIDEO board is an affordable **\$495**, and Concurrent DOS 8-16 V4.1 sells for **\$500**, but buy them both together and get them for just **\$895**—you save **\$100!** *Hurry! Offer expires April 30, 1986.*

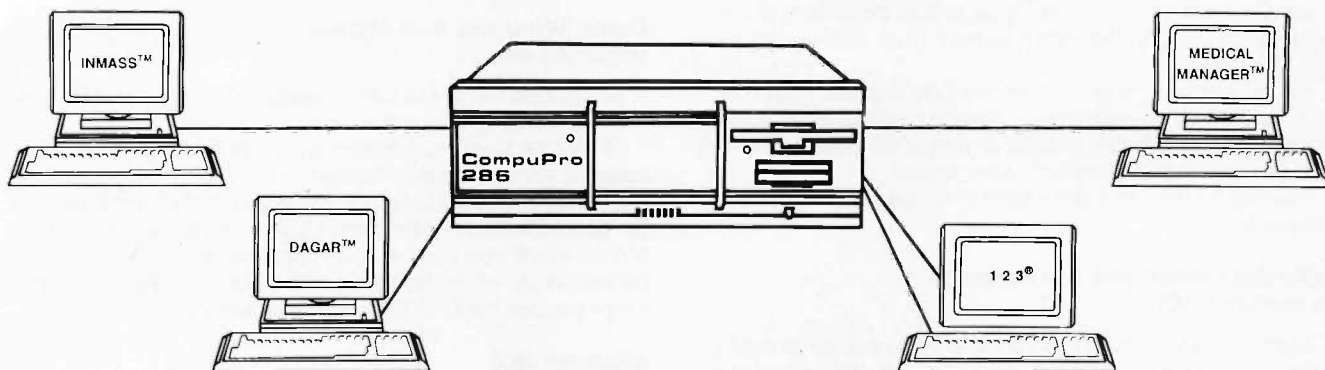

## Boost Your System Performance With Our CPU 286™

Your system should have the most advanced CPU available—and that's our CPU 286 which features an 8MHz 80286 and a socket for the 80287 math co-processor. **\$895**. Order it with Concurrent DOS 816 V4.1 and get them both for **\$1295**—give your system all the power it deserves and save **\$100** to boot! *Hurry! Offer expires April 30, 1986.*

## Other S-100/IEEE 696 Boards From CompuPro

**CPU 8085/88™**: Our still popular 8/16 bit workhorse features a 10 MHz 8088 and a 6 MHz 8085 for 8 bit program capability. **\$350.**

**CPU 8086™**: A no-nonsense 16 bit CPU featuring a 10 MHz 8086, socket for 8087 math co-processor. Works with 8 or 16 bit memory. **\$395.**

**CPU-Z™**: Our popular 8 bit CPU now features an 8 MHz Z80H. **\$275.**

**CPU 68K™**: Features the powerful 68000 processor and runs it at 10 MHz. Has socket for Memory Management Unit. **\$425.**  
**\$795 with MMU.**

**CPU 32016™**: Features the 32 bit 32016 processor. Includes interrupt controller/timer chip, sockets for math processor and memory manager **\$895.**

**SPUZ™**: Our 8 bit slave processor features an 8 MHz Z80H and either 64K or 256K of local RAM. Allows concurrent processing of 8 bit tasks in a 16 bit system without slowing down the host, multiple boards are supported as well. **\$295 with 64K.**  
**\$395 with 256K—runs four tasks.**

**STATIC RAM BOARDS**: Available from 64K to 1 Megabyte. All feature fast, static, low power operation. Compatible with 8 or 16 bit processors per IEEE 696 specifications. **RAM 23™ w/64K: \$250.**  
**RAM 23 w/128K: \$350. RAM 22™ w/256K: \$595.**

### Call The Distributor Near You For The Name Of Your Local Dealer:

**Arizona**—Micro Peripheral Marketing (602) 991-7870  
**California**—Compac Microelectronics Inc. (408) 773-0444  
**Hawaii**—Viaduct (808) 536-5263  
**Illinois**—Tek-Aids Industries Inc. (312) 870-7400  
**North Carolina**—General Semantics (919) 378-1500  
**Ohio**—QDP Computer Systems Inc. (216) 526-0838  
**Pennsylvania**—Tek-Aids Industries Inc. (215) 337-3220  
**Texas**—Business Systems (214) 785-0041

**NEW RAM 24™** with 1 megabyte of extra fast static RAM on a single board: **\$2995.**

**M-Drive/H™**: Our solid-state disk emulator can increase system throughput by as much as 3500%. Also used as a hard disk cache with Concurrent DOS 816 V4.1. **\$495** for 512K version, **\$1095** for a 2 megabyte version.

**Disk 1A™**: The most popular floppy disk controller on the market features simultaneous operation of both 5.25" and 8" drives and DMA transfers. **\$495.**

**Disk 3™**: Intelligent hard disk controller for ST-506/412 interface type drives. Features high level command interface, DMA transfers and high speed operation. **\$595.**

**Interfacer 3™**: Eight serial RS-232C ports. **\$495.**

**Interfacer 4™**: Three RS-232C serial ports, Centronics-type parallel printer port, and a general purpose parallel port. **\$350.**

**System Support 1™**: Multi-function board includes interrupt controllers, timers, real time clock/calendar with battery back-up, serial port, sockets for RAM/ROM and math chip. **\$350.**

**Net 100™**: Local Area Network board features high speed (2.5 MBPS) transfers using standard coax cable. Allows multiple CompuPro systems to be networked together to form even larger installations. Uses ARCNET® hardware and DR-NET™ software protocols. **\$395.**

\*The following minimum hardware configuration is needed to run Concurrent DOS 816: 384K of RAM, Disk 1A, System Support 1, Interfacer 3 or 4, and one of the following CPUs: CPU 8085/88, CPU 8086 or CPU 286.

# CompuPro™

Inquiry 368

CompuPro/Viasyn Corporation 26538 Danti Court,  
Hayward, CA 94545-3999 (415) 786-0909

CompuPro, PC VIDEO, CPU 286, CPU 8085/88, CPU 8086, CPU-Z, CPU 68K, CPU 32016, SPUZ, RAM 23, RAM 22, RAM 24, M-Drive/H, Disk 1A, Disk 3, Interfacer 3, Interfacer 4, System Support 1, and NET 100 are trademarks of Viasyn Corporation. Concurrent DOS 816 is compound trademark

of Digital Research Inc. and Viasyn Corporation. ARCNET is registered trademark of Datapoint Corporation. DR-NET is a trademark of Digital Research Inc. IBM is a registered trademark of International Business Machines Corporation. 123 is a registered trademark of Lotus Development Corporation. Medical Manager is a trademark of Personalized Programming, Inc. INMASS is a trademark of Microcomputer Consultants, Inc. DAGAR is trademark of Software Development Corporation.

every little blit. The RastPort structure is needed for the image in your window or screen, but for all the other little images floating around in your code, bit maps are a lot simpler.

**amiga/softw.devlpmt #408, from cheath:**  
a comment to 406

I agree that RastPorts are not a good way to read in such things as sprites, but there are times when I'd like to write the contents of a window without doing a ClipBlit into a bit map. Those 256K-byte machines are so small!

I'm not sure what my problem with the ColorMap was. I was using the screen ViewPort -> ColorMap. I seem to have had some problems writing into a subdirectory, probably an AmigaDOS problem with seek, etc. Have you seen any problems in this regard?

How are the IFF sound specs coming? I'd love to get them whenever they're done.

**amiga/softw.devlpmt #414, from mposehn:**  
a comment to 408

Changing colors in ViewPort -> ColorMap won't have any immediate effect because the colors are actually controlled by instructions in the Copper list. So after changing the color map, you must rebuild the Copper list. Here's the magical incantation I use (if there is a better way, duck, please advise):

```
Forbid();
MakeScreen(myscreen);
MrgCop(myview);
WaitTOF();
LoadView(myview);
Permit();
```

I've had no problems using subdirectories. You can either concat the path and file name before opening the file or use Lock() to gain access to the subdirectory before opening the file.

The IFF sound specs are not there yet. I need them very badly, too. Jerry Morrison at EA is still working on a way to factor everyone's requirements for music, MIDI, and sound effects into a clean spec.

**amiga/softw.devlpmt #418, from cheath**

TITLE: IFF for Sprites?

It seems to me that there is a lot of redundancy in using ILBMs and DESTs for defining animated images. The format allows a lot of flexibility and is nice for editing the images; however, for use in an application program, the overhead can be substantial for small images with many animations. Has anyone defined a FORM designed for applications use of sprites?

**amiga/softw.devlpmt #428, from mposehn:**  
a comment to 418

In Deluxe Video we read files in a simple IFF animation scheme called an ANimated BitMap object or ANBM. It's a simple sequence of frames of the same size and relative position with an IFF file structure like this:

```
FORM ANBM
SEQN
LIST ILBM
  PROP ILBM
    BMHD
    CMAP
  FORM ILBM    } repeat this part once per frame
  BODY        }
```

We have written a program called "Framer" that lets you cut a multiple frame sequence out of a picture (an IFF file created by Deluxe Paint or by Graphicraft) and save it in this ANBM format. You can then put that animation into a video or use it in some other program. We plan to include Framer with Deluxe Video.

Hopefully, someone will write a tool for creating more complex animated objects and save them in IFF format.

**DISKS, WINDOWS, AND MENUS**  
**amiga/main #806**

A BIX participant who uses both an Amiga and a Macintosh compared mouse functions, menus, and windows.

He liked the Mac's one-button mouse and found using the second button for menus a moderate annoyance. He found it frustrating that he had to put his windows back to where he wanted them, since the Intuition desktop would not leave them in position. He felt both the Mac and the Amiga were equal as far as responsiveness, once your preferences are set, though he missed the clock time-stamping on the Amiga (he used the alarm-clock desk accessory instead).

**amiga/main #800**

Another Macintosh/Amiga user commented that she was accustomed to the responsiveness of the Amiga. She didn't like the response of the Mac with a one-button mouse but hadn't tried the Atari.

**amiga/main #809**

Another Amiga owner offered a way to make Intuition leave the disks and windows the way you had them. With the Snapshot menu option, you should indicate the disk concerned as "selected."

**amiga/main #812, from pariseau:**  
a comment to 806

Icon and window positions on the Amiga can be recorded using the Snapshot menu item. Taking a snapshot on an icon whose window is open records the window position and size as well as the icon location. You can use Extend Select to snapshot a bunch of stuff at once—hold down either Shift key while clicking each icon with the Select button (left mouse button); release Shift key and choose Snapshot with the Menu button (right mouse button).

We chose explicit rather than automatic position recording because

1. We wanted to have a disk eject *button* so that folks wouldn't get paranoid about not being able to remove their disks.
2. Given that we couldn't cache the positions in memory, we felt it was too sluggish to write them out every move.

Oh, yes, the snapshot stuff for windows only works for Workbench disk and drawer windows—there is currently no way to change the initial window position and size for an application window such as the clock.

By the way, is it true that the ST does not let you arbitrarily position your icons?

**amiga/main #814 [Tom Thompson, Technical Editor, BYTE]:**  
a comment to 812

Thanks for the inside design info on something apparently "simple" as saving the "desktop." Of course, then you run the risk of somebody ejecting a disk during the update sequence (it's mentioned in your manuals) or using a paper clip to physically eject the disk when the Mac won't let you have it. An interesting choice, no?

(continued)



“The Boys Club helped me run my life.”

Pres., O.J. Simpson Enterprises

*O.J. Simpson*

“When I was growing up, I was the quickest kid on the block. But the streets were catching up with me. I’m sure glad there was a Boys Club around to help keep me a step ahead.

“You know, a Boys Club shows kids there are lots of ways to reach goals, besides scoring touchdowns. It gives them every chance to be leaders. And encourages something every bit as important as good leadership—good citizenship.

“They sure pointed me in the right direction, and I’ve been running my life ever since—running through

lines, running through airports. Now I’m even running my own business!

“It’s no wonder so many Boys Club kids grow into productive, civic-minded adults, like teachers, politicians, business executives and professional athletes. Which gives more than 1,200,000 young people, at 1,100 Boys Club facilities across the country, something to look forward to.

“Hey, I’m not saying a Boys Club can turn every kid into a star. But a Boys Club sure can teach ’em how to reach for one.”



**The Club that beats the streets.**

**AMIGA IBM PC EMULATOR**

amiga/main #778, from atm [Andrew McLaughlin]

Does the IBM PC emulator allow the Amiga to operate "normally"? By that I mean, can you boot the emulator, start something running under the emulator, and then also run Amiga programs (e.g., Boing!)?

Also, what is Commodore planning to do when they finalize the ROMs? Will we have to ship them to West Chester for service or ?

amiga/main #787, from cheath:  
a comment to 778

The emulator is "stand alone"; it takes over the whole machine.

Regarding ROMs, it has been a unanimous plea among developers to *never* put the ROM software in ROM. This is to allow alternative operating systems like UNIX to run without using any extra RAM. If the Writable Control Store is always there, alternative operating systems can count on it. The short-term policy of Commodore seems to be to keep the WCS. I don't know if they have a long-term policy.

**MORE ABOUT BOING!**

[Editor's note: For more on this topic, see *Best of Bix—Atari*]

amiga/main #736, from greggw

Regarding the bouncing-ball demo, is it true that the Amiga bouncing-ball demo *could* have been faster but was slowed down to make it look realistic? (Just idle curiosity.)

amiga/main #747, from greggw:  
a comment to 736

Folks, Bob Pariseau sent me a letter that includes the following remarks about the Boing! the bouncing-ball demo; I thought I'd share them. (Letter excerpt follows.)

The ball can be made blindingly fast without any significant increase in 68000 overhead. The ball rotation is done by color cycle animation. Each red and white patch on the ball is actually 7 strips of color.

Push the Workbench screen to the back while the ball is forming (LeftAmiga-M), and you'll see what I mean. We assign 14 of the 32 color registers to ball rotation. At any instant 7 are white and 7 are red. We cycle the colors through them to make the ball appear to rotate. To rotate faster, just cycle faster. How fast can *you* change 14 memory locations with a 68000?

The ball bouncing is done by changing the start-of-data pointers for the ball/shadow bit planes with respect to the grid bit plane. By clever use of the video DMA pointers, the grid appears stationary while the ball appears to move. Again, no blitting is involved. Again, making it go faster is easy.

Curiously enough, the hard thing is making the ball go *slowly* and still appear to be smooth. We can get as slow as you see on the Amiga because, with 32 color registers, we can afford to burn 14 just on ball rotation.

**ATARI**

[Editor's note: Before using February's instructions to upgrade your 520ST, read Atari/tech.st #239 or download ST.DOC from BYTENet Listings.]

This month, Dave Betz describes his experiences in porting XLISP successfully to the Atari 520ST, David Allen presents some background information on the new Grolier/Activenture CD-ROM encyclopedia, and there are comments on BASIC, DEGAS, and the Atari Boink demo.

**XLISP**

atari/tech.st #122, from dbetz [David Betz, Contributing Editor, BYTE]

I just got my Atari ST development system and software. I'm intending to port my XLISP interpreter to the ST. My first goal is just to get the generic version running on the Atari. Then, I'm going to add some support for interfacing with the GEM graphics routines. My first problem is that, looking through the C compiler disk that came with the development package, I seem to be missing the setjmp.h include file that supports the setjmp/longjmp library routines. These routines are mentioned in the CP/M-68K C manual that came with the development package, but I have been unable to find the supporting include file. Anyone have any idea where I can get a copy of it (it should be only a single line long)?

atari/tech.st #125, from dbetz

Well, I've just gotten all of the XLISP source code to compile and link on my ST (but not run, unfortunately). I thought that I'd share something of my experiences in accomplishing this.

First, I'm sure that I had the same reaction as everyone else the first time I realized the number of cables required to hook up this beast. I have two drives and both monitors, so I guess I have the maximum number of cables possible. Before I could do anything with the machine I had to buy one of those multi-way power adapters just to free up enough outlets to plug in the four power cables! It really is pretty easy to set up, though. I didn't read any of the manuals and managed to get it to work the first time. Once I had all of the cables and power supplies (three) hidden behind the machine and under the table, it really looked nice sitting on my computer table (next to an old DEC Rainbow with only 256K of memory).

The first thing I needed to do was to copy all of the XLISP source code from my Rainbow to the ST. I used a program called LCTERM on the Rainbow and Kermit on the ST. The transfers happened flawlessly! I typed a single command on each machine and transferred all 24 XLISP source files to the ST without any errors at 9600 baud. This took a while, but since everything happened automatically, I didn't have to stay and babysit. I went off to the living room and read about GEM.

After transferring the files, I had to do some minor editing in order to select the correct options for compiling with the DRI C compiler. I used MicroEmacs and had no trouble changing the few lines required to tailor XLISP.H for the ST.

Then I started to compile the sources. My first problem was to track down three include files that should have been part of the C development package but were left out of the version that I received. The files in question were setjmp.h, ctype.h, and math.h. I searched through all of the disks that came with the development package and couldn't find any of them. The C documentation mentioned the existence of both setjmp.h and ctype.h but didn't even mention math.h. Well, in order to proceed, I made an educated guess about what went into those files and created my own versions. After this, all 23 XLISP source modules compiled without errors!

Then it was necessary to link all of the resulting object modules. I used MicroEmacs to create a batch file to run the LINK68 and RELMOD programs to create an executable version of XLISP. Because there are so many object files in XLISP, I had to create a separate input file for the linker. This was easy to create using MicroEmacs also. I had no trouble linking XLISP and creating an executable file with RELMOD. My only problem now will be to find out why XLISP doesn't work! When I run XLISP, I get the banner line and then the program immediately exits. Just before exiting, I get two tiny mushroom-shaped characters at the left-hand side of the screen centered vertically. I have

(continued)

# A COMPUTER PROGRAM THAT SPEAKS YOUR LANGUAGE



**The Computer Chronicles**, a half-hour weekly television series brings you news and information from Silicon Valley and around the world. Correspondent Stewart Cheifet and Gary Kildall, creator of CP/M cover today's headlines and the stories behind them. Find out what is, what was and what will be, with the only

computer program you're ever going to need. **The Computer Chronicles**,

every week on a public television station near you.

(Check local listings for time and channel.)

Produced by KCSM, San Mateo, CA and WITF, Harrisburg, PA with funding from AFIPS and McGraw-Hill's **BYTE** magazine.



no idea what these mean or why the program just exits without doing anything, but in the next few days I hope to find out.

All in all, I am impressed with the ST. It hasn't crashed as much as I had been led to believe that it would. It has a very nice crisp monochrome display (I haven't really tried the color monitor much yet). The keyboard seems reasonably good. The desktop software seems to work well, although I did experience some strange behavior after compiling about 15 of the 23 XLISP source files. When one of the compiles finished and I returned to the desktop, one of the disk windows had mysteriously been closed. When I tried to reopen it, I was unable to. I had to reset the machine to continue with the next compile.

The COMMAND.PRG doesn't seem to be very useful on its own. It doesn't have any way to copy files from one disk to another. It doesn't have a way to rename files, and its delete program (RM.PRG) doesn't accept wild-card file specifications. When I invoked MicroEmacs from the command-line interface, I ended up in the editor with no visible cursor! I was able to edit, but I had to insert dummy characters to determine where the cursor was. Fortunately, it isn't really necessary to use the command-line interface. Everything that you need to do can be done through the GEM desktop.

In summary, I really am impressed with this machine. I like the crispness of the display in monochrome and the window system seems to be fairly responsive. I wish the packaging was a little nicer (fewer cables, maybe one built-in disk drive, no external power supplies). It could use higher capacity disks. (I am aware that a double-sided disk is now available. It should probably be made standard.) What I *really* like about it is that I get a fast, 68000-based machine with a high-resolution bit-mapped display for under \$1000! I think that this machine has quite a bit of potential, and I intend to continue to explore its capabilities. I want to develop a good interface to the graphics support from within XLISP, and I'm sure that I'll have some comments about programming with GEM in the process.

atari/tech.st #126, from jsan [Jez San, Argonaut Software]:  
a comment to 125

If you are not already linking the file apstart.O to the front of your object files, then please do so! It sets up and reserves a Stack area for your application program to use and thus is vital to the correct execution of your program. Simply ensure when linking your file together that apstart.O is the first one in the list.

Failing that, two mushrooms means an address error (I think, or is it bus error?).

Let me know how you get on.

atari/tech.st #128, from dbetz:  
a comment to 126

I am linking with gemstart, gemlib, and libf. I just noticed that the default stack size is only 1000 bytes, so I'm going to try increasing that to about 16K and see what happens. Thanks for the advice.

atari/tech.st #129, from jsan:  
a comment to 128

I'm not familiar with gemstart, so I wouldn't know if it performs the functions of apstart too, but just in case, please try linking in apstart *before* gemstart and see what happens?

atari/tech.st #130, from dbetz:  
a comment to 128

Well, I increased the stack size to 16K by reassembling gemstart.s and XLISP came up and printed its prompt. I tried typing an expression

(just a number) to see if it really worked and got no response. XLISP thinks that all lines need to be terminated by a linefeed, and I suspected that the run-time library might be looking for a CR-LF pair at the end of a line, so I typed Ctrl-J (the code for LF) and XLISP printed the result of evaluating the expression! I would have been impressed except that immediately after printing the result, XLISP exited back to the desktop. The only reason that XLISP would do this is if the next call to getc returned end-of-file. In order to test the behavior of terminal input in a simpler environment, I wrote a *very* simple test program. Here is the text of the program:

```
#include <stdio.h>
main()
{
  int ch;
  for (;;) {
    ch = getc(stdin);
    printf("%02x ",ch);
    if (ch == '\n')
      printf("\n");
  }
}
```

This program just reads characters from stdin and echoes the ASCII code of the character in hexadecimal. It starts a new line every time it gets the LF character. I ran this program, and absolutely nothing happened when I typed characters. I did some further investigation and found out that getc(stdin) was *always* returning -1 (end-of-file). I have no idea what I am doing wrong and am not sure how to proceed from here. It seems as though the standard I/O library just doesn't work correctly when reading from the keyboard.

In addition to this problem, I have been continually plagued by disk windows getting closed automatically on return from an application. Whenever this happens, I am unable to reopen them. I must reset the machine and start the desktop over again.

While I still like the hardware on this machine, the software seems to leave a lot to be desired. Why doesn't it come with its own development documentation? The C manual and the system documentation are for CP/M-68K; the GEM documentation is for PC-DOS. After taking a few minutes to look at the documentation for the Amiga, I am left with the feeling that this machine was released too soon. It doesn't really have adequate development tools. I suppose that someone will point out that the Macintosh didn't have any decent development tools when it was released either. The difference is that the ST doesn't come with any useful applications (like MacWrite and MacPaint) or any decent tools to build your own applications. In its current state, it's a not a very useful machine for either a software developer or an end user. I'm going to continue to struggle with it for a while. Maybe the support for developing native applications is better than the support for porting generic programs like XLISP.

atari/tech.st #131, from jsan:  
a comment to 130

On CompuServe, Russ Wetmore (sysop of Atari SIG) has uploaded the C stdio header file. I suspect it will work better than the ones you are presently using.

I'm afraid I have no experience of C. I only use the ST from an assembly-language viewpoint and can easily help you with I/O that bypasses TOS, but I can do nothing much to help you with OS calls of any description.

(continued)



# MOST COMPATIBLE — LEAST EXPENSIVE XT and AT Compatibles by: AFTON COMPUTER



## QUANTUM XT™ \$799.00

- 256K Expandable to 640K
- 2 x 360K Floppy Drive
- 135W Power Supply
- Color or Monochrome Card
- Hi-Res Monitor
- Keyboard
- Parallel Port
- Socket for 8087 CoProcessor

## QUANTUM XT TURBO™ \$749.00

System includes:

- 640K on MB
- 360K Floppy Drive
- Keyboard
- 135W Power Supply
- Fully Assembled and Tested



## QUANTUM AT™ \$1995.00

(Includes 20MB Hard Disk)

- 512K
- 1.2 MB Floppy Drive
- Floppy/Hard Controller
- 200 W Power Supply
- Keyboard
- Socket for 80287
- 20 MB Hard Drive

**60 MEG TAPE  
STREAMER**  
For the AT or XT



**\$999.00**

**MONOCARD**  
Monochrome  
Display Card with  
Parallel Port



**\$110.00**

**STANDARD MFC**

- Clock/Calendar
- Serial Port
- Parallel Port
- Game Port
- Software



**\$129.00**

**COMPLETE HARD  
DISK SYSTEMS!**

For The  
**IBM PC™**  
and Compatibles  
1 YEAR WARRANTY!

Half Height  
Hard Disk Kits  
for the IBM PC™



- Boots from Hard Disk
- Instruction Manual
- Cables and Mounting Hardware
- Half Height Bezel
- Hard Disk Controller

**20MB \$465.00**  
**33MB \$849.00**

**MONO MONITOR**  
TTL or  
COMPOSITE



**\$99.00**

**FDC**  
Controls Up To 4  
Floppy Disk  
*Includes  
Internal Cables.*



**\$45.00**

**NAME BRAND  
FLOPPY DISK  
DRIVES**

- Half Height
- DS/DD

**\$95.00**

**STANDARD  
AT-MFC w/128K**  
Up to 2.5 MB Memory  
Expansion. Serial and  
Parallel Port  
for IBM AT.



**\$275.00**

**I/O**  
Serial & Parallel  
Port Card for  
IBM PC and AT



**\$99.00**

**COLOR CARD**  
Color Graphic Card  
w/ Parallel Port



**\$99.00**

**TAPE BACKUP  
SYSTEM**

- 10.35 Meg Formatted Capacity
- Half Height
- Low Power



**\$450.00**

**5150  
KEYBOARD**



**\$89.00**

**135 WATT  
Replacement  
Power Supply**



**\$85.00**

— 48 Hour Burn In Period And Testing On Every Machine —

**FULL ONE YEAR WARRANTY**

CALL for FREE CATALOG and PRICE LIST

**AFTON COMPUTER**

**(714) 259-1127 • TELEX 756731**

24825 CALLE EL TORO GRANDE ★ EL TORO, CALIFORNIA 92630

Prices and availability subject to change without notice. • IBM® is a registered trademark of International Business Machines Corporation.

atari/tech.st #140, from dbetz

Well, I finally finished my port of XLISP to the 520ST. It seems to work pretty well. It is a bit faster than XLISP on the Macintosh, but you have less space to work with on an ST than on a 512K Macintosh. I assume this will be fixed once the OS comes out in ROM. The only major problems that I encountered were some missing include files (ctype.h, setjmp.h, and math.h). I invented my own versions of those files and was able to compile all of the XLISP code without further problems. My next problem was that the standard I/O library that comes with the DR1 C compiler doesn't seem to work when doing I/O to the terminal (keyboard/screen). I ended up writing my own code for terminal I/O. Once those two problems were solved, XLISP came up and ran without a hitch. I uploaded it to the Atari area of the Listings conference. The file is called XLISPTTP and should be downloaded in binary mode. The documentation for the ST version is the same as the IBM version and the Macintosh version. You should be able to find the documentation text file in the Macintosh area of Listings under the name XLISP.MEM. If you download XLISP, please let me know what you think and report any problems you might encounter.

## CD-ROM

atari/tech.st #11, from dpallen [David Allen]

Grolier engaged with Activenture to produce this CD-ROM as the first practical exercise of a new CD-ROM authoring language by Activenture (a company formed by Gary Kildall of Digital Research fame) called KRS, or Knowledge Retrieval System. This is a high-level "language" that is designed to work on a DEC VAX-11/750. When fed with any large database from a master machine-readable source, KRS creates a "file inversion" or electronic index of the database. This can be as large as the database itself, and in the case of the Grolier encyclopedia, does, in fact, occupy 60 megabytes of CD-ROM real estate, the same amount that the encyclopedia itself occupies. KRS is written in C.

In comparison, the encyclopedia itself also occupies 60 megabytes of CD-ROM space and is the equivalent of 10 volumes of 10,000 pages of nine million words. So there is room for *three* more totally different "encyclopedias" of the same size! (Don't look—they aren't there!)

The file inversion is a specially constructed file of *all* of the keywords in the database less some "stop words." Stop words are those words that appear in the database more than 32,767 times and are considered unworthy of search. These include words such as "the," "an," "and," "of," and about 25 other words in the case of the encyclopedia.

The user may institute a search for any combination of keywords and the KRS will come back with suggestions. For example, if a student was writing a report about the relationship between Eisenhower and Nixon, he might ask for all the entries with those two names. The system would respond by asking if the user wished those entries with the keywords in the same paragraph or same article. Within 3-5 seconds the system will deliver a list of all entries so described. The user may apply any sort of Boolean logic to enter the keywords (all that have word A but not word B, or all that have word A and word B or word C, etc.).

Activenture is promoting itself as "optical typesetters" and is prepared to massage *any* third-party database with KRS for similar results.

The encyclopedia disk will be marketed by Grolier, and there will be a parallel marketing campaign for the necessary hardware to play the disk on. The hardware will not be OEM'd by Grolier but will be marketed by the manufacturer of the hardware. No official announcement yet of the brand(s) of CD-ROM hardware to be available at that time nor of the computers to be initially interfaced, but my intuition says to expect that the initial computers to be interfaced will be the IBM PC (and clones) and the Atari ST.

atari/tech.st #39, from dmenconi [Dave Menconi]

I can't help but think that the encyclopedia is going to be important. I have always thought that the *real* use for computers would be to supply users with a library of information in an easily indexed way. That way the user could find facts quickly. This will eliminate a lot of the half-truth myths and "pseudo-science" that plagues us now. Is anyone writing a more sophisticated access system for all that data than just a word search? Like something that would answer the question: "What is the relationship among average rainfall, the value of the dollar, and the age of the president?" I admit that this data is not going to be on the first disk, but there will be other disks and a word search just doesn't do it. Anybody have any ideas about the best way to access all that data?

atari/tech.st #40, from dpallen:

a comment to 39

I played around with the Grolier on an IBM PC last week. KRS really works very well, although I think they are a bit optimistic on their maximum search time of 5 seconds. More like 10.

I exercised using some Boolean functions and it handled them very nicely. (Find A and B and C; find A and B and not C; etc.) Came up with just what I was looking for.

Philips was showing off a new CD-ROM database manipulation consisting of a newspaper file with pictures in both black-and-white and color. Used an AT&T video digitizer board that worked really well. (Expensive.) It also provided sound over still voice with each picture.

atari/tech.st #41, from neilharris [Neil Harris, Atari Corp.]:

a comment to 40

I think the way to go is to develop a parsing language similar to the one that Infocom uses in their adventure games. Searching the database itself is easy using Activenture's inversion process, but some intelligent preprocessing would add a dimension that would make life easy.

## FIRST WORD ON BASIC

atari/news.st #136, from jimj [James Joyce]

I sent in my registration card and Atari sent me ST BASIC this week. The package included disk and manual. The manual is much better than the Logo manual I received when I bought my system. There are some typos and errors. One major omission is a chart for the SHAPE argument of WAVE. (And I sure would like to know how to use WAVE.)

The sample programs they give in the back are nice. The one titled "Low Resolution Demo" seems to be excessively slow, but I haven't checked to see if I inserted my own typos here, so it may be my fault.

## BOINK AND THE AMIGA

atari/non.tech.st #102, from jsan

In our latest game (on the Atari ST) we've got sampled sounds and speech working! Yes, it *can* be done. It's just nowhere near as good as the Amiga's hardware, since ours is done in software and requires about 6 percent overhead in processor time to accomplish an 8-kHz bandwidth. It's not bad, nevertheless.

I would say that Atari's Boink program is a stunning effort of high ingenuity in trying to beat the Amiga. I'm very impressed that they got it *that good!*

atari/non.tech.st #105, from cheath [Charlie Heath, MicroSmiths]:

a comment to 102

> Six percent of cycles; what percent of development effort?

(continued)

**ACM SIGGRAPH 86**

Dallas Convention Center  
Dallas, Texas  
August 18-22, 1986

*A combination of the highest standards in technical achievement, creative artistry and today's most advanced graphics systems.*

*13th Annual Conference on Computer Graphics and Interactive Techniques*

*Sponsored by the Association for Computing Machinery's Special Interest Group on Computer Graphics in cooperation with the IEEE Technical Committee on Computer Graphics.*

*Technical Papers  
Panel Sessions  
Courses  
Industry Exhibition  
Art Show  
Electronic Theatre*

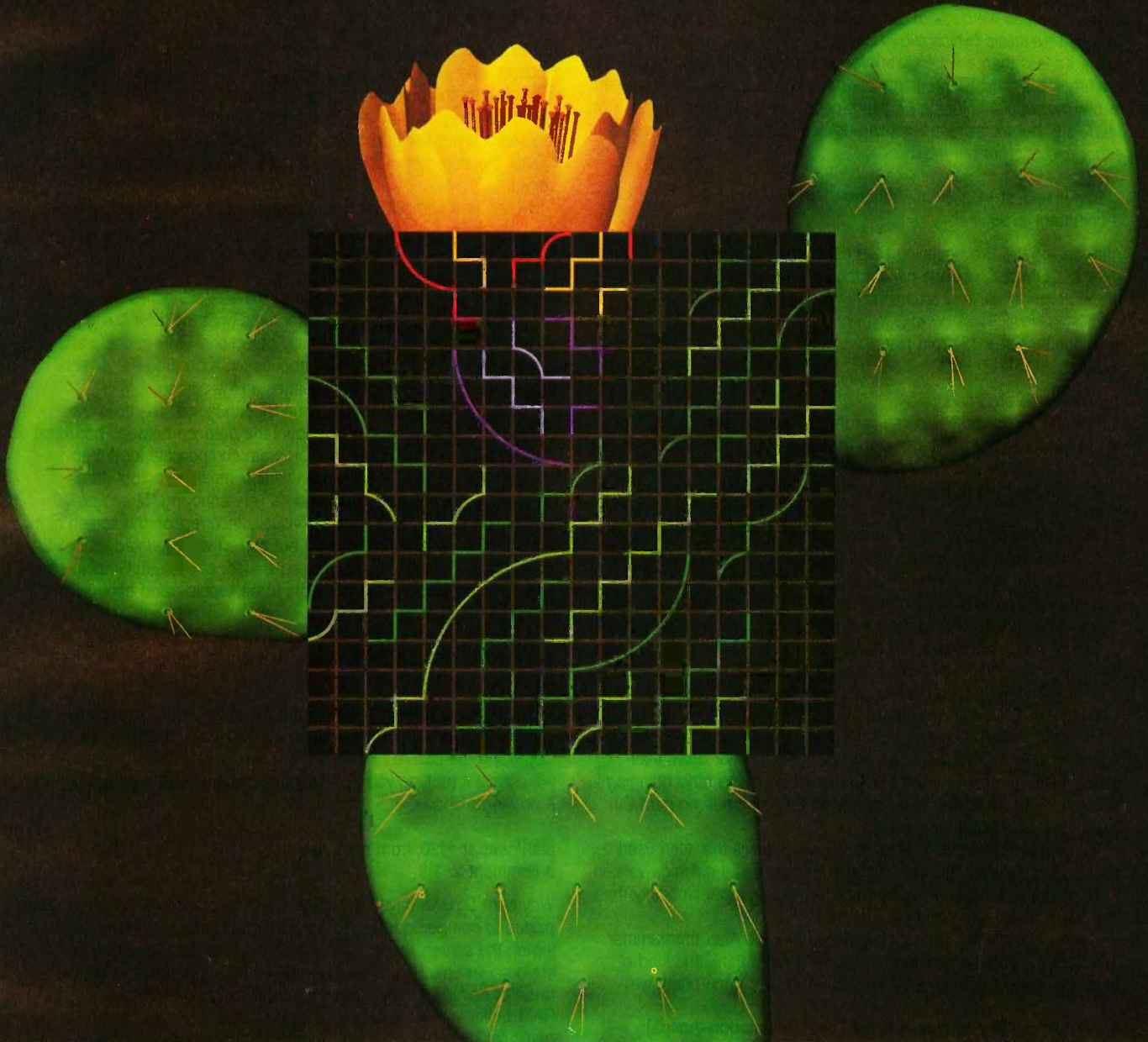

**ACM SIGGRAPH 86**

Conference Management  
111 East Wacker Drive #600  
Chicago, IL 60601  
312/644-6610

*Please send a copy of the SIGGRAPH '86 advance program to:*

NAME

COMPANY

ADDRESS

CITY/STATE/COUNTRY

ZIP

TELEPHONE

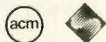

*Members of ACM SIGGRAPH will automatically receive these materials in the mail in April and need NOT return this coupon.*

atari/non.tech.st #106, from jsan:  
a comment to 105

Hmm, what do you mean what percent of development effort!?

If you mean how hard was it to write, then, well, it was an offshoot from the normal Sound (d)effects subroutines that we had to write *anyway*, and so we decided to go one stage further and add full sampled synthesis (which allows Speech, or any other digitized waveform). It's less than a week's work for a full-time machine code programmer, but most ST programmers don't do machine code. (C seems to be overpopular!) Here in England, people are raving about Modula-2, but as far as I'm concerned nothing beats machine code for either execution or readability!

atari/non.tech.st #112, from neilharris:  
a comment to 95

After seeing the two bouncing balls (ST and Amiga) side by side for 5 days at COMDEX, not one person thought Amiga's was any better, faster, or smoother! Any arguments?

atari/non.tech.st #113, from jsan:  
a comment to 112

Yes, here's an argument.

The Atari bouncing-ball demo is running *flat out*, using every trick in the book to get its speed and smoothness working. It is using 100 percent processor time, and so nothing else could be working at the same time, nor could two or three bouncing balls be working at the same time.

The Amiga bouncing ball, on the other hand, is done using total *hardware* register modification. What that means is that not only the ball's spin, but even its *movement* is done without any loss of processor speed or software. It *moves* the instant that the bit-plane Start registers have been altered, whereas the Atari one must block move the entire beachball in order to make it move. The bottom line is that the Amiga bouncing demo is an incredible effect, considering it's using a *negligible* amount of processor, whereas the Atari gains the effect working *flat out* as hard as it can!

The Amiga can, of course, pull up a screen in front of or *behind* that bouncing ball, and the user can pull the screen up or down interactively with the mouse while the ball is still bouncing (and boinging in stereo, I might add!). The Atari cannot do that, as it has no hardware registers at all, except for a Palette.

The reason the Atari ball appears to spin faster is that Atari used fewer colors to define the ball, half the number that the Amiga version used; thus the Amiga one spins smoothly—much more smoothly than the Atari version ever could.

Having said all that, I'm *very* impressed that the Atari programmer managed to get it Sooo Good on an ST! I didn't think that kind of graphics was possible on an Atari. He must have done pretty well!

atari/news.st #159, from duck [Dale Luck, Commodore-Amiga]:  
a comment to 158

It was probably running faster because that is the way the programmer wanted it. It looked *very* nice.

atari/non.tech.st #1\*7, from duck

The first Amiga version was programmed between the hours of 12 midnight and 4 a.m. on about January 7, 1984. Although the initial spinning ball had been created some time before then.

About May, another 8 hours was devoted for sound and left-right bounce effects. Once the demo was running, little was done to make it

faster; it seemed to create the right effect.

[Editor's note: For further comment from the staff at Commodore-Amiga, see the comments of Bob Pariseau in *Best of BIX—Amiga*.]

## DEGAS

atari/news.st #117, from rsimonsen [Redmond Simonsen]:  
comment to 115

[Editor's note: This dispatch is in response to comments by thud, Tom Hudson, who implemented DEGAS.]

If you plan the program for use by both casual *and* serious users, joystick, mouse, and tablet support is really desirable. Serious drawing requires a stylus-like instrument. Unfortunately, such tablets are not cheap, therefore not widely owned nor supported by commercial software.

By way of a compliment, your program made me feel better about the potential of the 520ST, and I'm now actively rooting for its success. know how feature glut can make one freeze in anticipation of all that revision. But press on.

I am struck by a false separation in software categories between "paint" programs and "drawing" programs (with the latter being more elaborate and expensive and usually object-oriented). To artists and architects, there is little to applaud about such a dividing line in technique and approach to putting images on the screen.

Speaking of screens, is that of the ST orthogonal; i.e., does the distance between vertical pixels equal the distance between horizontal pixel positions? If not, does your program compensate for the appearance of images on the screen versus the same output on a printer? My PC Paint does not and it's very annoying. Moreover, mathematically correct circles are visually incorrect on the screen of my AT&T 6300 (they look like ellipses) but correct when printed (but all the freehand stuff in the drawing gets squashed, of course). Graphic software for machines like the ST ought to be sophisticated enough to compensate for these differences.

atari/news.st #119, from thud [Tom Hudson]:  
a comment to 117

DEGAS generates true circles on the ST, as far as the x and y size is concerned. Unfortunately, the screen shows them as *slightly* elliptical. Outputting the picture to a printer or plotter with a correct aspect ratio will correct it (but, as you say, freehand drawing will be squashed). It's a no-win situation.

atari/news.st #120, from rsimonsen:  
a comment to 119

Why can't DEGAS have an intelligent picture processor that remaps the picture to compensate for the peculiarities of various printers? All drawing on the screen should be done on a "looks right" basis (i.e., circles are *not* x,y correct, but they *look* right). When the picture is printed instead of doing a simple screen dump, the picture is redrawn into a RAM buffer with the y-axis appropriately scaled to compensate for the particular printer being used. Sounds like pretty simple software to me.

I wrote a turtle-graphics system on the Apple II (in FORTH) that did circle and polygon compensation on the screen. I didn't do a printer output processor, but all you'd have to do is rotate the bit map and rescale the now-horizontal lines. Correct?

atari/news.st #121, from mdulcey [Mark Dulcey]:  
a comment to 120

It's not that simple. The catch is that scaling the bit map like that (especially by a small scale factor) will lead to excessive jaggies on

(continued)

**NEW  
LOW PRICE**

# THE X-10 POWERHOUSE DOES EVERYTHING BUT PUT OUT THE CAT.



Model CP290



## THE X-10 POWERHOUSE INTERFACES WITH YOUR COMPUTER TO CONTROL YOUR HOME...FOR SECURITY, COMFORT AND ENERGY SAVINGS.

This remarkable Interface lets you run your home through your Apple IIe, IIc, Macintosh, Commodore 64 or 128 and a mouse, keyboard or joystick.

When you're away, it makes your home look and sound lived in. When you're home, it can turn off the TV at night and wake you up to stereo and fresh brewed coffee in the morning. It can even turn on your air conditioner and control your heating.

### SPECIAL COLOR GRAPHICS MAKE PROGRAMMING A SNAP.

You simply pick a room from the display screen. Use your mouse, joystick, or keyboard to position graphics of lights or appliances. Then follow on-screen instructions to program any light or appliance to go on or off whenever you choose. You can even control thermostats, light intensity and more.



**THE WAY IT WORKS.** The X-10 Powerhouse Interface is cable-connected to an Apple RS-232 port or a Commodore "User" port and plugged into a standard 110V outlet. After it is programmed, the Interface sends digitally encoded signals through your home wiring to special X-10 Modules. To control a lamp or appliance, you simply plug the electrical device into a Module



and then plug the Module into an outlet. The Interface can control up to 256 Modules throughout your home and won't interfere with normal use of lights and appliances.

There are plug-in Appliance Modules, Lamp Modules, Wall Switch Replacement Modules and Special 220V Modules for heavy duty appliances such as water

heaters and room air conditioners. Plus Thermostat Controllers for central heating and air conditioning, Telephone Responders to control your home from any phone, and much more.

**IT WON'T TIE UP YOUR COMPUTER.** Use your computer only for programming. When you're finished, disconnect the Interface from your computer and keep it plugged into any convenient power outlet in your home. It will operate as a stand-alone controller with battery back-up and will run your home automatically.

**NEW LOW PRICE!** A Powerhouse System including the Interface, software and connecting cables now costs less than \$70. X-10 Modules are less than \$17 each.

Software for IBM PC and compatibles available soon.

For the Dealer Nearest You Call: **1-800 526-0027**  
or, write to: X-10 (USA) [in NJ: (201) 784-9700]

185A Legrand Avenue  
Northvale, NJ 07647

**X-10 POWERHOUSE**  
NUMBER ONE IN HOME CONTROL

Apple, Apple IIe, Apple IIc and Macintosh are registered trademarks of Apple Computer, Inc. Commodore 64 and 128 are registered trademarks of Commodore Int'l Ltd. IBM PC is a registered trademark of International Business Machines Corporation.

some objects. Remember, you want the *text* to print correctly, not just the circles and polygons.

The *real* solution would seem to be for Atari to adjust the monitors so the aspect ratio is correct. The pixel counts are appropriate for this, given the size of the screen.

atari/news.st #139, from al:  
a comment to 121

No, no, the *real* solution is device independence.

atari/news.st #123, from rsimonsen:  
a comment to 121

Actually, I assert that it *is* that simple. It should at least be attempted and tested. Yearning for Atari to change their monitor is a cop-out, since they'll never do that to address this problem.

atari/news.st #125, from thud:  
a comment to 120

Actually, DEGAS doesn't do a raw screen dump but uses special printer drivers that may scale the output any way they like. Therefore, in theory, all the printers/plotters could have perfect aspect ratios, as long as they were written properly. In practice, though, most dot-matrix printers give trouble, because their pin-spacing/linefeed ratios aren't infinitely variable to provide accurate scaling. Somebody give me a laser printer.

atari/news.st #126, from thud:  
a comment to 123

It could be done to a certain extent, but your average, casual computer user isn't going to care about it that much. Plus, the cost for the additional factory alignment would probably be a no-no for Atari right now. Not to mention the in-the-field variables involved.

atari/news.st #128, from rsimonsen:  
a comment to 125

Regarding scaled pictures: On my AT&T 6300 using PC Paint, the ratio of depth to width is 1.2; i.e., a square box (in terms of pixels) measures (with a ruler) 20 percent deeper than its width. I presume it's something similar on the 520ST. What should happen with regular polygons, circles, et al., is this:

1. The on-screen image is presented as visually correct (so, for example, a square 100 pixels wide would only be 83 pixels deep). This would make it look correct on the screen.
2. When printed (presuming we have a printer that spaces its dots evenly in both directions), the image is first rotated 90 degrees in memory, and then the bit string is scaled by 1.2, then printed.
3. Printers that were incapable of producing a truly square grid of dots *would* have the picture processed by a scaling factor that approximated their aspect ratio.
4. The user would be given the option of printing the picture without processing.

Since the greatest use of pictures is "on screen," it is important to be able to produce geometric figures that look geometric and can be easily made so (as opposed to the approximation methods one must now resort to by twiddling with the mouse-cursor).

atari/news.st #131, from mdulcey:  
a comment to 128

This procedure won't produce optimal results in all cases. Suppose I carefully design a font to use only straight and diagonal lines (say I

don't like jaggies). After this is scaled, it won't look right anymore.

There are only two good solutions:

1. Use object-oriented draw software.
2. Use monitors with the same aspect ratio as the printer.

atari/news.st #138, from al:  
a comment to 117

Of course, he said, climbing onto a convenient soapbox, if such "paint" and "draw" programs simultaneously saved away a list of the instructions used in creating the image (in a convenient notation like NAPLPS, hint, hint), then circles would be circular whatever the output device.

Rather than simply transfer the screen bit map to the printer (and end up with aspect-ratio problems), simply pass the NAPLPS file to an appropriate printer driver, and there you are.

(And you have the added benefit of being able to send the pictures over phone lines in reasonable amounts of time—and displaying them on otherwise incompatible computers.)

See also (plug, plug) the conference Graph.exch, particularly the "naplps" topic.

## IBM

This month we are featuring the discussions in the MS-DOS conference. The section on DOS commands focuses on FORMAT errors and use of the RESTORE command. Another discussion covers hard-disk slowdowns.

### MS-DOS COMMANDS

ms.dos/commands #90, from mose [Michael Mosely]

Backup using DOS 2.0: Help, please. Awhile back I used the BACKUP command to back up a directory or two using DOS version 2.0 on an IBM PC XT. Today I tried to restore them using "RESTORE A: C:." Well, the system clicked and whirled and told me there were no files to restore. DIR finds all of them including the BACKUPID.@@@ file. I'm kind of stuck because I can't even do a straight COPY operation and have my .EXE file execute. The files copy okay with the same number of bytes and all, but when I try to run them the system complains about not having enough memory. BACKUP must diddle something. Can anyone offer advice or sympathy?

ms.dos/commands #91, from petewhite [Pete White]:  
a comment to 90

If you were backing up a subdirectory, try the "/S" option. Other than that, RESTORE should work.

ms.dos/commands #92, from rich [Rich Sidney]:  
a comment to 90

Try

```
C>RESTORE A: \ *.* C:/S
```

You have to tell RESTORE which files to restore. It does *not* assume any files. As you gave it a null filename, it restored nothing.

ms.dos/commands #95, from kebrown [Ken Brown]:  
a comment to 90

You will not be able to just copy the files off the backup disk, you

(continued)

# TAKE THE 3-VOLUME HANDBOOK OF ARTIFICIAL INTELLIGENCE (A \$141.95 VALUE) FOR ONLY \$4.95

when you join the Library of Computer and Information Sciences.

You simply agree to buy 3 more books—at handsome discounts—within the next 12 months.

Just completed, the massive, 3-volume HANDBOOK OF ARTIFICIAL INTELLIGENCE promises to become the standard reference work in the growing AI field.

Conceived and produced by leading scientists and researchers at Stanford University, with contributions from universities and laboratories across the nation, the *Handbook* makes available to scientists, engineers, students, and hobbyists who are encountering AI for the first time the techniques and concepts in this rapidly expanding computer universe.

The 200 articles cover the emerging issues, technical problems, and design strategies which have been developed during the past 25 years of research. The *Handbook* has been written for people with no background in AI; jargon has been eliminated; and, the hierarchical organization of the book allows the reader to delve deeply into a particular subject or browse the articles which serve as overviews of the various subfields.

The 15 chapters (5 per volume) include: the history, goals, and current areas of research activity; the key concept of "search"; research on "natural languages"; the design of programs that understand spoken language; applications-oriented AI

The comprehensive HANDBOOK OF ARTIFICIAL INTELLIGENCE answers questions like:

- What is a "heuristic problem-solving program?"
- How do computers understand English?
- Can computer programs outperform human experts?

AND INCLUDES:

- Over 1,450 pages.
- More than 200 articles in 15 chapters.
- With numerous charts, tables, and schematics.
- Edited by Avron Barr, Paul Cohen and Edward Feigenbaum.

research in science, medicine, and education; automatic programming; models of cognition; automatic deduction; vision and learning research; and, planning and problem solving.

The Library of Computer and Information Sciences is the oldest and largest book club especially designed for the computer professional. In the incredibly fast-moving world of data processing, where up-to-date knowledge is essential, we make it easy for you to keep totally informed on all areas of the information sciences.

Begin enjoying the club's benefits today!

**MEMBERSHIP BENEFITS:** In addition to getting the 3-volume Handbook of Artificial Intelligence for only \$4.95, when you join, you keep saving substantially on the books you buy. Also, you will immediately become eligible to participate in our Bonus Book Plan, with savings of up to 70% off the publishers' prices. At 3-4 week intervals (16 times per year) you will receive the Book Club News, describing the coming Main Selection, and Alternate Selections, together with a dated reply card. If you want the Main Selection, do nothing and it will be sent to you automatically. If you prefer another selection, or no book at all, simply indicate your choice on the card, and return it by the date specified. You will have at least 10 days to decide. If, because of late mail delivery of the News, you should receive a book you do not want, we guarantee return postage.

If the reply card has been removed, please write to:

The Library of Computer and Information Sciences  
Dept. 7-DN7-00614, Riverside, N.J. 08075  
to obtain membership information and an application.

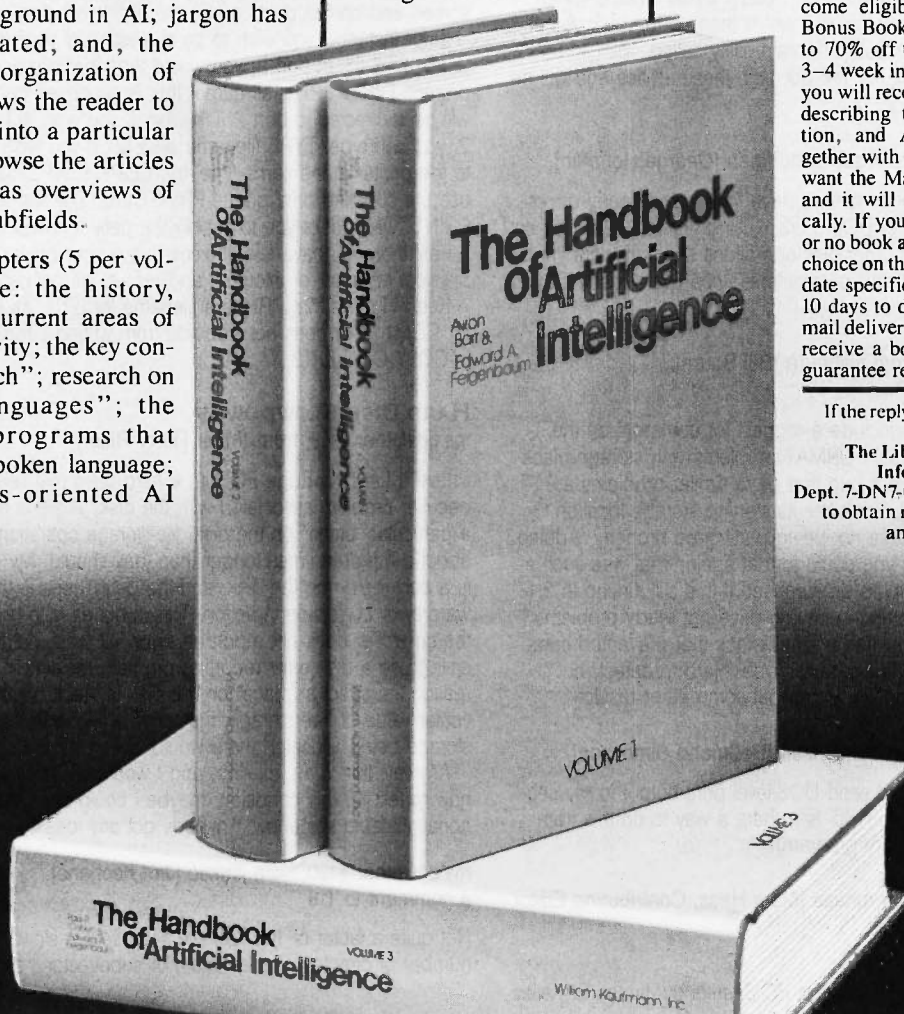

Byte 3/86

have to use RESTORE. BACKUP adds a 128-byte header to the front of each file as it backs it up, so if you copy an executable file off a backup disk it will not run. If there is really something wrong with the backup disk and RESTORE won't get it, there are programs on some bulletin-board systems that allow you to copy individual files off backup disks.

ms.dos/commands #96, from Imowatt [Lee Mowatt]:  
a comment to 91

RESTORE will only restore those files on disk that came from the directory in question. If it finds none from the directory, then it restores none.

ms.dos/commands #98, from leroy [Leroy Casterline]:  
a comment to 94

Under Compaq DOS 2.1 and PC-DOS 3.0/3.1, RESTORE A: C:/S works fine. I haven't seen a version of DOS that required the " \*.\* ". The /S is very important, however, if the files were backed up from a subdirectory. RESTORE isn't smart about restoring files and must be told to put them back in subdirectories with the /S. Another possible cause is a damaged BACKUPID.@@@ file. Check the length of the file; if it's 0 bytes long, it's bad and RESTORE will fail. One possible solution is to use UNDOBACK (a public-domain utility) on each individual file. UNDOBACK removes the "header bytes" that BACKUP puts at the beginning of every file as it writes them to the disk. A better solution is to use another public-domain utility called "BF" to recreate the BACKUPID.@@@ file. I've got both these utilities and will be glad to share them if need be.

ms.dos/commands #100, from georgehoffman [George Hoffman]

FORMAT 3.x errors?: I've been getting drive timeout/not ready errors trying to format floppies under DOS 3.0/3.1 using Qume 142 drives on an XT. Any suggestions? All other disk operations seem to work fine. It's *not* head settle or motor start parameters, since I've already played with these.

ms.dos/commands #103, from billbourn [Bill Bourn]:  
a comment to 100

I would amend the query to include a request for comment on the status of the previous releases' FORMAT problems with storage placement. FORMAT used to have a bug that gave similar problems as George mentions because it didn't like its starting storage location. Something about the work area not being partitioned properly. Adding a buffer or two "fixed" it so you could format again. That was such a well-known problem that I would be surprised if it is still lurking in 3.1. I also seem to remember someone having drive not ready problems with a drive whose door lever had a small crack that prevented complete and tight closing of the drive hub inside. Hard to detect, but push on the lever a bit to see if you can get some other results.

ms.dos/commands #106, from rsimonsen [Redmond Simonsen]

How do I get my AT&T 6300 to send DOS-level print output to my second parallel port? MODE is no help. Isn't there a way to do this from DOS (without some sort of utility program)?

ms.dos/commands #108, from mhaas [Mark Haas, Contributing Editor, BYTE]:  
a comment to 106

I strongly recommend getting a copy of *PC Secrets* by James E. Kelley.

On page 87, it has an assembly-language program for swapping LPT1 and LPT2. It also contains tons of other useful goodies.

ms.dos/commands #116, from inci [Claude West Jr., AT&T]:  
a comment to 106

Your MODE command should have provisions for LPT2. My copy of MS-DOS 2.11 does. Look in one of the previous issues of *PC World*; in the \*.\* Global column; there's a program to switch between LPT1 and LPT2. [Editor's note: *PC World*, November 1985, page 95.]

ms.dos/commands #121, from mmb [Michael Bosen]:  
a comment to 106

There is a book called *A Guide to the AT&T PC* by Robert Traister, published by Prentice-Hall. It's not terribly good, but that's from one person's point of view. It has some technical information, some info on software, running XENIX, etc. Nothing is done to completion, but there's a little for everyone. As far as really technical stuff, AT&T has the *Programmers' Guide* available at around \$65. You might like to visit The Softline BBS in Wakefield, MA, at (617) 245-4909, where you'll find a newly formed AT&T Users Forum.

ms.dos/commands #125, from bomb [Jerry McReynolds]:  
a comment to 106

I can help you out on redirection ">" and COPY commands; print screen and control print screen are a different story.

If, for instance, you wish to send a listing of your directory to the printer that sits at port 2, you would type the following at the system prompt: DIR >LPT2:; all output that is supposed to go to the screen will be redirected to port 2. Likewise, if you wish to list a text file to port 2, you can type: TYPE filename >LPT2:; if you wish to list several files to the printer at the same time, try: COPY \*.TXT LPT2:. You can also use the supplied print queue PRINT.COM. The first time you load PRINT.COM it asks you to supply the default printer port.

Past that, you have few choices; move your printer, change the physical address, or intercept and reroute printer calls.

Keep in mind that PRN is a filename for LPT1, as AUX is a filename for COM1. That does not stop you from writing directly to the device as in COPY CON LPT2:.

## HARD-DISK SLOWDOWNS

ms.dos/other #119, from tfritter [Terry Ritter]

I have a Leading Edge PC with a hard drive that seems to have a peculiar problem associated with the disk. There is no data loss, but, at a particular "place" on the disk, file-storage operations seem to take about a hundred times longer than they should. My guess is that there is a bad region on the disk, and the delay I see is the result of software error correction in action. This is not easy to tell, though, since the controller does not report an error—at least, not through the BIOS call. (I use a disk error reporting program resident in memory.) The reason I suspect a "place" on the disk is that it occurs around a particular value of free storage; if storage is allocated sequentially, the storage being allocated there would always be the same.

Anyway, this is an irritation, and I would like to remove it. If I knew how to test for this condition, maybe I could force that storage to be nonallocatable somehow. Anybody got any ideas?

ms.dos/other #120, from jimkeo [Jim Keohane]:  
a comment to 119

Not quite a factor of 100, but I've seen severe slowdowns once the number of directory entries (main or subdirectory) exceeds some value.

(continued)



Actually, we give you two things free.  
Our source code. And your freedom.

Just buy part or all of our excellent integrated  
business accounting system, the SBT Database  
Accounting Library.

We'll give you our source code absolutely free.

Which, in turn, gives you the freedom to  
customize our software to fit your business needs.

Say, for instance, you want to change the  
way a management report is formatted. Our free  
source code enables you to change it.

What's more, the change will be quick and  
simple because our software is written in easy-to-  
use dBASE.

In fact, the entire SBT Database Accounting  
Library runs with dBASE III or dBASE II,\* so you  
get the power and flexibility of those best-selling  
programs. Plus the freedom to use any computer  
that runs dBASE.

The SBT Database Accounting Library.  
Great software and freedom. All in the same box.

Call today for our demo disk and brochure.  
(415) 331-9900.

**THE SBT DATABASE ACCOUNTING LIBRARY.**

dProfessional	Time & Billing	\$395
dOrder	Sales Order processing	\$195
dInvoice	Billing/Inventory Control	\$195
dStatement	Accounts Receivable	\$ 95
dPurchase	Purchase Order	\$195
dPayable	Accounts Payable	\$295
dPayroll	Payroll/Labor	\$395
dLedger	General Ledger/Finance	\$395
dAssets	Asset/Depreciation	\$295
dProject	Project/Job Accounting	\$395
dBackup	Menu/Backup	\$ 65



Three Harbor Drive  
Sausalito, CA 94965  
(415) 331-9900

Call today for the name of the SBT consultant  
in your area.

# Free source code in every box.

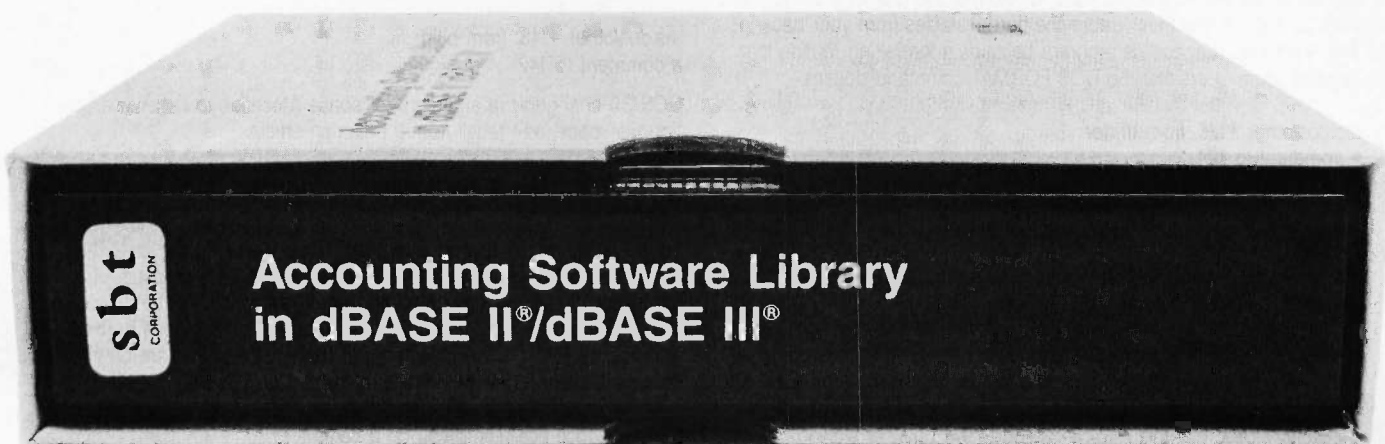

Could it be disk directory thrashing, jumping back and forth between parts of a directory that is too large to be read in all at once? This might fit better than free space as an indicator, since I believe allocation is no longer sequential once files have been deleted and their clusters reused.

ms.dos/other #121, from tfritter:  
a comment to 120

Don't think so; the symptom appears repeatedly during Turbo development. That is, a new file is created, an old one erased. Moreover, if I allow stuff to collect, I seem to get out of the area, and everything looks fine then. This is old-time MS-DOS 2.11, so I think allocation here is sequential (could be wrong, though). I'm also running 99 buffers, so the directory, at least, should be mostly in RAM (there will probably be a reload after Turbo terminates, but the symptom also appears during in-memory execution, so the only files created are text and overlays). The factor of 100 is, of course, an approximation. The delay is not just a casual burp; it seems to be on the order of 2 seconds. I imagined that this is the controller doing error correction.

ms.dos/other #122, from jimkeo:  
a comment to 121

Don't know if there's a connection but I read somewhere that Turbo reopens the overlay for each fetch (to keep the number of open files to a minimum). Are the overlay files in same directory?

ms.dos/other #123, from tfritter:  
a comment to 122

Yes, I think so, but doubt connection. The big slowdown comes at end-of-edit (new text-file creation), not execution per se. And if I unload 1 megabyte or so from the drive, no problem, or if I let it load up (this would be approaching *full*), again, no problem. Probably I could learn how to command the controller to read and write sectors, then analyze errors, but in the process I would be stamping on my working drive—a little scary!

ms.dos/other #124, from barryn [Barry Nance]:  
a comment to 123

The IBM Advanced Diagnostics program, as well as several public-domain programs, already provides for the kind of disk-error scanning that you refer to. Why don't you try the Advanced Diagnostics program and see what it says? If there are errors, I think your worst-case situation would be that you would have to reformat the disk in order to mark the bad sectors and then restore the hard-disk files from your backup. The Advanced Diagnostics program contains a formatting routine that catches some errors that the DOS FORMAT command doesn't.

ms.dos/other #126, from tfritter:  
a comment to 124

I guess the main reason that I have not tried the IBM Advanced Diagnostics is that I don't have it. I have a Leading Edge machine, and I would not know what is in the IBM Advanced Diagnostics program that would be worth whatever effort would be required to locate and purchase a copy.

The diagnostics program with this machine (DIAGX) does do a hard-drive write/read test (apparently), and part of the time it does come up with an error on a particular track and sector. Not all the time, just sometimes; as likely as not, FORMAT will not find it. Moreover, it is not particularly clear that this error is related to the peculiar slowdown problem—the error is on track 610 (out of 1224), which would make it

about halfway through allocatable storage, but the problem occurs somewhere around 2.8 megabytes free, which would seem to make it somewhere else.

It seems to me that the ability to access the collective experience of a large segment of power users is one of the advantages a network has over a magazine. If exposing my private problems to the world is inappropriate here, I would be glad to refrain.

ms.dos/other #128, from billn [Bill Nicholls]:  
a comment to 121

It may not be a bad disk. Your BUFFERS=99 is fine except when DOS has to look through them to find something. I recall a Peter Norton column in *PC Week* some time ago that recommended 8 buffers for a PC, 16 for a XT, and 32 for an AT, based on performance testing he had done. You may have too many buffers.

ms.dos/other #140, from bomb:  
a comment to 119

Your problem seems twofold. First, jimkeo is right about nonsequential allocation of file space after files have been deleted. DOS will allocate on an as-needed basis, using the lower offset clusters first. If you wish to see how your files are linked, use the CHKDSK program included on your DOS disk.

Use the command line "CHKDSK \*.\* /V" to get the program to list all of the errors that it encounters (the switch /V) and to list all the files that are not stored in contiguous areas (the file spec \*.\*). I am sure that you will find quite a few of your files are spread all over the disk. (Note: Norton's Utilities shows a graphic view of how the files on your disk are allocated.)

If you COPY all your files to some other disk, reformat your hard disk, then COPY all your files back to the hard disk, those files will be contiguous. This will help speed up the loading of the large files.

As for setting your BUFFERS=99, I have yet to see a situation that warrants that many buffers. As a rule of thumb, I set my buffers to match the amount of files that can be concurrently open. That is, if I have FILES=20, then I set BUFFERS=20; from that point it is simple to time my sessions and adjust the buffers accordingly.

ms.dos/other #142, from billbourn:  
a comment to 140

I'm not so sure about contiguous allocation in DOS 3.0 and 3.1. I have seen some strange allocations of space for those releases of PC-DOS. Maybe the MS-DOS has a saner allocation algorithm.

ms.dos/other #143, from billn:  
a comment to 142

DOS 3.0 changed the algorithm for space allocation to better use contiguous space, as I recall from the Norton article.

ms.dos/other #144, from billbourn:  
a comment to 143

So the totally empty disk situation might give the same results to the reorganization. The funny results I mentioned are for a hard disk that has seen quite a few files come and go. I hate to think of the fragmentation on that disk now. It seems to me that the most serious problem with fragmentation is the placement of subdirectories that are on the command path. If one of those is misplaced or gets fragmented by overfilling one cluster's worth of entries, the access arm is going to grind a bunch every time you do a command.

(continued)

# LycO Computer Marketing & Consultants

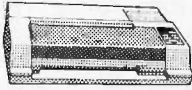

## SAVE ON THESE IN STOCK PRINTERS

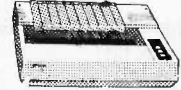

1091.....\$233

### AXIOM SEIKOSHA

GP550AT (Atari).....222  
GP550CD (C-64).....232  
GP700AT (Atari).....439  
GP700AP (Apple).....439  
FITESCD (C-64).....225

### C. ITOH

ProWriter 8510Sp+.....349  
1550Sp+.....469  
StarWriter.....769  
PrintMaster.....929

### TOSHIBA

P1340.....469  
P351+.....1149  
P341P.....969  
P341S.....999  
351 Sheet Feeder.....529

### CARDCO

32K BUFFER (C-64).....59

### CORONA

LP300 Laser Printer.....2686  
200361 Toner Cartridge.....89

### EPSON

FX85 (New).....333  
LX80.....212  
FX185 (New).....464  
LX90 (New).....226  
SQ2000 (New).....1555  
JX80.....467  
Homewriter 10.....193  
CR-220-Atari.....153  
DX-220-C-64.....153  
DX-10 (New).....207  
DX-20 (New).....297  
HS-80 (New).....288  
LQ1500P.....975  
LQ1500S.....1039  
RX-100.....356  
FX-100+.....CALL

### CITIZEN

MSP-10.....269  
MSP-15.....358  
MSP-20.....337  
MSP-25.....495  
Sheetfr (10/20).....189  
Sheetfr (15/25).....199

### OKIDATA

Okimate 10.....179  
Okimate 20.....CALL  
182.....214  
182.....348  
192.....563  
92P.....349  
93P.....565  
84P.....645  
92 Imagewriter.....349  
IBM versions also

### BROTHER

HR-15XL-P.....359  
HR-15XL-S.....359  
HR-35P.....239  
HR-35S.....839  
2024L-P.....949  
M1009-P.....189

### JUKI

Juki 6100.....347  
RS232 Serial Board.....55  
6100 Tractor.....119  
6100 Sheet Feeder.....209  
Juki 6300.....757

### LEGEND

880.....188  
1080.....222  
1380.....262  
1385.....296  
LEGEND 808.....159

### DIGITAL DEVICES

15K BUFFER.....75  
32K BUFFER.....69  
64K BUFFER.....125

### DIABLO

D25.....549  
630 API.....1599  
630 ECS.....1759  
D 80 15F.....2395  
P 32 CQ1.....699  
P 38.....1749  
C 150.....999  
DX-35 (NEW).....CALL  
AP-80.....CALL

SG-10.....\$208

### PANASONIC

1091.....233  
3131 (NEW).....269  
1092.....373  
1093.....426  
3151 Letter.....426  
4K Buffer.....65

### SILVER REED

EXP400.....249  
EXP500.....295  
EXP550.....369  
EXP770.....749

### STAR MICRONICS

SG-10.....208  
SG-15.....373  
SD-10.....336  
SD-15.....442  
SR-10.....483  
SR-15.....583  
SB 10.....595  
Power Type.....303  
SG-10 C-64 (NEW).....CALI

## MONITORS

### TAXAN

115 12" Green Composite.....CALL  
116 12" Amber Composite.....CALL  
121 12" Green TTL.....135  
122 12" Amber TTL.....145  
220 14" Color Composite.....259  
410 12" RGB Hi Res IBM.....329  
420 12" RGB Super Hi IBM.....409  
440 12" RGB Ultra Hi Res.....555  
Tilt Stand.....35

### ZENITH

ZVM 122A Amber.....75  
ZVM 123G Green.....75  
ZVM 124 Amber IBM.....129  
ZVM 131 Color.....275  
ZVM 133 RGB.....389  
ZVM 135 Composite.....449  
ZVM 136 Hi Res Color.....589  
ZVM 1220.....95  
ZVM 1230.....95  
ZVM 1240.....149

### TEKNIKA

MJ-10 Composite.....179  
MJ-22 RGB.....255

### AMDEK

300 Green.....118  
300 Amber.....128  
310 Amber IBM.....155  
Color 300 Audio.....234  
Color 500 Composite.....369  
Color 600.....397  
Color 700.....495  
Color 710.....569

### PANASONIC

DT1300D 13" RGB Composite.....247  
DTM140 14" RGB Composite.....329  
DT1103 10" RGB Hi Res.....395  
DTS101 10" Composite.....175  
DT100G 10" RGB.....166  
TX12H3P 12" Color.....419  
TR12M1PA 12" Green.....109  
TR120MBPA 12" Amber.....109  
TR122M9P 12" Green IBM.....148  
TR122MYP 12" Amber IBM.....148

### SAKATA

SG 1000 12" Green.....99  
SA 1000 12" Amber.....109  
SG 1500 12" Green TTL.....119  
SA 1500 12" Amber TTL.....129  
SC 100 13" Color Comp.....209  
SC 200 13" RGB.....389  
STS1 Tilt Stand.....29

### X-TRON

Comcolor 1 Composite Green.....177

### NEC

JB-1260 Green.....95  
JB-1210 Green.....135  
JC 1215 Color.....235  
JC 1216 RGB.....375  
JC 1460 Color.....265

### PRINCETON GRAPHICS

MAX-12 Amber.....185  
HX-12 RGB.....465  
SR-12 RGB.....595

## MODEMS

### HAYES

Smartmodem 300.....133  
Smartmodem 1200.....377  
Smartmodem 1200B.....347  
Smartmodem 2400.....598  
Micromodem IIE.....135

### TELE LEARNING

Total Telecommunications (C-64).....29.95  
AP-250 (300 Baud Apple).....69.95  
IB-250 (300 Baud IBM).....69.95

### ANCHOR

Volkmodem 20.....55  
Volkmodem 12.....186

### US ROBOTICS

Password 1200M.....229  
Password 1200F.....229  
Password 300M.....139  
Password 300F.....139  
Autodial 212A.....359  
PCM5.....319  
PCM64.....519  
PCM256.....769  
S-100.....379  
Courier.....469  
Microlink.....469  
Teipac Ms-DOS.....79

## DRIVES

### INDUS

GT ATARI.....215  
GT COMMODORE.....235

### TANDON

\*320K 5 1/4" Drive.....115

### MSD

SD1 Drive (C-64).....229  
SD2 Drive (C-64).....469

### TYMAC

MDD-640 3 1/2" Apple Drive 640K.....289

## DISKETTES

### DENNISON

ELEPHANT 5 1/4" SSDD.....11.99  
ELEPHANT 5 1/4" SSDD.....12.99  
ELEPHANT 5 1/4" DSDD.....14.99  
PREMIUM 5 1/4" SSDD.....13.99  
PREMIUM 5 1/4" DSDD.....15.99



### VERBATIM

5 1/4" SSDD.....13.99  
5 1/4" DSDD.....19.99

### BONUS

5 1/4" SSDD.....9.99  
5 1/4" DSDD.....12.99

## IBM-PC COMPATIBLE

### \*QUADRAM

Quad Jr. Exp. Chassis.....519.00  
Quad Jr. Exp. Memory.....209.00  
Quad Memory Jr.....209.00

### \*LOTUS

Lotus 1-2-3.....309.00  
Symphony.....439.00

### MICROPROSE (IBM)

F-15 Strike Eagle.....20.75  
Solo Flight.....20.75  
Helicat Ace.....20.75  
Spitfire Ace.....18.75

### \*LEADING EDGE

Nutshell.....69.95  
LEWP Basic.....65.00  
LEWP Merge Print.....99.00  
LE Spell Correction.....169.00

# TOLL FREE 1-800-233-8760



TO ORDER



RISK FREE POLICY

CALL TOLL FREE  
**800-233-8760**

Customer Service 1-717-327-1825

or send order to  
LycO Computer  
P.O. Box 5088  
Jersey Shore, PA  
17740

In-stock items shipped within 24 hours of order. No deposit on C.O.D. orders. Free shipping on prepaid cash orders within the continental U.S. Volume discounts available. PA residents add sales tax. APO, FPO, and international orders add \$5.00 plus 3% for priority mail service. Advertised prices show 4% discount for cash, add 4% for MasterCard or Visa. Personal checks require 4 weeks' clearance before shipping. Ask about UPS Blue and Red label shipping. All merchandise carried under manufacturer's warranty. Free catalog with order. All items subject to change without notice.

ms.dos/other #146, from rbrukardt [Randall Brukardt]:  
a comment to 121

DOS 2.11 (etc.) never keeps more than one 512-byte block of a directory in memory at one time, no matter how many buffers you use. That's the best reason for buying DOS 3.1, because it doesn't suffer from that stupid design. It makes a large difference for software that does a lot of directory searching (such as our Janus/Ada compiler); on the compiler, DOS 3.1 is almost 50 percent faster, all other things being constant.

ms.dos/other #148, from johnf [John Fistere]:  
a comment to 126

I don't think that you can correlate the track number with its usage with a certain level of memory usage. It will write to whatever empty areas it finds, depending on what has been deleted. Of course, if your disk is new, there is a correlation. The fact that your DIAGX program finds a bad sector part of the time correlates well with slow writing. Can you mark the sector with DIAGX?

ms.dos/other #149, from tfritter:  
a comment to 148

Yes, you are probably right. Even though disk storage is allocated in sequence, only free store can be reallocated. If, somehow, there is a lot of high-end store allocated, this would mean that the free store may be in the middle (low store is always gobbled first). I did not expect to see this in my case, since I rarely fill the disk over 8 megabytes, but I may have done so, and this may be the case; will try to check it out.

No, cannot mark the sector with DIAGX, nor with anything else I have, as far as I know. The problem is an annoyance; I would spend *some* money to fix it, but not a lot. I guess there probably are public-domain programs available to do this, and the best deal would be to get the source. Any such program would probably be free, but I would be more interested in reading the code, to see what they do, and maybe to extend it.

ms.dos/other #150, from barryn:  
a comment to 149

I recall seeing some public-domain disk utility programs on a variety of bulletin boards. I think the BYTEnet Listings node has quite a few, if memory serves. I haven't accessed it in a while. The number and communication parameters are as follows:

BYTEnet Listings     1 (617) 861-9764     1200-8-N-1

Although some of the material available in the Listings conference appears to have been copied from the BYTEnet Listings files, I think there a few files that haven't been copied. Until Listings becomes fully operational, it might be advantageous to look in BYTEnet for the kind of program you need.

ms.dos/other #184, from tfritter

The problem I have previously reported (a 2-second pause during hard-drive file store) does, indeed, turn out to have something to do with my original BUFFERS=99 command (as suggested by billn in message 128 and bomb in 140). Reducing BUFFERS to 10 or 20 either solves or hides the problem; BUFFERS=90 and 99 show similar results. Now, a 2-second pause is a *long, long* time at computer speeds. Even a linear search of 100 buffers should be possible in milliseconds, not seconds. The Norton article on buffers was, in fact, the reason for choosing a large number; as I recall, the article did show that there is often an optimum number of buffers for a particular pro-

gram. Above the maximum, there was some decrease in efficiency, due, we would expect, to buffer search time. But below the maximum, the cutoff was dramatic. It thus seemed reasonable to me that a large number of buffers would avoid dramatic inefficiencies, while accepting lesser inefficiencies for most programs. I think that so far the reasoning is valid. But there must be something else involved, because of the weird 2-second delay problem that I had with BUFFERS=90 or 99. This just cannot be a search. Maybe if they moved the contents of each buffer up one, for some reason. During this period the drive light is off—the problem is not a disk access. Anyway, the nuisance of the delay is gone, so I expect to let the puzzle rest as it is. Thanks to those who contributed suggestions, and to everyone else for putting up with my particular problem.

ms.dos/other #185, from bahama [Joe Galen]:  
a comment to 184

According to the PC-DOS 2.1 manual, pages 4–6, for most database applications, a value between 10 and 20 buffers will usually provide the best results. Beyond that point, the system may appear to start running slower. This is because with a very large number of buffers it can take DOS longer to search all buffers for the record than it would take to read the record from disk.

ms.dos/other #186, from tfritter:  
a comment to 185

The delay was 2 whole seconds! It doesn't take 2 seconds to search all the buffers. In fact, it shouldn't even take close to 50 msec, which would approximate the disk access time. There seems to be a small matter of 1.5–2 orders of magnitude here. I don't know—I guess one could write code to run that slow, but I think they probably would have to work at it.

ms.dos/other #188, from tfritter:  
a comment to 185

This actually would make sense if there were a lot more going on in BUFFERS than just caching. Suppose somebody thought it would be a good idea to *sort* the buffers? I guess this might make a convenient multisector disk write. Now suppose that the sorting algorithm used was a simple bubble sort (and that the data in each buffer would also have to be relocated); now *that* could take 2 seconds.

Of course, this is all mental vaporware. I have no more evidence than I ever did.

ms.dos/other #191, from cjackson [Craig Jackson]:  
a comment to 188

Actually, if one is writing more than a sector, DOS doesn't even put the full-sector portions of the write into the buffers, let alone use them for multisector work. Anyway, the buffer control information is stored next to the buffer.

ms.dos/other #192, from billn:  
a comment to 184

The second part of the problem may be due to directory and FAT updating. Does the problem happen as you open/close files? I got the impression from the Norton article that degradation got serious as buffers exceeded approximately 32 and was not a linear process. No doubt DOS 9.4 will address that problem.

ms.dos/other #193, from rbrukardt:  
a comment to 186

I often think Microsoft *did* work at making DOS slow. You have to think  
(continued)

# Betcha our compiler can beat up your compiler.

*Or your money back.*

If you program in BASIC, Pascal, Fortran or C, you're using yesterday's technology. We know this statement will start a brawl, but it's true. So, before you start a fight you can't win, take a closer look at the Modula-2 language and the Modula-2 Software Development System (M2SDS) from Interface Technologies. Just compare the features and performance of M2SDS to your system. You'll find a new language and a programming environment that's more flexible, much faster and works on any IBM® PC or 100% compatible with 256 K memory or more.



**Trade In and Trade Up.** Just to prove that we're not all brag... we'll send you M2SDS for just \$50.88 if you mail us your present compiler or interpreter diskette.\* That's \$30.00 off the regular price. If within 30 days you're not programming faster than ever, just return the diskette and we'll send you your money back.

**Heavyweight Champion SDS-XP.** If you're ready to move into light-speed, you need SDS-XP. It has everything M2SDS has with a little "punch" added. Like Extended Libraries, M2MAKE and a Foreign Object Module Importer. SDS-XP offers buyers a stout discount when compared with the cost of buying M2SDS and the additional components as add-ons. For a limited time only, SDS-XP is available for \$99.00 with compiler trade-in. That's \$150.00 off the advertised price of \$249.00.

	M2SDS
<b>COMPILE SPEED (MIN:SEC)</b>	
30 LINES	0:15.58
300 LINES	0:25.48
<b>EXECUTION SPEED (MIN:SEC)</b>	
SIEVE	0:13.92
FIBONACCI	0:53.49
30X30 MATRIX (8087)	0:08.84
FP OPERATIONS	0:27.56
FP OPERATIONS (8087)	0:01.97
SYNTAX CHECKING EDITOR	YES
MULTIPLE WINDOW EDITING	YES
EDITOR FILESIZE LIMIT	MEMORY SIZE
COMPILE ERROR CALLS EDITOR	YES
LINKER	YES
PRODUCES .EXE FILES	YES
EXECUTABLE CODE SIZE LIMIT	DISK SPACE
DOS ACCESS FROM EDITOR	YES
DOS ACCESS FROM PROGRAMS	YES
8087 SUPPORT STANDARD	YES
COPY-PROTECTED DISK	NO
COST WITH 8087 SUPPORT	\$50.88/\$80.88

Source: Software Resources, Inc. Sieve program from BYTE, January 1983. Fibonacci program from Dr. Dobb's Journal, February 1985. Matrix program from BYTE, October, 1982. FP Operations program from BYTE, May 1985. M2SDS with or without 8087 uses 8-byte accuracy. Programs compiled with all checking options on. All tests conducted on a standard IBM-PC/XT with 512K of memory and an 8087 math coprocessor.

\*Original or back-up diskette may be sent for trade-in. Diskette will be destroyed immediately upon receipt so that your current compiler license agreement is not violated.

IBM is a registered trademark of International Business Machines Corporation.

## Knock Out Bugs \$79.95.

Announcing M2DEBUG. A symbolic, compact (only 20K RAM) interactive run-time debugger with features most requested by software programmers and system developers. It comes with a Virtual Resource Overlay Operating Manager (VROOM) that speeds up compile time 50%.

**Calling All Compilers.** So now that you're wise to the limitations of your system, why not trade it in. You'll soon see that it was smarter to switch than fight. And a pretty safe bet.

Here's my diskette. Rush me:

- M2SDS for \$50.88 each, plus \$7 shipping and handling.
- SDS-XP for \$99.00 each, plus \$7 shipping and handling.

Or, send me:

- M2SDS for \$80.88 each, plus \$7 shipping and handling.
- SDS-XP for \$249.00 each, plus \$7 shipping and handling.
- M2DEBUG for \$79.95

- My check is enclosed.
- Apply charges to credit card indicated below:

VISA/MasterCard/American Express (circle one).

Credit Card # \_\_\_\_\_

Expiration Date \_\_\_\_\_

Signature \_\_\_\_\_

Name \_\_\_\_\_

(please print)

Shipping Address \_\_\_\_\_

City \_\_\_\_\_

State/Zip \_\_\_\_\_

Day Phone \_\_\_\_\_

Texas residents add 6.125% Sales Tax.  
International orders add \$30 for shipping/handling.  
If paying by check, check or draft must be in U.S. dollars drawn on a U.S. bank.

INTERFACE TECHNOLOGIES CORPORATION  
3336 Richmond, Suite 200, Houston, Texas 77098

**INTERFACE TECHNOLOGIES**  
3336 Richmond, Suite 200, Houston, TX 77098

**1-800-922-9049**

(In Texas, call 713/523-8422) Telex: 322127  
In Europe, call ITC in Switzerland at (01) 700-3037

that they know more about timing issues than that. A program running under DOS 2.0 or later is supposed to let the operating system do its buffering for it, but I can often cut the run time of a program in half by adding buffering routines. That's not helping the programmer at all!

ms.dos/other #194, from Leroy;  
a comment to 190

When I was using a Compaq Plus (bought one when they first appeared), I had a problem with the thing *stopping* for a while in the middle of heavy disk activity. When I say a while, I mean between 5 and 10 seconds. The machine would just stop dead, then continue as if nothing had happened. I was using 20 buffers, and adjusting the buffer size seemed to make no difference, so this is clearly a different problem. The pause would occur even while copying a file from one sub-directory to another.

ms.dos/other #196, from tfritter;  
a comment to 194

I don't know, it could be the same thing. Maybe changing the buffers has just hidden the problem.

*Stopping* is right! Since I spend most of my computer time in Turbo Pascal, that is where I noticed it. It is real noticeable when the line count stops incrementing, the disk light is off, and this continues for several seconds. Then it would start again and complete okay. It was fairly common; I suppose it happened hundreds of times over the course of a few months. When I first started to notice it I assumed the problem had something to do with filling the disk to a level beyond what I normally run. But reducing the BUFFERS spec sure seems to either have solved it, hidden it, or reduced it to the extent that it is no longer a problem.

## MACINTOSH

Discussions of the Macintosh this month cover file transfers, use of the Finder as an aid for the blind, multitasking capabilities, and projecting the Macintosh screen display. Information is posted on the Mac serial port, on programming the Mac to eject a disk, and one programmer's experience with debuggers on a 1.5-megabyte Mac.

### PROJECTOR FOR THE MAC

macintosh/qanda #143, from frankb [Frank Boosman]

TITLE: Cinemascope mac?

I've read plenty on projectors for the Macintosh, but all of them presuppose a deep bank account. Is there a cheap, homegrown way to magnify the Mac's image large enough for a roomful of viewers? The quality doesn't have to be great or even good, just viewable.

As an example of the kind of thing I'm thinking of, would it be possible to align the upper half of an overhead projector with a Macintosh laid on its back, thereby projecting the screen image up?

macintosh/qanda #144, from lloeb [Larry Loeb];  
a comment to 143

Someone I know actually did lay his Mac over on its back and tried that. Burned up the power supply on it after 1 hour. There is a magnifying Fresnel lens that's not projection, but makes the image about two times larger. You can even make a holder for one you buy out of coat-hanger wire. *MacNifier* is a commercial product just along those lines, I

believe. Other than that you may have to have deep pockets. Or wait for Apple to announce a Mac monitor.

macintosh/qanda #145, from c Crawford [Chris Crawford];  
a comment to 143

It is possible to train a video camera onto a Mac screen and get a usable image. You could then feed the video into any number of video devices (large-screen TVs, for example). That is the quickest, simplest video interface.

macintosh/qanda #146, from dpallen [David Allen];  
a comment to 143

I have installed the Mentauris Technologies composite video adapter in my Macintosh, and it works very well. It provides a BNC connector on the back of the Mac. You connect this with any monitor that can handle a 21-kHz sweep rate and has a 20-30 MHz video bandpass. There are quite a few monitors that meet this specification, and Mentauris provides a full-page list of them, both CRT screens and projectors.

Mentauris costs about \$200, and they can provide the special tools needed to get inside the Mac. No soldering is required, but you do have to drill a small hole in the Mac plastic case, very easy to do.

For more information, contact Mentauris Technologies, 1658 Interstate 35 S, POB 1467, San Marcos, TX 78667-1467.

### FILE TRANSFERS

macintosh/qanda #175, from bbayer [Barry Bayer]

TITLE: Red Ryder Text Files

I have a problem with a text file received by Red Ryder. I know it is a perfectly good file, because I just uploaded it from the Compaq. (Simple, if sometimes expensive, way of file transfer between machines.) I use the Receive ASCII option on the Red Ryder File menu.

Reading it into MacWrite (with a carriage return signifying paragraph breaks), I get a small square at the beginning of each line. Presumably this stands for some sort of character, but I am not sure what. How do I get rid of this? Is there a filter on Red Ryder that I should set? (Removing them one at a time is just a little tedious. Help!)

macintosh/qanda #176, from lloeb;  
a comment to 175

The square is a linefeed. You can strip all control characters with an option available under the Mode menu. This will also drop the CRs as well.

macintosh/qanda #177, from tom\_\_thompson [Tom Thompson,  
Technical Editor, BYTE]

In reference to lloeb's message #176, he's correct that it's linefeeds. An alternative method in MacWrite is to cut one of the linefeeds, then paste it into the Find What input box under the Search menu. Leave the Change To box empty and click on Change All. This zaps every linefeed without obliterating the CRs in the file. *Warning:* Some people have had this technique crash the system, so work on a copy of the file. I've used this technique successfully with MacWrite and the MDS editor many times. Another alternative is Scott Watson's *Didler* program, which will selectively strip linefeeds (or add them) from a text file. It's fast, too. I have Red Ryder and *Didler* on one disk that I use to transfer source code between the Mac and the IBM-compatible machines here.

[Editor's note: The problem just discussed occurs with any text-file transfer between the Mac and an MS-DOS machine, regardless of the communications program. Both computers have different formats for

(continued)

# OUR COMMUNITY NEEDS MORE CORPORATE HEROES.

The United Way volunteer gives a gift that's hard to measure.

Because without his or her contribution of time, energy and dedication, the community services and local programs of United Way simply cannot exist.

United Way has much to do in our community. From day care for the young to services for the elderly.

So this year, be generous.

Give yourself.



**United Way**

THANKS TO YOU IT WORKS  
FOR ALL OF US.

© United Way 1984



A Public Service of This Publication

text files, and linefeeds must be stripped or added to the file depending on destination machine.]

**THE MAC AND THE BLIND**

macintosh/software #97, from hbj [Henry Brugsch]

TITLE: Talking Software

I would like to start some discussion about the potentials for the development of Macintosh, specifically in terms of applications for blind users. Ever since the advent of the Mac, some blind users, myself included, have perceived it as a threat. Since the Mac relies upon user-driven icons instead of text from the keyboard to control applications, there is a tendency on the part of software manufacturers to develop software that is, naturally, screen-oriented.

Macintosh is one of the best speech software programs I have heard. But there is, as far as I know, no way for a blind user to interface with this tool. It will do a fine job with text files, clearly reading what is coming up on the screen. Yet, the blind user has no way of accessing the software, since there is no way of translating the icon into speech. Thus, some of us perceive the Mac as a real threat to the ability of users to benefit from new speech technology. This seems to be borne out by the fact there has been no development of a keyboard-driven speech program. I would like to see some comments on this subject and also invite members to come down to Handicapped conference and post some thoughts in the Speech topic.

macintosh/software #98, from lloeb:  
a comment to 97

You raise an interesting point in this. That the Finder itself handles the icon highlighting when selected indicates that is where the hook to call the speech routine must fall. I'm not sure that a cracked Finder with a Macintosh driver inserted isn't possible, you understand. But it would be *lots* easier if Apple was involved in it. It's their code.

**MULTITASKING**

macintosh/prod.discussn #177, from jamurphy [Joe Murphy]

I just received the software upgrade of my Thunderscan software, and the new version (2.7) allows multitasking with Switcher. It lets you scan a document in the background while you work in another program. It seems to work well; disk access and the clicking of the mouse, however, stop the scanning in the background. This is my first experience with multitasking and the Macintosh. Are there any other programs that multitask with Switcher? Anyone have any other experiences?

macintosh/prod.discussn #179, from rschnapp [Russell Schnapp]

All desk accessories have a certain amount of background processing capability. This is mostly at the mercy of the foreground (application) task. It's not the nicest form of concurrency, but a careful programmer can do neat things.

A trivial example of a background processing DA: the alarm clock. Also, check out MacWait in the Listings/Macintosh conference. It makes the hands on the waiting watch spin!

macintosh/prod.discussn #184, from deu [William Deu]

I was wondering, how do you like the resolution of your Thunderscan? Does it pick up details well?

macintosh/prod.discussn #187, from jamurphy

The new software gives you much better control over the scanning. I am very satisfied with the resolution. It can only get text in a readable

format by 300-400 percent enlargement of what you're scanning. That takes up a lot of memory and would not be practical on a 128K Mac. What is really neat is you can print the scanned document on a LaserWriter to get really nice results. The manual shows an example of a map scanned at 400 percent magnification and then printed at 25 percent reduction on a LaserWriter, giving a printed resolution of 288 dots/inch.

macintosh/hardware #25, from richard [Richard Shuford]

**Fact and Opinion Concerning the Macintosh Serial Port**

The serial port on the Apple Macintosh is not an implementation of the EIA's RS-232C standard, as are most other serial ports on microcomputers. The electrical characteristics of the Mac's port approximate the higher-speed RS-422A standard, but an RS-422A port is supposed to be wired according to a connection standard called RS-449. The Macintosh's port is not.

However, the Macintosh port seems to work okay according to its own odd setup, and with careful wiring it can be made to talk to devices that use an RS-232C interface.

The definitions of the serial-port pin-out from an early printing of *Inside Macintosh* are as follows:

Pin	Signal	RS-232C Interconnection Notes
1	frame ground	
2	+5 V	don't use this
3	signal ground	
4	TXD +	ignore pin 4
5	TXD -	use this as RS-232C TD (Transmitted Data)
6	power-on detect (+12 V)	can be used to provide Data Terminal Ready
7	HSK (handshake)	can be used somewhat like Clear To Send
8	RXD +	ignore pin 8
9	RXD -	use this as RS-232C RD (Received Data)

Several RS-232C/Macintosh interconnection schemes have been posted on various bulletin-board systems around the country. Some of them have been strange in some respect. I'm not necessarily saying that they do not work for the purpose for which they were wired, but that some unnecessary or illogical cross-connections were made in them.

**USING SOFTWARE TO RESET THE MAC**

macintosh/softw.devlpmt #2, from ccrwfor

Does anybody know how to get the system to cycle through a cold start? *Inside Macintosh* refers to system initialization procedures in its index, but these are in a manual that is not part of *Inside Macintosh*. My goal is to eject the disk on command and shut the system down, rather like the results of the Shut Down menu item in the new Finder. I've got the Eject function working fine but can't kill the system; it just asks the user to insert the disk again.

macintosh/softw.devlpmt #3, from callen [Chris Allen]:  
a comment to 2

The assembly for reboot on the Macintosh is quite simple: Take the ROM base, add 1C to it, then jump to that location. If the computer is a Lisa, you have to go into a little more involved process.

Or if you have Lisa Pascal 3.0 and a disassembler, make a program with one command, REBOOT, and disassemble it.

(continued)



# Computers For The Blind

Talking computers give blind and visually impaired people access to electronic information. The question is how and how much?

The answers can be found in "The Second Beginner's Guide to Personal Computers for the Blind and Visually Impaired" published by the National Braille Press. This comprehensive book contains a Buyer's Guide to talking microcomputers and large print display processors. More importantly it includes reviews, written by blind users, of software that works with speech.

This invaluable resource book offers details on training programs in computer applications for the blind, and other useful information on how to buy and use special equipment.

Send orders to:  
National Braille Press Inc.  
88 St. Stephen Street  
Boston, MA 02115  
(617) 266-6160

\$12.95 for braille or cassette, \$14.95 for print. (\$3 extra for UPS shipping)  
NBP is a nonprofit braille printing and publishing house.

## BYTE back issues for sale

	1981	1982	1983	1984	1985	1986
Jan.	\$3.25		\$3.70	\$4.25	\$4.25	\$4.25
Feb.	\$3.25	\$3.70	\$3.70	\$4.25	\$4.25	\$4.25
March		\$3.70	\$3.70	\$4.25	\$4.25	
April	\$3.25	\$3.70	\$3.70	\$4.25	\$4.25	
May		\$3.70	\$3.70	\$4.25	\$4.25	
June		\$3.70	\$3.70	\$4.25	\$4.25	
July		\$3.70	\$4.25	\$4.25		
Aug.		\$3.70	\$4.25	\$4.25	\$4.25	
Sept.		\$3.70	\$4.25	\$4.25	\$4.25	
Oct.	\$3.25	\$3.70	\$4.25	\$4.25	\$4.25	
Nov.	\$3.25	\$3.70	\$4.25	\$4.25	\$4.25	
Dec.	\$3.25	\$3.70	\$4.25	\$4.25	\$4.25	

### SPECIAL ISSUES and INDEX

BYTE '83-'84 INDEX	\$1.75
1984 Special Guide to IBM PC's (Vol. 9, No. 9)	\$4.75
1985 INSIDE THE IBM PCs (Vol. 10, No. 11)	\$4.75

Circle and send requests with payments to:

**BYTE Back Issues**  
**P.O. Box 328**  
**Hancock, NH 03449**

Prices include postage in the US. Please add \$.50 per copy for Canada and Mexico; and \$2.00 per copy to foreign countries (surface delivery).

Payments from foreign countries must be made in US funds payable at a US bank.

Check enclosed  VISA  MasterCard

Card # \_\_\_\_\_

Exp. \_\_\_\_\_

Signature \_\_\_\_\_

Please allow 4 weeks for domestic delivery and 12 weeks for foreign delivery.

NAME \_\_\_\_\_

ADDRESS \_\_\_\_\_

CITY \_\_\_\_\_

STATE \_\_\_\_\_ ZIP \_\_\_\_\_

PS.: The JMP is legal Apple—they will not change it in future releases of the ROM.

**DEBUGGER PROBLEMS**

macintosh/softw.devlpmt #9, from ephraim [Ephraim Vishniac]

TITLE: Very Large Macs and RAM Disks  
 I'm currently working on RAM-disk software for two local (Boston area) companies that offer Mac memory upgrades past 512K. I've been beating my head against the wall on one particular problem: If I have a 1-megabyte RAM disk running in my 1.5-megabyte Mac and MacsBug is installed, the Mac heads west when the RAM disk goes past about half-full. If MacsBug isn't installed, all's well. Out of curiosity, I tested some other RAM disks. The Assimilation Process RAM disk doesn't blow up, but MacsBug is dead! (I press the interrupt switch and nothing happens.) The public-domain RamStart program also appears to kill MacsBug, but still blows up. The results suggest chance, not design.

Questions: Who out there has a Mac with >1-megabyte memory? What RAM disk(s) are you using? Ever try it with MacsBug?

Progress: I've been slowly crawling toward the exact point where the system dies. I think it croaks during a block move during a compaction of the application heap. I'm not sure yet, and I have no idea why.

macintosh/softw.devlpmt #12, from ephraim

After more investigation, I think the problem is most likely with MacsBug (I'm using Maxbug, actually, but close enough). I hope to confirm the diagnosis within a few days using a hardware emulator (how else to debug when the debugger breaks?), but my current belief is that MacsBug is relying on memory wraparound. That is, it writes/reads at some very high address, expecting that the data will wind up in real memory at some useful place. With a power-of-two memory size fully recognized by the system, that's probably a safe policy (although not a very good one). With an odd memory size, such as my 1.5-megabyte, that policy is a big loser.

Does the Levco upgrade have a 512K mode in which the system recognizes a half-megabyte and the rest is reserved for RAM disk? I would expect that configuration to have the same problem. If anyone wants to try this stunt at home, just boot from a disk with MaxBug installed (i.e., renamed to "MacsBug"), then start filling up your RAM disk. If you hit the problem, you'll know it. Symptoms vary, but are swift and fatal.

macintosh/softw.devlpmt #13, from ephraim

TITLE: MaxBug Bites Programmer, MacNosy to Rescue  
 While developing away on my 1.5-megabyte Mac, I found that I had system crashes when my 1-megabyte RAM disk reached about half-full *only with MaxBug installed*. Without MaxBug, no problems. I struggled with this problem for several days (Is it me? Is it hardware? Is it MacsBug?) and gradually became convinced that the problem lay with MacsBug.

Last week, I bought a copy of MacNosy, "the disassembler for the rest of us." (Note: Apparently, "the rest of us" use glass TTys with bizarre command-line syntax and inscrutable abbreviations.) Happily, one of the sample MacNosy journals was a disassembly of the very same version of MaxBug I was wrestling with. The cause of the problem?

Read on.

MacsBug (and MaxBug and TermBug) assume:

- That wraparound provides reliable access to top-of-memory relative locations.
- That the world ends at 1 megabyte.

So, if you've got a Mac with more than 1 megabyte, MacsBug is not for you. Also, MacsBug will bomb if you've got a 1-megabyte Mac that doesn't map video to the top of memory but uses the additional memory solely for RAM disk.

The fix? I wrote an MS-BASIC (gasp!) program (below) that filters a copy of MaxBug, looking for certain addresses. The output of the filter has these addresses patched to other, hardware-dependent values. But at least I have a version that works on my machine.

```

1 Program to patch up MacsBug
2 Ephraim Vishniac   October 2, 1985
3 Send BIX mail to "ephraim"
4 Send Usenet mail to decvax!wanginst!vishniac
    
```

```

5 MacsBug addresses its variables as though the Mac had
6 1-megabyte memory and relies on wraparound to fix things up.
7 These are bad assumptions on > 1-megabyte Macs and on
8 1-megabyte Macs operating in 512K mode. This program takes
9 an original copy of MacsBug and creates a version that expects
10 some different memory size. This program has been tested using
11 MaxBug and a 1.5-megabyte Mac. To adapt this program for
12 your memory size, alter the line that defines the string named
13 "Replace$."
    
```

```

SourceFile$ = FILE$(1,"????")
IF SourceFile$ = "" THEN END
OPEN "1", #1, SourceFile$
DestFile$ = FILE$(0,"Output file name?")
OPEN "0", #2, "Temp MacsBug"
PRINT "Converting "SourceFile$" to "DestFile$
    
```

```

14 Test$ is set to the 16-bit value $000F. This is used to detect
15 the high word of possible offending addresses.
Test$ = CHR$(0) + CHR$(15)
16 Replace$ is set to the 16-bit value $0017 (for 1.5-megabyte
17 memory). When an offensive address is detected, Replace$ is
18 substituted for its high-order word.
19 *****Change the next line to fit your real memory size! *****
Replace$ = CHR$(0) + CHR$(23)
    
```

```

20 Within the following loop, we search for 4-byte sequences of the
21 form $000FAxxx. Because of alignment constraints, we only
22 have to test on word boundaries, not at every byte.
    
```

```

23 Start the pipeline.
x$ = INPUT$(2,#1)
Gotten = 0 : Number of addresses patched

24 WHILE NOT(EOF(1))
    y$ = INPUT$(2,#1)
    IF (x$ = Test$) AND ((ASC(LEFT$(y$,1)) AND &HF0) =
    &HA0) THEN x$ = Replace$ : PRINT "Got one!"
    : Gotten = Gotten + 1
    PRINT #2,x$;
    x$ = y$
25 WEND
    
```

```

26 Flush the pipeline
PRINT #2,x$;
    
```

```

CLOSE #1
CLOSE #2
    
```

```

NAME "Temp MacsBug" AS DestFile$,"????"
PRINT "Conversion done."
PRINT Gotten" patches made." ■
    
```

# Program faster, debug faster.

## Source Print™

### Source Formatting Utility

For C, Pascal, BASIC, dBASE II, III, III+, Modula-2

Everything you'd expect...

**Index/Cross reference.** This is particularly useful for locating identifiers in source listings when you are away from your editor; SOURCE PRINT™ can list line and page numbers of all occurrences for each alphanumeric identifier.

**Page headings and line number.** SOURCE PRINT gives you page headings which include current and file date/time, page number, and source line-number range. Lines may be numbered if desired.

**Table of contents.** You may imbed titles and subtitles in your source text; SOURCE PRINT can then generate a table of contents. Titles and subtitles will also appear on page headings.

**Automatic indentation.** SOURCE PRINT can automatically indent source listings based on control-structure nesting. For Pascal and Modula-2, indentation is also based on procedure and module nesting.

**Printer control.** Extensive control of your printer's features: size, font, emphasis,...

Plus these new tools...

#### Pascal

```

46 procedure shellsort; (* <S> Shell Sort *)
47 label 1;
48 var ind1, ind2, hint, vect: integer;
49 begin
50   hint := 1;
51   repeat
52     hint := 3 * hint + 1
53   until hint > STEPS;
54   repeat
55     hint := hint div 3;
56     for ind1 := hint + 1 to STEPS do
57       begin
58         vect := array[ind1];
59         ind2 := ind1;
60         if array[ind2-hint] > vect then
61           repeat
62             array[ind2] := array[ind2-hint];
63             ind2 := ind2 - hint;
64           until ind2 <= hint or array[ind2-hint] <= vect;
65         array[ind2] := vect;
66       end;
67     until hint = 1;
68 end;

```

#### Routine Extraction

Copy c:\c2.c c:\c4.c @strp/cabg @procln,control,procln2,src\col,dml\A  
Source Print v. 1.10 (C) Copyright 1985 Aldebaran Laboratories Inc. 1172  
89 lines extracted of 1853 lines from c1.c  
91 lines extracted of 1610 lines from c2.c  
64 lines extracted of 1251 lines from c4.c

#### BASIC

```

10 REM ***** <S> Shell Sort *****
20 H = 1
30 H = 3 * H + 1
40 IF H <= N THEN GOTO 30
50 H = INT(H / 3)
60 FOR I = H + 1 TO N
70   V = A(I) : J = I
80   WHILE A(J - H) > V
90     A(J) = A(J - H)
100    J = J - H
110   IF J <= H THEN GOTO 130
120   WEND
130   A(J) = V
140 NEXT I
150 IF H <> 1 THEN GOTO 50

```

**Program structure outlining.** SOURCE PRINT can draw lines to connect the beginning and end of nested control structures. Even complex structures stand out clearly.

**Key words emphasis.** Emphasize key words in your programming language with styles your printer supports: boldface, underline,...

**Extraction of routines.** SOURCE PRINT can extract selected subtitled procedures or functions from one or more source files to form a new source file. Selection may also be done by line-number range.

**Printing selected routines.** Save time and paper by printing only part of a file, using the above selection methods.

...all in one utility program!

**Easy to use, one-line commands.**

All combinations of features can usually be specified on a single command line!

For IBM PC, PC/XT, PC AT, portable, compatibles, floppy or hard drive; ≥128K RAM, DOS 2 or 3.

Not copy protected

Order Source Print by phone:

800-257-5773 (outside CA)

800-257-5774 (within CA)

Immediate delivery

for only \$97<sup>00</sup>

30-Day unconditional money-back guarantee  
VISA, MC, Am. Ex.

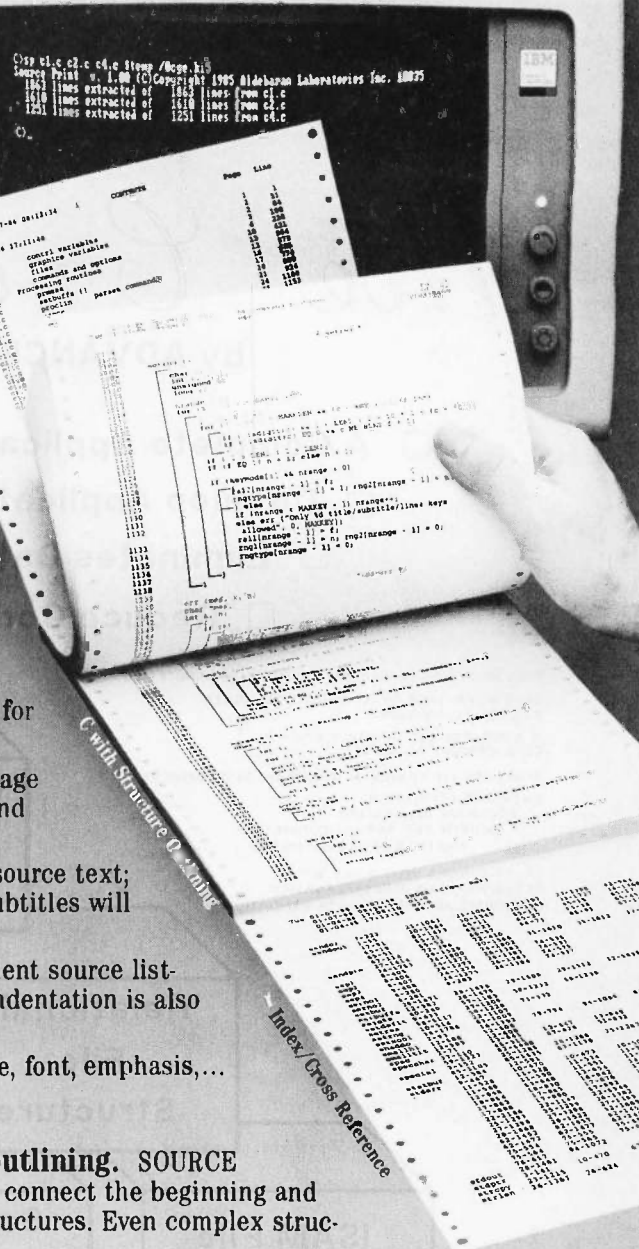

Inquiry 382

**Aldebaran Laboratories Inc.**

Developers of High-speed Professional Software  
3738 Mt. Diablo Blvd., #312  
Lafayette, CA 94549

Call (415) 283-7084 for technical brochure

SOURCE PRINT is a trademark of Aldebaran Laboratories, Inc.

dBASE II, III, & III+ are trademarks of Ashton Tate.



# The Creator™

by ADVANCED DEVELOPMENT TECHNOLOGIES

- A Complete Application Generation Environment
- Develop Applications in Less Time
- Eliminates Database Management Systems
- Reduce Code Requirements by 90 Percent

TURN HOURS OF DEVELOPMENT TIME INTO MINUTES  
TAKE ADVANTAGE OF ADVANCED COMPUTER SCIENCE TECHNIQUES  
A COMPLETE SET OF APPLICATION DEVELOPMENT TOOLS  
MANAGES ALL PHASES OF PROGRAM DEVELOPMENT  
DATABASE DEFINITION  
PROGRAM GENERATION  
SCREEN AND REPORT FORMATION  
MULTIPLE LEVELS OF MENUS  
TRAPS ERRORS INTO A FILE WITH DETAIL ANALYSIS AND EXPLANATION  
PERFORMS AUTOMATIC DATA VALIDATION

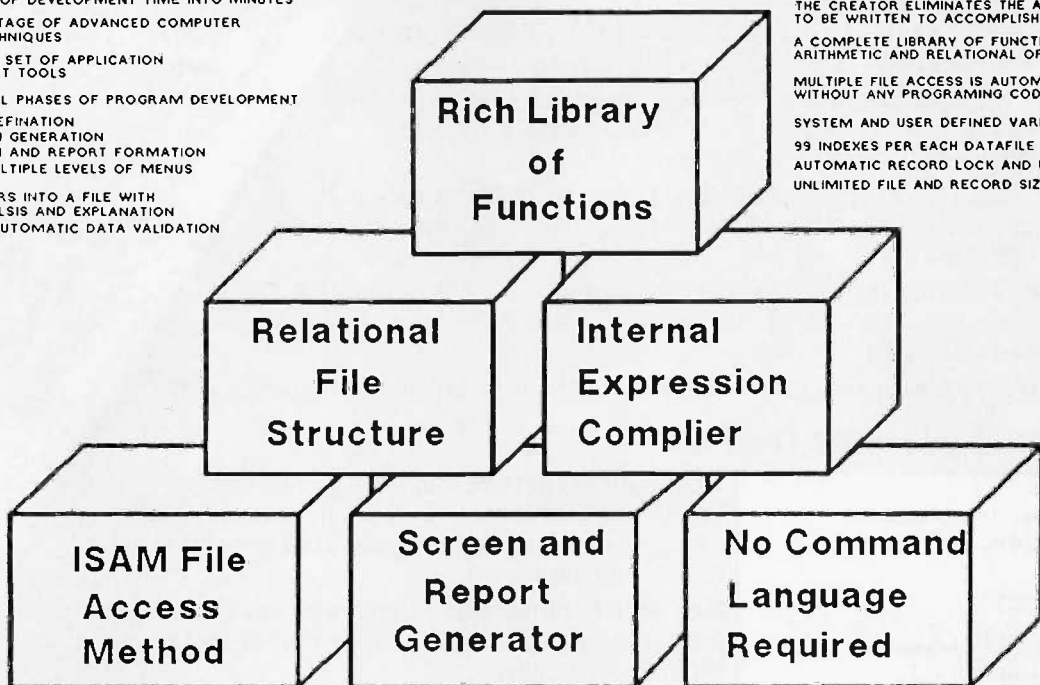

THE CREATOR ELIMINATES THE AMOUNT OF CODE TO BE WRITTEN TO ACCOMPLISH A SPECIFIC TASK  
A COMPLETE LIBRARY OF FUNCTIONS INCLUDING ARITHMETIC AND RELATIONAL OPERATORS  
MULTIPLE FILE ACCESS IS AUTOMATICALLY PROVIDED WITHOUT ANY PROGRAMMING CODE  
SYSTEM AND USER DEFINED VARIABLES AVAILABLE  
99 INDEXES PER EACH DATAFILE  
AUTOMATIC RECORD LOCK AND UNLOCK  
UNLIMITED FILE AND RECORD SIZE

## Complete Development System

Available for the IBM PC, XT and AT

Requires 256K Ram

**\$99**

Includes Unlimited Run Time

Master Card/VISA

Advanced Development Technologies

2720 N 68 St., Suite 5379

**800 528 6600**

Scottsdale, Arizona 85251

EXT. 239

Checks and Money Orders Accepted

(C) The Creator is a trademark of Advanced Development Technologies

## NEW SYSTEMS

**Transportable  
from Bondwell**

The Bondwell 18 is a transportable computer that runs on a 4.77-MHz 8088 microprocessor and is compatible with the IBM PC. It comes with 512K bytes of RAM, two 5¼-inch double-sided double-density floppy-disk drives, a keyboard, and a built-in 9-inch monochrome monitor with a resolution of 640 by 200 pixels.

Also included is an RS-232C and a parallel port, standard 9-pin RGB output and composite color output, a real-time clock, and a 110/220-volt power supply.

The Bondwell 18 comes with MS-DOS 2.11 and GW-BASIC. It weighs 29 pounds and, according to the company, is smaller than comparably equipped transportable computers.

The suggested retail price for the Bondwell 18 is \$1295. For more information, contact Bondwell, 3300 Seldon Court #10, Fremont, CA 94539, (415) 490-4300. Inquiry 564.

**Corona's  
AT-Compatibles**

The Corona ATD is based on an 8-MHz Intel 80286 microprocessor with no wait states and is compatible with the IBM PC AT. The ATD's motherboard also includes a floppy-disk-drive controller, a parallel



The Bondwell 18 transportable computer.

and serial port, a socket for an 80287 floating-point coprocessor, and 640K bytes of RAM.

Three models are available: The ATD-8-Q comes with a 1.2-megabyte floppy-disk drive. The ATD-8-Q20 has a 1.2-megabyte floppy-disk drive, a 20-megabyte hard-disk drive, and an AT-compatible hard-disk controller. The ATD-8-OT40 has a 1.2-megabyte floppy-disk drive, a 40-megabyte hard-disk drive and controller, and a 60-megabyte streaming-tape backup drive.

All models are equipped with a 14-inch monitor with 640- by 400-pixel graphics resolution or 640- by 200-pixel resolution in emulation mode. A color/monochrome graphics card lets you add a color monitor to the system.

Other standard features include four AT-compatible and two PC-compatible expansion slots, a real-time clock/calendar, a 130-watt switch-selectable power supply, and an AT-compatible detachable keyboard. All models come with MS-DOS 3.1 and GW-BASIC 3.1. Suggested list prices are \$3995 for the ATD-8-Q, \$5495 for the ATD-8-Q20, and \$8995 for the ATD-8-OT40. Contact Corona Data Systems Inc., 275 East Hillcrest Dr., Thousand Oaks, CA 91360, (805) 495-5800. Inquiry 565.

**Multuser Computer  
from Eagle**

Eagle Computer's multiuser computer, the Concorde, is compatible with

the IBM PC AT and VME/VMX 32-bit systems. The Concorde is based on an Intel 8-MHz 80286 microprocessor with no wait states. Each processor board comes with 1 megabyte of memory, a keyboard port, color monitor port, and an RS-232C port.

The Concorde runs the Pick operating system and supports up to 16 users. It has 12 AT-compatible and 12 VME-compatible expansion slots for additional processor boards, device controllers, and memory-expansion boards. The system supports most major device controllers, including the IBM PC AT ST506/ST412 and SA400 standards, QIC-02 and QIC-36 tape interfaces, and SMD and SCSI standards. You can install up to eight 5¼- and 8-inch drives in the system cabinet and upgrade the power supply to 1250 watts with add-on modules.

The base model with one 80286 main processor board, 16 serial ports, one 1.2-megabyte 5¼-inch floppy-disk drive, one 140-megabyte (unformatted) hard-disk drive, one 60-megabyte tape-cartridge drive, and the Pick operating system will sell for between \$25,000 and \$30,000. For more information, contact Eagle Computer Inc., 7100 Chapman Ave., Garden Grove, CA 92641, (714) 891-2665. Inquiry 566.

## PERIPHERALS

**Drives  
for the Mac Plus**

LoDOWN recently introduced a series of hard-disk drives and tape backup systems for the Macintosh Plus. Available with storage capacities of 10, 20, 40, or

80 megabytes, the hard-disk drives support Apple's enhanced system software, which provides larger volume sizes, more files per volume, hierarchical file management, and faster speed.

Two tape backup systems are available. A cassette unit uses 22-megabyte tape cartridges, while a standard ¼-inch DC600A unit uses 60-megabyte tape cartridges. Both systems back up or restore a 20-megabyte hard disk in 4 minutes and work

with Apple's Hard Disk 20, LoDOWN's hard disks, General Computer's Hyperdrive, and others.

You can connect up to eight LoDOWN hard disks

(continued)

## PERIPHERALS

and tape backup systems to a Macintosh Plus through the SCSI port on the computer's back panel. The 10-megabyte hard-disk drive costs \$795; the 20-megabyte, \$995; the 40-megabyte, \$1995; and the 80-megabyte, \$3995. The T20 tape backup system is \$895, and the T60 version, \$1795. For more information, contact LoDOWN, POB 5146, Pleasanton, CA 94566, (415) 426-1747.

Inquiry **567**.

### Excelsior RAM-Cache Disk Drives

Computer Products International has introduced the Excelsior line of disk drives, available in hard-disk and removable-cartridge versions, as well as in configurations that include both. The Excelsior drives support up to 48 megabytes of storage on removable cartridges and up to 360 megabytes on hard disks.

Designed to provide greater access speed, the drives use a RAM-cache disk controller incorporating a disk-caching algorithm that stores the most frequently used data in the controller's 256K-byte RAM buffer. The data is subsequently accessed at RAM speeds rather than at disk speeds. The average access time for the hard disk can be as low as 33 milliseconds, and for the removable cartridge, 85 milliseconds; maximum transfer rate is 570K bytes per second.

The Excelsior drives are available with 12 to 360 megabytes of hard-disk capacity and 12 to 48 megabytes of removable-cartridge capacity. Prices start at

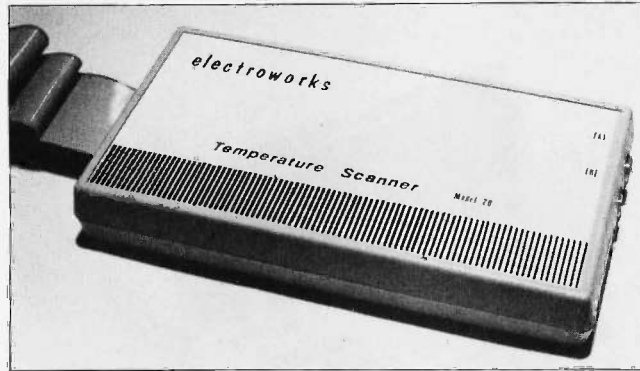

Electroworks' Model 20 Temperature Scanner.

\$1795 for a 12-megabyte hard-disk drive. A 24-megabyte hard-disk and 12-megabyte removable-cartridge system costs \$3495.

The drives are available for the IBM PC and compatibles, NEC APC, Epson QX-10, Victor 9000, Apple, Apricot, and other personal computers. Adapter boards for these computers sell for \$300 each. Contact Computer Products International Inc., 740 South Hillview Dr., Milpitas, CA 95035, (408) 945-0100.

Inquiry **568**.

### Temperature Scanner for Commodores and Apples

Electroworks' Model 20 Temperature Scanner for the Commodore 64 and Apple IIe computers measures temperatures from  $-20^{\circ}\text{C}$  to  $+100^{\circ}\text{C}$  with an accuracy of  $\pm 0.5^{\circ}\text{C}$ . The scanner is equipped with two solid-state temperature sensors and two input channels that are software selectable. You can program the computer to display temperatures in Fahrenheit or

Celsius, record temperatures at predetermined intervals, set audible alarms for high and low limits, and display and record the temperature differential between the two sensors.

The Model 20 scanner sells for \$179. Contact Electroworks, Building One, Brown Rd., Cornell Research Park, Ithaca, NY 14850, (607) 257-1344. Inquiry **569**.

### Sharp's 256-Color Ink-Jet Printer

Sharp's IX-720 color ink-jet printer can produce up to 256 colors and is designed for printing business-presentation graphics, CAD/CAM drawings, and other color images. The IX-720 prints text at 35 characters per second and a full-page 1024- by 1024-dot image in 2.2 minutes. Standard resolution is 120 dots per inch. With graphics software, you can adjust the resolution to produce half-tone images up to  $8\frac{1}{2}$  inches wide.

The IX-720 has four ink cartridges—yellow, cyan, magenta, and black. The printer is equipped with a Centronics parallel interface and an automatic print-head cleaner designed to mini-

mize problems with nozzle clogging. The IX-720 can print images on  $8\frac{1}{2}$ - by 11-inch cut sheets, overhead projector transparencies, and roll paper.

Suggested list price for the IX-720 is \$1495. For more information, contact Sharp Electronics Corp., Systems Division, 10 Sharp Plaza, Paramus, NJ 07652, (201) 599-3856.

Inquiry **570**.

### High-Speed Dot-Matrix Printer

The NP-2410 dot-matrix printer from Nissho Information Systems produces near-letter-quality text at 180 characters per second (cps) and draft-quality text at 300 to 540 cps, depending on pitch. The printer comes with a modular RS-232C or Centronics parallel interface and emulates the Epson LQ-1500 printer. Standard features include a 6K-byte buffer, friction feed, rear and bottom feed, and single-sheet feed.

The NP-2410 has three resident letter-quality fonts—Courier, Letter Gothic, and Century—and four resident draft-quality fonts. You can supplement these with additional fonts, including Prestige, Script, and OCR A and B, available on cartridges.

With a standard modular interface, the NP-2410 sells for \$1845. An optional 48K-byte buffered interface costs an additional \$150. Font cartridges cost \$60 each. Contact Nissho Information Systems, 3838 Carson St., Suite 105, Torrance, CA 90503, (213) 543-1885. Inquiry **571**.

(continued)

# Avocet turns an ordinary PC into an extraordinary development system. And saves you \$20,000 in the process.

Now, there's a way to see all your best microprocessor designs take root, easily and effectively. Avocet cross-assemblers, simulators,

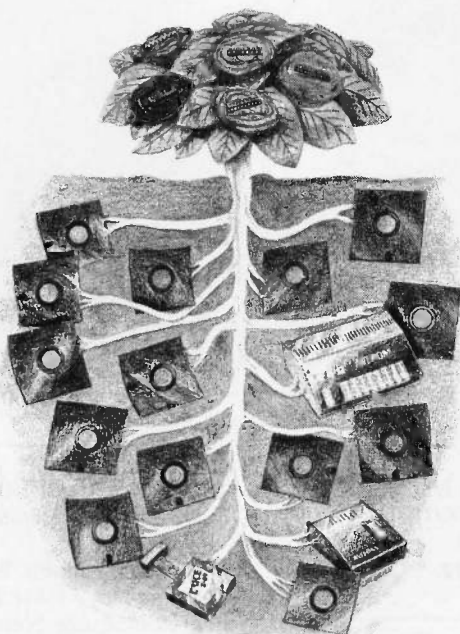

## THE AVOCET CROSS-ASSEMBLER FAMILY.

Avocet Cross-assembler	Target Micro-processor	CP/M*-80	IBM PC, MSDOS**
XASMO4	6804	\$250.00	\$250.00
XASMO5	6805	200.00	250.00
XASMO9	6809	200.00	250.00
XASM18	1802/1805	200.00	250.00
XASM48	8048/8041	200.00	250.00
XASM51	8051	200.00	250.00
XASM65	6502/65C02	200.00	250.00
XASM68	6800/01,6301	200.00	250.00
XASM75	NEC 7500	500.00	500.00
XASM85	8085	250.00	250.00
XASM400	COP400	300.00	300.00
XASMF8	F8/3870	300.00	300.00
XASMZ8	Z8	200.00	250.00
XASMZ80	Z80	250.00	250.00
XASM6811	68HC11	250.00	250.00
XASM180	HD64180	250.00	250.00
XMAC682	68200	595.00	595.00
XMAC68K	68000/68010	595.00	595.00

\* Trademark of Digital Research  
\*\* Trademark of Microsoft

emulators and EPROM programmers turn your personal computer into a sophisticated development system. No more waiting for the continually overloaded main-frame. Or, wondering how to pay for a \$20,000 dedicated development system. Avocet products save time and money, and provide the most flexible development system available.

Avocet allows you to develop software for practically any microprocessor without switching development systems. And equally important, Avocet development tools are easy to install and easy to use. We provide you with everything you need to develop microprocessor software, from data entry through assembly, debugging and final EPROMs.

## Now "debug" on your PC.

Avocet has realistic answers for users who want low cost debugging capability. Until now, engineers have been very much on their own in the area of testing. But now Avocet simulators



and emulators virtually eliminate the frustrating and often costly "crash and burn" method.

## New AVSIM family of full screen simulators.

Avocet's new software simulator/debuggers let you test your code in a crashproof, interactive environment, without additional hardware. Your PC's screen becomes a "window" into the simulated target CPU. Extensive break point, I/O, and interrupt facilities make AVSIM a truly useful development tool. Price \$299.

## New TRICE in-circuit emulator.

At last, an affordable in-circuit

emulator! With the self-powered TRICE, you can examine target memory and register, set break points, single-step, trace and more; TRICE recognizes 34 different commands. Its serial interface lets you control emulation and download code from your terminal or PC. Priced from \$498.

## AVPROM programmers work with any PC.

The AVPROMs program over 37 different devices, including EPROMs through 27512, CMOS and E<sup>2</sup> PROMS, and MPU/EPROM combos, using fast "adaptive" algorithms. Intelligent, self-contained units work with any personal computer, using Avocet's GDx driver software... from \$429. Gang programmers from \$979.

To find out more about Avocet software development tools and accessories, call us toll-free:

# 1-800-448-8500

(In the U.S. except Alaska and Hawaii.)

VISA and Mastercard accepted. Most popular disc formats now available—please specify. Shipping and handling additional—call for exact quotes. OEM INQUIRIES INVITED. Avocet Systems Inc., P.O. Box 490-B9, Rockport, Maine 04856, (207) 236-9055. Telex: 467210 AVOCET CI.

# AVOCET SYSTEMS INC.®

## PERIPHERALS

**Portable Optical-Disk Drive for PCs**

The BackPac BP-100+ from Portable Solutions is a portable optical-disk drive for IBM PC, XT, AT, and compatible computers. The drive reads removable, write-once laser disks with a minimum of 115 megabytes of formatted storage capacity. The drive's read-data rate is 10 megabytes per minute, and its data-transfer rate is 2.5 megabits per second. The average access time is less than 200 milliseconds, and the read error rate is 1 bit per  $10^{12}$ .

The BP-100+, which weighs 7 pounds, comes with three laser disks, each of which is encased in a hard plastic cartridge equipped with a built-in write-protect switch. The drive also comes with three Adaptacon plug-in boards, which provide power and interface connections for three computers and fit into short expansion slots. The BP-100+ is bundled with Survival software, a collection of utilities for backing up and restoring files.

The drive sells for \$4995. Additional LitePac 330 optical disks cost \$100 each, and additional Adaptacon boards cost \$99 each. For more information, contact Portable Solutions Inc., 1701

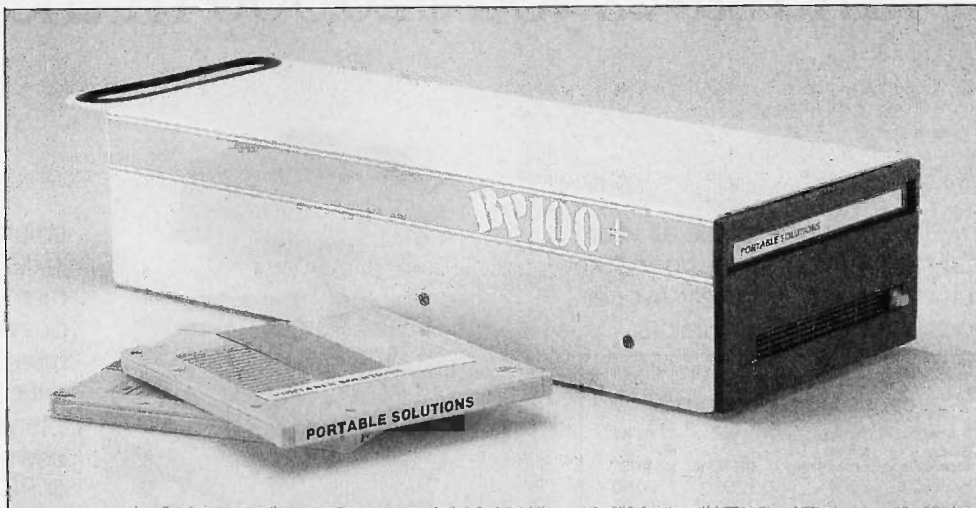

The BackPac BP-100+ portable optical-disk drive.

Directors Blvd., Suite 250, Austin, TX 78744, (512) 448-4965. Inquiry 572.

**Tempest-Certified Printers**

Tempest Technologies has introduced daisy-wheel and line printers that meet the U.S. Government's Tempest security standards.

The DWP5155SQ daisy-wheel printer, which operates at 45 characters per second, costs \$4500. Two line printers are available: The LPM5300XQ, a 300-line-per-minute model, costs \$9950; the 600-line-per-minute

LPF5600XQ is \$11,500. All three printers operate at less than 55 decibels.

Contact Tempest Technologies Inc., 11411 Isaac Newton Square South, Reston, VA 22090, (703) 471-0157. Inquiry 573.

**Low-Cost Modem with Phone**

The JC-1200A is a 1200-bps modem from Theall Engineering that includes a built-in telephone for voice communications. The unit's tone-sensing circuit detects carrier and voice signals and automati-

cally passes the signals to the computer or phone. The JC-1200A is Hayes-compatible and features auto-dial, auto-answer, auto-redial, and compatibility with Bell 103 and 212A standards.

The unit has a built-in speaker and clock/calendar that lets you track the length of calls on screen. Battery backup stores the time and phone numbers while the power is off.

The JC-1200A connects to computers through an RS-232C port and costs \$289.95. Contact Theall Engineering Co., POB 167, Oxford, PA 19363, (215) 932-3488. Inquiry 574.

## ADD-INS

**Data-Acquisition Board from Data Translation**

Data Translation's DT2821-F is a data-acquisition board compatible with the IBM PC AT. The board is designed for waveform, vibration, speech, particle analysis, and other applications that require high-

speed data acquisition. It has an A/D rate of 130 kHz and provides 12-bit resolution for 16 single-ended or 8 differential analog inputs, programmable gain, a programmable clock, and support for interrupts and DMA transfers. Sixteen digital I/O lines are standard.

A/D sampling is controlled

by a channel-gain list RAM that lets you sample input channels in any sequence and at any gain. The board uses two DMA channels on the IBM PC AT and switches between the two to provide continuous performance. Analog output is provided by two 12-bit independent deglitched digital-to-analog converters with a throughput of 130 kHz each.

The optional ATLAB software package contains a library of subroutines designed for the DT2821-F. List price for the board is \$1595; ATLAB costs \$449. Contact Data Translation Inc., 100 Locke Dr., Marlboro, MA 01752, (617) 481-3700. Inquiry 575.

(continued)



# Atari Explodes

Atari's new computer serious threat to Macintosh. Will the Amiga survive?

By Joseph Sugarman

Imagine this. If I could offer you a Macintosh computer—a computer that sells for over \$2000—for one third the price, you might wonder.

But what if I offered you a better computer with none of the disadvantages of the Mac and what if I added new features which improved its speed and performance? That's exactly what Atari has done in an effort to grab the ball from Apple and really explode into the personal computer market.

## HEADING EFFORT

Heading the effort at Atari is Jack Tramiel—the same man who built Commodore into a billion dollar corporation, sold more computers than any other man in the world and believes in giving the consumer incredible value without sacrificing quality. The new Atari is a perfect example.

First, let's compare the new Atari ST to the Macintosh and the Commodore Amiga. Sorry IBM, we can't compare the ST to your PC because yours is almost five years old, much slower, and, in my judgement, over priced.

**Price** The cheapest you can get the Macintosh with 512K of memory is \$1800 with a one-button mouse, a disk drive and a monochrome monitor. The Amiga sells for \$1995 with a two-button mouse, a disk drive and a color monitor. The Atari ST sells for \$699 with a two-button mouse, a disk drive and a monochrome monitor and for \$200 more, a color monitor. Read on.

**Monitor** With the Mac you can only use its 9" monochrome monitor and with the Amiga you can only use its 12" color monitor. With the ST you have a choice of either a 12" monochrome or high-resolution color monitor or your own TV set.

**Resolution** The number of pixels or tiny dots on a screen determine the sharpness of a computer monitor. The Mac has 175,104 pixels and has one of the sharpest screens in the industry. The Atari ST has 256,000 pixels or almost a third more than the Mac. And the Atari color monitor compared to the Amiga in its non interlace mode is 128,000 pixels or exactly the same.

**Power** All the computers have a 512K memory with a 68000 CPU operating with a 32-bit internal architecture. But Atari uses four advanced custom chips which cause the CPU to run faster and more efficiently giving it some tremendous advantages. For example, it has a faster clock speed of 8Mhz com-

pared to the Mac's 7.83 and the Amiga's 7.16. And the speed of the unit is hardly affected by the memory requirements of the monitor which in the Amiga can eat up much as 70% of the unit's cycle time or speed.

**Keyboard** This is the part I love. The Mac has a small 59-key keyboard and a mouse. That's all. The 95-key Atari has both a mouse, cursor keys, a numeric keypad and ten function keys. The keyboard looks fantastic and is easy to type on. Although the 89-key Amiga has almost all the features of the Atari keyboard, it looks like a toy in comparison. (Sorry Commodore, but that's my opinion.)

**Disk Drive** The Mac's 3½" disk drives run at variable speeds—slowing down as they run. The Atari 3½" drives run faster at a constant speed—and quieter than any other unit.

**Features** The Atari ST comes equipped with the same printer and modem ports as the IBM PC—a parallel and RS232C serial port. The Mac comes only with a tiny non-standard serial and modem port. The ST has a hard disk interface capable of receiving 10 million bits per second. There are two joy stick ports and a 128K cartridge port for smaller programs or games. It has 512 colors (for the color monitor), it has a unique MIDI interface into which you can plug your music synthesizer and record or play back your music.

**Software** Right now, the Mac has more than the Atari ST and the Amiga combined. The Atari is a new system but the track record of Atari's Jack Tramiel and the potential of the new unit is causing a flood of new software titles. In fact, I'll predict that eventually the Atari will have more software than the Mac. There are now hundreds of titles, from word processing to spread sheet programs, from graphics and games to data base management—all with those easy drop-down menus and windows. There's plenty from which to select now and plenty more to come.

If you think I'm enthusiastic over the ST, listen to what the press is saying. *Creative Computing* exclaimed, "Without question, the most advanced, most powerful micro computer your money can buy." and finally, the Atari ST is the best selling computer in Europe and acclaimed, "The computer of the year," by the European personal computer press.

I am going to make the ST so easy to test in your home or office that it would be a shame if you did not take advantage of my offer. First, I will offer the computer itself for only \$299. You will need, in addition, either

one or two disk drives and either an Atari monochrome or color monitor or your own TV. If you order with your credit card during our introduction I will ship your order and only bill you for the postage and 1/3 the purchase price. I will also add a few software packages free including "Logo"—a beginners programming language, a disk for programming in BASIC and Neochrome—a graphics paint program.

## COMPARE THE TWO

After you receive the Atari ST, put it next to your Mac or Amiga or even IBM. See how extremely sharp the graphics appear, discover what a perfect word processor it is, how great the keyboard feels and finally how much faster and quieter it runs.

If you're not convinced that the Atari is far superior to your present computer and a fantastic value, simply return it and I'll refund your modest down payment plus our postage and handling charges. If you decide to keep it, I'll bill your credit card account for the remaining balance and enroll you in our discount software club (a \$50 value) that lets you buy software for up to 50% off the retail price.

But act fast. We have only 2,000 units and 1,000 free memberships that we will offer as part of this introductory program and we are certain they will go fast. Order today.

To order, credit card holders call toll free and ask for product by number (shown in parentheses). Please add \$20 per order for postage and handling. (If you pay by check, you must pay the full amount but we will provide you with a bonus software package.)

ST Keyboard & CPU (4060BY) . . . . .	<b>\$299</b>
Disk Drive (4056BY) . . . . .	<b>199</b>
Monochrome Monitor (4057BY) . . . . .	<b>199</b>
RGB Color Monitor (4058BY) . . . . .	<b>399</b>

Note: A list of software will come with the unit. IBM is a registered trademark of International Business Machines Corp. Commodore & Amiga are trademarks of Commodore Electronics LTD. Apple & Macintosh are trademarks of Apple Computer, Inc. Atari, ST & Logo are trademarks of Atari Corp.

**JS&A** PRODUCTS  
THAT THINK

One JS&A Plaza  
Northbrook, Illinois 60062  
**CALL TOLL FREE 800 228-5000**  
IL residents add 7% sales tax. ©JS&A Group, Inc., 1986/1986

## ADD-INS

**CMS's Internal Hard Disks**

CMS has introduced the Drive Plus 20-megabyte internal hard-disk drives for the IBM PC XT and compatible computers. Several models of the disk drives are available: One version has an SCSI, the second has an ST506 interface, and the third has an ST506 interface and is ruggedized for use with portable computers.

Each Drive Plus fits in a full-sized expansion slot in the IBM PC XT. The ST506 models have a data-transfer rate of 5 megabits per second, and the SCSI model, 7.5 megabits per second. The drives will also run in the IBM PC and compatibles with upgraded power supplies.

Suggested list prices are \$995 for the standard ST506 drive; \$1159 for the ruggedized ST506 drive; and \$1239 for the SCSI drive. Prices include adapter boards and controllers. For more information, contact CMS Inc., 401-B West Dyer Rd., Santa Ana, CA 92707, (714) 549-9111. Inquiry 576.

**MDL-22 Data Logger**

The MDL-22 plug-in board for the IBM PC and compatible computers lets you monitor, control, and report real-time events. The board also works as a stand-alone data logger. Standard features include 22 8-bit analog inputs, 16 digital I/O lines, a DB-25 serial port for RS-232C or 20-mA current loop communications, a DB-25 parallel port, and a battery-backed clock. A piggyback switching power supply and 40-column printer are optional.

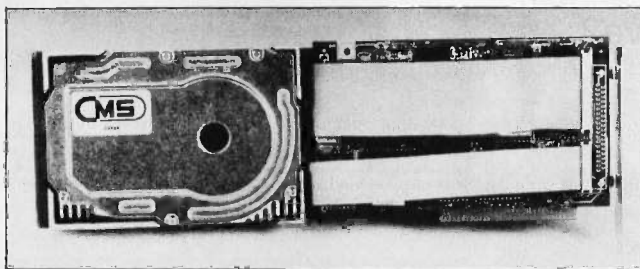

Drive Plus 20-megabyte internal hard-disk drive.

The MDL-22 sells for \$159. The optional power supply is \$45. For more information, contact The Automation Group Inc., 848-0 Nandino Blvd., Lexington, KY 40511, (606) 252-6753. Inquiry 577.

**Chromatography Board for the IBM PC**

MetaByte's CHROM-1 is a data-acquisition board that plugs into an expansion slot inside the IBM PC. The board has four software-selectable input ranges, a +1.000 volt reference for calibration, two software-selectable input channels, and 1000 volts of optical isolation. It also has four opto-coupled digital inputs and two double-throw, double-pole relay outputs.

The CHROM-1 board comes with a data-acquisition and display software package with no analysis capabilities. The software lets you set sample rate, test duration, input range, and other functions from a menu, and it can create ASCII files that you can download to other software for analysis. The optional CHROM+ software package provides a results report

with peak area, peak start, peak end, peak maxima, and other factors.

The CHROM-1 board costs \$595; the CHROM+ software costs \$995. For more information, contact Meta-Byte Corp., 254 Tosca Dr., Stoughton, MA 02072, (617) 344-1990. Inquiry 578.

**Smartek Board Plugs into IBM PC AT**

The Smartek 1 Mega Byte System Board is based on an Intel 6-MHz 80286 microprocessor that also operates at either 8 or 10 MHz. The board comes with 1 megabyte of parity-checked RAM, eight expansion slots, a socket for an 80287 math coprocessor, three programmable counter/timers, 7-channel DMA, and 16 levels of system interrupts.

The 12- by 13.8-inch board can be mounted in the PC AT or compatible chassis and, according to the company, is fully compatible with the PC AT. No selection jumpers are required for system configuration.

The Smartek-1 runs at 6 or 8 MHz and costs \$1295; the Smartek-2, which runs at 6 or 10 MHz, costs \$1495. Both boards are also available with no-wait-state mem-

ory for an additional \$300. For more information, contact Smartek Inc., 2000 Wyatt Dr., Suite 3, Santa Clara, CA 95054, (408) 988-4112. Inquiry 579.

**Image Digitizer from Genoa Systems**

The Capture plug-in board from Genoa Systems is an image digitizer for the IBM PC, XT, AT, and compatible computers. The board captures an image from a standard RS-170 video input, such as a camera, and stores the captured frame in on-board memory. You can simultaneously display the image on a monitor or print it on a standard graphics printer.

You can use the software bundled with the board to enhance the image by editing, binary thresholding, and filtering. Other capabilities include zoom, text on overlay, selective shading, cutting, and combining with previous pictures.

The Capture board supports a display resolution of 512 by 512 pixels with 64 colors. The digitization rate is 1/30 second per frame. An output table of four 256K by 8-bit hookup tables is standard. Options include piggyback boards for memory expansion, pseudocolor display, and an RGB hookup table of three 256K by 8 bits.

The board's suggested retail price is \$1495. Contact Genoa Systems Corp., 73 East Trimble Rd., San Jose, CA 95131, (408) 945-9720. Inquiry 580.

(continued)

# MICROWAY'S 8087 RUNS 1-2-3™!

MicroWay is the world's leading retailer of 8087s and high performance PC upgrades. We stock a complete selection of 8087s that run at 5 and 8mhz. All of our coprocessors are shipped with a diagnostic disk and the best warranty in the business - one year! We also offer daughterboards for socketless computers such as the NEC PC, and a board which increases the clock speed of the 80287 from 4 to 8 mhz. Our NUMBER SMASHER™ includes 512K ram. It will run the IBM PC at clock speeds up to 10mhz and achieves a throughput of .1 megaflops with

87BASIC/INLINE, Intel Fortran, or Microsoft Fortran. Software reviewers consistently cite MicroWay software and 8087 expertise as the best in the industry! Our customers frequently write to thank us for recommending the correct software and hardware to meet their specific needs. They also thank us for our same day shipping! In addition to our own products which support the 8087 and 80287, we stock the largest supply of specialized software available. For information call us at

**617-746-7341**

**FASTBREAK™** employs the 8087 to increase the speed of Lotus 1-2-3™ Version 1A or 1A\* by up to 36 to 1. . . **\$79**  
**FASTPAK™** includes FASTBREAK software and a 5mhz 8087 . . . . . **\$179**  
**87SFL™** - MicroWay's Scientific Function Library contains 170 scientific and engineering functions ranging from simple trigonometrics to Kelvin, Airy, Ellipticals, Integrals, Bessel, Weierstrass, Polynomials and Probabilities. It is callable from most 8087 compatible compilers.

First Language . . . . . **\$250**  
 Additional Languages . . . . . each **\$100**

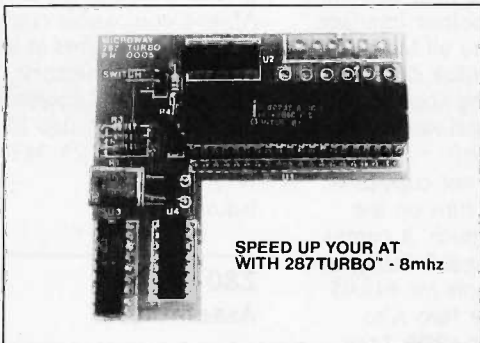

SPEED UP YOUR AT WITH 287TURBO™ - 8mhz

## MicroWay® 8087 Support

For the IBM PC, PC XT, PC AT and Compatibles.

**NUMBER SMASHER™** The World's Fastest Accelerator Card for the IBM PC, XT, and Compatibles! Includes an 8086 and 8087 pair tested to 10mhz, and 512K bytes of high speed ram. Compatible with all software, operating systems and hardware! Your program speed is increased by a factor of 2.5 to 4.0. Floating point programs run up to 2.8 times faster on the PC than on an 80287 equipped PC AT. . . . . **\$1049**

**MATRIXPAK™** manages a **MEGABYTE!** Written in assembly language, our runtime package accurately manipulates large matrices at very fast speeds. Includes matrix inversion and the solution of simultaneous linear equations. Callable from MS Fortran 3.3, MS Assembler, and 87BASIC/INLINE. . . . . each **\$99**

**87FFT™** Written in assembly language, performs Forward and Inverse FFTs on real and complex arrays which occupy up to 512K bytes of RAM. Also does convolutions, auto correlations, hamming, complex vector multiplication, and complex to radial conversions. Callable from MS Fortran, 87MACRO, C, TURBO PASCAL or 87BASIC/INLINE. . . . . **\$200**

**87FFT-2™** performs two-dimensional FFTs. Ideal for image processing. Requires 87FFT **\$100**

### GRAPHICS PACKAGES

Grafmatic for Fortran or Pascal. . . . . **\$125**  
 Plotmatic for Grafmatic. . . . . **\$125**  
 MultiHalo (one language) . . . . . **\$189**

**DFixer™** - A disk utility which thoroughly checks PC or AT hard disks for bad sectors and updates the MS DOS file allocation table accordingly. . . . . **\$149**

**A2D-160™** - MicroWay's Data Acquisition Board performs 160,000 12 bit Analog to Digital conversions per second! Includes software drivers. The fastest 12 bit A to D board available. For the IBM PC or XT. . . . . **\$1295**

**87BASIC/INLINE™** converts the output of the IBM Basic Compiler into optimized 8087 inline code which executes up to seven times faster than 87BASIC. Supports separately compiled inline subroutines which are located in their own segments and can contain up to 64K bytes of code. This allows programs greater than 128K! Requires the IBM Basic Compiler and Macro Assembler. Includes 87BASIC. . . . . **\$200**

**87BASIC™** includes patches to the IBM Basic or MS Quick Basic Compiler for USER TRANS-PARENT 8087 support. Provides super fast performance for all numeric operations including trigonometrics, transcendental, addition, subtraction, multiplication, and division. . . . . each **\$150**

**87MACRO/DEBUG™** - contains all the pieces needed for writing 8087/80287 assembly code including 8087 macros, object libraries for commonly used functions, including transcendental, trigonometrics and conversions between strings and real numbers. Our 87DEBUG completes the package. . . . . **\$199**

**OBJ→ASM™** - a multipass object module translator and disassembler. Produces assembly language listings which include public symbols, external symbols, and labels commented with cross references. Ideal for patching object modules for which source is not available. . . . . **\$200**

### RTOS - REAL TIME OPERATING SYSTEM

RTOS is a multi-user, multi-tasking real time operating system. It includes a configured version of Intel's iRMX-86, LINK-86, LOC-86, LIB-86, OH-86, and MicroWay's 87DEBUG. Runs on the IBM-PC, XT, PC-AT and COMPAQ. . . . . **\$400**

### INTEL COMPILERS

FORTTRAN-86 . . . . . **\$750**  
 PASCAL-86 . . . . . **\$750**  
 PL/M-86 . . . . . **\$500**  
 ASM-86 . . . . . **\$200**

All MicroWay product names are trademarks of MicroWay, Inc. Manufacturers' product names are trademarks of individual manufacturers.

**8087 5mhz** . . . . . **\$109**  
 Including DIAGNOSTICS and one-year warranty For IBM PC and compatibles.

**8087-3 5mhz** . . . . . **\$175**  
 For the Tandy 1200.

**8087-2 8mhz** . . . . . **\$175**  
 For Wang, AT&T, DeskPro, NEC, Leading Edge.

**80287-3 5mhz** . . . . . **\$199**  
 For the IBM PC AT and Compaq DeskPro 286.

**80287-8 8mhz** . . . . . **\$295**  
 For 8mhz sockets.

**287Turbo™ 8 mhz** . . . . . **\$395**  
 With Reset and Diagnostics for IBM PC AT.

**88Turbo™** . . . . . **\$195**  
 For the IBM PC and XT.

**64K RAM Set 150ns** . . . . . **\$9**

**256K RAM Set 150ns** . . . . . **\$29**

**256K RAM Set 120ns** . . . . . **\$39**

**128K RAM Set PC AT** . . . . . **\$89**

JRAM, MAYNARD, V20, V30 . . . . . CALL

### COMPILERS and UTILITIES

Microsoft Fortran Version 3.31 . . . . . **\$209**  
 IBM Professional Fortran . . . . . **565**  
 Ryan-McFarland Fortran . . . . . **399**  
 FORLIB+ or STRINGS and THINGS. . . . . **65**  
 Lattice C . . . . . **269**  
 Microsoft C. . . . . **299**  
 FLOAT87 . . . . . **150**  
 IBM Basic Compiler Version 2.0 . . . . . **465**  
 Microsoft Quick Basic . . . . . **89**  
 Summit BetterBASIC™ . . . . . **175**  
 True Basic. . . . . **105**  
 IBM Assembler with Librarian V. 2.0 . . . . . **155**  
 Microsoft Assembler Version 3.01 . . . . . **99**  
 Microsoft Pascal Version 3.31 . . . . . **199**  
 Borland Turbo with 8087 Support. . . . . **85**  
 STSC APL★PLUS/PC. . . . . **450**  
 STATGRAPHICS. . . . . **595**  
 COSMOS Revelation. . . . . **750**  
 Phoenix PLink86. . . . . **295**  
 SPSS/PC+ . . . . . **595**  
 SPSS ADVANCED STATISTICS . . . . . **275**  
 SPSS TABLES . . . . . **275**  
 EPSILON Text Editor. . . . . **195**  
 LABTECH NOTEBOOK. . . . . **CALL**

European Customers: Please call MicroWay in London at 01-223-7662.

**MicroWay**  
 P.O. Box 79  
 Kingston, Mass.  
 02364 USA  
 (617) 746-7341

**The World Leader  
in 8087 Support!**

**Multitasking for C**

**M**ulti-C is a library of C and assembly-language functions from Cytek that let you incorporate multitasking within programs. Designated functions become tasks that can schedule other tasks, communicate with each other using queues and flags, and use almost all standard C functions. The software supports interrupt handlers.

Multi-C is available for Lattice's and Computer Innovations' 8086 C compilers and Paragon's Z80 C cross compiler. The software runs on the IBM PC and compatible computers and sells for \$149. For more information, contact Cytek Inc., 805 Turnpike St., Unit 202, North Andover, MA 01845, (617) 687-8086. Inquiry **581**.

**Fundamental BASIC from Philon**

**H**enry's Fundamental BASIC is a simplified version of BASIC from Philon. It includes such features as a library of predefined functions; multiple-line, user-defined functions; support for a math coprocessor; double-precision math; and some FORTRAN functions. You can also call text editors and system utilities from within the interpreter.

Henry's Fundamental BASIC is a subset of Philon Fast/BASIC-M, a more advanced compiler. Priced at \$49, versions are currently available for the IBM PC and compatibles, Atari 520ST, and Commodore Amiga. A minimum of 128K bytes of memory is required. Contact Philon Inc., 641 Avenue of

the Americas, New York, NY 10011, (212) 807-0303. Inquiry **582**.

**Program Generator for Turbo Pascal**

**Z**eus, a program generator from JMC Research, works with Borland International's Turbo Pascal to let you generate database programs, write reports, and build menus. You build a menu-driven database program by drawing the input screen layout and naming the variables and their types. With minimum system requirements, you can build programs with a maximum of 300 fields per record and 80 characters per field.

The program includes a similar utility for writing reports. The menu builder lets you input multiple programs to execute with a single keystroke. These programs need not be written in Pascal.

Zeus runs on IBM PCs and compatibles, requires a minimum of 128K bytes of RAM and an RGB monitor, and costs \$59.95. A hard-disk drive is recommended. Contact JMC Research Inc., 803 Eisenhower Dr., Augusta, GA 30904, (404) 736-8265. Inquiry **583**.

**Multitasking FORTH for the Mac**

**D**esigned for developing multitasking Macintosh applications, MachI from Palo Alto Shipping is a 32-bit version of FORTH-83 that the company claims is twice as fast as other

FORTH applications. The program uses local variables and named input parameters for recursion, a standard Motorola assembler, a symbolic debugger, and normal text files from any editor, including MacWrite.

Other features include the 80-bit SANE floating-point library, a Toolbox interface for access to all Macintosh traps, MacinTalk drivers for programming speech, vectored I/O, and loading from the clipboard.

MachI is not copy-protected and runs on the 512K Macintosh. It comes with the latest Switcher and Edit programs for \$49.95. Contact The Palo Alto Shipping Co., POB 7430, Menlo Park, CA 94026, (415) 854-7994. Inquiry **584**.

**Structured Printing Aid**

**A**ldebaran Laboratories' Source Print is a utility program that formats printouts of source code written in C, Pascal, BASIC, and dBASE II and III. Designed to show a program's structure at a glance, Source Print draws lines that indicate nesting, indents the code based on nesting levels, and prints reserved words in boldface type.

Source Print's "library" function lets you insert titles and subtitles in a source file, usually within comment statements. The program tracks which file contains which subtitle and lets you select up to 40 subtitled functions or procedures from 1 to 16 files to form a

new source file. The program also prints page headings that can include the filename, date and time, titles, subtitles, and page numbers. You can use these headings to print only the parts of files you designate.

Source Print sells for \$97. It runs on the IBM PC, XT, AT, and compatible computers and requires at least 128K bytes of memory. Contact Aldebaran Laboratories Inc., 3738 Mt. Diablo Blvd., #312, Lafayette, CA 94549, (415) 283-7084. Inquiry **585**.

**Z80 Cross Assemblers**

**T**wo programs for assembling Z80 code on an IBM PC are available from United States Software Corp. AX Z-80, an absolute version, translates an assembly-language source file to a downloadable object file in Intel hexadecimal format. RX Z-80, a relocatable version with a linker, translates an assembly-language source file to a relocatable file. You can then link the file with other relocatable files to form a downloadable object file in Intel hexadecimal format.

Both versions of the cross assembler include pseudops, conditional assembly, and cross-reference tables. Both run on the IBM PC, XT, AT, and compatibles with 64K bytes of memory. The absolute version costs \$250, and the relocatable version with linker is \$400. Contact United States Software Corp., 5470 Northwest Innisbrook Place, Portland, OR 97229, (503) 645-5043. Inquiry **586**.

(continued)

# The Conference That Takes A Hard Look At The Business Side Of Software.

*The Software Business Conference April 2 & 3, Los Angeles, California*

This prestigious conference, held in conjunction with COMDEX/Winter, will provide a forum for developers, publishers and resellers of software to discuss common interests, challenges, and solutions.

*The Software Business Conference* will also create an environment in which to discuss and establish new business relationships.

By bringing the three main bodies of the software industry together at one major conference, the Software Business Conference proposes to raise the visibility of software issues worldwide, and to assist in bringing high quality products to the market.

To ensure that the Conference meets its goals and is relevant to your interests, these and other noted distinguished industry leaders are helping to shape this major event: Joel Berez, President, Infocom, Inc.; Daniel Bricklin, President, Software Garden, Inc.; Seymour Rubenstein, President, MicroPro International Corp.; Gary Kildall, President, ActiVenture Corp.

## *Software Business Conference Schedule*

### **Plenary Sessions**

A Marriage of Objectives; Keeping Pace with a Changing PC Environment.

### **Marketing Sessions**

What's Selling? The Software Marketplace; Who's Buying? Applications and Users.

### **General Sessions**

Managing the Successful Software Company; Software Development Technical Strategies; Software Development Management Strategies; Exploiting the New Software Product; Supporting the New Software Product; The Great Code Rush; Prospecting for New Packages

### **Workshops in Software Entrepreneurship**

Workshop in Creative Financing; Workshop in Creative Marketing and Selling

To be part of this exciting business and learning experience, send today for complete registration information.

---

Yes, I Want To Take A Hard Look At Software, Too.  
Send Me Detailed Information.

Name \_\_\_\_\_

Address \_\_\_\_\_

City/State/Zip \_\_\_\_\_

Phone \_\_\_\_\_

I'm a  Developer  Publisher  Reseller  Other

Mail to: Software Business Conference  
300 First Avenue  
Needham, MA 02194

---

Presented by



*The world's leading producer of computer and communications conferences and expositions.*

300 First Avenue, Needham, MA 02194

© Copyright 1986

## Timing Verifier for Circuit Designs

Case Technology has introduced the Case Timing Verifier (CT2600) for the IBM PC AT. Based on the original Scald timing verifier developed at Lawrence Livermore Laboratories, the program performs worst-case timing verification. It checks for all timing errors that might occur through the full range of a circuit's delays and generates waveforms displayed on screen that indicate a logic design's worst-case timing parameters.

The program verifies partial and completed designs and detects setup and hold errors, race conditions, minimum pulse width errors, and clock glitches. It accepts values for wiring delays generated by Case's PCB layout program and can reveal timing problems in the physical PCB layout.

The Case CT2600 Timing Verifier for the PC AT costs \$3500. For more information, contact Case Technology Inc., 633 Menlo Ave., Suite 250, Menlo Park, CA 94025, (415) 322-4057. Inquiry **587**.

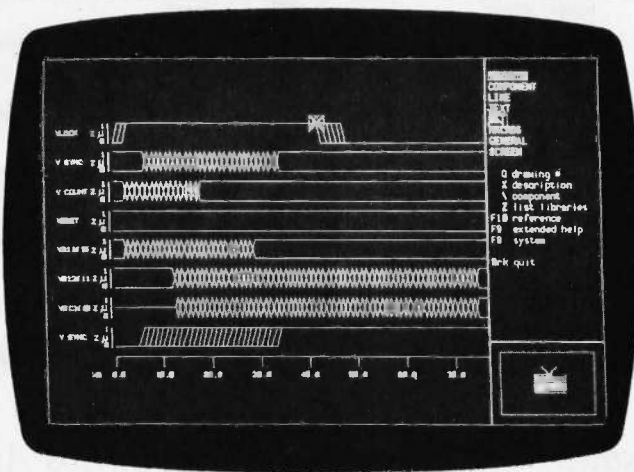

The Case CT2600 Timing Verifier.

## Tool for Scientific and Engineering Calculations

Calculus, from A I Ware, is a calculator program that features mathematical functions commonly used in scientific and engineering calculations.

Among the software's features are Bessel functions, polynomial-root calculations, matrix operations, and memory-management commands. The program supports real and complex numbers in most mathe-

matical functions. It operates in a simple calculator mode as well as in an advanced mode that, the company says, uses a command structure similar to that in spreadsheets.

Calculus costs \$99. It runs on the IBM PC, XT, AT, and compatibles. The program requires 192K bytes of memory and an 8087 or 80287 math coprocessor.

For more information, contact A I Ware Inc., POB 367, Rosemead, CA 91770, (818) 446-0998. Inquiry **588**.

## Structural Analysis and Design

Innovative Analysis's Larsa is a structural analysis and design program for engineers and architects. The software analyzes two- and three-dimensional structures such as buildings, bridges, towers, and most other conventional structures. It performs static and dynamic linear and static nonlinear analysis and lets you study displacements, stresses, and forces.

The software includes modules for data entry, editing, analysis, plotting, and report generation. It lets you display and plot complete and partial models and generate nodes, elements, and loads.

Larsa runs on the IBM PC, XT, and AT. It requires a minimum of 512K bytes of RAM, a 10-megabyte hard-disk drive, and an 8087 or 80287 math coprocessor. Larsa Linear and Nonlinear Analysis sells for \$3495. Larsa Linear Analysis costs \$1995. Contact Innovative Analysis Inc., 330 West 42nd St., New York, NY 10036, (212) 736-1616. Inquiry **589**.

## Relational Database Program

XDB, from Software Systems Technology, is a relational database system designed for generating sophisticated applications. The system includes a query language, command language, database editor, report writer, menu generator, utilities, and an optional forms manager and graphics module. XDB's forms manager can access and update multiple tables. The

program's import/export utility lets you transfer data to or from dBASE II and III, spreadsheet files, and other programs.

The software uses SQL, IBM's relational query language and the proposed ANSI standard for micro-computer and mainframe query languages. The company says that SQL minimizes the amount of programming required for generating applications.

XDB runs on IBM PCs and compatibles and requires between 192K and 320K bytes, depending on the modules you use. Three modules are available. The Extended Database System alone costs \$450 and includes a query language, report writer, database editor, command language, menu generator, and utilities. The Form Manager option costs \$225, and the Graph Writer option costs \$75. A C-language interface is available for \$500. Con-

tact Software Systems Technology, 7100 Baltimore Ave., Suite 206, College Park, MD 20740, (301) 779-5486. Inquiry **590**.

## 3-D Designs on the Mac

MacSpace, a computer-aided design program for the Macintosh, lets you design three-dimensional objects. The program divides the screen into four win-

(continued)



# The Computer Book Club®

Recognized as the authoritative source for micro users!

## WE SHOW YOU HOW TO GET THE MOST FROM YOUR COMPUTER

- Superior Selections
- Business Success
- Practical Prices
- Personal Achievement

# Select 5 Books for Only \$2<sup>95</sup>



Plus FREE copy of "Making Money with your Microcomputer"!



1948  
List \$22.95



1908  
List \$24.95



1939  
List \$24.95

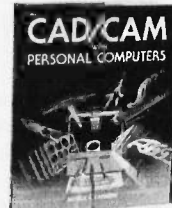

1852  
List \$21.95



1748P  
List \$10.95 (paper)

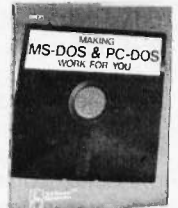

1848  
List \$19.95



1918  
List \$26.95



1874  
List \$21.95



1970  
List \$22.95

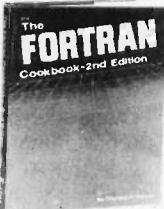

1737  
List \$18.95



2623  
List \$21.95



1556  
List \$21.95



2627  
List \$23.95



1437  
List \$18.95



1921  
List \$21.95



1907  
List \$21.95

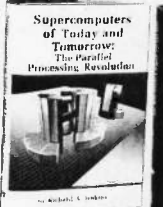

2622  
List \$21.95



1989  
List \$22.95

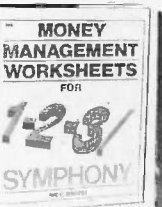

1968  
List \$21.95



1976P  
List \$17.95 (paper)



2652  
List \$24.95

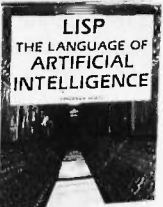

2620  
List \$25.95



1997  
List \$21.95



1993  
List \$21.95



1501  
List \$21.95



1901  
List \$22.95



1822  
List \$24.95



1873  
List \$21.95

## Making Money With Your Microcomputer FREE when you join!

Publisher's List \$8.25 (paper) No. 1506P



## 7 very good reasons to join The Computer Book Club®

- **Big Savings.** Save 20% to 75% on books sure to increase your computer know-how
- **No-Risk Guarantee.** All books returnable within 10 days without obligation
- **Club News Bulletins.** All about current selections—mains, alternates, extras—plus bonus offers. Comes 13 times a year with hundreds of up-to-the-minute titles to pick from
- **"Automatic Order."** Do nothing, and the Main selection will be shipped automatically! But . . . if you want an Alternate selection—or no books at all—we'll follow the instructions you give on the reply form provided with every News Bulletin
- **Bonus Books.** Immediately get Dividend Certificates with every book purchased and qualify for big discounts of 60% to 80%
- **Extra Bonuses.** Take advantage of added-value promotions, plus special discounts on software, games, and more
- **Exceptional Quality.** All books are first-rate publisher's editions selected by our Editorial Board and filled with useful, up-to-the-minute information

## The Computer Book Club®

P.O. Box 80, Blue Ridge Summit, PA 17214

Please accept my membership in The Computer Book Club® and send the 5 volumes circled below, plus my FREE copy of Making Money with your Microcomputer (1506P), billing me only \$2.95 plus shipping and handling charges. If not satisfied, I may return the books within ten days without obligation and have my membership canceled. I agree to purchase 4 or more books at regular Club prices (plus shipping/handling) during the next 12 months, and may resign any time thereafter.

1437 1501 1556 1737 1748P 1822 1848 1852 1873  
 1874 1901 1907 1908 1918 1921 1939 1948 1968 1970  
 1976P 1989 1993 1997 2620 2622 2623 2627 2652

Name \_\_\_\_\_  
 Address \_\_\_\_\_  
 City \_\_\_\_\_  
 State \_\_\_\_\_ Zip \_\_\_\_\_ Phone \_\_\_\_\_

Valid for new members only. Foreign applicants will receive ordering instructions. Canada must remit in U.S. currency. This order subject to acceptance by The Computer Book Club®

BY-386

## SOFTWARE • BUSINESS

dows that display top, front, and side views, as well as an axonometric projection of the object. Below the windows, an information strip displays various values of the object you're designing—its perimeter, surface, geometric quotes, or choice of drawings proposed.

MacSpace works with the Imagewriter and LaserWriter printers and can transfer drawings to MacPaint, MacDraw, and other graphics and drawing programs. It can also send output to a variety of Macintosh-compatible plotters.

The program runs on the 512K Macintosh and costs \$385. Contact Abvent, 9903 Santa Monica Blvd., Suite 268, Beverly Hills, CA 90212, (213) 659-5157. Inquiry 591.

### Low-Cost Word Processor

**W**Pro, a word-processing program for IBM PCs and compatible computers from Natural Language Inc., features a two-level interface designed for beginning and experienced computer users. You can customize and extend the interface with the macro definitions the program provides.

WPro has built-in forms management, windows, mail merge, label printing, concurrent print spooling, translation tables for foreign languages, automatic indentation, the ability to execute external programs or commands, and the ability to display directories. The program can combine text with images generated by business graphics and drawing programs. WPro can also import and export data to and from spreadsheets and database programs.

The program supports multiple fonts and runs on a variety of laser, dot-matrix, and daisy-wheel printers. WPro retails for \$96 and runs on IBM PC and compatible computers with 256K bytes of RAM. For more information, contact Natural Language Inc., POB 13467, Kanata, Ontario K2K 1X6, Canada, (613) 820-8299. Inquiry 592.

### Graphics Database for CAD

**M**icro-Vector's CADRover is a graphics database program that finds and retrieves stored images you've created with other CAD packages. Designed for presentation, CADRover lets you arrange and display drawings in sequences. If you specify one or more points in a drawing, the program activates these points to display selected images in an order you define. The program can also link graphics with text.

CADRover can read a variety of file formats used by other applications programs and currently reads files produced by CAD-Master and VersaCAD. Selling for \$495, the program runs on the IBM PC and compatibles. Contact Micro-Vector Inc., 1 Byram Brook Place, Armonk, NY 10504, (914) 273-8700. Inquiry 593.

### WHERE DO NEW PRODUCT ITEMS COME FROM?

*The new products listed in this section of BYTE are chosen from the thousands of press releases, letters, and telephone calls we receive each month from manufacturers, distributors, designers, and readers. The basic criteria for selection for publication are: (a) does a product match our readers' interests? and (b) is it new or is it simply a reintroduction of an old item? Because of the volume of submissions we must sort through every month, the items we publish are based on vendors' statements and are not individually verified. If you want your product to be considered for publication (at no charge), send full information about it, including its price and an address and telephone number where a reader can get further information, to New Products Editor, BYTE, 70 Main St., Peterborough, NH 03458.*

### Software for Speeding PC ATs

**D**ynamical Systems' software utility, AT Speed-Fixer, facilitates speeding up an IBM PC AT. The package consists primarily of a memory-resident program designed to prevent disk-drive errors that might occur with an AT running faster than 6 MHz. Also on the disk is a utility that increases keyboard speed by reprogramming the chip inside the AT keyboard.

Along with the software come instructions on how to speed up an AT by replacing the crystal and how to quicken a hard disk used with an accelerated AT.

AT SpeedFixer costs \$24.95. For more information, contact Dynamical Systems Inc., 2511 Fulton St., Berkeley, CA 94704, (800) 227-2400, ext. 929. Inquiry 594.

### Atari ST Graphics Software

**D**EGAS, from Batteries Included, runs on the Atari 520ST and 1040ST. The program incorporates GEM and adjusts to whichever ST graphics mode you use.

Within DEGAS, you can employ drawing functions; choose your colors; design your own brush, fill, and line patterns; and use magnify,

shadow, mirror, and airbrush features. The mouse acts as paintbrush or pencil, and a click can move you between the main menu and the drawing screen. The program allows combined text and graphics and lets you create your own text fonts.

The results of work with DEGAS can be printed on any Epson or compatible graphics printer. DEGAS costs \$39.95 U.S. (\$54.95 Canadian). Contact Batteries Included, 30 Mural St., Richmond Hill, Ontario L4B 1B5, Canada, (416) 881-9816. U.S. sales: 17875 Sky Park North, Suite P, Irvine, CA 92714, (714) 250-8723. Inquiry 595.

### CP/M for MS-DOS Computers

**R**UN/CPM, from Micro Interfaces, is packaged with NEC's V20/V30 micro-processor and is designed for running CP/M software on the IBM PC and compatible computers. In addition to being compatible with Intel's 8088 and 8086, the NEC microprocessor provides instructions for Intel's 8-bit 8080.

The software's features include 15 logical and physical drive assignments, support for subdirectories and path-name assignments, terminal emulation for many CP/M terminals, a disk-transfer utility for transferring CP/M software to MS-DOS format, and the ability to issue MS-DOS commands in CP/M mode.

RUN/CPM sells for \$99.95 and includes software, the NEC V20/V30 micro-processor, and documentation. Contact Micro Interfaces Corp., 6824 Northwest 169th St., Miami, FL 33015, (305) 823-8088. Inquiry 596.



# THE BUYER'S MART

## A Directory of Products and Services

THE BUYER'S MART is a monthly advertising section which enables readers to easily locate suppliers by product category. As a unique feature, each BUYER'S MART ad includes a Reader Service number to assist interested readers in requesting information from participating advertisers.

**RATES:** 1x—\$375 3x—\$350 6x—\$325  
Prepayment must accompany each insertion.

**AD FORMAT:** Each ad will be designed and typeset by BYTE. Advertisers must

furnish typewritten copy. Ads can include headline (23 characters maximum), descriptive text (250 characters maximum), plus company name, address and telephone number. Do not send logos or camera-ready artwork.

**DEADLINE:** Ad copy is due 2 months prior to issue date. For example: June issue closes on April 1. Send your copy and payment to THE BUYER'S MART, BYTE magazine, 70 Main Street, Peterborough, NH 03458. For more information call Karen Burgess at BYTE 603-924-9281.

### ACCESSORIES

#### SOFTWARE PACKAGING, DISKS

Cloth binders & slips like IBM's. Vinyl binders, boxes, and folders—many sizes. Disk pages, envelopes, & labels. Low qty. imprinting. Bulk & branded disks. Much More! Low prices. Fast service. Call or write for FREE CATALOG.

#### Anthropomorphic Systems Limited

376-B East St. Charles Road  
Lombard, IL 60148

1-800-DEAL-NOW (312) 629-5160

Inquiry 652.

### ACCESSORIES

#### FREE CATALOG

Outstanding prices on computer accessories for your computer and workstation. Our catalog features a wide selection of quality products to meet all your accessory needs. Call or write today to receive your free catalog.

#### LINTEK COMPUTER ACCESSORIES

POB 8056, Grand Rapids, MI 49508

(616) 241-4040

Inquiry 747.

### COMMUNICATIONS

#### SMART ANSWERING MACHINE

SAM transforms your IBM PC into an intelligent phone answering & real-voice messaging center. FEATURES: 999 personal messages, call screening, message forwarding, timed or grouped message delivery, sortable phonebook/autodialer, time/date log, voice prompted remote access, AND MORE!! All hardware & software included. Retail \$295. VISA/MC.

#### DIALECTRON, INC.

2035 California St., Ste #17, Mountain View, CA 94040  
(415) 960-3040

Inquiry 743.

#### PERIPHERAL SWITCHES

2 Position Serial \$39.95  
2 Position Parallel \$59.95

Common Cable Included  
Various Connector Options  
Write or Call for Free Brochure

#### SYNTAX ENGINEERING

Rte. 3, Box 344, Escondido, CA 92025  
(619) 741-4000

Inquiry 736

### BAR CODE

#### BAR CODE READERS/PRINTING

Programs \$49-\$299. Readers \$325 up. PRINT Bar Codes on PC and Epson/Okidata or IBM Proprinter - Code 39, 1 2of5, UPC, MSI, DOD-LOGMARS, AIAG. Graphics chs up to 1". Labels, Catalogs from files. Subroutines for BASIC, Cobol, Clipper, Turbo, Pascal, C, dBASE III Plus.

#### Worthington Data Solutions

130 Crespi Court, Santa Cruz, CA 95060

(408) 458-9938

Inquiry 678.

### CONTRACTS

#### FOR ENTREPRENEURS

Legal contracts for hardware/software developers. Employee agreement, non-disclosure form, contracts for sale (hardware and/or software), consulting, development, hardware & software maintenance, non-competition, project delivery & more.

\$50 Waters Publishing \$50

8235 Douglas - Suite 1000 -  
Dallas, TX 75225  
800-628-2828

Inquiry 741.

#### LASER PRINTERS

I will pay you cash for your used toner cartridges!!!  
(HP, Apple, Canon, etc.)

Recharging Service ..... \$40  
Call or write for free instant pickup service:

#### PC Corporation, Laser Printer Products

11 Freeman Street, Stoughton, MA 02072

(617) 893-9000 (24 hours)

(617) 341-3005 (9-5 pm Eastern)

Dealer inquiries welcome

Inquiry 763.

### BOOKS / DISKS / VIDEOS

#### ★ ★ WORDSTAR USERS ★ ★

TRY THE NEW, DIFFERENT, UNIQUE APPROACH  
TO LEARNING WORDSTAR.

Introducing an Instruction book that skips the unnecessary and gets on with the substance of how to use your program! A superior primer and a concise reference in one manageable text!

#### CHEATBOOK FOR WORDSTAR

\$10 Post Paid, Send check or M.O., to:

The EASYKEY Company, Bx 1758  
Murphys, CA 95247 CA orders add 60c sales tax

Inquiry 684.

### DISK CONVERSION

#### INCOMPATIBLE WORD PROCESSORS!

We convert to and from: XEROX, DEC, IBM, LANIER, WANG, PC-DOS, CONVERGENT TECHNOLOGY, WORDSTAR, MULTIMATE, SAMNA ASCII, MICOM.

Also most CP/M systems.

LOWEST PRICES

#### DATA CONVERSION INC.

6310 Cabellero Blvd. • Buena Park, CA 90620  
(714) 522-7762 (800) 824-4851 in CA.

Inquiry 675.

#### DATA CABLES & PARTS

EIA RS232-C Data Cables - standard, extended distance, Teflon Assemblies. Also Centronics (parallel), Coaxial (RG59U, RG62A/U, Dual Wang, Twin-axial), Ethernet, Ribbon, IBM, DEC Compatible cables, AB switches, connector parts, bulk cable, tools & hardware (wall plates). Send for Catalog.

#### Communication Cable Co.

POB 600-B, Wayne, PA 19087

215-644-1900

Inquiry 666.

#### ★ HARD DISK MADE EASY ★

Every Hard Disk Owner Needs  
EASYBRIEF FOR COMPUTERS WITH  
A HARD DISK

A How-To Book

\$10 Post Pd. Send Ck or M.O.

CA Orders add 60c sales tax.

To: The EASYKEY Co.

Bx. 1758, Murphys, CA 95247

Inquiry 685.

### CONVERSION SERVICES

Convert any 9 track magnetic tape to or from over 500 formats including 3 1/2", 5 1/4", 8" disk formats & word processors. Disk to disk conversions also available. Call for more info. (312) 459-6010

#### Pivar Computing Services, Inc.

★ ★ 47 W. Dundee Road ★ ★  
Wheeling, IL 60090

Inquiry 672.

#### Self-Inking Printer Ribbon

For users of Okidata and other open spool ribbon printers. Controlled Printout Devices are a new kind of printing ribbon that re-ink themselves, and will last 15 times longer than the ribbon you are now using. For further information please call or write.

#### CONTROLLED PRINTOUT DEVICES, INC.

POB 869, Baldwin Rd., Arden, NC 28704

(704) 684-9044

Inquiry 670.

### BUSINESS OPPORTUNITIES

#### VIDEO STORES

We need ambitious dealers in all U.S. states and Canada to market a powerful system to computerize video tape rental stores.

#### WINCHESTER DATA PRODUCTS INC.

3301-Executive Drive., #204, Raleigh, N.C. 27609

(919) 872-0995

Inquiry 754.

#### DISK AND TAPE CONVERSIONS

High quality conversion services for Dedicated Word Processors, Mini and Microcomputers. Over 600 3 1/2", 5 1/4", and 8" formats. Also 800-1600BPI tape. Included: Wang, NBI, CPT, DEC, Videx, Lanier, OS/6, Xerox, IBM Sys/34/36/38/5520, Mac, Victor, TRS, Apple, NSTAR, IBM PC/AT, HP, and most of the other microcomputers. We can convert directly into word processing software such as: DW3, WP, MS/WRD, WS, Samna, MM, PFS, and many others.

DATA FORMATS, INC. (408) 972-1830

Inquiry 676.

# THE BUYER'S MART

## DOCUMENTATION

### COMPUTER ASSEMBLY MANUALS

**BIG BLUE SEED for IBM™ BUILDERS:** parts list, placement diagrams, instructions for assembling over 65 IBM compatible bare cards - \$14.95.  
**APPLE SEED II for APPLE™ BUILDERS:** instructions for assembling 77 Apple-compatible bare cards including the II+ and IIe motherboards - \$12.95.  
**OVER 40 DIFFERENT BARE CARDS IN STOCK FOR THE HOBBYIST**

**NuScope Associates**  
 P.O. Box 790 • Lewiston NY • 14092

Inquiry 723.

## DUPLICATING SERVICES

### DUPLICATION SOLUTIONS

We have the answer to your duplication needs, no matter what the volume. We supply auto-loaders, disks, and technical support. We provide copy protection, serialization, package assembly, and distributive shipping.

#### MegaSoft

P.O. Box 1143, Freehold, NJ 07728  
**1-800-222-0490 201-462-7628 (in NJ)**

Inquiry 707.

### WESTERN TRANSDATA, INC.

Why risk duplicating your important programs on your computer, when our equipment is designed solely to duplicate disks & verify their perfection 100%? Over 600 formats. 3 1/2", 5 1/4" & 8". Plus serialization, copy protection, labeling, packaging, shrink-wrapping and fast, personalized service.

#### WESTERN TRANSDATA, INC.

1701 E. Edinger Ave. A-4  
 Santa Ana, CA 92705  
**714/547-3383 (collect)**

Inquiry 761.

## HARDWARE

### USED APPLES & IBM's

APPLE II+ as low as **\$275.00**  
 APPLE IIe as low as **\$525.00**  
 Motherboards & accessories — call  
 We really do buy and sell used computers! Trade in your apple for an IBM or compatible.

#### SHREVE SYSTEMS

845 Lark Ave., Shreveport, LA 71105  
**318-865-6743 4-8 p.m. C.S.T. VISA/MC**

Inquiry 731.

### GOULD COLORPLOTTERS

Model 6120-HP Equivalent  
 small footprint under \$1000.

#### Everett/Charles® Marketing Services

6101 Cherry Avenue  
 Fontana, CA 92335  
**800-443-1860 Calif. 800-821-0589**

Inquiry 689.

### E(E)PROM, PROM PROGRAMMER

Program all EPROMS, EEPROMS, microcomputers, zero-power RAMs, 35 nS PROMS for under \$300!

#### B & C Microsystems

See our ads on page 424.

Inquiry 654.

## HARDWARE

### IAM . . . In-Circuit Emulators

Real time full function In-Circuit Emulators for *Design Engineers*. Load Hex Files. Assemble/Disassemble, Edit Memory, Set Constants, with Break and Print Points. Stand alone operation or turns your Personal Computer into a Development System. And at an incredibly low Price . . . \$498. Models Available Z80, 8085, 8088 and NSC800. For immediate response **Call (916) 961-8082**

#### IAM

P.O. Box 2545, FairOaks, CA 95628

Inquiry 699.

### POWERLINE GREMLINS?? POWER FAILURES??

The MEIRICK STANDBY POWER SYSTEM is the TOTAL SOLUTION to your powerline problems.  
 240 watt system - \$365; 400 watt system - \$495;  
 800 watt system - \$795

**MEIRICK Inc., POWER SYSTEMS DIV.**  
 Box 298, Frisco, CO 80443 303-668-3251

Inquiry 708.

### MATRIX CALCULATOR

Programmable calculator with 70+ matrix opns, statistics, system of lin & nonlin & diff eq'ns, numer. integral, 1-d optm. User program'd func. \$49.95 includes S&H, 100+ pg manual, 1 yr. support. Same for 8087 ver. Visa, MC accepted.

#### SoftTech Inc.

Suite 104, 18505 W. 8 Mile, Detroit, MI 48219  
 (For Credit Card orders) 1-800-835-2246 ext. 80  
**313-534-4933**

Inquiry 756.

### EPROM/EEPROM PROG. \$250

Programs 2716-27512, 25xx and 68764/66 eproms via RS-232. Also 874x micros and 28xxA & 52Bxx EEPROMs. Automatic baud rate select, built in help menus, no personality modules!

#### 16 BIT I/O MODULE \$75

Low cost control via RS-232. Expands to 512!

#### INTELLITRONICS

P.O. Box 3263, Tustin, CA 92680  
**(714) 669-0614**

Inquiry 701.

### SINGLE BOARD COMPUTER INDUSTRIAL STRENGTH

• FORTH O.S., Editor, Assembler, Target Compiler, RAM Disk • 8085 CPU • 16 A/D Channels • RS232 • Realtime Clock • Buffered Digital I/O • Battery Backed RAM • Single Supply • Watchdog Timer • Full Line of Support Hardware/Software • Counter/Timer • IBM/CPM Support • RS422 • FROM \$199.95 •

#### EMAC, INC.

1400 West Main, Carbondale, Illinois, 62901  
**(618) 529-4525**

Inquiry 688.

### KING OF MICROCONTROLLERS

• 4000 Microcontroller Boards & Kits for  
 8035/8039/8040/8048/8049/8050/8031/8032/  
 8051/8052/8751/6511/7001/7809 from \$19.95  
 • 4008 Mini RS232 Terminal Kit, Full Keyboard,  
 LCD Display \$159.95  
 • 4015 8052 Basic System, EPROM Programming,  
 RAMs & I/O \$299.95

#### TECH STAR LABORATORY

Suite 709 R&B Corp. Park, 1701 N. Greenville Ave.  
 Richardson, Texas 75081

Inquiry 738.

## HARDWARE ADD-ONS

### APPLE & IBM PERIPHERALS!

FACTORY DIRECT! IIe 64K/80 Column Bd. \$39.  
 II+ /IIe Cooling Fan \$24.95. II+ /IIe Mouse w/SFWR \$49.95. Joystick III w/wire on stick Apple or IBM \$24.95. 10 Ft IBM Parallel Cable \$12.95. RAM Set/9 PC-\$5 XT-\$7. Add \$3 Shipping. Write for complete list.

#### NEXO DISTRIBUTION

8824 Golf Drive - Spring Valley, CA 92077  
**(619) 589-7928**

Inquiry 721.

### TURBOCHARGER FOR IBM

✓ Increases processing speed over 300%  
 ✓ Full software compatibility with PC and XT  
 ✓ Supports Intel 10 MHz 8087 coprocessor

#### Everett/Charles® Marketing Services

6101 Cherry Avenue  
 Fontana, CA 92335  
**800-443-1860 Calif. 800-821-0589**

Inquiry 690.

### Tandy 1000 Hardware

TanPak Multifunction Cards . . . . . \$329  
 Memory to 512K, RS232, Clock, DMA  
 TanPak Secondary . . . . . \$249  
 Memory to 256K, RS232, Clock  
 10 Meg Hard Drive with Controller . . . . . \$549  
 20 Meg Hard Drive with Controller . . . . . \$749

#### Hard Drive Specialist

**1-800-231-6671 or 1-713-480-6000**  
 16208 Hickory Knoll, Houston, Texas 77059

Inquiry 695.

### HEATH/ZENITH UP TO 640K

Dolen's \$89.95 G-2 user-installed option upgrades 2960 memory board to full 640K for model 150 or 160. G-3 factory-installed memory expansion is only \$139.95. No additional board required. Prices include shipping. Call (203) 222-1174 to order.

**Dolen Computer Corporation**  
 10 Bay Street, Westport, CT 06880

Inquiry 782.

## SOFTWARE/BUSINESS

### TAXPAK™-86 Eases Tax Hassle

Fast, friendly, full-featured tax program in its 4th year. Menu driven. Unique status line shows wealth of info. What-if function explores tax options. Complete recalculation in only 1 second. Prints in IRS format. \$39.95 for IBM PC, Apple II, CPM-80. Try-it-first disk only \$3.

#### PEOPLEWARE

10762 Twin Spruce, Golden, CO 80403  
**(800) 621-8385 ext. 669 VISA/MC**

Inquiry 725.

### CUSTOM PAYROLL

All systems have multiple pay categories, calculation of all taxes, user defined deductions, 401(k) handling, many reports, paychecks, W-2 forms, and much more. Custom features are available. Prices start at \$695 for system, manual, and PC Basic source code.

#### Datasmith, Inc.

Box 8036, Shawnee Mission, KS 66208  
**(913) 381-9118**

Inquiry 677.

# THE BUYER'S MART

## SOFTWARE/BUSINESS

### Programmers:

We guarantee our products to be solid, bugfree.  
 \* CorrectForth - Very professional.  
 \* Correct\_Datamizer - 50:1 data compression guaranteed.  
 \* SafeModem - Hackerproof.  
 \$80.75 per program MC/VISA/MO/Check. Specify computer.

### Correct Software, Inc.

RR1 Box 140, Black Hawk, SD 57718  
 (605) 787-5904

Inquiry 671.

## SOFTWARE/BUSINESS

### PC-File III™ Version 4

Search, sort, browse, global changes, macros, mailing labels, format reports with selection & calculations, sub-totals, totals, averages, encryption. Exchange data with 1-2-3, WORD, WordStar. Over 190,000 users. \$59.95 + \$5 s/h. For IBM PC.

### ButtonWare, Inc.

P.O. Box 5786, Bellevue, WA 98006  
**1-800-J-BUTTON**

Inquiry 658.

## SOFTWARE/BUSINESS

### MINUTE-a-DAY MANAGER™ TAX SURVIVAL SPECIAL

New *Shadow Writing™* feature adds the power of AI to your record keeping. 256K MS/PC-DOS package includes FREE Custom Calendar Kit PLUS:

- CHECKBOOK/CREDIT CARD MANAGER
  - COMPUTER LOGGER • AUTO LOGGER
- Visa/MC (May be tax-deductible.) \$59.95 + \$3 s/h

### Multi-Data Management Associates

**1-800-255-2255 ext. 3300**

Inquiry 715.

### MoneyCounts™

Only \$29.95

A complete money management system that provides: Checking, Savings and Credit Card Management, a comprehensive budgeting tool, a financial statement generator, sharp graphics, and on-line help screens to guide you each step of the way. Great for home or small business use.

CPA designed. IBM PC/XT & compatibles with DOS 2.0 or later and 192K. \$29.95

### PARSONS TECHNOLOGY

6925 Surrey Dr. NE., Cedar Rapids, IA 52402

(319) 373-0197 CHECK/VISA/MC

Inquiry 724.

### PC-File/R™

All the power of PC-File III plus: Relational link to other databases, integrated letter writing & mailmerge, context sensitive pop-up help windows. New binary search retrieves data hundreds of times faster. \$149.95 + \$5 s/h.

### ButtonWare, Inc.

P.O. Box 5786, Bellevue, WA 98006

**1-800-J-BUTTON**

Inquiry 659.

## DATA ENTRY SYSTEM

Heads-down data entry with two-pass verification for the PC/XT/AT & compatibles. Loaded with features like: Auto dup & skip, verify bypass, range checks, & table lookups. Fully menu driven only \$395.

Call for free 30 day trial period.

### COMPUTER KEYS

6519 193 SW, Lynnwood, WA 98036

**(206) 776-6443**

Inquiry 668.

## WORD IMAGE

Edit 4 large files, undo, key macros, math, search/replace in ranges, all printers, help, on-screen attributes, sub-directories, command driven, batch, manual w/index & tutorial, fast, MORE!!! Needs 320KB, PC DOS 2.0 +. Intro: \$50.00, 30-Day trial.

### Software Ideology

P.O. Box 305, Brooklyn, N.Y. 11204

**718-236-3876**

Inquiry 757.

## LP88-LINEAR PROGRAMMING

A powerful menu-driven system for solving linear programs w/ up to 510 constraints & 2510 variables. Features include interactive & batch operation, spreadsheet-style input & editing, storage of problems & bases, Simplex Algorithm restart, report generator, sensitivity analysis. Req IBM PC, 192K. \$99 w/8087 support, user's guide. VISA/MC.

### EASTERN SOFTWARE PRODUCTS INC.

P.O. Box 15328, Alexandria, VA 22309

**(703) 549-5469**

Inquiry 682.

## ALL FORMS TAX SOFTWARE

- Individual Federal Income Tax Software
- Computes all forms and schedules
- Prints all forms
- IBM-PC, XT, AT & compatibles

\$49.95

### Unique Computer Systems

140 East Commonwealth Ave. #208

Fullerton, CA 92632

In CA. 1-800-331-5088

714-525-7118

Inquiry 753.

## ACCOUNTING SYSTEMS

\$49.95 + \$2.50 S&H

- Construction
- General Systems
- Medical Billing
- Retail Sales
- Equipment Rental
- Manufacturing
- Professional
- Wholesale

Menu-Driven — Full File Maintenance

Each includes GL, AR, AP, INVENTORY, PAYROLL & more!

### HIGH TECHNOLOGY, INC.

9312 W. 92nd Ave., Westminster, CO 80020

(303) 431-7596 VISA and MASTERCARD Accepted!

Inquiry 696.

## TSA88-TRANSPORTATION

A general-purpose system for solving transportation, assignment and transhipment problems. Solves transportation problems with up to 510 origins and/or destinations by applying the Transportation Simplex Algorithm. Menu-driven with features similar to LP88. Requires 192K, \$99 with 8087 support user's guide. VISA/MC.

### EASTERN SOFTWARE PRODUCTS, INC.

P.O. Box 15328, Alexandria, VA 22309

**(703) 549-5469**

Inquiry 683.

## TAX-PREP '86

### MAKES TAXES EASIER

Multiplan, 1-2-3 or Excel users, easily prepare totally professional tax returns. 22 linked schedules, IRS approved printout. IBM, Apple, TRS-80, CP/M \$129.95; MAC \$99.95. Call now for full information.

### EZWare Corporation

**(215) 667-4064**

Inquiry 691.

## MY WORD!® is just \$35.00

Complete word processing plus sort, add rows & columns, mergeprint, quickprint, macros, math, micro-justify, use all 256 char. Source: add \$35. 150 page printed manual. 30-day money-back guarantee. IBM PC or compatible, 128K, one drive, any printer.

### T.N.T. SOFTWARE, INC.

34069 Hainesville Road, Round Lake, IL 60073

**(312) 223-8595**

Inquiry 752.

### PC-Type™

Fast, compact, capable & easy! Help panels, hands-on tutorial, macros, multiple-line headings & footings, DOS path support, print spooling, block operations, etc. ASCII files. Install program allows customization. \$59.95 + \$5 s/h. For 128K IBM PC.

### ButtonWare, Inc.

P.O. Box 5786, Bellevue, WA 98006

**1-800-J-BUTTON**

Inquiry 660.

### PC-Write™ Shareware

Fast, friendly, flexible word processor and text editor for IBM PC. Easy to use. Advanced features like macros, split screen, footnotes, mailmerge. Many good reviews, thousands sold. All software, manual on disk \$10. OK to copy! Register for full manual, support, source \$75.

**Quicksoft (206) 282-0452 Visa/MC**

219 First N. #224J, Seattle, WA 98109

Inquiry 729.

## ★ FORECASTING ★ MODELING ★ PLANNING ★

Compatible with IBM PC & Apple II  
**MICRO-BJ™** NUAMETRICS™  
 • Box-Jenkins ARIMA • Econometrics package  
 • Identify, estimate, forecast \$195.00  
**\$295.00**  
**PROFESSIONALS CHOICE**  
 • XTRAPOLATOR™ • Link to Lotus, Visicalc  
 • Automatic forecasting • Multiple order discounts  
 \$195.00 50% off Apple II orders

### STRATIX

P.O. Box 4413 • Burlingame, CA 94011

(415) 697-0573 MC/VISA

Inquiry 750.

### PC-Calc™ Version 3

64 columns x 256 rows, math and stat. functions, horizontal bar graphs, title locking, individually adjustable column widths, IF...THEN, link to other spreadsheets or PC-File databases, much more. Requires 256K IBM PC. \$59.95 + \$5 s/h.

### ButtonWare, Inc.

P.O. Box 5786, Bellevue, WA 98006

**1-800-J-BUTTON**

Inquiry 661.

### TurboTax®

"Very easy to use. Documentation-Excellent!"—PC Magazine. POWERFUL and FAST! 33 forms plus multiples. CALCULATES in 3 seconds! Pop-up menus. IRS approved. 1986 planning module. Many extras. Simply the best! IBM & compatibles. 256K \$65 + \$5 S/H. Visa/MC. Many states avail.

### ChipSoft, Inc.

5674 Honors, San Diego, CA 92122.

**(619) 453-8722**

Inquiry 664.

# THE BUYER'S MART

## SOFTWARE/BUSINESS

### STANDARD FORMS

Easy to use with on screen step by step prompts. Prints data required in proper spaces on any preprinted form that fits in your printer. Free phone support. \$79 (VISA/MC/AMEX). MS-DOS/CPM-80. Other original software. **FREE** catalogue.

### MICRO-ART PROGRAMMERS

173 Birch Avenue, Cayucos, CA 93430  
(805) 995-2329 (24 hours)

Inquiry 709.

### TIME & BILLING

400 clients/20 partners/80 job & 40 out of pocket categories/20 areas of practice/fixd fee or hourly/more! Prints billing/statements/aged rec's/more! Free phone support. \$149 (VISA/MC/AMEX). MS-DOS/CPM-80. Other original software. **FREE** catalogue.

### MICRO-ART PROGRAMMERS

173 Birch Avenue, Cayucos, CA 93430  
(805) 995-2329 (24 hours)

Inquiry 710.

### INCOME TAX SOFTWARE

**TAXWORKS**® software to enter, calculate, and print Federal Form 1040 and 17 supporting schedules. 1985 marks 3rd year of production. 240 programs sold last season. Free phone support. For IBM, MS-DOS, CPM-80. Federal \$400. California \$100. Demo \$25.

### TAXWORKS™

881 Alma Real Dr., Suite T-2  
Pacific Palisades, CA 90272

(213) 459-2746, In Calif. (800) 232-11040''

Inquiry 697.

### Powerful Accounting Software At \$35 Per Package

For schools, municipalities, printers, accountants, contractors, & others. Acct. Rec/Billing/Inventory-G/L/Fund Accounting-Acct. Pay-Payroll/Job Cost-Work in Process.

### Elite Systems, Inc.

Box 820-4 Hayward Rd. • Carmel, ME 04419  
To Order Call 207-848-5771

Inquiry 746.

### INEXPENSIVE PC SOFTWARE

#1 Loan Amortization and Interest Calculations	\$50
#2 Business Costs and Breakeven Analysis	\$50
#3 Prolog Interpreter - Excellent teaching tool!	\$65
#4 Polynomial Roots - N degree real/complex!	\$45
#5 Curve Fitting - Ten different tests!	\$45

Add \$1.50 S&H. Va residents add 4% tax.

### VIRGINIA INFORMATION SERVICES, INC.

P.O. Box 6566, Richmond, VA 23230  
804-745-5012 10 to 6 EST

Inquiry 768.

### ABACUS

**ONLY FROM SUNSOFT** . . . Complete Accounting System for \$49.95 plus S&H. SOURCE CODE only \$20 extra!!! Complete documentation. Runs on CP/M & PC-DOS systems. 2.5" 1/4" DSDD min.

\* completely menu driven  
\* full file maintenance  
\* G/L, A/P, A/R, P/R, C/A

### SUNSOFT Inc.

P.O. 1168, Marquette, MI 49855  
For orders: 1-800-624-7008 For info.: (906) 226-3370

Inquiry 751.

## SOFTWARE/CHURCH

### Church Package

Parishioner Time, Talent and Treasure System program is written in modifiable dBASE source code.

- Contributions • Disbursements • Ledger
- Names with mailing labels
- Personal information database.

Requires dBASE II or III. PC-DOS/CPM-80 \$200.

### Feller Associates

550 CR PPA, Route 3, Ishpeming, MI 49849  
(906) 486-6024

Inquiry 692.

### ROMAR CHURCH SYSTEMS™

Membership-61 fields plus alternate address; labels, letters, reports any field(s). Offering-256 funds, optional pledge, statements; post to 255 x/year. Finance-G/L with budget; up to 500 sub-totals & 99 depts: month & YTD reports anytime for any month. Size 2000 people/floppy; 25000/10 meg. Ad too short!! Write!

### Romar Church Systems, Attn: BMB

P.O. Box 4211, Elkhart, IN 46514  
(219) 262-2188

Inquiry 749.

## SOFTWARE/EDUCATION

### War or Peace? YOU Decide!

Stimulates discussion on the role of nuclear weapons in national security. Players chose U.S. or Soviet side. High school or home use, both teacher and student manuals included. IBM or Apple. \$49.95 MC/VISA/AMEX

### Bright Ideas, Inc.

52 Exeter St., Portland, Maine 04102-2839  
1-800-628-2828 ext. 649

Inquiry 656.

### XENIX TUTOR AT LAST!!!

A 6 hr. training program on effective use of XENIX (UNIX) operating system. Ideal for non pros wanting grasp of multi-user/multi-tasking systems. Runs under PC-DOS on IBM PC, PC/XT, PC/AT & compatibles: Requires 128K + graphics board. \$350. COD/VISA/MC/AE.

### Hurricane Software

19415 S. Dixie Hwy., Miami, FL 33157  
800-238-2389 FL 305-238-4800

Inquiry 673.

## SOFTWARE/GENERAL

### SOFTWARE FOR PENNIES

GET BEST AND LATEST PC-DOS, CP/M-80 AND CP/M-86 PUBLIC DOMAIN PROGRAMS FOR BUSINESS, PERSONAL, EDUCATION, SOFTWARE DEVELOPMENT, MODELING, SCIENCE, AND MORE. AT LOW COST OF COPYING. 3-1/2, 5-1/4 AND 8" DISK FORMATS ARE SUPPORTED. SEND \$6.00 FOR CATALOG.

### MULTIPATH, INC.

Box 395, Montville, NJ 07045  
(201) 575-5880

Inquiry 716.

### Dr. T's MUSIC SOFTWARE

A music composition system with true word processing capabilities for APPLE and COMMODORE computers. Also, algorithmic composition programs for computer generation of sequences. Fully editable Bach songbook, Keyboard, Bass, and Drum disks. Patch librarians available for Yamaha and Casio synthesizers. Reviewed in Jan. '85 COMPUTE.

66 LOUISE RD.  
CHESTNUT HILL, MA 02167  
(617) 244-6954

Inquiry 680.

## SOFTWARE/GENERAL

### LEARN TOUCH TYPING NOW

Are you a hunt-and-peck typist? Then you need the TOUCH TYPIST computer typing course. Over 10,000 have already learned to type with TOUCH TYPIST. For IBM-PC, DEC Rainbow, or DECmate II and III. List \$79. SPECIAL PRICE \$27.97. FREE SHIPPING. MC/VISA. COD + \$3.

### Newline Software

P.O. Box 289, Tiverton, RI 02878  
(401) 624-3322

Inquiry 718.

### FREE SOFTWARE

Disk includes sample programs of TOUCH TYPIST, PROFESSIONAL TEXT PROCESSOR, and PROFESSIONAL SPELLING CHECKER. Plus information about other software and computer products. Indicate IBM-PC or DEC Rainbow or Zenith Z-100. \$3 s&h.

### Newline Software

P.O. Box 289, Tiverton, RI 02878  
(401) 624-3322

Inquiry 719.

### TAX PREPARER PROGRAM

Prepare client's or your own Fed. Income taxes on your PC. Simplified data input. Program calculates and produces printout for transfer to IRS forms 1040, 2210, Sched. A, B, C, G, & W. For IBM-PC, Zenith Z-89, Z-100, DEC Rainbow. Requires BASIC. List \$60. SPECIAL \$39 + \$3 s&h.

### Newline Software

P.O. Box 289, Tiverton, RI 02878  
(401) 624-3322

Inquiry 720.

**Personal Tax Planner, \$75.00** a lotus template for 1-2-3 or symphony One file includes the 13 most commonly used federal forms, which can be combined with one state file (all states with income tax & sales tax are available). All forms federal and state are interactive.

**Micro-One-Write, \$95.00** a checkbook accounting system This unique single entry system is fast, accurate, and very flexible. Unique features include windowing instant viewing of active account or department codes and running balance of money accounts. Export results to Lotus or dBase.

### PERMAR & ASSOCIATES

800-538-8157 ext. 955 In CA. 800-672-3470 ext. 955  
1125 Sunnyhills Rd., Oakland, CA 94610  
include \$3.00 s&h, CA residents add 6.5% sales tax.

Inquiry 726.

### THE MAGIC KEYBOARD \$46.50

Print Letters from 3/32" to 100", or Sideways to 12". 10 fonts. Print one line at a time or from text file. Store signs, posters, overheads, large labels, etc. Okidata 92-3,192-3, Epson FX, Star Micronics, Proprinter. MS-DOS & Kaypro. ©

### WOODSMITH SOFTWARE

Rt. 3 Box 550A, Nashville, IN 47448  
(812) 988-2137

Inquiry 742.

### AI for the IBM PC

TOPSI is a full version of OPSS which runs under MS-DOS, Unix or CP/M. A fast, efficient expert system development tool.

Prototyping: \$75  
Production: \$175  
C version, add \$20 Shipping, add \$5

### DYNAMIC MASTER SYSTEMS

POB 566456, Atlanta, GA 30356  
(404) 565-0771

Inquiry 681.

# THE BUYER'S MART

## SOFTWARE/GENERAL

**CPM-80 LIVES on your PC**  
 CPM/ulator puts a 4mhz 8 bit CPM emulator in your IBM-PC for \$99.  
 A great 8 bit development system  
 Saves expensive CPM-80 applications  
 Increases PC speed 10% for 8088 programs  
 Priced less than most software only products  
 - Uses no valuable board slots

**Source Information**  
 P.O. Box 2974, Warminster, PA 18974  
 Phone (215) 628-4719

Inquiry 733

## SOFTWARE/GRAPHICS

**FORTRAN PROGRAMMER?**  
 Now you can call 2-D and 3-D graphics routines within your FORTRAN program.  
**GRAFATIC:** 75 callable routines for screen output. \$135.  
**PLOTMATIC:** Pen plotter driver. \$135.  
 For the IBM PC, XT, AT and compatibles. We support a variety of compilers, graphics boards and plotters.

**MICROCOMPATIBLES**  
 301 Prelude Drive, Dept. B  
 Silver Spring, MD 20901  
 (301) 593-0683

Inquiry 711

## SOFTWARE/LANGUAGES

**CROSS ASSEMBLERS with "UNIVERSAL" LINKER and POWERFUL LIBRARIANS for IBM PC MS-DOS**

Full featured for most microprocessors

**ENERTEC, INC.**  
 BOX 1312, Lansdale, PA 19446  
 215-362-0966 **MC/VISA**

Inquiry 687

## APPLE II USERS:

**3780 RJE WORKSTATION EMULATION**  
**3270 TERMINAL EMULATION**

No special software or protocol converter is required in the mainframe. Interfaces to all major IBM operating systems. Fast, error-free bisynchronous transmission, easy to use. APPLE-BISYNC by Urgeo Software, Inc.

**Call us collect at: (509) 838-6058**

Inquiry 739

## GRAPHICS PRINTER SUPPORT

**AT LAST!** Use the *PrtSc* key to make quality scaled B&W or color reproductions of your display on any dot matrix, inkjet, or laser printer. **GRAFPLUS** supports all versions of PC or MS-DOS with IBM, Teemar, and Hercules graphics boards. \$59.95.

**Jewell Technologies, Inc.**  
 4302 SW Alaska St., Suite 207, Seattle, WA 98116  
 (206) 937-1081

Inquiry 760

## Symbolic Debugger for Turbo Pascal

- Set breakpoints at line numbers or procedures
- Display and modify variables symbolically
- Fully integrated into Turbo Pascal environment

Requires Turbo 2.0 or 3.0, IBM PC version.  
 Only \$49 plus \$2 S&H.

**KYDOR COMPUTER SYSTEMS**  
 812 S. Sherman St., Richardson, Texas 75081  
 (214) 669-1888

Inquiry 705

## SOFTWARE/LANGUAGES

**Boot Up Your Resume!**  
 Send your resume out on disk for a high impact impression. **THE RESUME DISK** offers standard resume form plus indepth information at a keystroke. Customize, update, and distribute your resume on **THE RESUME DISK**. IBM PC and compatibles. 128K/two drives. \$29.95. Checks. Visa/MC.

**MT. LOOKOUT SOFTWARE**  
 P.O. Box 26096, Cincinnati, Ohio 45226  
 513-871-5222

Inquiry 714

**\* INSTANT EDT/ASEM \$50 PPD \***  
 Full Macro Assembler. All the features of IBM's & Microsoft's. Syntax and file compatible. Runs like 'Turbo Pascal'. Write, assemble and run programs in seconds, in memory! 'WordStar' like editor built in. Supports full Intel 16-bit family. PC DOS-MS DOS compatible. Money back guarantee!

**Computer Solutions**  
 P.O. Box 354, Mason, Michigan 48854  
 1-800-874-9375 **VISA/MC** 1-517-628-2943  
 Catalog with 300 items sent with order.

Inquiry 669

## ATLAS SYNTAX VERIFIER & TUTOR

- \* In accordance with IEEE Std 716
- \* Save valuable test station debug time
- \* Runs on IBM PC or work-alikes
- \* \$400 each or \$550 for both

**DUBERT International, Inc.**  
 (619) 277-4700

Inquiry 745

## SOFTWARE/GRAPHICS

**THE DGI TYPE SHOP**  
 Turn your IBM or APPLE computer and HEWLETT-PACKARD plotter into a desktop publishing system. **THE DGI TYPE SHOP** offers a quick and economical alternative to typesetting - PLOTSETTING. Price \$175. Ten optional fonts that range from a very formal script to Greek - Scientific are available.

**DECISION GRAPHICS, INC.**  
 P.O. Box 2776-B, Littleton, Colorado 80161  
 Phone (303) 796-0341

Inquiry 679

**Minnesota SNOBOL4 Language**  
 Powerful string & data handling facilities. Interpreter compatible with mainframe SNOBOL4. 32K strings, 32 bit integers, 8087 for float & large memory model. Sample pgms include ELIZA. For >128K IBM PC & DOS or equivalent. Definitive "green" book by Griswold available.  
 Guide + 5 1/4" SSDD diskette..... \$44.95  
 Guide + diskette + "green" book..... \$59.95  
 "Green" book only..... \$24.95  
 Postpaid in USA. In NY add tax. **VISA/MC (914) 271-5855**

**BERSTIS INTERNATIONAL**  
 POB 441, Millwood, NY 10520

Inquiry 655

## K&R standard C COMPILER with extensions

Assembler, Overlay Linker, Librarian, Unix-like Shell w/hierarchical directories, Library source for Shell and ProDos interface, allows production of stand-alone programs. CDOS version w/complete o/s source \$49.95. ProDos versions: Entry: \$49.95, Professional \$99.95. No license fee.

**WSM GROUP INC.**  
 1161 N. Eldorado Place, #241, Tucson, AZ 85715  
 (602) 298-7910

Inquiry 767

**Z-100 GRAPHICS FOR TURBO**  
 Provides the graphics support that PC users get in Turbo Pascal 3.0 plus many enhancements for the Zenith Z-100. Handcrafted in Pascal and assembly language. Full source code included! Requires: 64K color ram, Turbo 2 or 3, MS-DOS. Price: \$29.95.

**Zimbazi Products**  
 7405 Berkman Drive, Austin, Texas 78752

Inquiry 755

**RUN FAST, LOOK BEAUTIFUL**  
 If this is what people expect from your BASIC programs, then you need YES MASTER! A DOS-resident development aid that includes a screen painter, an ISAM file manager, a window manager, a printer generator and more. All in one package. \$245. No royalty.

**SOFTWAY, INC.**  
 500 Sutter St., Suite 222 BC  
 San Francisco, CA 94102  
 (415) 397-6666

Inquiry 759

**68020**  
 Motorola compatible macro Assembler Package features linker, object librarian, symbol report generator with cross reference. Produces S-records and ROMable code. For CPM-68K, MS-DOS \$750. Portable Source in C \$3500. AVAILABLE NOW.

**Quelo, Inc.**  
 2464 33rd Ave. W. Suite 173, Seattle, WA 98199  
 206/285-2528 telex 910-333-8171

Inquiry 728

**ENG/SCI GRAPHICS PLUS**  
 GRIDS software system for mapping and processing 3D data on PCs and MINIs. Contouring, gridding, interpolation, Fourier transforms. No Programming. Large data sets. Screen, printer and plotter support. Grid operations in space and freq. domains. \$400.

**Machine Algorithms**  
 1515 - 9th St., Boulder, CO 80302  
 303-442-1072

Inquiry 706

**FINALLY!**  
**A Subroutine Library for Compiled BASIC**  
 OVER 100 SUBROUTINES AND FUNCTIONS for Use with MicroSoft QUICK BASIC or IBM BASIC Compiler 2.0. Full Documentation Package with Examples, 30 Day Money-Back Guarantee. **VISA/MC FINALLY!** is only \$99.00 + \$4.00 S&H

**KOMPUTERWERK, INC.**  
 851 Parkview Blvd., Pittsburgh, PA 15215  
 (412) 782-0384

Inquiry 703

**\$25 BASIC Screens & Forms**  
 Generate any size screen or form for input or output quickly. **SCRENGEN.COM** writes BASIC subroutines for incorporation into your program. Fully documented, not copy protected. Available in most CPM formats and MS-DOS & Atari 520ST - Specify BASIC version used.

**GALAXY COMPUTERS**  
 8112 5th Ave., Brooklyn, NY 11209  
 718-238-0464

Inquiry 693

# THE BUYER'S MART

## SOFTWARE/LANGUAGES

### UNIVERSAL CROSS-REFERENCER

—WORKS WITH ALL LANGUAGES—  
BASIC, C, Pascal, FORTRAN, COBOL, ASM...  
*You name it!*

MS/PC-DOS V2+, IBM PC, XT & compatibles  
Unbeatable at \$39.95 + \$3 s/h. MC/Visa/Check

#### DALSOFT SYSTEMS

3565 High Vista, Dept E2  
Dallas, TX 75234 (214) 247-7695

Inquiry 674.

## SOFTWARE/SCIENTIFIC

### SYSTEM DESIGNER

SD is a tool for the design of hierarchical systems and processes, representable by trees. SD breaks a task of designing a large system into a great number of small, easy tasks while keeping track of all pieces. SD plots a graph of a tree representing the proposed system. The price is \$399.

#### CUSTOM SYSTEMS

23 Crestwood Ct., Lansdale, PA 19446  
(215) 468-7773

Inquiry 766

## SOFTWARE/SCIENTIFIC

### CADD for \$99.95

FEATURES: Drawing layers • User Defined Fonts  
• Component Libraries • Video & Digitizer Menus  
• Color Graphics.

Autocad™ file conversion - \$24.95

Dot Matrix Printer/plotter option - \$24.95  
MC, VISA, COD, add \$3.00 for shipping  
60 day money back guarantee.

#### GENERIC SOFTWARE

13250 N.E. 40th St., Bellevue, WA 98005  
1-800-228-3601

Inquiry 694.

### WINDOW & SCREEN Mang'it

For Modula 2, C, Pascal, IBM/compatibles, Atari 520ST. Create overlap, pop-up menu/screen/windows without touch program, beat 64K limit. Save, move, zoom/shrink swap/delete, color, border, header, cursor control. \$59.00 VISA/MC.

#### APPLIED COMPUTING

3368 Westchester Rd., Bloomfield Hills, MI 48013  
519-254-4472

Inquiry 653.

### Affordable Engineering Software

CALL OR WRITE FOR FREE CATALOG  
Circuit Analysis • Root Locus • Thermal Analysis • Matrix Manipulation • Signal Processing • Filter Design • Graphics • Text Proofreader

#### BV Engineering

2200 Business Way Suite 207, Riverside, CA 92501  
VISA/MC (714) 781-0252

Inquiry 662

### —LINCAD-PC FOR DESIGN—

An interactive program for linear electronic circuits. Graphics, Optimization, Sensitivity, Filters, Active Devices, OpAmps. Introductory offer, \$79 for IBM/PC disk and manual + \$3.50 S/H. Oh. Res. add 5.5% sales tax. Check or M.O.

#### SOFCAD ELECTRONICS, INC.

P.O. Box 21845, Columbus, Ohio 43221

Inquiry 732.

## SOFTWARE/SCIENTIFIC

### ENGINEERING SOFTWARE WRITTEN BY ENGINEERS FOR ENGINEERS

Highest power per dollar. Highest power per K of memory. Satisfaction guaranteed.

Electronic Circuit Analysis ..... \$450.  
Logic Simulation System ..... \$395.

#### TATUM LABS

33 Main St., Newtown, CT 06470  
(203) 426-2184

Inquiry 737.

### BEAM ANALY. & SPRING DESIGN

Beam analysis program calculates shear, moments, reactions, slopes and deflections in beams. Price: \$50.00. Helical spring design program for compression, extension and torsion springs. Price: \$75.00. Both packages include disk and documentation. For Apple II series of computers or IBM PC, PCjr and compatibles.

#### SYLCA CORPORATION

33-47 14 Street, Dept B, Long Island City, NY 11106  
718-278-4604

Inquiry 734.

## SOFTWARE/SYSTEMS

### LASER TYPOGRAPHY \$495.

Typographic composition software to drive the Corona L300 Laser Printer as a typesetter. H & J 24 proportional space fonts, widths for 78 fonts available. Mix face & point size on any line, multicolumn capability.

#### Micro Print-X, Inc.

P.O. Box 581, Ballinger, TX 76821  
(915) 365-2343 Dealer Inquiries Welcome

Inquiry 712.

### Digital Logic Design on the Macintosh™

The LogicWorks™ series allows you to create, test and document digital circuitry on your Macintosh. Full simulation capability lets you catch design errors before committing your circuit to hardware. From \$79.95 (US). Demo pkg. \$10. Visa/MC Accepted.

#### Capilano Computing Systems Ltd.

Box 86971, N. Vancouver, B.C., Canada, V7L 4P6  
(604) 669-6343

Inquiry 663.

### ► SCIENTIFIC CALCULATOR ◀

Memory resident emulation of the HP-11C plus direct insertion of results in foreground program, graphically presented, decimal, hex, binary, & octal operations, boolean functions and more. Mouse support. 8087 or Standard versions \$49.95 + 3.00 s&h.

#### K SOFTWARE HOUSE

Rt. 2, Box 83B1 Unionville, TN 37180  
(615) 294-5090

Inquiry 704.

### BACKBONE™

The Easy DOS-Interface for IBM PC/XT/AT and Compatibles. Customize linked menus with the MENU PROCESSOR™. Then, any program, batch process, submenu, even DOS, may be accessed by a keystroke. A perfect hard disk organizer, ideal for LAN'S. Provides speed, convenience, simplicity. Only \$39.95 + \$4 p&h Guaranteed! And Well Supported!

#### SYNCHRONY SYSTEMS

4191 San Juan Ave., Jacksonville, FL 32210  
Orders: 1-800-237-6360 x314 In FL 1-800-282-1152 x314

Inquiry 735.

### DIGITAL SIGNAL ANALYSIS

Fourier Perspective II w/graphics. FFT/IFFT, convolution, deconvolution, Hanning, Power Spectrum, Cross Correlation, 25 more. Graphics 2D and 3D. 8087 recommended, not required. Easy to use menus. FP II \$395 or FP I (FFT w/graphics only) \$149. Runs on PC, PC-XT, PC-AT.

#### Alligator Transforms Scientific Software

P.O. Box 11386, Costa Mesa, CA 92627  
(714) 662-0660

Inquiry 650.

### MATRIX 100

Powerful Matrix operations with single statements in IBM PC BASIC. Perform multiple regression, solve simultaneous equations, invert matrices, etc. MATRIX 100 commands are fast, reliable and easy to use. Price \$80. 8087 support \$125; compiler support \$250. (\$4 shipping & handling, CA res. add sales tax).

#### STANFORD BUSINESS SOFTWARE, INC.

4151 Middlefield Rd., Suite 215, Palo Alto, CA 94303  
To Order Call (415) 424-9499

Inquiry 758.

### ACT1 PROFESSIONAL FULLY INTEGRATED ACCOUNTING SYSTEM for PC-DOS

Proven 3½ years. Includes General Ledger, Accounts Receivables, Order Entry/Inv., Accounts Payable, Inventory, Payroll (incl. Post Facto).

only \$99.50 plus ship. & hand.

(800) 344-2540

#### Cougar Mountain Software

Box 6886, Boise, ID 83707

Inquiry 672.

### FORTRAN SOURCE CODE

PROFESSIONAL SIGNAL PROCESSING & MATRIX ANALYSIS UTILITIES

34 PROGRAMS W/TUTORIAL & EXAMPLES  
Spectral Analysis, Digital Filters, Singular Value Decomp, Conj. Gradient, Root Finder, Graphics, More. Disk/Hardcopy. Documented. Arch Bibliography. Send for info. \$99.

#### CLAREN SOFTWARE

P.O. Box 5333 • MESA, AZ 85201

Inquiry 665.

### CMX MATRIX CALCULATOR

Evaluate complicated matrix expressions as easily as arithmetic on a calculator. Over a dozen useful operators invoked by a single keystroke. Fully prompting learning mode plus a rapid entry silent mode. MS/PC-DOS or CP/M68K (Sage/Stride) versions. \$55.

#### Estanco, Inc.

444 So. Cotner Blvd., Lincoln, Nebraska 68510  
phone (402) 489-6435

Inquiry 688.

### pcSHARE MULTI-USER O/S

pcSHARE allows your IBM-XT/AT or compatible to support up to 5 users running 1-2-3, dBASE, WordStar, etc. on inexpensive serial CRTs. For software developers, pcSHARE efficiently runs compiled Basic, Pascal & C programs with full DOS 3.0 compatible record locking.

#### DIGITROL COMPUTERS INC.

440 Phillip Street  
Waterloo, Ontario, CAN, N2L 5R9  
(519) 884-4541

Inquiry 744.

# THE BUYER'S MART

## STATISTICS

### STATISTIX™

\$75 - Satisfaction guaranteed

A comprehensive, powerful, yet easy-to-use statistical analysis system for IBM PC/XT/AT's, Apple II's, and MS-DOS machines. Clear 200p manual. Write for information.

#### NH ANALYTICAL SOFTWARE

801 West Iowa Ave., St. Paul, MN 55117  
(612) 488-4436

Inquiry 722.

## UTILITIES

### SOFTWARE DEVELOPMENT LIBRARY SYSTEM

**TLIB™** keeps ALL versions of your program in ONE compact library file, even with hundreds of revisions.

- 5 times faster than Unix SCCS
- LAN-shared libraries with PC Network

#### BURTON SYSTEMS SOFTWARE

POB 4156, Cary, NC 27511  
(919) 469-3068

Inquiry 727.

## UTILITIES

### ZERODISK

ZeroDisk runs dozens of copyprotected business packages from your hard disk without floppies. Call for the latest list of software it handles. Needs IBM AT, XT, PC, or compatible, DOS 2.0 or higher. ZeroDisk is revised monthly and is not copy protected. \$75 US. Check or Credit Cards accepted.

#### QUAID SOFTWARE LIMITED

45 Charles St. E. 3rd Fl.  
Toronto, Ontario, Canada M4Y 1S2  
(416) 961-8243

### The Statistician

Includes: Multiple Regression (Stepwise, ridge, all subsets, backward elimination)

- Time series analysis • descriptive statistics
- transformations • survey research • nonparametrics
- X-Y plots • ANOVA • random samples • data base
- data editor • search & sort • hypothesis tests

For IBM, MS-DOS, XENIX, CPM, TRS-DOS.

Please call TOLL FREE 1-800-334-0854 (Ext. 814)

#### QUANT SYSTEMS

Box 628, Charleston, SC 29402  
803-571-2825

Inquiry 764.

### IBM PC UTILITIES \$19.95

This high value utility package has 20 powerful system utilities. Some of the functions included are user spec'd keyboard redefinition, file compare, set screen colors, directory renaming, disk park, file kill & more. For information contact

#### Radcliffe R&D

4449 Snowden Ave., Lakewood, CA 90713  
(213) 420-3744

Inquiry 730.

### BASIC PROGRAMMERS

Add SALT & PEPPER to your existing/new programs. Create dazzling Menus, intelligent Input Screens, Walking Strings, ASC/Desc Sort, PRT, SCR, Date processing & more. SALT & PEPPER has 28 modules. (in MS-DOS compatible BASIC). They merge with your program in minutes. S & P performs all the tricks, YOU get the applause. \$59.95 plus \$2.50 s&h. Demo disk \$2.50 ppd. MC/VISA

#### COMPUTER GURU

40 Wagner Ave., Piscataway, NJ 08854  
201-356-6477

Inquiry 667.

### NUMBER CRUNCHER STAT SYS

Menu-driven. Multiple & stepwise regression, ANOVA, time series, discriminant analysis, principal components, scatter plots, histograms, t-tests, contingency tables, nonparametrics. Import export data. Sort, join, merge. Site license \$79. IBM PC/Macintosh.

#### NCSS-B

865 East 400 North, Kaysville, UT 84037  
801-546-0445

Inquiry 717.

### MEDIA MASTER PLUS

READ, WRITE, and FORMAT over 60 CP/M disks and run most CP/M-80 programs on your IBM PC! Two program package includes ZPIEM, a CP/M-80 emulator program that transforms your IBM PC into a 1-2 MHZ CP/M 2.2 computer. \$59.95 + \$3.00 S/H (CA 6%)

#### INTERSECTING CONCEPTS, INC.

4573 Heatherglen Ct., Ste. 10  
Moorpark, CA 93021  
(805) 529-5073

Inquiry 702.

### IBM - TOSHIBA PRINTER INTERFACE

- all extended capabilities of the TOSHIBAS available
- bit mapped graphics supported
- Prints all IBM extended ASCII characters
- screen dumps in text and graphics
- escape sequences supported
- popular software supported directly
- "Sideways" and "Pyxel Visuals" support
- dealers welcome \$79.95 (\$2.50 S&H)

#### Integrated Data Technologies, Inc.

4775 Bunchberry Lane, Colorado Springs, CO 80917  
303-488-2583 MC/VISA

Inquiry 700.

### RATS!

RATS is a fast, accurate & complete regression package with unsurpassed POWER. Has both time-series & cross section analysis. Includes Box-Jenkins, logit & probit. Spectral analysis & graphics also available. Requires 256K RAM, IBM PC or compatible. \$200. MC/VISA.

#### VAR Econometrics

P.O. Box 19334, Minneapolis, MN 55419  
(612) 822-9690

Inquiry 740.

### DOS PATHING EXTENSION

Give your software the full PATHING capabilities that are missing from the 2.xx and 3.xx versions of MS-DOS and PC-DOS. FULLPATH object license: \$19.95, source license: \$399.95, (+ \$5 S&H + 6% in MN). VISA/MC/PO/CHK 30 day money back guarantee.

#### P. R. GLASSEL and ASSOCIATES, INC.

30255 Fir Trail, Stacy, MN 55079  
612-462-1337

Inquiry 748.

### "USER-FRIENDLY" REDEFINED

Don't laugh. Now if your P.C.'s aren't friendly, it's your own fault. Meet TheEMCEE, your application manager. Replaces DOS prompt with custom menus. Runs programs, batch files and menus. 99 levels of password protection. Fast, friendly interface for users, powerful access and control for systems managers. Only \$49.95. What could be friendlier than that?

#### COMMAND SOFTWARE SYSTEMS, INC.

1-800-423-9147 or 1-818-707-7100

Inquiry 765.

### STATISTICS CATALOG!

If you need statistics for IBM PC or Apple II, call us and let our technical advisors help you find the statistics programs you need.

Write or call now to get a FREE catalog of statistics and quality control software.

#### HUMAN SYSTEMS DYNAMICS

9010 Reseda Blvd., Ste. 222  
Northridge, CA 91324

(800) 451-3030 (818) 993-8536 (CA)

Inquiry 698.

### PACKED UTILITY DISK

HOT  
STUFF!!

**\$10**

FOR  
IBM-PC

EXPECT A MIRACLE!

#### MICRO TOOLS INC.

POB 357 N. Chili, NY 14514 (716) 594-1088

Circle the Inquiry #713 . . . We'll do the rest

Inquiry 713.

## MMZ8 BUS/HARDWARE

### BCC 52 AND MMZ8 BUS COMPATIBLE

16 channel, 12 bit plus sign and overrange bit, A/D converter board is designed to interface to the MMZ8 Bus. Input voltage ranges include 0v to +10v, -10v to +10v, and -5v to +5v. Custom calibration is available. Software and documentation included. Price \$160 plus \$4 shipping and handling.

#### SMR DESIGN AND PROGRAMMING CO.

17509 Mapleboro Ave., Maple Hts., Ohio 44137  
(216) 663-7809

Inquiry 651.

Advertise your computer products for  
as little as \$325 in THE BUYER'S MART.  
For more information call  
Karen Burgess at BYTE 603-924-3754.

# WE HAVE THE LOWEST PRICES – MOST ITEMS IN STOCK WE WILL BEAT ANY ADVERTISED PRICE ON THE SAME TERMS!

## SPECIAL #1

### CORONA PORTABLE

- IBM Compatible
- 256K • 2 Drives
- Monitor • Keyboard • DOS

**\$1195**

All Sales Are Warranted for 90 Days, Parts & Labor

**WE SERVICE WHAT WE SELL!**

## MAIL ORDER AND SAVE

ORDER TOLL FREE (800) 621-0849 ext. 446

## SPECIAL #2

### IBM PC 256K

- Two 360K Drive

Only

**\$1499**

## SPECIAL #3

### COMPAQ PORTABLE

- IBM Compatible
- 256K • 2 Drives
- Monitor • Keyboard • DOS

**\$1875**

## SPECIAL #4

### COMPAQ 286 PORTABLE

- IBM AT Compatible • DOS
- 1.2 Meg Floppy • 640K
- 20 Meg Hard Disk • Monitor

**\$4589**

## SPECIAL #5

### 20 MEG HARD DISK FOR IBM

- Seagate
- Western Digital

**\$495**

## SPECIAL #6

### PC XT COMPATIBLE

- 256K • Two 360K Drives
- Keyboard • Green Monitor
- w/Graphics • Dos 2.1

**\$799**

## SYSTEMS

### IBM

PC 256K, 2 Drives .....\$1575  
XT 256K, 1 Drive ..... 1880  
XT 256K, 1 Drive 1-10 MG 2280

### COMPAQ

Portable, 2 Drives, 256K ..\$1875  
Call on Desk Pro's

### CORONA

Portable .....\$1195  
Desk Top, 2 Drives, 256K  
w/monitor ..... 1479

## MONITORS

### PRINCETON GRAPHICS

Max 12E .....\$159  
HX-9 ..... Call  
HX-12 ..... 425  
SR-12 w/doubler board ... 749

### TAXAN

620 Color .....\$399  
640 Color ..... 499  
121 Green ..... 125  
122 Amber ..... 135

### AMDEK

310A .....\$145  
600 Color ..... 389  
722 Color ..... 519

## PRINTERS

### EPSON

Call for Best Pricing

### OKIDATA

182, 120 cps .....\$218  
192, 160 cps, w/Roms .... 349  
193, 160 cps, IBM ..... 499  
84, 200 cps, IBM ..... 658  
OKI-MATE 20, Color, IBM . 229

### TOSHIBA

P1340 .....\$ 519  
P351 ..... 1059

### STARMICRONICS

SG10/15 .....\$219/389  
SD10/15 ..... 355/469  
SR10/15 ..... 489/589

### CITIZEN

MSP-10 .....\$259  
MSP-15 ..... 369  
MSP-20 ..... 399  
MSP-25 ..... 549

## DISKETTES

Qty. BULK PRICES

100 SS/DD 5¼ .....\$ 59.00  
100 DS/DD 5¼ ..... 69.00  
100 1.2MG for AT 5¼ .299.00

## IBM EXTRAS

### AST RESEARCH

SixPak+, 64K w/Side Kick ..\$209  
Reach w/Crosstalk ..... 369  
Preview Mono Card ..... 239  
Advantage w128K ..... 399

### D & D MEMORY CARD

MF-100+, 64K same/6Pak +\$109

### HERCULES

Color Card w/Printer Port ..\$149  
Mono Graphics Card ..... 305

### GOODIES

IBM Printer Cable .....\$19  
64K Ram Set of Nine Chips . 11  
256K Ram Set of Nine Chips 39  
Power Supply 135 Watts .... 84  
8087 CoProcessor ..... 109  
DOS 2.1 ..... 55  
DOS 3.1 ..... 64

## MODEMS

### HAYES

Micromodem IIE .....\$159  
300 ..... 149  
1200 ..... 379  
1200B IBM Internal ..... 349  
2400 External ..... 639

### PROMETHEUS

Promodem 1200 .....\$295  
Promodem 1200A ..... 309  
Promodem 1200B ..... 275  
Promodem 1200MAC ..... 339

## DISK DRIVES

### IBM COMPATIBLE

Teac 55B .....\$99  
Mitsubishi 4851 ..... 99  
Tandon TM 100-2 ..... 99  
Siemens DT542 ..... 89  
In quantities of 2 or more

### TEAC

55B, 320K .....\$119  
55GF, 1.2MG for AT ..... 149

### 100% APPLE

### COMPATIBLE 5¼"

525A for Ile and II+ .....\$109  
525C for IIc ..... 119  
350M for Mac ..... Call

## HARD DISKS

10 Meg for PC .....\$259  
20 Meg for PC ..... 359  
20 Meg for AT ..... 489  
30 Meg for AT ..... 789  
Controller for PC ..... 135

## BUILD A P.C.

640K Mother Board  
w/8 Slots .....\$179  
Flip Top Case w/speaker... 59  
Disk Controller ..... 49  
Color Card ..... 99  
Monochrome Card ..... 129  
5151 Keyboard ..... 99  
Dual Drive Kit ..... 189  
135 Watt Power Supply .... 79

**WE OFFER VOLUME DISCOUNTS! MAKE THAT CALL (800) 621-0849 ext. 446**

## SPECIAL #7

### PC XT Compatible Turbo

- 640K • 8 MHz • Keyboard
- Color Graphics • Color Monitor
- Dos 2.1

Complete **\$1149**

## SPECIAL #8

### IBM AT COMPUTER SYSTEM

- 20 Meg Hard Disk • 1.2 Meg Floppy
- Color Graphics • Color Monitor • Dos 3.1

**FREE UPS SHIPPING ON SPECIAL #8**  
**\$4,399**

## SPECIAL #9

### 10 MEG HARD DISK

- For IBM or Compatible

Complete **\$379**

**d&d Discount Computers**

SELLING TO YOU SINCE 1978

### MAIL ORDER:

13324 HAWTHORNE BLVD., SUITE 201  
HAWTHORNE, CA 90250

### ORDER DESK:

Inside California (213) 970-0206  
Outside California (800) 621-0849 x446

Hours: Monday—Friday 8 am to 6 pm  
Open Saturdays

WE CARRY TOO MANY ITEMS TO LIST.  
PLEASE CALL FOR A QUOTE ON ANY ITEM.



No Surcharge for Credit Cards

Terms: Prices reflect a cash prepaid discount. All merchandise new. We accept MC, Visa, Wire Transfer, C.O.D.'s require deposit, Certified Check, P.O.'s from qualified firms. Shipping: minimum \$4.00 first 5 pounds. Tax: California residents only add 6½% sales tax. All returns subject to 15% restock fee. Prices Subject to Change.



**SUN-ST COMPUTER SYSTEM**

**8 MHZ HIGH-SPEED**

**\$995<sup>00</sup>**



SUN-ST Computer System is an IBM Compatible System. It works with the same software used on the IBM; Lotus 1-2-3, Symphony, DBASE II & III, Framework, AutoC.A.D., Wordstar, MultiPlan, etc.

The basic system is fully operational. All you need to do is insert your DOS disk and application software. (Does not run programs that require ROM BASIC).

- Uses MS & PC DOS Operating System & XENIX Compatibility.
- 8MHz High Speed Operation Clock.

**HARDWARE INCLUDES:**

- 8 MHz CPU Board with 640K, 70% Faster Speed
- Computer Cabinet
- Enhanced Full Function Keyboard (Large RTN & Shift Keys)
- 2 Disk Drives (DSDD, 360KB, 1/2 Height)
- 135 Watt Power Supply
- Floppy Disk Controller
- 12" Green High-Resolution Monitor (TTL)
- Monochrome Graphic Card (720x348) with Parallel Printer Port
- Fully Assembled and Tested
- Meets FCC Class "A" Reg. for Industry & Business Use.

**SUN XT OEM System**

- SUN-XT CPU
  - 640K RAM
  - 135 WP.S
  - FDC W/Cable
  - Computer Cabinet
  - Full Function Keyboard
  - No Disk Drive
  - No Graphic Card
  - No Monitor
- System 1**  
**\$455<sup>00</sup>**  
(For Qty. 5-up)

- SUN-XT CPU
  - 640K RAM
  - 135 WP.S
  - FDC with Cable
  - Computer Cabinet
  - Full Function Keyboard
  - 1 Disk Drive
  - Mono G Card or Color G Card
- System 2**  
**\$625<sup>00</sup>**  
(For Qty. 5-up)

**SUN-XT Computer System**

- SUN-XT CPU w/640K
  - 2 Disk Drive w/Controller
  - Mono G Card w/Parallel P Port
  - 12" Green TTL Monitor
  - 135 W.P.S & Keyboard
  - Assembled & Tested
- ★ Please Call for Other Configurations Available.  
**\$895<sup>00</sup>**

**SUN AT Computer System**

- SUN-AT w/640K RAM
  - 1.2MB Disk Drive (1 each)
  - 200 W.P.S.
  - FDD & Hard Disk Controller
  - AT Enhanced Keyboard
- A&T ..... **\$1795<sup>00</sup>**

**SUN-XT CPU**

- 8088 CPU (8087 Option)
- RAM Expandable to 640K
- Fully IBM Compatible
- Same Dim. as IBM PC/XT
- No RAM Included
- 8 Expansion Slots

**\$165<sup>00</sup>**

**SUN-ST CPU**

Fully IBM PC/XT Compatible  
Run 8MHz using 8088-2 with 8087-2 Optional.  
Same Dimension as IBM PC/XT  
Expandable to 640K

**\$245<sup>00</sup>**

**SUN-AT CPU Board**

- 80286 CPU (80287 Optional)
- 640K Memory
- 6MHz System Clock
- Built-in Real-time Clock (Battery Back-up optional)
- Dimensions & Expansion same as IBM-AT (6-16 bit, 2-8 bit)
- Expand Multi-User Many Megabyte with XENIX
- Fully IBM/PC Compatible
- With BIOS

**\$899<sup>00</sup>**

**"GOLD STAR" RGB Monitor**

- 13" Display DB-9 Connect
- 640x400 High-Resolution (Requires Special Card)
- 2500 Characters (80x32)
- RGB TTL Level Signal
- 0.31MM Dot Pitch

**\$365<sup>00</sup>**

**Monochrome Graphics Card**

- 720(H) x 348(V) High-Res
- 80x25 Text Mode
- Runs Lotus 1-2-3, ect.
- With Parallel Printer Port

**\$110<sup>00</sup>**

**Color G Card**

- RGB & Composite Video
- 640x200 High-Res (B&W)
- 320x200 Mid-Res (Color)
- 80x25 Text Mode
- Light Pen Interface
- 16 Colors (160x100)

**\$99<sup>00</sup>**

**PC/XT Power Supply**

135 Watt **\$89<sup>00</sup>**  
150 Watt **\$109<sup>00</sup>**

**Floppy Disk Controller**

- Standard 5 1/4" DSDD
- Run 2 Internal & External Ports
- Cable for Internal Drive

**\$49<sup>00</sup>**

**Multi-I/O Plus Board**

- Parallel Printer Port
- Serial I/O Port (Opt. Dual)
- Clock Cal. w/Battery Back-up
- Game Port

**\$110<sup>00</sup>**

**Hi-Res Mono Monitor**

- 12" Green Monitor
- 800 Lines at Center
- 18MHz Band Width
- Separate TTL Sig. Input
- Dual Intensity Sig. Level

**\$105<sup>00</sup>**

**Full Function Enhanced Keyboard**

- Enhanced Layout like AT Keyboard
- Large Return Key
- Large Shift Key
- Caps, Numeric, Scroll, Lock Light Indicator

**\$75<sup>00</sup>**

**IBM PC/XT Style Case**

- 8 Slot Back Panel
- Incl. Mount Brk/Hardware
- Fits IBM Power Supply
- Side Switch Hole

**\$49<sup>00</sup>**

- AT Style Cabinet ..... **\$110<sup>00</sup>**
- 200 W Power Supply ..... **\$169<sup>00</sup>**
- AT Style Enhanced Keyboard ..... **\$110<sup>00</sup>**
- FDD & Hard Disk Controller ..... **\$265<sup>00</sup>**
- 1.2 MB 5 1/4 Disk Drive ..... **\$142<sup>00</sup>**
- 20MB Hard Disk Drive ..... **\$699<sup>00</sup>**

- 10Mb Hard Disk w/Controller ..... **\$450<sup>00</sup>**
- 20 Mb Hard Disk w/Controller ..... **\$550<sup>00</sup>**
- ASYNC RS232 Card ..... **\$59<sup>00</sup>**
- Parallel Printer Port ..... **\$39<sup>00</sup>**
- Dual Game Port ..... **\$39<sup>00</sup>**
- 576K RAM Expansion Card (OK) ..... **\$59<sup>00</sup>**
- KB5151 Compatible Keyboard ..... **\$109<sup>00</sup>**
- EPROM Prog. (2716, 32, 64, 128) ..... **\$139<sup>00</sup>**
- 256K RAM Kit (9 each) ..... **\$35<sup>00</sup>**
- Parallel Printer Cable ..... **\$15<sup>00</sup>**
- 6 Outlet Surge Suppressor (Midland Ross Ind.) ..... **\$14<sup>50</sup>**
- Citizen MSP-10 ..... **\$299<sup>00</sup>**
- Citizen MSP-15 ..... **\$375<sup>00</sup>**
- Swivel Monitor Base (MN-5) ..... **\$15<sup>00</sup>**
- Tatung 1370 High Resolution (800x400 with BOB Card) ..... **\$870<sup>00</sup>**
- 5 1/4" DSDD 1/2 Height Disk Drive ..... **\$89<sup>00</sup>**



**SUNTRONICS CO., INC.**

12603 Crenshaw Blvd., Hawthorne, CA 90250

**TERMS:** VISA, MasterCard (No Surcharge), C.O.D., Cash or Certified Check (VISA or MC Ref. Required), School & Gov. Contractor P.D. accepted. SHIPPING & H/C \$4.00 for 3 lbs plus \$.60 for each additional lb. CA residents add Calif. sales tax. \$10.00 Min. order. IBM is a registered trade mark of International Business Machines

# CCT-4 SYSTEM SERIES

The latest CCT implementation of the new generation Intel 16-Bit Processor technology. This means extreme speed, unequalled power, and the ultimate in reliability, and of course, the innovators at CCT behind it.

This series in the CCT line exploits the speed and power of the Intel 80286 and Zilog Z-80H (8MHz), on the 286Z CPU board. This combination, along with CompuPro DMA controllers and I/O boards, yields a dramatic improvement in system throughput speeds, from basic CP/M operation, up to large powerful multi-user/multi-tasking machines. The CCT-4 represents the most advanced hardware presently available in a microcomputer to run the thousands of CP/M type software programs on the market, and with CONCURRENT DOS 8-16 and the CompuPro PC Graphics board (when available), all software written for the IBM PC machines. This series is for the serious business/scientific user.

**CCT-4A** State-of-the-art power in it's basic form. Consists of CCT-286Z CPU board and CCT-M256 (256K), along with CompuPro: Enclosure 2 Desk (21 slot MF), Disk 1A, System Support 1, Interfacer 4, the CCT-2.4 floppy drive system, and CP/M 8-16, and with SF-200 surge suppressor system. . . . . **\$5,269.00**

**CCT-4B** Single-user/hard disk power. As the 4A, except priced without the CCT-2.4, to add in your choice of CCT hard/floppy combination drive subsystem, at the published pricing. . . . . **\$4,149.00**  
 (Example: CCT-4B Mainframe with CCT-10/1 = \$6,198.00) Plus cost of selected drive subsystem

**CCT-4C** Multi-user/hard disk power. As the 4B, with the CCT-M512 (512K static RAM board) instead of M256; Interfacer 3 instead of Interfacer 4; SF-400 instead of SF-200, plus Concur. DOS 8-16 O.S. (4 to 6 user system) . . . . **\$4,999.00**  
 (Example: CCT-4C Mainframe with CCT-40/1 = \$8,048.00) Plus cost of selected drive subsystem

**BATTERY BACK-UP ON CCT RAM!**

**Limited Time Offer - FREE 80287 Math Chip with any CCT-4!**

The above systems include all necessary cabling, assembly, testing, minimum 20 hour burn-in, and the CCT unconditional 12 month direct warranty.

**HUGE PRICE CUTS!**

**CCT-M512** WORLD'S TOP SELLING CCT STATIC RAM. IEEE Standard 12MHz. 512K in one slot! — **Special Price: \$799**

**CCT-M256** 256K version of M512 upgradeable to full 512K. Perfect 256K RAM board for any CompuPro system . . . . **\$439**

## CUSTOM COMPUTER TECHNOLOGY / BOX 4160 / SEDONA, ARIZONA 86340

TOLL FREE ORDERING: 800-222-8686 / For technical support / service: 602-282-6299

# IBM XT & AT Compatible Systems

### MONITOR ADAPTORS

- Mono w/o printer port . . . . \$89
- Color Graphics w/o pp . . . . \$89
- Mono w/printer port . . . . \$115
- Color Graphics w/p. port . . . \$115
- Mono Graphics w/p. port. . . \$135
- STB Chaffer . . . . . \$299
- Everex EDGE . . . . . \$299
- Taxan 555 . . . . . \$225
- Genoa Spectrum . . . . . \$315

### MULTIFUNCTION BOARDS

- AST Six Pak 64K . . . . . \$265
- 64K Generic 6-pack . . . . . \$145

### MISC. ITEMS

- Floppy controller . . . . . \$59
- Hard disk controller . . . . . \$175
- Floppy Drives . . . . . Call
- 135 W Power Supply . . . . . \$85
- 150 W Switching PS. . . . . 135
- XT Mother Bd OK . . . . . \$250
- Turbo Mother Bd OK . . . . . \$350
- Chassis . . . . . \$89
- 5150 style Keyboard . . . . . \$99
- 5151 style Keyboard . . . . . \$155
- AT style for XT. . . . . \$135

**AT SOLUTION** **\$ 1895**  
**IBM AT compatible**

- 1024K RAM on the Mother Board
- 1.2 Meg Floppy drive
- 192W Power Supply, 6 Keyboard
- Clock Calendar

**TURBO SOLUTION** **\$ 775**

360 Floppy, 640K, 135 watt power supply, 8 slots, Keyboard  
**Turbo Systems are equipped with 8088-2 processor with dual speed 4.77 & 7 MHZ. 40% Faster than IBM XT**

**PC SOLUTION XT . . . . \$649**  
 360K Floppy, 256K RAM, expandable to 640K, 135W Power Supply, enhanced Keyboard

**Complete System . . . . . \$995**  
 Two 360K Floppies, 256K Ram , 135W Power Supply, 8 Slots , Keyboard, Monographics adaptor, TTL Monitor, printer port.  
**Call for SUPER XT & Hard disk Configurations**

Maryland & D.C. Residents Include 5% Sales Tax.  
 All returns require RMA No. and subject to 15% restocking charge.  
 Advertised prices for mail orderonly. Retail prices slightly higher.  
 Prices subject to change, and limited to stock on hand. We reserve the right to limit quantities.

### Hard Disks & Controllers

- 20 Meg Internal . . . . . \$475
- 30 Meg Internal . . . . . \$895
- 20 Meg card. . . . . \$995
- 20 Meg streamer. . . . . \$725
- 10 Meg Reel tape. . . . . \$545

### MODEMS

- Hoyes 1200 . . . . . \$399
- Hoyes 1200B . . . . . \$355
- Everex 1200B . . . . . \$195

### MONITORS

- NEC TTL . . . . . \$160
- Amdek 310A . . . . . \$189
- PGS MAX-12 . . . . . \$185
- PGS HX-12 . . . . . \$450
- NEC Color . . . . . \$395
- Toxon 640 . . . . . \$550
- Xtron TTL . . . . . \$125

### PRINTERS

- Star 5G-10 . . . . . \$249
- Citizen 35 LQ . . . . . \$489
- Citizen MSP-10 . . . . . \$289
- Citizen MSP-15 . . . . . \$399
- Epson 800 . . . . . Call
- Epson 1000 . . . . . Call
- Epson 286 . . . . . Call
- NEC P5 . . . . . \$995

## Hi-Tec Computers & Electronics • (301) 564-9500

IBM is trade mark of IBM

10524 Detrick Ave., Kensington, MD 20895

PC Solution is trade mark of HI-TEC Enterprises Inc.

**TOLL-FREE  
ORDERING:  
800-222-8686**

# CCT<sup>®</sup> CUSTOM COMPUTER TECHNOLOGY

A PAT MARTINI COMPANY

**FOR TECHNICAL SUPPORT/  
SERVICE / IN ARIZONA:  
602-282-6299**

**1 CCT PLAZA — P.O. BOX 4160 — SEDONA, ARIZONA 86340**

Purchase your Hardware and Software directly from an OEM / Systems Integrator. Take advantage of our buying power! We stock a full line of Board Level Components, Software and Peripherals. Call for your needs. We'll give you the Lowest Prices, and the Technical Support and Know-How we are quickly becoming well-known for. Satisfied Customers Nationwide. The Nation's Custom Systems House for Business, Education and Science. Call for a system quote. CCT Implements Tomorrow's Technology Today!<sup>™</sup>

**• FOREMOST QUALITY • ADVANCED SUPPORT • REASONABLE COST •**



**80286 NOW!**

□ **CCT-286Z** is our model designation for the **MI-286** dual processor board from **Macrotech**. It features the super high speed combination of Z-80H and 80286, with provision for the 80287 math chip. Directly replaces 8085/88 and 8086 CPUs running CP/M, MP/M Concurrent DOS, and MS-DOS, at throughput increases of 3X to 5X!

**SPECIAL PRICE - \$795**  
**80287 Option - Installed - \$250**

**SEE THE CCT-4 SERIES  
USING THIS BOARD  
DETAILED ON THE FACING PAGE**

**NOW!  
BATTERY BACK-UP  
ON  
CCT RAM BOARDS!  
VOLATILE PRICES  
CALL FOR QUOTE**

**LIBERTY TERMINALS**  
• Superior Reliability •

110-14" GREEN-80/132 Column . . . **CLOSE**  
110-14" AMBER . . . . . **OUT**  
200-14" GREEN-80/132 Super Deluxe **PRICES**  
200-14" AMBER . . . . . **CALL!!**

**OKIDATA PRINTERS - Top Quality**

182 - 80 Col. . . **CALL 183 - 132 Col. . . CALL**  
192 - 80 Col. . . **CALL 193 - 132 Col. . . CALL**  
84 - 132 Col/200cps—Top of the Line . . . **CALL**  
For Serial Interfaces . . . . . **CALL**

**TOSHIBA P351 - 288 CPS/24 PIN - \$1499**

**DIABLO — Letter Quality Series**  
Model 620 . . \$969 Model 630 . . \$1799

**WE HAVE ALL SOFTWARE—CALL**

**\$ ACROSS THE BOARD PRICE REDUCTIONS \$**

**INDUSTRIAL GRADE  
SUPERIOR QUALITY**

**CCT DISK DRIVE SYSTEMS** ROLLS ROYCE OF THE INDUSTRY  
**S-100 HARD DISK SUBSYSTEMS**

Professionally engineered ST-506 type systems for the business market S-100 Computer user. Includes industry top quality drives, CompuPro Disk 3 DMA controller, all cabling, A&T, formatted, burned-in. Provisions for up to two hard disks in each system. We include operating system update. CP/M 80, CP/M 86, CP/M 8-16, CCP/M 8-16, CP/M 68K. (/1 Systems are CCT innovated hard/floppy combinations, with Mitsubishi DSDD 8" drive.) 12 month warranty.

CCT-10 (11 + MEG) . . . . .	<b>\$1399</b>	CCT-10/1 . . . . .	<b>\$1999</b>
CCT-20 (22 + MEG) . . . . .	<b>\$1549</b>	CCT-20/1 . . . . .	<b>\$2149</b>
CCT-40 (36 + MEG) . . . . .	<b>\$2579</b>	CCT-40/1 . . . . .	<b>\$3179</b>
CCT-75 (75 + MEG) . . . . .	<b>\$3349</b>	CCT-75/1 . . . . .	<b>\$3949</b>
CCT-90 (87 + MEG) . . . . .	<b>\$4799</b>	CCT-90/1 . . . . .	<b>\$5399</b>
CCT-125 (123 + MEG) . . . . .	<b>\$6099</b>	CCT-125/1 . . . . .	<b>\$6699</b>

**HOT NEW CCT BOARD PRINTERFACER 1™** - Print buffer I/O Board. Up to 1 Meg. RAM on board. Looks as/works with Interfacer 3/4. Single or Multiuser/Interrupt driven or polled. Super-slick design handles one serial, one parallel, software switchable. Also for Zenith and Alpha. Intro Price — **\$349** Incl. Cable Set.

**FLOPPY SYSTEMS**

**CCT-2.4 • Dual 8" DSDD** Mitsubishi 2.4 Megabyte in Extra Heavy horizontal enclosure, IBM Compatible Mitsubishi 360K. Extra Heavy Cabinet removeable filter air system, all cabling, A&T, Burned in. The fastest system available: . . . . . **\$1429**

**CCT-5 • 5 1/4" DSDD** IBM Compatible Mitsubishi 360K. Extra Heavy Cabinet accommodates two drives, hard or floppy. All cabling, A&T, Burned-in. Perfect for our Concurrent DOS Package . **\$349**

**CCT-8/5 • FULL IBM COMPATIBILITY**  
One Mitsubishi 8" DSDD (1.2 Meg)/One 5-1/4" DSDD (360K) IBM Drive  
For Concurrent DOS and PC DOS . . . . . **\$1029**

**★ SUPER PRICES ★ COMPUPRO COMPONENTS ★ IN STOCK ★**

CPU-Z - **\$159** • Disk 1A - **\$399** • Disk 1A w/CP/M - **\$499** • CPU 8086/10 - **\$359** • SPUZ/256K - **\$319**  
CPU 8085/88 - **\$229** • CPU 286 - **\$849** • CPU 68K - 10Mhz - **\$359**  
Disk 3 - **\$459** • RAM 22 (256K) - **\$489** • RAM 23/64K - **\$199/128K - \$289**  
Concurrent DOS 8-16 CCT Enhanced - **\$449** • **SUPER SALE** → M-Drive/H - 512K - **\$399** / 2 Meg - **\$899**  
Enclosure 2 Desk - **\$699/Rack - \$749** • Interfacer 3 - **\$409** • Interfacer 4 - **\$289** • System Support 1 - **\$299**  
Concurrent DOS 8-16 - **\$379** • CP/M 80 (CCTHMX) - **\$125** • CP/M 86 (CCTTMX) - **\$175**  
CP/M 8-16 (CCTTMX) - **\$199** • CP/M 68K (CCTCX) - **\$279** • **Operating System Updates/Remakes - \$30**

**16 Bit Upgrade Kit: CP/M 86, RAM 23, System Support 1, Cable \$649 □ CP/M 8-16 - Kit - \$673**

**CCT-1 — ENTRY LEVEL S-100 BUSINESS SYSTEM**

- Enclosure 2-Desk-21 Slot Mainframe •
- CPU-Z - 6 Mhz Z-80 CPU Board •
- Disk 1A - DMA Floppy Disk Controller •
- RAM 23 - 64K Static RAM - 12Mhz •
- Interfacer 4 - 3 Serial/2 Parallel I/O •
- CCT-2.4-Dual 8" Mitsubishi DSDD Drive System - 2.4 Megabytes •
- CP/M 80 - 2.2 HMX - CCT Modified •
- All Cabling, Complete CCT Assembly, Testing, and Minimum 20 Hour Burn-in •

**SPECIAL PRICE  
\$3,350**

**RUNS ALL STANDARD 8" CP/M SOFTWARE - INCLUDES OUR EXCLUSIVE 12 MONTH DIRECT WARRANTY**

Prices & availability subject to change. All products new, and carry full manufacturer's warranties. Call for catalog. Free technical help to anyone. All products we sell are CCT individually tested and set up for your system - Plug-In & Go! Arizona residents add sales tax CCT © Trademark — Custom Computer Technology; MS-DOS © Trademark — Microsoft; IBM © Trademark — International Business Machines; CompuPro © Trademark — W.J. Godbout; CP/M © MP/M © Trademarks — Digital Research HERCULES™ Trademark — Hercules Computer Technology

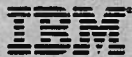

IBM PC, 256K, 1 Drive ... \$1589.00  
 IBM PC XT, 256K,  
 1 Drive ... \$1825.00  
 IBM AT 256K, 1.2 MB ... \$3199.00



Conquest PC Turbo 640K,  
 2 Drives ... \$1225.00



Deskpro 286, 256K,  
 1-2 MB Drives ... \$3349.00  
 Portable 286, 256K,  
 1-2 MB Drives ... \$3399.00  
 Deskpro 256K, 1 Drive ... \$1775.00  
 Portable 256K, 2 Drives .. \$1995.00



Amiga Computer 256K ... \$1195.00  
 256K Ram Memory  
 Cartridge ... \$ 175.00  
 3.5" External Disk Drive ... \$ 275.00



(714) 838-7530

2630 Walnut Avenue, Unit C, Tustin, California 92680

Prices & availability subject to change without notice—IBM is a registered trademark of IBM Corporation. COMPAQ is a registered trademark of COMPAQ Computer Corporation. Conquest is a registered trademark of Conquest Computer Industries.

**Printers**

Epson LX 80 ..... \$235.00  
 Epson FX 85 ..... \$369.00  
 Epson FX 185 ..... \$509.00  
 Epson JX 80 ..... \$299.00  
 Starmicronic SG 10 ..... \$249.00  
 Starmicronic SG 15 ..... \$395.00  
 Cannon Wide Carriage  
 PW-1156 A ..... \$299.00  
 Toshiba P351 ..... \$1125.00  
 Toshiba 1340 ..... \$535.00  
 Toshiba P-341 ..... \$899.00  
 Okidata 182 ..... \$235.00  
 Okidata 192 ..... \$369.00  
 Okidata 193 ..... \$515.00  
 Brother HR-25 ..... \$499.00  
 Brother HR-35 ..... \$775.00  
 IBM Pro Printer ..... \$425.00  
 Legend 1380 ..... \$280.00  
 Legend 1385 ..... \$375.00

**Monitors**

PGS HX-12 ..... \$459.00  
 PGS MAX-12 ..... \$179.00  
 PGS SR-12 ..... \$599.00  
 Amdek 300 Green ..... \$135.00  
 Amdek 300 Amber ..... \$145.00  
 Amdek 310 Amber  
 w/TTL Plug ..... \$165.00  
 IBM Monochrome Display ..... \$260.00  
 IBM Color Display ..... \$590.00  
 Taxan 620, 630 & 640 ..... CALL

★ **SPECIAL** ★  
**Eagle Monitor High Res**  
 Green Screen  
 720 x 350 TTL Plug  
**\$99.00**

**MONITOR CARDS**

Persyst Color ..... \$169.00  
 Persyst Monochrome ..... \$189.00  
 Hercules Color ..... \$169.00  
 Hercules Graphic ..... \$319.00  
 IBM Color  
 Graphic Adapter ..... \$225.00  
 IBM Mono  
 Printer Adapter ..... \$230.00  
 Paradise Modular  
 Graphic Card ..... \$299.00  
 Everex "The Edge" ..... \$299.00  
 Conquest Color ..... \$125.00  
 Conquest Monochrome .. \$145.00  
 Sigma Color 400 ..... \$495.00  
 Genoa Spectrum ..... \$299.00

**EVEREX**

20 MB Tape Internal ..... \$739.00  
 45 MB Tape Internal ..... \$899.00  
 45 MB Tape External ..... \$999.00

**PRINTERS**

OLYMPIA NP ..... \$285  
 OLYMPIA RO ..... 344  
 OLYMPIA Compact 2 ..... 349  
 Star SG-10 ..... 239  
 Cannon Laser Printer ..... 2169  
 Okidata, Epson, NEC ..... CALL  
 Brother 1009 ..... 149

**PLOTTERS**



OHP-29 ..... \$1795  
 DMP-41/42 ..... 2365  
 DMP-51/52 ..... 3579  
 Roland DXY-880 ..... 979  
 Roland DXY-980 ..... 1279

**EXPANSION CARDS**

Hercules Graphics Card .. \$325  
 AST 6-Pack ..... CALL  
 Paradise Multi Display ... 209  
 Orchid PC-Turbo 256K ... 679  
 Tecmar Graphics Master .. 499

**MASS STORAGE**

TALL GRASS

25 MB 1/2 Height Drive ... \$759  
 TG-4060 60MB Tape B/U ... 1299  
 25 MB w/60 MB Tape ... 2769  
 80 MB w/60 MB Tape ... 5899  
 10 MB Bernoulli Box ... 1859  
 20 MB Bernoulli Box ... 2299  
 Corvus Trimline Combo ... 2399  
 Corvus 21 MB ..... 2399  
 Tecmar 20/60 Disk/Tape ... 2559

**Scottsdale Systems**

617 N. Scottsdale Rd, Scottsdale, AZ 85257

(602) 941-5856

For Inquiries

1-800-367-2369

Toll-Free For Orders Only



**SOFTWARE**

Wordstar ..... \$195  
 Microsoft Word ..... 239  
 Samna Word III ..... 279  
 WordPerfect 4.1 ..... 235  
 Easy Writer II ..... 219  
 dBasell ..... 299  
 Friday! ..... 179  
 R:BASE 4000 ..... 269  
 pfs:File/Report ..... 159  
 Framework II ..... 419  
 Enable ..... 379  
 Supercalc 2 ..... 159  
 Multiplan ..... 119  
 Smart Series ..... 255  
 pfs:Plan ..... 89  
 GEM Draw ..... 150  
 Sidekick ..... 39  
 Superkey ..... 49  
 Print Shop ..... 45  
 Norton Utilities ..... 59  
 pfs:Graph ..... 89  
 Dollars and Sense ..... 109

Dow Jones Invest ..... 99  
 Peachtree GL/AR/AP .... 210

**ATARI 520ST**



Monochrome ..... \$699  
 RGB Color ..... 899

Precision Graphics/Mouse/68000  
 CPU/512K RAM/8MHZ Clock  
 Software/Parallel & Serial I/O  
 Optional DS Drive

**ATARI SOFTWARE**

VIP Professional ..... \$149  
 Final Word ..... 115  
 4 x Forth ..... 79  
 Express ..... 39  
 HippoWord ..... 75  
 Hippo-C Compiler ..... 65  
 Hippo-Disk Utilities ..... 44  
 Ultima II ..... 49

Prices listed are for cash/Mastercard and Visa add 3%/American Express add 5%/AZ residents add 6%/All items are new with manufacturer's warranty/Returned product subject to 20% restocking fee/Personal G Company checks take up to 3 weeks to clear/No COD's or APO's/Prices and specifications subject to change/Product subject to availability/All applicable trademarks recognized and on file.

H & D Toolkit ..... 25  
 H & D Database ..... 69  
 Zork I ..... 33  
 Zork II or III ..... 38  
 Hitchhiker's Guide ..... 33

**ALTOS**

2086-2 ..... \$14599  
 1086-T-50 ..... 10819  
 586, 986 ..... CALL  
 Altos Software ..... CALL

**PC-8088 by IDS**



An IBM-PC look-alike that's compatible with your bottom line.  
 ■8088 CPU or 4.77 MHz    ■Monochrome Monitor  
 ■Two DSDD Drives    ■MS-DOS, MyWrite, MyCalc  
 ■8 Expansion Slots    ■FILEBASE, Spell!  
 ■256K RAM    ■RGB/Composite Card  
 ■ 1 Year Warranty

The PC-8088 by IDS ... \$1149  
 with RGB Monitor ..... 1298

**COMPUTERS**

The Fox ..... \$995  
 TurboFox ..... 1499  
 The AMSTRAD System ... 439



# COMPUTERBANC

**FREE SHIPPING ON ALL SOFTWARE \$200 MIN.**

### HARD DRIVE KITS

20 MB Internal w/Controller **\$495**  
30 MB Internal for AT **\$759**

\* External Models Add **\$150**

### TAPE DRIVES

20 MB **\$699** | 45 MB **\$899** | 60 MB **\$999**

\* File by File  
\* Mirror Image \* Software Included

**IBM PC AT 20 MB**  
(Seagate Model 225)  
512 K, Serial, Parallel  
**\$4,299**

**Thesis FASTCARD IV**  
**\$259.00**

- Up to 2 MB Multifunction
- Lotus, Intel, Microsoft Specs

**IBM PC XT**  
20 MB, 256K  
**\$2549** / **\$1900**  
256K, 2 Drive  
**IBM PC**

**AT COMPATIBLES**  
Sperry IT 44 MB  
**\$3,999** / **\$2549**  
Compaq Desk Pro  
20 MB, 640K, Ser, Clock

**STB EGA Plus**  
**\$359.00**

- 16 Colors, 256K, Parallel
- IBM Compatible

**IBM PC COMPATIBLES**  
LEADING EDGE CALL  
ITT XTRA 2 Drive, 256K **\$1,495**  
AMIGA CALL  
PC Clone System **\$899**

\* All systems include monochrome monitor, DOS, and parallel port

### IBM SOFTWARE

LOTUS 123 ..... CALL  
Symphony ..... CALL  
ENABLE ..... 379.00  
GEM COLLECTION ..... 129.00  
ASHTON TATE Framework ..... 379.00  
dBASE II ..... 289.00  
dBASE III ..... 369.00  
CLIPPER dBASE III Compiler ..... 379.00  
MULTIMATE ..... 229.00  
SORCIM SUPERCALC III ..... 210.00  
Super Project ..... 210.00  
MICROSOFT Multiplan ..... 125.00  
Word ..... 229.00  
Project ..... 159.00  
FOX & GELLER Quickcode ..... 139.00  
NORTON UTILITIES ..... 52.00  
TURBO PASCAL ver 3.0 ..... 49.00  
SUPERKEY ..... 37.00  
SIDEKICK (unprotected) ..... 46.00  
ASCII PRO Comm Software ..... 69.00  
CROSSTALK XVI ..... 105.00  
PEACHTREE Back to Basics ..... CALL  
IN-HOUSE ACCOUNTANT ..... 89.00  
WORD PERFECT ..... 249.00  
MICROPRO WordStar Pro ..... 259.00  
WordStar 2000 + ..... 279.00  
SAMNA PLUS ..... 345.00  
WORD III ..... 279.00  
RBASE 5000 ..... 389.00  
PRINTMASTER ..... 35.00  
ENERGRAPHICS ..... 169.00  
BPI General Accounting ..... 316.00

QuadPort for AT ser & par ..... 115.00  
TECHMAR Graphics Master ..... 469.00  
STB Rio plus 64K 5 Function ..... 189.00  
Rio Grande 3 function for AT ..... 289.00  
COMPANION PC 0-2 MB ..... 189.00  
Chaffeur monographics ..... 234.00  
PARADISE Modular Graphics Card ..... CALL  
SIGMA High Res Color 400 ..... CALL  
IBM Compatibles  
Multifunction Card 384k s.p. c/cck ..... 169.00  
Multifunction Card OK-1, 2mb ..... 179.00  
Compatible Mono Card w/par ..... 129.00  
5151 Compatible Keyboard ..... 119.00  
Expansion Chassis ..... CALL  
130 WAH Power Supply ..... 85.00  
MONOCROME Graphics Card ..... 110.00  
Color Graphics Card ..... 99.00  
TALLGRASS W/Tape ..... CALL  
IRWIN Tape Drive ..... 499.00  
EVEREX TAPE Pc/Xi/AT ..... CALL  
Graphics Edge Card ..... 259.00  
TEAC 55B ..... 95.00  
1.2MB FLOPPY for AT ..... 189.00  
360K Floppy for AT ..... 115.00  
MOUSE SYSTEMS Mouse ..... 135.00  
FIELDMOUSE ..... 113.00  
MICROSOFT Mouse w/stwr. .... 117.00  
KOALA KAT ..... 149.00  
DISKETTES 2S DD ..... 15.00

### MODEMS

ANCHOR Express 300/1200 ..... 229.00  
Volsmodem 1200 (5 yr wrnly) ..... 169.95  
Lightning 2400 Baud ..... CALL  
HAYES 1200 ..... 379.00  
1200B ..... 349.00  
2400 ..... CALL  
Micromodem //e ..... CALL  
PROMETHEUS 1200 ..... CALL  
Promodem 1200B ..... for  
Promodem 1200A ..... Blow-out  
Promodem 300 lit ..... Prices

### MONITORS

AMDEK 300A ..... 139.00  
310A Hi-Res Amber ..... 155.00  
COLOR 600 HI-RES RGB ..... 433.00  
COLOR 710 ..... 474.00  
PRINCETON GRAPHICS HX-12 ..... 469.00  
HX-9 ..... 449.00  
SR-12 ..... 625.00  
MAX-12 ..... 179.00  
TAXAN 121/122 ..... 149.00  
620 (RGB) 640 x 200 NEW ..... CALL  
640 (RGB) 720 x 400 NEW ..... CALL  
PANASONIC DT-S101 Color ..... 141.00  
DT-H103 10" High Res RGB ..... 369.00  
IBM COMPATIBLE Monochrome ..... 99.00  
Color RGB Monitor (640 + 200) ..... 349.00

### PRINTERS

PANASONIC (2 yr warranty)  
KX-P1080 ..... 199.00  
KX-P1091 ..... 229.99  
KX-P1092 ..... 395.00  
KX-P1592 ..... 439.00  
KX-P3131 17cps Daisey ..... 269.00  
KX-P3151 22 cps Daisey ..... 395.00  
Citizen MSP-10 ..... 266.00  
MSP-15 ..... 355.00  
MSP-25 ..... 489.00  
STAR MICRONICS SG-10 ..... 219.00  
SG-15 ..... 399.00  
EPSON LX-80 ..... Call  
FX-286 ..... for  
LQ-800 ..... Best  
LQ-1000 ..... Prices  
BROTHER ..... We Will Beat  
Twinwriter 5 ..... Any Advertised Price  
OKIDATA - All Models ..... CALL  
TOSHIBA P351 ..... CALL  
CANNON Laser Printer ..... CALL  
HEWLETT PACKARD PRINTERS ..... CALL  
HOUSTON INSTRUMENTS Plotters ..... CALL  
Digitizers ..... CALL

### APPLE PRODUCTS

APPLIED ENG. Ramworks 64K ..... CALL  
AST Multi I/O ..... CALL  
MICRO SCI A2 Drive Iie ..... 169.00  
Iic compatible drive ..... 139.00  
APPLE Compatible Drive ..... 119.00  
MAC Compatible 3 1/2 drive ..... 229.00  
BERNOULLI 5MB MAC drive ..... CALL  
MACINTOSH Harddrive ..... CALL  
MICROSOFT Macenhancer ..... CALL  
Softcard II ..... 259.00  
Multi-plan //e & Mac ..... 129.00  
Basic (Mac) ..... 109.00  
ASCII XPRESS (Communications) ..... 69.00  
THE DESK ORGANIZER (Mac) ..... 133.00  
APPLE MOUSE II ..... 129.00  
APPELWORKS ..... 215.00  
SPELLWORKS ..... 39.00  
PRINTSHOP ..... 35.00  
Mach III Joystick ..... 39.00  
SYSTEM SAVER Fan ..... 69.00  
VIDEO 7 Iic Enhancer ..... CALL  
Titan Accelerator ..... 229.00  
VIDEX Ultraterm ..... 169.00  
APRICORN (Lifetime Warranty)  
Super Serial Imager ..... 75.00  
Graphics Interface ..... 65.00  
80 Column/64K ..... 75.00  
EXTEND IT 64K ..... 55.00  
KOALA SpeedKey ..... 99.00  
DISKETTES APPLE/MAC ..... 12.00/24.00  
ORANGE MICRO ..... CALL

### IBM HARDWARE

AST 6 Pack Plus w/384k ..... 249.00  
Advantage W/128k ..... 399.00  
HERCULES Mono Graphics ..... 319.00  
Color Card ..... 159.00  
ORCHID Turbo w/256k ..... 669.00  
QUADRAM Quadboard 0-K ..... 198.00  
EGA + NEW ..... 405.00

**Look for our Bulletin Board Featuring Multi-user Games**

Call for catalog. Thousands of products available. Volume discounts.



# COMPUTERBANC

16783 Beach Blvd., Huntington Beach, CA 92647  
TELEX #550757 ANSWER BACK—COMPUTER UD  
714/841-6160



No Charge for Credit Cards



Orders Only

**800/332-BANC**  
OUTSIDE CALIFORNIA

Cash prices indicated. All products are in factory sealed packages. We guarantee all items for 30 days. Within this period, defective merchandise returns must be accompanied by RMA number. All other returns will be subject to a 10% restocking fee. For prepaid orders, there will be a 3% shipping charge; 5% for UPS Blue Label; \$5.00 minimum; all orders outside U.S.A. at 15% shipping. California residents add 6% sales tax. Prices subject to change without notice.  
©Copyright 1985 COMPUTERBANC, All Rights Reserved.

## GET AN UKI FOR YOUR OKI

Now have the best of both worlds with the flick of a switch! Get the compatibility of IBM Plug-N-Play and the versatility of the OKIDATA instruction set for your OKI 82, 83, 92, 93, 192, 193. Have both available as your software and needs dictate. Easy, fast trouble-free installation, with no permanent modification to your printer. Complete, with no other ROM purchase necessary. OKI 82, 83, 92, 93: \$49.95. OKI 192, 193: \$79.95. Printer utility software included (if sold separately, \$7.95). Add \$3.00 shipping. [NY res add sales tax.]

### UKI-SWITCH CORP.

506 Hempstead Ave. [Suite 211]  
West Hempstead, NY 11552

Inquiry 360

## NEW AN I/O™ Series Analog Interfaces for your PC/APPLE

### Versatile Accurate and Fast



- MODELS**
- AP-8** • 8-bit A/D and D/A to 50Khz. amplifier, anti-aliasing filters, etc. \$299.
  - AP-12** • 12-bit A/D and D/A to 40Khz. analog multiplexer, amplifier, S/H, 8-bit I/O, clock, etc. \$450.
  - PC-12** • 12-bit A/D or D/A to 60Khz. analog multiplexer, amplifier, anti-aliasing filter, S/H, on board VCO function generator, 8-bit I/O, etc. \$750.
  - PC-DMA** • Our best available analog interface. 12-bit A/D or D/A to 100Khz. DMA driven to allow real-time processing, on board timer for zero timing jitter, input and output filters, amplifier, S/H, multiplexer 500Hz to 100Khz phase-locked (to timer) function generator. Fully program mable. \$1250.
- PC-model designation refers to IBM PC compatible boards. AP for Apple II. Prices include software. Peripheral channel input signal conditioner and filter, and PC-based FFT board available soon. For purchase or info please contact:

CANETICS, Inc. PO Box 70549, Pasadena, Ca 91107  
Telephone (818) 584-0438

Inquiry 57

## LOW COST UNIVERSAL PROGRAMMER KITS

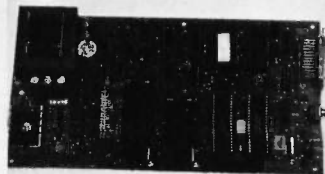

- \* NO PERSONALITY MODULES REQUIRED
- \* ON LINE HELP AND MENU SELECTION
- \* ON BOARD 110/220V POWER SUPPLY
- \* FAST PROGRAMMING MODE AT 6V VCC
- \* BUILT IN MONITOR FOR I/O DEBUG
- \* CAD PCB, SILKSCREEN & SCHEMATIC
- \* SOFTWARE DRIVERS FOR MOST PCs
- \* SUPPORTS ALL 5V EPROMS, EEPROMS AND INTEL MICROCOMPUTERS

KITS FROM \$125 ASSEMBLED \$295  
DRIVERS \$35 SHIPPING \$4  
VISA & MASTER CARD ACCEPTED

### B&C MICROSYSTEMS

6322 MOJAVE DR. SAN JOSE CA 95120  
PHONE (408) 937-7685 TELEX 4995363

## NEW! Convert RS-232 Signals to 20 MA Current Loop Signals and Back

New  
Low Price  
\$39.95

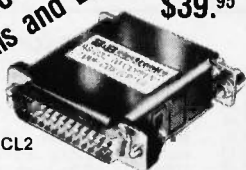

Model 232CL2

Interface any RS-232 Port with standard 20 Ma. Current Loop Systems. High speed optical isolators couple Transmit and Receive Data lines. Order now! Just \$39.95. Optional Power Supply \$14.95. All cash orders ppd. (IL res. add 6% sales tax); we accept MC, VISA. FREE: new illustrated catalog of RS-232 interface and testing equipment. Phone: 815-434-0846. Make checks payable to:

**B & B electronics**  
MANUFACTURING COMPANY  
P.O. Box 1008B, OTTAWA, IL 61350

Inquiry 34

## VAX/IBM PC

**DECKHAND™ Utilities**  
MS-DOS Utilities with VAX/PDP-11 switch processing. DIR, COPY, DELETE, RENAME, TYPE with extended wildcards, full DATE processing, attribute processing, query, backup and more. \$69.00

**ZSTEMpc™-VT100 Emulator**  
High performance COLOR VT100 / VT102. Double high/wide, smooth scrolling or ISO and attribute mapped color. XMODEM and KERMIT, softkey/MACROS. \$150.00

**ZSTEMpc™-4014 Emulator**  
Interactive zoom and pan. Save/recall images to/from disk. Keypad, mouse, printer, plotter support. \$99.00

### KEA SYSTEMS LTD.

#412 - 2150 W. Broadway  
Vancouver, B.C. CANADA V6K 4L9  
Support (604) 732-7411  
TELEX 04-352848 VCR

Order Toll Free (800) 663-8702

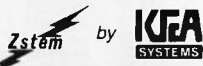

Inquiry 381

## UNIVERSAL EPROM PROGRAMMER

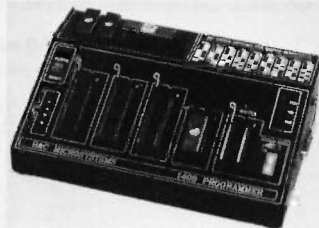

- \* NO PERSONALITY MODULES REQUIRED
- \* ON LINE HELP AND MENU SELECTION
- \* ON BOARD 110/220V POWER SUPPLY
- \* FAST PROGRAMMING MODE AT 6V VCC
- \* BUILT IN EPROM ERASER w/TIMER
- \* GANG PORT FOR FUTURE EXPANSION
- \* SOFTWARE DRIVERS FOR MOST PCs
- \* SUPPORTS ALL 5V EPROMS, EEPROMS AND INTEL MICROCOMPUTERS

1409C-33 \$545 1409C-34 \$695  
DRIVERS \$35 SHIPPING \$6  
VISA & MASTER CARD ACCEPTED

### B&C MICROSYSTEMS

6322 MOJAVE DR. SAN JOSE CA 95120  
PHONE (408) 937-7685 TELEX 4995363

## DYNAMIC RAMS

41256	100ns	\$4.85
41256	120ns	\$3.15
✓41256	150ns	\$2.50
4164	120ns	\$1.30
✓4164	150ns	\$1.05
4464	150ns	\$5.50

PROCESSORS			E. PROMS		
8087-2	8mhz	\$130.00	27C256	250ns	\$6.50
8087-3	5mhz	\$115.00	27256	250ns	\$4.25
80287-3	5mhz	\$185.00	27129	250ns	\$2.75
80287-3	8mhz	\$ CALL	27064	200ns	\$3.75
V-20	8mhz	\$ CALL	2764	250ns	\$2.50
V-30	8mhz	\$ 20.00	2732A	250ns	\$2.75
STATIC RAMS			8000's		
6264LP-15	150ns	\$2.95	(Parts In stock)		

## I.C. EXPRESS

15358 Valley Blvd., City of Industry, CA 91746  
Phone: 818-369-2688 (Mon-Fri • 8-5)

ORDER TOLL FREE  
(800) 892-8889 • (800) 882-8181

CALL FOR CURRENT PRICES & VOLUME DISCOUNTS.  
Prices Shown for UPS COD Cash + MasterCard/VISA add 3% more.  
Prices are subject to change. Minimum order \$10.00.  
California residents must add 6.5% sales tax.  
Shipping & Handling: UPS Ground \$5.00, UPS Air \$7.00 (under 1 lb.)  
ALL MERCHANDISE IS 100% GUARANTEED.

Inquiry 167

## Heritage Systems Corp.



**HSC-9128 Video Terminal Card**  
80 by 24 Alpha-numeric video display  
ANSI X3.64 command set  
TTL/CMOS serial port (50 to 38.4K baud)  
Off card line drivers (RS-232, Fiber optic)  
IBM PC compatible keyboard input  
On Screen configuration utility  
100 by 10mm, 5V only, 200mA

HSC-9128 video terminal card	\$129
HSC-9128 with RS-232, cables	\$159
HSC-9129 keyboard	\$119
Amdek 300G Video monitor (Green)	\$139
Amdek 300A Video monitor (Amber)	\$149

PO Box 10588,  
Greensboro, NC 27404-0588  
(919) 274-4818

Inquiry 154



"Touch-Tone® In Voice Out."

Computer access. Without a terminal. Impossible? Not with **Computerfone™**. Think. Every Touch-Tone® phone becomes a terminal which can communicate with any computer. Over 180 million terminals. Free.

At the heart.  
• High Fidelity Digitized Speech.  
• Human Quality Synthesized Speech.  
• Call In Or Autodial Out.  
• Touch-Tone® To Character Conversion.

Hear our difference. Today. Call 1-904-478-6477 for immediate information. And remember. Touch-Tone® In Voice Out.

**Computerfone™**  
©1985 Suncoast Systems, Inc.

Inquiry 330

# Compu\$ave Of Arizona

Call Toll Free: 1-800-624-8949

### COMPUTERS

Altos 586T-40 Multiuser System... 7695  
 Corona PPC-400 Port/2 FDrives... 1159  
 AT&T 6300/1 FDrive Monitor... 1695  
 Teletideo PM-4T Multiuser Syst... 4895  
 Wyse-PC/2 Floppy Drives... 1159  
 Zenith 171-PC Port/2 FDrive... 1879  
 Zenith 158-PC/1 Floppy Drives... 1549  
 Alloy/Corvus/IBM/Molecular... CALL  
 NEC/Sharp/Sperry/Other Models CALL

### PC-XT CLONE \$925

640K/2 DRIVES & CONTROLLER/KEYBOARD  
 MONO GRAPHICS CARD/135W POWER  
 SUPPLY TTL MONITOR/PARALLEL PORT  
 (WITH TURBO 4.77 & 3 MHZ BRD... \$1015)  
 PC-AT 1M/3MHZ/20MDR/TTL MONITOR... \$2795

### TERMINALS

Adds Viewpnt+... 429 Kimtron KT7... 495  
 Altos III... 595 Qume 101G... 293  
 Ampex 210... 365 Qume 201G... 525  
 Ampex 219... 495 Visual 65... 425  
 Ampex 230... 449 Wyse 30... 293  
 Teletideo 921... 415 Wyse 50... 418  
 Teletideo 9220... 545 Wyse 85... 499  
 Teletideo 955... 455 Zenith 229... 595  
 CIE/DEC/Esprit/IBM/Liberty... CALL

### MONITORS

Princeton HX9... 415 Amdek300G 116  
 Princeton HX12... 435 Amdek310A 143  
 Princeton HX12E... 499 Amdek 600. 389  
 PrincetonMAX12E.162 Sharp RGB. 398  
 Taxan 115... 115 Taxan 620. 399  
 Taxan 121... 132 Taxan 640. 519  
 Wyse 600 W/Card.519 Wyse 500. 169  
 Zenith 122/123... 75 Zenith 1330.465  
 Roland/12"/RGB/640x240... 325  
 Thomson/14"/RGB & Comp... 299  
 NEC/Quadram/Talung/Samsung. CALL  
 Cables/Video Interfaces/Stands... CALL

### MODEMS

AST Reach Half-Card W/Soft... 345  
 Anchor Volksmodem... 55  
 Anchor Volksmodem 12... 179  
 Hayes Micromodem IIE W/Soft... 132  
 Hayes Smartmodem 1200... 365  
 Hayes Smartmodem 1200B W/Soft... 345  
 Prometheus Promodem 1200... 285  
 Prometheus Promodem 1200B W/Soft... 235  
 US Robotics Password 1200... 194  
 Rascal-Vadic 1200PC W/Soft... 215  
 Rascal-Vadic 2400PC W/Soft... 399  
 Ven-Tel PC Modem Half-Card... 365  
 Novation/Rixon/UDS/Zoom... CALL

### PRINTERS

Canon LBPA1... 1999 Abati LQ20... 299  
 Citizen MSP10... 250 Diablo 635... 1155  
 Citizen MSP25... 479 Epson LX80... 218  
 C. Itoh 8510... 379 Epson LX90... 255  
 Corona LP300... 2599 Juki 6100... 345  
 Data Prod. 8052.1129 NEC P5... 975  
 Data South 220.1295 Star SG-10... 209  
 Panasonic 1080... 205 Tally MT86... 425  
 Panasonic 1091... 234 T1 865... 725  
 Toshiba 1340... 435 Cables 10'... 19  
 Anadex/Brother/Fujitsu/Legend... CALL  
 Okidata/OTC/Qume/Teletideo... CALL  
 Buffers/Sheet Feeders/Tractors... CALL  
 Stands/Switch Boxes/Ribbons.25%OFF  
 Houston DMP 51/52 Plotter... 3995  
 Roland DXY 880 Plotter... 975  
 Houston TG8017 Digitizer... 1395  
 Other Plotters And Digitizers... CALL

### DISK DRIVES

Apple Compatible Floppy Drives... 124  
 Seagate 10MKit/IBM Compatible... 425  
 Seagate 20MKit/IBM Compatible... 525  
 Western Digital 10M Hard Card... 715

### OTHER FLOPPY AND HARD DRIVES

ALPHA OMEGA • CDC • CORVUS  
 IOMEGA • MAYNARD • MICRO SCI  
 MITSUBISHI • PRIAM • SHUGART  
 TANDON • TEAC • TECMAR  
 LOW PRICES... CALL

### BOARDS

AST Advantage/128K... 375  
 AST Six Pack Plus/64K... 218  
 AST Six Pack Clone/Game/384K... 185  
 Cardo G-Whiz (Commodore)... 55  
 Hercules Color Card... 148  
 Hercules Color Card Clone... 99  
 Orange Grappler + (Apple)... 70  
 Orange Hot Link (Apple)... 52  
 Orchid Conquest/OK... 265  
 Paradise Modular Graphics... 258  
 PC I/O Card/1 Par.2 Ser Ports... 85  
 PC Mono. Graphics (Par Port)... 109  
 PC RAM Board/OK... 69  
 Persyst Bob Board... 335  
 Quadram Silver Quadboard/OK... 219  
 Sigma 400 High Res Card... 455  
 STB Graphics Plus II... 235  
 Taxan 555 High Res Card... 189  
 Tecmar Maestro AT... 379  
 ABM/Micro Sci/Microtek/PGA... CALL  
 Prac. Peripherals/Thesys/Vutek... CALL

### SOFTWARE/ALL TYPES...CALL

### WE ALSO CARRY

Bonus Diskettes/DS-DD (10 Per Bx)... 13  
 Maxell/Memorex/Verbatim/3-M... CALL  
 Keyboards/Joysticks/Power Supplies  
 Chips/Mice/Labels/Surge Protectors  
 Cables/Graphics Tablets/Light Pens

**HOURS: MON - FRI 8AM - 6PM/SAT 9AM - 2PM  
 IN ARIZONA CALL (602) 437-4855**

CompuSave: 4207 S. 37th St., Phoenix, AZ 85040/For Customer  
 Service Call (602) 437-4856/Prices Reflect Cash Discounts And Are  
 Subject To Change Without Notice/Minimum Shipping Charge \$4  
 Purchase Orders & Major Credit Cards Welcome  
 CompuSave Is A Division Of Adlanko Corp.

# BYTE CONNECTION INC.

## BOTTOM LINE PRICE BUSTERS! - "Who you gonna call?"

### (714) 778-6496

#### PERSONAL COMPUTERS:

**IBM ★ I (IBM Compatible)**, 640K, two 360 floppies, hi-res graphics card, monitor and K.B. .... \$ 995  
**IBM ★ II**, all the above, w/10MB HD ..... \$1495  
**AT & T 6300**, 256K, two 360 floppies, AT & T graphics card, monitor and K.B. .... \$2095  
 all the above, w/360 floppy and 20MB HD drive ..... \$2525  
**AT & T 6300 Plus**, 640K, 1.2 MB floppy, 360 floppy, 20MB HD, K.B., AT & T monitor DOS ..... \$4295  
**COMPAQ PORTABLE**, 640K, 360 floppy, 10MB HD ..... \$2595  
**COMPAQ DESK PRO**, 640K, two 360 floppies, hi-res graphics card, K.B. .... \$2020  
 all the above w/360 floppy, 10MB HD, 10MB tape b/u ..... \$3131  
 with 30MB ..... \$3636  
**COMPAQ PORTABLE MODEL 286**, 512K, two 1.2 MB floppies ..... \$3838  
 above with one 1.2 floppy, 20MB HD ..... \$4444  
**COMPAQ DESK PRO MODEL 286**, 640K, two 1.2 floppies, hi-res graphics card, monitor and K.B., S., P., C/C ..... \$3838  
 above with one 1.2 MB floppy, 20MB HD, 10MB tape b/u ..... \$4994  
 above w/30MB HD ..... \$5353  
 above w/70MB HD and 60MB tape b/u ..... \$6969  
**IBM PC**, 256K, two 360 floppies, hi-res graphics card, monitor, P., S., C/C, K.B. .... \$2099  
 above w/360 floppy, 10MB HD, 10MB tape b/u ..... \$3131  
**IBM PC XT**, 640K, 360 floppy, 20MB HD, 10MB tape b/u ..... \$3663  
**IBM PC AT**, 512K, 1.2 MB floppy, 20MB HD, S., P., C/C, hi-res graphics card, monitor, K.B. .... \$4444  
**IBM PC AT**, above with 70MB HD, 60MB tape b/u ..... \$6969

#### PRINTERS:

**ANADIX 9620 - 9752** ..... \$1129 - \$1350  
**BROTHER DM40 - DH45** ..... \$ 950 - \$1050  
**CITIZEN MSP15 - 25** ..... CALL  
**DATA PRODUCT 8070 - 8072** ..... \$1750 - \$1850  
**DIABLO P32 - 34LQ** ..... \$ 685 - \$1250  
**DIABLO AP1 - P38** ..... \$1550 - \$1595  
**EPSON** ..... CALL  
**HP LAZERJET** ..... \$2350  
**HP LAZERJET PLUS** ..... \$3250  
**NEC** ..... CALL  
**OKIDATA 192 - 193** ..... \$ 389 - \$ 495  
**PANASONIC 1093** ..... \$ 499  
**TOSHIBA P351** ..... \$1159

#### PLOTTERS & DIGITIZERS:

**CALCOMP 1043** ..... CALL  
**HP 7475** ..... \$1659  
**HITACHI DIGITIZERS** ..... CALL  
**H1 DMP 41 - 42** ..... \$2865  
**H1 DMP 51/52** ..... \$4345  
**H1 DMP 51MP-52MP** ..... \$5650  
**NICOLET DPX** ..... CALL  
**ROLAND DPX** ..... \$3850  
**10 LINE** ..... \$4095

#### SPECIAL OF THE MONTH

**20 MB HD, SUBSYSTEM** ..... \$550  
**30, 40, 70 MB** ..... CALL

We carry all name brand MFC, modems, monitors, monitor adapters and software.  
 Call for what is not listed. Prices and availability subject to change without notice.

**WE GUARANTEE THAT YOUR CALL WILL NOT BE A WASTE.**

**163 West Cerritos Ave., Anaheim, CA 92805**  
**(714) 778-6496**

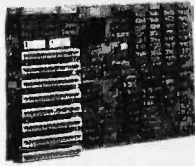

## Bullet-286 8-MHz 80286 XT Motherboard

- Faster and more compatible than turbo expansion cards
- 9 times faster than XT, 65% faster than AT
- Completely XT hardware and software compatible\*
- Up to 1 MB onboard RAM with no wait states
- 10-minute, screwdriver-only installation
- One-year warranty

Marchand International  
1240 N. Van Buren, Unit 108, Anaheim, CA 92807  
(714) 630-3382

\*Except IBM ROM BASIC

Inquiry 409

## MODULAR DATA ACQUISITION

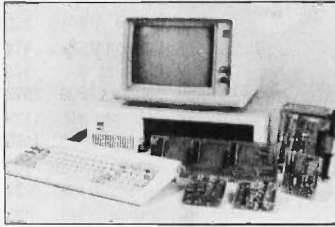

- For IBM & Compatibles
- Flexible and Inexpensive
- Money Back Guarantee
- Free Technical Support

**Fast Delivery**  
**QUA TECH, INC.**

478 E. Exchange St. Akron OH 44304  
(216) 434-3154 TLX: 5101012726

Inquiry 289



## PORTABLE MEMORY EXPANSIONS

**8K MEMORY MODULES \$29**

For Model 100, NEC PC-8201A  
& Olivetti M10

**24K MEMORY MODULES \$89**

For Tandy 200

**128K SIDESTAR \$399**

A Ram Disk Cartridge for the NEC Starlet

**128K SIDECAR \$259**

Ram Cartridge for the NEC PC-8201A

**TTXpress 1280 \$99**

Portable Thermal Printer—2.2 lbs., bat. oper.

**FREE SHIPPING IN USA**

(800) 732-5012

(805) 987-4788 (in Calif.)

**PURPLE  
COMPUTING**

VISA M/C &  
AMER. EXP.

420 Constitution Ave., Camarillo, CA 93010

Inquiry 285

## TERMINAL EMULATION

**Softerm PC** emulates over 30  
popular terminals including the:

- DEC VT102, VT220
- Data General D200, D410
- IBM 3101-20 (block mode)
- Hewlett-Packard 2622A
- Honeywell VIP7801, VIP7803

**Guaranteed Compatibility**

Call for free product brief

\$195 MC-VISA-COD

For the IBM PC/XT/AT, DG1, NEC,  
Wang PC, TI Pro, Gridcase, Tandy

**SOFTRONICS**

7899 Lexington Dr., Ste 210  
Colorado Springs, CO 80918  
(303) 593-9540

Inquiry 314

## TIME SAVING — MONEY SAVING PRINTER BUFFER



SPOOL-Z-Q PLUS

SPOOL-Z-Q PLUS is a parallel printer buffer which works with any parallel printer and frees up your computer for productive use while printing. Very high capacity (128K to 512K) and full time space and null character compression means that Spool-Z-Q Plus is ready to take on the really big jobs. A special Pause-on-Finished feature allows printing single sheets from the buffer. Spool-Z-Q Plus also has Copy, Clear, and Self-Test functions built in. Supplied complete with ULCSA fused power supply, the Spool-Z-Q Plus buffer is easy to install and use. All models are user expandable to 512K at any time by just plugging in standard 256K RAM chips. Spool-Z-Q Plus is the professional's choice, for size, features, and price!

(Without Cable) 128K-\$279 256K-\$309 512K-\$369  
(Including Cable) 128K-\$309 256K-\$339 512K-\$399  
SPOOL-Z-Q BLUE PLUG IN PRINTER BUFFER FOR THE IBM PC and compatible computers IS A GENUINE HARDWARE PRINTER BUFFER, NOT A SPOOLER. Parallel only and Serial/Parallel models available. Works with any software and does not use any of the computer's memory. Sizes from 256K to 1,024K are available. Spool-Z-Q Blue replaces the parallel printer card in the PC (May be LPT1, 2, or 3). Many, many advanced features. Call or write for full details. Prices start at \$119 (Parallel only) and \$399 (Serial capable).

Available from dealers or direct from us. We accept M/C, VISA, AMEX or COD orders. No charge for shipping or COD 15 day trial period (no-hassle refund policy) on all products. CA residents — 6% tax.

**DEALER INQUIRIES INVITED.**  
O.E.M.s — We can modify our buffers to meet your special requirements.

**electronics**  
1601 Fulton Ave., Suite 10A  
Sacramento, CA 95825  
(916) 483-0709

Inquiry 193

## FREE IBM PC

COMPATIBLE COMPUTER

When you buy one of the following products at very affordable introductory prices.

**UNIVERSAL PROGRAMMER \$1,595**  
Programs EPROMS & PAL expandable to Bi-POLAR and single chip micro

**LOGIC ANALYZER \$1,795**  
50 MHz, 8 channel expandable to 32 channel

**GANG PROGRAMMER \$1,295**  
Programs 8 EPROMS with same data, or different data.

**PROTOCOL ANALYZER \$1,595**  
Monitor and Simulator.

ABOVE PRODUCTS AVAILABLE WITHOUT PC.

**Advanced Microcomputer  
Systems, Inc.**  
2780 S.W. 14th St.  
Pompano Bch., FL 33069  
1-800-9PC-FREE



Inquiry 9

## 9-TRACK MAG. TAPE SUBSYSTEM FOR THE IBM PC/XT/AT



\$4757

For information interchange, backup and archival storage, IBEX offers a 9-track, IBM format-compatible 1/2" magnetic tape subsystem for the IBM PC, featuring:

- 42 M-Bytes on a single reel.
- IBM format 1600 cpi.
- Software for PC-DOS, MS-DOS.

Write, phone or TWX for information

**IBEX**

IBEX COMPUTER CORP  
20741 Marilla St.  
Chatsworth, CA 91311  
(818) 709-8100  
TWX: 910-493-2071

Inquiry 162

## RS-422 Communications Board

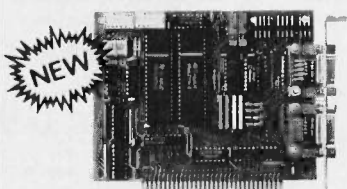

- For IBM-PC/AT/XT and compatibles
- Dual RS-422 serial interface
- Programmable to 56k baud
- Differential drivers to 4000 ft.

**\$345.00**

**QUA TECH, INC.**

478 E. Exchange St. Akron OH 44304  
(216) 434-3154 TLX: 5101012726

Inquiry 288

## Maxell Floppy Disks

The Mini-Disks  
with maximum quality.



Dealer inquiries invited. C.O.D.'s accepted. Call FREE (800) 235-4137.



**PACIFIC EXCHANGES**  
100 Foothill Blvd., San Luis  
San Luis Obispo, CA 93401.  
In Cal. call (800) 592-5935 or  
(805) 543-1037.

Inquiry 260



# ATTAK-286™

**HIGH SPEED 12 MHZ OPERATION** Software Selectable for **6,8,10, and 12 MHZ!**

- FULL IBM PC-AT\* COMPATIBILITY!
- FOUR MEGA-BYTE RAM CAPACITY ON MOTHERBOARD! USING 1 MEGA-BIT DRAMS.

**QUANTITY DISCOUNTS AVAILABLE FOR QUALIFIED DEALER, OEM, UNIVERSITY AND CORPORATE ACCOUNTS.**

**NEW!**

## HIGH SPEED INDUSTRIAL GRADE COMPUTER FOR:

- Scientific
- Engineering
- Industrial
- Medical
- University/Education
- Artificial Intelligence
- Etc., Etc., Etc.

Eight Compatible I/O Interface Connectors (Same as PC-AT)

Keyboard Interface (Same as PC-AT)

On Board Battery

CMOS Clock Calendar

Standard Power Connector (Same as PC-AT)

80287 Math Processor (Same as PC-AT)

Runs Intel 80286 at 6,8,10&12 MHZ! (Software selectable)

Peripheral Support Circuits (Same as PC-AT)

Extended ROM Capability (Operates on all compatible BIOS ROMS)

Extended Memory Capacity! Full Four Mega-Byte Capacity on Motherboard! (Uses 256k or NEW 1 Mega-Bit Drams)

**ORDER NOW!!**

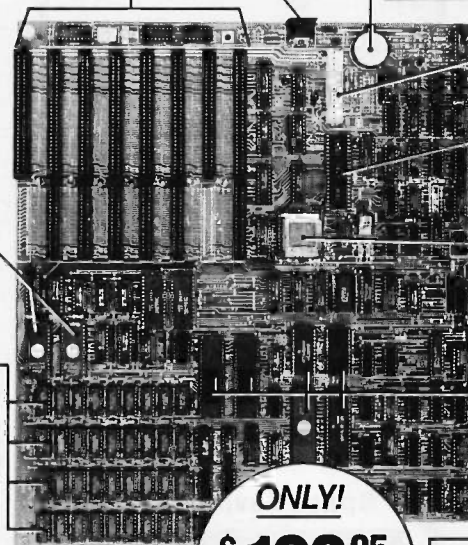

**ONLY!**

**\$199<sup>95</sup>**  
EVALUATION BOARD KIT

- ATAK-286™ FULLY ASSEMBLED (LESS ICS) ..... \$499.95
- AT CASE 100% COMPATIBLE..... \$129.95
- AT POWER SUPPLY 192V..... \$129.95
- ATAK-286™ TECHNICAL REFERENCE MANUAL... \$ 29.95
- TURBO-SCOPE™ A/D BOARD..... \$ 99.95

Board Size: Standard IBM-AT\* Dimensions: 12 inch x 13.8 inch with 6 mounting holes to fit all AT compatible cases.

100% SATISFACTION GUARANTEED.  
10 DAY MONEY BACK GUARANTEE IF NOT COMPLETELY SATISFIED!



ATAK-286™ evaluation board kit highest quality multi-layer PC board with full assembly instructions and parts lists!

**AiT CORPORATION** ADVANCED INTELLIGENCE TECHNOLOGY

4100 Spring Valley Road  
Suite 400  
Dallas, Texas 75244  
(214) 490-0344

TERMS: We accept cash, checks, money orders and credit cards. Prices and availability subject to change without notice. Shipping and handling charges via UPS ground 50c/lb UPS air \$1.00/lb. Minimum charge \$3.00.

\*IBM and IBM PC-AT are trademarks of International Business Machines

© 1986 AIT CORP.

# Osborne

As available only! Very limited quantity.

Important: Always call to check availability before ordering.	To fix yourself, or for parts. Complete, but known not working.	Guaranteed for 30 days. May be new or return, depending on avail. Exch/Repair	Outright
Main Board OS-1	\$79	\$79	\$139
Main Board Exec.	\$159	\$139	\$299
Battery Pack, 40 Watt	—	—	\$49
Double Density Kit **	—	—	\$79
** Includes board, cable, documentation & disk			
5" CRT (Grn/White)	\$9.95	\$19	\$29
7" CRT (Amber)	\$19	\$49	\$99
15" CRT, no case	—	—	\$85
Drive Analog Card	\$9.95	\$29	\$59
Drive Mechanism	\$19	\$25	\$59
Power Supply	\$4.95	\$24	\$29
Keyboard (No enclos.)	\$9.95	—	\$99

Shipping charged on all orders

Computer Parts Mart 415-493-5930  
3200 Park Blvd \* Palo Alto \* CA 94306

Inquiry 86

# TAX PAK<sup>®</sup>

INTEGRATED TAX PROGRAM WITH:

Forms	Schedules
1040 Tax Return	A Itemized Deductions
1040A Short Form	B Interest & Dividends
2106 Employee Bus. Exp.	C Business Profit or Loss
2119 Sale of Residence	D Capital Gains
2441 Child Care	E Supplemental Income
3468 Investment Credit	F Farm Income
3903 Moving Expense	G Income Averaging
4562 Depreciation	R Elderly/DisabledCredi
4684 Casualties & Thefts	SE Self Employment
5696 Energy Credit	W Married Cpl. Both Work

8" FORMATS: (SSSD only) CPM 2.2 (Z80), CPM86.  
5 1/4" FORMATS: (DSSD only) IBM PC-DOS 2.1 or later,  
CPM 2.2 (Z80) for Televideo, KayPro, Morrow, Osborne

Suitable for multiple clients or evaluating alternate filing strategies. Produces transcribable IRS forms \$33.  
For 1986 edition, return 1985 serialized disk and \$27.00.  
Licensing and volume discounts available.  
To order send check or money order to:

CANDELARIA WORKS  
3955 Club Dr. Atlanta, GA 30319  
**404/266-2420**

Inquiry 56

\$99.00

5 1/4" Hard Disk Controllers  
for Micromint COMM180 and others



SASI/SCSI to ST506 interface (all 5 1/4" hard disk drives)  
EMULATES: XEBEC S1410  
DTC 510  
SCSI-similar to Adaptec 4000

WORKS WITH MANY POPULAR SYSTEMS

- Micromint COMM180
- Wavemate Bullet
- AMPRO Little Board — All Boards
- MAC, APPLE IIe
- ACS 1000
- ISI 5160

Ask about others

These Shugart 1610 boards are new, Shugart tested controllers are guaranteed 90 days. They will mount on a 5 1/4" hard disk drive. Manual and schematic included.

Computer Surplus Store  
3675 Desoto Ave., Santa Clara, CA 95051  
(408) 248-0134  
Chuck Schuetz, proprietor  
Quantity and Dealer pricing available

Inquiry 87

**NEW!**

**SafeSkin™**  
KEYBOARD PROTECTOR  
Remains in place during keyboard use. Prevents damage from liquid spills, dust, ashes, etc. Fits like a second skin, excellent feel. Available for: IBM-PC, AT, Apple (all), Compaq, Model 100, NEC 8201, C64, Zenith 150, DEC, Kaypro and many others. Send \$29.95, check, M.O., Visa & MC include exp. date. Specify computer type. Dealer inquiries invited. Free brochure avail.  
Merritt Computer Products, Inc.  
2925 LBJ Fwy. #180 / Dallas, Texas 75234  
(214) 942-1142

Inquiry 230

I/O Bus for Data Acquisition & Control  
now available for IBM PC & Apple II series computers

The Local Applications Bus... 'LAB 40'  
In photo: LAB 40-PC generator & LAB 40-1 signal acquisition module.

- Modular approach to data acquisition and control. A 40 conductor ribbon cable bus is generated by a card in the host computer. Up to 8 low cost modules can be located anywhere on a cable up to 100 ft. long. Our LAB 40 generator cards for the IBM PC or Apple II are priced at \$185.
- Signal Acquisition and Control Module, model 'LAB 40-1': Features: 8 bit resolution, 4 channels, differential inputs, sampling rate up to 650KHz, software programmable gains and offset, digital output port, low price of \$220. Twelve bit module available.
- Full featured digital oscilloscope software. Documented and user modifiable. PC version \$175. Apple II version \$100. Complete data acquisition packages (hardware and software) start at \$450.
- Development tool. Unique to LAB 40 is its ability to interface directly to microprocessor compatible integrated circuits and hybrids. We encourage users to develop projects and products. LAB 40 is an ideal educational tool.
- New low cost modules. Twelve bit A/D Port/Relay Driver. Real Time Clock.

Computer Continuum  
75 Southgate Ave., Suite 6 • Daly City, CA 94015  
(415) 755-1978

Inquiry 107

**ATTENTION MEGABYTES**  
Beat The 33 Mbyte Limit!

Vfeature for **BIG** disks  
files  
User-Transparent  
Security Features Included.

Golden Bow Systems

\$80 — \$120  
Add \$3 for shipping/handling  
California residents add 6% sales tax.

619/298-9349  
P.O. Box 3039  
San Diego, CA 92103

Inquiry 145

**FREE CATALOG**

Space Saving CRT Arm

This sturdy steel arm swivels 360° at its base and its monitor tray swivels and tilts. It provides a comfortable, glare free viewing angle, while saving valuable desk space. Retail \$89.95

Lintek  
P.O. Box 8056  
Grand Rapids, MI 49508  
(616) 241-4040

Inquiry 207

**NO SHIPPING CHARGES**  
ORDER TOLL-FREE 800-824-3432

**DRIVES**

1/2 HT. IBM COMPATIBLE	89.99
TANDON 100-2	99.99
TANDON 100-4 (80 TRACK)	129.99

**MONITORS**

Princeton Graphics MAX-12E	159.99
Princeton Graphics HX-12	449.99

**ADD ON CARDS**

Multifunction Card w/384K RAM  
Included. Serial/Parallel Port.  
Clock/Calendar, Game Port

Monochrome Card	159.99
RGB Card	99.99
	119.99

**SYSTEMS**

**BLUE XTRA**

- PC/XT Compatible
- 1-1/2 HT. 360K Floppy
- 135W Power Supply
- 8 Slot Motherboard
- 256K RAM
- Runs IBM Dos 2.1 or 3.1

**FULL WARRANTY** 699.99

**HARD DRIVE SUB-SYSTEMS**

10 MEG. 1/2 HT.	449.99
20 MEG. 1/2 HT.	549.99
30 MEG.	1099.99
42 MEG.	1499.99
85 MEG.	2799.99

**NICORN ELECTRONICS**  
10010 Canoga Ave. • Unit B-8 Chatsworth, CA 91311

Minimum order \$10.00 — No shipping charges on prepaid orders — C.O.D. and \$3.00 — UPS Blue add \$3.00 — Calif. residents add 6 1/2% sales tax. Personal checks need clearance. VISA, MC.

Inquiry 361



Serial Parallel

**NEW!**



**Convert What You Have  
To What You Want!**

- RS232 Serial
- 8 Baud Rates
- Latched Outputs
- Centronics Parallel
- Handshake Signals
- Compact 3/4" x 4/4" x 1/4"

No longer will your peripheral choices be limited by the type of port you have available! Our new High Performance 700 Series Converters provide the missing link. Based on the latest in CMOS technology, these units feature full baud rate selection to 19.2K, with handshake signals to maximize transfer efficiency. Detailed documentation allows simplified installation. Order the Model 770 (Ser/Par) or Model 775 (Par/Ser) Today!

Buffer Products Coming Soon!

**ligertronics** INCORPORATED

2734-C Johnson Dr.  
Post Office Box 3717  
Venture, California 93006

Connector Option \$10.00  
CA Residents 6% tax  
UPS Shipping \$3.00

only **\$89.95**

CALL (805) 658-7466 or 658-7467  
For FAST Delivery

Inquiry 349

**ONE GPIB-488  
INTERFACE**

FOR ALL  
IBM PC, XT, AT,  
CLONES, APPLE MACINTOSH,  
TANDY 2000, 1200HD, 1000

ANY LANGUAGE  
EASY TO USE



MODEL 488-2000 PRICE \$675  
+ SHIPPING, INSURANCE & TAX  
When ordering specify computer for proper cable.

**Scientific Engineering  
Laboratories**

104 Charles St. • Ste. 143 • Boston, MA 02114  
Telephone: (617) 262-3903

Inquiry 305

**DATA FLEX™**

- Multi-user Database!
- Powerful!
- Multiple Operating System Compatibility!
- Attractive Dealer Pricing!
- Full Dealer Support!

Dataflex is a trademark of Data Access  
Dealer Inquiries Invited

**COGITATE**

24000 Telegraph Road  
Southfield, Michigan 48034 USA  
(313) 352-2345

Inquiry 70

**\$91.00**

Single Board Computer

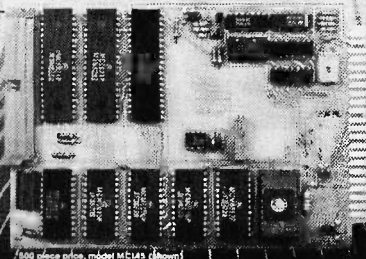

6800 MPU, serial I/O, parallel I/O, RAM, EPROM, 44-pin 4.5" x 6.5" PCB

EXPANSION MODULES: RAM, EPROM, CMOS RAM/battery, analog I/O, serial I/O, parallel I/O, counter/timer, IEEE-488, EPROM programmer, floppy disks, cassette, breadboard, keyboard/display.

**WINTERK**

Wintek Corp.  
1801 South Street  
Lafayette, IN 47904  
317-742-8428

Inquiry 377

**maxell.**

BULK DISKETTES

5 1/4" SS/DD **\$.70**

3 1/2" SS/DD **\$1.60**

Prices based on quantities of 500  
Orders shipped with 24 hours

VISA C.O.D. MasterCard

1-800 222-0490  
201-462-7628 in N.J.

**MEGAsoft**

P.O. Box 1143 • Freehold, N.J. 07728

Inquiry 228

DOUBLE PLOTTER COLOR PRINTER LETTER  
CASSETTE RECORDER VOICE RECORDER  
THE OPTION CAPACITY  
OF YOUR IBM PERSONAL COMPUTER

**PC-XTRA**

- DIRECT EXTENSION OF IBM PC BUS
- NO SOFTWARE CHANGES
- NO HARDWARE MODIFICATION
- STYLING CONSISTENT WITH IBM

Add all those special options that you've been wanting without worrying about filling your plug-in and back panel space



DEALER INQUIRIES INVITED.

**\$549.00\*** F.O.B. SANTA ANA  
CALIFORNIA RESIDENTS ADD 6% SALES TAX

**P C HORIZONS, INC.**

1701 E. Edinger, Ste. A6, Santa Ana, CA 92705  
(714) 953-5396

Inquiry 259

64K ■ 128K ■ 256K  
**DRAMS**

80287-8 ■ 80287-3  
8087-3 ■ 8087-2  
8087-1

BITTNER  
**BE**  
ELECTRONICS

899 SOUTH COAST HIGHWAY  
LAGUNA BEACH, CA 92651  
(714) 497-6200  
CALL NOW FOR **FREE CATALOG**

Inquiry 39

**P-tral:**  
BASIC to Pascal  
Translation Software

P-tral is the user-friendly translation software that converts Applesoft BASIC programs to Apple Pascal.

- Translates any business, scientific, graphics and game software from source.
- Translation results approach 100%.
- Translates any sized program—Large or Small.
- Essential compile directives generated.
- Version 1.0 \$179.00.

REQUIREMENTS: 64/128K RAM, Dos 3.3  
80-column card / Apple II, IIe, IIc  
Apple Pascal 1.1 or 1.2

To order or request more information contact: **WOODCHUCK INDUSTRIES-**  
340 West 17th Street, New York, NY 10011  
(212) 924-0576 / (212) 206-6490

Inquiry 379

**MARYMAC** INDUSTRIES INC.

800-231-3680

**Radio Shack® Tandy®  
Epson Printers**

People you Trust to give you the very best!



- Lowest Discount Prices
- Reliable Service
- Quality Products

"World's largest independent authorized computer dealer."

22511 Katy Fwy., Katy (Houston) Texas 77450  
(713) 392-0747 Telex 774132

Inquiry 222

# The Zipper™ 1200 bps & 2400 bps Modems

## Fully Hayes Compatible 2 Year Warranty

Supports all 20 Hayes Commands  
and all 6 responses

- Tone & Pulse dialing • Built-in speaker
- Auto dial/auto answer • 8 status lights
- Auto speed selection • Self-test

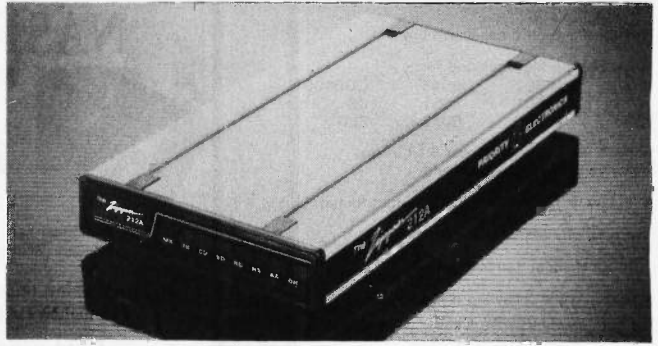

**1200 bps Standalone**  
Bell 103 and Bell 212A  
Compatible

**\$199**

**2400 bps Standalone**  
GCITT V22, V22BIS, Bell 212A,  
and Bell 103 Compatible

**\$399**

**1200 bps IBM PC**  
Compatible Card w/MITE  
Communications Software

**\$199**

BCPRIZIP12 (4 lbs.) Retail \$299.00 BCPRIZIP24 (5 lbs.) Retail \$599.00 BCPRIZIP12B (4 lbs.) Retail \$299.00

### VIDEO MONITORS

#### IBM-PC™ COMPATIBLE MONITORS

PGS MAX-12 Amber 12" 25lbs.	BCPGXMAX12	\$179
PGS HX-12 RGB 12" 37lbs.	BCPGXH12	\$479
AMDEK 310A Amber 12" 26lbs.	BCADK310A	\$169
AMDEK 600 RGB 640x240res 35lbs	BCADK600C	\$429
AMDEK 700 RGB 720x240res 35lbs	BCADK700C	\$479

#### GENERAL PURPOSE

AMDEK 300 Green Comp. 12" 25lbs	BCADK300	\$129
AMDEK 300A Amber Comp 12" 25lbs	BCADK300A	\$139
AMDEK 300C Color/audio Comp. 13" 25lbs.	BCADK300C	\$249
AMDEK 500 RGB/Color Comp. 13" 25lbs.	BCADK500C	\$369

### IBM COMPATIBLE BOARDS

#### AST

SixPacPlus 64K	BCAST6PACK64	\$259
RAM Page1 256K	BCASTRP256	\$399
MegaPlus II 64K	BCASTMP2	\$349
MegaPak 128K for above	BCASTPAK4	\$179
Preview!	BCASTPRVC	\$279

#### QUADRAM

EXPANDED QUADBRD zero K	BCQDRQDBRDXP0	\$239
QUADBOARD II zero K	BCQDRQDBRDII0	\$199
GOLD QUADBOARD zero K	BCQDRG0	\$449
SILVER QUADBOARD zero K.	BCQDRS0	\$269
LIBERTY BOARD 64K	BCQDRL64	\$349
QUAD 512+ 64K	BCQDR512	\$259
QUADCOLOR II	BCQDRQDCII	\$399

#### HERCULES

MONO GRAPHICS CARD	BCHECGC	\$329
COLOR graphics card	BCHECCC	\$179

#### ORCHID

CONQUEST zeroK	BCORCCQ	\$369
CRAMRAM Half card zeroK	BCORCCR	\$369
SIP panel mem exp for above 256K	BCORCCRRP	\$ 79
PC TURBO 186	BCORCT86	\$829
Serial daughter board for above	BCORCT8650	\$129

### PARADISE

5 PACK zero K	BCPAR5PACK	\$149
5PACK w/384K included you install	BCPAR5PACK384	\$199

#### EMULEX/PERSYST

BOB Super display adaptor	BCPSTBOB	\$399
---------------------------	----------	-------

### EXPANSION CHIPS

64K Expansion Contains 9 64K x 1 150nS RAMs	PDBIBMMEM9	\$12.00
256K Expansion Contains 36 64K x 1 150nS RAMs	PDBIBMMEM36	\$39.00

256K Expansion Contains 9 256K x 1 150nS RAMs	PDB256MEM9	\$39.00
MEG Expansion Contains 36 256K x 1 150nS RAMs	PDB256MEM36	\$189.00

### KEYTRONICS KEYBOARDS

Improved PC type 5lbs	BCKEYKB5151	\$189
KB5151 with touch pad 5lbs	BCKEYKB5153	\$379

### POWER SUPPLIES FOR IBM PC™

170watt replacement 7lbs	BCTEATP409B	\$159
130watt replacement 6lbs	BCTEATP412	\$ 99

### TERMINALS

WYSE 50 32lbs	BCWYS50	\$499
	BCWYS20	\$479
WYSE 30 32lbs	BCWYS30	\$359
QUME 101 Amber 32lbs	BCQMEQVT101AM	\$359
QUME 101 Green 32lbs	BCQMEQVT101GR	\$359

### MODEMS

#### HAYES

2400bps Smartmodem 4 lbs.	BCDCH2400	\$599
1200bps Smartmodem 4 lbs.	BCDCH1200	\$399
1200bps PC Smartmodem 4 lbs.	BCDCH1200B	\$379

### PROMETHEUS

ProModem 1200 Standalone 4lbs	BCPRMPM1200	\$299
ProModem 1200 for MAC 4lbs	BCPRMPM1200M	\$349
Communications buffer 1lb.	BCPRMOPTPRO	\$129
Alpha/num for ProModem 1lb.	BCPRMDISPLAY	\$ 79
512K ProModem upgrade 1lb.	BCPRMX512	\$ 99
ProModm 1200 Apple IIe card 4lbs	BCPRMPM1200A	\$349
ProModm 1200 PC crd/sftwr 4lbs	BCPRMPM1200B	\$279

#### PRACTICAL PERIPHERALS

†200bps ½ card w/software	BCPRPPM12	\$179
---------------------------	-----------	-------

### HARD DISK PC SUBSYSTEMS

Systems include drive, control & data cables & ½ card contrlr

#### INTERNAL (Include \$6 shipping)

10Mbyte ½ high	BCPRIPCSUB10I	\$399
20Mbyte ½ high	BCPRIPCSUB20I	\$559
30Mbyte full high	BCPRIPCSUB30I	\$999
42Mbyte full high	BCPRIPCSUB42I	\$1299

#### EXTERNAL (Include \$10 shipping)

Drives mounted in a IBM PC styled enclosure

10Mbyte subsystem	BCPRIPCSUB10X	\$599
20Mbyte subsystem	BCPRIPCSUB20X	\$759
30Mbyte subsystem	BCPRIPCSUB30X	\$1199
42Mbyte subsystem	BCPRIPCSUB42X	\$1499

### "AT" Subsystems - Drive, Cables & ROM

30 Mbyte Subsystem	BCPRIATSUB30I	\$899
40 Mbyte Subsystem	BCPRIATSUB40I	\$1499

### HARD DISK DRIVES (Sh. wt. 5 lbs.)

Shugart SA712 12Mbyte	BCSHUSA712	\$329
Seagate ST225 25Mbyte	BCSEAST225	\$ 449
Seagate ST4051 51Mbyte	BCSEAST4051	\$1199
Maxtor XT1140 143Mbyte	BCMXTXT1140	\$3295

### FLOPPY DISK DRIVES (Sh. wt. 3 lbs.)

TANDON 55-2 5¼" DS,40T,½ hi	BCTND552	\$ 79
Tandon TM100-2 5¼" DS,40T full hi	BCTNDTM1002	\$129

**Surge Suppressor  
Noise Filter**

**\$29.95**

BCWBR01158 List: \$49.95  
(Shipping Weight 2 lbs.)

IRVINE



**PRIORITY ONE ELECTRONICS®**



SAN JOSE

18241 Mc Durmott,  
Irvine, CA 92714  
(714)660-1411

Inquiry 282 Mail Your Order To:  
21622 Plummer St., Chatsworth, CA 91311-9970  
RETAIL: (818)709-5464 INDUSTRIAL: (818)709-5111

542 W. Trimble Rd.,  
San Jose, CA 95131  
(408)946-7010

MINIMUM PREPAID ORDER \$25.00. Terms U.S. VISA, MC, BAC, Check, Money Order, U.S. Funds ONLY. CA residents add 6%, 6½%, or 7% Sales Tax, depending on your local rates. Include MINIMUM SHIPPING & HANDLING of \$3.00 for the first 3 lbs., plus 50¢ for each additional pound (25¢ if within Calif.) Plus 25¢ per \$100.00 value of your order for PRIORITY ONE ELECTRONICS and PRIORITY 1 ELECTRONICS are registered service marks of the Heath Group, Ltd.

insurance. Orders over 70 lbs. sent freight collect. Just in case, include your phone number. Prices subject to change without notice. We will do our best to maintain prices through March 1986. Credit card orders will be charged appropriate freight. We are not responsible for typographical errors.

Zipper 212A, Zipper 2400, Zipper 1200B and Zipper Modem are trademarks of the Heath Group, Ltd.



**ORDER TOLL FREE (800)423-5922 (NOW IN CALIF. TOO!!)**



## CROSS-8

MAYBE THE ONLY DEVELOPMENT SOFTWARE YOU'LL EVER NEED

- Table based 8 bit cross-assembler
- Tables/Source files included for:
 

1802	6502	8048	COP400
3870	6801	8051	Z8
8096	6805	8085	Z80
- Modify/Create tables for most 8 bit micros  
Create your own instruction sets
- INTEL, MOTOROLA, TEKTRONIX output formats
- Use with any EPROM programmer
- 36 page manual, full instructions
- Available in the following disk formats:
  - 5" IBM-PC PC/MS-DOS 2.0 or greater, compatibles
  - 5" APPLE II+/IIe CP/M-80 (Softcard), compatibles
  - 8" SSSD CP/M-80 (Z80 only)

\$99.95 US    \$129.95 CDN

Credit card orders: Include card no., name on card, expiry date, signature. Nova Scotia residents add 10% sales tax.



**UNIVERSAL CROSS-ASSEMBLERS**  
P.O. BOX 384    BEDFORD    NOVA SCOTIA  
B4A 2X3    CANADA

Inquiry 363

## BULK DISKETTES

BY

## NASHUA



5 1/4" DS/DD with hub ring and Tyvek sleeve, bulk packaged, no labels, factory warranted. Shipping extra. For quantity 50, add 10¢ each.

Get the same low price our high-volume duplication customers get!

CALL TOLL FREE

1-800-321-4668

in Colorado, 303-234-0871

VISA, MASTERCARD, OR COD ACCEPTED

**ALF**

1315-F Nelson St.  
Denver, CO 80215

Inquiry 12



## Sure it's insured?

SAFEWARE® Insurance provides full replacement of hardware, media and purchased software. As little as \$39/yr. covers:

- Fire • Theft • Power Surges
- Earthquake • Water Damage • Auto Accident

For information or immediate coverage call:  
**1-800-848-3469**

In Ohio call 1-614-262-0559

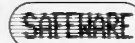

SAFEWARE, The Insurance Agency Inc.

Inquiry 302

## PC/XT USERS!

- COGTREE Utilities by
  - Cogitate ..... \$129.95
  - LYNC by Norton-Lamber... \$199.95
  - DATAFLEX by Data Access... *Varies*
  - RM/COBOL by Ryan/  
McFarland ..... *Varies*
  - Universe by Omnitrend... \$ 98.50
  - Blue MacI by Cogitate... \$599.00
  - CadPower+ by Trilex... \$995.00
  - Softext Teaching Aids... \$ 95.00
  - PrintSet by Cogitate... \$ 79.95
  - CogITAPE by Cogitate... **CALL!!**
  - Anti-Static Products... *Varies*
  - Uninterruptible Power  
Backups... *Varies*
  - TeleVideo Software... **CALL!!**

**COGITATE**

"A Higher Form of Software"  
24000 Telegraph Road  
Southfield, MI 48034  
(313) 352-2345/Telex 386581

VISA/MASTERCARD ACCEPTED  
Dealer Inquiries Welcomed

Inquiry 71

## DATA ACQUISITION TO GO INTERFACE FOR ANY COMPUTER

### FREE IBM SOFTWARE



Connects via RS-232. Fully IBM compatible. Built-in BASIC. Stand alone capability. Expandable. Battery Option. Basic system: 16 ch. 12 bit A/D, 2 ch. D/A, 32 bit Digital I/O. Expansion boards available. Direct Bus units for many computers.

(201) 299-1615

P.O. Box 246, Morris Plains, NJ 07950

**ELEXOR**

Inquiry 122

## 72 Digital I/O



### PXB-721 Parallel Expansion Board

- For IBM-PC & Compatibles
- 72 Digital I/O Lines
- Simple Programming
- Uses One Expansion Slot
- Fast Delivery

**\$195**

**QUA TECH, INC.**

478 E. Exchange St. Akron OH 44304  
(216) 434-3154 TLX: 5101012726

Inquiry 290

## 1st PLACE

COMPUTER SYSTEMS  
13422 N. CAVECREEK RD.  
PHOENIX, AZ. 85022

CALL FREE 1-800-841-2748

- ALDOS-2086T80 ..... \$14,599
- LEADING EDGE ..... \$CALL
- ITT PC ..... \$CALL
- ZENITH ..... \$CALL

### PRINTERS & TERMINALS

- STAR SG10 ..... \$214
- JUKI 6100 ..... \$339
- WYSE 50 ..... \$419
- QUME 101G ..... \$289
- CITIZEN MSP10 ..... \$255
- HARD DRIVES ..... \$CALL
- MODEMS ..... \$CALL

OTHER NAME BRANDS IN STOCK  
CALL FOR LOW PRICES

Inquiry 407

## 28 PIN PROM BLASTER WITH LIFETIME WARRANTY\*

Plugs into your IBM PC, XT or PPC and programs most 28 pin EPROMS. Includes the following features:



• Menu Driven • Edit function for the data buffer • Moves systems memory into data buffer • Performs a check sum • Reads EPROM into data buffer. Will program the following EPROMS: • 2764 • 27128 • 27256 • 2764A • 27128A

OTHER APPARAT ADD-ONS: 24 Pin Prom Blaster, AT 3rd Combo Card, 512K RAM Card, 384K RAM-Clock, Hard Disk Subsystem, Add-on Disk Drive, Clock Calendar, 256K RAM Card, Parallel-Serial Card for PPC, 128/384K Short Slot RAM Card for the PPC and more.

**Apparat, Inc.**

ADD ON AND ON AND ON AND ON AND ON

4401 So. Timarac Parkway / Denver, CO 80237 / 303-741-1778

ORDERING AND DEALER INFORMATION

800/525-7674

Stores in Denver & Chicago / \*On all cards sold after June 1, 1984

Inquiry 24

## M.A.G.I.C

### INLAB 28 LOGIC/MEMORY PROGRAMMER

It must be magic!

How else could

INLAB load all

- these features into such a small package:
- Capable of programming hundreds of logic and memory devices!
- Small and portable - less than 26 ounces!
- Inexpensive firmware updating!
- Available with CUPL™ design software!
- Standard RS232 interface!
- EPROM emulation, from 2716 up to 27256 (including CMOS)!

It's no illusion! For only \$1995, we can make a Model 28 appear before your very eyes! Just give us a call at 303/460-0103.

We'd like to do some magic for you!



**INLAB  
INC**

A Hathaway Company

2150-1 West 6th Avenue  
Broomfield, CO 80020

Inquiry 168

# DoKay

COMPUTER  
PRODUCTS,  
Inc.

ORDER TOLL FREE

(800)  
538-8800

(CALIFORNIA RESIDENTS)

(800)  
848-8008

VISA

MasterCard

## STATIC RAMS

1	256 x 4	450ns	1.90
2	1K x 1	450ns	.79
2L-4	1K x 1	450ns	.89
2L-2	1K x 1	250ns	1.29
1	256 x 4	450ns	2.29
2	256 x 4	450ns	2.29
4	1K x 4	450ns	.99
4-25	1K x 4	250ns	1.10
4L-4	1K x 4	450ns	1.20
4L-3	1K x 4	300ns	1.30
4L-2	1K x 4	200ns	1.40
7	4K x 1	55ns	3.95
1	256 x 4	450ns	CMOS 3.90
4044-4	4K x 1	450ns	2.95
4044-3	4K x 1	300ns	3.45
4044-2	4K x 1	200ns	3.95
4118	1K x 8	250ns	8.95
M2016-20	2K x 8	200ns	2.49
M2016-15	2K x 8	150ns	2.99
M2016-10	2K x 8	100ns	4.49
6118-4	2K x 8	200ns	CMOS 2.49
6118-3	2K x 8	150ns	CMOS 2.99
6118-2	2K x 8	120ns	CMOS 5.49
6118LP-4	2K x 8	200ns	CMOS 2.99
6118LP-3	2K x 8	150ns	CMOS 3.49
6118LP-2	2K x 8	120ns	CMOS 6.49
132	4K x 8	300ns	29.95
8284P-15	8K x 8	150ns	CMOS 5.95
8284LP-15	8K x 8	150ns	CMOS 6.95
8284LP-12	8K x 8	120ns	CMOS 8.95

## DYNAMIC RAMS

84027	4K x 1	250ns	1.45
8411	4K x 1	300ns	1.95
85280	4K x 1	300ns	1.95
84108	8K x 1	200ns	.49
85288	8K x 1	250ns	.49
8-20	18K x 1	200ns	.79
8-15	18K x 1	150ns	.99
8-12	18K x 1	120ns	1.49
8	18K x 1	150ns	5v 3.95
8	18K x 1	150ns	5v CALL
8	18K x 1	200ns	5v CALL
8	18K x 1	150ns	5v CALL
8	18K x 1	200ns	5v CALL
8	18K x 1	250ns	5v 2.99
8	18K x 1	150ns	2.99

## EPROMS

2	256 x 8	1 us	3.95
8	1K x 8	450ns	2.49
8	1K x 8	450ns	6.99
8	2K x 8	450ns	5v 2.95
8-1	2K x 8	350ns	5v 3.95
82518	2K x 8	450ns	5v 3.95
82718	2K x 8	450ns	5v 6.95
82832	4K x 8	450ns	5v 6.95
82832	4K x 8	450ns	5v 2.95
82 A-4	4K x 8	450ns	21v 2.95
82 A-35	4K x 8	350ns	21v 3.95
82 A-2	4K x 8	250ns	21v 5.95
82 A-2	4K x 8	200ns	21v 8.95
84	8K x 8	450ns	5v 3.95
84-25	8K x 8	250ns	5v 4.95
84-20	8K x 1	200ns	5v 5.95
82584	8K x 8	450ns	5v 9.95
M88784	8K x 8	450ns	5v 17.95
CM88788	8K x 8	350ns	5v 19.95
828-45	18K x 8	450ns	5v 5.00
828-30	18K x 8	300ns	5v 5.50
828-25	18K x 8	250ns	5v 6.00
828-25	32K x 8	250ns	14v 9.95

## 74LS00

74LS00	.23	74LS125	.48	74LS260	.58
74LS01	.24	74LS126	.48	74LS266	.54
74LS02	.24	74LS132	.58	74LS273	1.46
74LS03	.24	74LS133	.58	74LS275	3.30
74LS04	.23	74LS136	.38	74LS279	.48
74LS05	.24	74LS137	.98	74LS280	1.95
74LS08	.27	74LS138	.54	74LS283	.88
74LS09	.28	74LS139	.54	74LS290	.88
74LS10	.24	74LS145	1.15	74LS293	.88
74LS11	.34	74LS147	2.45	74LS295	.98
74LS12	.34	74LS149	1.30	74LS298	.88
74LS13	.44	74LS151	.54	74LS299	1.70
74LS14	.58	74LS153	.54	74LS323	3.45
74LS15	.34	74LS154	1.85	74LS324	1.70
74LS20	.24	74LS155	.88	74LS352	1.25
74LS21	.26	74LS156	.88	74LS353	1.25
74LS22	.24	74LS157	.84	74LS363	1.30
74LS26	.28	74LS158	.58	74LS364	1.90
74LS27	.28	74LS160	.88	74LS385	.48
74LS28	.34	74LS161	.84	74LS386	.48
74LS30	.24	74LS162	.88	74LS387	.44
74LS32	.28	74LS163	.64	74LS388	.44
74LS33	.54	74LS164	.88	74LS373	1.35
74LS37	.34	74LS165	.94	74LS374	1.35
74LS38	.34	74LS166	1.90	74LS377	1.35
74LS40	.24	74LS168	1.70	74LS378	1.13
74LS42	.48	74LS169	1.70	74LS379	1.30
74LS47	.74	74LS170	1.45	74LS385	1.85
74LS48	.74	74LS173	.88	74LS386	.44
74LS49	.74	74LS174	.54	74LS390	1.15
74LS51	.24	74LS175	.54	74LS393	1.15
74LS54	.28	74LS181	2.10	74LS395	1.15
74LS55	.28	74LS189	0.90	74LS399	1.45
74LS63	1.20	74LS190	.88	74LS424	2.90
74LS73	.38	74LS191	.88	74LS447	.38
74LS74	.34	74LS192	.78	74LS490	1.90
74LS75	.38	74LS193	.78	74LS624	3.95
74LS76	.38	74LS194	.68	74LS640	2.15
74LS78	.48	74LS195	.68	74LS645	2.15
74LS83	.58	74LS198	.78	74LS668	1.85
74LS85	.68	74LS197	.78	74LS689	1.65
74LS86	.38	74LS221	.88	74LS670	1.45
74LS90	.54	74LS240	.94	74LS674	9.90
74LS91	.88	74LS241	.98	74LS682	3.15
74LS92	.54	74LS242	.98	74LS683	3.16
74LS93	.54	74LS243	.98	74LS684	3.16
74LS95	.74	74LS244	1.25	74LS685	3.15
74LS98	.88	74LS245	1.45	74LS688	2.35
74LS107	.38	74LS247	.74	74LS689	3.15
74LS109	.38	74LS248	.98	74LS783	23.95
74LS112	.38	74LS249	.98	81LS95	1.45
74LS113	.38	74LS251	.58	81LS98	1.45
74LS114	.38	74LS253	.58	81LS97	1.45
74LS122	.44	74LS257	.58	81LS98	1.45
74LS123	.78	74LS258	.58	25LS2521	2.75
74LS124	2.85	74LS259	2.75	25LS2559	4.20

We will try to BEAT  
All Competitor's Prices  
CALL for Quote!

## 8000

8031	14.90	8253	6.90
8035	5.90	8253-5	7.90
8039	5.90	8255	4.45
1M8-8060	18.90	8255-5	4.90
1M8-8073	29.90	8257	7.90
8080A	3.90	8257-5	8.90
8085	4.90	8258	5.90
8085A-2	11.90	8258-5	6.90
8088	24.90	8271	69.90
8087-3 (5 MHz)	124.95	8272	19.90
8087-2 (8 MHz)	199.95	8274	28.90
8088	18.90	8275	28.90
8089	59.90	8276	6.90
		8279-5	7.90
		8282	8.45
		8283	8.45
		8284	4.90
		8286	6.45
		8287	6.45
		8288	12.90
		8289	44.90
		8292	12.90

## 8100

8131	2.90	8284	4.90
8155	6.90	8286	6.45
8155-2	7.90	8287	6.45
8156	6.90	8288	12.90
8185	28.90	8289	44.90
8185-2	38.90	8292	12.90

## 8200

8202	23.90	8303	2.90
8203	36.90	8304	1.90
8205	2.90	8307	2.90
8212	1.75	8308	2.90
8214	3.75	8310	3.90
8216	1.75	8311	3.90
8224	2.20		
8225	1.75		
8228	3.45	8741	28.90
8237	12.90	8748	19.90
8237-5	14.90	8749	28.90
8238	4.45	8755	23.90
8243	4.45		
8250	9.90		
8251	3.90	80186-8	99.90
8251A	4.45	80188	99.90

THIS IS A SAMPLING  
ONLY . . . CALL WITH  
ALL  
YOUR COMPONENT NEEDS

## CRYSTALS

ALL STANDARD VALUES . . . 1.69

CRYSTAL CLOCK OSC.

ALL STANDARD VALUES . . . 4.89

## DIP SWITCHES

4, 5, 6, 7, 8, 10 ALL . . . .79 ea.

## ZIF SOCKETS

14 pin ZIF	4.99
16 pin ZIF	4.89
24 pin ZIF	5.89
28 pin ZIF	6.89
40 pin ZIF	9.89

## ORBITAL SYSTEMS:

### EXTENDED 80-Column Card for APPLE IIe

- 64K to 128K Upgrade
- 2-Year Warranty . . . \$69.95

### Z-80 (CP/M) CARD

APPLE II+, IIe<sup>+</sup>

- Compatible w/all Apple CP/M
- Lifetime Warranty . . . 69.95

## MEG-O-RAM

EXPAND DESKTOP  
SPACE 1 MEGABYTE  
on APPLEWORKS<sup>+</sup>  
APPLE IIe<sup>+</sup> . . . \$259.00

## APPLE ACCESSORIES

Parallel Printer Card	49.95
80-Col. card for Apple II+	149.95
80-Col. card for Apple IIe	129.95
Serial Card (communication)	69.95
Cooling Fan	38.95
Power Supply	69.95
Joystick	29.95
Joystick Adaptor Apple IIc	14.95
RF Modulator	13.95
Disk Drive Full Height	169.95
Disk Drive 1/2 Height	169.95
Controller Card	49.95
Apple Paddles	5.95
16K Card	39.95

## ★ BULK DISKETTES ★

SS/DD . . . 25/\$17.25  
DS/DD . . . 25/\$19.75  
AT<sup>+</sup> disks . . . 25/\$50.00  
3 1/2" disks . . . 25/\$50.00

ALL DISKETTES HAVE  
A FULL 1-YEAR WARRANTY

## UV ERASERS

QUV-T8/1 \$49.95  
ECONOMY Model



- Erases 15 EPROMS in 20 minutes
- Plastic Enclosure

DOKAY carries the Full Line  
of LOGICAL DEVICES, Inc.

## MEMORY EXPANSION KIT



41256 150ns  
\$2.89 each!

APPLE<sup>+</sup> or IBM<sup>+</sup> JOYSTICK  
\$29.<sup>95</sup>

## ☆ MERCURY MODEMS ☆

For APPLE<sup>+</sup> and IBM<sup>+</sup>

HAYES COMPATIBLE MODEM 195.00

FULL ONE YEAR WARRANTY

IBM<sup>+</sup> ACCESSORIES ✓

8087-3 (5 MHz) . . . . . 124.95

8087-2 (8 MHz) . . . . . 144.95

TEAC 55B . . . . . 99.95

TANDON TM100-2 . . . . . 129.95

135W XT POWER SUPPLY . . . 99.95

512K RAM MEMORY BOARD . . 139.95

MULTIFUNCTION BOARD

with 384K RAM . . . . . 179.95

## MACINTOSH<sup>+</sup> UPGRADE

(Parts only)

128K to 512K . . . . . 50.00

Consists of: 16 41256 150ns

1 74F253

17 16 Pin Sockets

Resistors and Capacitors ALSO INCLUDED

† A TRADEMARK OF APPLE COMPUTER

‡ A TRADEMARK OF IBM CORPORATION

## CALL or WRITE for our FULL CATALOG

## BAR CODES MADE EASY

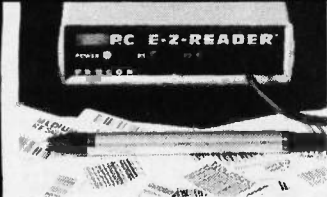

### PERCON® E-Z-READER™

Read the Fine Print before You Call.

PC/XT/AT/Compatibles **YES**. Serial and Multi-user **YES**. Auto-recognition of codes **YES**. Free phone support **YES**. 15 second keyboard installation **YES**. Bar code printing software **YES**. Software changes **HARDLY EVER**. 1000's in use. 2 Year Warranty. \$635 list.

NOW CALL US AT  
**503 344-1189**

2190 W. 11th St., Eugene, OR 97402

# PERCON®

Inquiry 269

### MEMO:

TO: COMPUTER COMPETENT O.E.M.s,  
ENGINEERS, & DEALERS.

FROM: MARTIN GREEN, PRESIDENT  
MASTERBYTE COMPUTERS  
OF N.Y. INC.

We are distributors for a 4th generation 68000 SUPERMICRO and are currently establishing dealerships and selling to sophisticated O.E.M.s. Contact us now for an exceptional opportunity.

## MASTERBYTE COMPUTERS OF NEW YORK, INC.

19 WEST 34TH STREET  
NEW YORK, NY 10001  
(212) 564 - 2247

TWX #9103801502 (MASTERBYTE)

[Listed in the D&B Procurement Planning Service Directory]

Inquiry 225

## ROSE DATA SWITCHES



SHARE computers, printers, any parallel or serial device  
ELIMINATE cable swapping  
INEXPENSIVE way to network  
COMPATIBLE with all computers.

Businesses, Schools, Homes

WE ALSO OFFER:

Data Buffers, Line Drivers, Modems, Protocol Converters, Parallel - Serial Converters, Cables, Computers, Printers, Disk Drives, and more.

**AUTOMATIC - CARETAKER** is ideal for a business or school to share a printer or modem among many computers. Operation is fully automatic with no software required.

Parallel or Serial 4 channels - \$295 8 channels - \$395

**MANUAL - HARDSWITCH** is operated with the flip of a switch. 2:2 and 2:4 models allow simultaneous communication.

Serial 1:2 - \$59 1:4 - \$ 99 2:2 - \$109 2:4 - \$169  
Parallel 1:2 - \$79 1:4 - \$139 2:2 - \$119 2:4 - \$199  
LED and spike protection on serial models add \$20.

**CODE ACTIVATED - PORTER** connects one computer to multiple peripherals. A software code selects the peripheral. Parallel or Serial 4 channels - \$295 8 channels - \$395  
Buffer option 64K - \$100 256K - \$250

**REMOTE - TELEPATH** connects multiple computers to multiple peripherals. A selector at each computer or terminal chooses up to 4 peripherals and displays busy status.  
4:4 - \$495 4:8 - \$795 selector and \$399

Give a Rose to your computer

ROSE ELECTRONICS (713) 933-7673  
P.O. BOX 742571 MC & VISA Accepted  
HOUSTON, TX 77274 Dealer Inquiries Invited  
CALL US FOR ALL YOUR INTERFACE NEEDS

Inquiry 298

## DATA ACQUISITION and control for ANY computer



The Model 1232 communicates via RS-232, and has 8 analog inputs ( $\pm 4$  VDC; 12 bits), 8 digital inputs and outputs, and a 2000 point buffer. Suitable for field data logging or lab use, the 1232 costs only \$690. The 8-bit system (0-5 VDC) is \$490. Detailed manual, \$6. Phone our applications engineer at 617-237-5514 or write:

★ ★ STARBUCK DATA COMPANY ★ ★

2 Mica Lane, Wellesley, MA 02181

Inquiry 326

## Publication Quality Scientific Graphics

GRAPHIC 3.0  
color

- linear, log, & polar plots
- bar charts & Smith charts
- contour plots with labels
- 3-D curves, 3-D surfaces with hidden line removal
- 4 curve types, 8 markers
- 14 fonts, font editor
- superscripts
- 4096 x 3120 resolution
- 16 colors on EGA, Tecmar, Sigma, TeleVideo HCB boards.
- zoom, pan, window plots
- multiple plots on a page
- high resolution printer dumps, full or half page

Over 100 routines can be called by your C program. SOURCE INCLUDED for personal use only. \$350  
256k, IBM & Corona PCs, DOS 2.0+, 3.+, Epson, Okidata, Prowriter, Toshiba printers  
Hewlett-Packard, Houston plotters  
IBM, Tecmar, Hercules, Sigma, TeleVideo graphics boards, D-Smet, Lattice, Aztec, Microsoft, & C-86 C compilers.

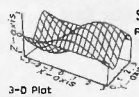

Scientific Endeavors  
Route 4, Box 78, Kingston TN 37783  
(615) 378-4148

3-D Plot

THIS AD WAS PRODUCED BY GraphiC™

Inquiry 225

## IBM PC/VT220

**EM220** • VT220, VT102 emulation  
\$149 • File Transfer  
• 132 Column modes  
• Color Support  
• Hot Key

## TEK 4010/4014

**EM4010** • Tektronix 4010 emulation  
\$249 • VT220, VT102 emulation  
• Picture files  
• High resolution hardcopy  
• Supports IBM, IBM Enhanced, Hercules, Tecmar and AT&T.

## Diversified Computer Systems, Inc.

3775 Iris Ave., Suite 1B  
Boulder, CO 80301  
(303) 447-9251

Trademarks: VT100 - Digital Equipment; IBM PC, XT - IBM Corp.

Inquiry 114



## Real-Time Multitasking Executive

- No royalties
- Source code included
- Fault free operation
- Ideal for process control
- Timing control provided
- Low interrupt overhead
- Inter-task messages
- Language Interfaces: C Pascal PL/M Fortran
- DOS File Access: CPM-80 IBM PC DOS

### Options:

- Resource Manager
- Buffer Manager
- Integer Math Library

AMX is TM of KADAK Products Ltd  
CPM-80 is TM of Digital Research Corp  
IBM PC DOS is TM of IBM Corp

AMX for 8080 \$ 800 US  
8086 950  
6809 950  
68000 1600  
Manual (specify processor) 75

KADAK Products Ltd. (604) 734-2796  
Telex: 04-55670  
206-1847 W. Broadway, Vancouver, B.C., Canada V6J 1Y5

Inquiry 194

## 5 1/4" 3M FLEXYDISKS

	10-90	100+
SS/DD Soft	\$1.15 <sup>ea</sup>	\$1.11 <sup>ea</sup>
DS/DD Soft	\$1.59 <sup>ea</sup>	\$1.54 <sup>ea</sup>
High Density (IBM-AT)	\$3.29 <sup>ea</sup>	\$3.19 <sup>ea</sup>
3.5/SS Micro	\$2.35 <sup>ea</sup>	\$2.25 <sup>ea</sup>

In Stock - Immediate Shipment.  
Mastercard, VISA, Check or Money Order.  
Add \$3.00 shipping charges per each 100 or part.  
Add \$2.50 additional for C.O.D. shipments.  
N.J. residents add 6% sales tax.

Data Exchange  
Dept. B, P.O. Box 993  
178 Route 206 South  
Somerville, N.J. 08876  
(201) 874-5050

Inquiry 108

## NEC PRINTERS

(1 Year Factory Warranty)

Pinwriter P5.....\$ 925  
Pinwriter P5XL.....\$1100  
Pinwriter P6.....\$ 445  
Pinwriter P7.....\$ 575  
Elf 350/360.....\$ 380  
3510/15/30/50.....\$ 715  
8810/15/30/50.....\$1040

Optional Forms Handling  
Devices ..... CALL

QUALITY PRINTERS  
8415 Cement City Road  
Brooklyn, Michigan 49230  
Phone: 517-592-3749

Inquiry 291



# BYTE

# LIMITED EDITION Classics

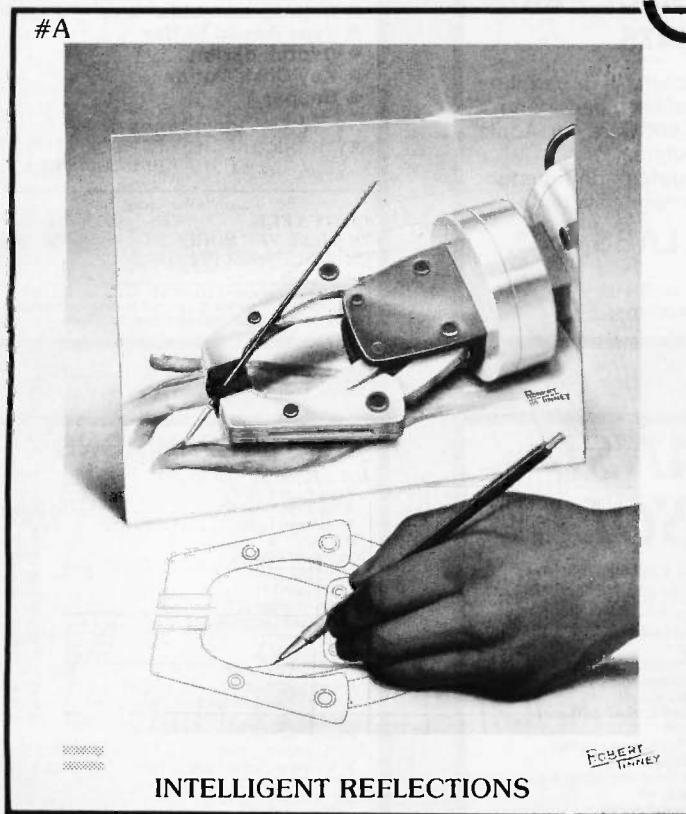

### Fascinating...And Unique!

The two 1985 Byte covers shown above are now available as 16" X 20" limited edition prints. Each edition is strictly limited to 1000 prints, which are individually inspected, signed and numbered by the artist, Robert Tinney. These excellent reproductions are made from the original paintings (not from transparencies or photos) to ensure accurate color fidelity.

Byte Limited Edition Classics are printed on select 100% cotton fiber stock. This is a museum grade acid free paper, highly resistant to yellowing and cracking; you will be assured of a print which will retain its color and beauty for generations. Accompanying each print is a handsome Certificate of Authenticity, which is also personally signed and numbered by the artist, and which certifies the quality and limited number of the edition.

### Price and Shipping

The price of each Byte Limited Edition Classic is \$55; if two or more prints are ordered, the price of each is only \$45.

Beautiful 16" X 20"  
Limited Edition Prints,  
each signed and numbered  
by the Artist.

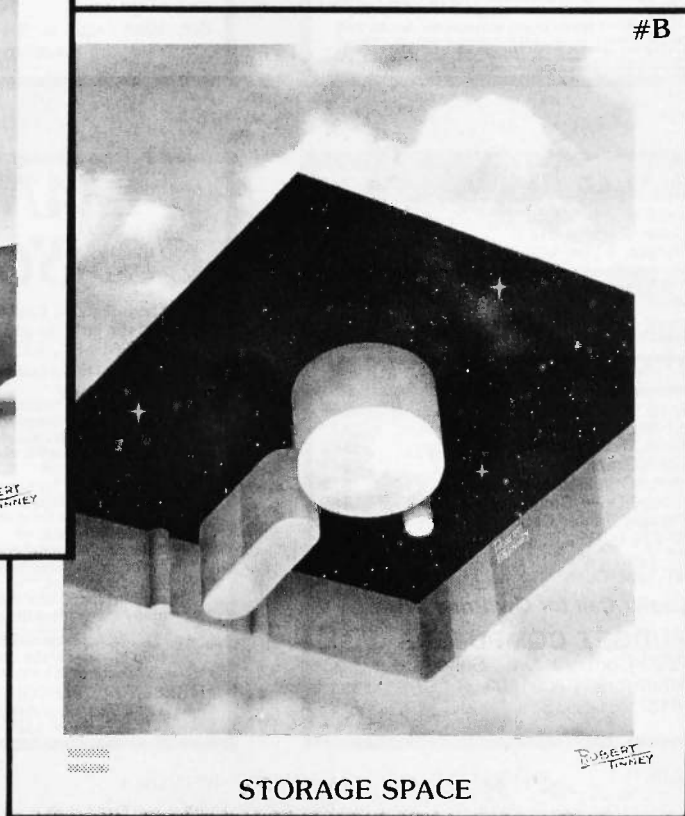

Byte Limited Edition Classics are shipped flat, and are guaranteed to arrive undamaged or be immediately replaced. In fact, if for any reason you are not satisfied with your order, you may return it within 30 days for a no questions asked refund. Your prints will be shipped UPS Blue Label (two day delivery), and will usually be shipped within one week of receipt of order.

### Ordering

To order your Byte Limited Edition Classic(s), just clip out and mail the coupon below. If you prefer, you may call in a MasterCard or Visa order to Robert Tinney Graphics, 1-(504)272-7266.

Send me the following print for \$55 (\$45 each for two or more).

Qty.	#	Title	Amount
_____	_____	_____	\$ _____
_____	_____	_____	\$ _____
postage & handling \$4 (\$10 overseas)			\$ _____
<b>Total \$</b>			\$ _____

Bill my  Visa or  Mastercharge: Exp. Date: \_\_\_\_\_

Card No. \_\_\_\_\_

I have enclosed check or money order to Robert Tinney Graphics  
 Please just send me your free color brochure.

**Ship To:**  
 Name: \_\_\_\_\_  
 Address: \_\_\_\_\_  
 City: \_\_\_\_\_  
 State: \_\_\_\_\_ Zip: \_\_\_\_\_

Mail this coupon to:  
**Robert Tinney Graphics**  
 1864 N. Pamela Drive  
 Baton Rouge, Louisiana 70815

**Visa or MasterCard orders  
 CALL 1-504-272-7266**

# ICs PROMPT DELIVERY!!!

SAME DAY SHIPPING (USUALLY)

OUTSIDE OKLAHOMA: NO SALES TAX

V20 \$16.00 V30 \$17.50  
8087-2 Math Coprocessors 145.00

### DYNAMIC RAM

256K 64Kx4 150 ns \$4.75  
256K 256Kx1 120 ns 3.37  
256K 256Kx1 150 ns 2.57  
128K 128Kx1 150 ns 5.50  
64K 16Kx4 150 ns 2.50  
64K 64Kx1 150 ns 1.15

### EPROM

27C256 32Kx8 250 ns \$7.50  
27256 32Kx8 250 ns 4.75  
27C64 8Kx8 250 ns 3.75  
2764 8Kx8 250 ns 2.75

### STATIC RAM

6264LP-15 8Kx8 150 ns \$3.15

QUANTITY ONE PRICES SHOWN  
100 ns 256Kx1 D-RAM @ \$5.15

640 Kaye MOTHERBOARD KITS: IBM PC/XT  
Zenith 150, Compaq Portable & Plus: \$66.25

OPEN 7 DAYS: WE CAN SHIP VIA FED-EX ON SAT.

MasterCard/VISA or UPS CASH COD

Factory New, Prime Parts  $\mu$ 100

MICROPROCESSORS UNLIMITED, INC.

24,000 S. Peoria Ave. (918) 267-4961

BEGGS, OK. 74421

Prices shown above are for Jan. 20, 1986

Please call for current prices. Prices subject to change. Please expect higher or lower prices on some parts due to supply & demand and our changing costs. Shipping & insurance extra. Cash discount prices shown. Orders received by 6 PM CST can usually be delivered to you by the next morning, via Federal Express Standard Air @ \$8.00, or Priority One @ \$13.00!

Inquiry 238

## 16-BIT RESOLUTION ANALOG-TO-DIGITAL CONVERTER 12,000 SAMPLES/SEC for IBM PC, XT & AT SINGLE PIECE PRICE \$475

We manufacture a broad line of data acquisition and control hardware and software for Apple and IBM computers.

Call for quotes on custom hardware or complete systems.

### LAWSON LABS, INC.

5700 RAIBE ROAD  
COLUMBIA FALLS, MT 59912  
406-387-5355

Inquiry 205

## USE AN IBM STYLE KEYBOARD ON ANY COMPUTER!

### BUY CORVATEK'S KEY-UP INTERFACE

FEATURES \$129.00

- Reprogrammable Keys
- Type Ahead Buffer
- Dvorak option
- Key Click Option
- Beeper

### KEYBOARDS

KEYTRONICS KB5150 KB5150D† \$112.00  
KB5151 KB5151D† \$164.00

Order Now From: (503) 752-4833

**CORVATEK**  
1100 N.W. VAN BUREN ST.  
CORVALLIS, OR 97330

Key-up is a trademark of CORVATEK. Keytronics and IBM are trademarks of Keytronics Corp. and International Business Machines. † Dvorak keyboard layout on D version.

Inquiry 98

### DATA SWITCH ..... \$39

Parallel 2 pos(A-B) ..... \$39  
Serial 2 pos(A-B) ..... \$35  
Parallel 4 pos(A-D) ..... \$52

### XT, AT POWER SUPPLY

\$65 XT-135 Watt AT-200 Watt \$129

### ADD-ON & ACCESSORY

5150 Style Keyboard ..... \$56  
AT Style Keyboard ..... \$77  
384K Multifunction (OK) ..... \$95  
Color/Graphic/Printer ..... \$63  
Mono/Graphic/Printer ..... \$79  
Floppy Drive Controller ..... \$39  
Parallel Printer Cable ..... \$10  
RS232 to RS232 Cable ..... \$10  
XT Type Case ..... \$39  
AT Type Case ..... \$95

Dealer Call for Qty Price

### BUDGET COMPUTERS

2620 Concord Ave., Suite 108  
Alhambra, CA 91803  
(818) 281-2833

Inquiry 49

## FANSI- CONSOLE™

The Integrated Console Utility™  
All the little things IBM forgot!  
for IBM—PC, XT, AT & clones.

- 1.2 to 3.0 times faster DOS & BIOS screen writing
- more escape sequences than ANSI.SYS
- usable in any language
- scroll recall facility
- compatibility w/PC & AT software
- full EGA support
- 255 character typeahead buffer
- increase key repeat rate
- no scroll blink for some adaptors
- VT 100/52 emulation
- auto dual screen disable
- keyboard induced breakpoints
- window support
- support for 50 line display
- many many more little features

Shareware disk \$25 or  
400p Manual (w/slip case) & disk \$75  
As described in Lotus June 85 pg. 8

HERSEY MICRO CONSULTING, INC.  
Box 8276J, Ann Arbor, MI 48107  
(313) 994-3259 x525 VISA/MC

Inquiry 155

controls up  
to 4 motors  
from any CRT,  
terminal or  
computer



### CENTROID STEPPING MOTOR CONTROLLER

- CHOPPER or R/L drives
  - RS232 interface
  - acceleration deceleration
  - 1-4 axis moves
- Standard R/L Version with BASIC \$985  
16K BASIC, R/L, Battery Backup \$1335  
CNC R/L Version \$1950  
Stepping Motor Tips Cookbook \$8  
Users Manuals \$12

CENTROID (814) 237-4535  
Box 739, State College, PA 16804

Inquiry 61

### STATE-OF-THE-ART MAGNETIC MEDIA

#### 5 1/4" DISKETTES



- With Hub Rings
- Write Protect Tabs
- Envelopes
- User ID Labels
- In Factory Sealed Poly Packs of 10

(YOU GET EVERYTHING BUT THE BOX)  
Prices are per Disk

QTY	50	100	500	1000
SSDD	.59	.56	.52	.49
DSDD	.64	.61	.57	.54

Library Case Holds 15 Diskettes. Only ... \$1.00! plus 50¢ S&H

The 100 File. Only ... \$10.95! plus \$2.00 S & H  
100% ERROR FREE — LIFETIME WARRANTY  
Min. order \$25.00. Add 10% for less than 50 diskettes. Shipping and Handling: \$4.00 per 100 diskettes. Reduced shipping for larger quantities. C.O.D. add \$4.00. Cash or certified check.

Precision Data Products  
P.O. Box 8367, Grand Rapids, MI 49518  
(616) 452-3457 • Michigan 1-800-632-2468  
Outside Michigan 1-800-258-0028

Inquiry 275

### ICs and Disk Drives

- 64K / 128K / 256K D-RAMs at LOW PRICES
- TEAC FD-55BV DSDD Disk Drives \$89.00 each [w/one year factory warranty!]
- V-20 5-MHz @ \$14.00  
B-MHz \$17.00  
V-30 8-MHz \$19.95
- MEMORY BOARDS  
\*IBM MULTI-FUNCTION BOARD w/384K \$185.00  
\*IBM MEM512 w/512K RAM \$159.00  
\*TALL-TREE JRAM-2 w/2-MB \$285.00  
\*JRAM-3 w/2-MB \$400.00
- 155W POWER SUPPLY FOR IBM PC & XT \$135.00
- INTERNAL 300/1200-B MODEM for PC, XT and AT by Best Data Products for only \$245.00 each  
\* Most popular brand 1200-B Modem compatible  
\* Complete with communications software.  
\* With 2 year factory warranty. \* Made in U.S.A.

WARRANTY: All ICs are guaranteed for 180 days from the invoice date on defective items. We will replace them free of charge.

### ExcelTec Industries, Inc.

P.O. Box 2205 Silver Spring, MD 20902

Phone: (301) 933-3523

OEMs and DEALERS are invited  
CALL US FOR THE LATEST PRICES

Inquiry 130



# FORTRON CORPORATION

3225 SELDON CT., FREMONT, CA 94538

IN CALIF: (415) 490-8171  
 TLX: 559291 FORTRON  
 FAX: (415) 490-9156

ORDER TOLL FREE: (800) 821-9771

## U.L. Rated • High Reliability • Full Technical Support

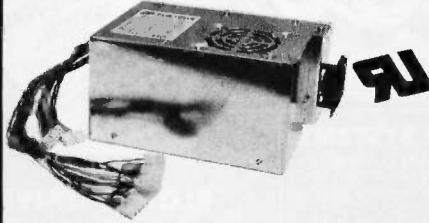

**FC 135-40 150W (max)**  
 PC/XT \$129.00





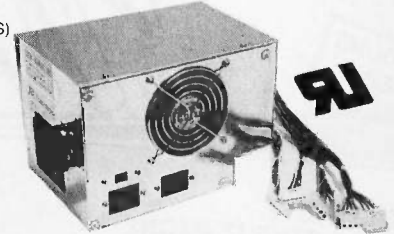

- U.L. recognized, yellow card available File # E-101115(S)
- Meet FCC class B, european safety spec.
- 115/230V AC convertible
- Low noise DC fan
- OVP, OCP, short circuit protection
- IBM® standard pin out or Faraday type pin out selectable
- 100% 24 hrs. burn-in 100% pre-shipment test.
- One full year warranty





Your PC represents a substantial investment. It does not make sense to risk costly down time due to bargain power supply when for a few dollars more you can have the confidence of FORTRON QUALITY.



**FC 5192 200W (max)**  
 PC/AT \$189.00

## PROFITABLE DISCOUNT PRICES FOR SYSTEM INTEGRATORS & DEALERS – PLEASE CALL

<p><b>FC 520</b> Color Graphic/Mono/Printer</p>  <ul style="list-style-type: none"> <li>• TTL/composite level outputs</li> <li>• 320 x 200 (color) 640 x 200 (B&amp;W)</li> <li>• Centronics printer port</li> </ul> <p style="text-align: right;"><b>\$99.00</b></p>	<p><b>FC 550 (CT-6040)</b> Monochrome/Graphic/Printer</p>  <ul style="list-style-type: none"> <li>• 80 x 25 text mode</li> <li>• 720 x 348 graphic mode</li> <li>• Run Lotus 1-2-3 auto cad, etc.</li> <li>• Hercules® compatible</li> </ul> <p style="text-align: right;"><b>\$119.00</b></p>	<p><b>FC 730 (CT-6050C)</b> 384K Multifunctions</p>  <ul style="list-style-type: none"> <li>• Memory expansion to 384K</li> <li>• Clock/calendar</li> <li>• Serial, parallel ports</li> <li>• Game port</li> </ul> <p style="text-align: right;"><b>(0K) \$129.00</b></p>	<p><b>FC 730 AT</b> Multifunction Card for PC AT</p>  <ul style="list-style-type: none"> <li>• 1 EIA-RS232C port (2nd optional)</li> <li>• 128K to 1.5 MB memory</li> <li>• Expandable to 3 MB (optional) by piggy back board</li> <li>• Game port</li> </ul> <p style="text-align: right;"><b>\$219.00</b></p>
<p><b>FC 740</b> Multi-I/O w/Floppy Controller</p>  <ul style="list-style-type: none"> <li>• 1 EIA-RS232C port (2nd optional)</li> <li>• 1 Centronic port, game port</li> <li>• Clock/calendar</li> <li>• Control 2 floppy drives (FC770) w/o Floppy Controller</li> </ul> <p style="text-align: right;"><b>\$119.00</b></p>	<p><b>FC 930 AT</b> RS232/Printer Port for PC AT</p>  <ul style="list-style-type: none"> <li>• EIA RS232C port (2nd optional)</li> <li>• Centronics parallel port</li> </ul> <p style="text-align: right;"><b>\$109.00</b></p>	<p><b>FC 940</b> RS232/Real Time Clock</p>  <ul style="list-style-type: none"> <li>• RS232C port</li> <li>• To 9600 baud</li> <li>• Battery back-up</li> </ul> <p style="text-align: right;"><b>\$69.00</b>  <b>\$59.00 (clock only)</b></p>	<p style="text-align: center;"><b>Plus More... for PC XT</b></p> <ul style="list-style-type: none"> <li>• 512K memory expansion card (0K) ..... <b>\$89.00</b></li> <li>• RS232/parallel port ..... <b>\$69.00</b></li> <li>• Monochrome controller with printer port <b>\$99.00</b></li> <li>• Floppy drive controller (w/cable) ..... <b>\$59.00</b></li> </ul>

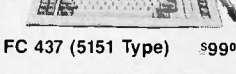
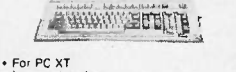
<p><b>XT HD Controller</b> AT FD &amp; HD Controller</p>  <p>XT HD Controller        DTC 5150 BX ..... 159.00        WD WX-2 ..... 149.00        Cable ..... 10.00        AT FD &amp; HD Controller        DTC 5290 ..... 270.00        WD WA-2 ..... 265.00        Cable set ..... 20.00</p>	<p><b>Internal Modem</b></p>  <ul style="list-style-type: none"> <li>• Free PC Talk software</li> <li>• 300/1200 baud</li> <li>• Auto busy redial, auto answer</li> <li>• Dual phone jack plus RS232 port</li> </ul> <p style="text-align: right;"><b>\$179.00</b></p>	<p><b>XT CPU Board</b></p>  <ul style="list-style-type: none"> <li>• 4.77 MHZ, 8088 cpu</li> <li>• Optional 6.77 MHZ</li> <li>• 8 slots</li> <li>• Expandable to 640K on board memory</li> <li>• Optional 8087 co-processor</li> <li>• Optional IBM® comp. BIOS</li> </ul> <p style="text-align: right;"><b>\$169.00 (0K)</b></p>	<p><b>FC 447</b> PC/AT Keyboard</p>  <ul style="list-style-type: none"> <li>• IBM AT compatible keyboard</li> <li>• Enlarge return key</li> <li>• Light on num. lock key</li> </ul> <p style="text-align: right;"><b>\$109.00</b></p>	<p><b>FC 427 (5150 Type)</b> \$79.00</p>  <p><b>FC 437 (5151 Type)</b> \$99.00</p>  <ul style="list-style-type: none"> <li>• For PC XT</li> <li>• Large return key</li> <li>• Light on num. lock keys</li> </ul>
---	---	--	---	--

## CABINETS & EXPANSION CHASSIS

<p><b>FC 630 A-2</b></p>  <ul style="list-style-type: none"> <li>• For PC XT compatible. \$99.00</li> <li>• To use FC 135-40 power supply</li> <li>• Complete mounting hardware</li> </ul>	<p><b>FC 630 A-T</b></p>  <ul style="list-style-type: none"> <li>• For PC AT compatible</li> <li>• LED lamps, key, key lock, speaker and mounting hardware, included.</li> </ul> <p style="text-align: right;"><b>\$139.00</b></p>	<p><b>FC 610</b> Drives Chassis</p>  <ul style="list-style-type: none"> <li>• Capable of holding 2 half-height drives</li> <li>• Come w/power supply, fan</li> <li>• LED power indicator</li> </ul> <p style="text-align: right;"><b>\$149.00</b></p>	<p><b>FC 640 5 Slot</b> Expansion Chassis</p>  <ul style="list-style-type: none"> <li>• W/5 slot mother board</li> <li>• 100W power supply, fan</li> <li>• Capable of holding 3 half-height drives</li> <li>• Dia. 15 1/2" x 12" x 5 1/2"</li> <li>• Option of system interface adaptor</li> </ul> <p style="text-align: right;"><b>\$259.00</b>  <b>\$159.00</b></p>	<p><b>FC 650 8 Slot</b> Expansion Chassis</p>  <ul style="list-style-type: none"> <li>• PC XT identical size</li> <li>• W/8 slot mother board</li> <li>• 140W power supply</li> <li>• 4 half-height drives</li> <li>• System interface adaptor</li> </ul> <p style="text-align: right;"><b>\$259</b>  <b>\$159</b></p>	<p><b>FC 660 12 Slot</b> Expansion Chassis</p>  <ul style="list-style-type: none"> <li>• Dia. 15 1/2" x 15 1/4" x 5 1/2"</li> <li>• W/12 slot mother board power supply, fan</li> <li>• Capable of holding 2 half-height drives</li> <li>• System interface adaptor</li> </ul> <p style="text-align: right;"><b>\$299</b>  <b>\$159</b></p>
--	---	--	--	--	--

<p><b>MONITORS</b></p> <ul style="list-style-type: none"> <li>• Monochrome</li> <li>Tatung MM 1222 A/G ..... 129.00</li> <li>Golden Star Green ..... 109.00</li> <li>Color Hi-Res (640 x 200) ..... 359.00</li> <li>Tatung CM-1360 ..... Call</li> <li>Enhanced Graphic</li> <li>Tatung CM-1380 ..... Call</li> <li>Super Hi-Res (640 x 300) ..... Call</li> </ul>	<p><b>DISK DRIVES</b></p> <ul style="list-style-type: none"> <li>• Floppy</li> <li>CDC 360K ..... 99.00</li> <li>Taac 55BV ..... Call</li> <li>1.2 MB ..... 139.00</li> <li>Hard (w/controller &amp; cable)</li> <li>10 MB ..... 419.00</li> <li>20 MB ST-225 ..... 519.00</li> <li>20 MB ST-4026 (40ms) ..... Call</li> <li>30 MB ST-4038 (40ms) ..... Call</li> </ul>	<p><b>ENHANCED GRAPHIC ADAPTOR</b>  <b>IBM Compatible</b></p>  <ul style="list-style-type: none"> <li>• For PC/XT/AT and compatibles</li> <li>• 256K on board memory</li> <li>• Full 16 colors in 640 x 350 on IBM® enhanced color display</li> <li>• Support 640 x 350 IBM® compatibles enhance color and monochrome monitors</li> <li>• Parallel port • Light pen interface</li> </ul> <p style="text-align: right;">• call for price</p>	<p><b>RAM CHIPS</b></p> <ul style="list-style-type: none"> <li>• 64K RAM ..... 10/9-PC</li> <li>• 256K ..... 33/9-PC</li> <li>• 128K ..... 53/9 set</li> </ul> <p style="text-align: center;">(for PC AT)</p> <p><b>Terms:</b></p> <ul style="list-style-type: none"> <li>• Min. shipping &amp; handling \$6.00</li> <li>• CA res. add 6.5% tax</li> <li>• Restocking charge 15%</li> <li>• No rtn. goods w/o a RMA no.</li> <li>• Prices subject to change w/o notice</li> </ul>
--	---	---	---

# MARCH Madness

**NEW HOURS**  
7AM-6PM  
P.S.T.

**FREE DIGITAL WATCH**  
With the purchase of any disk drive in this issue, we'll include a 7 melody alarm Quartz chrono watch FREE! (limit one per customer)

**YOU LIKE IT. OR WE TAKE IT BACK!**  
If for any reason, you are not satisfied with any product you purchase, you may return it within 10 days of receipt for replacement, credit or a full refund.\*

**WE'LL PAY YOU IF YOU FIND A LOWER PRICE!**  
If you buy any item from us at pricing in this ad and find a lower price from any source in this issue, that has the identical product in stock, we'll not only refund the difference you paid, but also pay you 20% of the difference for your trouble! If you find a lower price in this issue before you buy, from any source that has the identical product in stock, we'll beat it!\*\*\*

**GUARANTEED AVAILABILITY!**  
Any item you order will be shipped within Two working days or you will be given a firm ship date when you order! If for any reason we cannot ship by the date you are given, we will deduct 5% from the price of the products shipped late and credit your order accordingly.\*\*

## COMPLETE INTERNAL HARD DRIVE SYSTEMS

Includes drive, PC/XT controller card, cables and install procedures. Capacities listed are unformatted. We sell only the finest drives from Seagate, Mitsubishi, Microscience, and others guaranteed to meet or exceed original manufacturer's specifications.

<b>13MB</b> 1/2 Ht. 85ms	<b>\$388.</b>
<b>25MB</b> 1/2 Ht. 85ms starting at	<b>\$438.</b>
<b>38MB</b> Full Ht. 40ms	<b>\$788.</b>
<b>51MB</b> Full Ht. 40ms	<b>\$928.</b>

## FLOPPY DRIVES

PC COMPATIBLE

<b>PANASONIC</b> 1/2 Ht.	<b>\$89.88</b>
<b>SANYO</b> 1/2 Ht.	<b>\$79.00</b>
<b>APPLE II</b> Compatible, inc. cable	<b>\$97.75</b>

## MODEMS

**SmarTEAM 103/212A**  
1200/300 baud auto answer/auto dial. Hayes™ (AT) compatible external modem. Monitor speaker, tone/pulse dialing, status indicator lights.  
**\$178.00**  
2 Year Warranty

## ZOOM 1200

1200/300 baud, auto answer/auto dial, Hayes™ (AT) compatible internal modem. Deamon dialing, monitor speaker, tone/pulse dialing, dual phone jacks, call progress tone detection. 2 Year Warranty. Made in USA.  
**\$199.88**  
INCLUDING SOFTWARE!

## MONITORS

**TATUNG**  
The highest image quality, most reliable monitors we've tested.  
**1360 13" Hi-Res RGB 640 X 200** ..... **\$367**  
**1370 13" Ultra Hi-Res RGB 720 X 400** ..... **\$447**

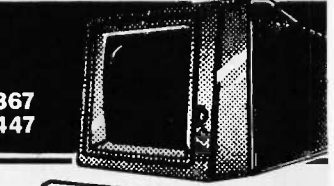

## BORLAND

<b>SIDEKICK 1.5 c/p</b>	<b>\$27.75</b>
<b>SIDEKICK 1.5 nc/p</b>	<b>\$42.99</b>
<b>SIDEKICK MAC nc/p</b>	<b>\$42.99</b>
<b>TURBO PASCAL 3.0 nc/p</b>	<b>\$35.33</b>
<b>SUPERKEY 1.1 nc/p</b>	<b>\$35.33</b>

**REPEAT OF A SELLOUT!**

<b>TRAVELING SIDEKICK nc/p</b>	<b>\$39.97</b>
<b>TURBO LIGHTNING nc/p</b>	<b>\$55.00</b>
<b>REFLEX nc/p</b>	<b>\$55.00</b>

## COMPONENTS

Quality Japanese mfg. from companies like OKI, HITACHI, TOSHIBA and FUJITSU.

<b>256K DRAMS</b> Set of 9-150ns	<b>\$26.46</b>
<b>64K DRAMS</b> Set of 9-150ns	<b>\$8.91</b>
8087-3	\$93.00
8087-2	\$129.60
80287	\$178.00
27128	\$2.90
V20-5MHz replaces 8088	\$11.00
27286	\$4.50
2764	\$1.98

## FUJI

Certified Quality 5 1/4" FUJI Bulk Disks With or without box.

**DS/DD in White Box**  
With sleeves, labels and w/p tabs. Priced per box of 10.

<b>1-19</b>	<b>20-99</b>	<b>100-499</b>	<b>500-999</b>	<b>1000+</b>
9.99	9.30	8.79	8.32	7.99

## DISKETTES

**NEW LOWER PRICES!**  
DS/DD Bulk w/o box, sleeves, labels or w/p tabs  
Price each, in increments of 20 only, poly bagged

<b>60-180</b>	<b>200-480</b>	<b>500-980</b>	<b>1000-4980</b>	<b>5000+</b>
.92	.82	.76	.71	.67

## MULTITECH MULTIFUNCTION BOARD

AST Sixpack™ compatible. Serial port, Parallel port, Game port, Clock/Calendar, RAMDISK and PSPOOL software. Up to 384 K memory expansion (empty).

**\$99**  
1 Year Warranty

## ACCESSORIES

### PC POWER SUPPLIES

**150 WATT** ..... **\$94**  
**KEYBOARDS:** IBM/XT™ and KEYTRONICS™ COMPATIBLE:  
**5150 style** ..... **\$69**  
**5151 style** ..... **\$89**

### REPLACEMENT HARD DISK DRIVES:

<b>25MB</b> 1/2 ht. 85ms or better	<b>\$348</b>
<b>25MB</b> Full ht. 40 ms	<b>\$568</b>
<b>38MB</b> Full ht. 40ms	<b>\$678</b>
<b>51MB</b> Full ht. 40ms	<b>\$848</b>

### BOARD PRODUCTS:

<b>Western Digital PC/AT</b> type Hard/Floppy cont.	<b>\$279</b>
<b>MULTITECH</b> 2 Drive PC floppy controller	<b>\$45</b>
<b>MULTITECH</b> 4 drive PC floppy controller	<b>\$58</b>
<b>AST Advantage 128K</b>	<b>\$384</b>
<b>MULTITECH</b> color graphics board (1-2-3 comp.)	<b>\$98</b>
<b>HERCULES</b> graphics board	<b>\$287</b>

**QUADRAM** Quadboard w/64K ..... **\$197**  
**MULTITECH 384K** mem. exp. board (empty) ..... **\$49**

### MODEMS:

**NOVATION SMARTCAT+** 1200/300 baud, int. or ext. Auto ans/Auto dial Hayes™ (AT) comp w/MITE ..... **\$308**  
**HAYES 1200B** w/Smartcom II ..... **\$349**  
**NOVATION 2400** with MS-DOS or Macintosh software ..... **\$548**  
**ZOOM IIE 300** baud A/A/D Hayes™ comp W/software ..... **\$96**

### MONITORS:

<b>AMDEK 710 RGB 720 X 400</b>	<b>\$486</b>
<b>PRINCETON MAX-12 Amber</b>	<b>\$166</b>
<b>PRINCETON HX-12E RGB</b>	<b>\$544</b>
<b>TATUNG-1222 12" Amber</b>	<b>\$118</b>
<b>TAXAN 122</b> monochrome	<b>\$137</b>
<b>TAXAN 640 RGB 720 X 400</b>	<b>\$529</b>

Inside California **1-800-358-8881** Outside California **1-800-826-3736** Inquiry 395

### \* THE FINE PRINT

Excluding software. Prior return authorization required; all items returned must be in original condition with carton, packing and all manuals, etc. We accept Cashier and Certified checks, Money Orders, personal checks (product shipped when check clears), VISA and MasterCard with no surcharge and American Express (4% surcharge). All products shipped UPS ground unless specified otherwise (freight FREE for orders over \$100). All normal manufacturer's warranties apply.

## WORLDWIDE ACCESS

Everybody hates us but our customers.

6311-L Desoto Ave., WOODLAND HILLS, CA 91367  
HOURS: 7:00AM-6:00PM Pacific Time

### \*\* IF YOU DON'T SEE IT, CALL!

We have virtually any product available at the best pricing. Space limits us to only a fraction of what we sell. Call us for a quote and delivery information. If we don't have it, we'll try to get it for you! All items priced and in stock at time of ad placement and subject to vendor changes and prior sale at time of ad publication.

Dealers: Call for quantity prices!

1-800-826-0843

# THE COMPUTER BARN

Super Low Prices on Micro Computers and Accessories...

WYSE 30	\$ 330	TeleVideo 905	\$ 285
WYSE 50	409	TeleVideo 9220	485
WYSE 75	539	Canon Laser 8A1	2195
WYSE PC	1159	Canon A40	245
WYSE 85	439	Diablo 635	1095
Compaq Port 2100		Compaq DskPro2	
IBM PC	1650		
WY-500 (Green Mono)	\$ 160		
IBM XT w/10MB	3295		
IBM AT w/20MB	5095		

CASE/RIXON, ARK PARADYNE, PRENTICE, Modems. Complete line of Canon, Diablo, Datasouth Printers. Many other Products.

CALL FOR FREE BROCHURE

Inquiry 79

## FREE SOFTWARE FROM THE PUBLIC DOMAIN

User Group Software isn't copyrighted, so no fees to pay! 1000's of CP/M and IBM software programs in .COM and source code to copy yourself! Games, business, utilities! All FREE!

	Rent	Buy
IBMPC-SIG 1-454 Diskslides	475.	950.
IBMPC-BLUE 1-175 Diskslides	200.	495.
SIG/M UG 1-246 Diskslides	160.	675.
CP/M UG 1-92 Diskslides	45.	250.
PICO NET 1-34 Diskslides	25.	100.
KAYPRO UG 1-60 Diskslides	70.	210.
EPSON UG 1-52 Diskslides	65.	200.
Commodore CBM 1-93 Diskslides	100.	200.

Public Domain User Group Catalog \$5 pp.

(payment in advance, please)

Rental is for 7 days after receipt, 3 days grace to return. Use a credit card, no disk deposit.

Shipping, handling & insurance \$9.50 per library.

(619) 941-0925 Orders & Technical (9 to 5)

(619) 727-1015 24 Hr. 3 Min. Info Recording

Have your credit card ready!

National Public Domain Software

1533 Avohill Dr.

Vista, CA 92083

800-621-5460

then dial 782-542



BBB



AM EX.

Inquiry 249

## ROMDISK

### EPROM OR RAM DISK AND DISK DRIVE EMULATORS

IBM PC\*, COMPATIBLES and APPLE IIe\*

- Diskless control and communications system
- Autoboot applications for dedicated workstations and improved productivity
- Customized high speed, smart terminals
- Solid state speed, reliability and performance
- Self contained control and EPROM program circuitry
- PC and MS DOS\* compatible
- ROMDISK and RAMDISK are I/O mapped
- RAM disk - with battery back-up
- Plug compatible EPROM and RAM modules

ROMDISK PC-1 (180K) \$495

ROMDISK PC-2 (360K) \$595

RAMDISK PC-D (360K) \$595

ROMDISK A FOR //E (144K) \$349



CURTIS, INC. 22 Red Fox Road

St. Paul, MN 55110 612/484-5064

\*IBM PC and PS DOS is a registered trademark of IBM Corporation. MS DOS is a registered trademark of Microsoft Corporation. Apple //e is a registered trademark of Apple Computer Corporation.

Inquiry 103

## APPLE II COPROCESSOR & I/O



### INTRODUCING THE BUKOWSKI ROBOTICS VIP CARD

A VERSATILE CONTROLLER CARD THAT CAN STAND ALONE

OR IN AN APPLE SLOT AS AN INTELLIGENT PERIPHERAL CARD THE VIP CARD NOT ONLY GIVES YOU 16 I/O PORTS (EXPANDABLE TO 48) BUT ALSO AN ONBOARD 65C02 MICRO-COMPUTER. YIP WILL RUN MINIBASIC AND HAS ENDLESS APPLICATIONS. FOR EXAMPLE: PARALLEL OR SERIAL PRINTER PORTS, PRINTER CARD, INDUSTRIAL AND HOME CONTROL.

ONLY \$129 VISA/MASTERCARD ACCEPTED

BUKOWSKI ROBOTICS  
1555 W. UNIVERSITY #105  
TEMPE, AZ 85281  
(602)966-6230



Inquiry 50

## FOR THE BEST OF US... THE CYPHER™

A COMPLETE 68000 & Z80A SINGLE BOARD COMPUTER SYSTEM WITH ULTRA-HIGH-RES GRAPHICS!!

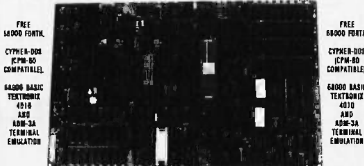

- FREE 16000 DORTH
  - CYPHER-DOS (CPM-80 COMPATIBLE)
  - 68000 BASIC TEXTBOOK
  - 48000 BASIC TEXTBOOK
  - 4810 ASCII
  - 4800-3A TERMINAL EMULATOR
- LOWER PRICES! 1 MEGABYTE CYPHER FROM \$849 (100 QUANTITIES ASSEMBLED WITH:
- 68000 & Z80A DUAL PROCESSORS (BEST OF BOTH WORLDS) - OPTIONAL Z80 AND FASTER 80000
  - 1 MEGABYTE MEMORY (ULTRA-DENSE)
  - DOUBLE DENSITY FLOPPY DISK CONTROLLER w/ 5 1/4" OR 5 1/8" DISKS
  - DIAG CONTROLLER FOR FAST IMAGE TRANSFER (UP TO 800K WORDS MEMORY) (w/ 10000)
  - 3 FLOPPY SERIAL PORTS (250K)
  - 24 BIT ADDRESS MANAGEMENT FOR Z80
  - 4 LAYER P.C.B. (9" x 14")
  - 256K CPM-80, 320K CPM-80, 320K CPM-80A, 256K INCLUDED COMES WITH CYPHER-DOS, RAM DISK, 80000 BASIC TEXTBOOK AND TRANSFER TO TERMINAL EMULATOR AND BIOS FOR ALL CPM-80 VERSIONS
  - 16K HIGH RESOLUTION GRAPHICS (PRIVATE TOSHIBA PROGRAMMABLE UP TO 1024 x 1024 PIXEL SOLUTION) - GREAT FOR CAD/STYLING
  - REAL TIME CLOCK (W/ BATTERY CAPABILITY)
  - PROGRAMMABLE I/O AND A/D CONVERTER SOLUTION (MUSIC RHYTHMIC LAB WORK)
  - 16K MEMORY EXPANDABLE TO 64K
  - 4K STATIC RAM (EXPANDABLE TO 64K)
  - PROGRAMMABLE AUDIO RATE GENERATOR (8KHZ)
  - PARALLEL ASCII ASCII TERMINAL INPUT
  - 16K 8000 EXPANSION BUS (80 PIN HEADER, BUFFERS BUS)
- ALL ON ONE BOARD!
- 16K MEMORY EXPANSION (80 PIN HEADER WITH OTHER 16K MEMORY SERIAL HARD DISK)
  - CYPHER-DOS (CPM-80 COMPATIBLE) - 16000 DORTH
  - 68000 BASIC TEXTBOOK
  - 48000 BASIC TEXTBOOK
  - 4810 ASCII
  - 4800-3A TERMINAL EMULATOR
- WHOLE AND QUANTITY PRICES:
- ASSEMBLED CYPHER - SINGLE CHECK 16000 EACH
  - 16000 BASIC TEXTBOOK QUANTITY PRICES: 16000 EACH
  - ASSEMBLED CYPHER - QUANTITY PRICES: 16000 EACH
  - 16000 BASIC TEXTBOOK QUANTITY PRICES: 16000 EACH
  - 48000 BASIC TEXTBOOK QUANTITY PRICES: 48000 EACH
  - 4810 ASCII QUANTITY PRICES: 4810 EACH
  - 4800-3A TERMINAL EMULATOR QUANTITY PRICES: 4800-3A EACH
- ALL PRICES ARE IN U.S. DOLLARS. WE SHIP WORLDWIDE. OUR SHIPPING CHARGES ARE \$10.00 PER UNIT. WE DO NOT SHIP TO CANADA, MEXICO, SOUTH AMERICA, AUSTRALIA, AND NEW ZEALAND. WE DO NOT SHIP TO CUBA. WE DO NOT SHIP TO COUNTRIES UNDER U.S. ECONOMIC SANCTIONS. WE DO NOT SHIP TO COUNTRIES UNDER U.S. TRADE EMBARGOS. WE DO NOT SHIP TO COUNTRIES UNDER U.S. TRADE RESTRICTIONS. WE DO NOT SHIP TO COUNTRIES UNDER U.S. TRADE SANCTIONS. WE DO NOT SHIP TO COUNTRIES UNDER U.S. TRADE RESTRICTIONS. WE DO NOT SHIP TO COUNTRIES UNDER U.S. TRADE SANCTIONS.

Inquiry 242

IN-PUT RS232 SERIAL OUT-PUT

IN-PUT PARALLEL OUT-PUT

BI-DIRECTIONAL

Printer Buffer

This is the most sophisticated Printer Buffer in the market today. Microprocessor controlled, with two separate inputs, Serial and Parallel, and two outputs, Serial and Parallel. Automatic selection of input/output, wherever you connect your units. Comes in two models: 1) w/64K to 256K and 2) w/256K to 1 Mbyte of buffer. Including COPY, RESET and PAUSE that allows you to print single sheets. External power supply included.

Also we have a BI-DIRECTIONAL Serial Parallel converter, without buffer, fully modes, baud rate and protocol programmable by jumpers, with DTR, RTS or XON/XOFF protocol. External power supply (not included).

DCB-A 64K (exp. up to 256K) \$ 255. =

DCB-B 256K (exp. up to 1 MB) \$ 295. =

DCU BI-directional converter \$ 80. =

?? Order today at:

INTECTRA INC. - Department 232  
2629 TERMINAL BLVD  
MOUNTAIN VIEW - CA - 94043  
(415) 967-8818 - TLX 345545

IN-PARALLEL OUT-PARALLEL IN-SERIAL OUT-SERIAL

## IMPORT YOUR OWN PC XT & AT CLONES

<b>MASTER PACKS</b>	<b>SAMPLE</b>	<b>IMPORT</b>	<b>IMPORT*</b>
WE RETEST EVERY PACK BEFORE WE SHIP	1-9	10+	100+

<b>PC-XT</b>	<b>\$898.00</b>	<b>\$595.00</b>	<b>\$474.00</b>
256K RAM - 360K FLOPPY - KEYBOARD MONO-CHROME/GRAPHICS/PRINTER CARD (Hercules Comp.)			
12" TTL HIGH RES MONITOR			

<b>PC-XT TURBO</b>	<b>\$999.00</b>	<b>\$696.00</b>	<b>\$595.00</b>
640K RAM, 8088-2, (4.77 MHZ or 6.66 MHZ)			
360K FLOPPY - KEYBOARD - MONOCHROME/ GRAPHICS PRINTER - 12" TTL HIGH RES MONITOR			

<b>PC-AT</b>	<b>\$1695.00</b>	<b>\$1595.00</b>	<b>\$1299.00</b>
512K RAM (Up to 1M on Board)			
1.2 M FLOPPY - FLOPPY & HARD DISK CONTROLLER AT KEYBOARD - CLOCK WITH BATTERY BACKUP			
195W POWER SUPPLY - DOS 3.10 & MANUAL			

<b>PC-AT COLOR</b>	<b>\$2199.00</b>	<b>\$1995.00</b>	<b>\$1699.00</b>
SAME AS ABOVE WITH COLOR MONITOR AND COLOR/GRAPHICS CARD			

### DRIVES

	1-50	50+
XT 360K FLOPPY	\$89.00	\$65.00
XT 10 MEG INTERNAL 1/2 HEIGHT	\$395.00	\$355.00
XT 20 MEG INTERNAL 1/2 HEIGHT	\$495.00	\$465.00
AT 1.2 MB FLOPPY	\$149.00	\$129.00
AT 20 MEG INTERNAL 40 MSEC	\$599.00	\$579.00
AT 30 MEG INTERNAL 40 MSEC	\$749.00	\$699.00

### INDIVIDUAL PART PRICING FOB COUNTRY OF ORIGIN

	10+	100+
PC-XT-256K 8 SLOTS (super XT BIOS)	\$74.75	\$65.00
135W POWER SUPPLY	\$51.75	\$45.00
FLIP-TOP CLONE BOX	\$26.45	\$23.00
MONOCHROME/GRAPHICS/PRINTER CARD (Herc Comp)	\$52.90	\$46.00
KEYBOARD	\$36.80	\$32.00
FLOPPY DISK CONTROLLER	\$23.00	\$20.00
RAM KITS 256K	\$25.30	\$22.00
12" TTL HIGH RES MONITOR	\$74.75	\$65.00

SUBTOTAL BASIC PC NO DRIVES \$365.00 \$318.00

RESIDENT AGENT INSPECTION FEE	\$12.00	\$12.00
OCEAN FREIGHT	\$24.00	\$20.00
AIR FREIGHT	\$100 extra	
DUTY	4.1%	\$14.99
ACS IMPORT FEE	\$350.00/ENTRY + 10%	\$71.57
TOTAL LANDED COST, L.A. HARBOR	\$488.26	\$398.34

### AD ON BOARDS - PARTIAL LIST

	10+	100+
PC-XT-640K MOTHER BOARD 8 SLOT		
4 LAYER (MEGA BIOS)	\$150.65	\$131.00
PC-XT-640K TURBO 4.77/6.66 MHZ	\$145.00	\$123.00
TRANS-NET (LAN) CARD 1.0 MHZ	\$199.00	\$185.00
384K MULTI-FUNCTION (OK: AST Sx Pack comp)	\$66.70	\$58.00
RAM KITS 384K	\$36.80	\$32.00
MODEM CARD 300/1200 BAUD (Hayes comp)	\$166.75	\$145.00
COLOR GRAPHICS CARD	\$42.55	\$37.00
AB SWITCH BOX (Centronics 2-1 or 1-2)	\$27.60	\$24.00
AB SWITCH BOX WITH 64K BUFFER	\$65.55	\$57.00

\* 100 UNIT ORDERS MAY BE SCHEDULED OVER 6 MONTHS

### ACS IMPORTERS

5311 DERRY AVE., UNIT A

AGOURA HILLS, CA 91301

(818) 889-1092

TELEX: 299353 POST UR

SATISFACTION GUARANTEED

ASK ABOUT OUR 30 DAY RETURN POLICY

# THE DIVERSIFIED GROUP

**2% DISCOUNT ON ALL ADVERTISED PRICES  
WITH PREPAYMENT — Call (800) 523-1041 TO ORDER NOW!**

## MARCH DISCOUNTS

### HERCULES MONOCHROME COMPATIBLE

\*Parallel Port  
\*Hi-Res Video Graphics  
**\$109.95**

### 1/2 HEIGHT DISK DRIVES

\*360K \*6 Month Warranty  
\*Double/Double  
**2 for \$150**

### 20 MEGABYTE HARD DISK

\*w/Controller & Cables  
\*1 Yr. Warranty  
**\$479.95**

### IBM PRINTER CABLES

\*6 Foot Shielded  
\*Lifetime Warranty  
**\$9.95**

### TEAC 55BV

\*In Stock  
\*360K Dbl/Dbl  
**\$99.95**

### BELKIN AB SWITCH BOX

Parallel Printers  
\*Two Position  
**\$49.95**

**SERVICE CONTRACTS AVAILABLE — CALL (800)523-1041**

### HARD DISK DRIVES

All Hard Disks Come With: 1 Yr. Warranty, Cables, Controller and are Formatted

	QTY. 1	QTY. 5
10 Megabyte w/Controller	\$369.95	\$359.95
20 Megabyte w/Controller	489.95	469.95
30 Megabyte w/Controller	789.95	779.95

For 1/2 Height Drives add \$50  
Most Hard Disks are Shugart, Microsci, CMI, Rodine  
Call for Others

#### BERNOULLI BOX

10 Meg	\$1779.95	—
20 Meg	2399.95	—

#### TAPE BACK-UP BY IRWIN

10 Meg internal 1/2 Height,		
Low Power	\$495.95	\$485.95
10 Meg External Back-up	635.95	615.95

#### DISK DRIVE CONTROLLERS

Western Digital Hard Disk Cont.	\$179.95	—
Adaptec Hard Disk Cont.	199.95	—
DG Hard Disk Cont.	139.95	—

### DISK DRIVES

#### MPI B-52

\*Tandon Compatible • 360K  
Double Side/Double Density • Full Height  
2 for \$137.00

#### 5 1/4" DISK DRIVES

	QTY. 1	QTY. 5
Teac 55B	\$ 99.95	\$ 99.95
Epson	89.95	86.95
IBM "Logo" Drives	119.95	109.95
Tandon TM100-2	89.95	87.95
MPI (Tandon Compatible)	69.95	69.95
AT 360K w/whiteface	109.95	—

#### DISK DRIVE CONTROLLERS

IBM (Original) Controller	\$ 99.95	—
IBM Compatible Controller	59.95	—

### PRINTERS

LETTER QUALITY — DOT MATRIX

#### OKIDATA

ML182P, 120 cps, Parallel	\$229.95
ML182S, 120 cps, Serial	309.95
ML192P, 160 cps, w/NLQ	339.95
ML192S, 160 cps, Serial	439.95
ML193P, 15" Carriage, 160 cps, w/NLQ	539.95
ML193S, 15" Carriage, 160 cps, Serial	639.95
ML84P, 15" Carriage, 200 cps	749.95
ML84S, 15" Carriage, 200 cps, Serial	859.95

#### EPSON — Call for Availability

We also carry Juki, Dynax, Toshiba, Star,  
Panasonic, NEC, Brother  
We Will Also Beat All Competitors Prices on These Too.

### MONITORS

#### AMDEK

300G Composite Green	\$124.95
300A Composite Amber	134.95
310A Monochrome Amber	159.95

#### TAXAN

620 (640 x 200)	\$399.95
630 (640 x 400)	499.95
640 (720 x 400)	549.95

#### PRINCETON GRAPHICS

HX12, 640x200 Dot Pitch .31	\$442.95
HX12E, 640x350 Dot Pitch .28	517.95
SR12, 640x400 Dot Pitch .31	573.95
SR12P, 640x480 Dot Pitch .26	787.95
HX-9, 640x350 Dot Pitch .28	432.95
MAX12E, 720x350	169.95

#### DIVERSIFIED GROUP

100 Hi-Res Green 18MHZ Compos 80 col.	\$ 79.95
100 Hi-Res Amber 18MHZ Compos. 80 col.	89.95
200 Hi-Res Green 20MHZ Mono. 80 col.	89.95
200 Hi-Res Amber 20MHZ Mono. 80 col.	99.95

DG Monitors come with 1 Year Warranty



No Surcharge on Credit Cards

# THE DIVERSIFIED GROUP

MAIL ORDERS TO:

8726 S. Sepulveda, Suite A132, Los Angeles, CA 90045  
WAREHOUSE: 4732 Rosecrans, Hawthorne, CA 90250

TOLL FREE ORDER LINE  
**(800) 523-1041**

INSIDE CALIFORNIA  
**(213) 675-0717**

TERMS:  
P.O.'s from Government Institutes,  
Universities, Fortune 1000  
C.O.D.'s w/Guarantee, Visa, MC, MO,  
Cashier's Check, Cash. Please Call for Shipping:  
Approx. system \$25, printers & monitors \$15.  
Minimum Shipping \$4.50  
We Ship Federal Express, UPS, U.S. Mail

# THE DIVERSIFIED GROUP

The DG PC Series computers offers the maximum alternatives in the PC XT compatible market. Alternatives which exceed current PC XT configurations.

Standard features on all DG PC Series computers include:

- Full compatibility with IBM PC XT® machines
- 640K bytes of parity checked memory, 8 slots
- 150 watt power supply • Keytronics 5150 compatible keyboard
- 1 Full Year Warranty on Parts and Labor.
- 4 Layer Motherboard

## SYSTEMS

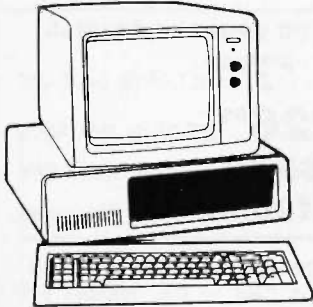

### DG-PC

#### BASE UNIT

System Unit  
640K on Board  
One 360K Drives  
w/Controller  
150 Watt  
Power Supply  
**\$699.95**

#### SYSTEM

System Unit  
640K on Board  
Two 360K Drives  
150 watt pwr sply  
Hi-Res Green Mon  
w/Interface Card  
**\$847.95**

#### AT

System Unit  
80286 Microprocessor  
512K Memory  
1.2 Meg Floppy  
AT Type Keyboard  
Runs PC, XT & AT Sftwr  
**\$1889.95**

#### XT

System Unit  
640K on Board  
One 360K Drive  
10Meg w/150 watt  
Monochrome Mon  
Hercules comp. Mono Card  
**\$1195.95**

20 Day Trial Period / 100% Credit Towards IBM PC  
All DG Systems are fully IBM Compatible w/1 Year Warranty

### DESKPRO

Model I \$1724.95  
Model II 2049.95  
Model III 3549.95

### COMPAQ

286  
Deskpro 286 w/128K 1.2 Meg \$3295.95  
Portable 286 w/128K 1.2 Meg 3295.95

### IBM

#### IBM PC

One 360K Dr, 256K \$1389.95  
Two 360K Dr, 256K 1492.95

#### IBM SYSTEM

PC-XT  
with 10 Meg  
One 360K Drive,  
Hercules Color  
Compatible Card  
Hi-Res Green Monitor  
Dos 2.1  
**\$2392.95**

#### PORTABLE

Two 360K Drives,  
256K  
**\$1987.95**

#### PORTABLE + DG

One 360K Drive, 256K  
10 Meg Hard Disk  
**\$2389.95**

#### IBM XT

One 360K Drive & 10 Meg Drive  
**\$2197.95**

#### IBM AT

Unenhanced \$3395.95  
Enhanced 3995.95

Some Compaqs have been Enhanced by The Diversified Group  
All Come with 1 Year Warranty through The Diversified Group

### EXPANSION CARDS

AST SixPac+ w/64K 2 Yr War \$239.00  
MF-100 SixPac Compatible plus Gameport  
Par., Ser., Game, OK-384K, Software  
Clock Calendar, 2 Year Warranty \$109.95  
AST Advantage w/1.5 Megabyte of Memory  
Parallel & Serial Ports \$497.95

### MEMORY

**64K SETS**  
All Upgrades Carry a 2 Year Warranty  
Nine 4164, 150ns \$8.95  
10 Sets \$8.45 ea. 100 Sets \$7.95  
**128K SETS** 256K SETS  
Nine, 4128 \$39.95 9, 41256, 200ns \$28.95  
25 Sets \$2.95 ea. 25 Sets 27.95 ea.

### IBM ACCESSORIES

**A-B SWITCH BOXES**  
Parallel 2 pos. \$49.95 Serial 2 pos. \$64.95  
**DISKETTES**  
Polaroid Dbi/Dbi 5 Year Warranty  
1 bx. \$12.95 10 bxs. \$11.95 100 bxs. \$9.95  
**KEYTRONICS KEYBOARDS**  
5153 Touch Pad \$289.95  
5150 Standard \$169.95 5151 Deluxe \$179.95

### VIDEO CARDS

**HERCULES COMPATIBLE**  
Color Graphics w/Parallel Port 2 Yr. War. \$104.95  
Monochrome Graphics w/Par Port 119.95  
**EVEREX**  
The Edge Color/Mono \$269.95  
The Graphics Edge 269.95  
**IBM**  
IBM Monochrome w/Parallel Port \$219.95  
IBM Color Card w/Parallel Port 214.95  
**PARADISE**  
Modular Graphics Card \$259.95  
Multi Display 219.95  
**SIGMA**  
Color 400 Board \$539.95

### MODEMS

#### HAYES

1200B w/Smartcom II \$356.95  
1200 External \$385.95 2400 External \$599.95

#### PROMETHEUS

Pro 1200 Ex. \$289.95 Pro 1200B Int. \$309.95

#### 80287

5MHZ for AT & Deskpro \$189.95

#### 8087-3

5MHZ Math Co-Processor  
for IBMPC \$109.95

#### 8087-2

8MHZ Math Co-Processor  
for AT&T, Compaq, Deskpro  
\$124.95

#### BELKIN CABLES

6 foot Shielded  
IBMPC to Par. \$14.95 IBMPC to Modem \$16.95

# THE DIVERSIFIED GROUP

**TERMS:**  
P.O.'s from Government Institutes,  
Universities, Fortune 1000  
C.O.D.'s w/Guarantee, Visa, MC, MD,  
Cashier's Check, Cash. Please Call for Shipping:  
Approx. system \$25, printers & monitors \$15.  
Minimum Shipping \$4.50  
We Ship Federal Express, UPS, U.S. Mail  
No Surcharge on Credit Cards



MAIL ORDERS TO:



8726 S. Sepulveda, Suite A132, Los Angeles, CA 90045  
WAREHOUSE: 4732 Rosecrans, Hawthorne, CA 90250

TOLL FREE ORDER LINE  
**(800) 523-1041**  
INSIDE CALIFORNIA  
**(213) 675-0717**

**TOLL FREE**  
**800-854-8230**  
**CA Residents 714-558-8813**

**OUR POLICY**  
•Surcharge for VISA or Mastercard.  
•Volume purchasing agreements available.  
•Orders subject to availability. •Supply limited on certain items.  
•Pricing subject to change without notice.  
•ACP Retail Store pricing may vary. Not responsible for typos.

Inquiry 10

# IBM Compatible PRICE BREAKTHRU



Don't miss out on this unbeatable system manufactured by Toshiba for ACP. ACP has sold over 3,000 **ADVANCED XT's** to satisfied customers including "true blue" users like Rockwell, Hughes, and Kodak. Not only is the price affordable but the features and compatibility are unbeatable. For more details call one of our expert consultants. Don't hesitate this will be a sellout!

**ACP**  
**BASE**  
**PRICE**     **\$ 699<sup>00</sup>**

Call for complete Monochrome or Color RGB system packages with 10 or 20 Mb hard disk drives.

## IBM COMPUTERS

- IBM PC w/256K, Keyboard, (2) 360K Floppy Disk Drives, Floppy Disk Controller..... **\$1585.00**
- IBM XT w/256K, Keyboard, 360K Floppy Disk Drive, Floppy Disk Controller, Hard Disk Optional..... **1725.00**
- IBM AT w/256K, 1.2 Mb Floppy Disk Drive..... **3199.00**
- COMPAQ PORTABLE w/256K, (2) 360K Floppy Disk Drives..... **1845.00**
- COMPAQ 286 DESKPRO w/256K, 1.2 Mb Floppy, 20 Mb Hard..... **4595.00**
- COMPAQ DESKPRO w/640K, 360K Floppy, 10 Mb Hard..... **2495.00**
- COMPAQ DESKPRO w/640K, 360K Floppy, 10 Mb Hard, 10 Mb Tape back-up..... **3099.00**

## IBM HARDWARE

- ACP**
- 130 Watt Power Supply..... **\$89.95**
- PC/AT Keyboard..... **89.00**
- ACP Color Graphics Card..... **95.00**
- ACP Monochrome Graphics..... **135.00**
- ACP Floppy Controller..... **75.00**
- 384K Card Sixpak Comp (OK)..... **129.00**
- Parallel Cable (IBM)..... **19.00**
- Serial Cable (IBM)..... **21.00**
- 12" Monochrome Green TTL..... **99.95**
- Green Composite Monitor..... **69.95**
- 6 Slot Expansion Chassis..... **399.00**
- ACP Hi-res Text Mono Card..... **149.00**
- ACP IBM Style Flip Case..... **69.95**
- ACP Hard Disk Case (FH or HH)..... **169.95**

## ARCHIVE

- 20 Mb Tape Back-up (Ext)..... **\$795.00**
- 60 Mb Tape Back-up (Ext or Int)..... **Call**

## AST

- Sixpak Plus w/64K..... **\$235.00**
- Advantage 128K, AT..... **399.00**
- AST 5251-11..... **575.00**
- AST 3780..... **575.00**
- RAMpage up to 2 Mb..... **Call**

## DCA

- Irma..... **\$785.00**
- Irmaline..... **895.00**

## DIABLO/XEROX

- 620 Serial LQP..... was 1495 now **\$395.00**
- 620 API LQP..... **445.00**
- 620 D36 (36cps)..... **495.00**

- Tractor..... was 395 now **\$99.00**
- F-21 Sheet Feeder..... was 896 now **249.00**
- Cable for 620 (to IBM)..... **29.00**
- Diablo P-11 100cps..... **129.95**
- Diablo S-11 100cps Serial..... **139.95**
- Diablo P-31 Wide..... **249.95**
- Diablo S-31 Wide..... **269.95**
- Other Diablo Dot Matrix's available..... **Call**

## EPSON

- FX85 160cps NLQ..... **\$375.00**
- FX185 160cps Wide..... **499.00**
- All Epson Models..... **Lowest Price**

## EVEREX

- Graphics Edge or Edge..... **\$259.00**

## HAYES

- Smartmodem 1200..... **\$385.00**
- Smartmodem1200B..... **349.00**
- Smartmodem 2400..... **575.00**
- Smartcom II 2.1 Software..... **88.00**
- Hayes Comp. 1200 (Int) w/SW..... **169.95**
- Hayes Comp. 1200 (Ext)..... **199.95**

## HERCULES

- Color Card..... **\$166.00**
- Graphics Card w/Software..... **295.00**

## INTEL

- Above Board PC or AT..... **Lowest Price**

## IRWIN

- 310A 10 Mb Tape (Ext)..... **\$849.00**
- 110D 10 Mb (Int)..... **495.00**

## KEYTRONICS

- 5151 Deluxe Keyboard..... **\$169.95**
- 5153 w/Touchpad..... **285.00**
- PC Jr. Numeric Keypad..... **39.95**

## MICROSOFT

- Mouse..... **\$125.00**
- Mouse (Serial)..... **145.00**

## MOUSE SYSTEMS

- PC Mouse w/Paintbrush..... **\$138.00**
- ACP Mouse w/Keyboard..... **149.00**

## ORCHID

- PC Turbo 186 w/256K..... **\$585.00**

## PARADISE

- Color/Monocard..... **\$185.00**
- Modular Graphics Card..... **274.00**

## PERSYST

- Mono Board w/Parallel..... **\$159.00**
- Color Board..... **139.00**
- Time Spectrum..... **Sale Call**

## PRINCETON GRAPHICS

- HX-12 RGB (640x240)..... **\$445.00**
- MAX-12E Amber TTL..... **175.00**
- SR-12..... **575.00**
- HX-12E (690x350)..... **545.00**

## PROMETHEUS

- ProModem 1200 w/Mite (Int)..... **\$239.00**
- ProModem 1200B (Hayes Comp.)..... **289.00**
- Alpha/Num or Options Proc..... **79.95**

## QUADRAM

- Expanded Quadboard (OK)..... **\$185.00**
- Gold Quadboard (OK)..... **385.00**
- Silver Quadboard (OK)..... **215.00**
- Quadlink..... **399.00**

## SIGMA

- Color 400 Card..... **\$485.00**

## SHARP

- 12" Med-res RGB Monitor..... **\$269.95**
- Color Plotter w/Software..... **219.00**

## STAR MICRONICS

- Gemini 10X..... reduced **\$149.95**
- Gemini 15X..... sale **179.95**
- SG10, SR10, Radix etc... **Lowest Price Yet!**

## TAXAN

- 415 (640x260) RGB... was 699 now **\$279.95**
- Mod. 640 (Ultra Hi-res)..... **595.00**

## TEMPLATES

- Lotus, dBase III, etc..... **Lowest Price**

## TITAN

- Accelerator PC w/256K..... **sale Call**

## TOSHIBA

- P1340 24 Pin 80 Col..... **sale \$399.00**
- P341 24 Pin 136 Col..... **869.00**
- P351 24 Pin w/Serial & Parallel..... **1099.00**
- T-300 MS-DOS Computer..... **Call**

## WESTERN DIGITAL

- Filecard 10 Mb Plug-in..... **Call**
- Cobra Hard Disk Controller..... **\$179.95**

## ZENITH

- ZVM-1220/30 12" Grn/Amb TTL..... **\$109.00**
- ZVM-1240 & ZVM-135 RGB..... **Call**

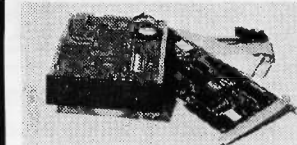

- 10 Mb Upgrade **\$379**
- 20 Mb Upgrade **\$469**
- Package (1 Yr War)     Package 1 Yr War)
- 20 Mb Package for AT..... **\$556.00**
- SA 712 10 Mb..... **\$229.00**
- ST225 20 Mb..... **\$349.00**
- Tulin 30 Mb..... **Call**
- Western Digital Controller... **\$179.95**

## PC UPGRADE SPECIAL

**\$7<sup>95</sup>** SET OF (9) 64K RAMS

**\$26<sup>95</sup>** SET OF (9) 256K RAMS

**\$5.95** 4128 PIGGYBACK RAM

**\$120.00** 8087-2 Coprocessor

**1200 Baud Hayes™ Comp. Modem**  
Short Card by U.S. Robotics with Telpac I Software.  
List \$499 ACP... **\$169.95**  
Buy (6)..... **\$159.95**

## 20Mb Tape Back-up

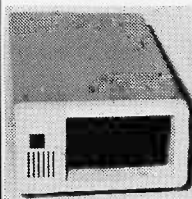

Archive, #1 in tape back-up technology.  
High speed 20Mb back-up for only

**\$795.00**

**Gavilan Compass MS-DOS Lap Computer Demo Sale** Call for Details. 100's in **\$999<sup>00</sup>** Stock as Low as

## STAR MICRONICS One Time Offer

We have 1000's of new in the box dot matrix printers including SG-10, SR-10, Gemini 10X & 15X, all priced substantially below market price. Call now as they will move fast at our too low to print prices!

## APPLE Add-on SALE

- All ACP Apple Product is priced to move out. Call for values such as:
- Joysticks..... **\$7.95**
- Disk Drives..... **119.00**
- 80 Column Cards..... **69.00**
- 16K Cards..... **34.95**



**WE WILL MEET ANY PRICE FOR CURRENT PRODUCT ADVERTISED IN POPULAR MAGAZINES. POLICY APPLIES FOR BOTH SOFTWARE AND HARDWARE!**

**GET OUR FLYERS!**  
IF NOT - CALL & GET ON OUR MAIL LIST.

**MARCH SPECIALS**  
(SUPPLY LIMITED)

**From AMPEX** ALL NEW FACTORY BOX with 1 Year Warranty!

**MODEL 127 20Mb HARD DISK**  
External Unit with Controller Built-in. Available with Host Adaptor for IBM-PC, IBM-XT or Apple II (Add \$149.95 for Host Adaptor).  
**Reg Retail \$1495 ACP \$499.00**

**MODEL 227 20Mb w/TAPE**  
Complete Subsystem with 20Mb Hard Disk and High Speed Tape Back-up. Requires Host Adaptor at \$149.95.  
**Reg Retail \$2995 ACP \$1399.00**

**For PC Jr.**  
**SUPER NUMERIC KEYPAD**  
Manufactured by Keytronic. We have sold 100's of these.  
**Reg Retail \$99 ACP \$29.95**  
or 6 for 21.95 ea

**UPS POWER SUPPLY**

Back Up Power for your IBM,  
Apple or Compatible  
UPS-PC 200 Watts \$277.00  
UPS-XT 300 Watts \$418.00  
UPS-AT 300 Watts 739.00

**A-B PRINTER SWITCH**

An AB Switch allows use of two printers with your computer system. We stock over 15 different configurations.  
AB Switch (Centronics) \$59.00  
AB Switch (DB25) \$9.00

**NEW NEC V20**  
PIN up 70108  
Replace your 8088 to increase Speed up to 40%  
**\$18.95**

**DEC RAINBOW UPGRADE**  
192K CARD  
SPECIAL BUY - Only \$129.95

**640K XT Compatible Motherboard**  
• 8 Expansion Slots  
• Expandable to 640K  
• IBM Compatible  
**ACP only \$159.95**  
XT-BIOS Add. \$39.95

**CAPACITORS**  
.01uF DISC BYPASS CAPACITOR 100x5.50  
.1uF DISC BYPASS CAPACITOR 100x9.50  
.01uF MONOLITHIC CAPACITOR 100x12.25  
.1uF MONOLITHIC CAPACITOR 100x14.25

**CORCOM EMI FILTER**  
STO CORCOM 3 Conductor Filter \$4.50  
Line Cord for above - 8 foot 1.49  
Line Cord 2 Conductor - 8 foot 3.39  
Line Cord 3 Conductor - 8 foot 9.99

**MUFFIN FANS**  
Over 10,000 in Stock  
Torin 4 1/2" Fan NEW \$9.95  
12VDC Fan NEW \$12.95  
12VDC Fan NEW \$14.95  
Finger Guards add 1.49  
Power Cords add 1.49

**IC SOCKETS**  
SOLDERTAIL  
8 Pin ST/PL \$1.10  
14 Pin ST/PL \$1.11  
16 Pin ST/PL \$1.12  
20 Pin ST/PL \$2.26  
22 Pin ST/PL \$2.27  
24 Pin ST/PL \$2.27  
28 Pin ST/PL \$3.39  
36 Pin ST/PL \$4.42  
40 Pin ST/PL \$4.42  
64 Pin ST/PL \$9.35

**WIREWRAP (GOLD)**  
8 Pin WW/L \$1.49  
14 Pin WW/L \$2.49  
16 Pin WW/L \$2.55  
18 Pin WW/L \$6.77  
20 Pin WW/L \$8.96  
22 Pin WW/L \$1.19  
24 Pin WW/L \$1.25  
28 Pin WW/L \$1.49  
40 Pin WW/L \$8.96

**TEXT/DOLZIF ZERO INSERTION**  
16 Pin \$6.75 24 Pin \$7.85 28 Pin \$8.95  
(We Stock All Types of Sockets)

**DRIVE CABINETS**

IBM Style Hard Disk with power Supply and fan  
Dual Head Disk w/upper sup & fan \$179.00  
Dual 5 1/4" Full Height vertical mount 65.00  
Dual 5 1/4" Full Height horizontal mount 99.00  
Single 5 1/4" Thinline w/upper sup & fan 80.00  
Single 5 1/4" Thinline w/upper sup & fan 56.00  
Single 5 1/4" Thinline w/upper sup & fan 60.00

**FLOPPY DRIVES**

TEAC FD55S \$89.95  
TEAC FD55F \$99.95  
TARCON T1402-2 \$99.95  
CXC 1/2 HEIGHT IBM \$79.25  
REDC 2/3 HEIGHT \$89.95  
SIEMENS FD100-8 \$119.00  
SIEMENS FD200-8 D5DD \$179.00

**INTERISL STD BUS BOARDS**  
ALMOST SOLD OUT  
Send or Call for List

**TRANSISTORS/DIODES**

PN2222A 7151.00 2N3804 11151.00  
PN2369A 5/1.00 2N3906 11/1.00  
PN818 3/1.00 TIP26A 2/1.00  
2N2222A .45 TIP32A 2/1.00  
2N2905 .45 TIP131A 2/1.25  
2N2907 .25 1N4148 20/1.00  
2N3055 .60 1N751 5/1.00  
2N3855 4/1.00 1N4002 12/1.00  
2N3638 4/1.00 1N4004 10/1.00  
2N3372 1.69 1M92C232 1.49

**OPTO ISOLATORS**

MCT-2 \$ .50 4N33 \$ .80  
MCT-1 1.39 4N35 1.25  
MCT-3 55 4N37 1.25  
MCA-255 1.69 4N38 .98  
4N28 .85 TL117 .79  
4N27 .55 5P3X3 .25  
4N26 .59 4N125 5/1.00

**LED LAMPS**

1-99 100  
Jumbo Red \$ .90 \$ 1.00  
Jumbo Green .77 .15  
Jumbo Yellow .17 .15  
Mini Size Red .09 .09  
Mini Size Green .10 .10  
Mini Size Yellow .10 .10

**SPECIAL VALUES!**

MC486705 EPROM \$3.95  
6112016-150MS 10/19.95  
DB25P Male 10/17.50  
DB25P Female 10/19.95  
2732A-2 10/29.95  
27160-50MS 10/29.95  
27160-100MS 10/24.50

**CALL ACP FOR ALL YOUR VOLUME IC REQUIREMENTS**

**EDGE CONNECTORS**

S-100 ST 1-99 100  
S-100 ST \$3.95 \$3.25  
S-100 WW 4.75 4.10  
44 Pin ST 2.75 2.60  
44 Pin WW 4.75 4.25  
72 Pin ST 6.25 6.10  
72 Pin WW 6.50 6.35

**D-SUBMINIATURE**

DB25S (Female) \$1.24 .25  
DB25S (Male) 2.40 2.29  
Hood \$1.25 Mfg WW \$9.99  
DE37S (Female) \$5.99 \$5.75  
DE37P (Male) 5.25 5.10  
Hood \$1.75 Mfg WW \$9.99  
DD05S (Female) \$8.95 \$8.85  
DD05P (Male) 8.00 7.95  
Hood \$3.25 Mfg WW \$9.99

**(OTHER STYLES IN CATALOG)**

ICD 36 Pin Male \$8.95  
ICD 36 Pin Female 9.49  
Soldier 36 Pin Male 7.49  
Soldier 36 Pin Female 8.95  
(CALL TOLL FREE FOR IDC'S)

**IDC CONNECTORS**

IDC TYPE	ACP NO	NUMBER OF CONTACTS				
		10	20	26	34	50
Solder Header	IDHxxS	.79	1.20	1.65	2.10	2.40 3.00
Rt Angle Solder Header	IDHxxSR	.79	1.20	1.65	2.10	2.40 3.00
Ribbon Header Socket	IDSxx	.75	.95	1.35	1.50	1.85 2.10
Ribbon Header	IDMxx	—	5.25	5.95	6.75	7.25 8.25
Ribbon Edgecard	IDExx	1.70	2.15	2.50	2.80	3.70 3.95
Wirewrap Header	IDHxxW	1.80	2.90	3.75	4.25	4.95 8.50
Rt Angle WW Header	IDHxxWR	1.99	3.10	4.10	4.20	4.60 7.15

NOTE: To order Insert number of contacts in place of xx in ACP part number.  
ORDER QUANTITY OF 50pcs (mixes) AND TAKE AN ADDITIONAL 10% OFF.

**UV EPROM ERASER**  
We Stock Full Line of UV Products  
**CALL FOR PRICES**

**LOGICAL DEVICES SIX-SHOOTER**  
Programmer for IBM  
We Stock All Models  
**\$395.00**

**8000**

68000	\$19.85	6810	\$ 2.85	6850	\$ 3.25
68001-10	39.95	6820	3.75	6852	5.65
68002	2.90	6821	2.60	6853	9.50
6802	7.75	6822	1.50	6875	7.70
6803	18.95	6840	12.75	6880	22.90
6809E	9.50	6841	11.95	68047	22.95

**6500**

65002	\$4.50	6504	\$6.75	6522	\$3.25
6502A	6.50	6505	7.75	6523	8.50
6502B	2.50	6520	4.25	6551	11.50

**8000**

8003	\$ 5.75	8214	\$ 3.75	8239	\$ 6.75
8004	5.75	8215	3.75	8241	6.95
8005A	2.95	8224	2.20	8272	26.95
8006A	4.90	8226	1.95	8278	7.95
8006B	8.95	8228	3.40	8282	6.95
8006	24.50	8237	13.75	8283	6.25
8007-2	129.95	8237-5	15.95	8284	5.50
8008	17.50	8238	4.25	8288	8.45
8009	88.95	8243	3.95	8287	6.45
8155	6.75	8250	10.50	8288	11.45
8156	6.75	8251	4.25	8289	44.45
8185	26.95	8251A	5.95	8292	12.95
8202	23.95	8253	7.75	8741	27.95
8203	37.95	8255	4.25	8740	24.50
8206	3.25	8255A	5.95	8749	24.50
8212	1.95	8257	7.75	8755A	34.95

**Z-80**  
2.5MHz "A" 4.00MHz "B" 6.0MHz

**Z80-CPU** 2.25 2.75 6.95  
**Z80-CTC** 2.50 2.75 9.25  
**Z80-DART** 7.50 8.50 17.95  
**Z80-DMA** 6.00 8.95 17.95  
**Z80-PID** 2.95 3.50 6.50  
**Z80-SIO** 8.50 9.50 —  
**Z80-SIO2** 8.50 9.50 22.95  
**Z80-SIO3** 8.50 9.50 —

**Z80CPU \$34.95** 25001 \$34.95 26132 \$37.95  
26350 \$4.95 28000 \$4.95 28671 \$39.95

**DISK CONTROLLERS**  
PDP765 \$89.95 1797 \$21.95 6843 \$28.95  
1771 \$11.95 2711 \$2.95 6844 \$2.95  
1791 22.75 2793 32.95 1691 6.95  
1793 21.50 2795 32.95 2143 6.95  
1795 21.50 2797 27.95 9216 12.95

**CRT CONTROLLERS**

6845 \$11.95 8272 \$28.50 LM5918 \$30.50  
6845 15.95 7220 34.95 8350 39.95  
6847 17.95 8271 32.95 8351 44.95  
4550 14.75 5037 21.95 8002 19.95  
68047 19.50 NEC7200 Graphics 34.95

**UARTS/ARTS**

1602B \$3.95 2350 \$ 8.95 IM403 \$ 8.75  
1013A 3.75 8260 10.50 TMS5501 14.95  
1015A 6.75 IM602 7.75 2651 8.95

**EPROMS**

\$ 3.90 2732A (4050S) \$ 4.50  
2708 (4050S) 3.55 2732A (250S) 8.95  
2758 (5V) 3.80 2732A (250S) 8.95  
6847 17.95 2764 (4050S) 1.95  
2716 (350S) 3.95 2764 (250S) 2.95  
2518 (5V) 2.95 2764 (200S) 2.95  
TMS716 1.50 TMS256A (450S) 5.50  
TMS252 5.00 MCM6878A (450S) 19.95  
2732 (450S) 1.95 MCM6878B (350S) 21.95  
2732 (250S) 2.95 27128 (350S) 8.50  
2732 (200S) 3.95 27128 (250S) 15.95

**CMS EPROMS**

27C16 \$4.95 27C64 \$6.95

**STATIC RAMS**

2101 (4050S) \$1.89 MK418 \$4.95  
2102 (450S) .98 TMM2016-2 (200S) 31.90  
2102-1 (450S) .79 TMM2016-15 (150S) 39.95  
2102-2 (450S) 1.39 TMM2016-1 (200S) 3.00  
2111 (450S) 2.75 H4116P-4 (200S) 4.75  
2112 (450S) 2.75 H4116P-3 (150S) 3.25  
2114 (450S) 1.45 8090 H4116P-2 (100S) 5.75  
2114L-4 (450S) 1.89 81250 H4116LP (LP) 3.50  
2114L-3 (200S) 1.79 81300 H4116LP (LP) 3.50  
2114L-2 (200S) 1.89 81300 H4116LP (LP) 3.50  
2147 (650S) 3.50 2B132 (200S) 32.95  
4044 (450S) 3.25 H416284P-15 (150S) 9.50  
4044-3 (300S) 4.75 H416284P-16 (LP) 11.95  
4044-2 (200S) 4.35 74818 (350S) 1.85  
UPD410 (100S) 3.76 93416 (50S) 3.95  
5101 (CMOS) 3.50 TMS5501 (350S) 3.95

**DYNAMIC RAMS**

4027 (250S) \$ .99 TMS4416 (100S) 36.95  
1103 (300S) .75 TMS4418 (150S) 7.75  
4116N-2 (150S) .85 41256-150 (200S) 1.75  
4116N-3 (200S) .85 41256-200 (200S) 2.75  
4116N-4 (250S) .49 TMS4050 (100S) 11.95  
4154-1 (150S) 9/75 MMS280 (300S) 1.85  
4164N-200 (200S) 9/750 MMS280 (300S) 1.85  
4164N-120 (120S) 2.95 UPD411 (300S) 1.85  
TMS4164 (150S) 2.95 MMS280 (250S) 1.85

**DISK SPECIAL (IBM PC D5DD)**

**79¢** "IBM PC" D5DD  
IBM Hubs  
Tyvac Cover  
Major Mfg.  
Supply Limited

**5 1/4" DISKETTES**  
VERBATIM 550-1 D5DD \$29.95 10x10 \$19.95  
VERBATIM 550-1 D5DD (IBM) 27.95 54.95  
MAXELL MD-1 S5DD (Alt) 18.95 17.95  
MAXELL MD-2 D5DD (IBM) 24.95 22.95  
MAXELL DISKS for AT (800) 14.95 13.95  
DYSAN 10470 D5DD (Alt) 27.95 25.95  
DYSAN 10470 D5DD (IBM) 34.95 31.95  
DYSAN 10470 D5DD (IBM) 34.95 31.95  
DYSAN 10470 D5DD (IBM) 34.95 31.95  
**3 1/2" DISKETTES**  
VERBATIM 3V-1 MFS50 (MAC) 32.00 29.95  
MAXELL 3V-1 MICRODISK (MAC) 33.00 31.00  
**B" DISKETTES**  
VERBATIM B" S5DD 26.95 26.95  
VERBATIM B" D5DD 45.95 45.95  
DYSAN B" S5DD 32.95 30.95  
DYSAN B" D5DD 49.95 47.95

**HEAD CLEANING KIT—\$9.95**  
2 1/4" DISK TUB \$8.95  
3 1/4" DISK TUB \$14.95  
HEAD CLEANING KIT—\$9.95

**CMOS**

4000	5.26	4028	8.65	4058	\$7.90	4505	8.95
4001	2.22	4029	7.75	4060	8.95	4506	1.10
4002	2.22	4030	7.75	4061	8.95	4507	1.10
4006	7.00	4031	3.25	4062	28.95	4508	1.90
4007	2.22	4032	2.15	4070	35.45	4510	.79
4008	2.22	4033	1.91	4071	28.45	4511	.79
4009	39.00	4035	7.75	4072	28.45	4512	.79
4010	39.00	4037	1.95	4073	28.45	4514	1.10
4011	24.40	4040	7.75	4075	28.45	4517	1.79
4012	24.40	4041	7.75	4076	75.45	4519	1.10
4013	35.40	4042	8.65	4077	35.45	4518	8.65
4014	7.75	4043	8.65	4078	35.45	4520	.75
4015	7.75	4044	8.65	4079	35.45	4521	.75
4016	35.40	4046	8.65	4082	29.45	4556	.95
4017	45.40	4047	8.65	4085	95.45	4598	1.35
4018	7.75	4048	9.95	4086	95.45	90C95	1.50
4019	39.40	4049	4.45	4093	4.45	80C94	4.99
4020	69.40	4050	34.40	4094	2.95	MC1408	12.95
4021	69.40	4051	7.75	4099	1.90	MC14409	12.95
4022	69.40	4052	1.91	4100	1.91	MC14410	9.95
4023	25.40	4053	7.75	4501	6.90	MC14411	9.95
4024	58.40	4055	3.95	4502	95.45	MC14412	12.95
4025	25.40	4056	2.95	4503	49.45	MC14419	9.95
4027	45.40	CALL FOR 74HC					

**74C00**

74C00 2.29 74C74 \$8.85 74C161 \$1.15 74C373 \$2.35  
74C02 2.29 74C85 1.89 74C175 1.15 74C374 2.35  
74C04 2.29 74C90 1.15 74C240 1.89 74C901 .59  
74C05 2.29 74C93 1.15 74C241 1.89 74C922 .45  
74C10 3.25 MORE 74CIN STOCK - ALSO IN CATALOG

**LINEAR**

LM1084A	\$3.95	NE590	32.45	LM3909	98
LM3000	99				

## Computer Systems

**CompuPro 816/286-H40 w/256K SPUZ & 5MDrv/H. \$\$\$PECIAL... TOO LOW TO ADVERTISE!!!**

VIASYN 816/C2 w/ 80286, 512K RAM, SPUZ-256, 40Mb H.D., 10Mb Tape, 5 1/4" 96TPI FLPY, CDOS 816/286, NewWord & Supercalc II... **REDUCED!! \$7,499**  
VIASYN CORE SYSTEM w/256K RAM, I/F-4, Syst. Supp. 1, ENCL. 2D, Disk 1A, Disk 3, 5 1/4" FLPY, & 20Mb H.D. Add Your Choice of CPU & Oper. Sys... **\$3,939**  
VIASYN 816/10-H40 w/Tape & 1Mb MDrv... **\$5,177**  
**CALL FOR OTHER SYSTEM CONFIGURATIONS**

## MORROW

**MORROW MICRODECISION MD-3 W/MDT-70** Terminal, CP/M & NewWord Word Processor... **\$1,149**  
**MORROW MICRODECISION MD-11 W/ MDT-70** Terminal, CP/M 3.0, 128K, 11 Mb H.D., FLPY, NewWord Word Processor... **\$1,849**



**CORONA PPC-400-22** Portable 256K, Dual Flpy's, 640x400 GRN Monitor, 4 Expan. Slots, Serial & Paraf. Ports, MS DOS, GW-Basic & PC-Tutor... **\$1,279**  
**CORONA PPC-400-XT** Portable w/20Mb H.D. ... **\$1,895**  
**CORONA PPC-400-XT** Portable w/40Mb H.D. ... **\$2,198**  
**CORONA PC-400-22** Desk TOP PC Same Ful Featured PC-Like The Portable w/14" Green Tilt & Swivel Monitor... **\$1,525**  
**CORONA PC-400-HD2** w/10Mb HARD DISK... **\$2,049**  
For 20Mb... Add **\$195/For 40Mb**... Add **\$450**



## PC COMPATIBLE & FASTER TOO!

**ZENITH Z-158 PC-DESK TOP SYSTEM:** 256K RAM, 2 DSDD FLPY DRIVES, Serial, Paraf. Monochrome & Color Composite & RGB Color Ports, & MS-DOS w/4.77 & 8 MHz CPU Clock Rates, G or A Monitor... **\$1,849**  
**Z158 with Floppy & 20Mb H.D. DRVS.**... **\$2,395**  
**Z158 with Floppy & 40Mb H.D. DRVS.**... **\$2,798**  
**1/2 HT 10Mb TAPE OPTION INT \$498/EXT**... **\$598**  
**Z-148 PC** w/256K, 2 FLPYS, MS-DOS, 4.77 & 8MHz, Serial & Parallel Ports, Amber Monitor... **\$1,259**  
**Z-138 PC TRANSPORTABLE** 24 Lbs, 320K, Dual FLPYS, 7" Amber Screen, MS-DOS, 4.77 & 8MHz, Serial & Parallel Ports... **\$1,499**  
**Z-171 Lap-Top Portable**, Dual Drvs., 640K, MS-DOS Battery, Padded Carrying Case, Video RGB & CMPST., Hayes Compatible 300/1200 Baud Modem... **\$2,739**

## Power Solutions.

**PC/XT REPLACEMENT P/S** 130 WATT \$89, 150W \$99  
**SAFT SPS 400VA** 400 WATT & SINE WAVE... **\$475**  
**SAFT SPS 1000VA** 1000 WATT/SINE WAVE... **\$999**  
**SOLA 750/4500 WATT** HI-INRUSH UPS... **\$1,795**  
**TRIPLITE ISOBAR** Line Suppressor-Filters from \$375  
**TRIPLITE BC-425-FC** 425 Watts 15-20 Minutes... **\$398**  
**TRIPLITE BC-1000** Watts 20-30 Minutes... **\$925**  
**TRIPLITE LC-1800** Conditioner/Stabilizer... **\$215**  
**TRIPLITE COMMAND CONSOLE** CCI 8-12... **\$110**

## Diagnostic-Keyboards-Voice

**DATACOM TRI-STATE RS232 V.24** Break-out Box \$189  
**DYAN DISK DRIVE INTERROGATOR**... **\$115**  
**DYAN DDD** Digital Diagnostic Disk SS \$30 / DS \$40  
**DYAN AAD** Analog Alignment Disk SS \$25 / DS \$50  
**DYMEK RID** FLPY DRV. DIAGNOSTIC DISKETTE \$29  
**DYMEK "THE DRIVE ALIGNER"** PC-XT... **\$85**  
**FLUKE 77 DVM** with Holster... **\$129**  
**KEYTRONICS 5150**... \$169 / 5151... \$185 / 5153... **\$299**  
**VOTRAX PERSONAL SPEECH SYSTEM**... **\$295**

## Hard Disk/Tape Subsystems

### PC's-MAC's-S-100's

**AT-INSIDER, PC-INSIDER, PC-OUTSIDER HARD DISK SERIES** FOR IBM, BOOTS FROM HARD DISK, FORMATTED W/ CONTROLLER & ALL NECESSARY CABLES, HARDWARE & P/S or PC STYLE CABINET.  
**PC-INSIDER-33** 33Mb Formatted 1/2 HT, TULIN... **\$939**  
**PC-OUTSIDER-33** W/T 33Mb & 10Mb Tape... **\$1,539**  
**PC-INSIDER-72** 72Mb FMT. Micropolis 1325... **\$1,795**  
**PC-OUTSIDER-72** W/T 72Mb & 60Mb Tape... **\$2,995**  
**PC-INSIDER-116** 116Mb Formatted... **\$3,989**  
**PC-OUTSIDER-116** W/T 116Mb & 60Mb Tape... **\$5,195**  
**AT-INSIDER-33** 33Mb FMT. Quantum Q540... **\$1,129**  
**AT-INSIDER-72** Micropolis 1325... **\$1,599**  
**AT-INSIDER-120** 120Mb FMT. Maxtor XT-1140... **\$3,895**  
**ALLOY PC-BACKUP** 17.7Mb TAPE... **\$1,729**  
**ALLOY PC-QICTAPE** Up to 69Mb... **\$1,719**  
**ALLOY PC-9TRACK** 42Mb... **\$4,995**  
**IRWIN 10Mb Tape Drive** SELLOUT: INT \$498EXT \$598  
**TECMAR QIC60 TAPE** For PC'S... **\$1,299**  
**TECMAR QIC60 HOST I/F** Board... **\$109**  
**TECMAR 40200 II** Slot Expan. Chassis w/ 10Mb \$1,795  
**TECMAR 40410** 33Mb Fixed/5Mb Removable In 11 Slot Expansion Chassis... **\$2,495**  
**TECMAR 73200 MACDRIVE** 10Mb 1/2 HT. with Software and Hardware For Easy Installation... **\$1,325**  
**TECMAR 73210 MACDRIVE** with 10Mb Fixed And 5Mb Removable Cartridge... **\$2,195**  
**WANGTEK PC-36** 60Mb Tape Internal-Same As Tecmar QIC60 Tape For PC'S... **\$1,095**  
**CALL FOR DLR &/or QTY. PRICES ON HARD DISKS:**  
**MICROPOLIS 1303** 43Mb 30MS... **\$1,195**  
**MICROPOLIS 1323** 43Mb 25MS... **\$1,300**  
**QUANTUM Q540** 40Mb **FACTORY DIRECT!! 1 YEAR WARRANTY!**... **REDUCED!!! \$1,095**  
**S-100 BUS SUBSYSTEMS** Supporting Turbodos, Concur. Dos, CP/M 80 & 816 Operating Systems **CALL DRIVE SUBSYSTEMS FOR COMPUPRO** with DISK 3, CABINET, P/S, FAN, CABLES, ETC...  
•20Mb SEAGATE... **\$1,139**  
•37Mb QUANTUM Q540... **\$1,775**  
•45Mb MICROPOLIS 1304... **2,179**  
•72Mb 1325... \$2,195/XT-1085 or M6085... **\$2,295**  
•89Mb MAXTOR XT-1105... **\$3,695**  
•116Mb MAXTOR XT-1140... **\$4,395**  
**10Mb TAPE INTERNAL \$498**... **EXTERNAL \$598**  
**ALLOY ITS-100+ 9TRACK** 42Mb/S-100... **\$4,995**  
**ALLOY IDXCS-100T** 17.7Mb External Tape Subsystem For CP/M 80, 86, CDOS-816... **\$1,699**

## Floppy Disk Drives

**MITSUBISHI 2894 STD** 8" \$395... 2896 1/2 HT 8" \$369  
**TEAC FD55GFV/AT** 96TPI... **\$129**  
**TEAC FD55FV** 96TPI... **\$115**  
**MITSUBISHI MF501** 48TPI \$95... **TEAC FD55BV** \$99

## Mainframe & Drive Enclosures

**ECT RM-10** Rack Card Cage 10 Slot-15A... **\$250**  
**ECT TT-10** Desk 10 Slot - 15 AMP... **\$365**  
**FULCRUM 880** with Front Panel & 20 Slots... **\$565**  
**INTEGRAND 2200A** w/4 Slots & 2 X 8" 1/2 HT FLPY \$349  
**INTEGRAND 2210** w/4 Slots & 5 1/4" FLPY + H.D. \$315  
**INTEGRAND Laser Turbo** 10 Slots, 2 H.D. 5 1/4" \$498  
**PARA DYNAMICS 3020D** 20 Slot Desk... **\$639**  
**PARA DYNAMICS 5820-S "TOWER"** with SNAP-ON PANELS For Easy Access to Drive, 20 Slot Card Cage and Power Supply Compartments. Status LED'S and ON-OFF-RESET Key Switch on Front Panel, Houses 5 1/4 & 8" Drives... **\$1,869**  
**INTEGRAND 2909 2X8"** 1/2 HT Horiz. Stack... **\$189**  
**JMR 1H5 5 1/4"** H.D. PC Style Cabinet... **\$189**  
**JMR 25V8** Dual Vertical 1/2 HT. 8"... **\$175**  
**JMR 2H5** Dual 5 1/4" Horizontal H.D... **\$225**  
**MPS 8462** Dual Horizontal 8" Slimline... **\$215**  
**MPS 8465** Dual 5" & 8" Horizontal Slimline... **\$225**  
**MPS 5500 5 1/4"** STD. HT. H.D. & 1/2 HT. Drive... **\$225**  
**MPS 5505 5 1/4"** H.D. & 1/2 HT FLPY or Tape... **\$209**  
**MPS 5401 5 1/4"** STD HT H.D. or Dual 1/2 HT... **\$215**  
**MICROWARE SINGLE STD.** 5 1/4" Flpy Horizontal... **\$59**  
**MICROWARE DUAL HORIZ.** 5 1/4" 1/2 HT. Flpy... **\$79**  
**MICROWARE 9200A** Dual STD. 5 1/4, PC-Style... **\$149**  
**PARA DYNAMICS 2300-G3 2X8"** Flpy & 5 H.D... **\$395**

## Chips

We Have Some of the **LOWEST PRICES** in the Nation!!  
64K, 256K, 8087, & 80287... **CALL**

## Printers, Plotters & Buffers

**ANADEX DP9620B** 240 DATA/120NLQ 15"... **\$1,135**  
**BROTHER HR-15-XL** 17CPS Daisywheel S or P... **\$359**  
**BROTHER HR-10** 12CPS Daisy w/ TRACC. S&P... **\$249**  
**BROTHER TwinRiter** 5 Dot Matrix & Daisywheel... **\$849**  
**BROTHER 2024L** 24 Pin Hi-Res Print & Graphics... **\$809**  
**BROTHER M-1509** 180/45 NLQ, P&S I/F... **\$359**  
**BROTHER M-1009** EPSON Compatible Plug & Play \$119  
**BROTHER HR-5** Plain-Paper Thermal Portable... **\$169**  
**CITIZEN MSP-10** 160/40 NLQ 80/132... **\$269**  
**CITIZEN MSP-15** 160/40 CPS 15" Low Profile... **\$365**  
**CITIZEN MSP-20** 200/50 NLQ 80/132... **\$389**  
**CITIZEN MSP-25** 200/50 CPS 15" ULTRA QUIET \$515  
**CORONA LASER LP-300** w/IBM CTRL CARD... **\$2,698**  
**CORONA LASER PRINTER FONTS**... **\$29**  
**EPSON LQ-1500** Cut-Sheet Feeder, Single Bin... **\$309**  
**NEC 3550/PC** 30 CPS Daisy Wheel... **\$1,097**  
**OKIDATA 182** 80 Column 120 DATA/60 NLQ... **\$222**  
**STAR 120** DATA, 30NLQ: SG10 \$239... SG15 \$409  
**STAR 160** DATA, 40NLQ: SD10 \$369... SD15 \$495  
**STAR 160** DATA, 40NLQ: SD10 \$369... SD15 \$495  
**STAR 200** DATA, 40NLQ: SR10 \$535... SR15 \$659  
**TEXAS INSTRUMENTS 855** with TRACTOR... **\$679**  
**HOUSTON INST. PLOTTERS & DIGITIZERS**... **CALL**  
**HANZON 12315** 64K-256K INTELLIGENT BUFFER SER.-SER., SER.-PAR., PAR.-SER., PAR.-PAR. Computer to Printer Combinations Possible. So easy to use-instructions printed on bottom of cabinet... **\$289**  
**HANZON ADD-IN MODULE** 64K RAM... **\$45**  
**PRACT. PERIPH. APPLE GRAPHICARD & CBL.**... **\$70**  
**PRACTICAL PERIPH. APPLE SERIAL BOARD**... **\$112**  
**PRACTICAL PERIPH. APPLE PRINTERFACE**... **\$55**

## Monitors & Terminals

**AMDEK 310 AMBER** IBM-PC TTL Monochrome... **\$133**  
**PRINCETON GRAPHICS HX-12** 690X240RGB... **\$485**  
**PRINCETON GRAPHICS SR-12** 690X480RGB... **\$589**  
**TATUNG CM-1372** 640X200 RGB Same as IBM... **\$375**  
**TATUNG CM-1360** LIKE 1322 with G-A Switch... **\$419**  
**TATUNG CM-1370** 720X480 RGB w/GRN Switch, Long Persist Phos. Works w/ STB's SUPER RES 400... **\$469**  
**TATUNG DM-12V12** 12" Monochrome A \$114 / G \$109  
**TATUNG MM-1222** Hi-Res 12" TTL (IBM) A \$125/G \$119  
**TAXAN 12" 116** AMB... \$119/115 GRN... **\$109**  
**TECMAR ZVM-136** 640X480 RGB 13", Grn Switch \$499  
**ZENITH ZVM122A** AMB or ZVM123A GRN... **\$79**  
**KIMTRON KT-7** 14" Green... **\$459**  
**LIBERTY FREEDOM TERMINALS**... **CALL**  
**LINK 125** Wyse 50 Compat. 14" GRN or AMB w/Higher RES., More Emul'S, Electric K.B., 6 Scroll Rates \$429  
**LINK PC-TERM** IBM or ASCII VIDEO, 14" GRN or AMB, IBM-AT Keyboard Layout, 132 Column, also Compatible with WY-50 & TVI 925... **\$449**

## Computer Accessories

**CA P15** Expandable 5 Circuit Monitor Base with Modern Protection & Surge/Noise... **\$101.97**  
**CA P150, P151, P152, P15** with ABC Data Switch \$217.28  
**CA C1-6** 6" IBM-Paraf. CBL... (1-9) \$9.50, (10+) \$8.83  
**CA C1-9** 9" IBM-Paraf. CBL... (1-9) \$11.95, (10+) \$11.06  
**CA C200 SERIES** Premium Molded RS232 Cables... (1-9) \$12.48 TO \$28.47, (10+) \$11.86 TO \$27.05  
**CA C300 SERIES** Premium Molded Parallel Cables... (1-9) \$19.98 TO \$45.57, (10+) \$18.98 TO \$43.29  
**CA C400** VIDEO CABLES... (1-9) \$2.48 TO \$21.29, (10+) \$2.36 TO \$18.10  
**CA C500 SERIES** Cable Extender Packs w/ MON, PWR, VIDEO & KEYBD. CBL'S... (1-9) \$29.98, (10+) \$28.48  
**CA S4** 4 Circuit Surge Supp. (1-9) \$26.47, (10+) \$25.15  
**CA S6** 6 Circuits Surge & Cable Storage... (1-9) \$31.77, (10+) \$30.18  
**Monitor Tilt & Swivel Stand.** (1-9) \$14.95, (10+) \$12.95

## Diskettes & Cartridges

**3M TAPES** In Stock 300XL & 600A \$29.95/1000A \$19.95  
**DYAN SSSD 3.5"** \$28.95... **CASE \$270**  
**DYAN SSSD 3.5"** \$34.50... **CASE \$325**  
**DYAN 104/1D** SSSD 5 1/4" \$18.95... **CASE \$171**  
**DYAN 104/2D** SSSD 5 1/4" \$22.50... **CASE \$212**  
**DYAN 204/1D** 96TPI SSSD 5 1/4" \$28.95... **CASE \$271**  
**DYAN 204/2D** 96TPI SSSD 5 1/4" \$36.95... **CASE \$347**  
**DYAN UHR2** Ultra HI-Density \$47.50... **CASE \$449**  
**DYAN 3740/1D** SSSD 8" \$23.95... **CASE \$225**  
**DYAN 3740/2D** SSSD 8" \$29.95... **CASE \$282**  
**FUJI SSSD 5 1/4"** \$15... **DSSD 5 1/4"** \$19  
**XIDEX PRECISION** DSSD 5 1/4" \$8.95... **CASE \$77**

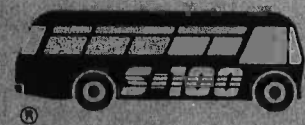

**S-100 DIV./696 CORP.**  
14455 NORTH 79th ST.  
SCOTTSDALE, AZ 85260

Inquiry 300 for End-Users. Inquiry 301 for DEALERS ONLY.

**FULL DEALER SUPPORT**  
**VISIT OUR SHOWROOM**  
**HRS: 8:00AM - 5:00PM M-F**

PLEASE NOTE: We Now Accept AMERICAN EXPRESS... Add 5% To The Cash Prepaid Price

# WORLD'S LARGEST SELECTION OF PC & S-100 PRODUCTS



## Networking & Switch Boxes

INTERCONT. MICRO SYS. LAN-PC w/o RAM...	\$469
INTERCONT. MICRO SYSTEMS LANS-100	\$359
COMPUPRO/VIASYN NET 11 For 816/10 Sys...	\$448
COMPUPRO/VIASYN NET 100/ PC-S-100 BUS	\$297
<b>GILTRONIX MANUAL and AUTOMATIC SWITCHING UNITS</b> to Fit all of your SHARED PRINTER, TERMINAL, MODEM & other Peripheral Needs. These Units In Stock:	
5100 8 Wire A-B Serial	CALL
5110 8 Wire A-B-C Serial	CALL
5200 24 Wire A-B Serial	CALL
5210 24 Wire A-B-C Serial	CALL
5400 CENTRONICS A-B	CALL
5500 IBM - Parallel A-B	CALL
Call For Prices & Configurations On Other Units	

## PC & AT Multifunction/Slave Bds.

We Have a Good Selection of Multifunction and Memory Boards for PC, XT, AT, JR, AT & T, and PC Portables

INTEL ABOVE BOARD PCMB 1010 PC/XT 64K to 2Mb Allows Lotus, Symphony, Framework, Etc. to Run Above 640K	\$299
INTEL ABOVE BOARD AT 128K-4Mb w/ CPU to Address all Available Memory	\$459
LASER DISK I/O FLYP CTRL, S,P & G Ports, CLK-CAL, Ram-Disk & Print Spool, MS-DOS	\$195
MACROTECH MSR-AT Unpopulated to 3Mb For PC/AT 120msEC to Keep Pace With 80286	From \$269
STB GRANDE BYTE 128K	\$225
STB RIO PLUS II 64K-512K, S.P. Clock	\$216
STB SUPER RIO 256K, CLOCK, S.P. & G Ports	\$239
STB RIO GRANDE PC-AT 128K-1.5Mb, S.P.&G.	\$319
TECMAR CAPTAIN UNPOP w/Treasure Chest	\$154
TECMAR EXPANSION CHASSIS With 8 Slots	\$675
TECMAR MAESTRO Unpopulated for IBM-AT	\$325
TECMAR MAESTRO For PC/AT 2.5Mb	\$529
TECMAR WAVE 64K to 256K Fits XT Short Slot	\$179

## PC & AT Slave Boards/Pkgs

### Make Your Computer A Mighty Multi-User

ADVANCED DIGITAL PC-SLAVE w/256K, 8MHz 8088 CPU, 2 S Ports, RTNX S/W-For Multi-User P.C.	\$695
ADVANCED DIGITAL PC-SLAVE PACKAGE with Link PC Term Terminal, RTNX Software	\$999
ALLOY PC-SLAVE 16 256K to 768K RAM	\$629
ALLOY PC-SLAVE PKG: 256K With Link PC-TERM Terminal And 9' Cable	\$1,095

## PC Video/Graphics & Cad

STB EGA PLUS TTL MONO. & HI-RES. RGB	\$371
STB CHAUFFEUR RGB Port/16 Grey Shades Produced on Monochrome TTL Monitor	\$209
STB GRAPHICS PLUS II w/ Paral. PRT Port	\$249
STB SUPER RES 400 Color Hi-Res w/ 32K	\$325
TECMAR GRAPHICS MASTER 16 Color Hi-Res	\$439
TECMAR GRAPHICS TENDER RGB/PRT Port	\$195
CSD-PC AUTOCAD-2 PACKAGE: 1024X1024 Monochrome Graphics • 15" 1100X1250 Res.	\$3,149
ILLUMINATED TECHNOLOGIES AUTOCAD PACKAGE: 8 Color 1024X1024 S-100 Board • Inside Autocad Handbook • Autocad 2 • Mitsubishi 19" 1024X874 RGB Analog Color Monitor • Hitachi Tiger 11"X11" Tablet with 12 Button Cursor	\$4,995
TECMAR SUPER-RES PKG: Board & 13" ZVM-136 Monitor with 16 Colors @ 640X400	\$925
VECTRIX VXPCA 4096 Colors	CLOSE-OUT \$1,795
VECTRIX VX/PC Video Cable	\$79

## PC Scientific/Industrial Boards

**INDUSTRIAL COMPUTER DESIGNS:**

- 1018-PC with 96TTL I/O Ports. Like Baseboard Only More Features \$469
- A/D 64-PC 64 Input \$469
- D/A 64-PC 64 Output \$555

TECMAR BASE BOARD 96 Digital I/O Lines	CALL
TECMAR DADIO D to A Up to 24 Devices	CALL
TECMAR IEEE-488 Board	CALL
TECMAR LABMASTER	CALL
TECMAR EXPANSION CHASSIS 12AMP P/S, Dual AC Outlets, 7 Useable Slots, Space for Hard Disk	\$675
PC PROTOTYPING BOARD	\$18.95

## S-100 Bus BDS & Accessories

If you purchased before calling us, you probably paid too much! We stock ACKERMAN DIGITAL, ADVANCED DIGITAL, CCS, COMPUPRO, CROMEMCO, DUAL, ELECTROLOGICS, ICM, KONAN, MULLEN, PICKLES & TROUT, INDUSTRIAL COMPUTER DESIGNS, TARBELL, TECMAR, VECTOR ELECTRONICS

### A FEW OF THIS MONTH'S SPECIALS ARE...

ACKERMAN MEMORIZER 0-64K Ram&Eprom	\$211
ACKERMAN KLUGE CARD A&T	\$175
ACKERMAN PROMBLASTER II Up to 27256K'S	\$306
ACKERMAN PROMBLASTER EXTENDER	\$79.95
SPECTRONICS PE24T/9 EPROM ERASER/TIMER 146	
ADV. DIGITAL SUPER 186/256K MASTER	\$1,495
CCS 2422 Dual Floppy CTRL With CP/M 8"	\$350
CCS 2710 4 Port Serial Board	\$275
CCS 2720 4 Port Parallel Board	\$215
CCS 2810 Z80 CPU with Serial Port	\$235
COMPUPRO RAM 16 64K STATIC	\$95
COMPUPRO RAM 22 256K STATIC	\$479
COMPUPRO RAM 23 128K STATIC	\$285
COMPUPRO MDRIIVE 'H-10-1Mb for 816/10	\$589
COMPUPRO PC-VIDEO BOARD	\$398
COMPUPRO DISK 1A 5" & 8" Floppy CTRL	\$398
COMPUPRO Disk 3 ST506 5" H.D.C.	\$479
COMPUPRO SYSTEM SUPPORT 1 w/ CLK-CAL	\$289
COMPUPRO MOTHER BOARD 21 Slot	\$239
COMPUPRO CPU 8085/88 6 & 10 MHz	\$285
COMPUPRO CPU 8086 - 10MHz	\$319
COMPUPRO CPU 68K - 10MHz	\$340
COMPUPRO CPU 286 - 8MHz	\$719
CROMEMCO XPU 10MHz 68000 CPU	\$1,196
CROMEMCO DPV 68000/Z-80 Dual CPU	\$636
CROMEMCO SCC Z-80 Single BD, Computer	\$396
CROMEMCO 8P10 8 Port Parallel	\$276
CROMEMCO D+7A 8 Channel 8 Bit D/A	\$276
CROMEMCO BIART Dual Sync/Async	\$636
CROMEMCO 64FDC 5" & 8" Floppy CTRL	\$476
DUAL AIM-12 A/D Input 12 Bit/32 Channel	\$629
DUAL AOM-12 D/A Output 12 Bit/4 Channel	\$540
DUAL WDC Winchester DMA 2 BD, Set SA-4000	\$840
INTERCONTINENTAL MICRO SYSTEMS MASTER & SLAVE BDS. 8&16 Bit	From AS LOW AS \$395

### INDUSTRIAL COMPUTER DESIGNS:

•D/A 64-100 64 Analog Outputs	\$375
•A/D 64-100 64 Analog Inputs	\$279
•CCT-100 Highly Accurate Time & Date Controller with Battery Back-Up	\$315

KONAN DGC-100 ST 506 5 1/4 H.D. Controller	\$325
KONAN SMC-200 SMD 8" Controller	\$450
MACROTECH VRAM 512K Static with Battery Back-Up and MDrive/H Capability	\$769
MACROTECH MI-286 80286/Z80H Dual Proc	\$675
MACROTECH MSR-11 1Mb Dynamic Ram	\$825
MACROTECH MSR-11 2Mb Dynamic Ram	\$1,059
MULLEN ZB-1 EXTENDER with ZIF Sockets	\$125
MULLEN TB4A EXTENDER BD. w/ Logic Probe	\$69
MULLEN /CB10 8 Channel Low Voltage Controller	\$165
PICKLES & TROUT P&T 488 IEEE 488 BD & S.W.	\$429
VECTOR RAM 17 64K Static Ram (VIASYN) Excellent with Z80 CPU'S	\$299
VECTOR INTERFACER I Dual Serial (VIASYN)	\$199
VECTOR INTERFACER II 3 Para. 1 Serial	\$219

## Modems

PROMETHEUS PROMODEM 1200 Hayes Compatible w/ Built-In PWR Supply-RS232 Stand Alone Unit	\$289
<b>OPTIONS FOR PROMODEM 1200 ARE:</b>	
COMMUNICATIONS PROC. BUFFER 2K-512K	\$99
512K RAM for Communications Buffer	\$49
ALPHA NUMERIC DISPLAY	\$75
PROMETHEUS 1200A Apple II, II+, IIe Card w/Terminal Software in ROM	\$265
PROMETHEUS 300C Apple IIC Piggy Back	\$139
PROMETHEUS 1200B For PC'S with Procom	\$239
PROMETHEUS 1200M Stand Alone MAC Modem with Cable and Communications Software	\$348
HAYES SMART MODEM 1200 RS-232	\$429
HAYES SMART MODEM 2400 Universal	\$659
U.S. ROBOTICS PASSWORD 1200	\$225
U.S. ROBOTICS AUTO DIAL 212A	\$309
U.S. ROBOTICS PC/XT MODEM with TELPAC	\$199
U.S. ROBOTICS PC MULTI-MODEM with Clk-Cal., Batt. Back-up, PRT Port, 256K RAM Telpac	\$395
U.S. ROBOTICS MULTILINK COURIER 2400	\$421

## Software • Software • Software

We have Access to all Well Known Brands - ORDER CORRECTLY -- SOFTWARE IS NOT RETURNABLE!

### Word Proc./Screen Formatter

MICROPRO CORRECT STAR / PC-DOS	\$95
MICROPRO MAIL MERGE / CP/M-86 "	\$75
MICROPRO PROPAG	\$309
MULTIMATE WORD PROCESSOR / PC-DOS	\$315
NEW STAR NEWWORD II w/Merge Print, The Word PLUS Spelling Checker - Easier Than WordStar But File Compatible: 8 Bit \$79.95 16 Bit \$129.95	
NEW STAR NEWWORD III For PC Compatibles, With Context Spelling Checker, Indexing, Table Of Contents, Shorthand Keyboard, Macro's, Run Other Programs In Middle Of NewWord, Supports File Paths For Hard Disks Plus Greatly Increased Speed	\$209
PFS WRITE	\$89
OASIS THE WORD PLUS Spelling Checker	\$95
OASIS PUNCTUATION & STYLE	\$79
MARK OF THE UNICORN THE FINAL WORD	\$189
COMPUVIEW VEDIT 1113 VEDIT Plus	\$169
COMPUVIEW VEDIT PLUS, V-PRINT & SPELL	\$259
COMPUVIEW V-SPELL CP/M 80 8" & PC DOS	\$59

### Communications Programs

MICROSTUF CROSS TALK XVI	\$115
MYCROFT LABS MAXIMITE PLUS For PC'S	\$159
WOLF MOVE-IT PC-PC Communications	\$96

### Language And Tools

BD SOFTWARE "C" Compiler 8" SS SD 8 BIT	\$95
BORLAND PC TURBO PASCAL 3.0	\$44
BORLAND PC TURBO PASCAL 3.0 W/ 8087	\$70
DIGITAL RESEARCH Most Products	36% OFF
LATTICE "C" Compiler	\$299
MICROSOFT Complete Line	32% OFF
SUPERSOFT FORTRAN PC/MSDOS	\$199
DIGITAL RESEARCH COMPLETE LINE	36% OFF
AMERICAN TRAINING INT'L TUTORIALS	36% OFF
BORLAND PC SIDEKICK (Unprotected)	\$54
BORLAND PC SUPERKICK (Unprotected)	\$41
BORLAND PC TURBO GRAPHIX TOOLBOX	\$35
BORLAND PC TURBO TOOLBOX	\$35
BORLAND PC TURBO TUTOR	\$22
FOX & GELLER QUICKCODE For dBASE 2	\$184
FOX & GELLER dGRAPH For dBASE 2	\$187
FOX & GELLER dUTIL For dBASE 2	\$63
FOX & GELLER QUICK SCREEN For dBASE 2	\$94
FOX & GELLER PC GRAFOX BUS, GRAPHICS	\$159
FOX & GELLER PC QUICKREPORT III	\$187

### Data Bases & Spreadsheets

ASHTON-TATE ALL PRODUCTS	32% OFF
DATAFLEX FILE/RECORD Locking Multi-User	CALL
MDBS KnowledgeMan CP/M86 8"	\$295
MICROPRO REPORT STAR	\$119
MICROPRO INFO STAR/16 Bit	\$239
MICROROM R: BASE 5000	\$439
PFS FILE	\$85/REPORT
SORCIM SUPERCALC-3 Better Than 1-2-3!!	\$179
V.I.P. PROFESSIONAL For ATARI 520ST	\$139

### Hobby Corner

**SOLD "AS IS" WITH NO RETURNS**

ELECTROLOGICS QUASI-DISK CP/M80 RAM DISK with Battery Back-up-2Mb. \$1,695/4Mb	\$3,095
ITHACA PASCAL Z CP/M80 8" Version 4.0	\$195
MORROW MD-2 w/MP100 Daisy Printer, CP/M 2.2, Word Proc., Spreadsheet, Basic, Etc., Software	\$695
NORTH STAR ADVANTAGE G/MSDOS & CP/M	\$169
NOVATION SMART CAT 212	\$219
PMMI MM-103 600 Baud S-100 Modem	\$139
PRAGMATIC DESIGNS PD20MS 8" FUJITSU 20Mb H.D. Add-On Drive For CompuPro System	\$2,495
REMEX RFD-480 48 TPI 5 1/4 Standard HT	\$65
SD SYSTEMS XRAM-4 256K EDC	\$195
SD SYSTEMS VERSAFLOPPY III with CP/M 3.0	\$195
SD SYSTEMS RAMDISK 256K	\$195
SD SYSTEMS MPU-100 Z80 CPU Kit	\$89
SEATTLE SYSTEM SUPPORT BOARD	\$169
SMS STATIC RAM 64K For N.S. Horiz. Etc	\$149
TEI TFD-O Cabinet For 3 STD 5 1/4" FLY. DRVS.	\$195
TRANSEND/SSM MB8A Kit 16K EPROM BD	\$59
TRANSEND/SSM EP128 Reads Up To 16 EPROMS89	

All merchandise new. Advertised prices are cash prepaid only. MC, Visa & P.O.'s from qualified firms - add 3%. Wires, COD's (\$5 min. fee) with Cashiers Check/MO & APO's accepted. Shipping: minimum \$4 first 3 lbs. Tax: AZ RES ONLY add 8% sales tax. All returns subject to 20% restocking fee or credit towards future purchases: Retail prices slightly higher. All prices subject to change without notice.



PLEASE NOTE: We Now Accept AMERICAN EXPRESS... Add 5% To The Cash Prepaid Price

# California Digital

17700 Figueroa Street • Carson, California 90248

## IBM Compatible Computer

# \$495



**Eclipse**  
DATA PRODUCTS

- 256K Expandable to 640K on Motherboard
- Double Sided Double Density Disk Drive
- IBM Type Keyboard (with LED Indicators)
- Floppy Controller Card
- Eight Expansion Slots
- 135 Watt Power Supply

The Eclipse 16 is an outstanding value in IBM Compatible Computers. After careful research and evaluation we found it to be the most reliable unit.

Our computer includes some of the newest features available, such as the 4.7MHz, multi-layer motherboard with 256K of RAM upgradable on board to 640K. A generous eight expansion slots and 135 Watt power supply give you ample room and power for add-on boards. The enclosure has an easy-access flip top lid making upgrades a breeze. And our floppy controller supports up to four drives, so as many as three additional drives can be used. Finally, each computer is configured and fully tested before sending it to you.

**Satisfaction Guaranteed!** We're really excited about this new unit, and so sure you will be too... that you may return the Eclipse 16 for a full credit towards an IBM PC if you are not completely satisfied.

### OPTIONS

- |  |  |
|--|--|
| 20MB Hard Drive w/Controller.....\$495 | RGB Color Monitor.....199                  |
| Additional Drive-Installed.....99      | TTL Monochrome Monitor.....139             |
| Irwin 10 Meg. Tape Back up.....489     | Microsoft Mouse.....139                    |
| Upgrade from 256K to 640K RAM.....79   | Upgrade from Floppy Controller to Disk I/O |
| 8087 Math Co Processor.....119         | 2 drive controller, clock/cal., software   |
| Color Graphics Card.....79             | parallel, serial, and game ports.....79    |
| Monochrome Graphics Card.....99        | 1200 Baud Internal Modem w/Software 179    |

## XEROX \$299 SUNRISE COMPUTER

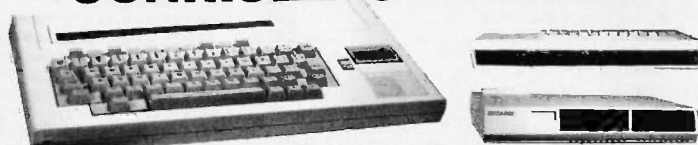

The Xerox Sunrise 1810 is by far the best value we have ever seen in a micro computer. This is a self contained battery and AC operated portable. The Sunrise was originally priced at \$299. Xerox has since elected to drop the computer from their product list. California Digital has purchased all the remaining inventory and is making the unit available at a fraction of its original cost.

This portable features a built in 80 column liquid crystal display, 64K of memory along with both RF monitor and television outputs. The internal 300/1200 baud modem includes an auto dial telephone assembly. The units has both centronics parallel and a serial port programmable to 19,200 baud. The self contained micro cassette is capable of capturing data from the keyboard as well as doubling as an recorder for dictating messages.

An optional dual floppy disk drive module, pictured above, is available for only \$219. Also available, for \$59 is an 80 column printer that mounts in the drive module. The Sunrise features a CP/M operating system which allows the operator to use any CP/M program in Xerox 5 1/4" disk format and over 5000 CP/M programs available in public domain.

We have available a 15 minute tape on the Sunrise Computer. The tape is in VHS format and was produced by Xerox to promote the computer. California Digital is offering the promotional tape at \$15. This will be applied towards purchase price of the Sunrise 1810 computer.

## Eclipse 1200 \$179

1200 Baud Hayes Compatible Your Choice

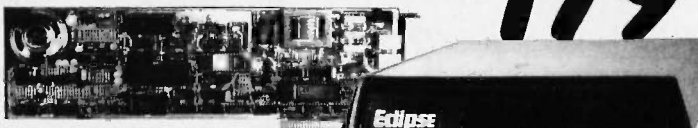

The Eclipse 1200 and 1200B (IBM internal) represent the best value we have ever offered in a fully Hayes Compatible 300/1200 baud modem. Both units include speaker, auto dial and data communication software. The external also features status indicators LED's. The internal includes an auxiliary RS-232 serial port. California Digital is so confident of your complete satisfaction that we will allow the return of either Eclipse 1200 modem and apply the full credit towards the purchase price of any other modem.

## 1200 BAUD MODEMS

**PROMETHEUS ProModem 1200**  
**\$289**

This Hayes compatible modem features completely unattended operation, auto answer/auto dial and even includes "redial number when busy". Help commands, real time clock and internal speaker add to the ease of use of this unit.

**SMARTTEAM 1200**  
**\$189**

The Team 212A offers all the features of the Hayes Smart Modem 1200 for a fraction of the price. Now is your opportunity to purchase a 1200 baud modem at the price of a 300 baud modem.

**SIGNALMAN MARK VI 300 BAUD**  
**\$49**

The Anchor Automation Mark VI is a 300 baud direct connect modem that plugs into any slot of your IBM/PC. This modem supports auto answer and auto dial capabilities. Other features include telephone number storage, send / receive text files, single key-stroke dialing along with many other functions provided on disk. The Mark VI was originally priced at over \$300.

## UltraLink 1200



The UltraLink is a 1200 baud HALF DUPLEX bell 202 compatible internal modem card for the IBM/PC. This unit operates full duplex at 300 baud. The UltraLink adds a voice/data demension to your PC. Manufacturer's original suggested price on this modem is \$795. California Digital's price is only \$99.

# \$99

## MODEMS

Eclipse 1200 - 100% Hayes, with status lamps.	ECP-1200	179.00
Eclipse 1200B internal with software	ECP-1200B	179.00
Hayes Smartmodem 2400 baud modem	HYS-2400	599.00
Fujitsu 2400/1200 baud auto everything.	FUJ-1935D	459.00
Team 1200 Hayes Compatible, 300/1200 baud.	TEM-SM1200	189.00
UltraLink 1200 data and voice on same line.	UTL-1200A	99.00
CTS 212AH 1200 baud, auto dial	CTS-212AH	219.00
Terminal software for CTS 212AH	CTS-212SFT	35.00
Prometheus 1200 super features	PRM-P1200	289.00
Prometheus 1200B Internal PC	PRM-P1200B	279.00
Signalman Mark VI, 300 baud Internal PC	SGL-MK6	49.00
Hayes Smart Modem 1200 baud, auto dial	HYS-212AD	369.00
Hayes 1200B for use with the IBM/PC, 1200 baud.	HYS-1200B	299.00
Hayes Smartmodem, 300 baud only, auto dial	HYS-103AD	199.00
Hayes Chronograph, time & date	HYS-CHR232	199.00

## Seagate \$359

20 MEGABYTE WINCHESTER HARD DISK DRIVE

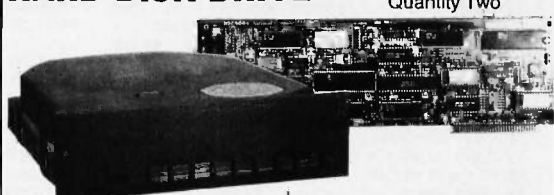

Five Inch Winchester Disk Drives

	each	two+
SEAGATE 225 20 Meg. 1/2 Hi.	369	359
SEAGATE 4026 26 M. 35mS.	859	829
SEAGATE 4051 51 M. 35mS.	1095	1059
FUJITSU 2242 55 M. 35mS.	1799	1729
FUJITSU 2243 86 M. 35mS.	2295	2219
RODIME RO-202E 27 Meg.	759	729
RODIME RO-203E 40 Meg.	995	959
RODIME RO-204E 53 Meg.	1259	1195
CONTROL DATA 94155-86 M.	1829	1779
MAXTOR XT1140 140 Meg.	3379	3295
HONEYWELL 85M. 27 mS.	1795	1695
TOSHIBA MK5670 M. 30mS.	1789	1729
TANDON 502 10 Meg.	419	379

- Winchester Controllers for IBM/PC
  - FALCON FT-HDC half card
  - XEBEC 1220 with floppy controller
  - NATIONAL COMPUTER 5004
  - DTC 5150BX
  - OMTI 5510 half card
  - ADAPTEC 2010A software install
  - WESTERN DIGITAL WD/1002
- SCSI/SASI Winchester Controllers
  - XEBEC 1410A 5 1/4" foot print
  - OMTI 20L

- Winchester Accessories
  - Installation Kit with manual
  - Winchester enclosure and supply
  - Dual 20/34 cable set
  - Switching power supply

TOLL FREE ORDER LINE  
**(800) 421-5041**

TECHNICAL & CALIFORNIA  
**(213) 217-0500**

# California Digital

17700 Figueroa Street • Carson, California 90248

## LETTER QUALITY F-10 DAISY WHEEL PRINTER

**\$429**  
Quantity Two

Single piece price \$499. But if you have already purchased an F-10 printer from California Digital, we will honor the \$429 price on the second printer.

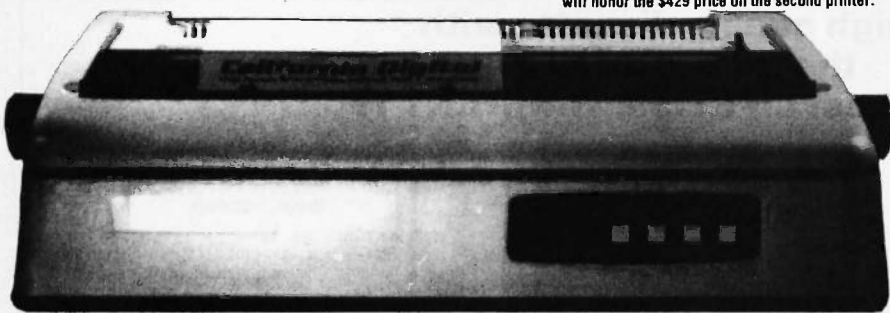

The TEC F-10 Daisy Wheel printer is the perfect answer to a reasonably priced 40 character word processing printer. While this printer is "extremely" similar to C. Itoh's F-10/40 Starwriter printer. Legal counsel for the C. Itoh Company have advised us that we should refrain from referring to the TEC printer as a Starwriter. This 40 character per second printer auto installs with Wordstar and Perfect Writer. Features extensive built-in word processing functions that allow easy adaptability and reduced software complexity. Industry standard Centronics interface provides instant compatibility with

all computers equipped with a parallel printer port. The TEC F-10 accepts paper up to 15 inches in width.

These printers were originally priced to sell at over \$1400. Through a special arrangement California Digital has purchase these units from a major computer manufacturer and is offering these printers at a fraction of their original cost.

Options available include sheetfeeder, tractor feed, buffered memory and an assortment of printer cables for a variety of computers.

## 5 1/4" DISK DRIVE SALE \$89

Quantity Two

Your Choice any 48 or 96 TPI drive  
SHUGART • TEAC • QUME  
MITSUBISHI • MATSUSHITA



One Two Ten

TEAC FD55B half height	99	89	89
TEAC FD55F 96 TPI, half ht.	119	89	89
TEAC FD55FG for IBM AT	189	179	175
SHUGART SA455 Half Height	99	89	89
SHUGART SA465 1/2 Ht. 96TPI	99	89	89
TANDON 100-2 full height	129	125	119
MITSUBISHI 4851 half height	99	89	89
MITSUBISHI 4853 96/TPI 1/2 Ht.	99	89	89
MITSUBISHI 4854 B" elec.	295	285	275
QUME 142 half height	99	89	89
Switching power supply			49
Installation Kit with manual			10
Dual enclosure for 5 1/4" drives			59
34 pin edge connectors			5
Scotch head cleaning kit			19
Flip & File Storage tubs			15

## MITSUBISHI SUBSYSTEM

**\$239**

The dual Mitsubishi subsystem features two M48535 (96 tpi) 5 1/4" double sided disk drives. Also supplied within the subsystem is 50 watt power supply



## PLOTTER

**\$219**

The Comrex Comscribe I is the ideal solution to make short work of translating financial and numeric data into a graphic presentation. Many ready to run programs such as Lotus 1-2-3, Visi-on and Apple business graphics already support this plotter.

The Comscribe I features programmable paper sizes up to 8 1/2 by 120 inches, 6 inch per second plot speed and 0.004" step size. Easy to implement Centronics Interface allows the Comscribe I immediate use with the printer port of most personal computers.

The Comscribe I is manufactured for Comrex by the Enter Computer Corporation. The plotter is marketed by Heath Kit and also sold under Enters own "Sweet P" Label. This is your opportunity to purchase a plotter which was originally priced at \$795 for only \$219. Also available is a support package which includes demonstration software, interface cable, a multicolor pen assortment and a variety of paper and transparency material.

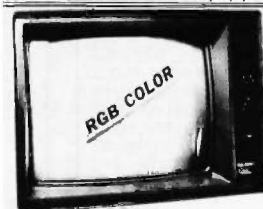

## NEC RGB COLOR MONITOR

**\$219**

The NEC JC-1401D is a 13" medium/high resolution RGB monitor suitable for use with the Sanyo MBC-550/555 or the IBM/PC. The monitor features a resolution of 400 dots by 240 lines. Colors available are Red, Green, Blue, Yellow, Cyan, Magenta, Black and White. The NEC monitor carries the Union-Monroe label and was originally scheduled for use in their "Office of the Future" equipment. A change in Monroe's marketing strategy has made these units excess inventory which were sold to California Digital. We are offering these "new" RGB monitors at a fraction of their original cost. Sanyo compatible NEC-1401/S; IBM/PC Computer compatible NEC-1401/PC

## IRWIN Streamer Tape Back Up

**\$489**

The Irwin Streamer Tape Drive is a low cost answer to backing up your hard disk drive. One removable cartridge can backup 10 megabytes of data in less than eight minutes.

The Irwin drive includes software for file by file or total disk backup. All programs are menu driven for easy use.

## Quick-Link 300

**\$59**

The Quick-Link 300 gives you an instant link to any dial up data base. Such as Dow Jones, Western Union or the Source. The Quick-Link has four user programmable log-on keys, allowing the operator, with only one key stroke, to dial the data base, log in and give the password. All this information is permanently stored in non-volatile RAM.

Features include video output to television or monitor, auto dial, auto-log, full sized keyboard, 300 baud modem and 1200 baud auxiliary printer port. All this is available for only \$59.

## DRAGON \$99



Compatible with most Radio Shack Color Computer software. The world famous Dragon computer is now available in the United States. Manufactured by the Tano Corp. under license of the British Broadcasting Company. The Dragon comes complete with 84K Byte of memory, serial modem port along with a Centronics printer interface. This unique microcomputer features Motorola's advanced 6809E microprocessor and comes standard with Micro-Soft Color Basic, data base manager, and a complete word processing package. The computer outputs color composite video along with R.F. video that allows the unit to be used in conjunction with any color television. This is the ideal low cost computer to be used with any dial up information system such as the Source, EasyLink or any other time share service.

## QUME \$149

Eight Inch Single Sided Drives

QUME 841 single side	159	149	call
SHUGART 801R	359	359	354
SIEMENS FDD 100-8	119	115	109

Eight Inch Double Sided Drives

QUME 842 "QUME TRACK 8"	189	179	call
SHUGART SA851R	495	485	475
OLIVETTI double sided	189	179	159
REMEX RFD-4000	179	169	159
MITSUBISHI M2896-63 1/2 Ht.	459	449	409
Dual 8" enclosure with power and fan			259
Switching power supply			89
Installation kit with manual			10

## PRINTERS

### MATRIX PRINTERS

Star Gemini-SG10 120 char./sec.	STR-SG10	239.00
Star Gemini-SG15, 100 char./sec. 15" paper.	STR-SG15	389.00
Star Gemini Delta 10, 160 Char./sec	STR-D10	359.00
Citizen MSP/10FT 160 char./sec.	CIT-MSP10	359.00
Toshiba P1351, 192 char./sec. letter quality	TOS-1351	1495.00
Okidata 182A serial & parallel 9 1/2" paper	OKI-182A	257.00
Okidata 192A parallel interface, 160 char./sec.	OKI-192A	345.00
Okidata 84P parallel 15" paper	OKI-84P	789.00
Epson LX-80 10" 120 Char./sec.	EPS-LX80	239.00
Epson FX90FT, 10" 160 char./sec. with graphitax	EPS-FX90	369.00
Epson RX100+ 15" with Graphitax	EPS-RX100	389.00
Epson FX100FT 15" 160 char./sec. with graphitax	EPS-FX100	489.00
Epson LQ1500, 15" correspondence quality	EPS-LQ1500	895.00
Epson L800 Color printer	JPS-L800	519.00
Prowriter 8510 parallel 9 1/2" paper	PRO-8510P	329.00
Dataproducts B-800-3, band printer 600 LPM.	DPF-8600	695.00
Printronix P300 high speed printer 300 lines per minute.	PTX-P300	599.00
Printronix P600 ultra high speed 600 lines per minute.	PTX-P600	5795.00

### WORD PROCESSING PRINTERS

Starwriter F10 parallel, 40 char./sec.	PRO-F10P	499.00
NEC8B10 55 char/second, serial interface	NEC-8B10	1659.00
NEC8B30 55 char/5sec. par1 interface	NEC-8B30	1659.00
NEC2550 popular printer designed for the IBM/PC	NEC-2550	1599.00
NEC2050 designed for IBM/PC 20 char/sec. par1	NEC-2050	689.00
Silver Reed EXP500, 14 char/sec. par1 interface	SRD-EXP500	319.00
Silver Reed EXP550 17 Char/sec. par1 interface	SRD-EXP550	429.00
Diablo 630 40 char./sec. serial	DLB-630	1569.00
Diablo 620, proportional spacing, horz. & vert. tab. 20 cps.	DLB-620	789.00
Juki 8100, 18 char./sec.	JUK-8100	399.00
Juki 8300, 40 char./sec.	JUK-8300	699.00
Comrex CR2, 5k buffer, proportional spacing, par1.	CRX-CR2P	395.00

Shipping: First five pounds \$3.00, each additional pound \$.50  
Foreign orders: 10% shipping, excess will be refunded.  
California residents add 6 1/2% sales tax. • COD's discouraged.  
Open accounts extended to state supported educational institutions and companies with a strong "Dun & Bradstreet" rating.



# What the world really needs is a 69 cent Double Sided, Double Density Diskette with a LIFETIME WARRANTY!

## And DISK WORLD! has it.

### Introducing Super Star Diskettes: the high quality diskette with the lowest price and the best LIFETIME WARRANTY!

In the course of selling more than a million diskettes every month, we've learned something: higher prices don't necessarily mean higher quality.

In fact, we've found that a good diskette manufacturer simply manufactures a good diskette...no matter what they charge for it. (By way of example, consider that one of the brands that we carry has a return rate of greater than 1/1,000th of 1 percent!)

In other words, when people buy a more expensive diskette, they aren't necessarily buying higher quality.

The extra money might be going toward flashier advertising, snazzier packaging or simply higher profits.

But the extra money in a higher price isn't buying better quality.

All of the good manufacturers put out a good diskette. Period.

#### How to cut diskette prices ...without cutting quality.

Now this discovery posed a dilemma: how to cut the price of diskettes without lowering the quality.

There are about 85 companies claiming to be "diskette" manufacturers.

Trouble is, most of them aren't manufacturers.

Rather they are fabricators or marketers, taking other company's components, possibly doing one or more steps of the processing themselves and pasting their labels on the finished product.

The new IBM diskettes, for example, are one of these. So are IBM 5 1/4" diskettes. Same for DYSAN, Polaroid and many, many other familiar diskette brand names. Each of these diskettes is manufactured in whole or in part by another company!

So, we decided to act just like the big guys. That's how we would cut diskette prices...without lowering the quality.

We would go out and find smaller companies to manufacture a diskette to our specifications...specifications which are higher than most...and simply create our own "name brand" diskette.

Name brand diskettes that offered high quality at low prices.



Super Star diskettes are sold in multiples of 50 only. Diskettes are shipped with white Tyvec sleeves, reinforced hubs, user ID labels and write-protect tabs.

#### Boy, did we get lucky. Our Super Star Diskettes are the same ones you've been using for years...without knowing it.

In our search for the low priced, high quality diskette of our dreams, we found something even more interesting.

We found that there are several manufacturers who don't give a hoot about the consumer market for their diskettes. They don't spend millions of dollars in advertising trying to get you, the computer user, to use their diskettes.

Instead, they concentrate their efforts on turning out the highest quality diskettes they can...because they sell them to the software publishers, computer manufacturers and other folks who (in turn) put their name on them...and sell them for much higher prices to you!

After all, when a software publisher or computer manufacturer or diskette marketer puts their name on a diskette, they want it to work time after time, everytime. (Especially software publishers who have the nasty habit of copy-protecting their originals!)

#### Super Star Diskettes. You already know how good they are. Now you can buy them...cheap.

Well, that's the story.

Super Star diskettes don't roll off the boat from Pago-Pago or emerge from a basement plant just east of Nowhere.

Super Star diskettes have been around for years...and you've used them for years as copy-protected software originals, unprotected originals. Some of them, depending on which computer you own, the same diskette may have been on a Super Star diskette. And you may have used more than once, you've bought a box or two or more of Super Star diskettes without knowing it. They just had some "big" company's name on them.

Super Star Diskettes are good. So good that a lot of major software publishers, computer manufacturers and other diskette marketers buy them in the tens or hundreds of thousands.

We buy them in the millions.

And then we sell them to you.

Cheap.

#### When every little bit counts, it's Super Star Diskettes.

You've used them a hundred times...under different names.

Now, you can buy the real McCoy, the same diskette that major software publishers, computer manufacturers and diskette marketers buy...and call their own.

We simply charge less.

#### Super Special!

Store 75 diskettes for only \$5.95!

Yep, that's right: order 50 Super Star diskettes, add \$5.95 and we'll include a Media Products DISK MINDER II...a well made unit that we're impressed with.

It holds 75 diskettes securely and looks nice too!



#### FRAUD ALERT!

Please be careful!

A lot of the "no-name" diskettes flooding the market at prices of less than \$1.00 are what we in the industry call "floor sweepings."

In other words, they're garbage...stuff that six months ago, no self-respecting manufacturer would have sold.

But times got tough and some people's scruples got a little lost in desperation...and so a lot of computer users are getting some really bad disks...and that isn't bargain at all.

So, when the price seems too good to be true...like 39 cents, be careful...very careful!

HOURS:

Human: 8AM-6PM Central Time, Monday through Friday

#### HOW TO ORDER:

ORDERS ONLY:

1-800-621-6827

(In Illinois: 1-312-256-7140)

INQUIRIES:

1-312-256-7140

FOR FASTEST SERVICE, USE NO-COST MCI MAIL: Our address is DISKORDER. It's a FREE MCI MAIL letter. No charge to you. (Situation permitting, we'll ship these orders in 24 hours or less.)

SHIPPING: 5 1/4" & 3 1/2" DISKETTES—Add \$3.00 per each 100 or fewer diskettes. OTHER ITEMS: Add shipping charges as shown in addition to other shipping charges. PAYMENT: VISA, MASTERCARD and Prepaid orders accepted. COD ORDERS: Add additional \$5.00 special handling charge. APO, FPO, AK, HI & PR ORDERS: Include shipping charges as shown and additional 5% of total order amount to cover PAL and insurance. We ship only to United States addresses, except for those listed above. TAXES: Illinois residents, add 7% sales tax.

MINIMUM ORDER: \$35.00.

#### The Super Star LIFETIME WARRANTY!

Super Star Diskettes are unconditionally warranted against defects in original material and workmanship so long as owned by the original purchaser. Returns are simple: just send the defective diskettes with proof of purchase, postage-paid by you with a short explanation of the problem, and we'll send you the replacements. (Incidentally, coffee stained diskettes and diskettes with staples driven through them don't qualify as "defective".)

WE WILL MEET OR BEAT ANY NATIONALLY  
ADVERTISED PRICE  
ON THE SAME PRODUCTS AND QUANTITIES  
SUBJECT TO THE SAME TERMS AND CONDITIONS.

# DISK WORLD!, INC.

629 Green Bay Road  
Wilmette, Illinois 60091

# KODAK DISKETTES:

Discover the future today!

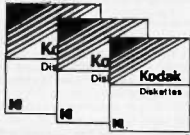

**KODAK THE NAME SAYS IT ALL.**

Take a Century of experience in coating products like photo film, add two brand-new state-of-the-art plants for manufacturing diskettes and you have something new: KODAK diskettes, a taste of the future.

Kodak spends more than three million dollars a day in research and development. They have more than 120,000 employees and manufacture and market more than 30,000 products.

**But George Eastman said it best:**

George Eastman, the founder of Eastman Kodak and the man who made it possible for everyone to have a family album expressed Kodak's philosophy almost a century ago: make "good goods!"

That's why we're so pleased to add KODAK diskettes to our line.

**Great quality, great value!**

For those of you who want a "brand name" diskette with top-of-the-line quality...without paying through the nose, the choice is simple: KODAK.

**Of course, there's a LIFETIME WARRANTY!**

Except as noted, all KODAK diskettes are packed in boxes of ten with Tyvek sleeves, user ID labels and write-protect tabs. Bulk packed diskettes are labelled as KODAK diskettes and are packed in 4 bundles of 25 diskettes with Tyvek sleeves, user ID labels and write-protect tabs.

	Qty. 20-40	Qty. 60+	Qty. 100
5.25" SSDD	\$1.11 ea.	\$1.01 ea.	
5.25" DSDD	\$1.46 ea.	\$1.33 ea.	
5.25" DSDD-HD	\$3.47 ea.	\$3.15 ea.	

### 3.5" KODAK DISKETTES

3.50" SSDD	\$2.06 ea.	\$1.87 ea.
3.50" DSDD	\$2.73 ea.	\$2.48 ea.

### KODAK LABELLED BULK DISKETTES

5.25" SSDD in package of 100	\$ .93
5.25" DSDD in package of 100	\$1.24

**FOR ORDERS ONLY: 1-800-621-6827** (In Illinois: 1-312-256-7140)

**INFORMATION & INQUIRIES: 1-312-256-7140**

HOURS: 8AM-5PM Central Time, Monday-Friday  
**WE WILL BEAT ANY NATIONALLY ADVERTISED PRICE ON THE SAME PRODUCTS AND QUANTITIES!**

**DISK WORLD!, Inc.**  
 629 Green Bay Road • Wilmette, Illinois 60091

**DISK WORLD!**



## FANTASTIC LOW PRICES ON

# BASF QUALIMETRIC DISKETTES!

LIFETIME WARRANTY!

Buy in bulk and save. 150 to the carton with envelopes, write-protect tabs and user ID labels. Boxed product is the same, except in cardboard boxes of 10.

	Qty. 50	Qty. 150
5.25" SSDD	.83 ea.	.80 ea.
5.25" DSDD	.94 ea.	.92 ea.
5.25" DSDD-HD	2.13 ea.	N/A
5.25" SSDD-96TPI	.94 ea.	N/A
5.25" DSDD-96TPI	1.06 ea.	N/A
3.50 SSDD-135TPI	1.84 ea.	1.88 ea.
3.50 DSDD-135TPI	2.40 ea.	2.28 ea.

NOTE: 3.50" diskettes in Quantity 50 are packed in plastic library cases. That's why they seem to be a better buy. But there are only 5 diskettes to a case...so the bulk diskettes are really a better deal, unless you like expensive little library cases.

**FOR ORDERS ONLY: 1-800-621-6827** (In Illinois: 1-312-256-7140)

**INFORMATION & INQUIRIES: 1-312-256-7140**

HOURS: 8AM-6PM Central Time, Monday-Friday  
**WE WILL BEAT ANY NATIONALLY ADVERTISED PRICE ON THE SAME PRODUCTS AND QUANTITIES!**

**DISK WORLD!** Authorized Reseller Information Processing **BASF** Media

## DISK WORLD! Ordering & Shipping Instructions

Shipping: 5 1/4" & 3 1/2" DISKETTES—Add \$3.00 per each 100 or fewer diskettes. Other Items: Add shipping charges as shown in addition to other shipping charges. Payment: VISA and MASTER-CARD accepted. COD Orders: Add additional \$5.00 Special Handling charge. APO, FPO, AK, HI & PR Orders: Include shipping charges as shown and additional 5% of total order amount to cover PAL and insurance. Taxes: Illinois residents only, add 7% sales tax.

Prices subject to change without notice.  
 This ad supercedes all other ads.  
 Not responsible for typographical errors.  
 MINIMUM TOTAL ORDER: \$35.00

**FOR ORDERS ONLY: 1-800-621-6827** (In Illinois: 1-312-256-7140)

**INFORMATION & INQUIRIES: 1-312-256-7140**

HOURS: 8AM-6PM Central Time Monday-Friday

**WE WILL BEAT ANY NATIONALLY ADVERTISED PRICE ON THE SAME PRODUCTS AND QUANTITIES!**

**DISK WORLD!, Inc.**  
 629 Green Bay Road • Wilmette, Illinois 60091

**DISK WORLD!**

## ATHANA DISKETTES

The great unknown!

**60¢** ea. — 5 1/4" SSDD Qty. 50

**74¢** ea. 5 1/4" DSDD Qty. 50

You've used these diskettes hundreds of times...as copy-protected originals on some of the most popular software packages. They're packed in poly-bags of 25 with Tyvek sleeves, reinforced hubs, user identification labels and write-protect tabs.

**LIFETIME WARRANTY!**

**SOFT SECTOR ONLY!** Sold in multiples of 50 only.

**FOR ORDERS ONLY: 1-800-621-6827** (In Illinois: 1-312-256-7140)

**INFORMATION & INQUIRIES: 1-312-256-7140**

HOURS: 8 AM-6PM Central Time, Monday-Friday

**WE WILL BEAT ANY NATIONALLY ADVERTISED PRICE ON THE SAME PRODUCTS AND QUANTITIES!**

**DISK WORLD!, Inc.**  
 629 Green Bay Road • Wilmette, Illinois 60091

**DISK WORLD!**

Authorized Distributor **ATHANA MAGNETIC MEDIA**



Now, the lowest prices ever on **3M** diskettes. **LIFETIME WARRANTY!**

All 3M diskettes are factory packed in boxes of 10 and come with Tyvek sleeves, user ID labels and write-protect tabs.

	Qty. 20-40	Qty. 50+
5.25" SSDD	\$1.20 ea.	\$1.09 ea.
5.25" DSDD	\$1.70 ea.	\$1.54 ea.
5.25" SSDD-96TPI	\$2.18 ea.	\$1.98 ea.
5.25" DSDD	\$2.73 ea.	\$2.48 ea.
5.25" DSDD-HD	\$3.45 ea.	\$3.14 ea.
3.50" SSDD	\$2.18 ea.	\$1.98 ea.
3.50" DSDD	\$3.09 ea.	\$2.81 ea.

### 3M DATA CARTRIDGES

(Sold 10 to a carton only.)

(Add \$5.00 shipping charges for cartridges!)

DC1000	\$12.43 ea.
DC300XLP	\$19.09 ea.
DC600A	\$20.30 ea.

**DISK WORLD!**

Authorized Distributor Information Processing Products



## PRINTER RIBBONS:

at extraordinary prices!

Brand new ribbons, manufactured to Original Equipment Manufacturer's specifications, in housings. (Not re-inked or spools only.)

LIFETIME WARRANTY!

Epson MX-70/80	\$2.70 ea. + 25¢ Shpng.
Epson MX-100	\$4.08 ea. + 25¢ Shpng.
Okidata Micro83	\$1.37 ea. + 25¢ Shpng.
Okidata Micro84	\$2.98 ea. + 25¢ Shpng.

**FOR ORDERS ONLY: 1-800-621-6827** (In Illinois: 1-312-256-7140)

**INFORMATION & INQUIRIES: 1-312-256-7140**

HOURS: 8AM-6PM Central Time, Monday-Friday

**WE WILL BEAT ANY NATIONALLY ADVERTISED PRICE ON THE SAME PRODUCTS AND QUANTITIES!**

**DISK WORLD!, Inc.**

629 Green Bay Road • Wilmette, Illinois 60091

**DISK WORLD!**

## DISKETTE STORAGE CASES

### AMARAY MEDIA-MATE 50: A REVOLUTION IN DISKETTE STORAGE

Every once in a while, someone takes the simple and makes it elegant! This unit holds 50 5 1/4" diskettes, has grooves for easy stacking, inside nipples to keep diskettes from slipping and several other features. We like it!

**\$9.69** ea. Shpng. + \$2.00

**DISKETTE 70 STORAGE: STILL A GREAT BUY.** Dust-free storage for 70 5 1/4" diskettes. Six dividers included. An excellent value.

**\$9.95** Shpng. + \$3.00

**DISK CADDIES** The original flip-up holder for 10 5 1/4" diskettes. Beige or grey only.

**\$1.65** ea. + \$2.00 Shpng.

**FOR ORDERS ONLY: 1-800-621-6827** (In Illinois: 1-312-256-7140)

**INFORMATION & INQUIRIES: 1-312-256-7140**

HOURS: 8AM-6PM Central Time, Monday-Friday

**WE WILL BEAT ANY NATIONALLY ADVERTISED PRICE ON THE SAME PRODUCTS AND QUANTITIES!**

**DISK WORLD!, Inc.**

629 Green Bay Road • Wilmette, Illinois 60091

**DISK WORLD!**

The value leader in Computer supplies And accessories.

7400			
Part No.	Price	Part No.	Price
SN7400N	.19	SN7485N	.55
SN7402N	.19	SN7486N	.35
SN7404N	.25	SN7489N	1.95
SN7405N	.29	SN7490N	.39
SN7406N	.29	SN7493N	.35
SN7407N	.29	SN74121N	.29
SN7408N	.19	SN74123N	.49
SN7410N	.29	SN74125N	.45
SN7414N	.45	SN74126N	.49
SN7416N	.35	SN74143N	3.95
SN7417N	.35	SN74150N	1.29
SN7420N	.19	SN74154N	1.25
SN7430N	.19	SN74158N	1.39
SN7432N	.25	SN74173N	.75
SN7438N	.29	SN74174N	.59
SN7442N	.45	SN74175N	.59
SN7445N	.69	SN74176N	.89
SN7446N	.79	SN74181N	1.95
SN7447N	.79	SN74189N	1.95
SN7448N	.39	SN74193N	.89
SN7472N	.39	SN74198N	1.35
SN7473N	.35	SN74221N	.89
SN7474N	.35	SN74273N	1.95
SN7475N	.39	SN74365N	.59
SN7476N	.35	SN74367N	.59

74LS			
Part No.	Price	Part No.	Price
74LS00	.19	74LS165	.79
74LS02	.19	74LS166	.79
74LS04	.25	74LS173	.49
74LS05	.25	74LS174	.39
74LS06	.99	74LS175	.39
74LS07	.99	74LS189	3.95
74LS08	.19	74LS191	.49
74LS10	.19	74LS193	.79
74LS14	.25	74LS193	.59
74LS27	.25	74LS240	.69
74LS30	.19	74LS243	.69
74LS32	.25	74LS244	.69
74LS42	.39	74LS245	.79
74LS47	.89	74LS259	1.19
74LS57	.35	74LS264	.99
74LS57	.35	74LS264	.99
74LS75	.29	74LS322	2.95
74LS76	.29	74LS365	.39
74LS85	.49	74LS366	.39
74LS86	.25	74LS367	.39
74LS90	.39	74LS368	.39
74LS93	.39	74LS373	.79
74LS123	.49	74LS374	.79
74LS125	.39	74LS393	.79
74LS138	.39	74LS590	5.95
74LS139	.39	74LS624	1.95
74LS154	1.49	74LS629	2.49
74LS157	.35	74LS640	.99
74LS158	.35	74LS645	.99
74LS163	.49	74LS670	.99
74LS164	.49	74LS688	1.95

74PROMS*			
Part No.	Price	Part No.	Price
74S00	.29	74S188*	1.75
74S04	.35	74S189	1.95
74S08	.35	74S196	1.49
74S10	.29	74S240	1.49
74S32	.35	74S241	1.49
74S74	.49	74S253	.79
74S85	1.49	74S287*	1.69
74S86	.35	74S288*	1.69
74S124	.75	74S373	1.69
74S174	.29	74S374	1.69
74S175	.79	74S472*	3.49

74ALS			
Part No.	Price	Part No.	Price
74ALS00	.35	74ALS138	.89
74ALS02	.35	74ALS174	.89
74ALS04	.39	74ALS175	.89
74ALS08	.35	74ALS240	.79
74ALS10	.35	74ALS244	1.79
74ALS27	.39	74ALS245	2.49
74ALS30	.35	74ALS373	1.95
74ALS32	.39	74ALS374	1.95
74ALS74	.55	74ALS573	1.95

74F			
Part No.	Price	Part No.	Price
74F00	.59	74F139	1.29
74F04	.65	74F157	1.29
74F08	.59	74F193	4.95
74F10	.59	74F240	2.49
74F32	.65	74F244	2.49
74F74	.69	74F253	1.79
74F86	.89	74F373	2.95
74F138	1.19	74F374	2.95

CD-CMOS			
Part No.	Price	Part No.	Price
CD4001	.19	CD4081	.25
CD4011	.19	CD4082	.25
CD4013	.35	CD4093	.35
CD4016	.29	CD4094	1.49
CD4017	.49	CD4103	2.95
CD4018	.69	CD4503	.49
CD4020	.59	CD4510	.69
CD4024	.49	CD4511	.69
CD4027	.39	CD4515	1.39
CD4030	.39	CD4518	.79
CD4040	.65	CD4520	.79
CD4049	.29	CD4522	.79
CD4050	.29	CD4538	.89
CD4051	.65	CD4541	.89
CD4052	.65	CD4543	.89
CD4053	.65	CD4553	4.95
CD4059	3.49	CD4559	.89
CD4060	.89	CD4566	1.95
CD4066	.29	CD4583	1.19
CD4069	.25	CD4584	.59
CD4070	.29	CD4585	.75
CD4071	.25	MC14411	9.95
CD4072	.29	MC1493OP	4.49
CD4076	.89	MC14572	.89

### SPECIAL! SPECIAL! SPECIAL!

**MOTOROLA**  
  
**MC68701 - Microcomputer with EPROM**  
 The MC68701 is an 8-bit single chip microcomputer unit (MPU) which significantly enhances the capabilities of the MC6800 family of parts. On-chip resources include 2048 bytes of EPROM, 128 bytes of RAM, Serial Communications Interface (SCI), parallel I/O, and a three function Programmable Timer.  
**MC68701.....\$24.95**

### CUSTOM COMMODORE CHIPS

for VIC-20, C-64 and C-128 Personal Computers

Part No.	Description	Price	Part No.	Description	Price	Part No.	Description	Price
*6510	CPU	\$19.95	*6526	CIA	\$25.95	*6581	SID	\$32.95
*6525	TPI	\$20.95	*6560	VIC-I	\$29.95	825100PLA		\$37.95
*Specs. Available @ \$1.50 ea.			*6567	VIC-II	\$44.95	NOTE: 825100 = U17 (C-64)		

### MICROPROCESSOR CHIPS

MICROPROCESSOR CHIPS		6500/6800/68000 Cont.		8080 SERIES Cont.	
Part No.	Price	Part No.	Price	Part No.	Price
D765AC	.495	6840	6.75	8243	2.49
CDP1802CE	9.95	6843	19.95	8250A	6.95
2661-3	6.95	6845	4.95	8250B (For IBM)	5.95
Z80, Z80A, Z80B, SERIES		6850	1.95	8251A	2.25
Z80	1.75	6852	4.75	8253-5	2.25
Z80-CTC	1.79	6800LB	9.95	8254	9.95
Z80-DART	4.95	6861	8.95	8255A-5	2.25
Z80-P10	1.79			8257-5	2.49
Z80A	1.85			8259-5	2.49
Z80A-CTC	1.89			8272	4.95
Z80A-DART	5.25			8279-5	2.95
Z80A-P10	1.95			8741	7.95
Z80A-S10/O	5.25			8745	8.95
Z80B	3.95			8749	9.95
Z80B-CTC	4.95			8751	29.95
Z80B-P10	4.95			8755	14.95
6500/6800/68000 SER.					
6502	2.75				
6525	2.95				
6526	4.95				
6532	6.49				
6551	6.95				
6800	1.95				
6802	4.95				
6810	1.95				
6821	1.95				
8088	7.95				
8116	8.95				
8155	2.45				
8156	2.75				
8202	9.95				
8203	29.95				
8212	1.95				
8224	2.25				
8226	3.49				
8237-5	6.95				

DYNAMIC RAMS		
Part No.	Function	Price
4116N-20	16,384 x 1 (200ns)	.39
4128	131,072 x 1 (200ns)	4.95
4164N-150	65,536 x 1 (150ns)	.89
TMS4416-12	16,384 x 4 (120ns)	4.95
MM5280	4096 x 1 (120ns) 2107	1.95
8118	16,384 x 1 (150ns) (+5V Only Required)	1.95
41256-150	262,144 x 1 (150ns)	3.29
50464-15	65,536 x 4 (150ns) (4464) (4164)	7.95

STATIC RAMS		
Part No.	Function	Price
TMM2016-12	2048 x 8 (120ns)	1.69
2102	1024 x 1 (350ns)	.89
2102-2L	1024 x 1 (250ns) LP (91L02)	1.49
2114N	1024 x 4 (450ns)	.99
2114N-2	1024 x 4 (200ns) LP	1.09
2114N-2L	1024 x 4 (200ns) LP	1.49
21C14	1024 x 4 (200ns) (CMOS)	.49
2149	1024 x 4 (45ns)	4.95
5101	256 x 4 (450ns) CMOS	3.95
HM6116P-3	2048 x 8 (150ns) CMOS	1.75
HM6116LP-3	2048 x 8 (150ns) LP CMOS	1.85
HM6264P-12	8192 x 8 (120ns) CMOS	4.69
HM6264LP-12	8192 x 8 (120ns) LP CMOS	4.79
HM6264P-15	8192 x 8 (150ns) CMOS	4.49
HM6264LP-15	8192 x 8 (150ns) LP CMOS	4.59
6514	1024 x 4 (350ns) CMOS (UPD444C)	4.49

PROMS/EPROMS			
Part No.	Price	Part No.	Price
1702A	256 x 8 (1µs)	3.95	
2708	1024 x 8 (450ns)	3.95	
TMS2716	2048 x 8 (450ns) 3 voltage	6.49	
2716	2048 x 8 (450ns)	2.49	
27C16	2048 x 8 CMOS	9.95	
2732	4096 x 8 (450ns)	2.49	
2732A-20	4096 x 8 (200ns) 21V	3.95	
2732A-45	4096 x 8 (450ns) 21V	2.75	
27C32	4096 x 8 CMOS	10.95	
2758	1024 x 8 (450ns) Single +5V	3.95	
2764-20	8192 x 8 (200ns) 21V	3.95	
2764A-25	8192 x 8 (250ns) 12.5V	2.95	
2764-45	8192 x 8 (450ns) 21V	2.19	
27C64	8192 x 8 CMOS	6.95	
27128-25	16,384 x 8 (250ns) 128K 21V	2.95	
27256-25	32,768 x 8 (250ns) 256K (12.5V)	7.95	
27C256-25	32,768 x 8 (250ns) 256K (CMOS) (12.5V)	13.95	
68764	8192 x 8 (450ns) 25V	15.95	
68796	8192 x 8 (350ns) 25V	16.95	
74S387	256 x 4 PROM TS	1.69	
74S471	256 x 8 PROM TS	4.95	
82S123	32 x 8 PROM TS	2.95	
82S129	256 x 4 PROM TS	2.95	

LOW PROFILE (TIN) SOCKETS				WIRE WRAP SOCKETS (GOLD) LEVEL #3			
Part No.	1-9	10-99	100-up	Part No.	1-9	10-99	100-up
8 pin LP	.13	.12	.11	8 pin WWW	.55	.49	.45
14 pin LP	.15	.13	.11	10 pin WWW	.65	.59	.55
16 pin LP	.17	.15	.13	14 pin WWW	.69	.65	.65
18 pin LP	.25	.23	.21	16 pin WWW	.75	.69	.65
20 pin LP	.28	.26	.23	18 pin WWW	.85	.79	.75
22 pin LP	.30	.28	.26	20 pin WWW	.95	.89	.85
24 pin LP	.31	.30	.29	22 pin WWW	.99	.95	.89
28 pin LP	.39	.37	.35	24 pin WWW	1.19	1.09	.99
40 pin LP	.49	.46	.43	28 pin WWW	1.39	1.29	1.19
				36 pin WWW	1.49	1.39	1.29
				40 pin WWW	1.79	1.69	1.59

— SOLDER TAIL STANDARD (GOLD & TIN) AND HEADER PLUG SOCKETS ALSO AVAILABLE —

Part No. Function Price  
**2816A 2048x8 16K E<sup>2</sup>PROM 350ns .. \$8.95**  
 • On-board Address/Data Latches • Auto-Timed Byte Write (on-chip timer) • 5V Erase/Write/Read • Opt. High Voltage Erase/Program (9-15V) • Power Up/Down Write Protection • Auto Erase before Write The 2816A is an ideal nonvolatile memory providing in-system alterability with the same ease and with the same features as 2Kx8 Static RAMs.

**DT1050** — Applications: Teaching aids, appliances, clocks, automotive, telecommunications, language translators. The DT1050 is a standard DIGITAL TALKER kit encoded with 137 separate and useful words, 2 tones, and 5 different silence durations. The words and tones have been assigned discrete addresses, making it possible to output single words or words concatenated into phrases or even sentences. The "voice" output of the DT1050 is a highly intelligible male voice. The DT1050 consists of a Speech Processor Chip, MM54104 (40-pin) and two (2) Speech ROMs, MM52164SR1 and MM52164SR2 (24-pin) along with a Master Word list and a recommended schematic diagram on the application sheet.  
 Part No. Description Price  
**DT1050** DigitalTalker™ ..... **\$24.95**  
**MM54104** Processor Chip ..... **\$12.95**

**DT1057** — Expands the DT1050 vocabulary from 137 words to over 250 words. Includes two (2) ROMs and specs.  
**DT1057** ..... **\$11.95**

Part No.	Price	Part No.	Price
FE0202D	12.95	7207AEV/Kit	8.49
FE0203D	12.95	7211IPL (TTL)	7.95
7106CPL	8.95	7212IPL (Micro)	8.49
7106EV/Kit	46.95	7217JUL	10.95
7107CPL	8.95	7217AIPL	8.95
7107EV/Kit	46.95	7224IPL	10.95
7207AIPD	5.95	7226AEV/Kit	99.95

74HC			
Part No.	Price	Part No.	Price
74HC00	.35	74HC175	.89
74HC02	.39	74HC221	1



# Worldwide • Since 1974

• QUALITY COMPONENTS • COMPETITIVE PRICING • PROMPT DELIVERY

Mail Order Electronics • Worldwide  
**Jameco**  
ELECTRONICS

## COMMODORE® COMPATIBLE ACCESSORIES



**RS232 Adapter for VIC-20 and Commodore 64**

The JE232CM allows connection of standard serial RS232 printers, modems, etc. to your VIC-20 and C-64. A 4-pole switch allows the inversion of the 4 control lines. Complete installation and operation instructions included.

Plugs into User Port. Provides Standard RS232 signal levels. Uses 6 signals (Transmit, Receive, Clear to Send, Request to Send, Data Terminal Ready, Data Set Ready).

**JE232CM. . . . . \$39.95**

**Voice Synthesizer VIC-20 & C-64 Plug-In - Talking in Minutes!**

**JE520CM. . . . . \$99.95**

**300 Baud Auto Modem Mitey-MO (For C-64). . . . . \$74.95**

**Parallel Printer Interface FREE 4K Buffer Included! MW350 (For VIC-20, C-64 & C-128). . . . . \$69.95**

## TRS-80 COMPATIBLE ACCESSORIES

**E-X-P-A-N-D TRS-80 MEMORY All kits come complete with documentation**

**TRS-80 MODEL I, III**  
TRS-16K3 200ns (Model III). . . . . \$5.95  
TRS-16K4 250ns (Model I). . . . . \$5.49

**TRS-80 COLOR AND COLOR II**  
TRS-64K-2. . . . . \$9.95

**TRS-80 MODEL 4, 4P**  
TRS-64K-2. . . . . \$9.95  
Expands Model 4 from 16K - 64K or Model 4P from 64K - 128K  
TRS-64K-2PAL. . . . . \$29.95  
Expands Model 4 from 64K to 128K

**TRS-80 Model 100 • NEC • Olivetti**  
M1008K. . . . . \$29.95 ea. or 3 for \$79.95  
TRS-80 Model 100 Expansion  
NEC8KR. . . . . \$29.95 ea. or 3 for \$79.95  
NEC Model PC-8201A Expansion  
OM108K. . . . . \$29.95 ea. or 3 for \$79.95  
Olivetti Model M10 Expansion

**TANDY 200**  
M200R. . . . . \$99.95 ea. or 2 for \$189.95  
Tandy Model 200 Expansion

## PROMETHEUS MODEMS



**Intelligent 1200/300 Baud Modem with Real Time Clock/Calendar**

The ProModem™ is a Bell 212A (1200/300) intelligent stand-alone modem. Hayes command set compatible plus an additional extended command set. Shows with alphanumeric display option. RS-232 Stand-Alone Unit.

**PM1200. . . . . \$299.95**

**Options for ProModem 1200**  
PM-COM. . . . . \$79.95  
ProCom Communications Software. Please specify Operating System - Apple: ProDOS or CP/M - IBM: PC DOS or MS DOS  
PM-OP512K. . . . . \$129.95  
Communications Buffer Option  
BU512K. . . . . \$54.95  
512K Memory for PM-OP512K  
PM-ALP. . . . . \$79.95  
Alphanumeric Display for ProModem 1200  
PM-SPECIAL #2. . . . . \$249.95  
Includes PM-OP512K, BU512K and PM-ALP

## APPLE® COMPATIBLE ACCESSORIES

All Apple Cards come complete with instructions. MADE IN THE USA!

**16K RAM CARD (Language Card) For Apple II and II+\***



Expand from 48K-64K. Runs AppleSoft, DOS, CP/M and Pascal. (ARC-16K/MEM-1)  
**JE860\*\* . . . \$39.95**

**CONTROLLER CARD For Apple II, II+ and IIe\***



Capable of handling up to two drives. Recommended drives: ADD-514 or ADD-12. (ACC-1)  
**JE875 . . . \$49.95**

**80-COLUMN PLUS 64K RAM For Apple IIe\***

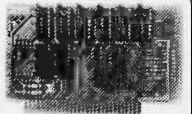

JE864 doubles the amount of data the Apple IIe can display, and memory capacity too.  
**JE864 . . . \$99.95**

**128K RAM CARD For Apple II, II+ and IIe\***



Five key software programs are included: Memory Management System, Utilities, Diagnostics, Demos, and RAM Disk Emulators for DOS 3.3, CP/M & Apple Pascal. Features DOS relocater. Expand-A-RAM.  
**JE868\*\* . . . \$119.95**

**APPLESURANCE DIAGNOSTIC DISK CONTROLLER CARD For Apple II, II+ and IIe\***

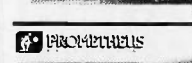

PREVENTS CRASHES! Test your RAM, ROM, CPU and Disk Drives. DRV-1/Applesurance II:  
**JE877. . . . . \$69.95**

**PARALLEL PRINTER CARD For Apple II, II+ and IIe\***



Fully compatible with Apple CP/M, Apple Pascal (for FORTRAN), and most other operating systems and software packages. Available for Apple II, II+ and IIe\*.  
**JE880. . . . . \$59.95**

**PARALLEL/SERIAL 64K BUFFER CARD For Apple II, II+ and IIe\***

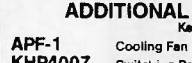

Using the parallel jumper cable supplied, the JE883 will attach to the JE880 (above). Parallel Card needed for operation. The JE883 includes a standard parallel input with both parallel and serial (RS232) buffered outputs. P/S Buffer:  
**JE883. . . . . \$79.95**

**APF-1 Cooling Fan with Surge Protection • Key: (a,b). . . . . \$ 39.95**

**KHP4007 Switching Power Supply • Key: (a,b). . . . . \$ 39.95**

**JE614 Numeric/Aux. Keypad - 11 accessible functions • Key: (b). . . . . \$ 49.95**

**AMON 12" Green Monitor with Swivel Stand • Key: (a, b and I/c). . . . . \$ 99.95**

**KB-EA1 Apple Keyboard and Case • Key: (a). . . . . \$ 99.95**

**JE520AP Voice Synthesizer - Plug-In, User Ready • Key: (a,b). . . . . \$119.95**

**ADD-12 5 1/4" Half-Height Disk Drive • Key: (a,b). . . . . \$129.95**

**ADD-11c 5 1/4" Half-Height Disk Drive • Key: (I/c). . . . . \$129.95**

**ADD-514 5 1/4" Full Height Disk Drive • Key: (a,b). . . . . \$139.95**

**PM1200A Prometheus Internal Modem - 2 Cards • Key: (a,b). . . . . \$299.95**

**PM1200M Prometheus Macintosh Ext. Modem • Key: (Macintosh). . . . . \$349.95**

## GENERAL APPLICATION POWER SUPPLIES

**Power/Mate Corp. REGULATED POWER SUPPLY**  
Input: 105-125/210-250VAC @ 47-63Hz • Line regulation: ±0.05% • 3 mounting surfaces • Overvoltage protection • UL recognized • CSA certified  
Part No. Output Size (Inches) Weight PRICE  
EMA5/6B 5V @ 3A / 6V @ 2.5A 4 1/8" x 4W x 2 1/2" 2 lbs. \$29.95  
EMA5/6C 5V @ 6A / 6V @ 5A 5 1/2" x 4 1/2" W x 2 1/2" 4 lbs. \$39.95

**4-CHANNEL SWITCHING POWER SUPPLY**  
Microprocessor, mini-computer, terminal, medical equipment and process control applications • Input: 90-130VAC, 47-440Hz • Output: +5VDC @ 5A, -5VDC @ 1A, +12VDC @ 1A, -12VDC @ 1A • Line regulation: ±0.2% • Ripple: 30mV p-p • Load regulation: ±1% • Overcurrent protection • Adjustment: 5V main output ±10% • Size: 6 1/2" L x 1 1/2" W x 4-15/16" H • Weight: 1 1/2 lbs.  
**FCS-604A. . . . . \$59.95**

## IBM® COMPATIBLE ACCESSORIES

Build an IBM PC/XT Compatible!



- 8 Card Slots
- Flip-Up Lid
- All necessary hardware for expansion is included
- Weight: 17 lbs.

**IBM-Case. . . . . \$59.95**

### Additional Add-Ons Available!

**IBM-KB** Keyboard. . . . . \$ 79.95  
**IBM-FCC** Disk Controller. . . . . \$ 59.95  
**IBM-MCC** Monochrome Card. . . . . \$ 89.95  
**IBM-MON** 12" Monochr. Monitor. . . . . \$109.95  
**IBM-5151** Keyboard. . . . . \$ 99.95 (Equivalent to Keytronics' 5151)  
**IBM-ICB** Color Card. . . . . \$109.95 (With Printer Port)  
**IBM-E384K** 384K RAM Card. . . . . \$169.95  
**IBM-MB** Motherboard. . . . . \$269.95  
**IBM-10MBK** 10MB HH Hard Kit. . . . . \$499.95  
**IBM-20MBK** 20MB HH Hard Kit. . . . . \$599.95



**IBM PC/XT Equivalent 130 Watt Power Supply Upgrade Your PC!**  
Input: 110V @ 60Hz • Output: +5VDC @ 15A, -5VDC @ 0.5A, +12VDC @ 4.2A, -12VDC @ 0.5A • Plug compatible connectors • Fits into IBM PC • Weight: 8 lbs.

**IBM-PS. . . . . \$99.95**



**IBM Compatible! DISK DRIVES**  
Documentation Included  
**FD55B** Toac 5 1/4" DS 1/2-Height. . . . . \$99.95  
**SA455** Shugart 5 1/4" DS 1/2-Height. . . . . \$99.95  
**TM100-2** Tandon 5 1/4" DS Full-Height. . . . . \$99.95

## JMR 5 1/4" DISK DRIVE ENCLOSURES

Complete with power supply, switch, power cord, fuseholder and connectors.  
**DDE-1FH** Houses 1 Full-Height 5 1/4" Floppy Drive. . . . . \$69.95  
**DDE-2HH** Houses 2 Half-Height 5 1/4" Floppy Drives - Vertical. . . . . \$79.95  
**HDDE-1FH** Houses 1 Hard Disk Drive. . . . . \$199.95

## UV-EPROM ERASER

Erases all EPROMs. Erases up to 8 chips within 21 minutes (1 chip in 15 minutes). Maintains constant exposure distance of one inch. Special conductive foam liner eliminates static build-up. Built-in safety lock to prevent UV exposure. Compact - only 9.00" L x 3.70" W x 2.60" H. Complete with holding tray for 8 chips.  
**DE-4** UV-EPROM Eraser. . . . . \$74.95  
**UVS-11EL** Replacement Bulb. . . . . \$17.95

## DATA BOOKS

**30003** National Linear Data Book (82). . . . . \$14.95  
**30009** Intell Data Book (85). . . . . \$ 9.95  
**30013** Zilog Data Book (85). . . . . \$ 9.95  
**30022** Nat'l. Logic Data Book Set (84). . . . . \$24.95  
**210830** Intel Memory Handbook (83/84). . . . . \$19.95  
**230843** Intel Microsystem Hndbk. (83/84). . . . . \$19.95

## MUFFIN/SPRITE-STYLE FANS

**MUF60** (SPN3-15-2462). . . . . \$9.95  
Howard Industries (4.68" sq, 60 cfm)  
**SUC27**. . . . . \$9.95  
EG&G Rotron (3.125" square, 20 cfm)

\$20 Minimum Order - U.S. Funds Only  
Shipping: Add 5% plus \$1.50 Insurance

California Residents: Add 6% or 6 1/2% Sales Tax

Spec. Sheets - 30¢ each  
Prices Subject to Change

Send stamped, self-addressed envelope to receive a Quarterly Sales Flyer - FREE!



Mail Order Electronics • Worldwide  
**Jameco**  
ELECTRONICS



Send \$1.00 Postage for a FREE 1986 JAMECO CATALOG

1355 SHOREWAY ROAD, BELMONT, CA 94002 • PHONE ORDERS WELCOME 415-592-8097 Telex: 176043

## Why pay \$1149 for a C.Itoh STARWRITER™ F-10

When our 40 cps letter quality daisywheel from the same manufacturer is only

AS **\$399.95**  
LOW  
AS



EACH 2 to 5 or more  
\$499 \$429 \$399

Bi-directional deluxe tractor \$249  
Automatic cut sheet feeder \$449 \$199.95

\*StarWriter is a Trademark of C. Itoh  
Digital Products, Inc.



Mannesmann-Tally Pixy 3

## PLOTTER \$195

List Price \$795 You save \$600!

- Fast 8 ips plotting speed
- 3 pen auto select plotter
- Parallel or serial (specify)
- 90 day factory warranty
- HURRY! Limited quantity

OPTIONS	LIST	JADE
8 extra water base pens	\$30	\$16.95
4 extra oil base pens	\$30	\$16.95
100 sheets 8 1/2 x 11 paper	\$9	\$4.95
50 sheets 8 1/2 x 11 transparencies	\$9	\$4.95
Plotter software for IBM-PC	\$195	\$59.95



## High Resolution Video Monitors

	LIST	JADE
Amdex 300G	\$179	\$139.95
Amdex 300A	199	\$149.95
Amdex 310A	230	\$179.95
PGS MAX-12 E 720 x 350	269	\$179.95
PGS HX-12 640 x 240	699	\$449.95
PGS HX-12E 690 x 350	785	\$549.95
Taxan 640 Ultra Hi-Res RGB	799	\$599.95
JADE Hi-Res TTL Monochrome 750 x 350 w/free tilt & swirl; green/amber	229	\$149.95

HIGH RESOLUTION  
640 x 240, .37 Dot Pitch

## RGB COLOR MONITOR

LIMITED QUANTITY  
List Price \$699  
IBM cable \$149.95

## 20 MEGABYTE HARD- CARD \$799

- Uses only one slot
- 21.3 MB formatted capacity
- Low power—only 11 watts
- Installs in just minutes
- Works with standard power supply

## 10 MEGABYTE Hard Disk System FOR YOUR IBM PC \$399.95



Complete with controller card, data cable, and mounting hardware, totally PC/XT compatible. For external model (cabinet & power supply)—add \$199.

10 MB Internal 1/2 High	\$990	\$399.95
20 MB Internal 1/2 High	\$1550	\$489.95
20 MB for AT, 60-80 ms	\$999	\$399.95
20 MB Hi-Speed for AT	\$1250	\$649.95
30 MB Hi-Speed for AT	\$1550	\$829.95
10 MB Tape Back-up	\$699	\$399.95

## 64K RAM Chip Upgrade Kits \$1485

High speed RAM upgrade kit with FREE parity (error detection) and one year warranty. We ship thousands of these kits to satisfied customers every week.

	LIST	JADE
128K RAM Chip Kit for AT	\$359	\$99.95
256K RAM Chip Kit	\$99	\$39.95

## 360K Disk Drive

\$69.95 IBM PC, XT or compatible

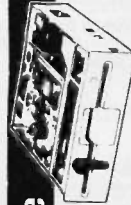

TANDON 100-2, DS, DD \$299 \$119.95  
TEAC 55B, DS, DD \$249 \$119.95

## 1200 BAUD MODEM \$168.95

Guaranteed Hayes compatible!

	LIST	JADE
JADE 1200 Baud External	\$349	\$168.95
JADE 1200 Baud PC Card	\$299	\$159.95
JADE 2400 Baud External	\$699	\$499.95
JADE 2400 Baud PC Card	\$595	\$399.95

## New HAYES 1200B Internal

	LIST	JADE
New 2400B Card w/Smartcom	\$799	\$579.95
HAYES Smartmodem 2400	\$899	\$629.95
HAYES Smartmodem 1200	\$699	\$389.95
HAYES 1200B w/o Smartcom II	\$539	\$339.95
HAYES 1200B for IBM PC	\$599	\$359.95

## PROMETHEUS Promodems

	LIST	JADE
ProModem 1200B for IBM PC	\$399	\$289.95
ProModem 1200 RS-232	\$495	\$299.95
Alpha/num Display Option	\$99	\$79.95
New Options Processor	\$149	\$109.95
64K Mem Expansion for Above	\$99	\$19.95

## 135/150 WATT Drop-in replacement POWER SUPPLY

	LIST	JADE
135 Watt	\$199	\$89.95
150 Watt	\$249	\$99.95

## High Speed APU Chips

8087-3	\$119.95	80287	\$199.95
8087-2	\$129.95		

## KEYTRONICS

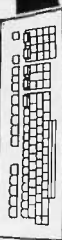

	LIST	JADE
KB5150 Improved IBM Keyboard	\$209	\$159.95
KB5151 Deluxe IBM Keyboard	\$299	\$199.95
KB5153T Touch Pad	\$399	\$299.95
KB5151jr Deluxe PCjr Keyboard	\$299	\$179.95

## AST Boards On Sale!

	LIST	JADE
AST Six Pak Plus 64K	\$395	\$249.95
AST Six Pak Plus 384K	\$945	\$299.95
AST Rampage 256K	\$495	\$379.95
AST Rampage 2 MB	\$1995	\$679.95
AST Advantage-AT 128K	\$595	\$399.95
AST Advantage-AT 3 MB	\$4145	\$999.95
IRMA 3270 Board	\$1195	\$988.95

## TALLTREE JRAM-2/JRAM-3

0K JRAM-2	\$179.95
1 MB JRAM-2	\$399.95
2 MB JRAM-2	\$599.95
256K JRAM-3	\$329.95
1 MB JRAM-3	\$499.95
2 MB JRAM-3	\$629.95

## INTEL/LOTUS Above Board

	For IBM PC-AT
64K	\$349.95
128K	\$529.95
256K	\$399.95
512K	\$449.95
1 MB	\$729.95
2 MB	\$929.95
4 MB	\$1599.95

## Multifunction Card For Your IBM PC \$129.95

Up to 384K, parallel printer port, RS-232 serial port, game port, clock/calendar, RAM disk, printer buffer, software package.

	LIST	JADE
0K JADE 7 Pak Plus	\$299	\$129.95
384K JADE 7 Pak Plus	649	\$199.95

## IBM Video Boards

	LIST	JADE
Hercules Color Graphics	\$245	\$189.95
JADE Color Graphics	\$199	\$99.95
Hercules Monochrome Graphics	\$339.95	\$499
JADE Monochrome Graphics	\$299	\$129.95
JADE Color w/Par & Serial	\$299	\$199.95
Tecmar Graphics Master	\$699	\$499.95
Everex Edge	\$399	\$299.95
Paradise Graphics Card	\$395	\$319.95

## Printers

- EPSON FX-85
- EPSON FX-286
- EPSON LQ-800
- EPSON LX-80
- EPSON JX-80

**PRICED TOO LOW TO PUBLISH!**  
Call us for our best price.

## ISO-BAR

These industrial quality ISO-BAR's contain surge suppression circuitry and built-in noise filters plus a 15 amp circuit breaker.

	LIST	JADE
6 Socket, 1 Filter ISO-BAR	\$69	\$44.95
4 Socket, 2 Filter ISO-BAR	\$89	\$59.95
8 Socket, 4 Filter ISO-BAR	\$99	\$69.95

## FREE Software With MOUSE

	LIST	JADE
Microsoft Mouse w/Paintbrush	\$199	\$139.95
PC Mouse w/PC Paint+	\$195	\$139.95

## STAR GEMINI 10-X

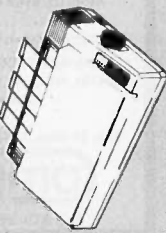

120 cps, Friction & Adjustable Tractor Feed w/Graphics, Limited Quantity.

# \$179.95

## MICROFAZER Buffers

Expandable to 64K (Par model to 512K)

8K Parallel in/Parallel out	\$169	\$139.95
64K Parallel in/Parallel out	\$225	\$164.95
128K Parallel in/Parallel out	\$445	\$269.95

Your choice: serial in/serial out; parallel in/serial out; serial in/parallel out.

8K	\$199	\$169.95	64K	\$260	\$199.95
----	-------	----------	-----	-------	----------

## Microbuffers

Parallel or serial for printers and modems. Expands to 256K

	LIST	JADE
32K Microbuffer	\$299	\$219.95
64K Microbuffer	\$349	\$249.95
256K Microbuffer	\$499	\$349.95

## Back-Up Power Supply

Emergency back-up power to save your computer system. A must for every computer system.

200 Watt UPS	\$359	\$269.95
425 Watt UPS	\$539	\$449.95

# JADE XPC IBM PC



- 640K of RAM
- 135 Watt Power Supply
- 8 Expansion Slots
- Deluxe Keyboard
- 90 Day Warranty

- 256K of RAM
- 63 Watt Power Supply
- 5 Expansion Slots
- IBM Keyboard
- 90 Day Warranty

256K of RAM, Two 360K Disk Drives & Disk Controller

## \$995

### OPTION #3

640 K of RAM  
20 MB hard disk  
One 360K drive  
135 Watt power supply  
Mono graphics card  
Parallel printer port  
PGS MAX-12E monitor

### OPTION #1

256K PC/640K XPC  
Two 360K drives  
Mono graphics car  
Amdtek 310A

**OPTION #2**  
256K PC/640K XPC  
Two 360K disk drives  
Monochrome card  
Amdtek 310A monitor

IBM PC — \$1995  
JADE XPC — \$1295

IBM PC — \$2395  
JADE XPC — \$1395

## IBM PC-XT W/ 20 MB HARD DISK

- 256K RAM
- 20 MB hard disk
- Mono graphics card
- Parallel printer port
- Amdtek 310A

## \$2895

## IBM PC-AT

- 512K RAM
- 20 MB 60 ms hard disk
- 1.2 MB disk drive
- Parallel printer port
- Serial RS-232C port
- Color graphics card
- PGS HX-12 monitor

## \$4795



PLACE  
ORDERS  
TOLL  
FREE!

Continental U.S.A.  
(800)421-5500  
Inside California  
(800)262-1710  
Los Angeles Area  
(213)973-7707

# JADE COMPUTER

4901 W. Rosecrans Ave. Box 5046  
Hawthorne, CA 90251-5046

We accept cash, checks, credit cards or purchase orders from qualified firms and institutions. Minimum prepaid order \$15.00. California residents add 6.75% tax. Prices & availability subject to change without notice. Shipping & handling charges via UPS Ground 50¢/lb. UPS Air \$1.00/lb. Minimum charge \$3.00.

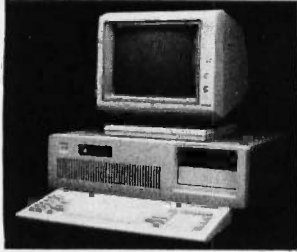

**WEDGE-PC OEM PRODUCTS**

**PC-AT Compatible \$1659/one**  
512k RAM, 1.2M disk drive, hard disk & floppy disk controller, monochrome card, 200W power, keyboard, enclosure.

**PC-XT compatible \$595/one**  
256k RAM, one 340 disk drive, monochrome card, keyboard, 130W power, enclosure.

20M hard disk with control \$555  
Color monitor \$319 Monochrome monitor \$109  
Dealer call for qty price

**WEDGE TECHNOLOGY INC.**  
1190 Mt. View-Alviso Rd., Suite R  
Sunnyvale, CA 94089 (408) 734-9866  
Telex 3719075 EDGE UB

Inquiry 373

**DISKETTES & MORE**

**NORTH HILLS CORP.**

1-800-328-3472

**Maxell Brown 3M Diamond**

**Competitive Prices**

COD — VISA — MasterCard  
All orders shipped within 24 HRS.



**NORTH HILLS CORP. INTERNATIONAL**

3564 Rolling View Dr.  
White Bear Lake, MN 55110  
MN. call collect—612-770-0485

Inquiry 254

**M68000 SINGLE BOARD COMPUTER**



On board 6-10 MHz CPU, 20K RAM, 32K EPROM, two RS-232, 16-bit port, 5-counter/timers expandable via Memory/FDC Board.

M68K CPU (bare board)	\$ 89.95
M68K CPU A&T (6MHz)	\$495.00
MD512K Memory/FDC (bare board)	\$ 89.95
MD512K Memory/FDC (128K)	\$495.00
FDC/Hard Disk Interface option	\$150.00
M68KE Enclosure w/power supply	\$249.00
M68K Monitor EPROM's	\$ 95.00
M68K Macro Cross Assembler	\$195.00
4XFORTH OS w/ assembler, editor	\$295.00
CP/M 68K OS w/"C" compiler	\$395.00

**EMS** Educational Microcomputer Systems P.O. Box 16115 Irvine, CA 92713 (714) 854-8545

Inquiry 120

**BAR CODE READER**

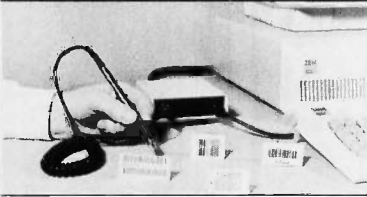

- IBM PC/XT COMPATIBLE (AND MOST CLONES)
- CONNECTS BETWEEN KEYBOARD AND THE PC
- NO CARD SLOT REQUIRED/SIMPLE INTERCONNECT
- NO CUSTOM SOFTWARE DRIVERS REQUIRED
- HIGH FIRST READ RATE
- READS DOT MATRIX & PRINTED BAR CODE LABELS
- CODE 3 OF 9, INTERLEAVED 2 OF 5, UPC
- AUTOMATIC BAR CODE SELECTION
- AUDIO AND VISUAL INDICATORS
- READS HIGH, MED. AND LOW DENSITY LABELS
- SWITCH SELECTABLE OPTIONS
- SELF-TEST DIAGNOSTICS

**\$495 ea.**

PC/MS DOS BAR CODE PRINTING SOFTWARE \$79 ea.

**AMERICAN MICROSYSTEMS**  
P.O. BOX 830551, RICHARDSON, TX. 75080  
(817) 834-9659



MASTERCARD AND VISA ACCEPTED



Inquiry 74

Still Waiting?  
**ATTENTION BERNOULLI BOOSTERS**  
Go Either Way!

**BOOT**  
from the Bernoulli Box!  
from the AT Hard Disk!

FORMAT WITH DOS  
PARTITION WITH FDISK  
NO SLOWING  
We've been shipping Bernoulli Boots  
that work for over a year —  
still waiting?

**Golden Bow Systems**

\$95-\$110

Add \$3 for shipping/  
handling  
California residents add  
6% sales tax



P.O. Box 3039  
San Diego, CA 92103  
(619) 298-9349

Inquiry 146

**WE CAN MAKE INCOMPATIBLE DATA COMPATIBLE!**

We can transfer datafiles between different operating systems; convert media (disks and tapes); decode and translate documents between major dedicated word processors and/or major PC software; re-arrange database files; transfer texts and re-formulate spreadsheet data.

Write or call to discuss your needs, then send a disk or tape sample of your datafile for a complimentary translation.

**CompuData Translators, Inc.**  
6565 Sunset Blvd., Suite 301  
Hollywood, CA 90028  
(213) 462-6222  
ADAPSO Member

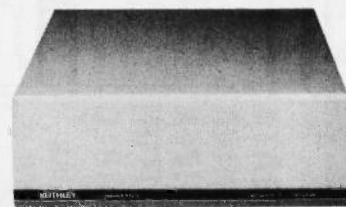

**System 501: \$2245**

DATA ACQUISITION & CONTROL

Call or write for FREE brochure

**KEITHLEY**

Keithley Data Acquisition and Control, Inc.  
28775 Aurora Road  
Cleveland, Ohio 44139  
(216) 248-0400 Telex: 98-5469

Inquiry 195



**DUST COVER PROTECTION WITH ANTI-STATIC, LINT FREE NYLON PACK CLOTH**

Keyboard	14.00
Monitor	16.00
Drive	16.00
Mon/Dr Combination 1 pc.	28.00
Mon/Dr/Kybd Comb. 1 pc.	38.00
Printers	from 16.00
Macintosh Set: Compu, Ky, Image Wr.	24.00

IBM, APPLE, COMPAQ, AMIGA, AT&T, EPSON, OKI, NEC, HP — OTHER COVERS AVAILABLE  
Silver Gray with Black Trim  
CHECK/VISA/MC

Plus \$2 Ship. & Hand. (401) 245-0532

**ComputerAid**

P.O. BOX 293, BARRINGTON, R.I. 02806

Inquiry 78

**EPROM PROGRAMMER**



APROTEK 1000 ONLY  
**\$265.00**

COMPLETE WITH PERSONALITY MODULE

117 VOLT AC POWER-RS232  
-6 BAUD RATES - HANDSHAKE TO HOST  
**ALLOWS READ, WRITE, VERIFY & COPY**

Comes complete with a CPM, IBM-PC or Apple Driver Program on Disc.

Programs the following 5 Volt 24 or 28 pin devices: 2716 series through 27256, 28xx series, 68764 plus others. Please Specify Personality Module desired with order. Additional Personality Modules only \$15.00 ea. Full 1 year warranty.

TO ORDER: CALL 1 800 962 5800 OR WRITE  
APROTEK  
1071 A AVENIDA ACASO Ariz  
CAMARILLO, CA 93010 \$4.00 Shipping USA  
Info (805) 987 2454 VISA or MC Add 3%

Inquiry 27

**LOOK** what's Inside!

### 5 Complete Systems

**Pricing!**



**XAT TURBO**

The **XAT** is our most versatile and powerful system. Using Intel's 80286 processor, the system runs at 6 and 8 MHz with a true 16-bit data bus. Comes standard with a 3 meg Add-On board, 2 parallel & one serial port, monitor, keyboard, DOS 3.1, two 1/2-height DS DD 1.2 meg floppies.



**XPC TURBO**

This standard system is as compatible with IBM as it can be. Featuring a 4-layer motherboard, 8-slot expansion, up to 640K memory on the motherboard, and the 6.87 MHz **TURBO** mode. Also included: DOS 3.1, keyboard, 135 watt power supply, TTL 720 x 348 resolution video card, green or amber monitor, serial & parallel ports, Real Time Clock and software.

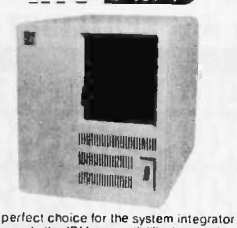

**XTC TURBO**

The perfect choice for the system integrator who needs the IBM compatibility, but not in the standard PC cabinet. This model features hinged and removable sides, up to 3 1/2 height peripherals out front, front mount AC switch and rear mount 135 watt power supply. Also makes an ideal "Host" or "File Server" unit in multi-user configurations!



**XTjr.**

The **XTjr.** is only junior in size! With up to 640K memory on the motherboard and four expansion slots, this stand-alone system is also great for workstations in a networking environment. It can be upgraded to the **TURBO** two speed motherboard and you can also add up to 2 serial & 2 parallel ports or any IBM compatible expansion card. A perfect word processing data entry system.



**XPC Compact**

This is truly the affordable portable, and we'll build it to your specifications. Need a 20 meg hard disk and 20 meg tape with 640K memory in your portable? No problem! The **XPC Compact** comes standard with a 9" amber TTL monitor, 135 watt P.S., 256K memory, two 360K drives, Real Time Clock, Calendar w battery Back-up, serial and parallel ports, and our **TURBO** Motherboard.

Amsterdam ■ 020-45-26-50

### 24 Add-On Cards

Germany ■

**2 Meg Above Board**



This board satisfies the new "Above Board" approach suggested by INTEL and Lotus 1-2-3. Also may be used on our **XT-SBC TURBO** board for memory based at 0K.

**Hard Disk Controller**



This Western Digital controller handles 1 or 2 drives, 5 to 140 megabytes with minimum software configuration. Features DOS 2.1 & 3.1 compatibility, and ST-506 Interface.

**384K Multi-Function**



A Multi-function board featuring Parallel Port, Serial Port, Game Port, Real Time Clock, Calendar with Battery Back-up. Expand to 384K, all Cables, PrintSpooler and RAM Disk Software, and Manuals.

**4 Meg Token Ring**



Connect your workstation to an existing 4 Megabyte IBM token ring system or build up your own IEEE 802.5 standard system. The lowest possible cost for 100% industry standard compatibility.

**AT H.D. & Floppy**



This new Western Digital combo board with its hi-speed VLSI technology will give you a data transfer rate 50% faster than the existing combo board in the AT. Runs both 360K and 1.2 meg floppy disk drives.

**Mono & Color Graphics**



Supports two levels of graphics and text in composite monochrome or RGB color. Low resolution 320 x 200 pixel, high resolution 640 x 200 pixel.

**7 PAK Multi-Function**



Features Floppy Controller, Parallel Port, Serial Port (optional 2nd Serial), Game Port, Real Time Clock, Calendar with Battery Back-up, RAMdisk, Print-Spooler, all cables & manuals.

**PROM Laser**



Hi-speed algorithms will burn 2716, 2732, 2732A, 2764 (in 52 sock), 27128, 27256 EPROMs under software control right in your PC. Zero Force Insertion Sockets, Software, and Manual.

England ■

### 35 Components

Bombay ■ 357172

**Motherboards**

**XAT TURBO XT-SBC**

- RTC Calendar
- 6 & 8 MHz clock
- 8-slot expansion
- Intel 80286
- 4.77 & 6 MHz clock
- Serial & Parallel
- 4-layer PCB design
- RTC Calendar

**XPC TURBO XPC-XT**

- 4.77 & 6.67 MHz
- 4-layer PCB design
- up to 640K Memory
- 8086-2 processor
- Standard 4.77 MHz
- up to 640K memory
- 8-slot expansion
- standard 8088 CPU
- 8087 socket avail

**Power Supplies**

**XT 135 watt XT 150 watt**

- 135w switching
- Whisper fan
- Side AC switch
- +5V15A - 5V.5A
- +12V-4.2A - 12V.5A
- Whisper fan
- Hi-output 150 watt
- 4 DC connectors
- +5V15A - 5V.5A
- +12V-5.5A - 12V.5A

**AT 200 watt XTC 135**

- 200 Watt power
- Exterior AC switch
- 4 DC power conn.
- +5V20A - 5V.5A
- +12V-7.7A - 12V.5A
- Rear Mount
- Rear On Off switch
- extra AC outlets
- +5V15A - 5V.5A
- +12V-4A - 12V.5A

**Cabinets**

The **XTjr.** cabinet is only 3" x 16.5" x 15" yet it will hold a standard XT compatible motherboard, includes a switching power supply. Front panel cut-out for a half-height floppy or hard disk.

Our **XPC-XT** cabinet has an 8-slot back panel with additional cut-outs for two RS-232C I/O ports. Features mounting for up to four half height peripherals.

The right choice for an external add-on cabinet! Add-on a floppy, tape back-up, or up to 33 meg of hard disk (half-height). Switching power supply is included.

**Keyboards**

**AT**

This Keyboard is standard equipment with all of our **XAT** systems, but the layout is so well liked, we're offering it here.

**XT**

Our volume purchases of these IBM style units allows us to lower the price once again.

**5151**

Now a fully electric unit at an affordable price. Features a 10-key numeric pad & a separate cursor pad.

**Drives**

**Archive**  
**Irwin**  
**Maxtor**  
**Memtek**  
**Miniscribe**  
**Panasonic**  
**Seagate**  
**TEAC**  
**Tulin**

### 3 Sub-Systems

### 3 Networks

### Cassette Training

### Int/Ext Modems

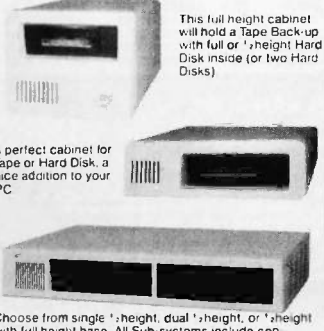

This full height cabinet will hold a Tape Back-up with full or 1/2 height Hard Disk inside (or two Hard Disks).

A perfect cabinet for Tape or Hard Disk, a nice addition to your PC.

Choose from single 1/2 height, dual 1/2 height, or 1 1/2 height with full height base. All Sub-systems include controllers, cables, software, and manuals.

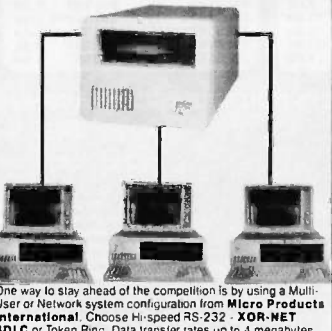

One way to stay ahead of the competition is by using a Multi-User or Network system configuration from **Micro Products International**. Choose Hi-speed RS-232 - **XOR-NET** SDLC or Token Ring. Data transfer rates up to 4 megabytes second can be obtained.



What is the Cassette Training concept? Using Interactive Audio Training to combine the advantage of classroom and self-teaching methods.

The Method One audio track delivers a lecture explaining the program, while the second track emulates the keyboard, actually running the student's computer. At frequent intervals the tape pauses automatically to allow the student keyboard input, which is monitored for accuracy by the **MITS COED**.



- FCC approved for direct RJ-11 connection
- Phone Cable & Power Supply
- Finally a price breakthrough on a Hayes compatible, external 300-1200 baud modem. Includes driver software.
- Runs the popular Hayes communications software
- Q-Modem software included
- Also runs XCOM software
- All cables included
- Runs the popular Hayes communications software

We included every feature you would want in a modem card. It's FCC registered for direct connection to your modular phone jack with the cord included.

# BUILD A COMPLETE XT SYSTEM—\$698

## STATIC RAMS

2101	256x4	(450ns)	1.95
5101	256x4	(450ns)(CMDS)	3.95
2102L-4	1024x1	(450ns)(LP)	.99
2102L-2	1024x1	(250ns)(LP)	1.45
2112	256x4	(450ns)	2.99
2114	1024x4	(450ns)	.99
2114L-4	1024x4	(450ns)(LP)	1.09
2114L-2	1024x4	(200ns)(LP)	1.49
2114L-15	1024x4	(150ns)(LP)	1.95
TMS4044-4	4096x1	(450ns)	1.95
TMM2016-150	2048x8	(150ns)	1.49
TMM2016-100	2048x8	(100ns)	1.95
HM6116-4	2048x8	(200ns)(CMDS)	1.39
HM6116-3	2048x8	(150ns)(CMDS)	1.49
HM6116LP-4	2048x8	(200ns)(CMDS)(LP)	1.49
HM6116LP-3	2048x8	(150ns)(CMDS)(LP)	1.59
HM6116LP-2	2048x8	(120ns)(CMDS)(LP)	2.95
HM6264P-15	8192x8	(150ns)(CMDS)	3.99
HM6264LP-15	8192x8	(150ns)(CMDS)(LP)	3.95
HM6264LP-12	8192x8	(120ns)(CMDS)(LP)	4.49

LP—Low power

## DYNAMIC RAMS

4116-250	16384x1	(250ns)	.49
4116-200	16384x1	(200ns)	.69
4116-150	16384x1	(150ns)	.89
4116-120	16384x1	(120ns)	1.49
MK4332	32768x1	(200ns)	6.95
4164-200	65536x1	(200ns)(5V)	1.19
4164-150	65536x1	(150ns)(5V)	1.29
4164-120	65536x1	(120ns)(5V)	1.95
MCM6665	65536x1	(200ns)(5V)	1.95
TMS4164	65536x1	(150ns)(5V)	1.95
4164-REFRESH	65536x1	(150ns)(5V)(REFRESH)	2.95
TMS4416	16384x4	(150ns)(5V)	4.95
41128-150	131072x1	(150ns)(5V)	5.95
41256-200	262144x1	(200ns)(5V)	2.95
41256-150	262144x1	(150ns)(5V)	2.95

5V—Single 5 Volt Supply

REFRESH—Pin 1 Refresh

## ★★★★ HIGH-TECH ★★★★★

### NEC V20 UPD70108 \$1495

REPLACES 8088 TO SPEED UP IBM PC 10-40%

- \* HIGH-SPEED ADDRESS CALCULATION IN HARDWARE
- \* PIN COMPATIBLE WITH 8088
- \* SUPERSET OF 8086/8088 INSTRUCTION SET
- \* LOW POWER CMOS

8 MHz V20 UPD70108-8 \$24.95

8 MHz V30 UPD70116-8 \$26.95

## ★★★★ SPOTLIGHT ★★★★★

ORDER TOLL FREE  
800-538-5000  
800-662-6279 (CA)



## EPROMS

2708	1024x8	(450ns)	3.95
2716	2048x8	(650ns)	2.29
2716-1	2048x8	(450ns)(5V)	2.25
TMS2532	2048x8	(350ns)(5V)	2.79
2732	4096x8	(450ns)(5V)	3.95
2732A	4096x8	(250ns)(5V)(21V PGM)	2.45
2732A-2	4096x8	(200ns)(5V)(21V PGM)	3.95
27C64	8192x8	(250ns)(5V)(CMOS)	5.95
2764	8192x8	(450ns)(5V)	2.45
2764-250	8192x8	(250ns)(5V)	2.45
2764-200	8192x8	(200ns)(5V)	3.49
TMS2564	8192x8	(450ns)(5V)	8.95
MCM68766	8192x8	(350ns)(5V)(24 PIN)	17.95
27128	16384x8	(250ns)(5V)	2.79
27C256	32768x8	(250ns)(5V)(CMOS)	12.95
2756	32768x8	(250ns)(5V)	7.49

5V—Single 5 Volt Supply 21V PGM—Program at 21 Volts

## SPECTRONICS CORPORATION EPROM ERASERS



Model	Timer	Capacity Chip	Intensity (uW/Cm <sup>2</sup> )	Unit Price
PE-14	ND	9	8,000	\$83.00
PE-14T	YES	9	8,000	\$119.00
PE-24T	YES	12	9,600	\$175.00

## 8000

8035	1.49
8039	1.95
8080	2.95
8085	2.49
8087-2	139.95
8087	109.00
8088	6.95
8088-2	9.95
8155	2.49
8155-2	3.95
8748	7.95
8755	1.95
80286	129.95
80287	185.00

## 8200

8203	29.95
8205	3.29
8212	1.49
8216	1.49
8224	2.25
8237	4.95
8237-5	5.49
8250	6.95
8251	1.69
8251A	1.89
8253	1.89
8253-5	1.95
8255	1.69
8255-5	1.89
8259	1.95
8259-5	2.29
8272	4.95
8279	2.49
8279-5	2.95
8282	3.95
8284	2.95
8286	3.95
8288	4.95

## Z-80

Z80-CPU 2.5 MHz	1.69
4.0 MHz	
Z80A-CPU	1.79
Z80A-CTC	1.89
Z80A-DART	5.95
Z80A-DMA	5.95
Z80A-PID	1.89
Z80A-SIO/0	5.95
Z80A-SIO/1	5.95
Z80A-SIO/2	5.95
6.0 MHz	
Z80B-CPU	3.75
Z80B-CTC	4.25
Z80B-PIC	4.25
Z80B-DART	14.95
Z80B-SIO/0	12.95
Z80B-SIO/2	12.95
Z8671 ZiLOG	19.95

## 6500

6502	2.79
65C02 (CMOS)	12.95
6507	9.95
6520	1.95
6522	4.95
6526	26.95
6532	6.95
6545	5.95
6551	5.95
6561	19.95
6581	34.95

## 2.0 MHz

6502A	2.95
6520A	2.95
6522A	5.95
6532A	11.95
6545A	7.95
6551A	6.95

## 3.0 MHz

6502B	6.95
-------	------

## 6800

6800	1.95
6802	4.95
6803	9.95
6809	5.95
6809E	5.95
6810	1.95
6820	2.95
6821	1.95
6840	6.95
6843	19.95
6844	12.95
6845	4.95
4702	9.95
6847	11.95
6850	1.95
6883	22.95

## 2.0 MHz

68B00	4.95
68B02	5.95
68B05E	6.95
68B09	6.95
68B21	3.50
68B45	6.75
68B50	3.95
68B54	7.95

## CLOCK CIRCUITS

MM5369	1.95
MM5369-EST	1.95
MM58167	12.95
MM58174	11.95
MSM5832	2.95

## GRT CONTROLLERS

6845	4.95
68B45	8.95
6847	11.95
H046505SP	6.95
MC1372	2.95
8275	26.95
7220	19.95
CRT5027	12.95
CRT5037	9.95
TMS9918A	19.95

## DISK CONTROLLERS

1771	4.95
1791	9.95
1793	9.95
1795	12.95
1797	12.95
2791	19.95
2793	19.95
2797	29.95
6843	19.95
8272	4.95
UPD765	4.95
MB8876	12.95
MB8877	12.95
1691	6.95
2143	6.95

## BIT RATE GENERATORS

MC14411	9.95
BR1941	4.95
4702	9.95
CDM8116	8.95
MM5307	4.95

## UARTS

AY5-1013	3.95
AY3-1015	4.95
TR1602	3.95
2651	4.95
IM6402	6.95
IM6403	9.95
INS8260	6.95

## SOUND CHIPS

76477	3.95
76489	8.95
SSI-263	39.95
AY3-8910	12.95
AY3-8912	12.95
SP1000	39.00

## CRYSTALS

32.768 KHz	.95
1.0 MHz	2.95
1.8432	2.95
2.0	1.95
2.097152	1.95
2.4576	1.95
3.2768	1.95
3.579545	1.95
4.0	1.95
4.032	1.95
12.0	1.95
5.0688	1.95
6.0	1.95
6.144	1.95
6.5536	1.95
8.0	1.95
10.0	1.95
10.738635	1.95
12.0	1.95
14.31818	1.95
15.0	1.95
15.0	1.95
17.3430	1.95
18.0	1.95
18.432	1.95
20.0	1.95
22.1184	1.95
24.0	1.95
32.0	1.95

## CRYSTAL OSCILLATORS

1.0MHz	5.95
1.8432	5.95
2.0	5.95
2.4576	5.95
2.5	4.95
2.0	4.95
5.0688	4.95
6.0	4.95
6.144	4.95
8.0	4.95
10.0	4.95
12.0	4.95
12.480	4.95
15.0	4.95
16.0	4.95
18.432	4.95
20.0	4.95
24.0	4.95

## MISC.

TMS99531	9.95
TMS99532	19.95
ULN2003	.79
3242	7.95
3341	4.95
MC3470	1.95
MC3480	8.95
MC3487	2.95
11C90	13.95
2513-001 UP	6.95
AY5-2376	11.95
AY5-3600 PRO	11.95
74LS00	.16
74LS01	.18
74LS02	.17
74LS03	.18
74LS04	.16
74LS05	.18
74LS08	.18
74LS09	.18
74LS10	.16
74LS11	.22
74LS12	.22
74LS13	.26
74LS14	.39
74LS15	.26
74LS20	.17
74LS21	.22
74LS22	.22
74LS27	.23
74LS28	.26
74LS30	.17
74LS32	.18
74LS33	.28
74LS37	.26
74LS38	.26
74LS42	.39
74LS47	.59
74LS48	.69
74LS51	.17
74LS73	.29
74LS74	.24
74LS75	.29
74LS76	.29
74LS83	.49
74LS85	.49
74LS86	.22
74LS90	.39
74LS92	.49
74LS93	.39
74LS95	.49
74LS107	.34
74LS109	.36
74LS112	.29
74LS122	.45
74LS123	.49
74LS124	2.75
74LS125	1.18
74LS126	.39
74LS132	.39
74LS133	.49
74LS136	.39
74LS138	.39
74LS139	.39
74LS145	.99
74LS147	.99
74LS148	.99
74LS151	.39
74LS153	.39
74LS154	1.49
74LS155	.59
74LS156	.49
74LS157	.35
74LS158	.29
74LS160	.29
74LS161	.39
74LS162	.49
74LS163	.39
74LS164	.49
74LS165	.65
74LS166	.95
74LS169	.95
74LS173	.49
74LS197	.59
74LS175	.39
74LS197	.49
74LS192	.69
74LS193	.69
74LS194	.69
74LS195	.69
74LS196	.59
74LS197	.59
74LS221	.69
74LS240	.69
74LS241	.69
74LS242	.69
74LS243	.69
74LS244	.69
74LS245	.79
74LS251	.49
74LS253	.49
74LS256	1.79
74LS257	.39
74LS258	.49
74LS259	1.29
74LS260	.49
74LS266	.39

# PARTIAL LISTING ONLY — CALL FOR A FREE CATALOG

## CMOS

4001	.19	14419	4.95
4011	.19	14433	14.95
4012	.25	4503	.49
4013	.35	4511	.69
4015	.29	4516	.79
4016	.29	4518	.85
4017	.49	4522	.79
4018	.69	4526	.79
4020	.59	4527	1.95
4021	.69	4528	.79
4024	.49	4529	2.95
4025	.25	4532	1.95
4027	.39	4538	.95
4028	.65	4541	1.29
4035	.69	4553	5.79
4040	.69	4585	.75
4041	.75	4702	12.95
4042	.59	74C00	.29
4043	.85	74C14	.59
4044	.69	74C74	.59
4045	1.98	74C83	1.95
4046	.69	74C85	1.49
4047	.69	74C95	.99
4049	.29	74C150	5.75
4050	.29	74C151	2.25
4051	.69	74C161	.99
4052	.69	74C163	.99
4053	.69	74C164	1.39
4056	2.19	74C192	1.49
4060	.69	74C193	1.49
4066	.29	74C221	1.75
4069	.19	74C240	1.89
4076	.59	74C244	1.89
4077	.29	74C374	1.99
4081	.22	74C905	10.95
4085	.79	74C911	8.95
4086	.89	74C917	8.95
4093	.49	74C922	4.49
4094	2.49	74C923	4.95
14411	9.95	74C926	7.95
14412	6.95	80C97	.95

## 7400/9000

7400	.19	74147	2.49
7402	.19	74148	1.20
7404	.19	74150	1.35
7406	.29	74151	.55
7407	.29	74153	.55
7408	.24	74154	1.49
7410	.19	74155	.75
7411	.25	74157	.55
7414	.49	74159	1.65
7416	.25	74161	.69
7417	.25	74163	.69
7420	.19	74164	.85
7423	.29	74165	.85
7430	.19	74166	1.00
7432	.29	74175	.89
7436	.29	74177	.75
7442	.49	74178	1.15
7445	.69	74181	2.25
7447	.89	74182	.75
7470	.35	74184	2.00
7473	.34	74191	1.15
7474	.33	74192	.79
7475	.45	74194	.85
7476	.35	74196	.79
7483	.50	74197	.75
7485	.59	74199	1.35
7486	.35	74221	1.35
7489	2.15	74246	1.35
7490	.39	74247	1.25
7492	.50	74248	1.85
7493	.35	74249	1.95
7495	.55	74251	.75
7497	2.75	74265	1.35
74100	2.29	74273	1.95
74121	.29	74278	3.11
74123	.49	74367	.65
74125	.45	74368	.65
74141	.65	9368	3.95
74143	5.95	9602	1.50
74144	2.95	9637	2.95
74145	.60	96502	1.95

## 74S00

74S00	.29	74S163	1.29
74S02	.29	74S168	3.95
74S03	.29	74S174	.79
74S04	.29	74S175	.79
74S05	.29	74S188	1.95
74S08	.35	74S189	1.95
74S10	.29	74S195	1.49
74S15	.35	74S196	1.49
74S30	.25	74S197	1.49
74S32	.35	74S226	3.99
74S37	.69	74S240	1.49
74S38	.69	74S241	1.49
74S74	.49	74S244	1.49
74S85	.95	74S257	.79
74S86	.35	74S253	.79
74S112	.50	74S258	.95
74S124	2.75	74S280	1.95
74S138	.79	74S287	1.69
74S140	.55	74S288	1.69
74S151	.79	74S299	2.95
74S153	.79	74S373	1.69
74S157	.79	74S374	1.69
74S158	.95	74S471	4.95
74S161	1.29	74S571	2.95

## VOLTAGE REGULATORS

**TO-220 CASE**

7805T	.49	7905T	.59
7808T	.49	7908T	.59
7812T	.49	7912T	.59
7815T	.49	7915T	.59

**TO-3 CASE**

7805K	1.39	7905K	1.49
7812K	1.39	7912K	1.49

**TO-92 CASE**

78L05	.49	79L05	.69
78L12	.49	79L12	.69

**OTHER VOLTAGE REGS**

LM323K	5V 3A	TO-3	4.79
LM338K	A4 5A	TO-3	3.95
78H05K	5V 5A	TO-3	7.95
78H12K	12V 5A	TO-3	8.95
78P05K	5V 10A	TO-3	14.95

## LINEAR

TL066	.99	LM733	.98
TL071	.69	LM741	.29
TL072	1.09	LM747	.69
TL074	1.95	LM748	.59
TL081	.59	MC1350	1.69
TL082	.99	MC1350	1.19
TL084	1.49	MC1372	6.95
LM301	.34	LM1414	1.59
LM309K	1.25	LM1458	.49
LM311	.59	LM1488	.49
LM311H	.89	LM1489	.49
LM317K	3.49	LM1496	.85
LM317T	.95	LM1812	8.25
LM318	1.49	LM1889	1.95
LM319	1.25	ULN2003	.79
LM320	see 7900	KR2206	3.75
LM322	1.65	KR2211	2.95
LM323K	4.79	MP2240	1.95
LM324	.49	MP02907	1.95
LM331	3.95	LM2917	1.95
LM334	1.19	CA3046	.89
LM335	1.40	CA3081	.99
LM336	1.75	CA3082	.99
LM337K	3.95	CA3086	.80
LM338K	3.95	CA3089	1.95
LM339	.59	CA3130E	.99
LM340	see 7800	CA3146	1.29
LM350T	4.60	CA3160	1.19
LF353	.59	MC3470	1.95
LF356	.99	MC3480	8.95
LF357	.99	MC3487	2.95
LM358	.59	LM3900	.49
LM380	.89	LM3909	.89
LM383	1.95	LM3911	2.25
LM386	.89	LM3914	2.39
LM393	.45	MC4024	3.49
LM394H	4.60	MC4044	3.99
TL494	4.20	RC4136	1.25
TL497	3.25	RC4558	.69
NE555	2.29	LM13600	1.49
NE556	.49	75107	1.49
NE558	1.29	75110	1.95
NE564	1.95	75150	1.95
LM565	.95	75154	1.95
LM566	1.49	75188	1.25
LM567	.79	75189	1.25
NE570	2.95	75451	.39
NE590	2.50	75452	.39
NE592	.85	75453	.39
LM710	.75	75477	1.29
LM723	.49	75492	.79

H-TO-5 CAN, K-TO-3, T-TO-220

## DATA ACQ INTERFACE

ADC0800	15.55	8T26	1.29
ADC0804	3.49	8T28	1.29
ADC0809	4.49	8T95	.89
ADC0816	4.45	8T96	.89
ADC0817	9.95	8T97	.59
ADC0831	8.95	8T98	.89
DAC0800	4.49	DM8131	2.95
DAC0806	1.95	DP8304	2.29
DAC0808	2.95	DS8833	2.25
DAC1020	8.25	DS8835	1.99
DAC1022	5.95	DS8836	.99
MC1408L8	2.95	DS8837	1.65

## IC SOCKETS

8 PIN ST	1.99	100
14 PIN ST	.13	11
16 PIN ST	.15	12
18 PIN ST	.20	18
20 PIN ST	.29	27
22 PIN ST	.30	27
24 PIN ST	.30	27
28 PIN ST	.40	32
40 PIN ST	.49	39
64 PIN ST	4.25	CALL

**ST-SOLDERTAIL**

8 PIN WW	.59	.49
14 PIN WW	.69	.52
16 PIN WW	.69	.58
18 PIN WW	.99	.90
20 PIN WW	1.09	.96
22 PIN WW	1.39	1.28
24 PIN WW	1.49	1.35
28 PIN WW	1.69	1.49
40 PIN WW	1.99	1.80

**WW-WIREWRAP**

16 PIN ZIF	4.95	CALL
24 PIN ZIF	5.95	CALL
28 PIN ZIF	6.95	CALL
40 PIN ZIF	9.95	CALL

**ZIF-TEXT TOOL**  
(ZERO INSERTION FORCE)

## EDGE CARD CONNECTORS

100 PIN ST	S-100	.125	3.95
100 PIN WW	S-100	.125	4.95
62 PIN ST	IBM PC	.100	1.95
50 PIN ST	APPLE	.100	2.95
44 PIN ST	STD	.156	1.95
44 PIN WW	STD	.156	4.95

## 36 PIN CENTRONICS

ICEN36	RIBBON CABLE	6.95
CEN36	SOLDER CUP	4.95
CEN36PC	RT ANGLE PC MOUNT	4.95
ICEN36/F	RIBBON CABLE	7.95

## INTERSIL

ICL7106	9.95
ICL7107	12.95
ICL7680	2.95
ICL8038	4.95
ICM7207A	5.95
ICM7208	15.95

## DIP CONNECTORS

DESCRIPTION	ORDER BY	CONTACTS								
		8	14	16	18	20	22	24	28	40
HIGH RELIABILITY TOOLED ST IC SOCKETS	AUGATxxST	.62	.79	.89	1.09	1.29	1.39	1.49	1.69	2.49
HIGH RELIABILITY TOOLED WW IC SOCKETS	AUGATxxWW	1.30	1.80	2.10	2.40	2.50	2.90	3.15	3.70	5.40
COMPONENT CARRIES (DIP HEADERS)	ICCxx	.49	.59	.69	.99	.99	.99	1.09	1.49	
RIBBON CABLE DIP PLUGS (IDC)	IOPxx	---	.95	.95	---	---	---	1.75	---	2.95

FOR ORDERING INSTRUCTIONS SEE D-SUBMINIATURE BELOW

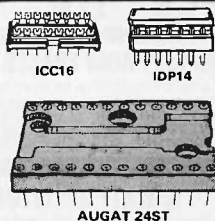

## DIODES/OPTO/TRANSISTORS

1N751	.25	4N26	.69
1N759	.25	4N27	.69
1N4148	25/1.00	4N28	.69
1N4004	10/1.00	4N33	.89
1N5402	.25	4N37	1.19
KBPO4	.95	MCT-2	.59
KBUBA	.55	MCT-6	1.29
MDA990-2	.35	TIL-111	.99
N2222	.25	2N3906	.10
PN2222	.10	2N4401	.25
2N3905	.50	2N4402	.25
2N2907	.25	2N4403	.25
2N3055	.79	2N6045	1.75
2N3904	.10	TIP31	.49

## D-SUBMINIATURE

DESCRIPTION	ORDER BY	CONTACTS					
		9	15	19	25	37	50
SOLDER CUP	MALE DBxxP	.82	.90	1.25	1.25	1.80	3.48
	FEMALE DBxxS	.95	1.15	1.50	1.50	2.35	4.32
RIGHT ANGLE PC SOLDER	MALE DBxxPR	1.20	1.49	---	1.95	2.65	---
	FEMALE DBxxSR	1.25	1.55	---	2.00	2.79	---
WIRE WRAP	MALE DBxxPWW	1.69	2.56	---	3.89	5.60	---
	FEMALE DBxxSww	2.76	4.27	---	6.84	9.95	---
IDC RIBBON CABLE	MALE IDBxxP	2.70	2.95	---	3.98	5.70	---
	FEMALE IDBxxS	2.92	3.20	---	4.33	6.76	---
HOODS	METAL MH00Dxx	1.25	1.25	1.30	1.30	---	---
	GREY HOODxx	.65	.65	---	.65	.75	.95

ORDERING INSTRUCTIONS: INSERT THE NUMBER OF CONTACTS IN THE POSITION MARKED "xx" OF THE "ORDER BY" PART NUMBER LISTED.

EXAMPLE: A 15 PIN RIGHT ANGLE MALE PC SOLDER WOULD BE DB15PR.

**MOUNTING HARDWARE \$1.00**

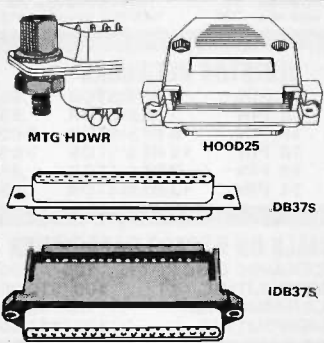

## IDC CONNECTORS

DESCRIPTION	ORDER BY	CONTACTS				
		10</				

## BARGAIN HUNTERS CORNER FRANKLINAGE-10 DISK DRIVE FOR APPLE II

- \* RELIABLE, DIRECT DRIVE MECHANISM MADE FOR FRANKLIN BY MITAC, A WORLD LEADER IN FDDs FOR APPLE
- \* 100% COMPATIBLE WITH APPLE II, II+ AND IIe; USE W/STANDARD APPLE CONTROLLER OR OPTIONAL \$49.95 CONTROLLER
- \* FULL HEIGHT BEIGE ENCLOSURE MATCHES APPLE; BAKED ENAMEL FINISH RESISTS SCRATCHES
- \* SHIELDED CABLE WITH GROUNDING PLUG FOR EMI-FREE OPERATION

ONE YEAR WARRANTY  
**ONLY \$79.95**

HURRY - QUANTITIES ARE LIMITED!  
SPECIALS END 3/31/86

## PAGE WIRE WRAP WIRE PRECUT ASSORTMENT IN ASSORTED COLORS \$27.50

100ea: 5.5", 6.0", 6.5", 7.0"  
250ea: 2.5", 4.5", 5.0"  
500ea: 3.0", 3.5", 4.0"

### SPOOLS

100 feet \$4.30 250 feet \$7.25  
500 feet \$13.25 1000 feet \$21.95

Please specify color:  
Blue, Black, Yellow or Red

## EMI FILTER \$4.95

- \* MANUFACTURED BY CORCOM
- \* LOW COST
- \* FITS LC-HP BELOW
- \* 6 AMP 120/240 VOLT



### 6 FOOT LINE CORDS

LC-2 2 CONDUCTOR .39  
LC-3 2 CONDUCTOR .99  
LC-HP 3 CONDUCTOR W/STD FEMALE SOCKET 1.49

### MUFFIN FANS

3.15" SQ ROTRON 14.95  
3.63" SQ ETRI 14.95  
3.18" SQ MASUSHITA 16.95

## WIRE WRAP PROTOTYPE CARDS FR-4 EPOXY GLASS LAMINATE WITH GOLD-PLATED EDGE-CARD FINGERS



IBM-PR2

### IBM

BOTH CARDS HAVE SILK SCREENED LEGENDS AND INCLUDES MOUNTING BRACKET

IBM-PR1 WITH +5V AND GROUND PLANE \$27.95  
IBM-PR2 AS ABOVE WITH DECODING LAYOUT \$29.95

### S-100

P100-1 BARE - NO FOIL PADS \$15.15  
P100-2 HORIZONTAL BUS \$21.80  
P100-3 VERTICAL BUS \$21.80  
P100-4 SINGLE FOIL PADS PER HOLE \$22.75

### APPLE

P500-1 BARE - NO FOIL PADS \$15.15  
P500-3 HORIZONTAL BUS \$22.75  
P500-4 SINGLE FOIL PADS PER HOLE \$21.80  
7060-45 FOR APPLE IIe AUX SLOT \$30.00

## SOCKET-WRAP I.D.™

- \* SLIPS OVER WIRE WRAP PINS
- \* IDENTIFIES PIN NUMBERS ON WRAP SIDE OF BOARD
- \* CAN WRITE ON PLASTIC, SUCH AS IC #

PINS	PART#	PCK. OF	PRICE
8	IDWRAP 08	10	1.95
14	IDWRAP 14	10	1.95
16	IDWRAP 16	10	1.95
18	IDWRAP 18	5	1.95
20	IDWRAP 20	5	1.95
22	IDWRAP 22	5	1.95
24	IDWRAP 24	5	1.95
28	IDWRAP 28	5	1.95
40	IDWRAP 40	5	1.95

PLEASE ORDER BY NUMBER OF PACKAGES (PCK. OF)

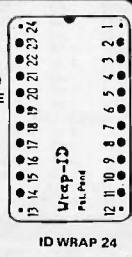

## FRAME STYLE TRANSFORMERS

12.6V AC CT 2 AMP 5.95  
12.6V AC CT 4 AMP 7.95  
12.6V AC CT 8 AMP 10.95  
25.2V AC CT 2 AMP 7.95

## 25 PIN D-SUB GENDER CHANGERS \$7.95

## SWITCHING POWER SUPPLIES

### PS-IBM \$99.95

- \* FOR IBM PC-XT COMPATIBLE
- \* 130 WATTS
- \* +5V @ 15A, -12V @ 4.2A
- \* -5V @ 5A, -12V @ 5A
- \* ONE YEAR WARRANTY



### PS-130 \$89.95

- \* 130 WATTS
- \* SWITCH ON REAR
- \* FOR USE IN OTHER IBM TYPE MACHINES
- \* 90 DAY WARRANTY



### PS-DAY \$49.95

- \* USE TO POWER APPLE TYPE SYSTEMS
- \* +5V @ 4A, +12V @ 2.5A
- \* -5V @ 5A, -12V @ 5A
- \* APPLE POWER CONNECTOR



### PS-SPL200 \$49.95

- \* +5V @ 25A, +12V @ 3.5A
- \* -5V @ 1A, -12V @ 1A
- \* UL APPROVED
- \* ALUMINUM ENCLOSURE



### PS-TDK \$29.95

- \* +5V @ 4A, +12V @ 2A
- \* +12V @ 2.8A, -12V @ .30A
- \* 6.2" x 7.4" x 1.7", 1.6 LBS.



### PS-11951 \$29.95

- \* MANUFACTURED BY ASTEC
- \* +5V @ 6A, +12V @ 2A
- \* +12V @ 1.5A, -12V @ 2A,
- \* 5.0" x 8.0" x 2.0", 1.6 LBS.



## CAPACITORS

TANTALUM			
1.0µf	15V .35	.47µf	35V .45
6.8	15V .70	1.0	35V .45
10	15V .80	2.2	35V .65
22	15V 1.35	4.7	35V .85
.22	35V .40	10	35V 1.00

### DISC

10µf	50V .05	.680	50V .05
22	50V .05	.001µf	50V .05
27	50V .05	.0022	50V .05
33	50V .05	.005	50V .05
47	50V .05	.01	50V .07
68	50V .05	.02	50V .07
100	50V .05	.05	50V .07
220	50V .05	.1	12V .10
560	50V .05	.1	50V .12

### MONOLITHIC

.01µf	50V .14	.1µf	50V .18
.047µf	50V .15	.47µf	50V .25

### ELECTROLYTIC

RADIAL		AXIAL	
1µf	25V .14	1µf	50V .14
2.2	35V .15	10	50V .16
4.7	50V .15	22	16V .14
10	50V .15	47	50V .20
47	35V .18	100	35V .25
100	16V .18	220	25V .30
220	35V .20	470	50V .50
470	25V .30	1000	16V .60
2200	16V .70	2200	16V .70
4700	25V 1.45	4700	16V 1.25

COMPUTER GRADE 44,000µf 30V 3.95

## DATASE EPROM ERASER \$34.95

- \* ERASES TWO EPROMS IN 10 MINUTES
- \* COMPACT-NO DRAWER
- \* THIN METAL SHUTTER PREVENTS UV LIGHT FROM ESCAPING



## 1/4 WATT RESISTORS

5% CARBON FILM ALL STANDARD VALUES FROM 1 OHM TO 10 MEG. OHM  
10 PCS same value .05 100 PCS same value .02  
50 PCS same value .025 1000 PCS same value .015

## RESISTOR NETWORKS

SIP 10 PIN 9 RESISTOR .69
SIP 8 PIN 7 RESISTOR .59
DIP 16 PIN 8 RESISTOR 1.09
DIP 16 PIN 15 RESISTOR 1.09
DIP 14 PIN 7 RESISTOR .99
DIP 14 PIN 13 RESISTOR .99

## SPECIALS ON BYPASS CAPACITORS

.01 µf CERAMIC DISC 100/\$5.00  
.01 µf MONOLITHIC 100/\$10.00  
.1 µf CERAMIC DISC 100/\$6.50  
.1 µf MONOLITHIC 100/\$12.50

## NEW BOOKS BY STEVE CIARCIA

BUILD YOUR OWN Z80 COMPUTER \$19.95  
CIRCUIT CELLAR VOL 1 \$17.95  
CIRCUIT CELLAR VOL 2 \$18.95  
CIRCUIT CELLAR VOL 3 \$18.95  
CIRCUIT CELLAR VOL 4 \$18.95

## MICROCOMPUTER HARDWARE HANDBOOK FROM ELCOMP \$14.95

OVER 800 PAGES OF DATA SHEETS ON THE MOST COMMONLY USED ICs. INCLUDES TTL, CMOS, 74LS00, MEMORY, CPU, MPU SUPPORT. AND MUCH MORE!

## WISH SOLDERLESS BREADBOARDS

PART NUMBER	DIMENSIONS	DISTRIBUTION STRIP(S)	TIE POINTS	TERMINAL STRIP(S)	TIE POINTS	BINDING POSTS	PRICE
WBU-D	.38 x 6.50"	1	100	---	---	---	2.95
WBU-T	1.38 x 6.50"	---	---	1	630	---	6.95
WBU-204-3	3.94 x 8.45"	1	100	2	1260	2	17.95
WBU-204	5.13 x 8.45"	4	400	2	1260	3	24.95
WBU-206	6.88 x 9.06"	5	500	3	1890	4	29.95
WBU-208	8.25 x 9.45"	7	700	4	2520	4	39.95

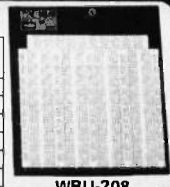

## LITHIUM BATTERY AS USED IN CLOCK CIRCUITS

3 VOLT BATTERY \$3.95  
BATTERY HOLDER \$1.49

## IC MASTER \$79.95

THE INDUSTRY STANDARD

VISIT OUR RETAIL STORE LOCATED AT 1256 SOUTH BASCOM AVENUE IN SAN JOSE



1224 S. Bascom Avenue, San Jose, CA 95128  
800-538-5000 • 800-662-6279 (CA) • (408) 995-5430  
FAX (408) 275-8415 • Telex 171-110

HOURS: M-W-F, 9-5 TU-TH, 9-9 SAT, 10-3

PLEASE USE YOUR CUSTOMER NUMBER WHEN ORDERING

TERMS: Minimum order \$10.00. For shipping and handling include \$2.50 for UPS Ground and \$3.50 for UPS Air. Orders over 1 lb. and foreign orders may require additional shipping charges - please contact our sales department for the amount. CA residents must include applicable sales tax. All merchandise is warranted for 90 days unless otherwise stated. Prices are subject to change without notice. We are not responsible for typographical errors. We reserve the right to limit quantities and to substitute manufacturer. All merchandise subject to prior sale.



# PARTIAL LISTING ONLY — CALL FOR A FREE CATALOG

## DISK DRIVES FOR APPLE COMPUTERS

**AP-150**  
**\$99.95**

- 1/2 HT. DIRECT DRIVE
- 100% APPLE COMPATIBLE
- SIX MONTH WARRANTY

**BAL-500**  
**\$129.95**

- TEAC MECHANISM-DIRECT DRIVE
- 100% APPLE COMPATIBLE
- FULL ONE YEAR WARRANTY

**AP-135**  
**\$129.95**

- FULL HT SHUGART MECHANISM
- DIRECT REPLACEMENT FOR APPLE DISK II
- SIX MONTH WARRANTY

**MAC535**  
**\$249.95**

- 3.5" ADD-ON DISK DRIVE
- 100% MACINTOSH COMPATIBLE
- SINGLE SIDED 400K BYET STORAGE
- HIGH RELIABILITY DRIVE
- HAS AUTO-EJECT MECHANISM
- FULL ONE YEAR WARRANTY

**AD-3C**  
**\$139.95**

- 100% APPLE IIc COMPATIBLE, READY TO PLUG IN, W/ SHIELDED CABLE & MOLDED 15 PIN CONNECTOR
- FAST, RELIABLE SLIMLINE DIRECT DRIVE
- SIX MONTH WARRANTY

**DISK DRIVE ACCESSORIES**  
FDD CONTROLLER CARD \$49.95  
IIc ADAPTOR CABLE \$19.95  
ADAPTS STANDARD APPLE DRIVES FOR USE WITH APPLE IIc

**KB-1000** **\$79.95**

- CASE WITH KEYBOARD FOR APPLE TYPE MOTHERBOARD
- USER DEFINED FUNCTION KEYS
  - NUMERIC KEYPAD WITH CURSOR CONTROL
  - CAPS LOCK
  - AUTO-REPEAT

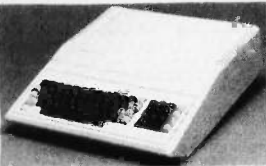

**KEYBOARD-AP** **\$49.95**

- REPLACEMENT FOR APPLE II KEYBOARD
- CAPS LOCK KEY, AUTO-REPEAT
- ONE KEY ENTRY OF BASIC OR CP/M COMMANDS

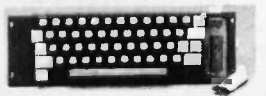

**EXTENDER CARDS**

IBM-PC	\$45.00
IBM-AT	\$68.00
APPLE II	\$45.00
APPLE IIc	\$45.00
MULTIBUS	\$86.00

## APPLE COMPATIBLE INTERFACE CARDS

**EPROM PROGRAMMER \$59.95**

**MODEL RP525**

- DUPLICATE OR BURN ANY STANDARD 27xx SERIES EPROM
- EASY TO USE MENU-DRIVEN SOFTWARE IS INCLUDED
- MENU SELECTION FOR 2716, 2732, 2732A, 2764 AND 27128
- HIGH SPEED WRITE ALGORITHM
- LED INDICATORS FOR ACTIVITY
- NO EXTERNAL POWER SUPPLY NEEDED
- ONE YEAR WARRANTY

**16K RAMCARD \$39.95**



- FULL TWO YEAR WARRANTY
- EXPAND YOUR 48K APPLE TO 64K
- USE IN PLACE OF APPLE LANGUAGE CARD

BARE PC CARD W/ INSTRUCTIONS \$9.95

**IC TEST CARD \$99.95**



- QUICKLY TESTS MANY COMMON ICs
- DISPLAYS PASS OR FAIL
- ONE YEAR WARRANTY
- TESTS: 4000 SERIES CMOS, 74HC SERIES CMOS, 7400, 74LS, 74L, 74H & 74S

**300B MODEM \$49.95**

FOR APPLE OR IBM  
INCLUDES ASCII PRO-EZ SOFTWARE



• FCC APPROVED

- BELL SYSTEMS 103 COMPATIBLE
- INCLUDES AC ADAPTOR
- AUTO-DIAL/AUTO-ANSWER
- DIRECT CONNECT

CABLE FOR APPLE IIc \$14.95

**JOYSTICK CR-401 \$7.95**

FOR ATARI 400, 800, 2600, VIC 20/64 AND APPLE IIc

**DISKFILE**

HOLDS 70 5 1/4" DISKETTES



**\$895**  
3.5" DISKFILE HOLDS 40 \$995

**POWER STRIP**

- UL APPROVED
- 15A CIRCUIT BREAKER



## BAL 3-WAY SWITCH BOXES

- SERIAL OR PARALLEL
- CONNECTS 3 PRINTERS TO ONE COMPUTER OR VICE VERSA
- ALL LINES SWITCHES
- HIGH QUALITY ROTARY SWITCH MOUNTED ON PCB
- GOLD CONTACTS
- STURDY METAL ENCLOSURE



**SWITCH-3P CENTRONICS PARALLEL \$89.95**  
**SWITCH-3S RS232 SERIAL \$89.95**

## BAL PRINTER BUFFERS

- FREES COMPUTER FOR OTHER TASKS WHILE PRINTING LONG DOCUMENTS
- STAND-ALONE DESIGN, WORKS WITH ANY COMPUTER OR PRINTER
- ALL MODELS FEATURE PRINT PAUSE MEMORY CHECK, GRAPHICS CAPABILITY

**SP120P PARALLEL \$139.95**

- 64K UPGRADABLE TO 256K
- LED INDICATOR SHOWS VOLUME OF DATA IN BUFFER

**SP120S RS232 SERIAL \$159.95**

- 64K UPGRADABLE TO 256K
- 6 SELECTABLE BAUD RATES, FROM 600B-19,200B

**SP110P PARALLEL \$249.95**

- 64K UPGRADABLE TO 512K
- SPOLDS OUTPUT OF UP TO 3 COMPUTERS
- LED BARGRAPH DISPLAYS AMOUNT OF DATA IN BUFFER
- RESET FUNCTION CLEARS DATA IN BUFFER
- REPEAT FUNCTION CAN PRODUCE MULTIPLE COPIES OF A DOCUMENT



## NASHUA DISKETTES DEALS

5 1/4" SOFT SECTOR  
DS/DD WITH HUB RINGS

**\$990** **69¢<sup>ea</sup>** **59¢<sup>ea</sup>**  
BOX OF 10 BULK QTY 50 BULK QTY 250

NASHUA DISKETTES WERE JUDGED TO HAVE THE HIGHEST POLISH AND RECORDED AMPLITUDE OF ANY DISKETTES TESTED ACCORDING TO "COMPARING FLOPPY DISKS", BYTE 9/84

## DISKETTES

**NASHUA 5 1/4"**

N-MD2F DS/DD SOFT \$9.90  
N-MD2F DS/QUAD SOFT \$34.95  
N-MD2H DS/HD FOR AT \$49.95

**NASHUA 8"**

N-FD1 SS/DD SDFT \$27.95  
N-FD2 DS/DD SOFT \$34.95

**NASHUA 3.5"**

N-3.5SS 3.5" SS/DD FOR MAC \$32.95

**VERBATIM 5 1/4"**

V-MD1D SS/DD SDFT \$23.95  
V-MD2D DS/DD SOFT \$29.95  
V-MD110D SS/DD 10 SECTOR HARD \$23.95

## Sakata

120 CPS DOT MATRIX PRINTER

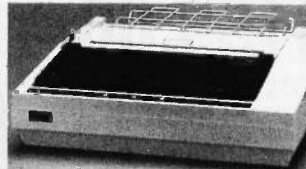

**MODEL SP-1200 \$169.95**

- EPSON/IBM COMPATIBLE
- 9-WIRE PRINTHEAD
- 120 CPS-BIDIRECTIONAL, 80 COL.
- FRICTION AND TRACTOR FEED
- PROPORTIONAL SPACING
- CENTRONICS PARALLEL INTERFACE
- 8 CHARACTER SETS AND GRAPHICS

6 FOOT IBM PRINTER CABLE \$9.95  
REPLACEMENT RIBBON CARTRIDGE \$11.95

## 5 1/4" FLOPPY DISK DRIVES

- TEAC FD-55B 1/2 HT DS/DD (FOR IBM) \$99.95
- TEAC FD-55F 1/2 HT DS/QUAD (FOR IBM) \$99.95
- TEAC FD-55GFV 1/2 HT DS/HD (FOR IBM AT) \$154.95
- TANDON TM100-2 DS/DD (FOR IBM) \$99.95
- TANDON TM60-2 1/2 HT DS/DD (FOR IBM) \$69.95
- MPI-B52 DS/DD (FOR IBM) \$89.95
- QUME QT-142 1/2 HT DS/DD (FOR IBM) \$69.95

## 8" FLOPPY DISK DRIVES

- FD 100-8 SS/DD (SA/801 EQUIV) \$119.00
- FD 200-8 DS/DD (SA/851R EQUIV) \$159.00

## DISK DRIVE ACCESSORIES

- TEAC SPECIFICATION MANUAL \$5.00
- TEAC MAINTENANCE MANUAL \$25.00
- 1/2 HT MOUNTING HARDWARE \$2.95
- MOUNTING RAILS FOR IBM AT \$4.95
- "Y" POWER CABLE FOR 5 1/4" FDD \$2.95
- 5 1/4" FDD POWER CONNECTORS \$1.19

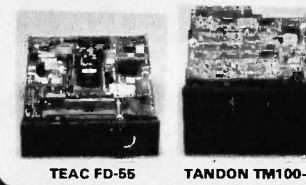

## DISK DRIVE ENCLOSURES

**CAB-APPLE \$24.95**

APPLE TYPE CABINET W/OUT POWER SUPPLY

**CAB-1FH5 \$89.95**

FULL HT 6 1/2" BEIGE CABINET W/POWER SUPPLY

**CAB-28V5 \$49.95**

DUAL SLIMLINE 5 1/4" CABINET W/POWER SUPPLY

**CAB-25V8 \$209.95**

DUAL SLIMLINE 8" CABINET W/POWER SUPPLY

**CAB-2FH0 \$219.95**

DUAL FULL HT 8" CABINET W/POWER SUPPLY



## TEST EQUIPMENT FROM JDR INSTRUMENTS

**DIGITAL MULTIMETER PEN DPM-1000**

AUTO RANGING, POLARITY AND DECIMAL!

**\$54.95**

- LARGE 3.5 DIGIT DISPLAY
- DATA HOLD SWITCH FREEZES READING
- FAST, AUDIBLE CONTINUITY TEST
- LOW BATTERY INDICATOR
- OVERLOAD PROTECTION

**20MHZ DUAL TRACE OSCILLOSCOPE MODEL 2000 \$389.00**

**35MHZ DUAL TRACE OSCILLOSCOPE MODEL 3500 \$549.00**

FOR MORE INFORMATION ON THE OSCILLOSCOPES, SEE OUR FULL PAGE AD ON PAGE 233

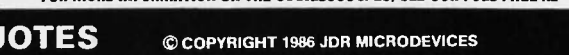

**CALL FOR VOLUME QUOTES**

© COPYRIGHT 1986 JDR MICRODEVICES

# BUILD A COMPLETE XT SYSTEM—\$698

## XT COMPATIBLE MOTHERBOARD

# \$169.00

- 4.77 MHz 8088 CPU, OPTIONAL 8087 CO-PROCESSOR
- 8 EXPANSION SLOTS
- 0K RAM INSTALLED, EXPANDABLE TO 640K ON-BOARD MEMORY
- ALL ICs SOCKETED-HIGHEST QUALITY PC BOARD
- ACCEPTS 2764 OR 27128 ROMS

**PRO-BIOS \$29.95**

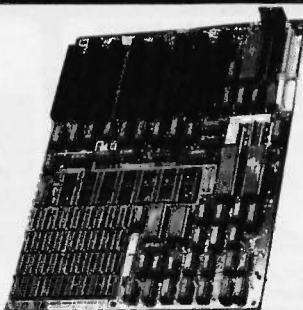

## HARD DISK SYSTEMS

Includes short slot HD Controller, cables, mounting hardware and instructions. All drives are pre-tested and come with a one year warranty.

**10 Mb \$389**  
**20 Mb \$489**

## IBM COMPATIBLE INTERFACE CARDS

ALL WITH A ONE YEAR WARRANTY

### MULTI I/O FLOPPY CARD \$129.95

PERFECT FOR THE 640K MOTHERBOARD



- 2 DRIVE FLOPPY DISK CONTROLLER
- 1 RS232 SERIAL PORT, OPTIONAL 2nd SERIAL PORT
- PARALLEL PRINTER PORT
- GAME PORT
- CLOCK/CALENDAR
- SOFTWARE: CLOCK UTILITIES, RAMDISK, SPOOLER

### MULTIFUNCTION CARD \$119.95

ALL THE FEATURES OF AST'S 6 PACK PLUS AT HALF THE PRICE



- CLOCK/CALENDAR
- 0-384K RAM
- SERIAL PORT
- PARALLEL PORT
- GAME PORT
- SOFTWARE INCLUDED

PRINTER CABLE \$9.95  
64K RAM UPGRADE 9/\$11.61

### COLOR GRAPHICS ADAPTOR \$99.95

FULLY COMPATIBLE WITH IBM COLOR CARD



- 4 VIDEO INTERFACES: RGB, COMPOSITE COLOR, HI-RES, COMPOSITE MONOCHROME, CONNECTOR FOR RF MODULATOR
- COLOR GRAPHICS MODE: 320 x 200
- MONO GRAPHICS MODE: 640 x 200
- LIGHT PEN INTERFACE

### MONOCHROME GRAPHICS CARD \$119.95

FULLY COMPATIBLE WITH IBM MONOCHROME ADAPTOR & HERCULES GRAPHICS

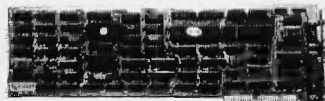

- LOTUS COMPATIBLE
- TEXT MODE: 80 x 25
- GRAPHICS MODE: 720 x 348
- PARALLEL PRINTER INTERFACE
- OPTIONAL SERIAL PORT \$19.95

### MONOCHROME ADAPTOR \$49.95

ANOTHER FANTASTIC VALUE FROM JDR!

• IBM COMPATIBLE TTL OUTPUT • 720 x 350 PIXEL DISPLAY  
PLEASE NOTE: THIS CARD WILL NOT RUN LOTUS GRAPHICS AND DOES NOT INCLUDE A PARALLEL PORT

### FLOPPY DISK DRIVE ADAPTOR \$49.95



- INTERFACES UP TO FOUR STANDARD FDDs TO IBM PC OR COMPATIBLES
- INCLUDES CABLE FOR TWO INTERNAL DRIVES
- STANDARD DB37 FOR EXTERNAL DRIVES
- RUNS QUAD DENSITY DRIVES WHEN USED WITH JFORMAT

## EASYDATA 1200 BAUD MODEM FOR IBM

INCLUDES PC TALK III COMMUNICATIONS SOFTWARE



- HAYES COMPATIBLE
- AUTO DIAL/AUTO ANSWER
- AUTO RE-DIAL ON BUSY
- INCLUDES SERIAL PORT!
- ONE YEAR WARRANTY

# \$169.95

## CRT MONITORS FOR ALL APPLICATIONS



**TAXAN RGB VISION III MODEL 415**

- MADE FOR TAXAN BY ACORN
- 640 x 252 PIXEL RESOLUTION
- 16 COLORS
- 18 MHZ BANDWIDTH
- 12" BLACK MATRIX
- IBM AND LOTUS COMPATIBLE CABLE FOR IBM \$15.95

**\$289.95**



**SAKATA COMPOSITE COLOR MODEL SC-100**

- TOP RATED FOR APPLE
- 13" COMPOSITE VIDEO
- RESOLUTION: 280H x 300V
- INTERNAL AUDIO AMPLIFIER
- ONE YEAR WARRANTY

**\$169.95**



**SAMWOOD/ALPHA MONOCHROME MODEL DM-216B**

- PERFECT COSMETIC MATCH FOR IBM PC
- IBM COMPATIBLE TTL INPUT
- 12" NON-GLARE SCREEN
- P39 GREEN PHOSPHOR
- HI-RES 22 MHZ BAND WIDTH

**\$99.95**

## BUILD YOUR OWN XT COMPATIBLE SYSTEM!

- XT MOTHERBOARD \$169.00
- PRO-BIOS \$29.95
- 64K RAM \$8.91
- 130 WATT POWER SUPPLY \$89.95
- FLIP-TOP CASE \$49.95
- DKM-2000 KEYBOARD \$79.95
- 1/2 HEIGHT DISK DRIVE \$69.95
- FLOPPY DISK CONTROLLER \$49.95
- MONOCHROME ADAPTOR \$49.95
- MONOCHROME MONITOR \$99.95

**TOTAL: \$697.51**

## MONITOR STAND



TILTS AND SWIVELS

**ONLY \$12.95**

## IBM PRINTER CABLE



- DB25 TO CENTRONICS
- SHIELDED CABLE \$9.95

## IBM STYLE COMPUTER CASE

AN ATTRACTIVE STEEL CASE WITH A HINGED LID FITS THE POPULAR PC/XT COMPATIBLE MOTHERBOARDS

- SWITCH CUT-OUT ON SIDE FOR PC/XT STYLE POWER SUPPLY
- CUT-OUT FOR 8 EXPANSION SLOTS
- ALL HARDWARE INCLUDED

**\$49.95**

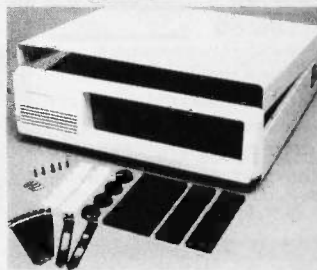

## IBM COMPATIBLE KEYBOARDS

**DKM-2000 \$79.95**

**KB-5151 \$99.95**



- FULLY IBM COMPATIBLE
- LED STATUS INDICATORS FOR CAPS & NUMBER LOCK
- 83 KEY IDENTICAL TO IBM



- ENHANCED IBM COMPATIBLE
- SEPARATE CURSOR & NUMERIC KEYPADS
- CAPS LOCK & NUMBER LOCK INDICATORS
- IMPROVED KEYBOARD LAYOUT

## POWER SUPPLY



**NOW ONLY \$89.95**

- FOR IBM PC-XT COMPATIBLE
- 130 WATTS
- +5V @ 15A, +12V @ 4.2A
- -5V @ .5A, -12V @ .5A

**150 WATT MODEL \$99.95**

## DISK DRIVES TANDON TM50-2

# \$69.95

- 1/2 HT DS/DD
- IBM COMPATIBLE
- EXTREMELY QUIET!

- TEAC FD-55B DS/DD \$89.95
- TEAC FD-55F DS/QUAD \$89.95
- TEAC FD-55G DS/HD \$154.95
- QUME QT-142 DS/DD \$89.95
- MOUNTING HARDWARE \$2.95
- AT/RAILS \$4.95

# U·N·C·L·A·S·S·I·F·I·E·D A·D·S

**WANTED:** Nonprofit chemical-dependency treatment center seeks tax-deductible donation of computer, peripherals, and equipment for academic use. Prefer IBM, Apple, Commodore, or compatible. Will pay shipping and provide receipt. Robert Sundrud, Odyssey House of Louisiana, 1125 North Tonti St., New Orleans, LA 70119, (504) 821-9211.

**WANTED:** San Francisco Bay Area Council needs old video and computer equipment for regular cable TV show they produce called "Young Ideas." Tax-deductible. Keith St. Clare, Explorer Scouts and Boy Scouts of America, 150 2nd St., 5th Floor, San Francisco, CA 94105.

**NEEDED:** Nonprofit legal-aid organization seeks tax-deductible donation of TRS-80 Model 100 or Tandy 200 portable computer. Will pay shipping and provide receipt. Florida Institutional Legal Services Inc., 2614 Southwest 34th St., Gainesville, FL 32608, (904) 377-4212.

**WANTED:** Magic Computer Users Group or any Magic users interested in forming a users group. Together we can discover how to reconfigure the function keys. Dean H. Brailey, POB 16201, Lansing, MI 48901, (517) 772-0432.

**WANTED:** Two bezels to fit Siemens FDD 120-8 drives. Mine were destroyed by shippers. Might buy a couple of old drives for the needed parts. O. K. Hudson, POB 68, New Strawn, KS 66839, (316) 364-8635.

**WANTED:** Public-domain software for the IBM PC and compatibles. Send your list of programs. P. Rathod, Revéfaret 4, 0491 Oslo 4, Norway.

**NEEDED:** Two parts for NCR 1-9020 computer: AS 6090-F208 to add 256K memory and AK 6081-K901, a universal dynamic addressing translator. Julio Guzman, Constructora Lobeira, Monterey, Mexico, telephone: (011-5283) 77-7100 or 77-9615; Telex 382132 MOTIME.

**FOR SALE:** Conographic Cono-Color 40 adapter for IBM PC, Amdek Color IV video monitor with cable, and more: \$1500. Teac model FD-55F disk drive for IBM PC: \$150. Roland processing unit and interface card: asking \$200. Terry Gilmore, Hatfield Village, AA-2-12, Hatfield, PA 19440, (215) 855-0741.

**FOR SALE:** Slicer 80186 SBC: \$2350. Apple II+ with 64K, dual floppies, 10-megabyte drive, SP-PP-CC MFC, 300/1200 modem, carry case, PROM burner, 80-column display, and more. All for \$2250 or separately. Ed O'Neill, 633 Cotton Ave., Birmingham, AL 35211, (205) 787-4195.

**FOR SALE:** HP 82163A HP-IL video interface with all accessories and manual. As-new condition. \$100 includes UPS. Steve Tedder, IITRI/NIPER, POB 2128, Bartlesville, OK 74005, (918) 337-4250.

**FOR SALE:** Tandon Half-Height 8-inch floppy-disk drive. Brand new. \$95. Several hard-disk drives for IBM PC AT. Joowon Kim, 473 Sapena Court #11, Santa Clara, CA 95050, (408) 727-6995 or 378-1246.

**WANTED:** Formula 1 development system(s). Eric Rossi, EMAC, 1400 West Main St., Suite 5, Carbondale, IL 62901, (618) 529-4525.

**FOR SALE:** Apple IIe with 65C02 enhancement, one Disk II, IDS 480 printer, Taxan RGB Vision III monitor with RGB 64K extended 80-column card. Apple-mouse IIe, all cables and more. Dan Rosenberg, 252 Spring Ridge Dr., Berkeley Heights, NJ 07922, (201) 464-5269.

**WANTED:** RCA 1802/Super Elf user seeks a copy of Quest 12K Super Basic and manual. Will pay reasonable price. Also interested in other 1802 software and correspondence with hobbyists still using the 1802. Douglas Connolly, 5415 Connecticut Ave. NW, Apt. 307, Washington, DC 20015, (202) 362-2089.

**WANTED:** Comrex ComFiler hard disk, 8000 series disk-formatted or other hard-disk drive for Epson QX-10. Americus Mitchell, POB 1335, Kilmarnock, VA 22482, (804) 435-3489.

**WANTED:** Manual and schematics for Xcomp S-100 hard-disk interface boards (or copies). Forrest Anderson, POB 31790, Phoenix, AZ 85046, (602) 863-9981.

**FOR SALE:** TI PC, two 320K drives, Persyst board, 256K main memory, 13-inch high-resolution color monitor, 3-plane graphics board, and 850 printer with tractor feed. David Pearl, R.R. 4, Box A-33, Warsaw, IN 46580, (219) 269-2744.

**FOR TRADE:** Hewlett-Packard Series 200 for IBM PC XT in good condition or PC XT hardware clone. Brandon Jones, 115 Home Estate Dr., Slidell, LA 70460, (504) 643-2329, evenings.

**FOR SALE:** BYTE: May 1977 through present. Excellent condition. \$200 or best offer. Stewart Fleisher, 2000 South Logan, Denver, CO 80210, (303) 722-7247.

**FOR SALE:** Radio Shack 32K expansion interface for RS Model I, with cable: \$150. One Tandy disk drive and one Teac disk drive for Model I, both in case and with power supply: \$100 each. Perfect condition. R. Friedman, 495 East 18th St., Brooklyn, NY 11226, (718) 282-4029.

**FOR SALE:** Heathkit H-19 video terminal and Anderson Jacobson A-242A acoustic coupler. Asking \$175, or will swap for HP 41CX calculator. Robert David, 975 Valle Vista, Pittsburgh, PA 15234.

**FOR SALE:** Sorcerer II computer, disk display unit with two 77-track drives, S-100 expansion box, and extensive documentation. Asking \$500. B. Walther, POB 58, Tam-Sui, Taiwan.

**WANTED:** Student of electrical engineering seeks old computer hardware. Will pay. Will also trade public-domain programs. T. Belding, POB 743, Granger, TX 76530-0743.

**FOR SALE:** California Computer Systems computer, CP/M, Z80, NEC 5500D Spinwriter, two Shugart 500K drives, Hazeltine 1420 monitor, and more: \$3500. Bill Barto, 323 Haddon Ave., Westmont, NJ 08108, (609) 858-4201.

**FOR SALE:** CompuPro 20-slot computer, 68K CPU, 640K RAM, two Shugart SA851s, cabinet, power supply, and more: \$2500. Dale Satterfield, 1122 Kelly Dr., San Jose, CA 95129, (415) 367-4421.

**FOR SALE:** Two Hewlett-Packard HP 87XMs, \$900 each. Three HP 9130As, \$290 each. Hard-disk unit, modules, ROMs and accessories. Don Person, Box 3103, Albany, NY 12203, (518) 482-9023.

**NEEDED:** Student seeks information on computer graphics. Jerzy Mityk, 25-531 Kielce, Rew Pzadz 47/139, Poland.

**WANTED:** Hewlett-Packard 16K memory module for HP 85A computer. Gordon Kirchhevel, POB 14172, Chicago, IL 60614, (312) 549-1475.

**FOR SALE:** Apple IIe, enhanced. Apple extended 80 card, Duodrive and controller, Grappler+ printer interface, Gemini-10X, Hayes micromodem IIe, Apple joystick, Monitor II, Commodore color monitor, and more. \$1600. You pay shipping. Timmy Hu, 11 Benford Dr., Princeton Junction, NJ 08550.

**FOR SALE:** Two Teletype Model 33 ASRs with built-in reader and punch, RS-232C interface and pedestal, \$90 each. Need a service technician or can barter above item for fix of a Reactron editing typewriter with IBM Selectric Printer, D. Test, POB 9064, North Newark, NJ 07104.

**FOR SALE:** Intel 80286 Microsystem Design Kit. Complete with 14 ICs and Intel data sheets including 80286, 80287, 82062, 8272A, 82730, 8207, 8208, 82586, and more. \$350 firm. Fred Moran, 2604 West 24th St., Wichita, KS 67204, (316) 838-5234.

**FOR SALE:** BYTE: All issues from September 1975 through September 1982, except January 1976. Best offer over \$200. George Colman, 44 Fox Hill Rd., Framingham, MA 01701, (617) 879-4031, evenings and weekends.

**FOR SALE:** Digital Group cards: Parallel, TV/CASS, Z80 CPU: \$30 each; Serial: \$40; Ham: \$75; 32K

Memory: \$80; Proto: \$20; UNROM: \$15. Dual 8019 drives and DD Controller: \$400 or best offer. Keyboard: \$40; terminated expanded mother board: \$75; printer: \$40. Jerry Flanders, 1767 Gregory Lake Rd., North Augusta, SC 29841, (803) 278-0984.

**WANTED:** Aeronautics engineer turned analyst/programmer seeking correspondence with computer science students/engineers. Also seeking public-domain assembly-language listings and information on addressable bit-mapped graphics. Will pay mailing. Dante S. Ponte, 5617 Tramo St., San Dionisio, Paranaque, Metro Manila, Philippines.

**WANTED:** Seeking information for a graduate research project in computer music and music education. Also interested in looking at privately developed music programs for any microcomputer system. Jerry Ozpiko, 12223 Eighty-Seventh St., Edmonton, Alberta T5B 3N9, Canada, (403) 477-2984.

**FOR SALE:** IBM 3101 Video terminal in good condition: \$200 plus shipping. Shugart 860 disk drive, DS/DD 8-inch, like new: \$250 plus shipping. Matthew Boytos, 19 Canal Run W., Washington Crossing, PA 18977, (215) 493-1554.

**FOR SALE:** NEC 8001A microcomputer (32K RAM, M-BASIC in ROM, parallel port, serial port). CPU/key-board unit only; great shape. \$100 or best offer. Thomas Trana, POB 829, East Lansing, MI 48823.

**FOR SALE:** Heath 3400 microprocessor course with trainer. Theodore Turk, 17820 Schenley Ave., Cleveland, OH 44119, (216) 692-1607.

**FOR SALE:** Heathkit H-89, 48K RAM, 100K floppy-disk drive, monitor, two serial ports, and more. \$1000 or best offer. Peter Lunde, 104 Spragg Circle, Markham, Ontario L3P 5C2, Canada, (416) 471-1616.

**FOR SALE:** MPX-16 microcomputer, 256K, two DS/DD Tandon drives, IBM-type Key Tronic keyboard, Quadcolor-1 color graphics adapter, 640 by 200 NEC RGB monitor, Epson MX-80 printer. \$1500. Narayan Nayak, 1 Foxglove Court, Yarmouth, ME 04096, (207) 846-3867.

**FOR SALE:** Radio Shack LP-I (Centronics 779) printer; willing to trade. Set of ACCESS Journal, No. 1 to No. 24. Jerry Sabin, 6022 Sage Dr., Orlando, FL 32807.

**WANTED:** Seattle and Tecmar S-100 boards. Must be fully operational with complete documentation and schematics. A. B. Price, 545 East Orange Grove, Burbank, CA 91501, (818) 841-8542.

**FOR SALE:** Atari 800XL, 64K, with disk drive, printer, and more. \$525 or best offer. Duy Nguyen, 3783 Kauai Dr., San Jose, CA 95111, (408) 629-5965.

**FOR SALE:** Tecmar 5-megabyte removable hard-disk subsystem for IBM PC or compatibles. Includes controller, three cartridges, and all documentation. \$650. Will pay shipping. Mike Heck, 1104 Continental Dr., Harleysville, PA 19438, (215) 368-7059.

**WANTED:** Documentation on Rockwell AIM 6500-series micros. Hardware manuals, schematics, programmer's manuals, memory map, etc. Also information on any peripherals or operating systems still available. Will pay shipping. Rick Gerlach, RD 1, Box 300, Walkkill, NY 12589.

**FOR SALE:** Heathkit H-89 microcomputer, two drives, serial card, Magnolia Microsystems 128K card, Novation Auto 212 1200-bps modem, and more. \$700 plus shipping. Michael Smith, 3203 Alma, Palo Alto, CA 94306-2925, (415) 494-7098.

**WANTED:** Someone willing to trade their used Apple IIe with one disk drive for TRS-80 Model 100 (24K) with DMP-105 printer and acoustic couplers. All manuals and cables included. Daniel Warren, 10 Parkview Ave., Buffalo, NY 14210, (716) 822-7191.

**FOR SALE:** Apple accessories: speech synthesizer: \$50; 16-channel A/D plus D/A: \$150; clock/calendar: \$140; RF modulator: \$30. Full documentation. Excellent condition. J. Michael Callahan, Old Colony Rd., Eastford, CT 06242, (203) 974-3842.

**FOR SALE:** Cromemco Z80 S-100 kit. Dual 8-inch drives, CRT: \$800. Factory-built dual 5 1/4-inch drives and 64K: \$800. J. Soderblom, POB 160, Olema, CA 94950, (415) 663-8356.

**FOR SALE:** Used Alpha Micro Systems AM-1000 multiuser system. Dual 800K drives, 128K RAM (68000), three serial ports and multiuser operating system. Includes AM-60 terminal and more. \$3000. Creigh Shank, POB 4764, Coral Gables, FL 33114, (305) 442-0234. ■

UNCLASSIFIED ADS MUST BE noncommercial, from readers who have computer equipment to buy, sell, or trade on a onetime basis. All requests for donated computer equipment must be from nonprofit organizations. Programs to be exchanged must be written by the individual or be in the public domain. Ads must be typed double-spaced, contain 50 words or less, and include full name and address. This is a free service; ads are printed as space permits. BYTE reserves the right to reject any unclassified ad that does not meet these criteria. When you submit your ad (BYTE, Unclassified Ads, POB 372, Hancock, NH 03449), allow at least four months for it to appear.

# B·O·M·B

## BYTE'S ONGOING MONITOR BOX

ARTICLE#	PAGE	ARTICLE	AUTHOR(S)	ARTICLE#	PAGE	ARTICLE	AUTHOR(S)
1	9	Microbytes	staff	15	191	Increasing Independence for the Aging	Engelhardt, Edwards
2	37, 399	What's New	staff	16	199	Computing for the Blind User	Arditi, Gillman
3	44	Ask BYTE	Ciarcia	17	217	Kaypro 286i	Krause
4	57	Book Reviews	Crabb, Kenner, Norman, Price	18	225	Modula-2 System for Z80 CP/M	Anderson
5	84	Product Preview: The Atari 1040ST	Robinson, Edwards	19	237	Pocket APL	Johnson
6	96	Finding the Titanic	Spalding, Dawson	20	245	Arity/Prolog	Wong
7	112	Ciarcia's Circuit Cellar: Real-Time Clocks: A View Toward the Future	Ciarcia	21	251	Braille-Edit	Brugsch
8	128	Programming Project: A Simple Windowing System. Part I: Basic Principles	Webster	22	261	Printit	Brugsch, Lazzaro
9	135	An ANSI Standard for the C Language	Hersee, Knopoff	23	269	Computing at Chaos Manor: All Sorts of Software	Pournelle
10	145	Programming Insight: Macintosh Explorer	Andrade	24	297	Applications Only: First in a Series	Shapiro
11	155	Working at Home with Computers	Tazelaar	25	305	According to Webster: 68000 Wars: Round I	Webster
12	160	Using Images to Generate Speech	Baker	26	327	BYTE Japan: A New Language and a Laptop	Raie
13	171	The Electronic University Network	Osgood	27	333	BYTE U.K.: The Amstrad PCW 8256	Pountain
14	177	The Technology of the Kurzweil Voice Writer	Kurzweil	28	343	Mathematical Recreations: Diophantine Equations	Kurosaka
				29	367	Best of BIX	staff

## BOMB Results

### ENTER: THE WINNERS

According to Webster: "Microcomputer Color Graphics—Observations" Bruce Webster's column, wins first place in December BYTE. In second is Ciarcia's Circuit Cellar: "Turnkey Bulletin-Board System" by Steve Ciarcia. "The Norton Utilities" is third: Ruben Rabinovitz wins the \$100 bonus

because his Software Review was the first nonstaff-written article to appear in the lineup. In fourth place, and the winner of the \$50 bonus, is Bob Troiano for his System Review of "The AT&T PC 6300." Dick Pountain's BYTE U.K. covering "The Torch Triple X" came in fifth. We all applaud the winners of the final 1985 issue.

### BYTE ADVERTISING SALES STAFF:

**Dennis J. Riley, Advertising Sales Manager, 70 Main Street, Peterborough, NH 03458, tel. (603) 924-9281**

**NEW ENGLAND**  
ME, NH, VT, MA, RI,  
EASTERN CANADA  
Paul McPherson Jr. 1617) 262-1160  
McGraw-Hill Publications  
575 Boylston Street  
Boston, MA 02116

**ATLANTIC**  
NY, NYC, CT, NJ (NORTH)  
Leah G. Rabinowitz (212) 512-2096  
McGraw-Hill Publications  
1221 Avenue of the Americas—  
39th Floor  
New York, NY 10020

Dick McGurk (203) 968-7111  
McGraw-Hill Publications  
Building A—3rd Floor  
777 Long Ridge Road  
Stamford, CT 06902

**EAST**  
PA (EAST), NJ (SOUTH),  
MD, VA, W.VA, DE, D.C.  
Daniel Ferro (215) 496-3833  
McGraw-Hill Publications  
Three Parkway  
Philadelphia, PA 19102

**SOUTHEAST**  
NC, SC, GA, FL, AL, TN  
Maggie M. Dorvee (404) 252-0626  
McGraw-Hill Publications  
4170 Ashford-Dunwoody Road—  
Suite 420  
Atlanta, GA 30319

**MIDWEST**  
IL, MO, KS, IA, ND, SD, MN, WI, NB, IN  
Bob Denmead (312) 751-3740  
McGraw-Hill Publications  
Blair Building  
645 North Michigan Ave.  
Chicago, IL 60611

**GREAT LAKES, OHIO REGION**  
MI, OH, PA (ALLEGHENY), KY,  
ONTARIO, CANADA  
Mike Kisseberth (313) 352-9760  
McGraw-Hill Publications  
4000 Town Center—Suite 770  
Southfield, MI 48075

**SOUTHWEST, ROCKY MOUNTAIN**  
UT, CO, WY, OK, TX, AR, MS, LA  
Kevin Harold (214) 458-2400  
McGraw-Hill Publications  
Prestonwood Tower—Suite 907  
5151 Beltline  
Dallas, TX 75240

**SOUTH PACIFIC**  
SOUTHERN CA, AZ, NM, LAS VEGAS  
Jack Anderson (714) 557-6292  
McGraw-Hill Publications  
3001 Red Hill Ave.  
Building #1—Suite 222  
Costa Mesa, CA 92626

Karen Niles (213) 480-5243, 487-1160  
McGraw-Hill Publications  
3333 Wilshire Boulevard #407  
Los Angeles, CA 90010

**NORTH PACIFIC**  
HI, WA, OR, ID, MT, NORTHERN CA,  
NV (except LAS VEGAS), W. CANADA  
McGraw-Hill Publications  
425 Battery Street  
San Francisco, CA 94111

Bill McAfee (415) 964-0624  
McGraw-Hill Publications  
1000 Elwell Court—Suite 225  
Palo Alto, CA 94303

**WEST COAST SURPLUS  
AND RETAIL ACCOUNTS**  
Tom Harvey (805) 964-8577  
3463 State Street—Suite 256  
Santa Barbara, CA 93105

**The Buyer's Mart**  
Karen Burgess (603) 924-9281  
BYTE Publications  
70 Main Street  
Peterborough, NH 03458

**BYTE BITS (2x3)**  
Dan Harper (603) 924-6830  
BYTE Publications  
70 Main Street  
Peterborough, NH 03458

**Post Card Mailings  
National**  
Bradley Browne (603) 924-6166  
BYTE Publications  
70 Main Street  
Peterborough, NH 03458

### International Advertising Sales Representatives:

Mr. Hans Csokor  
Publimedia  
Reisnerstrasse 61  
A-1037 Vienna, Austria  
222 75 76 84

Mrs. Gurit Gepner  
McGraw-Hill Publishing Co.  
PO Box 2156  
Bat Yam, 59121 Israel  
3 866 561 321 39

Mr. Fritz Krusebecker  
McGraw-Hill Publishing Co.  
Liebigstrasse 19  
D-6000 Frankfurt/Main 1  
West Germany  
69 72 01 81

Mrs. Maria Sarmiento  
Pedro Teixeira 8, Off. 320  
Iberia Mart I  
Madrid 4, Spain  
1 45 52 891

Mr. Andrew Karnig  
Andrew Karnig & Associates  
Finnbodavagen  
S-131 31 Nacka, Sweden  
8-44 0005

Mr. Alain Faure  
McGraw-Hill Publishing Co.  
17 rue Georges Bizet  
F 75116 Paris  
France  
(4) 47-20-33-42

Mr. Arthur Scheffer  
McGraw-Hill Publishing Co.  
34 Dover St.  
London W1X 3RA  
England 01 493 1451

Mr. Savio Pesavento  
McGraw-Hill Publishing Co.  
Via Flavio Baracchini 1  
20123 Milan, Italy  
02 86 90 617

Seavex Ltd.  
400 Orchard Road, #10-01  
Singapore 0923  
Republic of Singapore  
Tel: 734-9790  
Telex: RS35539 SEAVEX

Seavex Ltd.  
503 Wilson House  
19-27 Wyndham St.  
Central, Hong Kong  
Tel: 5-260149  
Telex: 60904 SEVEX HX

Hiro Morita  
McGraw-Hill Publishing Co.  
Overseas Corp.  
Room 1528  
Kasumigaseki Bldg.  
3-2-5 Kasumigaseki,  
Chiyoda-Ku  
Tokyo 100, Japan  
3 581 9811

# R·E·A·D·E·R   S·E·R·V·I·C·E

Inquiry No.	Page No.	Inquiry No.	Page No.	Inquiry No.	Page No.	Inquiry No.	Page No.
407 1ST PLACE COMP. SYSTEMS.....	432	63 CHINA EXTERNAL TRADE.....	195	134 FLAMINGO MICRO.....	182	400 LOGICSOFT.....	144 A-D INSERT
2 A.S.T. RESEARCH.....	19	66 CLASSIC TECHNOLOGY.....	371	135 FORTRON, INC.....	437	212 LOGITECH INC.....	221
3 A.S.T. RESEARCH.....	19	67 CLASSIC TECHNOLOGY.....	371	136 FORTRON, INC.....	437	213 LOGITECH INC.....	223
4 AB COMPUTERS.....	60	68 CMS.....	190	137 FOX SOFTWARE, INC.....	32	214 LOMAS DATA PRODUCTS.....	257
5 ACM SIGGRAPH '86.....	381	69 CMS.....	190	138 FUJITSU AMERICA.....	157	215 LUCKY-GOLDSTAR INT'L.....	289
* ACS IMPORTERS.....	439	70 COGITATE.....	430	139 FUNK SOFTWARE.....	345	216 LYBEN COMP. SYS.....	144
6 ADV. DIGITAL CORP.....	36	71 COGITATE.....	432	140 GABE TECH LTD.....	54	217 LYCO COMPUTER.....	389
7 ADV. DIGITAL CORP.....	36	* COMMODORE BUSN. MACH.....	111	141 GENEST TECH.....	316	* MACMILLAN BOOK CLUBS.....	385
8 ADV. INTELLIGENCE TECHN.....	427	* COMPAQ COMPUTER CORP.....	207	142 GENETECH.....	316	218 MAIN STREET COMPUTER.....	210, 211
9 ADV. MICROCOMPUTER SYS.....	426	73 COMPETITIVE EDGE.....	314	143 GENOA SYSTEMS CORP.....	311	219 MANX SOFTWARE SYS.....	25
10 ADVANCED COMP PROD.....	442, 443	* COMPUADD CORP.....	176 A-B INSERT	144 GLENCO ENGINEERING.....	93	409 MARCHAND INT'L.....	426
11 ADVANCED DEVLPMNT. TECHN.....	398	74 COMPUATA TRANSLATORS INC.....	454	145 GOLDEN BOW SYSTEMS.....	428	220 MARK WILLIAMS CO.....	59
405 AFTON COMPUTER.....	379	368 COMPUPROVIASYN CORP.....	373	146 GOLDEN BOW SYSTEMS.....	454	221 MARK WILLIAMS CO.....	61
406 AFTON COMPUTER.....	379	75 COMPUSAVE.....	425	148 GTEK INC.....	181	222 MARYMAC INDUSTRIES INC.....	430
382 ALDEBARAN LABS INC.....	397	76 COMPUSERVE.....	170	* HARMONY COMPUTERS.....	316	223 MASTER VOICE.....	321
12 ALF PRODUCTS, INC.....	432	77 COMPUTER AFFAIRS INC.....	110	151 HAYES MICROCOMP. PROD.....	47	224 MASTER VOICE.....	321
13 ALLOY COMPUTER PRODUCTS.....	173	78 COMPUTER AID.....	454	152 HERCULES COMPUTER TECH.....	154	225 MASTERBYTE COMP. OF NY.....	434
14 ALLOY COMPUTER PRODUCTS.....	173	79 COMPUTER BARN THE.....	439	153 HERCULES COMPUTER TECH.....	287	226 MAXELL DATA PRODUCTS.....	7
15 ALLOY COMPUTER PRODUCTS.....	273	80 COMPUTER BOOK CLUB THE.....	409	154 HERITAGE SYSTEMS CORP.....	424	227 MAYNARD ELECTRONICS.....	15
16 ALLOY COMPUTER PRODUCTS.....	273	* COMPUTER CHRONICLES.....	377	155 HERSEY MICRO CONSULTING.....	436	* MCGRAWHILL BOOK CO.....	352, 353
17 ALPHA MICRO.....	264	* COMPUTER CONTINUUM.....	428	156 HEWLETPACKARD.....	41	228 MEGASOFT.....	430
18 AMDEK CORP.....	103	396 COMPUTER FAIRE, INC.....	172	157 HEWLETPACKARD.....	302, 303	229 MEGATEL COMPUTER TECH.....	363
* AMER. DESIGN COMPONENTS.....	429	82 COMPUTER INNOVATIONS.....	279	158 HITEC COMP & ELECTR.....	420	230 MERRITT COMP PRODUCTS.....	428
* AMERICAN MICROSYSTEMS.....	454	83 COMPUTER INNOVATIONS.....	281	159 HOOLEON COMPANY.....	163	410 MFI ENTERPRISES, INC.....	178
20 AMERICAN MICRO TECHNOLOGY.....	326	84 COMPUTER MAIL ORDER.....	188, 189	160 HOOLEON COMPANY.....	163	231 MICRO DATA BASE SYS.....	139
392 AMERICAN RESEARCH.....	193	86 COMPUTER PARTS MART.....	428	161 HOUSTON INSTR./BAUSCHELOMB.....	22	232 MICRO DESIGN INT'L.....	347
393 AMERICAN RESEARCH.....	193	87 COMPUTER SURPLUS STORE.....	428	167 IC EXPRESS.....	424	233 MICRO MART, INC.....	64, 65
22 AMPRO COMPUTERS INC.....	318	88 COMPUTER WAREHOUSE.....	250	162 IBEX COMP CORP.....	426	234 MICRO PRODUCTS.....	455
23 AMPRO COMPUTERS INC.....	318	89 COMPUTER WAREHOUSE.....	250	166 IBM.....	198	235 MICROCOMPUTER ACCESSORIES.....	63
24 APPARAT INC.....	432	90 COMPUTERBANC.....	423	164 IBM - (ISG) SERVICES.....	263	236 MICROCOMPUTER ACCESSORIES.....	63
26 APROTEK.....	320	93 COMPUTRADE.....	312	165 IBM - (ISG) SERVICES.....	323	237 MICROGRAFX.....	17
27 APROTEK.....	454	94 CONCORD TECHNOLOGY CO.....	70	397 IBS.....	312	* MICROIMP INC.....	342
28 ARITY CORPORATION.....	174	95 CONROY-LAPOINTE.....	72, 73	398 IBS.....	312	238 MICROPROCESSORS UNLTD.....	436
29 ARTEK CORP.....	214	96 CONROY-LAPOINTE.....	72, 73	168 INLAB INC.....	432	* MICRORIM INC.....	324, 325
383 ASHTON-TATE.....	20, 21	97 CONROY-LAPOINTE.....	72, 73	169 INMAC.....	163	239 MICROSHOP.....	422
* AT&T COMMUNICATIONS.....	158	98 CORVATEK.....	436	* INTECTRA INC.....	439	* MICROSOFT CORP.....	32 A-H INSERT
* AT&T COMMUNICATIONS.....	159	385 COTTON SOFTWARE INC.....	30	171 INTEGRAND.....	26	* MICROSOFT CORP.....	51
* AT&T INFO. SYS.....	285	102 CUESTA SYSTEMS CORP.....	30	172 INTERCONTN. MICRO SYS.....	131	* MICROSOFT CORP.....	126, 127
* AT&T INTERNATIONAL.....	369	103 CURTIS INC.....	439	173 INTERCONTN. MICRO SYS.....	131	240 MICROWAY.....	249
30 AT&T PHOTO & IMAGING CTR.....	183	104 CUSTOM COMP TECH.....	420	174 INTERFACE GRP. SFT. BUSN.....	407	241 MICROWAY.....	405
31 ATRON CORP.....	336	105 CUSTOM COMP TECH.....	421	175 INTERFACE INC.....	270	* MIX SOFTWARE.....	244
32 ATRONICS INT'L. INC.....	66	106 D AND D DISCOUNT.....	418	176 INTERFACE INC.....	270	242 MOTEL COMPUTERS LTD.....	439
33 AVOCET.....	401	107 DATA EXCHANGE.....	428	* INTERFACE TECH CORP.....	253	243 MOUNTAIN VIEW PRESS.....	164
34 B&B ELECTRONICS.....	424	108 DATA EXCHANGE.....	434	* INTERFACE TECH CORP.....	391	245 NANA USA CORP.....	355
* B&C MICROSYSTEMS.....	424	401 DATA SPEC.....	283	181 ITT INFORMATION SYSTEMS.....	359	246 NANA USA CORP.....	355
* B&C MICROSYSTEMS.....	424	402 DATA SPEC.....	283	182 ITT INFORMATION SYSTEMS.....	359	247 NANTUCKET.....	27
35 BASF SYSTEMS.....	236	110 DIGITALK, INC.....	18	183 IADE COMP. PROD.....	452, 453	248 NANTUCKET.....	27
36 BASIC TIME.....	335	111 DISKETTE CONNECTION.....	363	184 IAMECO ELECTRONICS.....	450, 451	249 NAT'L. PUBLIC DOMAIN SFTW.....	439
37 BASIC TIME.....	335	394 DISKS PLUS.....	320	185 IDR INSTRUMENTS.....	233	250 NATIONAL INSTRUMENTS.....	167
38 BAY TECHNICAL ASSOC.....	23	112 DISK WORLD! INC.....	448, 449	186 IDR MICRODEVICES.....	456, 457	251 NATIONAL MEMORY SYSTEMS.....	299
39 BITTNER ELECTRONICS.....	430	113 DISPLAY TELECOMMNTNS.....	288	187 IDR MICRODEVICES.....	458, 459	252 NEC HOME ELECTR. USA.....	12, 13
450 BIX.....	356, 357	114 DIVERSIFIED COMPUTER SYS.....	434	188 IDR MICRODEVICES.....	460	253 NEC INFORMATION SYS.....	CIII
40 BLAISE COMPUTING INC.....	360	115 DIVERSIFIED GROUP THE.....	440, 441	* ISEA GROUP INC.....	403	* NEWSNET INC.....	16
41 BLAISE COMPUTING INC.....	360	116 DOKAY COMP. PROD. INC.....	433	193 IVB ELECTRONICS.....	426	254 NORTH HILLS CORP.....	454
42 BORLAND INT'L.....	CII, 1	117 EARTH COMPUTERS.....	4	194 KADAK PRODUCTS LTD.....	434	* NRI SCHOOLS ELECTR. DIV.....	337
43 BORLAND INT'L.....	CII, 1	118 EARTH COMPUTERS.....	4	381 KEA SYSTEMS.....	424	255 O'HANLON COMP. SYS.....	307
46 BORLAND INT'L.....	39	147 EAST DIGITAL CO.....	74	195 KEITHLEY DAC.....	454	256 O'HANLON COMP. SYS.....	307
47 BORLAND INT'L.....	39	119 ECOSOFT.....	332	196 KEY SOLUTIONS CO.....	306	257 ORCHID TECHNOLOGY.....	255
48 BROWN BAG SOFTWARE.....	201	120 EDUCATIONAL MICROCOMP. SYS.....	454	197 KEY SOLUTIONS CO.....	306	258 ORION INSTRUMENTS.....	349
92 BTE COMPUTERS.....	68	121 ELEKTEK.....	328	198 KEY TRONIC CORP.....	235	259 PC HORIZONS, INC.....	430
91 BUDGET COMPUTERS.....	436	122 ELEXOR INC.....	432	199 KYOCERA.....	329	260 PACIFIC EXCHANGES.....	426
50 BUKOWSKI ROBOTICS.....	439	123 ELLIS COMPUTING INC.....	77	200 KYOCERA.....	329	261 PANASONIC INDUSTRIAL DIV.....	55
51 BUSINESS TOOLS INC.....	277	124 EMERSON COMP. POWER.....	216	201 LABORATORY MICROSYS.....	308	262 PANASONIC INDUSTRIAL DIV.....	194
* BYTE BACK ISSUES.....	395	125 EMERSON COMP. POWER.....	216	202 LAHEY COMPUTER SYSTEMS.....	187	263 PC NETWORK.....	79
* BYTE MARKETING.....	364, 365	126 ESSENTIAL SOFTWARE INC.....	282	203 LANG-ALLAN, INC.....	314	264 PC NETWORK.....	80, 81
* BYTE SUB. MESSAGE.....	222	128 EVEREX SYSTEMS.....	43	204 LATTICE, INC.....	276	265 PC TECH.....	62
* BYTE SUB. SERVICE.....	346	129 EVEREX SYSTEMS.....	43	205 LAWSON LABS, INC.....	436	266 PC'S LIMITED.....	52, 53
52 BYTE CONNECTION, THE.....	425	130 EXCELTEC INDUSTRIES, INC.....	436	206 LIFEBOAT ASSOC.....	205	267 PC'S LIMITED.....	361
53 BYTEK COMP. SYS. CORP.....	74	131 FACIT AB.....	271	207 LINTEK INC.....	428	268 PECAN SOFTWARE SYS. INC.....	351
* C WARE/DESMET C.....	148	132 FLAGSTAFF ENGINEERING.....	143	210 LOGICAL DEVICES.....	242	269 PERCON.....	434
54 C.I. COMPUTERS.....	48	133 FLAGSTAFF ENGINEERING.....	143	211 LOGICAL DEVICES.....	243	270 PERSOFT INC.....	8
55 C.I. COMPUTERS.....	48					272 PINE COMPUTER INC.....	184
* CALIFORNIA DIGITAL.....	446, 447					273 PLUS DEVELOP. CORP.....	149, 150, 151
56 CANDELARIA WORKS.....	428					276 PRECISION DATA PRODUCTS.....	436
57 CANETICS, INC.....	424					278 PRICE-LINE COMPUTERS INC.....	331
58 CAPITAL EQUIPMENT CORP.....	180					279 PRINCETON GRAPHIC SYS.....	49
60 CAUZIN SYSTEMS.....	294, 295					280 PRINCETON GRAPHIC SYS.....	341
99 CEC.....	322					281 PRINTER ACCESSORIES DIRECT.....	70
61 CENTROID CORP.....	436					282 PRIORITY ONE.....	431
62 CERMETEK MICROELECTRONICS.....	134					283 PROGRAMMER'S SHOP.....	275

.....  
 TO GET FURTHER information on the products advertised in BYTE, either pick up your touch-tone telephone and use TIPS (if you are a subscriber), or fill out the reader service card. Either way full instructions are provided following this reader service index which is provided as an additional service by the publisher, who assumes no liability for errors or omissions. \*Correspond directly with company.



# TODAY IS THE BLACKEST DAY IN DOT MATRIX PRINTER HISTORY.

It would pay you to mark it on your calendar.

Because today is the day we introduce our new Pinwriter™ P5XL dot matrix printer. The only dot matrix printer available capable of producing the rich, black printing you associate with a letter-quality printer. Because it's the only one designed to use a multi-strike film ribbon — the same ribbon used in typewriters and letter-quality printers.

## A LITTLE BLACK MAGIC.

Actual line printed with the  
Pinwriter P5XL printer.

Black letter-quality printing is only the beginning. The Pinwriter P5XL printer can also use an optional ribbon to print in seven other colors. And it has the finest graphics resolution of any impact printer you can buy. Plus it's very fast and exceptionally quiet.

It's only natural that

the first dot matrix printer with true letter-quality printing should be an NEC. After all we make Spinwriter® letter-quality printers, the most popular line today, as well as the Pinwriter P5 dot matrix printer, the most advanced 24-pin printer.

The Pinwriter P5XL printer is part of the most extensive line of 24-pin printers available. You'll find a model designed to fit every need and budget. See them at your dealer or call 1-800-343-4418 (in MA 617-264-8635). Or write: NEC Information Systems, Dept. 1610, 1414 Massachusetts Ave., Boxborough, MA 01719.

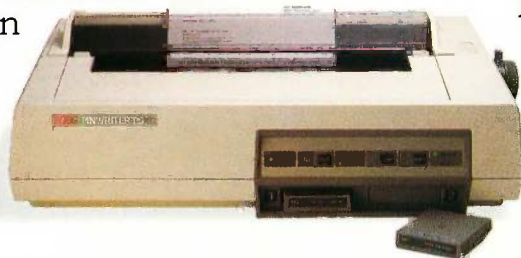

**NEC PRINTERS. THEY ONLY STOP  
WHEN YOU WANT THEM TO.**

# NEC

NEC Information Systems, Inc.

Inquiry 253

# DeskMate® 7-in-1 software makes your Color Computer better than ever.

Now our popular DeskMate® software is available for disk-based Color Computers! DeskMate (26-3259, \$99.95) features seven popular personal-productivity programs—all on one disk! A general-purpose *TEXT* entry and editing program is ideal for writing correction-free letters, memos and short reports. *LEDGER*, a simple spreadsheet program helps you do budgeting, sales forecasting, profit-

and-loss projections and other "What if...?" calculations. Using the four-color *PAINT* picture editor,



LEDGER

The *INDEX CARDS* personal filing system lets you enter and edit data and perform simple sorts and searches. It's ideal for keeping track of



TELECOM

names and addresses. *TELECOM* gives you access to national information services, plus transmits



INDEX CARDS

and receives files from other computers by phone (requires modem). A simple monthly calendar program displays "to do's" for any date. *CALENDAR* is an easy way to organize your day. A four-function *CALCULATOR* is also available within the operations of any application.



TEXT EDITOR

With DeskMate, you get the power of seven programs for one low price! Come in today.

If you don't already have a disk drive for your Color Computer, you can add one for just \$299 (26-3131). The 5 1/4" thinline floppy drive plugs into your Program Pak® port for over 156,000 characters of storage. Add a second drive at any time, too.



CALENDAR

**Radio Shack®**  
The Technology Store™

A DIVISION OF TANDY CORPORATION

Prices apply at Radio Shack Computer Centers and participating stores and dealers. DeskMate/Registered TM Tandy Corp.

Inquiry 293

