

# BYTE

THE SMALL SYSTEMS JOURNAL

OCTOBER 1984 VOL. 9, NO. 11

\$3.50 IN UNITED STATES  
\$4.25 IN CANADA / £2.10 IN U.K.  
A MCGRAW-HILL PUBLICATION  
0360-5280

**DATABASES**



ROBERT  
S. TINNEY





# Announcing a small imp

It's 12" x 11¼" x 2¼"

It weighs less than 8 pounds.\*

And costs less than \$1,300.\*\*

Yet with 128K, the new Apple® IIc Personal Computer is a lot bigger than it looks.

*The IIc has a full size keyboard.*



Because it's inherited all the talents of the eminently talented Apple IIe:

The versatility to run over 10,000 different software programs.

The ironclad reliability of the first true VLSI motherboard.

And the artistic ability of 16 high-resolution colors.

The IIc also has some talents of its very own.

For instance, a switchable 80/40-character display.

Switchable QWERTY/Dvorak keyboard.

A built-in half-high 143K single-sided disk drive.

Built-in serial ports for modems, printers and an extra half-high drive.

Even built-in mousetronics so it's ready to use a mouse and all the new Apple II mouseware.

And our newest brainchild is certainly not an orphan.

You can grow it with a whole family of Apple II accessories and peripherals.



*Thin, isn't it? Even with its built-in disk drive.*





# Improvement on the Apple IIe.

Including the new Apple Scribe—Apple's first full-color print-on-anything printer for under \$300, it can handle anything from business graphics to term papers.

The IIc's father, of course, is the granddaddy of the whole personal computer industry, the Apple IIe. Which, lest we forget, has quite a few improvements of its own this year.

The IIe can now use our ProFile™ hard disk—so it can store about 2400

pages of anything you'd like to remember.

And the Apple IIe is still the most expandable personal computer there is.



*Built-in ports for making all the right connections.*

You can increase its RAM to an elephantine 512K. Add a Z-80 card to run CP/M.\*\*

In fact, you can grow it with enough cards and peripherals to run just about any family business. Like Saudi Arabia.

So you see, the only question is whether you need an expandable Apple II. As in IIe.

Or a compact Apple II. As in IIc.

Just visit your friendly authorized Apple dealer.

And tell them what size improvement you'd like.



\* Don't asterisks make you suspicious as all get-out? Well, all this one means is that the IIc CPU alone weighs 7.5 pounds. The power pack, monitor, an extra disk drive, a printer and several bricks will make the IIc weigh more. Our lawyers were concerned that you might not be able to figure this one out for yourself. \*\* The FTC is concerned about price fixing. So this is only a Suggested Retail Price. You can pay more if you really want to. Or less. © 1984 Apple Computer, Inc. Apple, the Apple logo and ProFile are trademarks of Apple Computer, Inc. CP/M is a trademark of Digital Research Inc. For an authorized Apple dealer nearest you, call (800) 538-9696. In Canada, call (800) 268-7796 or (800) 268-7637.



# CONTENTS

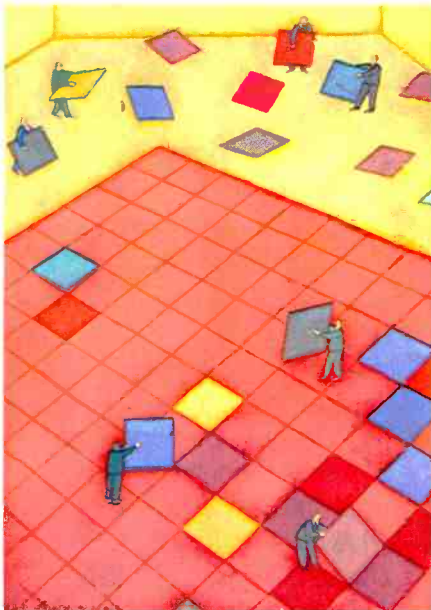

## FEATURES

<b>INTRODUCTION</b> .....	107
<b>THE IBM PC AT</b> <i>by BYTE Staff</i> .....	108
IBM's latest offering provides powerful hardware with a split personality.	
<b>CIARCIA'S CIRCUIT CELLAR: AN ULTRASONIC RANGING SYSTEM</b> <i>by Steve Ciarcia</i> .....	112
Build your own SonarTape to measure distances from 1½ to 35 feet using sound waves.	
<b>USING A MOUSE WITH LOTUS 1-2-3</b> <i>by John Doolittle</i> .....	124
You can write a driver to adapt a Microsoft mouse for use with this popular interactive software package and other programs.	
<b>IMPLEMENTING CRYPTOGRAPHIC ALGORITHMS ON MICROCOMPUTERS</b> <i>by Charles Kluepfel</i> .....	126
The muMath/muSimp package lets you build 200-digit cryptographic keys on an Apple.	
<b>GENERATING AND TESTING PSEUDORANDOM NUMBERS</b> <i>by Charles A. Whitney</i> .....	128
When you want to analyze haphazard occurrences, some random-number generators may be more useful than others.	
<b>DATA ABSTRACTION</b> <i>by Gary F. Simons</i> .....	130
A BASIC program illustrates abstraction techniques that let you manipulate data structures without concern for the type of data that will populate these structures.	

## THEME: DATABASES

<b>INTRODUCTION</b> .....	135
<b>DATABASE TYPES</b> <i>by Rich Krajewski</i> .....	137
There's more than one way to manage information.	
<b>TEXT DATABASES</b> <i>by Ezra Shapiro</i> .....	147
Integrating database and editing functions simplifies the creative process.	
<b>THE DAYFLO ARCHITECTURE</b> <i>by Robert W. Atkins and Walter L. Mazur</i> .....	155
Two DayFlo designers describe the internal workings of a free-form word-oriented database.	
<b>LOW-COST ON-LINE DATABASES</b> <i>by Matthew Lesko</i> .....	167
Using your computer to track down information doesn't have to be expensive.	
<b>THE PICK OPERATING SYSTEM, PART I: INFORMATION MANAGEMENT</b> <i>by Rick Cook and John Brandon</i> .....	177
This information-oriented operating system has a built-in relational database and multiuser capabilities.	
<b>ADDING A HARD DISK</b> <i>by Roy M. Matney</i> .....	203
An engineer discusses kits, components, and expansions for the IBM PC.	
<b>OPTICAL MEMORY: DATA STORAGE BY LASER</b> <i>by Edward S. Rothchild</i> .....	215
The technology continues to develop, and erasable media may soon be available.	
<b>A DATABASE CATALOG</b> <i>by George Bond</i> .....	227
This survey of 47 database-management programs may lead you to the system you need.	

## REVIEWS

<b>INTRODUCTION</b> .....	243
<b>REVIEWER'S NOTEBOOK</b> <i>by Rich Malloy</i> .....	245
BYTE's product-review editor comments on XyWrite, two IBM compatibles, and more.	

BYTE is published monthly by McGraw-Hill Inc. Founder: James H. McGraw (1860-1948). Executive, editorial, circulation, and advertising offices: 70 Main St., Peterborough, NH 03458. phone (603) 924-9281. Office hours: Mon-Thur 8:30 AM - 4:30 PM, Friday 8:30 AM - 1:00 PM. Eastern Time. Address subscriptions to BYTE Subscriptions, POB 590, Martinsville, NJ 08836. Postmaster: send address changes. USPS Form 3579, undeliverable copies, and fulfillment questions to BYTE Subscriptions, POB 596, Martinsville, NJ 08836. Second-class postage paid at Peterborough, NH 03458 and additional mailing offices. USPS Publication No. 528890 (ISSN 0360-5280). Postage paid at Winnipeg, Manitoba. Registration number 9321. Subscriptions are \$21 for one year, \$38 for two years, and \$55 for three years in the USA and its possessions. In Canada and Mexico, \$23 for one year, \$42 for two years, \$61 for three years. \$69 for one year air delivery to Europe, 17,100 yen for one year surface delivery to Japan, \$37 surface delivery elsewhere. Air delivery to selected areas at additional rates upon request. Single copy price is \$3.90 in the USA and its possessions, \$3.95 in Canada and Mexico, \$4.50 in Europe, and \$5 elsewhere. Foreign subscriptions and sales should be remitted in United States funds drawn on a U.S. bank. Please allow six to eight weeks for delivery of first issue. Printed in the United States of America.



<b>THE FUJITSU MICRO 16s</b> by Alex Pournelle .....	246
Adaptability is the system's greatest strength.	
<b>THE PANASONIC SR. PARTNER</b> by Rich Malloy .....	254
This IBM PC-compatible portable packs its own printer.	
<b>VOLKSWRITER DELUXE</b> by Sievanne Ruth Lehrman .....	263
Lifetree Software's new package for the IBM PC is a serious word processor that's easy to use.	
<b>HOMEWORD AND CUT &amp; PASTE</b> by Keith Carlson .....	271
Both these word processors, intended for home use, are cheaper and simpler to use than those designed for the office, and both run on the Apple II series.	
<b>CLOUT AND SALVO</b> by George Bond .....	279
Two natural-language query programs for the IBM PC attempt to simplify the task of data retrieval.	
<b>DATAEASE VS. CONDOR AND dBASE II</b> by Bill Jacobson .....	289
Find out how the menu-driven program compares to two command-driven programs.	
<b>REVIEW FEEDBACK</b> .....	306
Readers respond to previous reviews.	

## KERNEL

<b>INTRODUCTION</b> .....	315
<b>COMPUTING AT CHAOS MANOR: MINOR PROBLEMS</b> by Jerry Pournelle .....	317
Jerry resolves a difficulty with his CompuPro 8/16 and goes on to report on a wide array of hardware and software.	
<b>CHAOS MANOR MAIL</b> .....	346
Jerry's readers write, and he replies.	
<b>BYTE WEST COAST: FIDONET, SIDEKICK, APPLE, GET ORGANIZED!, AND HANDLE</b> by John Markoff and Ezra Shapiro .....	357
Two California-based editors comment on homebrew electronic mail, some integrated software, and other tidbits.	
<b>BYTE JAPAN: BITS AND PIECES</b> by William M. Raike .....	369
Highlights from the Japanese computing scene include news on the Hitachi CMOS 68000, the Brother EP-44, and the Casio FP-6000.	
<b>BYTE U.K.: POP AND SNAP</b> by Dick Pountain .....	381
Two artificial-intelligence languages offer alternatives to LISP and Prolog.	

<b>EDITORIAL: THE CHALLENGE OF THE HOME COMPUTER</b> .....	6	<b>BOOK REVIEWS</b> .....	65
<b>MICROBYTES</b> .....	9	<b>EVENT QUEUE</b> .....	89
<b>LETTERS</b> .....	14	<b>BOOKS RECEIVED</b> .....	468
<b>FIXES AND UPDATES</b> .....	33	<b>UNCLASSIFIED ADS</b> .....	525
<b>WHAT'S NEW</b> .....	39, 473	<b>BYTE'S ONGOING MONITOR BOX, BOMB RESULTS</b> .....	526
<b>ASK BYTE</b> .....	48	<b>READER SERVICE</b> .....	527
<b>CLUBS AND NEWSLETTERS</b> .....	59		

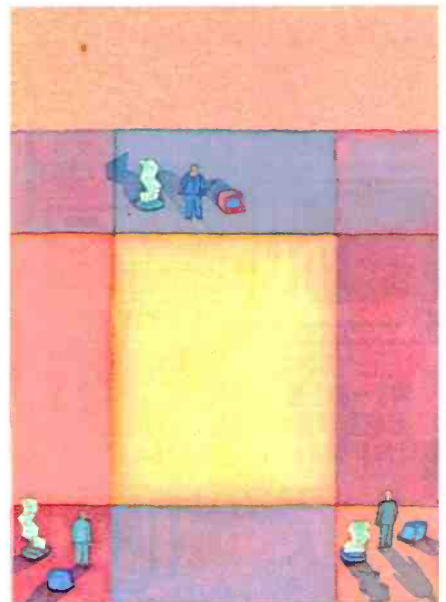

Address all editorial correspondence to the Editor, BYTE, POB 372, Hancock, NH 03449. Unacceptable manuscripts will be returned if accompanied by sufficient first-class postage. Not responsible for lost manuscripts or photos. Opinions expressed by the authors are not necessarily those of BYTE. Copyright © 1984 by McGraw-Hill Inc. All rights reserved. Trademark registered in the United States Patent and Trademark Office. Where necessary permission is granted by the copyright owner for libraries and others registered with the Copyright Clearance Center (CCC) to photocopy any article herein for the flat fee of \$1.50 per copy of the article or any part thereof. Correspondence and payment should be sent directly to the CCC, 29 Congress St., Salem, MA 01970. Specify ISSN 0360-5280/83 \$1.50. Copying done for other than personal or internal reference use without the permission of McGraw-Hill Inc. is prohibited. Requests for special permission or bulk orders should be addressed to the publisher. BYTE is available in microform from University Microfilms International, 300 North Zeeb Rd., Dept. PR, Ann Arbor, MI 48106 or 18 Bedford Row, Dept. PR, London WC1R 4EJ, England.

Subscription questions or problems should be addressed to: BYTE Subscriber Service, POB 328, Hancock, NH 03449





# MicroTime



**800-MICRO 84**

**PC-150**



**ZENITH**  
THE BEST IBM®  
COMPATIBLE

**LOWEST  
PRICES**

**FREE  
SERVICE  
BY ZENITH  
FOR 90 DAYS**



**PC-160**

**WE SPECIALIZE IN  
SYSTEM SALES AND  
CAN PROVIDE BOTH  
HARD AND SOFTWARE  
SUPPORT FOR MOST  
POPULAR COMPUTERS  
AND PERIPHERALS**



**ALL  
MODELS  
FAST  
DELIVERY**

**MS-DOS**



**ALL MODELS**

**CALL FOR LOWEST  
PRICES ON ALL  
COMPUTER PRODUCTS**

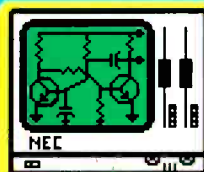

**NEC APC  
HI-RES  
COLOR  
GRAPHICS**



**BERNOULLI  
10-20 MEG**



**COMPAQ**

**COLUMBIA  
FRANKLIN  
EAGLE**



**ADD-ONS**



**DIABLO  
PRINTER  
SPECIALS**

**800-642-7684  
IN ARIZONA 602-791-9030**

IBM is a registered trademark of International Business Machines, Corp.

411 West Grant Road  
Tucson, Arizona 85705



# BYTE

**EDITOR IN CHIEF**

PHILIP LEMMONS  
**MANAGING EDITOR**  
GENE SMARTE  
**CONSULTING EDITORS**  
STEVE CIARCIA  
JERRY POURNELLE

**SENIOR TECHNICAL EDITORS**

RICHARD MALLOY, *Reviews*  
G. MICHAEL VOSE, *Features*  
GREGG WILLIAMS

**TECHNICAL EDITORS**

THOMAS R. CLUNE  
GLENN HARTWIG  
RICHARD KRAJEWSKI  
BRUCE ROBERTS  
KEN SHELTON  
RICHARD S. SHUFORD  
JANE MORRILL TAZELAAR  
STANLEY WSZOLA  
MARGARET COOK GURNEY, *Associate*  
ALAN EASTON, *Drafting*

**WEST COAST EDITORS**

EZRA SHAPIRO, *Bureau Chief, San Francisco*  
JOHN MARKOFF, *Senior Technical Editor, Palo Alto*  
PHILLIP ROBINSON, *Senior Technical Editor, Palo Alto*  
DONNA OSGOOD, *Associate Editor, San Francisco*  
BRENDA MCLAUGHLIN, *Editorial Assistant, San Francisco*

**MANAGING EDITOR, USER NEWS**

GEORGE BOND  
**USER NEWS EDITORS**  
ANTHONY J. LOCKWOOD, *What's New*  
MARK WELCH, *Microbytes*

**CONTRIBUTING EDITORS**

DENNIS ALLISON, *at large*  
MARK DAHMKE, *video, operating systems*  
MICHAEL W. ECKER, *mathematical recreations*  
RIK JADRNICEK, *CAD graphics, spreadsheets*  
MARK KLEIN, *communications*  
ALAN MILLER, *languages and engineering*  
DICK POUNTAIN, *UK*  
WILLIAM M. RAIKE, *Japan*  
PERRY SAIDMAN, *computers and law*  
ROBERT STERNE, *computers and law*  
BRUCE WEBSTER, *software*  
RICHARD WILLIS, *at large*

**COPY EDITORS**

ELIZABETH R. COOPER, *Chief*  
DENNIS BARKER  
ANNE L. FISCHER  
NANCY HAYES  
LYNNE M. NADEAU  
PAULA NOONAN  
JOAN V. ROY  
BUD SADLER  
WARREN WILLIAMSON

**ASSISTANTS**

PEGGY DUNHAM  
MARTHA HICKS  
BEVERLY JACKSON  
FAITH KLUNTZ, *Copyrights and Permissions*  
LISA JO STEINER

**ART**

ROSSLYN A. FRICK, *Art Director*  
NANCY RICE, *Assistant Art Director*

**PRODUCTION**

DAVID R. ANDERSON, *Associate Director*  
DENISE CHARTRAND  
MICHAEL J. LONSKY  
JAN MULLER  
SHERRY MCCARTHY, *Chief Typographer*  
NAN FORNAL  
LEN LORETTE  
LEILA MATTSOON  
DONNA SWEENEY

**Editorial and Business Office:** 70 Main Street, Peterborough, New Hampshire 03458, (603) 924-9281  
**West Coast Offices:** McGraw-Hill, 425 Battery St., San Francisco, CA 94111, (415) 362-4600  
McGraw-Hill, 1000 Elwell Court, Palo Alto, CA 94303, (415) 964-0624.

Officers of McGraw-Hill Publications Company: President, John G. Wrede; Executive Vice Presidents: Paul F. McPherson, Operations; Walter D. Serwatka, Finance & Services; Senior Vice President-Editorial: Ralph R. Schulz; Senior Vice President-Publishers: Harry L. Brown, David J. McGrath, James R. Pierce, Gene W. Simpson, John E. Slater; Vice President-Publishers: Charlton H. Calhoun III, Richard H. Larsen, John W. Patten; Vice Presidents: Kemp Anderson, Business Systems Development; Shel F. Asen, Manufacturing; John A. Bunyan, Electronic Information Services; George R. Elinger, Circulation; Michael K. Hehir, Controller; Eric B. Herr, Planning and Development; H. John Sweger, Jr., Marketing; Virginia L. Williamson, Business Development.

Officers of the Corporation: Harold W. McGraw Jr., Chairman; Joseph L. Dionne, President and Chief Executive Officer; Robert N. Landes, Senior Vice President and Secretary; Ralph J. Webb, Treasurer.

**PUBLISHER**

GENE W. SIMPSON  
**ASSOCIATE PUBLISHER/PRODUCTION DIRECTOR**  
JOHN E. HAYES  
**PUBLISHER'S ASSISTANT**  
DORIS R. GAMBLE

**ADVERTISING SALES**

J. PETER HUESTIS, *Sales Manager*  
SANDRA FOSTER, *Administrative Assistant*

**ADVERTISING**

DEBORAH PORTER, *Supervisor*  
MARION CARLSON  
ROB HANNINGS  
JEANNA REENSTIARNA  
LISA WOZMAK  
WAI CHIU LI, *Quality Control Manager*  
JULIE NELSON, *Advertising/Production Coordinator*  
LINDA J. SWEENEY, *Advertising/Production Coordinator*

**CIRCULATION**

GREGORY SPITZFADEN, *Director*  
ANDREW JACKSON, *Subscriptions Manager*  
CATHY A. R. DREW, *Assistant Manager*  
PHIL DECHERT  
MARY EMERSON  
LOUISE MENEGUS  
AGNES E. PERRY  
JENNIFER PRICE  
JANE VARNUM  
JAMES BINGHAM, *Single-Copy Sales Manager*  
LINDA TURNER, *Assistant Manager*  
CAROL AHO  
CLAUDETTE CARSWELL  
EDSON WARE

**MARKETING COMMUNICATIONS**

HORACE T. HOWLAND, *Director*  
DOUG WEBSTER, *Director of Public Relations*  
VICKI REYNOLDS, *Marketing Associate*  
PRISCILLA ARNOLD, *Marketing Assistant*  
STEPHANIE WARNESEY, *Graphic Arts Supervisor*  
SHARON PRICE, *Graphic Arts Designer*  
MICHELE P. VERVILLE, *Research Manager*  
PATRICIA AKERLEY, *Market Research Analyst*  
CYNTHIA DAMATO SANDS, *Reader Service Coordinator*

**ACCOUNTING**

DANIEL RODRIGUES, *Business Manager/Controller*  
KENNETH A. KING, *Assistant Controller*  
MARY E. FLUHR, *Accounting & D/P Manager*  
KAREN BURGESS  
LYDA CLARK  
MARILYN HAIGH  
DIANE HENRY  
VERN ROCKWELL  
LINDA SHORT  
JOANN WALTER  
VICKI WESTON

**TRAFFIC**

N. SCOTT GAGNON, *Manager*  
ANTHONY BENNETT  
BRIAN HIGGINS

**RECEPTIONISTS**

L. RYAN MCCOMBS  
DENISE A. PROCTOR

**PERSONNEL/OFFICE MANAGER**

CHERYL A. HURD



# 68000-based systems. Just tell us what you need.

## 68000-based systems to fit your application.

Right from the pages of our catalog, we can deliver 68000-based supermicro systems to match virtually any application.

Including yours.  
Here's how.

Built on the IEEE-696 (S-100) bus, Cromemco systems offer up to 21 board slots. And a family of 35 boards — CPU, memory and specialized I/O — to fill the slots any way you choose.

At the heart of each system is our 68000/Z-80 dual processor. Backed by as much as 16 Mb of error-correcting RAM. Full multi-tasking capability. I/O to handle up to 16 terminals.

And that's just the beginning. You can select single or dual floppies, 5¼" or 8" A 50 Mb 5¼" Winchester hard disk. And a nine-track tape drive.

We can accommodate your taste for the exotic, too. With boards like our SMD interface that supports up to 1200 Mb of disk storage. A fast floating-point processor. A color graphics interface. A TV camera digitizer. An IEEE-488 bus interface. Communications. And more.

## Intelligent workstations.

Then, if you're designing a distributed processing system, you'll want to take a look at our C-10 personal computer. The Z-80-based C-10 can serve our 68000-based systems

as a powerful intelligent workstation in a distributed processing mode. Or as an independent personal computer with its own floppy storage.

## High-level languages and applications software.

That brings us to software. It starts with CROMIX<sup>®</sup>, our UNIX<sup>™</sup>-like operating system that you're free to tailor to your application.

CROMIX can execute both 68000- and Z-80-based programs. So right along with your 68000-based packages, your system will accommodate a wide selection of CP/M<sup>®</sup> software written for the Z-80.

And our high-level language support is second to none. From a 68000 Macro Assembler. To 68000 FORTRAN 77, PASCAL, GSA-certified high-level COBOL, C and BASIC.

## Cromemco means business. Your business.

You see, when we say, "Just tell us what you need?" we're not kidding.

You won't find another family of 68000-based microcomputers that can fit your needs as exactly as ours.

So if you're in the business of providing specialized computing solutions, you really should be doing business with Cromemco.

For a copy of our Systems Catalog, contact: Cromemco, Inc., 280 Bernardo Avenue, P.O. Box 7400, Mountain View, CA 94039. (415) 964-7400.

In Europe: Cromemco GmbH, 6236 Eschborn 1, Frankfurter Str. 33-35, P.O. 5267, Frankfurt Main, Germany or Cromemco Ltd., The Cambridge House, 173-182 Upper Richmond Rd., Putney, London SW15 England.

# Cromemco<sup>®</sup>

\* Cromemco and CROMIX are registered trademarks of Cromemco, Inc. <sup>™</sup> UNIX is a trademark of Bell Laboratories. <sup>®</sup> CP/M is a registered trademark of Digital Research. ©1983, Cromemco, Inc.

Circle 36 on Inquiry card.

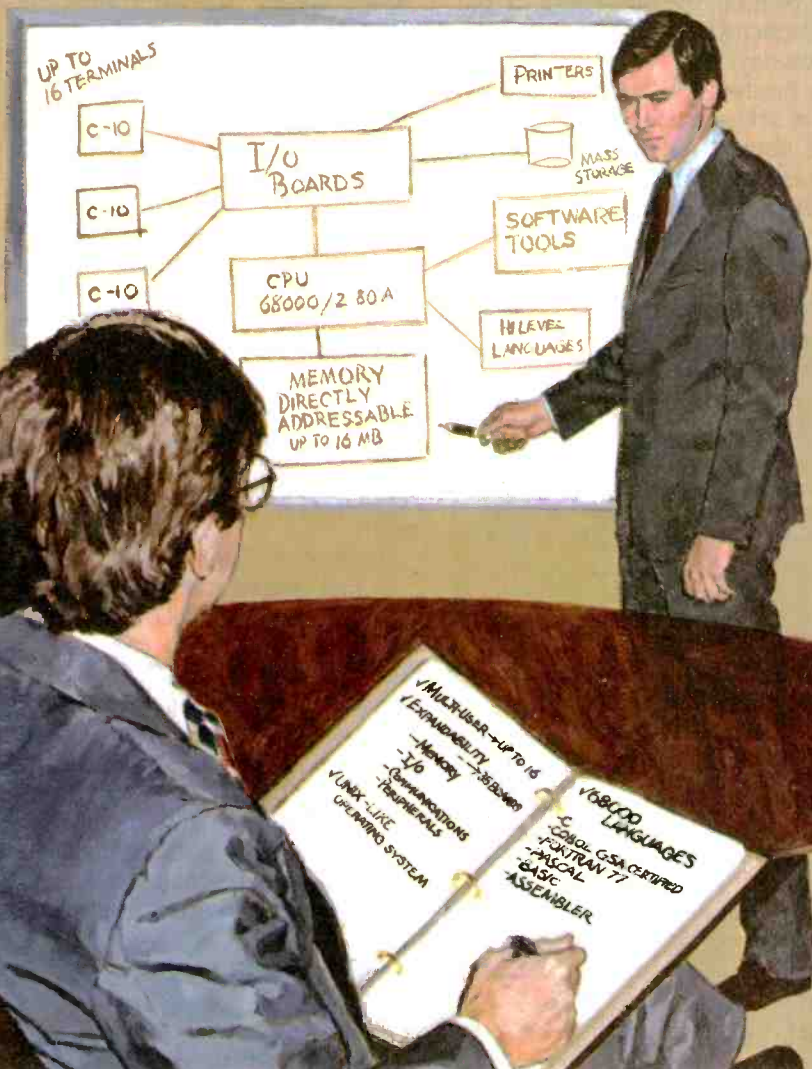



## THE CHALLENGE OF THE HOME COMPUTER

Almost all major makers of personal computers have concentrated on the business market and on its most obvious applications. From the moment when VisiCalc made the Apple II useful in business, computer makers and software houses changed their blue jeans and sandals for gray flannels and wingtips. There was nothing wrong about this. Business applications were the things that could be done easily for the dollars that were available and with the technology that was available.

Unfortunately, the rush to the business market somehow tainted the home computer. Some people forgot that the problem was with the technology available for the dollars the home could afford—not with the concept of the home computer. The edu-

cational and entertainment value of today's home computers makes them hot consumer items for many people but is not sufficient to make the home computer a universal appliance. Neither technology nor economics is yet ready for that.

Home computers must advance by a generation before they will be useful, friendly, and entertaining enough for everyone. At the prices of today's Commodore 64, home users will need the computing power of 32-bit processors, a megabyte or more of memory, and compact but high-capacity and high-speed mass-storage devices.

This hardware will be necessary to run the software required for success in the home. The software must be multitasking, highly integrated, and very friendly. It must do something useful and entertaining for every member of the family. It must elimi-

nate much domestic drudgery: scheduling vacations, holidays, medical appointments, and social events; handling business and personal communications; managing finances and keeping records; helping with school work and with work brought home from the office; and providing access to important reference works. Perhaps most important, the home computer must be able to learn by observing, to acquire expertise in the family's interests and needs.

Curiously, the successful home computers of tomorrow may resemble today's revered AI research machines. These often have 3½ megabytes of RAM, 32-bit processors, very high resolution graphics, and large Winchester disks.

Similar developments in home computers may seem distant indeed. But Philips and Sony are both working on 800-megabyte optical-storage devices based on compact audio disks. Production 256K-bit RAMs will soon abound, and megabit chips are on the horizon. Several 32-bit microprocessors are here or soon will be. And some AI researchers say we are very, very close to creating software that learns.

These developments won't have their first commercial applications in the home, but they will one day make the home computer a universal appliance. Today's pause in the sales of personal computers gives manufacturers a chance to confront the challenge of developing successful home computers, opening a vast market, and enriching the lives of millions. Let's hope someone will be ready to meet the challenge as soon as technology and economics permit.

—Phil Lemmons, Editor in Chief

## THE BIRTH OF BYTENET

In September, BYTE started a project in computer conferencing as a means of enhancing the content of the magazine. The 200 participants, to whom we are providing free connect time for the months of this experiment, include about 100 of our subscribers chosen by lot (many in a drawing at the BYTE Computer Show in San Francisco), several of our authors, and other people interested in personal computing. The first conferences will discuss Macintosh, the IBM AT, BYTE Reviews, Ciarcia's Circuit Cellar, Pournelle's Computing at Chaos Manor, and other topics. Steve Ciarcia and Jerry Pournelle will be among the participants, as will Bill Raike, our man in Tokyo, and Asao Ishizuka of Nikkei BYTE.

We believe that this project will lead to enhancements in the content of the magazine. It will keep us in closer touch with the interests of our readers and will help us learn the best ways to use electronic communications in conjunction with our traditional print publication. We'll let you know about new developments in this area as soon as we can.

As a service to all subscribers, we are making some listings from BYTE articles available on a bulletin board that we call Baby BYTenet. The number is 603-924-9820. For the present, there is only one telephone line available, and users must bear their own long-distance charges.

For those not yet participating in BYTE electronic communications, please write us about your interests and needs in telecommunications.

**OVER 15 COPIES NOW IN USE AT  
LAWRENCE LIVERMORE NATIONAL LABORATORIES**

(Also used at Polaroid, General Motors, Westinghouse, 3M, ITT, Reynolds Metal, Ernst Whitney, Owens Corning, Amoco, Christensen Diamond Products ... etc.)

# DATAVU™ Plus

**A COMPLETE INFORMATION MANAGEMENT FACILITY**

**It constructs and customizes your  
own menu-driven application software.**

## Featuring:

### 1. Automatic Screen Design

Multi-page Free Form / Calculated Fields /  
Search Fields / Wildcard & Continuous Search /  
User Definable Function Keys

### 2. Relational DBM

Select / Joint / Sort / Index / Add / Change / Delete, etc.

### 3. Report Generation

Multiple File Data Retrieval / Calculations /  
Posting / Over 30 Format Commands

### 4. Automatic Menu Generation

Free Form Multi-page / Batch Processing

### 5. File Maintenance Programs

Multi Key Sort / Post / Reformat / Merge / Compress

# DATAVU™ Plus

## What They Say

At Lawrence Livermore  
National Laboratories:

*"After many frustrating days and nights with dBase II, Easyfiler's labyrinthian manual, Lotus' anemic macro feature and other so-called full featured programs, I have found Thinkers' Soft's DATAVU Plus for the IBM PC."*

*"I have built several large databases with DATAVU and many people have used these packages with little or no trouble. If you are considering building a database, whether it be small or large, DATAVU offers an attractive solution."*

From June 1984  
Personal Computer News  
By Brian Morgan  
Lawrence Livermore Laboratories  
(Free copy on request.)

**DATAVU™ Plus needs no utility or  
program enhancements for ease of operation.  
It is a complete software package.**

**FREE!**  
inventory  
management system  
with the purchase  
of DATAVU™ Plus.

**Disks & User's Manual**

**\$250**

plus \$7.50 for U.S. & Canada shipping and handling. \$20 for overseas air shipping. American Express, Visa and Mastercard Accepted.

### Available for

CP/M<sup>1</sup>-80: DEC Rainbow, Kaypro, NEC, Sanyo, Heath 89/Z100, Epson Qx-10, Micro Decision, North Star, Osborne, Xerox, Apple II CP/M, Televideo, Superbrain, Eagle.

CP/M<sup>1</sup>-86

MS-DOS<sup>2</sup>: Wang (PC), DEC Rainbow, Heath, Zenith  
IBM PC DOS

**Thinkers' Soft, Inc.** P.O. Box 221, Garden City, NY 11530 (516) 294-8104

<sup>1</sup>CP/M is a registered trademark of Digital Research, Inc., <sup>2</sup>MS-DOS is a registered trademark of Micro-Soft, Inc.



# SEEQUA SHOWS YOU HOW TO GET AN IBM PC FOR JUST \$1595.

## BUY A CHAMELEON BY SEEQUA.



The Chameleon by Seequa does everything an IBM PC does. For about \$1000 less than an IBM.

The Chameleon lets you run popular IBM software like Lotus® 1-2-3™ and dBase II.® It has a full 83 key keyboard just like an IBM. A disk drive like the IBM. And a bright 80 × 25 character screen just like an IBM.

But it's not just the Chameleon's similarities to the IBM that should interest you. Its advantages should, too. The Chameleon also has

an 8 bit micro-processor that lets you run any of the thousands of CP/M-80® programs available. It comes complete with two of the best programs around, Perfect Writer™ and Perfect Calc.™ It's portable. And you can plug it in and start computing the moment you unwrap it.

So if you've been interested in an IBM personal computer, now you know where you can get one for \$1595. Wherever they sell Chameleons.

### The Chameleon by



**SEEQUA**  
**COMPUTER**  
**CORPORATION**

8305 Telegraph Road  
Odenton, MD 21113

Chameleon shown with optional second disk drive.

To learn more about Seequa or for the location of the Seequa dealer nearest you, call (800) 638-6066 or (301) 672-3600.

IBM is a registered trademark of International Business Machines Corporation.

## **Data General Unveils 9-pound Portable Computer**

Data General planned to introduce its Data General/One in late September. The computer includes a CMOS 8088 microprocessor, 128K bytes of CMOS RAM (expandable to 512K), a 640- by 256-pixel liquid-crystal display (7½ by 10¼ inches) with full-height characters, and two RS-232C serial ports, one of which is also RS-422A compatible. Functionally compatible with the IBM PC, the DG/One will be priced at less than \$3000 with one 720K-byte 3½-inch floppy-disk drive and room for a second drive and for a 300-bps modem. An optional external 5¼-inch disk drive and a portable printer are also available.

## **IBM Announces PC AT, Network**

The Personal Computer AT is an 80286-based computer using PC-DOS 3.0, a 1.2-megabyte floppy-disk drive, and an optional 20-megabyte hard disk. The base machine with one floppy-disk drive and 256K bytes of memory is priced at \$3995; with 512K bytes and a hard disk, the price is \$5795. The display adapter and monitor are not included. The AT is compatible with the IBM PC but can also use expansion cards using an extended 16-bit bus. IBM also announced Topview, a multitasking windowing environment that can run MS-DOS 1.0 or 2.0 programs, and the PC Network, a broadband local-area network for the IBM PC, PC XT, and AT. (See page 108 for more information.)

## **Commodore Will Not Advertise Vaporware, Buys Amiga**

The Federal Trade Commission and Commodore Business Machines signed a consent agreement in August, under which Commodore agreed not to advertise capabilities that don't yet exist. Commodore had advertised CP/M capabilities for its Commodore 64 computer long before its optional Z80 coprocessor was available.

The FTC says it will investigate any companies that advertise capabilities or products that are not ready at the time the ad is run. (A company may advertise planned products if the ad mentions that the product is not yet available.) The FTC efforts will not apply to company announcements of product plans, unless paid ads are run.

Meanwhile, in England, Sinclair Research agreed not to make unrealistic claims about delivery dates for new products, following complaints under Great Britain's Fair Trading and Trade Descriptions Acts. Sinclair missed delivery schedules following introduction of each of its computers in England, including the recently announced QL.

Commodore has purchased Amiga Corp., which has developed a 68000-based microcomputer with a custom-graphics coprocessor. Amiga had planned to sell the machine for less than \$1500. Shortly before the sale was announced, Atari sued Amiga, charging that the sale to Commodore violates agreements between Atari and Amiga through which Atari would have licensed the Amiga computer technology. Earlier, Amiga had sold its joystick line to Pride Electronics, which manufactures the joysticks.

## **IBM, DEC Announce Artificial-Intelligence Products**

IBM displayed a number of products at the National Conference on Artificial Intelligence in August. It showed versions of the LISP and Prolog programming languages for the IBM 370; Scratchpad II, software that allows algebraic information to be entered directly on the screen instead of requiring a computer program; PRISM, an experimental expert system "shell"; and Handy, an IBM PC-based tool that can be used as an interface for AI applications.

Digital Equipment Corporation also displayed new third-party products at the conference. For the Rainbow 100 computer, DEC showed Gold Hill's GCLISP and Prologia's PROLOG II. DEC also showed products for its VAX and PDP-11 computers, including Inference Corporation's Automated Reasoning Tool, for developing expert systems; Interlisp, a LISP-based programming environment; PLUME, a tool for constructing natural-language database interfaces; and SRL+, an environment for developing expert systems.

*(continued)*



## Tabor Adds 3½-inch Drive

Tabor Corporation, Westford, MA, is now making a 3½-inch floppy-disk drive in addition to the 3¼-inch drive that was its only product for the past year. Tabor and Dyan Corp. had sought to make the 3¼-inch soft-jacket disk the standard microfloppy, but major computer makers—including Apple and Hewlett-Packard—chose the 3½-inch hard-jacket disk and drive instead.

Tabor says it will continue to support the 3¼-inch drive and that several manufacturers are shipping computers using the drives. However, only one company sells a microcomputer using the 3¼-inch drive. Seequa began shipping the Seequa 325, similar to its IBM-compatible Chameleon portable computer, in August, but a spokesman said that the 3¼-inch disk version would be manufactured in quantity only if demand is present. "We're not betting the farm on it," he said.

Two other companies had announced machines using the 3¼-inch drives. Educational Microcomputer Systems says its product is on hold while it is converted to use 3½-inch disk drives instead. General Scientific Corporation says it is shipping workstations with 3¼-inch drives but in limited quantity because of the small market for its PDP-11/23-based product.

Micro Peripherals Inc. had begun manufacturing 3¼-inch drives under a license from Tabor, but it has since discontinued them due to a lack of interest. Seagate also licensed the 3¼-inch drive but has not produced any. Dyan, which makes 3¼-, 5¼-, and 8-inch floppy disks, said it would publish popular MS-DOS software titles on 3¼-inch disks this spring. Instead, Dyan began selling the software in August for the Seequa 325 only.

## NANOBYTES

**Microsoft** will unveil version 2.0 of its BASIC for the Macintosh. The new version will be priced well under \$200, with upgrades available to those who bought the earlier BASIC. Among the changes are sound and music capabilities, multiple output windows, pull-down menu design, structured programming features, optional use of line numbers, and access to Quickdraw graphics routines from BASIC. . . . **Verbex** plans to unveil a continuous speech-recognition workstation this month. The Model 6000 will have a vocabulary of 100-120 words and a price less than \$5000. . . . **American Optical** is selling special Videoterminal Glasses for people who use computers. The tinted safety glasses are priced at about \$100 and are also available in prescriptions. . . . **ENG Manufacturing Inc.**, Chandler, AZ, has announced Chirpee, a \$180 "voice command module." The speech-recognition unit works with Commodore computers, with versions planned for the Apple II and IBM PC. Chirpee does not work with off-the-shelf software. . . . **DFE Electronic Data Systems**, Stutensee, West Germany, has announced the Tiger-32, a coprocessor board for the IBM PC. Included for \$2495 are National Semiconductor's 16-/32-bit 32016 processor, 512K bytes of RAM, and the XENIX operating system. . . . **Tandy** now sells a \$400 direct-connect 300/1200-bps modem. . . . **VisiCorp** has sold its Visi On integrated-software technology to **Control Data Corporation**. . . . **Intel** is now shipping 512K-byte EPROMs. . . . **IBM's** new keyboard for the PCjr may have had the desired effect: by late August, many dealers reported strong sales even though the replacement keyboards weren't sent to dealers until mid-September. . . . **Corona Data Systems** unveiled a laser printer using the same Canon printer mechanism found in Hewlett-Packard's LaserJet and other laser printers. The Corona Laser Printer will have a list price of \$3395. . . . **The International Standard Book Numbering Agency** announced that microcomputer software should be included in the ISBN system used by book publishers. More than 10,000 software titles from 1500 companies had been assigned numbers by August. . . . **Newstar Software**, Pleasant Hill, CA, has introduced a Japanese version of its NewWord word processor that supports English, kanji, and katakana characters. . . . **Osborne Computer Corp.**, now reorganized and expected to emerge from Chapter 11 protection, is selling the same IBM-compatible, battery-powered portable computer overseas that **Morrow** is selling in the U.S. Morrow calls the machine the Pivot; Osborne will sell it in England as the Encore and elsewhere as the Osborne 3. The computer was developed by Vadem, a start-up company funded by Morrow.

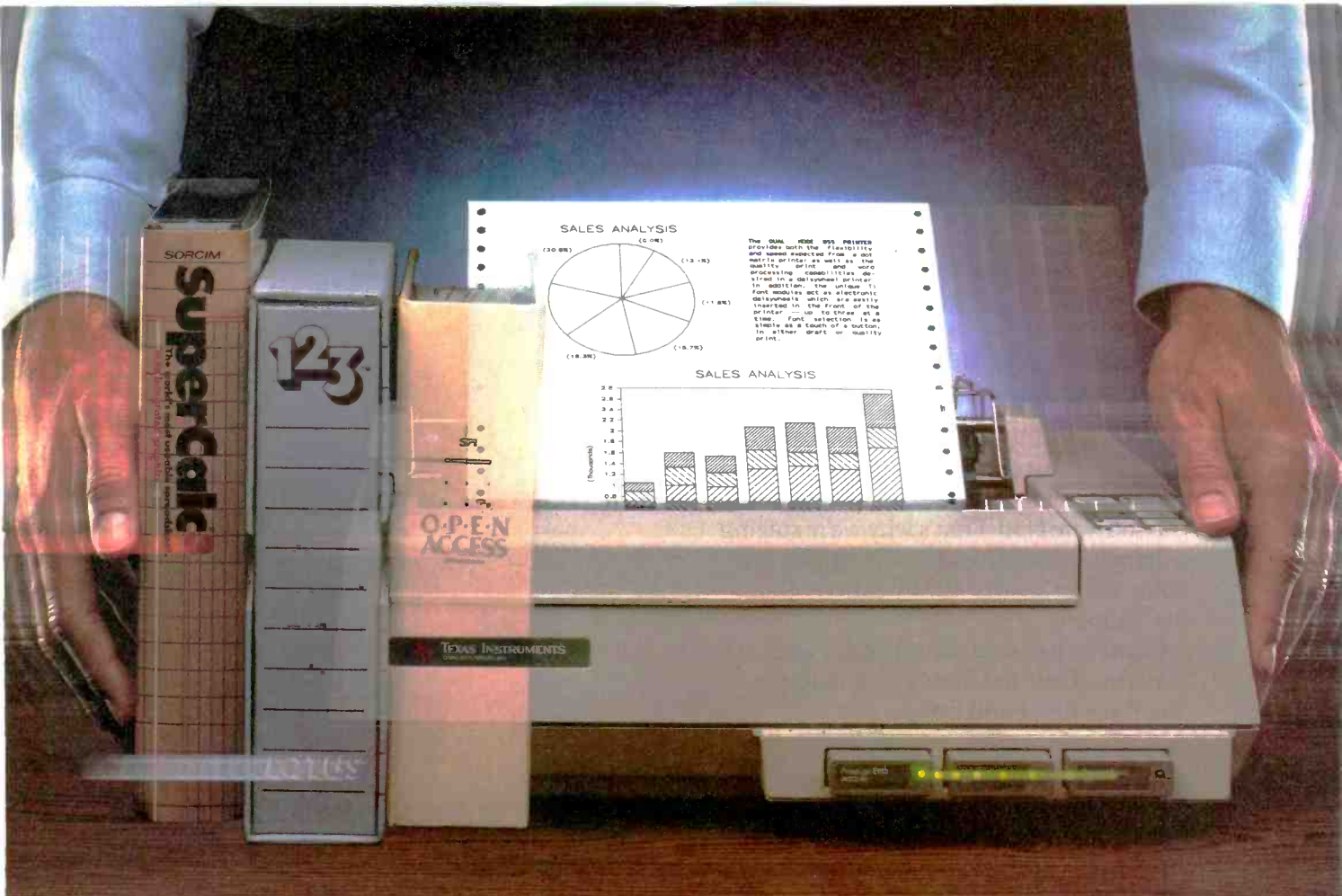

# Integrated. Printegrated.

Now, translate your integrated software into integrated hard copy, with the TI OMNI 800™ Model 855 printer. So versatile, it combines letter-quality print, draft-quality print and graphics as no other printer can. **It prints letter-quality twice as fast** as comparably priced daisy wheel printers, yet gives you characters just as sharp, just as clear.

**It prints rough drafts ten times faster** than daisy wheel printers... faster than most any other dot matrix printer. **Only the TI 855 has snap-in font modules.** Just touch a button; change your typestyle. The 855 gives you more typestyles to choose from than ordinary dot matrix printers. It makes them quicker, cleaner, easier

to access than any other dot matrix or daisy wheel printer. **The 855's pie charts are rounder...** all its graphics are sharper than on other dot matrix printers, because the TI 855 prints more dots per inch. As for daisy wheel printers... *no graphics.*

## The TI 855 Printer

The printer for all major PC's



**For under \$1,000** you get twice the performance of typical dot matrix printers. Or all the performance of a daisy wheel printer, and then some, for half the price.

So get the best of all printers, and get optimum results from your integrated software. With the TI 855. See it at your nearest authorized TI dealer. Or call toll-free: 1-800-527-3500. Or write Texas Instruments Incorporated, P.O. Box 809063, Dept. DPF-182BY Dallas, Texas 75240.

**TEXAS INSTRUMENTS**

Creating useful products and services for you.

OMNI 800 is a trademark of Texas Instruments Incorporated  
Copyright © 1984 Texas Instruments Incorporated.

2764-04

OCTOBER 1984 • B Y T E 11



# “Dare to

## **TI makes the best software perform even better.**

When choosing a computer, there are two important things to look for. Who runs the best software—and who runs the software *best*? That's why we're staging a dramatic country-wide side-by-side comparison against IBM™ called “Dare to Compare.”

Come to a participating dealer and take the “Dare to Compare” challenge. You'll see first-hand how...

## **TI makes software faster to use.**

Take a closer look. See how we give you more information on-screen than the IBM PC? That way you'll spend less time looking for data, and more time using it. We also give you 12 function keys, while they give you 10. Unlike IBM, we give you a separate numeric keypad and cursor controls. And that saves you both keystrokes and time. We also isolated the edit/delete keys to reduce the chance of making mistakes.

## **TI makes software easier to use.**

TI gives you up to 8 colors on-screen simultaneously, which makes separating the data a lot easier. IBM displays only 4. Our graphics are also sharper. And easier on the eyes.



IBM Personal Computer

# Compare”

And TI makes it easier to get your data on-screen. Our keyboard is simpler—it's more like the familiar IBM Selectric™ typewriter than the IBM PC keyboard is.

## TI lets you see for yourself.

Right now, you can “Dare to Compare” for yourself at participating TI dealers all over the country. Stop in, put both machines through their paces using the same software titles, and see for yourself how the Texas Instruments Professional Computer makes the best software perform even better.

For the name of a participating dealer near you, please call TI toll-free at 1-800-527-3500, or write: Texas Instruments Incorporated, P.O. Box 402430, Dept. DCA-232BY, Dallas, Texas 75240.



TEXAS  
INSTRUMENTS



## TEXAS INSTRUMENTS

Creating useful products and services for you.

### FIRST QUARTER SALES BY SALES REGION

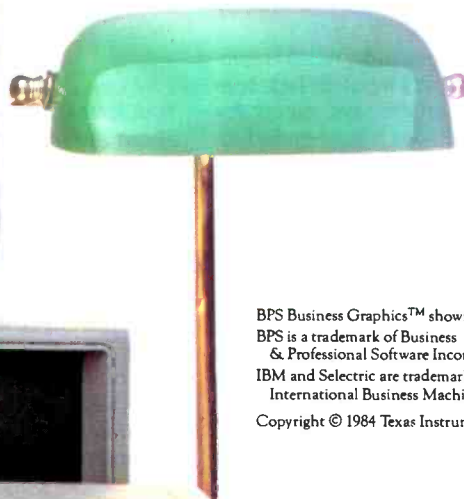
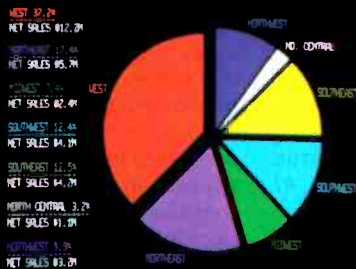

BPS Business Graphics™ shown.  
BPS is a trademark of Business & Professional Software Incorporated.  
IBM and Selectric are trademarks of International Business Machines, Inc.  
Copyright © 1984 Texas Instruments

**Texas Instruments Professional Computer**



## DATA COLLECTION WITH AN IBM PC

This letter concerns your May article by Stephen C. Gates, "Laboratory Data Collection with an IBM PC" (page 366). I am writing to correct some errors I found in the article and to explain some inadequacies of the Tecmar LabMaster board.

My first comment is about using a low-pass filter. When doing A/D sampling, a low-pass filter is not just optional but required. This is because of the sampling theorem that says A/D conversion must be done at twice the rate of the highest frequency desired; otherwise the high frequency will fold back into the low frequencies and produce erroneous results. Dr. Gates seems to think that one can oversample and then use software filtering to eliminate noise. Although it may eliminate certain types of noise, software filtering can never correct the aliased signal, and it is dangerous because the result seems clean but may contain low-frequency signals that were never sent by the instrument. The proper way is to use a sharp cut-off filter, reduce the noise in the system, and don't waste space or time by oversampling.

The first step in eliminating noise is sampling, using differential input. In fact, contrary to what the article says, except for measuring DC voltages, single-ended input should never be used. Next, the wires connecting the instruments should be a shielded twisted pair with only one end of the shield grounded. Finally, to avoid having the wires act as an antenna, the DC potential between the instrument and the A/D converter should be minimized. This can be done either by using an isolation transformer in the circuit or by using filters with a DC offset adjustment. However, an isolation transformer changes the phase of the signals in a complicated (nonlinear) way. Using such techniques, I am able to use 12-bit A/D sampling with wires over 40 feet long and keep the outside noise down to less than 1 bit. Thus one should use good filters and low noise connections and not go through software hoopla in a doomed effort to "fix up" a signal.

For the past six years I have been using

high-quality A/D and D/A sampling to analyze and synthesize speech on a PDP 11/34, a VAX 780, and, most recently, an IBM PC. We tried the Tecmar board but found it inadequate for our use and had to return it. The board we use now is the Data Translation DT 2801-A and it works very well.

As Dr. Gates observes, it is necessary to turn off the system clock interrupts to avoid missing data even at moderate sampling rates. This fact in and of itself is a clear indication that the Tecmar board is inadequate for the job. Keeping structure in a program or hardware system dictates that one part should not affect another. The Data Translation board, because it has DMA, allows one to sample at over 25 kHz and continue to do disk, terminal, and other I/O without skipping a beat. I have no vested interest in selling the DT board; however, I would like to keep people from making a mistake by trying to use an unsuitable board in their work.

Dr. Gates's article presents many good and useful ideas but misses on some of the most basic ideas of data acquisition. And readers should be aware that data acquisition requires more than just blindly connecting hardware.

JOHN MERTUS  
Providence, RI

*Your letter discusses some useful points about interfacing. I think, however, that you missed one of the central points about the article: the interface I described was designed to be used on a variety of instruments and hence has to be more general purpose than the approach you describe. Indeed, much of what you suggest I have used for several years on a system in my research laboratory dedicated to collecting data from a high-performance liquid chromatograph. The difference is that for a single-purpose system, parameters can be optimized for that single purpose, whereas a more general approach must be taken if the computer is to be interfaced to several instruments, each of which has its own frequency of collection, noise characteristics, etc. It would be difficult to suggest a single set of filters, isolation devices, etc., that would suffice for all of these in-*

*struments. For example, what is a low-pass filter for one device may turn out to completely eliminate the signal of interest from another.*

*However, for dedicated applications of the type you describe, your comments are largely correct. For such applications, I would highly recommend to the user that he or she consult a more complete reference on the topic, such as Electronics and Instrumentation for Scientists by Malmstadt, Enke, and Crouch (Benjamin/Cummings, 1981). The considerations that you mention are just a few of the many that are described in that text and others. For example, Malmstadt et al. recommend band-pass, rather than low-pass, filtration as a preliminary step but still suggest the need for software filtering, such as Fourier transform-based filtration. Indeed, the reduction of noise by various techniques is different for almost every case and often requires considerable experimentation before the desired result can be achieved.*

*I think that you overstate the case for direct memory access (DMA) devices. While they are useful, particularly for high-speed applications, they are gathering dust in many labs where they were purchased for low-speed applications. In any case, in a single-user system, I do not consider the necessity of turning off the clock for a few milliseconds or even a few seconds to be a major problem. I suspect that if you had turned off interrupts before using the Tecmar LabMaster at high speeds, your feelings about it would be quite different. However, I certainly did not mean to imply in my article that the LabMaster would satisfy all users; fortunately, there are several manufacturers and a variety of options on each board that allow the user to select the board most suitable to her/his needs.*

STEPHEN C. GATES, PH.D.  
Normal, Illinois

## A BYTE APOLOGY

Regarding your May issue on computers and the professions—your cover artwork makes me wonder. Are there no women

(continued)

# WHO SAYS "YOU CAN'T TAKE IT WITH YOU"?



When we at Intertec introduced our new HeadStart™ computer we said "it's the fastest, smallest, most powerful business computer in its class."

What more could we say?

How about "it's also portable."

Every HeadStart computer comes with its own easy-carrying handle. You can choose between a full size keyboard or a special compact version that snaps easily on the front of the screen. Either way, you get all the great features that make HeadStart unique. A big twelve inch screen, eight and sixteen bit processors, upgradable to one megabyte and it's networkable up to 255 users.

We named our new business computer "HeadStart" because

that's exactly what it'll give you. And because it's also portable, you can take it anywhere.

Well, almost.

For more information call us at (803) 798-9100 or write: Intertec, Dept. "HeadStart," 2300 Broad River Road, Columbia, SC 29210.



**intertec**™

## HeadStart Standard Features:

Size: 15.75" wide, 12.75" deep, 11.30" high.  
Weight: 25 lbs.

Processors: Z80A (8 bit) and 8086 (16 bit).

Memory: 128K to 1MB depending on model. All models are expandable to 1MB.

Disk Storage: 500K to 1MB (unformatted) on a 3½" Micro-Disk RAM disk feature emulates second system drive. Optional 3½" or 5¼" external drives.

Display: 12" (diagonal) P31 phosphor, non-glare screen, 25 lines x 80 or 132 columns.

Keyboard: Detachable with 104 total keys. A portable version snaps onto the front screen for easy transportability.

Disk Operating Software: \*CP/M 80 for 8 bit.

\*\*MS DOS for 16 bit. LAN DOS for multi-user 8 or 16 bit operation.

\*Concurrent CP/M 86 optional.

Interfaces: One RS 449/RS 232 compatible serial port.

One Centronics compatible parallel printer port.

External data bus. Coaxial communications interface.

External disk I/O interface. Optional network print spooling interface.

Networking: Up to 255 HeadStarts may be connected via a coaxial, multi-user network into one of 2 optional data storage systems.

Optional Data Storage Systems: Two models are available. A 10MB, 5¼" system is expandable to 20MB. A 50MB, 8" system (25MB fixed, 25MB removable) is expandable to 545MB in 165MB increments.

\*CP/M 80 and Concurrent CP/M 86 are registered trademarks of Digital Research.  
\*\*MS DOS is a registered trademark of Microsoft.





# The 'C' for the Macintosh

**AZTEC C68K-C** ..... \$499  
commercial software development system

• Full Version 7 'C' Compiler • Fast and Compact Code • Linker (overlay) • Resource Editor • No Royalties • Source Editor • Compatible with AZTEC 'C' for PC DOS, CP/M-86, CP/M-80, APPLE II, TRS-80, COMMODORE 64 • 68000 Macro Assembler • Extensive Run Time Support • Utilities • Shell Environment • Requires 128K MACINTOSH • Compatible with LISA MACWORKS and 512 MACINTOSH • Full access to MACINTOSH TOOLBOX (ROM & OS)

**AZTEC C68K-P** ..... \$199  
personal software development system

**AZTEC C68K TOOLS** ..... \$249  
(make, grep, diff, Z editor)

**MAC CROSS COMPILER HOSTS & TARGETS**  
LISA, PC DOS, MS DOS, CP/M-80, APPLE II, VAX, PDP 11 .....



# MANX

TO ORDER OR FOR INFORMATION  
CALL OR WRITE:

MANX SOFTWARE SYSTEMS  
Box 55  
Shrewsbury, NJ 07701  
TX 4995812



NJ RESIDENTS ADD 6% SALES TAX

**CALL:**  
**800-221-0440**  
**201-780-4004 (NJ)**

TRS-80 IS A TRADEMARK OF TANDY CORP. MACINTOSH IS A TRADEMARK OF APPLE. CP/M-86 & CP/M-80 ARE TRADEMARKS OF DIGITAL RESEARCH. PC DOS IS A TRADEMARK OF IBM

## LETTERS

judges? Are there no women doctors/scientists? Are there no women contractors in construction? Are there no women surveyors? Are there no women professional types? (For the word "women" you can also substitute "black," "handicapped," or any minority. I am a white female.)

In other words, are all professionals white, male, storybook characters?

CAROL J. BUECHLER  
Kettering, OH

*Clearly we goofed, and we apologize.*

### RE: THE SIMPLEX ALGORITHM

The article by Marco S. Caceci and William P. Cacheris ("Fitting Curves to Data," May, page 340) was excellent—clear, lucid, and a big byte in the direction of better numerical software for microcomputer users. Using the authors' flowchart (figure 4 on page 346) I was able to write a routine in BASIC for the Radio Shack Color Computer that takes under 3K bytes. By replacing the sum of squares criterion by  $(-2) \times$  the log likelihood, the algorithm obtains maximum-likelihood solutions (rapidly) to problems that SPSS on the local Cyber 170/720 cannot touch (logistic regression, unbalanced random-effects models, etc.). For the first time I appreciate the power of the home computer.

For other BASIC programmers, I would like to make a couple of remarks to speed up the program. On each iteration, the first step should be finding and storing the sum by columns of the parameter values in the Simplex (i.e., a multiple of the centroid of all the points). The values of the reflected, extended, and contracted points may then be written down without any IF statements. Second, both the best and worst vertices have to be found only initially and after shrinking all vertices toward the best. If the expanded or reflected vertices are accepted, then only the new worst has to be found. If the contracted vertex is used, then either it or the previous best is best and, again, only the worst has to be found. In the flowchart, the question of termination cannot be examined until the new best and worst vertices are known.

In the Michaelis-Menten example, when holding parameter  $a$  fixed, to determine standard errors (see below), negative (inadmissible) values of parameter  $b$  sometimes occurred. Following the authors' suggestion, I added Booleans to the sum of squares criterion, i.e.,

*(continued)*



**“We sell IBC computers because it’s the best way to attain a low cost, high performance multi-user system.”**

Roger Scaggs  
President, APS Systems, Inc.  
Dallas, Texas

“APS is the nation’s leading supplier of medical office management systems, serving over 1,000 practices in 30 states.

Most of our customers require more than a single-user desk top system. They need a good, fast multi-user computer without a minicomputer price tag.

We looked at many of the so-called low-cost “Supermicros” running UNIX™ but decided to continue selling **IBC-OASIS™** computers. UNIX requires a lot of horsepower to run well, and the low cost UNIX systems did not have the performance to do our customers job to our satisfaction.

APS sells high performance systems based on the OASIS multi-user operating system. OASIS provides all the features that you find on a good minicomputer multi-user operating system. OASIS is user friendly and performs very well on low cost multi-user systems.

At APS, we have selected **IBC** for our customers, because they provide a computer that allows us to efficiently run up to 16 users with our OASIS software.

Do you want a multi-user system which has hundreds of applications already available? Do you want to sell user friendly, low cost, multi-user computers that outperform the low end UNIX systems? Then I suggest you contact **IBC** immediately.”



**IBC/Integrated Business Computers** is the leader in multi-user technology. To find out more about the company, its products and support, please call or write:

OUTSIDE THE USA

**IBC** Integrated Business Computers

21621 Nordhoff Street  
Chatsworth, CA 91311  
(818) 882-9007 Telex No: 215349

UNIX is a trademark of Bell Laboratories  
OASIS is a trademark of Phase One Systems



# Dow Jones Accounting Series™

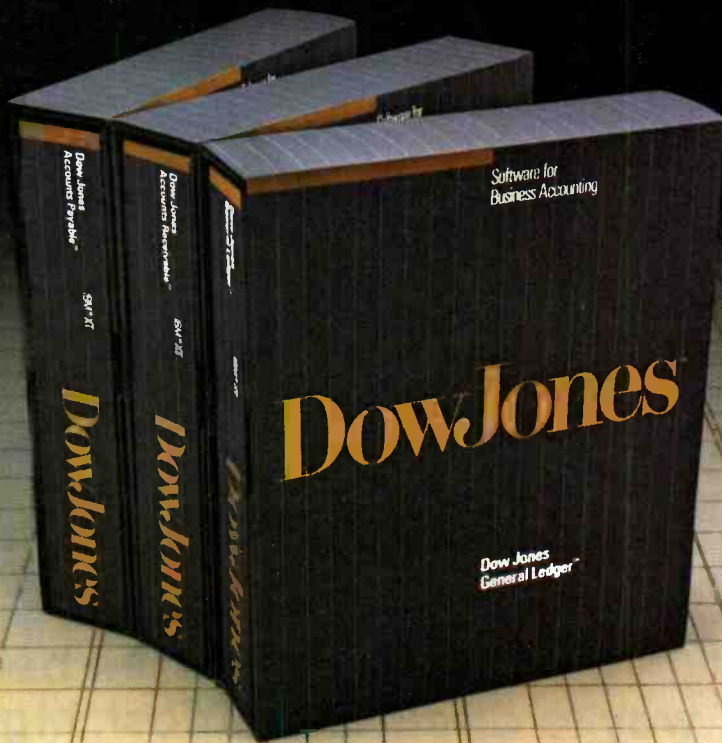

## Accounting software for small businesses who think big.

If you are serious about computerized business accounting, the only software to invest in is the Dow Jones Accounting Series. Your business is worth it.

No other accounting software combines the business expertise of Dow Jones with an easy-to-use format and development and support by top accountants. When you buy one of the core modules of the series — Dow Jones General Ledger™, Dow Jones Accounts Receivable™ or Dow Jones Accounts Payable™ — you are eligible for a free training seminar designed by Arthur Young, one of the nation's foremost accounting firms. And the Dow Jones Accounting Series is fully supported by a toll-free customer service hotline staffed by computer experts trained in accounting.

### Big accounting power for the small business.

Seq	Account	Description	Debit	Credit
1	410	Sales - Computers		8,355.00
2	411	Sales - Peripherals		1,150.00
3	412	Sales - Software		75.00
4	211	Sales Taxes Payable	7,812.38	
5	112	Trade		376.93
6	Totals		7,812.38	10,357.93

For a free brochure on Dow Jones business, investment and home software, call:

**1-800-345-8500  
ext. 244**

(Alaska, Hawaii and foreign call  
1-215-789-7008 ext. 244)

By Trademark Software and  
Dow Jones & Company, Inc  
Available for the IBM® XT.

Copyright © 1984 Dow Jones & Company, Inc. All Rights Reserved.

## LETTERS

$C = C - (A \leq 0) \times 1000 - (B \leq 0) \times 1000$  (the Color Computer returns -1 for true statements). This appears to be a technique superior to the so-called "penalty" methods, especially when, zero is admissible and minima may occur on the boundaries.

In many experimental situations, the standard errors are not of great interest; the usual interest is in comparing the values taken by the criterion, both when the unrestricted model is fitted and when (some of) the parameters are fixed at certain prestated values, such as zero. If the values of the criterion under these two situations are  $C_1$  and  $C_0$ , respectively, then when the sum of squares is used, the  $F$ -test has the value  $F = (C_0 - C_1) \times (n-r) / (C_1 \times p)$  with  $p$ ,  $(n-r)$  degrees of freedom, where  $n$  is the total number of observations,  $r$  is the total number of parameters fitted (for  $C_1$ ), and  $p$  is the number of parameters constrained (for  $C_0$ ).  $0 < p \leq r$ . If  $(-2) \times \log$  likelihood is used as the criterion, then for medium to larger samples the corresponding chi-square test is  $X = C_0 - C_1$  on  $p$  degrees of freedom. If  $p = 1$ , the square root of  $F$ , or  $X$ , is the usual  $t$  (with  $n-p$  d.f.) or  $Z$ , statistic when the appropriate sign is attached.

In nonlinear problems the standard error varies as the value of the parameter varies. If  $(a_1, b_1, c_1)$  is the minimum point, take  $a$  fixed at  $a_0 = a_1 - d$ , where  $d$  is "small," and find the new constrained minimum, say  $(a_0, b_0, c_0)$ . The standard error of  $a$  is roughly  $d$  divided by  $t$ , or  $Z$ .

J. B. GARNER, PH.D.

Halifax, Nova Scotia, Canada

"Fitting Curves to Data" highlights splendidly one of the major deficiencies of Pascal.

Back in my college days I grumbled if I had to use FORTRAN for these purposes. I had to take care of libraries for friends and then link the main program (plus necessary routines) with the code that described the model function (and its gradient). No wonder I always preferred the slowly chugging BASIC version on the HP 9830 to the blitzkrieg version in FORTRAN that ran on the Cyber. At least the users were not on my heels all the time.

Now, in Pascal you have to recompile everything, not just relink, when the model function changes. I hear comments that the version  $x$  of  $y$  compiler, interpreted on  $z$ , can support separate compilation. As far as I understand, Pascal is Pascal as defined by Niklaus Wirth (thank goodness for that at least). And I saw no hopeful words

(continued)



# Meet the Standard.



## **AST SixPakPlus™ has set the standard 100,000 times.**

We have manufactured and shipped more than 100,000 SixPakPlus multifunction boards in less than a year — an event that proves quality and quantity are compatible.

Important as it is, quality is just one factor that has made SixPakPlus the most popular, most respected multifunction board available today.

Performance is another. SixPakPlus provides IBM PC, XT, and compatibles users with an ideal combination of enhancements:

- Run sophisticated software programs and process more data with an additional 64K to 384K RAM memory capability.
- To add peripherals such as printers, modems, mice, plotters or joysticks, we give you more Input/Output ports — serial, parallel and optional game adapter.

Circle 3 for Dealer inquiries. Circle 4 for End-User inquiries.

- More convenience, thanks to a built-in clock-calendar that provides automatic time and date stamping.
- More productivity with SuperPak™ utility diskette including SuperDrive™ PC World's User Survey award-winner, that works like a drive but fifty times faster — and SuperSpool™ so you can print and input at the same time.

Quality extends to documentation, too. SixPakPlus is one of the easiest hardware/software packages to install and operate.

And, with our new audio cassette, you don't even have to crack our manual to learn how to take full advantage of SixPakPlus' features and functions.

Meet the standard for multifunction enhancement boards in person. Get a SixPakPlus from a dealer near you. SixPakPlus is a member of the complete AST family of multifunction boards, Micro-to-Mainframe communications, LAN and graphics products.

Contact:

AST Research Inc.  
2121 Alton Avenue  
Irvine, CA 92714  
Phone: (714) 863-1333  
TWX: 753699ASTR UR



\*IBM PC and XT are registered trademarks of International Business Machines.

# AST

RESEARCH INC.



# SURPRISE! A PER THAT WON'T SURPR

The NCR PC 4 is everything you'd expect from one of the largest computer companies in the world.

It's a personal computer that's easy to use, reliable, versatile and elegantly designed.

So you get all the advantages a personal computer should have. And no unpleasant surprises.

## **SOFTWARE, SOFTWARE, EVERYWHERE.**

The NCR PC 4 is compatible with thousands of programs available at computer stores everywhere. From the best-selling Lotus 1-2-3™ to all sorts of other business programs, educational programs, or just plain fun programs.

## **IT'S COMPATIBLE WITH PEOPLE, TOO.**

You'll get along with this computer the moment you take it out of the box. There are no complicated wires or clumsy boxes to set up. All you



# PERSONAL COMPUTER USE YOU.

have to do is plug it in and you're ready to go.

The keyboard is designed to help you work faster and with fewer strokes.

To make things easier still, we include two special self-teaching programs.

One is called NCR PAL. It shows you, step by step, how to use the computer itself.

NCR TUTOR introduces you to the operating system as well as to word processing, spreadsheets and other popular business applications.

## **YOU WON'T OUTGROW THIS ONE.**

The NCR PC 4 can grow as your needs grow. Our basic model, for instance, starts you out with enough memory to run most popular programs. Then you can easily add more. Up to 640K.

You can also add printers, a modem for telephone communications, a mouse, and

many other industry standard accessories.

For larger businesses, the NCR PC 4 networks with other computers, including mainframes.

## **WE'LL BE THERE WHEN YOU NEED US.**

While the NCR PC is exceptionally reliable, it's nice to know that if it ever needs service you've got a big company like NCR behind it.

Our dealers have the backing of our extensive service organization, one of the largest and most experienced in the world.

The NCR Personal Computer looks better the closer you look into it.

So look into it closer at your nearest Authorized NCR Personal Computer Dealer.

We think you'll be pleasantly unsurprised.

For the name of your nearest dealer, call toll-free: 1-800-544-3333.\*



**NCR**

**A BETTER PERSONAL COMPUTER  
IT'S EXACTLY WHAT YOU'D  
EXPECT FROM NCR.**

Circle 248 on inquiry card.



affordable & reliable...

# NETWORKING



Networking begins with your fine computer. Where it goes is unlimited when you interface your peripheral devices with a 4, 8 or 18 port BayTech Serial Port Expander. With BayTech's units you can mix-and-match other computers and/or peripheral devices of different configurations without the need to reconfigure. Port configuration of the peripheral device ports may be changed by the user with BayTech's menu-driven software.

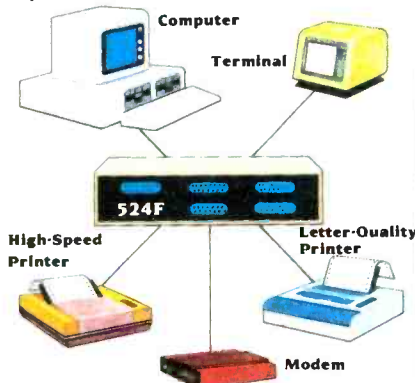

BayTech's versatile networking multiports, capable of any-port-to-any-port interconnection, have virtually unlimited applications. With their features and low cost, the user can create a local network providing simultaneous communication for 5, 9, or 18 RS-232C devices.



**A few companies make a good, expensive Serial Port Expander. One company makes an excellent, affordable line of them - BayTech.**

- Model 524F ..... \$ 329.
- Model 528F ..... \$ 619.
- Model 5218F ..... \$1750.

"We design and price BayTech Multiports so everyone can have an affordable and reliable computer network. To solve your networking problems, call us."

Charles R. Ramsey, President  
Bay Technical Associates, Inc.

**1-800-523-2702**

**BIA**  
BAY TECHNICAL ASSOCIATES, Inc.  
HIGHWAY 603, P.O. BOX 387  
BAY ST. LOUIS, MS 39520 (601) 467-8231

## LETTERS

about separate compilation there.

Has anybody given any thought to the possibility that there are cases where a part of the problem changes from user to user? So (again) a part of the code has to change, but just a part—three or four lines, or less than 1 percent. Why not have something like comlink...end comlink in the main program, which would read the input file and compile instead of compute?

Well, in the meantime I will stick to interpreters. They are getting faster.

VITO SMOLEJ, PH.D.  
Don Mills, Ontario, Canada

### ID PROGRAM

Thanks for the Subscriber Identification Card. It is a valuable part of my subscription. Presented in listing 1 is an IBM Macro Assembler program that will display your number on your terminal when BYTE is entered from DOS. If you don't have a color/graphics adapter or CONFIG.SYS with DEVICE = ANSI.SYS, just delete the color statements and it will display in black and white.

ALEXANDER V. PINTER  
Columbus, GA

### ENTHUSIASM FOR APL AND LOGO

Thank you for publishing Fred Masterson's article "Languages for Students" (June, page 233).

I have been using APL since the late 1960s and, although I routinely use about a dozen languages, I use APL or Logo unless there are overwhelming reasons to do otherwise. I have often tried to explain why I do this to other programmers and I have found that the reaction I get is either instant enthusiasm or total rejection. Before reading Mr. Masterson's article, I had decided that discussing the value of APL and Logo is like discussing the price of a Rolls-Royce: If you need to ask the question, the answer is probably beyond your means. Mr. Masterson has provided a clear and concise explanation.

There is an extension to Mr. Masterson's discussion that is worth mentioning: Most expert programmers have a stock of idioms (chunks of code that are used so often that they have become as automatic as primitives) that are major contributors to their high productivity. The APL programmer's stock of idioms tends to be richer, more concise, and much more powerful. Another advantage is that many idioms are handled like icons. They are used and read like pictures or single symbols (the APL "teepee" commonly used for handling leading and trailing elements of a vector is an excellent example); something that is not possible with the lengthy, multiple-line idioms of more primitive languages.

I was also delighted to learn about AMPL. The first APL I used was on the SDS Sigma 7, which included mnemonics for ordinary ASCII terminals. I have had many opportunities to regret the loss of

Listing 1: The Subscriber Identification Number Macro Assembler program.

```

.....
:BYTE — Displays Subscriber Identification No.
.....
CSEG SEGMENT
BYTE PROC FAR
ASSUME CS:CSEG
START: PUSH DS
      PUSH AX
      MOV DX,OFFSET MSG + 100H
      MOV AH,9
      INT 21H
      RET
MSG DB 27,[36m' ;CYAN
   DB 13,10;'ALEXANDER V. PINTER'
   DB 27,[31m' ;RED
   DB 13,10;'SUBSCRIBER IDENTIFICATION '
   DB 27,[33m' ;YELLOW
   DB 13,10;'NUMBER xxxxxxx',13,10
   DB 27,[32m$'
BYTE ENDP
CSET ENDS
END START

```

## LETTERS

this capability and I hereby volunteer for any reasonable task the creators of AMPL would like to assign me that will assist in the promulgation of this language and its availability on as many mainframes as possible.

MARC THIBAUT  
Mississauga, Ontario, Canada

### THE KELLER PLAN

Stephen Chorover's article "Cautions on Computers in Education" (June, page 223) was marred by a serious error of fact as well as several questionable interpretations. Prior admission that he is presenting a caricature does not excuse the mistakes in description and interpretation. The "Keller Plan," developed by B.F. Skinner's best friend and colleague Fred Keller, is a teaching method that enhances student learning by (1) behavioral analysis of the responses to be acquired so that an appropriate sequence of learning exposures is planned, and (2) intensive interaction between the student and the teachers and proctors. This method did not involve automation. Moreover, like Mark Twain's famous reply to his obituary, reports of the plan's demise are greatly exaggerated. Pennypacker and his colleagues at the University of Florida have developed an individualized instructional system along the lines described by Keller that has not only successfully taught less able students in lower division courses, but also has helped them acquire the general reading and study skills that permitted over 80 percent of them to graduate.

That application illustrates the same lesson that some of the early, less-successful teaching-machine experiments also showed. The materials ("software") with which the student interacts are more important than the machine that presents them. Successful applications await both an adequate understanding of what's involved in learning (as Keller's reinforced learning procedures do) and the investment of time and testing the Florida group contributed to make the materials work.

LEWIS R. GOLLUB  
College Park, MD

### THREADED-SUBROUTINE INTERPRETED LANGUAGE

It was a pleasure to read Ronald L. Greene's article "Faster FORTH" in the June issue (page 127). I struggled with the same conflict of speed versus utility in

designing an application program. After reading Ronald Loeliger's *Threaded Interpretive Languages* and articles on Warnier-Orr diagramming by David A. Higgins, et al. (in *Programming Techniques*, volume 1; *Program Design*. Byte books; and *Program Design and Construction*. Prentice-Hall) and comparing the goals of using a threaded interpretive language with the microprogramming of the 8088, I decided to use a threaded-subroutine interpretive language. My initial attempts at a fast inner interpreter appeared much the same as Dr. Greene's (see listing 1 on page 420). I even tried to speed things up by adding hashing and token address tables. Not having read the BYTE article by Terry Ritter and Gregory Walker ("Varieties of Threaded Code for Language Implementation," September 1980, page 206) I did not know that a threaded-subroutine (or subroutine-threaded) method of language implementation was good practice, but I tried it anyway.

For my application, and for transport to other computers (e.g., the Macintosh, which has almost 500 subroutines in its ROM) from the IBM PC, the threaded-subroutine method appears to be optimum; my apologies to FORTH users. This does not detract from the major goals of a threaded interpretive language but is simply an alternate method of implementation.

Thank you for printing Dr. Greene's article. It was nice to see someone else confirming my experiments.

RICHARD DOUGLAS GREEN  
Los Angeles, CA

### MACINTOSH PASCAL VERSUS WATCOM PASCAL

I would like to bring to your attention a fact that must have escaped G. Michael Vose, judging from what he wrote in his article "Macintosh Pascal" (June, page 136).

For two years I have used an interpreted version of Pascal to teach the language. On the same computer, I have used interpreted FORTRAN, again in an introductory course on the language. After seeing a microcomputer spend several minutes compiling simple Pascal and FORTRAN programs, I had begun to be very pessimistic about the prospects of teaching FORTRAN and Pascal on microcomputers because the students would be lucky to be able to enter, debug, and run even very simple programs within an hour. Then I was able to try a Commodore

(continued)

## affordable & reliable... PORT CONTENTION



Add more users to your multi-user computer without expensive hardware or software modifications. A BayTech Port Contention unit will maximize utilization of available ports, thereby minimizing idle, valuable system time. With 6-to-3, 8-to-4 and 12-to-6 port models available, Port Contention problems can be solved from micro to mainframe computers.

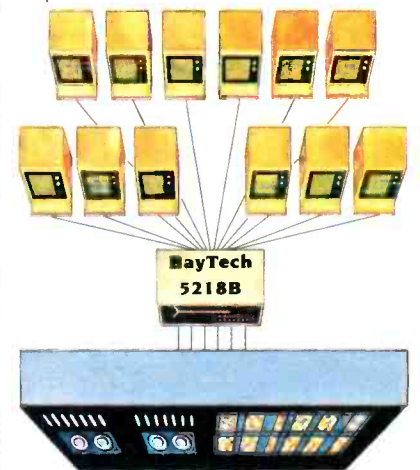

The graphic above illustrates a typical BayTech Model 5218B Port Contention application. By adding a single 5218B unit, a 6-port multi-user computer gains six additional users, thereby doubling accessibility to the computer.

- Model 528B: 6 ports to 3 ... \$ 625.
- Model 5212B: 8 ports to 4 ... \$1095.
- Model 5218B: 12 ports to 6 ... \$1750.

To solve your port contention problems ...

**1-800-523-**

**BAY TECH ASSOCIATES**  
HIGHWAY 603  
BAY ST. LOUIS, MS

Now You're Talking!™



SuperPET, with its interpreted BASIC, FORTRAN, Pascal, APL, and COBOL. These interpreters were written by Waterloo Computing Systems Limited and I understand they are now available for the IBM PC as well as the SuperPET.

While these interpreters do not offer the windows as Macintosh Pascal does, they do offer single stepping in the debugging mode, as well as the ability to add break-

points in the program and to display values of variables, and to change their values during these breaks.

I share Mr. Vose's enthusiasm for interpreted Pascal for learning the language. I cannot, however, join in his congratulating Apple for "introducing" something that has been around for some time.

DOUGLAS H. UNDERWOOD  
Walla Walla, WA

Mr. Underwood is correct in pointing out that the former Waterloo Computing Systems' interpreted Pascal (formerly called microPascal) is an earlier version of interpreted Pascal than Macintosh Pascal. He errs in claiming that I credited Apple with "introducing" an interpreted Pascal. I said only that Macintosh Pascal is a "significant new Pascal product."

Watcom (the company's new name) Pascal has languished in obscurity since its 1980 release mostly because of its target market—the education industry. Watcom Products Inc. also produces interpreters for APL, BASIC, FORTRAN, and COBOL. These language systems run on IBM 370 mainframes, DEC VAXes, DEC Pro 300 series machines, Commodore SuperPETs and 64s, and IBM PCs. The FORTRAN and COBOL interpreters offer only subsets of the languages (primarily because of memory limitations) and are intended strictly for educational purposes. Compilers for the mainframe versions of COBOL and FORTRAN are available, but no BASIC or Pascal compilers are available through the company.

In fact, company president Ian McPhee claims that Watcom Products' market is solely the "post-secondary education market" and that the company does not advertise in consumer markets or distribute its products outside the educational mainstream. Commodore and IBM are the only microcomputer manufacturers selling Watcom's products. Commodore bundles all five languages with the SuperPET and IBM sells the five Watcom languages plus a micro-to-mainframe link called Waterloo PC Network as a package through its personal computer education division.

McPhee claims an installed base of 25,000 Watcom Pascal systems on microcomputers. An IBM PC version of the language costs \$250 while a Commodore 64 version lists for \$150. Quantity central-processor-unit licenses are available to educational institutions.

For further information, contact Watcom Products Inc., 158 University Ave. West, Waterloo N2L 3E9, Canada.

G. MICHAEL VOSE  
BYTE Features Editor

MACGROANS REFUTED

The press is alive with the sounds of MacGroans.

David Nibbelin (June Letters, page 14) objects to subsidizing the Japanese

(continued)

**YOUR PC CAN BE YOUR NEXT SMART TERMINAL.** SmarTerm software can make your personal computer a lot more intelligent than it really is. Our terminal emulators have the features that do the job: Full keyboard emulation. Multiple setups. TTY mode. "Smart" softkeys. Printer support. Help screens. And a friendly user manual. Built-in text and binary file transfer is powerful and simple to use, and does not require

any special host software. SmarTerm also features automatic file transfer and two different "error-free" protocols, including XMODEM. There's a SmarTerm emulator that matches your needs: SmarTerm 100 for emulation of DEC VT100, VT102 and VT52. This program now features 132-column display mode support, using either horizontal scrolling or special 132-column video display boards. SmarTerm 125 includes all the features of SmarTerm 100, plus VT125 ReGIS graphic support. SmarTerm 400 for emulation of Data General Dasher D100, D200 and D400. More than 10,000 customers have discovered just how smart their PCs can be with SmarTerm. We think you'll agree. Try it for 30 days with full refund privilege.



Call today for more information. Available through your local software dealer, or Persoft, Inc., 2740 Ski Lane, Madison, WI 53713. Phone (608) 273-6000. TELEX 759491.

SMARTERM is a trademark of Persoft, Inc. • DEC, VT & ReGIS are trademarks of Digital Equipment Corp. • Dasher is a trademark of Data General Corp. • IBM is a registered trademark of International Business Machines Corp.

# IN A WORLD OF CHANGE, THE SMART GET SMARTER™



Announcing  
the sudden obsolescence  
of the floppy disk.

# NEW HELIX PC BUBBLE DISK™

HALF-MEGABYTE MEMORY BOARD

The first bubble memory board for  
IBM PC/XT and compatible computers.

- NON-VOLATILE: You don't lose data when there is no power.
- Eight times faster than a floppy disk.
- For fixed or portable use without need for back-up storage.
- Impervious to dust, dirt, humidity, cold— as reliable in the North Sea, the Sahara, a Space Station, as in your office.
- Mean time between failure (MTBF) more than 20 years.
- Rugged enough to withstand vibration and shock up to 200Gs.

For complete details contact:



Helix Laboratories, Inc., 8123 Remmet Ave.,  
Canoga Park, CA 91304  
(818) 710-0300—outside California, 800-468-0004  
Dealer Inquiries Welcome

See us at

COMDEX™/Fall '84

BOOTH #R8027

© 1984, Helix Laboratories, Inc.



# LOOK NO FURTHER! we'll get you low prices and fast service, or else!

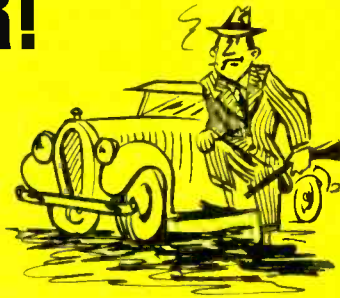

## LETTERS

# ALPHA OMEGA

## COMPUTER PRODUCTS

### COMPUTERS

TAVA PC IBM Compatible, 128K, 3-320K Drives, Parallel Port, Monitor	\$1989
SANYO MBC 555 w/software	1049
ROMAR 64K Apple compatible	SAVE
IBM PC 64K, 2-320K Drives, Color Graphics Board, DOS 2.1, Amdek 300G	2669

### DISKETTES

SCOTCH 3M SSDD	\$23
MAXELL MD2 DSDD	39

### PRINTERS

C. ITOH 8510 P. 120 cps	\$349
EPSON FX80 160 cps	439
EPSON FX100 160 cps	679
EPSON LQ 1500	1189
OKIDATA Microline 92 160 cps	419
OKIDATA Microline 93 160 cps	699
GEMINI 10X 120 cps	279
GEMINI 15X 120 cps	389
NEC 3550 35 cps L/Q	1715
JUKI 6100 L/Q 18 cps	435
C. ITOH F-10 40 cps	1075

### MODEMS

HAYES Smartmodem 1200	\$482
HAYES Smartmodem 1200B IBM	425
HAYES Micromodem IIe	249
BIZCOMP IBM Int. 1200	345
ANCHOR A. Mark XII 300/1200	259

### MONITORS

TAXAN 12" Amber	\$125
TAXAN 121 IBM green	159
AMDEK 310A for IBM PC	169
AMDEK 300G 12" Green	135
AMDEK 300A 12" Amber	145
AMDEK Color I + 13"	299
PRINCETON HX-12 RGB	495
PRINCETON SR15 Super Hi Res	SAVE

### APPLE PERIPHERALS & SOFTWARE

VIDEX Videoterm 80C w/softswitch	\$209
VIDEX Ultraterm	279
MICROSOFT 16K RAMcard	69
MICROSOFT 280 Softcard	245
MICROSOFT Premium Pack	479
MICROSOFT Premium Softcard IIE	345
KRAFT & TG Joystick	45

HAYES Mach II Joystick	33
PROMETHIUS 1/2 Height Drives	189
WIZARD IPI Parallel Interface	75
PROMETHIUS Versacard	149
EPS Keyboard	289
KENSINGTON Systemsaver	68
COOL & TIME (fan, surge, clock)	75
KOALA Pad	79
PFS Filing System	81
PFS Report	81
DBase II	389
Wordstar	249
Home Accountant	SAVE
Multiplan	165
DB Master Version 4	249
DB Utility 1 or 2	95
Magic Window II	109
Multiplan McIntosh	159
Microsoft Basic McIntosh	115
Thinktank for Mac	79
Memorex Diskettes for Mac	59
Mac Carrying Case	69

### IBM PERIPHERALS & SOFTWARE

TURBO 10 Int. 10MB Hard Disk	\$949
TANDON TM100-2 360K	219
TEAC 1/2 Height 360K	195
MICROSOFT Mouse	139
QUADRAM Quadboard w/64K-384K	319
QUADRAM Quadlink	489
QUADRAM Quadcolor I	209
64K RAM Kit 200 ns	55
AST 6-pack plus w/64K	279
STB w/64K clock, par, serial, game	295
HAYES Mach II Joystick	35
Property Management	335
Home Accountant +	SAVE
Multimate	319
PFS Filing System	85
PFS Report	81
Lotus 1,2,3	319
Lotus Symphony	485
DBase III	449
DBase II	389
Framework	SAVE
Wordstar	249
Wordstar Propack w/Mailmrg,	
Spellstar	309
Multiplan	165
Flight Simulator New RGB	39

See our ad on page 90.

Hundreds of available items. Call for complete pricing information.

**We do not charge for VISA or MASTERCARD**

(213)  
(818) **345-4422**



18612 Ventura Blvd., Tarzana, CA 91356

All products are in factory sealed packages. We guarantee all items for 30 days. Within this period, defective merchandise returns must be accompanied by RMA number. All other returns will be subject to a 10% restocking fee. For prepaid orders there will be a 3% shipping charge; 5% for UPS Blue Label; \$5.00 minimum; all orders outside U.S. at 15% shipping. There will be an additional \$4.00 surcharge on C.O.D. orders. Cash or Cashiers Check is required on C.O.D. orders. Calif. residents add 6.5% sales tax. Prices subject to change without notice.

economy by using its parts in Macs. (Find me a computer with all American-made parts, Mr. Nibbelin.)

Susan Gold (June Letters, page 33) can't see the Mac as a productivity aid.

Everyone is having hysterics about the lack of Mac software.

Well folks, I say sour grapes and fie upon you! I have had my own (as opposed to company-owned) Mac for just over two months now and my valuation of it is still growing. It rides back and forth to my office with me, through Washington traffic, shoulder-harnessed and seat-belted in the passenger seat three or four days a week.

I'm "suffering" along with the thousands of other Mac users, from the inferred "awful burden" of only three useful tools: MacWrite, MacPaint, and Microsoft Multiplan. Instead of a burden, I find these three tools can handle 90 percent of my daily information-processing requirements. The secretaries in my daytime office are estatic because they don't have to type from my scribbles anymore, and my weekly and monthly status reports are now on time, coherent, and edited when they get them.

All of my production organization charts and other business graphics that used to go through an iterative process at a local high-priced graphic arts firm, now come out finished the first time and ready to paste into product documents.

My project-cost accounting and projection is all done in about 10 minutes a week and presented to management in a far superior form and content than I could find time for pre-Mac. Project planning milestone/resource schedules are a snap with Multiplan (now that the more serious flaws have been patched).

Presentation-quality overhead transparency material with variable fonts and classy-looking text/graphics go directly from my Imagewriter to the transparency format on our office copier and then to the conference-table projector, untouched by an artist's or secretary's hands. Our valuable secretarial staff now have a partially new lease on life, doing more with their heads and less with their fingers, at least with respect to my material.

Sure, I have outstanding orders at my helpful Apple dealer (Falcon Systems Inc., of Bethesda, Maryland) for MacDraw and MacProject as well as for Microsoft Chart, but those are frosting on the already delicious cake. For business, for me, Mac is already a success.

When the Applemodem/MacTerminal combination arrives, I will be able to trans-

(continued)

# The MacClassics™ from Videx. Legends in Their Own Time.

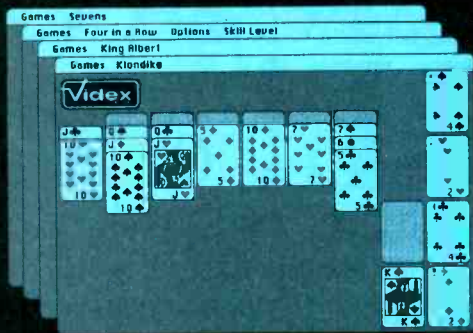

**FunPak™ - \$39**

**Klondike Solitaire ·  
King Albert Solitaire ·  
Four in a Row · Sevens**

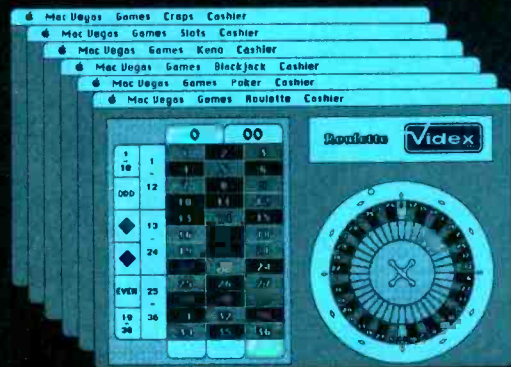

**MacVegas™ - \$59**

**Roulette · Poker · Blackjack ·  
Keno · Slots · Craps**



**MacCheckers™ - \$49**

**Checkers · Reversi**

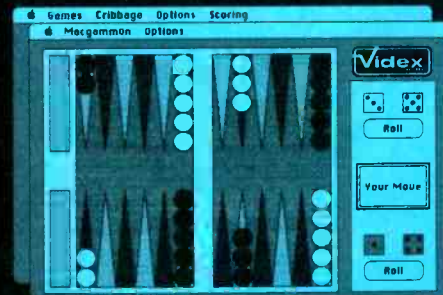

**MacGammon™ - \$49**

**Backgammon · Cribbage**

Introducing the MacClassics, a collection of familiar games designed to entertain and challenge. With Macintosh™ or a friend as an opponent, you can enjoy such classic games as solitaire, poker, checkers, backgammon, roulette, etc., and they're all more fast-paced and exciting than ever before, with a little assistance from Macintosh. MacClassics let you enjoy and explore the power of your Macintosh while you relax and have a good time.

The MacClassics are just another example of the kind of high-quality

products you've come to expect from Videx. With a solid reputation for dependable, innovative business software and hardware, Videx is consciously building that same degree of excellence into its entertainment software. Through development of Apple® and Macintosh software, Videx continues to provide the micro-computer industry with an ever-expanding line of exciting, reliable products.

Call today for more information.  
(503) 758-0521.



Innovation Backed by Support

Videx, Inc. • 1105 NE Circle Blvd. • Corvallis, OR 97330



Macintosh is a trademark of Apple Computer, Inc. Apple is a registered trademark of Apple Computer, Inc.









INTRODUCTORY OFFER

**\$49.95**

Copy Protected Version

Here's Sidekick in action. That's Lotus 1-2-3 running underneath. In the Sidekick Notepad you can see data that's been imported from the Lotus screen. On the upper right, that's the Sidekick Calculator.



NOW... Whether you're working in dBase, Lotus, Wordstar or whatever... you can unleash the full power of your computer... and make a lot of extra space on your desk at the same time.

Whenever you're using your computer... from start to finish of your session... Sidekick™ will be there... ready to serve. And it's as lightning-fast and compact as only Borland knows how to make it.

There's a notepad that has a full-screen editor that can time and date stamp your notes, and then save them to disk. You can even pull information into the notepad directly from the screen of your "underlying" software.

Suppose you're working in Lotus and the phone suddenly rings. Give your Sidekick a call and it pops right up over Lotus with the notepad you need. Or an appointment calendar... one you can never misplace.

What if you need to do a quick calculation? A keystroke instantly brings up the calculator. And the results of your calculations can even be transferred to your "underlying" software.

Need to make a phone call? Up pops your personal phone directory. Type in the name you want... and Sidekick jumps right to the phone number. Another keystroke, and the phone is automatically dialed for you.†

There's lots more, too. You can move the Sidekick windows anywhere on the screen you like. And you can have as many on screen at a time as you need. There's even an on-line help window for each of Sidekick's features.

We designed it because we needed it. If you've ever been writing a report and needed to do a quick calculation, or jot down a note, then you need Sidekick, too.

†Only with Hayes Smartmodem and compatibles.

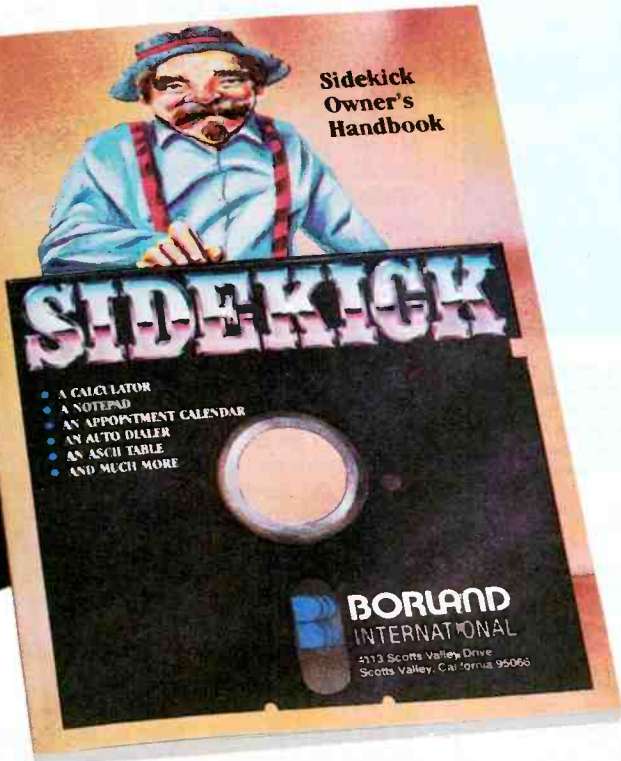

# GOT YOUR SIDEKICK YET?

YOU CAN ORDER YOUR COPY OF SIDEKICK™ TODAY!

For VISA and MasterCard orders call Toll Free **1-800-255-8008** in California **1-800-742-1133**  
(lines open 24 hours, 7 days a week) Dealer Distributor Inquiries Welcome 408-438-8400

SIDEKICK™ \$49.95   
Non-copy protected  
Version: \$79.95   
(Plus \$5.00 shipping  
and handling.)

Check  Money Order   
VISA  MasterCard   
Card # \_\_\_\_\_

Expiration Date \_\_\_\_\_

\*PC Jr. runs non-copy protected version only.

Please be sure your computer is an IBM PC, XT, jr., or true compatible!

NAME \_\_\_\_\_

ADDRESS \_\_\_\_\_

CITY/STATE/ZIP \_\_\_\_\_

TELEPHONE \_\_\_\_\_

California residents add 6% sales tax. Outside U.S.A. add \$15.00. (If outside of U.S.A. payment must be by bank draft payable in the U.S. and in U.S. dollars.) Sorry, no C.O.D. or Purchase Orders.

S F 15



**BORLAND INTERNATIONAL**

Borland International  
4113 Scotts Valley Drive  
Scotts Valley, California 95066  
TELEX: 172373

Circle 39 on inquiry card.



# PERIPHERAL POWER



1. **Model # 5SVA&T** - Designed to house one full size or 2 half height 5 1/4" floppy disk drives in the vertical position. As an added feature, the mounting holes are duplicated in reverse so the user can mount the drives door left or door right. The power supply is a custom linear, proven in thousands of installations over the years!

Retail....\$60.00, (\$67.00 for half hgt version) 1 year warranty

2. **Model # 5DVA&T** - The 5DV is custom designed for 2 full size 5 1/4" floppy disk drives to mount vertically. The mounting holes are duplicated in reverse so the drives may be mounted door left or right. The power supply is our custom linear.

Retail....\$85.00 1 year warranty

3. **Model # FD-PC8** - This unique enclosure is designed to match the styling and size of the IBM-PC and can mount on top of, under or along side the PC. It is designed to house Shugart 8 inch half height floppy disk drives, and affords mainframe compatibility using 8 inch floppy diskettes.

Retail....\$399.00 1 year warranty

4. **Model # DH8A&T** - The DH8 is designed for one or two standard size 8 inch disk drives such as Shugart 800 series, Qume DT-8, and SIEMENS. The power supply is 206 series commercial grade with a 2 year warranty! Cooling fan standard. There is a space designed in above the disk drive area for mounting circuit boards if needed. Specify double or single sided connectors.

Retail....\$295.00 2 year warranty

5. **Model # FD-PC-jr.** - For those needing expansion of their PC-jr., here is a matching enclosure to house your disk drive. We have the controller available also. The case has an injected molded front bezel to duplicate the looks of the jr.

6. **Model # FD-PC5** - This unique enclosure is designed to match your IBM-PC perfectly. Injected molded front bezel, with all steel 18 gauge construction for shielding and strength. It boasts a custom linear supply that delivers 5 amps continuous current. The FD-PC5 is pre-drilled to hold any 5 1/4" half height floppy or hard disk or any 5 1/4" full size floppy or hard disk. We even have adaptor brackets to mount a Syquest 5meg removable!

Retail....\$295.00 1 year warranty

7. **Model # 5DHHHA&T** - The 5DHHH is designed to house 1 or 2 half height floppy or hard disk drives in the horizontal side by side mode. A lit on-off switch is mounted in the front where it's convenient, and uses our custom linear power supply. A blank plate is available for one drive installations.

Retail....\$125.00 (floppy model)  
\$195.00 (hard disk model)  
1 year warranty

8. **Model # SH8A&T** - Will house one full size 8 inch floppy or one or two half height 8" floppy disk drives. Uses a commercial grade 206 series supply, and carries a full 2 year warranty!

Retail....\$199.00

9. **Hard disk & Floppies**, we carry only the top brands like Shugart and Qume! Don't be fooled by the cheap imitations. We carry only the best, with the strongest warranty around. For example, all Shugart disk drives carry a 1 year warranty. So call for the latest pricing to upgrade your PC, Zenith, Heath, Radio Shack, TI or one of the many other computer systems on the market!

10. We also carry data cables for your system. We can custom make them to your specs, or allow us to help you choose what's right for you.

Floppy Disk Services, inc. is entering our 6th year of supplying disk drives and custom enclosures to the computer industry. Companies that demand quality such as CBS-TV, IBM and NASA to name a few, purchase our products. Space restrictions do not allow us to show all our products, so call toll free for our FREE catalog of products. Or better yet, let one of our sales staff help you make the right choice .... Ask about our REPLACEMENT warranty policy.

Dealer inquiries invited. All products available in OEM quantities. Prices and specs subject to change without notice.



39 Everett Dr., Bldg. D  
Lawrenceville, N.J. 08648  
(609) 799-4440

TOLL FREE (800) 223-0306

Circle 138 on inquiry card.

## LETTERS

mit my text output directly into our office word processor through the modem from my desk at the office, at home, or on the road. Nothing new or earthshaking to the initiated, but I suspect the Mac will rapidly widen the initiated ranks.

As well as being a senior technical manager for TRW Inc., I have my own boat agency at home. A couple of MacWrite files handle my PR material/mailling list sufficiently well that I am pleased with the results. Pricing of a custom set of options for a boat customer takes only a few minutes using a combination of Multiplan and MacWrite to create a neatly printed, signed, formal quotation.

My kids do homework on the Mac.

My wife has some of her professional material on MacWrite documents.

While the Mac is my first personally owned computer, I have been in the computer business since 1965. I have daydreamed about a user interface like the Mac's often. I recognized my daydream machine, or a close facsimile thereof, as soon as I palmed my first Macintosh mouse. I ordered instantly.

My company DP department is pushing the PC XT. I looked it over and found it a poor buy for me. It's a long way behind the Mac in interface philosophy. The diehard MS/PC-DOS experts mesmerized by the IBM logo can have it. I prefer to communicate directly with my software's capabilities rather than through a middle-man translation protocol.

Despite the software delays and numerous phone calls to Microsoft to report bugs and find out my Multiplan version 1.02 *still* hasn't arrived, I have no regrets.

Anyone who bought a Mac expecting a mature stable of software this year hasn't enough experience in the computer business to be seriously voicing publishable complaints. I note with interest that Jerry Pournelle has been relatively silent on the issue. I suspect that's because he has enough experience to wait until the product is more mature before committing his time to evaluate it.

The competition has been printing largely inaccurate reviews of prerelease Mac software: many of them seem like rewrites of producers' public-relations material rather than valid, in-use evaluations. I have several prerelease programs and they are bug-ridden as well as incomplete. I'm hanging in there and waiting for the production stuff to appear on retail shelves. That's when the payoff comes, and I'm not interested in promises of the Real-Soon-Now family.

(continued)

Circle 351 on inquiry card. →



# In the Hard Disk Jungle Tallgrass Clears A Path



In today's hard disk jungle, Tallgrass clears a path by offering high performance, integrated mass storage solutions for the IBM® PC/XT, the T.I. Professional and related computers.

## TALLGRASS INNOVATIVE FEATURES

**MASS STORAGE SYSTEMS** with formatted HardFile™ capacities of 6, 12, 20, 35 and 70 Mb, all with built-in tape backup.

**CONVENIENT INTEGRAL TAPE BACKUP SYSTEM** allows rapid tape "image" streaming, or incremental file-by-file backup and restore on ANSI standard inexpensive data cartridges, instead of the usual floppies, video cassettes, or low-capacity removable Winchester devices.

**NETWORK READY** and fully compatible with networks such as PCnet® and EtherShare™

**HIGH RELIABILITY** with dual directory and read-after-write verify options. A dedicated landing zone, where the read/write heads reside when the disk is idle, provides data protection during powerdowns and transportation.

Follow the Tallgrass path to your local computer dealer and watch your personal computer transform into a powerful data processing system.

Available from COMPUTERLAND®, Entré® Computer Centers, MicroAge® Computer Stores and other participating computer dealers.

## New! IBM-XT Cartridge Tape Backup

World Headquarters: Tallgrass Technologies Corp., 11100 W. 82nd St.  
Overland Park, KS 66214 / 913/492-6002 / Telex: 215406 TBYT UR

Canadian Headquarters: Tallgrass Technologies (Canada), 1775 Meyerside Drive  
Mississauga, Ontario, Canada L4V 1H2 / 416/673-4244

European Distributor: CPS Computer Group, LTD  
Birmingham, England B276BH / (021) 7073866

Australian Headquarters: Tallgrass Technologies (Australia) / Five Dock Plaza,  
Suite 12/50 Great North Road / Five Dock / Sydney, N.S.W. 2046 / (02) 712-2010



**Tallgrass  
Technologies  
Corporation**



If anyone is interested in an owner's advice, read the Cary Lu book and the Clegg book, and then run, don't walk, to your nearest Apple dealer and get your order in. Even if you are one of the thundering herd with IBM engraved inside your eyeballs, you won't be sorry.

And to the software developers whose product ads state only "for IBM and compatibles," I say: Wake up folks, there's an-

other large, hungry, and growing market out here that you would do well to service!"

And to Susan Gold: My thanks for reminding me that there are toy aspects to the Mac. I had almost forgotten in my daily use of the Mac that it's fun to use.

I have no trouble telling where the insertion point is located despite bifocals. I find editing with the mouse to be a joy

compared to the old Xerox, DEC, and Wang word-processor methods I struggled with in the past.

My government customers have been enthusiastic recipients of the graphics in our deliverables already, and we have just begun. Onward and upward with Project Chart, Draw, and da Vinci! The Mac is a productivity aid—and a very cost-effective one.

BILL MONROE  
Fort Washington, MD

# GET UP THE RAMP

WITH OUR **EEPROM PROGRAMMERS & UV ERASERS**

**R**eliability  
**A**ffordability  
**M**aintainability  
**P**rogram



Choose from our **Stand Alone, Intelligent, RS-232 units.**  
COMPATIBLE WITH ANY COMPUTER OR TERMINAL.

**GANGPRO-8 . . . . . \$995.00**

High throughput. Gang 8 EPROMS with the fast Algorithm. Optional 512K buffer. Programs **ALL** 24 pin & 28 pin EPROMS. Other units to gang 24 EPROMS.

**PROMPRO-8 . . . . . \$689.00**

Powerful commands, easy communications, 128/256K buffer. Alpha Display, Simulation and Keypad option. Programs **ALL** EPROMS & MPU's.

**PROMPRO-7 . . . . . \$489.00**

32K RAM buffer, ideal for programming 8748, 8749, other Intel MPU's and 16K-128K EPROMS.

**BIPOLAR & PAL Programmers.. Call!**

TELEX 383 142

**UV ERASERS**

**ECONOMY MODEL QUV-T8/1 . . . . \$49.95**

Erases over 15 EPROMS. Plastic case.

**INDUSTRIAL QUV-T8/2N . . . . . \$68.95**

Metal case, UV indicator, tray, erases over 15 EPROMS in 15 minutes

**INDUSTRIAL QUV-T8/2T . . . . . \$97.50**

With 60 minute timer and safety switch.

**INDUSTRIAL QUV-T8/Z. . . . . \$124.95**

Fast Eraser, 15 EPROMS in 7 minutes, 30 EPROMS in 15 minutes

**PRODUCTION UNIT. . . . . \$149.95**

Model. ULTRA-LITE™. Erases 50 EPROMS in 15 minutes.

TOLL FREE **1-800-EE1-PROM**  
(331-7766) · FLORIDA (305) 974-0967

**AVAILABLE SOFTWARE DRIVERS**

- |                 |                |                 |         |
|-----------------|----------------|-----------------|---------|
| 1. IBM PC       | 2. APPLE II    | 3. Intel-MDS    | 4. CPM  |
| 5. TEXTRONX8002 | 6. COMMODORE64 | 7. TRS-80 COLOR | 8. FLEX |

**LOGICAL DEVICES, INC.**

DEPT. 6, 132-E N.W. 65th PLACE · FT. LAUDERDALE, FL 33309  
DISTRIBUTORS INQUIRY WELCOME



I am writing in response to Susan Gold's letter, which appeared in the June issue. Ms. Gold uses the example of deleting a single character to establish the inefficiency of the Macintosh's mouse. The same analogy could be applied to the automobile: It would be inefficient indeed to use an automobile to go to your next-door neighbor's house.

Ms. Gold has, obviously, given the Macintosh a cursory inspection and has not used it to the point an owner would (at which time use of the mouse becomes second nature). Many editing functions can be called from the keyboard (if you want to memorize the commands). In short, the mouse provides the operator the freedom of choosing which mode to use. In fact, I usually do use keyboard commands. But, unlike the VAX I use at work, if I haven't been on the machine for some time I don't find myself having to pull out the owner's manual to rediscover some obscure editing command.

The Mac is not just a toy. It is as powerful or more powerful than any micro on the market I know of priced under \$5000. Ultimately, like any machine, the Mac will only be as good as its software. As business applications software becomes available for the Mac, I am sure it will be at least competitive with the IBM machines in speed, capability, and efficiency, and superior in ease of operation.

JOHN BICKNELL  
Lawton, OH ■

LETTERS POLICY: To be considered for publication, a letter must be typed double-spaced on one side of the paper and must include your name and address. Comments and ideas should be expressed as clearly and concisely as possible. Listings and tables may be printed along with a letter if they are short and legible.

Because BYTE receives hundreds of letters each month, not all of them can be published. Letters will not be returned to authors. Generally, it takes four months from the time BYTE receives a letter until it is published.

# F·I·X·E·S A·N·D U·P·D·A·T·E·S

## BYTE'S BUGS

### Bugs Sneak Through Sieve

A pair of bugs slipped through the Sieve of Eratosthenes benchmark program that complemented Rich Krajewski's review of the Chameleon Plus (June, page 327).

The Sieve benchmark in listing 1 (page 334) and listing 2 (page 336), beginning with 5 REM: THE SIEVE... and ending with 180 PRINT..., is incorrect as it appears. Cut and paste listing 1 as presented here.

We apologize for the error.

Listing 1: *The corrected version of the Sieve of Eratosthenes benchmark program for the IBM PC and Apple IIe.*

```
5 REM: THE SIEVE BENCHMARK
10 SIZE = 7000
20 DIM FLAGS(7001)
30 PRINT "start one iteration"
40 COUNT = 0
50 FOR I = 0 TO SIZE
60 FLAGS(I) = 1
70 NEXT I
80 FOR I = 0 TO SIZE
90 IF FLAGS(I) = 0 THEN 170
100 PRIME = I + 1 + 3
110 K = I + PRIME
120 IF K > SIZE THEN 160
130 FLAGS(K) = 0
140 K = K + PRIME
150 GOTO 120
160 COUNT = COUNT + 1
170 NEXT I
180 PRINT "done: ";COUNT;" primes
found"
```

### Sorry, Wrong Numbers

A pair of incorrect telephone numbers appeared in recent issues of BYTE.

The telephone number given for Multimate in the review published in the BYTE Guide to the IBM Personal Computers was incorrect. The correct number is (203) 522-2116.

In the August 1984 BYTE on page 308, the telephone number for the SIGSTAT (Special Interest Group for Statistics) bulletin board was incorrectly listed. It should have read (301) 596-3569. Please

note that the board's hours are 5:30 p.m. to 9:30 a.m.

We apologize to all who have been inconvenienced.

## FEEDBACK

### Controlling Legalities with Editors

Legal difficulties forced us to alter the program listing of the videodisc game that accompanied the article "Controlling Videodiscs with Micros," by Rod Daynes and Steve Holder (July, page 207). It seems, however, that in our editing process we took all the flavor out of the program.

Messrs. Daynes and Holder's program is based on timing computer commands to disc frames. By replacing the frame numbers with a purely sequential series of numbers, we completely undermined the program's logic. The authors would like to offer a listing that retains the intent of the original to anyone interested in more than a mere vanilla version. For details, write to Rod Daynes or Steve Holder, Interactive Technologies Corp., 1131 G St., San Diego, CA 92101.

### Show of Interest to Videodisc Community

Steven D. Bristow, director of Technicom Design Center Inc. in Mountain View, California, sent us an update to a table in Stan Jarvis's article "Videodiscs and Computers" (July, page 187).

Under the heading "Information Sources and Conferences" in table 2 on page 190, please add the annual International Conference on Consumer Engineering. This conference, which features technical papers of interest to the videodisc community, is sponsored by the Consumer Electronics Society of the IEEE and is held in conjunction with the Consumer Electronics Show. The venue is Las Vegas, early in January.

Further information on the show can be obtained from the Consumer Electronics Shows Office, Suite 300, 2001 Eye St. NW, Washington, DC 20006. (202) 457-8700. The IEEE can be contacted at POB 639, Silver Spring, MD 20901. (301) 921-3491.

### Magnetic-Stripe Card Stores 2K Bytes

Vertex Industries markets a magnetic-stripe card and card reader/writer with a storage capacity of 2K bytes, according to a letter we recently received from Jim McMenamy, Vertex's product marketing manager. This information refutes the 212-byte limit claimed by Mark Mills in his January article "Memory Cards: A New Concept in Personal Computing" (page 154).

Vertex's product, called the KB-32, is being used in machine-tool and health-care fields. The company is located at 23 Carol St., POB 1123, Clifton, NJ 07014-1123, (201) 777-3500.

## BYTE'S BITS

### Call for Papers

Two calls for papers recently arrived at our office.

The organizing committee for the Ninth Annual Western Educational Computing Conference seeks papers that deal with computers and computer applications in any area that might interest instructors and administrators at the college level. The conference is to be held in Oakland, California, in November 1985, under the sponsorship of the California Educational Computing Consortium.

The deadline for submissions is April 1, 1985. Send two copies of original papers to Dr. Virginia S. Lashley, Glendale College, 1500 North Verdugo Rd., Glendale, CA 91208.

The Popular Culture Association will hold its annual meeting from April 3 to 7, 1985, in Louisville, Kentucky. One session will explore the question: Can computer adventure games be considered literature? They are, after all, built from words, and many of them have complex plots, characters, and settings.

A lively discussion is expected. If you're interested, contact Dr. Peter Jordan, School of Arts and Sciences, Tennessee State University, 10th and Charlotte, Nashville, TN 37203.

(continued)





**IEEE-488**  
High Speed Interface  
For Personal Computers

**IBM PC™**  
PC/XT, PCjr...

**Compatibles**  
AT&T, COMPAQ™...

Language Support — Interpretive  
BASIC, Compiled BASIC, C,  
FORTRAN, Pascal, Assembly.

Operating Systems — PC DOS,  
MS DOS, CPM 86/80, FORTH.

Software Compatible with our family  
of IEEE-488 Interfaces for VAX,  
PDP-11, LSI-11, S-100 BUS, STD  
BUS, MULTIBUS, VMEbus,  
Rainbow 100, and SBX.



**NATIONAL  
INSTRUMENTS**  
The Leader in IEEE-488  
Computer Interfaces

12109 Technology Blvd.  
Austin, Texas • 78727  
800/531-5066 • 512/250-9119

Rainbow™ is a trademark of Digital Equipment Corp.  
IBM PC™ is a trademark of International Business Machines.

**FIXES AND UPDATES**

**Modify the Sanyo Drives' LEDs**

Frans J. Janson, a BYTE reader in Santa Barbara, California, sent us directions for modifying the LED indicator used in the Teac drives built into the Sanyo MBC 550 series computer. Normally, the LED lights on the active drive and stays on until the drive's operation is completed. Mr. Janson's modifications change the LED operation so that it lights only when a drive access or an attempted access is taking place. The rest of the time the light is off.

Here's how you do it: Disconnect the power supply and remove the computer's top cover. Figure 1 (presented here) represents your work area; it's located on the top right-hand quadrant of the printed-circuit board on each drive. Next, locate and cut the trace on the printed-circuit board as indicated in the figure. Install the components listed in table 1. (Note that no wires are needed, that the lead length on the parts used is adequate, and that the lead length may need to be shortened for some connections.)

Make sure that there are no solder bridges or splashes that can cause a short. Component leads that are too close or

that are touching something will also cause a short. Reconnect the power supply and check for satisfactory operation before replacing the cover.

**Swiss Finance Center for Computer Music**

The Swiss government agreed to finance a Swiss Center for Computer Music last May. Situated in the picturesque village Oetwil am See near Zürich, the center is the brainchild of Gerald Bennett, Rainer Boesch, Dr. Antonio Greco, and Bruno Spoerri.

The Center provides facilities for visiting and local composers, and sponsors concerts, workshops, and courses in computer music. It's equipped with a Micro-VAX, two PDP 11/17s, and a DMX-1000 signal-processing computer.

Future plans call for a second studio to be located near Geneva and international summer courses for composers having previous experience in some area of computer music. For more information, contact Schweizerisches Zentrum für Computermusik, Sommerau, CH-8618 Oetwil am See, Switzerland. ■

Table 1: List of components needed for modifying the Teac drives.

Number Required	Part Description
4	2N4401 silicon NPN transistors
6	1N4148 silicon diodes
4	10K-ohm, 1/4-watt resistors

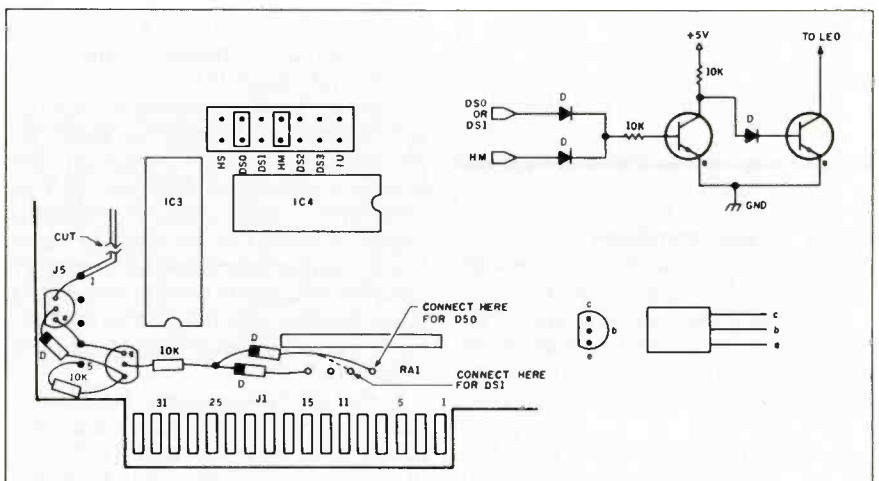

Figure 1: Work area for modifying the operation of the LED indicators on the Sanyo's Teac drives.



## UDS gives 212 users three ways to go!

**212A** — Today's most popular modem. UDS offers a fully Bell-compatible unit with complete local and remote test capability. Select 0-300 or 1200 bps for full-duplex asynchronous communication. The UDS 212A is FCC certified for direct connection to the dial-up telephone network, and available in multi-channel, rack-mounted configuration.

SINGLE UNIT PRICE ..... \$595

**212 LP** — Compatible with 212As at the 1200 bps, full-duplex asynchronous communication rate. No power supply or AC connection required; the 212 LP derives its operating power directly from the telephone line. Ideal for applications requiring 212A capability at 1200 bps only. The 212 LP is direct-connect certified.

SINGLE UNIT PRICE ..... \$345

**212A/D** — Identical to the 212A, with automatic dialing capability added! The unit stores and dials up to five 30-digit numbers. CRT menu prompting, single-stroke commands and automatic test capabilities are provided. The 212A/D is direct-connect certified.

SINGLE UNIT PRICE ..... \$645

Inquiry Hotline: 800/633-2252, ext. 357

 **Universal Data Systems**

 **MOTOROLA INC.**  
Information Systems Group

5000 Bradford Drive, Huntsville, AL 35805. Telephone 205/837-8100; TWX 810-726-2100

DISTRICT OFFICES: Atlanta, GA, 404/998-2715 • Bellevue, WA 206/455-4429 • Blue Bell, PA 215/643-2336 • Boston, MA, 617/875-8868 • Columbus, OH, 614/895-3025 • Englewood, CO, 303/694-6043 • Glenview, IL, 312/998-8180 • Houston, TX, 713/988-5506 • Huntsville, AL, 205/837-8100 • Mountain View, CA, 415/969-3323 • Old Bridge, NJ, 201/251-9090 • Richardson, TX, 214/680-0002 • Silver Spring, MD, 301/587-0166 • Tampa, FL, 813/684-0615 • Tustin, CA, 714/669-8001

Circle 364 on Inquiry card.

Created by Dayner/Hall, Inc., Winter Park, Florida



# THE END OF SOFTWARE FREEBIES.

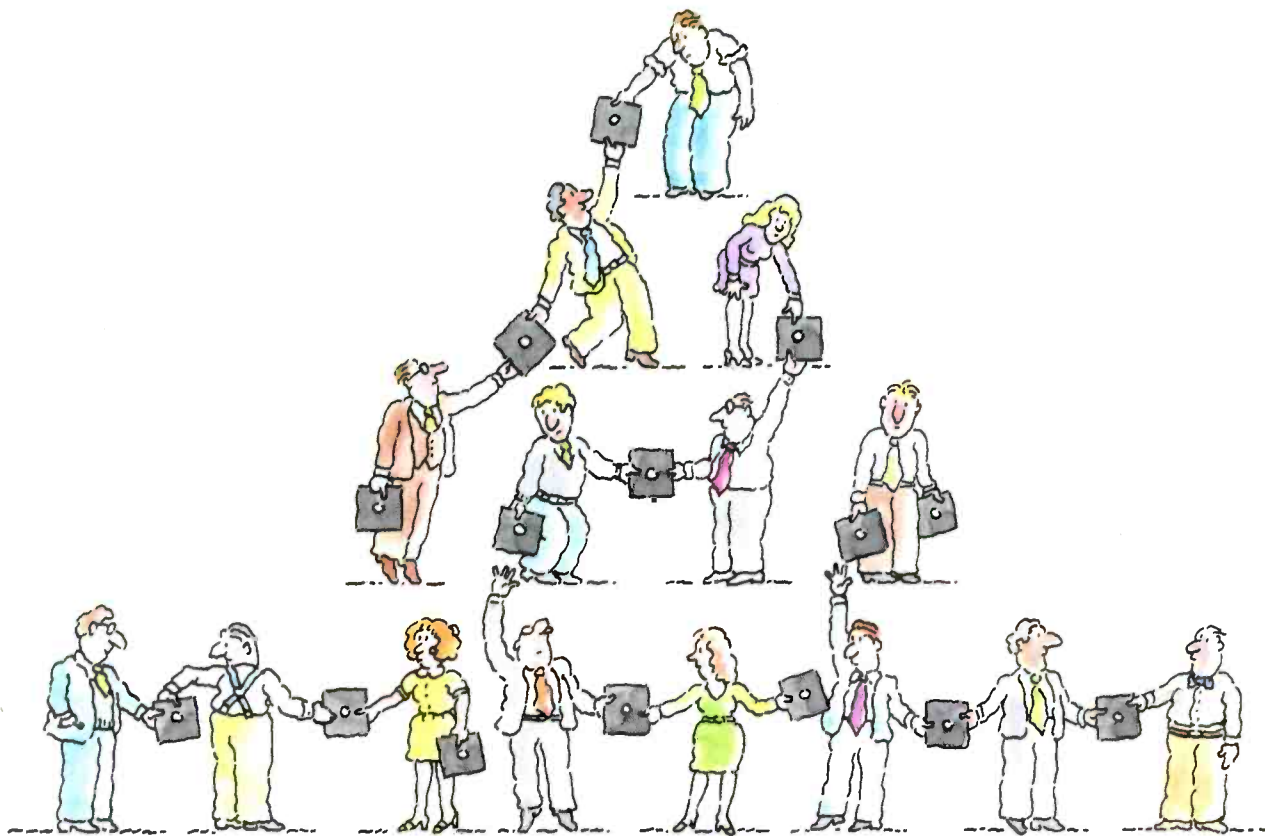

Finally there's a foolproof way to protect software against unauthorized duplication. And the technology is all on the disk itself.

The new Prolok™ disk doesn't need add-on hardware. Instead each diskette is marked with a unique, physical "fingerprint." No two are alike. A precise description of the individual print is encoded magnetically. The fingerprint AND the description must match exactly before the software is decrypted and released to the system. No match, no access.

Its genius is its simplicity and familiarity. Prolok looks like an unprotected disk, loads like an unprotected disk, works like an unprotected disk. The user feels immediately at home and in command. It's as easy as A>PROLOK B: filename.

Backups are easily made via normal system utilities. However, to be read they must be accompanied in the system by the original Prolok disk.

Prolok puts the casual copier—and even the deliberate pirate—out of business. It barely

## PROLOK. SOFTWARE

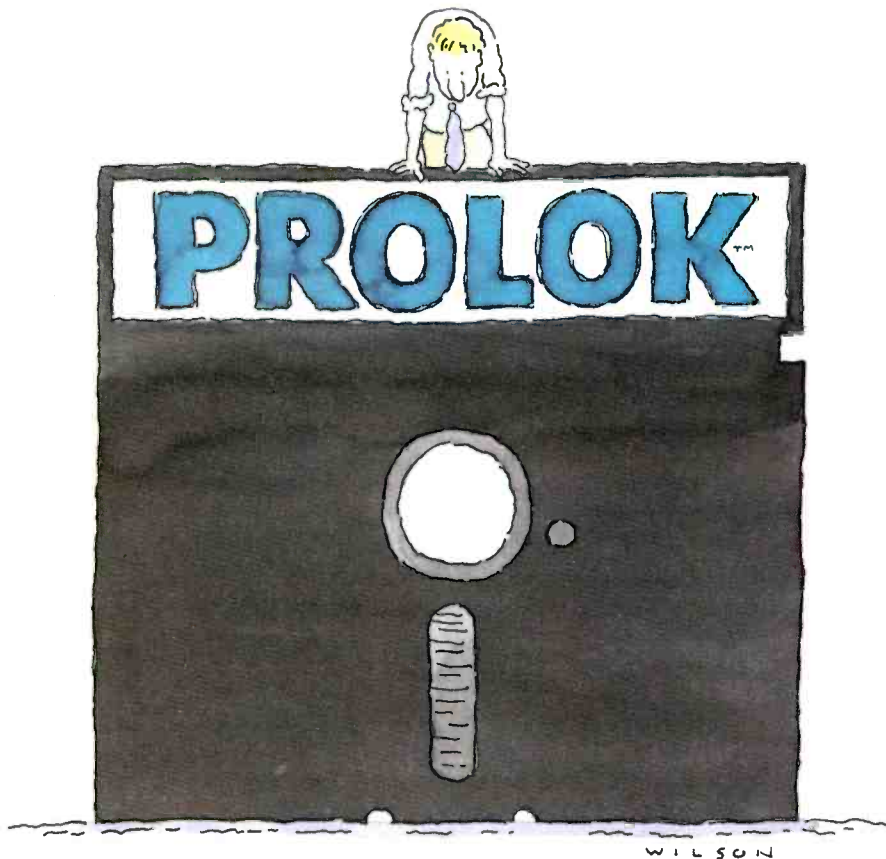

WILSON

increases the price of your product, yet it makes sure your customers don't buy one program and copy ten.

Several command line slash (/) options are built into Prolok diskettes for customized security, depending on your needs.

Software can be loaded easily onto Prolok diskettes using any system from a PC to commercial mass duplication equipment.

Prolok is an engineering breakthrough of Vault Corporation, which has been successfully

safeguarding software since the inception of security disk technology. Over 2000 businesses and organizations protect their valuable programs with Prolok.

Simply contact Vault Corporation at 2649 Townsgate Road, Suite 500, Westlake Village, CA 91361. Or phone us at 800-445-0193 (U.S.) or 800-821-8638 (California). And find out why software freebies are becoming a thing of the past.



# PROTECTION, RIGHT ON THE DISK.

Copyright © 1984 Vault Corporation. Prolok is a trademark of Vault Corporation



# THE RACE FOR SPACE

**Maynard's in the lead with an expanding universe of space-saving systems for your PC!**

Modular disk drive systems by Maynard Electronics drive technology to the limit to deliver unmatched performance with PC-DOS compatibility including self-booting off the hard disk.

## 10MB Winchester Internal Hard Disk Drive System!



This dynamic system lets you upgrade your PC or compatible to XT effectiveness, is internally installed, and does not require an additional power supply! The 10MB Hard Disk Drive System is equipped with the SandStar™ Hard Disk Controller Card which can accept up to three additional modular functions. Or, configure your system with the Hard Disk Controller Module and the SandStar Floppy Drive Controller Card which runs 5 1/4" and 8" Floppy Drives while still leaving four expansion slots for additional boards! Or, if you prefer, arrange your system with the Hard Disk Controller Module and the SandStar™ Memory Card which lets you add from 64K to 576K of memory using only one card slot!

## Maynard's SandStar™ Cards and Modules can put you lightyears ahead...

With technology racing into the future, serious computer users need to set their sights beyond obsolescence. Through the use of versatile SandStar™ Cards and Modules, Maynard has been able to engineer hardware to keep pace with tomorrow's needs. With Maynard's Disk Drive Systems and SandStar™ Cards and Modules, you won't be left behind in the race for space. For more details, call your dealer or distributor today.

## NEW! "The Apollo" 30MB Internal Hard Disk Drive.

This powerhouse comes with 30MB of on-line storage using PC DOS without any special software drivers. Discover new worlds of data efficiency and versatility. Our 30MB system includes the Hard Disk Controller Card or any of the other SandStar™ Cards with Hard Disk Controller Module.



## NEW! "The Gemini" Hard and Floppy Drive System.

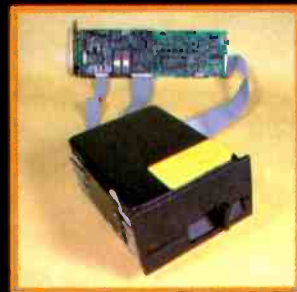

Now, for the first time, add the Gemini to your one drive system and take full advantage of internal Hard Disk power along with two internal Floppy Drive units. The Gemini comes with a sleek 10MB Half-Height Hard Disk Drive, a Half-Height Floppy Disk Drive (DS/DD), and the

SandStar™ Floppy Drive Controller Card with the Hard Disk Controller Module. Boost memory capacity dramatically while using no more space than a standard floppy drive! The Gemini can also be configured with either the SandStar™ Hard Disk Controller Card or the SandStar™ Memory Card with the Hard Disk Controller Module.



## MAYNARD ELECTRONICS

430 E. Semoran Blvd.  
Casselberry, Florida 32707  
305/331-6402

**We make modern times better.**

\* Serial Port, Parallel Port, Hard Disk Controller, Clock Calendar, Game Adaptor, and Prototyping Modules are available.

## AI System Runs Smalltalk-80, Priced Less Than \$15,000

**T**ektronix's 4404 Artificial Intelligence System runs Xerox's Smalltalk-80. The 4404 generates an interactive integrated software environment that supports simultaneous program design and implementation. Reportedly, the 4404's architecture, when coupled with Smalltalk-80's sophisticated graphics interface, is so responsive that on-screen animation can be realized.

Tektronix, one of four major companies selected by Xerox in 1980 to evaluate Smalltalk, announced that the 4404 with Smalltalk-80 will sell for \$14,950. Shipments are to begin after the first of the year. Smalltalk was the topic for the August 1981 issue of BYTE.

Smalltalk-80 creates an integrated exploration and development environment. An object-oriented language, it facilitates the invention of large, complex systems by letting programmers defer many constraints and commitments until the overall framework has been defined.

Smalltalk-80 works with symbolic descriptions of objects and incorporates such concepts as classes and messages. Routines can be executed immediately upon definition, and Smalltalk's internal definitions are available through windows.

The basic 4404 is a desktop unit built around the 10-MHz 16-/32-bit Motorola 68010 microprocessor. Floating-point operations are supported through a hardware accelerator. Mass storage is provided by



a 20-megabyte hard-disk drive and a 5¼-inch floppy-disk drive. User memory comprises 1 megabyte of RAM, which can be expanded to 2 megabytes. Page-on-demand memory management produces an 8-megabyte virtual address space, which permits development of complex programs without segmentation or overlays.

A 13-inch bit-mapped monochrome graphics display operating at 60 Hz, noninterlaced, is standard

equipment. The display format is 640 by 480 pixels, which serves as a window into the 1024 by 1024 display address space. Smooth panning over the entire display area is featured. A mouse completes the user interface.

The 4404 has Centronics-type parallel, RS-232C, and SCSI interfaces for connections to host computers and peripherals. In addition, an ANSI X3.64-compatible terminal emulator furnishes immediate access to other

computers.

An Ethernet networking interface will be ready in the spring. Optional languages available include Franz LISP and Prolog. A 40-megabyte hard disk with streaming-tape backup is also offered. For further information on the 4404 Artificial Intelligence System, write on company letterhead to Tektronix Inc., Marketing Communications Dept., Mail Station 63-635, POB 500, Beaverton, OR 97077.

Circle 600 on inquiry card.

## Expert System Capabilities for the PC XT

**T**IMM (The Intelligent Machine Model) is an expert system for the IBM PC XT that has been ported from mainframes. It is written in FORTRAN, a reflection of its mainframe origin. Minimum hardware requires an XT with 512K bytes of RAM and an 8087 mathematics coprocessor chip.

In operation, TIMM organizes information into sets of specific rules. These rules are then generated into general rules, which are used by the program to solve problems. A certainty factor is produced at the same time as a solution. The program also will explain, if asked, how it

reached a decision by listing the rules used to make the decision.

TIMM costs \$9500. Call for an on-line dial-up demonstration. Contact General Research Corp., POB 6770, Santa Barbara, CA 93160-6770, (805) 964-7724.

Circle 601 on inquiry card.

(continued)



## 32-bit Computer Series Has Networking Abilities

Sage Computers has changed its name to Stride Micro and introduced a new series of multiuser microcomputers. The Stride 400 series is made up of three base units ranging in price from \$2900 to \$8900.

The Stride 420 is the series' vanguard. Its foundation is a VME-compatible bus and a 10-MHz 68000 microprocessor. True vectored interrupts, asynchronous operation, a 24-bit address bus that can address 16 megabytes, and optionally polled I/O are standard bus attributes. The 68000 performs 2.5 million operations per second; it has 16-bit data paths and 32-bit registers.

System memory comprises 256K bytes of parity RAM, expandable to 512K bytes, 4K bytes of battery-backed CMOS RAM, and 16K bytes of boot/debugger ROM. One or two floppy-disk drives each manage 640K bytes worth of your data.

Liaison software and the Omninet interface provide



Photo 1: The Stride 420 is the base model of Stride Micro's Series 400 microcomputer. Stride Micro was formerly known as Sage Computers.

access to a file server. The local-area network has a 1-million-bps transfer rate and uses a twisted-pair cable. Stride 420 can accommodate four users, run concurrent operating systems, and serve as a communications hub through Liaison.

Four serial RS-232C ports with data rates spanning 300 to 38,400 bps and a

Centronics-type parallel port connect peripherals to the 420.

System software includes the p-System, a screen-oriented editor, filer, utilities, multiuser BIOS, RAM disk, and communications. Software options such as CP/M-86K, P-DOS, APL, BASIC, FORTRAN, and LISP are offered. A floating-point processor is also optional.

The Stride 440 comes with 256K bytes of RAM, expandable to 2 megabytes. One floppy-disk drive, a 10-megabyte Winchester, and 10 RS-232C serial ports are standard. It can handle up to 16 users. A streaming-tape backup and UNIX V are optional.

Up to 22 users can be linked to the Stride 460. Some of its additional features are a VME card cage, space for up to 3 megabytes of RAM, 10 to 22 serial ports, and Winchester storage capacities that range as high as 448 megabytes.

A Stride 420 with two disk drives and 512K bytes of RAM would cost \$3900. The top-of-the-line Stride 460 with one 640K-byte floppy drive, a 40-megabyte Winchester, 2 megabytes of RAM, and a streaming-tape backup is \$18,300. For further information, contact Stride Micro, 4905 Energy Way, Reno, NV 89502. (702) 322-6868.

Circle 602 on inquiry card.

## Xerox Demonstrates AI System Linked to IBM PC Peripherals

Xerox recently demonstrated an interface option for its 1108 AI workstation that provides connections for third-party peripherals designed for use with the standard IBM Personal Computer extension card cage.

Pricing for the 1108 interface was not available at press time. A company spokesperson did, however, say that shipments will begin in the first quarter of 1985.

At the press conference, Xerox demonstrated two different ways in which the 1108 can be used with IBM PC peripherals. The first presentation showed how a

low-cost color monitor can be used with the 1108; the other displayed an analog-to-digital speech input scheme running with the 1108.

The Xerox 1108 AI workstation is a single-user system. It has a large-format, high-resolution display, keyboard, mouse, and InterLISP-D. A variety of memory, processor, and disk-drive configurations are offered. It's marketed by Xerox Special Information Systems, Xerox Artificial Intelligence Systems Business Unit, 250 North Halstead St., POB 7018, Pasadena, CA 91109. (818) 351-2351.

Circle 603 on inquiry card.

## S-100 Board Features 80186 and Z80 Processors

The Duplex 816 is a dual-processor, S-100 board from Tarbell Electronics. Standard hardware includes an 8-MHz Z80H microprocessor, an 8-MHz Intel 80186 microprocessor, a floppy-disk interface, the 4K-byte 2732A PROM with monitor, two RS-232C serial ports with full handshaking, an interrupt handler, and memory-management capabilities for up to 16 megabytes.

The Intel 80186 features 16-bit registers and data paths. The Z80H is the 8-MHz version of the Z80.

The disk interface can accommodate up to four 8-inch drives and four

5¼-inch drives at once. The system BIOS can read CP/M-86 disks formatted on the IBM Personal Computer. The Duplex 816 has provisions for an 8087 co-processor, which is not yet available in an 8-MHz version.

A complete system can be created with the Duplex 816 and a memory board. A manual, BIOS and XIOS drivers for CP/M-86 and MP/M-86, and cables are included in the package, which sells for \$1100. Contact Tarbell Electronics, 950 Dovlen Place, Carson, CA 90746. (213) 538-4251.

Circle 604 on inquiry card.

(continued)

# This is THE PASCAL COMPILER You've Been Hearing About

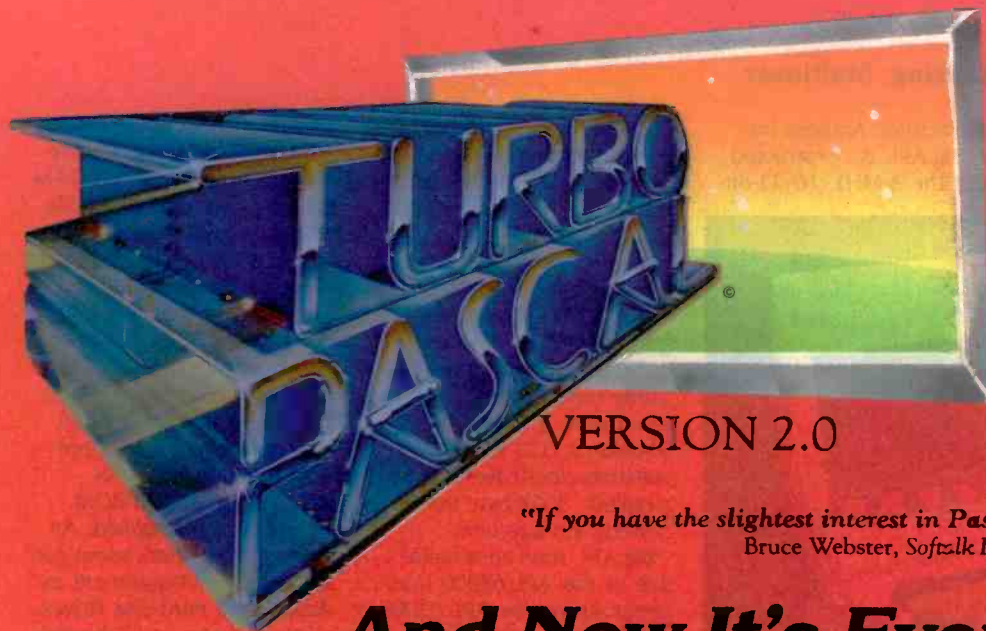

VERSION 2.0

"It's almost certainly better than IBM's Pascal for the PC... Recommended."

Jerry Pournelle  
Byte, May 1984

## \$49.95

"If you don't have CP/M [for your Apple], Turbo Pascal is reason enough to buy it."

Cary Hara  
Softalk Apple, May 1984

"If you have the slightest interest in Pascal... buy it."  
Bruce Webster, Softalk IBM, March, 1984

## And Now It's Even Better Than You've Heard!

- Windowing (IBM PC, XT, jr. or true compatibles)
- Color, Sound and Graphics Support (IBM PC, XT, jr. or true compatibles)
- Optional 8087 Support (available at an additional charge)
- Automatic Overlays
- A Full-Screen Editor that's even better than ever
- Full Heap Management—via dispose procedure
- Full Support of Operating System Facilities
- No license fees. You can sell the programs you write with Turbo Pascal without extra cost.

Yes. We still include Microcalc... the sample spreadsheet written with Turbo Pascal. You can study the source code to learn how a spreadsheet is written... it's right on the disk.\* And, if you're running Turbo Pascal with the 8087 option, you'll never have seen a spreadsheet calculate this fast before!

\*Except Commodore 64 CP/M.

### Order Your Copy of TURBO PASCAL® VERSION 2.0 Today

For VISA and MasterCard orders call toll free:  
In California:

1-800-255-8008  
1-800-742-1133

(lines open 24 hrs, 7 days a week)

Dealer & Distributor Inquiries Welcome 408-438-8400

Choose One (please add \$5.00 for shipping and handling for U.S. orders. Shipped UPS)

\_\_\_\_\_ Turbo Pascal 2.0 \$49.95 + \$5.00

\_\_\_\_\_ Turbo Pascal with 8087 support \$89.95 + \$5.00

\_\_\_\_\_ Update (1.0 to 2.0) Must be accompanied by the original master \$29.95 + \$5.00

\_\_\_\_\_ Update (1.0 to 8087) Must be accompanied by the original master \$69.95 + \$5.00

Check \_\_\_\_\_ Money Order \_\_\_\_\_  
VISA \_\_\_\_\_ MasterCard \_\_\_\_\_  
Card #: \_\_\_\_\_  
Exp. date: \_\_\_\_\_



**BORLAND**  
INTERNATIONAL

Borland International  
4113 Scotts Valley Drive  
Scotts Valley, California 95066  
TELEX: 172373

My system is: 8 bit \_\_\_\_\_ 16 bit \_\_\_\_\_

Operating System: CP/M 80 \_\_\_\_\_

CP/M 86 \_\_\_\_\_ MS DOS \_\_\_\_\_ PC DOS \_\_\_\_\_

Computer: \_\_\_\_\_

Disk Format: \_\_\_\_\_

Please be sure model number & format are correct.

Name: \_\_\_\_\_

Address: \_\_\_\_\_

City/State/Zip: \_\_\_\_\_

Telephone: \_\_\_\_\_

California residents add 6% sales tax. Outside U.S.A. add \$15.00 (if outside of U.S.A. payment must be by bank draft payable in the U.S. and in U.S. dollars.) Sorry, no C.O.D. or Purchase Orders. F15



## Lap-sized Big.APL Is Multitasking, Multiuser

A lap-sized computer running APL has been introduced by the Japanese

manufacturer Ampere Inc. The Big.APL is constructed about the 8-MHz, 16-/32-bit

HD68000 microprocessor and is said to possess all the functions, expandability, and flexibility of a desktop microcomputer.

Its basic hardware is 64K bytes of battery-backed CMOS RAM, 128K bytes of system ROM, a full-sized keyboard with programmable function and command keys, a 16-line by 80-column LCD screen, a real-time clock/calendar, and a built-in, 300K-byte microcassette storage unit.

Big.APL runs an adaptation of the APL.68000 Interpreter, known as APL.63000, under the control of the Big.DOS operating system. APL.63000 is a full implementation of IBM APL.SV that's been enhanced with a component file system, alpha report formatting, text handling, and full-screen editing capabilities.

A multitasking, multiuser operating system, Big.DOS lets you execute two tasks concurrently. It provides multiwindow control and supports multiple character sets for APL and applications programming. Simultaneous program execution and interaction with an external network can be achieved with Big.DOS.

The LCD screen uses a bit map with a 480- by 128-dot resolution and two frame memories. The microcassette tape recorder can be used for storing data and as a call recorder for automatic

transmission/reception of both voice and digital information. Both ROM and RAM file areas are user-definable, and data in the file areas is retained on power-off.

Expansion possibilities begin with the Big.APL's two-channel RS-232C serial interface; one of the channels serves as the built-in modem port. A parallel printer interface and three slots for plug-in CMOS RAM, ROM, and EPROM cartridges are supplied. An external bus offers room for such optional equipment as floppy- and hard-disk drives, memory units, and Ethernet interface.

Among the other options available are up to 256K bytes of RAM and an integrated software package with a full-screen function, I/O editor, word processor, graphics, and data manager.

The Big.APL weighs 6 pounds and measures 11.8 by 11 by 2.9 inches. It's powered by nicad batteries or by an AC adapter. Power is switched on and off by opening or closing the case. The main Big.APL unit costs \$1495. Each 64K-byte CMOS RAM cartridge is \$500, and the 1-megabyte microfloppy disk is \$500. Contact Ampere Inc., Asahi Building, 5-20, Nishi-Shinjuku 7-Chome, Shinjuku-Ku, Tokyo, Japan; tel: 03-365-0825; Telex: J33101 AMPERE.

Circle 605 on inquiry card.



## Card Lets PC Read/Write Apple Disks

Vertex Systems' Apple-Turnover permits direct file transfers between Apple and IBM Personal Computer disks, eliminating serial-file transfers and modems.

The Apple-Turnover package contains a half-sized printed-circuit board, disk-drive attachment cable, sup-

porting software, and a test disk. The board can be installed in any IBM PC slot between the regular controller card and the PC's disk drives. The test disk assures proper installation and operation.

The file-copying process is straightforward. You insert

an AppleDOS 3.3 or Apple CP/M disk into the IBM, follow Apple-Turnover's menu instructions, and copy individual or complete disks of Apple or IBM files. Blank disks can be formatted within the IBM for use on the Apple.

Apple-Turnover requires a

128K-byte IBM PC or PC XT with two disk drives and MS-DOS. Most hard-disk drives are supported. It sells for \$279.50. Contact Vertex Systems, Suite 3, 6022 West Pico Blvd., Los Angeles, CA 90035, (213) 938-0857.

Circle 606 on inquiry card.

(continued)

# NEW PRODUCT NEWS FROM TELETEK

**Systemmaster II.** Responding to market demand for speed and increased versatility, Teletek is proud to announce the availability of the next generation in 8-bit technology — the new Systemmaster II! The Systemmaster II will offer two CPU options, either a Z80B running at 6 MHz or a Z80H running at 8 MHz, 128K of parity checked RAM, two RS232 serial ports with on-board drivers (no paddle boards required), two parallel ports, or optional SCSI or IEEE-488 port. The WD floppy disk controller will *simultaneously* handle 8" and 5¼" drives. A Zilog Z-80 DMA controller will provide instant communications over the bus between master and slave. Add to the DMA capability a true dedicated interrupt controller for both on-board and bus functions, and the result is unprecedented performance. Systemmaster II will run under CP/M 3.0 or TurboDOS 1.3, and fully utilize the bank switching features of these operating systems.

**SBC 86/87.** As the name indicates, Teletek's new 16-bit slave board has an Intel 8086 CPU with an 8087 math co-processor option. This new board will provide either 128K or 512K of parity checked RAM. Two serial ports are provided with individually programmable baud rates. One Centronics-compatible parallel port is provided. When teamed up with Systemmaster II under TurboDOS 1.3, this 5MHz or 8MHz multi-user, multi-processing, combination cannot be beat in speed or feature flexibility!

**Teletek Z-150 MB.** Teletek is the first to offer a RAM expansion board designed specifically for the Z-150/Z-160 from Zenith. The Teletek Z-150 MB is expandable from 64K to 384K. Bring your Z-150 up to its full potential by adding 320K of parity checked RAM (or your IBM PC, Columbia, Compaq, Corona, Eagle, or Seequa to their full potential). The Teletek Z-150 MB optionally provides a game port for use when your portable goes home or a clock/calendar with battery backup!

Evaluate the Systemmaster II, SBC 86/87 or Teletek Z-150 MB for 30 days under Teletek's Evaluation Program. A

money-back guarantee is provided if not completely satisfied! All Teletek products carry a 3-year warranty.

(Specifications subject to change without notice.)



## TELETEK

4600 Pell Drive  
Sacramento, CA 95838  
(916) 920-4600  
Telex #4991834  
Answer back — Teletek

Circle 353 on inquiry card.

**In Europe:**  
Kode Limited  
Station Road  
Calne, Wiltshire  
SN11 0JR England  
tel: 0249-813771  
telex: 449335

**In Canada:**  
MAE Microsystems  
8255 Mountain Sights, Ste.150  
Montreal, Quebec  
H4P1W1 Canada  
tel: 514-341-1210

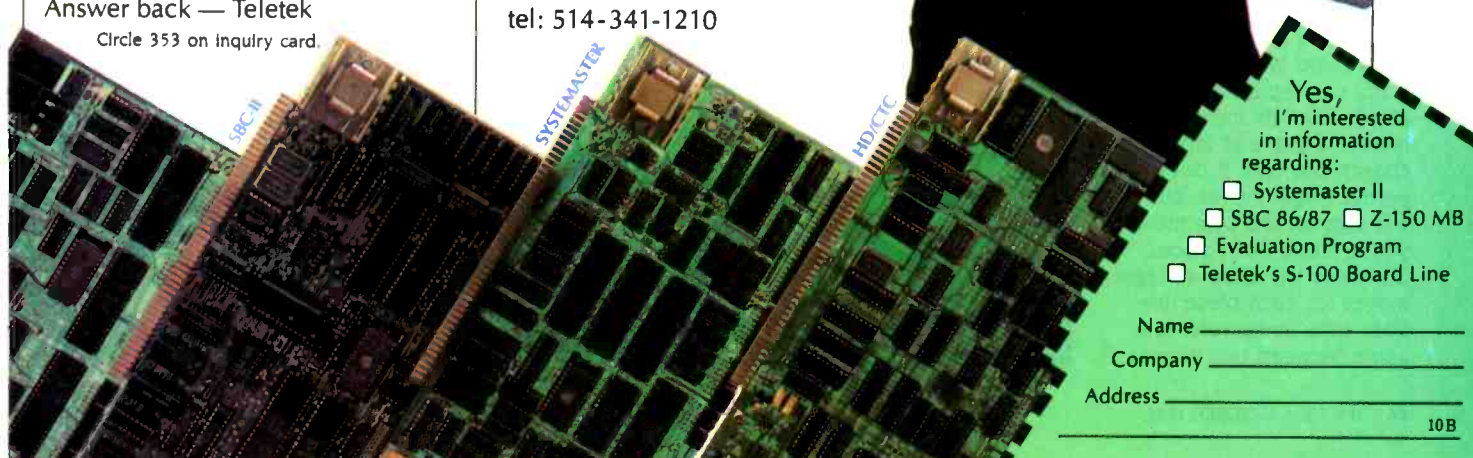

Yes,  
I'm interested  
in information  
regarding:

- Systemmaster II
- SBC 86/87  Z-150 MB
- Evaluation Program
- Teletek's S-100 Board Line

Name \_\_\_\_\_

Company \_\_\_\_\_

Address \_\_\_\_\_



## Multiprocessor Mega PC Supports up to Eight Users

**C**orona Data Systems Mega PC multiprocessor, multiuser microcomputer gives your office shared integrated system processing and stand-alone IBM PC XT-compatible processing. The power supply, mass-storage units, and peripheral connections for up to eight workstations are centralized in the Mega PC, and two or more Mega PCs can be networked together using commercial PC-compatible network schemes.

The main unit of the Mega PC contains a file-server board with 256K bytes of RAM and an 8088 microprocessor that oversees all housekeeping chores. Eight of its 11 bus expansion slots can be used for APCs (applications processor cards), which are required for every workstation. Empty slots can be occupied by any IBM PC peripheral card. An APC board contains a serial port and a dedicated 8-MHz 8088-2 microprocessor and



256K bytes of user RAM.

A workstation consists of a monitor and an 83-key keyboard. The 14-inch green-phosphor display has a 640-by 400-pixel resolution. Coaxial cables are used to connect users with the central file server.

The Mega PC has two

modes of operation: stand-alone IBM Personal Computer-compatible processing and shared resources. Different users can operate under either mode concurrently, with each user being assured of password and read/write protection and the ability to

access system resources.

System resources also incorporate a hard-disk controller with a real-time clock/calendar, a 10-, 20-, or 40-megabyte Winchester hard-disk drive, a 16K-byte ROM BIOS that boots the hard disk, and single serial and Centronics-type parallel ports.

Bundled software includes MS-DOS, GW BASIC, and a productivity package. A second 10-, 20-, or 40-megabyte Winchester drive, a 10-megabyte removable-cartridge Winchester drive, and a 43-megabyte streaming-tape backup are optional.

A two-user Mega PC with 256K bytes of RAM and a 10-megabyte hard-disk drive sells for \$7805. Additional workstations are \$1495, including an APC card. For more information, contact Corona Data Systems Inc., 275 East Hillcrest Dr., Thousand Oaks, CA 91360, (805) 495-5800.

Circle 607 on inquiry card.

## Chess Computer Has 10 Levels of Play

**C**onchess, a chess-playing computer, offers challengers five levels of play, five levels of practice play, and two levels of game analysis. At tournament level 4, Conchess has an estimated British Chess Federation performance rating estimated between 140 and 155. Its automatic sensory recognition lets you move pieces in a normal manner; a keyboard is not required.

You can replay completed games from its memory or reenter a game at any chosen position. It does not permit illegal moves, but it will suggest the best move if you're stuck. For novices, Conchess will show all legal moves for each piece, impose time limits, referee a game between two players,

and play against itself. It even lets you take back a move.

The average response time at the practice level ranges

from 5 seconds to 30 minutes. At the tournament level, response time averages between 5 seconds and 3 minutes 45 seconds.

Conchess uses the 6502A chip, backed by 24K bytes of ROM and 4K bytes of RAM. Both the hardware and software are packaged in a plug-in cartridge. Two cartridge spaces for new programs and an additional port for future peripherals are standard.

The Conchess playing board is rosewood and mahogany marquetry, silver and black, or silver and copper. It costs from £179 to £279, depending on model. Contact Contemporary Chess Computers, 2-3 Noble Corner, Great West Rd., Hounslow, Middlesex TW5 0PA, England; tel: 01-5771700; Telex: 932905 LARCH.G.

Circle 608 on inquiry card.

(continued on page 473)



# BUYING A PASSWORD™ MODEM CAN SAVE YOU UP TO \$250.

## AND THAT AIN'T HAYES!\*

You can bank on it. Your outlay will be less than if you settle for our major competitor, but not your output! A Password™ modem sends and receives up to 120 characters per second. Provides both 1200 and 300 baud capacity. Offers total interchangeability that lets you transmit information from any make microcomputer to any other make. And your investment is protected by a 2-year warranty.

Unlike our major competitor, Password™ delivers operating simplicity, plus the convenience of uncommon portability. Thanks to lighter weight, it goes almost anywhere. And because of the ingenuity of Velcro™ strips, it attaches wherever you need it, from the side of a desk to the side of a computer!

This means that Password™ doesn't tie you down, and its price won't hold you up. It features auto-dial, auto-answer, and even knows when to disconnect. If you're cost conscious, but refuse to sacrifice high-speed capability and performance, hook up with the right modem—Password™. The smart decision.

**PASSWORD™**  
by U.S. Robotics, Inc.



1123 W. Washington  
Chicago, IL 60607  
Phone: (312) 733-0497  
**Outside Illinois:**  
**1-800-DIAL USR**



\*Based on suggested retail price comparisons of U.S. Robotics, Inc. and Hayes Microcomputer Products, Inc.



# Introducing the new United they stand.



Programs in IBM's Assistant Series are like actors in a play. Alone, each gives an outstanding performance. Together, they've been directed to act well as a troupe. (In the software world, this interaction is called "integration.")

Just as actors can easily perform on different stages, these programs can easily work on different IBM personal computers — from PCjr to larger systems like PC/XT.

## ***How integrated software works.***

Want to get your facts and figures in order? Start with IBM Filing Assistant. Then, to print the facts in tabular form, add IBM Reporting Assistant. To write about what you've been working on (and make sure the spelling's accurate), use IBM Writing Assistant — the word processing program. Want to put a chart in the middle of your text? Use IBM Graphing Assistant. It takes data directly from IBM Filing Assistant to turn numbers into pictures. When it's time to think ahead with schedules and forecasts — get IBM Planning Assistant,\* the spreadsheet program. The finishing touch? IBM Assistant Solutions. They

Little Tramp character licensed by Bubbles Inc., s.a.

\* Available early next year.

\*\* Prices apply at IBM Product Centers

# *IBM Assistant Series. Divided they stand.*

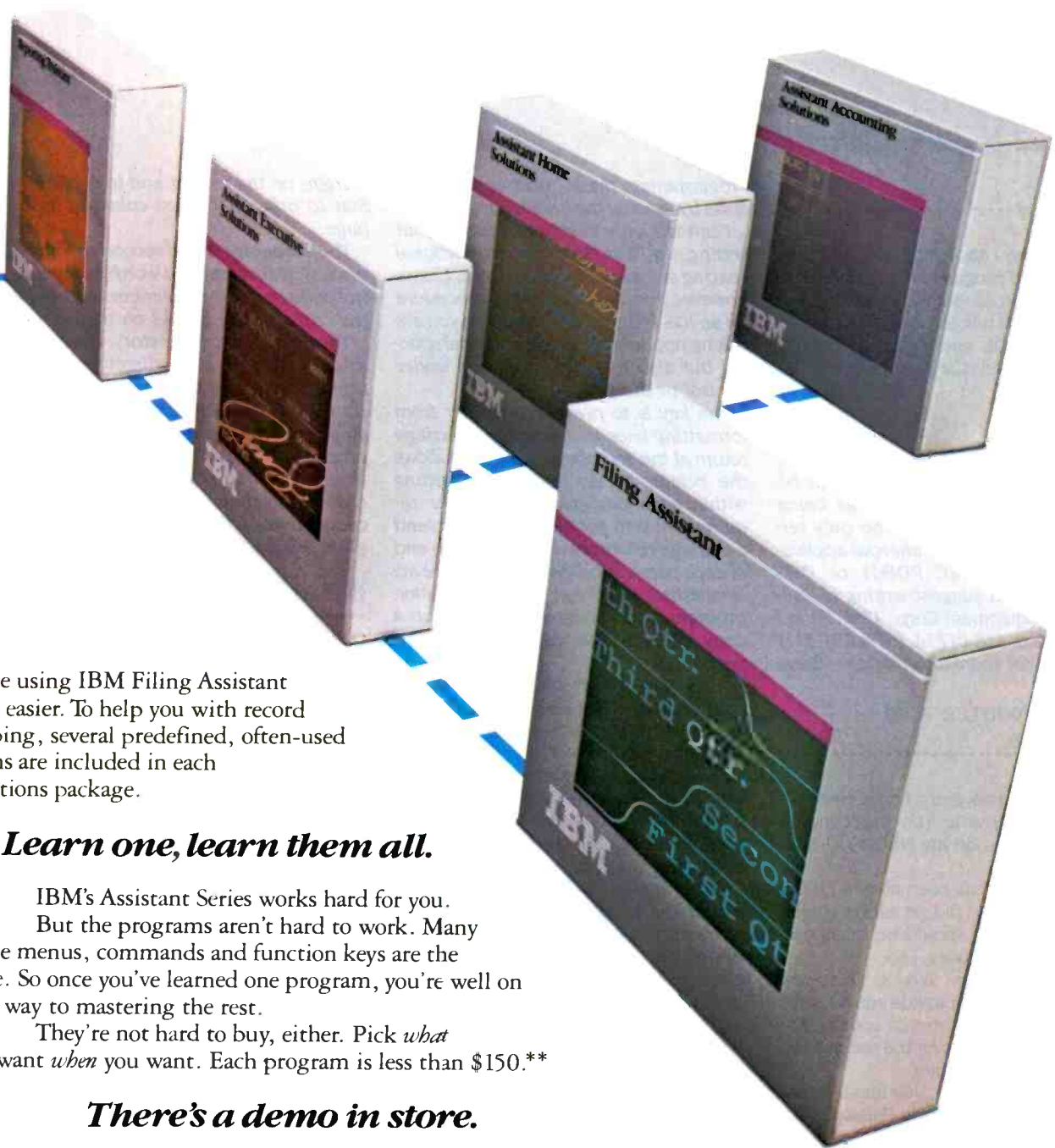

make using IBM Filing Assistant even easier. To help you with record keeping, several predefined, often-used forms are included in each Solutions package.

## ***Learn one, learn them all.***

IBM's Assistant Series works hard for you.

But the programs aren't hard to work. Many of the menus, commands and function keys are the same. So once you've learned one program, you're well on your way to mastering the rest.

They're not hard to buy, either. Pick *what* you want *when* you want. Each program is less than \$150.\*\*

## ***There's a demo in store.***

We've shown you how affordable the new IBM Assistant Series is. But we can't show you how easy. Your dealer can. Simply ask for a demonstration. For the authorized IBM Personal Computer dealer or IBM Product Center near you, call 800-447-4700. In Alaska or Hawaii, 800-447-0890.

**IBM®**

***Personal Computer Software***



## Conducted by Steve Ciarcia

### DIBOL

Dear Steve,

At one time I thought I saw an ad in BYTE that said programs written in DIBOL could be run on an IBM PC. PC-DOS would be preferable. If not, any operating system that runs DIBOL and works on the PC would be helpful. Can you help me?

STEVE GENTRY  
Richland, IN

A survey of listings in several current system-software publications reveals no mention of the DIBOL language being available on the IBM PC. The only reference to it was for commercial applications using the DEC PDP-11 or DEC VAX-11. I would suggest writing or calling Digital Equipment Corp., 129G Parker St., Maynard, MA 01754, (617) 897-5111 and asking for more information.—Steve

### THE SPINWRITER AND WORDSTAR

Dear Steve,

For the past two years, I have been trying to learn how to run proportional-spaced thimbles on my NEC 5510 Spinwriter.

So far, no one has been able to help in any specific terms. I did get a lot of general advice, such as, it should be really easy with the right software, etc.

I have WordStar version 2.10 and wonder if you could provide some instructions to make proportional spacing and the extra characters (over the standard 98) work with my Spinwriter.

GABRIEL BERCZI  
Pacific Palisades, CA

Printing the special characters on your Spinwriter requires programming two of the USER printer functions to send the ASCII SO (shift out) and SI (shift in) codes. This switches the printer back and forth between standard and special characters. The SO character, which is ASCII 14, selects the special character mode, and the SI character (ASCII 15) returns to standard type. The USER codes recommended are ^PO for SO and ^PW for SI.

Programming these functions can be done by running the installation program.

I can talk only in general terms about setting up WordStar for proportional spacing since I have never tried it. I have, however, tried the following procedure on an IDS Prism printer. I assume you are talking not only about proportional spacing but also margin justification under control of the printer.

The key is to prevent WordStar from formatting lines and sending a carriage return at the end of every line. This allows the printer to do its own formatting within each paragraph. The other requirement is to get the program to send a carriage return and linefeed at the end of each paragraph. These can both be accomplished with the aid of the installation program, and it seems best to set up a copy of WordStar especially for this purpose.

After you are set up to install a new copy, start the installation program, go to the WordStar features menu, and set the justification default to OFF. Of course, you can also set any other options you want at this time. Next, go to the custom printer installation menu to set up WordStar to allow the printer to control formatting.

There may be two ways to do this: one where the printer decides how many characters to put on a line, and another where the printer just distributes the given line of characters uniformly. To operate in the first mode, go to the carriage-return function in the printer-installation menu and replace the codes there with a 20 hexadecimal (the code for a space). This will prevent WordStar from sending carriage returns at the end of lines. Next, set one of the USER functions to send a carriage return/linefeed pair (0D,0A hexadecimal). You will use this to mark the end of paragraphs.

To operate in the second mode, if it is available, find the code that the printer wants to see at the ends of lines in place of a carriage return. On the Prism, it is ^Z (1A hexadecimal). You will probably also need the 0D,0A hexadecimal USER function as in the first mode also. For both modes, it is necessary to set the

margins on the printer and to set WordStar to print in the first column on the page.

The advantage of the second mode, by the way, is that it allows WordStar to control page lengths and numbers and show the correct page breaks on the screen.

This isn't a complete story, especially since it doesn't refer directly to your printer, but I hope it's enough to get you started in the right direction. Don't be afraid to play around with the installation procedure. You can't really hurt anything, as any function you don't like can be changed by running the installation procedure over on the same copy of the program.—Steve

### IMSAI INFORMATION

Dear Steve,

In the December 1983 Ask BYTE, Gisle Hannemyr inquired about IMSAI manuals. You responded with information about Fischer-Freitas. I thought you should know that Fischer-Freitas is out of business. I bought \$1400 worth of hardware from the company for my IMSAI 8080. What I received were wrong parts or damaged parts. I wrote a complaint but received no answer. I called, but the phone was disconnected. I finally received a letter stating that Computer Performance (2479 Industrial Parkway West, Unit F, Hayward, CA 94545, (415) 887-2381) has contracted the repair and warranty work from IMSAI and Fischer-Freitas. I wrote to Computer Performance about the wrong parts, but I again got no answer. Evidently, this is an example of the kind of service that we can expect.

And now a question: How do I get updates to CP/M? I wrote to Digital Research about CP/M patches. While the company was helpful with my other questions, it wasn't able to answer this one.

GEORGE L. MORGAN  
Cedar Park, TX

Thank you for your information about Fischer-Freitas and Computer Performance. I will have to store that away for future reference.

(continued)

**PRINCETON™**  
An Intelligent Systems Company

# If you're looking for a quality monitor, look for this symbol.

**HX-12. A high resolution monitor at a medium resolution price.**



HX-12 is a high resolution RGB color monitor that's colorful enough for all your graphics needs and sharp enough for word processing.

With its own cable that plugs directly into the IBM PC, the HX-12 delivers a rainbow of 16 colors on a non-glare screen. All that includes clean whites without red bleed. In fact, all the colors are clean and crisp thanks to the HX-12's .31mm dot pitch and 690 x 240 (non-interlaced) resolution.

Shop around. Nothing else compares to the HX-12 priced at just \$695.

**The SR-12 delivers even better resolution color for a better-than-ever price.**



At first glance, the SR-12 might appear similar to the HX-12 with a non-glare screen and .31mm dot pitch supporting 690 horizontal resolution. But take a closer look. SR-12's scan frequency is 31.5 KHz, allowing the SR-12 to support 480 vertical resolution in non-interlaced mode. That means a high-quality, flickerless image with text that's up to monochrome standards. What's more, you get all that quality for \$799.

For full compatibility with all IBM software, get the **Princeton Scan Doubler**. Priced at \$249, it allows you to run the SR-12 from a standard IBM or IBM equivalent color card in the IBM PC.

You can't beat the SR-12 for resolution or price.

**MAX-12. You won't find a better monochrome monitor for a better price.**



PGS combines easy-on-the-eyes amber phosphor and exceptional 800 x 350 resolution to give you the MAX-12, the best monochrome monitor for your money.

Check the non-glare screen. Dynamic focusing circuitry keeps the image sharp, not only in the center, but around the edges and in the corners. Then check the price. At \$249 the MAX-12 is less expensive than the leading green-on-black competitor. And there's more. The MAX-12 works with the IBM PC and other IBM compatibles.

For clarity, performance and price, your choice is clear. Make it the new MAX-12.

IBM® PC are registered trademarks of International Business Machines Corporation.

©Copyright 1984 Princeton Graphic Systems. All rights reserved.

**PRINCETON™**  
An Intelligent Systems Company

**Princeton Graphic Systems**

170 Wall Street, Princeton, N.J. 08540  
(609) 683-1660/(800) 221-1490 EXT. 31  
Telex: 821402 PGS PRIN

Circle 286 on inquiry card.



# Perfect Compatibility

IBM™ & ACP

Circle 24 on inquiry card.

## HARDWARE

### COMPUTER SYSTEMS

#### IBM

- PC w/256K 2 DS/DD Disk Drives . . . \$ Call
- PC w/256K 1-360K Drive  
1-10MB Hard Disk . . . \$ Call

#### COMPAQ

- w/256K 2 DS/DD Disk Drives . . . \$ Call

### COMMUNICATION PRODUCTS

#### HAYES

- Smartmodem 300 . . . \$ 209
- Smartmodem 1200 . . . \$ 489
- Smartmodem 1200B w/Smartcom II . . . \$ 419
- Smartmodem-to-IBM 6 ft. Cable . . . \$ 25
- Smartcom II . . . \$ 99

#### TAC

- Irma (Emulates 3278 Terminal) . . . \$ Call
- Irma Line (For Remote Emulation) . . . \$ Call

### FLOPPY & HARD DISK DRIVES

#### CONTROL DATA

- Full Size 320K DS/DD . . . \$ 209
- Half-Height 320K DS/DD w/Bracket . . . \$ 179

#### DAVONG

- 10 MB to 41 MB Hard Disk Int./Ext. . . \$ Call

#### IOMEGA

- Bernoulli Box (10 or 20MB) . . . \$ Call

#### TALLGRASS

- 12-70 MB Hard Disk w/Tape Backup . . . \$ Call

#### TEAC

- Half-Height 320K DS/DD w/Bracket . . . \$ 179
- Half-Height 640K DS/DD w/Bracket . . . \$ 265

#### MAYNARD ELECTRONICS

- 10MB Hard Disk WS-1 (XT Lookalike) . . . \$ 949
- 10MB Hard Disk WS-2 (XT Lookalike) . . . \$1149

### EXPANSION BOARDS

#### MAYNARD ELECTRONICS

- Modular Memory Brd. w/64K to 576K . . . \$ 219
- Modular Multifunction Board . . . \$ 95

#### AST RESEARCH

- (All AST boards include SuperDrive, SuperSpool and 1 year warranty)

- SixPack Plus w/64K to 384K . . . \$ 269
- MegaPlus II w/64K to 512K . . . \$ 269
- Memory Board II w/64K to 384K . . . \$ 239
- I/O Plus II . . . \$ 139
- MegaPack w/128K or w/256K . . . \$ Call
- Parallel, Serial, Game Options . . . \$ 35

#### ORCHID TECHNOLOGY

- Blossom w/64K to 384K . . . \$ 249

#### TECMAR

- Captain w/64K to 384K w/Software . . . \$ 269

#### EXPANSION BOARDS CONT.

#### QUADRAM

- Quadboard w/64K to 384K . . . \$ 269

### PRINTERS & PLOTTERS

#### C. ITOH

- Starwriter Letter Quality 40 cps . . . \$1195
- Printmaster Letter Quality 55 cps . . . \$ Call
- Cut Sheet Feeder (Feeds 200 sheets) . . . \$ 445

#### EPSON

(All Printers include GRAPHTRAX-Plus)

- RX-80 (120 cps, 80 cols) . . . \$ Call
- RX-80 F/T (120 cps, 80 cols) . . . \$ Call
- RX-100 F/T (100 cps, 132 cols) . . . \$ Call
- FX-80 F/T (160 cps, 80 cols) . . . \$ Call
- FX-100 F/T (160 cps, 132 cols) . . . \$ Call
- Epson-IBM Cable . . . \$ 30

#### HEWLETT PACKARD

- HP-7470A Two Pen Plotter . . . \$ Call
- HP-7475 Six Pen Plotter . . . \$ Call
- HP-IBM Cable (works w/Lotus 1-2-3) . . . \$ 50

#### NEC

- NEC 3550 Letter Quality 35 cps . . . \$1699
- NEC 2050 Letter Quality 18 cps . . . \$ 895
- Bi-Directional Tractor . . . \$ 235
- Cut Sheet Feeder (Feeds 200 Sheets) . . . \$ 445
- NEC-IBM Cable . . . \$ 30

#### OKIDATA

- Microline 83A (120 cps, 132 cols) Best Price
- Microline 92 (160 cps, 80 cols) . . . Best Price
- Microline 93 (160 cps, 132 cols) . . . Best Price
- Microline 84 (200 cps, 132 cols) . . . Best Price
- Plug n' Play . . . Best Price
- Okidata-IBM Cable . . . \$ 30

#### SILVER-REED

- EXP 550 (20 cps, 132 cols) . . . \$ 595

### VIDEO—MONITOR BOARDS

#### HERCULES

- Graphics Card . . . \$ 359
- Color Card . . . \$ 179

#### PC COMPONENTS

- Bi-Graphix I . . . \$ Call

#### PARADISE SYSTEMS

- Multidisplay . . . \$ 339

#### PC+ PRODUCTS

- Colorplus . . . \$ 419

#### STB

- Graphix Plus . . . \$ 389

#### QUADRAM

- Quadcolor I . . . \$ 199

#### TECMAR

- Graphics Master \$ 499

### MONITORS

#### AMDEK

- Video 300 Green Screen . . . \$ 140
- Video 300A Amber Screen . . . \$ Call
- Video 310A IBM Monochrome in Amber . . . \$ 170

#### PRINCETON GRAPHICS

- HX-12 RGB Hi Resolution Color . . . \$ 499
- Max-12 IBM Monochrome in Amber . . . \$ Call
- SR-12 Hi Resolution Color . . . \$ Call

## ASK BYTE

*It looks like you took the right approach when you wrote to Digital Research. I would try again, but this time write to the newsletter staff at Digital Research News, POB 579, Pacific Grove, CA 93950, (408) 649-3896.*

*Microsystems magazine also covers most of the new happenings in the CP/M world. The July/August 1982 issue has an article called "CP/M V2.2 Patches." It is a reprint of a Digital Research article describing CP/M patches 1 through 9. Write to Microsystems, One Park Ave., New York, NY 10016, (212) 725-6856. —Steve*

### NORTH STAR CP/M

Dear Steve,

I have an S-100-based homebrew micro-computer system that uses a North Star single-sided double-density disk drive. I have been using the North Star DOS and now want to switch to CP/M. I would like to know of sources of CP/M for the North Star and how to customize the operating system for my computer system's I/O. My system uses an S-100 Z80 processor card.

Also, could you please describe the differences between CP/M 2.2 and CP/M 3.0.

Thank you.

GEORGE C. LYSY  
Palm Harbor, FL

*Microsystems magazine publishes a great deal of material on the North Star systems. In the May 1983 issue, "S.A.I.L.ing Without a Lifeboat," written by Steve Leibson, discusses a version of CP/M 2.2 for the North Star being sold by S.A.I.L. Software. The price is \$165. Write to S.A.I.L. Software, 86 West University Ave., Suite 14, Mesa, AZ 85201.*

*CP/M 3.0 has many features that CP/M 2.2 was lacking. I will not go into the details of these features, but the following list should give you an idea of some of the new features provided: time and date stamp, multisector disk I/O, device redirection vectors, banked memory access, and disk media change signals. —Steve*

### ISAM FACILITY

Dear Steve,

I wish the popular operating systems like CP/M, MS-DOS, and UNIX had an ISAM (indexed sequential-access method) facility. Compared to the operating systems on minicomputers, the operating systems on micros are abominations. Don't you think

**WE'LL GIVE YOU \$10.00**

Simply refer to this reference number—B11 with your order and receive \$10.00 credit toward your next purchase.\*

\*Minimum order \$100.00. Limit one credit per customer.

## ASK BYTE

it's time for the microcomputer industry to move forward a step by providing an indexed or symbolic key-access capability for keyed files?

LAMONT PHEMISTER  
Mt. Vernon, IL

*You're right about microcomputers not having the greatest operating systems in the world, but unless someone writes better ones, we'll be stuck with what we have.*

*Several companies sell programs that add such features as you've described. For instance, SofTech Microsystems Inc. (16885 West Bernardo Dr., San Diego, CA 92127, (619) 451-1230) sells KSAM for the Apple IIe. This is a keyed-sequential-access-method utility that operates under the p-System operating system. For other companies, check the ads in BYTE or try a software directory.—Steve*

### MEMORYWRITER

Dear Steve,

I am having a problem with my Xerox 615 Memorywriter. I bought it with an informal understanding that I would be able to use it as a letter-quality printer for a microcomputer. I am now having difficulty getting this accomplished.

I have written Xerox to ask about the feasibility of having an RS-232C port put in my typewriter. I was told that this could be accomplished only by upgrading my 615 Memorywriter to a 620 Memorywriter at a cost of more than \$900. I have located several companies that can change IBM electronic typewriters into printers for micros for less than \$500. I would appreciate any help you can give me. I am not prepared to spend \$900 to upgrade my typewriter into a typewriter with a preview screen and additional memory. I am prepared to spend \$500 to convert my typewriter into a machine that could function as my printer.

JOHN C. TOTH  
Jackson, MS

*Spending \$900 is a high price to pay if the only benefit is that the machine can now be used as a printer for your computer. At those prices, it would be better to purchase a dedicated printer for the computer and leave the typewriter as it stands. Daisy-wheel printers with rates of 10 to 15 characters per second are now selling for less than \$500. Ads can be found in the advertising pages of BYTE.*

(continued)

# Perfect Compatibility

IBM™ & ACP

## DISK CONTROLLERS

### MAYNARD ELECTRONICS

Standard Disk Controller	\$ 115
with Parallel Port	\$ 165
with Serial Port	\$ 175
Sandstar Modular Disk Controller	\$ 209
All Sandstar Modular Options Avail.	\$ Call

## SOFTWARE

### ASHTON TATE

dBase II	\$ 285
dBase III	\$ Call
Framework	\$ Call

### FOX & GELLER

Quickcode II or III	\$ 169
dGraph (Requires Graphics Card)	\$ Call
dUtil (Utilities For dBase II or III)	\$ Call

### FUNK—Sideways

	\$ 49
--	-------

### HAYES—Smartcom II

	\$ 99
--	-------

### IMSI—4 Point Graphics (Rated #1)

(Inhance Lotus Graphics)	\$ 119
--------------------------	--------

### INDIVIDUAL SOFTWARE

Tutorial Set (IBM PC/XT and DOS)	\$ 79
Typing Instructor	\$ 39

### INFOCOM—Zork I, II, III

All games available	\$ Call
---------------------	---------

### INFORMATION UNLIMITED SOFTWARE

EasyWriter II System	\$ 195
Accounts Receivable	\$ 299
Accounts Payable	\$ 299
General Ledger	\$ 299
Payroll	\$ 369

### LATTICE

C-Compiler	\$ 299
C-Food Smorgasboard	\$ 110

### LIFETREE

Volkswriter Deluxe w/TextMerge	\$ 169
--------------------------------	--------

### LOTUS DEVELOPMENT

Lotus 1-2-3 (Version 1A)	\$ Call
Symphony	\$ Call
Symphony Upgrade	\$ Call

### MICRO DATA BASE SYSTEMS

Knowledgeman	\$ 299
--------------	--------

### MICROPRO

Wordstar w/Tutorial on Disk	\$ 229
ProPack (Wordstar/MailMerge/ CorrectStar/StarIndex)	\$ 329
ProfessionalPlus (ProPack plus TelMerge Electronic Mail System Mailing List Management and Business Letters)	\$ Call

### MICRORIM

R.base 4000	\$ 299
Clout	\$ 139
Extended Report Writer	\$ Call

### MICROSOFT

C-Compiler	\$ 349
Flight Simulator	\$ 35
Multiplan (New Version)	\$ 149
Project (Project Manager)	\$ 180
Chart	\$ 180
Word	\$ 239
Word w/Mouse	\$ 299
Mouse w/Software	\$ 139

- No Credit Card Surcharge
- Special Corporate Accounts Division
- Company P.O. Accepted
- Training
- Equipment Maintenance
- Next Day Shipping

### MICROSTUF

Crosstalk XVI (for Hayes Smartmodem)	\$ 99
---	-------

### MORGAN COMPUTING

Trace 86 (Assembly Language Debug)	\$ 99
Ted (Program Editor)	\$ 79
Professional Basic (170K Work Space w/8087 Support)	\$ 259

### MULTIMATE INTERNATIONAL

Multimate	\$ 269
-----------	--------

### PETER NORTON

Norton Utilities	\$ 55
------------------	-------

### ROSESOFT

Prokey (Newest Version)	\$ 95
-------------------------	-------

### SATELLITE SOFTWARE INTERNATIONAL

Word Perfect (includes Speller)	\$ 269
---------------------------------	--------

### SOFTWARE PRODUCTS

Open Access	\$ 299
-------------	--------

### SOFTWARE PUBLISHING

PFS/Access	\$ 65
PFS/File	\$ 89
PFS/Graph	\$ 89
PFS/Report	\$ 79
PFS/Write	\$ 79

### WANG PUBLICATION

Random House Proof Reader (50K)	\$ 45
---------------------------------	-------

### WORDTECH SYSTEMS

dB/Compiler (True dBase II Compiler)	\$ 450
---	--------

### OUR POLICY

- We accept VISA, MasterCard, Money Orders, Certified Checks, Cashiers Checks, Personal Checks, Wired Funds • We do not charge your card until we ship • No surcharge added on VISA and MasterCard • Allow one week for personal and company checks to clear • COD maximum \$500 Cash or Certified check on delivery • Please use local phone number for order status inquiries • Prices subject to change without notice • Returns may be subject to restocking fee.

**SHIPPING (U.S.).** For monitors, and hard disk drives add 2% to all orders. Blue label and Next Day Air available. For all other items add \$4. **Most orders shipped next day.**

**When you need competitive prices, prompt service and complete support, call us.** Circle 25 on inquiry card.

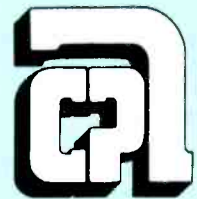

## APPLIED COMPUTER PRODUCTS INC.

1916 Welsh Road #6, Philadelphia, PA 19115  
215-934-6990 Telex 756876 UD

# 1-800-223-3860

\*IBM is a registered trademark of International Business Machines.



A new product for transforming electronic typewriters into computer printers is being advertised by Cord Ltd. The product, SuperCord II, is an update of the original SuperCord. The claim is that the SuperCord II can transform typewriters such as Adler, Brother, Royal, Smith-Corona, Silver Reed, etc. into computer printers. Maybe the etc. includes the Xerox machines. The address is Cord Ltd., 2815 Junipero Ave., Bldg. 102, Signal Hill, CA 90806. The price of the SuperCord II ranges from \$295 to \$365, depending on the model selected.—Steve

**MICRO DECISION**

Dear Steve,

I have not seen any reviews and/or letters to the editor on the quality/ease of use of the Morrow Micro Decision. Have I missed something? Would you ask users to write in? It seems a shame that the unit isn't covered, since it seems to be a true bargain.

Thank you.

HOWARD BURNS  
Diamond Bar, CA

The Micro Decision system looks like a fine CP/M machine from the articles that I have read. The terminal is an ADM 20 made by Lear Siegler, and the keyboard is detached. In the rear of the machine are two RS-232C serial ports and a card-edge connector for the addition of outboard disk drives. Inside the main box are a switching power supply and a single-board computer driven by a Z80. The CP/M BIOS is claimed to be well written and gives meaningful disk error messages. The BIOS also supports a virtual-disk drive that can be used to overcome some of the disadvantages of a standard CP/M system when changing disks.

Reviews of the Micro Decision can be found in the October 1983 BYTE and the February 1983 issue of Microsystems. A review of Morrow's Decision I can be found in the April 1983 Microsystems.—Steve

**UPDATING WORDSTAR**

Dear Steve,

Neil G. Wallace's "Full Use of the Epson MX-80 Under Wordstar" (May 1983, page 203) was about the IBM PC and Epson MX-80. I have a Zenith Z-89 64K-byte computer running CP/M and a Star Micronics Gemini-10 printer. I would like to update my version of WordStar, which is version

2.25. I need a step-by-step guide, such as this article. I understand that the Gemini is a clone of the Epson. Where could I go to get this information?

DAVID L. OWSLEY  
Birmingham, AL

The procedure for modifying your CP/M version of WordStar is the same as for the IBM PC version. Since you are working with CP/M, however, the debugger is DDT instead of Debug. WordStar is loaded from your experimental disk by entering the command DDT WS.CMD. The detailed procedure is too long to put in a letter, but I will give you the differences from the procedure shown in the May 1983 article.

First, the addresses you will see when you enter the data will look different than those given in BYTE because they won't be in the 8088 segment:offset format. Where the addresses displayed by the IBM PC look like 04B5:0793, you should see just 0793. Second, the addresses used are a little different. You should look in your WordStar installation manual in the "Printer Patch Area" section to check this, but the information I have shows that the "RIBBON" section, which is the first (^PY) place where code is entered, starts at 06DD hexadecimal. Remember that DDT loads the program at an offset of 100 hexadecimal, so you will have to start entering at 07DD hexadecimal, or 004A hexadecimal higher than the offset addresses given for the IBM PC version. This delta should hold for all addresses given. Check the instructions on using DDT in your CP/M manual for details on writing the revised program back onto your disk.

The Gemini-10 is supposed to be Epson compatible, and it is in most respects. The codes given in the BYTE article should work, but when in doubt, go to the manual—the printer manual in this case. Once you get into it, you may find that you can add other printer features to the program.—Steve

**FAST FOURIER**

Dear Steve,

Would you publish a fast Fourier transform routine for a 6809/68000 or Z80? In case you can't, please tell me who could supply me with this program. I would like to do some applications on random noise and spectral analysis.

GEZA HOLZHAKER  
Mérida, Venezuela  
(continued)

**R**oland DG manufactures a complete line of high quality monitors, each designed to suit specific uses and applications, from composite monochrome and color monitors to monochrome TTL-signal monitors (ideally suited for use with the IBM PC).



MODEL  
CB141

Composite  
Color  
Monitor

MODEL  
MB121G



Monochrome  
Composite  
Monitor  
(available in  
Amber or Green)



MODEL  
MB122A

Monochrome  
TTL-Signal  
Monitor  
(available in  
Amber or Green)

# What Business Can Afford To Use Fuzzy Information?

**I**n this age of information processing, perhaps the most important information processing occurs between your eyes and your monitor screen. An unclear on-screen image can visually distort the most accurate information, leaving valuable information lost somewhere between the lines.

You won't take that chance with a monitor from Roland DG. For us, clarity is not just a good feature, it's our most important feature.

We designed the Roland DG monitors as if a sharp image was all that mattered. Then we start adding on the extras—like easy plug-compatibility, non-glare screen and other features. Then we styled them so that they look sharp from any angle—not just the front.

Roland DG makes a broad range of monitors, to suit any personal computer and to please any computer's person. From high resolution RGB and Composite Color monitors to Monochrome Composite or TTL signal (IBM-PC) in either Amber or Green.

If accuracy is important to you, you shouldn't settle for anything less than a Roland DG monitor—the clear choice. Because the most important information processor is you.

Roland monitors are available at fine computer dealers everywhere. Roland Digital Group, 7200 Dominion Circle, Los Angeles, CA 90040 (213) 685-5141.

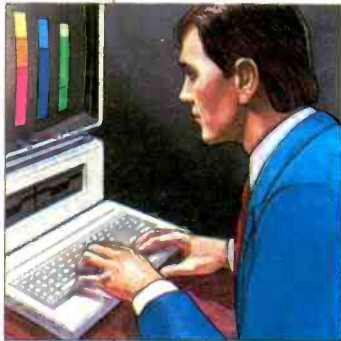

**M O D E L**  
CC141



**t**he most important information processing occurs between your monitor and your eyes.

**d**esigned to be as beautiful on the outside as on the inside.

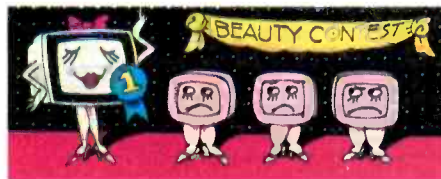

**t**here's a Roland DG monitor for every computer's person!

IBM is a trademark of International Business Machines

**Roland DG**



Two articles published in *BYTE* may be of use to you. The first ("Fast Fourier for the 6800," Richard H. Lord, February 1979, page 108) presents a program for the 6800, which is very similar to the 6809; the second article ("Fast Fourier Comes Back," Alastair Roxburgh, May 1981, page 458) discusses an overflow error in the first program and presents an improved program for the 8080. This program will run on a Z80 if your assembler uses the 8080 mnemonics.

EDN magazine is running a series of articles by R. F. Cobb on Fourier transforms, including one with an FFT BASIC program in the March 8, 1984 issue. This program will process 1024 points, but since it is in BASIC it is slow, taking about a second per point. You can obtain a copy of the series by writing to Art Lehman, Cahners Reprint Service, Cahners Plaza, 1350 East Touhy Ave., Box 5080, Des Plaines, IL 60018.

Two sources of information that may be of use to you are Fast Fourier Transform by E. Oran Brigham (Prentice-Hall, 1973) and "A Guided Tour of the Fast Fourier Transform" in the IEEE Spectrum for July 1969. These give routines written in FORTRAN, which should be useful if you have a compiler for one of the processors you mention.—Steve

### EXIDY SORCERER

Dear Steve,

I am trying to connect an Exidy Sorcerer microcomputer running CP/M to an HP 150, using the RS-232C connectors and a cable. Could you direct me to software to run on the Exidy to act as a monitor or terminal so that I could pass files between the two systems? I would also like to get software for the Exidy that would allow me to use a modem. So far, I have not been able to get the machines to even talk to each other. Thanks.

ROB RANDALL  
Sunnyvale, CA

The cable you need to interface the two computers is called a null modem. This usually has the connections shown in figure 1.

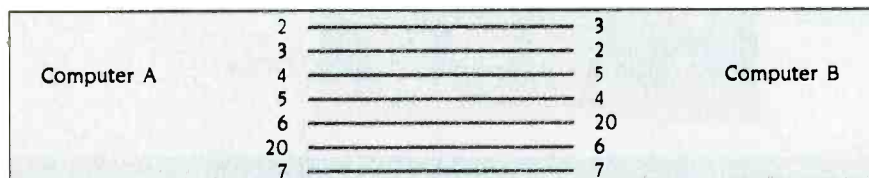

Figure 1: A null modem usually has the connections shown here.

Pins 2 and 3 are DATA OUT and DATA IN, 4 and 5 are REQUEST TO SEND and CLEAR TO SEND, and 6 and 20 are DATA SET READY and DATA TERMINAL READY. You can get by with only pins 2, 3, and 7 if you use the XON/XOFF handshaking protocol, and you may not need the pin 6-20 connections.

Since the HP 150 uses MS-DOS 2, and you are running CP/M on the Exidy Sorcerer, you may be able to pass files between the two computers using a simple communications program in the Exidy and the MS-DOS COPY command in the HP 150. The procedure for setting up the HP 150 is as follows:

1. Open the serial port on the HP 150 using the MODE command, for example: MODE COM1:12,N,8,1,P to open port for 1200 bps, no parity check, 8 data bits, 1 stop bit, and printer mode for continuous retries on time-outs.

2. Set the system up to send a file, say from the B disk drive, with the command COPY B:file.ext COM1:. To receive a file, the command would be COPY COM1: B:file.ext.

Don't press the Enter key until the other computer is ready to go.

You may be able to use the PIP command on the Sorcerer in a similar manner if you have the proper device driver installed for the serial port, but CP/M doesn't seem to be as standardized in this respect as MS-DOS. The command would probably be PIP OUT:= B:file.ext to send to the HP and PIP B:file.ext=INP: to receive a file. To ensure that data will not be lost, you should press the Enter key on the receiving computer first. Be sure to set the serial ports up for the same data rates and protocols on both computers.

If you need to transfer files frequently, you should probably get a communications program for at least one of the computers and preferably both. HP has a versatile program for the 150, the Series 100/DSN/Link. I haven't seen any other communications programs for the HP, but an excellent program is available for the IBM PC. PC-Talk III comes from FreeWare, POB 862, Tiburon, CA 94920. You might write the company and ask if it has

or plans to convert the program to the HP format.

On the CP/M side, a lot of communications software is available. One popular program is Crosstalk from Microstuf Inc., 1845 The Exchange #140, Atlanta, GA 30339. Another one that is popular and inexpensive is Modem7 from the CP/M Users Group, 1651 Third Ave., New York, NY 10028. You might also send \$3 to SIG/M, POB 97, Iselin, NJ 08830 for its public-domain software catalog. There are probably several communications programs to choose from.—Steve

### TI-99/4A PINOUT

Dear Steve,

I need the pinout of the TI-99/4A bus so that I can build my own peripherals. I assume your 32K-byte memory expansion for the TRS-80 Color Computer could be slapped right on a TI if someone would come up with the pinout of the TI bus. I tried once and nearly went blind trying. Are there any sources for information such as this? I enjoy your columns and books.

GERALD APPLEGATE  
Erie, PA

The pinout for the TI-99/4A is given in the book The S-100 & Other Micro Buses by Elmer C. Poe and James C. Goodwin (Howard W. Sams & Co., 1981).

You can also get a technical manual from Texas Instruments that gives schematics and bus data.

The TI-99/4A is a 16-bit computer, but the port has an 8-bit data bus, and data is multiplexed onto the bus under control of the processor, which always sends 16 bits. Since this is handled internally, almost any static-RAM board could be adapted as long as it uses 5-V chips.—Steve ■

IN "ASK BYTE," Steve Ciarcia answers questions on any area of microcomputing. The most representative questions received each month will be answered and published. Do you have a nagging problem? Send your inquiry to Ask BYTE c/o Steve Ciarcia POB 582 Glastonbury, CT 06033

Due to the high volume of inquiries, personal replies cannot be given. All letters and photographs become the property of Steve Ciarcia and cannot be returned. Be sure to include "Ask BYTE" in the address.

The "Ask BYTE" staff includes manager Harvey Weiner and researchers Bill Curlew, Larry Bregoli, Dick Sawyer, and Jeannette Dojan.





## INPUT/OUTPUT TECHNOLOGY, INC.

25327 Avenue Stanford, Unit 113, Valencia, CA 91355 • [805] 257-1000

### Uncompromising Additions to your S-100/IEEE-696 BUS

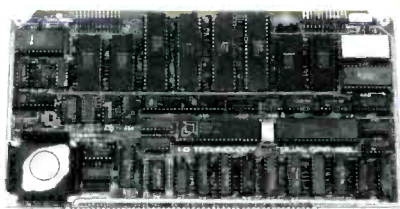

#### DUAL GPIB-488 INTERFACE BOARD

A Stand-Alone, Independently Controlled Dual Channel IEEE-488 I/O Processor. Interface Activity Modes for Controller-in-Charge, Controller Assigned or Terminal Bus Slave, and all Interface Functions are handled transparent to Host System CPU through an on-board CPU and DMA controller. User Friendly operation.

**A&T, P/N 52748-800-102**

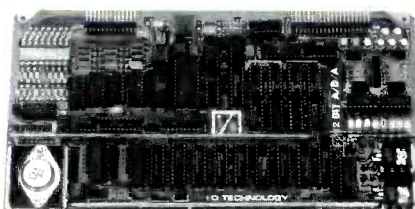

#### 12-BIT A-D-A CONVERTER BOARD

**8 Channel A-D:** 12 microsec. Conversion, 50KHz Sample Rate, Programmable Gains, Offset and Diff./Single Modes.

**8 Channel D-A:** 2 microsec. Settling, Bipolar V or Unipolar I Output, Programmable Reference levels, Dual-Ported Channel Refresh RAM. **16/8-Bit Data Transfers** via I/O or Memory Mapped

**A&T, P/N 52748-900-101**

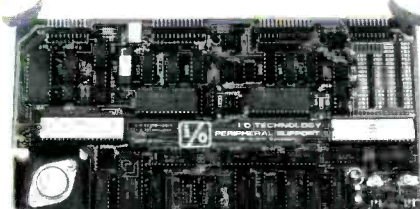

#### PERIPHERAL SUPPORT BOARD

Two Serial SYNC/ASYNCR Ports with RS-232, TTL or Current Loop Outputs, three 8-Bit Parallel Ports, three Timers, Real Time Clock/Calendar and Response Programmable Interrupt Controller. Small Proto Area with +5 and  $\pm 12v$ .

**A&T, P/N 52748-150-101**

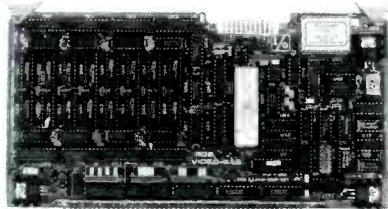

#### RGB COLOR GRAPHICS BOARD

Programmable resolution up to 512 x 512 pixels with 4 local video planes and on-board graphics processor. Color mapper allows 16 colors from a palette of 4096. Light pen input. Plus more ...

**A&T, P/N 52748-300-101**

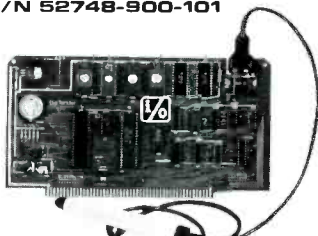

#### BAR CODE PROCESSOR BOARD

The BarTender is a stand-alone I/O Processor that reads and prints most common Bar Codes. Includes bi-directional reading, wand interface, clock/calendar with battery. Extensive documentation and software.

**A&T, 52748-500-101** Without Wand  
**A&T, 52748-500-201** With Wand

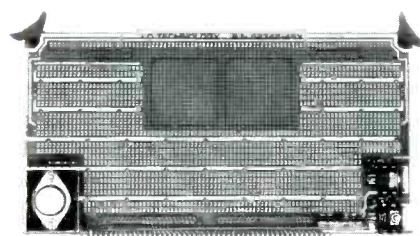

#### MULTI-PURPOSE PROTOTYPING KIT

Industrial Quality with Plated-Thru holes for Wire-Wrap or Solder projects. Complete with +5,  $\pm 12v$  Regulators, Bus Bar, Filter Capacitors, and Manual.

**P/N 52748-450** Circle 174 on inquiry card

**ALSO AVAILABLE: MULTI-FUNCTION I/O BOARD, SMART PROTOTYPING KIT, 128Kx8/64Kx16 STATIC RAM MODULE**

SPECIFICATIONS SUBJECT TO CHANGE WITHOUT NOTICE.



# "Excuse Me,



## "Make Way for Hayes' Please"

An advanced, easy-to-use data management system for the IBM® PC and compatibles.

Want to get your paperwork out of a clumsy file cabinet and onto your PC's screen, where you can manage it better? Frustrated with data base software that's either too limited or too difficult to use? Hayes offers you a simple word of kindness.

*Please*™. A powerful, yet easy-to-use, system for organizing and managing your information. *Please* is flexible enough to store any data you enter, and it'll return data to you in exactly the form you need. *Please* does more.

It does it all faster. And it's sure to please!

## "The menu, Please?"

Menus list all your options and tell you exactly which keys to press for every *Please* feature.

That's to be expected. As the telecomputing leader, Hayes built its reputation on quality design, reliability

and customer support. Now these same standards have been applied to a new data management system that is going to instantly change the way you do business!

Say you're looking for an efficient way to maintain sales data. *Please* leads you every step of the way in creating a sales database that might include names, addresses, dates and figures. These categories are called "fields" in database lingo, and they're the very heart of your database structure.

Want last month's total in a particular region? Press a few keys and it's yours! A few more keystrokes and you'll know who's moving product, and what's your biggest seller.

*Please* will supply you with labels for a mailing to selected customers. It can send customer information to your word processor for a promotional letter. And it can receive data from

your spreadsheet program. *Please* will even look up a name and company for you, your Hayes Smartmodem\* will dial the phone number, and you're ready to talk!

Taking this same sales database, you might also want to define special

fields for a custom Output Plan. With a defined field for "COMMISSIONS DUE,"

*Please* can automat-

ically compute each salesman's commissions, and print them out in a report of your own design. All this and more, just for saying "Please?"

And if you ever change your mind and want to change the structure of your database, please feel free. Step-by-step instructions show you how.

You have this same flexibility with any database you and *Please* design. You can store up to 16 million records† and 200 custom Output Plans for each database! More than you're likely ever to require. But isn't it nice

## "Make it snappy, Please!"

Need a report fast? You and *Please* can put together a Quick List in a matter of seconds.



# Please™

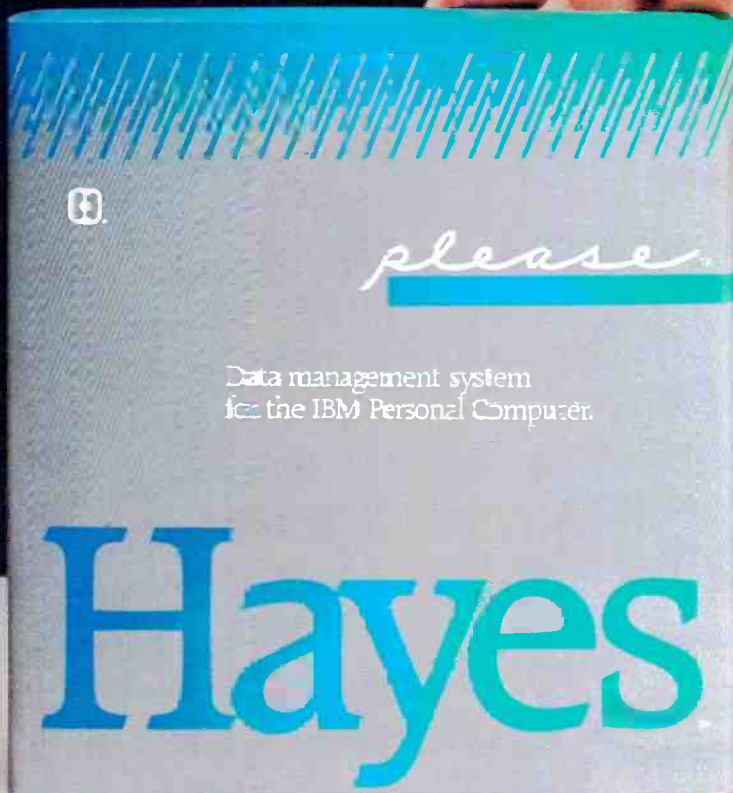

## "Put it here, Please."

Design a special screen format to position data in a particular place.

Just in case you ever need it?

Now you might think that a data management system that does all this must be difficult to use. Right? Rest assured. *Please* works hard so you don't have to. An easy-to-follow sample disk shows you everything

you need to know to create your first database. Three *Please* menus show you which keys to press to access every feature.

And whenever you need it, *Please* provides on-screen HELP messages, tailored to a specific task. So you needn't waste time reading through a list of unrelated instructions on your screen. Or stop what you're doing to consult a manual. In no time at all, and with no assistance at all, you'll be a *Please* database pro!

knowing all that storage power is there?

## "Merge these, Please."

Combine data from one database into another, without changing your original.

Everything about *Please* is designed to save you time and effort. So what could make data management even easier? *Please Application Templates*, that's what!

To help you get up-and-running immediately, we've developed a series of practical, pre-designed templates. You'll appreciate their well-thought-out structure, and "fill-in-the-blank" ease. Choose several for business and personal use.

Including *Mailing List, Membership, Appointments, Household Records, Contacts, Applicants,*

*Employee Files, Inventory, Payroll, Ledger, Invoices, Cash Flow and Stocks.* And look for several new templates, before you can say "More, please."

See your dealer right away for a demonstration of *Please* (and its templates). You'll wonder how you ever managed information without it!

"My free Template, Please?" Which template would you like? Mail in your *Please* Product Registration Card, and Hayes will send it to you, absolutely free!



# Hayes

Hayes Microcomputer Products, Inc.  
5923 Peachtree Industrial Blvd.  
Norcross, Georgia 30092 404/441-1617



# Now you can get personal with a Datasouth.



Say hello to the Datasouth Personal Printer—an office-quality printer that makes itself right at home next to your personal computer.

Technically speaking, the Personal Printer is “Epson compatible.” But it’s better than the competing Epson because it also does letter-quality printing.

Personally speaking, the Personal Printer is “checkbook compatible.” So you don’t have to sacrifice the money you need to get the printer you want. And it comes in two models—one with a 10-inch and one with a 17-inch carriage.

Make a personal visit to your local computer store, and bring home legendary Datasouth performance for an affordably personal price. The Personal Printer. Only from Datasouth.



*personal*

**datasouth**

H I G H P E R F O R M A N C E M A T R I X P R I N T E R S

Find Datasouth Printers At  
Participating **ComputerLand**® Stores  
And Other Fine Dealers.

Datasouth Computer Corporation  
Box 240947 • Charlotte, NC 28224  
704/523-8500 • Telex 6843018 DASOU UW

CALL TOLL FREE:  
**1-800-222-4528**

# CLUBS & NEWSLETTERS

● **CONNECT WITH THE MAC**—*The Macintosh Connection* is a newsletter for Apple's latest computer. Each issue contains news, trends, purchasing tips, questions and answers, useful contacts, accessory products sources, reviews of books about the Macintosh, and an updated listing of the Macintosh product line. It is produced every month except August and December; a subscription (10 issues) is \$35. For details, contact Hi-tek Publications, POB 99, North Salem, NH 03073.

● **TRS IDEAS GALORE**  
*Compu-Hints Eighty* is a newsletter that contains programs, hints, techniques, and reviews of material related to the TRS-80 Models I, III, and 4. A \$3 fee covers postage and handling; a disk of the programs costs an additional \$8. Contact Eighty Computing, 49 Sleepy Hollow Lane, Orinda, CA 94563.

● **GEORGIANS MEET IN ATLANTA**—The Atlanta Area Color Users Group meets at 7 p.m. at the Nash Middle School in Smyrna, Georgia, and uses a BBS at (404) 378-4410. Due to the school schedule, it only meets ten months a year. Dues have not been established. For details, contact Gary McConville, 4144 Rebel Trails, Douglasville, GA 30135, (404) 949-0369.

● **TWIN STATE COMPUTERISTS MEET**—For computerists in Kentucky and Indiana, a BBS is up and running at (502) 896-4419 from 6 p.m. to 9 a.m. every day. The Kentucky-Indiana Personal

Computer Users Group (KIP-CUG), formerly known as the Louisville or Capital Holding Users Group, maintains the BBS and offers a program library and a monthly newsletter. It meets at 7 p.m. on the first Wednesday of every month in Building #4 of General Electric's Appliance Park in Louisville. For details, contact Robert Hastings, KIPCUG, POB 3564, Louisville, KY 40201, (502) 589-0254.

● **REVIEW MORROW**  
The *Morrow Owners' Review* is a newsletter that is mailed free to all owners of Morrow computers. Although production and mailing costs are paid by Morrow Designs Inc. of San Leandro, California, editorial control remains with the users. For details, contact Sytko Andreae, *Morrow Owners' Review*, POB 5487, Berkeley, CA 94705, (415) 654-3798.

● **DELAWARE'S NORTH STAR**—Details about the North Star Users Group of Delaware County can be obtained from Gil Holdsworth, POB 298, Newtown Square, PA 19073, (215) 566-2696.

● **HARD COPY OF SOFT HORIZONS**—For a free copy of the first issue of a newsletter for owners and users of Tandy's Model 2000, write to Soft Horizons, RD 1, Box 432, State Highway 83,

Cape May Court House, NJ 08210, (609) 886-1511.

● **TELECOMMUNICATIONS NEWSLETTER**—Reviews of computers, modems, printers, and software relating to telecommunicating are featured in *DS/DD*, a monthly newsletter devoted to telecommunications. It is sponsored by WDI Telecommunications, a computer services company. An annual subscription is \$14. For details, write to WDI Telecommunications, *DS/DD*, POB 1512, Ames, IA 50010.

● **JOIN UP**  
An upcoming *National Directory of User Groups* welcomes information from all users groups. For a questionnaire and information, send a stamped, self-addressed envelope to Ken Ryder, POB 4102, Rome, NY 13440, (315) 339-1069.

● **IBM SUPPORTS GROUPS**  
A bulletin board, a monthly newsletter distributed on disk, and a telephone number for general information are offered by the new IBM PC User Group Support Department in Boca Raton, Florida. Any IBM Personal Computer user group can receive support and information directly from IBM's Entry Systems Division by registering the group's officers. Contact Gene Barlow, IBM PC User Group Support

(2900), POB 3022, Boca Raton, FL 33432.

● **DENTAL REVIEW**  
An international group of dentists, physicians, and office-management people who are interested in office computers of all brands offers members a variety of services. The monthly newsletter, *Dental Computer Newsletter*, provides a forum for a software exchange, hardware and software reviews, hotline, and experienced advice for users around the world. The annual membership dues are \$15; \$30 overseas. For details, contact S. Nye or K. Elsbury, 1000 North Ave., Waukegan, IL 60085, (312) 223-5077.

● **TEENAGE COMPUTING**  
A monthly magazine designed for teenage owners of Apple computers, *The Apple's Apprentice* is also suitable for readers of all ages. Topics range from fantasy to reviews, and articles comment on the use of Apples in everyday applications. A subscription is \$24 a year. Contact *The Apple's Apprentice*, Emerald City Publishing Inc., POB 582-AA, Santee, CA 92071, (619) 562-7785.

● **VOICES THAT CARRY**  
The Screaming Eagles, a users group for owners of the Eagle IIE 8-bit computer, welcomes inquiries and interaction with other users. Contact Dave Yaros, 1006 Second National Building, 830 Main St., Cincinnati, OH 45202.

● **NET WITH 73s**  
In order to join the Computer Nut Net all you need

(continued)

.....  
CLUBS & NEWSLETTERS is a forum for letting *BYTE* readers know what is happening in the microcomputing community. Emphasis is given to electronic bulletin board services, club-sponsored classes, community-help projects, field trips, and other activities outside of routine meetings. Of course, we will continue to list new clubs, their addresses and contact persons, and other information of interest. To list events on schedule, we must receive your information at least four months in advance. Send information to *BYTE, Clubs & Newsletters*, POB 372, Hancock, NH 03449.





## LMC's 32-Bit Virtual Memory MegaMicro Is The-State-Of-The-Art UNIX Microcomputer

LMC's 32-bit MegaMicro provides mainframe or super-minicomputer performance at prices competitive with today's far less powerful 8- and 16-bit microcomputers. This is made possible by use of the next generation of logic chips—the National Semiconductor 16000-series. LMC MegaMicros incorporate: the NS16032 central processing unit which has true 32-bit internal logic and internal data path configured on the IEEE 796 multibus; demand-paged virtual memory implemented in hardware; and hardware 64-bit double-precision floating-point arithmetic.

The LMC MegaMicro is supplied with HCR's UNITY\* which is a full implementation of UNIX\*\* and includes the Berkeley 4.1 enhancements to take advantage of demand-paged virtual memory. Also included are C and FORTRAN. Typical multi-user systems with 33 megs. of fast (30 ms. average access time) winchester disk storage, a half meg. of RAM, virtual memory, hardware floating-point arithmetic, UNIX, C, and FORTRAN 77 are available for \$20,000 (and even less with quantity or OEM discounts).

\* UNITY is a Trademark of Human Computing Resources.

\*\*UNIX is a Trademark of Bell Laboratories.

LMC MegaMicros *The Logical Alternative*™

# LMC

The Logical MicroComputer Company

4200 W. Diversey, Chicago, IL 60639 (312) 282.9667



A member of The Marmon Group of companies

## CLUBS & NEWSLETTERS

is an amateur radio license and an interest in personal computers. Meet with other amateurs every Saturday morning at 1430 Z (GMT) standard time at the frequency of 3.939 MHz. During daylight saving time the frequency is 7.232 MHz. Net control: K5DHZ Bud, or write Bud Atkinson, 6708 San Luis Obispo NE, Albuquerque, NM 87109.

● **PCs IN THE OIL PATCH**  
The Permain PC Users Group meets at 10 a.m. on the third Saturday of the month in the Composite Technology Building of Odessa College. For information, contact the EDP Department Chairman, Odessa College, Odessa, TX 79760.

● **WHAT COLOR AMERICA?**  
A public bulletin board system (BBS) sponsored by Color America Users Group is operating in the Los Angeles, California, area. The group is dedicated to users of the Tandy Color Computer; users of all kinds of microcomputers are welcome to participate on the BBS at (818) 334-2864. For user group information, contact Mark Randall, 2227 Canyon Rd., Arcadia, CA 91006, (818) 331-7903.

● **ATARIS IN PALM BEACH**  
The Atari Computer Club of the Palm Beaches meets at 7:30 p.m. every second Tuesday of the month in the auditorium of the Science Museum at Dreher Park in West Palm Beach, Florida. Members can access a program/book lending library, buy software and hardware at discounts, converse with other programmers, and see demonstrations of new products. A monthly newsletter contains club news, listings of regional bulletin board services, product and software reviews, and want

ads. For details, call or write Marvin Cox, 4106 Fern St., Lake Worth, FL 33461, (305) 967-8895.

● **INSTRUMENTAL FOR ENGINEERS**—*Personal Engineering & Instrumentation News* is a monthly newsletter for engineers and scientists who use personal computers on the job. It contains industry news, applications, a forum for exchanging tips, comments on the latest products and design techniques, and an annotated review of relevant articles in the computer media. A \$25 annual subscription fee entitles you to membership in the Personal Engineering Computer Users' Society (PECUS), producer of the newsletter. For details, contact Paul Schreier, Personal Engineering Communications, Box 983, Back Bay Annex, Boston, MA 02117, (617) 536-8124.

● **IRISH CLUB FOR THE 64**  
A nonprofit club centered in Dublin, Ireland. CLUB64 invites owners of the Commodore 64 to make use of its debugged, public-domain, program-disk library at no extra cost. News, information, product details, or programs are welcome for inclusion in a proposed disk-formatted newsletter. A charge of £5 per disk includes the cost of shipping disks within the British Isles; the international cost is higher. For details, contact Brendan Conroy, c/o Upper Drumcondra Rd., Dublin 9, Ireland.

● **COMPUTER OLYMPICS**  
The Olympian Computer Club of Athens, Greece, represents users of all brands of computers. It is located on the Hellenikon Air Base and welcomes correspondence. Write to Paul Mullens, Olympian Computer Club, Box 4277, APO New York, NY 09223. ■

**WHAT WOULD YOU SAY  
TO A NEW LAP-SIZE COMPUTER  
WITH SEXY GOOD LOOKS  
LIKE THE APPLE IIc AND  
BONE CRUSHING POWER LIKE  
THE \$3000 H-P PORTABLE,  
ALL FOR \$995?**





# “GIMM

Of course you want it.

The Epson® Geneva™. A full-function, battery powered lap-size computer with 64K of memory, an 80 character 8-line screen, a big, responsive keyboard, cassette storage, plus four powerful, popular programs on ROM capsules, all included free.

All Epson quality. All for \$995.

Now that's technology.

If the Geneva is small where it counts, it is also big where it counts. In software, you get the big advantage of a universal operating system—

CPIM.® And to start you off at freeway speed, the Epson Geneva

comes complete with WordStar.® Also included is Portable Calc, an electronic spread-

sheet, Portable Scheduler, and Microsoft® BASIC.

Want more?

The Epson Geneva offers a complete collection of advanced, battery-powered mini-peripherals. Customize your perfect computer

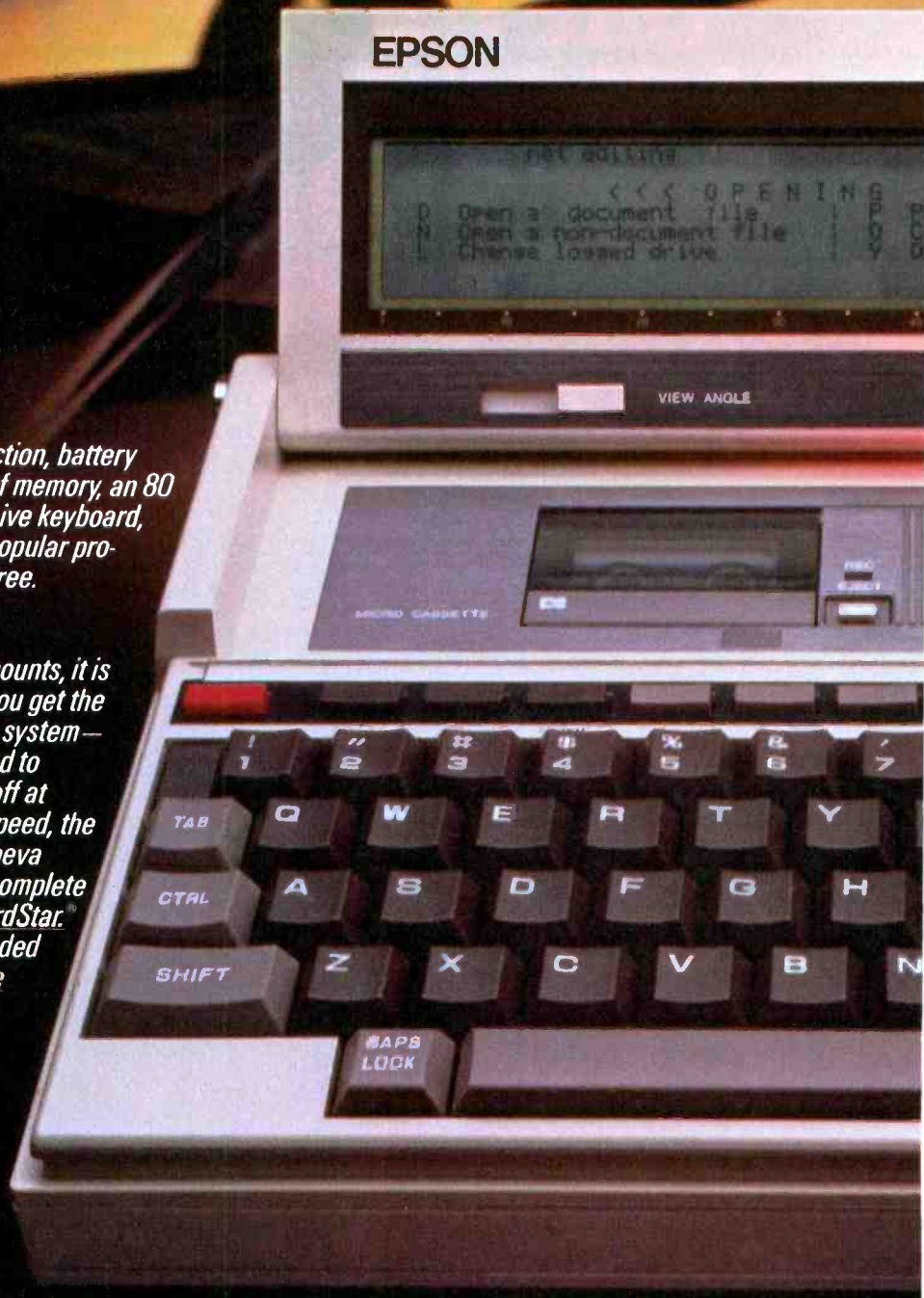

E P S O N



# TIME"

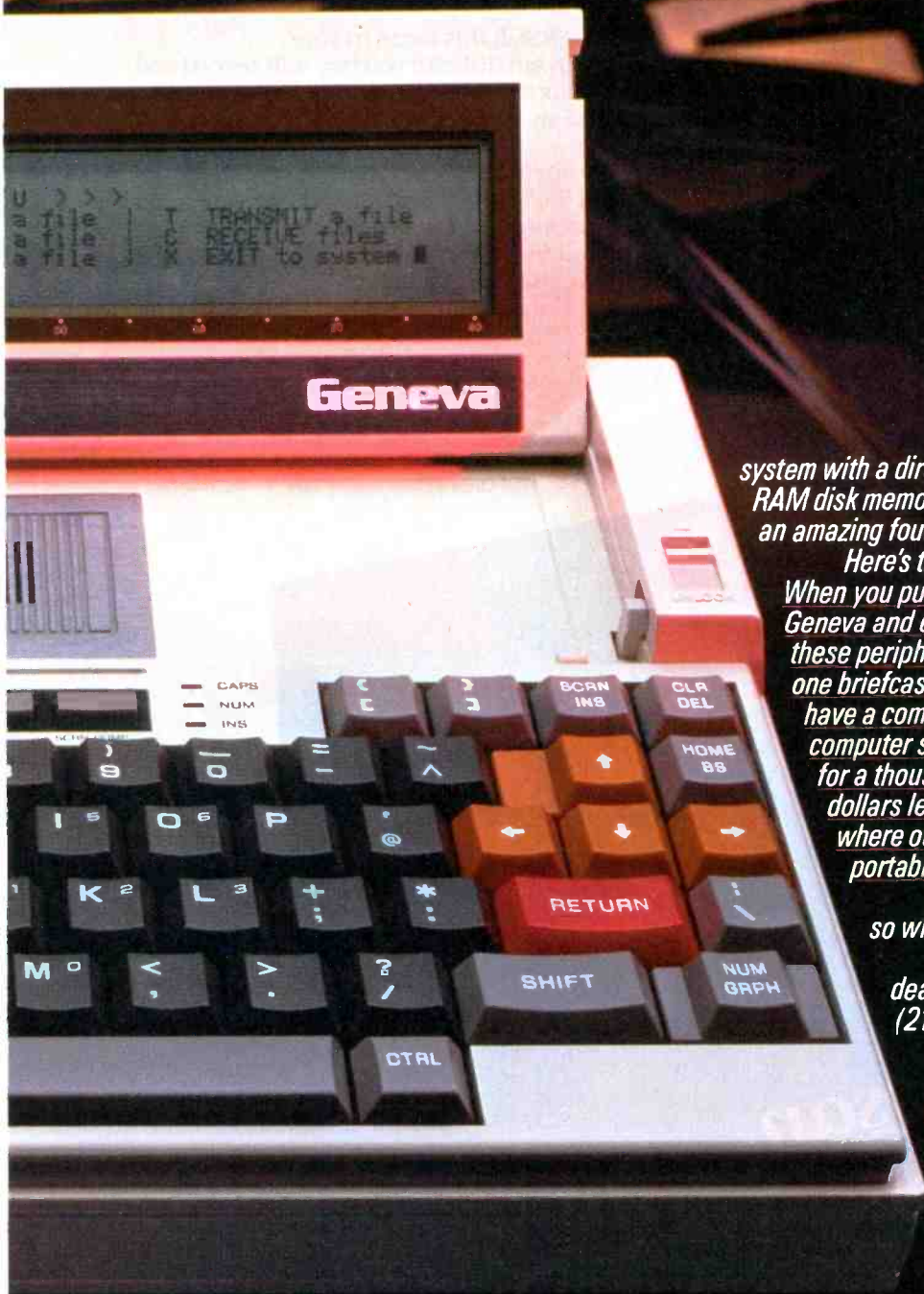

system with a direct connect modem; an extra 120K of RAM disk memory; a 320K 3 1/2" disk drive; there's even an amazing four pound 80-column printer.

Here's the best part. When you put an Epson Geneva and every one of these peripherals into one briefcase, you have a complete computer system for a thousand dollars less than where other powerful portables begin.



The Epson Geneva. You know you want it, so when are you going to get it?

For the name of your nearest Epson dealer, call (800) 421-5426. In CA, call (213) 539-9140.

**NEVER HAS** **\$995**  
**BOUGHT SO MUCH. AND SO LITTLE.**

Epson, Apple, WordStar, CP/M, and Microsoft are registered trademarks of Epson Corporation, Apple Computer, Inc., MicroPro, Digital Research, and Microsoft Corporation, respectively. Geneva is a trademark of Epson America, Inc.

# GENEVA



# Somebody has to be better than everybody else.

It's inevitable.

Somebody is always more determined. Works harder. And winds up on top.

Take Dysan, for instance.

We were the ones who helped develop the first 5¼" flexible diskette.

And while everybody else was trying to figure out how to make them, we were busy making them better.

With superior materials. A special lubricant and jacket liner that extend diskette life.

Unique manufacturing techniques. Like our bur-nishing process that helps eliminate read/write errors.

And an almost fanatical corporate commitment to quality.

See us at

**COMDEX / Fall '84**

**BOOTH #1378**

What does all this mean to you?

Every Dysan diskette you buy will record and retain all your data all the time. For as long as you own the diskette and treat it right.

Dysan.

We're not just like everybody else.

Dysan 5¼" and 8" flexible diskettes are available at your computer products dealer.

Call toll free for the name of the Dysan dealer nearest you. (800) 551-9000.

Dysan Corporation, 5201 Patrick Henry Drive, P.O. Box 58053, Santa Clara, CA 95050, (408) 988-3472.

## *Dysan*®

Circle 122 on inquiry card.



# BOOK REVIEWS

**SMALLTALK-80:  
THE LANGUAGE AND  
ITS IMPLEMENTATION**  
Adele Goldberg and  
David Robson  
Addison-Wesley  
Reading, MA: 1983  
740 pages, \$34.95

**SMALLTALK-80:  
THE INTERACTIVE  
PROGRAMMING  
ENVIRONMENT**  
Adele Goldberg  
Addison-Wesley  
Reading, MA: 1984  
530 pages, \$24.95

**SMALLTALK-80:  
BITS OF HISTORY,  
WORDS OF ADVICE**  
Glenn Krasner, ed.  
Addison-Wesley  
Reading, MA: 1984  
354 pages, \$19.95

**SMALLTALK-80: THE LANGUAGE  
AND ITS IMPLEMENTATION**  
Reviewed by Richard Fritzon

The programming language Smalltalk was de-

signed and developed during the last decade by researchers at Xerox's Palo Alto Research Center (PARC). Over a period of 10 years, without much publicity, the language went through about five repetitions of a design/implement/test cycle: programmers would design a new version of the language, implement it on one or more computers, and test it, stretching it as far as they could. Then, they would go back and redesign it. (Few programming languages, if any, have received such intensive work before being released in the marketplace.)

In 1979, Xerox PARC decided to disseminate Smalltalk to computer scientists outside of the PARC environment. A collection of articles about

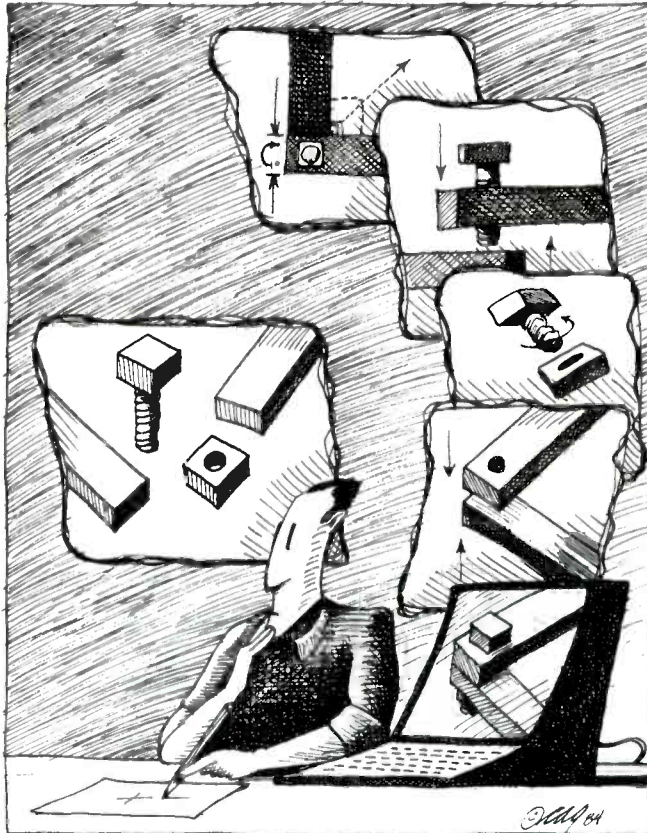

Smalltalk appeared in the August 1981 BYTE, and PARC's computer scientists began collaborating with four hardware manufacturers to implement Smalltalk on machines other than Xerox's in-house research computers.

In 1983, Addison-Wesley began releasing a series of books describing the Smalltalk-80 programming system (the version designed in 1980). Three of these books have been released; the fourth, *Smalltalk-80: Creating a User Interface and Graphical Applications*, is scheduled to be published this fall. The three books I review here are *Smalltalk-80: The Language and Its Implementation*; *Smalltalk-80: The Interactive Programming Environment*; and *Smalltalk-80:*

*Bits of History, Words of Advice.*

The first book is a complete description of the Smalltalk computing environment and the associated language. The four hardware companies used a draft of this book as the main guide to implement the language. (It contains a complete and highly detailed description of how to implement the Smalltalk-80 programming system.) The second book describes programming in Smalltalk. While the first book accurately describes the language, the second one provides detailed descriptions of the elaborate and interactive mechanisms the Smalltalk-80 programming system provides to design, write, debug, and use programs in Smalltalk.

The third book is a collection of papers written by programmers who have implemented Smalltalk on one machine or another. This group includes not only the Xerox PARC programmers but also those from Apple, Hewlett-Packard, Tektronix, and Digital Equipment Corporation (DEC) who participated in the Smalltalk dissemination project.

Because these books come from Xerox PARC, I expect a lot from them. Because they describe a novel programming language and an exceptional programming environment at a time when people still can't sit down in front of a Smalltalk system and try things out while reading, the books must be models of clarity. The standards by which they have to be judged are higher than those for

(continued)



books on languages (such as BASIC or LISP) where the readers are expected to be using the language while they read.

*The Language and Its Implementation*, co-authored by Adele Goldberg and David Robson, is the backbone of this series. The book is divided into four parts. The first covers the theory behind the language and its syntax. The second is on the features provided by this implementation (a survey of the objects that are pre-defined in Smalltalk-80). And the last two parts provide some detailed examples of using Smalltalk in simulations and a complete description of how Smalltalk is implemented.

Smalltalk is an unusual language because it is designed to facilitate programming in an unusual environment. The Smalltalk computing world contains a collection of small computing *objects*, each of which knows

how to do a few particular things by following small programs (called *methods*). The methods are internal to the objects, but all objects can send *messages* to other objects requesting that they execute one of their methods. Programming in this world consists of specifying what kinds of objects there are, which ones should send which messages, and when.

Although it sounds tricky, you need to acquire only a few new concepts. Three of them are mentioned in the preceding paragraph (objects exchange messages and execute methods when they receive them). The rest of the theory is that each object is an *instance* of a *class* (in the sense that each of us is an instance of the class of human beings) and the classes are broken into paradigms of *subclasses* (just as human beings might be considered a subclass of mammals, which are a subclass of verte-

brates, which are a subclass of animals, and so on). Objects inherit their methods and internal variables from their classes (and subclasses inherit these from their superclasses). This makes it particularly easy for related objects to share code, which, in turn, makes it easier to understand and maintain programs.

The basic syntax of the language is a new adaptation of an old idea. While most languages (including Pascal or LISP) use *prefix* notation for procedure calls, and a few others (such as FORTH) use *postfix* notation, Smalltalk has, roughly speaking, adapted *infix* notation. The receiver of a message comes first, then the word that identifies the message (the selector or keyword), followed optionally by one or more parameters, with other keywords (resembling prepositions) identifying their roles in the message. For instance

```
7 + 3 ; Send 7 a message
      ; to add 3 to itself
30 sin ; Send 30 a message to
      ; compute the sine
      ; of itself
anArray at: 3 put: 30.4
      ; Send to the array variable
      ; "anArray" a message
      ; to put the value 30.4
      ; at its 3rd cell:
```

While the first example makes Smalltalk look familiar and the second makes it look like FORTH (a recurring impression), the third resembles the style of English used when instructing individuals in a group: "John, stand here. Mary, get the shovel. Steve, take this down. . . ." The expressions have a subject (the receiver), a verb (the message selector), and objects (with prepositions).

The first part of this book does an excellent job of explaining the theory of the system. The language chosen to describe the system (Smalltalk-80) is clear. The presentation is well organized; questions, both obvious and subtle, are raised and answered in turn using simple examples to illustrate. After my first reading, I

(continued)

**PC FORTH™**  
**IBM PC & XT,**  
**HP-150,**  
**Macintosh,**  
**Apple II,**  
**CompuPro,**  
**Sage & CP/M-68K,**  
**Wang PC,**  
 All CP/M and  
 MSDOS computers.

Try the *professional language* offering the *u\*most performance* in the *shortest development time*. Transport your applications between any of our enhanced 83-Standard compilers or expanded 32-bit versions. Choose from our wide selection of programming tools including native code compilers, cross-compilers, math coprocessor support, and B-Tree file managers. All fully supported with hotline, updates, and newsletters.

**Laboratory Microsystems Incorporated**  
 Post Office Box 10430, Marina del Rey, CA 90295  
 Phone credit card orders to (213) 306-7412





# COMPUTERS and more. . .

Member: BBB  
S.D. Chamber of Commerce  
NOMDA

is your place to buy for SELECTION, SERVICE and SAVINGS.

We know that your needs are not the same as everyone's, so we don't treat you "just like every one else."  
Your needs are special. That's why COMPUTERS and more. . . is your place to buy for. . .



"Tomorrow's Technology at Prices You Can Afford Today"

## COMPUTERS

IBM	CORONA
256K PC w/2 . . . . . 1750	DeskTop w/2 Drives 2099
PC w/10 Meg & 1.320 2495	Portable w/2 Drives 2099
PC w/ 2.320K & 10 Meg 3195	Models w/Hard Disk CALL
Extended Warranty	New Models CALL
Available on All Models	
APPLE	SHARP
Hot New IIC . . . . . 1150	PC 5000 . . . . . CALL
MAC - All Models CALL	Modem . . . . . CALL
LISA - All Models CALL	Built Mem . . . . . CALL
Apple IIE . . . . . 750	
EAGLE	NEC
Spirit II . . . . . 1499	8201A (Portable) . . . . . 489
Turbo XL . . . . . 3759	APC H01 . . . . . 2095
Spirit XL . . . . . 3150	APC H02 . . . . . CALL
Plus XL . . . . . 3169	APC H03 . . . . . CALL
PC Plus I . . . . . 1407	APC H04 . . . . . 2659
PC Plus II . . . . . 1784	
TELEVIDEO	KAYPRO
Televideo 1605H . . . . . 3294	II Plus . . . . . CALL
Televideo 1605E . . . . . 2298	IV Plus . . . . . CALL
TPC II . . . . . 1939	10 Meg . . . . . CALL
803H . . . . . 2949	
804 . . . . . 3289	
Extended Warranty	
Available on All Models	
COLUMBIA	ZENITH
Columbia 1600 I . . . . . 1789	DeskTop 151-21 . . . . . 2159
Columbia 1600 4 . . . . . 3199	DeskTop 151-22 . . . . . 2495
VP Portable . . . . . 1959	Portable 161-21 . . . . . 2349
	Portable 161-22 . . . . . 2639
	CALL FOR PRICES ON:
	KAYPRO • SHARP •
	COMPAQ • EAGLE •
	OTRONO • NOVELLE •
	NORTHSTAR • ALTOS •
	DEC • EPSON •
	SANYO • ATARI •

## ACCESSORIES

IBM	AST 6 PAK
Hercules Color Card . . . . . 199	Quad Link . . . . . 469
Vutek CPS Cd . . . . . 229	PC Saver . . . . . 39
Keytronic 5151 - 5151 Jr . . . . . 209	TG Joystick . . . . . 44
	64K Ram Chips . . . . . CALL
	CALL FOR PRICE LIST!!
BI-GRAPHICS I	APPLE
Bi-Graphics I . . . . . 459	Disc Washer Cari . . . . . 199
Bi-Graphics II . . . . . 229	PrinterFace by P.P. . . . . 64
Smart Cable by IQ . . . . . 64	GraphicCard by P.P. . . . . 79
Jr. Extender by . . . . . CALL	2.80 Card . . . . . 69
Falcon . . . . . CALL	Touch Pad by Koala . . . . . 84
UltraPak by TSENG . . . . . 489	MicroSoft Acces. . . . . CALL
UltraRam by TSENG . . . . . 199	Grappler-Plus . . . . . 109
Multidisplay by PS . . . . . 239	Videx 80 Col.w/St. Switch . . . . . 179
Plantronics Color Plus . . . . . 299	Wesper Full Graphics . . . . . 78
Orchid Blossom . . . . . 299	System Saver FAN . . . . . 67
Orchid PCNet . . . . . 389	
Orchid Combo . . . . . CALL	

WE'VE EXPANDED TO A NEW LOCATION TO SERVE YOU BETTER



## PRINTERS

JUKI	TOSHIBA
Juki . . . . . 389	Toshiba P 1351 P . . . . . 1259
Tractor . . . . . 109	Toshiba P 1351 S . . . . . 1259
630C . . . . . CALL	Toshiba P 1340 se . . . . . 749
	Toshiba P 1340 Pr . . . . . 749
EPSON	MANN-TALLY
Fx-100 . . . . . CALL	Spirit . . . . . 294
Fx-80 - 30 F/T . . . . . CALL	160 I . . . . . 539
LQ-560 . . . . . 1199	160 L . . . . . 619
	180 I . . . . . 769
PANASONIC	C. IITEK
1052 . . . . . 449	420 I 123 . . . . . 2369
1053 . . . . . 689	420 L 112 . . . . . 1939
DAISYWRITER	STAR
Daisy 2000 w/48 . . . . . CALL	STX-80 . . . . . 139
K Bu . . . . . CALL	Gemini 10X . . . . . 259
Tractor for Daisy 2000 . . . . . CALL	Gemini 15X . . . . . 379
	Delta-10 . . . . . 389
	Delta-15 . . . . . 569
	Radix-10 . . . . . 579
	Radix-15 . . . . . 639
	Power Type . . . . . 389
QUADRAM	OKIDATA
Quadlet . . . . . 695	MicroLine 84 P . . . . . CALL
IB-4 K I . . . . . 19	MicroLine 92 P . . . . . CALL
Apple Kit . . . . . 49	Pacemark 2350 P . . . . . CALL
	Pacemark 2410 P . . . . . CALL
NEC	
New! Pinwriter 2 . . . . . CALL	
New! Pinwriter 3 . . . . . CALL	
2C0-Farallel . . . . . 679	
2C0-Farallel . . . . . 889	
3C50-FS232 . . . . . 1299	
3C50-FS232 . . . . . 1299	
3C50-Farallel . . . . . 1279	
3C50-Farallel . . . . . 1599	
Extended Warranties CALL	

## FREE SHIPPING

### "MODEMS"

HAYES	RIXON
I C Compatible w/St . . . . . 59	R 103J ASYN . . . . . 229
MicroModem Iie . . . . . 29	PC 212A IEM Internal . . . . . 429
Hayes 120CB . . . . . 89	PC 212A-WA . . . . . 499
SmartModem 300 RS232 . . . . . 59	w ASYN Port . . . . . 499
SmartModem 1200 RS232 . . . . . 59	R 212A I RS232 . . . . . 429
ChronoGraph RS232 . . . . . 89	
U.S. ROBOTICS	NOVATION
IB-4 PC Modem . . . . . 549	Access 1-2-3 . . . . . 399
Password 300/1200 . . . . . 379	J-Cat . . . . . 99
VEN-TEL	103 Smart Cat . . . . . 189
1290 Plus . . . . . 54	212 Auto Cat . . . . . 397
	Apple-Cat II . . . . . 229

### DISK DRIVES

FLOPPY DRIVES	HARD DISK
Tarcom 100 2 . . . . . 469	10 Meg Internal . . . . . 995
Slim Line Drives . . . . . 149	QuarterMaster ON SALE!
Apple Compatible . . . . . 159	10 Meg External . . . . . 1095
FUJII DISKETTES	15 Meg External . . . . . CALL
SS 3D . . . . . 22	Bennouli by Iomega 2799
DS 3D . . . . . 27	QUADRAM • TECMAR •
	CONTROL DATA

## SOFTWARE

FOR PC & XT	APPLE
OZ by Fox & Geller . . . . . 299	dBase III by Ash/Tare . . . . . 419
Quick Code . . . . . 219	Findy by Aston-Tare . . . . . 199
FrameWork by . . . . . SALE!	Bottom Line Strategist . . . . . 269
cBase III . . . . . 419	C Dex Packages (each) . . . . . 39
Friday . . . . . 199	CPA Modules 1 thru 4 . . . . . 174
Please by Hayes . . . . . CALL	OZ by Fox & Geller . . . . . 319
Lotus 1-2-3 . . . . . 275	Graphox . . . . . 197
Mayday by Teletex . . . . . CALL	Sales Edge . . . . . 174
Symphony by Lotus . . . . . SALE	Format Iie . . . . . 104
Upgrades for 1-2-3 . . . . . CALL	Knoware . . . . . 64
DESO . . . . . CALL	Master Type . . . . . 27
Inves. Anyl. by Dow Jones . . . . . 249	Micro Pro . . . . . CALL
Market Analyzer . . . . . 219	Micro Soft . . . . . CALL
Market Manager . . . . . 219	PFS: Access Iie . . . . . 49
PFS: Access . . . . . 65	PFS: File Iie . . . . . 84
PFS: File . . . . . 89	PFS: File Iie . . . . . 84
PFS: Write . . . . . 89	The Handlers (all) . . . . . 149
PFS: Report . . . . . 84	Terrapin Logo . . . . . 99
Bankstreet Writer . . . . . 47	VersaForm . . . . . 259
EasyWriter II by JUS . . . . . 269	PI GL . . . . . 267
Dow Jones Soft . . . . . CALL	Be Writer by Hayden . . . . . 97
Volkswriter Deluxe . . . . . 179	Persona Pearl . . . . . 194
R-Base by MicroRim . . . . . 319	Dow Jones . . . . . CALL
WordStar . . . . . ON SALE!	Lock Smith . . . . . 78
MBSI Feal World . . . . . CALL	Zork I, II or III (each) . . . . . 26
T.I.M. . . . . 329	Deadline . . . . . 33
VersaForm . . . . . 279	Flight Simulator II . . . . . 37
Call for Complete Price List	Jack Report . . . . . 74

## MONITORS

Rolanc DG 121 G . . . . . 139	Quadscreen w/Card . . . . . 1650
Rolanc DG 121 A . . . . . 249	Zenth 131 . . . . . 319
Rolanc CB-141 . . . . . 319	Zenth 135 . . . . . 487
Rolanc CC-141 . . . . . 595	Zenth 122 . . . . . 109
Taxan 420 . . . . . 389	Amdek 310 . . . . . 159
Taxan Amber . . . . . 119	Amdek Color IV-T . . . . . 597
Taxan 415 . . . . . 499	NEC JC 1215 . . . . . 265
RGB-60 col Iie . . . . . 139	NEC JC 1215 . . . . . 397
RGB Card Iie . . . . . 89	Amdek 300 G . . . . . 134
Quadchrome . . . . . 559	Amdek 300 A . . . . . 144

## TERMINALS call

## SERVICE

WE OFFER EXTENDED WARRANTIES ON ALL OF OUR PRODUCTS. OUR EXPERIENCED TECHNICIANS ARE HERE FOR YOU!



# COMPUTERS and more. . . . .

8625 Commercial Dr., La Mesa, CA 92041



1-800-433-9449



For CA, HI and Alaska (619) 466-4895

NO SERVICE CHARGE FOR CREDIT CARDS  
NATIONAL LEASING AVAILABLE

F.O.'S ACCEPTED  
ON APPROVAL

\* On All Pre-paid Cash Orders In Cont. U.S.





# MicroAge<sup>®</sup>

## "THEY PROVIDED THE LINK BETWEEN US AND MILWAUKEE'S MAJOR CORPORATIONS."

*"Both of us had experience in the corporate world and we wanted to open a business reflecting that orientation. We chose MicroAge because they shared our business philosophy."*

*"Back in 1981, some of the major vendors still hadn't entered the microcomputer market. We anticipated that when they did, they would channel their products through a national organization. With MicroAge behind us, we're able to offer Milwaukee businesspeople and professionals such respected products as IBM, Compaq, Hewlett-Packard and most recently AT&T. And we have the technical expertise to provide service after the sale."*

*"MicroAge has supported us from day one. Without this help, we wouldn't be opening our second store!"*



Ernie Venta  
Franchise Owner



Elayne Kalman  
Franchise Owner

To build your own professional computer sales organization with MicroAge requires an initial investment of \$200,000 to \$350,000 which includes \$80,000 in liquid assets. Write to:

## MicroAge<sup>®</sup> COMPUTER STORES

*"The Solution Store"*

1457 West Alameda • Tempe, Arizona 85282

(602) 968-3168

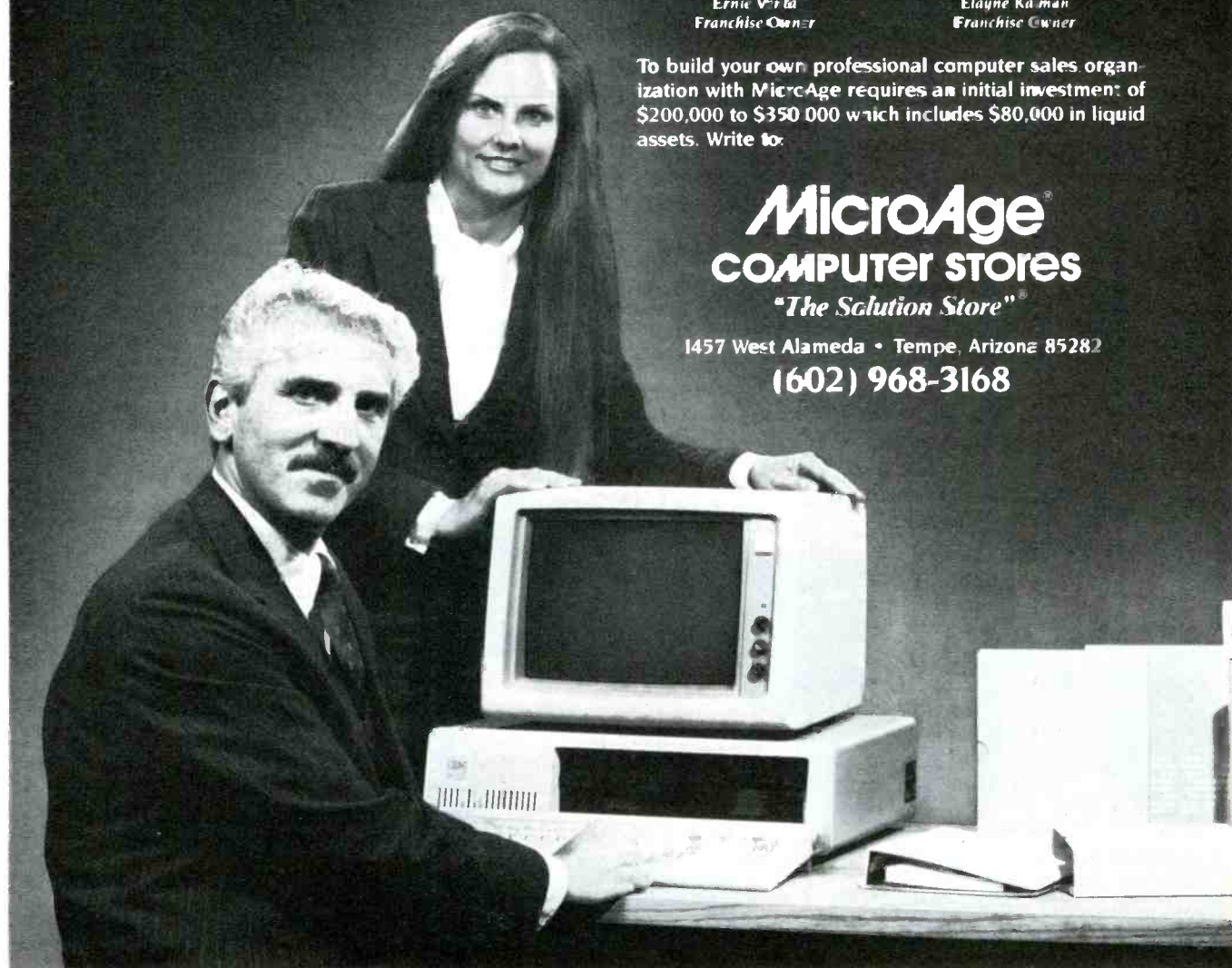

MicroAge franchisees Ernie Venta and Elayne Kalman shown with an IBM Personal Computer.

Circle 223 on inquiry card.



In addition to the powerful collection of information structures, this chapter also describes specific types of objects: numbers (integers, floating point, rationals), strings and characters, date and time quantities, a variety of display objects for use on the bit-mapped display screen, process schedulers (Smalltalk supports multiple processes with objects such as queues and semaphores), and others.

These sections contain pages of Smalltalk source code and associated text, providing dozens of examples on the uses of these objects. (Many Smalltalk objects implement messages that provide examples of their uses.) Two chapters in particular made me want to start trying things out: chapter 18, which is a detailed discussion of the graphics kernel of Smalltalk, and chapter 17, which provides a brief look at the system's programming interface. (Because the second

book in the series is entirely about the programmer's interface, I'll reserve comments on this matter until then.)

### A BIG EXAMPLE

The third part of the book consists of five chapters about using Smalltalk to design and implement discrete simulations. The topic here is technical; a quick look at these chapters might scare a reader off. However, for anyone who stays with it, the effect of this extended example is to clarify how programming in Smalltalk can make a complex task both manageable and understandable. As a programmer, you feel more like a director: you explain to each object how to carry out the instructions (messages) it is supposed to understand, and then you step back and direct your cast of objects to perform in a well-coordinated fashion.

A simple example, occupying only

one chapter or less, wouldn't have been sufficient. Any language can look good when handling a simple example. This section also shows how Smalltalk lets you interactively develop tools for working on a class of problems, resulting in a language that easily implements simulations, instead of just a simulation program. The authors deserve recognition both for the effort involved in writing these chapters and for devoting so much space to an illustration. Readers who skip these chapters risk missing much of the point of Smalltalk.

If you read the first book, you'll know that a program is a description of a group of new object classes needed to implement a task. Each class is described by first saying what it is a subclass of (is it an array, a display form, or something completely new?) and then optionally adding local variables: the names of new messages that objects in the class understand (entry points), a description of what effect the messages are supposed to have (documentation), and the methods needed to implement these messages (the code).

However, programming in Smalltalk-80 isn't done by typing the text of the program into a text editor and then compiling it. For one thing, you'd need an encyclopedia of Smalltalk by your side in order to take advantage of the objects already in the system. For another, the researchers at Xerox PARC seem to believe that the computer should help with the programming task as much as possible.

The researchers have turned the Smalltalk system into an electronic encyclopedia with an interactive mechanism for accessing classes, objects, methods, and documentation. This interface, described briefly in Goldberg and Robson's book, is explained in detail in the second book.

SMALLTALK-80:  
THE INTERACTIVE  
PROGRAMMING ENVIRONMENT

Adele Goldberg's *Smalltalk-80: The Interactive Programming Environment* is  
*(continued)*

**IF POWER FAILS, DATASAV<sup>®</sup> TAKES OVER!**

**PROTECTION** - saves data during power failures.  
- saves hardware from overvoltage transients.

**PORTABILITY** - allows mobile or extended holdup time using auxiliary 12 volt battery.

**FEATURES** - internal battery provides 5 min. + operating time - AC line conditioning  
- audible and visual alarms, interrupt signal - compact, desktop styling  
- no installation required.

200 WATT - \$495 / 90 WATT - \$350  
For special applications and product information, call 805-541-4160.

Instant power order line  
**805-541-4161**

**CUESTA SYSTEMS, INC.**  
3440 Roberto Court, San Luis Obispo, California 93401

**INSTANT AC POWER**

# When Lotus™ wanted better graphics for 1-2-3™, they chose a better graphics card—HERCULES™.



## And then we became a standard.

When the IBM® PC was introduced over 2 years ago, the talented people at Lotus realized that it was limited by a lack of high resolution graphics. They knew that this was going to have an adverse effect on 1-2-3's graphics. And Lotus didn't want anything to hold back their revolutionary software.

So they turned to Hercules.

Lotus recognized that the Hercules Graphics Card delivered the performance they wanted. It offered high quality text and high resolution graphics on IBM's monochrome display. It completely replaced the IBM monochrome card. And it didn't cost an arm and a leg.

Since then, Hercules has sold a lot of Graphics Cards. So many that the Hercules Graphics Card has become the high resolution standard for the IBM PC. And this means that there is more high resolution graphics software available for Hercules than for any other graphics card you can buy.

Software like Microsoft® Word. Our high resolution makes Word's text much sharper and easier on your eyes. And there are other programs for business graphics, computer aided design, terminal emulation and programming.

Call for our free information kit. See why the company that made the first graphics card for the IBM PC still makes the best.



**Hercules. We're strong on graphics.**  
**800 255 5550 Ext. 408**

Address: Hercules, 2550 Ninth St, Berkeley, CA 94710 Ph: 415 540 6000 Telex: 754063 Features: IBM monochrome display graphics resolution of 720x348; parallel printer port; text mode software compatibility; free software for programming; 2 year warranty. Foreign distributors: Compuserve/Canada; Reflex/U.K.; Computer 2000/W. Germany; Edisoft/France; SourceWare/Australia. Trademarks/Owners: Hercules/Hercules Computer Technology; Microsoft/Microsoft Corp; IBM/International Business Machines; Lotus & 1-2-3/Lotus Development.





# An Easy to Use Word Processor with the Power of BASIC

VEDIT PLUS will change your concept of what a word processor can do. It's a significant extension of VEDIT, acclaimed for the past 4 years by reviewers as the industry standard text editor. VEDIT PLUS makes other word processors or even program compilers seem obsolete.

Any system looks good at first, but down the road you may outgrow it. Not with VEDIT PLUS. It's not only easy to learn, but it can do things that other word processors can't:

- Sort a mailing list
- Perform arithmetic computations
- Compare two files and show you the differences
- Automatically search files for particular data
- Format text in any special way.

Actually VEDIT PLUS can do virtually anything, since it has the power of a high level programming language. Things you previously had to write complex programs for in BASIC, PASCAL or C can be done much more easily with VEDIT PLUS.

Sound Complicated? It's not.

VEDIT PLUS has two modes of operation. One mode offers what reviewers call the most intuitive style of editing of any package available - Full cursor control, single key search and selective replace, horizontal scrolling, printing, cut & paste and much more. Plus special features for program development.

## V-PRINT - Print Formatter

For enhanced print formatting with VEDIT PLUS. Features automatic table of contents and index generation, underlining, overstrike, foreign character support, and more. V-PRINT is compatible with virtually all word processing systems; CP/M, CP/M-86, MS-DOS and CP/M-68K. \$120

## Z80 to 8086 Translator

A complete translator written in the VEDIT PLUS language. Translates 8080 or Z80 to ready-to-assemble 8086. It can show you areas for possible hand optimization. The supplied 'source-code' may be modified or used as a model for other translators. \$50

The second mode gives you extensive file handling capability. Merging sections of multiple files has never been so effortless. Any editing operation can be automated and run on multiple files - without intervention. On-line help is a keystroke away. Its programming language gives you:

- Numeric capability (including a built-in calculator)
- Pattern matching
- Variables and strings
- Testing and conditional branching
- User prompts and input

With VEDIT PLUS you will get capabilities that you will never outgrow - which even a non-programmer will find easy to use. As a serious professional who needs the best in word processing, expect a lot from VEDIT PLUS - it was developed specifically for you.

VEDIT PLUS runs on practically every computer, CRT terminal, and memory mapped display made. (CP/M, CP/M-86, Concurrent CP/M-86, MS-DOS, etc.) To order, call (313) 996-1299 or ask for it from a reputable dealer.

VEDIT PLUS .....	\$225
VEDIT PLUS with V-PRINT .....	\$295
VEDIT PLUS with V-PRINT & V-SPELL .....	\$395

# CompuView

1955 Pauline Blvd., Ann Arbor, Michigan 48103 (313) 996-1299 Telex - 701821  
Orders: P.O. Box 1349, Ann Arbor, Michigan 48106

# Leave Your Dictionary On the Shelf Where it Belongs

## V-SPELL Spelling Corrector vs. A Spelling Checker – No Contest.

Every spelling checker on the market today will point out the words that you have misspelled.

Then what?

You still have to look up the correct spelling in a dictionary and in most cases correct it yourself with your word processor. (Try looking up a number of words you didn't know how to spell in the first place.)

Introducing V-SPELL - the spelling corrector.

V-SPELL not only finds misspelled words, it highlights each word in context and immediately displays a choice of correct spellings from its dictionary. Choose or enter the right spelling and V-SPELL will automatically make the correction. You won't have to spend time leafing through a dictionary.



Several spelling checkers provide hyphenation based on a mathematical formula. It guesses where hyphenation should occur. No guessing with V-SPELL. Its hyphenation is built directly into the dictionary.

V-SPELL provides you with two dictionaries - a 60,000 word main dictionary, carefully balanced to include often used and commonly misspelled words, and an extra dictionary for your own words. You can add as many words as you like to either dictionary.

V-SPELL is fast. It can proof 40 pages of text in under 2 minutes. Menu driven operation and on-line help make it easy to learn, easy to use.

Every spelling checker can show you words you've misspelled - only V-SPELL will help you correct them.

	V-SPELL Spelling Corrector	The Word Plus	Super Spell- Guard
Displays words in context	Yes	Yes	No
Automatically provides alternative spelling	Yes	No	No
Corrects automatically	Yes	Yes	No
Special use dictionary	Yes	Yes	Yes
Size of dictionary	60,000	45,000	20,000
Expandable dictionary	Yes	Yes	Yes
Dictionary hyphenation	Yes	No	No

### Technical Features

V-SPELL can ignore printer control characters and other non-ASCII characters in your document.

Any text can be hyphenated by V-SPELL for typesetting and other professional applications.

Parameters and options such as the number of lines of text displayed in context, character to use for hyphenation, and treatment of high-bit characters may all be customized.

V-SPELL runs on practically every computer made (CP/M, CP/M-86, Concurrent CP/M-86, MS-DOS, etc.) and is compatible with most word processing programs. To order, simply call (313) 996-1299 or ask for it from a reputable dealer . . . . . \$125

# CompuView

Circle 79 on inquiry card.

1955 Pauline Blvd., Ann Arbor, Michigan 48103 (313) 996-1299 Telex - 701821  
Orders: P.O. Box 1349, Ann Arbor, Michigan 48106

The Word Plus is a registered trademark of Oasis Systems, Inc. Super SpellGuard is a registered trademark of Sorcim Corporation, CP/M is a registered trademark of Digital Research, Inc. MS-DOS is a registered trademark of Microsoft, Inc.

OCTOBER 1984 • BYTE 73



divided into five parts. The first is a general introduction to the Smalltalk environment. This environment is where the desktop metaphor originated. In fact, one thing that becomes clear as you read these books is that Apple's Lisa-technology software environment is directly descended from Smalltalk, not from Xerox's 8010 computer. Not only the windows, the menus, and, of course, the mouse, but the Macintosh's text- and graphics-editing programs also have precursors in Smalltalk's built-in text and graphics editors. There are small differences in style that are related to the fact that Smalltalk uses a three-button mouse while Apple uses a one-button mouse, but a Macintosh user would feel right at home. Conversely, perhaps, a Smalltalk user might feel constrained on a Macintosh because Smalltalk provides a completely integrated computing environment with

text manipulation, graphics, and programming, while Macintosh provides more traditional application programs and operating system.

The next three parts of the book are ordered in the same way you would actually begin programming: how to find things in the system, how to change things, and how to correct things.

Much of a programmer's interaction with Smalltalk happens through a window called a *system browser*. This resembles a four-pane slot machine with a jackpot window in the bottom part of the screen. The window at far left displays categories of classes defined in the system. If you select one, the next window lists all of the classes in that category; if you select one of those, the next window (third one over) lists the kinds of messages this class of object can understand; and if you select one of those, the

names of these messages appear in the far right-hand window. Select one of these and the large window underneath displays both the Smalltalk code that implements the message and its documentation.

You can edit the contents of the window, immediately recompile the code, and try it out. At any step along the way, you can add new categories of classes, new classes, new kinds of methods, or new methods, and the text in the window will display an appropriate skeletal form for carrying out that operation. You edit it, with a minimum of typing, and the operations are carried out.

Another type of interaction with the system is done through an *inspector*. Every object in the Smalltalk system is capable of presenting its internal state in a separate window along with a workspace in which you can test ex-

(continued)

EVENT: COMPETITION OF HI-RES COLOR DISPLAY FOR IBM PC

# WHO IS THE WINNER?

You are the Judges!!

Exceeds 700 dots resolution	★		
Ergonomical tilt/swivel	★		
Green text mode	★		
One year warranty*	★		
.31mm pitch CRT	★		
2000 characters	★	●	●
16 colors (by intensity)	★	●	●
FCC class B	★	●	●
Direct Plug-in to IBM PC/XT	★	●	●
Price \$	699	695	680

Quimax PX-IV

PGS MK-12

IBM 5153



\* MONITOR NEWS \*

PX-IV TAKES THE GOLD!

By Hyres Vesion

The crowd is ecstatic as Quimax congratulates their Hi-Res champion PX-IV. One observer at the Olympiad Mr. Misty Focus stated, "That PX-IV clearly demonstrated to the competition what a real winner is made of, superior pixel resolution like I've never seen before." Another observer Mr. Hunch Neckacker states "PX-IV displayed tremendous tilt and swivel action that looks fantastic from any position." Finally, Mr. Tex Writer shouts, "PX-IV showed his switching versatility between color and green text display, he really knows how to turn it off and turn it on."

**Quimax**  
SYSTEMS, INC.

568 WEDDELL DR. SUITE 4  
SUNNYVALE, CA 94089

408-734-8283 (Sales Manager)  
408-734-8476 (Customer Service Manager)

— COME TO SEE US —

- San Francisco PC Faire Booth #12
- COMDEX/Fall Las Vegas Booth #M1346

IBM is a trademark of International Business Machines, Inc. PGS is a trademark of Princeton Graphic systems, Inc.

\* See our warranty policy for details

Ask your local dealer for a demo.

# NOW YOU CAN HAVE YOUR IBM<sup>®</sup> AND KEEP YOUR APPLE II<sup>®</sup>

## A Piece of Cake

Finally! A disk to disk transfer from Apple to IBM and back again. Impossible! Not with APPLE-TURNOVER<sup>™</sup>. An extraordinary new PC Board from the innovators in microcomputer products at VERTEX SYSTEMS. No modems! No serial links! But a truly compatible way to quickly copy any file back and forth, from IBM to Apple—from Apple to IBM in just seconds!

An APPLE-TURNOVER<sup>™</sup> in your IBM PC<sup>®</sup>, PCXT<sup>®</sup>, or PC Compatible allows direct reading, writing, and formatting of APPLIEDOS<sup>®</sup> 3.3 and Apple CP/M<sup>®</sup> disks.

## Choices Abound

APPLE-TURNOVER<sup>™</sup> isn't choosy, either! It can copy Datafiles; Textfiles; Spreadsheets; Program source codes, and more. It supports all Apple II formats. APPLE-TURNOVER<sup>™</sup> makes sharing files so easy you'll be amazed with the endless possibilities.

For Example: Create a Visicalc<sup>®</sup> spreadsheet on your Apple computer at Home. At Work insert the Apple II disk into your PC. Use your APPLE-TURNOVER<sup>™</sup> to copy the Visicalc file to your IBM disk. Now use an advanced 16 Bit program like Lotus 1 2 3<sup>®</sup> to work on the spreadsheet. APPLE-TURNOVER<sup>™</sup> will then copy the spreadsheet file back to the Apple II disk. That night at Home use it on your Apple computer. It's that Simple! And it works!

## XENO COPY PLUS 2.0 ★IMPROVED

**NOW YOU CAN FORMAT, READ, AND WRITE OVER 70 DIFFERENT DISKS!** Think of the advantages of effortlessly moving foreign disk files to your PC and back again with XENO COPY PLUS 2.0<sup>™</sup>. Without Modems, Serial links or Hardware your PC can copy a 16K file in well under a minute! It supports most soft-sector double density CP/M-80/86 formats. TRSDOS; p-System<sup>®</sup> (read only), NECDOS, TurboDOS and other popular international formats. XENO COPY PLUS 2.0<sup>™</sup> runs under DOS in the IBM PC, PCXT, and most PC Compatibles with 128KB. Also available is IMPORT<sup>™</sup> for the DEC Rainbow. Ask about new formats, features and hosts coming soon. **\$149.50**

\*APPLE-TURNOVER, XENO COPY PLUS 2.0, XENO DISK, 80 MATE, 80 TERM, IMPORT, APFORMAT, APREAD, APWRITE, and APSIFT are registered trademarks of VERTEX SYSTEMS, INC.

IBM, IBMPC, PCXT, are registered trademarks of International Business Machines Corp.

APPLE and APPLIEDOS are registered trademarks of Apple Computers, Inc.

MS DOS is a registered trademark of Microsoft Corp.

CP/M, CP/M-80 and 86 are registered trademarks of Digital Research, Inc.

Visicalc is a registered trademark of VisiCorp.

Lotus 1-2-3 is a registered trademark of Lotus Development.

p-System is a registered trademark of Softech Microsystems.

© Copyright 1984 VERTEX Systems, Inc. All rights reserved.

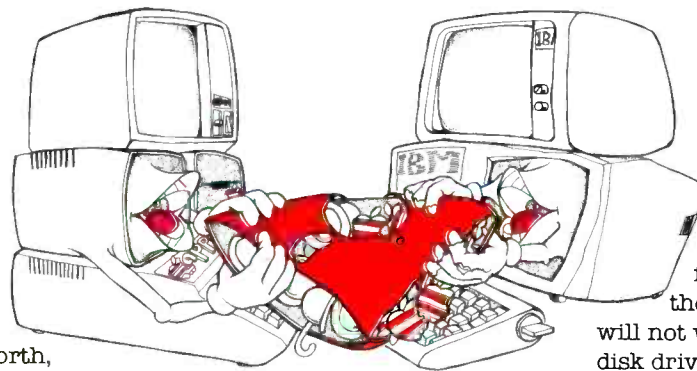

WITH

## APPLE-TURNOVER<sup>™</sup>

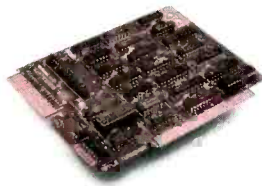

**COPY FILES FROM APPLE  
DISKS TO IBM DISKS  
OR IBM TO APPLE.  
NO MODEMS! NO SERIAL LINKS!  
NO HASSLES!**

## Sideorders

Add 80MATE 2.0<sup>™</sup>. Now you can run most Apple CP/M and other CP/M-80 programs directly in your IBM without an expensive coprocessor board or other hardware!

Add XENO-COPY Plus 2.0<sup>™</sup>. Now you can copy your Apple and IBM files to more than 70 different disk formats including most CP/M formats and read those formats, too! Version 2.0 will now initialize blank disks also.

## XENO DISK

**TURN YOUR PC INTO A DISK PRODUCTION MACHINE.** If you need to produce different disk formats but shreek at the high cost of other solutions try the XENO DISK<sup>™</sup> Software Development System. Import and Export disk files plus initialize blank disks in foreign formats. Fast track-by-track duplication and extensive table-driven text-translation capabilities are just two of many features needed by businesses, DP space departments, software developers and publishers, typesetters, schools and other organizations. XENO DISK<sup>™</sup> supports more than 80 different 40 track, 80 track and 8 inch floppy formats. **\$379.50**

**SEE YOUR DEALER OR CALL FOR  
INFORMATION**

**213/938-0857**

## The Minimums

All you need to free yourself of the Apple/IBM dilemma is a PC, PCXT or Compatible with 128K of memory and two disk drives. One of those drives can be a hard disk! DOS 2.0 or later is required for full wild cards! One thing though . . . APPLE-TURNOVER<sup>™</sup>

will not work properly with TEAC disk drives. **It will not support copy-protected disks.**

## In The Box

Included with your purchase of the half-sized APPLE-TURNOVER<sup>™</sup> board you get an additional cable to connect it to your regular disk controller card. An APPLE-TURNOVER<sup>™</sup> Software program disk (unprotected) which contains four main files: APFORMAT<sup>™</sup> for formatting a blank disk, APREAD<sup>™</sup> to copy a file from Apple disks to DOS disks, APWRITE<sup>™</sup> to copy a file from DOS disks to pre-formatted Apple disks, and APSIFT<sup>™</sup> a text file modification utility.

## One To Go . . . Please!

What are you waiting for! Say goodbye to the past. Say hellow to APPLE-TURNOVER<sup>™</sup>. Your high performance alternative to complicated serial links and modem madness! Set yourself free in business and in the home with the fastest and simplest way to copy Apple/IBM information ever developed.

APPLE-TURNOVER<sup>™</sup> is your key to unlocking the Tower of Apple Babel! **\$279.50**

## 80MATE

**RUN CP/M-80 AND Z-80 PROGRAMS ON YOUR IBM PC WITH NO ADDITIONAL HARDWARE!** 80MATE<sup>™</sup> Software CP/M 2.2 emulator with 80-TERM<sup>™</sup> video emulator allows your IBM PC or PC Compatible to run almost any CP/M program. Many MS DOS<sup>®</sup> programs are simply translations so why duplicate your software library when you can legally transfer them to your PC. All the familiar CP/M commands are included. 80MATE<sup>™</sup> uses ordinary DOS disks and devices such as your printer, hard disk, ramdisk, etc. Version 2.0 adds Z-80 capability and video and keyboard emulation for Apple CP/M. **\$149.50**

**Vertex**  
systems, inc.

**INNOVATION IN MICROCOMPUTER PRODUCTS**  
6022 West Pico Blvd., Los Angeles, CA 90036



*To implement Smalltalk on a given machine, you implement the virtual machine then load the virtual image into the virtual machine.*

pressions and inspect their effects on the object.

If you read this book without sitting in front of a Smalltalk machine, you will have no difficulty following the text. This is due to an abundance of large, clear illustrations of both the computer screen and the state of buttons on the mouse. The pictures, typically one-half page in size, average more than one per page. However, because the system is so much fun to use, the frustration of reading text like "Here, try this to see how it works" will probably force you to put the book down from time to time. In a field where many people say they love their work but so few books show it, these two books are pleasant exceptions to the rule.

The level of detail here goes beyond what a casual reader needs to know. You'll learn what it's like to program in a highly interactive environment where spelling checking is automatic and where interactive debugging tools appear in separate windows and disappear when not needed. It lets

you edit, debug, consult, reprogram, and then pick up where your program left off, without you even being aware that you were using three or four different tools.

The book concludes with a section on linking Smalltalk with external files to facilitate the exchange of information and programs. It also contains a Smalltalk-programming appendix of "do's and don'ts" written by a member of Xerox's Special Information Systems (SIS) group. This group distributes and supports the commercial version of Smalltalk; the appendix makes it clear that there are programmers outside of Xerox who are using this language to implement complex, interactive systems. This appendix and the final section offer suggestions and practical advice.

#### IMPLEMENTING SMALLTALK

To get a Smalltalk implementation, call Xerox's SIS branch in Pasadena, California, and arrange to send them \$55,000 for a Xerox 1100 SIP computer, plus \$5000 for a Smalltalk license. If you can do that, you'll become the best-equipped programmer on the block. If you can't afford \$60,000, you'll have to wait, but not that long.

All current Smalltalk implementations use the *virtual-machine* technique for implementing languages. First, you decide what kind of machine the language should run on, considering both the design and the run-time characteristics of the language. Then,

you implement a virtual-machine emulator in software (usually in machine language or microcode). However, most of the system is written in hardware-independent Smalltalk code. This collection of Smalltalk objects is called the *virtual image*. To implement Smalltalk on a given machine, you implement the virtual machine and then simply load the Smalltalk virtual image (the objects) into the virtual machine. A well-known example of this technique for a simpler language is UCSD Pascal with its p-code interpreter serving as the virtual machine while most of the system is written in machine-independent Pascal.

All of the details of how to implement a Smalltalk virtual machine are spelled out in the last part of the first book I review here. And it's not easy: the virtual machine is a complex program. But the details are there. In fact, a complete implementation of the virtual machine is provided as an illustrative sample implementation. Individuals with experience writing large programs will look at the description and say, "Hey, I can do that." In fact, this was the purpose of this part of the book: to guide Smalltalk implementers.

However, the implementers the authors had in mind were a small group of individuals involved in a research project with Xerox. While the description of the virtual machine is very clear, there is no incentive for an

(continued)

## DATA TRANSFER PROBLEMS?

Your Simple Solution is **REFORMATTER®** Diskette Conversion Software

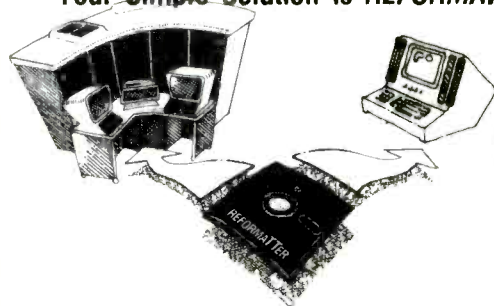

- Avoids serial communication protocols.
- Needs only one system to transfer data.
- Converts source code and data files.
- Allows 2-way transfer.
- Quick, reliable, and inexpensive.



VERSIONS	
Runs On	Reads/Writes
CP/M	↔ IBM 3740
CP/M	↔ DEC RT-11
CP/M-86	↔ IBM 3740
CROMIX	↔ DEC RT-11
DEC RT-11	↔ CP/M
MS-DOS	↔ IBM 3740
TRSDOS II*	↔ CP/M
TRSDOS II	↔ DEC RT-11
PRICE	\$350 *\$249

Requires 8" floppy drive

(415) 324-9114 TWX: 910-370-7457  
467 Hamilton Avenue, Suite 2, Palo Alto, Calif. 94301

# BIG FOUR

NEW 128K —MEGA BYTE DUAL DISK DRIVE—80 COLUMN

# COMPUTER SYSTEM SALE!

HOME • BUSINESS • WORD PROCESSING



LOOK AT ALL YOU GET FOR ONLY \$895.

List Price \$3717.95

- |   |  |           |
|---|--|-----------|
| ① | B128 COMMODORE 128K 80 COLUMN COMPUTER             | \$ 995 00 |
| ② | 8050 DUAL DISK DRIVE (over 1 million bytes)        | 1795 00   |
| ③ | 4023 100 CPS 80 COLUMN BIDIRECTIONAL PRINTER       | 499 00    |
| ④ | 12" HI RESOLUTION 80 COLUMN GREEN OR AMBER MONITOR | 249 00    |
| • | BOX OF 10 LORAN LIFETIME GUARANTEED DISKS          | 49 95     |
| • | 1100 SHEETS FANFOLD PAPER                          | 19 95     |
| • | ALL CABLES NEEDED FOR INTERFACING                  | 102 05    |

TOTAL LIST PRICE \$ 3717.95



Printer replacement options (replace the 4023 with the following at these sale prices)

	LIST	SALE
★ Olympia Executive Letter Quality Serial Printer	\$ 699 00	\$ 399.00
★ Comstar Hi Speed 160 CPS 15 1/2" Serial Business Printer	\$ 779 00	\$ 499.00
★ Telecommunications Deluxe Modern Package	\$ 199 00	\$ 139.00

Plus You Can Order These Business Programs At Sale Prices

	LIST	SALE		LIST	SALE
Professional 80 Column Word Processor	\$149.95	\$99.00	Payroll	\$149.95	\$99.00
Professional Data Base	149.95	99.00	Inventory	149.95	99.00
Accounts Receivable	149.95	99.00	General Ledger	149.95	99.00
Accounts Payable	149.95	99.00	Financial Spread Sheet	149.95	99.00
			Program Generator	149.95	99.00

**15 DAY FREE TRIAL** We give you 15 days to try out this SUPER SYSTEM PACKAGE!! If it doesn't meet your expectations, just send it back to us prepaid and we will refund your purchase price!!  
**90 DAY IMMEDIATE REPLACEMENT WARRANTY** If any of the SUPER SYSTEM PACKAGE equipment or programs fail due to faulty workmanship or material we will replace it IMMEDIATELY at no charge!!

**Write or Call For Free Catalog and Spec Sheets!!**

Add \$50.00 for shipping and handling!!

\$100.00 for Canada, Puerto Rico, Hawaii orders.

WE DO NOT EXPORT TO OTHER COUNTRIES

Enclose Cashiers Check, Money Order or Personal Check. Allow 14 days for delivery, 2 to 7 days for phone orders, 1 day express mail!! Canada orders must be in U.S. dollars. We accept Visa and MasterCard. We ship C.O.D. to U.S. addresses only.

**PROTECTO ENTERPRISES** (WE LOVE OUR CUSTOMERS)

BOX 550, BARRINGTON, ILLINOIS 60010  
 Phone 312/382-5244 to order

Circle 293 on inquiry card.



**FREE SHIPPING**WEST OF MISSISSIPPI  
EAST — ½ UPS CHARGESCALL FREE  
1-800-841-2748**COMPUTERS**

ALTOS 580-20	\$3350
ALTOS 586-20	\$5899
ALTOS 986-40	\$CALL
APPLE LOOK-A-LIKE	\$CALL
IBM PC	\$CALL
CORONA	\$CALL
NEC 8201	\$459
SANYO 550-555	\$CALL

**TELEVIDEO**

803	\$1769	1603	\$2019
1605			\$CALL

**NORTHSTAR**

ADV	\$2135	15MEG	\$3799
-----	--------	-------	--------

**PRINTERS**

ABATI	\$389
BROTHER HR 15P	\$479
DAISYWRITER 48K	\$CALL
EPSON	\$CALL
GEMINI 10X	\$258
JUKI 6100	\$429
OKIDATA (LOW PRICES)	\$CALL
QUME 1140+ W/INF	\$1365

**CITOH**

8510	\$319	1550	\$499
F10-40C PS	\$899	F1055	\$1179

**DIABLO**

620	\$769	630 API	\$1669
-----	-------	---------	--------

**NEC**

3550	\$1495	3510	\$1235
7710	\$1645	2030	\$659

**TERMINALS — MONITORS**

ALTOS II	\$755
QUME 102G	\$529
WYSE 50	\$485
TELEVIDEO 924	\$655
TELEVIDEO 950	\$895
TELEVIDEO 970	\$965
AMDEK 300G	\$129
AMDEK 300A	\$145
AMDEK COLOR I+	\$275
AMDEK COLOR II+	\$399
B.M.C. COLOR	\$235
PRINSTON HX12	\$464

**DISK DRIVES — MODEMS**

INDUS APPLE	\$259
MICRO SCI A2	\$185
ATARI 1050	\$365
INDUS ATARI	\$345
RANA 1000	\$299
PROMODEM 1200	\$325
HAYS SMART MODEM	\$199
SMARTMODEM 1200	\$469
SMARTMODEM 1200B	\$415
MICROMODEM II E	\$235
RIXON 212A	\$449
U.S. ROBOTICS PASSWORD	\$325

**1st PLACE**COMPUTER SYSTEMS  
13422 N. CAVECREEK RD.

PHOENIX, AZ. 85022

OTHER INFORMATION: 602-867-9897



Free shipping is on UPS ground only.

Send cashier's check or money order .... all other checks will  
delay shipping two weeks.

Prices &amp; availability subject to change without notice.

**BOOK REVIEWS**

average reader of these books to implement the machine. The reason is that while the virtual-machine description is in the public domain, the virtual image of the Smalltalk system (more than half a megabyte of Smalltalk objects) is owned and copyrighted by the Xerox Corporation and can be acquired only by hardware companies that purchase a license to incorporate the image into a hardware product.

While this is a good guide to implementing Smalltalk, and the details illustrate some of the difficulties of implementing an object-oriented language on a standard computer, it may be wasted on those who are reading the book primarily to learn about Smalltalk.

SMALLTALK-80: BITS OF  
HISTORY, WORDS OF ADVICE

*Smalltalk-80: Bits of History, Words of Advice* delivers the essential implementation details to the programmers who seek them. It is a collection of papers edited by Glenn Krasner and written by people who are reporting the results of implementing Smalltalk on some machine. The quality of the papers ranges from fair to fascinating, and the quantity of detail is great. Amusing Smalltalk cartoons drawn by Ted Kaehler and Jean Depoian add to the lightness of the book. The four sections that the papers are broken down into are "Background," "Experiences," "Measurements and Analyses," and "Future Proposals."

In the first of four "Background" papers, Adele Goldberg describes the process of releasing Smalltalk outside of Xerox. The second, written by Dan Ingalls, presents a short history of the Smalltalk language, beginning with Smalltalk-72 (which started as a 1000-line BASIC program and became an assembly-language implementation for the Nova minicomputer). One interesting nugget of information is that Smalltalk-78 was designed for, and ran on, a transportable computer with an 8086 microprocessor in a box resembling current transportable-computer designs.

Glenn Krasner describes how the world of Smalltalk objects is translated into the more traditional world of disk files for communication between machines. The final paper was written by Allen Wirfs-Brock of Tektronix (the first three authors are from Xerox PARC), and it is the starting point for implementers looking for advice from someone with experience. The writer recommends that you implement in a high-level language first, study the results, optimize, experiment, and only then go on to assembly language.

The papers in "Experiences" are detailed descriptions of problems encountered, ranging from coding errors and Pascal-compiler bugs to using implementations that required 10 minutes to clear a screen. It also contains the decisions made while implementing Smalltalk. The implementations described are for a range of computers, including the MC68000, the VAX-11/780, and Xerox PARC's Dorado (a desktop unit more powerful than the VAX). In both this and the next section, you can glimpse some well-trained professional programmers who spend a significant amount of time analyzing, studying, and criticizing the performance of their work; they know where to put the intensive effort at improving code. The details presented at this level will probably stop most people who haven't worked on a large and complex computer program.

The programmers at Tektronix, who worked with an in-house MC68000 machine, present a history of their successful attempt to implement the Smalltalk virtual machine in Pascal (cross-compiled from a DECSYSTEM 20). They include their analyses, improvements, and error logs.

At Hewlett-Packard, the implementation team also used DECSYSTEM 20 Pascal, but they actually ran the code on the system (using a graphics terminal). Later they moved it to a VAX running UNIX and translated their virtual machine into C. Their paper presents the changes they had to make to adapt the standard Small-

(continued)

# PC vs JC



Most Choose PC,  
but  
Most Need JC.

PC, personal computer has become a commodity product. It is just like a personal car. It has limitations and problems. People expect PC to do more than it can do.

JC is a growing computer. The superb architecture can offer you painless expansion for your organization. If your computer must be able to grow as you grow, JC is your only choice.

JC computers have been available thru our world-wide dealer network since 1979. The installed base of computers is now reaching 10,000 units. Our latest addition features a **multi-user, multi-processor system**, based on our 80186 master/slave processor modules. It runs under TurboDos\* 1.4 operating system with PC/DOS emulation.

JC users agree that our computers truly offer **expandability, low cost, and high performance.**

If you want to know more, contact us. Let one of our professional dealers help you. They will hold your hand until you get solutions, not problems.



See us at

COMDEX™/Fall '84

Las Vegas Hilton  
Booth #7220



**JC SYSTEMS**

HIGH PERFORMANCE COMPANY

JC INFORMATION SYSTEMS, INC.

469 Valley Way  
Milpitas, CA 95035  
(408) 945-0318  
TWX 910-381-7041

\*TurboDos is a trademark of Software 2000, Inc.  
\*PC/DOS is a trademark of IBM Corporation.





# Now last minute presentations can be made from your personal computer. In color. In house. In minutes.

## Introducing Polaroid Palette.

Whether your presentation is in 30 minutes or 30 days, the new Polaroid Palette Computer Image Recorder will make it easier. Priced at under \$1800\*, it lets you make Polaroid instant 35mm slides or prints from personal computer-generated data. Right at your desk. So now you can create a presentation in minutes. Without sending out for processing, paying premiums for rush service or risking the security of your confidential information.

**Works with the graphics packages of the IBM PC or XT, DEC Rainbow, Apple IIe and II+ as well as other pcs.**

The Polaroid Palette is designed to work with many graphics software packages. In fact, when using such popular programs as Graphwriter, Chart-Master, Sign-Master, DR Draw and DR Graph, Palette can virtually double both the horizontal and vertical resolution of your monitor. Plus, a

"backfill" feature reduces raster lines for a smoother, more finished appearance. The result—presentation quality slides. On-the-spot.

### **Color 35mm slides, even from a black and white CRT**

Think of it as an artist's palette. Because Palette "paints" your graphs, charts and text. You're choosing from up to 72 colors. If you don't want red, press a few keys—it's green. And if you're not the artistic-type, Polaroid has developed a menu of color sets: combinations of colors that have been specially coordinated to complement your presentations. And all of this is yours, even if you have a black and white monitor.

### **Lets you make last minute changes or add up-to-the-minute information.**

The Polaroid Palette is the fast, convenient, low-cost way to prepare slides for your presentation. And perhaps

even more important, Palette allows you to keep confidential information confidential. You won't have to send your work out to anyone again.

So why wait until the last minute to find out about Polaroid Palette? Call this toll-free number or return this coupon. Because with Palette you'll make your deadlines, in no time.

For a demonstration, call toll-free, or mail the coupon to Polaroid Corp., E.I. Marketing, Dept. 604, 575 Technology Sq., Cambridge, MA 02139.

**CALL 1-800-225-1618**

Send information.  I have representative call.

B 10/84

Name \_\_\_\_\_ Title \_\_\_\_\_

Company \_\_\_\_\_

Address \_\_\_\_\_

City \_\_\_\_\_ State \_\_\_\_\_ Zip \_\_\_\_\_

Telephone (\_\_\_\_\_) \_\_\_\_\_

PC make and model \_\_\_\_\_

 **Polaroid**

\*Suggested list price. Polaroid®



*The HP team concluded that a system this flexible is vulnerable and will not make a supportable product.*

talk image into an environment where 32-bit addresses are typical. As with all papers here, details are not skimmed on; bugs in the virtual image, problems with floating-point arithmetic, and problems in getting the input and output routines running efficiently are mentioned, as well as a description of the multilevel debugging system used to attack development problems. Unlike the others involved, the HP team was disappointed in Smalltalk and concluded that a system this flexible is vulnerable and thus will

not make a supportable product.

The paper on the Xerox Dorado implementation presents the issues that confront those who are in a position to implement all or part of their virtual machine in their processor's microcode. Here they chose to split the implementation between microcode and macrocode (conventional machine language) and described the details as they apply to the unique architecture of the Dorado computer.

The DEC group tried an initial implementation on a PDP-11/23 but later moved to a VAX-11/780; all of their details apply to the latter. Unlike most other implementations, where memory management is handled by reference counting, the DEC team adapted an incremental garbage-collection algorithm. While they prefer their technique, the body of the paper suggests they haven't reached a consensus.

The "Measurements and Analyses"

section's papers are primarily tables of performance analyses. (In particular, the question repeatedly answered is: Where is the interpreter spending all of its time?) However, the first paper, by Kim McCall of Xerox, has a table of benchmarks using a collection of well-described tests that ran on 10 implementations. The paper quite rightly disclaims the significance of any comparison, both because of the disparity of the hardware involved and the varying levels of effort that had been applied to optimizing different implementations. However, there are still some interesting facts here. First, the Xerox Dorado implementation was between five and twenty times faster than its next competitor, the Xerox Dolphin (which is the Xerox 1100 SIP). The second fact is that one of the implementations, on a 10-MHz MC68000 chip, compared very favorably with Xerox's implementation on its 1100 SIP. Other papers in the book make it clear that this chip has been targeted for intensive work by many implementers. This suggests that we might soon see a Smalltalk machine with a 68000 processor for much less than \$60,000.

The final section of the book contains six papers discussing proposals for improving Smalltalk. Three discuss projects under development that were at the time just proposals. At Xerox, Glenn Krasner and Ted Kaehler are working on an object-oriented (as opposed to the traditional page-oriented) virtual-memory scheme, and they describe the system here. Steve Putz, also of Xerox, is in charge of managing the evolution of Smalltalk-80 systems. This is a common problem with all extensible languages: isolated implementations (installed in non-networked environments) tend to quickly evolve into incompatible dialects where improvements to one version are difficult to transfer to another. (LISP is one example.)

D. Jason Penney of Tektronix describes using Smalltalk to implement a file system. Interesting bugs and snags aside, he liked its reliability and usability, and he was using only an ex-

(continued)

## MODULA-2

FOR MACINTOSH, APPLE II's  
IBM-PC AND LISA



**MODULA-2 COMPILER/INTERPRETER — \$90**  
An advanced programming environment supplied on diskette for the Apple II, II+, and IIe, Macintosh, Lisa and the IBM PC, XT and compatibles.

**PASCAL-TO-MODULA-2 CONVERTER — \$100**  
Increase the efficiency of your Pascal programs by converting to Modula-2. Run larger programs and take advantage of Modula Corp's efficient interpreter.

**MODULA ENHANCER MEMORY CARDS FOR APPLE II's AND IBM-PC's — \$245**  
A revolutionary idea. An extra 64K of memory and a four times increase in execution speed of your Modula-2 programs compared to Pascal.

**MODULA ENHANCER MEMORY CARDS AND MODULA-2 SOFTWARE FOR ONLY \$285**  
Get the combination for a \$50 savings. The card requires its own version of the compiler and interpreter to work properly.

# MODULA

CORPORATION

**950 N. University Ave., Provo, UT 84604 801/375-7400 or 800/LILITH2**

1984 by Modula Corporation. Apple - Apple Computer Inc., IBM - IBM Corp.

# ADS 2000 DOT MATRIX PRINTER

**165 CPS DRAFT MODE 9X9 DOT MATRIX**  
**40 CPS VERY NEAR LETTER QUALITY 17X17 DOT MATRIX**  
**QUAD DENSITY HIGH RESOLUTION GRAPHICS**

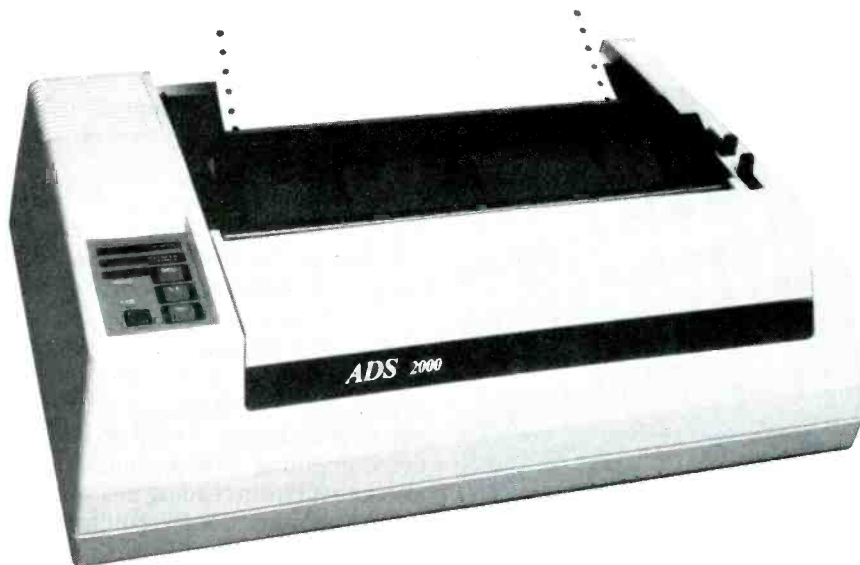

# DATA EXCHANGE/ 64K SPOOLER



The ADS-8212 DATA EXCHANGE/64K is a computer independent interface converter and print spooler. It can be installed between virtually any computer and any peripheral.

Data can be input in either serial or parallel, stored in its 64K bytes of RAM, and output serial or parallel. Serial ports support baud rates from 50 to 19,200 and both hardware and software handshaking. The input and output ports are completely independent; input data with one protocol and baud rate and output it with a different protocol and baud rate. Selections are dip switch selectable.

A unique feature is its ability to make unlimited numbers of copies. Hitting the copy button will send another copy to the printer. When done making copies, hit the reset button to clear the memory.

Included with the DATA EXCHANGE/64K are two 4 foot output cables, one parallel cable with standard Centronics type connector and one serial cable with standard DB 25 connector. Standard plugs are supplied for input ports.

Suggested list price: \$339.00

Dealer inquiries welcome.

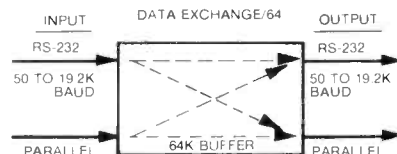

**RS-232 HANDSHAKING:**  
**RDY/BSY (DTR)**  
**Xon/Xoff**  
**ETX/ACK**

The Antex Data Systems ADS 2000 prints at 165 characters per second in correspondence quality using a 9x9 dot matrix. By turning on the "FINE" mode with a push of a button or through software command it is possible to obtain Very Near Letter Quality (VNLQ) at 40 characters per second using a 17x17 dot matrix. The Epson FX-80 compatible ADS 2000 uses the full 96 character ASCII and includes true descenders and graphic resolution. Typestyles included with the ADS 2000 include Pica, Elite, Proportional and Italics and the ability to design up to 256 characters that can be combined with the standard 128 typestyles. Subscripts and Superscripts can be used for scientific equations, notations and formulas. The ADS 2000 can interface to almost any computer on the market using the Centronics parallel interface or the optional RS 232-C serial interface.

**SuperFont**, an optional software program designed to utilize all the special features of the ADS 2000 is also available for popular computers.

SuperFont features include:

- A user friendly means of generating user designed fonts.
- 20 different fonts — the user can print these characters in an elongated or compressed character size as well as regular sizes.
- An editor able to interface with most commercially available word processing software for downloading the 20 different and user designed fonts.

## ADS

**ANTEX  
DATA  
SYSTEMS**

A Division of International Antex Inc.  
 2630 California Street • Mountain View, California 94040  
 (415) 941-7914 • Telex: 704 969 INTERAX UD

ADS is a registered trademark of International Antex, Inc.  
 Epson FX-80 is a registered trademark of Epson America.





## The Quick Silver Fox™ Jumps Over The Big Blue Dog.

We really hate to pick on the big guys but compared to the Silver Fox your basic IBM-PC™ is a slow, overpriced dog.

### 256k RAM

Why? Well, for starters, your basic Silver Fox comes with 256k of RAM which acts like a disk drive so that more of your software is accessed at the speed of light rather than the speed of a mechanical drive head.

### 1.6 Megabytes

You also have more than twice as much software to access because the Silver Fox comes with dual 800k disk drives for a total of 1.6 Megabytes. Yet the Silver Fox can read and write to all popular PC formats.

### 14 Free Softwares

1. MS-DOS
2. HAGEN-DOS™
3. M-DISK
4. WordStar™
5. EasyWriter
6. DataStar
7. ReportStar
8. FILEBASE
9. CalcStar
10. Color Graphics Basic
11. MailMerge
12. SpellStar
13. 10 Games, graphics and utilities

The best free software bundle in the business, and the Fox will run many programs written for the IBM-PC like dBase II and Multiplan, and programs written for Sanyo's new MBC-550 series.

### Reliability

Because the Silver Fox is born on a totally automated production line in Japan it is inherently more reliable than

systems built by hand. The Fox is burned and tested for 14 days in Japan, and further tested after final assembly here in the good old U.S.ofA.

### One Year Warranty

The Silver Fox is built better so we can back it with a limited, one-year warranty, four times longer than IBM. We're Scottsdale Systems and since 1980 we've shipped over \$10,000,000 of microcomputer equipment directly to microcomputer users.

Because we deal directly with users, we think we have a better idea of what you want. So the Silver Fox includes graphics with twice IBM's resolution, a printer port, a keyboard with a big return key, and a 12", high-resolution monitor as standard equipment.

Of course, you could spend \$4729 at Computerland for an IBM-PC that will perform almost as well as a Silver Fox. But why bother when you can call

**1-800-FOR-A-FOX**

and get your

**\$1398**

to perform like \$4729?

For additional information call 1-800-367-2369, or in AZ, AK, or HI call (602) 941-5856. Or write SilverFox Computers, 617 N. Scottsdale Road #B, Scottsdale, AZ 85257.

IBM-PC price is based on a phone quote from the Mesa, AZ Computerland on July 30, 1984. Price included 256k RAM, dual 360K drives (800K's weren't available), software, and a graphics monitor.

Trademarks: Silver Fox and Hagen-DOS, Scottsdale Systems Ltd. IBM-PC, International Business Machines Corporation, Wordstar, Calcstar, Mailmerge, Spellstar, and Infostar, Micropro International, MS-DOS, Multiplan, Microsoft Corporation, Filebase, EWDP Software, Inc. dBASE II, Ashton-Tate.

Ordering: Telemarketing only. Silver Fox price is for cash, F.O.B. Scottsdale, price subject to change, product subject to limited supply. Visa, Mastercard add 3%, AZ residents add 6%. Returned merchandise subject to a 20% restocking fee. Personal/company checks take up to 3 weeks to clear. No C.O.D.'s or A.P.O.'s.

perimental implementation.

The remaining text contains three proposals for future implementations. One sketches an implementation on the Intel 432. Another discusses general ways of speeding up the system by reducing the time necessary to find the method that implements a message. And the last is about adapting an old, but not widely used, reference-counting technique to replace the current one.

### SUMMARY

Every student of computer science should read *Smalltalk-80: The Language and Its Implementation*. Whether or not Smalltalk becomes a successful and widely used language, the ideas it embodies will be essential parts of future programming systems. Anyone else planning to design or work on interactive computing environments would also benefit from reading this volume.

The two other books require more specialized interests. *The Interactive Programming Environment* is plainly a manual for Smalltalk users. While it is definitely readable without an accompanying Smalltalk system, you'll need to want to know the details of working with the Smalltalk-80 system in order to read it through. The third volume, *Bits of History, Words of Advice*, contains papers that are essential to implementers of Smalltalk, are potentially useful to implementers of complex programming systems, and might be interesting to advanced computer science students.

As a result of these three books, Smalltalk, if and when it becomes widely available, will be one of the best-documented languages around. We can only hope that when other programming languages are introduced to the computing community, they are complemented by texts of similar scope, clarity, and style. ■

[Editor's Note: A review of the last book in this Smalltalk series is forthcoming.]

.....  
Richard Fritzon (5814 Russett Rd. #4, Madison, WI 53711) is a consultant and proprietor of Computing Insights, a software company based in Madison, Wisconsin.

# Trivia Quiz #1

## Fill in the Blank.

It takes \_\_\_\_\_ programmers to change a database.  
 Cerberus was a mythical \_\_\_\_\_ with three \_\_\_\_\_ and guarded the gate of \_\_\_\_\_.

## Multiple Choice.

On Howdy Doody Time the kids sat  
 A. On the Hot Seat.  
 B. In the Peanut Gallery.  
 C. Jammed in the office IN basket.

## Fill-in & Calculate.

### SHIPPING INVOICE

VESSEL Noah's Ark ACCOUNT # 00202-21 WEIGHT RATE 8.665 VOLUME RATE 3.750

QTY	DESCRIPTION	UNIT	WEIGHT	VOLUME	RATE	AMOUNT
2	Hippos		978 kilo	200 cubits	8.655	8464.59
2	Caged Doves		6.5 kilo	350 cubits	3.750	1312.50
2	Giraffes		760 kilo	2987 cubits	-----	-----

### If you can fill out a form, you can automate your business.

New VersaForm XL is designed for real people working in real offices. Unlike other databases, you don't have to learn programming to use it.

### Speed and simplify office paperwork.

Write invoices. Do payroll. Control inventory. Track receivables. Post disbursements. Process insurance claims. Maintain mailing lists. Analyze sales. Record patient histories. Prepare bids. Often with single entry simplicity. Without changing your existing forms.

### Fill in the Blank. Multiple Choice. Calculate.

Creating a database is as easy as typing your current forms onto the screen. Filling in the blanks enters your data. VersaForm XL even checks your entries for correctness. Multiple files can be quickly updated. Type in the item and quan-

tity. VersaForm XL fills out the invoice, checks inventory, posts to accounts receivable, and ages the client's account — all at the same time.

VersaForm XL has a versatile calculator. Total across, down, or select from different rates based on your own criteria. VersaForm XL makes the job easy.

### Instant Productivity.

VersaForm XL will format the screen, enter data, manage the databases, generate reports, and print forms. It's a complete business management system in one integrated package.

Our optional templates save you even more time by giving you a pre-designed form. With templates you'll be automated the very first day for: Invoicing, Purchase Order, Mailing List, Expense Journal, Cash Receipts Journal, Check Writer, Job Costing, Legal Office Manager, Medical Billing, and Medical Insurance Claims. Just open the box, insert the diskette, and you're off.

### Free Offer.

Send us just \$1.00 for postage and handling and receive our free VersaForm XL demo disk. You'll also receive a free template coupon. Buy one template program, get the second template free (up to a

\$50 retail value). Proof of purchase required.

VersaForm XL is used with IBM PC, XT and compatibles. Available soon for TI Pro, DEC Rainbow, and Wang PC.

List price \$449.00.

**VersaForm XL**  
 Applied Software Technology 170 Knowles Dr., Los Gatos CA 95030

## \$50 Template—Free!

OK, convince me. I'm enclosing \$1.00 for postage and handling. Please send me your demo disk and my free template coupon. Offer expires December 31, 1984.

Check your computer:  
 IBM PC or XT  
 Eagle PC or Spirit  
 Columbia  
 Compaq  
 Hyperion  
 TI Pro  
 Wang PC  
 DEC Rainbow  
 Other IBM compatible



Applied Software Technology

170 Knowles Drive  
 Los Gatos CA  
 95030  
 (408) 370-2662

Name \_\_\_\_\_  
 Company \_\_\_\_\_  
 Address \_\_\_\_\_  
 City \_\_\_\_\_ State \_\_\_\_\_ Zip \_\_\_\_\_

IBM



OUR AD # B9

THE WORLD'S LARGEST COMPUTER RAIL ORDER FIRM

CONROY

ALL MAIL: Conroy-LaPointe, Inc. 12060 SW Garden Place, Portland, OR 97223  
SHOWROOMS AT: PORTLAND, OR and SEATTLE, WA — BOTH OPEN M-SAT 10-6

National Toll Free (800) 547-1289

## HARDWARE for your APPLE

**APPLE IIc**  
**APPLE MACINTOSH**  
**APPLE IIe, STARTER SYSTEM BY APPLE**  
LIMITED WARRANTY is 100% Parts & Labor for 90 days by us

### DISK DRIVES

	LIST PRICE	OUR PRICE
AMDEK Amdisk 1, 3" Micro-Floppy, 143K	\$ 299	\$ 249
* CENTRAL PT., Filer, Utility & Apple DOS	\$ 20	\$ 15

### CONCORDE

C1214 Dual Drives, 1/2 Height, flat pack (like Apple Duodisk*)	NEW \$ 589	\$ 425
C130 Controller (DOS & ProDOS)	NEW \$ 89	\$ 65

	LIST PRICE	OUR PRICE
* A2, 143K Disk Drive	\$ 345	\$ 219
A2 Controller Card	\$ 110	\$ 79
* A4Q, 160K, Drive	\$ 449	\$ 299
* A7Q, 286K, Drive	\$ 599	\$ 299
A4Q/A7Q Controller	\$ 100	\$ 79

TEAC TEAC, T4Q, Direct Drive, 163K	\$ 349	\$ 239
TEAC, T80, Double Sided, 326K	\$ 449	\$ 329
1/2 HIGH Controller Card by ComX	\$ 110	\$ 49

Rana Elite 1, 163K, 40 Track	\$ 379	\$ 239
Elite 2, 326K, 80 Track	\$ 649	\$ 389
Elite 3, 652K, 160 Track	\$ 849	\$ 499
Elite Controller	\$ 145	\$ 89

### RAM EXPANSION

* ComX, 80 col. +64K RAM, for 1le, 1 Yr. Wty	\$ 199	\$ 99
* RAM Card, 1 Yr. Wty (II+)	\$ 16K	\$ 179
* Microsoft, RAM Card (II+)	\$ 100	\$ 69
* Titan/Saturn RAM Card (II+)	\$ 32K	\$ 249
* RAM Card (II+)	\$ 64K	\$ 425
* RAM Card (II+)	\$ 128K	\$ 599
Software		Call

### VIDEO CARDS

	LIST PRICE	OUR PRICE
* ComX, 80 col. +64K RAM (1le) 1 yr. wty	\$ 199	\$ 99
* Videx, Video Term 80 col. (+ or e)	\$ 279	\$ 189
* UltraTerm (+ or e)	\$ 379	\$ 279
* Soft Video Switch (II+)	\$ 35	\$ 25
Enhancer II (II+)	\$ 149	\$ 99
Function Strip (II+)	\$ 39	\$ 29

We Have Full Videx Line. Call Up to 35% off!

## MISCELLANEOUS

* ALS, The CP/M Card V3.0 (+ or e) SPECIAL	\$ 399	\$ 169
ASTAR, RF Modulator, to use TV	\$ 35	\$ 25
* CCS, Serial Interface 7710 (Set BAUD)	\$ 150	\$ 99
* CPS/Eastside, Wild Card 2 (copier, + or e)	\$ 140	\$ 99
Chalkboard, Power Pad (Requires Kit)	\$ 110	\$ 73
Digital Res., CP/M Gold Card (w/64K)	\$ 495	\$ 359
Expand 64K Gold Card to 192K	\$ 325	\$ 239
* Kensington, System Saver	\$ 30	\$ 65
Key Tronic, KS200 Keyboard (II+)	\$ 298	\$ 219
Koala, Touch Tablet w/Micro Illustrator	\$ 125	\$ 85
Kraft, Joystick (Ap II, II+)	\$ 65	\$ 49
Paddle/Map II (II+)	\$ 50	\$ 39
M&R, Super R fan (+ or e)	\$ 50	\$ 30
* Microsoft, Z80 Softcard (+ or e)	\$ 345	\$ 235
* Z80 Softcard Plus (+ or e)	\$ 695	\$ 465
* Z80 Softcard Premium (Ile)	\$ 395	\$ 275
* Orange Micro, Grappier Plus (+ or e)	\$ 149	\$ 119
16K Buffer Board for Grappier Plus	\$ 175	\$ 119
Buffered Grappier Plus, 16K	\$ 239	\$ 179
Paymar, Lower Case Chip, Rev. 7 (II+)	\$ 50	\$ 39
* PCPI, Applicator, 14 features, 6MHz	\$ 375	\$ 275
RH Electronics, Super Fan II	\$ 75	\$ 59
* Titan/Saturn, Accelerator II	\$ 599	\$ 399
Transend/SSM, AIQII, Serial/Para I/F	\$ 225	\$ 169
TG Products, Game Paddles (II+)	\$ 40	\$ 29
Joystick (II+)	\$ 60	\$ 45
Videx, PSIO I/F Card	\$ 229	\$ 169



for your MAC

Bluechip, Millionaire	\$ 60	\$ 45
Continental, Home Accountant	\$ 100	\$ 75
Human Edge, Sales Edge	\$ 250	\$ 188
Kensington, Modem	\$ 140	\$ 99
Surge Suppressor	\$ 50	\$ 39
Starter Pak	\$ 90	\$ 64
Microsoft, File or Word, each	\$ 195	\$ 145
Multiplan	\$ 195	\$ 145
Chart	\$ 125	\$ 94
BASIC	\$ 150	\$ 113
BASIC Interpreter	\$ 150	\$ 99
Penguin, Graphics Magician	\$ 50	\$ 37
Software Publishing, PFS: File	\$ 125	\$ 94
PFS: Report	\$ 125	\$ 94
PFS: File & Report	\$ 195	\$ 145
T/Maker, Clickart	NEW \$ 89	\$ 59
Videx, Calendar	NEW \$ 89	\$ 59
FunPak	NEW \$ 39	\$ 26

## SOFTWARE for your APPLE

### BUSINESS & TRAINING

* ALS/Silicon Valley, Word Handler	\$ 60	\$ 39
List Handler	\$ 50	\$ 33
* Applied Soft Tech., VersaForm	\$ 389	\$ 259
Arkrionics, Jane (II or Ile)	\$ 295	\$ 195
Arkrionics, Jane (Ile)	\$ 179	\$ 119
Artsci, Jagic Window II	\$ 150	\$ 99
* Ashton-Tate, dBase II (Reg CP/M 80)	\$ 495	\$ 349
Friday (Requires CP/M 80)	\$ 295	\$ 199
BPI Systems, GLAR,AP or INV, each	\$ 395	\$ 249
* Broderbund, Bank S.Writer or Speller, ea	\$ 70	\$ 45
Business Solutions, Jacc 2 (Ile) NEW	\$ 395	\$ 265
Incredible Jack NEW	\$ 129	\$ 89
Continental, GL,AR,AP or PR, each	\$ 250	\$ 165
Home Accountant	\$ 75	\$ 49
CDEX, for Visicalk, Market, Apple, Ite, each	\$ 60	\$ 40
Dow Jones, Market Analyzer	\$ 350	\$ 225
Market Manager	\$ 300	\$ 195
Market Microscope	\$ 349	\$ 289
Fox & Geller, Quikcode or dBase, ea	\$ 295	\$ 195
Friday (Requires CP/M 80)	\$ 99	\$ 65
Guthrie (for dBase II)	\$ 150	\$ 99
Hayden, Per Writer	NEW \$ 185	Call
Harvard, Harvard Project Manager	NEW \$ 250	Call
* Howard Soft, Tax Preparer, 1984	NEW \$ 95	\$ 64
Knoware, Knoware	NEW \$ 150	\$ 99
Living Videotext, ThinkTank	NEW \$ 150	\$ 99
LJK, Letter Perfect w/Mail Merge	\$ 150	\$ 99
Micro Pro, (all require Z80-CP/M Card)		
* WordStar**w/Applicard & CP/M SPECIAL	\$ 495	\$ 295
* WordStar Professional, 4 Pak SPECIAL	\$ 695	\$ 355
* WordStar**w/ Training Manual	\$ 495	\$ 239
* Options Pak, SS/MM/SI SPECIAL	\$ 345	\$ 159
* SpellStar**w/MailMerge** ea SPECIAL	\$ 250	\$ 129
* InfoStar w/Applicard & CP/M SPECIAL	\$ 495	\$ 295
* Microsoft, MultiPlan, Apple DOS or CP/M	\$ 135	\$ 129
* Osborne/ComX, (Disk and Book) Stat. Bus. MATH	\$ 100	\$ 49
Some Common Basic Programs (7/5 ea)	\$ 100	\$ 49
Practical Basic Programs (40 ea)	\$ 100	\$ 49
Peachtree, Requires CP/M & MBasic, 64K		
Series 40 GL & AR & AP, all 3	\$ 395	\$ 239
Perfect, Perfect Writer /Spell 2 pak (CP/M)	\$ 399	\$ 199
* Quark, Word Juggler & Lexcheck (Ile)	\$ 189	\$ 129
Sensible, Sen. Speller or Bookends, ea	\$ 125	\$ 85
Sierra/On-Line, ScreenWriter Pro, 2 Pak	\$ 200	\$ 135
ScreenWriter II	\$ 130	\$ 89
The Dictionary	NEW \$ 100	\$ 69
Gen. Manager II NEW	\$ 230	\$ 155
Homework	\$ 50	\$ 34
Handler Pak (Word, List & Spell)	\$ 130	\$ 85
Software Arts, TK(Solver for Ile or Iic)	\$ 299	\$ 199
Software Publishing, PFS: File	\$ 125	\$ 79
(specify + or e)	PFS: Report \$ 125	\$ 79
PFS: Graph	\$ 125	\$ 79
PFS: Write (Ile)	\$ 125	\$ 79
Stoneware, DB Master Version 4.0	\$ 350	\$ 229
DB Utility I or II	\$ 129	\$ 87
Videx, UltraPlan	\$ 189	\$ 119
Videx/Corp, Full Line In Stock	Call	Call

### UTILITY & SYSTEM

	LIST PRICE	OUR PRICE
Beagle, GPE or Alpha Plot, each	\$ 35	\$ 27
Ap. Mechanic, Disquick or Pronto DOS, ea	\$ 30	\$ 19
Double Take or Utility City, each	\$ 30	\$ 15
Typefaces, Top Desk #1 or DOS Boss, each	\$ 20	\$ 15
Central Point, Filer, DDS 3 & Uni.	\$ 20	\$ 15
* Copy II Plus (Bot copier)	\$ 40	\$ 30
Epson, Graphics Dump	\$ 15	\$ 9
Hayes, Terminal Pro (Smartmodem)	\$ 100	\$ 65
* Insoft, GraFont II by Paul Lutus	\$ 90	\$ 65
Microsoft, A.L.D.S.	\$ 125	\$ 85
Fortran 80	\$ 195	\$ 135

### COMPLETE MICROSOFT LINE IN STOCK

Penguin, Complete Graphics System II	\$ 80	\$ 54
Graphics Magician	\$ 60	\$ 41
Phoenix, Zoom Grafik	\$ 40	\$ 34
Quality, Bag of Tricks	\$ 40	\$ 29
Terrapin, Logo	\$ 99	\$ 65
United SWI, ASCII Express-The Pro	\$ 130	\$ 87
Uniloco, Essential Data Duplicator III	\$ 80	\$ 49

### HOME & EDUCATIONAL

Atari, Centipede, PacMan or Donkey K. ea	\$ 35	\$ 28
Ms. PacMan, Jungle Hunt NEW!	\$ 35	\$ 28
Barrons, Study Program for SAT	\$ 90	\$ 60
Beagle Bros., Beagle Bag	\$ 30	\$ 19
Bluechip, Millionaire	\$ 60	\$ 40
Broderbund, Print Shop NEW	\$ 50	\$ 34
Chopsticks or Lode Runner, each	\$ 35	\$ 23
Arcade Machine	\$ 60	\$ 40
Apple Panic	\$ 30	\$ 20
CBS, (Large Inventory)	35% off list	
* Continental, Home Accountant	\$ 75	\$ 49
Datasoft, Artex or Zaxxon, each	\$ 40	\$ 27
Davidson, Speed Reader II	\$ 70	\$ 47
Word Attack or Math Blaster! ea	\$ 50	\$ 34
Edu-Ware, (Large Inventory)	35% off list	
Harcourt, Computer Prep for SAT	\$ 80	\$ 54
Hayden, Sargon III (Chess)	\$ 50	\$ 34
Infocom, Zork I,II,III, or Starcross, each	\$ 40	\$ 27
* Insoft, 3 Games, Zarg, Spider Raid/Grapple	\$ 82	\$ 25
Knoware, Knoware NEW	\$ 95	\$ 64
Koala, Full line in stock, CALL	35% off list	
Learning Co., (Large Inventory)	35% off list	
Microgram, Typing Tutor II	\$ 25	\$ 17
Microgram, Dollars and Sense or S.A.M.	\$ 100	\$ 69
Orin, Ultima III	\$ 60	\$ 40
Ornigun, Transylvania NEW	\$ 35	\$ 24
Scarborough/Lightning, MasterType	\$ 40	\$ 27
Sierba/On-Line, Ultima II	\$ 60	\$ 40
Siir-Tech, Wizardry	\$ 50	\$ 35
Spinemaker, Full line in stock, CALL	35% off list	
Sub Logic, Flight Simulator II	\$ 50	\$ 37
"Night Mission Pinball"	\$ 40	\$ 22
Terrapin, Logo	\$ 99	\$ 65

## OVERSTOCK SPECIALS

### APPLE HARDWARE

ALS, The CP/M Card (3.0)	\$ 399	\$ 169
TG, Tracbal	\$ 40	\$ 24
Titan/Saturn, 32K RAM Card (II+)	\$ 249	\$ 139

### APPLE SOFTWARE

Ashton-Tate, dBase II (CP/M)	\$ 495	\$ 269
Broderbund, (Large Inventory)	Call	
Datamoet, Snack Attack	\$ 30	\$ 19
Hayden, Per Writer (Ver. 2.2)	\$ 150	\$ 89
Quark, Lexcheck (Ile)	\$ 129	\$ 79

### MISCELLANEOUS

	LIST PRICE	OUR PRICE
Electronic Protection, Lemon	\$ 60	\$ 40
Lime	\$ 90	\$ 60
Peach	\$ 98	\$ 66
Orange	\$ 140	\$ 95
Kensington, PC Saver** Line Cord w/filer	\$ 50	\$ 39
NetworkX, Wiretree, 4 Outlet, w/filer-surge	\$ 70	\$ 32

### CALCULATORS

41CX, Calculator NEW!	\$ 325	\$ 275
41C, Calculator	\$ 195	\$ 149
41CV, Calculator w/2.2K	\$ 275	\$ 219

### PLOTTERS

AMDEK, Amplot II, 6 pen, 10x 14 Bed	\$ 1099	\$ 899
-------------------------------------	---------	--------

### PRINTER SUPPLIES

Tractor Feed Paper, Ribbons, Daisy Wheels. Call

### ★ MEANS A BEST BUY

## DISKETTES

### \* CONROY-LAPOINTE™ DISKETTES NEW!

We guarantee these top quality products with the Conroy-LaPointe name. 3 YEAR LIMITED WARRANTY.

10 ea. SS/DD, 35 Track (Apple, etc.)	\$ 17
100 ea. SS/DD, 35 Track (Apple, etc.)	\$ 149
1000 ea. SS/DD, 35 Track (Apple, etc.)	\$ 1245
10 ea. DS/DD, 40 Track (IBM, H/P)	\$ 29
100 ea. DS/DD, 40 Track (IBM, H/P)	\$ 239
1000 ea. DS/DD, 40 Track (IBM, H/P)	\$ 1995
10 ea. DS/DD, 40 Track (IBM-PC Pre-formatted) NEW	\$ 34
100 ea. DS/DD, 40 Track (IBM-PC Pre-formatted) NEW	\$ 289
1000 ea. DS/DD, 40 Track (IBM-PC Pre-formatted) NEW	\$ 2495

	LIST PRICE	OUR PRICE
AMDEK, 3" Diskettes, Pac-10	\$ 60	\$ 49
CDC, 100 ea SS/DD, 40T (Apple, IBM)	\$ 550	\$ 195
10 ea SS/DD, 40T (Apple, IBM)	\$ 55	\$ 21
100 ea DS/DD, 40T (IBM, H/P)	\$ 750	\$ 295
10 ea DS/DD, 40T (IBM, H/P)	\$ 75	\$ 32
10 ea SS/DD (Apple, etc.)	\$ 40	\$ 27
10 ea DS/DD 48T (IBM, H/P, etc.)	\$ 69	\$ 35
MAXELL, 10 each, MD1, SS/DD	\$ 55	\$ 24
10 each, MD2, DS/DD	\$ 75	\$ 37
VERBATIM, 10 each, MD15-011, SS/DD	\$ 49	\$ 27
10 each, MD34, DS/DD	\$ 84	\$ 32

### GENERIC™ DISKETTES

AS LOW AS \$1

W/Jackets, no labels, top quality.

100 ea. SS/SD, 35 Track (Apple, Atari)	\$ 415	\$ 130
1000 ea. SS/SD, 35 Track (Apple, Atari)	\$ 4150	\$ 995
100 ea. DS/DD, 48TPI (IBM, H/P)	\$ 626	\$ 170
1000 ea. DS/DD, 48TPI (IBM, H/P)	\$ 6260	\$ 1400

NO HASSLE MONEY BACK GUARANTEE ON GENERIC S

## MODEMS AND ACCESSORIES

	LIST PRICE	OUR PRICE
ANCHOR, Signalman Mark XII	\$ 399	\$ 269
HAYES, IBM-PC Smartmodem 1200B	\$ 599	\$ 419
IBM-PC Smartmodem II Software	\$ 149	\$ 109
Microdemem 100 w/Smartcom	\$ 329	\$ 239
Microdemem 110 (S-100 bus)	\$ 399	\$ 275
Stack Chronograph (RS-232)	\$ 249	\$ 189
Stack Smartmodem 300/RS-232	\$ 289	\$ 225
Smartmodem 1200 (RS-232)	\$ 699	\$ 535
IBM-PC to Modern Cable	\$ 39	\$ 29



# -LA POINTE

SM

Formerly **Computer Exchange**



© 1984 by Conroy-LaPointe, Inc. All Rights Reserved

LOW PRICES TO PROFESSIONALS WHO KNOW WHAT THEY WANT AND KNOW HOW TO USE IT!

### 256K IBM-PC or XT

360K Disk Drives by CDC  
90 Day Limited Warranty By Us  
Call for Details

© 1983 Conroy-LaPointe, Inc.

## SUPPLY CENTER for IBM-PC or XT

<b>AMDEK</b>	MAI 4-in-1 Multiple Board/Color Graphics/Mono, Para Port.	\$ 499	\$ 399
<b>AST</b>	ComboPlus Products	Call	Call
	MegaPlus Products	Call	Call
	SxPakPlus, 64K S/P/CC+S/W	\$ 395	\$ 265
	SxPakPlus, 256K S/P/CC+S/W	\$ 695	\$ 495
	SxPakPlus, 384K S/P/CC+S/W	\$ 895	\$ 595
	Game Port for SxPak	\$ 50	\$ 39
	1/0 Plus II, S/P/CC	\$ 215	\$ 150
	1/0 Plus II, S/P/CC/G	\$ 265	\$ 185
	1/0 Plus II, ZS/P/CC/G	\$ 315	\$ 215
	MonographPlus™ (for Lotus)	\$ 495	\$ 375
	PCNet, Starter Kit, PC002	\$ 495	\$ 1095
	PCNet, Circuit Board, PC001	\$ 495	\$ 495
<b>*CCS</b>	SuperVision, 132 col. mono board	\$ 799	\$ 399
	Graphics Adapter for Supervision	\$ 250	\$ 99
<b>Chalkboard,</b>	Power Pad (Requires Kit)	\$ 100	\$ 73
	Chalkboard Starter Kit	\$ 50	\$ 34
<b>*ComX</b>	EconoRAM™ 256K RAM Card w/Fasttrak™ RAM disk emulator and spooler software	\$ 495	\$ 325
<b>CURTIS</b>	UNI-I, Monitor tilt & swivel base	\$ 50	\$ 39
	3 to 9 foot keyboard cable	\$ 40	\$ 30
	Vertical CPU "System Stand"	\$ 25	\$ 19
	Monochrome Ext. Cable Pair	\$ 50	\$ 35
	8087 Chip	NEW \$ 175	\$ 159
	8087 Math Pak	NEW \$ 295	\$ 245
	8087 Software Pak	NEW \$ 180	\$ 129
	8087 Micro Pak	NEW \$ 245	\$ 195
	Color Card w/Para	\$ 245	\$ 195
<b>HERCULES</b>	Graphics Card, Mono	\$ 499	\$ 349
	KB5150, Std. keyboard	\$ 209	\$ 159
	KB5151, Std. keyboard	\$ 255	\$ 199
	KB5151 jr., keyboard	NEW \$ 255	\$ 199
<b>Key Tronic,</b>	Koala Pad™ w/PC Design	\$ 150	\$ 89
	Programmer's Guide	\$ 15	\$ 14
<b>Koala</b>	Multifunction (6) Card, MFC	\$ 89	\$ 79
<b>MAYNARD</b>	Memory Card no RAM	\$ 199	\$ 169
<b>SANDSTAR</b>	Hard Card 256K	\$ 495	\$ 395
<b>SERIES</b>	Memory Card 1/0 Module (HDM)	\$ 499	\$ 399
	Hard Disk Cable	\$ 30	\$ 27
	Para Port Module (PPM)	\$ 95	\$ 79
	Serial Port Module (SPM)	\$ 95	\$ 79
	Clock Card Module (CCM)	\$ 55	\$ 48
	Game Adapter Module (GPM)	\$ 49	\$ 43
	Memory Module "OK" (MMO)	\$ 122	\$ 99
	Memory Module 256K (MM256)	\$ 422	\$ 357

<b>*Maynard,</b>	XT10 meg. Hard Disk & I/F WS1	\$ 1395	\$ 1150
<b>MICROSOFT</b>	SystemCard 256K	\$ 625	\$ 450
	Mouse	\$ 195	\$ 145
<b>MOUSE SYSTEMS,</b>	PC Mouse w/software	\$ 295	\$ 195
	PC jr. Booster with Mouse	NEW \$ 495	\$ 329
<b>MAGNUM</b>	PC MasterCard™ 1.536K Multifunction S/P/G/CC with SoftRAM™ software which provides printer spooler, RAM disk & many other functions	\$ 4995	\$ 3950
<b>PLANTRONICS</b>	Color Board & Colorpage, 16 color, w/Para Color Board & Draftsmen, 16 color, w/Para	\$ 559	\$ 395
		\$ 559	\$ 395
	PARADISE, MultiDisplay Card	NEW \$ 595	\$ 435
<b>QUADRAM</b>			
	NEWEST VERSION	\$ 680	\$ 480
	Quadboard, no RAM, expand to 384K	\$ 295	\$ 215
	Quadboard 64K, expand to 384K S/P/CC	\$ 395	\$ 265
	Quadboard 256K, expand to 384K S/P/CC	\$ 675	\$ 525
	Quadboard, 384K S/P/CC	\$ 795	\$ 625
	Quadboard II, no RAM, expand to 256K	\$ 295	\$ 215
	Quadboard II, 64K, expand to 256K/25/CC	\$ 395	\$ 265
	Quadboard II, 256K, 25/CC	\$ 595	\$ 395
	Quad 512 + 64K plus serial port	\$ 325	\$ 265
	Quad 512 + 256K plus serial port	\$ 550	\$ 420
	Quad 512 + 512K plus serial port	\$ 895	\$ 625
	Quadcolor I, board, 16 colors	\$ 295	\$ 215
	* Upgrade Quadcolor I to II kit	\$ 275	\$ 199
	Quadvide, board, Mono S/P/CC	Call	Call
	* Quadchrome, 12" RGB Color Monitor	\$ 795	\$ 495
	Quadchrome II, 14" RGB Color	NEW \$ 650	\$ 450
	Amberchrome, 12" Amber	NEW \$ 250	\$ 165
	Quad 3278	NEW \$ 1195	Call
	Quadnet IV	NEW	Call
	Quadnet IX	NEW	Call
<b>Tecmar</b>	Graphics Master	\$ 695	\$ 545
	1st MATE, 64K, S/P/CC	\$ 389	\$ 275
	1st MATE, 256K, S/P/CC	\$ 589	\$ 399
	Captain, 64K S/P/CC	\$ 424	\$ 324
	Captain, 384K S/P/CC	\$ 795	\$ 595
	Wave, 256K (short board)	\$ 499	\$ 369
	Bosun, S/P/CC (short brd.)	\$ 195	\$ 145
<b>Titan</b>	Accelerator PC (8086 + 128K)	\$ 995	\$ 750
<b>TG PRODUCTS,</b>	Joystick	\$ 45	\$ 30

© 1983 Conroy-LaPointe, Inc.

Prices and availability subject to change. Call.

★ Chip Kit \$49 Call for Larger Quantity Prices  
9 Each, 64K, 200 ns, MEMORY CHIP KIT  
90 Day Warranty by us

\$325  
\$295 Two or more.

ComX EconoRAM™ 256K BOARD  
With Fasttrak™ RAM Disk Emulator and Spooler Software  
Fully Compatible, 1 Year Limited Warranty by ComX  
Works on DOS 1.1, 2.0 or 2.1

★ MEANS A BEST BUY

for the IBM-PC or XT

### DRIVES AND ACCESSORIES

**ALLOY** LIST PRICE OUR PRICE  
PC-Backup, 1GB, Cartridge Tape System \$2195 \$1950  
PC-STORE, 41MB/7MB Disk & Backup System \$5995 \$5495

**AMDEK**  
Amdisk V, 1/2 height, internal, 320/360K \$ 329 \$ 249  
Amdisk III, 3" Dual Floppies, 500K \$ 499 \$ 439

**CONTROL DATA**

320K/360K DS/DD DISK DRIVES  
With Detailed Installation Instructions  
30 Day Limited Warranty by Factory Authorized Distributor  
Same as now installed by IBM

**\$185 FULL HEIGHT**  
**\$165 HALF HEIGHT**  
Call for Larger Quantity Prices

**CDC**, 1/2 H Dual Drive installation Kit \$ 30 \$ 16  
**MAYNARD**, Floppy Controller (w/Para.) \$ 300 \$ 239

**QUADRAM** Quaddisk Internal Hard Disks w/Controller  
5MB Removable NEW \$2295 \$1695  
5MB Fixed NEW \$1995 \$1495  
12MB Fixed NEW \$2250 \$1650  
27MB Fixed NEW \$2895 \$2195  
72MB Fixed NEW \$6500 \$4795

**10 MEG (XT) DISK KITS**  
Convert your PC to 10 meg and be to XT compatible with one of the following INTERNAL HARD DISK SYSTEMS. Kits are quality engineered to work with DOS 2.0/2.1. Completely XT compatible. All you need is your DOS manual. Easy to install. Includes 10 Megabyte Hard Disk, Controller Card and Instructions.

**ComX** Internal 10 meg Hard Disk Kit NEW \$ 869  
**Kammerman Labs**  
Megaflight 10Q, 10 mbyte Hard Disk Kit NEW \$ 869

**MAYNARD**  
10 meg Hard Disk Kit, WS1 Sandstar Controller will accept 3 Sandstar modules \$1395 \$1150

## SOFTWARE for IBM-PC or XT

<b>BUSINESS &amp; TRAINING</b>	<b>APPLIED SOFT. TECH.,</b> Versafont	\$ 389	\$ 265
	ARTRONICS, Jane	NEW \$ 295	\$ 195
	ASHTON-TATE, Friday	\$ 295	\$ 199
	Framework (avail. July/Aug)	NEW \$ 695	\$ 399
	dBase III (avail. July/Aug)	NEW \$ 695	\$ 399
	dBase II, (req. PC-DOS & 128K)	\$ 495	\$ 289
	dBase II to III upgrade	\$ 200	\$ 119
	dBase II User's Guide (Book)	\$ 30	\$ 20
	Everyman's DB Primer (Book)	\$ 15	\$ 12
	ATI, Training Programs—Wide line in stock	\$ 75	\$ 50
	* BRODERBUND, Bank Street Writer	\$ 80	\$ 56
	BPI, Gen'l Acctg. AR, AP or PR, each	\$ 595	\$ 395
	* BUSINESS SOLUTIONS, Jack 2 NEW	\$ 495	\$ 335
	CDEX, Training for... (Large inventory)	\$ 70	\$ 47
	CHANG LABS, Micro Plan	\$ 495	\$ 335
	* CONTINENTAL, Tax Advantage	\$ 70	\$ 45
	Home Accountant Plus	\$ 125	\$ 79
	FCM (Filing, Cataloging, Mailing)	\$ 125	\$ 79
	Property Management	\$ 495	\$ 329
	DOW JONES, Market Analyzer	\$ 350	\$ 225
	Market Manager	\$ 300	\$ 195
	Market Microscope	\$ 349	\$ 289
<b>FOX &amp; GELLER</b>	Quickcode, dGraph, Grafex or Oz, each (dUII MS-DOS or CP/M86, each)	\$ 295	\$ 195
		\$ 99	\$ 65
	HARWARD, Project Manager	NEW \$ 395	\$ 265
	HAYDEN, IBM Jr. Pe Writer	\$ 200	\$ 135
	Pe Writer or Sargon III, each	\$ 50	\$ 34
<b>HOWARD SOFT.</b>	Tax Preparer, 1984—for 1983 year	\$ 295	\$ 220
	HUMAN EDGE, Management or Sales, ex IUS, EasyWriter II System	\$ 250	\$ 169
	EasySpeller II	\$ 130	\$ 88
	Business System: GL+AR+AP	\$ 1495	\$ 995
	GLARAP, OE or INV, each	\$ 595	\$ 395
	* INSOFT, Data Design (easy to use DBMS): GrafORTH (animated) 3D graphics	\$ 250	\$ 95
		\$ 125	\$ 95
	KNOWARE, Knoware (reg. graphics)	NEW \$ 95	\$ 64
	LIFEBEAT, Lattice C	\$ 500	\$ 295
	LIFETREE, Volkwriter 1.2	\$ 195	\$ 130
	Volkwriter Deluxe	\$ 495	\$ 309
	* LOTUS, 1-2-3	NEW \$ 695	\$ 465
	Symphony, (avail. July/Aug)	NEW \$ 200	\$ 135
	1-2-3 to Symphony, (avail. July/Aug)	NEW \$ 200	\$ 135
	QUE, Using 1-2-3 (Book)	\$ 15	\$ 12
	LIVING WIDEXTEXT, Think tank	NEW \$ 195	\$ 129
	MICROPRO, WordStar*	SPECIAL \$ 495	\$ 239
	* WordStar Professional, 4 Pak	SPECIAL \$ 695	\$ 355
	CorrectStar™ (requires 120K)	NEW \$ 195	\$ 125
	MailMerge	\$ 250	\$ 129
	StarIndex™	\$ 195	\$ 109
	ProOptions, SS/MM/SS	SPECIAL \$ 345	\$ 155
	intoStar™	SPECIAL \$ 495	\$ 299

<b>BUSINESS &amp; TRAINING</b>	* MICROIRM, R base, Series 4000	\$ 495	\$ 299
	Extended Report Writer	NEW \$ 150	\$ 99
	Rbase Out	NEW \$ 195	\$ 129
	MICROSOFT, Chart	NEW \$ 125	\$ 85
	Project	NEW \$ 250	\$ 169
	Multiplex	\$ 195	\$ 129
	Word	\$ 375	\$ 259
	Word with Mouse	\$ 475	\$ 325
	MONOGRAM, Dollars & Sense	\$ 165	\$ 110
	MULTIMATE, Multimate	\$ 495	\$ 295
	NW ANALYTICAL, Statpak	NEW \$ 495	\$ 345
	OPEN SYS, GLARAP, PR, INV or PQ, each	\$ 695	\$ 429
	* OSBORNE/COMX, (Book & Business, Statistics & Math Programs on DS/DD Disks)	\$ 100	\$ 69
	Some Common Basic Programs (70 ea.)	\$ 100	\$ 69
	Practical Basic Programs (40 ea.)	\$ 100	\$ 69
	PEACHTREE, Peach Pak (GLARAP)	\$ 395	\$ 239
	Word	\$ 395	\$ 239
	Perfect, Perfect Writer	\$ 399	\$ 249
	Writer & Speller, 2 Pak	\$ 399	\$ 249
	Perfect Filter™ or Perfect Calc, each	\$ 249	\$ 149
	Perfect Writer, Speller, Filter, Calc, (4)	\$ 699	\$ 499
	SOFTWARE PUBLISHING, PFS:File	\$ 140	\$ 89
	PFS:Report	\$ 125	\$ 79
	PFS:Write	\$ 140	\$ 89
	PFS:Graph	\$ 140	\$ 89
	SORCIM, SuperCalc 2	\$ 295	\$ 195
	SuperCalc 3	\$ 395	\$ 265
	SSI/ SATELLITE, WordPerfect	\$ 495	\$ 275
	Practical WordPerfect	\$ 195	\$ 149
	STONEWALL, Advanced DB Master	\$ 595	\$ 395
	SUMMA, Trader's Forecast	NEW \$ 250	\$ 189
	Trader's Data Manager	NEW \$ 200	\$ 150
	Trader's Accountant	NEW \$ 350	\$ 259
	Complete System	NEW \$ 700	\$ 525
	T/MAKER, T/Maker III	\$ 275	\$ 169
	THOUGHTWERK, Mgt. Series	\$ 349	\$ 219
	VISICORP, VisiCalc 4	\$ 250	\$ 169
	Full Line in Stock	Call	Call
<b>UTILITY &amp; SYSTEM</b>			
<b>1983 CL SOFTWARE AWARD:</b>	* Copy II PC by Central Point Software is still one of the best software buys available. It will copy more copy protected software and faster than any other backup system. Unlike other copiers it makes an exact duplicate of your original and it does 100% verification of copy. Documentation is excellent.		
	* CENTRAL POINT, Copy II PC, Backup	\$ 40	\$ 30
	* COMIX, Fasttrak™, RAM, Disk emulator, and printer spooler program. Works on any PC/DOS version or RAMCard. Menu Driven	\$ 100	\$ 59

<b>UTILITY &amp; SYSTEM</b>	<b>DIGITAL RESEARCH,</b>	LIST PRICE	OUR PRICE
	Concurrent CP/M-86™ w/ windows	\$ 350	\$ 225
	CP/M-86™ (PC/X1)	\$ 60	\$ 40
	CBASIC 86™ (CP/M/86)	\$ 200	\$ 135
	CBASIC Compiler (CP/M-86 or PC-DOS, ea.)	\$ 600	\$ 365
	Pascal/MT+ (CP/M-86)	\$ 400	\$ 269
	Pascal/MT+ (PC-DOS)	\$ 600	\$ 399
	PL/I (PC-DOS or CP/M-86)	\$ 750	\$ 499
	Speed Prog. Pkg. (CP/M-86)	\$ 200	\$ 135
	DR LOGO-86 (CP/M/86)	\$ 100	\$ 69
	FUNK SOFTWARE, Sideways	NEW \$ 60	\$ 40
	HAYES, Smartcom II (Data Com.)	\$ 149	\$ 109
	* INSOFT, GrafORTH (animated 3D graph)	\$ 125	\$ 95
	MICROSOFT, Crosstalk XVI (Data Com.)	\$ 195	\$ 129
	MICROSTUF, muMtu/Simp	\$ 300	\$ 199
	Business BASIC Comp.	\$ 600	\$ 399
	Pascal Compiler	\$ 300	\$ 199
	C Compiler	\$ 500	\$ 329
	BASIC Compiler	\$ 395	\$ 269
	FORTRAN Compiler	\$ 350	\$ 250
	COBOL Compiler	\$ 700	\$ 469
	NORTON, Utilities 2.0, 14 programs	\$ 80	\$ 54
	ROSESOFT, Prokey	\$ 130	\$ 87
<b>HOME &amp; EDUCATIONAL</b>			
	ATARI, Centipede, PacMan or Donkey, each	\$ 35	\$ 28
	EPYV/Auto, Sim, Temple of Apshai	\$ 40	\$ 29
	ARMONK, Executive Suite	\$ 40	\$ 27
	BLUE CHIP, Millionaire or Tycoon, each	\$ 60	\$ 39
	BPI SYSTEMS, Personal Accounting	\$ 99	\$ 66
	* BRODERBUND, Apple Panic (Color)	\$ 30	\$ 19
	Lode Runner or Serpentine, each	\$ 35	\$ 23
	CBS, Chas. Goren Learn Bridge	NEW \$ 80	\$ 54
	COMPREHENS, PC Tutor (1.1 or 2.0, ea.)	\$ 60	\$ 40
	CONTINENTAL, Home Accountant Plus	\$ 150	\$ 89
	DAVIDSON, The Speed Reader II	\$ 75	\$ 49
	Word Attack! or Mathblast, each	\$ 50	\$ 34
	HAYDEN, Sargon III (Chess)	\$ 50	\$ 34
	INFOCOM, Deadline or Suspended, each	\$ 50	\$ 33
	Zork I or Zork II or Zork III, each	\$ 40	\$ 27
	* INSOFT, Mystix, Wordtris or Judoji, each	\$ 50	\$ 33
	MICROSOFT, Flight Simulator II	\$ 50	\$ 33
	MONOGRAM, Dollars & Sense	\$ 165	\$ 110
	ORIGIN, Ultima III	\$ 60	\$ 40
	PBL CORP., Personal Investor	\$ 145	\$ 99
	SCARBOROUGH, MasterType	\$ 50	\$ 34
	SPINNAKER, Snooper Troops (1 or 2)	\$ 45	\$ 35
	Story Machine or Face Maker	\$ 35	\$ 24
	STRATEGIC, The Warp Factor	\$ 40	\$ 30
	SUBLOGIC, Night Mission Pinball	\$ 40	\$ 27

**FREE GIFT** Mail To: 12060 SW Garden Place, Portland, OR 97223

Use of our order forms qualifies you for a free gift with your order. Get on our mailing list now for order forms, and our new newsletter and sales specials announcement. Our customers are already on our list.

**OUR AD # B9** COUPON

NAME \_\_\_\_\_  
ADDRESS \_\_\_\_\_  
CITY \_\_\_\_\_ STATE \_\_\_\_\_ ZIP \_\_\_\_\_

**OUR AD # B9**</



**GREAT DISPLAY.  
GREAT KEYBOARD.  
GREAT AESTHETICS.  
GREAT EMULATIONS.  
GREAT PRICE.**

**VISUAL 60...**  
**A truly great terminal**



**Great.** In one word, that's the new VISUAL 60. The display is crisp and clear for easy viewing. The low profile keyboard is built for comfort and speed, as well as high reliability. And the streamlined enclosure saves precious space—beautifully. Moreover, you get the emulation capabilities you'd expect from VISUAL—code-for-code compatibility with the Esprit I<sup>®</sup>, ADDS Viewpoint<sup>®</sup>, Lear Siegler ADM-3A<sup>™</sup> and DEC VT52<sup>®</sup>.

All this, plus renowned VISUAL quality throughout, at a price below any other terminal in its class. Contact VISUAL for full details or a demonstration. See for yourself just how great the VISUAL 60 really is.

**VISUAL** See for yourself<sup>®</sup>

Visual Technology Incorporated  
540 Main Street, Tewksbury, MA 01876  
Telephone (617) 851-5000. Telex 951-539

REGIONAL OFFICES:  
Northwest: (415) 490-1482  
Southwest: (213) 534-0200  
North Central: (513) 435-7044  
South Central: (214) 255-8538  
Northeast: (201) 528-8633  
Southeast: (301) 924-5330

# E·V·E·N·T Q·U·E·U·E

## October 1984

● **MEDICAL COMPUTER SEMINAR**—Medical Computer Weekends, various sites throughout the U.S. For cardiologists, internists, and primary-care physicians. Focuses on the role of the multipurpose medical office computer. Seminars qualify for 13 hours CME Category I credit. Contact International Medical Education Corp., 64 Inverness Dr. E, Englewood, CO 80112, (800) 525-8651; in Colorado, (303) 790-8445. *October*

● **SEMINARS FOR PROFESSIONALS**—Professional Development Seminars, various sites throughout the U.S. Topic areas: data communications, database management, EDP operations, microcomputers, software engineering, CAD/CAM, IBM mainframes, office automation, and others. Fees range from \$195 to \$1095. Contact Institute for Advanced Technology, 6003 Executive Blvd., Rockville, MD 20852, (800) 638-6590; in Maryland, (301) 468-8576. *October*

● **COURSES FROM ICS** Courses from Integrated Computer Systems, various sites throughout the U.S. Among the courses offered are "Computer Network Design and Protocols" and "Data Communications." Fees are generally \$895. For more information, contact Integrated Computer Systems, 6305 Arizona Place, POB 45405, Los Angeles, CA 90045, (800) 421-8166; in California, (800) 352-8251 or (213) 417-8888. *October–November*

● **SHOWS IN GERMANY** *Chip* Microcomputer Weeks,

various sites throughout West Germany. Microcomputer products, trends, and applications will be demonstrated. Sponsored by *Chip*, a leading German computer magazine. Contact Network GmbH, An der Friedenseiche 10, D-3050 Wunstorf 2, Bundesrepublik Deutschland (West Germany); tel: (0 50 33) 10 56; Telex: 92 45 45. In England, Network Events Ltd., Printers Mews, Market Hill, Buckingham MK18 1JX, England; tel: (02 80) 81 52 26; Telex: 83111. *October–November*

● **BRUSH-UPS FOR ENGINEERS**—Continuing Engineering Education Courses, George Washington University, Washington, DC. Among the course titles are "Microcomputer Application Workshop: Evaluating Microcomputer Software Packages" and "Workshop in Data Communications for Microcomputers." Tuition ranges from \$625 to \$875. Contact George Harrison, Continuing Engineering Education, George Washington University, Washington, DC 20052, (800) 424-9773; in the District of Columbia, (202) 676-6106. *October–December*

● **COMPUTER SHOWCASES** Computer Showcase Expo, various sites throughout the U.S. These traveling shows feature regional and national vendors of computer systems, peripherals, software, and accessories. Admission

is \$7.50 or \$5, depending on location. Discount tickets are available from participating exhibitors. For a schedule, contact The Interface Group Inc., 300 First Ave., Needham, MA 02194, (800) 325-3330; in Massachusetts, (617) 449-6600. *October–December*

● **INDUSTRIAL ENGINEER PROGRAMS**—1984 Institute of Industrial Engineers' Continuing Education Programs, various sites throughout the U.S. Among the programs on the agenda are "Robotics—Equipment, Applications, and Methodology" and "Effective Utilization of Microcomputers." A complete listing is available from the Institute of Industrial Engineers, 25 Technology Park/Atlanta, Norcross, GA 30092, (404) 449-0460. *October–December*

● **INFORMATION-PROCESSING SEMINARS** New York University Seminars in Information Processing, various sites throughout the U.S. "Fundamentals of Data Processing for Administrative Assistants and Secretaries" and "Managing Systems Projects" are two of the seminars offered. For a calendar listing and more information, contact School of Continuing Education, Seminar Center, New York University, 575 Madison Ave., New York, NY 10022, (212) 748-5094. *October–December*

.....  
IF YOU WANT your organization's public activities listed in *BYTE's* Event Queue, we need to know about them at least four months in advance. Send information about computer conferences, seminars, workshops, and courses to *BYTE*, Event Queue, POB 372, Hancock, NH 03449.

● **INTEL WORKSHOPS** Microcomputer Workshops, various sites throughout the U.S. and Canada. Intel, the semiconductor memory manufacturer, is offering more than 20 workshops on microprocessor applications. A brochure is available. Contact Customer Training, Intel Corp., 27 Industrial Ave., Chelmsford, MA 01824-3688, (617) 256-1374. *October–December*

● **LECTURE SERIES** Montclair State College Colloquium Lecture Series and the Nobel Laureate Lecture Series, Richardson Hall, Room W-117, Upper Montclair, NJ. Topics to be addressed include "The Birth and Prospects of Expert Systems" and "Industrial Applications of Input/Output Analysis." Admission is free. Contact Professor Gideon Nettler, Department of Mathematics and Computer Science, Montclair State College, Upper Montclair, NJ 07043, (201) 893-4294. *October–December*

● **PROFESSIONAL EDUCATION**—Seminars from the Institute for Professional Education, various sites in the U.S. Programs in statistics, management, simulation and modeling, personal computers, and computer science. Contact the Institute for Professional Education, POB 756, Arlington, VA 22216, (703) 527-8700. *October–December*

● **SHOWS IN FLORIDA** The Great Southern Computer Show, various sites throughout Florida. Computer hardware, software,

(continued)



# THE HARD ONE IS RIGHT TO FIND!

We've Got it at  
**ALPHA OMEGA**  
COMPUTER PRODUCTS

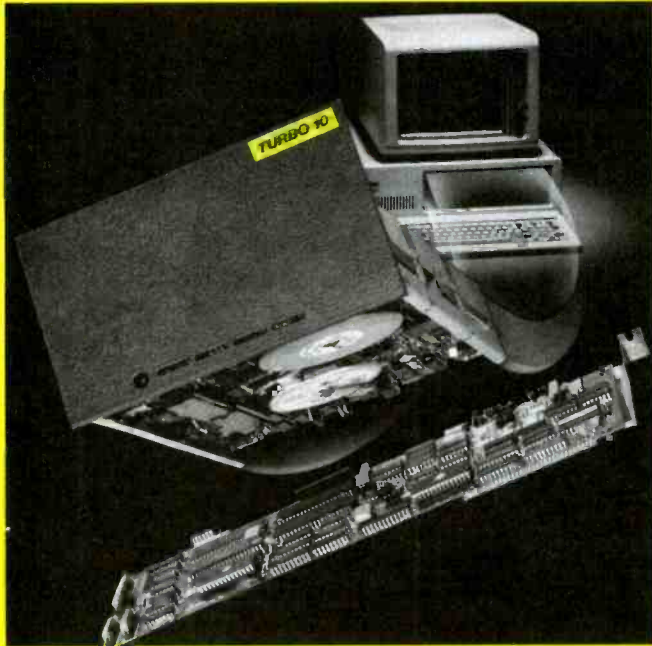

## **TURBO 10** HARD DISK PACKAGE \$949.00

- TURBO 10 is designed for the IBM PC®, to achieve IBM PC/XT® capacity, and full PC/XT compatibility.
- Access seek time 300% faster than IBM PC/XT®.
- Ideal with the use of serious application programs, such as Aston Tate™ dBase III and Framework, Lotus™ 1, 2, 3 and Symphony™, Micropro Wordstar, etc. . .
- 13 month defective exchange policy, covering both parts and labor.
- TURBO 10 comes complete with all necessary interfacing and cables, and installation and user documentation.
- Speed, Convenience, Affordability, and Reliability ...at Alpha Omega Computer Products we put it all together for you.

Contact your local dealer,  
and ask for the TURBO 10.  
or call:

(213)  
(818) **345-4422**

18612 Ventura Blvd., Tarzana, CA 91356

All products are pre-tested before delivery, and are guaranteed for 13 months. Within this period, defective returns must accompany an RMA number. All other returns subject to a 10% restocking fee. Please include \$6 for shipping and handling. There will be an additional \$4 surcharge on COD orders. Calif. residents include 6.5% sales tax.

## EVENT QUEUE

peripherals, accessories, and word- and data-processing equipment will be featured. Schedules are available from Great Southern Computer Shows, POB 655, Jacksonville, FL 32201, (904) 356-1044.

October-December

### ● MIDWEST ELECTRONICS

The Mid-America Electronics Convention, MAECON/84, St. Louis, MO. Exhibits seminars, tutorials, and symposia. Contact Electronic Representatives Association, 20 East Huron St., Chicago, IL 60611, (312) 649-1333.

October 10-11

### ● NETWORK ARCHITECTURES

Introduction to Network Architectures, Atlanta, GA. This course provides an introduction to network architectures and prepares participants to pursue the study of specific network components applicable to their needs. The fee is \$795. Contact Elaine Hadden Nicholas, Department of Continuing Education, Georgia Institute of Technology, Atlanta, GA 30332-0385, (404) 894-2547.

October 10-12

### ● NETWORKS EXPLORED

Localnet '84, Sheraton Harbor Island Hotel, San Diego, CA. Speakers, papers, and exhibitions will look at local network technology and the effects of office automation. Contact Online Conferences Inc., Suite 1190, 2 Penn Plaza, New York, NY 10121, (212) 279-8890.

October 10-12

### ● PROJECT MANAGEMENT SEMINAR

Software for Project Management and Estimating, Washington, DC. Fee: \$425. Contact CIP Information Services Inc., 1105-F Spring St., Silver Spring, MD 20910, (301) 589-7933.

October 11-12

### ● GOLDEN STATE EXPO

Computer Expo and PC Faire, Cal Expo, Sacramento, CA. Contact Computer Expo & PC Show, Suite 395, 2020 Hurley Way, Sacramento, CA 95825, (916) 924-9351.

October 11-14

### ● EDUCATIONAL COMPUTER FAIR

Fourth Annual Educational Computer Fair, Cleveland, OH. Contact Educational Computer Consortium of Ohio, 4777 Farnhurst Rd., Cleveland, OH 44124, (216) 291-5225.

October 12-13

### ● LONE STAR COMPUTING

The Second Annual Heart of Texas Computer Show, Convention Center, San Antonio, TX. Exhibits of computers, games, robots, and other high-tech products. Contact Heart of Texas Computer Show, POB 12094, San Antonio, TX 78212, (512) 681-2248.

October 12-14

### ● COMPUTERS IN LAB

Laboratory Computer Interfacing, McGill University, Montreal, Quebec, Canada. Two short courses, "Computers in the Laboratory" and "Laboratory Computer Interfacing," are offered. Contact Dr. Eric Salin, Department of Chemistry, McGill University, Montreal, Quebec H3A 2K6, Canada, (514) 392-5784.

October 13-14

### ● TENTH VIDEO SHOW

VIDCOM, Cannes, France. The tenth anniversary of this meeting of video-communications professionals. Contact Commissariat Général, 179, Avenue Victor-Hugo, 75116 Paris, France; tel: (33) (1) 505.14.03; Telex: 630.547 MIDORG. October 13-17

### ● FUTURE OF VIDEODISC

The Second International Conference on the Future of Optical Memories, Videodiscs, and Compact Disks to the Year 2000, Loew's Sum-

## EVENT QUEUE

mit Hotel, New York City. Speakers and demonstrations. The fee is \$795. Contact Technology Opportunity Conference, POB 14817, San Francisco, CA 94114-0817, (415) 626-1133. October 15-17

● **HIGH-TECH TUTORIAL**  
Tutorial Short Course from Hellman Associates, Boston, MA. Topic: "Error Correction." The fee is \$895. Contact Hellman Associates Inc., Suite 300, 299 California Ave., Palo Alto, CA 94306, (415) 328-4091. October 15-17

● **UNIX INSIDE AND OUT**  
UNIX Operating System Exposition and Conference, Sheraton Centre Hotel and Marina Exposition Complex, New York City. Seminars, social functions, and 350 exhibition booths. Contact National Expositions Co. Inc., 14 West 40th St., New York, NY 10018, (212) 391-9111. October 16-18

● **WEST COAST EXPO, CONFERENCE**—The West Coast Electronic Office Expo and Conference, EOE '84, Convention Center, San Jose, CA. More than 200 exhibits. Contact Carlidge & Associates Inc., Suite 205, 4030 Moorpark Ave., San Jose, CA 95117, (408) 554-6644. October 16-18

● **OFFICE COMPUTERS**  
The Sixth Annual Calgary Computer and Office Automation Show, Roundup Centre, Calgary, Alberta, Canada. Contact Industrial Trade Shows, 20 Butterick Rd., Toronto, Ontario M8W 3Z8, Canada, (416) 252-7791. October 17-18

● **COMPUTERS, COMMAND, CONTROL**—The Second Annual Symposium and Exhibition of AFCEA, Inn at Executive Park, Kansas City, MO. The theme for this year's symposium is "The

Role of Knowledge-Based Systems in Command and Control." Panel discussions, paper presentations, and exhibits. Contact Armed Forces Communications and Electronics Association, POB 456, Leavenworth, KS 66048, (913) 651-7800. October 17-19

● **ASIS MEETING**  
The Forty-Seventh Annual Meeting of American Society for Information Science, Franklin Plaza, Philadelphia, PA. This year's theme is "1984—Challenges to an Information Society." Contact 1984 ASIS Convention, The Automated Office, 3401 Market St., Philadelphia, PA 19104. October 21-26

● **HUMAN FACTORS**  
The 1984 Annual Meeting of The Human Factors Society, Hyatt Regency Hotel, San Antonio, TX. Panel discussions, workshops, and research reports will focus on the theme "New Frontiers for Science and Technology." Contact Patrick Dowd, USAF School of Aerospace Medicine, USAF-SAM/VN, Brooks AFB, TX 78235, (512) 536-3464. October 21-26

● **ISMM SYMPOSIUM**  
The Twenty-Sixth International Society for Mini and Microcomputers International Symposium, Statler Hotel, New York City. This symposium covers all areas of engineering, signal processing, communication, robotics, networks, education, and graphics. Contact Canadian Secretariat (ISMM), POB 25, Station G, Calgary, Alberta T3A 2G1, Canada, (403) 286-1589. October 22-24

● **SOFTWARE USERS MEET**  
Annual Meetings of the Oxford Software International User Group, Hyatt Regency, Crystal City, Washington, DC.

(continued)

High performance to cost ratio...

# Programming Chips?

Projects develop profitably with development hardware/software from GTEK.



**MODEL 7956**  
(with RS232 option) \$1099.  
**MODEL 7956 (stand alone) \$ 879.**  
GTEK's outstanding **Gang Programmer** with intelligent algorithm can copy 8 EPROMs at a time! This unit is used in a production environment when programming a large number of chips is required. It will program all popular chips on the market through the 27512 EPROMs. It also supports the Intel 2764A & 27128A chips. It will also program single chip processors.



**MODEL 7228 - \$549**  
This model has all the features of Model 7128, plus *Intelligent Programming Algorithms*. It supports the newest devices available through 512Kbits; programs 6x as fast as standard algorithms. Programs the 2764 in one minute! Supports Intel 2764A & 27128A chips. Supports Tektronics, Intel, Motorola and other formats.

EPROM & PAL

## PROGRAMMERS

—These features are standard from GTEK—

Compatible with all RS232 serial interface ports • Auto select baud rate • With or without handshaking • Bidirectional Xon/Xoff • CTS/DTR supported • Read pin compatible ROMs • No personality modules • Intel, Motorola, MCS86 Hex formats • Split facility for 16 bit data paths • Read, program, formatted list commands • Interrupt driven — program and verify real time while sending data • Program single byte, block, or whole EPROM • Intelligent diagnostics discern bad and/or erasable EPROM • Verify erasure and compare commands • Busy light • Complete with Textool zero insertion force socket and integral 120 VAC power (240 VAC/50Hz available) •



**MODEL 7324 - \$1199**  
This unit has a built-in compiler. The Model 7324 programs all MMI, National and TI 20 and 24 pin PALs. Has non-volatile memory. It operates stand alone or via RS232.



**MODEL 7128 - \$429**  
This model has the highest performance-to-price-ratio of any unit. This is GTEK's most popular unit! It supports the newest devices available through 256Kbits.

**MODEL 7316 Pal Programmer** ..... \$ 599  
Programs Series 20 PALs. Built-in PALASM compiler.

## DEVICES SUPPORTED

by GTEK's EPROM Programmers

NMOS		CMOS		EEPROM		MPU'S	
2758	2764A	2508	68764	27C16	5213	12816A	8748 8741H
2716	27128	2516	8755	27C16H	5213H	12817A	8748H 8744
2732	27128A	2532	5133	27C32H	52B13		8749H 8751
2732A	27256	2564	5143	27C64	X2816		8741 68705
2764	27512	68766		27C256	48016		8742H

## UTILITY PACKAGES

GTEK's PGX Utility Packages will allow you to specify a range of addresses to send to the programmer, verify erasure and/or set the EPROM type. The PGX Utility Package includes GHGX, a utility used to generate an Intel HEX file.

PALX Utility Package — for use with GTEK's Pal Programmers — allows transfer of PALASM® source file or ASCII HEX object code file.

Both utility packages are available for CPM®, MSDOS®, PC DOS®, ISIS® and TRSDOS® operating systems. Call for pricing.

## AVOCET CROSS ASSEMBLERS

These assemblers are available to handle the 8748, 8751, Z8, 6502, 68X and other microprocessors. They are available for CPM and MSDOS computers. When ordering, please specify processor and computer types.

## ACCESSORIES

Model 7128-L1, L2, L2A (OEM Quantity)	\$259. \$329.	XASM (for MSDOS)	\$250.
Model 7128-24	\$200.	U/V Eraser DE-4	\$ 80.
Cross Assemblers	Call for pricing	RS232 Cables	\$ 30.
STM48 Simulator	Call for pricing	8751 Adapter	\$174.
PGX Utilities	Call for pricing	8755 Adapter	\$135.
PALX	Call for pricing	48 Family Adapter	\$ 98.
		68705 Adapter	Call for pricing

# GTEK

Development Hardware/Software  
P.O. Box 289, Waveland, MS 39576  
601/467-8048  
, INC.

GTEK, PALASM, CPM, MSDOS, PC DOS, ISIS, and TRSDOS are all registered trademarks.



Everything  
you expected  
from  
Symphony™  
and Framework™  
is now  
being delivered.

By Enable.™

Think about it a moment.

If you were to sit down and design your own integrated PC software system, what would you aim for?

Wouldn't you want to be able to integrate information from all modules in one window right on the screen? And then print it?

Wouldn't you work at it until every module gave you the functionality of the very best stand alone programs?

Wouldn't you design each module to have its own appropriate file structure?

---

### Beyond the brass ring.

---

Naturally, you'd also want it to run on a standard 256K PC.

It goes without saying that you'd want compatibility with the leading single-purpose programs.

And if you were to dream a bit, you'd go for concurrency because it would be great to do two or three jobs at the same time.

If you'd do all that in designing your own integrated program you'd certainly expect companies like Lotus and Ashton-Tate to do the same.

It didn't happen.

---

### They left it all out. We put it all in.

---

And because we did put it all in, Enable lets you produce at levels far beyond Symphony or Framework.

Enable can integrate data from all modules in one window and then print or transmit it. For instance, you can create graphs from a spreadsheet or database. Then insert the graphs, the spreadsheet and DBMS data between text in a single word processing document *right on the screen*.

Functionality? Just as *you'd* do it, Enable's word processing, spreadsheet, database management, graphics and telecommunications are, without exception, equal to the leading stand alone business programs.

Further, Enable's files are not forced into clumsy or unsuitable structures. Enable isn't spreadsheet-based or document-based or DBMS based. Each module is designed for a specific application.

Symphony and Framework? Hardly.

---

### More? There's more.

---

Your eyes blinked at our mention of 256K. Yet that's all you need to operate a spreadsheet with 136K of workspace. Or a word processing document whose size is limited only by available disc space. Or a DBMS file with up to 130,000,000 bytes of data.

We're sure you put a high priority on compatibility. So did we.

With Enable, you can use files from dBase II, Lotus 1-2-3, VisiCalc, WordStar, Easywriter I and Volkswriter—all automatically, without conversion or rekeying. Then you can produce files in those formats for anyone who hasn't yet switched to Enable.

And you can work on your spreadsheet while you're printing a monthly report and receiving stock quotes over the wire—all at the same time.

---

### How much good news can you handle?

---

It's time to admit there's one area in which Enable does not rise head and shoulders above Symphony and Framework. Price. We're the same. \$695.

And now for the next step.

Borrow a loaner copy from one of our dealers and give it a workout on your own.

Or, if you're a company with at least 25 PCs we'll send you a complimentary copy. No obligation.

Once you're thoroughly satisfied with Enable you can trade up your Lotus 1-2-3 for \$200, your dBase II for \$400.

Just dial 1-800-932-0233. In New York dial 1-800-338-4646.

Will Enable live up to your expectations? Well, you designed it didn't you?

Integrated  
software shouldn't  
be a matter of  
choosing which compromises  
to live with.

**enable**<sup>TM</sup>  
integration without compromise



For the IBM®-PC and selected compatibles.

Trademarks: Enable—The Software Group, IBM—International Business Machines Corp., Volkswriter—Lifetree Software, Inc., EasyWriter I—Information Unlimited Software, Inc., WordStar—MicroPro International Corporation, dBase II, Framework—Ashton-Tate, Symphony, 1-2-3 and Lotus—Lotus Development Corporation, VisiCalc—Visicorp.

© Copyright 1984, The Software Group Northway Ten Executive Park, Ballston Lake, New York 12019



# EMACS™ FOR UNIX,™ MS-DOS™ & VMS™

UniPress  
Product  
UPDATE

You can now run the famed Gosling EMACS on your VAX, Sun, Pyramid, Cyb, Callan, Masscomp, Integrated Solutions, Apple Lisa, Pixel, Charles River Data, Perkin Elmer, Dual, Momentum, Cadmus, Tandy Model 16, NCR Tower, Fortune, Apollo, HP9000 and the list goes on!

**UniPress Gosling EMACS:** The famous multi-window full-screen editor. Edit several files at once. Interprocess communication on UNIX and VMS. Extensible via macros and the built-in compiled MLISP language.

**UniPress Gosling EMACS:** The ultimate programmer's tool: C, Pascal and MLISP language assist. EMACS manages execution of Unix makefiles, and automatically points to lines containing errors in the source code. Keys can be bound as desired, macros can be named, customized MLISP routines can supplement the many included packages, and much more!

**UniPress Gosling EMACS:** Use EMACS as your session manager — Divide your screen into a "shell window" to run commands, and one or more source file windows.

**UniPress Gosling EMACS:** Runs under Unix 4.1/4.2, System III/V and Version 7. VMS and MS-DOS too!

**PRICES:** UNIX: \$395/Binary; \$995/Source  
VMS: \$2500/Binary; \$7000/Source  
MS-DOS: \$375/Binary; \$995/Source  
(Requires at least 384K)

Call us with your hardware type.

**ALSO NEW! MINIMACS**—Special efficiency-conscious EMACS for Unix. Runs on a wide range of hardware types.

**MINIMACS:** Faster and smaller version of the famed Gosling Emacs. Its features include full screen editing, multiple windows allowing several files to be edited simultaneously, full EMACS keybindings, macro capability and many more powerful Emacs features, such as command output being directed to a window.

**MINIMACS:** Minimizes your resource load and is much smaller than the vi editor.

**Price:** \$375/Binary; \$795/Source

## UNIPRESS OFFERS A FULL LINE OF SOFTWARE FOR UNIX, VMS AND MS-DOS.

**Lattice® C compilers to the 8086-family;** both native and cross. Write programs on your mainframe for execution on the IBM-PC, etc. (Cross compilers for UNIX and VMS.)

**Window Shell:** Multiple windows on any CRT!

**Q-CALC • Lex • Phact • /RDB • The Menu System • UniCalc**  
• Full UNIX System V Operating System for the Apple Lisa  
• and much more powerful software.

Call or write for more information.

## UniPress Software, Inc.

2025 Lincoln Highway, Edison, NJ 08817  
201-985-8000 • Order Desk: 800-222-0550 (outside NJ)  
Telex: 709418

Mastercard and Visa

EMACS and MINIMACS are trademarks of UniPress Software, Inc. • Unix is a trademark of Bell Laboratories • VMS is a trademark of Digital Equipment Corp. • MS-DOS is a trademark of Microsoft  
• Lattice C and UniCalc are registered trademarks of Lattice Inc.  
• IBM-PC is a trademark of IBM.

## EVENT QUEUE

Commodore Grace Hopper will deliver the keynote address. Contact Oxford Software International User Group, 174 Boulevard Hasbrouck Heights, NJ 07604, (201) 288-1515. October 22-24

● **HOOSIER COMPUTER-FEST—Indy/Con '84.** Indiana Convention Center and Hoosier Dome, Indianapolis. The largest microcomputer/electronics exhibition and conference in the state. Contact Indy/Con, 5160 East 65th St., Indianapolis, IN 46220, (317) 842-3024. October 23-24

● **INTERNATIONAL CONFERENCE IN FRANCE** The Sixth International Conference—IDATE, Montpellier, France. A forum for the exchange of information and experiences. Contact Bureaux du Polygone, Rue des Etats du Languedoc, 34000 Montpellier, France; tel: (67) 65.48.48; Telex: IDATE 490290. October 24-26

● **COMPUTERS IN CONSTRUCTION**—Computers in Construction, Atlanta, GA. Fee: \$425. For further details, contact CIP Information Services Inc., 1105-F Spring St., Silver Spring, MD 20910, (301) 589-7933. October 25-26

● **COMPUTERS AND SOFTWARE**—The Third Annual Twin Cities Computer Show and Software Exposition. Minneapolis Auditorium, Minneapolis, MN. Contact CompuShows, POB 3315, Annapolis, MD 21403, (800) 368-2066; in Annapolis, (301) 263-8044; in Baltimore, (301) 269-7694; in the District of Columbia, (202) 261-1047. October 25-28

● **COMPUTERS IN ARTS** Symposium on Small Computers in the Arts. University Hilton Hotel, Philadelphia.

PA. Introductory and advanced courses in computer animation, music, graphics, interfaces, and legal issues complemented by talks, exhibits, research presentations, a computer art gallery, and film shows. Contact Symposium, POB 1954, Philadelphia, PA 19105. October 25-28

● **PC FAIRE** The Second Annual PC Faire. San Francisco, CA. Exhibits, speakers, seminars, and workshops. Contact Computer Faire Inc., 570 Price Ave., Redwood City, CA 94063, (415) 364-4294. October 26-28

● **ENGINEERS MEET IN NC** The 1984 North Carolina IEEE Symposium and Exhibition. Adam's Mark Hotel, Charlotte, NC. Seminars and a keynote session on "Personal Computers and Workstations: Applications for All Professionals" will be featured. Contact Gene Rohrer, 65C, 202-3, IBM Corp., 1001 W. T. Harris Blvd., Charlotte, NC 28257. October 29-30

● **FINANCIAL COMPUTING** MicroScape-84: Profits at Your Fingertips. Amfac Hotel and Resort, Dallas/Fort Worth Airport, TX. A conference and exposition for financial institutions. Hands-on workshops and evening labs using Apple, Compaq, and Wang computers. Contact Joanne Wise, Banking Administration Institute, 60 Gould Center, Rolling Meadows, IL 60008, (312) 228-6200. October 30-November 2

● **PROGRAM FOR PROFESSIONALS**—Wescon/84 and Mini/Micro West-84, Anaheim, CA. Topics include artificial intelligence, computer peripherals, graphics, speech recognition/synthesis, and telecommunications.

(continued)

# WE DRESSED OUR UNIX\* SOFTWARE FOR YOUR IBM PC/XT



**Try it Risk FREE** — the first AT&T-licensed UNIX implementation for the IBM PC/XT. Shipping since August 1983, Venix/86 is the popular choice among knowledgeable UNIX users and developers. Here's why!

#### **Multi-User Capability...**

Share the same PC, disk, and printer with up to three users! Simply plug in a CRT and run.

#### **Multi-Tasking...**

Edit a file, print a report, run a spelling check, format a diskette...all at the same time.

#### **Berkeley Enhancements...**

Including vi, termcap, more and the c shell.

#### **Real-Time Extensions**

With semaphores, raw and asynchronous I/O, priority, shared data, I/O page addressing.

#### **Quad-Screen Windowing...**

Featuring four unique and powerful windows.

#### **MS-DOS Partitioning...**

Keep your DOS files and programs!

#### **Lean and Clean...**

192K RAM, 3.5 Mbytes on disk. Proven reliability.

#### **Applications...**

Networking, word processors, database managers, spreadsheets, menu interfaces.

#### **One Source with Unisource...**

Unisource is the leading publisher and developer of UNIX software for the IBM PC/XT and compatibles, DEC Professional 350, Rainbow, Micro-11, PDP-11, VAX series, and NCR computers. All our packages are fully documented and supported by our 800 user hotline. Call for a complete information kit or to arrange your 30-day Risk FREE Trial of Venix/86. Unisource Software Corp. Department 4109  
71 Bent St., Cambridge, MA 02141.  
Telex 92-1401/COMPUMART CAM  
**CALL 617-491-1264**



**Getting UNIX Software  
Down to Business**



\*UNIX is a trademark of AT&T Technologies, Inc.  
Venix/86 implementation by VenturCom, Inc.

Circle 363 on inquiry card.



# EXPAND YOUR ACCOUNT... SAFELY!

GET SERIOUS. STOP PAYING HIGH PRICES NOW!

THOUSANDS OF AVAILABLE ITEMS. CALL FOR COMPLETE PRICING.

**SYSTEMS**

**IBM PC**  
256K, Two 360KB Disk Drives, Color Graphics/Monochrome Graphics board, Parallel Printer Port, Monochrome Display (Amber/Green), DOS 2.1.  
**LIST PRICE \$2950.00 — ONLY \$2095.00**

**CALL FOR OTHER BUNDLED SYSTEM CONFIGURATIONS INCLUDING PRINTERS MONITORS, CABLING, AND SOFTWARE!**

**IBM SOFTWARE**

**LOTUS 1-2-3** ..... \$299.00  
**LOTUS Symphony** ..... **449.99**  
**MICROPRO Wordstar** ..... **279.00**  
**ASCII Express For IBM** ..... **129.00**  
Wordstar Professional ..... **389.00**  
Infostar ..... **279.00**  
Multimate ..... **269.00**  
**MICROSOFT Word** ..... **229.00**  
Word W/Mouse ..... **279.00**  
Multiplan ..... **149.00**  
Project ..... **189.00**  
**ASETON TATE Friday** ..... **179.00**  
dBASE II ..... **295.00**  
dBASE III ..... **395.00**  
Framework ..... **395.00**  
**LIFETREE SOFTWARE Volkswriter** ..... **409.00**  
Volkswriter Deluxe ..... **179.00**  
**FOX & GELLER Quickcode** ..... **139.00**  
dUtil ..... **89.00**  
dGraph ..... **149.00**  
**MICROFORM Rbase 4000** ..... **298.00**  
**FPS Write** ..... **89.00**  
File ..... **89.00**  
Report ..... **89.00**  
Proof ..... **CALL**  
Access ..... **CALL**  
**ENERGRAPHICS** ..... **269.00**  
**NORTON UTILITIES** ..... **59.00**

**IBM HARDWARE**

**AST 516 Pack Plus 64K** ..... **259.00**  
**MegaPlus II** ..... **269.00**  
**PC Net 1 Starter Kit** ..... **830.00**  
**QUADRAM Quadboard 0-K** ..... **219.00**  
Quadcolor I or Microfazer 64K ..... **199.00**  
Quadlink ..... **479.00**  
**MICROSCIENCE**  
10MB Winchester ..... **899.00**  
**HERCULES Mono Graphics** ..... **335.00**  
Color Card ..... **199.00**  
**PLANTRONICS Colorplus** ..... **348.00**  
**STB Rio plus 64K** ..... **289.00**  
Super Rio ..... **259.00**  
Graphix +II NEW ..... **309.00**  
**TEAC 55B** ..... **169.00**  
55F ..... **229.00**  
**TANDON TM100-2** ..... **205.00**  
**TALL GRASS**  
12MB External W/Tape ..... **2799.00**  
20MB External W/Tape ..... **3149.00**  
**MOUSE SYSTEMS Optical Mouse** ..... **189.00**  
**ALSO - XCOMP, PERSYST, ORCHID, TITAN AND OTHERS**

**PRINTERS LETTER QUALITY**

**BROTHER HR 15** ..... **379.00**  
**HR 25** ..... **629.00**  
**HR 35** ..... **859.00**  
**JUKI 6100** ..... **429.00**  
**NEC 2030** ..... **659.00**  
2050 ..... **799.00**  
3530 ..... **1229.00**  
3550 ..... **1539.00**

**PRINTERS DOT MATRIX**

**STAR MICRONICS Gemini 10X** ..... **259.00**  
Gemini 15X ..... **389.00**  
**EPSON RX-80 F/T** ..... **329.00**  
FX-80 ..... **459.00**  
FX-100 ..... **689.00**  
**OKIDATA 92A** ..... **429.00**  
93A ..... **649.00**  
84A ..... **949.00**  
**PANASONIC 1091** ..... **310.00**  
**TOSHIBA 1350-P** ..... **1399.00**  
**EPSON LQ1500** ..... **1299.00**

**MONITORS**

**ANDEK 300** ..... **129.00**  
300A ..... **145.00**  
310A ..... **169.00**  
Color I+ ..... **269.00**  
Color II ..... **459.00**  
**TAXAN Composite Amber** ..... **119.00**  
121/122 ..... **149.00**  
420 (RGB) ..... **439.00**  
415 (RGB) ..... **489.00**  
**PRINCETON GRAPHICS HX-12** ..... **469.00**  
SR-12 ..... **649.00**  
MAX-12 ..... **CALL**  
**ZENITH ZVM-122 Amber** ..... **95.00**  
ZVM-123 Green ..... **95.00**  
ZVM-135 Color ..... **459.00**  
**NBC 1201 Hi Res Green** ..... **139.00**  
1205 Hi Res Amber ..... **139.00**  
1260 Green ..... **99.00**  
JC1215 Color ..... **255.00**

**MODEMS**

**HAYES 1200** ..... **469.00**  
1200B ..... **389.00**  
300 ..... **199.00**  
Micromodem //e ..... **219.00**  
**ANCHOR Mark X** ..... **109.00**  
Mark XII ..... **259.00**  
Volkmodem ..... **59.00**  
**NOVATION Smart Cat Plus** ..... **CALL**  
Access 1-2-3 ..... **419.00**  
Apple Cat II ..... **239.00**  
J-Cat ..... **99.00**  
**U.S. ROBOTICS PC Modem** ..... **365.00**  
Password ..... **349.00**  
**PROMETHEUS Promodem 1200** ..... **329.00**

**APPLE PRODUCTS**

**MICRO SCI A2 drives** ..... **189.00**  
**RANA ELITE I** ..... **219.00**  
**TEAC drive** ..... **189.00**  
**APPLE Compatible drive** ..... **169.00**  
**GRAPPLER Work-alike** ..... **69.00**  
**BUFFERED 16K** ..... **99.00**  
**SYSTEM SAVER Fan** ..... **69.00**  
**MICROSOFT Premium //e** ..... **279.00**  
Softcard CP/M ..... **229.00**  
Multiplan ..... **129.00**  
**MAC Multiplan (MacIntosh)** ..... **129.00**  
Basic (MacIntosh) ..... **109.00**  
**APRICORN Serial Card** ..... **69.00**  
Z-80 Card ..... **59.00**  
**ASCII Express Professional** ..... **89.00**  
**MAXELL S/S** ..... **19.00**  
D/S ..... **27.00**  
**KOALA Touch Tablet** ..... **79.00**  
**HAYES Mach III JoyStick** ..... **39.00**  
**THUNDERCLOCK** ..... **119.00**  
**MOCKINGBOARD** ..... **CALL**  
**APPLEMOUSE II** ..... **129.00**  
**VIDEX Ultraterm** ..... **179.00**  
**80 COLUMN/64K Interface //e only** ..... **99.00**  
**80 COLUMN Card II+ only** ..... **59.00**

**WE SUPPORT THESE FINE SYSTEMS:**  
Apple, Compaq, IBM, Sanyo and many more.

TELEX #550757/ANSWER BACK-COMPUTERBANK UD

**B**<sup>TM</sup>   **714/841-6160**  
**COMPUTERBANK**  
16783 Beach Blvd., Huntington Beach, CA 92647

All products are in factory sealed packages. We guarantee all items for 90 days. Within this period, defective merchandise returns must be accompanied by RMA number. All other returns will be subject to a 10% restocking fee. For prepaid orders, there will be a 3% shipping charge. 5% for UPS Blue Label \$5.00 minimum, all orders outside U.S.A. at 15% shipping. There will be an additional \$4.00 surcharge on C.O.D. orders. Cash or Customers check is required on C.O.D. orders. California residents add 6% sales tax. Prices subject to change without notice.  
© Copyright 1984 COMPUTERBANK. All Rights Reserved.

EVENT QUEUE

Contact Electronic Conventions Management, 8110 Airport Blvd., Los Angeles, CA 90045, (213) 772-2965.  
October 30–November 2

ness, and school. Admission is \$6. Contact Microshows, POB 4323, Foster City, CA 94404, (415) 340-9113.  
November 3–4

● **COMPUTER SHOW IN EDMONTON**—The Second Annual Edmonton Computer and Office Automation Show, Convention Centre, Edmonton, Alberta, Canada. Contact Industrial Trade Shows, 20 Butterick Rd., Toronto, Ontario M8W 3Z8, Canada, (416) 252-7791.  
October 31–November 2

● **SOUTHWESTERN FAIR**  
The Third Annual Tucson Computer Fair, Park Mall, Tucson, AZ. This fair, run entirely by students of the Management Information Systems Department at the University of Arizona, features hardware and software for business, home, personal, and entertainment use. Admission is free. Contact Tucson Computer Fair, Management Information Systems Association, S.U.P.O. Box 20826, Tucson, AZ 85720, (602) 621-4615.  
November 3–4

November 1984

● **CONFERENCES, MEETINGS**—Conferences and Meetings of the Institute of Electrical and Electronics Engineers, various sites throughout the U.S. and the world. A calendar of conferences and meetings complete with contact persons is available. Contact IEEE Computer Society, POB 639, Silver Spring, MD 20901, (301) 589-8142.  
November–January 1985

● **MEDICAL COMPUTING**  
The Eighth Annual Symposium on Computer Applications in Medical Care, SCAMC, Washington Hilton Hotel, Washington, DC. A varied program covering new, controversial, and state-of-the-art topics on computers and health care. Contact Gail Mutnik, SCAMC Symposium Coordinator, Office of Continuing Medical Education, George Washington University Medical Center, 2300 K St. NW, Washington, DC 20037, (202) 676-8928.  
November 4–7

● **EDUCATIONAL CONFERENCE**—The Fourth Annual Educational Computing Conference, Plymouth State College, Plymouth, NH. Six simultaneous sessions will explore the conference themes "Practical Applications in the Classroom" and "Computer Literacy for Students and Teachers." Contact Ms. Peggie Riley, Department of Computer Science, Plymouth State College, Plymouth, NH 03264, (603) 536-1550, ext. 533.  
November 3

● **GRAPHICS COURSE**  
Introduction to the Graphics Kernel System (GKS), Hyatt Regency Hotel, Austin, TX. In addition to its specific technical features, the history and the relationship of GKS to other standards will be covered. Tuition is \$495. Contact Nova Graphics International Corp., 1015 Bee Cave Woods, Austin, TX 78746, (512) 327-9300.  
November 5–6

● **COMPUTERS FOR SALE**  
The Computer Supermarket, Santa Clara County Fairgrounds, San Jose, CA. Retailers, manufacturers, and distributors will display and sell hardware and software for the home. soft-

● **SHOW IN BEIJING**  
China Comm 84, Beijing Ex-

(continued)



# Until now your PC was missing an essential piece.

## Master Piece.™

Introducing the only accessory your IBM® PC will ever need. The Master Piece is four accessories in one, offering your PC the protection and convenience it's been missing.

### SEE EYE TO EYE WITH YOUR IBM PC.

The Master Piece provides a swivel for your monitor. This swivel lets you adjust the viewing angle of your monitor with just the touch of a finger.

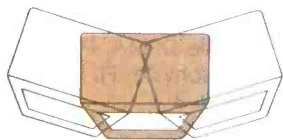

### PUTS YOUR ENTIRE SYSTEM AT YOUR FINGERTIPS.

Stop fumbling with cords and scrambling for outlets to plug in your peripherals. Stop lunging to the other side of the room just to turn on your printer. The Master Piece functions

as a five outlet power strip to organize all your power needs. Power up with the master switch, then use the individual switches to control your peripherals. Touch the master switch to shut down and the Master Piece makes sure you never accidentally leave your peripherals running overnight.

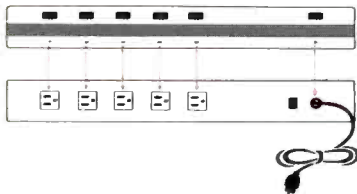

### POWER LINE PROBLEMS ARE NO PROBLEM.

Surges, spikes and line noise are responsible for 70-90% of PC malfunctions. They can wipe out memory in your PC, taking hours of hard work with them. That just costs you time. Even worse, they can zap your delicate chips, sending your PC in for repairs. That costs you money. The Master Piece stops power line problems dead. You end up with an IBM that's more accurate and more reliable.

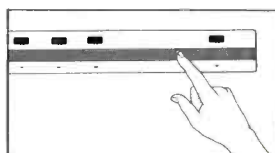

### EVEN YOU ARE A THREAT TO YOUR IBM PC.

During the course of an active day, you build up static electricity—just as much a threat as surges and spikes. Until now, the only solutions to static were unsightly floor mats or pads that fit under your computer. The Master Piece offers an elegant alternative. Just touch its nameplate before you begin work and all static charges are safely grounded.

Master Piece, the most versatile, most convenient, most useful peripheral ever made for the IBM. In fact, you'll come to think of it as the piece your PC was missing.

\$139.95 at computer stores everywhere.



251 Park Avenue South, New York, NY 10010, (212) 475-5200, Telex: 467383 KML NY.



# 'C' COMPILER

## AN OUTSTANDING VALUE

"We bought and evaluated over \$1500.00 worth of 'C' compilers... C/80 is the one we use."

Dr. Bruce E. Wampler, Aspen Software  
author of "Grammatik"

**C/80** Full featured C Compiler for CP/M® with I/O redirection, command expansion, execution trace and profile, initializers, Macro-80 compatibility, ROMable code.

**49.95**

**C/80 FLOATS & LONGS** Adds 32 bit data types to C/80 3.0 compiler. Includes I/O and transcendental function library.

**29.95**

**FREE CATALOG** Call or write for 16 page booklet detailing our programming languages LISP/80, RATFOR, Assemblers, and 25 other CP/M products.



15233 Ventura Blvd., #1118  
Sherman Oaks, CA 91403

(213) 986-4885  
Dealer inquiries invited.

CP/M is a registered trademark of Digital Research, Inc.

**NOT ANOTHER BLACK BOX**

## A Software Implementation within Your Product Hardware

If you manufacture a computer system or a computer based product, allow it to EMULATE/COMMUNICATE by installing one or more of Systems Strategies "C" Language based communication packages.

- 3270 SNA/SDLC Emulation
- 3270 BSC Emulation
- 2780/3780/HASP Emulation
- X.25 Levels 1, 2, 3 Communication

You can purchase these "C" Language packages with source code and license to distribute in your hardware product. Each package is available either "Port it Yourself" with instruction manual and training or ported to your hardware by Systems Strategies' communications staff.

**Systems Strategies/Advanced Technology Division  
Specialists in Data Communications Software**



**Systems Strategies Inc.**  
225 West 34th Street  
New York, New York 10001  
(212) 279-8400

## EVENT QUEUE

hibition Center, Peoples Republic of China. This exhibition includes telecommunications, electronics, and computer exhibits. Contact Clapp & Poliak International, POB 70007, Washington, DC 20088, (301) 657-3090. *November 5-13*

● **ERGONOMICS CONFERENCE**—The First International Symposium of Ergonomics, Industrial Design, and Manufacturing: Ergodesign '84, Conference and Exhibition Centre, Montreux, Switzerland. A non-commercial exhibit will present equipment and materials that meet ergonomic and aesthetic needs. Contact Ergodesign '84, Conference and Exhibition Centre, POB 97, CH-1820, Montreux, Switzerland; tel: (021) 630440; Telex: 453 222. *November 6-9*

● **DPMA SHOW IN FLORIDA**—The Fifth Annual Vendor and Trade Show, Sheraton Inn, Jacksonville, FL. Sponsored by the Jacksonville chapter of the Data Processing Management Association. Contact Jacksonville DPMA, POB 272, Jacksonville, FL 32201. *November 7-8*

● **COMPUTERS IN NUTMEG STATE**—The Computer and Electronics Show, Civic Center, Hartford, CT. More than 160 manufacturers will display a variety of electronic gadgetry, including hardware, software, peripherals, and communications equipment. Contact Daniels Productions Inc., 211 Park Rd., West Hartford, CT 06119, (203) 233-9611. *November 8-10*

● **MOTION CONTROL SEMINAR**—Seminar from the Electronic Motion Control Association, San Jose, CA. Contact EMCA, Suite 1200, 230 North Michigan

Ave., Chicago, IL 60601, (312) 372-9800. *November 12-13*

● **X.25, PACKET NETS** X.25 and Packet-Switching Networks, Atlanta, GA. This course will cover the internal operations of the packet-switching network and its implementation. International standards and X.25 interfaces will be discussed. Tuition is \$795. Contact Elaine Hadden Nicholas, Department of Continuing Education, Georgia Institute of Technology, Atlanta, GA 30332-0385, (404) 894-2547. *November 14-16*

● **WESTERN EDUCATORS MEET**—The Eighth Annual Western Educational Computing Conference, Vacation Village, San Diego, CA. Refereed papers on computer science, humanities and the fine arts. CAI, administration, and research support. Contact Dr. Virginia S. Lashley, Glendale College, 1500 North Verdugo Rd., Glendale, CA 91208. *November 15-16*

● **FORTH CONVENTION** The Sixth Annual FORTH Convention and Banquet, Hyatt Palo Alto, Palo Alto, CA. Contact FORTH Interest Group, POB 1105, San Carlos, CA 94070, (415) 962-8653. *November 16-17*

● **IBERIAN COMPUTING SIMO '84**—The XXIV International Show of Business Equipment and Data Processing, IFEMA Fair Grounds, Casa de Campo, Madrid, Spain. A conference and exhibition. Contact Feria de Muestras Monográfica Internacional del Equipo de Oficina y de la Informática, Plaza de Alonso Martinez, 3, Madrid 4, Spain; tel: 448 47 94; Telex: 27307 CLAVE 514. *November 16-25*

(continued)



## WHAT A RAGING FIRE TAUGHT US ABOUT RELIABLE PERSONAL PRINTERS.

**That's a printer?** We've always known that Okidata makes the toughest printers, but Robert Brannon really proved it. A fire left his Microline 92 looking more like a pile of charred Silly Putty® than a printer, but being an optimist, Mr. Brannon took it to his Okidata dealer to see if anything could be salvaged.

The service department at Wolff Computers in New York City wasn't quite as optimistic, especially when they saw that the heat of the blaze had actually melted the casing and molded the plastic onto the internal workings of the printer.

But willing to try anything once, they plugged the unit into one of their computers, snapped on the print mode, tapped the printhead lightly, and Robert Brannon's smokey, burned, half-melted Okidata did just what it had always done . . . it printed. It printed fast and it printed beautifully.

**Red-hot performance.** We're not surprised. The durability of Okidata printers has become downright legendary. With a printhead that lasts well beyond 200,000,000 characters and a warranty claim rate of less than 1/2 of 1%.

Okidata speed and versatility have become famous as well. The Microline models print data at rates up to 200 characters per second. That's three pages a minute. There's an additional print mode for enhanced or emphasized text. And their letter quality rivals a daisywheel for clarity with full graphics printing capabilities.

Okidata printers are fully compatible with all popular software packages and personal computers. Special configurations are available for IBM and Apple Macintosh™ at no extra cost. And if you're like Mr. Brannon and occasionally need a little service, it's easy to find at Xerox Service Centers nationwide.

Every now and then any printer can have a rough day, but the Okidata Microline printers are built to take it. Call 1-800-OKIDATA (609-235-2600 in NJ) for the Authorized Okidata Dealer nearest you. Okidata, Mt. Laurel, NJ 08054.

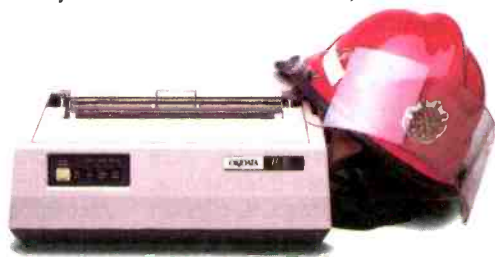

# OKIDATA

an OKI AMERICA company

Technological Craftsmanship.

Circle 253 on inquiry card.

Macintosh is a trademark of Apple Computers Inc.

Silly Putty is a registered trademark of Binney & Smith, Inc.



## EVENT QUEUE

● **FARM COMPUTER CONFERENCE**—The 1984 Purdue On-Farm Computer Use Conference and Trade Show, Purdue University, West Lafayette, IN. Workshops will complement exhibits and conference sessions. Contact Continuing Education Business Office, Stewart Center, Room 110, Purdue University, West Lafayette, IN 47907, November 18-20

● **CANADIAN CONFERENCE**—Annual CIPS Computer Conference, International Centre, Toronto, Ontario, Canada. Speakers will address a variety of issues. Contact Canadian Information Processing Society, Fifth Floor, 243 College St., Toronto, Ontario M5T 2Y1, Canada, (416) 593-4040, November 19-22

● **COMPUTERS IN TORONTO**—The Fifteenth Annual Canadian Computer Show and Conference, International Centre, Toronto, Ontario, Canada. Contact Industrial Trade Shows, 20 Butterick Rd., Toronto, Ontario M8W 3Z8, Canada, (416) 252-7791, November 19-22

● **SHANGHAI EXPOSITION** The China International Microelectronics/Computer Exhibition and Conference, Shanghai, Peoples Republic of China. Integrated circuits, semiconductors, personal computers, minicomputers, peripherals, and software will be exhibited. Contact American Exhibition Services International Inc., POB 66373, O'Hare International Airport, Chicago, IL 60666, (312) 593-2462, November 21-26

● **TRADE SHOW IN MOSCOW**—Systemotronica '84, Sokolniki Exhibition Centre, Moscow, Union of Soviet Socialist Republics. An international trade exhibition of office systems,

electronics, and components. Contact Düsseldorfer Messgesellschaft mbH-NOWEA, POB 32 02 03, D-4000 Düsseldorf 30, Federal Republic of Germany; tel: (0211) 45 60-729; Telex: 8 584 853 mes d, November 22-30

● **COMPUTER ATLANTIC SHOW**—Moncton Computer Exhibition '84, Moncton, New Brunswick, Canada. Home computers, video games, and office automation equipment will be displayed. Contact Anne LeBlanc, Commerce Building, University of Moncton, Moncton, New Brunswick E1A 3E9, Canada, (506) 858-4555, November 23-25

● **COMPUTERS IN CHINA** Computer China, Xiamen Special Economic Zone, Peoples Republic of China. Contact Kallman Associates, 5 Maple Court, Ridgewood, NJ 07450, (201) 652-7070, November 25-December 1

● **ENGINEERING INSTITUTE**—The Twenty-Second Annual Reliability Engineering and Management Institute, Tucson, AZ. Contact Dr. Dimitri Kececioglu, Aerospace and Mechanical Engineering, Building 16, Room 200-B, University of Arizona, Tucson, AZ 85721, (602) 621-6120, November 26-30

● **ROBOTICS IN WEST** Robots-West, Anaheim Convention Center, Anaheim, CA. Robot manufacturers and component suppliers will exhibit their wares. Contact Robot Institute of America, POB 1366, Dearborn, MI 48121, (313) 271-0778, November 27-29

● **LOCAL NETWORK COURSE**—Local Area Networks, Atlanta, GA. This course looks at the alternative technical approaches

(continued)

Prentice-Hall computer **BOOKWARE™** is available at these fine stores:

- ALABAMA**  
Madison Books  
8006-13 Madison Mall  
Madison(205) 772-9250
- ARIZONA**  
Arizona Bookstore  
815 North Park Ave.  
Tucson(602) 522-4717  
Bookminder's Medical & Technical Books  
1302 N. 1st St  
Phoenix(602) 254-0738  
Books, Etc.  
901 S. Mill  
Tempe(602) 967-1111
- CALIFORNIA**  
A Clean Well Lighted Place for Books  
21271 Stevens Creek Blvd  
Cupertino(408) 255-7600  
Associated Students UCLA Bookstore  
308 Westwood Plaza  
Los Angeles/  
(213) 825-7711  
Bookends Bookstore  
1014 Coombs St  
Napa(707) 224-1077  
Bookmania  
150 California St.  
San Francisco/  
(415) 421-7822  
Capitol Book Cate  
1475 41st Ave  
Capitola(408) 452-4415  
Computer Literacy Bkshp.  
520 Lawrence  
Sunnyvale(408) 730-9955  
Golden Gate Univ. Bkstr.  
28 Jessie St.  
San Francisco/  
(415) 442-7277  
Kegler's Books & Magazines  
821 El Camino Real  
Menlo Park(415) 324-4321  
Ocamp Technical Books  
1033 N. Sycamore Ave.  
Los Angeles/  
(213) 454-4322  
Pasadena Scientific & Technical Bkstr.  
4225 Rio Honda Ave.  
Rosemead(818) 444-3102  
Printer's, Inc.  
310 California  
Palo Alto(415) 327-6500  
Software Centre  
International  
477 University Ave  
Palo Alto(415) 327-0520  
Software Centre  
International  
4170 Convey St.  
San Diego(619) 576-1424  
Stacey's  
219 University Ave  
Palo Alto(415) 326-0681  
Stacey's  
581 Market St.  
San Francisco/  
(415) 421-4687  
Stanford Bookstore—  
Palo Alto  
135 University Ave  
Palo Alto(415) 327-3680  
Technical Book Co.  
2056 Westwood Blvd.  
Los Angeles/  
(213) 879-9411/  
(213) 475-5711  
Tow Books  
2538 Watt Ave.  
Sacramento/  
(916) 481-6600  
University Bkstr. 0-008  
Univ. of Calif. San Diego  
La Jolla(619) 452-3149
- COLORADO**  
Auraria Book Center  
955 Lawrence  
Denver(303) 629-3230  
Hippo  
1546 Pearl St  
Boulder(303) 447-0441  
Software Centre  
International  
1475 Lawrence St.  
Denver(303) 534-3707  
Tattered Cover Bkstr.  
2930 E. 2nd Ave.  
Denver(303) 322-7727
- CONNECTICUT**  
Huntington's Bookstore  
Asylum St.  
Hartford(203) 527-1835  
Univ. of Conn. Coop  
81 Fairfield Rd.  
Storrs(203) 486-3537  
Yale Coop  
77 Broadway  
New Haven/  
(203) 772-2200 x40
- DISTRICT OF COLUMBIA**  
Sidney Kramer Books  
1722 H St. N.W.  
Washington(202) 398-8071
- FLORIDA**  
Deiray Mall Bkstr.  
1660 S. Federal Hwy.  
Deiray Beach/  
(305) 272-6666  
Software, Software  
392 No. Federal Hwy  
Boca Raton(305) 391-7223
- GEORGIA**  
Oxford Bookstore  
2345 Peachtree Rd. N.E.  
Atlanta(404) 262-3332  
Software Atlanta, Ltd.  
Northlake Triangle  
2244 Henderson Mill Rd  
Atlanta(404) 934-0924
- ILLINOIS**  
Chicago Circle Center Bookstore  
750 S. Halsted  
Chicago(312) 996-2651  
Complete Computing  
898 E. Roosevelt Rd.  
Lombard(312) 620-0808  
DePaul Univ. Bookstore  
25 E. Jackson Blvd  
Chicago(312) 341-8313  
The Follett Student Center Bookstore  
100 N. Univ.  
Normal(309) 438-2581  
Follets U of I Book & Supply Store  
627-631 S. Wright St  
Champaign(217) 356-1369  
I.I.T. Book Store  
15 E. 32nd St  
Chicago(312) 567-3120  
Kroch's & Brentano's  
29 S. Wabash  
Chicago(312) 332-7500  
N. Center Store of Northwestern Univ.  
1999 Sheridan Rd.  
Evanston(312) 492-5295  
Student Center Bookstore  
Northern Illinois Univ.  
DeKalb(815) 753-1081  
The Univ. of Chicago Bookstore  
970 E. 58th St.  
Chicago(312) 962-7712
- INDIANA**  
Follets Purdue Bkstr.  
1400 W. State St.  
West Lafayette/  
(317) 743-9642  
Graham Electronics  
13 S. Pennsylvania St.  
Indianapolis(317) 263-6296  
Indiana Univ. Bookstore  
Indiana Memorial Union  
Bloomington/  
(812) 335-8487
- IOWA**  
Information Unlimited  
2380 Cumberland Sq.  
Barnes(319) 359-7593
- KANSAS**  
K-State Univ. Bkstr.  
Kansas State Univ.  
Manhattan(913) 532-6583
- KENTUCKY**  
Lingle's  
153 Patchen Village  
Lexington(606) 269-4611  
Prescott Books  
Civic Ctr. Mall 410 Vine  
Lexington(606) 254-7863
- LOUISIANA**  
Anders—The Bookstore  
210 E. St. Mary's Blvd.  
Lafayette(318) 232-2087  
Univ. of New Orleans Bookstore  
Lafayette Dr.—Univ. Ctr.  
New Orleans/  
(504) 286-6921
- MAINE**  
University Bookstore  
University of Maine Orono  
Orono(207) 581-1700
- MASSACHUSETTS**  
Boston Univ. Bkstr.  
660 Beacon St.  
Boston(617) 267-8484  
Computer Knowledge Str.  
48 Chelmsford St.  
Chelmsford(617) 250-0078  
Dartmouth Bookstore  
33 S. Main St.  
Hanover(603) 643-3616  
Either/Or Bookstore  
122 North St.  
Pittsfield(413) 499-1705  
Harvard Business Coop  
Soldiers Field St.  
Boston(617) 492-1000
- MICHIGAN**  
Campus Bookstore U of M  
4901 Evergreen Rd.  
Dearborn(313) 593-5530  
Michigan State Univ.  
MSU Bookstore  
East Lansing/  
(517) 355-3454
- MISSOURI**  
Campus Bookstore  
Washington Univ.  
Malinckrodt Ctr. Box 1074  
St. Louis(314) 889-5696  
West Port Bookshellers  
311 West Port Plaza  
St. Louis(314) 434-6499
- MONTANA**  
MSU Bookstore, Inc.  
185 Student Union  
Bozeman(406) 994-5845
- NEW ENGLAND MOBILE BOOK FAIR**  
82-84 Needham St.  
Newton Highlands/  
(617) 527-5817  
Paperback Booksmith  
Chelmsford Mall  
Chelmsford(617) 256-3514  
Software Centre  
International  
1000 Mass. Ave.  
Cambridge(617) 497-9128  
Tech Coop  
84 Mass. Ave.  
Cambridge(617) 491-4230
- NEW JERSEY**  
New York University  
New York(212) 675-5500  
Barnes & Noble Bookstore  
1400 Washington Ave.  
Albany(518) 457-7510  
Barnes & Noble Bookstore  
S.U.N.Y. at Stony Brook  
Student Union Center  
Stony Brook/  
(516) 246-3666  
Carnell Campus Store  
Cornell Univ.  
Ithaca  
(607) 256-3702  
Follets Univ. Bookstore  
200 Lee Entrance  
Buffalo(716) 836-3121  
Laco Bookstores, Inc.  
3610 Main St.  
Buffalo(716) 833-7131  
McGraw Hill Bookstore  
1211 Ave. of the Americas  
New York(212) 512-3663  
N.Y.U. Book Center  
18 Washington Pl  
New York(212) 598-2259  
Scranton's Books & Stationery  
334 East Main St.  
Rochester(716) 454-6060  
Syracuse Univ. Bkstr.  
303 University Pl.  
Syracuse(315) 423-4194
- NEW MEXICO**  
Holman's, Inc.  
401 Wyoming Blvd. NE  
Albuquerque/  
(505) 265-7981  
Newsland  
2112 Central S.E.  
Albuquerque/  
(505) 242-0694
- NEW YORK**  
Barnes & Noble Bookstore  
105 Fifth Ave.  
New York(212) 675-5500  
Barnes & Noble Bookstore  
1400 Washington Ave.  
Albany(518) 457-7510  
Barnes & Noble Bookstore  
S.U.N.Y. at Stony Brook  
Student Union Center  
Stony Brook/  
(516) 246-3666  
Carnell Campus Store  
Cornell Univ.  
Ithaca  
(607) 256-3702  
Follets Univ. Bookstore  
200 Lee Entrance  
Buffalo(716) 836-3121  
Laco Bookstores, Inc.  
3610 Main St.  
Buffalo(716) 833-7131  
McGraw Hill Bookstore  
1211 Ave. of the Americas  
New York(212) 512-3663  
N.Y.U. Book Center  
18 Washington Pl  
New York(212) 598-2259  
Scranton's Books & Stationery  
334 East Main St.  
Rochester(716) 454-6060  
Syracuse Univ. Bkstr.  
303 University Pl.  
Syracuse(315) 423-4194
- NORTH CAROLINA**  
Bulls Head Bookshop  
UNC Student Stores  
Chapel Hill(919) 562-5060  
The Computer Store  
1023 S. Main St.  
Laurinburg(919) 276-4424  
Duke University Bkstr.  
Bryan Center  
Durham(919) 684-6793
- OHIO**  
Abscop Computer Store  
225 E. 6th St.  
Cincinnati(513) 421-5900  
Books and Co.  
3164 Stroop Rd  
Dayton(513) 298-6540  
Cincinnati Computer Str.  
11711 Princeton Pike  
Cincinnati(513) 671-6440  
Howard's Office Supplies  
2639 Soloro Parkway  
Columbus(614) 876-8080  
MicroCenter  
Lane Ave. Shopping Ctr.  
Columbus(614) 481-8041  
Roth Office Equip. Co.  
108 N. Jefferson St.  
Dayton(513) 226-6175  
Wilkie News  
Corner of 4th & Ludlow  
Dayton(513) 223-2845
- OREGON**  
Book Vault  
Bernard's Mall  
3125 S. Cedar Hills Blvd.  
Beaverton(503) 646-0396  
Portland State Bookstore  
531 S. W. Hall  
Portland(503) 226-2631
- PENNSYLVANIA**  
Penn State Bkstr. on Campus  
Penn State Univ.  
University Park/  
(814) 863-3586
- RHODE ISLAND**  
Brown Univ. Bookstore  
71 Olive St.  
Providence(401) 863-3168
- TENNESSEE**  
Burke's Book Store, Inc.  
634 Poplar Ave.  
Memphis(901) 527-7484  
Univ. Book & Supply Str.  
Univ. of Tennessee  
University Center  
Knoxville(615) 974-1054
- TEXAS**  
Austin Community College Bookstore  
817 W. 12th St.  
Austin(512) 474-7534  
Book Merchant  
1810 Main St.  
Dallas(214) 748-5195  
Booktop  
1-10000 Amber Road  
San Antonio/  
(512) 697-0588  
The Brown Bookshop  
1129 Fannin  
Houston(713) 652-3937  
Houston Book Shop West  
10001 Westheimer  
Houston(713) 783-2002  
The Micro Store  
634 S. Central Expwy.  
Richardson(214) 231-1096  
Rich Campus Store  
6100 S. Main  
Houston(713) 527-4052  
The Software Place  
6369 Westheimer  
Houston(713) 781-1488  
Taylor's No. 1  
5455 Belt Line Rd.  
Dallas(214) 934-1500  
Taylor's No. 2  
4801 Northwest Pkwy  
Dallas(214) 363-5100  
Taylor's No. 3  
254 Lincoln Square  
Shopping Center  
Arlington(817) 277-1100  
Taylor's No. 4  
6348 Camp Bowie Blvd.  
Fort Worth(817) 763-0011  
Texas A & M Univ.  
Bookstore  
University Center  
College Station/  
(409) 845-4461  
Univ. Coop Society  
2246 Guadalupe  
Austin(512) 476-7211  
University Store  
North Texas State Univ.  
P. O. Box 1647  
Ingram Bldg  
Denton(817) 565-3194  
Univ. of Texas  
Arlington, Univ. Bkstr.  
501 Monroe  
Arlington(817) 273-2785  
Varsity Bookstore  
1305 University  
Lubbock(806) 763-9358
- UTAH**  
Varsity Bookstore  
200 Univ. St.  
Salt Lake City/  
(801) 585-5055
- WASHINGTON**  
Elliott Bay Book Co.  
103 S. Main St.  
Seattle(206) 624-6600  
Tower Books  
20 Mercer St.  
Seattle(206) 283-6333  
University Book Store  
4326 Univ. Way N.E.  
Seattle(206) 634-3400
- WISCONSIN**  
B&B Enterprises of WI  
d/b/a Software Centre Int'l  
2229 S. 108th St.  
West Allis(414) 545-5727  
Harry W. Schwartz Bkshp.  
Grand Avenue #1149  
275 W. Wisconsin Ave.  
Milwaukee(414) 276-4144  
Harry W. Schwartz Bkshp.  
205 S. Wisconsin Ave.  
Milwaukee(414) 276-4144  
Harry W. Schwartz Bkshp.  
440 W. Wisconsin Ave.  
Milwaukee(414) 272-2700



# CONSULT BOOKWARE™

for expert, affordable advice on your computer.

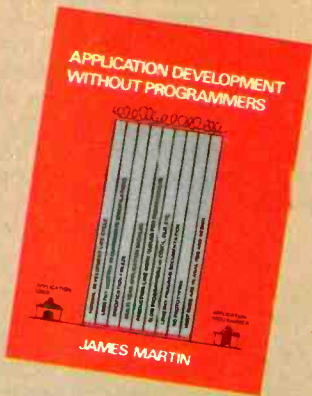

Application Development without Programmers by James Martin. \$40.00(c)

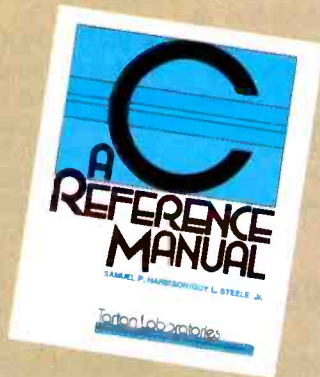

C: A Reference Manual by Tartan Laboratories, Inc. \$19.95(pa)

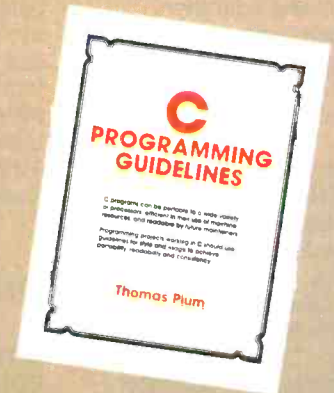

C Programming Guidelines by Thomas Plum. \$26.00(pa)

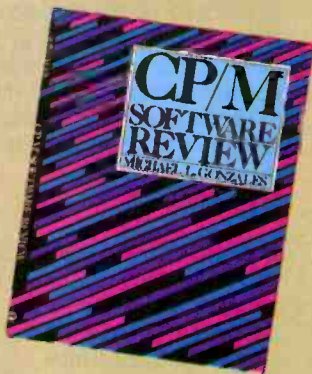

CPM Software Review by Michael Gonzales. \$19.95(pa)



Microcomputer Systems: The 8086/8088 Family, Architecture, Programming, and Design by Yu-Cheng Liu & Glenn Gibson. \$35.95(c)



Operating System Design: The XINU Approach by Douglas Comer. \$29.95(c)



Pascal Under UNIX by J.N.P. Hume & R.C. Holt. \$16.95(pa)

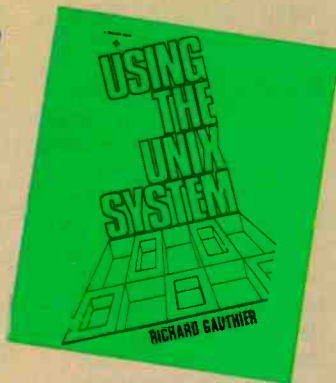

Using the UNIX System by Richard Gauthier. \$16.95(pa)

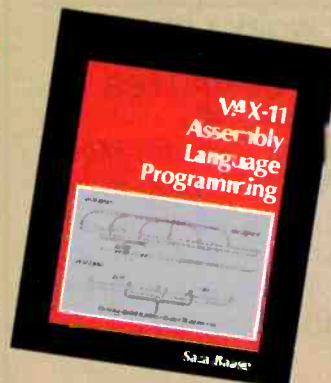

VAX-11 Assembly Language Programming by Sara Baase. \$28.95(c)

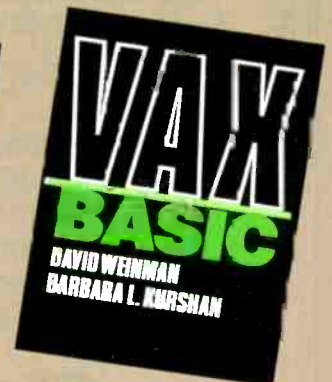

VAX BASIC by David Weirman & Barbara Kurshan. \$16.95(pa)

Bookware™ is a trademark of Prentice-Hall, Inc.

Prices are subject to change.

# Prentice-Hall, Inc.



on which local area networks are based. The fee is \$795. Contact Elaine Hadden Nicholas, Department of Continuing Education, Georgia Institute of Technology, Atlanta, GA 30332-0385, (404) 894-2547. November 28-30

● **SIMULATION CONFERENCE**—Winter Simulation Conference, Sheraton Dallas Hotel, Dallas, TX. Papers, tutorials, sessions, and panel discussions will complement commercial exhibits. Contact Udo Pooch, Department of Computer Science, College of Engineering, Texas A&M University, College Station, TX 77843, (409) 845-5498. November 28-30

● **KIDS SHOW**  
Bits & Bytes, Disneyland

Convention Center, Anaheim, CA. This conference and exposition attempts to show educators, parents, and children how to use computers in the home and classroom. Contact Information Processing Group, Suite 113-150, 350 South Lake Ave., Pasadena, CA 91101, (818) 792-5111. November 30-December 2

**December 1984**

● **TELECOMMUNICATIONS CONFERENCES**—Telecommunications Programs, various sites throughout the U.S. "Finding Telecommunications Information" and "Satellite Technology for the Nontechnical Manager" will be offered. Contact Phillips Publishing

Inc., Suite 1200N, 7315 Wisconsin Ave., Bethesda, MD 20814, (301) 986-0666. December-January

● **SNA EXPLAINED**  
Systems Network Architecture, Atlanta, GA. Systems Network Architecture (SNA), IBM's design for an end-to-end communications network, is investigated. Course fee is \$795. Contact Elaine Hadden Nicholas, Department of Continuing Education, Georgia Institute of Technology, Atlanta, GA 30332-0385, (404) 894-2547. December 4-6

● **BUSINESS SOFTWARE**  
Software Connection, Coliseum, New York City. This computer software exposition focuses on business applications. Contact Conference Management Corp., 17 Washington St., Norwalk, CT 06854, (203) 852-0500. December 5-7

● **OPTICAL, VIDEODISCS CONVOCATION**—The Fourth American Videodisc and Optical Disk Conference, Washington Hilton, Washington, DC. Speakers and sessions will highlight this event. Contact Meckler Communications, 520 Riverside Ave., Westport, CT 06880, (203) 226-6967. December 5-7

● **FIFTH GENERATION COMPUTERS**—Fifth Generation and Super Computers: An International Symposium, Rotterdam, The Netherlands. Lectures and panel discussions will be featured. Prototypes of Japanese machines are expected to be shown for the first time outside Japan. Contact Fifth Generation and Super Computers Symposium 1984, Rotterdam Tourist Office, Stadhuisplein 19, 3012 AR Rotterdam, The Netherlands; tel: (010) 14 14 00; Telex: 21228 vvvnl. December 11-13

● **DEC SHOW**  
DEXPO West 84, The Sixth National DEC-Compatible Industry Exposition, Disneyland Hotel, Anaheim, CA. Products and services that support Digital Equipment Corporation's machines will be displayed. Contact Ex-consul International Inc., 55 Princeton-Hightstown Rd., Princeton Junction, NJ 08550, (609) 799-1661. December 11-14

● **TECHNOLOGY UPDATE**—Hi-Tech Update '84, Delta Ottawa Hotel, Ottawa, Ontario, Canada. A series of presentations designed to inform senior management, engineers, and consultants. Sponsored by the Carleton University Faculty of Engineering. For further details, contact Conference Coll Inc., 1138 Sherman Dr., Ottawa, Ontario K2C 2M4, Canada, (613) 224-1741. December 12-13

● **EDUCATIONAL COMPUTING**—The Second Annual International Computers in Education Conference, Queen Elizabeth Hotel, Montreal, Quebec, Canada. More than 100 exhibitors and 125 speakers will participate in conferences sponsored by the McGill University Faculty of Education. For more information, contact GEMS Conference and Consulting Services, POB 367, Snowdon, Montreal, Quebec H3X 3T6, Canada, (514) 735-1388. December 12-14

● **COMPUTERS AND SOFTWARE**—The Fourth Annual Southeast Computer Show and Software Exposition, Civic Center, Atlanta, GA. Contact CompuShows, POB 3315, Annapolis, MD 21403, (800) 368-2066; in Annapolis, (301) 263-8044; in Baltimore, (301) 269-7694; in the District of Columbia, (202) 261-1047. December 13-16 ■

**WHAT DO ALL TABLETOP DIGITAL MULTIMETERS HAVE IN COMMON?**

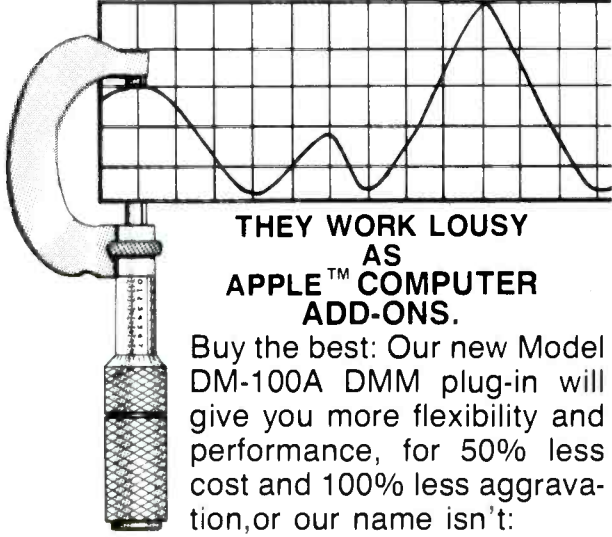

**THEY WORK LOUSY AS APPLE™ COMPUTER ADD-ONS.**

Buy the best: Our new Model DM-100A DMM plug-in will give you more flexibility and performance, for 50% less cost and 100% less aggravation, or our name isn't:

**Dataq**  
INSTRUMENTS, INC

100 Lincoln Street • Akron, Ohio 44308 • (216) 434-4284

#1 Rating  
(Spreadsheets Configuration)  
A Jerebach's Index

"... a terrific machine"  
Microcomputing May 1984

"... a great bargain"  
Computers and Electronics May 1984

"The MBC-550 is more computing machine for the dollar than any other personal computer on the market."

Byte August 1984



# We have the lowest prices for the Sanyo 550's (and more free software)\*

\*Our prices this month are at least \$10 less than any other bona-fide advertised price in this magazine for Sanyo 550's, 555's, 550-2's, 555-2, and our new 720's "dash fours". Plus in addition to Sanyo's regular software bundle we include two free disks with games, graphics, diagnostics, and more. Low prices aren't the only reason we've sold more Sanyo computers than any dealer in the United States. To find out why these "under \$1000" MS-DOS machines are the best value in microcomputing call or write for our free brochure.

Plus (w/free LG Printers) 1150's - \$1499 1250's - \$1849 4050's - \$1999



## ALTOS

From the lowest-priced dual-floppy multi-user systems to true 16-bit 10 Mhz. multi-user systems. Local service available via TRW. We will configure, test and install your systems for an additional charge (call for prices).

580-20 .....	\$3269	586-40 .....	\$7444
580-40 .....	\$3995	8000 Series .....	Call
586-20 .....	\$5995	Altos II .....	\$759

XENIX PHONE SUPPORT



## COLUMBIA

What are you looking for in a compatible system? If maximum compatibility, minimum prices, \$3000 worth of software, reliability and nationwide service are on your checklist you should consider buying a Columbia from Scansdale Systems. Each system comes with MS-RTOS, CP/M Calc, Fast Graphs, Home Acc'r Plus, Space Commanders, a tutorial and nationwide Bell and Howell service. (Prices for 1600 series include video card and keyboard).

V.P. (Portable) .....	\$1899	*600-1V .....	\$1899
The Pro-10Mb, 600K .....	Call	*600-4V (10mb) .....	\$3239

### TERMINALS



Wyse 50 .....

Also great prices on aDDS, other Wyse models, Televideo, Altos, Zenith and Game terminals.

### PLOTTERS

HI DMP-29 .....	\$1795
HI DMP-40 .....	\$745
HI DMP-41 .....	\$2340

### MODEMS

Password .....	\$309
Mark XII .....	\$249

### Compatible Drives Teac Slimline

FD54A (160K) .....	\$89
FD54B (360K) .....	\$149
FD55F (720K) .....	\$189

### APPLE MACINTOSH

### LIMITED SUPPLY

### PRINTERS

# Scottsdale Systems Ltd.

617 N. Scottsdale Road, Suite B, Scottsdale, Arizona 85257



(602) 941-5856



Call 8-5 Mon.-Fri.



We participate in arbitration for business and customers through the Better Business Bureau of Maricopa County.

SINCE 1980

TELEMARKETING ONLY: If you plan to visit please call first for an appointment. Prices listed are for cash and include a 3% discount. We sell on a Net 30 basis to Fortune 1200 companies and universities. No C.O.D.'s or A.P.O.'s. P.O.'s add 2%. Visa, Mastercard add 3%. Az. residents add 6%. Prices subject to change, product subject to availability. Personal, company checks take 3 weeks to clear. All items listed are new with manufacturers warranty, 0-20% restocking fee for returned merchandise. Shipping extra-products are F.O.B. point of shipment. Software is not warranted for suitability. Registered trademarks: Televideo-Televideo Systems, Inc.; Unix-AT&T Technologies, Inc.



Tally Spirit 80 .....	\$259
Okidata 92 .....	Same
Okidata 93 .....	\$350 Off
Plug n' Play .....	Free if you ask
Okidata 84 .....	Call
Dataproducts	
Prism 132 "loaded" .....	\$1488
Tally 160L .....	\$589
Tally 180L .....	\$789
Epson FX-80 .....	New Low Price
Panasonic 1091 .....	\$306
Toshiba P1340 .....	\$739
Toshiba P1351 .....	\$1299

### LETTER QUALITY

Diablo 630 .....	\$1649
Juki 6100 .....	\$418
Silver Reed 500 .....	\$355
Silver Reed 550 .....	\$414
NEC 3530 .....	\$1279
NEC 3550 .....	\$1595
NEC 7700's .....	\$1735
Daisywriter 2000 .....	\$824

### OKIDATA

Now you can have twice the resolution of an Okidata 92 for about the same price. Buy an Okidata 82 at the retail price of \$349 and we'll install an Ok-Writer enhancement for \$70. You'll have the perfect double duty printer with 120 c.p.s. in draft mode and an 18x17 resolution in correspondence mode - plus a serial port. Call for print sample.

\$419



Ok! 82

w/Ok-Writer

### STAR MICRONICS SALE

Gemini 10X PC .....	\$258
Power Type .....	\$358
Radix 15 PC .....	\$658





# DATAEASE™

**"DATAEASE is a true winner  
— on technical merit alone,  
DATAEASE would put dBASE II  
out of business."**

**Business Computer Systems  
April 1984**

DATAEASE is the most complete information management system available. While literally hundreds of systems claim to offer simple solutions to complex business information needs, rave reviews from our clients, application developers and the media confirm DATAEASE as the only product which delivers on this promise.

*"DATAEASE received the highest 'Overall Evaluation' rating of the five fully relational programs tested by Software Digest in its report on 20 IBM PC database and file management programs appearing in the March 1984 issue of The Ratings Newsletter."*

**The Ratings Newsletter  
Software Digest, 1984**

Thousands of business clients worldwide — large and small — say DATAEASE increases productivity. And that is why, in a few short months,

DATAEASE has become a top-seller within the Fortune 500 companies.

*"What took five man-months of development with dBASE II, was accomplished in two weeks with DATAEASE."*

**Bob Scavullo, President  
Noesis Computing Company**

*"DATAEASE enabled us to change files, records and reports with no fear of losing data — I can't begin to put a value on that."*

**Peter J. Newcombe, Corp. MIS Manager  
General Defense Corporation**

Here are some of the features that make DATAEASE the best buy on the market today:

- Layout your forms on the screen.
- Connect any number of files in seconds.
- Access functions with single keystrokes.
- Modify records and design custom reports.





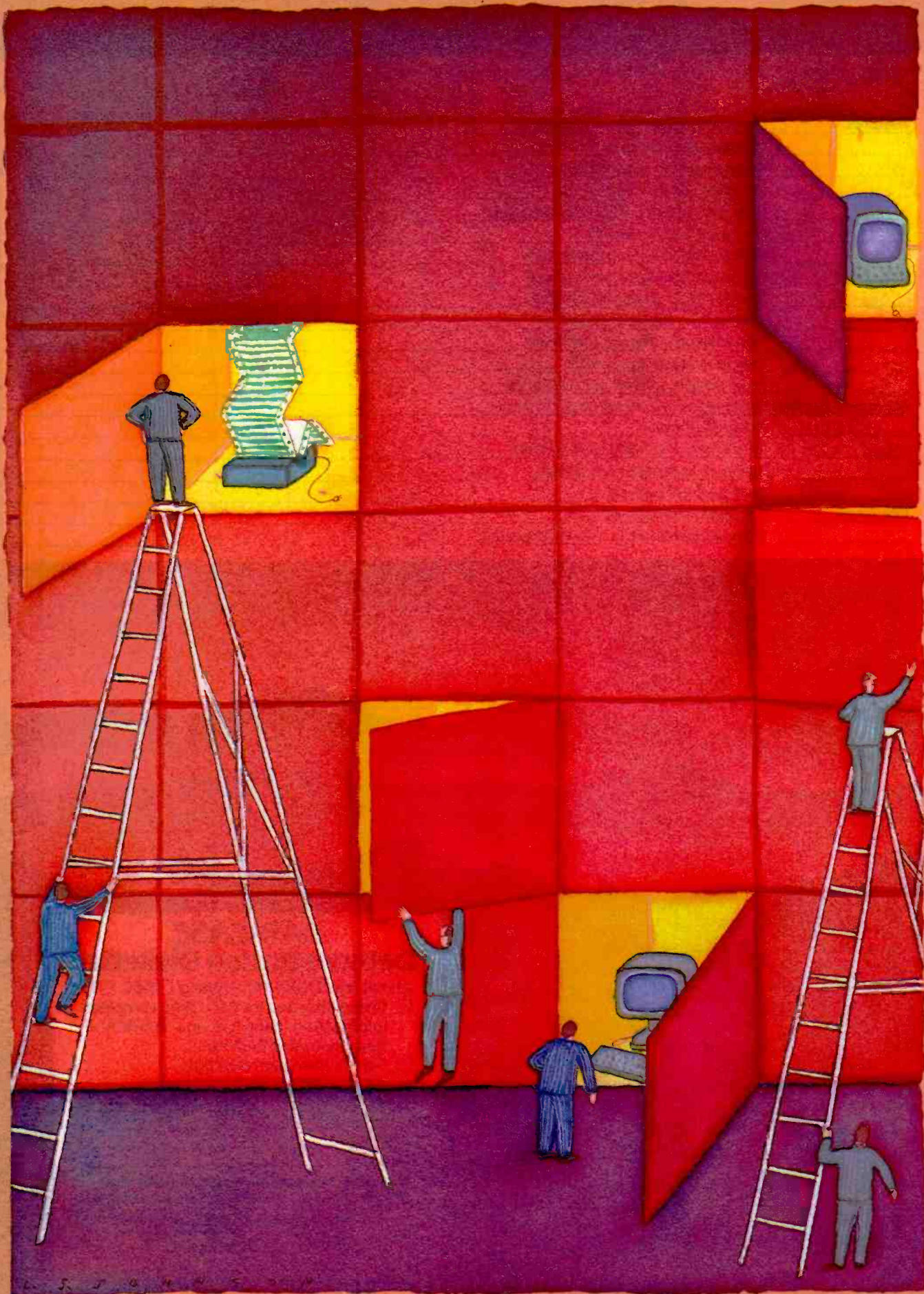

# Features

---

<b>THE IBM PC AT</b> <i>by</i> BYTE Staff .....	108
<b>CIARCIA'S CIRCUIT CELLAR: AN ULTRASONIC RANGING SYSTEM</b> <i>by</i> Steve Ciarcia .....	112
<b>USING A MOUSE WITH LOTUS 1-2-3</b> <i>by</i> John Doolittle .....	124
<b>IMPLEMENTING CRYPTOGRAPHIC ALGORITHMS ON MICROCOMPUTERS</b> <i>by</i> Charles Kluepfel .....	126
<b>GENERATING AND TESTING PSEUDORANDOM NUMBERS</b> <i>by</i> Charles A. Whitney .....	128
<b>DATA ABSTRACTION</b> <i>by</i> Gary F. Simons .....	130

---

CHASTISED FOR DUMPING the underwhelming PCjr on a new-technology-starved public, IBM blazed forth with its latest marvel, the Personal Computer AT, in mid-August. Our product description of the new machine reveals some curiosities: its Intel 80286 microprocessor runs at only 6 MHz; an upgraded PC-DOS is neither multitasking nor multiuser but does provide support for networking; and the redesigned AT keyboard breaks with the previous ISO standard layout, which will no doubt generate a sigh of relief from the PC-using public. (Alas, the AT cannot be used with prior-model Personal Computers.)

Our Circuit Cellar dweller Steve Ciarcia embarks on an ambitious project to build an ultrasonic ranging device called the SonarTape. It measures distances from 1½ to 35 feet using sound waves. It's the ultimate measuring tape based on a Polaroid ultrasonic transducer. Accurate to ¼ foot, the SonarTape can be built for about \$50.

Computer science has certain recurring themes—difficult problems that ideally test and eventually succumb to the number-crunching power of computing machines. Sorting and prime-number generation are two standard computer problems. The computation of irrational numbers to outrageous decimal places is another. But surely two of the science's favorites are cryptography and random numbers.

These two esoteric disciplines are often interwoven in the search for the ultimate cryptographic key. The generation of random numbers, however, plays a major role in numerous other endeavors, from simulation to statistical analysis. But random-number generation is not as easy as it might seem.

Two articles this month explore these classic problems. Charles Whitney's voyage into the murky world of random numbers shows that testing the random processes for generating these numbers is important but not difficult. Whitney's techniques may prove to be the definitive method for testing the high-level language routines, such as those used by the various purveyors of BASIC, for producing random numbers.

A feature by Charles Kluepfel shows how to build 200-digit cryptographic keys using a modified RSA algorithm and the muMath/muSimp package on an Apple computer. This article is an excellent introduction to both cryptography and to the LISP-like muMath package.

Complex computer-science concepts come to the fore again in Gary Simons's feature on data abstraction. The key to this idea is building data structures that you can manipulate without having to worry about the nature of the data that will eventually populate the structure. Simons explains the concepts of information hiding and abstract data types and presents a practical application of data abstraction in a BASIC program.

The mouse seems here to stay, so BYTE features an article that shows you how to write a driver to adapt a mouse for use with the popular Lotus 1-2-3 software. The technique involves reading the mouse pointer position and interpreting a mouse-click as a carriage return to select menu items.

—G. Michael Vose, Senior Technical Editor, Features



# THE IBM PC AT

*Powerful hardware with a split personality*

*Editor's Note: The following is a BYTE product description. It is not a review. We provide this advance look at this new product because we feel it is significant. A complete review will follow in a subsequent issue.*

Exactly three years after the introduction of the IBM PC, IBM announced the PC's second upgrade, the second network for its personal computers, and, finally, a reasonable keyboard. The new IBM PC AT (advanced technology) has a number of interesting features: a 6-MHz 80286 microprocessor (with 2 to 3 times increased performance over the PC), a 1.2-megabyte minifloppy-disk drive, an optional 20-megabyte hard-disk drive, an enhanced yet compatible expansion bus, the aforementioned keyboard, and an on/off lock switch. On the software side, IBM announced a new version of IBM PC-DOS (3.0), which has some minor improvements and supports networking but not multitasking. However, in the first quarter of 1985, IBM will release TopView, an operating environment that allows multitasking and costs \$149, and an 80286-based version of XENIX (UNIX System 3) with multitasking and multiuser capabilities.

The prices for these new products are surprisingly competitive. The base price of an IBM PC AT without the 20-megabyte disk drive is \$3995, but a working system in the standard BYTE configuration (two disk drives, 256K bytes of RAM, display, color capability, interfaces, DOS) costs about \$5700. In the standard BYTE configuration, plus a 20-megabyte hard-disk drive, total cost is about \$6700.

## THE SYSTEM UNIT

The system unit is about an inch thicker than the PC. Also, the disk drives are half-height and medium beige. Finally, what looks like an ignition key dangles from the front panel (see photo 1).

The most dramatic changes in the system are inside the unit. First is the 80286 microprocessor,

running at a clock speed of 6 MHz. Like the 8086 microprocessor, the 80286 is a true 16-bit microprocessor with both external and internal data buses 16 bits wide. Also, the 80286 has advanced memory-management capabilities that let it access a virtual memory address space of 1 gigabyte.

The 80286 can run under two modes. Under PC-DOS, the 80286 runs in the "real address" mode, in which it emulates an 8086 similar to the 8088 in the IBM PC. In this mode, the 80286 can access only 640K bytes of system memory directly. In the second mode, under XENIX, the 80286 can directly access up to 16 megabytes of physical memory.

IBM claims that the AT performs 2 to 3 times faster than the PC. We expected a 25 percent increase in speed just due to the difference in clock speed. The true 16-bit data bus usually provides another 40 percent increase in processing speed. In actual tests, we found an increase of 150 percent; that is, the AT is 2½ times faster than the PC.

Minimum system memory is 256K bytes; the maximum is 3 megabytes (using five 512K-byte memory expansion cards).

## DISK DRIVES

The AT comes with a new type of floppy-disk drive capable of storing 1.2 megabytes of data. These half-height drives achieve this high density by using special disks, a track density of 96 tpi (tracks per inch) as opposed to 48 tpi on the PC, and 15 sectors per track instead of 9 sectors per track as in PC-DOS 2.0. These drives can read standard 360K-byte disks but have trouble writing to these disks in a way that can be read by ordinary 360K-byte disk drives.

The AT has enough space for two of these drives. Or, for more compatibility with the PC, a regular 360K-byte drive can be installed in place of the second high-capacity floppy-disk drive.

In addition to the two possible floppy-disk drives, an optional 20-megabyte hard-disk drive is available for the AT. Also available is

## BY BYTE STAFF

Rich Malloy is Product Review editor; G. Michael Vose is Features editor; Tom Clune is a technical editor. They can be contacted at POB 372, Hancock, NH 03449.

a half-height version of this drive that lets you install two 20-megabyte drives with one floppy.

## OTHER HARDWARE

The expansion bus in the AT (see photo 2) features some compatibility with the PC but also lets the expansion cards have access to the 80286's extra data and address lines. Two connectors are provided for six of the eight slots. One is the standard 62-pin IBM PC expansion slot connector. Just forward of this is another 36-pin connector for the additional lines.

You can use the lock on the AT's front panel to lock the machine off or on. This lock disables the on/off switch along with the keyboard. It also locks the cover on. For example, if you are running a network or a program that requires a long time to execute, you can lock the system on. This disables the keyboard and prevents passersby from interfering with the system.

The keyboard itself looks perfect. It features oversized Return and Shift keys (see photo 3), and the dreaded Backslash key has been moved up next to the Backspace key. It also has indicator lights for Caps Lock, Num Lock, and Scroll Lock. The keyboard feels and sounds exactly like that of the PC. Also, the keyboard has a long cord that lets you put the system unit on the floor rather than on your desk.

We really like this keyboard, but we have used at least one word processor program (XyWrite II Plus) that does not work with the Caps Lock indicator light. Unfortunately, this keyboard *cannot* be used with the PC.

The AT has serial and parallel interfaces on combination serial/parallel expansion cards. Each card has one serial and one parallel interface. You can use up to two cards in the system. The parallel interface uses a female DB-25 connector, just like the PC, but the serial interface uses a male DB-9 connector. This means you have to buy a special DB-9/DB-25 cable. The reason for this strange connector is probably because the card did not have enough room for another DB-25 connector.

Despite the many rumors, the AT uses the same display adapter cards as the PC. However, these cards fit only in slots 1 or 7.

And IBM finally knows what time it is. The AT has a clock/calendar chip with a small bank of CMOS (complementary metal-oxide semiconductor) RAM powered by a battery. The 50 bytes of CMOS RAM store information such as how much memory is installed and what kind of drives are available. This eliminates the need for DIP switches on the motherboard. In

(continued)

## Specifications: IBM PC AT

### MANUFACTURER

IBM Entry Systems Division  
POB 1328  
Boca Raton, FL 33432  
(800) 447-4700

### PROCESSOR

16/16-bit Intel 80286, 6-MHz clock rate

### MEMORY

256K bytes to 3 megabytes

### DISK DRIVES

One 5¼-inch 1.2-megabyte floppy drive  
Optional 20-megabyte hard disk  
Optional 5¼-inch 360K-byte drive

### OPERATING SYSTEM

IBM PC-DOS 3.0  
Available soon: DOS 3.1 and XENIX

### SOFTWARE

IBM PC BASIC 3.0

### PRICE

With 1.2-megabyte disk drive.....	\$3995
Above with monochrome display, color graphics card, interfaces, second disk drive, and DOS..	\$5469
With 1.2-megabyte drive, 20-megabyte hard-disk drive, interfaces, and 512K bytes of memory..	\$5795
Above with monochrome display, color graphics card, and DOS.....	\$6694



Photo 1: The IBM PC AT with a 20-megabyte hard-disk drive. This unit is equipped with an IBM monochrome monitor and a second, 360K-byte floppy-disk drive. Note the switch lock on the front panel.



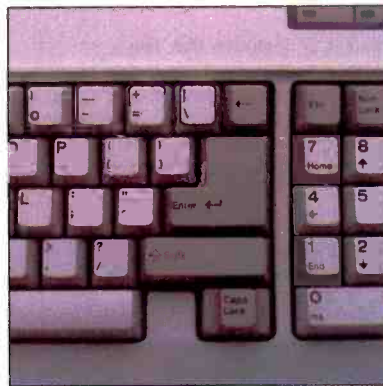
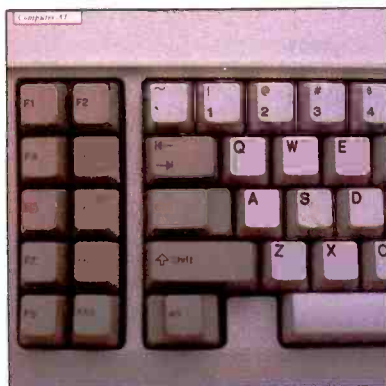
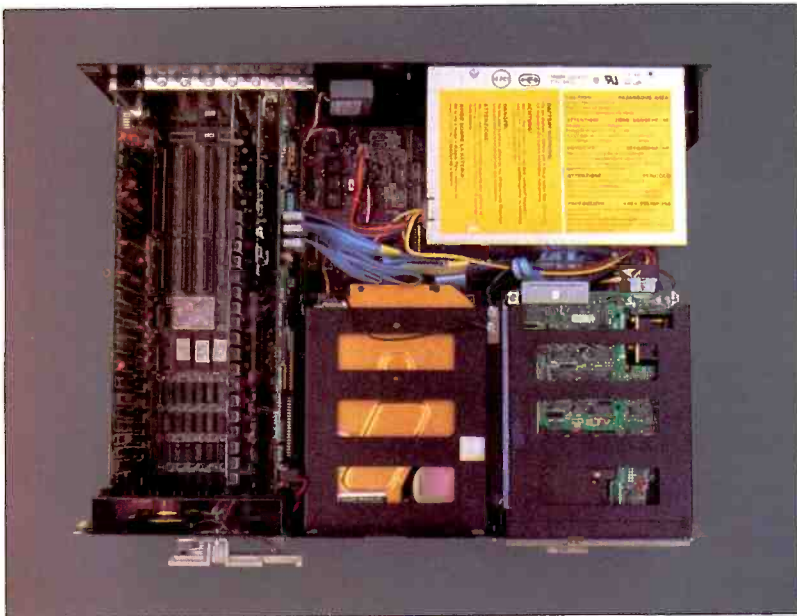

**Photo 2:** Inside the IBM PC AT. The expansion bus is at the left. Note the connectors for extra address and data lines. A 20-megabyte hard disk is in the lower middle. The power supply is in the upper right. **Photo 3:** Close-ups of the IBM PC AT keyboard. Note the proper position of the Shift key (left). Also note the indicator lights in the upper right and the large size of the Return (Enter) key (right).

fact, the only real switch on the motherboard is a poorly labeled slide switch that tells the system what type of display is attached.

### PC-DOS 3.0

An enhanced version of the PC-DOS operating system drives the IBM PC AT. Labeled version 3.0, it provides a software upgrade path within the PC product line while accommodating the hardware differences of the AT's architecture. The new DOS runs on IBM PCs and XT's and the PCjr as well as the AT.

The first time you use PC-DOS 3.0, you must run a startup routine. The routine defines the system's hardware—how many disk drives are installed, how much memory is installed, etc., and this information is stored in the above-mentioned CMOS RAM. This setup information is referenced each time you turn on the computer.

PC-DOS 3.0 supports the high-capacity (1.2-megabyte) floppy disks as well as the standard single- and double-sided floppies and one or

two fixed disks. These disks can be used in a variety of combinations.

The high-density floppies can store 600K bytes of information per side on 80 tracks, with 15 sectors per track. Four enhanced PC-DOS 3.0 commands, Format, Backup, and Diskcomp/Diskcopy, provide support for this new class of floppy disk.

Enhancements to Backup also permit selective backup in three categories: backup of files modified since the last backup, addition of new files to a backup disk, and backup of files modified after a certain date.

Perhaps the most significant new command is Device, which permits the installation of virtual disks. Virtual disks, often called RAM disks, can number up to 24 in PC-DOS 3.0. In IBM PC ATs with extended memory, it is possible to locate virtual disks above the 1-megabyte boundary.

Version 3.0 of PC-DOS comes with three manuals and a quick reference card. The *User's Guide* is an introduction to PC-DOS written for the novice user and covers the basics of the operating system with simple text and color graphics. An *Applications Setup Guide* prompts you through the process of porting existing PC-DOS applications over to version 3.0. The DOS reference manual is a standard three-ring, loose-leaf binder with documentation similar to previous versions. A technical reference for software developers is available at extra cost.

### BASIC, TOPVIEW, AND XENIX

Version 3.0 of BASIC incorporates several extensions.

The SHELL statement loads and executes a program file (called a child process) that can be run from the system level from BASIC. If the file executed is a .BAT file ending in EXIT, control is returned to BASIC. There is a wide variety of conditions under which SHELL might cause the system to crash, including accessing the DMA controller, interrupt controller, I/O (input/output) latch, or counter timer from a child process, or altering any file opened from BASIC from a child process.

The ENVIRON\$ function returns information on BASIC's environment table (position in DOS directory). The ENVIRON statement modifies BASIC's environment table.

TopView is a separate software package that contains what we expected to find in PC-DOS 3.0. It will be released in the first quarter of 1985. TopView is an interesting multitasking environment with windowing capability. The demonstration we saw of TopView showed that you can use it with a mouse to set up windows that can execute applications concurrently.

At \$149, this package will compete against Digital Research's Concurrent PC-DOS (Concurrent CP/M-86 version 3.1 with PC-DOS emulation), which is similar in features and price. However, Concurrent PC-DOS can also run CP/M-86 applications.

As is the case with TopView, we have not yet received XENIX for this system (release date is also set for the first quarter of 1985), but we have seen a demonstration. It is limited to three users (because of the AT's two-serial-port limitation). Also, it has a nice user shell that looks very much like Multiplan. In fact, as of this writing, Multiplan is the only application program that IBM has for XENIX.

### PC INCOMPATIBILITY

IBM states that the following PC hardware products will not work with the AT: the standard PC keyboard, the parallel-printer adapter card, the 64K to 256K-byte memory cards, the asynchronous communications (serial port) card, and the expansion unit. We have not yet tested any of the numerous third-party expansion cards, but we are not optimistic.

As for software, IBM states that the following programs (among others) will not run: BPI Systems Accounting (1.0); Peachtree Accounting (1.0); EasyWriter (1.0); pfs:File and Report (1.0); VisiCalc (1.0 and 1.1); and BASIC (1.X and 2.X). We were disappointed to find that Microsoft's Flight Simulator would not work. Most other programs that we have tried (WordStar, Lotus 1-2-3, Multiplan, PeachText) do work.

Technically, IBM states that the AT might not be able to run PC programs that include memory-specific commands such as POKE; programming loops to control timing; back-to-back I/O commands to the same port (because of insufficient recovery time); the PUSH SP command (this command on the AT pushes the current stack pointer, while the PC pushes the new stack pointer); and the divide-error exception (the AT pushes the address of the instruction causing the interrupt, while the PC pushes the next instruction's address).

### CONCLUSIONS

All testing we have done with the AT to date has involved only the real address mode (under DOS 3.0). Under this mode, we have found that the AT provides an increase of 2½ times the processing speed of the PC. We have no indication of how it will perform under XENIX in the multiuser environment.

The AT might be of interest in data-acquisition applications. The system comes with 16 interrupt levels and 7 channels of DMA. The DMA controller operates at 3 MHz, which is

relatively fast. DMA channels 0 through 3 support 8-bit transfers throughout the system's 16-megabyte physical address space in 64K-byte blocks. Channels 5 to 7 support 16-bit transfers in 128K-byte blocks. Channel 4 cascades channels 0 to 3 to the 80286. IBM has documented the AT's DMA controller in the *Technical Reference Manual*. The PC and XT are a little too slow to keep up with the output of most high-speed data-acquisition systems, so the AT might find a home in these applications.

The IBM PC AT is an impressive machine, but the most important reason for its existence has yet to arrive—a powerful multiuser operating system such as UNIX. When XENIX is available, we'll be able to give a more complete evaluation of this system. For now, the AT represents a solution for applications that are taxing the PC and XT to their limits. ■

## THE IBM PC NETWORK

BY GEORGE BOND

**I**BM's entry into the microcomputer local-area network field probably will have an impact similar to that of the original IBM PC on the personal computer field—big.

The company introduced a local-area network (LAN) for PCs and an emulation program to give PCs access to mainframes. The IBM PC Network Program is the LAN. It is designed to connect PC-family machines, except for the PCjr and PC Expansion Unit, to each other. The IBM PC Network SNA 3270 Emulation Program is meant to provide System/370 mainframe applications to PCs on the PC network using IBM 3270 or SDLC (synchronous data-link control) communications protocols. The LAN is scheduled for release in the first quarter of 1985, and the emulation program by midyear 1985.

The PC Network uses standard broadband hardware components and is designed for user installation. It transmits data at 2 megabits per second using carrier-sense multiple-access/collision-detect (CSMA/CD) protocol. The physical network consists of an IBM PC Network Translator Unit (\$595), IBM PC Network Adapters (\$695), and IBM PC Network Cabling Components. As many as 72 nodes can be attached within a 1000-foot radius of the translator unit.

The network adapter unit (made by Sytek), which looks like a regular add-in board for the PC, includes an Intel 80188 microprocessor and an 82586 communications controller among its circuitry. The Network Translator Unit is composed of a frequency translator, a directional tap, and an eight-way splitter.

IBM's vision of the future appears to be just that—vision. It is giving strong hints that its goal is to combine video with voice and computer data transmission, a prime AT&T objective, on the PC LAN. The LAN uses standard RG-11 coaxial cable, a broadband cable found in cable television installations. IBM notes in one of the printed announcements relating to the AT introductions that the cabling system and the IBM PC Network media have the "inherent capability to transmit voice, video (using additional vendor equipment), and data." In another piece of introductory literature, IBM notes that the 75-ohm coax is "CATV compatible."

George Bond is BYTE's managing editor for User News. He can be contacted at POB 372, Hancock, NH 03449.



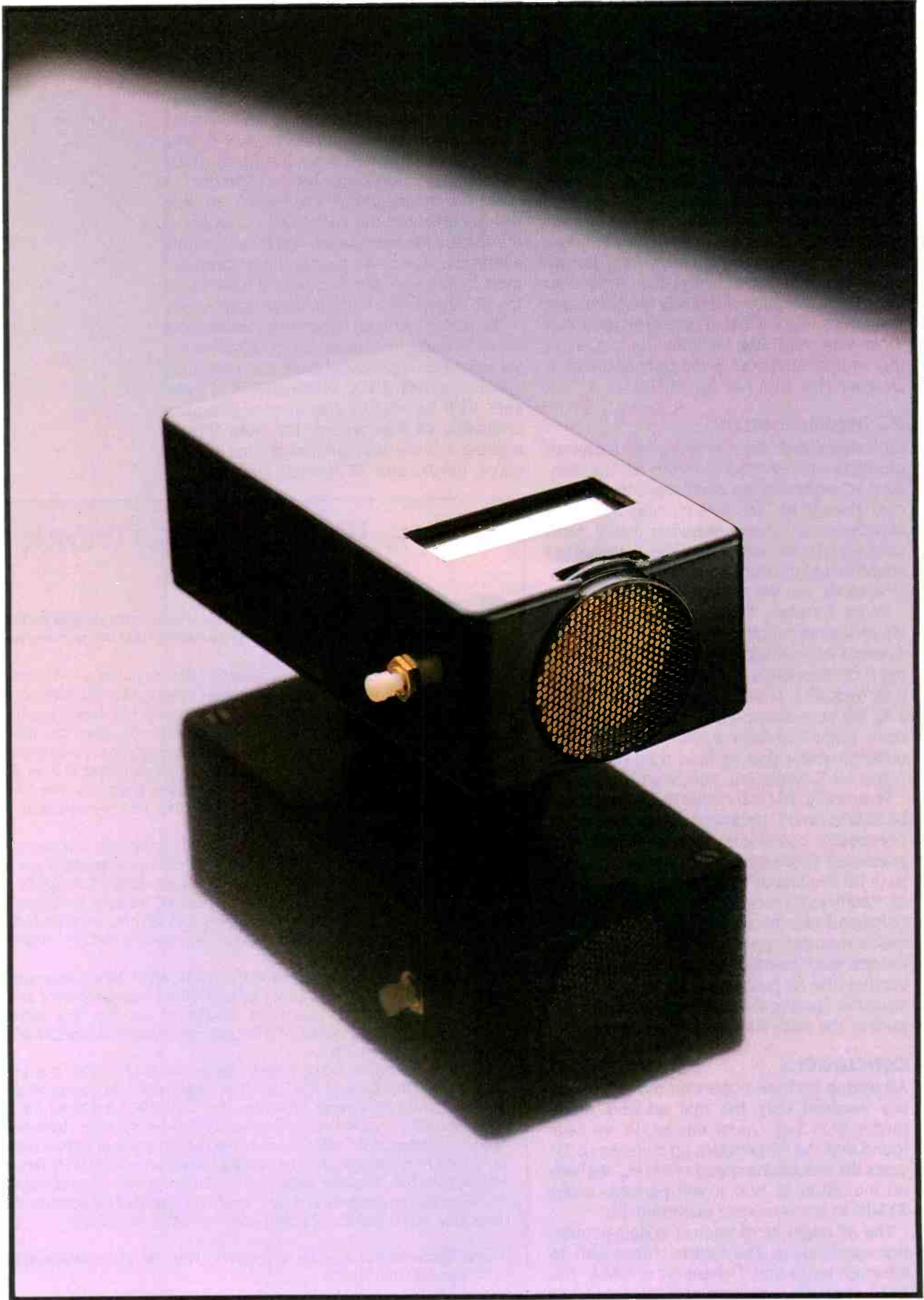

# AN ULTRASONIC RANGING SYSTEM

BY STEVE CIARCIA

## *Build the SonarTape*



Those of you who have followed the Circuit Cellar projects over the years will recognize that I have discussed sonar and ultrasonic ranging before. In November 1980's "Home on the Range! An Ultrasonic Ranging System" used the Polaroid Ultrasonic Ranging System Designer's Kit. This \$150 kit, based on a modified, custom-manufactured sonar-ranging circuit board from Texas Instruments for Polaroid's SX-70 camera, greatly simplified the circuitry normally associated with ultrasonics. The November 1980 project described circuit additions that facilitated connection of the ranging kit to a computer's I/O (input/output) port.

To my knowledge, these kits are still available from Polaroid if you are interested in producing the stepper-motor-driven scanning system described in the original article. However, if you are looking for a cost-effective distance sensor for your computer, you'll be happy to know that LSI (large-scale integration) technology did not stand still in the interim. Texas Instruments introduced a new sonar-ranging module that is both cost-effective and simple to integrate into computer-based systems.

I'll first describe this new module in detail and then demonstrate how easily you can attach it to a computer or use it indepen-

dently with an LCD (liquid-crystal display) to create an electronic tape measure.

### THE SONAR-RANGING MODULE

The latest Texas Instruments sonar-ranging module, the SN28827, is actually an updated and higher-functioning version of the original SX-70 module, both of which are shown in photo 1. The newer unit has similar performance characteristics but requires far less support circuitry and interfacing hardware. It is designed to drive a 50-kHz 300-volt (V) electrostatic transducer, which Polaroid is still manufacturing. The module and the transducer are the only components necessary to measure distances from 1.33 to 35 feet with an accuracy of  $\pm 2$  percent.

In operation, a pulse is transmitted toward a target and the resulting echo detected. The elapsed time between the transmission and echo detection is a function of the distance to the target. Basically, this distance in feet is simply the elapsed time in seconds (actually milliseconds) multiplied by the speed of sound in feet per second

*(continued)*

*Steve Ciarcia (pronounced "see-ARE-see-ah") is an electronics engineer and computer consultant with experience in process control, digital design, nuclear instrumentation, and product development. He is the author of several books about electronics. You can write to him at POB 582, Glastonbury, CT 06033.*



### Specifications

Minimum Transmitting Sensitivity at 50 kHz 300 V AC peak to peak, 150 V DC bias (dB re 20 $\mu$ Pa at 1 meter)	110 dB
Minimum Receiving Sensitivity at 50 kHz 150 V DC bias (dB re 1 V/Pa)	-42 dB
Suggested DC Bias Voltage	150 V
Suggested AC Driving Voltage (peak)	150 V
Maximum Combined Voltage	400 V
Capacitance at 1 kHz (typical) 150 V DC bias	400-500 pF
Operating Conditions	
Temperature	32°-140° F
Relative Humidity	5%-95%
Standard Finish	
Foil	Gold
Housing	Flat Black

Figure 1: Specifications for the Polaroid electrostatic transducer.

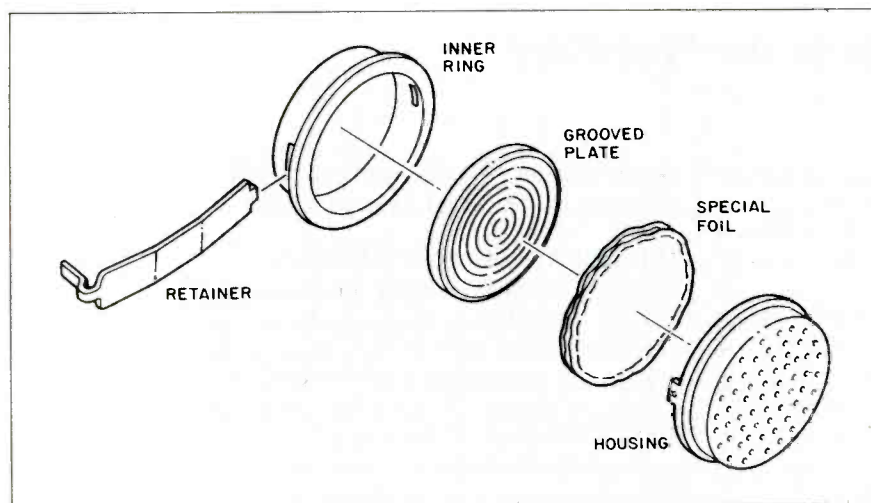

Figure 2: The parts of the transducer.

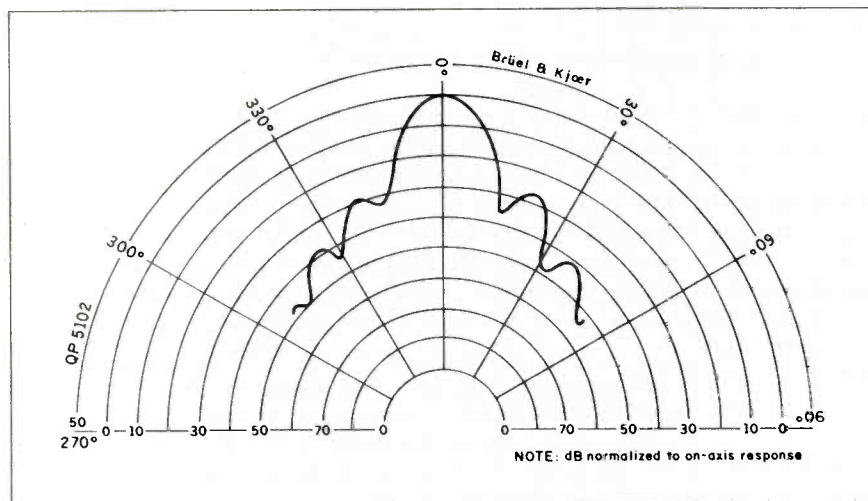

Figure 3: The transducer's beam pattern at 50 kHz

(approximately 1100 ft/sec). More specifically, the rate is 1.78 milliseconds (ms) per round-trip foot. It takes 3.55 ms for a pulse to leave the transducer, strike a target 2 feet away, and return to the transducer.

The transducer most frequently used with this module is the instrument-grade Polaroid electrostatic transducer (see figure 1 for its specifications), which acts as a speaker in the transmit mode and a microphone in the receive mode. The transducer (shown in photo 2 and disassembled into its component parts in figure 2) is 1.5 inches in diameter and consists of a 3-millimeter gold-plated foil stretched over a concentrically grooved aluminum disc.

The foil, electrically insulated yet bonded closely to the metallic backplate, forms a capacitor. The foil is the moving element in the transducer that converts electrical energy into sound and the returning echo into electrical energy.

The Polaroid sensor is larger and, in my opinion, considerably more expensive than other 50-kHz transducers. However, it is designed this way for a specific purpose. (I've tried 50-kHz transducers from two other manufacturers with no success.) The diameter of the transducer determines its directional sensitivity. The Polaroid unit is extremely directional, as indicated in the graph of acoustical-signal strength shown in figure 3.

### OPERATING THE MODULE

The sonar-ranging module (pictured in photo 3 and diagramed in figure 4) is a two-chip, 2- by 2-inch module. It is a 12-component, custom-manufactured module built around the Texas Instruments TL851 and TL852 sonar-ranging controller/receiver chip set. In small quantities, the assembled module is far less expensive than the individual components, and it eliminates the ever-present aggravation of finding the correct coils and chokes. Electrical connection is made through an eight-conductor flat ribbon cable or direct solder attachment to the connector base, which contains three output lines, three input lines, power, and ground.

The two basic modes of operation for the module are single echo and multiple echo. The single-echo mode

(continued)

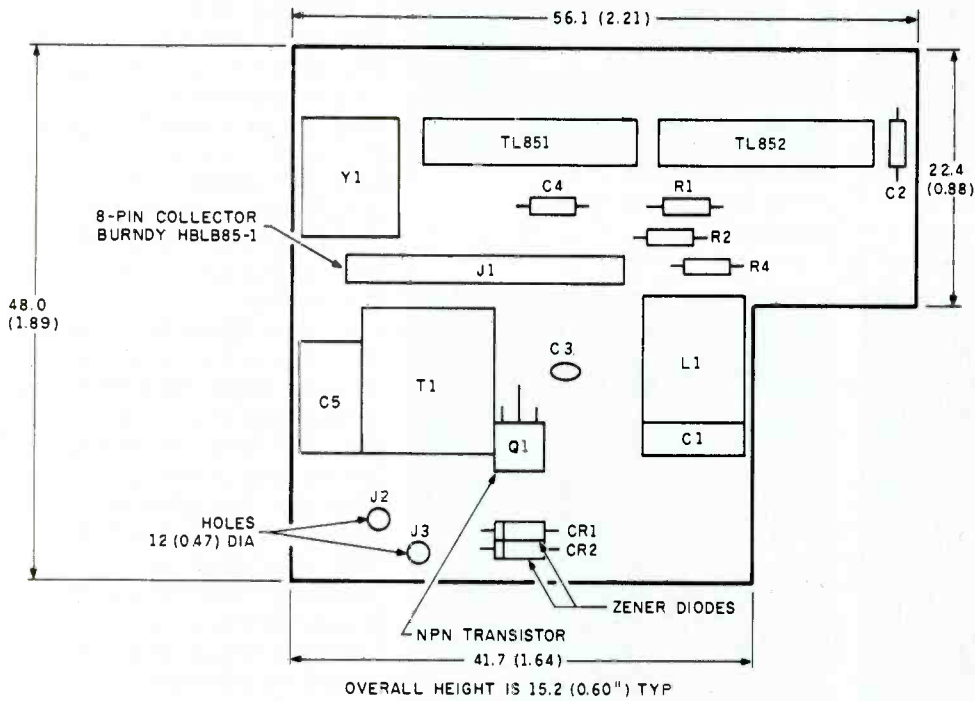
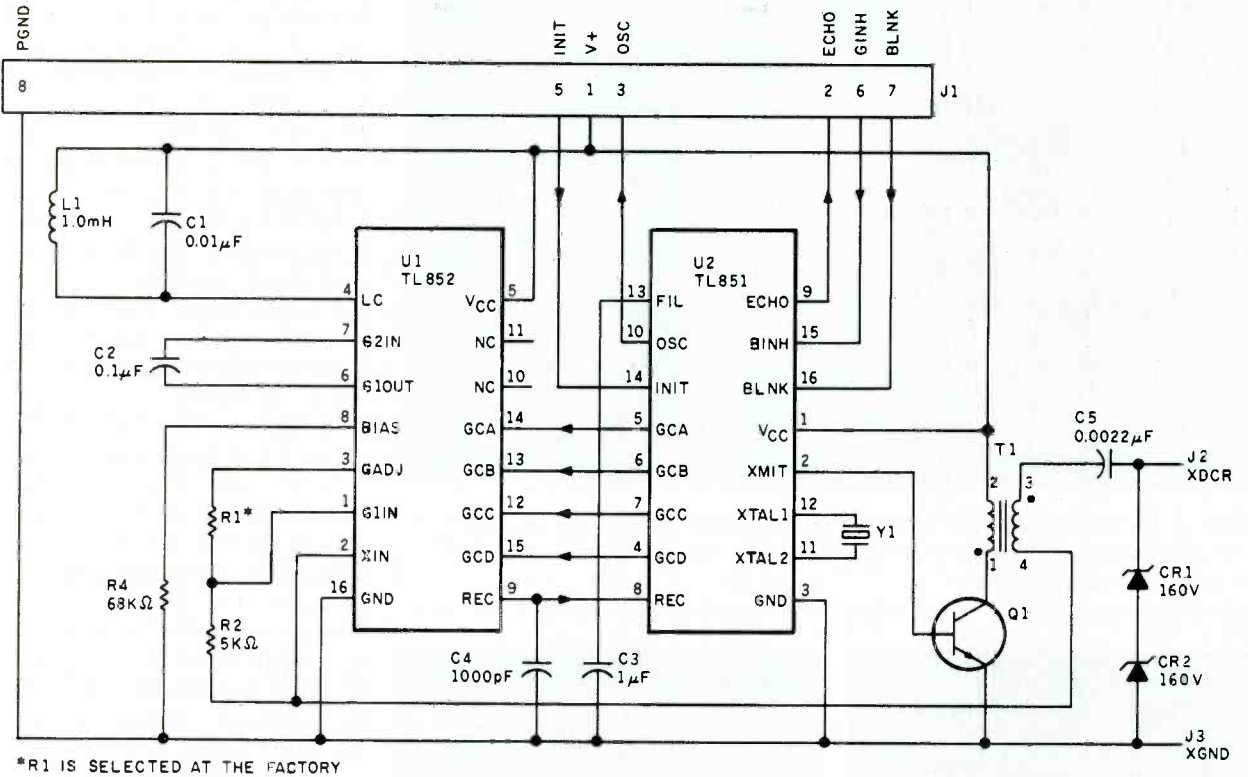

Figure 4: The schematic and layout of the Texas Instruments sonar-ranging module.



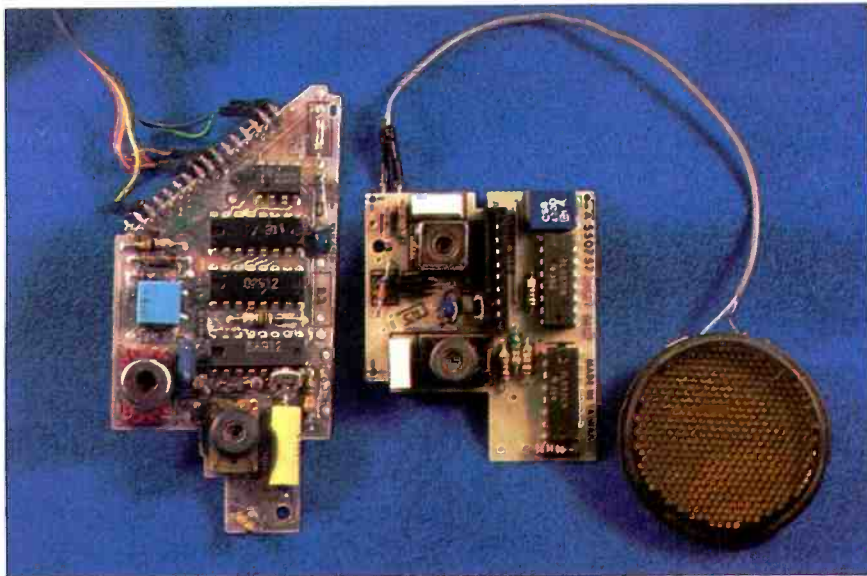

Photo 1: The original Texas Instruments ultrasonic ranging module (left) provided in the experimenter's kit from Polaroid compared to the new TI ranging module (right) that is the basis of this article.



Photo 2: A close-up of the Polaroid ultrasonic transducer.

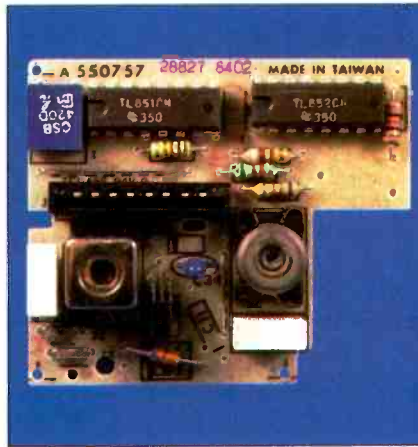

Photo 3: A close-up of the TI ranging module.

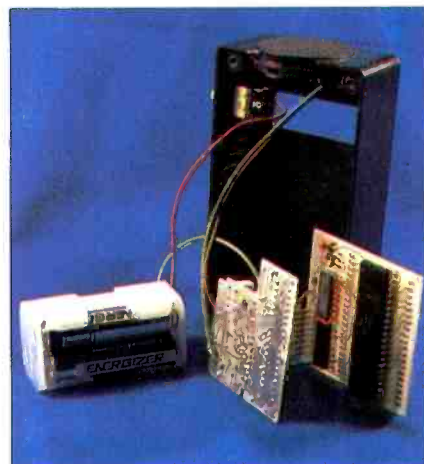

Photo 4: A rear view of the disassembled tape measure.

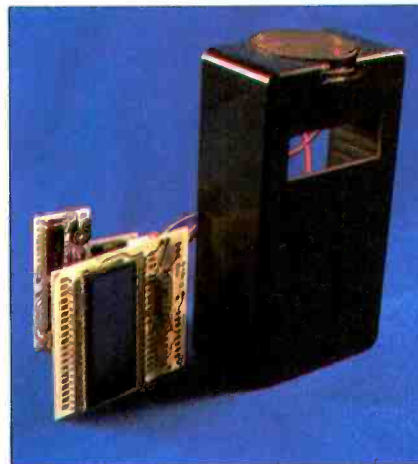

Photo 5: A front view of the disassembled tape measure.

implies that only one target exists and that a single ranging value is desired. In the multiple-echo mode, the echo monitoring time is extended to "hear" the echo from objects farther away than the closest target. Differentiating among these echoes can be a data-reduction nightmare, so I will limit my discussion and the use of the ranging module to the single-echo mode.

Figure 5 is the basic timing diagram of the ranging module. Within 5 ms of applying power (at 4.5 V to 6.8 V), the internal circuitry has reset and stabilized and the module is ready. The distance-measuring sequence is activated by raising the INIT input line to a logic 1 state. This enables the 420-kHz on-board ceramic resonator, and 16 cycles of a 300-V 49.4-kHz (420 kHz divided by 8.5) signal are generated. The 16 cycles are passed through a driver/transformer combination that boosts the signal's magnitude to 300 V at the transducer. At the end of the 16 cycles, a DC bias of 150 V remains on the transducer for optimum operation, and the oscillator output steps up to 93 kHz (420 kHz divided by 4.5), where it remains as long as INIT is high.

In order to prevent any ringing in the transducer from being detected as a return signal, the receive input of the ranging control IC (integrated circuit) is inhibited by an internal blanking signal for 2.38 ms. This blanking interval corresponds to 1.33 feet, which is the minimum distance that the ranging module can sense without external control intervention. To detect objects closer than 1.33 feet, the blanking inhibit line, BINH, can be taken high prior to 2.38 ms to enable the receiver.

In the single-echo mode, all that must be done is to wait for the echo from the target. After INIT, the transmitted pulse travels at a rate of 0.9 ms per foot. When the ranging module hears the echo, the ECHO output line goes high. The difference in time between INIT and ECHO both going high is a measure of the distance to the target. This elapsed time can be measured through a timing loop in a computer or gated with the oscillator output to increment a counter and drive a display. I will explore both of these techniques.

One final note on the ranging-module electronics. If you have experimented with ultrasonics, you've

probably found, as I have, that fixed-distance reception is far easier to accomplish than variable-distance reception. Sound intensity decreases geometrically proportional to increases in distance. If you have designed a transmitter-and-receiver system that works well at 6 feet, it may not function at 12 feet without substantially increasing the receiver sensitivity (gain) to account for the reduced echo amplitude. Leaving the sensitivity at a high level and reducing the distance again invites other interference and false-echo-detection problems. To adequately compensate for changing distances, the sensitivity setting must also be adjustable with distance.

The T1 ranging module dynamically tailors the receive amplifier's sensitivity. Lower amplification is needed for close objects, higher amplification for distant echoes. Twelve gain steps within the range of 0 to 35 feet are automatically incremented as the time between INIT and ECHO lengthens. If the distance is 6 feet, the receiver will be at its second gain setting. At 20 feet it will be at its sixth level. The twelfth level is sufficient for unaided reception of echoes from 35 feet. The addition of a direction cone to the transducer, which will further improve sensitivity, will facilitate measuring distances beyond 35 feet.

### COMPUTER CONNECTION

Figure 6 is the schematic for connecting the ranging module to the parallel port of a computer. The entire single-echo-mode interface requires only 1 input bit and 1 output bit. The output bit connects to the INIT line; the input bit connects to the ECHO line. To measure distance, the computer merely raises the INIT line and measures the time until ECHO goes high. The repetition rate depends on the distance. The cycle is repeated when INIT is lowered and raised again. This can occur at any point after ECHO. For short distances, a 100-Hz repetition rate is possible. To allow a full 35-foot range, however, the repetition rate should be limited to 10 Hz.

Unlike the Polaroid Designer's Kit, which is specified to run on 6 V, the T1 ranging module can function between 4.5 and 6.8 V. If you use a 5-V supply, the ranging module I/O is TTL

(continued)

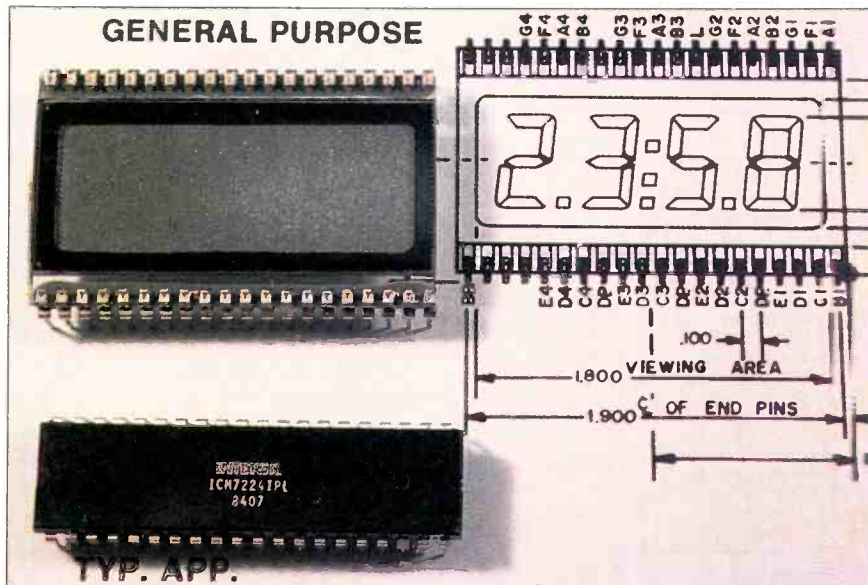

Photo 6: With the addition of the 4-digit LCD, such as the UXD unit shown, and a 4½-digit 7224 LCD counter/decoder/driver chip from Intersil, a hand-held tape measure can be easily constructed.

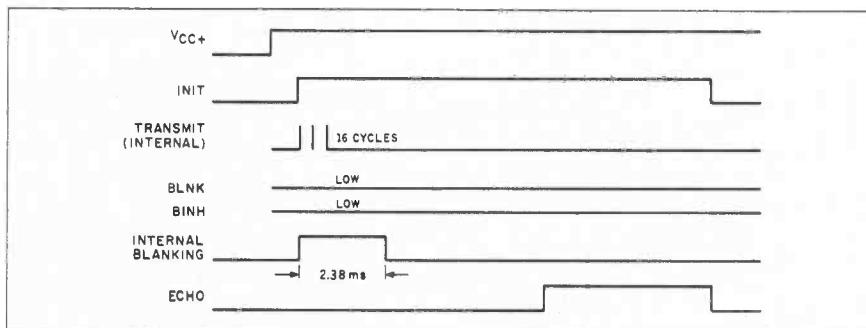

Figure 5: A timing diagram of the sonar-ranging module.

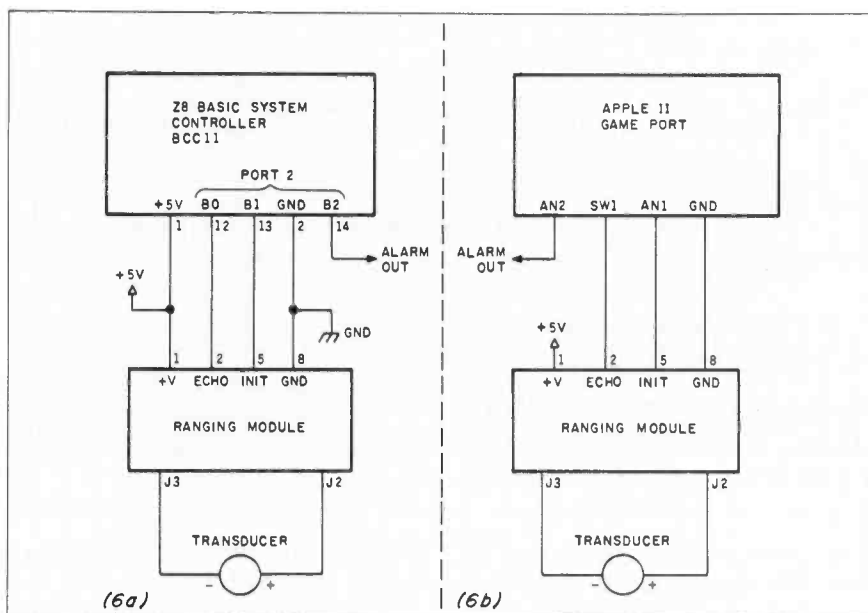
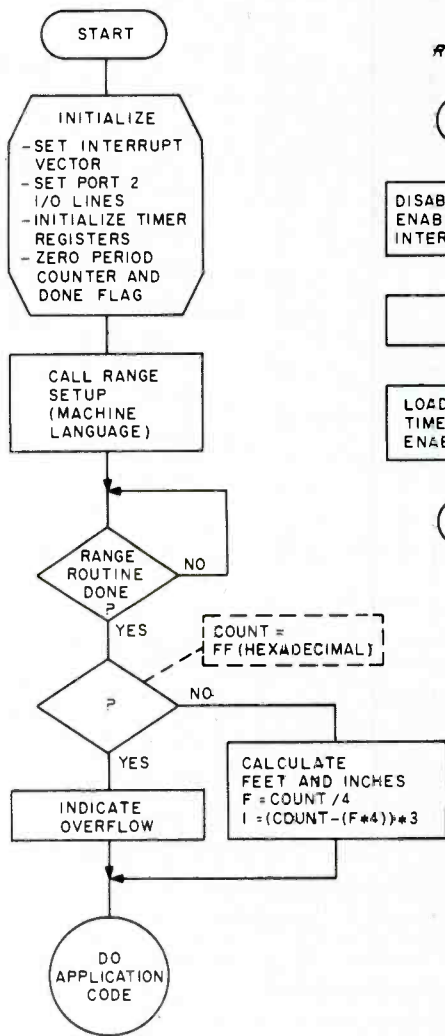

Figure 6: The sonar-ranging module's connection to the Z8 BASIC system controller (6a) and to the Apple II system controller (6b).



**MAIN BASIC PROGRAM:**



**RANGE SETUP:**

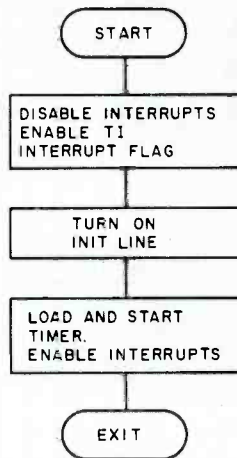

**INTERRUPT-DRIVEN RANGING ROUTINE:**

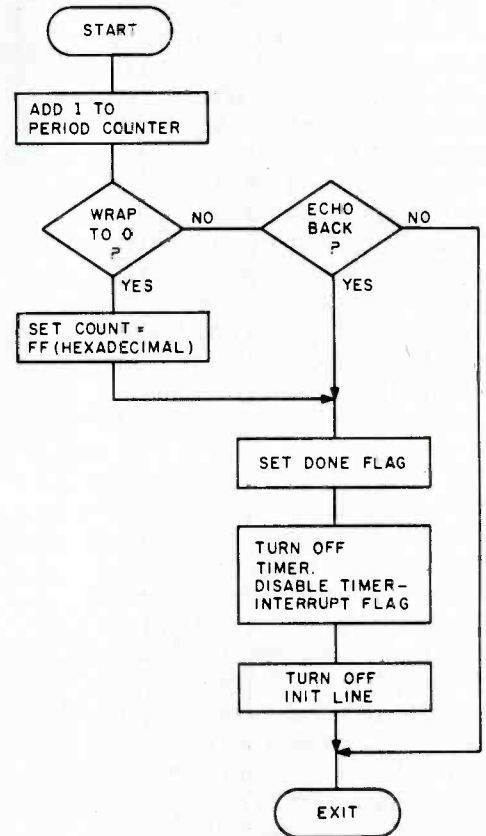

**Programming Notes**

A 1.78-ms period indicates a round trip of 1 foot. Maximum range assumed for programming purposes to be 40 feet. Counter for periods is 8 bits wide, yielding 255 counts. Each period count will represent 1/4 foot, or 3 inches. Valid range counts are 1 to 254. A count of 255 indicates overflow.  $1.78 \text{ ms} / 4 = 0.445\text{-ms period}$ .

**Z8 Version Ranging System**

Z8 timer-period calculation. 0.445 ms desired.

$i = t \times p \times v$ ; where  $t = 8/\text{sysclock}$ ,  $p = \text{prescale value}$ ,  $v = \text{timer value}$

$i = (8/7.3728 \times 10^6) \times 10 \times 41$

$i = 0.44487847 \text{ ms}$

Z8 program uses port 2 for I/O

B0 = Echo Line (IN)

B1 = INIT Line (OUT)

B2 = ALARM-activated-output (OUT)

Figure 7: A flowchart of the range-finder program for the Z8 controller.

(transistor-transistor logic) compatible and can be connected directly to most computers. The module normally requires about 100 milliamperes (mA) except during the 16-cycle transmission period, when it can

reach 2 amperes (A). Any power source intended for use with the module should have an intermittent power rating this high. For portable operation, you can use either standard AA or larger alkaline batteries or

Polaroid's Polapulse high-current batteries.

For the purposes of this article, I chose to demonstrate connection of the ranging module to an Apple II and the Z8 system-controller board, which

is an improved descendant of the original Z8-based computer controller presented in the June and July 1980 Circuit Cellar articles. The description of connecting the ranging module to the Z8 system controller through a parallel I/O port, measuring the elapsed time in a callable machine-language routine, and manipulating the results within the tiny BASIC interpreter are transferable in principle to any computer. (I have since had a Z8 FORTH chip produced that is interchangeable with the Z8671 tiny BASIC chip. The FORTH chip could also have been used.) By using the Z8 board, however, I can produce a dedicated measuring system that can sense and average a number of readings, make decisions, activate specific control outputs, and communicate readings to larger host systems serially.

Figure 7 is a block diagram of the necessary steps to initialize the module and measure distance with the Z8. Figure 8 is a block diagram of the Apple II version of the same code. Figure 9 is the block diagram of a typical proximity-detector application with alarm outputs. Listings 1, 2, and 3 show the code to perform these tasks.

### ELECTRONIC TAPE MEASURE

While describing the electrical characteristics and computer connection of the ranging module might ordinarily suffice as a Circuit Cellar project, I was intrigued by the simplicity of using the ranging module and decided to build the electronic tape measure shown in photos 4 and 5. The circuit shown in figure 10 required only three additional CMOS (complementary metal-oxide semiconductor) chips and can be constructed as a hand-held device.

The Circuit Cellar Sonar Tape Measure, hereafter called SonarTape, consists of the TI ranging module, a CD4049 inverter, a CD4029 counter, and an Intersil ICM7224 4½-digit LCD counter/decoder/driver chip (shown in photo 6). When pointed at an object or a wall and activated, the SonarTape transmits once and holds its reading (so that you can turn the unit and see the display if it wasn't already in view). The LCD indicates the distance in feet and tenths of feet.

The SonarTape is activated by turning on the power (6 V provided by  
*(continued)*

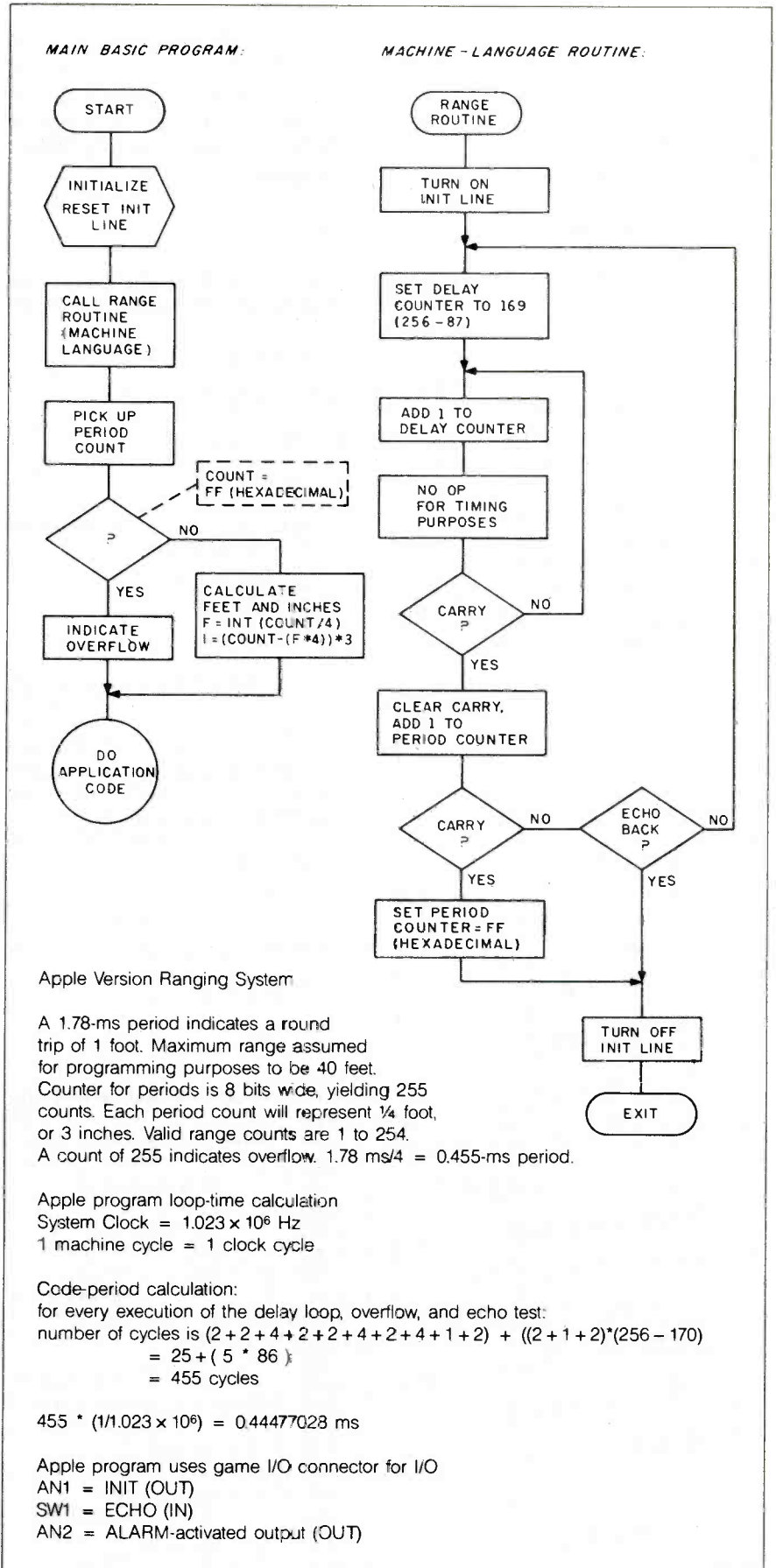

#### Apple Version Ranging System

A 1.78-ms period indicates a round trip of 1 foot. Maximum range assumed for programming purposes to be 40 feet. Counter for periods is 8 bits wide, yielding 255 counts. Each period count will represent ¼ foot, or 3 inches. Valid range counts are 1 to 254. A count of 255 indicates overflow.  $1.78 \text{ ms}/4 = 0.455\text{-ms period}$ .

Apple program loop-time calculation  
System Clock =  $1.023 \times 10^6$  Hz  
1 machine cycle = 1 clock cycle

#### Code-period calculation:

for every execution of the delay loop, overflow, and echo test:  
number of cycles is  $(2+2+4+2+2+4+2+4+1+2) + ((2+1+2)*(256-170))$   
 $= 25 + (5 * 86)$   
 $= 455$  cycles

$455 * (1/1.023 \times 10^6) = 0.44477028 \text{ ms}$

Apple program uses game I/O connector for I/O  
AN1 = INIT (OUT)  
SW1 = ECHO (IN)  
AN2 = ALARM-activated output (OUT)

Figure 8: A flowchart of the range-finder program for the Apple II.









## A sonar sensor would let a sightless person "hear" a picture of the environment.

verter to the count-inhibit line on IC3, goes high, indicating reception of the echo. Clock pulses will therefore have been counted during the elapsed time period between INIT and ECHO.

If the elapsed time were 6 ms, about 34 clock cycles would have been counted by IC3. With the decimal point permanently set between the least and next most significant digit, the indication on the LCD would have been 3.4 feet. Similarly, 31 ms of elapsed time would allow about 175 cycles to occur, which would indicate 17.5 feet.

### IN CONCLUSION

I did think about commercial applications for SonarTape. Just because I'd like one, however, doesn't mean it has any potential. The high cost of the additional circuitry, packaging, and LCD make it either a high-priced novelty or cost-effective only in mass production. I'll stick with my prototype and wait for the next development iteration so that I can cover this subject in another four years.

One additional application that I started prototyping but discontinued as not completely germane to this article was a blind sonar sensor. Such a device (for the blind or any sightless application, such as firemen entering a smoke-filled room) would conceivably allow a sightless person to "hear" a picture of the environment by sweeping a hand-held ranging unit in front as he or she walked. Rather than a visual display, the distance measurement would be a tone whose frequency was a function of distance. My initial design consisted of continuously triggering the INIT line with a 5-Hz oscillator and applying the INIT and ECHO signals to an AND gate to produce a single pulse output whose pulse width was the elapsed time between INIT and ECHO. Next, using an integrator circuit, or even a simple RC (resistor-capacitor) combination, the pulse width is converted to a DC voltage level. The longer the pulse width, the higher the DC level.

(continued)

```

0240 ECHO EQU $
0250     TM      02H,#01      ; IS ECHO BIT ON?
0260     JR      Z,EXIT      ; NO, LET ANOTHER PASS OCCUR
0270 DONE EQU $
0280     LD      31H,#0FFH   ; TURN ON DONE FLAG
0290     AND    TMR,#0F3H   ; TURN OFF T1 TIMER
0300     AND    IMR,#1FH    ; DISABLE IRQ 5 INTERRUPT
0310     LD      02H,#0     ; SHUT OFF INIT LINE
0320 EXIT EQU $
0330     IRET                     ; RETURN FROM INTERRUPT
0340 ;
0350 ; END OF MACHINE-LANGUAGE ROUTINES
0360 ;
0370 ZZZZ EQU $

```

### (1c)

```

RUN
32 FEET 3 INCHES
129 0.445-MS PERIODS

32 FEET 3 INCHES
129 0.445-MS PERIODS

```

Listing 2: The Apple II versions of the programs in listing 1. The output is the same as for the Z8.

### (2a)

```

1 REM APPLE II VERSION RANGING SYSTEM
10 POKE - 19293,0: REM SHUT OFF INIT LINE
30 PRINT CHR$(4);"BLOAD RANGE.0": REM LOAD OBJECT PROGRAM
40 POKE 12328,0: REM CLEAR COUNT
50 CALL 12288: REM CALL RANGING SUBROUTINE
60 C = PEEK (12328): REM GET COUNTER VALUE
70 F = 0:I = 0:O = 0: REM CLEAR FEET, INCHES, OVERFLOW
80 IF C = 255 THEN O = 1: GOTO 120: REM SET OVERFLOW IF
   COUNT=$FF
90 F = INT (C / 4): REM CALCULATE FEET
100 I = (C - (F * 4)) * 3: REM AND INCHES
120 REM APPLICATION CODE STARTS HERE
130 IF O = 1 THEN PRINT "OVERFLOW": GOTO 40
140 PRINT F;" FEET ";I;" INCHES"
150 PRINT C;" .455-MS PERIODS": PRINT
160 GOTO 40: REM AND MAKE ANOTHER PASS

```

### (2b)

```

0010 *-----
0020 * APPLE II  VERSION RANGING SYSTEM
0030 *-----
0040 *
0050     OR      $3000
0060 RANGE EQ *
0070     LDA    $C05B      * TURN ON INIT LINE
0080 DELAY EQ *
0090     LDA    #184      * SET DELAY COUNT TO 184
0100 LOOP  EQ *
0110     ADC    #1        * ADD 1 TO DELAY COUNTER
0120     NOP                    * NO OPERATION FOR TIMING
0130     BCC   LOOP      * LOOP UNTIL CARRY
0140     CLC                    * CLEAR CARRY FLAG
0150     LDA    COUNT     * PICK UP OLD COUNT
0160     ADC    #1        * ADD 1 TO IT

```

(continued)





# USING A M USE WITH LOTUS 1-2-3

*A more comfortable tool for cursor movement*

A MOUSE COMBINES the selection capability of a light pen with the maneuverability and precision of a joystick, but it's easier to use than either. Instead of the precise finger control and position estimation required of a light pen, a mouse allows you to use more comfortable arm and wrist movements, shows you exactly where it is pointing on the screen display, and allows you to specify several options because it typically has several buttons. A joystick may be the proper tool for a maze, but a mouse is a more comfortable tool for a word processor or for hand movement across a surface.

So I bought a mouse. A Microsoft mouse. After a minimal amount of practice, I became fairly proficient with it and decided to try it with some of my other programs. But I didn't have any other programs that already supported a mouse.

At this point I thought that it might have been a bad decision to get Microsoft's mouse. I thought of the ads that say, "And you can use our mouse immediately with your old programs because it simulates keyboard input." I thought that if I'd gotten one of those I'd be able to use my other programs with the mouse.

The rest of this article offers a solution to this

dilemma: a program that converts input from the Microsoft mouse to simulated keyboard input for the IBM Personal Computer (PC). You don't have to modify any Lotus code, but the program works so closely with Lotus 1-2-3 that it is actually faster to move the cursor with the mouse than with the arrow keys. Furthermore, you can easily modify the program to use it with other full-screen input programs.

The idea is straightforward. Write a small handler for mouse interrupts that converts mouse movement into arrow keys and button presses into carriage returns or function keys.

I'd originally planned a resident handler to present the same keys to all programs. I even hoped Microsoft might buy it and include it in its device driver. I had wondered why Microsoft had overlooked such an obviously useful routine, but the thought of using the mouse with my old programs dispelled my suspicions.

There are several problems with a resident handler. First, when true mouse-using programs run, they reset the mouse driver, which would destroy my pointer to the resident handler. The program would still take up storage, but it wouldn't be usable without a pointer.

Second, the programs you want to use with the mouse may use different keys to move the cursor. Some always use the arrow keys, but

some use the space bar or the backspace to position the cursor over the menu area and the arrow keys to move it in the display area.

Spreadsheet column width may vary also. In the menu area, an arrow key may jump six characters with each movement, while in the display area it moves one character at a time or, in the case of a spreadsheet, some other column width. The sensitivity to mouse movement must be variable so the cursor movement on the screen appears more intuitive. And the horizontal break between the menu and the display area is not standard, so you can't preset column-width sensitivity by the placement of the cursor.

Finally, unless the program knows about the mouse, it can't synchronize the mouse's cursor with its own cursor. It might be possible for the interrupt handler to search the screen buffer for something that looks like a cursor, but that's time-consuming and error-prone. Therefore, it is probably best if you don't display the mouse cursor.

The particular program presented here has essentially three parts. The first part sets up parameters and initializes the mouse interrupt handler. The second or main part loads and executes LOTUS.COM and then returns to DOS. The third part is the mouse interrupt handler that converts mouse signals into keystrokes and inserts them into the system's keyboard buffer. The farther you move the mouse, the more characters are inserted into the buffer.

MOUS123 requires DOS 2.0 but will work with either a color or monochrome monitor. Copy the MOUS123.COM and one of the Microsoft mouse driver programs (MOUSE.COM or MOUSE.SYS) to your Lotus 1-2-3 system disk. MOUSE.COM is a Microsoft-supplied program that installs the device driver from the command prompt after booting. MOUSE.SYS accomplishes the same thing but installs the driver during the boot in the same way the IBM virtual disk driver does, via an entry in CONFIG.SYS. The two methods are equally effective, but you must choose one. Change the AUTOEXEC.BAT member to execute MOUS123 instead of LOTUS. If you use MOUSE.COM, make MOUSE the first command in AUTOEXEC.BAT. The next time you boot the Lotus 1-2-3 disk, you will be able to use the mouse to move the Lotus 1-2-3 cursor and to make menu selections.

## USING THE PROGRAM

When using the mouse programs the Lotus 1-2-3 screen appears the same as it always did. The only difference is that the mouse moves the cursor on the screen. Actual data entry still requires the keyboard, but you can leave the Num Lock set and use the keypad for data entry while you use the mouse for cursor movement.

MOUS123 recognizes three button presses. Pressing both buttons together flips between the menu and the display area. A generalized program can't do that because the required keystrokes to switch to and from the menu vary, a slash instead of an Esc. Different programs have different conventions. MOUS123 is customized for Lotus 1-2-3. Pressing just the left-hand button simulates the return character, <CR>, the key that Lotus 1-2-3 uses for menu selection. Pressing just the right-hand button simulates the F1 function key that Lotus 1-2-3 uses to request Help screens.

## THE MOUS123 PROGRAM

The initialization routine first checks to see whether the mouse hardware and the driver software are present. Then it sets a mask to indicate which conditions to trap and passes them along with the address of the routine (MINT) to the mouse interrupt handler (INT 33h). [Editor's note: Whenever you find a number followed by a lowercase h in this article, the number given is in hexadecimal notation.]

When COMMAND.COM executes a program like MOUS123, it permits all the remaining memory to be used and sets the stack pointer so high in the segment that the program uses at least 64K bytes. You must take special action to share that memory with another program, namely Lotus 1-2-3. MOUS123 first points the stack pointer much lower, calculates the segment's new upper bound and the pointer to the stack's new top (see listing 1). It then rounds the new segment boundary up to the next 16-byte paragraph and releases all storage above it (using DOS function 4Ah) making room for Lotus 1-2-3. Finally, MOUS123 sets up the parameter lists and register values that are required to load and execute LOTUS.COM (using DOS function 4Bh).

That DOS 2.x function creates an entirely new environment-parameter area and a new segment prefix for 123.EXE, making it look as if COMMAND.COM had invoked it directly. When Lotus 1-2-3 completes and

John Doolittle (c/o Micro-Main Software Inc., 535 South Washington St., Naperville, IL 60540) is a developer of mainframe- and microcomputer-based software. He also enjoys reading and running.

(continued on page 391)



---

# IMPLEMENTING CRYPTOGRAPHIC ALGORITHMS ON MICROCOMPUTERS

**T**

BY CHARLES KLUEPFEL

THE JANUARY 1983 ISSUE of BYTE contained an article called "Public Key Cryptography" by John Smith. He presented a small-scale version of the RSA (Rivest-Shamir-Adleman) cryptographic algorithm to encode and decode messages. The algorithm was written in BASIC and limited to six-digit numerical "keys." At the end of his article, Smith posed the possibility of a full-scale encoding scheme for microcomputers using 100- to 200-digit keys.

The following article and accompanying programs will help you to create up to 200-digit cryptographic keys using the muMath/muSimp package, a variant of LISP distributed by Softwarehouse. The muMath package gets around BASIC's inability to handle large numbers, letting you use numbers with as many as 611 digits. I use the Apple II ADIOS version of this package, but all versions are essentially the same.

Although I developed these programs from the bottom up, I'll present them from the top down. Along the way I'll describe the workings of the muSimp language where necessary. In several instances, I use algorithms taken directly from Donald Knuth's text *The Art of Computer Programming: Semi-Numerical Algorithms* (volume 2, second edition), rather than Smith's modifications.

First, let's review the encoding scheme. The RSA algorithm, and public-key cryptography in general, allows you to encode and broadcast a message in numerals that anyone can receive but only the originator of the key can decipher. Conversely, because only the originator can produce a certain type of scrambled message, the recipient can verify that it came from a specific person.

The source of the secrecy is the RSA algorithm's use of modular arithmetic and the originator's "private" key.

Step one is to encode a message into numbers or a series of numbers. You can use any method to do this. (Smith's article describes a method based on converting letters to their ASCII [American Standard Code for Information Interchange] equivalents.) I'll assume that the sender and receiver share this numerical code.

The RSA algorithm uses cubes and cube roots in an arithmetic environment to further encode and decode the sender's message. The algorithm raises the numerical message to the third power mod  $n$  (modulo  $n$ ). In this case,  $n$  is the originator's widely publicized multi-digit number, his public key.

As encoding is cubing, to decode a message you must take the cube root. This is generally impossible for a large number of digits when the arithmetic is modular. What makes decoding (finding the cube root) possible is that  $n$ , the public key, is

chosen as the product of two large prime numbers,  $p$  and  $q$ , from which another number,  $d$ , called a "private" key, is derivable. The number  $d$  is about as long as the number  $n$ . To decode (take the cube root mod  $n$ ), you raise the encrypted number to the  $d$  power mod  $n$ .

The length of the number to be encoded (your message) must be more than one-third the length of the public key  $n$ , that is, larger than the cube root of  $n$ . Otherwise, the encoded message can be decoded by taking a non-modular cube root, for example, encoding 3:  $3^3 \bmod 100$  is 27. Twenty-seven is a perfect cube already, so that  $\sqrt[3]{27}$  (decoding) mod 100 is just  $\sqrt[3]{27}$  or 3, the number we originally encoded. When the encoded message (3) length is longer than the cube root of the modulo  $n$ , such as in  $3^3 \bmod 13$ , it's more difficult to determine the original number because  $3^3 \bmod 13$  is 1. To increase the length of any message number, just pad the message with blanks to make it large enough to decode.

The accompanying programs produce a unique  $n$  and  $d$  for each user for encoding and decoding messages converted to numbers. On the listings, note that the prompt is (?) similar to a READY or Apple's (]). The DISPLAY function, given in immediate mode, acts as a command to print the function named as its argument, similar to a LIST in BASIC.

Listing 1 shows one

version of the highest level block of code, SETUP, used in selecting the keys, public ( $N$ ) and private ( $D$ ). You can change this section depending on how many digits you want in the respective keys. The first function, RANDOMIZE, starts the random-number generator. The remainder depends on following Knuth's algorithm for determining the keys  $n$  and  $d$ . In Knuth's algorithm there are two stages: first a prime number with  $n_1$  digits is selected; then this is multiplied by an  $n_2$ -digit number. The next prime number (within certain restrictions) after that (having about  $n_1 + n_2$  digits) is selected as the  $p$  or  $q$  value used in forming  $n = pq$  and  $d = (2(p-1)(q-1)+1)/3$ , the public and private keys. Since we have to choose two primes,  $p$  and  $q$ , there are two assignment statements in SETUP, both referencing the function CHOOSEP. Assignment in muSimp is shown with the colon (:) rather than with either the equal sign (=) or the combination of the two (:=). The two numbers passed to CHOOSEP each time are the  $n_1$  and  $n_2$  referred to above. The sum of these four numbers is therefore the approximate length of each key (public and private) to be produced.

Listing 2 shows the CHOOSEP function. Recall that we invoked it with two arguments, but note that the parameter list shows eight parameters. The additional items mentioned, beyond

the number used in the reference, merely serve to declare these as local variables. Also, the two parameters that are passed are passed by value; that is, any changes made to  $N$  or  $N2$  within CHOOSEP in no way affect any variables outside of CHOOSEP, in particular, no variable called  $N$  or  $N2$ , nor whatever variable may be put into the argument list of the invocation.

Knuth describes a choice of  $p$  and  $q$  as follows:

Start with a truly random number,  $p_0$ , between  $10^{80}$ , and  $10^{81}$ . Search for the first prime number  $p_1$  greater than  $p_0$ ...[a "probable prime" after 50 iterations of the algorithm to be described below].... Then choose another truly random number  $p_2$ [not necessarily prime, despite its letter] between, say,  $10^{39}$ , and  $10^{40}$ . Search for the first prime number  $p$  of the form  $k p_1 + 1$  where  $k >= p_2$ ,  $k$  is even, and  $k \equiv p_1 \pmod{3}$ .... The prime  $p$  will be about 120 digits long; a similar construction can be used to find a prime  $q$  about 130 digits long. For extra security, it is probably advisable to check that neither  $p+1$  nor  $q+1$  consists entirely of rather small prime factors.... The product  $N=pq$ , whose order of magnitude will be about

(continued on page 395)

## Create up to 200-digit keys

Charles Kluepfel (11 George St., Bloomfield, NJ 07003) is a programmer/analyst with the New York Telephone Company. He holds a B.A. in mathematics from Queens College, City University of New York.



# GENERATING AND TESTING PSEUDORANDOM NUMBERS

BY CHARLES A. WHITNEY



## Analyze haphazard occurrences with linear congruential generators

 F A DRUNKARD starts from a lamppost and randomly staggers away, how far will he have progressed in one thousand steps? Expressed in varying forms, the "drunkard's walk" has become a staple of mathematical physics. How far will an impurity atom migrate in a crystal lattice? How many steps will be required for a photon to emerge from a foggy atmosphere? They are all the same question, and they can be treated with "Monte Carlo" calculations. These calculations are finding increasing applications in business, as well. For example, they provide an analysis of how best to serve customers arriving haphazardly at a counter. Carrying out such calculations depends on being able to imitate randomly generated numbers, and this is not easy. It has been said that more time has been spent generating and testing random numbers than using them.

You can find numerical examples of random series all around you. The final integers in a list of telephone numbers gives a good random series in the range 0 to 9. The face values of cards drawn from a well-shuffled deck and the final digits in licenseplate numbers on passing cars are usually quite reliable. (But the first digits of such numbers are often far from random.)

The property that defines a randomly generated series is that each number is independent of all earlier numbers. In other words, the process that generates the random series has no memory. Therefore, even if you know all the previous numbers, you cannot predict with certainty the next one. (And if you have been losing at a truly random game, you have no reason to think you will start winning.) That's why flipping a coin is such a good method of generating a random series of zeros and ones. Each flip is entirely independent of the others.

Before going further, I should try to clarify a point of language that can lead to confusion. Strictly speaking, no such thing as a random number exists—only a random process. The number 12345 is neither less nor more random than the number 32719. In a series of 100,000 randomly generated numbers, both of these would have the same chance of occurring. The idea that 12345 is less random comes from comparing it with a simple pattern of ascending digits. Thus, instead of saying you are trying to produce random numbers, you should say you are trying to construct a method that will produce a series of numbers that imitates the results of a random process. But for the purpose of this article, I will use the word "random" more loosely to refer to a random sequence or a random number, without worrying about the niceties. If a sequence looks like it was generated by a random process, I will call it random and will put off the question of how to judge appearances until I discuss methods of testing random-number generators.

To carry out a Monte Carlo calculation, you need to work with random numbers inside a computer. But you are faced with the fact that a purely digital computer is a deterministic machine—except on its "off" days—and such a device cannot truly generate a random process. You have to be satisfied with deterministic algorithms that imitate random processes. You can thus generate "pseudorandom" numbers with some of the earmarks of randomness. Naturally, some random-number generators work better than others, and you must be wary.

### LINEAR CONGRUENTIAL GENERATORS

Mathematicians have suggested many methods for generating pseudorandom numbers with a digital computer.

Happily, the most common and powerful one involves simple arithmetic. This method is the linear congruential generator, or LCG for short. An LCG produces a series of numbers,  $I_i$ , where the subscript " $i$ " indicates the location of the number;  $i = 1$  indicates the first number,  $i = 3$  is the third, and so on. Since each successive term,  $I_{i+1}$ , is computed from its predecessor, you can see right away that this series is not truly random because it has memory. That is why the LCG is called a "pseudorandom"-number generator.

To understand the LCG, look at the following linear expression:

$$I_{i+1} = aI_i + c, \quad (a > 0, c \geq 0)$$

This expression multiplies each number by the factor  $a$  and then adds  $c$  to find the next member. It produces an ascending series of numbers whose differences are given by the expression

$$I_{i+1} - I_i = (a-1)I_i + c$$

We call the process "mapping" because it carries the integer,  $I_i$  to  $I_{i+1}$ , from one point to the next in a one-dimensional space, as shown in figure 1.

Suppose  $a = 2$  and  $c = 1$ ; then you have 1, 3, 7, 15. As it stands, this series doesn't look random. To create a series that looks random, you need a method of scrambling the output, perhaps by cutting off the upward run. One way to achieve this appearance is to imagine you've subdivided the number line representing the  $I$ -space into segments of length  $m$ . If you make the multiplier,  $a$ , in the LCG suf-

*(continued on page 442)*

Charles A. Whitney is a physicist at the Harvard-Smithsonian Center for Astrophysics (60 Garden St., Cambridge, MA 02138) and is a professor of astronomy at Harvard.



# DATA ABSTRACTION

## A BASIC IMPLEMENTATION FOR PROBLEM SOLVING

*Editor's note: For more information and background reading on data abstraction, see the article by Niklaus Wirth in the August issue, "History and Goals of Modula-2."*

PROGRAMMERS, AND INDEED problem solvers in general, have two basic strategies for attacking new problems: decomposition and abstraction. These strategies offer two different ways of solving a complex problem by simplifying it in some way. Decomposition is the strategy embodied by the time-honored Machiavellian dictum to "divide and conquer"—solving large problems by dividing them into simpler, smaller ones that can be solved independently. Abstraction is the strategy of ignoring certain details about the original problem so as to transform it into a simpler and more general one.

For example, consider the problem of computing the sum of the squares of two numbers, 3 and 4 (that is, compute  $3^2 + 4^2$ ). We first simplify the problem by decomposing it into a sequence of three simpler problems: (1)

---

Gary F. Simons (7500 W. Camp Wisdom Rd., Dallas, TX 75236) is an International Consultant for Linguistics and Academic Computing with the Summer Institute of Linguistics.

compute the square of 3, (2) compute the square of 4, and (3) add the two results together. We assume that the final step of addition is sufficiently fundamental that we need not consider it further. However, the first two subproblems can be restated in more simple terms. "Compute the square of 3" means the same as "multiply 3 by 3," and "compute the square of 4" means the same as "multiply 4 by 4."

We may now apply the principle of abstraction to simplify the problem further. We see that there is something essentially the same about computing the square of 3 and computing the square of 4. By abstracting away the particular details of the 3 versus the 4, both subproblems can be solved by a single more general solution, namely, that of computing the square of  $n$ , where  $n$  can represent any number.

### INFORMATION HIDING AND ABSTRACT DATA TYPES

The essential design methodology for data abstraction is known as *information hiding*. The approach was first proposed by D. L. Parnas in 1972 (see reference 4). He proposed that the behavior of software modules be specified completely in terms of their external effects. Such a module hides a secret, namely, the representation of the data object that the module manages. To the outside user, the module provides a set of access functions that are used to create, alter, or observe instances of the abstract data object. There is no way for anyone or anything but the implementation of the module itself to access the ob-

jects, other than through those access functions.

The type of module that Parnas first described has come to be known as an abstract data type. It is abstract because the details of the concrete representation of the data type are unknown to the user. It has also been called an *encapsulated* data type, since the details of implementation are locked away from the user inside a capsule. The functions that access an abstract data type are now commonly referred to as its *operations*.

An abstract data type, therefore, presents itself to the user not as a data structure, but as a collection of procedural abstractions. These are the operations that allow one to create, observe, or alter objects of the abstract type. The task of implementing an abstract data type then consists of determining a concrete representation for objects of the type and writing the procedural abstractions that operate on objects thus represented.

### THE INFORMAL SPECIFICATION OF ABSTRACT DATA TYPES

Two methods for specifying the behavior of abstract data types have emerged. The first is an informal approach that uses prose statements to describe the effect of each of the operations of the data type. The second is a formal approach that uses algebraic statements that are precise and unambiguous. Both approaches are described in turn.

Barbara Liskov gives a complete example of the informal method in her paper "Modular Program Construc-

tion Using Abstraction." (See reference 3.) In Liskov's informal approach, the specification of a data abstraction has three parts: a header that names the data abstraction and its operations; a brief description of the data abstraction as a whole; and a specification for each of the operations. Each of the operations is a procedural abstraction. The specification of a procedural abstraction may have four parts: a header; a modifies line; a requires line; and an effect line. The header defines how the procedure interfaces with the outside world, that is, its name, the order and types of its inputs and outputs, and the error conditions it signals. The modifies line defines which of the inputs may be modified by the procedure. The requires line defines any assumptions that are made about the calling environment. The effect line describes what the operation is intended to do. Figure 1 gives some sample specifications for procedural abstractions based on Liskov's approach.

We may now illustrate the specification of a data abstraction. Figure 2 gives a sample specification of a data type called intset (set of positive integers). Note the three parts of the specification: the header that names the data type and lists its operations; a brief description of the data type as a whole; and the specifications for each of the operations.

### THE FORMAL SPECIFICATION OF DATA ABSTRACTIONS

The formal approach to specifying data abstractions defines an abstract

(continued on page 414)

```

divide (x,y:real) returns real signals divide-by-zero
  effect if y = 0 then signals divide-by-zero
  else returns x/y

sort (x:array[int])
  modifies x
  effect sorts the elements of x in ascending order

search (x:array[int], y:int) returns int signals no-match
  requires x is sorted in ascending order
  effect returns i such that x [i] = y;
  signals no-match if no such i is found

```

Figure 1: Sample specifications of procedural abstractions (after Liskov).

```

intset is create, insert, remove, isempty, ismember

  Intsets are sets of positive integers; the maximum size of an intset is  $2^{16} - 1$ 
  members. Intsets are either created empty (using create) or made from other intsets
  with a new member added (using insert) or removed (using remove). IsEmpty tests
  whether an intset has any members; ismember tests whether a given integer is a
  member of an intset.

create ( ) returns intset
  effect returns an empty intset

insert (s:intset, x:int) returns intset signals no-room
  effect if the size of s union {x} is less than or
  equal to the maximum size,
  then returns s union {x},
  else signals no-room

remove (s:intset, x:int) returns intset
  effect returns s minus x

isempty (s:intset) returns Boolean
  effect returns true if s has no members

ismember (s:intset, x:int) returns Boolean
  effect returns true if x is a member of s

```

Figure 2: Sample specifications of data abstraction (after Liskov).



# EPSON

EPSON LQ-1500

## Minor miracle.

You've never seen anything quite like the new Epson LQ-1500 Business Printer. It switches effortlessly back and forth between draft and letter-quality printing, on fanfold\* or single sheet paper. And it does it at a price every office can afford.

**Two for one.**

With the LQ-1500 in draft mode, you can race through a report at 200 characters per second. Then switch over to letter quality and polish off a pile of correspondence four times faster than the average daisy wheel.

Need graphics? The LQ-1500 gives you business charts with a crispness and definition you wouldn't think possible in a dot

matrix. And with the LQ-1500's 15.5-inch carriage, your spreadsheets and ledgers can take on a distinction they've never had before.

**The secret.**

The Epson LQ-1500 is the logical extension of Epson's outstanding dot matrix printers. Instead of nine "wires" forming each letter, however, the LQ-1500 has 24. So you get letter-quality characters to rival fine office typewriters. In proportional. Italic. And condensed, expanded, subscript, superscript and over 200 other different typefaces. All without changing a print wheel. With the LQ-1500, you can even create 128 characters or symbols of your own and add them to the printer's internal memory.

**String of miracles.**

For Epson, the LQ-1500 is just one more in a long line of miracles, many of which are also on display at your neighborhood computer dealer.

And like all products in the Epson line, the LQ-1500 is now backed by a one-year warranty on parts and labor, ready to go to work with just about any personal computer made, and available in more places than any other brand.

But that's not really miraculous. That's just Epson.

# Or how Epson® got two astonishing printers to occupy the same space. The new LQ-1500.

The way the LQ-1500 goes from high-speed draft... to letter quality printing is a positive miracle!

Actual LQ-1500 print sample.

Number one. And built like it.

**EPSON**  
EPSON AMERICA, INC.

2780 Lomita Boulevard • Torrance, CA 90505

Call (800) 421-5426 for the Epson dealer in your area. In California call (213) 539-9140.

Epson is a registered trademark of Epson Corporation.

\*With optional tractor unit

Circle 311 on inquiry card.



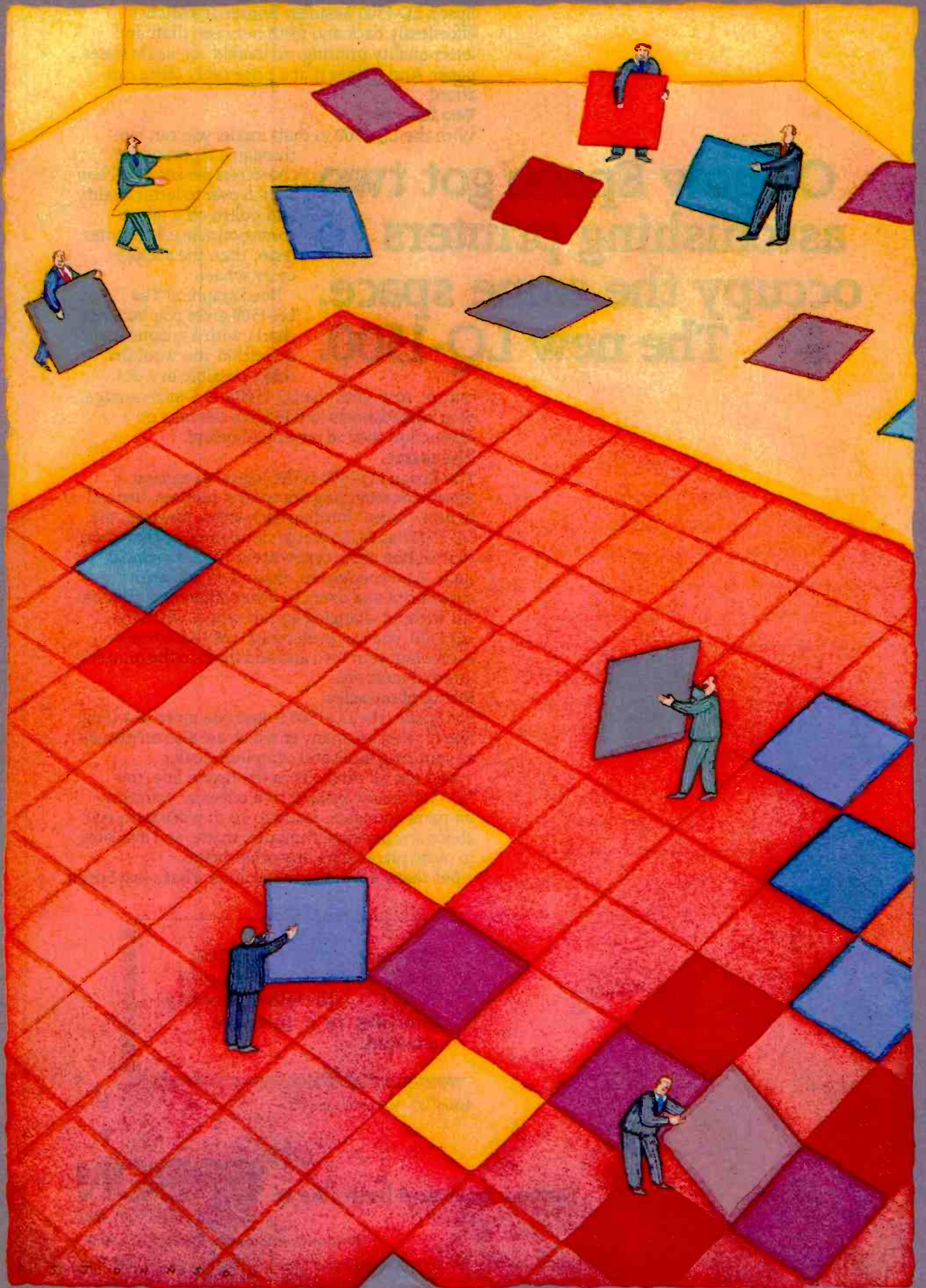



# Databases

---

<b>DATABASE TYPES</b> <i>by Rich Krajewski</i> .....	137
<b>TEXT DATABASES</b> <i>by Ezra Shapiro</i> .....	147
<b>THE DAYFLO ARCHITECTURE</b> <i>by Robert W. Atkins and Walter L. Mazur</i> .....	155
<b>LOW-COST ON-LINE DATABASES</b> <i>by Matthew Lesko</i> .....	167
<b>THE PICK OPERATING SYSTEM, PART I: INFORMATION MANAGEMENT</b> <i>by Rick Cook and John Brandon</i> .....	177
<b>ADDING A HARD DISK</b> <i>by Roy M. Matney</i> .....	203
<b>OPTICAL MEMORY: DATA STORAGE BY LASER</b> <i>by Edward S. Rothchild</i> .....	215
<b>A DATABASE CATALOG</b> <i>by George Bond</i> .....	227

---

DATABASES CONTINUE TO PLAY a large part in the development and acceptance of microcomputers. Just as the VisiCalc spreadsheet program shared a symbiotic relationship with the Apple II so that each bolstered the other, databases are a force for change in microcomputer technology and microcomputer technology is a force for change in database capability. That's why this month's theme articles discuss not only database software but hardware for databases.

Some of the terms you'll come across in these theme articles may be unfamiliar to you, so I've explained them in "Database Types." If you don't know a thing about databases, read this article first.

Ezra Shapiro, our West Coast bureau chief, tells about text, or free-form, database programs in his article "Text Databases." Text databases are hybrids: half word processor and half traditional database-management program. These programs should prove useful in organizing note taking and writing in general.

"The DayFlo Architecture" is a description of the DayFlo free-format, text-database program. This article isn't a review of the software but rather a look at the principles behind the software's operation by two DayFlo employees, Robert W. Atkins and Walter L. Mazur.

Microcomputer databases are fast, but they can't hold everything we need to know. For very large amounts of data, we turn to mainframe databases accessed via telephone lines. The bad news is that these "on-line" databases are expensive. The good news is that Matthew Lesko, author of *Information USA*, tells us how we can keep costs down and, in some cases, eliminate them altogether in "Low-Cost On-Line Databases."

Returning to microcomputer databases, we have Rick Cook and John Brandon's article "The Pick Operating System, Part I: Information Management," which talks about an unusual development in database software—an operating system that contains a relational database manager.

Large microcomputer databases need lots of storage space, and that means hard disks. Roy M. Matney's article "Adding a Hard Disk" discusses latching a hard disk onto an IBM Personal Computer.

Even hard disks have their limits. As microcomputer databases are expected to hold larger databases, we'll need storage devices with greater capacities. In the future, large databases may mean optical disks, which will be able to hold 10 to 20 megabytes on a 2-inch disk. Edward S. Rothchild, publisher of *Optical Memory News*, discusses optical disks in "Optical Memory: Data Storage by Laser."

We cap this month's theme section with a catalog of databases by George Bond, our managing editor of User News. While not an exhaustive catalog, it is representative.

—Rich Krajewski, Technical Editor



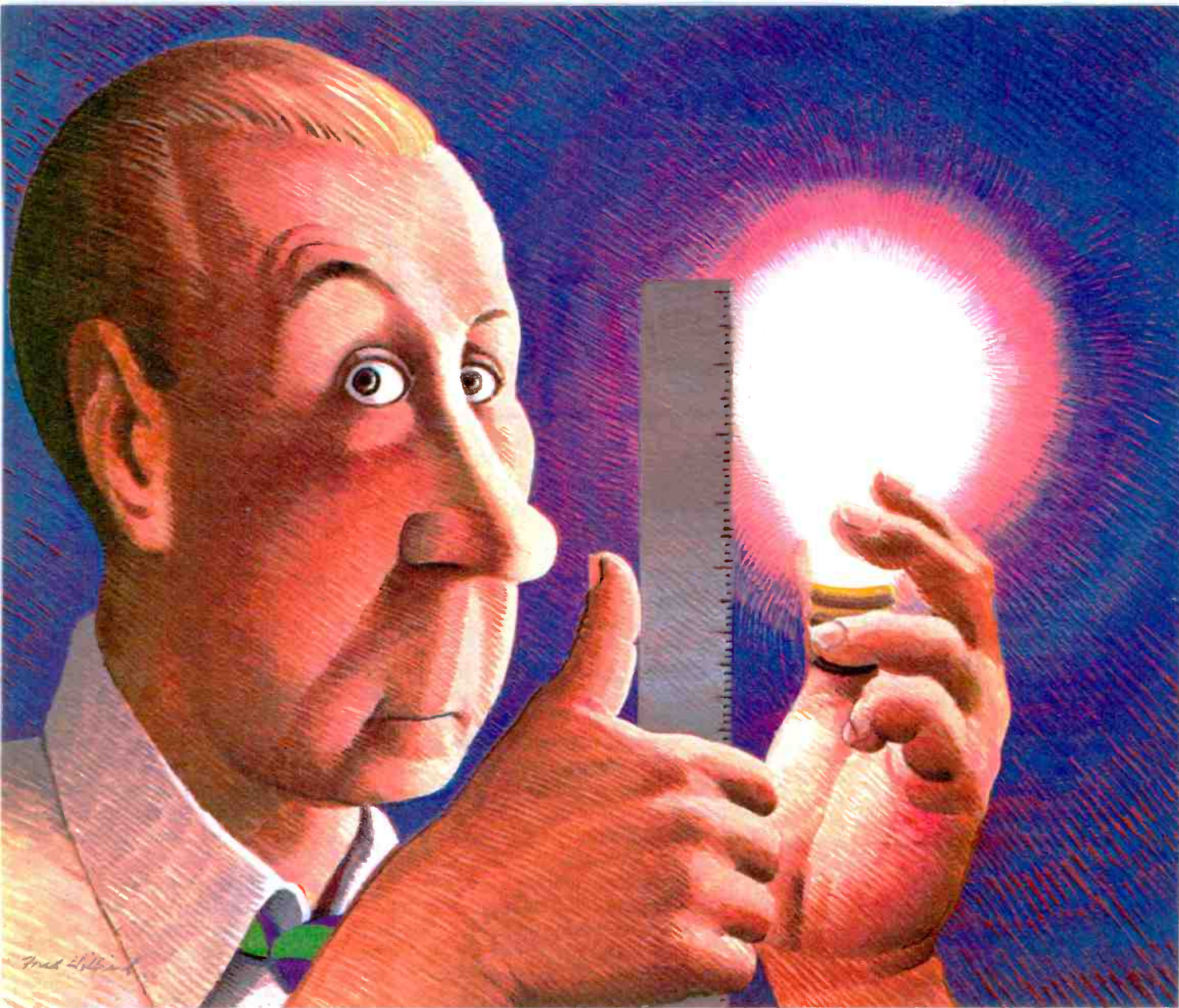

©1984 Cosmos Inc.

## How long is an idea?

With Revelation® by Cosmos, it won't matter. Our variable length structure lets you think long or short without worrying about needing disk space you don't have, or squandering space you can't afford. Think of it. Relational Data Base Management Software that saves up to 40% of your PC's disk space.

As a powerful, enhanced version of the PICK™ Operating System, Revelation uses plain English to create files, menus, entry screens, process information and generate reports. Plus, you can build,

customize and update your data base application without being an experienced programmer.

When you introduce your IBM® PC or compatible to Revelation, you'll see it change into a friendly brute that can communicate with other computers. Also featured is a hybrid full-structured programming language with an interactive debugging tool for serious development work.

Besides bringing the power, speed and flexibility of a minicomputer to your PC, Revelation works with

MS/DOS™ so you can use all the popular microcomputer software packages with the applications you develop.

Indeed, Revelation is easy to get along with. A veritable gentle giant. But, you need to know more before you decide to buy what may become your most valuable business tool. So call us at (206) 824-9942 and let us arrange for you to see what we've got here.

MS/DOS™ of Microsoft Corp. IBM PC Registered  
TM of International Business Machines Corp.  
PICK Operating System™ of PICK SYSTEMS.

Cosmos Inc. 19530 Pacific Highway S.

# COSMOS™

Seattle, WA 98188, (206) 824-9942

Circle 85 on inquiry card.

# DATABASE TYPES

BY RICH KRAJEWSKI

*A brief look at different ways  
of managing information*

IN RESEARCHING DATABASES, I came upon the trap that no doubt many of you run into when seeking information—hard-to-decipher technical articles. Even the technically sophisticated readers of BYTE, I am sure, have had difficulty understanding some of the esoteric notions behind databases. I hope this article will make the subject clearer for you.

Six overlapping categories are commonly used in describing database programs: file-management system, relational, hierarchical, network, free format, and multiuser.

## FILE-MANAGEMENT SYSTEM

A file-management system lets you save and retrieve records, made up of *fields*, into a file. An example of a record is:

Name	Type	Size
BYTE	computer	big

Name, Type, and Size are the names of the fields; BYTE, computer, and big are the values of the fields that make up the record. A record such as this one might go into a file called Magazines. The limitation of the file-management system is that it will not combine information in one file with

information in another file. In other words, a file-management system won't let you combine the record

Name	Circulation
BYTE	425,000

from the Circulation file with the record from the Magazines file. (Some file-management systems use more than one file, which you may combine, but the files always have the same field structures; though there are several files, there is only one record type.) In this respect, a file-management system is analogous to an index card file. However, while you may search a card file by only one field (such as company name), you can search a file-management system by any of the fields in the record; for instance, by Type as well as by Name.

## RELATIONAL DATABASE

A relational database is like a file-management system in that it is also made up of records, which in turn are made up of fields. It differs in that it can combine records from different

.....  
Rich Krajewski is a technical editor at BYTE. He can be contacted at POB 372, Hancock, NH 03449.

files as long as the records in the different files have one field in common. Under this system you can, theoretically, combine records using a common field from an unlimited number of files with commands such as PROJECT and JOIN. PROJECT creates subset records from existing records, such as

Name	City
BYTE	Peterborough

from

Name	Street	City
BYTE	70 Main	Peterborough

The JOIN command combines records into new records, such as

Name	Editor	Page Size
BYTE	J. Comma	8 by 11 inches

from

Name	Editor
BYTE	J. Comma

and

Name	Page Size
BYTE	8 by 11 inches

The relational database gets its name from the *relation*, which is a table

(continued)



of data in which every row is unique. Figure 1 is an example of a relation. Notice that the relational table looks exactly like a set of records from a file-management system. The records or rows in a relation are called *tuples*. The fields or columns are called *attributes*, *predicates*, or *classes*.

The beauty of relational systems is that, supposedly, you can enter data without too much regard for how you are going to use it; that is, you don't have to know how records will be combined when you enter the data, as you do when you use a file-management database. However, if you don't plan how you're going to use data and input it according to that plan, you're going to spend some time getting the information out as the database program searches through your database files, makes the proper combinations, and records the results. If you knew ahead of time how you wanted your information served, you could have recorded it

that way in a single file and saved yourself a bunch of time when you retrieved it.

**HIERARCHICAL DATABASE**

The hierarchical database is made up of records, as is the relational database, except that the records in a hierarchical database do not have to be broken up into fields. The records can look like relational records with several fields per record, like a word-processor file, or like a one-dimensional array of data items. They can look like anything you want because the hierarchical system doesn't look at the contents of a record the way a relational system does. In a relational system, the connections, or "hooks," between files depend on the data itself. For instance, although two files (or record sets) may have a common field, you don't join the files if the data in the two common fields is not alike. In the JOIN example I gave earlier, you couldn't join the two

*In a hierarchical system, connections between files are fixed for the life of the database. File A is always linked to File B regardless of contents.*

NAME	TYPE	SIZE
BYTE	COMPUTER	BIG
NEW YORKER	GENERAL INTEREST	MEDIUM

Figure 1: An example of a relation. The rows are called tuples and the columns are called attributes.

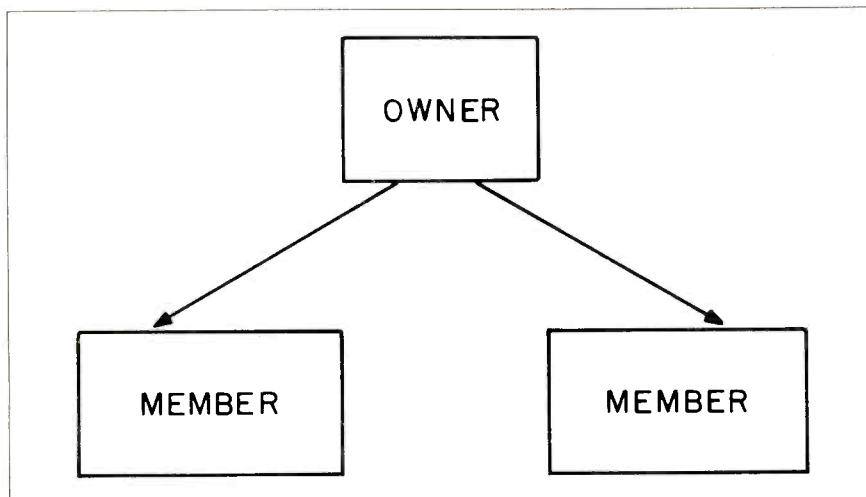

Figure 2: The structure of a simple hierarchical database.

record sets by the common field Name if the item BYTE were not listed in both record sets under Name.

In a hierarchical system, however, the connections between files don't depend on the data in the files. The connections are defined at the start and are fixed for the life of the database. In this system, file A is always linked to file B no matter what the contents of those two files are. And, naturally enough, the connection between record types is hierarchical.

These connections are called the *structure* of the data, and a diagram of them looks like an upside-down tree. Figure 2 shows the data structure of a hierarchical database. The file at the top is called the parent or owner file, while the files at the bottom are called the child or member files. The identifying characteristic of this system is the one-to-many connection between the owner and the member files. In other words, the member files have only one owner file. The hierarchical directory system of PC-DOS 2.0 is an example of this. Under PC-DOS 2.0, you can create subdirectories; when you call a directory such as User, it automatically comes up with several subdirectories, such as User1 and User2. Within those subdirectories will be either more subdirectories or files with data in them, but each of the subdirectories has only one owner directory. Another example of this system is the table of contents in a book. The table itself is the owner set, and the chapters that the table directs you to are the member sets.

In a hierarchical database, a search

*(continued)*



**C COMPILERS FOR  
PC DOS MS DOS CP/M-86 CP/M-80 APPLE II, IIe, IIc  
COMMODORE 64 RADIO SHACK and MACINTOSH**



**AZTEC C86**

**NEW RELEASE**

Optimized "C" compiler for PC DOS, MS DOS & CP/M-86  
PC DOS, UNIX I/O, math, screen, graphics libraries  
8086 assembler, linker & librarian, overlays  
/PRO—library source, debug, ROM, MASM & RMAC, 8087, large model

**NEW C COMPILERS  
AZTEC C68K for MACINTOSH  
VAX cross compilers**



**AZTEC C II**

**NEW RELEASE**

Optimized "C" compiler for CP/M, TRSDOS & LDOS  
assembler, linker & librarian, overlays, utilities  
UNIX I/O, math & compact libraries  
/PRO—library source, ROM, M80 & RMAC

**C TOOLS & AIDS**  
Z editor (like Vi), C TUTOR compiler, PHACT database,  
C GRAFX, UNI-TOOLS I, QUICK C, BABY BLUE for PC  
to CP/M cross, QUADLINK for PC to APPLE cross

**AZTEC C65**

"C" compiler for APPLE DOS 3.3, ProDOS or COMMODORE 64  
VED editor, SHELL, UNIX & math libraries  
/PRO—library source, ROM, overlays



**CROSS COMPILERS**

Compile & link on HOST—test on TARGET machine  
HOSTS: UNIX, PC DOS, CP/M-86, CP/M-80, VENIX, PCIX, APPLE  
TARGETS: PC DOS, CP/M-86, CP/M-80, APPLE, RADIO SHACK,  
COMMODORE 64, other hosts and targets available



**PRICES**

**AZTEC C86 C COMPILER**

PC DOS MSDOS	249
CP/M-86	249
BOTH	399
C86/PRO	499
/PRO UPGRADE	250
Z (VI EDITOR)	125
C TUTOR COMPILER	99
PHACT DATABASE	299
C GRAFX	99
SUPERDRAW	299
UNI-TOOLS I	99
QUICK C	125

**AZTEC C II C COMPILER**

CP/M	199
CII/PRO	349
/PRO UPGRADE	150
TRS 80 MODEL 3	149
TRS 80 MODEL 4	199
TRS 80 PRO (3 & 4)	299

**AZTEC C65 C COMPILER**

APPLE DOS 3.3	199
PRODOS	CALL
E EDITOR	99

**AZTEC C CROSS COMPILERS**

PDP-11 HOST	2000
PC DOS HOST	750
CP/M-86 HOST	750
CP/M-80 HOST	750
APPLE HOST	750
VAX HOST	CALL
MACINTOSH	CALL

**TARGETS**

PC DOS
CP/M-86
CP/M-80
APPLE
RADIO SHACK
COMMODORE 64
MACINTOSH

TRS 80 RADIO SHACK TRS DOS is a trademark of TANDY.  
APPLE DOS MACINTOSH is a trademark of APPLE.



**MANX SOFTWARE SYSTEMS**  
Box 55  
Shrewsbury, NJ 07701  
TELEX: 4995812

**TO ORDER OR FOR INFORMATION:  
CALL: 800-221-0440 (outside NJ)  
201-780-4004 (NJ)**

Australia: Blue Sky Industries — 2A Blakesley St. — Chatswood NSW 2067 — Australia 61-2419-5579  
England: TAMSYS LTD — Pilgrim House — 2-6 William St. — Windsor, Berkshire SL4 1BA — England — Telephone Windsor 56747  
Shipping: per compiler next day USA \$20, 2 days USA \$6, 2 days worldwide \$75, Canada \$10, airmail outside USA & Canada \$20  
UNIX is a trademark of Bell Labs. CP/M, CP/M-80 and CP/M-86 are trademarks of DRI. PC DOS is a trademark of IBM. MS DOS is a trademark of MICROSOFT.  
N.J. residents add 6% sales tax.



# MidWest Micro-Peripherals

Save with Confidence

Let us earn your trust as we have that of others, such as:  
 Goodyear • General Motors • US Navy • Bell Labs  
 Conrail • Texas A&M University • General Electric  
 General Dynamics.

	List	Our Price
<b>PRINTERS</b>		
Star Gemini 10X (120 CPS)	\$399	\$289
Star Gemini 15X	549	399
Star Delta 10 (160CPS)	549	399
Star Delta 15 (160CPS)	795	589
Star Radix 10 (200CPS)	849	639
Star Radix 15 (200CPS)	899	739
Star Radix 15	399	279
EPSON RX 80 (100 CPS)	499	319
Epson RX-80FT (100CPS)	499	319
Epson FX 80 (160CPS)	689	429
Epson LX 1500 (200 CPS)	1495	1199
Okidata 92P (80 Col., 160 CPS)	599	429
Okidata 82A (80 Col., 120 CPS)	349	319
Okidata 93P (136 Col., 160 CPS)	999	649
Okidata Pacemark 2350P, 2410P		SCALLS
Toshiba 1340P (54CPS)	985	769
Toshiba 1351P (100CPS)	1855	1299
Smith Corona, Complete Line		SCALLS
<b>DAISYWHEEL PRINTERS</b>		
Silver Reed EXP 400	399	299
Silver Reed EXP 500 (16 CPS)	539	399
Silver Reed EXP 550 (18 CPS)	699	439
Silver Reed EXP 770 (36 CPS)	1295	SCALLS
Brother HR-15 (13 CPS)	599	399
Brother HR-25 (23 CPS)	895	669
Juki 61CO (18 CPS, Bi-dir)	599	439
Diablo 36 (35 CPS)	1799	1299
Diablo 630 (40 CPS)	2499	1749
Daisywriter 2000 (40 CPS)	1495	979

**IBM PC SYSTEMS**

Will configure to your needs for PC's, XT's and Jr's. Save on complete systems



Ask for ext. 20!

**DISK DRIVES FOR IBM PC OR XT**

All Drives Pretested with Complete Instructions.

Panasonic: Half Heights	279	149
Panasonic: Dual Drive		
(Complete hardware, instructions & full warranty)	499	299
Tandon 100-2 (IBM Standard)	399	179
Maynard-10 Meg. Internal Drive	1395	998
Talgrass Drives		SCALLS

**MODEMS**

Smartmodem 300	289	219
Micromodem 11e	299	239
Smartmodem 1200	699	489
Smartmodem 1200B	599	419
Smartcom 11		SCALLS

**MONITORS**

Amdek 310-A	230	169
Amdek Color II	559	429

**EXPANSION CARDS**

<b>AST</b>		
Six Pac Plus, 64K, S/P/C+S/W	395	289
MegaPlus II, 64K, 2S/P/C	495	263
I/O Plus II	215	129
Complete AST Line		SCALLS
<b>QUADRAM</b>		
Quadboard, w/64K, Expandable 384K	295	289
Complete Quadram Line		SCALLS
<b>MERCULES</b>		
Graphics Card	449	339
Memory chip kit-64K 150ns-9 chips	99	54
64K 200ns-9 chips	95	49

**SOFTWARE**

Lotus 1-2-3 dBase Quickcode	Think Tank Multimate PFS	Hundreds of Titles!	SCALLS and SAVES
-----------------------------	--------------------------	---------------------	------------------

**VERBATIM DATA LIFE DISKETTE SALE**

SS/DD	10-90	100-Up
DS/DD	1.99	1.79
	2.99	2.69

**OUR PRICE COMMITMENT**

MidWest will try in good faith to beat any nationally advertised price.

**Call Today!**  
**1-800-423-8215**  
 In Ohio 1-800-321-7731  
**Information - Ordering**

We accept VISA, MASTER CARD, AMEX, certified checks, money orders & CDD's



MidWest Micro-Peripherals  
 (Division of Intel, Inc.)  
 135 South Springfield St.  
 St. Paris, Ohio 43072

AD #B-107

## DATABASE TYPES

of owner files can lead you to member files and vice versa. In good systems, any update of the records in an owner file automatically updates the records in the member files.

### NETWORK DATABASE

The network database is like a hierarchical database but with one modification—you can relate any record types or files with any other record types or files; that is, the data structure is many-to-many instead of one-to-many. A hierarchical database structure is a degenerate case of a network structure. Again, you must do the relation in advance. This is more restrictive than the relational database, but a program will run faster if you define the data structure in advance.

Figure 3 shows a simple network database structure. Notice that there can be many owner files for a single member file. A book contains a network database in the form of chapter cross-references, such as "see chapter 7 for more on fiber-optic modems."

An interesting thing about these database types is that they are just models. They are somewhat arbitrary in their definition. In fact, I've seen several varying definitions of data models and structures. Definitions are further clouded by the "procedural languages" included with some database programs. These languages enable you to, for example, define a network structure in a relational database. What counts more than these definitions is your application for data and how well a program meets the application, regardless of

whether the program calls itself relational, hierarchical, or whatever.

### FREE-FORMAT DATABASE

Another type of database is the free-format database, which lets you enter information in any format you want—text, tables, or numbers—and retrieve it by means of keywords that you use to tag the information. For instance, you could write a paragraph about one of your business contacts and give it the keywords "contact" and "Moe Shmoe." This way you could retrieve the paragraph by asking the database for information about Moe Shmoe, contacts, or both. A book is a free-format database because it may be searched with keywords in the index. Some file-management programs use a free-format structure.

You could consider free-format databases to be relational if you stretch things a bit. You could say that the paragraphs and keywords you enter are in fact records consisting of the fields Paragraph and Keyword. The Keyword field would be the field by which you search the database. You could mimic a free-format database with a relational one by following this procedure.

### MULTIUSER DATABASES

A multiuser database may have any of the database structures already discussed. Its defining feature is that it lets several people access a database at the same time. However, only one person ought to be able to change a record at any one time—other users should be either "locked

(continued)

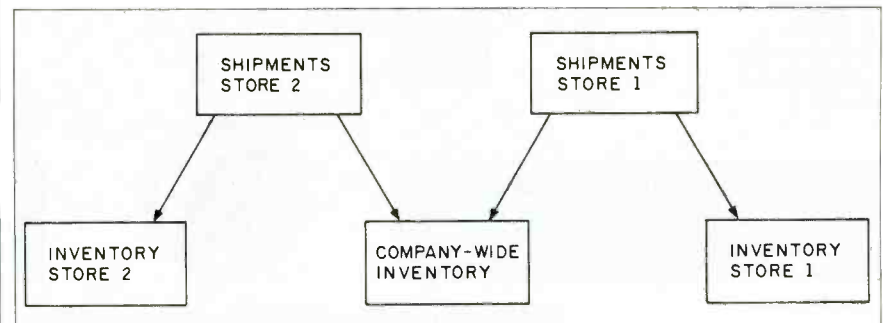
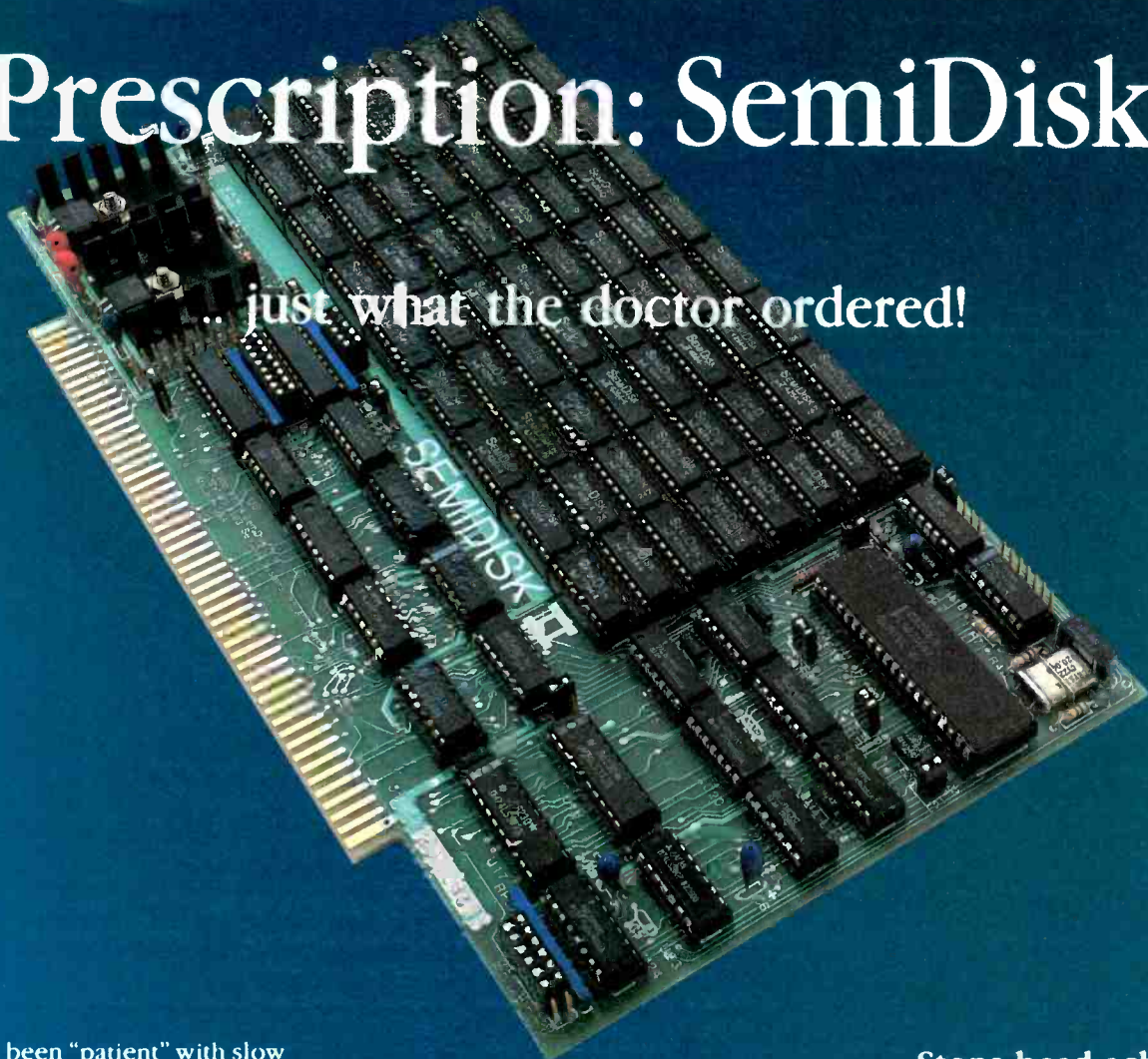

Figure 3: The structure of a simple network database.



# Prescription: SemiDisk.™

... just what the doctor ordered!



If you've been "patient" with slow disk drives for too long, SemiDisk will relieve your suffering.

## Fast-acting.

The SemiDisk, a super-fast disk emulator, stores and retrieves data much faster than either a floppy or hard disk. This is especially useful with programs such as editors, assemblers, compilers, spelling checkers, and large capacity data base managers.

## Easy to apply.

Installation is as easy as plugging the SemiDisk into an empty slot of your computer, booting up normally, and running the installation software provided. No assembly language programming is required.

## Comes in regular and extra-strength.

SemiDisk I is the standard model for S-100, for use with CP/M® 2.2. SemiDisk II is just as easy to use,

and offers extra speed and flexibility for custom S-100 applications. There are also SemiDisks for TRS-80 Model II, IBM PC, and Epson QX-0.

## Contains gentle buffers.

CP/M® 80 installation software includes SemiSpool, which temporarily stores print data in the SemiDisk, and continuously feeds the printer as it becomes ready for data. This buffering action allows the computer to be ready for other uses immediately after issuing a print command, while the printer is printing.

## No blackouts: A cure for emulator amnesia.

The optional Battery Backup Unit (BBU) plugs into the SemiDisk, and supplies power even when the computer is off. It contains a battery which keeps the data alive during prolonged power outages of four hours or more.

## Stops head-aches.

Unlike a hard disk, which can "crash" its head on the rapidly rotating disk surface, and a floppy, which grinds the disk constantly, the SemiDisk has no moving parts to break or wear out. No buzzing, clicking, grinding, or other noise. Just ultra-fast, silent data transfer.

## Won't bruise your wallet.

And now the really good news! SemiDisk's price won't raise your blood pressure.

	512K	1Mbyte
SemiDisk I, S-100	\$995	\$1795
SemiDisk II, S-100	\$1245	\$2095
SemiDisk, TRS-80 II	\$995	\$1795
SemiDisk, IBM PC	\$945	\$1795
SemiDisk, Epson QX10	\$995	

# SEMIDISK

SemiDisk Systems, Inc.  
P.O. Box GG, Beaverton, Oregon 97075  
503-642-3100



# PC SOFTWARE SALE!

WE'LL MATCH PRICES ON MOST PRODUCTS

LOTUS CALL	WORDSTAR \$229
RBASE 4000 \$315	dBASE II/III CALL
WORDSTAR PROF PAK \$359	EASYWRITER II SYSTEM \$185
HAYES SMARTMODEM 1200 \$489	AST SIX PAK PLUS \$269

## LOOK AT THESE SPECIAL PRICES!

ATI Training Power	CALL
Crosstalk	\$ 99
dBase II/III	CALL
Database Manager II	\$199
EasyWriter II System	\$185
Hayes Smartmodems	CALL
InfoStar	\$249
IUS Accounting	CALL
Lotus 1-2-3/Symphony	CALL
MicroPro Products	CALL
Microsoft Word	\$289
Microsoft Products	CALL
Multimate	\$269
Peachtext 5000	\$189
ProKey	\$ 87
Quadram Quadboards	CALL
RBase 4000	\$315
SuperCalc 2	\$155
SuperCalc 3	\$219
VisiCorp Products	CALL
Volkswriter Deluxe	\$175
Wordstar	\$229
Wordstar Prof. Package	\$359
All Other Products	CALL

To order:  
Call TOLL-FREE:  
800-227-4780 or 415-845-2651

Or write:  
ECONOMY SOFTWARE  
2040 Polk Street  
San Francisco, CA 94109

# ECONOMY SOFTWARE

- We guarantee our products against manufacturer's defects.
- Quantity discounts available. We are experienced with Corporate accounts.
- No surcharge added for charge cards. No charges until products are shipped.
- Purchase orders accepted.
- Call for shipping charges.
- Prices subject to change.

## DATABASE TYPES

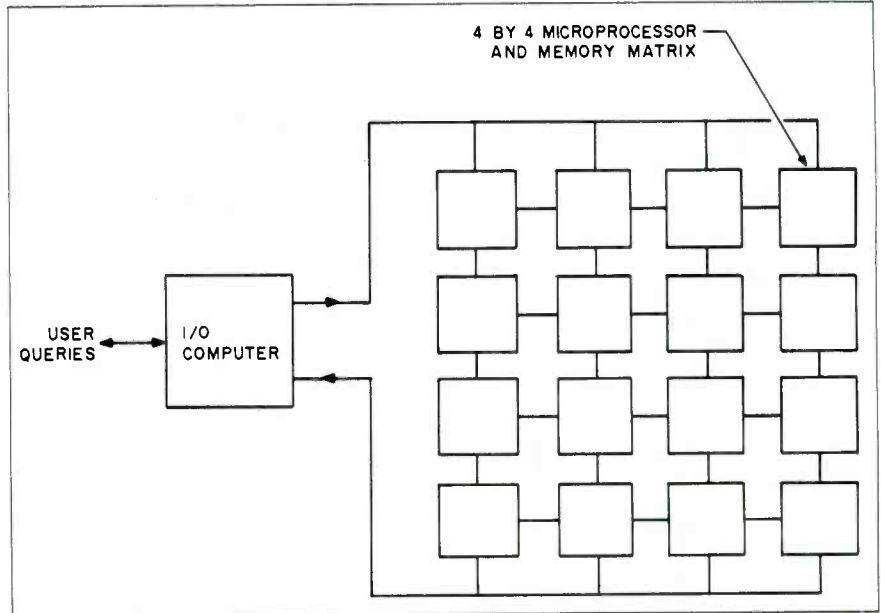

Figure 4: A diagram of a parallel-processing database machine. The query is prepared by the I/O computer for the computer matrix, where individual parts of the query are processed separately and simultaneously.

out" of the record entirely or admitted on a read-only basis. With large databases in corporate environments, this type of database will be a necessity.

### DATABASE MACHINES

Because some database systems are so input/output bound, database machines have been built to streamline the retrieval and processing of data. Figure 4 shows a model of a special type of database machine based on parallel processing. Parallel processors contain microprocessors

that work together on different pieces of a problem, in this case a database query. The query is handled by different processors containing the right information, and the results are compiled and presented much faster than if a single processor had retrieved the data from a traditional mass-storage device. The speed difference is noticed only when the query involves information from several different sets or files. If the query asks for something as simple as a list of addresses, any ordinary microcomputer would work just as fast. ■

## BOOKS ABOUT DATABASES

- |   |   |
|---|---|
| Brooner, E. G. <i>Microcomputer Data-Base Management</i> . Indianapolis, IN: Howard W. Sams & Co., 1982.      | Systems: A Guide to Microcomputer Software. Berkeley, CA: Osborne/McGraw-Hill, 1983.                  |
| Byers, Robert A. <i>Everyman's Database Primer, Featuring dBASE II</i> . Reston, VA: Reston Publishing, 1983. | Martin, James. <i>An End-User's Guide to Data Base</i> . Englewood Cliffs, NJ: Prentice-Hall, 1981.   |
| Date, C. J. <i>Database: A Primer</i> . Reading, MA: Addison-Wesley, 1983.                                    | Martin, James. <i>Managing the Data Base Environment</i> . Englewood Cliffs, NJ: Prentice-Hall, 1983. |
| Freiling, Michael J. <i>Understanding Data Base Management</i> . Sherman Oaks, CA: Alfred Publishing, 1982.   | Townsend, Carl. <i>CP/M Database Management Systems</i> . Beaverton, OR: dilithium Press, 1983.       |
| Kruglinski, David. <i>Data Base Management</i>  |   |

# SuperSoft Languages

## When Performance Counts

A programmer's most important software tool is the language compiler or interpreter he uses. He has to depend on it to work and work well.

At SuperSoft, we believe it. That's why we offer three excellent compilers: SuperSoft FORTRAN, SuperSoft C, and SuperSoft BASIC. They answer the programmer's need for rock solid, dependable performance on microcomputers.

## SuperSoft FORTRAN

With large code and data.

SuperSoft FORTRAN version 2.0 with large code and data space is now available under MS DOS and PC DOS. It gives you the power to compile extremely large FORTRAN programs on micros. It allows double precision and complex numbers, full IEEE floating point, and a full range of other important features for the serious FORTRAN programmer.

Both 8087 support and a RATFOR preprocessor are optionally available.

FORTRAN (CP/M-80 & 86, MS DOS, PC DOS): \$425

Small model under PC DOS and MS DOS: \$325

8087 support: \$50

RATFOR: \$100

## SuperSoft C

SuperSoft C is a high-powered, full-featured C compiler designed for serious C applications. It is fast – both in compilation and execution, and it is packed with more than 135 library functions (all delivered in source code form). SuperSoft C produces optimized assembly code, and object code can be ROMed.

SuperSoft C (for CP/M-80, CP/M-86, MS DOS, PC DOS): \$350



## SuperSoft BASIC

The SuperSoft BASIC compiler lets you get serious with business and financial programs. It uses BCD math to give you highly accurate results for demanding applications. SuperSoft BASIC is a true native code compiler that is generally compatible with Microsoft's BASIC interpreter. And an additional bonus – no run time license fee is required.

SuperSoft BASIC Compiler (for MS DOS, PC DOS, and CP/M-86): \$300

Also available for programmers:

Star-Edit, a full-featured programmer's text editor: \$225.00

Disk-Edit, an invaluable programmer's disk data editor: \$100.00



To order call: **800-762-6629**

In Illinois call 217-359-2112

In conjunction with SuperSoft, SuperSoft FORTRAN was developed by Small Systems Services, Urbana, IL, a leader in FORTRAN development.

Japanese Distributor: ASR Corporation International, TBL Building, 7th Floor, 1-199 Toranomon, Minato-Ku, Tokyo 105, Japan Tel. 03-05025550. Telex 222-5850 ASRTYO J.

European Distributor: SuperSoft International Ltd., 50 The Pantiles, Tunbridge Wells, Kent, England TN2 5TE. Tel. 0892-45433. Telex: 95441 Micro-G.

PC DOS is a trademark of International Business Machines.

MS DOS is a trademark of Microsoft.

CP/M-80 and CP/M-86 are trademarks of Digital Research, Inc.

# SuperSoft®

SuperSoft, Inc., 1713 S. Neil St.,  
P.O. Box 1628, Champaign, IL 61820



# "SINCE COOKING ON MY TV HAS TURNED OUT SOME RECIPIES

If my colleagues have asked me once they've asked a thousand times, 'How do you turn out such scrumptious-looking pies? So crisp, and sharp and contrasty?' Well fortunately for you, I'm

not the kind of petty person who refuses to share his recipes.

So you can know all my pie secrets—even the way I manage to get those mouth-watering



The Color 300.

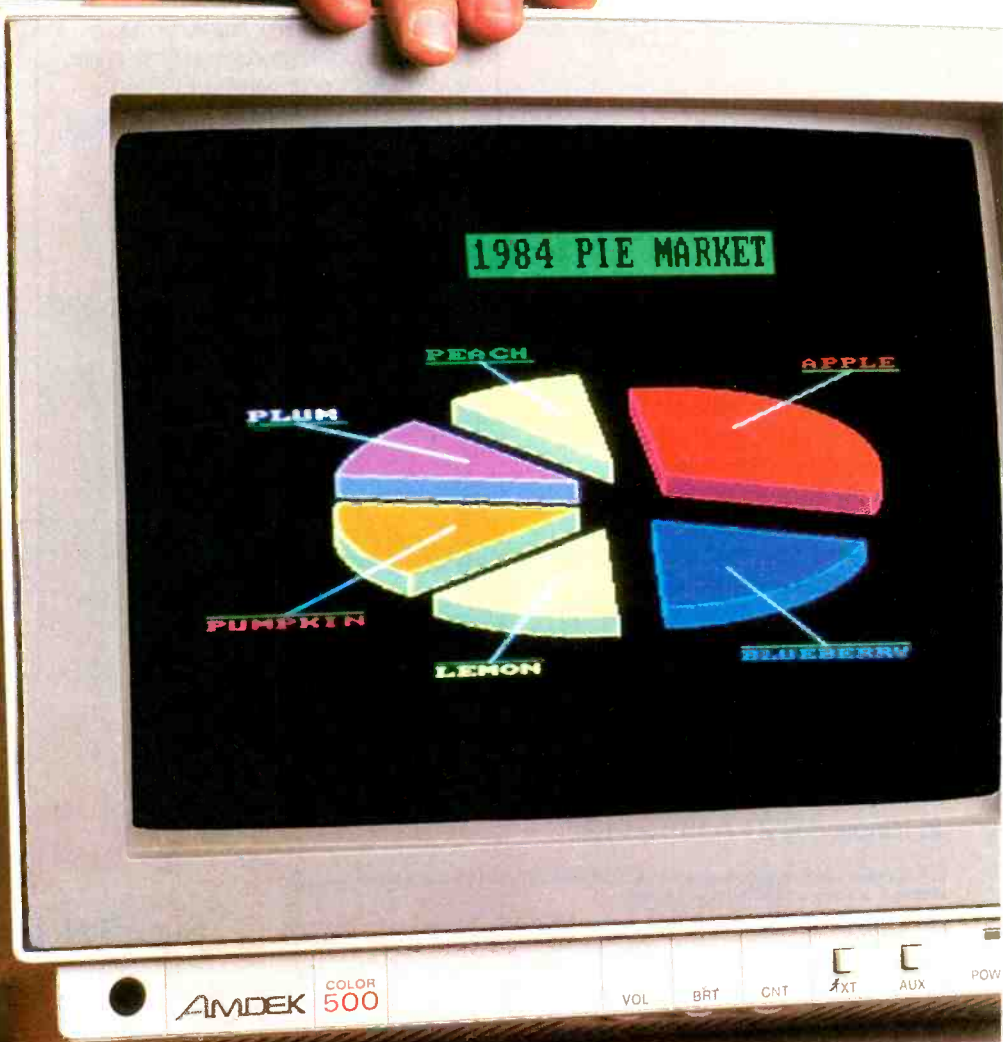
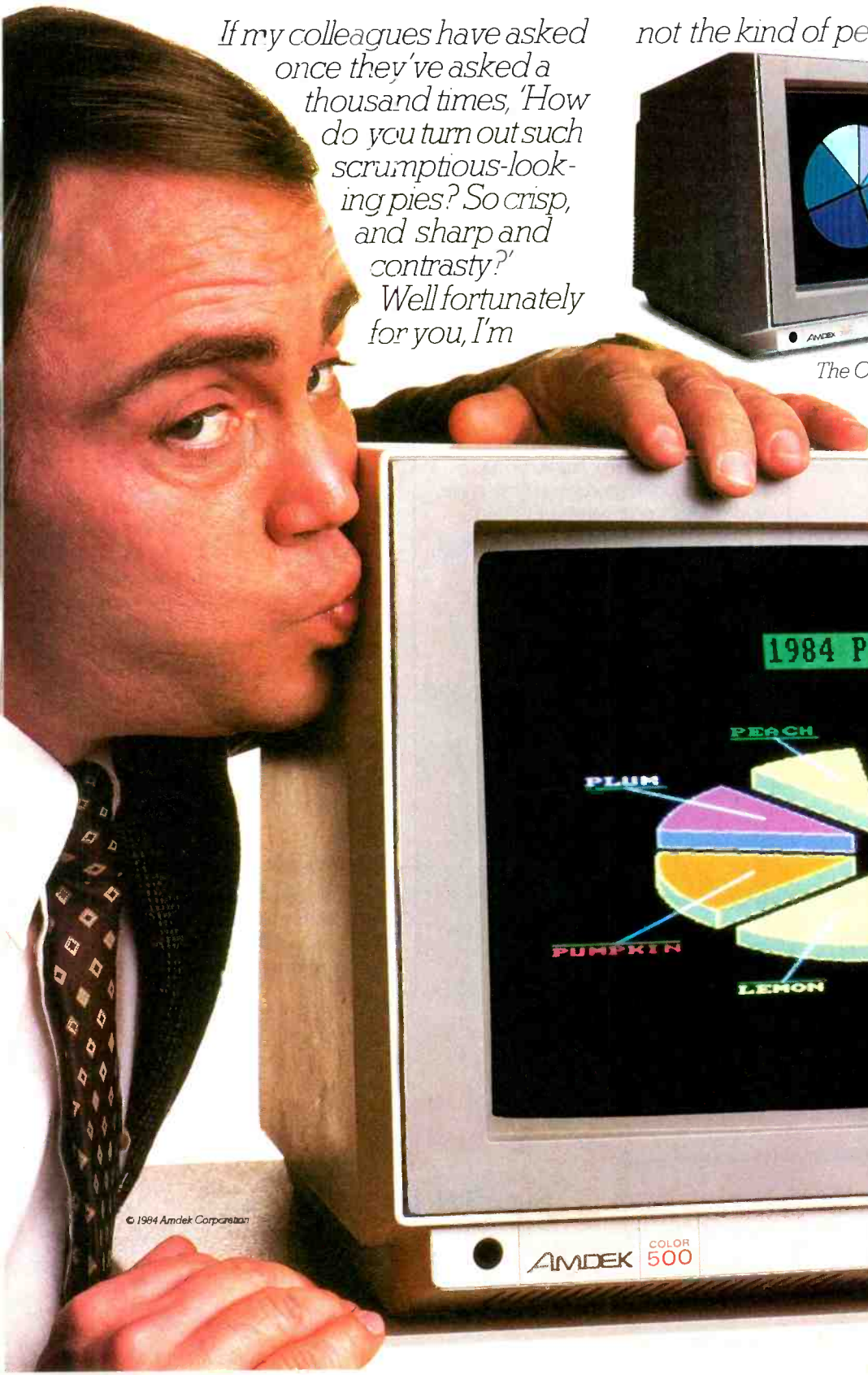

© 1994 Amdek Corporation

AMDEK COLOR 500

VOL BRT CNT XT AUX POW

# AMDEK MONITOR, I'VE ALLY HEAVENLY PIES."

colors — lemony yellows; rich, chocolate browns; cherry reds.

It's really simple. The single most important ingredient in preparing a pie chart is the monitor. And in this chef's opinion, the name that stands above the rest is Amdek.



The Color 400.

## PIE A-LA-GRAPHICS MODE.

Like all business graphics, the pie helps you communicate with greater clarity.

So you need a monitor that gives you loads of quality and reliability.

And features, too. All Amdek Monitors offer a black matrix picture tube for super color definition.

Some provide a built-in speaker, audio amplifier and head-phone jack.

One model allows you to hook up to your VCR. Others let you flip a text switch and change the color to green, for easier reading.

Versatility is the key. From a relatively low-cost composite model, to an ultra high-resolution RGB unit (as high as 720(H) x 480(V)), Amdek has literally anticipated your monitor needs, present and future.

The Color 500.

## APPLE PIES, IBM PIES, ETC.

One thing every pie-maker should know. Amdek Monitors are compatible with virtually every personal computer available today.



The Color 700.

## A WORD ABOUT DOUGH.

Amdek Monitors are surprisingly affordable. Which allows you to turn out really first-rate pies at a price not limited to the upper crust.

And underscoring this value is a special Amdek plum. A two-year warranty on electronics, three years on the tube — the best warranty in the field.

## BAKE-OFF

Compare for yourself. For high-quality resolution, sharpness, color, styling and price, you won't find a better value than the Amdek Monitor.

And, why shouldn't people be saying about your pies what they're already

saying about mine: That they rise above all others.

# AMDEK COLOR MONITORS



The Color 600.

Amdek Corporation, 2201 Lively Boulevard, Elk Grove Village, IL 60007 Phone 312/595-6890

Circle 16 on inquiry card.



# Top Modem



- Hayes Compatible • More Features • Only \$495

The best price/performance ratio of any 212A modem on the market today for under \$500! That puts ProModem 1200 on top of the stack. Compare the 26 features. You'll see why. Only ProModem offers all 26. 15 are exclusive.

They're important features. The Real Time Clock/Calendar for example. Used with Applications Programs, or the OPTIONS PROCESSOR, gives you pre-set timed operation of the modem. Also, time and duration records of all calls. The convenient HELP command makes ProModem easy to use. It promptly displays the Instructions Menu whenever there's a question about what to do next. With Call Progress Detection, you can "tell" ProModem to do things like automatically "Redial When Busy."

It's the only modem that lets you expand into a full telecommunications center with add-ons. The OPTIONS PROCESSOR gives you Data Store and Time Base Continuity with battery backup, Personal/Business Telephone Directory, and Automatic Receipt/Transfer Buffer, expandable to 64K. The OPTIONS PROCESSOR also enables ProModem to operate unattended, with or without your computer.

The optional 12-character ALPHANUMERIC DISPLAY indicates modem operating status, system diagnostics, message status, phone numbers, and real time clock data. . . to name just a few.

Together, these standard and optional features give you a sophisticated electronic mail and communications capability unmatched by any other modem in this class. And, there's more. See your local dealer for additional information and a demonstration. He'll show you why ProModem 1200 is tops.

ProModem 1200 from . . .

## PROMETHEUS<sup>®</sup>

Prometheus Products, Inc., 45277 Fremont Blvd., Fremont CA 94538, (415) 490-2370

NOW AVAILABLE

- ProModem plug-in cards for IBM PC and Apple II
- ProCom Software

### 212A Modem Comparison Chart \*

#### STANDARD FEATURES

- 300/1200 Baud (212A)
- Intelligent Microprocessor
- Tone and Pulse Dialing
- Hayes Command Compatible (Works with Smartcom<sup>®</sup>)
- Additional telephone jack with exclusion switching
- Analog loop back self test
- Self Test at Power Up
- Call Progress Detection (Busy, Dial Tones, Trunk Busy, etc.)
- Speaker and External Volume Control
- Full Complement of Status Lights
- 8 Switch Selectable power-up defaults
- Adaptive Dialing
- Auto Redial on Busy
- Ergonomically designed easy to read front display panel
- Internal Stand-Alone Power Supply
- Built in Real Time Clock/Calendar
- Help Command
- 300 baud connect while maintaining 1200 baud RS-232 link

#### EXPANDABLE OPTIONS

- Automatic Receiver Buffer
- Automatic Transmit Buffer
- On-board Personal/Business Directory
- Buffer, Expandable to 64K
- Auto Logon Macros
- Auto message transmission to groups of numbers
- Records call duration
- 12-character Alphanumeric Display

#### PRO

	✓	✓	✓	✓
	✓	✓	✓	✓
	✓	✓	✓	✓
	✓	✓	✓	✓
			✓	ANCHOR 1200
			✓	
		✓	✓	US ROBOTICS PASSWORD
		✓	✓	
		✓	✓	HAYES STACK
	✓		✓	
	✓			NOVATION SMARTCAT+
	✓			
	✓			

\*Comparison made by Prometheus on the basis of the best information available to Prometheus at time of printing.



# TEXT DATABASES

BY EZRA SHAPIRO

---

*Integrating database and editing functions  
simplifies the creative process*

ASSEMBLING A REPORT from a large collection of data—even if that data is entirely textual—can be tricky business. If you use a traditional word-processing program to store individual elements as you develop your materials, you'll wind up with a group of separate files that have to be pulled into one document for the final edit (see figure 1). Depending on the number of files, you might be facing a lengthy, repetitive series of maneuvers to read each element into your report, and that's before you start polishing, rearranging, and formatting the output. And if you are trying to gather your report from a large universe of text files, you'll have a tough time making sure you get everything (unless you have a photographic memory and an effective system for naming each file). The larger the collection of files, the more difficult it is to remember what's what.

A second approach involves using a database management program to store and catalog your information. Each chunk of text is labeled with a few keywords, and retrieving the appropriate data becomes a snap (see figure 2). However, most database software is designed merely to manip-

ulate individual records, not to gather text into a document that can be edited. You have to output your text blocks somehow and then work on them with a word processor.

Neither solution is particularly comfortable. A pure word processor lacks sophisticated data-retrieval mechanisms, and a database manager lacks the editing facilities you need.

In recent months there's been an explosive growth of software products designed to solve this dilemma. These new products are ambiguously referred to as "idea processors" or "text database management systems." These programs are, for the most part, blends of text editors and data-retrieval shortcuts that let you rapidly locate text fragments and incorporate those fragments into longer documents.

The integration of text editing and text management, in an effort to provide software tools that enhance human creativity, has resulted in programs that are widely divergent in

.....  
*Ezra Shapiro is bureau chief at BYTE's West Coast bureau. He can be reached at McGraw-Hill, 425 Battery St., San Francisco, CA 94111.*

guiding philosophy. (This is one of the most hotly debated areas of software design.) Should software lead you to a more productive method of working? Or should it let you reproduce, as closely as possible, your current work habits (which may be extremely disorganized and downright sloppy)?

The models that follow are generic; they are not exact descriptions of specific programs on the market today, though a number of products come close to fitting some of these descriptions. Some of the models are purely theoretical. The best design for an editor/database might depend on personal taste, might never exist, or might require years of study and development.

## OUTLINE PROCESSORS

One answer to the question of how to provide more effective text management is the outline processor, which represents a kind of text database and is certainly a major step beyond word processing. Outline processors enable you to organize material in the form of an indented outline (see figure 3). You construct a skeleton of

*(continued)*



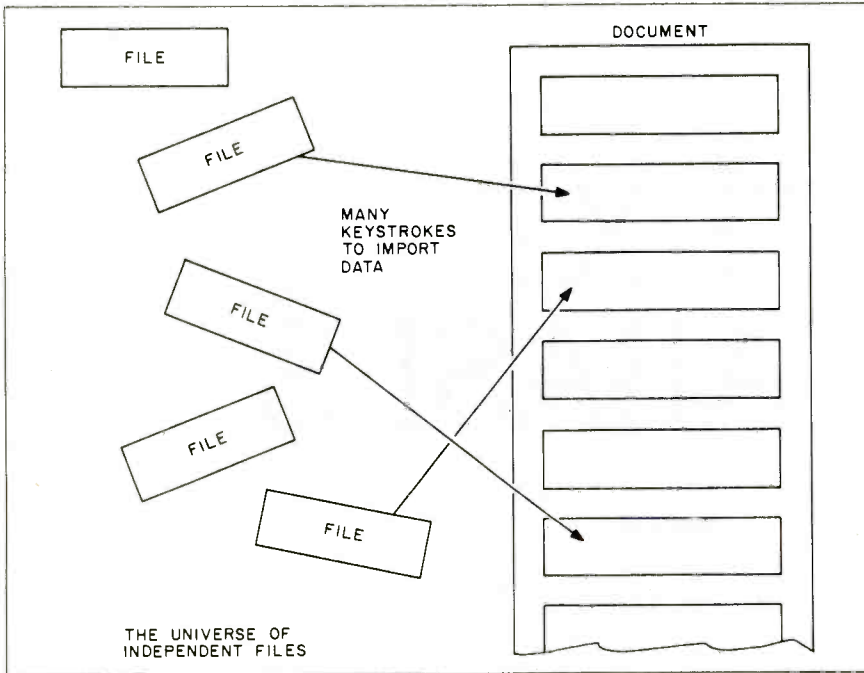

Figure 1: The "flat text" model, which represents data as prepared by a word-processing program. Individual blocks of text are arranged one after another as entered. New blocks can be pulled in from outside the editor, but you must remember which external file contains the needed material.

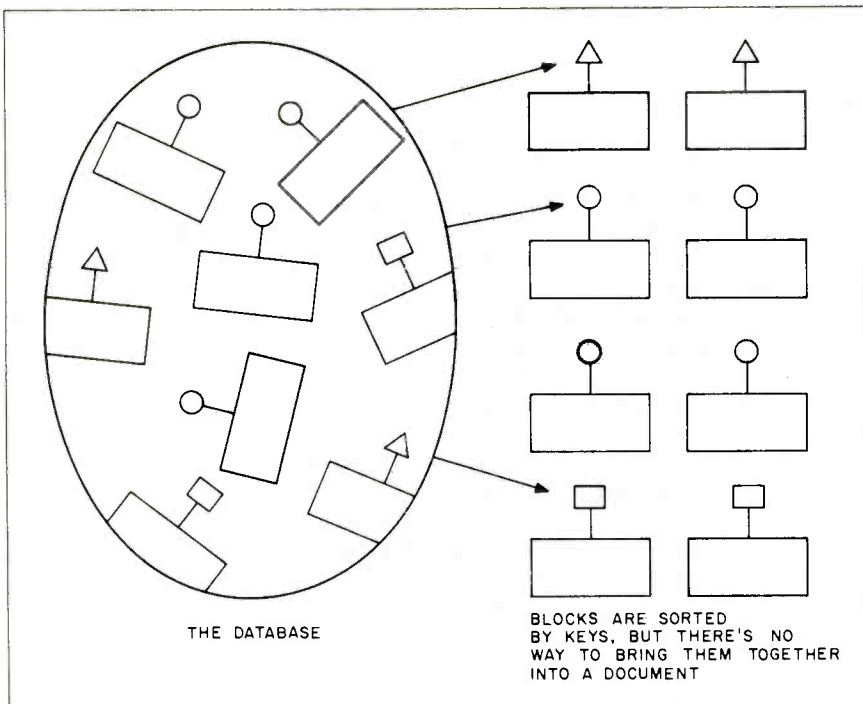

Figure 2: The database model. Related text blocks can be retrieved from within a large library of randomly entered data, but there are no facilities for molding the fragments into a coherent document. Final editing must still be done with a text processor.

*Outline processors impose a structure on the data-entry process, which may inhibit spontaneity.*

levels of topics and subtopics, any of which can be expanded to incorporate manageable chunks of text. You have the option of viewing your report as a full document or "collapsing" the view to show just the headings of each subsection. This collapsing feature lets you shrink your report to a size that's easy to comprehend at a glance. While your text remains hidden from the display, the program keeps track of it; large sections of text can be moved around within the document simply by moving a heading within the outline.

If you begin collecting your original notes with an outline processor, you can easily keep your data under control. Because most outline processors have the capability to read external files as sections under headings in the outline, you can import data from other sources, such as traditional word processors or database managers.

It is also possible to stretch the outline out on its side so it resembles an upside-down tree standing on its branches instead of on its trunk (see figure 4). This way, subsidiary topics on the same level of indentation are seen as equally weighted options and are not unintentionally ranked by the natural downward flow of an outline.

However the views are constructed, outline processors do impose a structure on the data-entry process, which may inhibit spontaneity. An outline is necessarily hierarchical in nature, with one item following another, and reorganization can be cumbersome. Random note-taking is discouraged by the system, and if you haven't developed a clear picture of the expected final report, you might find it tough to position an idea that seems appro-

priate to the topic but doesn't yet fit into the framework.

Although outline processors can expand and collapse the view of text within a document, they are essentially document-oriented in both size and function; that is, they are not designed to handle large amounts of data that require heavy sorting and weeding. An outline processor may be ideal for one report at a time, but it is not a good tool for managing a large bank of data.

**NONHIERARCHICAL DATABASES**

The simplest form of text manager consists of an editor with two modes of operation, "record" mode and "document" mode. In record mode, the program creates records that are stored in a database. The least complex of these programs uses short records that are identified by a limited number of keywords. In document mode, the program functions basically as a word processor handling longer reports. Editing commands are the same in each mode, but record mode has an additional set for the filing of individual records; document mode lets you locate records by keyword and read them into your report for editing.

The free-form text database is a far less structured model (see figure 5). Any block of text created by the editor can be assigned one or more identifying keywords and stored in a database. A command toggle lets you title parts of your text, or flag words within the text, as keywords. A record can be called up either by keyword or by searching for a string of characters contained within the block. (If the database has grown large, a string search through every character stored in the database would not be a good idea.) Obviously, the editor has to have some kind of intermediate buffer in case a given keyword or string produces a whole bunch of text fragments. The editor can file individually any blocks it creates, and the database can index a whole group of text blocks to a single keyword so that an entire document can be reassembled from its components. There is no

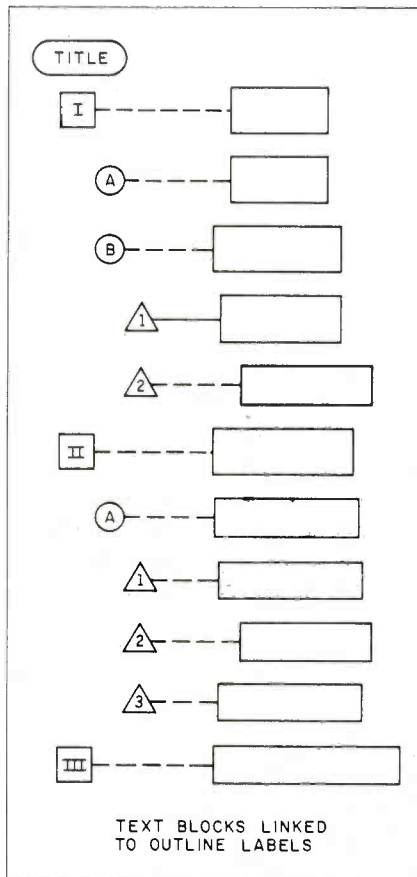

Figure 3: The outline model. This is indeed a kind of database because it organizes blocks by keeping track of block labels (or headings). However, the outline framework imposes a rigid structure on the creative process and might be helpful only because it can show a schematic view of a project.

need to differentiate between a record and a document; the free-form system is essentially modelless.

The editor is the only visible environment; moving data to and from the surrounding database can be accomplished with short commands from within the editor. The only exception to this rule is a program that lets you work on several files at the same time, in which case there is an intermediate state in which you can get an overview of the available documents.

The flexibility of this sort of program should be clear. You need not be

(continued)

# ERG/68000 MINI-SYSTEMS

- Full IEEE 696/S100 Compatibility

## HARDWARE OPTIONS

- 8MHz, 10 MHz, or 12 MHz 68000/68010 CPU
- 68451 Memory Management
- Hardware Floating Point
- Multiple Port Intelligent I/O
- 64K/128K Static RAM (70 nsec)
- 256K/512K/1MB Dynamic RAM (150 nsec)
- Graphics-Digital Graphics CAT-1600
- DMA Disk Interface
- SMD Disk Interface
- 1/4" or 1/2" Tape Backup
- 5 1/4" or 8" Floppy Disk Drives
- 5MB-474MB Hard Disk Drives
- 7/10/20 Slot Back Plane
- 20 or 30A Power Supply
- Desk Top or Rack Mount Encl.

## SOFTWARE OPTIONS

- 68KFORTH<sup>1</sup> Systems Language
- CP/M-68K<sup>2</sup>O/S with C, 68K-BASIC<sup>1</sup>, 68KFORTH<sup>1</sup>, FORTRAN 77, EM80 Emulator, Whitesmiths' C, PASCAL
- IDRIS<sup>3</sup> O/S with C, PASCAL, FORTRAN 77, 68K-BASIC<sup>1</sup>, CIS COBOL<sup>4</sup>, INFORMIX<sup>5</sup> Relational DBMS
- UNIX<sup>6</sup> SYS V O/S with C, PASCAL, FORTRAN 77, BASIC, RM COBOL<sup>7</sup>, ADA<sup>8</sup>, INFORMIX<sup>5</sup>, Relational DBMS
- VED 68K Screen Editor
- Motorola's MACSBUG and FFP Package

Trademark <sup>1</sup>ERG, <sup>2</sup>Digital Research, <sup>3</sup>Whitesmiths, <sup>4</sup>Micro Focus, <sup>5</sup>RDS, Inc., <sup>6</sup>Bell Labs, <sup>7</sup>Ryan McFarland, <sup>8</sup>U.S. DoD

30 Day Delivery - OEM Discounts



since 1974

**Empirical Research Group, Inc.**  
P.O. Box 1176  
Milton, WA 98354  
(206) 872-7665



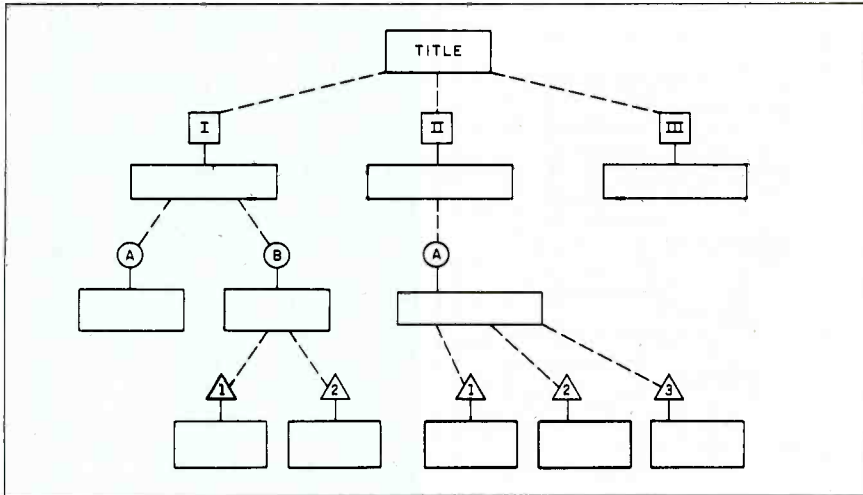

Figure 4: The tree model. The outline in figure 3 can be tilted on its side, providing a series of alternatives on each level. This method of viewing the outline places less emphasis on the chronological order in which items were entered, but it is still essentially hierarchical.

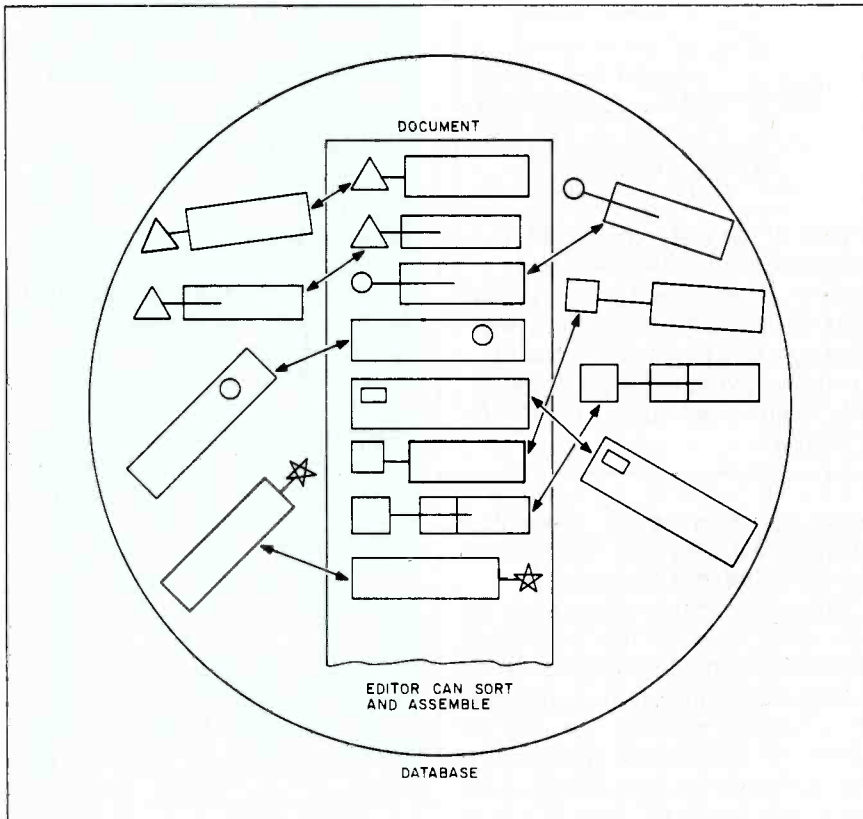

Figure 5: The free-form text database model. Text developed with the editor is stored in a large database and indexed by keywords. The editor itself contains database search commands that can be used to pull up all fragments relating to the current topic, either by keyword or by string search. The editor can also store text in the database for later retrieval. This system is inherently nonhierarchical.

*The beauty of text database systems lies in how they free you from thinking of computers as merely a way to reproduce paper processes in an electronic medium.*

hampered by the constraints of a fixed record format with limited field lengths. Even on a stock template like an employee record, you can add as much (or as little) information as you like, because the whole document can be retrieved as a unit by assigning a title to it, length is not an issue.

By assigning keywords that link related data, it's possible to assemble into one report materials of many different types, including short text blocks, lengthy documents, memos, letters, and record forms. The database can grow to enormous size and, in fact, the program becomes more useful the more data you have; the more extensive the library of text, the more meaningful the topics on which you can prepare reports.

### USING TEXT DATABASES

There is, of course, a price to pay for all this flexibility. Most of the programs currently in the categories I've described have made a few sacrifices to keep the command set, memory requirements, and processing time within reasonable boundaries. As a result, they're not all as easy to grasp as they might be.

But the beauty of text-database systems lies in the way they can free you from thinking of computers as merely a way to reproduce paper processes in an electronic medium. Filing and fetching are reduced to fast, complete routines; digging out resources becomes an easy, minor part of the creative process. More time can be spent creating rather than researching. ■

## With the right terminal, WordStar can be simply beautiful.

The Wyseword™ 50 has a beautiful way of making WordStar® simpler.

Its special keyboard reduces WordStar's multiple keystroke command sequences to single keystrokes. Commands relate easily to what's written on the keyboard.

So, WordStar becomes easier to learn, faster, more accurate. More productive.

And it's never looked better. The 14" Wyseword non-glare screen tilts, swivels, and displays a full 132 columns, beautifully.

To find out where you can see the Wyseword 50 demonstrated, call the regional office nearest you:

Southwestern (213) 340-2013;

Midwestern (313) 471-1565;

Northeastern (201) 725-5054;

Southeastern (305) 862-2221;

Northwestern (408) 946-3075 ext. 256.

For more information about our complete line of products, write or call Wyse Technology, 3040 N. First Street, San Jose, CA 95134. (408) 946-3075. Outside of California, 800-421-1058. Circle 382 on inquiry card.

# WYSE



CITIZENS  
AGAINST UGLINESS,  
UNRELIABILITY,  
HASSLES AND  
HIGH PRICES.

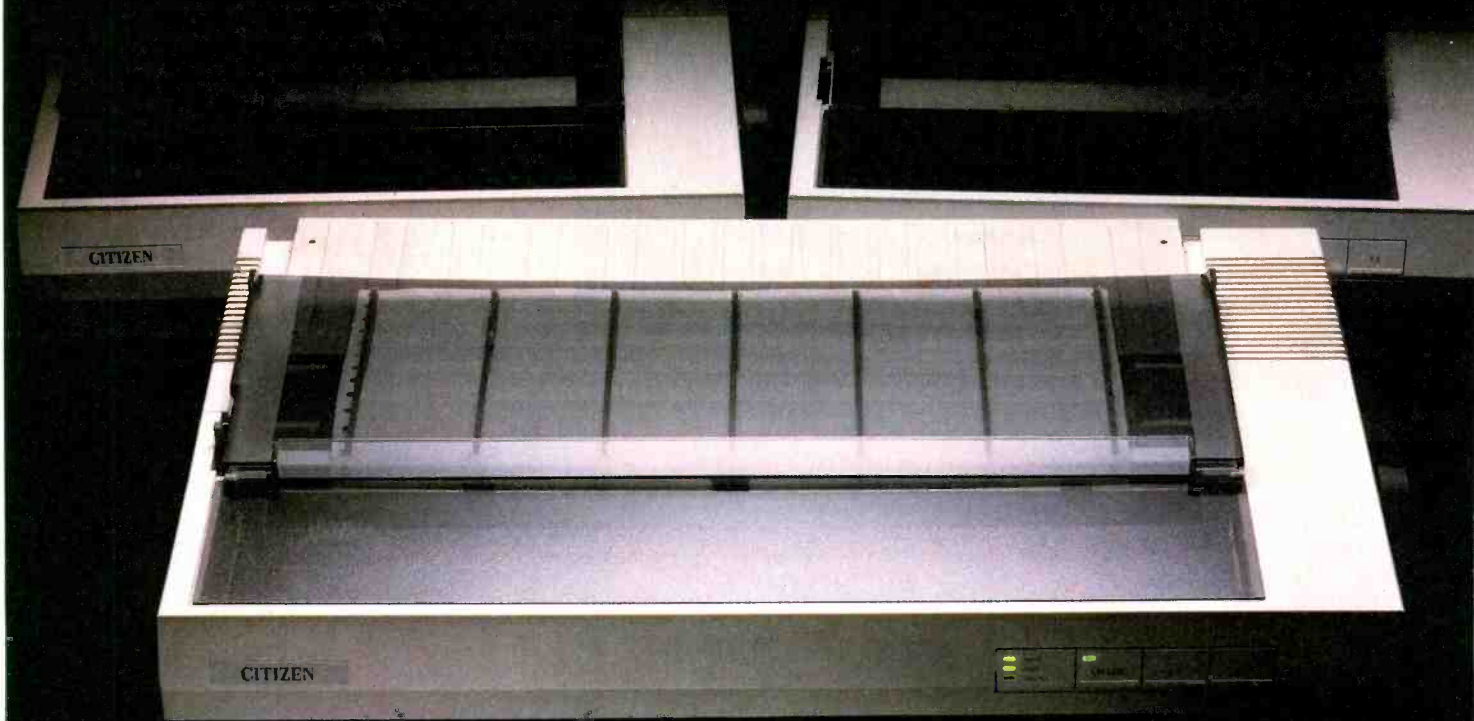

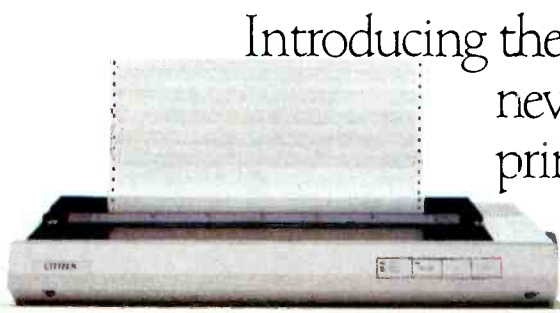

Introducing the Citizens. A whole new line of dot matrix printers, precision-engineered by the people who've become a wristhold word in fine, precision-engineered watches.

The Citizens are very sleek, very quiet, and reliable as the day is long.

They're IBM® or Epson® compatible, with output speeds of 160 cps, or 40 cps correspondence-quality at the flick of a switch.

They're also exceptionally easy to use, thanks to our unique new push-feed paper loading system.

And if all this weren't enough to tick off the competition, wait 'til you see what a value Citizen™ is for the money.

Stop by one of our dealers today and watch what the Citizens can do for you.

For more information, call 1-800-556-1234, Ext. 34. In California, 1-800-441-2345, Ext. 34.

Or write Citizen America Corporation, 2501 Colorado Avenue, Santa Monica, CA 90404.

**CITIZEN**

© 1984 Citizen America Corporation. Citizen is a trademark of Citizen America Corporation. IBM is a registered trademark of International Business Machines Corporation. Epson is a registered trademark of Epson America, Inc.







# adds VISION to your PC

## 20/20 Vision for \$495.

Quick and versatile, PC-EYE converts your IBM PC or PC/XT into a high-performance image processing system. It improves productivity through better communications. \$495 for PC-EYE will allow you to capture any object that can be viewed with a standard EIA RS-170 compatible video camera. The image can then be displayed, stored, processed, printed, or remotely transmitted. High resolution and real-time display interaction allow simple adjustment of light, focus, or object position for superb quality pictures.

### Adds computer picture power for . . .

- Graphic Presentations
- Personal Teleconferencing
- Document/Report Generation
- Surveillance/Security
- Measurement and Inspection
- Thermography

Uses are so varied that Chorus offers software developers the chance to promote their products in our PC-EYE Catalog. Special awards will be given periodically for the software judged most unique or of greatest interest.

### Software makes it happen

Utility software is included with menu driven support for various graphics adaptors and printers. This support includes interactive control of image borders, white and black level, and image location within the borders. The user can direct input to

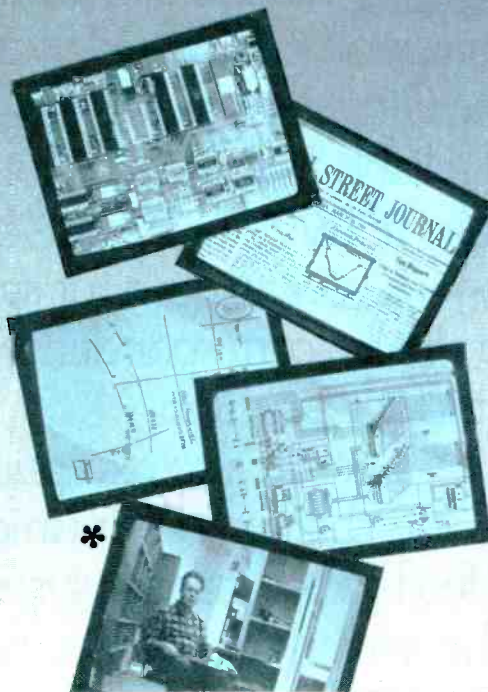

main memory or the graphics adaptor memory; compare images; and store images or set-up parameters on disc.

Software application packages soon to include PC-EYE support are: digital paint and drawing, slide generation, word processing, communications, and data base management.

### Compare our specifications:

**Input:** Any EIA RS-170 (Monochrome or RGB) video source

**Spatial Resolution:** Up to 640 x 512 pixels

**Intensity Range:** 2, 4, and 16 levels (or pseudo-colors) standard; 64 levels optional

#### Capture Speed:

.33 seconds for a 640 x 400 x 16 level image

.1 second for a 320 x 200 x 4 level image

.6 seconds for a 640 x 400 x 64 level image

**Input Channels:** Four video plus external trigger

**I/O Slots:** 1 IBM PC or PC/XT compatible

### Get started with the CHORUS family of products

We offer a selection of cameras, accessory kits, and compatible graphic adaptors. For our price/catalog and further details, write,

or call 1-800 OCHCRUS  
or 1-(603) 424-2900

\* The B&W pictures are taken with a 35mm SLR camera. The pictures were captured with an RCA TC 1005 video camera on an IBM XT and sent to the monitor with a Tevmar Graphics Master™ graphics adapter in the 640 x 400 x 16 level mode via its composite output.

™Trademark for CHORUS DATA SYSTEMS' family of video capture products.

# CHORUS

Chorus Data Systems, Inc., 6 Continental Blvd., P.O. Box 370, Merrimack, New Hampshire 03054

# THE DAYFLO ARCHITECTURE

BY ROBERT W. ATKINS AND WALTER L. MAZUR

*A look at the internal workings  
of a free-form word-oriented database*

THE TREMENDOUS GROWTH in personal computers over the last year or so has led to a great demand for simple yet powerful database-management systems for small computers. Unfortunately, just about all the systems available today use a traditional fixed-format type of database originally developed for mainframes and minicomputers. Such an approach, while perhaps acceptable for large corporate databases, is not quite as satisfactory as a personal-productivity tool.

There are two reasons for this. The first is that even when you're trying to keep track of a collection of items that have some common factors (a contact-management file, for example), in reality no two records are ever likely to be exactly the same. Someone is bound to have two phone numbers, or a foreign address, or an unexpectedly long title. Then you're faced with the almost impossible problem of squeezing all those odd bits of information into a format that doesn't allow for exceptions.

Secondly, and perhaps more significantly, it is not natural to expect that all the different types of information you'll want to record are going to fit

nically into predefined categories. For instance, do you file a note to be sent to a client in the contact file, the client file, the memo file, or some other file? Even if that decision can be made, will you ever be able to remember enough to retrieve it?

## THE FREE-FORMAT APPROACH

Any real-world environment involving individuals requires much more flexibility than the fixed-format approach allows. One solution is to regard each record as unique but containing whatever common elements you choose. Furthermore, you should not have to know ahead of time how you're going to use the information you might want to enter impulsively. The concept of a schema or template for the database (which requires preplanning and locks you into a certain mode of

.....  
*Robert W. Atkins is senior systems architect at DayFlo Software and is the chief architect of the DayFlo system.*

*Walter L. Mazur is a senior member of the technical staff at DayFlo and was responsible for the design and implementation of the DayFlo database. They may be reached at DayFlo Software, 2500 Michelson Dr., Building 400, Irvine, CA 92715.*

operation) is unacceptable.

Since the majority of information processed by most individuals is textual in nature, fixed-length fields and fixed numbers of values per field are uncomfortably limiting. In addition, the data's textual nature suggests that the natural way to create and edit it would be with a text processor of some sort.

When we designed DayFlo, we integrated the database-management system with an appropriate text processor. We also developed an operational desktop metaphor—with stacks of records, a trash bin, a scratch pad, and a filing cabinet—that corresponds closely to the paper world with which most of us are familiar.

## DATA RECORDS AS PAPER

In DayFlo, records are simply pieces of paper that can be scribbled on, edited, trashed, shuffled, moved around the desktop, or put back in the files. As you might expect, whichever record (possibly a blank one) is in front of you can be modified just by typing. In fact, in DayFlo you never leave the editor except momentarily to perform some utility functions. All

*(continued)*



you do is pass different records through the editor. Thus, with a single keystroke you can move from record to record—editing or cutting and pasting, even creating new records—just by typing.

This paper model (as opposed to an exclusively forms-oriented one) requires a new method of database organization. Since a record can contain any sort of information and might not resemble any other in the database, the concept of different files within the database makes no sense. As such, the database cannot be described as either hierarchical or relational. Think of DayFlo's database as a single file rather like a shoe box into which you toss everything.

Retrieval of records from the database system is associative, based solely on the content of each record. For instance, you could say to the system, "Retrieve everything having to do with business plans or financing that con-

cerns John Smith." The system would then locate a bunch of records, some of which could be memos, letters, reports, or just informal notes, and put them in front of you for your perusal. The top one is immediately available for viewing and/or editing and the others are easily accessible by either cycling or searching through the stack.

**THE ARCHITECTURE OF DAYFLO**

The architecture of DayFlo, as shown in figure 1, is both symmetric and open-ended. That is, any part of the system can call any other part of the system. Furthermore, all system functions return standardized function results, thus permitting DayFlo to keep track of the progress of all operations. The system is essentially a matrix of different types of operations that can be performed on different types of data and set up as a collection of relatively independent modules.

Currently, the system includes a group of basic functions, such as the editor, a desktop organizer, a sorter, a find-and-retrieve processor, a screen-display manager, and so forth. It also supports standard data types, such as text, numbers, and dates, which are universally understood throughout the system. New functions and data types, however, can be added. This permits extended functionality relative not only to existing data types but also to new data types as they are added.

The underlying layer of DayFlo is host-independent, which makes it easy to port from one computer to another. This is the only part of the system in which assembly language is used (and then only in a few cases); the rest of the program is written in C, to further enhance portability. One of the key features of this bottom layer, called Executive Services, is a specially designed virtual memory and dynamic-linking facility. Executive Services permits DayFlo to make maximum use of all available memory by rolling out specific program modules when required. It also lets you call any function within the system (including those provided by add-on applications) without having to relink the system each time a new one is added.

The Command and Response processor handles all communication with the user and acts as a gigantic switch, capable of selecting the appropriate system module for each operation. It carries on simultaneous dialogues with both the user and the system to acquire and validate all the parameters necessary to perform each operation. Control is passed to the appropriate service routine only when validation is completed. Up to that point, a trace is kept of how the dialogue has progressed. This central control allows DayFlo to provide not only context-sensitive help but rapid error recovery. If you're on the wrong path, you can retrace your steps to the point where you went astray and head in the correct direction.

Because all dialogue is handled cen-  
*(continued)*

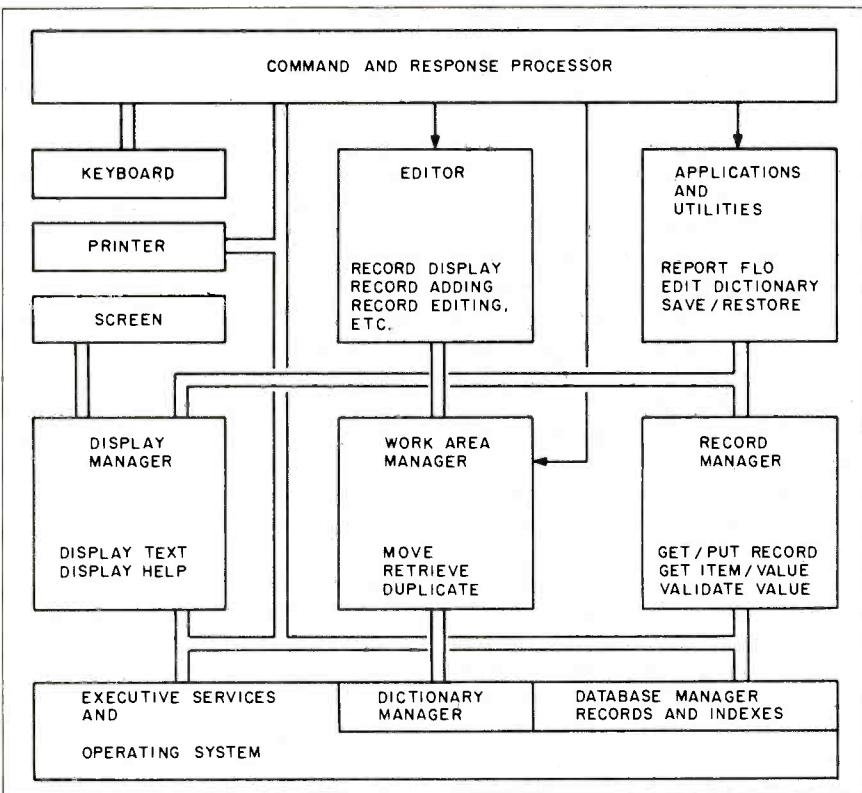
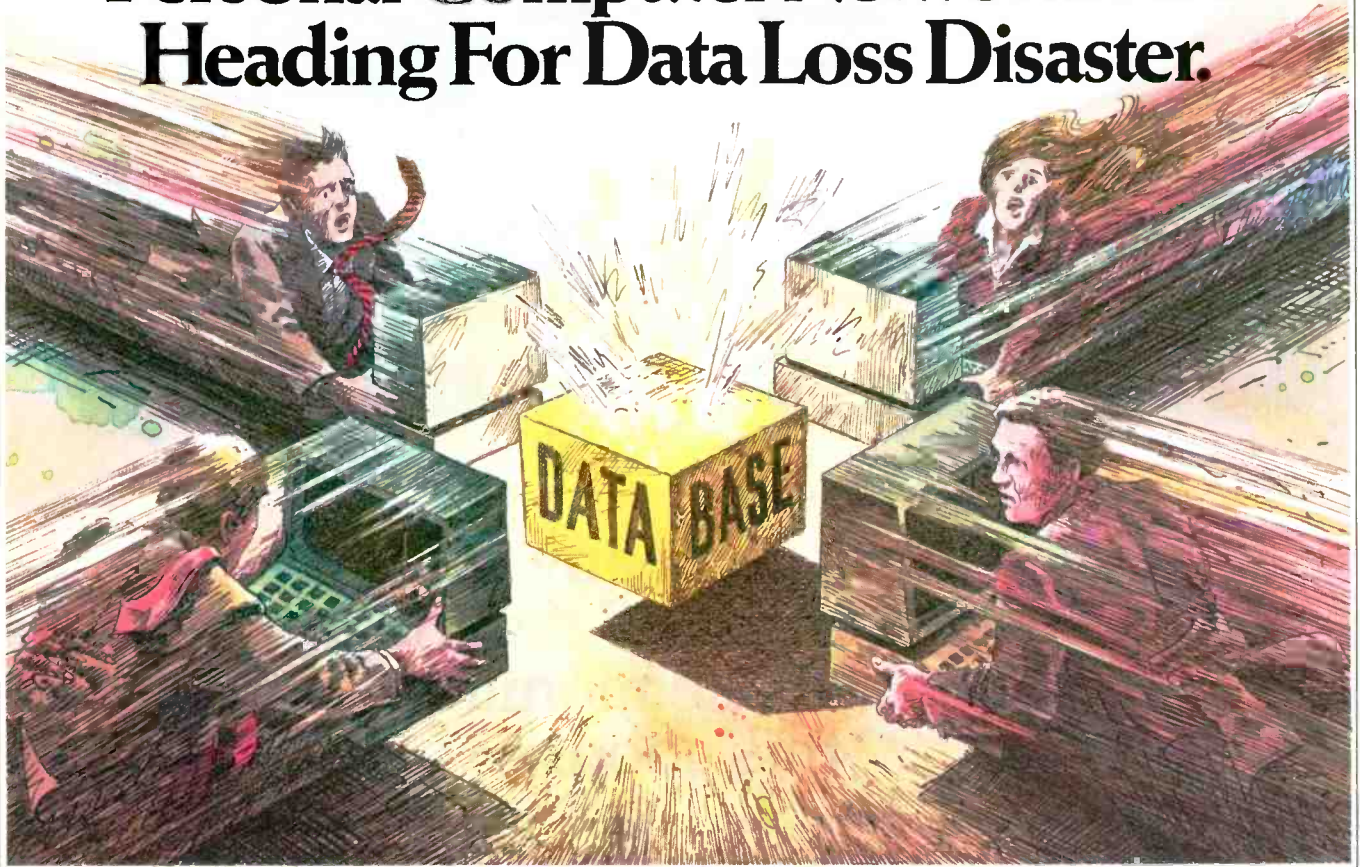

Figure 1: A simplified diagram of the DayFlo system architecture. The single lines represent top-level command flow between the components. The double lines represent internal command and data flow.

# Personal Computer Networks Are Heading For Data Loss Disaster.



## INTRODUCING THE SOLUTION. DATASTORE:lan.

**The database management software that prevents costly data loss when several users share the same data.**

Hardly anyone knows about it until it happens. And then it's too late. There's a collision. An entire database is destroyed. Vital records and information are lost. And untold dollars and man-hours are required to replace them. An entire business is thrown into chaos.

Why does database destruction occur? Because today's leading database management systems were designed for single users only. So when you have more than one employee accessing the same database, look out.

Happily, there is now a simple solution to this serious problem—DATASTORE:lan, the first software designed specifically for personal computer networks. DATASTORE:lan puts an end to data loss once and for all. And, it offers many other sophisticated database advantages as well:

■ **SECURITY AND PRIVACY** unheard of in single-user database systems. It permits selective access to sensitive information, screening

out all those who should not see it. You can even protect data down to the field and record level with DATASTORE:lan.

■ **BUSINESS-SIZE CAPACITY** for growth. It provides up to 16 megabytes of information per database with no limitation on the number of records, and each record can be up to 16,000 bytes with over 500 fields. In addition, there are 16 key fields, and you can join up to 15 different databases. Obviously, single-user systems pale by comparison.

■ **EASILY COMPATIBLE.** If you are currently using single user database management software there's no need to re-enter files when you upgrade to DATASTORE:lan. Compatible with leading database management software including dBase II™ and PFS:file.™

■ **EASIER TO USE** than virtually any other database product on the market. A step-by-step menu leads any user easily through the program.

■ **AVAILABLE** for IBM PC and

compatibles, TI Professional and all leading networks including Corvus, 3Com, Nestar, Novell, Davong and PCnet.™

If you don't want to gamble with your company's data, call us or write to find out more about DATASTORE:lan. Or stop in to Businessland, participating ComputerLands, or other major retailers.

For more information, a full-function demonstration disk, or the dealer nearest you, call toll-free:

**1-800-LAN-DBMS**  
or 1-800-LAN-DATA in California.

Or write:

Software Connections  
2041 Mission College Blvd.  
Santa Clara, California 95054

BT-10

Name \_\_\_\_\_

Address \_\_\_\_\_

City \_\_\_\_\_

State \_\_\_\_\_

Zip \_\_\_\_\_

 **SOFTWARE CONNECTIONS™**  
THE FIRST NAME IN NETWORK SOFTWARE.



1948



One of the first Zenith television receivers.

1984

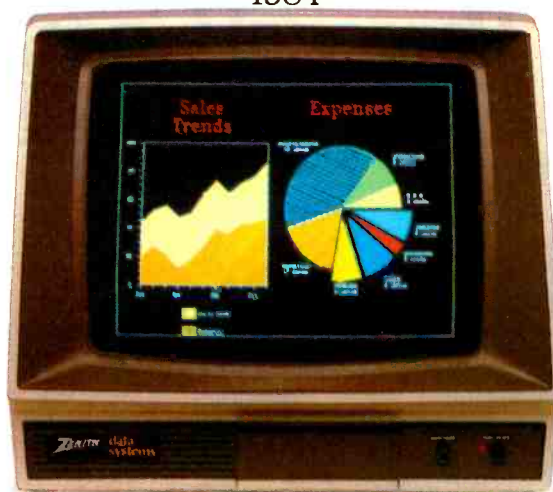

ZVM-133: 80 column display. Ideal for IBM PC and compatibles.

## Only a company with 36 years of TV smarts could make monitors this good.

**Z**enith introduced its first television receiver to a delighted America in 1948. It had single-knob tuning and an 11-inch porthole screen.

Earlier this year, Zenith made its sixty millionth television set. And every one has been built according to this credo: "The Quality Goes In Before The Name Goes On."

Zenith continues this tradition of video excellence with its extensive line of monitors. Monitors that will first dazzle you with their graphic display, then earn your admiration over time with their reliability. And surprise you with their very competitive prices.

There's a Zenith monitor for just about any personal computer, including IBM and Apple, with seven models offering everything from monochrome green or amber to high-resolution color. And some models can also be used with VCR or video disc systems.

Nobody understands video like Zenith. To find out more about their fine monitors, call 1-800-842-9000, ext. 1, for the name of your nearest Zenith Data Systems dealer.



ZVM-122A: Non-glare amber screen. Compatible with most microcomputers.



ZVM-123A: Non-glare green screen. Composite video input.



ZVM-124: Super resolution for IBM PC with monochrome adapter.

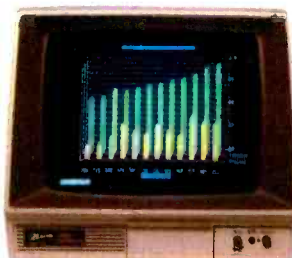

ZVM-131: 40 column display. Audio amplifier. Ideal for IBM PC Jr. or Adam.



ZVM-135: 80 column display. Audio feature ideal for expanded IBM PC Jr.

© 1984, Zenith Data Systems

trally, your perception of the system is one of a homogeneous whole, with very little implied structure. The isolation of all dialogue from the rest of the system also permits DayFlo to support different types of dialogue mechanisms without affecting the rest of the system. Thus, natural-language command implementations can be added, as well as user interfaces like mice, and speech recognition and generation.

**INTERNAL MANAGERS**

The part of the program that manages the database uses a simple, fast, multikeyed access method for the storage of all records in a single file—DayFlo's universe of data. This file is nonhierarchical, and its multiple keys permit data to be retrieved based solely on content. Optional indexing lets you flag those items that are of particular interest, thus optimizing

their retrieval. Indexes are stored in the same place as the records themselves.

A dictionary is used to specify which items are to be treated globally throughout the system, their type definitions (used for data-entry checking, etc.), and whether they are indexed. The Dictionary Manager is responsible for providing information about a given item to the other parts of the system when needed. The dictionary is normally core-resident. At cleanup time it is archived in a fixed area at the start of the database file together with other dynamic tables (such as the configuration of the work area and the current editor settings) so that it's possible to resume working with DayFlo at the point where you left off.

The Work Area Manager is responsible for determining which records are currently in use. It also maintains

a table showing the contents of all stacks and the trash. Additionally, it provides the necessary functions for moving records around the work area and for retrieving, sorting, and printing them.

DayFlo structures its database records in a manner unique among databases. While any record in DayFlo can be of any shape and size, internally they are stored as continuous byte streams of unique DayFlo characters. The DayFlo character set was specially designed to facilitate the types of operations performed in the DayFlo system. DayFlo records thus can be passed between the different components of the system, and the appropriate operation performed on them, without requiring transformations at each stage. Each DayFlo record contains not only the values of its items but also information about

*(continued)*

**2 YEAR WARRANTY ON CARD AND DRIVE**

**10 Mbyte**  
**SATISFACTION**  
**GUARANTEED**

Suggested retail price \$1095

**\$945 SPECIAL SALE PRICE**

Expires November 30, 1984

100% refundable within 30 days.

For IBM PC\* & compatibles. 2 Years Warranty on disk drive and controller card.

- Half-height drive with controller card
- Low error rate
- Low power
- High performance and reliability
- Easy installation

**20 Mbyte for \$1,495.**

**TO ORDER SEND CHECK OR MONEY ORDER TO:**

**Linde Technology, Inc.**  
8820 S. Sepulveda Blvd.,  
Suite 204  
Los Angeles, CA 90045

**OR CALL TOLL FREE:**

1 (800) 227-2400 x974

In California call

1 (800) 227-2666 x974

Visa and Mastercard accepted.

California residents add 6% sales tax.

For dealer inquiry and more information call: (213) 315-9484

\*IBM is a registered trademark of International Business Machines Corp.

**Yes, send me more information on:**

- 10 Mbyte Disk Drive
- 20 Mbyte Disk Drive

**Linde Technology, Inc.**

8820 S. Sepulveda Blvd., Suite 204  
Los Angeles, CA 90045

NAME \_\_\_\_\_

ADDRESS \_\_\_\_\_

CITY \_\_\_\_\_ STATE \_\_\_\_\_ ZIP \_\_\_\_\_





its structure and current state. The overall DayFlo record structure also provides a framework to which special representations of data can be attached, which can then be handled by add-on processors that understand this internal format.

From a database point of view, a DayFlo record is a series of items (or fields). Each item has a name and any number of values (see figure 2). The first item in any record is always "&UNNAMED ITEM" whose name is hidden from the user but that can be accessed for database retrieval. The special character STARTNAME (0F hexadecimal) marks the start of an item name. (Unless noted otherwise, the following values are hexadecimal.) STARTVALUE (0E) marks the end of the name and the start of the values. ENDVALUE (1D) separates one value from the next. Since all DayFlo records are variable length, there is no limit to the number of item names or values except the size of a record, 32K bytes.

The rest of the special characters used by DayFlo are ignored by the database but are used by DayFlo's word-processing functions. Lines are separated by NEWLINE (08), and extra spaces are inserted by the Editor for formatting by EDITBLANK (1C). Tabs are forbidden, as are any characters less than blank (20) or greater than DEL (7F). However, any character, *x*, from 00 to 1F can be represented by "1E 80+*x*", and any char-

acter from 80 to FF by "1F *x*". Thus, for example, on the IBM Personal Computer (PC), a "happy face" would be 1E 81, and a square root symbol 1F FB.

Changes in video-display attributes (underlining, etc.) are also represented by 2-byte codes. The first byte is always 05. The next byte is 80 with the desired video code added to it. The video code for reverse video is 1, underline 2, highlight 4, and blinking 8. Thus, code 05 8A makes subsequent characters underlined and blinking. The effect of a video code continues until the next video code, or the end of the value, or the start of the next item. The assumed video at the start of a value is normal (05 80).

DayFlo's ability to support free-format textual records is inherent in the relationship that exists between the Editor and the Record Manager. As you move around the work area, the Editor obtains from the Work Area Manager the designator of the current record. It then calls the Record Manager to get this record into memory for update. If the Record Manager doesn't find it already there, it makes a request to the Database Manager to read it into a specified location. The current values of any indexed items are then saved (so that the Database Manager can be told to adjust any indexes that may be changed when it comes time to write the record back into the database).

The Record Manager then informs the Editor of the location of the record and hands it over. Changes to the record are then made using DayFlo's standard word-processing commands. When editing is completed, the Editor returns the record to the Record Manager, which informs the Database Manager of any changes in indexes, and the record is rewritten.

Given the complexity of the DayFlo system and the relatively small amount of memory provided in modern microcomputers, a major performance factor is the fact that all the drivers understand the internal-record format. Thus, a record is displayed on the screen simply by having the Editor call the Display Manager and give it the location (both on the screen and in memory) of the first and last characters to be displayed. There is no requirement for additional buffers, and any needed translations are done as each DayFlo character is interpreted. Since all drivers are part of Executive Services, all machine/peripheral dependencies are localized in one component.

The Applications Manager provides general-purpose routines that allow new applications (like ReportFlo, DayFlo's document formatter and report generator) to be added to the system. It also lets the rest of the system get at special-purpose routines for such generic functions as Edit and Print.

The Utilities Manager provides a set of interactive routines that maintain the Dictionary and Database, including transferring information into and out of the system, and archiving and restoring it. When saving records, the Utility Manager uses a format (see figure 3) that is an extension of the DayFlo character set. This Save Record format also can be generated by programs other than DayFlo, which lets them transfer information into DayFlo with all the necessary item names, value separators, and video changes included.

<b>Name:</b> Pete James	<b>Phone:</b> 800-7DAYFLO ▼(work) ▼ 714-556-2312 ▼(home)
<b>Company:</b> DayFlo Inc.	
<b>Title:</b> Programmer	<b>Type:</b> Friend (work)
<b>Address:</b> 2500 Michelson Drive; Building 400	▼ 406 Nelson Ave.
<b>City:</b> Irvine	▼ Costa Mesa
<b>State:</b> CA	▼ CA
<b>Zip:</b> 92715	▼ 92626
<b>Notes:</b> Pete's main interests outside of work are outdoor activities. He likes to bike a lot and is an enthusiastic sailor. He is unmarried and has folks on the East Coast.	

Figure 2: The above record is a contact-management record. Note both traditional forms-oriented fields like Name: and Phone: and also free-form textual items like Notes: The presence of the ▼ symbol indicates that several items have multiple values.

## USING DAYFLO

The actions of the various managers are, of course, unseen by the user. DayFlo

(continued)

# The portable "MUGEN" IBM PC compatibles.

**New  
Portable**

Microvoice introduces the "MUGEN", your charming better-half goes anywhere you go.

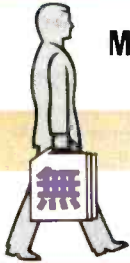

## MOBILE

### Runs IBM software

The "MUGEN" runs all the most popular software written for the IBM PC.

### BUNDLED SOFTWARE

MS-DOS  
GW-BASIC



# MUGEN

### Hardware Specification

- ☐ PROCESSOR  
16 bit 8088
- ☐ USER MEMORY (RAM)  
256KB standard, expandable to 512KB on the system board(option). By optional 128KB expandable slot, total capacity is 640KB.
- ☐ PERMANENT MEMORY (ROM)  
16KB standard, expandable to 64KB(option). Includes BIOS, auto Power-on Self-test, and I/O device control program.
- ☐ KEYBOARD  
Detachable and IBM PC plug compatible  
81 keys.
- ☐ DISPLAY  
Built-in 9" high-resolution graphics, high-contrast monochrome display.  
25 lines by 80 characters and 640 x 200 dots.
- ☐ FLOPPY-DISK DRIVE  
Two built-in 5.25" floppy-disk drives.  
360KB double-sided, double-density.
- ☐ EXPANSION SLOT  
6 slots for various option to the system.  
3 out of them are occupied on the system board.
- ☐ INTERFACE  
Centronics standard interface  
RGB color monitor interface  
Composite video monitor interface  
Asynchronous communication interface  
8" floppy disk interface

**OPTION** : Memory slot / GP-IB control slot / EP-ROM programmer slot / Hard disk control slot / SDLC communication slot, etc.

**DISTRIBUTOR & OEM Inquiries Invited**

IBM is a registered trademark of International Business Machines Corporation. WordStar, CalcStar and InfoStar are registered trademarks of MicroPro International Corporation.  
MS-DOS and GW-BASIC are registered trademarks of Microsoft Corporation. MUGEN is a registered trademark of Microvoice Corporation.



Computer System Engineering  
**MICROVOICE CORPORATION**

Shinei Bldg., 8-5 Nishishinjuku 3-chome, Shinjuku-ku, Tokyo, 160 JAPAN Telephone: (03)377-1661 Telex: 2325279 MVOICE J



presents a desktop view with 20 stacks (or folders) available for data extracted from the main database. You can move

rapidly from one stack to another and thus shift from one project to another as your needs dictate. At any time you

can either retrieve more material from the database or return items when you are finished with them.

Because record formats are not fixed, it is simple to combine records into larger documents (without destroying the original source entries), which can then be stored as new elements. A larger item can be split into its component parts merely by reversing the process. Note taking is a relatively minor operation; you just move to a new line, name your new field, and begin typing. The note can be stored later as an independent record or left where it is.

DayFlo is designed for a full range of text-manipulation activities, from the generation of reports out of diverse source material to the maintenance of flexible-record files built on standard templates. Though free-form data operations are the basis of the DayFlo philosophy, you can easily develop record-keeping schemes that parallel those in fixed-format databases. ■

DayFlo Save Record Format	
<b>Codes</b>	<b>Usage</b>
08 52 03 45 04 43 05 52 06 44	Record Format Indicator
01 00	Volume 1
00 00 00 00	Length (not used)
74 00	Last Volume flag
0F "&UNNAMED ITEM" 0E	1st Record
(value 1) 1D	
(value 2) 1D	
...	
0F (item name) 0E	
(value 1) 1D	
...	
00 04 00 00 00 00 00 00 00	End of Record Indicator
(record 2)	2nd Record
...	
(record n)	nth Record
00 04 00 00 00 00 00 00 00	End of Record Indicator
00 00 00 00	End of Save Record File

Figure 3: The save-record format used by the Utility Manager to save DayFlo records. The actual format of each record uses the DayFlo character set.

ORDER LINE  
800-354-7330

## FREE SHIPPING

### WE PAY THE SHIPPING ON THESE SELECTED PRODUCTS

EPSON	OKIDATA	STAR MICRONICS	WYSE	TELEVIDEO
RX-100 Printer	82A Printer	Radix 10 & 15 Printers Delta 10 & 15 Printers	75 Terminal	TPC-2 Dual Drive Portable Computer
<b>NEC</b>	<b>QUME</b>		<b>SONY</b>	<b>MAXELL</b>
2015 Printer	Letter Pro 20 Printer		19" RGB Monitor 25" RGB Monitor	MD-1 Diskettes

Free shipping is by U.P.S. ground only

PRINTERS	TERMINALS	DISKETTES
<b>NEC</b>	<b>ADDS</b>	<b>MAXELL</b>
2010, 2015, 2030	A-2	MD-1 (Qty 100) \$175
2050	A-3	MD-2 (Qty 100) \$225
3510, 3515, 3530	Viewpoint 60	<b>SCOTCH</b>
3550	Viewpoint 90	5 1/4 SS/DD (Qty 100) \$175
7710, 7715, 7730	<b>ALTOS</b>	5 1/4 DS/DD (Qty 100) \$245
<b>OKIDATA</b>	Smart II	<b>ELEPHANT</b>
All Printer Models	<b>QUME</b>	5 1/4 SS/DD (Qty 100) \$155
<b>PANASONIC</b>	QVT 102, 103, 108	5 1/4 DS/DD (Qty 100) \$218
All Printer Models	<b>TELEVIDEO</b>	<b>COMPUTERS</b>
<b>SILVER REED</b>	All Terminal Models	<b>ALTOS</b>
All Printer Models	<b>WYSE</b>	All Computer Models
<b>STAR MICRONICS</b>	All Terminal Models	<b>EAGLE</b>
All Printer Models	<b>MONITORS</b>	All Computer Models
<b>STAR MICRONICS</b>	<b>AMDEK</b>	<b>NEC</b>
MT-160Lw/Tractors	300 Green	8201 Computer
MT-180Lw/Tractors	300 Amber	<b>SANYO</b>
Spirit 80	310 Amber	All MBC Models
<b>TOSHIBA</b>	Color 1+	<b>ZENITH</b>
P1340 Parallel or Serial	<b>ZENITH</b>	All Model
P1351 Parallel or Serial	All Monitor Models	Z-150 & Z-160
<b>TRANSTAR</b>	<b>MODEMS</b>	
120 Parallel or Serial	<b>HAYES</b>	
130 Parallel or Serial	Smartmodem 300 Baud	
T315	Smartmodel 1200 Baud	
<b>DISK DRIVES</b>	Smartmodem 1200 B	
<b>RANA</b>	<b>US ROBOTICS</b>	
Elite I	Password 1200 Baud	
Elite II	212A Autodial	
Elite III		

Prices reflect 3% to 5% cash discount. Product shipped in factory cartons with manufacturer's warranty. Please add \$8.00 for U.P.S. handling and shipping costs. Prices & availability subject to change without notice. Send cashier's check or money order, all other checks will delay shipping two weeks.

SILICON SPECIALTIES  
 2034 WEST SOUTHERN  
 MESA, ARIZONA 85202  
 602-969-0909

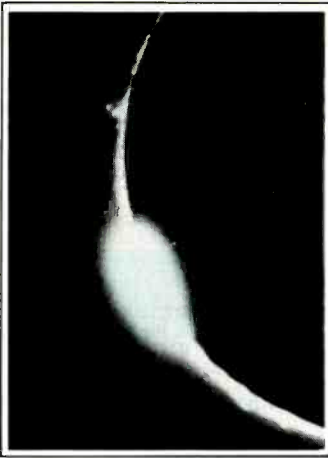

# A New Age Dawns for Microcomputer Programming

**Meet PROMAL™. The First Fast Structured Language That Lets You Program The Way You Always Wanted To. And For Only \$49.95.**

**PROMAL™ is innovative.** PROMAL (PROgrammer's Micro Application Language) was designed to achieve maximum performance from small computers...performance previously impossible except with machine language. And it was developed, specifically, to meet the need for a development system for limited memory environments.

**PROMAL is complete.** It's a fast, structured programming language. It's also a true development system, complete with its own command-oriented operating system executive; fast one-pass compiler, and full-screen cursor-driven editor. In short, PROMAL is the complete set of tools that microcomputer programmers have been waiting for.

**PROMAL is fast.**

Commodore 64 Benchmark (Sieve of Eratosthenes)	PROMAL	BASIC	COMAL	FORTH	PASCAL
Execution Time (secs.)	30	630	490	51	55
Object Code Size (bytes)	128	255	329	181	415
Program Load Time (secs.)	3.2	3.8	6.3	11.2	23.5
Compile Time (secs.)	8.5	—	—	3.9	108

As the benchmark results in the table show, PROMAL is much faster than any language tested. From 70% to 2000% faster! And it generates the most compact object code. The PROMAL compiler is so fast that it can compile a 100-line source program in 10 seconds or less. And, not only is it fast in compile and run time, it also speeds programming development time.

**PROMAL is easy.**

It's easier to learn than Pascal or C or FORTH. It makes use of powerful structured statements, like IF-ELSE, WHILE, REPEAT, FOR, and CHOOSE. Indentation of statements is part of the language's syntax, so all programs are neatly and logically written. There are no line numbers to complicate your programming. And comments don't take up memory space, so you can document programs completely. And with the full-screen editor, you can speed through program development

with saves to memory and compilation from memory workspace.

**PROMAL is elegant.**

PROMAL overcomes the performance limitations inherent in all small systems. It gives you access to the power of the machine. But it doesn't require the complexity of machine language programming. With PROMAL, you can have performance the easy way...since it was developed from the very beginning to work on small systems...elegantly.

**PROMAL may be the answer to your programming needs.**

Finally, there's an answer to the need for a complete environment for simple and rapid program development. Finally, a new age has begun for microcomputer programmers. Finally, there's PROMAL.

## PROMAL FEATURES

### COMPILED LANGUAGE

Structured procedural language w/indentation  
Fast, 1-pass compiler  
Simplified syntax requirements  
No line numbering required  
Long variable names  
Global, Local, & Arg variables  
Byte, Word, Integer types  
Dec or Hex number types  
Functions w/passed arguments  
Procedures w/ passed arguments  
Built in I/O library  
Arrays, strings, pointers  
Control Statements: IF-ELSE, IF, WHILE, FOR, CHOOSE, BREAK, REPEAT, INCLUDE, NEXT, ESCAPE, REFUGE  
Compiler I/O from/to disk or memory

### EXECUTIVE

Command oriented, w/line edit  
Memory resident  
Allows multiple user programs in memory at once  
Function key definitions  
Program abort and pause  
22 Resident system commands, 8 user-defined resident commands, no limit on disk commands  
Prior command recall  
I/O Re-direction to disk or printer (UNIX-like)

### EDITOR

Full-screen, cursor driven  
Function key controlled  
Line insert, delete, search  
String search and replace  
Block copy, move, delete & write to/read from file  
Auto indent, undent support

### LIBRARY

43 Machine language commands  
Memory resident  
Call by name with arguments  
I/O, Edit, String, Cursor control and much more

PROMAL runs on Commodore 64s with disk drive.

**PROMAL is available for the Commodore 64 now.**

**PROMAL is scheduled for release on the Apple IIe in December, 1984 and on the IBM PC in 1st Quarter, 1985.**

### HOW TO ORDER

- Please send me my copy of PROMAL for the Commodore 64 at \$49.95 plus \$5.00 for shipping and handling at a total cost of \$54.95. Satisfaction guaranteed.
- Please send me a PROMAL demo diskette for the Commodore 64 at \$10 for the diskette plus \$2.50 for postage and handling for a total cost of \$12.50. (Non-refundable.)
- My check is enclosed.  Please charge my purchase to my...  Visa  MasterCard

Card Number \_\_\_\_\_ Expiration Date \_\_\_\_\_

Signature \_\_\_\_\_

Name \_\_\_\_\_

Address \_\_\_\_\_

City, State, Zip \_\_\_\_\_ North Carolina residents add 4 1/2% sales tax.

For quicker response on credit card orders, call...  
**Toll Free 1-800-762-7874 (In North Carolina 919-787-7703)**

### Our Guarantee

Try your copy of PROMAL for 15 days. If you are not completely satisfied, return it to us undamaged and we'll refund your money. No questions asked. Dealer inquiries invited.



**SYSTEMS MANAGEMENT ASSOCIATES**  
3700 Computer Drive, Dept. PB-1  
Raleigh, North Carolina 27609





# the best prices



## data systems

PC COMPATIBLE  
16 BIT SYSTEMS  
Call for price and configurations

### APPLE/FRANKLIN DISK DRIVES MICRO-SCI

A2.....\$199.00  
A20.....Call

#### RANA

Elite 1.....\$279.00  
Elite 2.....\$389.00  
Elite 3.....\$569.00

#### INDUS

GT-Drive (Apple).....\$249.00

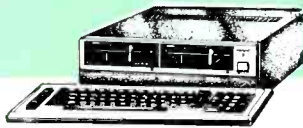

MBC 550.....CALL  
MBC 550-2.....CALL  
MBC 555.....CALL  
MBC 555-2.....CALL

### HEWLETT PACKARD



HP 71B.....\$419.99  
41CV.....\$189.99  
41CX.....\$249.99  
HP 11C.....\$62.99  
HP 12C.....\$92.99  
HP 15C.....\$92.99  
HP 16C.....\$92.99  
HP 75D.....\$879.99  
HPIL Module.....\$98.99  
HPIL Cassette or Printer.....\$359.99  
Card Reader.....\$143.99  
Extended Function Module.....\$63.99  
Time Module.....\$63.99

#### MAXELL

5 1/4" MD-1.....\$19.99  
5 1/4" MD-2.....\$28.99  
8" FD-1.....\$39.99  
8" FD-2.....\$49.99

#### VERBATIM

5 1/4" SS/DD.....\$26.99  
5 1/4" DS/DD.....\$34.99

#### BIB

5 1/4" Disk Head Cleaner.....\$14.99

Atari (ROM).....\$79.99  
C-64 (ROM).....\$79.99



ACE 1000 Color Computer.....CALL  
ACE PRO PLUS System.....CALL  
ACE 1200 Office Mgmt. SystemCALL  
ACE PORTABLES.....CALL

## APPLE

APPLE IIe STARTER PACK  
64K Apple IIe, Disk Drive & Controller  
80 Column Card, Monitor II & DOS 3.3  
COMPLETE.....CALL  
APPLE IIe.....CALL  
APPLE IIc.....CALL  
MacINTOSH.....CALL



### SHARP

PC-1500A.....\$165.99  
PC-1280A.....\$88.99  
CE-125 Printer/Cassette.....\$128.99  
CE-150 Color Printer Cassette\$171.99  
CE-151 4K RAM.....\$29.99  
CE-155 8K RAM.....\$49.99  
CE-161 16K RAM.....\$134.99  
CE-500 ROM Library ea.....\$29.99



### NEC

PC-8221A Thermal Printer\$149.99  
PC-8281A Data Recorder.....\$99.99  
PC-8201-06 8K RAM Chips.....\$105.00  
PC-8206A 32K RAM Cartridge\$329.00

#### ELEPHANT

5 1/4" SS/SD.....\$17.99  
5 1/4" SS/DD.....\$21.99  
5 1/4" DS/DD.....\$26.99

#### DISK HOLDERS

INNOVATIVE CONCEPTS  
Flip-n-File 10.....\$3.99  
Flip-n-File 50.....\$17.99  
Flip-n-File 50 w/lock.....\$24.99  
Flip-n-File (400/800 ROM).....\$17.99

IBM.....\$99.99  
Apple/Franklin.....\$85.99

#### PERSONAL PERIPHERAL

Super Sketch Graphics Pad.....\$39.99

## HOME COMPUTERS



850 Interface.....\$159.00  
1010 Recorder.....\$71.99  
1020 Color Printer.....\$219.00  
1025 Dot Matrix Printer.....\$299.00  
1027 Letter Quality Printer.....\$269.00  
1030 Direct Connect Modem.....\$99.99  
1050 Disk Drive.....\$349.00  
1064 Memory Module.....\$125.00  
Touch Table/Software.....\$64.99  
Light Pen/Software.....\$72.99  
CX22 Track Ball.....\$39.99  
7097 Atari Logo.....\$74.99  
4018 Pilot (Home).....\$57.99  
405 Pilot (Educ).....\$99.99  
8036 Atari Writer.....\$77.99  
5049 VisiCalc.....\$139.99

### WHILE SUPPLIES LAST

600XL.....CALL  
800XL.....CALL  
1200XL.....CALL  
CX30 Paddles.....\$11.99  
CX40 Joystick.....\$7.99  
4011 Star Raiders.....\$31.99  
4022 Pac Man.....\$31.99  
4025 Defender.....\$31.99  
8026 Dig Dug.....\$31.99  
8031 Donkey Kong.....\$35.99  
8034 Pole Position.....\$37.99  
8040 Donkey Kong Jr.....\$33.99  
8043 Ms Pacman.....\$37.99  
8044 Joust.....\$37.99  
8045 Pengo.....\$33.99  
8052 Moon Patrol.....\$33.99  
4003 Assembler.....\$44.99  
8126 Microsoft Basic I or II.....\$64.99

### MEMORY BOARDS

ATARI  
Axlion 32K.....\$59.99  
Axlion 48K.....\$99.99  
Axlion 128K.....\$299.00  
APPLE/FRANKLIN  
Axlion 128K.....\$299.00  
Axlion 320K.....\$849.00  
MSD  
MSD-1 Disk Drive.....\$349.00  
MSD-2 Disk Drive.....\$599.00

### DISK DRIVES FOR ATARI

INDUS  
GT Drive (Atari).....\$379.00  
RANA  
1000.....\$299.00  
TRAK  
AT-D2.....\$389.00  
AT-D4.....\$539.00



CBM 8032.....\$639.00  
CBM 8096.....\$869.00  
CBM 9000.....\$999.00  
B128-80.....\$769.00  
8032 to 9000 Upgrade.....\$499.00  
2031 LP Disk Drive.....\$299.00  
8050 Disk Drive.....\$999.00  
8250 Disk Drive.....\$1249.00  
4023 Printer.....\$399.00  
8023 Printer.....\$589.00  
6400 Printer.....\$1449.00  
Z-RAM.....\$369.00  
Silicon Office.....\$499.00  
The Manager.....\$199.00  
SoftROM.....\$125.00  
VisiCalc.....\$159.00

#### PRECISION SOFTWARE

Superbase 64.....\$69.99  
PROFESSIONAL SOFTWARE  
Word Pro 2 Plus.....\$159.00  
Word Pro 3 Plus.....\$189.00  
Word Pro 4 Plus/5 Plus each\$279.00  
Info Pro.....\$179.00  
Administrator.....\$399.00  
Power.....\$79.99

SX-64 Portable.....\$839.00  
CBM 64.....\$199.00  
C1541 Disk Drive.....\$249.00  
C1530 Datasette.....\$69.99  
C1520 Color Printer/Plotter.....\$129.00  
M-801 Dot Matrix Printer.....\$219.00  
C1526 Dot Matrix/Serial.....\$299.00  
C1702 Color Monitor.....\$259.00  
C1311 Joystick.....\$4.99  
C1312 Paddles.....\$11.99  
C1600 VIC Modem.....\$59.99  
C1650 Auto Modem.....\$89.99  
Logo 64.....\$49.99  
Pilot 64.....\$39.99  
Word Pro 64 Plus.....\$59.99  
Calc Result 64.....\$65.99  
Calc Result Easy.....\$39.99  
MCS 801 Color Printer.....\$499.00  
DPS 1101 Daisy Printer.....\$459.00  
Magic Voice Speech Module.....\$54.99  
Desk Organizer Lock.....\$49.99  
Vidtext Telecommunications.....\$34.95  
Super Sketch Graphics Board.....\$39.99

#### MSD DISK DRIVES

SD1 Disk Drive.....\$349.00  
SD2 Disk Drive.....\$599.00

# COMPUTER MAIL ORDER

west

800-648-3311

In NV call (702)588-5654, Dept. 100  
Order Status Number: 588-5654  
P.O. Box 6689  
Stateline, NV 89449

canada

Ontario/Quebec 800-268-3974  
Other Provinces 800-268-4559

In Toronto call (416)828-0866, Dept. 100  
Order Status Number: 828-0866  
2505 Dunwin Drive, Unit 3B  
Mississauga, Ontario, Canada L5L1T1

east

800-233-8950

In PA call (717)327-9575, Dept. 100  
Order Status Number: 327-9575  
Customer Service Number: 327-1450  
477 E. 3rd St., Williamsport, PA 17701



CANADIAN ORDERS: All prices are subject to shipping, tax and currency fluctuations. Call for exact pricing in Canada. INTERNATIONAL ORDERS: All orders placed with U.S. offices for delivery outside the Continental United States must be pre-paid by certified check only. Include 3% (minimum \$5) shipping and handling. EDUCATIONAL DISCOUNTS: Additional discounts are available to qualified Educational Institutions. APO & FPO: Add 3% (minimum \$5) shipping and handling.

Circle 70 on inquiry card.





# LOW-COST ON-LINE DATABASES

BY MATTHEW LESKO

*Cheaper ways to obtain information  
with your computer*

WHY PAY DOW JONES & CO. a \$75 initiation fee and up to a \$72 per hour usage charge for stock quotations when you can get the same information for free? Why pay CompuServe up to an \$89.95 initiation fee and a \$12.50 per hour usage charge to find the latest weather trends when you can tap into the world's largest weather database for free?

The world of databases has entered the information age and, like all information products, it has quickly become a buyer-beware market. What someone sells on one side of the street for \$100 to \$200 per hour, someone on the other side of the street gives away or sells at a substantially lower cost. Unfortunately, most information and database buyers become aware of only those products that sell for high prices because they are most heavily advertised. Free or low-cost database suppliers are typically government or nonprofit organizations with no advertising budget or businesses that can keep their charges low because they have a small advertising budget.

Although many low-cost databases

are available, don't think that database searching is an inexpensive way to obtain information. Recent studies show that major users of databases can spend an average of over \$100 per hour searching for on-line information. Some databases charge more than \$400 per hour, and if you are not familiar with the search procedure, you can ring up a substantial bill before you get any information.

Some of the major database vendors have such complex systems that, for a fee, they offer full-day training sessions to acquaint potential users with the system. I find it strange that vendors can charge for a course to tell you how to use their product in order

.....  
*Matthew Lesko is the author of six information and reference books, including Information USA (Penguin Books) and The Computer Data and Data Base Source Book (Avon Books). He is also the publisher of The Data Base Informer, a monthly newsletter that identifies free and low-cost databases. For a free sample copy of the newsletter, contact Information USA Inc., 12400 Beall Mt. Rd., Potomac, MD 20854, (301) 983-8220.*

to earn them more money. In the future this type of problem will decrease as more database vendors recognize the industry trends toward making systems user friendly and charging only for information units delivered in the form of abstracts, pages, print lines, etc.

Database users should be discriminating consumers. Don't take the first database that seems to fit your needs. Would you buy the first car you see? As databases proliferate (well over 3000 are now available), you will have to do a bit of shopping. You will find alternatives to most any database, but they might not be obvious. Doing some homework is worthwhile, since you might be able to cut 10, 50, or even 100 percent of your database bill. Here are some tips for reducing your on-line costs as well as a listing of some free databases and bulletin-board systems (BBSs), some of which you already support through your tax dollars.

## ON-LINE SAVING TIPS

You can start by saving money on nec-  
*(continued)*



essary equipment. A modem can cost between \$50 and \$1000. The average price of a 300-bps modem is about \$160; however, discounters are selling Anchor Automation's \$80 Volks-modem for as little as \$50. Telecommunications software can range from \$50 to \$200, but users clubs will offer you the basics for under \$50.

If you are a beginner, be careful about buying a Cadillac when you need a Chevy. Your needs might change and prices will probably continue to drop during the next few years.

To save on connection expenses, use your subscription to MCI, Sprint, or other long-distance telephone discounters when tapping into databases. Although most major vendors offer local telephone numbers in major markets, many databases require a long-distance call, in which case a discounter can save you up to 35 percent of AT&T's rates.

A discount service can make your dialing procedure a bit more complicated. Some telecommunications software might require you to call the telephone discounter yourself, after which it uses the modem to dial into the database. Check with the telecommunications software manufacturer if you have problems.

You can also save up to 84 percent by using a database vendor's files at night rather than at prime time. But before you take advantage of night discounts, be sure you don't have a cheaper alternative. Pricing schedules can be complicated when you begin to figure in initiation fees, monthly minimums, and so on. Table 1 is a

sampling of evening discounts from several major vendors (note that I.P. Sharp, SDC, and Vu/Text offer no night discounts).

Wholesalers can cut your costs by at least the amount you spend on initiation fees and monthly minimums. Business Computer Network offers subscribers access to BRS, CompuServe, NewsNet, and other services for a basic price of \$50 per year or \$5 per month. This saves you the \$50 initial fee charged by BRS, the \$15 monthly minimum from NewsNet, and the \$39.95 to \$89.95 initial fee charged by CompuServe. This appears to be a good idea, so you should watch for other wholesalers coming on line.

You can get a volume discount on management information. Executive Information Service by John Wiley & Sons offers unlimited use of four databases for a flat fee of \$100 per month. The files are Harvard Business Review, Management Contents, Academic American Encyclopedia, and ABI/Inform. Using Management Contents and ABI/Inform (which cover most business-oriented literature) can be a bargain for big users because their costs range from \$56 to \$84 an hour on other systems.

**GOOD DATA CHEAP**

The Berkeley Solar Group, CompuServe, Dow Jones & Co., General Videotex, The Source, and WSI Corp. all offer the latest weather at prices ranging from \$3 to \$90 per hour. The cheapest appears to be the Berkeley Solar Group, which charges \$3 to \$12. Or if you want weather information

free from Uncle Sam, see the free Climate Assessment Database later in this article.

Daily news junkies can find their cheapest hourly rate on CompuServe (Columbus, Ohio) at \$12.50 per hour.

If you need more comprehensive information, you can pay \$55 per hour to use Grolier's Academic American Encyclopedia on BRS, or \$36 per hour to use it on Dow Jones. Or you can save yourself a bundle and use it on CompuServe for \$12.50 per hour.

Other cheap sources of information are those files available on vendor systems that are also available from the producer at a cheaper rate. For example, the U.S. Federal Government has over 3000 files that vendors like Dialog sell to their clients at up to \$100 per hour. If you have a big enough mainframe computer in your organization, you can purchase many of these files for under \$200 and use them all you want. Other organizations, like the Bureau of the Census and the Department of Labor, are beginning to offer files in disk format. You can purchase them to cut down the cost of continually accessing a database for the information.

Of course, the best way to find out if something is of value is to try it for free. Dow Jones and Dialog offer free demonstrations and clinics. CompuServe offers a free trial with a special password. To find out more, contact the companies directly from the list in the text box titled "Directory of Database Vendors."

You can also find free listings of information and sources. GTE Telenet offers a 110-page directory that describes over 300 databases as well as 140 database vendors and computer services that use the Telenet system. I.P. Sharp offers two free monthly newsletters: one covers finance and the other energy. Contact the companies directly if you want further information.

**FREE DATABASES**

The following is a descriptive listing of various free databases and bulletin boards that you can access. Where

*(continued)*

Table 1: Database night discounts.

Database Vendor	Night Discount
Data-Net Inc.	84.4 percent
Dow Jones & Co.	22.2-78.3 percent
BRS	62.5-80.9 percent
The Source	62.7 percent
Dialog	53.3 percent average
CompuServe	52 percent
ADP (some services), Network	50 percent
Mead Data Central	50 percent on searching
General Videotex	45 percent
NewsNet	25 percent

# Now there's no excuse to drop dead.

Producing a brochure. Introducing a new product. Moving your entire company across town. Every project has a start date, a completion date, and a date beyond which you absolutely, positively cannot go. The drop dead date. Blow that date and you've got positively, absolutely no excuses.

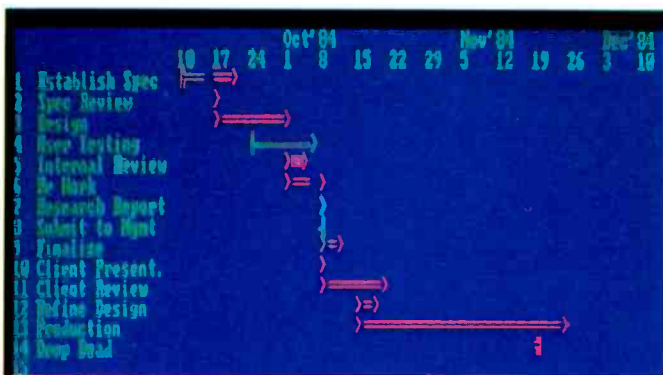

Better to arm yourself with Microsoft® Project, the new software tool for business managers and their IBM® PCs. Microsoft Project tells you which activities are essential to keeping your schedule. And which you can let slide.

## Microsoft Project keeps you on a healthy track.

What a spreadsheet does for financial planning, Microsoft Project does for start-to-completion scheduling. Give it your best to worst "what-if" scenarios. It tells you what must be accomplished. By whom. By when. At what cost.

When management needs detailed

status or budget reports, it prints them out. In text and bar charts. And it can also send budgeting information to programs like Multiplan®, Microsoft Chart, or Lotus™ 1-2-3™.

## Get Microsoft Project. No excuses.

Microsoft Project is easy to use. Especially if you're familiar with electronic spreadsheets. It saves your company time, work, money. Makes you an on-time, on-budget manager. Not to mention it's from Microsoft. We're the people who designed the MS™ DOS operating system that tells the IBM **MICROSOFT** PC how to think. The High Performance Software. And our BASIC is the language spoken by nine out of ten microcomputers worldwide.

For the name of your nearest Microsoft dealer, please call 800-426-9400. In Washington State, Alaska and Hawaii 206-828-8088.

Should you decide you can face another drop dead date without Microsoft Project, tell us where to send the flowers.

The word 'MICROSOFT' is rendered in a large, bold, black, blocky font. A hand is visible at the bottom right, with fingers gripping the letters 'O', 'F', and 'T', giving the impression of holding up the text.



**More Than  
Artificial  
Intelligence.**

## **Genuine Genius.**

*When it comes to expert systems,  
we wrote the library.*

Human Edge™ Business Strategy Software.

Smart, tough, tactical programs that provide the user with personality profiles of two people dealing in a business situation.

The Sales Edge™ gives you a handle on your prospect. You'll know when to be aggressive. And when to back down. How to best prepare, open and close to sell anyone the way they want to be sold.

The Management Edge™ helps you better analyze, understand and manage the

people you work with. You can hold the bright ones. Lose the losers. And keep an easy grip on the reins.

The Negotiation Edge™ helps you size up your opponents. You'll see where they're strong. Where they're vulnerable. No matter what's on the table, a property deal, a merger, or the promotion you're overdue. In short, the Negotiation Edge will help you win.

The Communication Edge™ shows you how to make your conversations and meetings more meaningful and effective. How to make your point with a specific person so

there's no doubt that you've said what you meant. And meant what you've said.

In just a few minutes your IBM, Macintosh or Apple II pc will give you a strategic report that's cunningly accurate.

The Sales and Management programs are \$250. The Negotiation Edge is \$295, and The Communication Edge is \$195.

Your personal strategy is as close as your nearest Computer Dealer. Or your phone.

 **HUMAN EDGE**

*We Make Computers Think.*

1-800-624-5227 (in California 1-800-824-7325)

Human Edge Software Corporation  
2445 Faber Place, Palo Alto, CA 94303



I've given a name and address, you need to contact the database producer to receive the computer phone number and password. At times, access might be limited in order to deal with volume. I've provided direct computer telephone numbers in those instances where no password or authorization is required.

**FOREIGN AFFAIRS**

Clearpoint International News offers daily transcriptions of news monitored from foreign dispatched national news agencies such as the BBC and Radio Moscow; this allows a comprehensive comparison of opposing perspectives on global events. On oc-

casion, it also carries some regional news that cannot be obtained elsewhere. Contact Clearpoint, POB 31577, San Francisco, CA 94131.

The U.S. Naval Observatory has over 64 data files on time and travel covering such information as the time of sunrise, sunset, twilight, and moonrise on a given day anywhere in the world; the times transit satellites pass over a particular area during the upcoming 24 hours; and the direction and distance in nautical and statute miles between any two points on earth. Contact Mihram Miranian, U.S. Naval Observatory, Time Service Division, Washington, DC 20390, or call (202) 653-1079 with your modem at 300

bps. Make sure you use even parity.

The Climate Assessment Database provides information on short-term climate conditions throughout the world, including temperature, precipitation, weather indexes, heating and cooling days, energy conditions, and assessment of the climate's effect on crops. The information is updated continually from 8000 stations worldwide. For a password, contact Mr. Paterson, NOAA, National Meteorologic Center, W353, WBBB, Room 201, Washington, DC 20233, or call (301) 763-8071.

Another database contains plant-site-selection data and market demo-

*(continued)*

## DIRECTORY OF DATABASE VENDORS

**ADP NETWORK SERVICES**

175 Jackson Plaza  
Ann Arbor, MI 48106  
(313) 769-6800  
(800) 521-3166

**BERKELEY SOLAR GROUP**

3140 Grove St.  
Berkeley, CA 94703  
(415) 843-7600

**BIBLIOGRAPHIC RETRIEVAL SERVICES (BRS)**

1200 Rt. 7  
Latham, NY 12110  
(800) 833-4707  
in NY (800) 553-5566

**BUSINESS COMPUTER NETWORK**

POB 36  
1000 College View Dr.  
Riverton, WY 82501  
(800) 446-6255  
in WY (800) 442-0982

**COMPUSERVE INC.**

5000 Arlington Center Blvd.  
Columbus, OH 43220  
(800) 848-8199  
(614) 457-0802

**DATA-NET INC.**

POB 652  
Fairport, NY 14452  
(716) 323-1141

**DIALOG INFORMATION SERVICES INC.**

3460 Hillview Ave.  
Palo Alto, CA 94304  
(800) 227-1927  
(415) 858-3785

**DOW JONES & Co. INC.**

POB 300  
Princeton, NJ 08540  
(800) 257-5114  
(609) 452-1511

**EXECUTIVE INFORMATION SERVICE**

POB 437  
Somerset, NJ 08873  
(212) 850-6360

**GENERAL VIDEOTEX CORP.**

3 Blackstone St.  
Cambridge, MA 02139  
(800) 544-4005  
(617) 491-3393

**I.P. SHARP ASSOCIATES**

Box 418 Exchange Tower  
2 First Canadian Place  
Suite 1900  
Toronto, Ontario  
Canada M5X 1E3  
(416) 364-5361

**MEAD DATA CENTRAL**

POB 933  
Dayton, OH 45401  
(800) 227-4908  
(513) 227-4908

**NEWSNET INC.**

945 Haverford Rd.  
Bryn Mawr, PA 19010  
(800) 345-1301  
(215) 527-8030

**SDC INFORMATION SERVICES (ORBIT)**

2500 Colorado Ave.  
Santa Monica, CA 90406  
(800) 421-7229  
in CA (800) 352-6689

**SOURCE TELECOMPUTING**

1616 Anderson Rd.  
McLean, VA 22102  
(800) 336-3366.  
(703) 734-7500

**VU/TEXT INFORMATION SERVICES**

1211 Chestnut St.  
Philadelphia, PA 19107  
(800) 258-8080  
(215) 854-8297

**WSI CORP.**

41 North Rd.  
POB B  
Bedford, MA 01730  
(617) 275-5300



*One service provides the latest information on investment strategies and techniques.*

graphics. Users have access to demographic data, tax information, union and labor profiles, and dozens of other characteristics on both domestic and foreign cities, counties, or states. Contact Conway Data Inc., 1954 Airport Rd. NE, Atlanta, GA 30341, (800) 554-5686; in Georgia, (404) 458-6026. Or ask for the SIT service via CompuServe or Uninet.

**INVESTMENT OPPORTUNITY**

Nonclients can tap into a system from 5 p.m. to 9 a.m. and all day on weekends to find out the latest stock prices and other stock information. Clients have 24-hour access and can also buy and sell stocks via computer. For more information contact Max Ule & Co., 6 East 43rd St., New York, NY 10017, (800) 223-6642 or (212) 687-0705.

If you use your computer to analyze or make investments, one service provides the latest information on investment strategies, software and hardware performance evaluations, and computer-related investment techniques. It also provides a free software exchange program. Contact American Association of Individual Investors, 612 North Michigan Ave., Chicago, IL 60611, (312) 280-0170, or use your modem to call (312) 280-8764.

For those interested in the latest techniques and strategies for investing in the commodities market, another database has over 112 available files. These free files are provided by Club 3000 in Augusta, Michigan, and cover such topics as how to use the latest spreadsheets (such as SuperCalc) for analyzing trades, the best discount brokers, the latest software products available for commodity investing, and the good and bad effects of using the latest hot investment strategy. Use your modem to call (616) 731-5330.

If you need commodity news, from 4 p.m. to 7 a.m. you can get the latest on world commodities, the Minneapolis grain market, the Minneapolis wheat futures markets, and excerpts from commodity publications. Contact Nedbalek Enterprises Inc., 1154 Grain Exchange, Minneapolis, MN 55415, (612) 340-9030, or use your modem to call (612) 333-8970.

**MICRO HELP**

The National Bureau of Standards sponsors the Microcomputer Electronic Information Exchange BBS. Its number is (301) 948-5718. Contact Shirley Radack, Institute for Computer Sciences and Technology, A209 Administration Bldg., National Bureau of Standards, Washington, DC 20234.

If you have a technical question related to an Apple or IBM computer, place it on the Computerease Bulletin Board and the technical staff will try to help you. Contact Computerease, 2323 Boston Post Rd., Milford, CT 06460, (203) 877-7447, or use your modem to call (203) 878-6869.

Exec-PC is designed to help those who use an IBM PC or compatible for serious business pursuits. It offers the latest information on effective use of such programs as Lotus 1-2-3, dBASE II, and WordStar, as well as tutorials on databases, spreadsheets, and communication programs. Free software programs include PC-Write, PC-File, and PC-TalkIII. Use your modem to call (414) 964-5160.

Pacific Net-Works helps you locate any kind of PC software you might need and even lets you use an 800 number to call its free service if you are a regular user. Regular users are those residing in southern California who use the service at least three times a week and others who use it at least once a week. Use your modem to call (805) 985-2591 between 6 a.m. and 6 p.m. PST and 24 hours a day on weekends.

**SPACE SAVINGS**

The Satellite-Cable TV Network bulletin-board system includes an impressive log of satellite data and cable TV news. The satellite data shows profiles

of Satcom, Westar, Comstar, and Galaxy satellites, plus orbit positions for all the general service satellites. Also, a listing includes all the services that each one carries. Other information includes a schedule of launches and operation dates for new satellites. Use your modem to call (618) 451-1041.

The National Aeronautics and Space Administration (NASA) in Houston provides the latest activities on current space shuttle missions, including crew wake-up and sleep times, satellite hand-off points, downlink points for video transmission from the shuttle, and current press-conference information. Use your modem to call (713) 483-4115.

Gas Net, a bulletin board provided by NASA, gives you all the latest information on how to include an experiment on the next space shuttle. The cost of the experiments, called Get Away Special Payloads, ranges from \$3000 to \$10,000. Gas Net tells about the latest results of experiments, who is going to be included in the next set of experiments, when and where conferences will be held on the subject, and what you should consider when sending an experiment into space. If you want to know more about how to send something into space, contact Bob Pincus, NASA, Goddard Space Flight Center, Code 743G, Greenbelt, MD 20771, (301) 344-5874, or use your modem to call (301) 344-9156.

**MISCELLANEA**

The Alternative Fuel Data Bank contains information about the use of alternative fuels in three data categories: bibliographies of publications, synopses of ongoing research activities, and discussions of topics of current interest. Contact Russell Simkis or Carol Morrison, Alternative Fuel Data Bank, Bartelsville Energy Technology Center, POB 1398, Bartelsville, OK 74005, (918) 336-2400.

Coping with AT&T is a system that helps the consumer better understand his or her phone service and equipment. It contains the latest news

*(continued)*



# computers of New York wholesale

# 315-676-3004

Box 150 Brewerton, N.Y. 13029

Circle 76 on inquiry card.

*We pay UPS shipping charges  
on prepaid orders.*

## —PRINTERS—

<b>ANADEx</b>	
DP-9501B	\$1049
DP-9620B	1099
DP-9625B	1199
DP-6500	2399
WP-6000	2159

## TEXAS INSTRUMENTS

TI 850 Par.	499
TI 855 w/T	899

## C. ITOH

Prowriter 8510A Par.	\$345
Prowriter 8510A Ser.	499
Prowriter II Par.	565
Prowriter II Ser.	699

## EPSON

RX-80	299
RX-80FT	Call
FX-80	Call
FX-100	Call

## GEMINI

10X	\$295
15X	435

## MANNESMAN TALLEY

MT-160 I	\$529
MT-160 L	579
MT-180 L	859

## DIABLO

620 RO 25 CPS	\$919
630 RO 40 CPS	1769

## OKIDATA

ML-82A	Call
ML-83A	Call
ML-92 Par.	Call
ML-92 Ser.	Call
ML-93 Par.	Call
Pacemark 2350	Call
Pacemark 2410	Call

## PANASONIC

KX-P1090	\$319
----------	-------

## NEC NEW NEC 2050

3510	\$1399	3530	\$1490
3550	1849	7710	1899
7715	1949	8023	399

## QUME

Sprint 11/40	\$1299
Sprint 11/55	1499

## RITEMAN Inforunner

	\$299
--	-------

## SILVER REED

EXP 500 Par.	\$459
EXP 550 Par.	529
EXP 770 Par.	939

Advertised prices reflect a cash discount on prepaid orders only. Most items are in stock for immediate delivery in factory sealed cartons with full factory warranties.

## —MONITORS—

<b>AMDEK</b>	
Color I	\$275
Color I +	319
Color II (RGB)	399
Color III (RGB)	349
300 G (12" green)	135
300 A (12" amber)	145
310 A (IBM PC)	169

## BMC

12 AU (12" green)	\$79
-------------------	------

## NEC

JB-1201 (12" green)	\$155
JB-1205 (12" amber)	155
JC-1212 (12" color)	339
JC-1216 (12" RGB)	439

## PANASONIC

12" Green Monochrome	\$169
12" Amber Monochrome	179
13" RGB	389

## SAKATA

SG-1000 12" Green	\$99
SC-100 13" Color	269
SC-200 13" RGB	499
SC-300 13" RGB	659

## TAXAN

KG 12N (12" green)	\$129
210 (13" color)	299
400 (13" RGB color)	299
410 (13" RGB color)	379

## ZENITH

Z-122 (12" amber)	\$139
Z-123 (12" green)	109

## —HARD DISKS—

## CORVUS

Omninet 6	\$1695
Mirror Back-up	670
Print Server	839

## TALLGRASS TECHNOLOGIES

20MB Hardfile Disk for IBM-PC	2695
70MB Hardfile Disk for IBM-PC	Call

## —DISKETTES—

<b>Maxell</b>	
5 1/4" MD1	\$22.95
5 1/4" MD2	32.95

<b>3M/Scotch</b>	
5 1/4" SSDD	\$21.95
5 1/4" DSDD	30.95

<b>Educator</b>	
Lifetime Warranty	
5 1/4" SSDD	\$16.95
5 1/4" DSDD	21.95
Flip 'n' File/holds 50 Disks	17.95

## —BOARDS—

### IBM PC BOARDS

Amdek MAI Graphics Board	\$479
AST Sixpak plus 64k	299
AST Megaplus 256k	569
CCS 132 Column Board	589
Microsoft 256k RAM Board	299
Plantronics Color + Board	399
Quadram New Quadboard	Call
Quadram Quadlink Board	Call
Tecmar 1st MATE Board	229
Tecmar Graphics Master Board	569
PC Peacock Graphics Board	299
64k Chip Kit (9 Chips)	Call

## —SYSTEMS—

### COLUMBIA

VP Portable	Call
MPC 1600-1	Call
MPC 1600-4	Call

### CROMEMCO

CS-1	3195
CS-2	3755
CS-3	5595
64 FDC	475
TUART	255

## —COMPAQ—

Computers Wholesale  
Now Stocks COMPAQ

**Call for Prices!**

### MORROW

New Portable w/2 Drives & Software	Call
MD11 w/H Disc & Software	Call

### NEC

PC-8201 Portable	Call
PC-8800 Small Business System	1669
PC-8800 16-Bit System	1999
PC-8800 System w/8-in. Drives	2299

### NORTHSTAR

Advantage	Call
-----------	------

### SANYO

MBC 1200	1299
MBC 550	Call
MBC 555	Call
CRT-36	159

### TELEVIDEO

TS-803	\$1989
--------	--------

### ZENITH

151-22 w/2 Drives	\$2495
151-22 w/Hard Disk	3995
161-22 Portable	Call

## —TERMINALS—

### ESPRIT SYSTEMS

Esprit	\$489
Esprit II	499
Esprit III	649
Exec. 10/102	799
Exec. 10/102G	1249

### New!

<b>Teleideo Personal Terminal</b>	
Personal Terminal	\$399
Personal Terminal w/300 band modem	529
Personal Terminal w/1200 band modem	849

### TELEVIDEO

910	\$439
914	579
924	695
925	699
950	865
970/50	949

### QUME

102	\$569
108	715

### WYSE

50	549
75 color	Call

### ZENITH

Z-29	\$659
ZTX-10	319
ZTX-11	389

## —MODEMS—

### HAYES

Smartmodem 300	199
Smartmodem 1200	498
Smartmodem 1200B	Call

### NOVATION

D-Cat	\$149
J-Cat	99
Apple Cat II	269
103 Smart Cat	179
103/212 Smart Cat	399
212 Auto Cat	549
Access 1-2-3	449

### SIGNALMAN

Mk IIL	\$75
Mk XII	279
Mk VII	\$95
Volks-modem	59

### U.S. ROBOTICS

300 Baud Password	\$149
1200 Baud Password	339
PC 1200 Baud Modem	329
S 100 1200 Baud Modem	329

N.Y. residents, add appropriate sales tax. We accept VISA and Master Card. Personal and company checks, allow 2 weeks to clear. C.O.D.'s require a 25% deposit. All prices and offers may be withdrawn without notice.



# The Preferred C Compiler

"...C86 was the only compiler we tested that ran every benchmark we tried and gave the expected results... Computer Innovations C86 was the compiler that our staff programmers used both before and six months after we conducted the tests."

J. Houston, BYTE MAGAZINE - February 1984

\*FAST EXECUTION -  
of your programs.

\*FULL & STANDARD  
IMPLEMENTATION OF C -  
includes all the features described by  
K & R. It works with the standard  
MSDOS Linker and Assembler; many  
programs written under UNIX, can  
often be compiled with no changes.

\*8087 IN-LINE -  
highly optimized code provides 8087  
performance about as fast as possible.

\*POWERFUL OPTIONS -  
include DOS2 and DOS1 support and  
interfaces; graphics interface capability;  
object code; and librarian.

\*FULL LIBRARY WITH SOURCE -  
6 source libraries with full source code  
the "large" and "small" models, soft-  
ware and 8087 floating point, DOS2  
and DOSAL.

\*FULL RANGE OF SUPPORT  
PRODUCTS FROM COMPUTER  
INNOVATIONS -  
including Halo Graphics, Phact File  
Management, Panel Screen Manage-  
ment, C Helper Utilities and our  
newest C to dBase development  
tool.

\*HIGH RELIABILITY -  
time proven through thousands of  
users.

\*DIRECT TECHNICAL  
SUPPORT -  
from 9 a.m. to 6 p.m.

Join The Professional Programmers Who Agree C86™ Is The C Compiler Of Choice

For Further Information Or To Order Call:

**800-922-0169**

Technical Support: (201) 542-5920

980 Shrewsbury Avenue  
Suite PW509  
Tinton Falls, NJ 07724



Computer Innovations, Inc.™

# C86™

PRICES SUBJECT TO CHANGE WITHOUT PRIOR NOTICE  
UNIX IS A TRADEMARK OF BELL LABS. C86 IS A TRADEMARK OF COMPUTER INNOVATIONS, INC. WINDOWS IS A TRADEMARK OF MICROSOFT  
PC DOS IS A TRADEMARK OF INTERNATIONAL BUSINESS MACHINES

## LOW-COST DATABASES

Keep up on the latest in bulletin boards by calling any directory number.

about the AT&T breakup and other developments, as well as equipment information, such as how to install your own telephone. Use your modem to call (516) 581-8696.

Microserve, located in Hawkins, Texas, offers you 20 minutes of free time on a variety of on-line databases and bulletin boards that include information such as the latest sports scores, weather, a listing of 800 numbers, horoscopes, and software and hardware products, as well as the national telephone listing of Source-net and Telenet. Use your modem to call (214) 769-3036.

The Handicapped Educational Exchange, located in Silver Spring, Maryland, provides information on how the latest technology can aid the disabled. Topics covered include computer use by the disabled, buying special equipment (such as braille printers) at the lowest possible prices, meeting notices, and listings of organizations for the disabled. Use your modem to call (301) 593-7033.

Information Intelligence provides current job openings throughout the United States and Canada in the field of library automation. Also on file is a directory of on-line employment sources, as well as job lines and hot-lines. Job openings remain on line for 30 days. Contact Information Intelligence Inc., POB 31098, Phoenix, AZ 85046, (602) 996-2283.

If you are still looking for the ideal BBS, keep up on the latest in bulletin boards by using your modem to call any of the following directory numbers: (213) 653-6398, (619) 561-7277, (818) 881-6880, or (913) 649-1207. ■

*Editor's Note: Bulletin-board systems are usually noncommercial ventures and so are under no commitment to continue operation. This means you should not depend on any free bulletin board for continuing information.*



# Be confident because your PowerType Daisywheel correspondence becomes you.

When you can't personally be there, only the clearest typed correspondence should be your substitute. With a PowerType Daisywheel printer your documents look highly professional. And so do you!

PowerType. It's 'typewriter friendly.' Using a simple drop-in ribbon cassette, it bi-directionally types executive quality correspondence at 18 cps with a print wheel that holds 96 flawless characters.

Designed for personal or business applications, PowerType's carriage accepts paper that ranges

from letter to legal size, from fanfold to roll to cut sheet. You can set right and left margins, vertical and horizontal tabs.

Plus, of course, PowerType has both serial and parallel interfaces to enable it to connect to just about any personal or business computer.

So the next time you're going face to face through the mail, rely on PowerType. It will help you make a professional impression. And that's always very becoming.

**star**  
MICRONICS, INC.

THE POWER BEHIND THE PRINTED WORD.

Computer Peripherals Division

P.O. Box 62186, Dallas/Ft. Worth Airport, TX 75262 (214) 456-0052

Circle 340 on Inquiry card.

**star**  
MICRONICS, INC.

Dear Manager,

Believe it or not, this letter is being typed by our new daisywheel printer. I'm pleased to announce that the quality of its 96 characters has met our highest expectations.

She's also called PowerType, and she's here and ready to go!

As you certainly know, this has been a hot product all over the world's accounting to see the actual finished product line up on top of mountains. It would seem that I guess I should feel like a great teacher.

Send requests to Alan and Jane and tell them to call you on their own time! We'll be sending PowerType and literature only each week.

And remember, with PowerType, she's not the only one going strong, it's a computer that's doing it!

All my best,

PowerType

**star**  
MICRONICS, INC.



# The Ven-Tel Half Card.<sup>™</sup> The only 1200 baud modem for your IBM XT or IBM Portable PC.

The Ven-Tel Half Card<sup>™</sup> is the only internal 1200/300 baud modem that fits in the small expansion slots of the IBM-XT and the IBM Portable.

**Free Expansion Slot.** If you own an IBM PC-XT, look inside the chassis sometime. You'll see a number of standard sized expansion slots and one unused half-sized slot. That's where the Half Card<sup>™</sup> fits—in a spot that would otherwise be wasted. So why take up one (or sometimes two) valuable full-size slots for your modem? With the Half Card,<sup>™</sup> it's like getting an extra expansion slot for free.

**True Portability.** IBM Portable PC owners will appreciate the true portability offered by the Half Card,<sup>™</sup> the only modem that fits in the half-sized slots of the Portable. When you're on the road, you won't need to pack along a bulky external modem, cable and power supply. Your modem will already be inside your computer, ready to go!

Although it's half the size of other modems, the Half Card<sup>™</sup> has all of the high performance features you expect: selection of 1200 or 300 baud,

automatic dialing using the industry standard "AT" command set, automatic answer on any ring, and full compatibility with virtually all software.

The Half Card<sup>™</sup> comes complete with one of the most popular communications software packages available, CROSSTALK XVI by Microstuf. Whether you use an information service such as The Source or Dow Jones News Retrieval, or transfer files and electronic mail, the Half Card<sup>™</sup> connects your Portable or XT to the world.

Effortless Communication  
**From Ven-Tel Inc.**

2342 Walsh Ave.  
Santa Clara, CA 95051  
(408) 727-5721

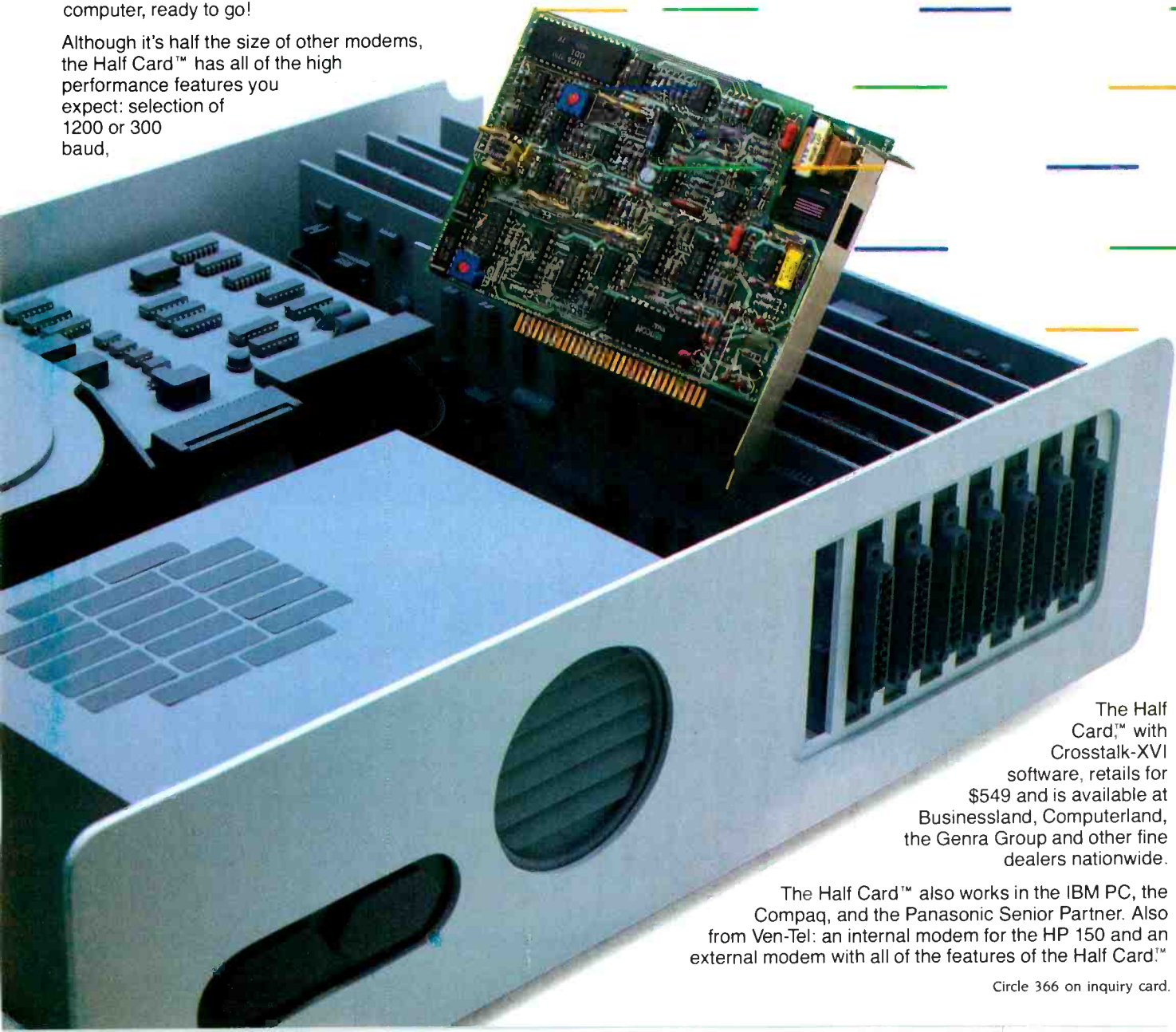

The Half Card<sup>™</sup> with Crosstalk-XVI software, retails for \$549 and is available at Businessland, Computerland, the Genra Group and other fine dealers nationwide.

The Half Card<sup>™</sup> also works in the IBM PC, the Compaq, and the Panasonic Senior Partner. Also from Ven-Tel: an internal modem for the HP 150 and an external modem with all of the features of the Half Card.<sup>™</sup>

Circle 366 on inquiry card.

# THE PICK OPERATING SYSTEM

## PART 1: INFORMATION MANAGEMENT

BY RICK COOK AND JOHN BRANDON

*This information-oriented operating system  
has a built-in relational database and multiuser capabilities*

[Editor's Note: You might ask why BYTE has included an operating system article in this month's database theme. We had two reasons. First, the Pick operating system includes a built-in relational database and an easy-to-use English-like query language. Second, Pick, like UNIX, is a large, complex operating system that is migrating from minicomputers to microcomputers and is well suited for managerial and business applications.

This month, in part 1, Rick Cook and John Brandon introduce the Pick operating system and discuss its structures, query language, and dictionaries.]

THE REAL JOB of a computer in a management context is reducing data to information and helping people manage the information. One way to measure how difficult that can be is to consider all the times you confuse data with information and end up processing data instead of managing information.

Data includes such things as invoice numbers and customer addresses, price lists, and style codes. Information answers questions: Am I making or losing money? Have I got enough material on hand to produce what I

need for next month? Where did I put that magazine article? How well is George doing in sales? Why does it cost so much to answer a customer letter? And how much does it cost, anyway?

By using computers you can sort out relevant data, better discern important relationships, and apply both to the questions at hand. But on most computer systems, machine needs (and not user needs) predominate. Instead of helping you squeeze information out of the real world, the computer traps you in an unreal world conditioned on its own structure.

Ideally, the structure of the query put to the computer should match the

.....  
Rick Cook (2318 West Hayward, Phoenix, AZ 85021) is a freelance writer specializing in computers and high technology. He has written for Popular Computing and many other computer magazines. John Brandon (2432 West Peoria Ave., Suite 1303, Phoenix, AZ 85029) has worked with the Pick operating system for eight years and is president of Interactive Systems, a Phoenix corporation that supplies software, education, and consulting for the Pick operating system.

structure of the problem. You should be able to think in terms of questions and answers and convey them to the computer without having to translate them into a language of files and fields, record lengths, and search keys.

Unfortunately, reality is not static. Not only does the data change, but relationships change, too. You try new ways of doing things, new people join the business, responsibilities shift, even the rules and laws you follow change. The computer's metastructure should adapt to these changes as they occur.

The Pick operating system represents one attempt to meet this challenge. Pick is a virtual-memory multiuser operating system specifically designed to help you get the information you need. The structure of Pick focuses your attention on information rather than on the workings of the computer.

Although it is an extremely sophisticated system, Pick is easy for non-programmers to use. In a few minutes, you can learn Pick's English-like query language well enough to begin

(continued)



answering complex questions about data stored in the built-in relational database. With a little more work, you can learn to modify the commands, write elaborate instruction sequences that can be stored and used as needed, and work in the high-level programming language that is part of the system.

The closest thing to Pick in size and feel is probably UNIX. Both are big, complex operating systems that are migrating down to the microcomputer world after having been developed and refined on minicomputers. Both systems are sophisticated and very powerful, and both tend to produce vehement partisans. One of the big differences, though, is that UNIX partisans tend to be programmers, especially systems programmers. Pick's partisans tend to be users and applications programmers. Of the two systems, UNIX is the more powerful

for scientific and engineering applications. Pick, by its structure, is better adapted for business and managerial applications.

But Pick is hardly perfect. Structured programming purists shudder over the fact that Pick's only high-level language is an extensively reworked version of BASIC. The present release is multiuser, but not multitasking, and rather lacking in communications capability. Some of the UNIX-type concepts, such as pipes and filters, which are becoming widely available on other operating systems, are not fully developed in Pick. Software hackers generally dislike Pick because it is difficult to get inside the system and play with it.

On the other hand, for the manager who needs to find out what's going on, the applications programmer who has to get a piece of software up and running, or anyone with a lot of infor-

mation to organize, Pick's design and structure make it hard to beat.

If Pick is so good, you might well ask, why isn't it better known? That's a question Pick enthusiasts frequently ask themselves. Part of the answer is that, until recently, Pick was confined to the minicomputer world, where it was generally sold under a house name. Microdata, for instance, calls its version of Pick "Reality." Another reason is that, unlike some operating systems, Pick has been carefully controlled. It is not available on all machines, and Pick Systems Inc. has no intention of making it available for all of them. Pick software is highly portable, but the operating system itself is not. Getting Pick running on a new machine takes a lot of work.

Although most of the microcomputers running Pick are high-end multiuser systems costing \$10,000

*(continued)*

## DISK COPYING SERVICE

*Fast • Reliable • Low Cost*

If you produce software, ALF's disk copying service is the quick, convenient answer to your duplication needs. Fifty copies or thousands, standard or copy-protected formats, just disks or a whole package—call ALF. Consider:

• **FAST.** Most orders are shipped in a week or less. Prompt service on custom printing, too.

• **LOW COST.** Set-up charges start at \$10, copy protection set-up at \$25. Copying charges are 30¢ to 40¢ per side (see blank disk prices at right). No extra charge per copy for protected formats.

• **CONVENIENT.** We offer label application, shrink packaging, heat sealing, and other services. Need custom printed labels and sleeves? We can handle it and much more. We have vinyl folders, binders with slip cases, 3-hole vinyl disk pages, and disk mailers in stock—and can custom print them for packaging in a hurry.

• **TOP QUALITY.** We start with the finest disks available. Your choice of 3M, Memorex, Verbatim, or other major brands—or you can supply your own blank disks. Every disk we copy is verified bit by bit and guaranteed 100% flawless.

• **RELIABLE.** ALF designs and manufactures copying equipment that other copying services and software publishers rely on every day. Our complete understanding of duplication technology assures you of the finest reproduction available—and has since 1980.

*We're eager to meet your duplication and packaging needs. Give us a call today!*

## BLANK DISKS

ALF buys large quantities of top quality, bulk packaged disks for our disk copying service. We avoid the expense of fancy printing and labeling—and can pass these savings on to you! The disks listed below are 5¼", soft sector, double density, unlabeled, with hub reinforcement ring. Call for information on other disks, too.

3M	call for details
<b>MEMOREX</b>	<b>\$146</b> per 100 SINGLE SIDED
	<b>\$180</b> per 100 DOUBLE SIDED
<b>VERBATIM</b>	<b>\$150</b> per 100 SINGLE SIDED
	<b>\$192</b> per 100 DOUBLE SIDED

*Without sleeves:*

add \$2.50 shipping per 100.

*With tyvek sleeves:*

add \$7 plus \$2.50 shipping per 100.

*Packed in boxes of 10 with tyvek sleeves:*

add \$15 plus \$3.00 shipping per 100.

**ALF**

To order, call 1-800-321-4668. Inside Colorado & customer service: 1-303-234-0871.

ALF Products Inc. 1315F Nelson St. Denver, CO 80215

# **COHERENT™ IS SUPERIOR TO UNIX\* AND IT'S AVAILABLE TODAY ON THE IBM PC.**

Mark Williams Company hasn't just taken a mini-computer operating system, like UNIX, and ported it to the PC. We wrote COHERENT ourselves. We were able to bring UNIX capability to the PC with the PC in mind, making it the most efficient personal computer work station available at an unbelievable price.

For the first time you get a multi-user, multitasking operating system on your IBM PC. Because COHERENT is UNIX-compatible, UNIX software will run on the PC under COHERENT.

The software system includes a C-compiler and over 100 utilities, all for \$500. Similar environments cost thousands more.

COHERENT on the IBM PC requires a hard disk and 256K memory. It's available on the IBM XT, and Tecmar, Davong and Corvus hard disks.

Available now. For additional information, call or write,

Mark Williams Company  
1430 West Wrightwood, Chicago, Illinois 60614  
312/472-6659





FANTASTIC LOW PRICES ON

# BASF QUALIMETRIC DISKETTES!



BASF QUALIMETRIC DISKETTES have a lifetime warranty and are packed in plastic storage cases. TYVEK sleeves, reinforced hubs, user identification labels and write-protect tabs included.

**\$139** ea. 5 1/4" SSDD Qty. 20  
**\$189** ea. 5 1/4" DSDD Qty. 20

**SOFT SECTOR ONLY!**

**3M HEADCLEANING KITS**

Stop swearing and start cleaning. This non-abrasive cleaning kit has everything you need for 30 applications. **\$18.00** Shprng.

**AMARAY MEDIA-MATE 50: A REVOLUTION IN DISKETTE STORAGE**



Every once in a while, someone takes the simple and makes it elegant. This unit holds 50 5 1/4" diskettes, has grooves for easy stacking, nipples to keep diskettes from slipping and several other features. We like it.

**\$10.95** ea. \$2.00 Shprng.

**DISKETTE 70 STORAGE: STILL A GREAT BUY**



Dust-free storage for 70 5 1/4" diskettes. Six dividers included. An excellent value.

**\$11.95** Shprng.

**DISK CADDIES**



The original flip-up holder for 10 5 1/4" diskettes. Beige or grey only.

**\$1.65** ea. +20¢ Shprng.

**PRINTER RIBBONS AT BARGAIN PRICES!**

Brand new ribbons produced to manufacturer's specs.

Epson MX-70/80 **\$3.58** ea. + 25 Shprng.  
Epson MX-100 **\$6.99** ea. + 25 Shprng.  
Okidata Micro 83 **\$1.48** ea. + 25 Shprng.  
Okidata Micro 84 **\$3.66** ea. + 25 Shprng.

Shipping: 5 1/4" DISKETTES—Add \$3.00 per 100 or fewer diskettes. Other Items: Add shipping charges as shown in addition to diskette shipping charges. Payment: VISA and MASTERCARD accepted. COD orders only add \$3.00 handling charge. Taxes: Illinois residents only, add 8% sales tax.

**FOR ORDERS ONLY:**

**1-800-621-6827**  
(In Illinois: 1-312-944-2788)

**INFORMATION & INQUIRIES:**

**1-312-944-2788 only!**

HOURS: 9AM - 5PM Central Time,  
Monday - Friday

**WE WILL BEAT ANY NATIONALLY ADVERTISED PRICE ON THE SAME PRODUCTS AND QUANTITIES!**

**DISK WORLD!, Inc.**

Suite 4806 • 30 East Huron Street • Chicago, Illinois 60611

**DISK  
WORLD!**

Authorized Reseller  
Information Processing  
Media

**BASF**

## PICK

and more, Pick Systems Inc. has recently transported Pick to the IBM PC XT. The PC version of Pick is a full implementation that supports up to three users and sells for \$495.

### AN OVERVIEW OF PICK'S STRUCTURE

Although Pick is technically an operating system, it contains much more than the regular operating-system functions. As part of the operating system, Pick has a wealth of features that are applications programs or add-ons in other systems.

The heart of the Pick operating system is its relational database. In Pick, the database-management system is an inherent part of the operating system and not a utility or an add-on.

Other parts of the operating system include an English-like nonprocedural query language called Access; a compiled version of BASIC with major enhancements for business and data management; Proc, a stored-procedure processor that lets you write and store elaborate command sequences, much like scripts in UNIX; a command processor called Terminal Control Language (TCL, pronounced "tickle"); a print spooler; and a number of other utilities. You will spend most of your time with Access, TCL, Proc, and BASIC.

Most of the utilities associated with microcomputer operating systems are either invisible or nonexistent in Pick; as much as possible, chores like file handling and memory allocation are done by the operating system. You are free to concentrate on the information. However, Pick is rich in utilities related to information handling.

Underpinning all of this is an elaborate and complex software structure. Pick is implemented as a virtual machine with limited, carefully optimized connections to the underlying hardware through a section of code called the monitor. Pick's designers started out by coming up with the best possible paper computer they could imagine for managing information. Then they wrote an operating system to emulate their design on real computers.

The Pick virtual machine has its own internal structure and even its own pseudo-assembly language, all designed for data-management tasks.

On a microcomputer, these features are implemented in software, right down to the virtual-memory management system. One result of having a virtual machine implemented in software is a high degree of applications portability. Any Pick machine will run almost any piece of Pick software. The only difference between running an application on an IBM PC XT and an IBM 4300 mainframe is that the application will probably run slower on the PC XT.

The usual penalty for having such an elaborate software superstructure is a loss of speed. You would expect that Pick would be slow, especially on something like the 8088 microprocessor in an IBM PC XT. That's not the case.

While the PC XT implementation is noticeably slower than Pick on 68000-based microcomputers, it doesn't drag. To someone used to microcomputers, Pick appears somewhat slow because most Pick implementations are designed to work with terminals via serial I/O (input/output) ports rather than the kind of memory-mapped video used on most microcomputers.

Processing speed, however, is good, especially on things like searches and sorts. The Pick operating system contains many commonly used functions, such as database management and the high-level BASIC language. Because these functions are so tightly integrated with the overall operating system, they tend to run fast.

There are a couple of other reasons why processing speeds stay reasonable. For one thing, Pick executes as machine-language code on whatever machine it is running on. Other operating systems that use the virtual-machine concept are usually interpreted or compiled/interpreted. Another reason is that Pick is carefully optimized for each implementation to be as fast as possible. That is one of the reasons Pick isn't as portable as

(continued)

# Not Dow Jones.

THE SOURCE INVESTOR SERVICES -- MR. WYATT: THIS IS TO CONFIRM YOUR ONLINE PURCHASE OF 500 SHARES WESTINGHOUSE AT \$25 5/8 UNIT. YOUR CONFIRMATION TIME: 10:52:25. YOUR PORTFOLIO VALUE: \$42,817.56

# Not MCI Mail.

VIA SOURCEMAIL -- DEAR BOB: I FOUND YOUR NAME IN THE SOURCE MEMBER DIRECTORY. COULD YOU PLEASE JOIN OUR WEEKLY COMPUTER CONFERENCE ON PC APPLICATIONS FOR ARCHITECTS? HOWARD -STC 301■

# Not CompuServe.

THE SOURCE/MICROSEARCH -- THIS IS THE REVIEW YOU REQUESTED ABOUT SYMPHONY SOFTWARE. TITLE: A SYMPHONIC PERFORMANCE. AUTHOR: ANDERSON, DICK. PUBLICATION: PC WORLD (JUL 1984) TEXT FOLLOWS:

# Only The Source.

Before you read this, read the computer screens above.

Because what you see there will tell you more about The Source than a magazine-full of copy.

And those are just a handful of the hundreds of innovative features you'll discover on America's first telecomputing service.

No wonder industry experts have hailed The Source as "ahead of its time" and "The most potent information pipeline."

And this year, we're giving them even more to boast about.

We've added another *dozen* major features, yet reduced our membership price to just **\$49.95**.

We've also published an information kit

that explains just how powerful a resource The Source is.

For your free copy, call **(800) 336-3366**. Or mail the reader card at the back of this magazine.

Then, the next fascinating screen you read might be your own.

Online trading provided by Spear Securities, Inc., an independent brokerage firm. The Source is a servicemark of Source Telecomputing Corporation, a subsidiary of The Reader's Digest Association, Inc. The Source services are offered in participation with Control Data Corporation. © Source Telecomputing Corporation, 1984  
1616 Anderson Road, McLean, VA 22102

INFORMATION NETWORK  
**The Source**<sup>SM</sup>

The most powerful resource any personal computer can have.

BYGA104



an operating system written in a high-level language. That said, it's important to note that Pick is not a number-crunching system. There are better operating systems for scientific and engineering work or for anything else that requires a lot of calculation. Pick will score poorly on a computational benchmark such as the Sieve of Eratosthenes.

On the other hand, Pick will shine

in an information-management test, particularly one with a lot of complex data manipulation. Because the database is relational and because of the way the system stores information, it can usually retrieve any piece of data with one or two disk accesses.

### THE PICK FILE STRUCTURE

Part of Pick's strength comes from its file structure. Everything is contained

in a file and the files are organized hierarchically.

There are three kinds of files in Pick, but you only have to deal with two of them—data files and dictionary files. (The third kind, binary files, hold compiled code and stored lists.) Both kinds of files are structured in the same manner. Broadly, the distinction between data and dictionary files is that data files hold the data and dictionary files establish and maintain relationships between the data.

In Pick, there is only one type of data file, but there are three types of dictionary files. The system dictionary defines the users (accounts) on the system. The master dictionary for each user defines the user's vocabulary, while data dictionaries describe the data and define the relationships (see figure 1).

One of the beauties of this separation of data and dictionary files is that it makes it easy to change relationships without affecting the data, and vice versa. Dictionary files can be edited, updated, or changed completely without disturbing the data entries to which they refer. In the same fashion, you can edit and update data without making any modifications to the dictionaries or disturbing the relationships already created. This gives you the flexibility to change the system as the real world changes.

If, for example, you need to go from five-digit to nine-digit ZIP codes, you can call up the ZIP-code item in the appropriate dictionary and change the length from five to nine digits. That takes about 30 seconds. Since data is stored only once in a well-designed Pick data structure, that change ripples through to every use in the system. (You still have the problem of updating the existing ZIP codes. Pick is neat, but it isn't magic.)

If you need five-digit ZIP codes for some uses and nine-digit codes for others, you can easily specify that, too. The system will present only the relevant five digits to the users that need it that way. If you only have five digits, there is no need to enter nulls or asterisks to take up the additional

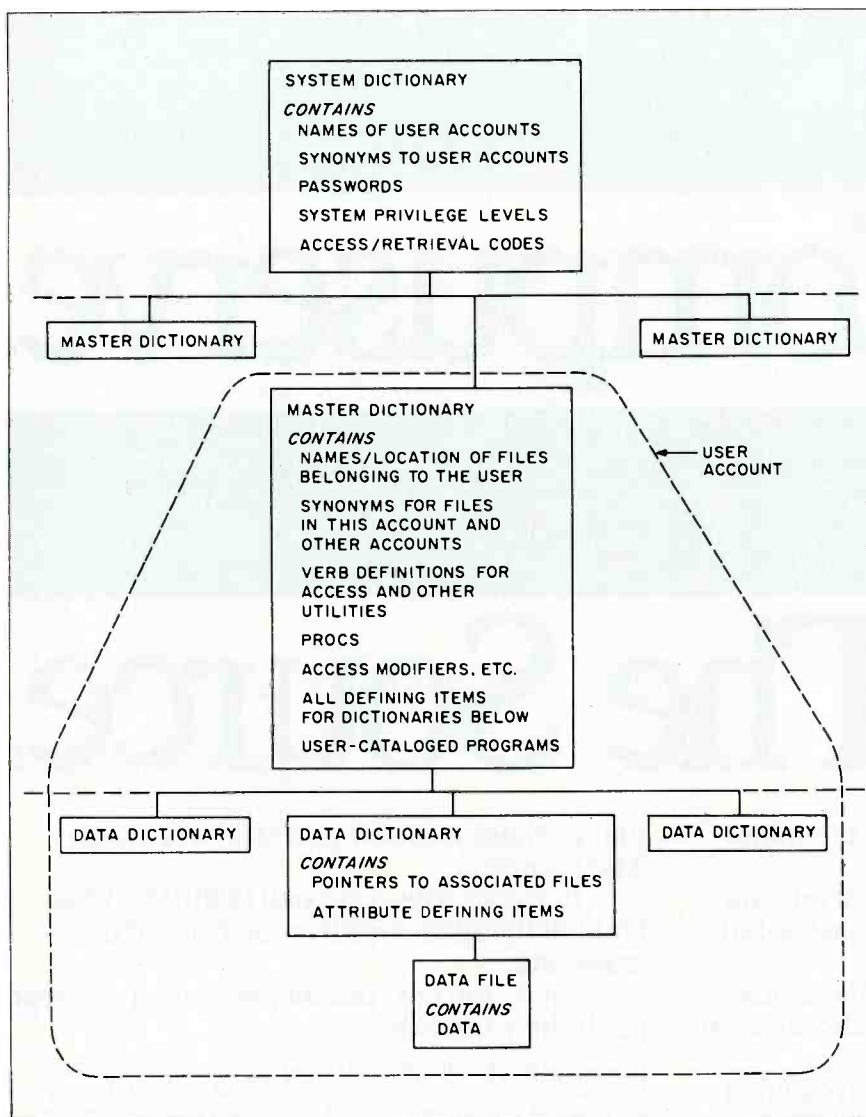

Figure 1: The Pick file hierarchy. There is only one system dictionary on the Pick operating system. Beneath it are any number of master dictionaries, one for each account on the system. Each master dictionary can have any number of data dictionaries beneath it, and each data dictionary points to one or more data files. A master dictionary and the subsidiary dictionaries and data files make up a user account on Pick.

(continued)

**AND NOW THE GAME BEGINS**

**PERSONAL COMPUTER**  
*The Game*

**BUSINESS EDITION**



# INTRODUCING THE AT&T

© 1987 AT&T

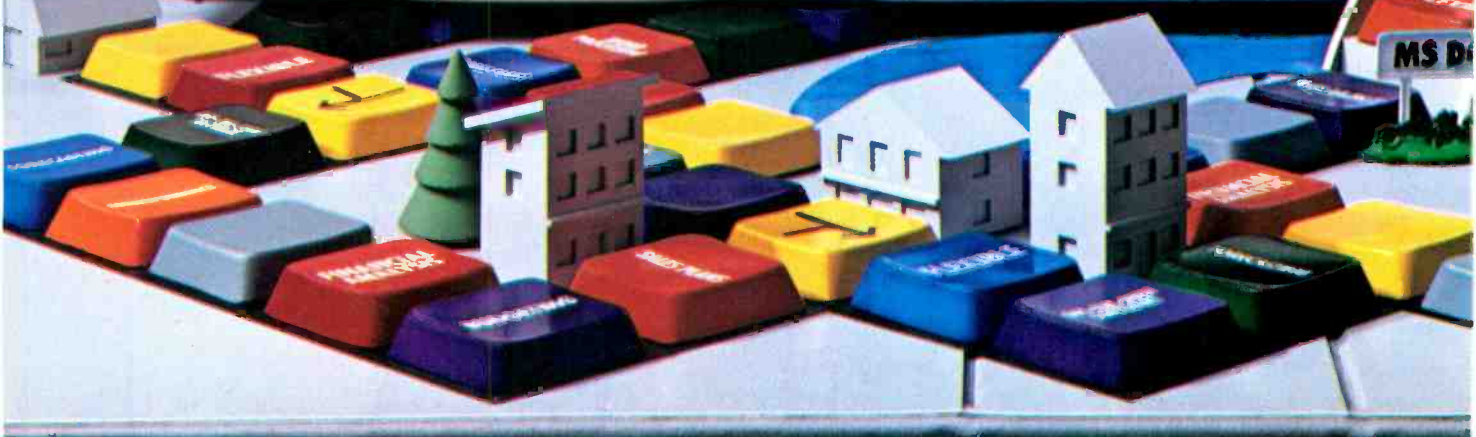
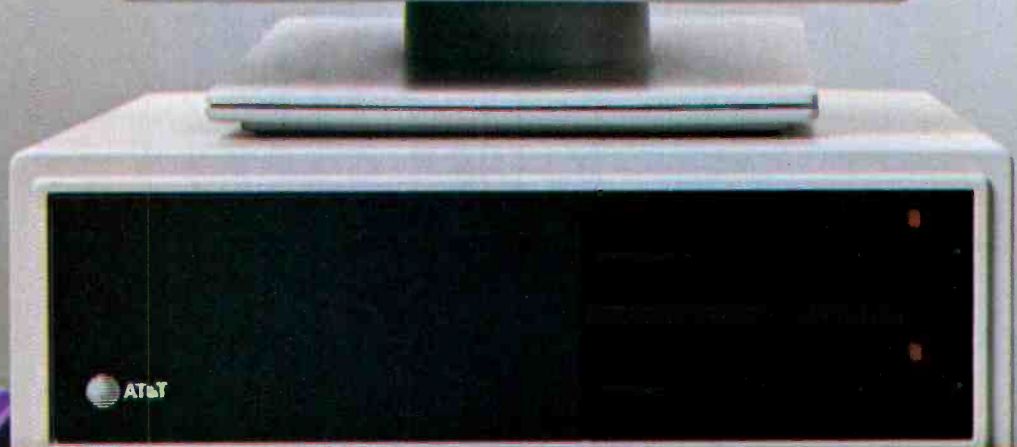

# PERSONAL COMPUTER.

The personal computer game is ready for business—and now it's your move. To win the game your company needs a fast, flexible, reliable personal computer that enables you to call the shots.

Go directly to the new AT&T Personal Computer.

The AT&T Personal Computer is more than just a superior piece of hardware. Behind it is a commitment to a better way of managing information and communications. One that can pay off handsomely in increased productivity and profits.

Because our AT&T PC is designed to be flexible enough to meet all your business needs—today and in the future.

Whether you use it as a stand-alone workstation or as a team player in a fully integrated system, you'll find our PC a high-performance machine. And a hard-working addition to your office.

Its fast processing and high-resolution graphics will help make any computer task a computing pleasure. In addition, you can expect more standard features. More expansion slots. More options for future growth.

## OFF-THE-SHELF SOFTWARE DOES THE JOB

Driven by the MS-DOS\* operating system, the AT&T PC runs the most popular off-the-shelf software for a wide range

of business applications. Financial analysis. Forecasting. Budgeting. Word processing. Inventory. The AT&T PC does it all.

And its flexibility means that when it's time to expand, our PC will actually make your computer growing pains painless.

With our unique PC Interface it can be linked to the more sophisticated, higher capacity world of the UNIX\*\* System V Operating System—the AT&T Computer “brain” that is emerging as the operating system standard for multi-user multi-tasking machines.

## THE AT&T TRADITION CONTINUES

Some things about our PC cannot be measured in bits and bytes, but are of immeasurable value.

For instance, the unmatched service and support of AT&T. The built-in reliability—and outstanding quality—of our products. The century-long tradition of technological innovation and personal attention to detail.

Think about it. Then make your move—to the AT&T Personal Computer, from AT&T Information Systems.

To get in on the game, call your AT&T Account Executive or 1 800 247-1212.

**AT&T INFORMATION SYSTEMS.  
WHEN YOU'VE GOT TO BE RIGHT.**



\*MS-DOS is a trademark of Microsoft Corporation.  
\*\*UNIX is a trademark of AT&T Bell Laboratories.  
© 1984 AT&T Information Systems





# Make an Intelligent Connection Today

- Compact single board design
- Replaces both IBM monochrome and color graphics adapters
- Software support in monochrome graphics mode
- Automatically switches modes
- Printer port available in both monochrome and color graphics modes
- VLSI design saves system's power
- Easily upgradable to 64K for additional function
- High resolution color graphics and interlace
- Monochrome graphics and interlace
- Priced competitively at \$299.00

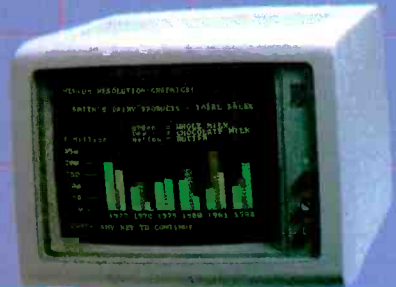
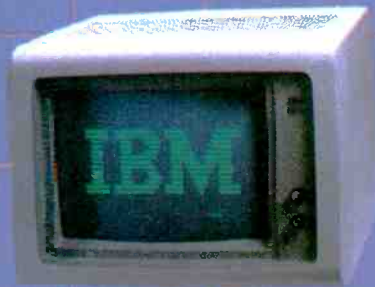
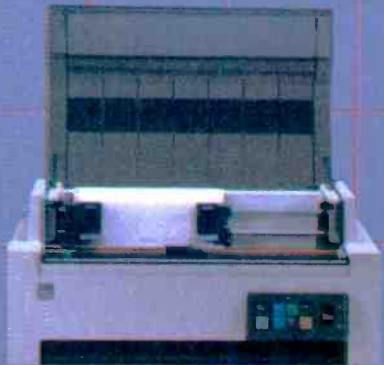

IBM is a Trademark of International Business Machine. ®



Dealer Inquires Welcome

Intelligent Data System Inc. 14932 Gwenchris Ct. Paramount, CA 90723

(213) 633-5504

TLX: 509098

Circle 176 on inquiry card.

## PICK

space. In fact, the system doesn't care how many characters are entered as the ZIP code; 5, 9, 20, 200, or none are all acceptable to the system. Of course, the applications programs would normally include checking routines to make sure only acceptable values were used. But that is your choice, not something forced on you by the database-management program.

Because of the data file and dictionary structure, data can be stored in any convenient form or length in the data file. Pick includes a large number of conversions and maskings that can be applied from the dictionary to produce output in the desired form.

The basic subdivisions of a Pick file are:

```
file
  item
    attribute
      value
        subvalue
```

A file is just what it is in any system: a collection of information that is (at least theoretically) related. In Pick, files can be any length and space is dynamically assigned for them. A single file can grow to fill an entire disk or shrink to almost nothing without intervention by the user or programmer.

An item in Pick is roughly equivalent to a record in a conventional database system (see table 1). In the present implementation of Pick, items in a file cannot be longer than 32K bytes. If that's not long enough for your purposes, you can link several items. However, in Pick, it is considered better design to use a number of small items rather than one large one. It is uncommon for items to seriously

press the 32K-byte limit.

An item is normally subdivided into attributes in the same way a record in a conventional database is subdivided into fields. Here, however, the parallels are less distinct. For one thing, within an item, the attributes, values, and subvalues that can make up items are not positionally oriented. Attributes, values, and subvalues are free to grow and shrink as needed. Like an item, the size of an attribute is variable up to 32K bytes, although the total length of the item containing the attribute must also stay under 32K bytes.

What's more, attributes can be added to an item at any time without disturbing the other attributes, relationships, or programs that use the item. The added attributes become a part of the item and they can be operated on in the same way. They are just ignored by the programs that don't need them.

To separate things inside an item, Pick uses delimiting characters rather than predefined field and record lengths. Attributes are delimited by hexadecimal FE (decimal 254), values are delimited by hexadecimal FD (253), and subvalues by hexadecimal FC (252). The user doesn't have to worry about inserting these marks; it's done automatically. Attributes within an item are referenced by their attribute number.

Figure 2 shows three typical items (or records) in a data file, in this case an inventory file. The attributes in each file are separated by a caret, which is the way Pick documentation represents the attribute delimiter. Notice that the attributes vary in length from item to item, and each

(continued)

**Table 1:** The file structure of the Pick operating system compared to a conventional database.

Pick	Conventional Database
File	File
Item	Record
Attribute	Field
Value	—
Subvalue	—



### IBM-PC or PC compatible IEEE-488 INTERFACE BOARD

## IEEE - 488

### VERSATILE

- Implements the entire IEEE-488(GP-IB, HP-IB) standard with high-level commands and standard mnemonics.
- Resident firmware routines support interpreted and compiled BASIC, Pascal, C, and other languages.
- Supports Lotus 123 and most wordprocessing programs.
- One board drives any combination of 15 IEEE-488 peripherals.
- Emulates most Hewlett-Packard controller functions and graphics language statements with single line BASIC statements.
- Supports Tektronix® Standard Codes and Formats.
- Small size - fits the PC/XT short slot.

### FAST

- Burst DMA > 800KB/sec
- Continuous DMA > 300KB/sec

### PROFESSIONAL

- Clear, concise documentation includes a complete tutorial and source code for interactive bus control, bus diagnostics, graphics plotting, and many other applications.
- \$395 complete. There are no extra software charges.



**CAPITAL EQUIPMENT CORP.**

10 Evergreen Avenue  
Burlington, MA. 01803  
(617) 273-1818

IBM is a trademark of International Business Machines Corp.  
Lotus 123 is a trademark of Lotus Development



takes up only the amount of space it needs. Note, too, that the file consists entirely of data. Information on what that data means is kept in the corresponding dictionary file.

The exception to this kind of free-style format is the first attribute in an item. This is attribute 0, or the ITEM-ID, which is the key for retrieving an item from a file. (See the text box, "Attribute 0, Modulo, and Separation" on page 190.) It is limited to 50 characters and it must be unique within the file. In other words, there can't be two items with the same attribute 0 in the same file, although there can be in different files.

An attribute other than attribute 0 can have multiple values, and each value can have multiple subvalues. By using attributes, values, and subvalues, a programmer can construct elaborate three-dimensional data matrices within a Pick item. This structure is called a dynamic array, and once you get used to it, it is a powerful tool for creating data structures that closely model the real world.

The Pick file structure explains a great deal about the power Pick offers. To really understand the way in which Pick handles data, you have to look at two closely related subjects—the Access query language and the way a data dictionary works. The best place to start is with Access and what it does. In a very real sense,

data dictionaries exist to support Access.

### THE ACCESS QUERY LANGUAGE

Access is designed to make it simple to turn data into information. It is easy to use and lets you get fast answers to even very complex questions.

The simplicity of Access stems primarily from three things: it uses words or universally recognized symbols (such as +, >, =) to express concepts, it requires a minimum of extraneous information from the user, and it works the way a user thinks. One result is that novices who are taught Access quickly feel at home with it. They can formulate questions in a perfectly natural way and then ask those questions in almost the same format.

Commands in Access are called verbs. They are action words like LIST or SORT. The usual sequence of an Access command is verb, filename (selection criteria, sequence criteria, report output attributes, and modifiers). However, you can use any sequence that seems comfortable as long as it starts with a verb. The elements in parentheses are optional. This follows the sequence you would use in asking a question of another person. "How many of the new PC boards for the RS-232C interface have we got on hand and what departments have them?" becomes:

```
LIST THE INVENTORY FILE WITH
PART-NUMBER "RS-232C-BOARD"
DEPARTMENT TOTAL QUANTITY-
ON-HAND.
```

This example assumes you have an Inventory file and attributes identified as PART-NUMBER, DEPARTMENT, and QUANTITY-ON-HAND.

In addition to verbs such as LIST and SORT, Access includes relational operators such as > and = and Boolean operators such as AND, OR, and NOT, which can modify them. You can stack up to nine separate selection criteria separated by AND operators into a single Access sentence. If you don't get the information you need with the first sentence, you can reformulate the query and try again or follow where the answer leads you. In use, Access is highly interactive. One question tends to lead to another as you zero in on the information you want or pursue the questions raised by the answer to the first question.

One way a system turns information back into data is to tell you more than you want to know. Computers are experts at this. In our example, all the questioner wants to know is how many parts are on hand and who has them. Other people in the company might need to know the part's price, vendor, quantity on order, quantity on back order, the amount owed the vendor, the shipping weight, when the next shipment is due to arrive, and perhaps 50 other things. All this information might be in the database, but giving any of it to the questioner would be unnecessary.

To prevent this, Access lets you specify selection and output criteria. This system shows you only what you are interested in. The rest of the information remains invisible and, in fact, may not be accessible to you as a security measure.

Here's a more complex Access sentence:

```
SORT INVENTORY WITH QUANTITY-
ON-HAND < "50" AND WITH
LEAD-TIME > "30" OR WITH
```

(continued)

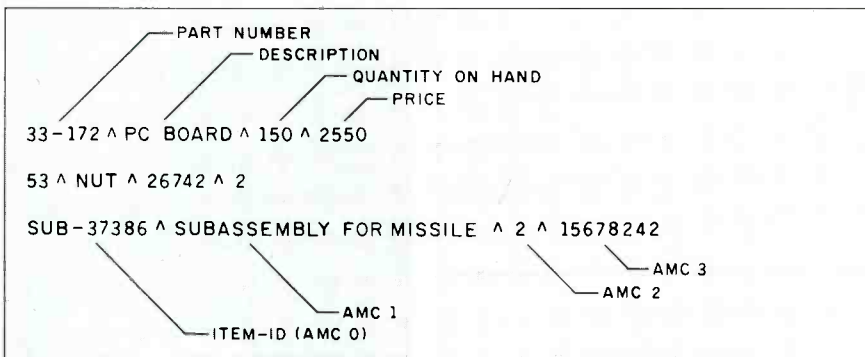

Figure 2: Data in a Pick file. This illustration shows three data items (records) from a Pick data file. In Pick, data is stored as unformatted strings of ASCII characters. The caret is the Pick convention for representing the separation of attributes (fields). Attributes are numbered by an attribute mark count (AMC) indicating their position in the item. A file may contain an unlimited number of items and within items attributes are totally variable in length.

# HIGH TECHNOLOGY AT AFFORDABLE PRICES

## Dot Matrix Printers

Brother 2044L/Dynax DM-40	\$ 1039.88
C. Itoh Prowriter (8510)	359.88
C. Itoh Prowriter-2, (136 col)	589.88
C. Itoh Prowriter BPI (IBM-PC)	389.88
C. Itoh HotDot	509.88
C. Itoh HotDot-2 (136 col)	729.88
DMX-80 (Panasonic 1090)	259.88
Epson RX/FX/LQ Series	CALL
<b>Epson/Imagewriter upgrade</b>	CALL
Inforunner Riteman	309.88
Mannesmann Tally Spirit-80	329.88
Okidata Microline 92	469.88
w/IBM graphics compatibility	469.88
<b>w/Imagewriter compatibility</b>	579.88
Okidata Microline 93	699.88
93 w/IBM graphics compatibility	699.88
Okidata Microline 84 Step II	889.88
NEC Pinwriter w/tractor (80 col)	699.88
NEC Pinwriter w/tractor (132 col)	929.88
Star Micronics Gemini 10X	289.88
Star Micronics Gemini 15X	429.88
Star Micronics Delta 10	399.88
Star Micronics Delta 15	589.88
Star Micronics Radix 10/15	CALL
Toshiba P-1351	1439.88
Toshiba P-1340	819.88
Printer Buffers (Quadram)	CALL

## Letter-Quality Printers

Brother/Dynax DX-15	\$ 399.88
Brother/Dynax DX-25	669.88
Brother/Dynax DX-35	939.88
C. Itoh A-10 Starwriter (18 cps)	549.88
C. Itoh F-10 Starwriter (40 cps)	1079.88
C. Itoh F-10 Printmaster (55 cps)	1379.88
Diablo 620/630/Series 35	CALL
NEC 2010/2030 (18 cps)	739.88
NEC 2050 for IBM-PC (18 cps)	889.88
NEC 3510/3530 (33 cps)	1379.88
NEC 3550 for IBM-PC (33 cps)	1639.88
NEC 7710/7730 (55 cps)	1779.88
Qume Sprint 11/40 (40 cps)	1519.88
Qume LetterPro 20 (18 cps)	709.88
Silver Reed EXP-770 (35 cps)	979.88
Silver Reed EXP-550 (18 cps)	469.88
Silver Reed EXP-500 (12 cps)	389.88
Silver Reed EXP-400 (10 cps)	329.88
Star Micronics PowerType (18 cps)	349.88

## Modems

Anchor Volksmodem, 300 bd.	\$ 69.88
Anchor Mark XII, 1200 bd.	299.88
Hayes Micromodem IIe (Apple)	249.88
Hayes Smartmodem, 300 bd.	229.88
Hayes Smartmodem, 1200 bd	549.88
Hayes Smartmodem 1200B (PC)	459.88
Novation AppleCat, 300 bd	239.99
Novation AppleCat, 1200 bd	449.88
Novation SmartCat+, 300bd	144.88
Novation SmartCat+, 1200bd.	349.88
USR Password, 1200 baud	369.88
Multi Phone-Line Junction Box.	29.88

## Monitors

Amdek 300G (green)	\$ 144.88
Amdek 300A (amber)	159.88
Amdek 310A (TTL amber)	179.88

## Monitors

Amdek Color-1+ (composite)	\$ 319.88
Amdek Color-2+ (RGB)	469.88
NEC JB-1201G (green)	159.88
NEC JB-1205M (amber)	159.88
Princeton Graphics HX-12	509.88
Princeton Graphics Max-12	199.88
Quadram QuadChrome	529.88
Roland DG-121 (green/amber)	144.88
Roland DG-122 (TTL output, green or amber, w/cable)	169.88
Monitor Stand (tilt/swivel)	39.88
Monitor Cable (NTSC composite)	9.88

## IBM-PC Peripherals

64K Memory (4164/200ns) 9/pkg.	\$ 69.88
Alloy 41 MB Hard Disk w/Tape	CALL
Alloy PC Tape Backup	CALL
Curtis Monitor Stand	64.88
Curtis Monitor Extension Cable	46.88
Curtis Keyboard Extension Cable	39.88
Curtis System Stand	24.88
Hercules Graphics Card	379.88
Hercules Color Graphics Card	CALL
Keytronics 5151 keyboard	219.88
Microsoft Mouse (parallel)	149.88
Mouse Systems PC-Mouse (3.0)	219.88
Paradise MultiDisplay	299.88
Quadram 384K Quadboards	CALL
Quadram Quad 512 + (64K)	239.88
Quadram Quad 512 + (512K)	609.88
Quadram QuadColor-1	219.88
Quadram QuadColor-2	229.88
QuadVue (TTL output)	259.88
Quadram Parallel Card, RS-232C Card or Clock/Calendar Card	79.88
Quadram Memory Boards (64K)	209.88
Quadram Memory Boards (128K)	269.88
Quadram Memory Boards (192K)	319.88
Quadram QuadLink	509.88
QuadLink (Columbia/Compaq)	539.88
STB Graphics Plus II	359.88
STB Memory Boards	CALL
STB Super I/O	169.88
STB Super RIO (64K)	289.88
STB Super RIO Plus (64K)	309.88
Tandon TM 100-2 DSDD	199.88
Titan Cygnus I/O (clock/parallel)	149.88
Titan Cygnus I/O (clock/RS-232)	169.88
TG Joystick	59.88

## Apple Peripherals

ALS CP/M Plus Card (CP/M 3.0)	\$ 299.88
ALS Smarterm II (80 col)	144.88
ALS Z-Card (CP/M 2.2)	119.88
ALS Dispatcher (RS-232)	79.88
AMT MicroDrive (half height)	219.88
Grappler+ Printer Card & cable	109.88
Buffered Grappler+ (16K)	184.88
Microsoft Softcard II (CP/M, 64K)	339.88

**SPECIAL!** Microsoft Softcard IIE  
(CP/M, 64K, 80 col) w/dBase II. .... 369.88

Pkasso-U Printer Card & cable	129.88
Quadram E-Ram (Ile, 80 col/64K)	119.88
Rana Elite-1 Disk Drive	259.88
TBL Printer Card & cable	79.88

## Apple Peripherals

TBL Cooling Fan	\$ 59.88
Titan Accelerator II	469.88
Titan Neptune (80 col/64K)	199.88
Videx VideoTerm	239.88
Videx UltraTerm (80/160 column)	289.88
Videx Enhancer II	109.88
Videx PSIO (parallel & RS-232 interface card)	174.88

## Macintosh Peripherals

1st Base DB	\$ 139.88
ATI MacCoach	54.88
Memorex Diskettes (10-pk)	43.88
Bluechip Millionaire	44.88
Daisywheel Printer Drivers	CALL
FieldPro Carrying Case	79.88
Habadex DataBase	139.88
Habadex Adapter	39.88
Hayden DaVinci Series	CALL
Human Edge Sales Edge	179.88
InfoCom Games	CALL
Intermatrix MacPhone	174.88
Kensington Starter Pak	69.88
Kensington Diskette Holder	29.88
Kensington Modem	119.88
Living Video Think Tank	99.88
MacForth (Level I)	119.88
MacForth (Level I/II)	189.88
Microcom MacModem	519.88
Micron Eye (digitizer)	CALL
Microsoft BASIC	109.88
Microsoft MultiPlan	139.88
Miles Comp. Mac the Knife	29.88
Monogram Dollars & Sense	114.88
Magnum McPic	39.88
Main Street Filer	179.88
Megahaus MegaMerge	89.88
Odesta Helix PDSS	279.88
Omnis 2	139.88
Penguin Games	CALL
PFS: File/Report	139.88
Soft-Life MacSlots	54.88
Softworks C Compiler	319.88
Telos FileVision	139.88
T/Maker Click Art	39.88
Tecmar MacDrive (5MB)	CALL

TECHNICAL INFORMATION/SALES  
**(603) 881-9855**  
TOLL-FREE ORDER DESK  
**(800) 343-0726**

Hours: 9:00 to 5:30 EST, Mon-Fri

- FREE UPS ground shipping on all orders over \$50 (under \$50 add \$2.50 handling)
- MasterCard, /ISA, American Express, Diners Club & Carte Blanche credit cards accepted
- No surcharges on credit card orders
- Credit cards are not charged until your order is shipped from our warehouse
- CODs accepted up to \$1000 (add \$10 for COD handling). Payable with certified check, money order or cash.
- Allow 10 days for shipping from date of order
- All personal checks held 30 days for clearance
- Full manufacturer's warranty on all products sold
- Software can be returned for an exact exchange only; no credits or refunds issued
- Sorry, no APO/FPO or foreign orders

# HIGH TECHNOLOGY AT AFFORDABLE PRICES

# THE BOTTOM LINE

MILFORD, NH 03055-0423 □ TELEPHONE (603) 881-9855



```

QUANTITY-ON-HAND < "10" AND
WITH LEAD-TIME < "30" BY VENDOR
BREAK-ON VENDOR-NAME
" P " PART-NUMBER DESCRIPTION
LEAD-TIME QUANTITY-ON-HAND
LPTR

```

This sentence produces a printed report (LPTR stands for line printer) consisting of part numbers, descriptions, lead times, and quantities on hand for parts with lead times of more

than 30 days with less than 50 in stock and lead times of less than 30 days if there are less than 10 in stock. The report will be printed out with each vendor starting on a new page (break-on) and with the headings "Part Number," "Description," "Lead Time," and "Quantity on Hand."

These are simple examples of Access sentences, the sort of thing you might be doing the first day or two you use Pick. Access contains a rich

variety of commands and options that give it great flexibility in managing information.

Generally, an Access sentence has three parts: the commands to select and operate on the data, the output field information telling the system what the user wants to see, and modifiers and options that let the user specify the output format, print headers, and so forth.

(continued)

## ATTRIBUTE 0, MODULO, AND SEPARATION

The reason for the attribute 0 size limit and the requirement that attribute 0 be unique has to do with its function. Attribute 0 is a keyword that identifies the item, so it must have a unique identifier. In addition, the system uses it to determine where to store the item on the disk.

The data and program storage space in Pick, both RAM (random-access read/write memory) and disk, is divided into "frames"—pages of 512 bytes each. For programming purposes, the frames on disk are organized into "groups" of frames, and a file is usually divided among several groups. When an item is added to a file, the system puts the keyword (in attribute 0) through a hashing algorithm and the result determines the group in which the item will be stored. Since it is possible for several ITEM-IDs to hash to the same group, the hashing algorithm doesn't give a unique location for the item. What the algorithm does do, however, is quickly determine which group of frames the item will be stored in—and which group to search to retrieve it.

If the space allocated for that group is full or if the item overflows (grows beyond the space available in that group), additional frames will be drawn from the pool of unallocated storage, linked to the group, and the data will be stored in them. If the item shrinks, the frames will be unlinked and returned to the pool of available storage space.

The advantage of this system is that no matter how big a file gets, the search for any item or part of an item

will be limited to one group of frames and it takes relatively few motions of the disk head to find an item. In other words, group size rather than file size determines search time.

The matter of group size is particularly important because of the way Pick divides resources among users. Each user on the Pick system gets a share of the system's time, called a time slice. The user's time slice ends either after a certain interval or before that if the user's application needs a page that's not in RAM. In the latter case, the operating system makes note of the user's need for a fresh page and goes on to the next user. When the first user's turn comes around again, the operating system has obtained the needed page and processing continues. Naturally, this is all invisible to the user. The only thing that isn't invisible is the time that it takes.

Suppose a file occupies five pages of memory and is organized into a single group, and suppose that the data sought is at the very end of the group. The operating system finds the group immediately by applying the hashing algorithm to the ITEM-ID, but then the system has to search sequentially through the group for the data. It starts searching at frame 1, doesn't find the data, needs to go to the next frame, and loses the time slice. The same thing happens at every frame boundary and it takes four time slices to find the data.

Now suppose the same file is organized as five groups of one frame each. This time the operating system goes to frame 5 and finds the data on

the first search. The system seems much faster to the user and it is certainly more efficient.

On the other hand, making the number of groups too large is also inefficient. Each group occupies at least one frame in memory. If the programmer sets the number of groups (modulo) at 10 for a file that holds only one item, the other nine frames are wasted.

Pick allows the programmer to change an item's modulo at any time. The system generates a report called "filestat" (for file statistics) that indicates how much overflow there is in each file. When the overflow becomes excessive, the programmer can change the modulo of the overflowing files, thus reducing the overflow.

Reducing overflow is one of the fastest ways to speed up a poorly performing Pick system. The other one is to add RAM. Due to the design of the system, adding hard-disk storage makes no difference in operating speed.

It is also possible to set the initial number of frames in each group, or "separation." When the separation is more than one, the frames allocated will be contiguous on the disk. In theory, choosing the proper separation should have a major impact on system performance, since the frames in a group could be accessed with minimum disk-head movement. In practice, it usually doesn't matter. Most of the time, another user will require disk access between your disk accesses, which effectively randomizes the head position. Most Pick programmers leave the separation at one.

# THE CHOICE IS YOURS NOT OURS.

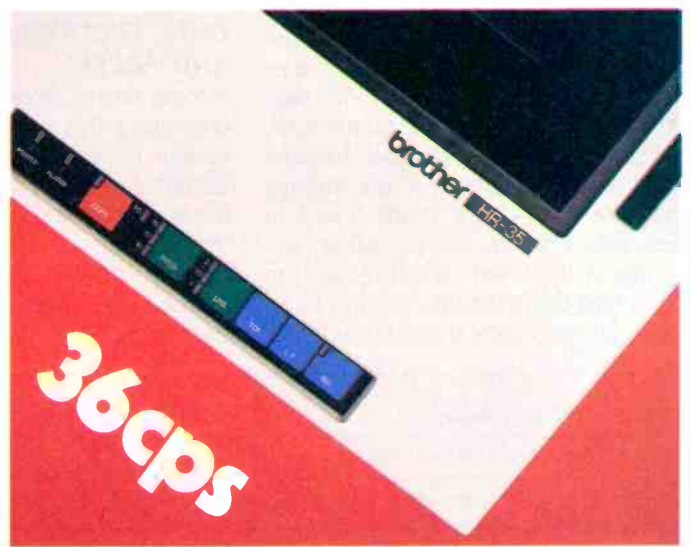

## HR-25 at 23cps or HR-35 at 36cps ?

Twenty-Three or Thirty-Six? It's up to you! Whether you choose the HR-35 at 36 cps and priced at only **\$1245\***, or the HR-25 at 23 cps costing less, you're getting the best price/performance ratio of any printers in their class on the market today. And whether you're high or low volume, there's an HR to meet your needs.

Such features as the "no mess" daisy wheel, encased in clear plastic, enables print change in seconds.



And, we offer ribbons in a variety of colors for those special printing applications. Add the optional Tractor and Cut Sheet Feeder and you have a package at a price that's unbeatable.

Best of all, they're backed by the Dynax reputation for quality and service response.

**The Choice is Yours!**

Optional Cut Sheet Feeder **\$269\***



Optional Tractor **\$149\***



Manufactured by **brother**

# Dynax, Inc.™

Circle 121 on inquiry card.



### DYNAX, INC. OFFICES

\*Suggested Retail Price

- HEADQUARTERS 6070 Rickenbacker Rd., City of Commerce, CA 90040 • (213) 727-1227
- ILLINOIS 543 W. Algonquin Rd., Arlington Heights, IL 60005 • (312) 981-5633
- NEW JERSEY One Madison St., East Rutherford, NJ 07073 • (201) 471-0100
- MASSACHUSETTS 400 W. Cummings Park, Suite 5300, Woburn, MA 01801 • (617) 933-8162
- TEXAS 6012 Campus Circle, Suite 250, Irving, TX 75062 • (214) 257-1700
- N. CALIFORNIA 1255 Oakmead Parkway, Sunnyvale, CA 94086 • (408) 730-1712



In Access, the same piece of information can be called by different names and it is easy to define synonyms.

Synonyms can be defined for the commands in Access, too. If you prefer DISPLAY to the Access verb LIST, it is simple to define DISPLAY as a synonym for LIST. If you want to use words like "please" in Access but have the computer ignore them, that's easy to do, too. In short order the results begin to look like natural-language programming. It also makes foreign-language versions of Pick easy to implement. All the commands, verbs, etc., can be given their foreign-language equivalents. If a company has users who are more fluent in Spanish, French, or any other language written with ASCII (American Standard Code for Information Interchange) characters than with English,

there is no problem accommodating them. Meanwhile, no one else on the system is affected, no matter how much a user plays with the entries in his or her account. In the same way, a programmer can define a complex series of commands as a procedure, or "proc," to be called by a single word. In this way an inexperienced user can perform complicated jobs in a simple, natural fashion.

**DATA, DICTIONARIES, AND ACCESS**

Access works closely with the Pick dictionary files, especially each user's master dictionary and the data dictionaries to which it points. Each data file is pointed to by a data dictionary that defines the data and its relationships. Attributes in a data-file item are defined by corresponding items in the data dictionary. The data dictionary

can also define information that isn't in the file, such as quantities that are computed rather than stored directly or data that is elsewhere in the database.

This can get confusing. Because Pick's file structure is so regular, there are items and attributes in both dictionary and data files. To keep things straight, we will call the item in the dictionary the DICT-ITEM and the attributes in the dictionary item the DICT-ATTS. The data item will be DATA-ITEM and its attributes will be DATA-ATTS.

Figure 3 shows how the DICT-ITEM and the DATA-ATT relate. The DICT-ITEM PRICE defines and specifies the fourth DATA-ATT for each DATA-ITEM in the data file. To the system, the fourth DATA-ATT in this particular data file is known by the name PRICE.

(continued)

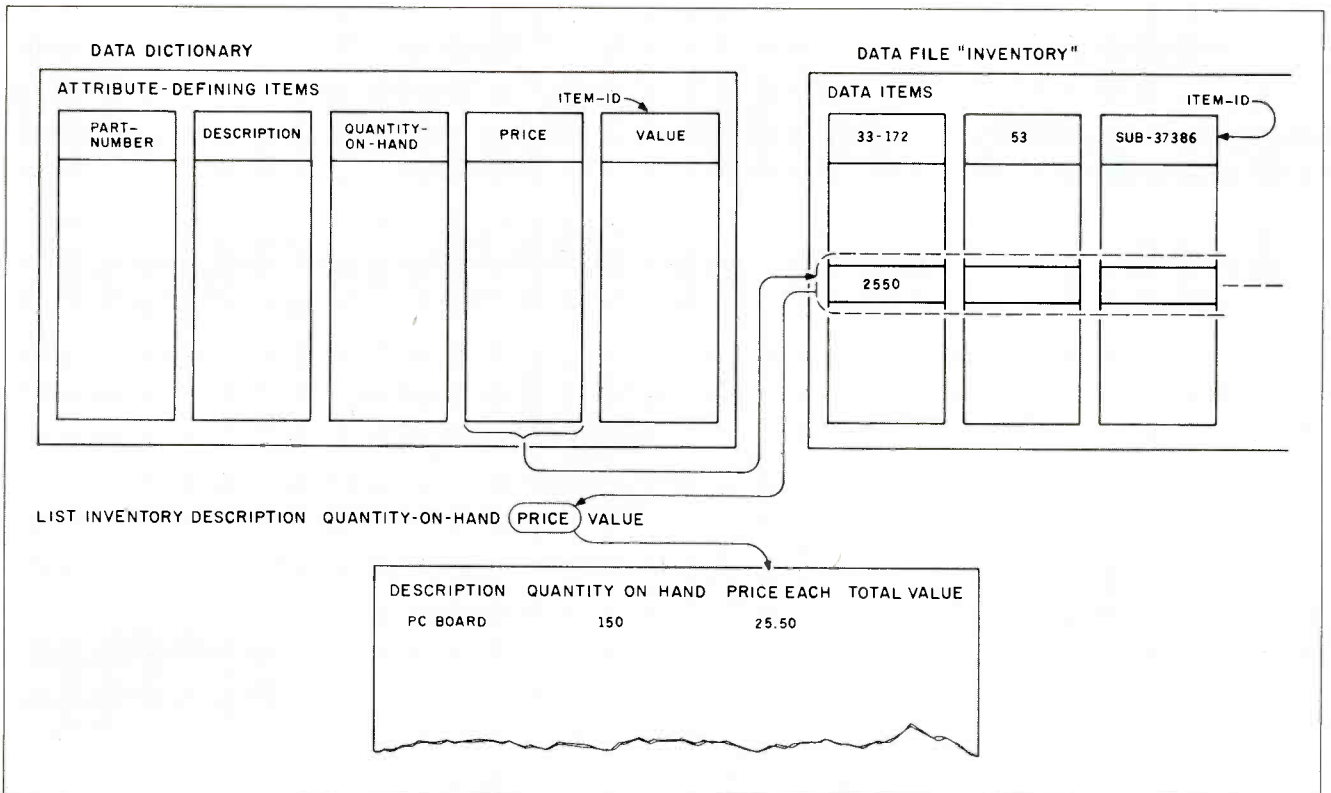

Figure 3: The relationship of data dictionaries and data files. The data dictionary on the left contains data dictionary items with the ITEM-IDs PART-NUMBER, DESCRIPTION, QUANTITY-ON-HAND, PRICE, and VALUE. Each of these dictionary items defines a data attribute in the associated

inventory data file. The dictionary item PRICE defines the fourth data attribute of every data item in the inventory file. The Access sentence asks for a list of data items in INVENTORY and instructs the system to display only the description, quantity on hand, price, and value.

# Panasonic Printers.

## We help you get it out of your system.



Panasonic can help you get the maximum performance from your computer system. The computer *has* the capabilities you need, but to get the most out of the system, a *quality* professional printer is vital.

And that's a Panasonic printer.

Look to Panasonic for a full line of printers, compatible with most popular computer systems. They feature speeds of up to 180cps, correspondence and near-letter quality, graphics capabilities, bi-directional printing with logic-seeking capabilities, proportional printing, carriages accepting paper 4" to 15" wide, cartridge ribbons, and adjustable tractor and friction feeds.

At Panasonic, we're very serious about the performance of our printers. Their reliability and our extensive

service network are a direct result of our commitment to quality. We offer a one-year limited warranty\*, a nationwide regional technical support network, and a toll free number. When you use a Panasonic printer, you have an *established* high tech manufacturer behind you.

It's our business to offer you high quality peripherals—printers, computer displays, plotters, and data entry terminals. Find out how Panasonic can help you get it out of your system. Contact: Computer Products Division, Panasonic Industrial Company, Division of Matsushita Electric Corporation of America, One Panasonic Way, Secaucus, N.J. 07094. Call TOLL FREE 800-222-0584, in New Jersey (201) 348-5337.

# Panasonic® Industrial Company

\*1-Year Limited Warranty. (Carry-in or mail-in service.)

Atlanta, GA - (404) 925-6830; Chicago, IL - (312) 364-7900; Dallas, TX - (214) 258-6400; Cypress, CA - (714) 895-7413.



# In the 92 seconds it find any file you need

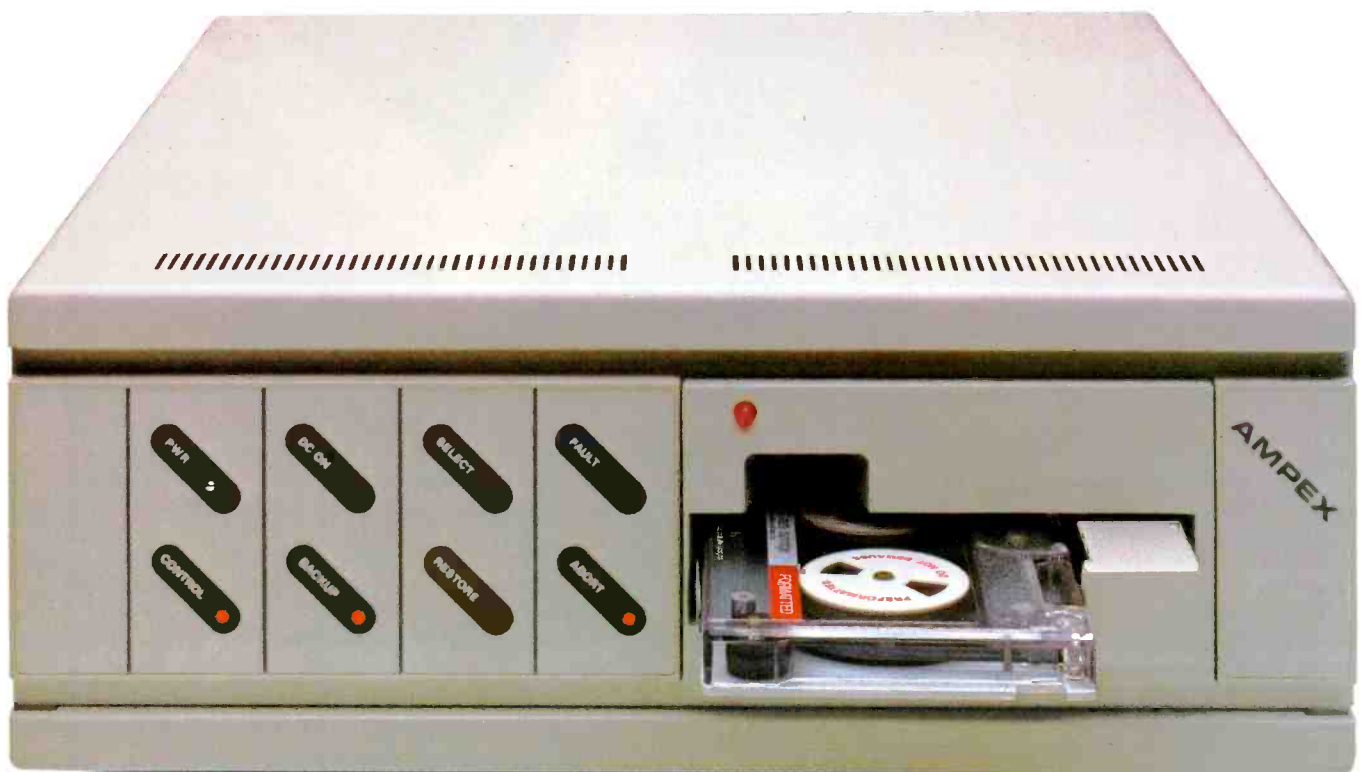

Ampex 20 MB hard disk with 25 MB tape backup.

# takes to read this ad, on our backup streamer.

Ⓛ In the 1 hour, 4 minutes other streamers take, you could call your broker. Linger over coffee. Wade through the Wall Street Journal. Ⓛ And read this PC Megastore ad too. Ⓛ So take the time.

You'll more than make it up with a PC Megastore hard disk and tape hooked to your IBM-PC® or compatible, Apple II or IIe®, because all the files you need—both current and archive—will always be right where you need them.

Ⓛ Just a keystroke away. Ⓛ The secret? Only Ampex backs up a 20 MB hard disk with another 25 megabytes\* of addressable storage—a unique, bootable streamer with cache memory. That not only means you can address a file in 92 seconds, you can backup files offline just by touching a couple of buttons. Ⓛ Without tying up your computer. Ⓛ Your time. Ⓛ Or a small fortune in floppies. (In fact, our 45 megabytes of available storage cost about half the price per MB of other hard disks.) So consider your time, money and convenience. Ⓛ And our quality. PC Megastore is backed by a full year warranty from Ampex, a company known for manufacturing quality computer peripherals for over 20 years. Ⓛ Take a moment to call us at 800 421-6863, or 213 640-0150 in California. Or write: Ampex Computer Products Division, 200 N. Nash St. MS M-11, El Segundo, CA 90215. We'll give you a dealer's name so you can buy PC Megastore. Ⓛ Then in no time at all, you'll make up for the 92 seconds you spent reading this ad.

**AMPEX**

Ampex Corporation • One of The Signal Companies

Circle 18 on inquiry card.



That data can be called and operated on by name or a name defined as a synonym. For the user, the main significance of attribute 0, the ITEM-ID, is that it serves to name the item.

Notice that both the DICT-ITEM and the DATA-ITEM have an attribute 0. In this example, the DICT-ITEM's attribute 0 is PRICE, while the first DATA-ITEM's attribute 0 is 33-172, which happens to be the part number. In a DICT-ITEM, the ITEM-ID names the elements, which in turn define a DATA-ATT. In turn, the ITEM-ID of a DATA-ITEM is the key for retrieval and names all of the elements in the associated DATA-ITEM.

As you can see in figure 4, there is more to a defining item in a data dic-

tionary than a name. Eight of the other 10 dictionary attributes can specify important parameters about this data attribute.

In our sample, the data-dictionary file contains DICT-ITEMs PART-NUMBER, DESCRIPTION, QUANTITY-ON-HAND, PRICE, and VALUE. To see what defining a DATA-ATT involves, let's look at the DICT-ITEM PRICE (see figure 4).

The first DICT-ATT in the DICT-ITEM is the ITEM-ID, in this case PRICE. It is the name for the data stored in its associated DATA-ATT. The second DICT-ATT is an A, for attribute. This tells the system that this DICT-ITEM defines a DATA-ATT. (This is one of about a half-dozen possibilities for

DICT-ATT 1.)

The next DICT-ATT is the AMC, or attribute mark count. It tells the system which DATA-ATT this DICT-ITEM defines. Counting the ITEM-ID as AMC 0, the DATA-ATT is the fourth DATA-ATT from the beginning of the item, so the AMC is 3.

The next DICT-ATT is the column heading to be used when the DATA-ATTs are displayed or printed out. The heading can be anything and can occupy more than one line on the display if needed.

DICT-ATT 4 (which is not used in this example) is used when a DATA-ATT contains multiple values or subvalues that are directly related to values or subvalues in another DATA-ATT. For instance, a jeweler's inventory might have a particular kind of watch with multiple values in the DATA-ATT for style and multiple values in the DATA-ATT for price. DICT-ATT 4 provides a way to match those sets of values and make sure the proper pairs appear together on displays or printouts.

DICT-ATTs 5 and 6 aren't used in a DICT-ITEM defining a DATA-ATT.

DICT-ATT 7 specifies any needed conversions. An entry here tells the system to apply some sort of formatting, masking, or other conversion process to the DATA-ATT before printing or displaying it.

Remember, in Pick the output specifications and the internal representation of data are only loosely coupled. This is one of the secrets of the system's flexibility. To take a simple example, Pick offers several options for displaying the date. Actually, Pick stores dates internally as the number of days after December 31, 1967 (a date, by the way, of no apparent significance to anyone except Pick's developer, Richard Pick). Similarly, time is figured internally as seconds after midnight, but it can be displayed as military time, regular 12-hour time, hours-minutes-seconds, or whatever.

Although the starting date for the system's internal representation of the date may be arbitrary, the method used to store the date is well thought out. Most systems and applications

(continued)

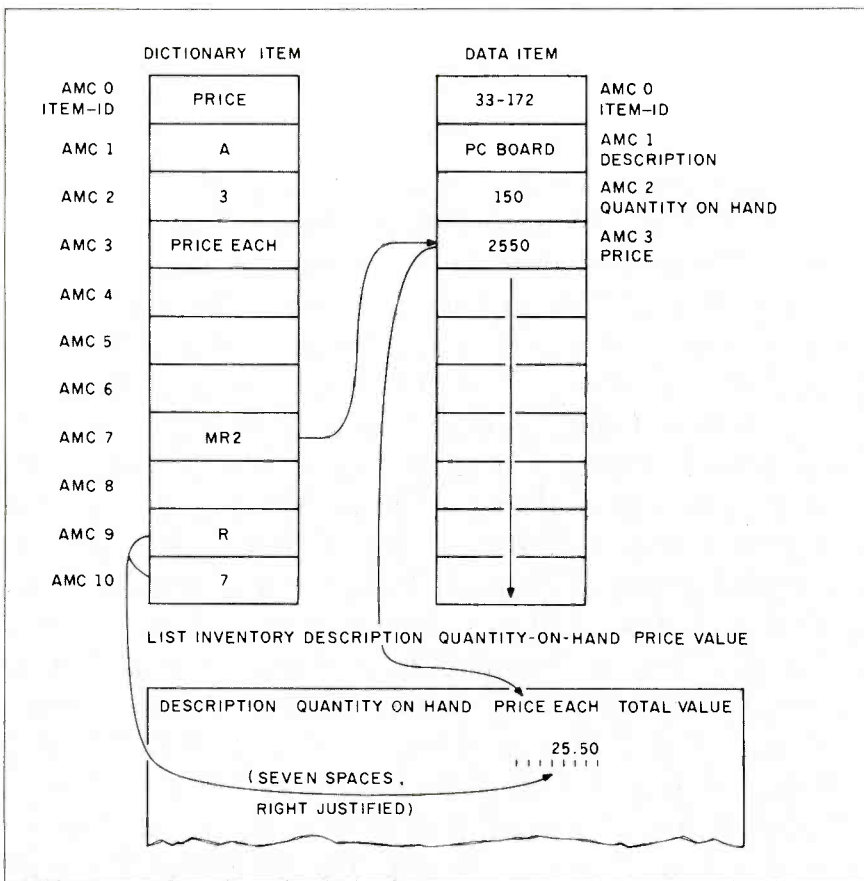

Figure 4: Data dictionary item definitions. A dictionary item defining a data attribute consists of eight dictionary attributes, each with its own function. Note that dictionary attribute 7, the conversion attribute, specifies the form in which the data attribute will be displayed. In this case, MR2 converts 2550 into 25.50 for display purposes. The final two dictionary attributes specify that the item will be displayed right justified and will take up seven spaces on the screen or report.





programs do it differently. For instance, many of them simply store the year as a two-digit number (i.e., 84). In these systems, dates are compared by subtracting one two-digit date from another one. Right now, these methods work, but in another 15 years, installations using them are going to face a nasty problem. The two-digit systems and the software written on them assume that the most recent year is the highest numbered. When they go from 1999 to 2000 that won't be true, and a lot of algorithms will fail. By storing its date internally as days since (or before) a given day, Pick avoids that problem.

The purpose of the conversion specification in DICT-ATT 7 is to tell the system how to convert the DATA-ATT before displaying or printing it. The list of available conversions that comes with Pick takes up several pages in the programmer's guide. Obviously, it would be much simpler to use a code in DICT-ATT 7 than to

write a program to format or convert data.

In this example, DICT-ATT 7 is MR2. That tells the system to display the data with two decimal places.

DICT-ATT 8 is the correlative for this DATA-ATT. A correlative specifies some type of computation to be performed on the data before further processing.

DICT-ATT 9 gives information on justification. In this case, the DATA-ATT will be right justified when printed or displayed.

DICT-ATT 10 specifies that the DATA-ATT will be allotted seven spaces when it is printed or displayed.

As mentioned, a DICT-ATT doesn't have to represent an actual DATA-ATT. It can represent a pseudoattribute—a DATA-ATT that is calculated rather than stored.

Figure 5 shows a DICT-ITEM for such a DATA-ATT. There is no DATA-ATT in the data file for VALUE, which is defined as price times quantity on hand. However, it can be calculated.

The DICT-ITEM VALUE is the same as any other DICT-ITEM. The ITEM-ID is VALUE; it has an A in DICT-ATT 1 to indicate that it works with a DATA-ATT. The AMC, however, is arbitrary. Since it doesn't refer to an actual DATA-ATT, it can be 0 or 99 or any other number. The print heading is TOTAL VALUE. DICT-ATT 7, the conversion, indicates that the results are to be displayed with two decimal places and with commas between each group of three digits (as in the number 100,000,000.00).

The real change is in DICT-ATT 8. It indicates that this DATA-ATT is to be calculated as the product of DATA-ATT 2 times DATA-ATT 3. The remaining DICT-ATTs show the DATA-ATT is to be right justified and allowed 10 spaces on the display.

This kind of pseudoattribute is not limited to the data in a single item. It can return and use data stored in other files in the user's account—or even other accounts.

In these examples, we have just touched on the power of conversions and correlatives. The conversion and correlative routines are numerous and

*The conversion and correlative routines are numerous and well chosen for business.*

well chosen for information management in business.

### OTHER DICTIONARIES

Above the data dictionaries in the Pick hierarchy are master dictionaries, one for every user account on the system. A master dictionary contains the names and locations of the files belonging to the user. It also contains synonyms for files in this account and other user accounts, verb definitions for Access and other utilities, attribute-defining items for dictionaries below it, user-cataloged programs, and stored procedures. Like a data dictionary or any other Pick file, a master dictionary is composed of items and attributes. When you log onto Pick, you attach to a master dictionary. Unlike some operating systems, more than one user can be active on a master dictionary at once.

At the top of the tree is the system dictionary. Among other things, it includes the names of the user accounts and synonyms to the user accounts as well as the password and system privilege level for each user.

### NEXT MONTH

In part 2, we'll take a close look at Pick BASIC, stored command sequences, terminal control features, and other Pick attributes. ■

### ACKNOWLEDGMENT

*The authors would like to thank Dennis Gallagher of Pick Systems Inc. for his assistance with this article.*

### REFERENCES

1. Overview of the Pick Operating System. Anaheim, California: General Automation, 1982.
2. Sisk, Jonathan E. *The Pick Pocket Guide*. Irvine, California: Pick Systems Inc., 1982.
3. Zarrella, John, ed. *The Pick Operating System: Microcomputer Operating Systems*, vol. III. Suisun, California: Microcomputer Applications, 1984.

ITEM-ID	DICTIONARY ITEM
AMC 0	VALUE
AMC 1	A
AMC 2	99
AMC 3	TOTAL VALUE
AMC 4	
AMC 5	
AMC 6	
AMC 7	MR2.
AMC 8	A; 2 * 3
AMC 9	R
AMC 10	10

Figure 5: A dictionary item defining a pseudoattribute. VALUE is calculated by multiplying the contents of data attributes 2 and 3, a process specified by the information in dictionary attribute 8. The AMC in dictionary attribute 3 is a dummy and is ignored by the system.



# BUILT FOR SPEED

**CompuPro** has now dramatically increased your micro-computing power and speed.

With our System 816/F™ super-micro with **CPU 286/287™** board. The computer that gives you results. Fast.

Built to provide sophisticated computer users with the fastest 16-bit system available, the System 816/F is a multi-user computer so powerful it virtually has no supermicro peer.

The reason for such a strong statement? We configure the system around the **80286**—among the most powerful 16-bit processors available anywhere and one that's built for speed. The 286/287 board lets you run anything from the 8086/8088 family and includes the 80287 math processor and as much as 16 Kb of EPROM on-board.

But this board is only part of the story. CompuPro has included a long list of features that enhance this exclusive system even more. Like 1.5 Mb of our

MDRIVE®/H—a solid-state disk with the capacity to dramatically increase the speed of the 286 processor even more . . . 512 Kb of 16-bit main memory expandable to 16 Mb . . . 1.2 Mb floppy disk and up to 80 Mb of hard disk storage . . . 12 serial ports . . . and much more.

And even though our System 816/F has set some industry standards, we still designed it to conform to the IEEE 696/S-100 bus standard. And virtually no one else can say that.

The time you save with CompuPro will save you money, too. Our System 816/F speeds up software development. So the quality and capacity of your programs is enhanced, and the value, maximized.

The CompuPro System 816/F. It's the essential system for OEMs and system integrators who want all the power and speed they can get. And best of all, we've shipped hundreds of them already.



**The Essential Computer™**

## CompuPro®

A GODBOUT COMPANY

3506 Breakwater Court, Hayward, CA 94545  
(415) 786-0909

MDRIVE is a registered trademark and System 816/F, CPU 286/287 and The Essential Computer are trademarks of CompuPro. Front panel shown is available from Full Service CompuPro System Centers only. ©1984 CompuPro.



# Get yourself a

This little critter comes with specially-designed software that flies through the maze of keystrokes on the most popular business programs faster than you can say "cheese."

Microsoft® Mouse puts the power to run Multiplan®, Lotus 1-2-3™, VisiCalc® and WordStar® in the palm of your hand. Click the left button on the mouse, a custom menu appears. In English, not hieroglyphics. Click the right button and execute your

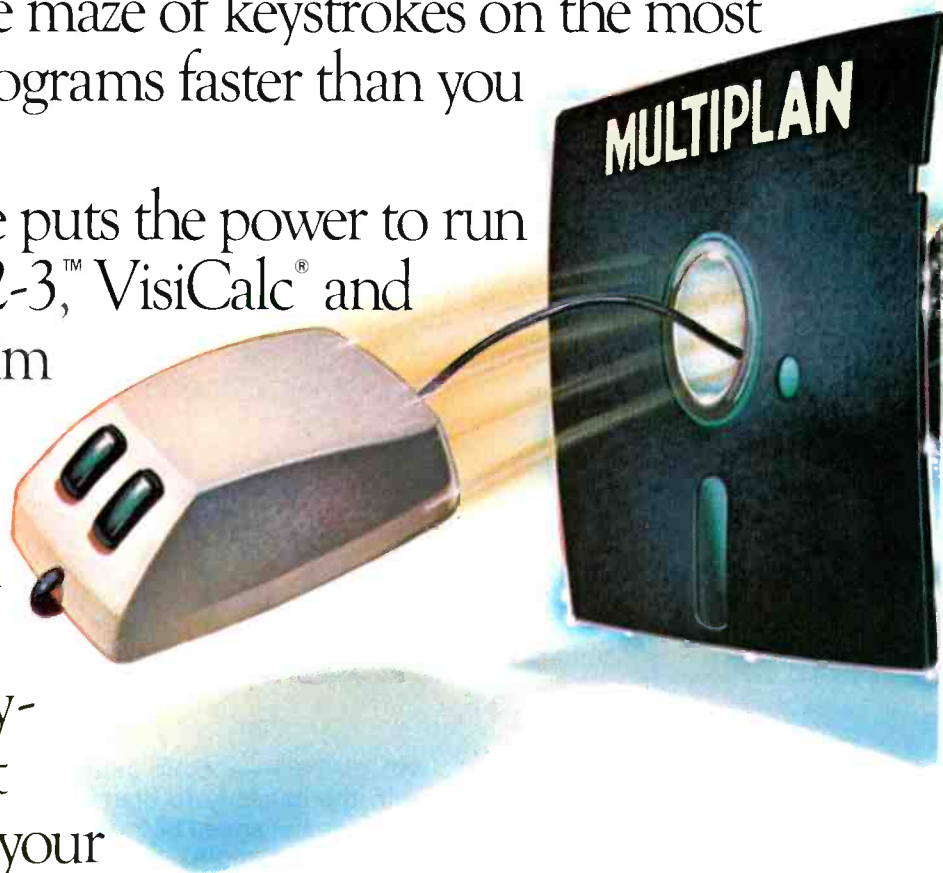

command: move text or data, edit, format, print. All at blinding speed without touching the keyboard.

It also lets you create your own menus for editing and formatting existing application programs. So people can learn programs quicker and do more productive work as they learn.

## The mightiest mouse.

Microsoft Mouse runs circles around other mice. It is the high performance mouse for the IBM® PC and PC XT. From the company known for high

# trained mouse.

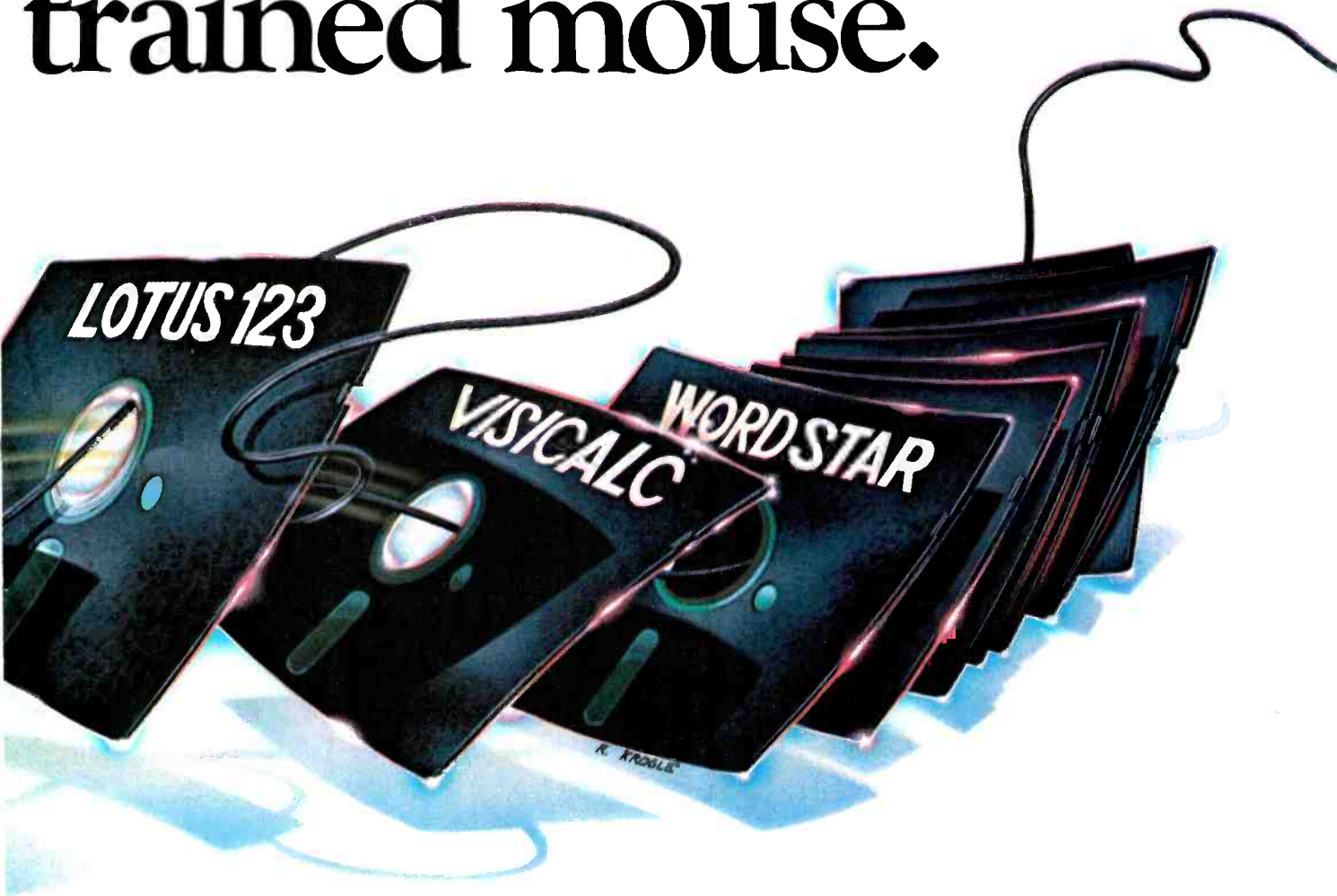

performance software. Microsoft BASIC is the language spoken by nine out of ten microcomputers worldwide.

**MICROSOFT** Our MS™-DOS operating system tells  
The High Performance Software your IBM PC how to think.

So don't monkey around with any other mouse. Call 800-426-9400 (in Washington State call 206-828-8088) for the name of your nearest Microsoft dealer. Then go with Microsoft Mouse. The mouse that soars.

A hand is shown holding the Microsoft logo, which is rendered in large, bold, black, three-dimensional block letters. The hand is positioned at the bottom right, with fingers gripping the letters. The background is a light blue gradient.

Microsoft and Multiplan are registered trademarks and MS is a trademark of Microsoft Corporation.  
Lotus 1-2-3 is a trademark of Lotus Development Corporation. VisiCalc  
is a registered trademark of VisiCorp. WordStar is a registered trademark of MicroPro  
IBM is a registered trademark of International Business Machines Corporation.



**IT'S A SMALL MIRACLE HOW HEWLETT-PACKARD  
PUT 656K OF MEMORY, LOTUS 1-2-3, WORD  
PROCESSING, A TELECOMMUNICATIONS MODEM  
AND COMPLETE IBM CONNECTABILITY INTO**



## **THE PORTABLE.**

For years business people had to choose between the power of a desktop computer and the limited capabilities of the first portables. That problem was solved when Hewlett-Packard introduced The Portable.

The Portable is designed with more total memory than most leading desktop personal computers...656K in fact. That includes 272K of user memory. So, The Portable's built-in business software can work with enormous amounts of data.

1-2-3™ from Lotus,™ America's most popular spreadsheet, file management and business graphics program, is permanently built into The Portable. So is Hewlett-Packard's word processing program, MemoMaker. Just press the key and you're ready to work.

The Portable even has a built-in modem and easy-to-use telecommunications software to send

or receive data using a standard telephone jack.

If you use a Hewlett-Packard Touchscreen PC, IBM® PC, XT or an IBM compatible you'll be glad to know that your desktop and The Portable can talk to each other with the simple addition of the Hewlett-Packard Portable-Desktop Link.

The Portable's rechargeable battery gives you 16 hours of continuous usage on every charge.

Finally, you can work comfortably on a full size keyboard and an easy-to-read 16-line by 80-column screen. And it all folds shut to turn The Portable into a simple nine-pound box.

The Portable. A small miracle...perhaps. But then consider where it came from.

See The Portable and the entire family of personal computers, software and peripherals at your authorized Hewlett-Packard dealer. Call (800) FOR-HPPC for the dealer nearest you.

Setting You Free



# ADDING A HARD DISK

BY ROY M. MATNEY

*Kits, components, and expansions  
for the IBM PC*

THE PRICE OF a hard disk for the IBM PC has dropped dramatically in the past few years—a Winchester drive is now within the means of the average owner. There are three ways to add a hard disk to your PC: buy an expansion chassis and disk from IBM, buy an add-on kit from another vendor, or install your own disk. Each method has advantages and drawbacks; you must balance cost against compatibility and power requirements.

Before you begin looking at hard disks, be sure your PC is equipped to handle a Winchester. Early PCs (the ones that have room for only 64K bytes of memory on the motherboard) will cause a problem. The BIOS (basic input/output system) will not check to see if other ROM (read-only memory) chips are in the system. This means that you cannot boot directly from the fixed disk. It also means that the controller won't work properly unless you install a different device driver.

IBM will sell you a new set of ROMs for your PC; they require you to return the originals when you buy the new ones. Once you have the new ROMs, all you have to do is plug them in. (IBM offers the 1501005 BIOS

upgrade kit with a new set of ROMs to plug into the motherboard. Only IBM computer models 1, 13, 14, 64, and 74 require you to update the BIOS ROMs. Models 104, 114, 164, and 174 already have the necessary functions.)

## DOS 2.0

Until IBM introduced DOS 2.0 in 1983, the PC lacked the software features to support hard disks. The directory was a one-dimensional array with a maximum of 64 to 112 files, depending on the type of disk drive. Under DOS 2.0, the directory is structured and can contain an unlimited number of files. Imagine trying to sort through 700 randomly arranged files, and you will appreciate the value of a well-defined mechanism to keep files organized.

DOS 2.0 contains several commands to support the hard disk. The BACKUP command backs up one or more files from a fixed disk to floppy disks. The RESTORE command rebuilds the fixed disk from floppies.

.....  
*Roy M. Matney is an engineer with a "great interest in the IBM PC." He can be reached at 2911 Blue Lakes Lane, Missouri City, TX 77459.*

The FDISK command initializes and configures the fixed disk.

Commands MKDIR, RMDIR, and CHDIR create, remove, and change directories, respectively. DOS 2.0 lets you define a main directory or sub-directory as the current one. The system works from this directory and normally doesn't need to refer to other directory nodes. This simplifies and speeds up the DOS's operation. It also helps you concentrate on a small area of the disk. The CHDIR command selects a new current directory. To allow program execution in subdirectories, DOS has a PATH command that lets it search other directories to find a file. The TREE command displays the specified disk's entire directory structure.

In addition to supporting its own fixed disk, IBM has a configuration file for adding another vendor's disk. It lets you replace existing drivers or add extra ones. The configuration file lists the drivers to be added.

## COST

As manufacturers' supplies increase and hard-disk technology matures, prices come down. Increased com-

*(continued)*



*Adding a hard disk to your system might overload the power supply.*

petition and imports might drive prices still lower. You can now purchase a complete add-on kit for less than \$900. If you buy the disk and the controller separately, the cost can be even lower. A 5-megabyte Winchester can cost less than \$300, and a 10-megabyte disk could cost less than \$400. Controllers for hard disks vary in price, starting at about \$150 for some SASI (Shugart Associates System Interface) controllers. Prices for single-board controllers designed to plug into the PC start at around \$295. IBM's 10-megabyte expansion chassis costs less than \$3000.

When you compare the cost of one

hard disk with another, consider speed; depending on your needs, a faster Winchester might be worth some additional expense. The speed of a fixed-disk system is largely determined by the time the head takes to get to the right track. Heads are positioned using either an open-loop positioner (similar to most floppy-disk drives) or a closed-loop servo system. The closed-loop servo system is newer, up to four times faster, more accurate, and more expensive. It also lets you store more data on each disk, since the tracks can be placed closer together.

**STANDARDS**

Most 5¼-inch fixed disks conform to the ST506 interface standard (named after the Seagate model ST506 disk) or a standard called ST412. The ST412 is much like the ST506 except that it supports buffered seek, which lets the heads move much faster over a long distance. The IBM controller supports

both the ST506 and the ST412 standards. Two other standards, the ST412HP and ESDI (enhanced small disk interface) support even higher performance.

Within the ST506/412 standard, data is encoded using an MFM (modified frequency modulation) scheme. Data is transferred to the controller serially at 5 megabits per second, in contrast to a floppy speed of 250 kilobits per second. The control and data lines for the ST506/412 standard are shown in table 1. As long as you stick with an ST506- or ST412-compatible disk and controller you will not have to worry much about the signals between the controller and the disk.

You also need two ribbon cables: one 20-conductor cable for the data and one 34-conductor cable for control lines. They are both standard cables with one card-edge connector and one 100-mil center header connector.

**POWER REQUIREMENTS**

A hard disk needs more power than a floppy disk. When you add a hard disk to your system, it is easy to overload the power supply. IBM rates its PC power supply at 5 volts for 7 amps, 12 volts at 2 amps. These are averages; IBM doesn't specify the peak current that you can pull out of the power supply. The power supply is protected for over- and under-voltages, as well as short circuits. If your power supply is overloaded, the system simply might not turn on. If you manage to squeak by with an almost overloaded system, a power supply running at its limit might have a much shorter than normal lifespan.

Let me demonstrate how easy it is to overload the PC's power supply. At 5 volts, the PC motherboard, including the keyboard, uses 1.6 amps. A monochrome or color graphics card display adapter draws 1.3 amps; a floppy-disk controller, 0.8 amp; and a hard-disk controller, 1.7 amps. A typical six-function board, memory, and I/O (input/output) draws 0.7 amp; a single floppy drive, 0.6 amp; and a standard size, 10-megabyte hard disk,

*(continued)*

Table 1: ST506/412 interface signals.

Control Signal	Pin
Reduced write current	2
Head select 2	4
Write gate	6
Seek complete	8
Track 000	10
Write fault	12
Head select 0	14
Reserved	16
Head select 1	18
Index	20
Ready	22
Step	24
Drive select 1	26
Drive select 2	28
Drive select 3	30
Drive select 4	32
Direction in	34
Ground	Odd pins
Data Signal	Pin
Drive selected	1
+ MFM write data	13
-MFM write data	14
+ MFM read data	17
-MFM read data	18

# THE 8087 IS IN STOCK!

MicroWay\* is the world's leading retailer of 8087s. We also have the most accurate statistics on chip reliability. They are: .01% infant mortality, .00% adult mortality and .02% 8088 incompatibility. As for ease of installation, we have never had a customer return a chip because of bent pins. We are so confident that you will be able to successfully install and use the chip that we offer a 180-day warranty with every chip we sell. That's 90 days more than anyone else!

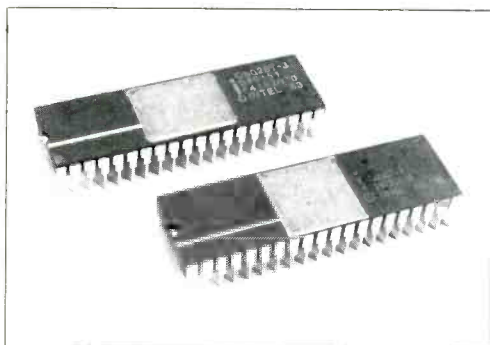

To support the 8087 we stock the largest selection of 8087 software anywhere. This includes: three FORTRANs, three PASCALs, APL, Intel's ASM86, PL/M-86, several Cs, 87BASIC, 87MACRO and MATRIXPAK. For real time or multi-user applications we offer RTOS™ - our implementation of Intel's iRMX executive. Our new products include a professional debugger with 8087 support, an interface library which enables MS Fortran users to call the IBM Basic

Compiler Library, and a translator that converts object modules into readable assembly language files. If you have a question about which computer, language, compiler, operating system or application package is best suited to your problem, we can answer it. Just call:

**Information and Orders—**  
**617-746-7341**  
**University, Corporate and**  
**Government Buyers—**  
**617-746-7364**

## MicroWay™ 8087 Support

**MWS-286™** Configured to your specifications, our computer runs RTOS-286 or XENIX. Includes one Intel compiler, seven slot multibus chassis, hard disk, streaming tape backup and Intel Service Contract. Six to twenty times faster than your PC ..... **CALL**

**REAL TIME MULTI-TASKING/ MULTI-USER EXECUTIVE - RTOS** RTOS is a MicroWay configured version of iRMX-86. Includes ASM-86, LINK-86, LOC-86, LIB-86, and the ROM Hex Loader. .... **\$600**

**87 FORTRAN/RTOS™** - our adaptation of the Intel Fortran-86 Compiler generates in line 8087 code using all 8087 data types including 80-bit reals and 64-bit integers. The compiler uses the Intel large memory model, allowing code/data structures of a full megabyte, and supports overlays. Includes RTOS and support for one year ..... **\$1350**

**87 PASCAL/RTOS™** is Intel's ISO-Standard Pascal with 8087-8088 exceptions. These make it possible to use all the 8087 data types directly, while generating modules in one of the three Intel Memory Models. Includes RTOS and support for one year ..... **\$1350**

**RTOS DEVELOPMENT PACKAGE** includes 87FORTRAN, 87PASCAL, PL/M-86, Utilities, TX Screen Editor and RTOS. .... **\$2500**

**OBJ-ASM™** - a multipass object module translator and disassembler. Produces assembly language listings which include public symbols, external symbols, and labels commented with cross references. Ideal for understanding and patching object modules and libraries for which source is not available ..... **\$200**

**FFT87** an FFT package for the 8087. Performs Forward and Inverse Transforms on complex data. Callable from SSS or MS Fortran ..... **\$150**

**MATRIXPAK™** manages a MEGABYTE! Written in assembly language, our runtime package accurately manipulates large matrices at very fast speeds. Includes matrix inversion and the solution of simultaneous linear equations. Callable from MS Fortran 3.2, 87MACRO, 87BASIC, and RTOS ..... each **\$150**

**87BASIC™** includes patches to the IBM Basic Compiler and both runtime libraries for USER TRANSPARENT and COMPLETE 8087 support. Provides super fast performance for all numeric operations including trigonometrics, transcendental, addition, subtraction, multiplication, and division ..... **\$150**

**87BASIC/INLINE™** generates inline 8087 code! Converts the IBM Basic Compiler output into an assembly language source listing which allows the user to make additional refinements to his program. Real expression evaluations run seven times faster than in 87BASIC. .... **\$200**

**87MACRO™** - our complete 8087 software development package. It contains a "Pre-processor," source code for a set of 8087 macros, and an object library of numeric functions including transcendental, trigonometrics, hyperbolics, encoding, decoding and conversions ..... **\$150**

**87DEBUG™** - a professional debugger with 8087 support, a sophisticated screen-oriented macro command processor, and trace features which include the ability to skip tracing through branches to calls and software and hardware interrupts. Breakpoints can be set in code or on guarded addresses in RAM ..... **\$150**

**FOR-BAS™** - a library of interface routines which allow MS Fortran programs to call the IBM Basic Compiler library and access features such as the RANDOM NUMBER GENERATOR, SOUND, PLAY, DRAW and SCREEN commands ..... **\$150**

**8087-3 CHIP** ..... **\$175**  
 including DIAGNOSTICS and 180-day warranty  
**64K RAM Set** ..... **\$45**  
**256K RAM Set** ..... **\$325**  
**80287 CHIP** ..... **\$350**  
**8087 8mhz** ..... **CALL**

**MICROSOFT FORTRAN 3.2** ..... **\$239**  
**MICROSOFT PASCAL 3.2** ..... **\$209**  
 These IEEE compatible compilers support double precision and the 8087.

**DIGITAL RESEARCH FORTRAN** ..... **\$279**

**MICROSOFT C COMPILER** includes Lattice C and the MS Librarian ..... **\$329**

**LATTICE C** with 8087 support ..... **\$329**

FLOAT87 for MS C ..... **125**  
 SuperSoft Fortran 66 ..... **329**  
 Computer Innovations C86 ..... **345**  
 STSC APL★PLUS/PC ..... **500**  
 TURBO PASCAL or SIDEKICK ..... **45**  
 TOOLBOX ..... **45**  
 TURBO PASCAL with 8087 Support ..... **85**  
 HALO GRAPHICS ..... **CALL**  
 GRAPHMATIC ..... **125**  
 ENERGRAPHICS ..... **295**  
 Professional BASIC ..... **295**  
 COSMOS REVELATION ..... **850**  
 SCO XENIX™ MICROSOFT ..... **595**  
 MAYNARD WS1 HARD DISK ..... **975**  
 MAYNARD WS2 HARD DISK ..... **1139**  
 smARTWORK by WINTEK ..... **895**  
 SPSS/PC ..... **695**

**NO CHARGE FOR CREDIT CARDS**  
**ALL ITEMS IN STOCK**  
**CALL FOR COMPLETE CATALOG**

**MicroWay** P.O. Box 79  
 Kingston, Mass.  
 02364 USA  
 (617) 746-7341

**You Can Talk To Us!**

\*Formerly MicroWare, Inc. - not affiliated or connected with MicroWare Systems Corporation of Des Moines, Iowa.



# magnum p.c.

**800-544-4354**



GA Residents  
(404) 441-3112



4056 WETHERBURN WAY, SUITE 205, ATLANTA, GA 30092

## PRINTERS

RITEMAN 3" TALL - LIKE EPSON BUT FASTER	BEST PRICE
C. ITOH LETTER QUALITY.....	CALL
OKIDATA ALL MODELS.....	CALL
NEC SPINWRITERS, P2 & P3.....	CALL
EPSON MX, FX, RX.....	CALL
STAR MICRONICS.....	SAVE
TOSHIBA P1351 & P1340.....	CALL
SILVER-REED.....	SAVE

## DISK DRIVES

TANDON TM100-2.....	199
TM65 1/2 HEIGHT.....	185
10 MEG HARD.....	1440
HALF HEIGHTS (FOR IBM).....	FROM 155
QUADDISK 6 MEG REMOVABLE.....	CALL
TECMAR 5 MEG REMOVABLE.....	CALL
MICRO SCI (FOR APPLE).....	CALL
QUENTIN (FOR APPLE & IBM).....	SAVE
TALLGRASS HARD DISK WITH BACKUP.....	CALL
IOMEGA BERNOULLI BOX (20 MEG).....	CALL
SHUGART HARD DISKS & CONTROLLERS.....	SAVE
EVEREX 10 MEG INTERNAL HARD DISK.....	950
PEACHTREE PERIPHERALS.....	CALL
TEAC 1/2 HT STREAMERS & HARD DISK.....	NEW
PCjr 2ND DISK DRIVE OR HARD DISK.....	CALL

## COMPUTERS

COMPAQ.....	CALL
IBM PC YOU CONFIGURE.....	CALL
SANYO MBC.....	NEW LOW PRICES
TAVA PC.....	MORE PC FOR LESS

## BOARDS

QUADRAM ALL PRODUCTS.....	CALL
AST SIX PAC PLUS.....	275 PERSYST CALL
IRMA 3278 EMULATOR.....	BEST PRICE
HERCULES GRAPHICS CARD.....	CALL
TECMAR ALL PRODUCTS.....	CALL
IDEASSOCIATES ALL PRODUCTS.....	CALL
STB GRAPHIX PLUS II.....	CALL
PCjr MEMORY EXPANSION (UP TO 512K).....	CALL
TITAN TECHNOLOGIES (FOR APPLE OR IBM).....	NEW
ACCELERATORS FOR IBM OR APPLE.....	CALL

## MONITORS

TAXAN 116 AMBER / 115 GREEN.....	137/131
410 - 415 RGB HI RES.....	CALL
420 - 425 RGB SUPER HI RES.....	CALL
440 ULTRA HI RES.....	CALL
AMDEK.....	CALL
QUADRAM QUADCHROME.....	CALL
PRINCETON GRAPHICS.....	SAVE

## SOFTWARE

LOTUS 1-2-3.....	SAVE MULTIMATE.....	CALL
KNOWLEDGEMAN.....	CALL 10 BASE.....	CALL
D-BASE III.....	455 SYMPHONY.....	475
WORDSTAR.....	CALL SUPERCALC 3.....	229

## MODEMS

NOVATION - ACCESS 1-2-3 W/CROSSTALK XVI.....	CALL
HAYES SMART MODEM 300/1200.....	212/499

## ACCESSORIES

SWITCH BOXES PARALLEL & SERIAL.....	SAVE
CHIPS 64K.....	49
MICROFAZER PRINT SPOOLER.....	FROM 127
COMPUSERVE STARTER KIT.....	32

## DISKETTES

	CASE 100	BOX 10
VERBATIM SS/DD	180	24
DS/DD	300	36

AVAILABILITY AND PRICES SUBJECT TO CHANGE

APPROVED CORPORATE ACCOUNTS WELCOMED

## HARD DISK

about 1.5 amps. If you add up these typical system requirements, it is clear that the power supply is overloaded at the total—8.2 amps. This does not count the heavy load (about 4 amps) to power up the hard disk. Also, since you use only four slots in this configuration, the fifth slot is wasted.

The add-on manufacturers get around this problem by using half-height drives. The half-height drives take about half the power of a full-size drive and work in a PC if the other power requirements (such as multi-function boards) are not too high.

When you select a Winchester drive, look carefully at the power requirements. Most are power hungry. Even the half-height drives often require more power than the PC has available. Only a few half-height drives can be directly powered from the PC.

One solution would be an additional, external power supply. You can buy a small power supply that bolts onto the back of the PC chassis, just to power the Winchester.

## CONTROLLERS

Several brands of controller cards are available. Prices vary from about \$150 to \$600, with IBM's at the top of the spectrum. Xebec (Sunnyvale, California), DTC (Santa Clara, California),

Maynard (Casselberry, Florida) and Western Digital (Irvine, California) also manufacture controller cards.

The controller card's most important feature is compatibility with DOS 2.0. To be completely compatible, the controller card must use direct memory access (DMA) and must use the same DMA channel (3), interrupt address (5), and controller commands that IBM uses. Of the controllers mentioned above, only Xebec's is compatible at this level—Xebec also manufactures IBM's own controller cards. The commands for the Xebec controller are close, but not identical, to those of the IBM, so slightly different software is required. The controller available from Xebec is a two-board controller; a SASI board plugs into the PC and a cable runs to the second board. This board is the same size as the outline of the fixed disk and is usually mounted next to it.

The controllers manufactured by DTC, Western Digital, and Maynard are not compatible at the controller command level. They pick up their compatibility at the level of the BIOS routines. These controllers' calls to the BIOS look like IBM's (as listed in table 2). Any programs that attempt to address the hard disk at a level

(continued)

Table 2: IBM controller commands.

Command	Op Code
Test drive ready	00
Recalibrate	01
Request sense status	03
Format drive	04
Ready verify	05
Format track	06
Format bad track	07
Read	08
Write	0A
Seek	0B
Initialize drive characteristics	0C
Read ECC burst error length	0D
Read data from sector buffer	0E
Write data to sector buffer	0F
RAM diagnostic	00*
Drive diagnostic	03*
Internal diagnostics	04*
Read long	05*
Write long	06*
*Class 7	

## Your Gateway to Artificial Intelligence

GOLDEN  
COMMON  
LISP

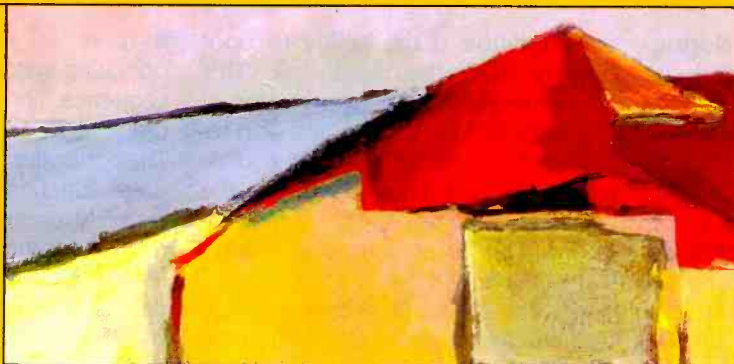

IBM  
Personal  
Computer

# Gold Hill Computers brings the language of Artificial Intelligence to Your Personal Computer.

You know you want to do more with Artificial Intelligence. Two problems have held you back: the expense of the hardware and the scarcity of LISP programmers. *But no longer.* GOLDEN COMMON LISP® makes it possible for you to learn and use LISP on your personal computer. You will know the excitement of expert systems, intelligent data access, and smart programs.

COMMON LISP is the new LISP standard developed by researchers from universities and corporations such as CMU, MIT, Stanford, UC Berkeley, Digital, LMI, Symbolics, and Texas Instruments. GOLDEN COMMON LISP is the right LISP for you because it is based on COMMON LISP. Programs you develop using GOLDEN COMMON LISP on your personal computer will run in the COMMON LISP environments of larger, more expensive machines.

With GOLDEN COMMON LISP, every programmer becomes a LISP programmer. GOLDEN COMMON LISP comes with the LISP Explorer™, an interactive instructional system developed by Patrick H. Winston and San Marco Associates. The San Marco LISP Explorer guides you through the steps of LISP programming and makes the full range of LISP's power accessible to both novices and experienced programmers. The new second edition of the classic LISP textbook by Winston and Horn is also included.

GOLDEN COMMON LISP comes complete with the intelligent GMACS

editor (based on EMACS), on-line documentation of all LISP and GMACS functions, a comprehensive user manual, and program debugging tools. In short, GOLDEN COMMON LISP comes with everything you need to program in LISP. Features of GOLDEN COMMON LISP for advanced users include co-routines for multitasking, macros for code clarity, streams for I/O, closures for object-centered programming, and multiple-value-returning functions for efficiency.

### *GOLDEN COMMON LISP—the intelligent path to Artificial Intelligence.*

GOLDEN COMMON LISP (GCLISP™) requires an IBM PC, PC XT, or IBM PC compatible running PC-DOS 2.0. 512K bytes of memory are recommended for program development. A version of GCLISP for the DEC Rainbow is also available. The package includes:

- an intelligent GMACS editor
- program development tools
- the San Marco LISP Explorer
- the new 2nd edition of *LISP* by Winston and Horn
- the *COMMON LISP Reference Manual* by Guy Steele
- on-line documentation of all GCLISP and GMACS functions
- the GOLDEN COMMON LISP Users' Guide and Reference Manual

ORDER GCLISP TODAY using the coupon below. Or call our Customer Service Department at:

**(617) 492-2071**

Gold Hill Computers		B10-84	
Customer Service 163 Harvard Street Cambridge, MA 02139			
Name _____			
Organization _____			
Address _____			
Phone _____		Today's Date _____	
Type of computer _____			
<input type="checkbox"/> Enclosed is a check to Gold Hill Computers for GCLISP.			
<input type="checkbox"/> Please bill my <input type="checkbox"/> MasterCard <input type="checkbox"/> VISA card.			
Card # _____		Expiration Date _____	
Signature _____			
Quantity	Description	Unit Price	Total Price
	GOLDEN COMMON LISP	\$495.00	
Subtotal			
MA residents add 5% Sales Tax			
Total Amount			
University purchasers should inquire about our educational discount. We pay shipping on all credit card and pre-paid orders within the United States.			
<input type="checkbox"/> Please send me more information about GCLISP.			

G O L D H I L L C O M P U T E R S

163 Harvard Street, Cambridge, Massachusetts 02139

GOLDEN COMMON LISP is a registered trademark of Gold Hill Computers. GCLISP is a trademark of Gold Hill Computers. The LISP Explorer is a trademark of San Marco Associates. LISP is copyrighted by Addison-Wesley Publishing Company, Inc. The *COMMON LISP Reference Manual* is copyrighted by Digital Equipment Corporation. Rainbow is a trademark of Digital Equipment Corporation. IBM is a registered trademark of International Business Machines.



lower than the BIOS (the Norton utilities, for example) will not work on these systems.

The controller typically contains a powerful processor such as a Z80 or a set of custom LSI devices. DMA is used to rapidly transfer data to or from memory. Controller commands such as READ or WRITE require no intervention by the 8088 after you issue them. Up to 64K bytes can be transferred by a single command. Each controller has its own unique command set, but the IBM controller's are typical.

Another important compatibility

consideration is the ability to boot directly from the fixed disk. This feature requires the newer version of the BIOS ROM in the PC, and also requires a special ROM on the disk-controller board or placed in the empty ROM socket on the PC motherboard. This is a feature you won't want to live without.

In some cases, differences in controllers can be corrected in the controller's BIOS ROM. The IBM controller has a ROM in the PC memory space starting at location C8000. When the PC powers up, it looks to see if a valid ROM is at that location;

if there is, it is bound into the operating system during the power-up sequence. The functions provided by the IBM ROM are shown in table 3. The controller and ROM must provide these functions for the fixed disk to be truly compatible. The IBM technical reference manual provides a listing of the IBM ROM that you can use as a model for developing your own BIOS.

The IBM controller is set up for several types of fixed disks. The disk parameters are specified in a table in the BIOS ROM. You can choose one of four disk types by changing jumpers on the controller board. If the parameters you need are not in the table, you can install a 2732 or 2532 EPROM in the board and modify the values as needed. The ROM space is 8K, but less than 2K is actually used.

If you do modify the table, remember to modify the checksum. A checksum is performed on the ROM during the power-up sequence and the fixed disk will not work if the checksum is wrong. A simple modulo 256 add generates the checksum.

Modifying the table lets you install a different disk in your system. IBM supplies only 10-megabyte units, but you can make yours as large as you want. See table 4 for the configuration table, along with the changes you need to make to use a 22-megabyte disk. Usually, you will not need to change more than a few entries in the table.

The first entry is the number of cylinders on your disk. (A cylinder is a collection of tracks, one from each disk surface, all the same distance from the disk axis. Imagine a cylinder that passes through track one in each of four stacked disks, for example.) The number of cylinders usually varies from manufacturer to manufacturer. The second entry is the number of heads. If you are installing a disk larger than 10 megabytes, this number will increase. The third entry tells the controller when to start using reduced write current. This information is usually supplied with the disk when you purchase it. The fourth

*(continued)*

**Table 3: IBM fixed-disk BIOS functions.**

Reset disk
Read status of last operation
Read sectors into memory
Write sectors from memory
Verify sectors
Format track
Format drive
Return drive parameters
Initialize drive parameters
Read long
Write long
Alternate reset
Read sector buffer
Write sector buffer
Test drive ready
Recalibrate
Controller RAM diagnostic
Drive diagnostic
Controller internal diagnostic

**Table 4: Disk configuration table.**

Parameter	Parameter Length Bytes	Value for 22 MB Decimal
Number of cylinders	2	320
Number of heads	1	8
Reduced write starting on cylinder #	2	132
Write precompensation starting cylinder #	2	0
Max ECC data burst length	1	13
Drive step option	1	5
Standard time out	1	12
Format time out	1	180
Check drive time out	1	40
Reserved	4	0

# Chart-Master™ turns volumes of complex data into easy-to-understand graphics.

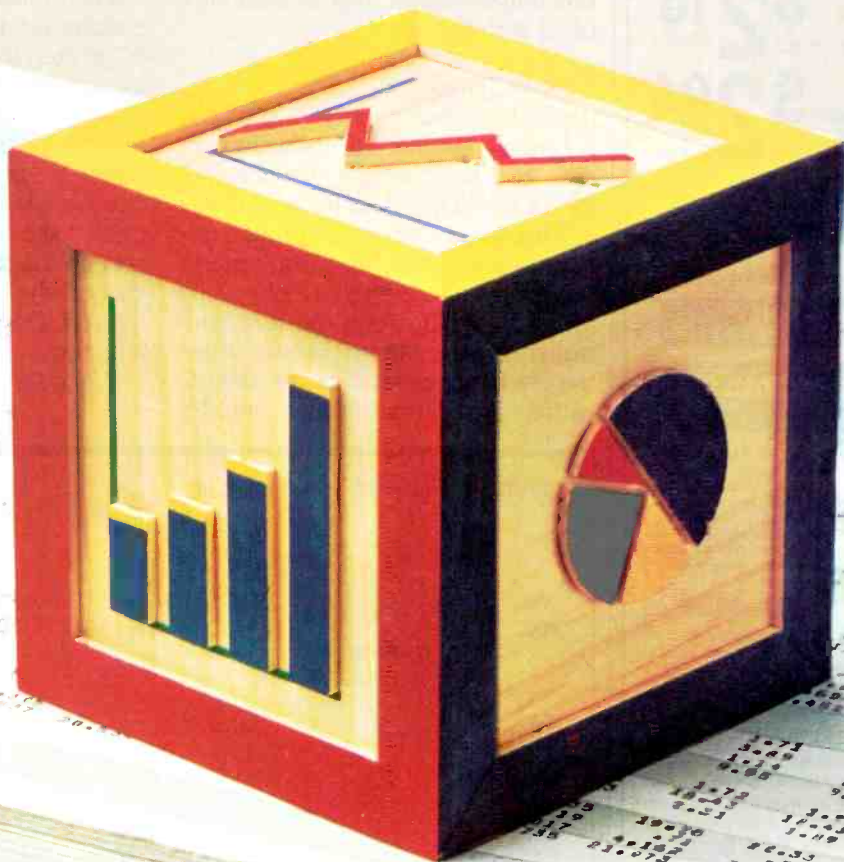

"A picture is worth a thousand words." With this simple concept as a building block, Chart-Master is changing the way busy executives, analysts and secretaries look at, interpret and present information. In a fraction of the time required to wade through volumes of printouts, you can

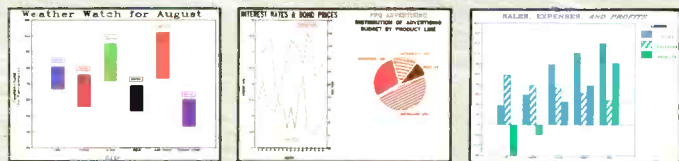

Values printed at data points; both left and right Y-axis scales; floating legends & bars; both horizontal & vertical formats; exploded pie sections.

produce easy-to-understand bar charts, pie charts and scatter diagrams quickly and dramatically. Chart-Master makes it easy to customize reports and presentations with six different fonts, label placement, proportional pie charts and more.

Menu-driven Chart-Master allows you to enter data and select a chart format at the press of a button. You then preview your selection on your personal computer screen as it would appear in final form. Or, you can review the various Chart-Master graphic options to make sure you have selected the most effective format. When satisfied,

you can transfer your selection to paper or acetate transparencies for a colorful, presentation-quality chart in seconds.

Chart-Master presents a *clear picture* of the "bottom line," which conveys information understandable and decision makers appreciate. That's why major corporations like GE, Eastman Kodak, Exxon, Union Carbide, GM, AT&T, DuPont, 3M, Citibank, Motorola, Procter & Gamble, and GTE rely on Chart-Master to translate "volumes of complex data into meaningful information."

Chart-Master supports the IBM instruments XY750, Panasonic VP Series, Houston Instruments DMP29, Yokogawa PL1000 and Strobe plotters, in addition to the Hewlett-Packard family of plotters, for use with IBM PC and other compatible computers.

The retail price of Chart-Master is \$375. For a complete information kit and name of your nearest dealer, contact Decision Resources, Inc., 25 Sylvan Road S., Westport, CT 06880. (203) 222-1374.

**DecisionResources**  
Software Designed for Decision Makers



NOW, THE LOWEST PRICES EVER ON



# 3M Scotch® DISKETTES

**\$158**<sup>ea.</sup> 5 1/4" SSDD Qty. 50  
**\$210**<sup>ea.</sup> 5 1/4" DSDD Qty. 50  
**\$233**<sup>ea.</sup> 5 1/4" SSDD-96TPI  
**\$294**<sup>ea.</sup> 5 1/4" DSDD-96TPI

**SOFT SECTOR ONLY!**  
 MINIMUM ORDER: 20 DISKETTES

These are factory-fresh 3M diskettes packed in boxes of 10 with Tyvek sleeves, reinforced hubs, identification labels and write-protect tabs.

Add 5% for orders less than 50 on 5 1/4" only.

**LIFETIME WARRANTY!**  
**ON ALL 3M SCOTCH DISKETTES!**

## SUPER SPECIAL!



Order 50 3M Scotch Diskettes on this special offer and you can get an Amaray Media Mate 50 for only \$9.99 (shipping included). Normally, a \$14.95 retail value, this is one of the best designed disk storage units we've seen. Special slots and ridges for stacking. A great buy.

With 50 3M Scotch 5 1/4" Diskettes **\$9.99**  
 Ordered alone: **\$10.95** + \$2.00 Shpng.

**8" 3M Scotch Diskettes**  
 8" SSDD **\$2.05** ea. 8" SSDD **\$2.50** ea.  
 8" DSDD **\$3.10** ea.

**SOFT SECTOR ONLY!**  
 MINIMUM ORDER 8" DISKETTES: 20

### 3M HEADCLEANING KITS

Stop swearing and start cleaning. This non-abrasive cleaning kit has everything you need for 30 applications. **\$18.00** Shpng.

**DISKETTE 70 STORAGE: STILL A GREAT BUY**  
 Dust-free storage for 70 5 1/4" diskettes. Six dividers included. An excellent value. **\$11.95** + \$3.00 Shpng.

**DISK CADDIES**  
 The original flip-up holder for 10 5 1/4" diskettes. Beige or grey only. **\$1.65** + 20¢ ea. Shpng.

### PRINTER RIBBONS AT BARGAIN PRICES!

Brand new ribbons produced to manufacturer's specs.  
 Epson MX-70/80 **\$3.58** ea. + 25 Shpng.  
 Epson MX-100 **\$6.99** ea. + 25 Shpng.  
 Okidata Micro 83 **\$1.48** ea. + 25 Shpng.  
 Okidata Micro 84 **\$3.66** ea. + 25 Shpng.

Shipping: 5 1/4" DISKETTES—Add \$3.00 per 100 or fewer diskettes. 8" DISKETTES—Add \$4.00 per 100 or fewer diskettes. Other Items: Add shipping charges as shown in addition to diskette shipping charges. Payment: VISA and MASTERCARD accepted. COD orders only, add \$3.00 handling charge. Taxes: Illinois residents only, add 8% sales tax.

FOR ORDERS ONLY:

**1-800-621-6827**

(In Illinois: 1-312-944-2788)

INFORMATION & INQUIRIES:

**1-312-944-2788 only!**

HOURS: 9AM - 5PM Central Time,  
 Monday - Friday

WE WILL BEAT ANY NATIONALLY ADVERTISED PRICE ON THE SAME PRODUCTS AND QUANTITIES!

**DISK WORLD!, Inc.**

Suite 4806 • 30 East Huron Street • Chicago, Illinois 60611

**DISK WORLD!**

Authorized Distributor  
 Information Processing  
 Products



## HARD DISK

entry tells where to start write precompensation. This is also supplied with the disk.

### FORMATTING

If you buy your controller and disk separately, the disk will not be formatted. You must format it yourself—the DOS will not do it for you. If you use the IBM or Xebec controller, formatting is relatively easy. You can use the program in listing 1 to physically format the disk using the IBM controller. The formatting process writes the track number and sector identification on each track so the controller

knows where to read and write data.

When initially formatted, the disk contains no data and has hexadecimal 6C written in each data location. To format the disk, you must create a data buffer containing 6Cs. You must tell the DMA controller where this buffer is located in memory. Three commands are issued to the controller. The first resets it, the second sets up the data buffer, and the third causes the entire disk to be formatted. This operation takes several minutes.

The next step is to run an IBM-

(continued)

Listing 1: Fixed-disk format program.

	TITLE	HDFMT	HARD DISK FORMAT
0000	STACK	SEGMENT PARA	STACK 'STACK'
0000	40 [	DB 64 DUP ('STACK')	
		53 54 41 43	
		4B 20 20 20	
0200	STACK	ENDS	
0000	WORK	SEGMENT PARA PUBLIC 'WORK'	
0000	0400 [	FILL DB 1024 DUP(6CH)	
		6C	
0400	24		DB '\$'
0401	WORK	ENDS	
0000	SOFT	SEGMENT PARA PUBLIC 'SOFT'	
0000	??	LOC DB ?	
0001	SOFT	ENDS	
0000	CSEG	SEGMENT PARA PUBLIC 'CODE'	
0000	START	PROC FAR	
		ASSUME CS:CSEG,DS:WORK,SS:	
		STACK,ES:SOFT	
0000	B8	0000	MOV AX,0
0003	1E		PUSH DS
0004	50		PUSH AX
0005	B8	----- R	MOV AX,WORK
0008	8E	D8	MOV DS,AX
000A	8E	C0	MOV ES,AX
			;DMA LOCATION
000C	B0	06	MOV AL,6
			;INTERLEAVE = 6
000E	B4	00	MOV AH,0
			;RESET
0010	B9	0001	MOV CX,1
			;CYL = 0
			SECTOR = 1
0013	BB	0000 R	MOV BX,OFFSET FILL
			;DMA OFFSET
0016	BA	0080	MOV DX,80H
			;HEAD = 0 DR = 0
0019	CD	13	INT 13H
			;RESET DISK
001B	B8	0F01	MOV AX,0F01H
			;LOAD BUFFER
001E	CD	13	INT 13H
0020	B8	0701	MOV AX,0701H
			;FORMAT
0023	CD	13	INT 13H
0025	CB		RET
			;RETURN TO DOS
0026	START	ENDP	
0026	CSEG	ENDS	
		END START	

Dear Smith-Corona,

Imagine sending an important letter printed on a dot matrix printer.

"Impossible," I would have said before. "Impeccable," I say, now that I've bought your new dot matrix.

A dot that has two kinds of printout (graphics and text) for very little shell-out. That's impressive. And so very practical. A "two-in-one" fast dot. One that does everything I used to use two to do.

I was going to call you to congratulate you on your ingenious dot. But then I thought, and decided a letter would be more perfect.

Thank you,

Ron Rosenfeld  
Co-Chairman  
Rosenfeld, Sirowitz & Lawson

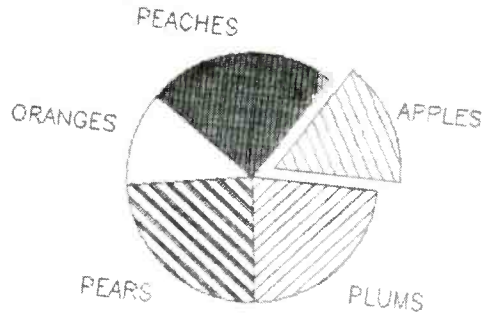

# At last, dot plus dash for very little cash.

The dot matrix printer with superb letter quality plus high-speed graphics. For under \$800.



Besides all the super high-speed graphics you expect, what else can you do with the Smith-Corona dual-interface D-200 dot matrix printer? You can print at a speed of 120 CPS (that's dash), with 80 characters per line. And you can write with quality. You can even use computer paper or letterhead with a removable tractor feed, which comes as standard equipment.

You can italicize to make a point. Emphasize to point out a good idea. Emphasize and italicize to make a point about a good idea. Enlarge if it's a big idea. Then subscript or superscript to make it all add up.

It's easy to see why so many people think a Smith-Corona printer is the one and only dot.

 **SMITH-CORONA**  
Smith-Corona is a trademark owned by SCM Corporation



*Once you install a hard disk in your PC, consider its care and maintenance.*

supplied program, FDISK, that lets you divide the disk into partitions to use several operating systems. FDISK lets you run one operating system on one part of the disk and another somewhere else, up to four divisions. FDISK asks how much of the disk to

allot to each operating system.

After running FDISK, you must issue the DOS FORMAT command. FORMAT checks the surface of the disk, sets up the directory and file allocation table for DOS, and copies the bootstrap and system onto the first track.

If this formatting sequence is not successfully completed, one of the disk installation programs might tell you that your hard disk is not usable. Don't panic. This is not necessarily a problem with the disk—it might be a problem with formatting.

The fixed disk will automatically be assigned the next drive letter after any

floppies and electronic drives. This will automatically change if you change the number of floppies in the system, so you don't have to worry about conflicts due to system reconfiguration. You can move new versions of DOS (such as 2.1) onto the fixed disk using the SYSTEM command. You do not have to reformat.

**HARD-DISK CARE**

Once you have a hard disk installed in your PC, give some thought to its care and maintenance. The hard disk's heads and surfaces are quite delicate—moving the unit around can damage them.

When the disk is running, the heads ride on a very thin cushion of air. They are extremely close to the disk surface and actually sit on it when stopped. Don't turn the power on and off with the heads over the outer track where the directory and file allocation segments are stored, since damage there could render the disk useless. Each time you turn the power off, you should move the heads to the center of the disk. This is extremely important when you plan to physically move the drive.

Listing 2 is a program to move the heads to the inside track. The program first sets up the DMA channel, then issues a SEEK command to the controller. The SEEK command specifies the innermost track.

Dust on a disk surface could cause damage, so hard disks are assembled in clean rooms and are heavily filtered. Still, no filter is perfect, so it is better not to smoke or stir up dust around your disk.

**CONCLUSION**

There are cost advantages in assembling your hard disk from different sources, especially for the higher-capacity disks. If you have experience in modifying your system, you might want to try it. If not, the expansion chassis from IBM or a kit from another vendor might be the best solution to your disk storage problems.

Whichever method you choose, you will soon find that the hard disk is indispensable. ■

Listing 2: Park fixed-disk heads program.

```

                                TITLE      STOP          ;HD POWER OFF
                                ;          PROG
                                ;          THIS PROGRAM MOVES THE HARD
                                ;          DISK
                                ;          HEAD TO CYL 320 BEFORE POWER
                                ;          DOWN
0000      STACK      SEGMENT PARA STACK 'STACK'
0000 40 [          DB 64 DUP('STACK')
                53 54 41 43
                4B 20 20 20
                ]
0200      STACK      ENDS
0000      WORK      SEGMENT PARA PUBLIC 'WORK'
0000 24          DB '$'
0001      WORK      ENDS
0000      SOFT      SEGMENT PARA PUBLIC 'SOFT'
0000 ??         DB ?
0001      SOFT      ENDS
0000      CSEG      SEGMENT PARA PUBLIC 'CODE'
0000      START     PROC FAR
                ASSUME CS:CSEG,DS:WORK,SS:
                STACK,ES:SOFT
0000 B8 0000      MOV AX,0
0003 1E          PUSH DS
0004 50          PUSH AX
0005 B8 ----- R  MOV AX,WORK
0008 8E D8      MOV DS,AX
000A 8E C0      MOV ES,AX ;DMA LOCATION
000C B8 0C01    MOV AX,0C01H ;SEEK COMMAND
000F B9 3F41    MOV CX,3F41H ;CYL = 320
                SECTOR = 1
0012 BB 0000    MOV BX,0 ;DMA OFFSET
0015 BA 0080    MOV DX,80H ;HEAD = 0 DR = 0
0018 CD 13      INT 13H ;CMD DISK
001A CB        RET ;RETURN TO DOS
001B          START ENDP
001B          CSEG  ENDS
                END START
    
```

# CompuPro 10

**Heavyweight** Performance  
At a Lightweight Price!

**\$7995.00**

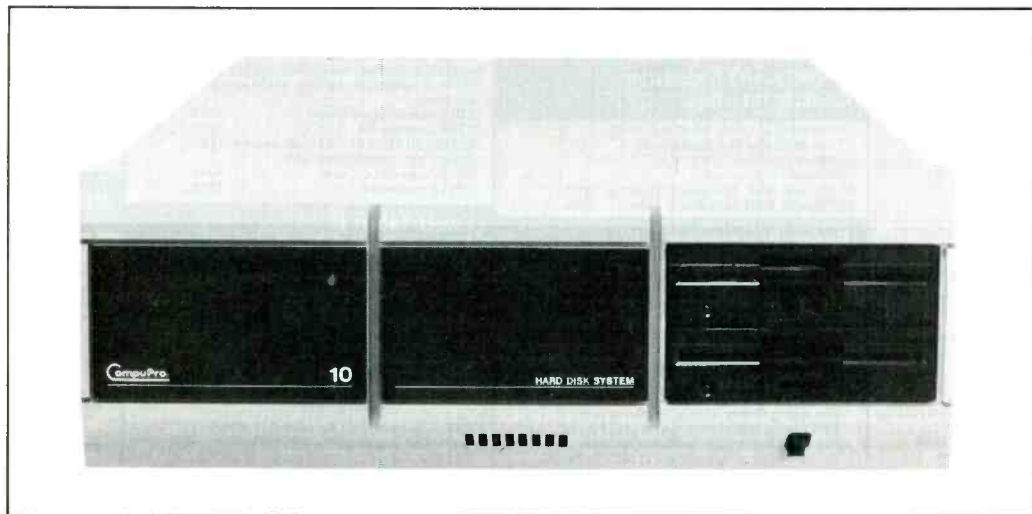

**Four-User Multiprocessor System**

**Price Includes:**

- 40 Mbyte Hard Disk
- 1 Mbyte Main Memory
- 7 Serial Ports and 1 Parallel Port
- Operating System • Word Processing • Spreadsheet • Database Management

Available now at CompuPro Full Service System Centers and better dealers worldwide.

Call (415) 786-0909 Ext. 206 for the location of the System Center nearest you.

**CompuPro®**

3056 Breakwater Court, Hayward, CA 94545



# The Micromint Collection



## TERM-MITE ST SMART TERMINAL BOARD

TERM-MITE is a completely self-contained video display controller.

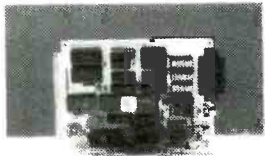

All you need to build a Smart Video Terminal equivalent to the types advertised for \$1000 or more is a Term-Mite ST circuit board, scanned or parallel keyboard, video monitor and power supply.

Uses brand new Nat'l Semi NS405 Terminal Processor.  
24 lines by 80 characters, 25th reverse-video status.  
Upper & lowercase. Line (block) graphics.  
Selectable data rate, parity & display options.  
Reverse video, half intensity, double height & width, underline, blinking and/or blank character.  
Separate sync or composite video output. Self Test.

TERM-MITE ST Video Display Terminal Board  
BCC22 Assembled & Tested ..... \$284.  
BCC23 Complete Kit ..... \$244.

## MPX-16 MICROCOMPUTER IBM PC COMPATIBLE



As featured on the cover of BYTE Magazine. Also featured in *Ciarca's Circuit Cellar* November, December 1982 & January 1983

### The Computer with a Split Personality

- Use it as an IBM PC look alike that directly boots PC DOS 2.0 and accepts all expansion boards designed for the IBM PC.
- Use it as a powerful 8088 single board computer for all your DEM applications. Just add serial terminal, disk drive and power supply. Directly boots CP/M-86.

Buy the MPX-16 in the form that best meets your needs or budget. As a bare board, as a wave soldered board that contains all components less ICs, as an assembled and tested circuit board or as a complete system.

- Directly boots PC DOS 2.0 and CP/M-86.
- Most IBM PC software executes with no modifications.
- IBM PC bus compatible +9 expansion slots.
- Intel 8088 16-bit microprocessor.
- Optional Intel 8087 math coprocessor.
- 256K bytes on board memory.
- Up to one megabyte of system memory.
- Up to 64K bytes of system ROM/EPROM.
- 2 RS-232C Serial & 3 Parallel I/O ports.
- Disk controller for 5 1/4" or 8" drives.
- Sixteen levels of vectored interrupts.

MPX-16 Circuit Board Assembled w/64K RAM	\$1,200.
DEM 100 quantity price	840.
MPX-16 Circuit Board Assembled w/256K RAM	1,400.
MPX-16 Semi-Kit (wave soldered circuit board w/all components) Less ICs	595.
Complete Kit of ICs w/256K RAM	595.
MPX-16 Unpopulated (bare) PC Board	300.
CP/M-86 Operating System + Manuals	80.
MPX-16 Switching Power Supply	300.
MPX-16 Technical Reference Manual	50.
MPX-16 Metal Enclosure with Fan	225.
Tandem TM 100-2 Double Sided/Density Drive	300.
IBM/PC Keyboard Interface Adapter	100.

Shipping and handling additional on MPX-16 orders

IBM PC is a trademark of International Business Machines Inc.  
CP/M-86 is a trademark of Digital Research Inc.  
Z8 is a trademark of Zilog Inc.

Circle 230 on inquiry card.

## Z8 COMPUTER SYSTEM

### BASIC System Controller



The Z8 Basic System Controller is an updated version of our popular BCC01. The price has been reduced and features added. The entire computer is 4" by 4" and includes a tiny BASIC interpreter, up to 6K bytes of RAM and EPROM, one RS-232C serial port with switchable baud rates and two parallel ports. BASIC or machine language programming is accomplished simply by connecting a CRT terminal. Programs can be transferred to 2732 EPROMs with an optional EPROM programmer for auto start applications. Additional Z8 peripheral boards include memory expansion, serial and parallel I/O, real time clock, an A/D Converter and an EPROM programmer.  
Uses Zilog Z8 single chip microprocessor.  
Data and address buses available for complete peripheral expansion.  
Can be battery operated.  
Cross assemblers for various computers.

New BCC11 Assembled & Tested ..... \$149. Low Price

### FORTH Language Version

With the new Z8 with on board 4K FORTH you can program high speed control functions in a few simple high level language commands. Perfect for data reduction, process control and high speed control applications.

BCC20 Z8F FORTH Microprocessor chip \$150.  
BCC21 Z8F FORTH System Controller (This board is a BCC11 with a BCC20 installed) Assembled & Tested ..... 280.

### Memory, I/O Expansion, Cassette Interface

8K bytes of additional RAM or EPROM.  
Three additional 8 bit parallel ports.  
Cassette interface - 300 baud K.C. Standard.  
Software real time clock.  
BCC33 w/0K RAM Assembled & Tested ..... \$150.  
BCC34 w/6K RAM Assembled & Tested ..... \$180.

### Eprom Programmer

- Transfer BASIC or Assembly Language application programs from RAM to 2716 or 2732 EPROM.  
Comes with programming & utility routines on EPROM.  
- Requires Z8 I/O Expansion Board for operation.  
BCC07 Assembled & Tested ..... \$145.

### Analog to Digital Converter

Uses Analog Devices 7581 IC, 8 channel 8-bit.  
Adds process control capability to the Z8 system.  
Over 1,000 conversions per channel per second.  
Monitors 8 analog signals in one of two 10v Ranges.  
BCC13 Assembled & Tested ..... \$140.

### Serial Expansion Board

Adds additional RS-232C and opto-isolated 20 ma. current loop serial port to the Z8 System.  
Runs at 75 to 19,200 baud in all protocols.  
Comes with routines of sample serial I/O routines.  
BCC08 Assembled & Tested ..... \$160.

### 16K Memory Expansion Board

Add up to 16K of additional memory, RAM or EPROM, to your Z8 System Controller in any multiple.  
Accepts 2016, 6116, 2716, or 2732 memory types.  
Four 16K cards may be installed on the Z8 System bringing the total memory to 64K.  
BCC14 Assembled & Tested w/4K RAM ..... \$120.

### Cross Assemblers

From Micro Resources  
IBM PC, APPLE, 6502 Systems 5 1/2", CP/M 2.2 8" ..... \$75.

From Allen Ashley  
TRS-80 Model I, III, Northstar 5 1/4" ..... 75.  
CP/M 2.2 8" ..... 150.

### Five Slot Mother Board

Expand your Z8 BASIC System with minimum effort.  
Contains five slots complete w/44 pin connectors.  
MB02 Assembled & Tested ..... \$69.

### Triple Voltage Power Supplies

+5V @ 300 ma. +/- 12V @ 25 ma.  
UPS01 Assembled & Tested ..... \$35.  
UPS02 Complete Kit ..... 27.  
+5V @ 1 Amp. +12V @ .5 Amp. 12V @ 50 ma.  
UPS03 Assembled & Tested ..... 60.  
UPS04 Complete Kit ..... 50.

## SPEECH PRODUCTS

### Lis' ner 1000 Voice Recognition Board



Uses the new, high performance SP1000 voice recognition chip.

The LIS'NER 1000 provides voice input capability for your computer. The unit functions in the same manner as your keyboard, serving as a data entry device for application programs or the normal operation of the computer.

The LIS'NER 1000 recognition system works by analyzing human speech and extracting the most important features. These impressions of words are compacted into "templates" which can be stored and later compared to someone talking to the recognition unit. The LIS'NER 1000 supports a 64 word vocabulary in speaker dependent, discrete utterance mode. The recognition accuracy is greater than 98%. Each unit comes with a professional quality headband style electret microphone to assure accuracy, software on diskette and a user's manual.

The APPLE II LIS'NER board has provision for an SSI 263 phonetic speech synthesizer chip with text-to-speech algorithm. This addition provides all the features described for the Sweet Talker II as well as speech recognition.

APPLE II LIS'NER 1000 with SP1000 recognition/synthesis components only  
VR01 Assembled & Tested ..... \$189.  
VR02 Complete Kit ..... \$149.  
APPLE II LIS'NER 1000 with SP1000 recognition/synthesis components and SSI 263 phoneme synthesizer chip with text to speech algorithm.  
VR03 Assembled and Tested ..... \$259.  
VR04 Complete Kit ..... \$219.  
COMMODORE 64 LIS'NER 1000 with SP1000 recognition/synthesis components  
VR10 Assembled & Tested ..... \$149.  
VR11 Complete Kit ..... \$119.

### Sweet Talker II Text-to-Speech Synthesizer



SWEET TALKER II, a 3rd generation speech synthesizer, is based on the SSI 263. SWEET TALKER II directly drives a speaker to provide music, sound effects and continuous speech of unlimited vocabulary at data rates as low as 50-70 bps.

- SSI 263-based Apple II compatible speech synthesis board
- Comes with text-to-speech algorithm on disk (DOS 3.3)
- Appropriate control inputs for mapping with several buses
- On-board 1 watt amplifier with volume control
- Measures 3" x 3 1/4"
- Operates on +5 and +12v

ST22 SWEET TALKER II Apple II compatible speech synthesizer with text-to-speech algorithm on disk ..... \$104.

### Microvox Text-to-Speech Synthesizer



Microvox is a professional voice quality text-to-speech synthesizer that is easily interfaced to any computer, modem, RS-232C serial or parallel output device and provides speech of unbelievable clarity.

- Unlimited vocabulary.
- 64 programmable inflection levels
- 6K text-to-speech algorithm.
- Full ASCII character set recognition and echo
- RS232C and parallel input
- 1000 Character buffer, 3000 optional
- Adjustable baud rates (75-9600)
- Spelling output mode
- 7 octave music and sound effects
- On board audio amplifier & power supply
- X-On/Off hands/shaking
- MV01 Assembled with 1K buffer ..... \$349.
- MV02 Complete Kit with 1K buffer ..... \$269.
- Add \$15.00 for 3K buffer option.

## Speech Synthesizer IC's

The SC-01A Speech Synthesizer is a completely self-contained solid state device that phonetically synthesizes continuous speech of unlimited vocabulary.

SC01A Quantity 1-99 ..... \$32  
100- ..... \$24  
1000+ ..... call

The Silicon Systems SSI 263 Speech Synthesizer Chip is a third generation speech synthesizer chip that produces even more intelligible speech than did older devices. The SSI 263 has improved into nation, inflection and filtration.

SSI 263 Quantity 1-9 ..... \$42. ea.  
10-99 ..... \$34. ea.  
100 ..... \$30. ea.

The Micromint is stocking thousands of SP1000 voice recognition chips. Call us for a quote.

## MICRO D-CAM DIGITAL TV CAMERA



Give your computer the dimension of sight. Interpret, enhances and stores images. 256 x 128 digital image sensor. Plug-in boards for the IBM PC, APPLE II or e. Software includes utilities for auto exposure multi-level greyscale, screen dump and image enhancement.

Includes interface card, 4 foot extension cable camera assembly, manual, and software on diskette.  
DC01 IBM PC Assembled & Tested ..... \$299.  
DC02 IBM PC Complete Kit ..... \$264.  
DC03 APPLE II Assembled & Tested ..... \$299.  
DC04 APPLE II Complete Kit ..... \$264.

## ULTRASONIC RANGING SYSTEM

The Micromint Sonar Ranging Experimenters Kit is an updated and higher functioning version of the Polaroid SX-70 Camera sonar ranging circuit used in the original Polaroid Ultrasonic Ranging System Designer's Kit. There are similar performance characteristics but this unit requires far less support circuitry and interface hardware.

The TR ranging module can function between 4.5 and 6.8v. With a 5v supply, the ranging module I/O is TTL compatible and can be connected directly to most computers with one input and one output bit.

The Sonar Ranging Experimenters Kit includes one SN28827 ranging module, one Polaroid 50 KHz electrostatic transducer, and user's manual with data sheets.  
T101 Sonar Ranging Experimenters Kit ..... \$60.

## 300 BAUD ANSWER/ ORIGINATE MODEM KIT



Micromint's latest 300 Baud Modem Kit is crystal controlled, uses the TI TMS99532 IC, contains just 25 parts and requires no calibration or adjustments. Use with acoustic coupler or in direct connect mode.  
M004 Complete Kit as shown ..... \$60.  
M005 Transformer for Direct Connect Mode \$9.  
AC01 Acoustic Coupler Kit ..... \$20.

MICROMINT INC. 561 Willow Avenue

Cedarhurst, NY 11516

To Order: Call Toll Free 1-800-645-341

For Information Call: 1-516-374-679

Call: Monday-Friday, 9-5 PM



# OPTICAL MEMORY: DATA STORAGE BY LASER

BY EDWARD S. ROTHCHILD

*Erasable media  
may soon be available*

AFTER MORE THAN 12 years of research and development in laboratories in the United States, Europe, and Japan, optical-memory drives and media are finally being shipped to customers. Optical-memory storage, the laser writing and reading of information on sensitive removable media in the user's drive, is a spinoff of laser videodisc technology. However, perfecting digital read/write optical-memory systems has posed greater technical problems than analog read-only videodisc or digital read-only compact disk systems. These problems include developing optical media sensitive enough to be marked at high data rates with low-power lasers and maintaining almost error-free data at acceptable computer industry standards for at least 10 years, or no more than one uncorrectable error in  $10^{12}$  (one trillion) bits.

In reviewing optical-storage developments since my last article appeared ("Optical-Memory Media" March 1983 BYTE, page 86), the most significant trend emerging is the realization that the spectacular success of 5¼-inch and smaller rigid and flexible

magnetic disk drives and media could be duplicated in small, low-cost, read/write and read-only removable-disk, optical-storage products. This trend also occurred to people wrestling with the problems associated with making high-density magnetic recording work with rigid disks. We might call 1984 "The Year of the Small Disk." The concept of a 2-inch optical disk and drive was proposed at a scientific conference at Lake Tahoe, Nevada, in January 1983 by Dr. Ingolf Sander, now with Verbatim in Sunnyvale, California. He described a 2-inch drive with 10 to 20 megabytes of user capacity using magneto-optic erasable techniques, which could be sold for the cost of a micro-Winchester drive.

All optical drives introduced to date .....  
Edward S. Rothchild (POB 14817, San Francisco, CA 94114) is chairman of Rothchild Consultants, a firm specializing in offering consulting services, conferences, and research studies in optical memory, interactive videodisc, and compact-disk technologies. He is also editor and publisher of the bimonthly journal *Optical Memory News* and the annual *Optical Memory Report*.

use nonerasable media. Although you can add information to unrecorded areas of the disk and obliterate information already recorded, you cannot erase and update data in place as with magnetic media. The lack of erasability is actually an advantage in many applications; with so much user capacity on removable optical disks, you can simply put a disabling code in a sector containing obsolete data and a pointer to new data recorded elsewhere on the disk. This feature permits reconstruction of an audit trail at a later date, which would be impossible with media that are updated in place.

Despite the advantages of permanent, tamperproof, write-once disks, many applications call for the "update in place" capability of erasable media. Coupling erasability with the random-accessibility of rigid magnetic disks and the removability of magnetic tape makes erasable, high-capacity, low-cost optical media ideal for storage. Erasable optical disks have been demonstrated mainly using two different types of techniques, magneto-optic

*(continued)*



and crystalline-to-amorphous phase change.

### MAGNETO-OPTIC TECHNOLOGY

In magneto-optic recording (figure 1), a process similar to vertical magnetic recording (see "The Promise of Perpendicular Magnetic Recording," March 1983 BYTE, page 56), a laser

beam is used to temporarily reduce the magnetic medium's coercivity, i.e., render it more susceptible to a change in its magnetic charge. The recording materials that are used most frequently are terbium and iron, sometimes alloyed with gadolinium or bismuth. The typical magneto-optic head has a coil wrapped around the

lens. This coil produces a field of moderate strength (typically 100 to 600 oersteds) over a large area centered on the lens axis. This field is perpendicular to the medium; a magnetic plate is frequently placed on the far side of the medium to maintain that orientation. The applied field is not strong enough to affect the medium unless that medium is heated to near its Curie temperature (the point at which the coercivity is zero and the medium is most susceptible to magnetic change). This is the job of the laser beam, which supplies both energy and localization for the writing process.

Reading is done via either the Kerr or the Faraday effect, both based on the rotation of the plane of polarized light when it is passed through a magnetized material. Typical rotations of polarized light range from 0.3 degree for simple single-layer media to 9 degrees for multilayer structures. Reading contrast (i.e., the sharpness of the recorded marks) on such erasable media is not as high as with write-once media; achieving a good signal-to-noise ratio requires a fairly strong laser read beam, but the power must be kept below that which affects previous writing. Still, carrier-to-noise ratios over 50 decibels (dB) have been achieved. Erasure and rewriting follows the procedure for writing, but with the applied field reversed.

### PHASE-CHANGE MEDIA

One of 1983's most notable events was the public demonstration in New York by Matsushita of its Panasonic erasable optical videodisc and drive, which employs the crystalline-to-amorphous phase-change technique (figure 2). The sensitive layer of the disk is made of tellurium suboxide alloyed with small amounts of germanium, indium, and lead. In the read/write process, this crystalline phase, which has high reflectivity, is converted into an amorphous phase of low reflectivity; the reverse occurs during erasing. Writing and reading are done with an 830-nanometer laser, writing at 8 milliwatts of power

(continued)

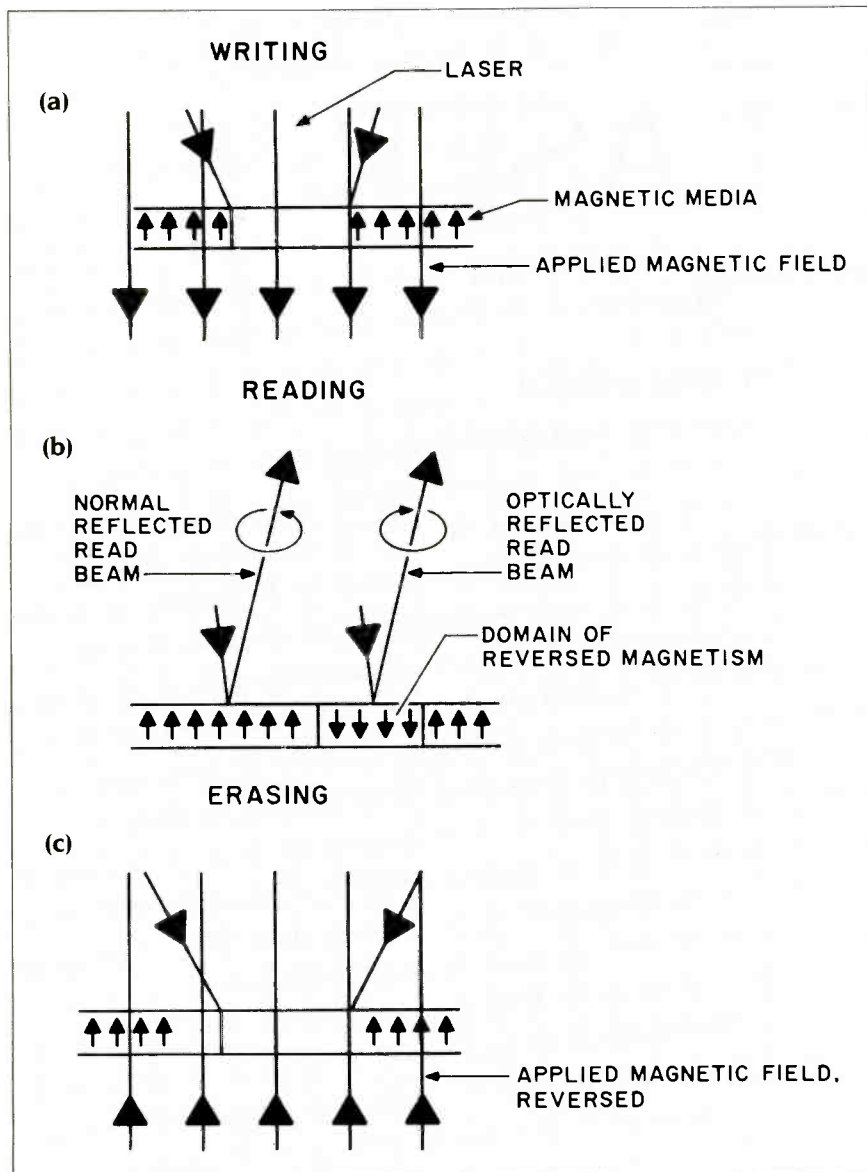
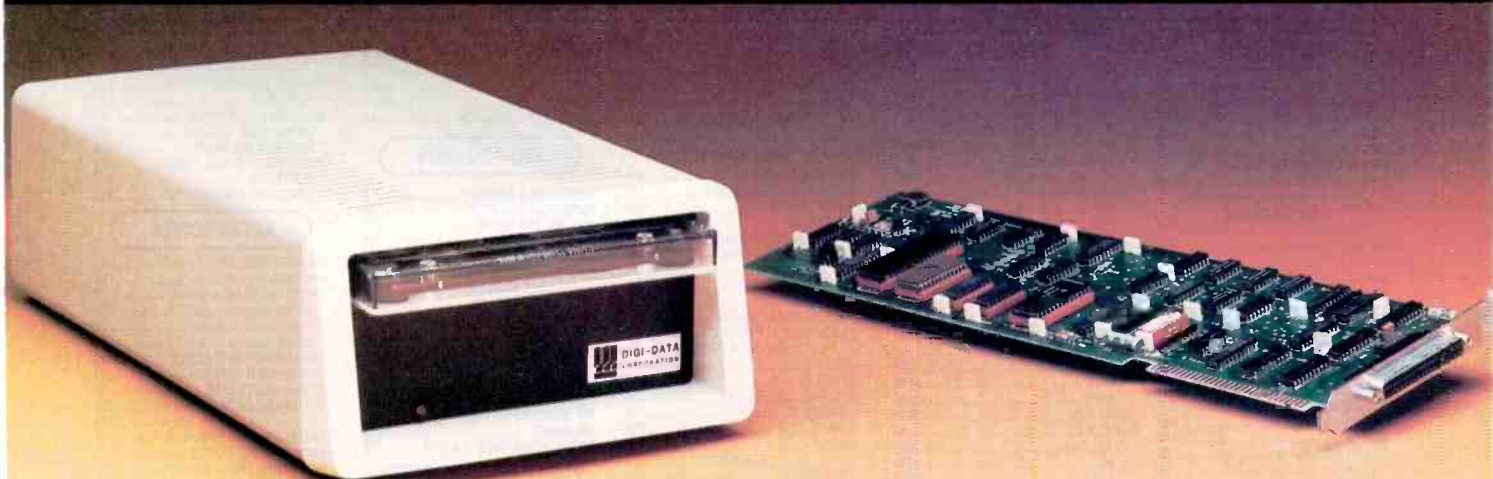
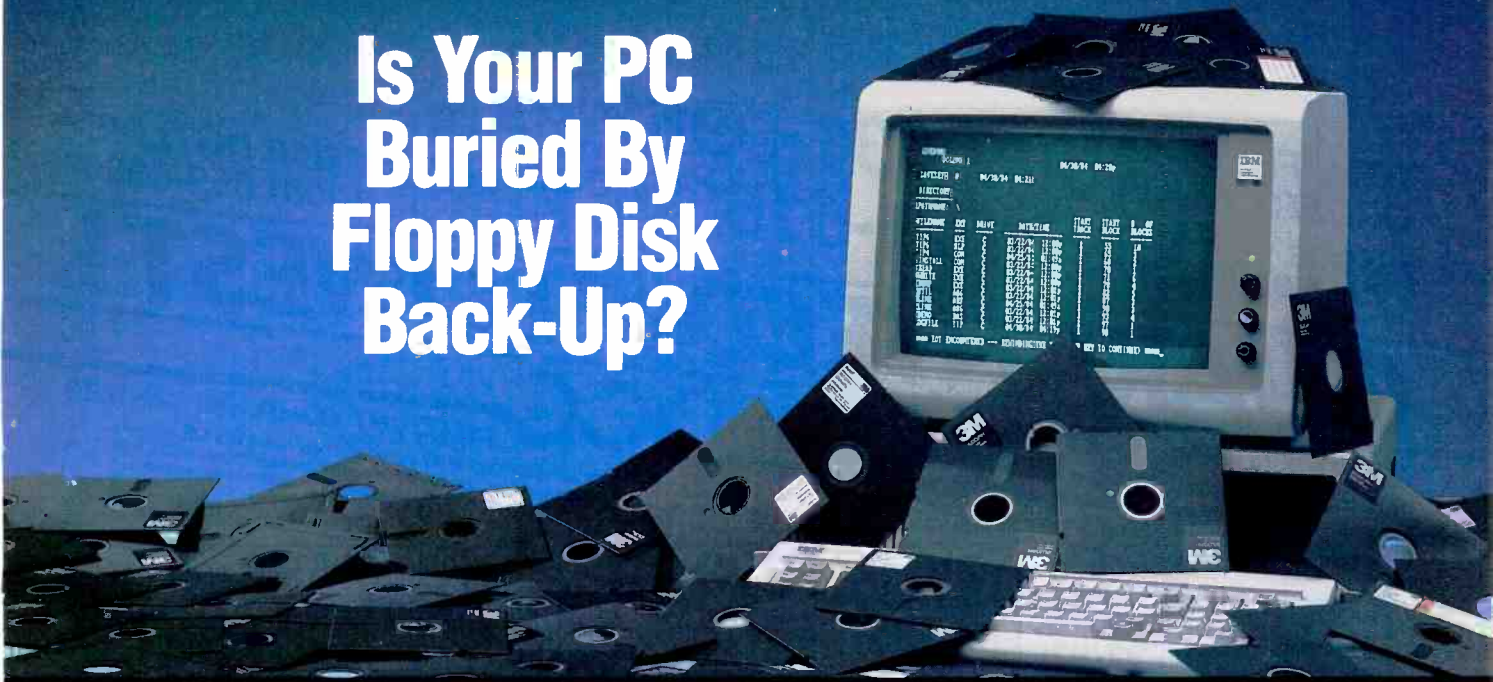

Figure 1: (a) In magneto-optic recording, a magnetic field applied to the medium is not strong enough to affect it until it is heated with a laser beam. (b) A domain of reversed magnetism is formed, which rotates the plane of reflected light (Kerr effect) differently than unswitched regions of media. (c) Erasure and rewriting is accomplished by reversal of the magnetic field. (Courtesy of Alan Bell, IBM Research Division, San Jose, CA.)

# Is Your PC Buried By Floppy Disk Back-Up?



## Dig Out With Model 70 PC Cartridge Tape System

Digi-Data's Model 70 PC cartridge tape system lets you back-up your PC's Winchester drive without getting buried in floppies. One cartridge holds 16.5 Mbytes of data, more than you can put on 51 floppy disks! And you can back-up your 10 Mbyte PC XT® drive in less than 15 minutes of *unattended* operation. That is a small fraction of the time it would take with the PC's floppy, with you standing there changing disks.

Our file-oriented structure makes it possible for you to back-up only what has to be changed on your disk. That saves still more time and storage capacity.

70 PC comes ready to run on your IBM PC XT and most compatibles like Compaq, Columbia Data Products and Eagle. Complete with controller board, driver software and cables.

Digi-Data's products also include 1/2 inch and 1/4 inch start/stop and streaming drives and systems.



DIGI-DATA CORPORATION

... First In Value

8580 Dorsey Run Road  
Jessup, MD 20794  
(301) 498-0200 Telex 87580

In Europe contact:

DIGI-DATA LTD  
Unit 4  
Kings Grove  
Maidenhead, Berkshire  
England SL6 4DP  
Tel. 0628-29555-6  
Telex 847720

® PC XT is a registered trademark of IBM Corporation



TOLL FREE ORDERS ONLY! **800-631-0962**  
 (INSIDE CALIFORNIA) **800-521-6162**

Customer Service HOTLINE  
 (408) 559-6556

**GUARANTEED the LOWEST!**

OUR PRICE GUARANTEE - It's Simple! We'll beat any ad in this magazine - same terms - call TOLL FREE for details!

**DCC DISCOUNT COMPUTER CENTERS**  
 OUR CUSTOMER SATISFACTION GUARANTEE: If for any reason your DCC purchase fails to meet manufacturers specifications within 30 days of purchase, please return it to us for a full refund or exchange of your choice! Sorry, software excluded due to copyright laws.

**EPSON all models!**

RX/FX and LQ1500

Ridiculously Low - \$CALL!!

**82/83**  
 and **92/93!!**  
 all models **OKIDATA**

**IBM PC \$1629** 1 drive 64K  
 with 2 drives 256K

**\$1895**

256K, 10 mg. hard disk  
 1-360Kb drive

**IBM XT**

**\$3895** only

**WORDSTAR PRO PACK**

- Wordstar
- Correct Star
- Star Index
- Mail Merge

only **\$295**

**COMPUTERS**

IBM PC & XT... See special above!!  
 COLUMBIA w/\$3000 retail software!  
 VP Portable - 256K... ridiculously low!!  
 1600-1 2 drives... low!!  
 1600-4 Hard Disk... please call!!  
 VISUAL COMMUTER New 16 lb IBM  
 Compatible 256K, 2 drives... \$CALL

**MONITORS**

IBM MONOCHROME... 259  
 COLOR... 589  
 AMDEK 300G... 129  
 300A... 145  
 310A... 165  
 GORILLA Composite monochrome... Sale!  
 Green or Amber... 85  
 TAXAN 12" Green... 114  
 12" Amber... 117  
 420 RGB... 439  
 PRINCETON HX-12... 467  
 SR-12... 649  
 MAX-12... 184  
 ZENITH 122-12" G... 93  
 12" A... 93  
 124 MONO - IBM... 169  
 133 RGB... 446  
 135 RGB/COMP... 475

**MODEMS**

HAYES 300... 199  
 1200... 468  
 1200B IBM INTERNAL... 398  
 MICROMODEM II E... 229  
 ANCHOR MARK XII... 259

**PRINTERS**

\*\*\*\*\*DOT MATRIX\*\*\*\*\*  
 EPSON RX 80 100 cps... 294  
 RX 80 FT 100 cps... 328  
 RX 100 100 cps. 132 col... 522  
 FX 80 160 cps... low!!  
 FX 100 160 cps. 132 col... low!!  
 LX 1500 200 cps NEW!... low!!  
 OKIDATA 82A 83 84... Save  
 92P... All  
 93P... Models  
 2410... Drastically Reduced!!  
 GEMINI 10-X... 258  
 15-X... 369  
 C-10H PROWRITER... 324  
 \*\*\*\*\*DAISY WHEEL\*\*\*\*\*  
 PRIMAGE I 55 cps, SER PARR... 1495  
 w/Cut Sheet Feeder... 1795  
 BROTHER DAISY WHEEL  
 HR-15... 398  
 HR-25... 662  
 HR-35 (36 cps)... 985  
 JUKI 6100... 429  
 DTC 380 Z... 949  
 DIABLO 620... 829  
 36... 1276  
 630... 1689  
 TTX 1014 SER-PAR TRACTOR... 360  
 DYNAX DX-15... 398  
 SILVER REED 550P... 560  
 NEC 3550... 1645  
 15 LQ P... 559

**DRIVES**

IBM 360 KB... 219  
 TANDON 100-2 360KB... 185  
 PANASONIC HI-360 KB... 149

TEAC 1/2 HI-260 KB... 159  
 SHUGART 1/2 HI-360 KB... 159  
 EVEREX 10 MG H.D. W/CONTROL... 885  
 ATARI INDUS GT... 349

**IBM SOFTWARE**

\*\*\*\*\*SPREADSHEETS\*\*\*\*\*  
 FRAMEWORK Monthly Special... 439  
 MANAGING YOUR MONEY... 138  
 SUPERCALC 3... 228  
 MULTIPLAN... 126  
 \*\*\*\*\*IBM WORDPROCESSORS\*\*\*\*\*  
 WORDSTAR PRO PACK... 298  
 PFS WRITE... 84  
 MULTIMATE... 268  
 WORD W/MOUSE... 285  
 VOLKSWAGEN DELUXE... 179  
 PEACHTREE SOFTWARE all... \$CALL  
 \*\*\*\*\*IBM DATA BASE\*\*\*\*\*  
 dBASE II... 284  
 dBASE III... 411  
 PFS FILE... 84  
 CONDOR III... 289  
 R-BASE 4000... 285  
 FRIDAY... 182  
 \*\*\*\*\*IBM MISC\*\*\*\*\*  
 CROSSTALK... 104  
 COPY II PC... 29  
 MASTERTYPE... 37  
 PROKEY 3.0... 85  
 HARVARD PROJECT MGR... 245  
 SIDWAYS... 45  
 NORTON UTILITIES... 55  
 PFS REPORT... 79  
 DOW JONES... 219  
 SET FX +... 47  
 \*\*\*\*\*IBM GAMES\*\*\*\*\*  
 FLIGHT SIMULATOR... 34

**IBM - BOARDS**

HERCULES GRAPHICS... 315  
 HERCULES COLOR New!... 199  
 AST SIX PAK W 64K... 249  
 MEGAPLUS... 259  
 STB GRAPHIX PLUS... 322  
 EVEREX GRAPHIC EDGE... Low!!  
 H.D. CONTROLLER... 299  
 MAJIC CARD... Low!!  
 QUADRAM QUADBOARD W/64K... 269  
 QUADBOARD I... 199  
 QUADLINK... 449  
 IBM MONOCHROME... 249  
 COLOR GRAPHICS... 219  
 PLANTRONICS COLOR PLUS... 358  
 MA SYSTEMS PC PEACOCK... 300 w...  
 GRAPHICS... 235  
 TECHMAR GRAPHICS MASTER... 475

**IBM ACCESSORIES**

64K RAM CHIPS 200ns... 44  
 150ns... 48  
 IBM KEYBOARDS... 179  
 KEYTRONICS 5151 NEW!... 199  
 5150... 189  
 MICRO-SOFT MOUSE... low!!  
 MOUSE SYSTEM-MOUSE... 149  
 KOALA PAD... 85  
 KRAFT JOYSTICKS... 45

**APPLE - BOARDS**

ORANGE MICRO GRAPPLER... 113  
 BUFFERED... 168  
 MICROMAX GRAPHMAX... 99  
 VIEWMAX 80... 139  
 VIEWMAX 80E W/64K... 189  
 MICROSOFT 16 RAM CARD... 75  
 SOFTCARD... 239  
 SOFTCARD PREMIUM PAK... 475

**ACCESSORIES**

PRINTER RIBBONS all makes... Low!!  
 64K RAM chips SALE... 44  
 VERBATIM SS DD diskettes... 21  
 DS DD diskettes... 28  
 DYSAN SS DD diskettes... 26  
 DS DD diskettes... 34  
 DISK MINDER-PLEXI (75)... 29  
 DISK MINDER W/KEY (100)... 34  
 SURGE PROTECTOR Compugard... 69  
 PTI POWER BACK-UP 200 w... 329  
 300 w... 549  
 FINGERPRINTS - EPSON all models... 48  
 PRINTER DUST COVER all models... 10  
 MONI-BASE Monitor Stands... 22  
 COMPUTER PAPER all makes... Low!!  
 PRINTER STANDS Plexiglass... 29/39  
 COMPILERS... \$CALL

**ATARI/C-64**

ACCESSORIES low-low... CALL!!  
 C-64 CARDCO + G... 79  
 ATARI MP1150... 94  
 APE FACE... 69  
 PRINTER INTERFACES all... \$CALL

**QUADRAM 384K QUADBOARD**  
 w/64K RAM **\$249**

**AST \$229 SIX PAK PLUS**  
 w/64K RAM **\$249**

**FRAMEWORK ASHTON-TATE**  
 It's Here! **\$429**

**EVEREX GRAPHICS EDGE**  
 IN STOCK!

**SHUGART 1/2 Hi-Drives \$149**  
**IBM™ \$219**  
 360Kb drvs.

**DCC DISCOUNT COMPUTER CENTERS**  
 an established mail order/retail distribution network

BUYER FRIENDLY TERMS! • DELIVERY We ship immediately! Most orders delivered within 5 days! Add 3% (15% min) for UPS shipping, handling, insurance Calif. residents add 6.5% sales tax. 2nd day UPS available at extra charge. • PAYMENT Visa, M/C, cashiers checks, money orders, personal checks accepted. (Allow 10 business days for personal/company checks to clear). WE NEVER CHARGE EXTRA FOR CREDIT CARDS! C.O.D.'s welcome (20% p.p. deposit) with cash, certified check or money order. • WARRANTY All items shipped are new, include FACTORY WARRANTY and are GUARANTEED TO WORK. DCC is an AUTHORIZED DEALER and SERVICE CENTER for most major brands. • RETURNS Must be accompanied by RMA number (supplied by DEALER) and may be subject to a 20% restocking fee. Prices and availability subject to change without notice. All items limited to stock on hand. • MAIL ORDER PRICES NOT VALID AT RETAIL OUTLETS DUE TO REGIONAL PRICING RESTRICTIONS. Minimum order \$50.

FREE - VISA/MC!



1707 S. BASCOM AVE • SAN JOSE, CA 95008 • (408) 559-6556  
 1243 W. EL CAMINO • SUNNYVALE, CA 94081 • (415) 965-4494  
 1341 FULTON AVE • SACRAMENTO, CA 95825 • (916) 971-3503

**VISIT OUR DISCOUNT SHOWROOMS!**

## IBM may be close to releasing a read-only optical-disk that holds 40 mb of software.

and reading at 1 milliwatt. Erasing is done at 780 nanometers with 10 milliwatts of incident laser power, creating a spot 1 by 10 microns in size, small enough to allow almost simultaneous erasing and recording with a single focusing lens. Matsushita claims over 1 million erase cycles (erasing and rewriting a million times) have been achieved with its disk, which spins at 1800 revolutions per minute (rpm). When in mass production in several years, Matsushita expects its 8-inch erasable disk to retail for \$30, with the write-once disk selling for \$20. The Panasonic digital data erasable drive and media with 700 megabytes of user capacity on one disk side will be introduced by Matsushita in the spring of 1985.

Phase-change media do not require as complicated a drive as magneto-optics, and they permit nonalterable recording by increasing laser power to the point of permanently burning holes in the recording layer rather than simply changing its phase. Recently, several erasable polymer/dye binder media have been shown that offer the simplicity of drive design of phase-change media, but are producible at lower cost without using toxic materials such as tellurium, selenium, and arsenic.

### COMPACT-DISK TECHNOLOGY

In the spring of 1983, compact-disk (digital-audio) players from Sony went on sale in the United States at a list price of \$900. By October of that year, 20 brands of players were on sale and list prices had dropped to \$400, less than half the price of the first models a year earlier. This is rare with a new consumer product. The spectacular success of compact-disk players enabled makers of critical components to build up such large inventories that the price of integrated op-

tical heads dropped to about \$40. This year, they are expected to drop to \$20, making a \$200 player possible, the price at which retailers expect massive product acceptance. Over 500,000 players and 10 million disks were sold worldwide in 1983, making the compact disk the most successful new electronic product ever introduced.

Digital-data versions of compact-disk players will be on sale as small-computer peripherals this year, called either OROM (optical read-only memory) or CD-ROM (compact-disk read-only memory). N.V. Philips and Sony, codevelopers of the compact disk, are supporting a standard for putting 550 megabytes of user data on a replicated 4.72-inch (12-cm) disk that transfers data at 1.44 megabits per second. (An entire replicated disk is stamped from a master disk, similar to the way records are made—as opposed to copying information bit by bit, as in floppy-disk reproduction.) IBM is believed to be close to releasing a read-only replicated optical-disk system with a smaller, faster format—possibly as small as 2 inches—containing 40 megabytes of information, including the UNIX operating system,

application software, and various databases.

The compact disk has done for optical-disk-drive developers what they had expected the slower-selling optical videodisc players to do: dramatically lower the cost of lasers, tracking and servo mechanisms. Accordingly, several firms have announced plans to build very low cost read/write optical drives, using as many components as possible common to compact-disk players and magnetic-disk drives. Developers are taking this strategy of producing drives and disks at relaxed technological levels before pushing for maximum capacity and performance.

An example of this strategy is Information Storage Inc. in Colorado Springs, Colorado, which has announced plans to introduce a 5¼-inch write-once optical drive in the spring of 1985 at original equipment manufacturers (OEMs) prices below \$800. The first drive product will have 150 megabytes of user data, less than one-third the capacity possible. Erasable drives are expected about one year later.

At the Tokyo Business Show in May

(continued)

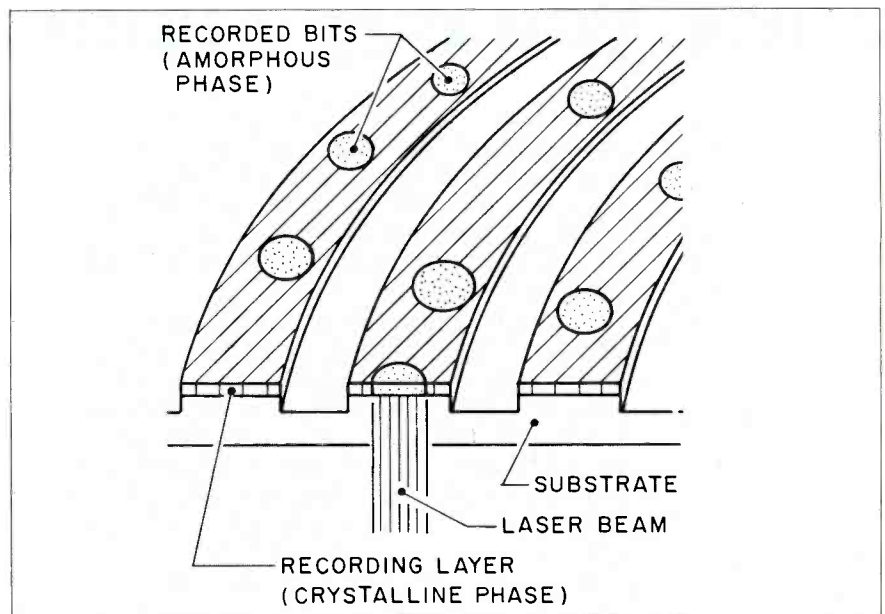

Figure 2: Phase-change recording involves the transition of media from a high-reflectivity (crystalline) phase to a low-reflectivity (amorphous) phase.



1983, Hitachi, Matsushita, NEC, Sanyo, Sharp, Sony, and Toshiba showed complete optical-disk document-storage systems. At the National Computer Conference in Anaheim, California, that month, NEC showed its drive, and an Optical Peripherals Laboratory drive was shown by Control Data. All of these drives are designed to be controlled by a mini-computer or supermicrocomputer. Most use 12-inch disks with user capacity over 1000 megabytes on a side; several double-sided disks are already available.

**FUTURE DIRECTIONS**

Among the 79 papers at the huge optical-memory conference held in June 1983 in Arlington, Virginia, were several that indicated possible future directions the technology might take: stacks of small optical disks spinning at very high rpm to achieve high data

rates; polymer/dye binder media for high packing density (the number of bits that can be handled per inch of media) and low manufacturing cost, leading to optical floppy disks; and a variety of materials for erasable media including: combinations of terbium, iron, gadolinium, cobalt, and dysprosium; tellurium alloys; liquid crystal; vanadium dioxide; yttrium indium garnet; and photochromic and photodichroic materials (whose optical characteristics change upon exposure to radiant energy).

Last summer, I had the opportunity to visit nine research and development facilities in Japan as part of an international study of optical disk drive and media projects. Perhaps the most significant insight into the near-term viability of optical storage came from Professor Shinichi Iwasaki of Tohoku University, one of the world's most highly regarded authorities on

high-density, vertical magnetic recording. It is Dr. Iwasaki's opinion that vertical magnetic recording is most suited to lower-capacity flexible disks and tape, not rigid disks, and that the head design must be changed for rigid-disk vertical recording. According to Dr. Iwasaki, higher flying heights are possible with perpendicular than with longitudinal recording, but vertical magnetic media production is currently limited by the technology for deposition of thin-film recording media on a substrate, known as sputtering. He indicated that it may be possible to produce vertical media with vacuum evaporation, another thin-film deposition technique.

Professor Iwasaki feels that vertical magnetic recording is much easier to accomplish than magneto-optic recording, but mass production of vertical magnetic media awaits improvement in vacuum deposition, which he

# 10,000,000 FREE

## When you buy a Primage I Printer.

When you buy a Primage I printer, Primages will give you, absolutely FREE, four daisy wheels in the fonts of your choice and 42 ribbon cartridges. That's enough cartridges to print about 10,000,000 characters. All told, a \$300.00 value!

And the printer is an even greater value. It utilizes patented new technology that is simpler, less expensive and more reliable than other printers on the market today. In addition to the new technology there are new design features as well. Like the time-saving automatic forms thickness adjustment. Dual interface ports that can connect virtually any computer system without special adaptor cables. And a snap-on sheet feeder that can feed 200 sheets without reloading—and without skew or crunch.



thinks will take several years. The problems associated with perfecting such high-density, high-capacity rigid magnetic media indicated that a window of opportunity has been opened for optical-memory developers, during which optical storage can take hold without fear of serious competition from high-density magnetics.

Furthermore, even if vertical or other high-density magnetic recording techniques are perfected for rigid-disk applications, researchers will still have to cope with their most serious drawbacks compared with optical recording: they are not removable and should be backed up, requiring additional hardware, media, space, personnel, and cost.

A milestone occurred at the by-invitation-only September 1983 meeting at Lake Arrowhead, California, where U.S. magnetic-industry gurus admitted privately that serious

problems exist in making rigid vertical magnetic media work, and that magneto-optic media look promising. It was said that small low-cost magneto-optic drives might experience tremendous growth similar to micro-Winchester drives.

One sign of the concession to magneto-optic technology was the suggestion by Leonard J. Laub, president of Vision Three consulting firm, that the technology be dubbed "optically assisted magnetic recording"—a term that both camps readily endorsed.

**PRODUCT INTRODUCTIONS**

Storage Technology Corporation (STC) on September 20, 1983, became the first to introduce an optical disk drive and media for mainframe computer users. Although its drive subsystem is priced high at \$130,000 for the drive and \$40,000 to \$70,000 for the controller (depending on its configura-

*Vertical magnetic media are not removable and should be backed up.*

tion), STC's 14-inch write-once phase-change disk with 4000 megabytes of user capacity is priced at \$140 to quantity buyers. This drops the cost per stored megabyte to five cents, much lower than any magnetic media.

Also in late September, KDD and Sony announced joint development of a magneto-optic erasable disk using a terbium-iron-cobalt material that yields over 52 dB carrier-to-noise ratio at 1 megahertz. The disks are designed for digital and analog uses including continuous-motion (as opposed to still-frame) video recording.

*(continued)*

# CHARACTERS!\*

Primage I will print perfect, letter quality manuscripts at a brisk 45 characters per second. There's absolutely no preventative maintenance required. And it's serviced nationally by Sorbus at their lowest printer rates. Yet it costs hundreds of dollars less than other, less capable printing systems.

See your Primages dealer for a demonstration of the Primage I, and for details about our remarkable 10,000,000 free character offer or attach your business card to this ad and send it to Primages.

\*Offer good for 4 free daisy wheels and 42 free ribbon cartridges with purchase of each Primage I printer. Retail value \$300.00. Expires 11/30/84.

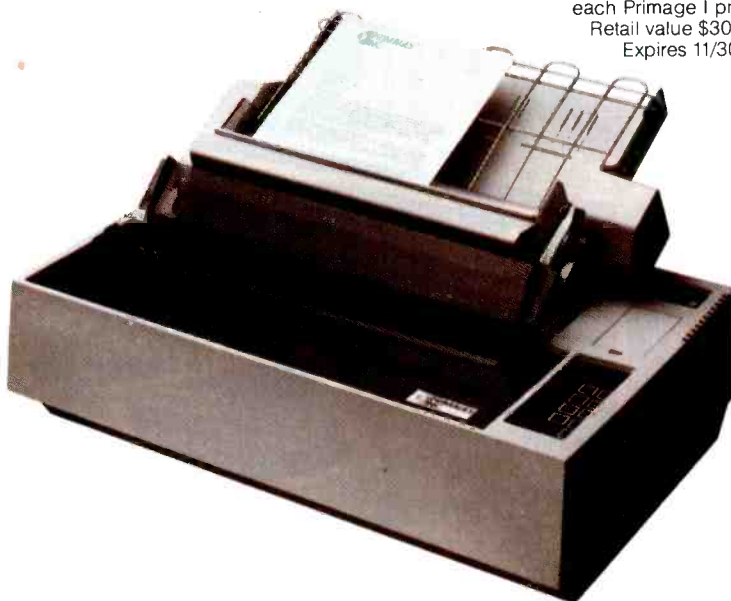



Products using the disks are due in 1985. The performance of the disk is considered by those familiar with it to be among the best developed to date.

Optimem introduced its drive on October 10, 1983, using gold-platinum alloy write-once media supplied by the French firm, Thomson-CSF. The Optimem drive has a user

capacity of 1000 megabytes and is aimed at mini- and supermicrocomputer OEM digital and image applications, especially documented storage and retrieval. Optimem, a division of Xerox's Shugart Associates, is offering the first medium-priced American optical drive to OEMs at \$6000 to \$9000. Thomson-CSF introduced

its drive and media in Paris on November 17, 1983, aimed at the same users as Optimem.

At the 1983 Data Show in Tokyo, Canon and Hitachi each introduced complete optical-disk-based document-storage systems. To date, Canon has shown the most comprehensive and cost-effective optical-disk-based system. Canon's system integrates micrographic, magnetic, and optical storage systems under one controller, and includes very high resolution scanning, display, laser printing, and telecommunications. The system goes on sale in Japan in late 1984 at about \$40,000, or about half the price of other electronic filing systems with similar features. Both Hitachi's and Canon's drives can be used for digital-data applications, as they correct errors to  $10^{-12}$  (one every  $10^{12}$  bits), the maximum hard error (corrected) rate tolerable to the computer industry.

At the seventh Applied Magnetics Conference in Tokyo in early November 1983, 35 magneto-optic papers were presented, indicating how serious Japan is about developing erasable optical media. Included were papers from a large number of firms not previously known to be active in optical-recording research. The emphasis was on advances in carrier-to-noise ratio and environmental stability.

#### NONDISK FORMATS

We have discussed mostly optical-disk and compact-disk developments, but the past year was also a year in which nondisk formats attracted increasing attention. Drexler Technology Corporation ended the year with 13 licensees signed to distribute its laser cards, which are the size of credit cards and have optical media on them. Most of the licensees will manufacture their own read/write or read-only hardware. The read-only cards will soon be used in small computers for operating systems, application software, and distributed databases (such as catalogs, price lists, etc.). Read/write laser cards will be used for many of the same applications as

(continued)

# WIPE OUT STATIC FAST

It's easy with Staticide® Wipes.™

One quick application cleans CRT screens, copiers, keyboards, or any clear surface. And as it cleans, Staticide Wipes will eliminate static—the major cause of dust attraction on CRT screens, computer glitches, malfunctions and downtime. And these handy towelettes are non-streaking and will not leave a vision impairing residue. So instead of tuffing down, you can get down to work! Consider the thousands of dollars you've invested in equipment. And now a few cents more will help keep it clean and operating, without the risk of harming sensitive electronic components.

**Staticide WIPES**  
The towelette for cleaning and static control

**Staticide® WIPES™**  
A product of ACL, Incorporated  
1960 E. Devon Avenue  
Elk Grove Village, IL 60007  
(312) 981-9212

**WHEN HEWLETT-PACKARD  
DEVELOPED A PERSONAL COMPUTER  
PRINTER THAT USES A QUIET JET OF INK,  
PRINTS 150 CHARACTERS PER SECOND  
AND COSTS ONLY \$495,**

**THE WORD TRAVELED FAST.**



**hp** HEWLETT  
PACKARD

## **THINKJET.**

Hewlett-Packard research has used inkjet technology to make the ThinkJet personal computer printer surprisingly quiet while printing 150 high quality, dot-matrix characters per second for text or graphics. The ThinkJet printer weighs only 6½ pounds and it takes up just a bit more room than your telephone. So, it can work right on your desk. There's even a battery-powered model that lets you print anywhere. And, the ThinkJet printer's ink supply and printhead are designed in one neat disposable unit that simply clicks out when it's time to change.

The ThinkJet printer will work with most popular personal computers, including Hewlett-Packard, IBM®, COMPAQ™, TI® or Apple IIe®.

Finally, as quiet, fast and compact as the ThinkJet printer is, it still has one more feature that's going to cause a commotion; its price... \$495.00\*.

See the entire family of personal computers, software and peripherals at your authorized Hewlett-Packard dealer.

Call (800) FOR-HPPC for the dealer nearest you.

Setting You Free

**hp** HEWLETT  
PACKARD

PG02409 276 W

IBM is a registered trademark of International Business Machines Corporation. COMPAQ is a trademark of COMPAQ Computer Corporation. TI is a registered trademark of Texas Instruments, Inc. APPLE is a registered trademark of Apple Computer, Inc. \*Suggested retail price.



*Optical media may soon allow a personal computer to replace a costly graphics system.*

floppy disks but are so compact that the cards lend themselves to use in hand-held computers. It seems clear that there will soon be several other vendors offering optical-card media, and a number of media vendors are interested in optical tape. One of Drexler's licensees, NCR, may put 100 megabytes of user data on an optical card. Incidentally, Drexler says that almost all of the interest in its disks for the past year has been for its 4.72-inch (12-cm) size.

Interactive videodisc technology finally came into its own in 1983, due largely to its discovery by the video-arcade-game industry. The boom put Pioneer's videodisc hardware and disk-pressing operations in the black and has brought several other companies' videodisc programs much closer to profitability.

Although there are signs that the arcade-game sales boom is weakening, computer, automobile, telephone, and defense applications are more stable and represent the long-term growth of interactive videodisc technology. There was strong growth in the past year in point-of-sales, industrial training, simulations, military use, and educational applications. Orders for hundreds or thousands of systems are coming in with increasing frequency. The capabilities and speed of computer-controlled videodisc systems are increasing, and with the dramatic decreases in price due by year's end with the introduction of fully integrated systems, there is no longer doubt that the continued growth of the optical videodisc is assured.

#### COMING THIS YEAR

Two significant optical-memory announcements have already been made in 1984: Optical Disc Corporation and Matsushita each announced

real-time direct-read-after-write (DRAW) videodisc recorders for delivery in midyear. Optical Disc Corporation will sell its 12-inch polymer/dye media for as little as \$50.

The rest of 1984 should see numerous 8-inch and 12-inch optical disk and drive announcements. I expect several read/write and read-only disk announcements shortly from IBM and others, offering from 40 to 550 megabytes of user data on disks that range from 2 inches to 5¼ inches. What will users do with that much storage in a small computer? They will store huge databases, graphics, CAD/CAM, documents, and images on those disks.

By the end of 1984, we expect to see desktop computers with single-user 5¼-inch or smaller optical-disk-based storage systems for under \$15,000 and capable of document and image storage, data processing, word processing, CAD/CAM (computer-aided design/computer-aided manufacturing), and graphics. Multiple-user systems with two drives, four high-resolution displays, input scanner, page printer, operating system, application software, and a jukebox holding 50 disks will be sold by an American systems integrator for under \$65,000.

The ability of optical media to store huge numbers of images and digital data will make it feasible for low-cost personal computers to replace expensive computer graphics systems and will result in the same explosive growth as the magnetic drive and media business experienced in the last few years.

The actual growth rate of 5¼-inch floppy-disk drives last year was 270 percent, but magnetic-industry forecasters had predicted only a 54 percent rise. This proves the public's appetite for ever greater data storage capacity and leads some observers to call us "informivores."

That is one reason why 64 firms are now researching or developing optical drives and media, including companies from Atari to Xerox. Obviously, there will be a shakeout of many of these organizations, but many new firms and startups entered the busi-

ness last year, and more will do so this year.

#### OBJECTIONS ANSWERED

Objections to optical recording have been raised by magnetic partisans. Some of these are simply not fair. Why wait for adoption of interchange standards before using optical disks? That will probably occur within three years; officially sanctioned standards groups have been at work for over a year in the U.S., Europe, and Japan. It took the magnetic industry 17 years to arrive at magnetic tape interchange standards, and people did not wait to see if magnetic media were archivable for 10 years before using them. Magnetic media do not last that long and there is no reason that all optical media must do so. There will be as wide a range of optical media as magnetic, with varying archivability, cost, quality, performance, size, and shape. There is also no reason to wait for erasability; for many optical-storage applications, erasability is neither needed nor desired. After all, if we waited for erasability, we might never have used photography.

#### CONCLUSION

I believe that optical storage definitely will become established as a major information storage and retrieval technology by 1990. I forecast a U.S. installed base of over 8.5 million optical drives in 1990, of which 5¼-inch and smaller optical drives should total over 90 percent, or 7.7 million units. Similarly, 5¼-inch and smaller optical disks will account for over 90 percent of the 553 million disks to be sold in the U.S. in 1990.

There definitely remain problems to be solved concerning optical media and drive stability, producibility, and erasability. Nevertheless, the benefits of optical-storage technology—such as removability, huge capacity, low cost per bit stored, no backup hardware or media needed, no media wear, and the ability to mix digital data, still images, motion video, and audio on the same medium with viable cost/benefits—will ensure that the effort to solve the problems will be worthwhile. ■

# THE SAKATA CONNECTION

## Your personal computer deserves the unequalled monitor quality of Sakata

Your computer deserves the most monitor quality value possible...and so do you. SAKATA CRT DISPLAY MONITORS give you more monitor quality than the most expensive monitors available. Each SAKATA MONITOR provides unequalled color reproduction; sharpest and most vivid graphics; text that you read more easily than you ever expected; and technical characteristics and capabilities that will amaze you.

Protect your personal computer's

performance by utilizing SAKATA CRT MONITORS which provide the utmost in monitor value. Choose from an entire line of Composite Color; RGB High Resolution Color; RGB Super High Resolution Color and two monochromes (green and amber) that have more quality than other monochrome monitors. **"We promise performance"**.

SAKATA CRT MONITORS are available wherever personal computers are sold or write for technical and illustrated literature and prices.

SAKATA U.S.A. CORPORATION  
651 Bonnie Lane, Elk Grove Village, IL 60007  
(312) 593-3211 800-323-6647 (outside Illinois)

# Sakata

"Serving industry worldwide since 1896"

SC-100  
COLOR COMPOSITE



SC-200  
RGB HIGH  
RESOLUTION COLOF



SC-300  
RGB SUPER HIGH  
SOLUTION COLOR



SG-1000  
MONOCHROME GREEN



SA-1000  
MONOCHROME AMBER

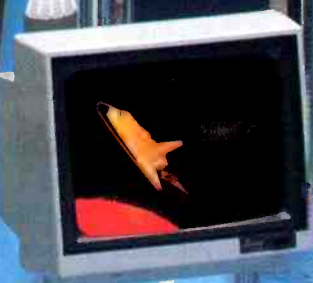



# COMPUTER WAREHOUSE

CALL TOLL FREE **1-800-528-1054**

## PRINTERS

<b>Brother</b>	
DX-15	\$369
HR-25	\$619
HR-35	\$875
<b>C-Itch</b>	
A10-30	\$459
F-10 Parallel or Serial	\$909
55 CPS Serial or Parallel	\$1189
8510 Parallel (Prowriter)	\$315
8510 SP	\$435
8510 SCP	\$509
8510 BPI	\$335
<b>Computer International</b>	
Daisywriter 2000 W/48K	\$985
<b>Comrex</b>	
CR-2 Parallel or Serial	\$429
CR-2 Keyboard	\$129
CR-3	Call
<b>Datasouth</b>	
DS180	\$1149
DS220	\$1469
<b>Diablo</b>	
620	\$729
630 API	\$1609
630 ECS	\$1999
630 ECS/IBM	\$1879
Series 36	\$1245
<b>Epson</b>	
All Printer Models	Call
<b>Inforunner</b>	
Riteman	\$249
<b>Juki</b>	
5500	Call
6100	\$409
6300	Call
<b>NEC</b>	
2010	\$639
2015	\$639
2030	\$639
2050	\$785
3510	\$1215
3515	\$1215
3530	\$1215
3550	\$1509
7710	\$1649
7715	\$1649
7730	\$1649
P2	Call
P3	Call
<b>Okidata</b>	
All Printer Models	Call
<b>Panasonic</b>	
1090	Call
1091	Call
1092	Call
<b>Qume</b>	
Letter Pro 20 Parallel or Serial	\$619
11/40 W/Interface	\$1369
11/55 W/Interface	\$1569
<b>Silver Reed</b>	
EXP400	\$289
EXP500 Parallel	\$355
EXP500 Serial	\$419
EXP550 Parallel	\$419
EXP550 Serial	\$419
770P	\$849
770S	\$849
<b>Star Micronics</b>	
All Printer Models	Call
<b>Tally</b>	
MT 160L	\$555
MT 180L	\$769
Spirit 80	\$255
<b>Toshiba</b>	
P1340 Parallel or Serial	\$719
P1351 Parallel or Serial	\$1249
<b>Transtar</b>	
120 Parallel or Serial	\$395
130 Parallel or Serial	\$549
<b>MODEMS</b>	
<b>Hayes</b>	
Smartmodem 300 Baud	\$199
Smartmodem 1200 Baud	\$480
Smartmodem 1200B Baud (IBM)	\$405
Micromodem II E (Apple)	\$225
<b>US Robotics</b>	
212A Autodial	\$419
Password 1200	\$309

**TECMAR**

**HARD DISK SUB-SYSTEMS**

## Macintosh

5 Megabyte Removable	\$1480
10 Megabyte Fixed	\$1480
10 Megabyte Fixed/5 Megabyte Removable	\$2450
5 Megabyte Fixed/5 Megabyte Removable	\$2450

10 Megabyte in Mini Cabinet	\$1775
15 Megabyte in Mini Cabinet	\$2050
5 Megabyte Removable in Mini Cabinet	\$1495

## VIDEO TERMINALS

<b>ADDS</b>	
A-2 Green	\$469
A-3	\$469
Viewpoint 60	\$485
Viewpoint 90	\$849
<b>Altos</b>	
Smart II	\$899
<b>Qume</b>	
QVT 102 Green	\$535
QVT 102 Amber	\$545
QVT 103 Green	\$850
QVT 103 Amber	\$850
QVT 108 Green	\$629
QVT 108 Amber	\$639
<b>Televideo</b>	
910	\$439
910+	\$515
914	\$515
924	\$635
925	\$700
950	\$905
970	\$985
800A (User Station)	\$979
Personal Terminal	\$385
<b>Wyse</b>	
50	\$489
75	\$565
<b>Zenith</b>	
Z-29	\$599

## MONITORS

<b>Amdek</b>	
All Monitors	Call
<b>Princeton Graphic</b>	
HX-12	\$479
<b>Sanyo</b>	
CRT-30	\$99
CRT-36	\$149
CRT-50	Call
CRT-70	\$549
<b>Sony</b>	
19" RGB (KX1901A)	\$709
25" RGB (KX2501A)	\$1089
<b>Taxan</b>	
12" Amber	\$125
<b>Zenith</b>	
ZVM-122 Amber	\$95
ZVM-123 Green	\$95
ZVM-124	\$129
ZVM-133 Color/RGB	\$410
ZVM-135 Color/RGB W/Audio	\$459
<b>Rana</b>	
Elite I	\$215
Elite II	\$340
Elite III	\$410
Controller (W/Drive Only)	\$65
1000 W/DOS for Atari	\$305

## COMPUTERS

<b>Altos</b> All Computer Models		Call
<b>Columbia</b>		Call
<b>Eagle</b> All Computer Models		Call
<b>Leading Edge</b> Personal Computer		Call
<b>NEC</b>		
PC-B201 Computer	\$459	
PC-B201A-90 Battery Pack	\$17	
PC-B206A 32K Ram	\$305	
PC-B271A-01 AC Adapter	\$17	
PC-B271A-02 AC Adapter	\$17	
PC-B281A Recorder	\$89	
<b>Northstar</b>		
All Computer Models	Call	
<b>Sanyo</b>		
MBC-550 System	Call	
MBC-555 System	Call	
MBC-550-2 System	Call	
MBC-555-2 System	Call	
1150 System W/5000 Printer	\$1599	
<b>Televideo</b>		
802H	\$4285	
803	\$1765	
803H	\$2850	
806/20	\$4640	
TPC-1	\$1539	
TPC-2 Dual Drive	\$1749	
TPC-2 Single Drive	\$1509	
1605	\$1729	
<b>Zenith</b>		
Z-150 Single Drive	Save 25%	
Z-150 Dual Drive	Save 25%	
Z-150 W/10 Megabyte	Save 25%	
Z-160 Single Drive	Save 25%	
Z-160 Dual Drive	Save 25%	

## DISKETTES

<b>Maxell</b>	
MD-1 (Qty 100)	\$175
MD-2 (Qty 100)	\$225
<b>Scotch</b>	
5 1/4 SS/DD (Qty 100)	\$175
5 1/4 DS/DD (Qty 100)	\$245
<b>Elephant</b>	
5 1/4 SS/SD (Qty 100)	\$155
5 1/4 DS/DD (Qty 100)	\$218
<b>FUJI</b>	
MD1 D (Qty 100)	\$159

## TECMAR

Graphics Master	\$449
128K Dynamic Memory	\$225
256K Dynamic Memory	\$299
Captain 128K	\$299
Captain 256K	\$399

## SONY

<b>Walkman</b>		<b>Video Recorders</b>	
FM/Stereo Cassette (WM-F10)	\$111	Beta Video Recorder (SL2300)	\$389
Stereo Cassette	\$85	Beta Video Recorder w/Remote (SL30)	\$499
<b>Watchman</b>		<b>Beta Movie</b>	
AM/FM Stereo TV (FD30A)	\$222	Beta Movie Camera (BMC-110K)	\$1165
B & W TV	\$172	Other Sony Products	Call

Order Line: 1-800-528-1054

Order Processing & Other Information: 602-954-6109



2222 E. Indian School Rd.  
Phoenix, Arizona 85016

Store Hours: Mon-Fri 10-5:30 Saturday 9-1  
Order Line Hours: Mon-Fri 8:30 - 5:30 Saturday 9-1



Prices reflect 3% to 5% cash discount. Product shipped in factory cartons with manufacturer's warranty. Please add \$8.00 per order for UPS shipping. Prices & availability subject to change without notice. Send cashier's check or money order...all other checks will delay shipping two weeks.

# A DATABASE CATALOG

BY GEORGE BOND

*47 database programs  
at a glance*

THE DATABASE-MANAGEMENT systems described on the following pages include a few old favorites and represent a selection of the new generation of programs designed to take advantage of the new generation of microcomputers with their larger memories and faster processors.

With new database-management systems (DBMSs) coming on the market at an incredible pace, we made no attempt to compile a fully inclusive list of programs. Indeed, this would be impossible for anything but an on-line electronic publication—and even an on-line system would keep its operator busy making additions and updates.

The programs are grouped into three broad classes:

- file managers
- relational database managers
- multiuser DBMSs

File managers are roughly the equivalent of a robotic arm and eye that leaf through a card file. They might include sophisticated features but are limited to working with a single file at a time. Relational has

taken on many meanings when used to describe a microcomputer-based database program. In general, it means that the user can manipulate more than one file at once when creating reports. It also means that new files can be created—"joined"—from sections of two or more existing files.

Some of the programs listed in this survey have versions that run on local-area networks (LANs). Ideally, a multi-user program would lock a record when it is in use so that only one user at a time could change it. This is not always the case. Databases coupled to LANs constitute a rapidly growing trend. Since we compiled the list, a number of other companies have released programs for use in LANs or have announced their intention to do so.

Some other trends are clear. Just a few years ago, the only powerful DBMS programs generally available for micros were dBASE II, Condor,

.....  
*George Bond is managing editor of User News for BYTE. He can be contacted at POB 372, Hancock, NH 03449.*

MDBS, and a handful of others. Today, the choice is so wide as to be bewildering. Off the shelf you can buy relational systems or hierarchical systems; systems using B-trees or inverted B-trees or keyed sequential indices; menu-driven systems and command-driven systems; query-by-example systems and systems with query languages modeled on the mainframe world's SQL (system query language). Even the low end of the market is getting reasonably powerful DBMS programs—there is even a "freeware" DBMS with muscle for the IBM PC.

Prices have not risen proportionally with power. Many very flexible and powerful DBMS programs sell for well under \$500 (in real, what-you-actually-pay prices, \$595 and \$695 still seem to have some sort of magic as list prices) and few DBMS programs for micros break the kilobuck barrier.

The information in the table was provided by the programs' vendors. Most of the research was done by Faith Kluntz and Beverly Jackson, two of the unheralded stalwarts of the BYTE staff.

*(continued)*



# CATALOG

## FILE MANAGER PROGRAMS

PRODUCT NAME	Aura	BPI Information Management	CataList	Concentric Information Processor (CIP)	Database Manager II/ The Integrator
<b>VENDOR</b>	Softrend, 2 Manor Parkway, Salem, NH 03079, (603) 898-1896	BPI Systems Inc., 3423 Guadalupe, Austin, TX 78705, (512) 454-2801	Stone and Associates Software Publishing Inc., 7910 Ivanhoe Ave., Suite 319, La Jolla, CA 92037, (800) 624-2262; in CA (619) 459-9173	Concentric Data Systems Inc., 18 Lyman St., Westboro, MA 01581, (617) 366-1122	Alpha Software Corp., 30 B St., Burlington, MA 01803, (617) 229-2924
<b>MINIMUM HARDWARE</b>	IBM PC, XT, or compatible; 256K bytes RAM. Two double-sided floppy-disk drives or one floppy-disk drive and one hard-disk drive.	IBM PC, XT, or Compaq; 128K bytes RAM, two 320K-byte floppy-disk drives.	IBM PC, XT, or compatible; 128K bytes RAM, two double-sided floppy-disk drives.	IBM PC, XT, or compatible; 128K bytes RAM (DOS 1.1), 192K bytes RAM (DOS 2.0); two double-sided, double-density floppy-disk drives or one floppy-disk drive and one hard-disk drive.	IBM PC, XT, or compatible; 128K bytes RAM (DOS 1.1), 192K bytes RAM (DOS 2.0), two floppy-disk drives, at least one double-sided.
<b>PRICE</b>	\$595	\$425	\$195	\$395	\$295
<b>OPERATING SYSTEMS</b>	MS-DOS 2.0, PC-DOS 2.0	PC-DOS or MS-DOS	PC-DOS, MS-DOS	PC-DOS or MS-DOS	PC-DOS, MS-DOS
<b>MAXIMUM CHARACTERS PER FIELD</b>	255	76	186	50	60
<b>MAXIMUM FIELDS PER RECORD</b>	unlimited	100	20	40	40
<b>MAXIMUM RECORDS PER FILE</b>	unlimited	unlimited	unlimited	65,000	32,767
<b>MAXIMUM NUMBER OF FILES OPEN AT ONE TIME</b>	1	1	1	1	1
<b>FIXED OR VARIABLE RECORD LENGTHS</b>	variable	fixed	fixed	both	fixed
<b>MAXIMUM NUMBER OF KEY FIELDS</b>	8	50	3	40	5
<b>TYPE OF INDEX ORGANIZATION</b>	inverted B-tree	N/A	N/A	B+ tree	ISAM
<b>COPY PROTECTED</b>	yes	no	no	yes	no
<b>OTHER FILE FORMATS SUPPORTED</b>	Soon will import ASCII, DIF, 1-2-3, WordStar.	Future add-on	ASCII; output only WordStar, MultiMate	DIF, ASCII, delimited ASCII	ASCII, WordStar, 1-2-3, SYLK, MailMerge
<b>COMMENTS</b>	Can reformat data any time; automatically reconstructs data; constructs its own menus; comes with spreadsheet, word processing, and graphics; has password protection levels; menu-driven applications development.	Two levels of password protection; supports word-processor-like global search of files.	Supports 30 different printers, PC version holds 2000 records per disk and can span disks, XT versions sells for \$250 and allows 32,000 records on the hard disk.	What-you-see-is-what-you-get report generation, horizontal scrolling to 132 columns.	—

# CATALOG

DATAHANDLER-PLUS	DB Master Version 4PLUS	FASTFILE	FilePlan	Micro IPF	Next Step
Miller Microcomputer Services, 61 Lake Shore Rd., Natick, MA 01760, (617) 653-6136	Stoneware Inc., 50 Belvedere St., San Rafael, CA 94901, (415) 454-6500	Datamate Co., 4135 South 100th East Ave., #128, Tulsa OK 74146, (918) 664-7276	Chang Laboratories Inc., 5300 Stevens Creek Blvd., San Jose, CA 95129, (800) 973-8800; in CA (800) 831-8080	Control Data Corp., 8100 34th Ave. S, Bloomington, MN 55440, (612) 690-3530	Execuware Inc., 4018 Country Club Rd., Winston-Salem, NC 27104, (919) 760-3576
IBM PC or compatible; one 160K-byte floppy-disk drive, MMSFORTH 2.2.	Apple II+ with 16K-byte RAM card or Apple IIe, one to four floppy-disk drives.	IBM PC, XT, or compatible; 128K bytes RAM, two floppy-disk drives or one floppy-disk drive and one hard-disk drive.	IBM PC or compatible; 64K bytes RAM, two 190K-byte floppy-disk drives.	IBM PC or Zenith Z-100; 128K bytes RAM, two floppy-disk drives or one floppy-disk drive and one hard-disk drive.	IBM PC or Compaq; two disk drives, 128K bytes RAM.
\$100	\$350	\$195	\$295	\$465	\$345
MMSFORTH/IBM PC	DOS 3.3	PC-DOS, MS-DOS	PC-DOS, MS-DOS, CP/M	PC-DOS, ZDOS, MS-DOS	PC-DOS, MS-DOS
255	100	40	75	60	78
255	100	50	32	200	99
unlimited	unlimited	unlimited	2048	unlimited	32,767
1	1	1	1	1	1
variable	fixed	fixed	both	fixed	fixed
unlimited	10	1	0	3	15
N/A	ISAM	keyed	B-tree	B-tree	B-tree
no	yes	no	no	no	yes
ASCII (export only)	DIF	none without programming	MailMerge	uses DIF, ASCII	ASCII
Predefined or user-defined templates, active windows, supports FORTHWRITE word-processing program, requires \$249.95 MMSFORTH system disk.	Supports disk spanning of up to 200 floppy disks, does not support an 80-column card, a Macintosh version has been announced at \$195.	Written in MVP COBOL, includes inquiry-based report writer.	Allows worksheet format similar to spreadsheets.	Graphics subsystem supports monitor, printer, or plotter; supports text merge into documents; can call other DOS programs using defined menu functions; supports communication with CDC Cyber; includes sophisticated report writer.	Generates BASIC programs with built-in menus and Help screens.



# CATALOG

PRODUCT NAME	Nutshell Information Manager	OMNIFILE	Organizer I	PC-File III	ResQ
<b>VENDOR</b>	Leading Edge Products Inc., 225 Turnpike St., Canton, MA 02021, (800) 343-6833	SSR Corp., 1600 Lyell Ave., Rochester, NY 14606, (716) 254-3200	Random House School Division, 400 Hahn Rd., Westminster, MD 21157, (800) 331-5469	Jim Button, POB 5786, Bellevue, WA 98006, (206) 746-4296	Key Software Inc. 1000 Skokie Blvd., Suite 200, Wilmette, IL 60091, (312) 256-6776
<b>MINIMUM HARDWARE</b>	IBM PC, XT, and compatibles; 256K bytes RAM; one double-sided, double-density floppy-disk drive or one floppy-disk drive and one hard-disk drive.	IBM PC, XT, or compatible; 128K bytes RAM, two floppy-disk drives, at least one of which is 320K bytes. With PC-DOS 2.0, 192 bytes RAM.	(IBM PC) 96K bytes RAM; (TRS-80 III or 4) 48K bytes RAM; two floppy-disk drives.	128K bytes RAM, one 320K-byte floppy-disk drive or two 160K-byte floppy-disk drives or one floppy-disk drive and one hard-disk drive.	IBM PC, XT, or compatible; 128K bytes RAM, two floppy-disk drives or one floppy-disk drive and one hard-disk drive.
<b>PRICE</b>	\$395	\$425	\$81	\$49	\$295
<b>OPERATING SYSTEMS</b>	PC-DOS, MS-DOS	PC-DOS, MS-DOS	PC-DOS, TRSDOS	PC-DOS 1.1 or later, MS-DOS 2.0 or later	PC-DOS, MS-DOS
<b>MAXIMUM CHARACTERS PER FIELD</b>	unlimited	1828	40(IBM), 32(TRS-80)	65	80
<b>MAXIMUM FIELDS PER RECORD</b>	unlimited	64	15(IBM), 11(TRS-80)	42	60
<b>MAXIMUM RECORDS PER FILE</b>	unlimited	unlimited	variable	10,000	32,767
<b>MAXIMUM NUMBER OF FILES OPEN AT ONE TIME</b>	1	1	1	1	1
<b>FIXED OR VARIABLE RECORD LENGTHS</b>	variable	variable	variable	fixed	fixed
<b>MAXIMUM NUMBER OF KEY FIELDS</b>	unlimited	2	0	42	38
<b>TYPE OF INDEX ORGANIZATION</b>	keyed	modified B-tree	sequential	pointer	N/A
<b>COPY PROTECTED</b>	no	yes	yes	no	no
<b>OTHER FILE FORMATS SUPPORTED</b>	ASCII	DIF, ASCII	none	DIF, ASCII, MailMerge, PC-Calc	ASCII, 1-2-3
<b>COMMENTS</b>	Every word in every field is indexed. A multifile version is planned.	Can support multiple logical files.	—	User-supported software. Menu-driven program, full-screen data entry, macro keys, calculated field entries.	Nine security levels per field, password protection on files, fast sorts, calculated fields.

# CATALOG

## RELATIONAL DATABASE PROGRAMS

Superbase 64	TMP/MANAGER I	UltraFile	10-Base	Citation	CodeWriter
Precision Software Inc., 820 Second Ave., Suite 1100, New York, NY 10017, (212) 490-1825	The United Software Co., 2431 East Douglas, Wichita, KS 67211, (316) 684-5281	Arrays Inc./Continental Software, 11223 South Hindry Ave., Los Angeles, CA 90045, (213) 410-3977	Fox Research, 7005 Corporate Way, Dayton, OH 45459, (513) 433-2238	Eagle Enterprises, 2375 Bush St., San Francisco, CA 94115, (415) 346-1249	CodeWriter Corp., 7847 North Caldwell Ave., Niles, IL 60648, (800) 621-4109
Commodore 64; one floppy-disk drive or one floppy-disk drive and one hard-disk drive.	IBM PC or compatible; one floppy-disk drive, 128K bytes RAM.	IBM PC, XT; 128K bytes RAM, two double-sided floppy-disk drives or one floppy-disk drive and one hard-disk drive.	IBM PC XT, or compatible; 192K bytes RAM; MS-DOS 2.0, two disk drives, cursor-addressable monitor.	IBM PC or compatible; 96K bytes RAM. CP/M systems; 58K bytes RAM. Two floppy-disk drives or one floppy-disk drive and one hard-disk drive.	Apple II+, IIe, Commodore 64, PCjr; one floppy-disk drive. IBM PC: two floppy-disk drives.
\$99	\$365	\$195	\$495	\$185	\$249; Commodore version \$99
proprietary	PC-DOS, MS-DOS	PC-DOS 1.1 or 2.0	MS-DOS 2.0	CP/M-80, PC-DOS	standard operating system for each machine listed
1108	50	100	9999	800	39 (40 column), 79 (80 column)
127	150	50	unlimited	24	49 (40 column), 100 (80 column)
unlimited	unlimited	32,767	unlimited	unlimited	operating system limited
1	1	1	16	1	3 (40 column), 4 (80 column)
fixed	both	fixed	fixed	both	both
1	0	5	unlimited	unlimited	2
B+ tree	sequential	pointer	B-tree	B-tree	sequential, random
yes	yes	no	no	no	yes
none	TMP/Free Form	ASCII, DIF, FCM, WordStar	DIF, ASCII	ASCII	none
—	Menu-driven, but commands available.	Up to five user-defined report forms per database, graphing module supports screen or printer (plotter support announced), menu-driven hardware configuration, supports disk spanning.	Can be used in a network.	Three predefined templates for journal and book reference files and address files; user may define others; up to six key words/record (unlimited total key words) and up to 800 characters of free-form text/record.	Tutorials on disk; written in BASIC.



# Find Out What

Do your own research.

Call your favorite computer products supplier. Or thumb through the rest of this magazine. Price the quantities of the items you really want.

Then call us.

What's in store for you is the largest selection of computer products around. At the most competitive prices you'll find anywhere.

## Networking/ Protocol Conversion

We're at the cutting edge of Corporate Networking and Protocol Conversion products. We're experts in Emulation Boards. Call for our unadvertised special manufacturers and products.

**SNA & BISYNC** 3780, 5251, 3274, 3278

**PC TURBO** 186 by ORCHID, 80186 coprocessor board, speeds up your PC 5 times.

**IRMA / IRMALINE** Replaces 3278's with PC's.

**PCnet** by ORCHID, we carry the complete line.

**BLUE LYNX 5251 Mod 12 & 3276** Emulators by TECHLAND.

## Printers & Plotters

Micro Mart has thousands of printers in stock, both IBM and Apple compatible.

**AMDEK AMPLOT II**, 6 pen plotter, supports Lotus.

**HOUSTON INSTRUMENTS** Plotters and digitizers.

### Dot Matrix

**SMITH CORONA D-300**, manufactured by TEC, 140 cps.

**EPSON FX80 & 100**, 160cps.

**EPSON RX80 & 100**, 100 cps.

**EPSON LQ 1500**, letter quality in a dot matrix.

**OKIDATA 92 & 93**, optional IBM PROMS, 160 cps.

**OKIDATA ML84**, 200 cps, optional IBM PROMS.

**OKIDATA Pacemark 2410**, 350 cps.

**TOSHIBA P-1351 & 1340**, superb letter quality and graphics.

**DATAPRODUCTS PRISM 8050 Color**, IBM's choice for less. 132 column, superb graphics, 200 cps.

**STAR MICRONICS** We carry the entire Star line of *Gemini*, *Delta* and *Radix* printers.

**TEXAS INSTRUMENTS** *The 855*, w/replaceable font cartridges.

**NEC Pinwriters**, *P2 & P3*, 180 cps.

### Letter Quality

**NEC Spinwriters 2050, 3550 & the new 8850.**

**DIABLO 620, 630 & 630 ECS.**

**C-ITOH Starwriter**, 40 cps; *Printmaster*, 55 cps.

**QUME Sprint 11/40 Plus, Sprint 11/55 Plus.**

Micro Mart has a full range of Form Handling options and Peripheral Devices. Call us for any printer accessory need.

## Floppy Disk Drives

**TANDON TM 100-2**, Dbl. sided, dbl. density, 360K, The IBM Drive.

**1/2 HEIGHT DISK DRIVES** From SHUGART, PANASONIC, TEAC. We have the south's largest supply of top names.

## Chips

We've stock-piled the best for you. Call us for quantity prices.

**INTEL 8087** High speed math coprocessor.

**64K RAMCHIPS** For the IBM-PC compatibles and their boards.

## Hard Discs

We carry all major name brands so if you don't see it—ask for it, and we'll give you our best price.

**PEACHTREE PERIPHERALS** *The P-10, 20 & 50*, auto boot, internal & external installation.

**SYSGEN 10 & 20** Meg w/streamer tape for faster streaming & formatting.

**SYSGEN Image**, streamer tape back-up for your IBM XT.

**BERNOULLI TECHNOLOGY** Hard Disc Subsystems.

## Multifunction Boards

We sell more of these than anyone else, so we've become experts on boards of all types.

**ULTRA PAK** 64-384K, mono & color graphics, multifunc. board.

**SIX PAK** 64-384K, multifunc.

**MEGAPLUS** 64-512K, maximum 8 function.

**I/O PLUS** Ser., Clk., Splr., Ramdisk, opt. 2nd Ser., Par., & Game.

**QUADRAM QUADBOARD**, New Version, 64-384K, multifunc.

**TECMAR CAPTAIN**, 64-384K, multifunc.

**TALLTREE J-RAM II**, 0-512K, multifunc., w/J-RAM Software.

**PROFIT SYSTEMS** 64-512K, *RAM Plus & Elite* with Tascmaster software.

**MICROLOG BABY BLUE II**, 64-256K, Z80 coproc., extra software.

**ORCHID PC Blossom**, 64-384K multifunction with optional *PCnet Piggy-Back*.

**MAYNARD Sandstar**, mod. Floppy & Hard Disc Controllers.

## Graphic Cards

**PERSYST BoB board**, Best of Both, doubles text resolution & color graphics.

**STB Graphics Plus II**, color & mono, w/parallel port & software.

**HERCULES** Mono & color graphics cards support Lotus on IBM.

**PLANTRONICS ColorPlus +**, HiRes color board, parallel port, with *Color Magic* or *Draftsman*.

**TECMAR Graphics Master**, HiRes color & mono supports Lotus.

**QUADRAM QUADCOLOR I & II**, upgradable color cards for IBM.

**PROFIT SYSTEMS Multigraph**, 132 column monochrome 720h x 350v, color graphics 640h x 400v.

**PARADISE SYSTEM Multi-display** or *Modular Graphics Cards*, color & mono, parallel port.

## Software

We also carry the most popular software for the Apple Macintosh.

### Accounting

**IUS A/P, A/R, G/L**, inventory, order entry, payroll.

**PEACHTREE A/P, A/R, G/L**, payroll, job cost, inventory, order entry.

**Spreadsheets & Integrated Packages ASHTON-TATE Framework.**

**LOTUS Symphony and Lotus:** spreadsheet, word processing & data base.

**MICROSOFT MultiPlan**, comes with choice of templates.

**MDBS Knowledge Man**, spreadsheet, data base & graphics.

**PEACHTREE Decision Manager**, micro to mainframe integrated package.

**SORCIM SuperCalc 3 & 4**, superior graphics to Lotus.

**SPI Open Access:** spreadsheet, 3-D graphics, word processor, time manager & communications in one package.

### Enhancements & Utilities

**FOX & GELLER** Complete line of enhancement products for *dBase II, III & Rbase 4000*.

**NORTON** Complete line of utility programs for IBM-PC.

Micro Mart is a registered trademark of Micro Mart, Inc.. IBM is a registered trademark of International Business Machines Corporation. Apple and Macintosh are registered trademarks of Apple Computer, Inc.

Atlanta, New Orleans, Charlotte, Louisville, Nashville, Raleigh, Ft

# t's In Store.

## **ROSESOFT ProKey 3.0** **CENTRAL POINT SOFTWARE**

*Copy II PC.*  
**ATI Training**, critic's choice software tutorials.  
**SOFTSTYLE Set FX**, Epson font control package.  
**SIDEWAYS** Inverts printout.  
**BORLAND Sidekick**.

### **Compilers & Language Tools**

**LATTICE C-Compilers**, most popular 1 Meg RAM on PC.  
**MICROSOFT** Complete line of compilers.  
**DIGITAL RESEARCH** Complete line of compilers.  
**BORLAND Turbo Pascal**, Turbo Toolbox and more.

### **Graphics & CAD**

**Zsoft PC Paint Brush**, mouse driven graphics w/screen dump util.  
**DECISION RESOURCES Chart-Master/Sign-Master** graphics pkgs. for printers & plotters.  
**AUTODESK AutoCAD**, the most popular graphics package in the world.  
**ENERTRONICS Energraphics**, low cost graphics & CAD package.  
**MICROPRO ChartStar**.

### **Communications**

**MICROSTUF CROSTALK XVI**, communications.  
**HAYES SMARTCOM II**, communications.  
**VM Relay**, communications.

### **Word Processors**

**MULTIMATE** Latest version with spelling checker and tutorial.  
**SAMNA III**, New Flagship word processor.  
**MICROSOFT Word**; 4th generation word processor, w/or without mouse.

### **LIFETREE**

**VOLKSWRITER DELUXE**  
**MICROPRO WordStar Professional** series with Tutor, CorrectStar, MailMerge & Star Index.  
**SSI WordPerfect**; popular word processor emulates IBM's Displaywriter.

**PEACHTREE PeachText 5000**, Personal Productivity Series.

### **Office & Project Planning**

**HARVARD Harvard Project Manager**.  
**IUS Easy SalesPro**.  
**MICROSOFT Project**.

### **Data Base Managers**

**MICRORIM 4000 or 6000**, Report Writer & Clout options.  
**GMS SYSTEMS Power-base**, relational and hierarchical data base.  
**ASHTON-TATE dBase II & III**.  
**MICROSTUF Infoscope**, critically acclaimed data base.

## **Modems**

**HAYES Smartmodem 300, 1200, & 1200B**.  
**NOVATION** Complete line of internal & external.  
**RIXON 1200-4800 BAUD** synchronous & asynchronous models.  
**ANCHOR AUTOMATION Signalman Mark XII**, 300-1200 direct connect.  
**VEN-TEL** The 1200 BAUD & Half Card for the IBM portable & XT.

## **Miscellaneous Hardware & Accessories**

Be sure to ask about our Apple compatible products.  
**DYSAN** The #1 Quality Diskette in the World. Quantity savings.  
**MICRO MART DISKETTES** Our own brand is dbl. sided/dbl. density and carries a 7 year warranty.  
**KEYTRONICS 5150 & 5151** keyboards for the IBM-PC.  
**LQ SHEET FEEDERS** Cut sheet feeders for the NEC 3550 & C-ITOH printers.  
**MOUSE SYSTEMS PC Mouse**, optical type, 3 button with software.  
**MICROSOFT Mouse**; Bus or serial mechanical mouse with mouse menu software.  
**CURTIS** Monitor pedestal, keyboard extension cable, monitor extension cable.  
**QUADRAM MICROFAZER**, print buffer: 8-128K.  
**TRIPPELITE** Back up power supply 200-1000 Watts, and *ISOBAR* surge protectors with 4 & 8 plug.

## **Monitors & CRT's**

**PGS MAX 12**, amber, runs off the IBM Mono Card, 720 h x 350v.  
**PGS SR-12**, 690h x 480v, HiRes RGB with dual scan card.  
**PGS HX-12**, HiRes 690 Dot RGB.  
**QUADRAM QUADCHROME**, HiRes 690 Dot RGB.  
**AMDEK COLOR I, IIA & IVT**, The industry standard RGB's.  
**AMDEK COLOR 300, 500, 600, 700, 710**, new complete line of HiRes RGB's.  
**AMDEK 300A/300G**, Industry std. composite monitors.  
**AMDEK 310A**, amber 12" improved alternate IBM Green Screen.  
**WYSE Terminals**, 100, 75, 50, entire line in stock.

## **Size, Service & Support.**

When you're calling around for prices, remember the kind of service and support our 40,000 square foot Service and Distribution Center can give you. Plus we have over one hundred people whose job it is to serve you.

Our service and support are so good, we ought to be able to charge retail prices. But we don't.

**Call us for expert advice and your best price.**

©1984 Micro Mart, Inc.  
Technology Corporate Campus  
3159 Campus Drive  
Norcross, GA 30071

## **America's PC Specialist.**

# MICRO MART

ORDERS ONLY

# 1-800-241-8149

FOR INFORMATION

# 1-404-449-8089

TELEX 880497

**Lauderdale, Orlando, Tampa, Miami, Tyson's Corner, Rockville.**



# CATALOG

PRODUCT NAME	Condor 3	DataEase	DATAVU PLUS	DB3	dBASE II 2.4
VENDOR	Condor Computer Corp., 2051 South State St., Ann Arbor, MI 48104, (800) 221-8479	Software Solutions Inc., 305 Bic Dr., Milford, CT 06460, (203) 877-9268	Thinkers' Soft Inc., POB 221, Garden City, NY 11530, (516) 294-8104	Tarbell Electronics, 950 Dovlen Place, Suite B, Carson, CA 90746, (213) 538-4251	Ashton-Tate, 10150 West Jefferson Blvd., Culver City, CA 90230 (213) 204-5570
MINIMUM HARDWARE	8088 computers with 80K bytes RAM, one double-sided floppy-disk drive; DECmate; also 8-bit CP/M computers with 64K bytes RAM (including APPLE II with CP/M card).	IBM PC, XT, or compatible; DEC Rainbow; TI Professional; Wang Professional; Victor 9000.	CP/M-80 systems: 64K bytes RAM; PC-DOS, MS-DOS, and CP/M-86 systems: 128K bytes RAM.	Intel 808X CPU system: 56K bytes RAM; one floppy-disk drive.	IBM PC, XT, or compatible; 128K bytes RAM, one floppy-disk drive CP/M-86 machines with 128K bytes RAM. CP/M-80 2.0 or later with 48K bytes RAM. Cursor-addressable monitor.
PRICE	\$650	\$600	\$250	\$249	\$495
OPERATING SYSTEMS	PC-DOS, MS-DOS, CP/M-80, CP/M-86, MP/M-80	PC-DOS, MS-DOS	PC-DOS, MS-DOS, CP/M-86, CP/M-80	CP/M 2.2, 3.0, -86, CCP/M-86	see above
MAXIMUM CHARACTERS PER FIELD	127	255	127	1000	254
MAXIMUM FIELDS PER RECORD	127	255	127	100	32
MAXIMUM RECORDS PER FILE	65,535	65,535	unlimited	unlimited	65,535
MAXIMUM NUMBER OF FILES OPEN AT ONE TIME	1	32	8	19	2
FIXED OR VARIABLE RECORD LENGTHS	fixed	fixed	both	both	fixed
MAXIMUM NUMBER OF KEY FIELDS	8	unlimited	4	100	7
TYPE OF INDEX ORGANIZATION	B-tree	B-tree	N/A	B-tree	B+ tree
COPY PROTECTED	no	no	no	no	no
OTHER FILE FORMATS SUPPORTED	ASCII	ASCII, DIF, SYLK	ASCII	ASCII	ASCII
COMMENTS	Large user base, established program, multiuser version planned for XENIX and UNIX, very limited relational capabilities.	All options (filename, fields, etc.) always showing on screen; three levels of password protection; multiuser version has been announced.	Automatic screen design, report generator.	CCP/M-86 version supports multiusers, program generator built in.	Includes programming language; utilities available. multiuser system for TurboDOS, 3COM, Ethernet \$995; dBASE III requires 256K bytes RAM; PC-DOS 2.0 allows 4096 characters/field, 128 fields/record, unlimited records/file, 10 files open at once, copy protected.

# CATALOG

FMS-80	Fast File	filePro	filePro 16	Knowledgeman	LAN: DATASTORE
FMS Software Ltd., 54 North Main St., Spring Valley, NY 10977, (914) 425-3333	ICCS, 777 Leesburg Pike, Falls Church, VA 22043, (703) 893-4404	The Small Computer Co. Inc., 230 West 41st St., Suite 1200, New York, NY 10036, (800) 847-4740	The Small Computer Co. Inc., 230 West 41st St., Suite 1200, New York, NY 10036, (800) 847-4740	Micro Data Base Systems Inc., POB 248, Lafayette, IN 47902, (317) 463-2581	Software Connections Inc., 2401 Mission College Blvd., Santa Clara, CA 95054, (800) LAN-DBMS; in CA (800) LAN DATA
48K bytes RAM (64K bytes recommended), two 240K-byte floppy-disk drives or one floppy-disk drive and one hard-disk drive.	IBM PC: 128K bytes RAM.	Apple II with CP/M SoftCard, 64K bytes RAM; two floppy-disk drives; most CP/M systems.	IBM PC: 256K bytes RAM; one hard-disk drive.	192K bytes RAM.	IBM PC, XT, or compatibles or TI Professional 192K bytes RAM, one floppy-disk drive and one hard-disk drive or two floppy-disk drives.
\$395	\$350	\$199	\$495	\$500	\$450
CP/M, CP/M-86, PC- or MS-DOS, MmmOST, TurboDOS, MP/M	PC-DOS	CP/M	PC-DOS	CP/M-86, PC-DOS, MS-DOS	MS-DOS, PC-DOS, p-System
255	256	1020	999	65,535	4096
255	96	99	999	255	512
65,535	65,535	65,535	16,000	65,535	unlimited
19	5	1	10	unlimited	15
both	fixed	variable	variable	fixed	fixed
unlimited	25	1	12	unlimited	16
ISAM	ISAM	N/A	B-tree	B + tree	B + tree
no	yes	no	no	no	no
ASCII	none	ASCII	ASCII, DIF, SYLK, WordStar	ASCII	DIF, ASCII, WordStar
Runs under UNIX-like shell, 16-bit version costs \$495, multiuser version that supports record locking only on change costs \$595	Applications generator producing Microsoft BASIC source code, should be used with Microsoft BASIC compiler for adequate speed, provides interactive inquiry screens	—	Processing language available for sophisticated applications development; programming not necessary for most applications; dBASE II, pfs. File interchange utilities available at \$50 each; upwardly compatible with multiuser system.	Integrated spreadsheet, statistics, printed-forms management, SQL-like inquiry, screen I/O management, structured program language. Options: graphics (\$225), screen print (\$100), mouse support (\$100), run time support (\$100).	Help screen indexed to manual, levels of password protection.



# CATALOG

PRODUCT NAME	power-base 2.0	R:base 4000	RL-1 Data Base	Revelation	SALVO
VENDOR	PowerBase Systems Inc., 12 West 37th St., New York, NY 10018, (212) 947-3590	MicroFIM Inc., 3380 146th Place SE, Bellevue, WA 98007, (206) 641-6619	ABW Corp., POB M1047, Ann Arbor, MI 48106, (313) 663-3011	Cosmos, 19530 Pacific Highway S, Suite 102, Seattle, WA 98188, (206) 824-9942	Software Automation Inc., 14333 Proton Rd., Dallas, TX 75234, (214) 392-2802
MINIMUM HARDWARE	IBM PC, XT, or compatible; 256K bytes RAM, two double-sided floppy-disk drives or one floppy-disk drive and one hard-disk drive.	IBM PC or compatible, DEC Rainbow, TI Professional, HP 150, most CP/M systems; 256K bytes RAM, two double-sided floppy-disk drives.	IBM PC, XT, or compatible; 128K bytes RAM, one floppy-disk drive (two recommended) or one floppy-disk drive and one hard-disk drive.	IBM PC, XT, or compatible; 320K bytes RAM, two 320K-byte floppy-disk drives, 8087 NDP chip recommended.	64K bytes RAM (CP/M), 128K bytes RAM (MS-DOS), two 256K-byte floppy-disk drives.
PRICE	\$395	\$495	\$495	\$950	\$496
OPERATING SYSTEMS	PC-DOS, MS-DOS	PC-DOS, MS-DOS, CP/M-80	PC-DOS, MS-DOS	PC-DOS, MS-DOS, Pick	MS-DOS, CP/M, PC-DOS
MAXIMUM CHARACTERS PER FIELD	80	1530	1024	65,535	78
MAXIMUM FIELDS PER RECORD	64	400	unlimited	65,535	16
MAXIMUM RECORDS PER FILE	65,534	unlimited	65,531	unlimited	32,767
MAXIMUM NUMBER OF FILES OPEN AT ONE TIME	10	40	unlimited	unlimited	16
FIXED OR VARIABLE RECORD LENGTHS	both	fixed	fixed	variable	fixed
MAXIMUM NUMBER OF KEY FIELDS	6	400	unlimited	unlimited	variable
TYPE OF INDEX ORGANIZATION	B-tree	inverted B-tree	modified E-tree	inverted list	B-tree
COPY PROTECTED	no	yes	no	no	no
OTHER FILE FORMATS SUPPORTED	1-2-3, DIF, pfs, dBASE II, MultiMate	ASCII, SYLK, 1-2-3, DIF	ASCII	ASCII	DIF, ASCII (export only)
COMMENTS	Data-zoom allows linking of related records for special uses, mailing-label generator.	CLOUT natural-language query program available (\$195), procedural language included. R:base 6000 is a multiuser version of this program.	SQL-like query language menu-driven data definition and relational editor, programming interface to any language.	Application generator included; RBASIC is a true 16-bit structured BASIC worth a look in its own right; network version with semaphore locking announced (\$1400 for 1-4 users).	Expert system query, automatic navigation through multiple files.

# CATALOG

## MULTIUSER SYSTEM PROGRAMS

SAVVY PC	Sensible Solution	Smart Data Manager	filePro 16	Informa
Excalibur Technologies Corp., 800 Rio Grande NW, Suite 21, Albuquerque, NM 87104, (800) 551-5199	O'Hanlon Computer Systems Inc., 11058 Main St., Suite 225, Bellevue, WA 98004, (206) 454-2261	Innovative Software, 9300 West 110 St., Overland, KS 66210, (913) 383-1089	The Small Computer Co. Inc., 230 West 41st St., Suite 1200, New York, NY 10036, (800) 847-4740	Unlimited Processing Inc., 8382 Baymeadows Rd., Suite 8, Jacksonville, FL 32216, (800) 874-8555
IBM PC, XT, or compatible; 64K bytes RAM, one double-sided or two single-sided floppy-disk drives.	128K bytes RAM, two 320K-byte floppy-disk drives or one floppy-disk drive and one hard-disk drive, 80 by 24 screen with addressable cursor.	IBM PC, XT, or compatible; 192K bytes RAM, two double-sided floppy-disk drives or one floppy-disk drive and one hard-disk drive.	TRS-80 Model 16 (XENIX) or many UNIX systems; 256K bytes RAM, one hard-disk drive.	64K bytes RAM (CP/M-80, DPCOS, MmmOST, TurboDOS); 256K bytes RAM (DPCOS-86, CP/M-86, MP/M-86, MS-DOS 2.X); two 320K-byte drives.
\$395	\$695	\$495	\$495	\$795
SAVVY	CP/M, MS-DOS, TurboDOS, MP/M, CPC/OS, MmmOST	PC-DOS, MS-DOS	XENIX, UNIX	see above, and 3COM, PCNet, Davong, Novell, Corvus
255	255	1000	999	*
254	384	255	999	*
20,000	1000	100,000	16,000	65,535
10,000	10	10	10	unlimited
variable	fixed	variable	variable	fixed
254	10 per file	15	12	50
N/A	B + tree	pointer	B-tree	B-tree
no	no	yes	no	no
ASCII	N/A	ASCII, DIF, 1-2-3, WordStar	ASCII, DIF, SYLK, WordStar	DIF, import ASCII, and delimited ASCII
Includes procedural language, has a unique pattern-recognition facility that lets you query on inexact descriptions, report-writing and file-creation features are menu-driven.	Multiuser version available that supports record and file locking (\$995).	Supports 8087 NDP, mouse, has math, statistical, business, and decision functions.	dBASE, pfs interchange utilities available; XENIX system marketed by Radio Shack as ProFile 16; UNIX system sells for \$995; programming language for sophisticated applications; no programming necessary for most applications.	*1022 characters per record single-user system; 8190 multiuser; multiprocessor version \$995; network version requires hard-disk drive, costs \$1495; all support multiusers, but multiuser version locks records only at write; menu-driven; has password protection levels.



# CATALOG

PRODUCT NAME	LAN:DATASTORE	Optimum Version 7.03	PDBase	Unify
<b>VENDOR</b>	Software Connections Inc., 2401 Mission College Blvd., Santa Clara, CA 95054, (800) LAN-DBMS; in CA (800) LAN-DATA	Uveon Computer Systems Inc., 300 South Jackson St., Suite 250, Denver, CO 80209, (303) 831-7000	IOTC Inc., 211 South 3rd, Laramie, WY 82070, (307) 721-5818	Unify Corp., 4000 Kruse Way Place, Bldg. 2, Lake Oswego, OR 97034, (503) 635-6265
<b>MINIMUM HARDWARE</b>	IBM PC, XT, or compatibles or TI Professional; 192K bytes RAM, one floppy-disk drive and one hard-disk drive or two floppy-disk drives.	Two 320K-byte floppy-disk drives, 64K bytes RAM (CP/M) or 128K bytes RAM (IBM PC).	64K bytes RAM, two floppy-disk drives.	256K bytes RAM, one floppy-disk drive and one hard-disk drive.
<b>PRICE</b>	\$945	\$595	\$245*	\$1495
<b>OPERATING SYSTEMS</b>	MS-DOS, PC-DOS, p-System	CP/M-80, -86, PC-DOS, MP/M-86, TurboDOS, MmmOST	p-System, CCOS, PC-DOS, MS-DOS	UNIX, XENIX, and other UNIX implementations.
<b>MAXIMUM CHARACTERS PER FIELD</b>	4096	255	32,767	256
<b>MAXIMUM FIELDS PER RECORD</b>	512	50	1000	256
<b>MAXIMUM RECORDS PER FILE</b>	unlimited	varies	2500	unlimited
<b>MAXIMUM NUMBER OF FILES OPEN AT ONE TIME</b>	15	10	32	unlimited
<b>FIXED OR VARIABLE RECORD LENGTHS</b>	fixed	variable	variable	fixed
<b>MAXIMUM NUMBER OF KEY FIELDS</b>	16	3	1000	unlimited
<b>TYPE OF INDEX ORGANIZATION</b>	B + tree	hashed	hashed	hashed
<b>COPY PROTECTED</b>	no	no	no	no
<b>OTHER FILE FORMATS SUPPORTED</b>	DIF, ASCII, WordStar	MailMerge	ASCII	ASCII
<b>COMMENTS</b>	Can be networked. \$945 version supports up to five users; a second version is available to support up to 16 users for \$1945.	Shared multiuser version available; procedural language; two levels of password protection; also supports n/Star, Novell, NETWORK.	*Apple version, concurrent systems from \$795, nine levels of password security, PD-Base language allows access from other languages, network environment lets you mix/match computers, run-time packages available, user-tailorable error messages, single-user pBASE \$125.	Four different index organizations: the primary field is hashed, others use B-trees. Cross-files linking is available. Menu-driven operation or applications development providing host language interface to C library subroutines. Prices to \$14,500 on VAX 780.

# CONDOR

## Data Management Software

### Condor's IBM™ PC - compatible Relational Data- base Management

is the effective way to manage your office automation needs, such as personnel management, inventory control, billing, manufacturing systems, educational, and other office, school or home needs.

With Condor you get the power and flexibility of a fully relational database system complete with a "Step-by-Step" MENU system to guide the new user. On-line help is integrated into the Menu system. A complete REPORT WRITER is also included, that even the newcomers in our field recommend.

With Condor, setting up a new database of information, is as simple as typing on a blank sheet of paper . . . typically, it takes a minute, maybe two. You are then ready to enter your data into the database you just created, again just like typing on a sheet of paper.

Then, you can SORT, SELECT, COMPUTE, POST, or PRINT your information in almost any way that you desire. Plus, you can easily pass information from Condor to your word processor's mail-merge, or pass spreadsheet information into Condor. It's all very easy, and also very English.

Begin with Condor jr. (\$195), the advanced file manager. Upgrade later as your business and your data grow, to Condor3 (\$650-or less the \$195 if you bought Condor jr.), the fully relational data management system. It's the same system that hardware manufacturers like DEC, Sony, Zenith, and Hewlett-Packard have selected to market with their personal computers. There are well over 100,000 satisfied users. To find out how condor data management software can make your business easy to handle, see your personal computer dealer, or call 1-800-221-8479 (In Michigan call 0-313-769-3992 collect) for your nearest dealer. He'll prove our point. That Condor is the data management software powerful enough to be useful to business, yet simple enough for business to use.

IBM is the registered trademark of International Business Machines Corp.



2051 South State Street Ann Arbor, MI 48104 313-769-3988

Circle 80 on inquiry card.





# You can't buy an IBM® PC with

## Here are five important measurements to help you make the best choice:

IBM forces you to choose:

Buy a monochrome card and monitor for high-resolution text. (Essential for word processing and spreadsheets.)

Or buy a color card and color monitor for graphics. (Lotus™ 1-2-3,™ for example, uses lots of graphics, as well as text.)

You can invest in both; you can sacrifice one or the other; you can settle for a non-standard compromise.

Or you can buy Paradise.

Here's how we've measurably eased your job of choosing the best video display (saving you a lot of money in the process).

### 1. Measure video functions.

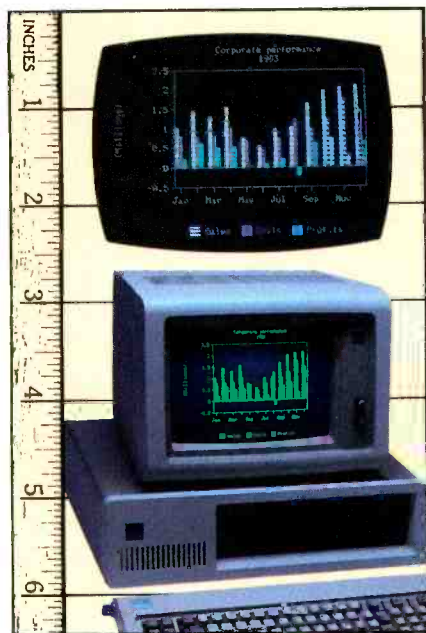

The Paradise Modular Graphics Card™ gives you *full screen, 16-shade* graphics on *any* display, including IBM's high-resolution monochrome monitor.

IBM's color/graphics card can display 16 colors on a color monitor.

So can the Paradise Modular Graphics Card.

But that's where the similarity ends. When you use color/graphics software with the Paradise Modular Graphics Card and a monochrome monitor, it translates those colors into a true 16-shade gray scale. With full screen display, flicker-free scrolling and clear, crisp character sets (like those of IBM) in all modes.

Naturally, the best video card fits either the IBM PC or XT, and works with any monitor you choose: IBM monochrome (or equivalent), RGB or composite video.

### 2. Measure software compatibility.

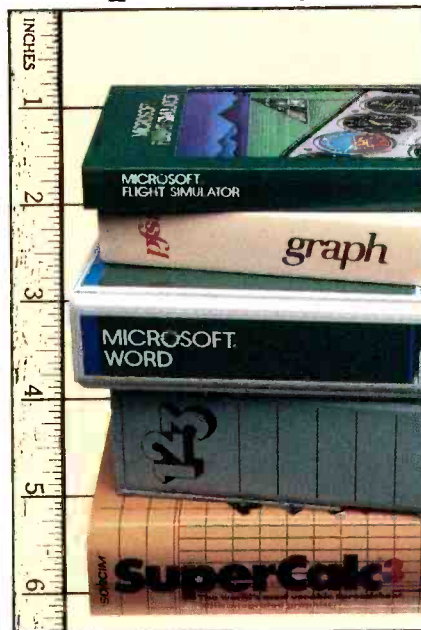

Many video cards only work with specially modified software. The Paradise Modular Graphics Card runs popular off-the-shelf color/graphics software on your choice of monitors. *Unmodified.*

Most cards that offer graphics on a monochrome monitor force you to

sacrifice off-the-shelf software compatibility.

Paradise doesn't want you to compromise.

Of course the Paradise Modular Graphics Card runs Lotus 1-2-3 graphics on an IBM monochrome monitor.

But it also runs almost all unmodified off-the-shelf color/graphics software.

Like PFS®:GRAPH, SuperCalc,®<sup>3</sup> Flight Simulator®, and Symphony.™

No wires. No tricks.

A menu-driven software system—with a user interface much like that of Lotus 1-2-3—lets you take advantage of all the Paradise Modular Graphics Card's features.

### 3. Measure slot utilization.

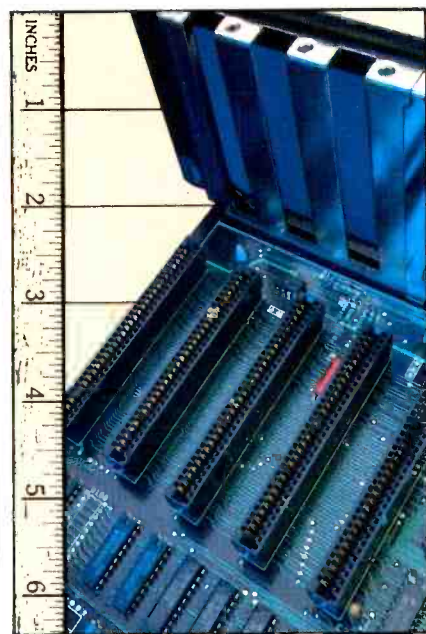

Unlike other video cards, the Paradise Modular Graphics Card gives you *additional popular functions in a single slot*. This may be the only card you'll ever need.

You need to worry about slots for future expansion. Since you *must* use

# out choosing a video card.

a slot for video support, why not pack it with more functions?

The Paradise Modular Graphics Card puts color and monochrome video support *plus* your choice of the most commonly requested enhancements into one slot.

Enhancements like extra memory, clock/calendar, floppy disk controller, parallel, serial or game ports.

Leaving you measurably more room to expand.

## 4. Measure cost efficiency.

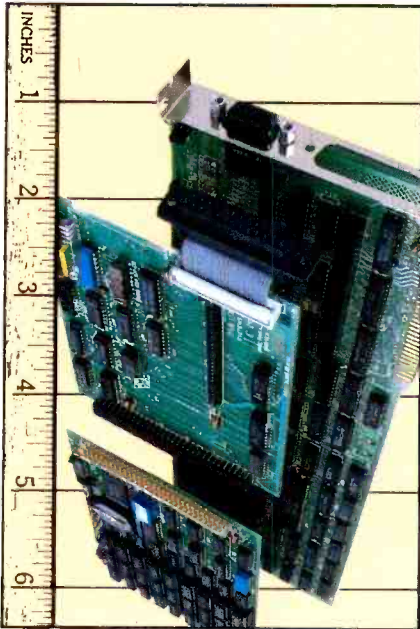

**Unlike other multifunction cards, the Paradise Modular Graphics Card lets you choose the options you need, now or later.**

You select the features you *want*, when you want them—no more, no less. So you pay only for what you need.

Choose one module from list A, one from list B, or one from each list. The Paradise Modular Graphics Card fits in a single PC or XT slot, even with both modules attached. And without imposing on adjacent slots.

## 5. Measure value.



**Value: the ratio of performance to price. No matter how you configure the Paradise Modular Graphics Card, you get more performance for your money, and more performance for your slot.**

You'd have to combine several other cards to even approach the Paradise Modular Graphics Card's functionality.

Obviously, that would take up several slots in your PC.

It would also cost you a lot more money.

And if you review measurements one through four in this ad, you'll realize that no other card—or combination of cards—can give you better PC performance.

What about reliability?

*Guaranteed by a one year warranty.*

## Paradise Modular Graphics Card and Options.

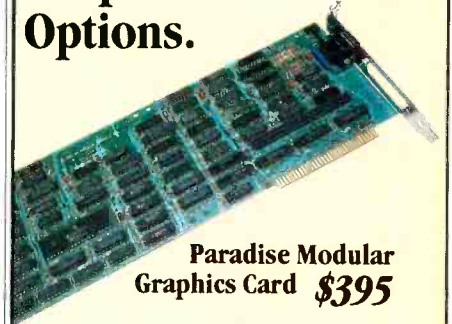

**Paradise Modular Graphics Card \$395**

### Connectors for:

IBM (or equivalent) monochrome monitor *or* • RGB monitor *or* • Composite video monitor • Light pen • RF modulator • Expansion modules

### Addressing:

16K video memory starting at B8000H

### Software included:

RAM disk • Print buffer

### A Module Options:

Parallel printer port *or* • Serial RS232 port *or* • Game port

### B Module Options:

256K RAM memory/clock/calendar *or* • 384K RAM memory *or* • Floppy disk controller/parallel printer port

**Go to the IBM dealer nearest you or call us toll-free.**

**Within CA:**

**800-822-2020 (Dept. 110 )**

**Outside CA:**

**800-527-7977 (Dept. 110 )**

150 North Hill Drive, Brisbane, CA 94005  
(415) 468-6000

# PARADISE

---

## *You can measure it.*







# Reviews

<b>REVIEWER'S NOTEBOOK</b>	
<i>by Rich Malloy</i> .....	245
<b>THE FUJITSU MICRO 16S</b>	
<i>by Alex Pournelle</i> .....	246
<b>THE PANASONIC SR. PARTNER</b>	
<i>by Rich Malloy</i> .....	254
<b>VOLKSWRITER DELUXE</b>	
<i>by Stevanne Ruth Lehrman</i> .....	263
<b>HOMEWORD AND CUT &amp; PASTE</b>	
<i>by Keith Carlson</i> .....	271
<b>CLOUT AND SALVO</b>	
<i>by George Bond</i> .....	279
<b>DATAEASE VS. CONDOR AND dBASE II</b>	
<i>by Bill Jacobson</i> .....	289
<b>REVIEW FEEDBACK</b> .....	306

IN JUNE OF 1983 we published a design article on a new machine from Fujitsu, the largest computer manufacturer in Japan. This product, the Fujitsu Micro 16s, features 8086 and Z80 processors with interchangeable microprocessor boards and a variety of operating systems and disk-drive formats. Unfortunately, it took quite a while to get most of the products mentioned in that article. The main system arrived one month, the 8-inch disk drives another, and so on until we got a fairly complete and powerful system. We gave the project to Alex Pournelle, a resident of Chaos Manor, and asked him to put it through its paces. His findings lead off our review section this month.

Another Japanese company that has rather recently entered the U.S. micro-computer market is Panasonic (a division of Matsushita). Panasonic's entry is a sleek transportable that, unlike the Fujitsu, is compatible with the IBM Personal Computer. It also contains its own 8½-inch thermal printer and a sizable bundle of software. I could go on, and in fact I already have. For more details, see my review of this impressive little machine.

Next we offer a look at yet another word processor for the IBM PC. This one is called Volkswriter Deluxe. Stevanne Ruth Lehrman examines this package to see if it is indeed the people's word processor.

Speaking of word processors for the people, two other word processors may make a similar claim. In fact, since both of these programs run on the Apple II and will soon run on the Commodore 64, they may have a better shot at that title. These products, HomeWord and Cut & Paste, are inexpensive and easy to use. Keith Carlson looks at just how useful they are. Of course, neither program is meant to help you write the Great American Novel, but each provides some good features for an inexpensive price.

Lastly, we move on to some products that are related to this month's theme of Databases. First, George Bond, our managing editor of User News, looks at two products for the IBM PC that make an attempt at understanding English. These are CLOUT, from MicroRIM, which works with files created with R:Base database-management programs, and SALVO, a self-contained database-management program that features a natural-language query system. George answers the questions that these two programs cannot answer: What can these programs really do? And which one is better?

Finally, Bill Jacobson reviews two relatively new relational database-management programs, again for the IBM PC. In a fairly detailed comparison, he measures DataEase against Condor 3 and dBASE II, two older, established database-management systems.

—Rich Malloy, Product-Review Editor



# THE AT&T INTERNATIONAL BUSINESS NETWORK: IT MAKES USING THE PHONE A SOUND BUSINESS DECISION.

Talking business around the world on the AT&T Network saves a lot of money.

First, it's the fastest way. And anything that saves time is like money in the bank.

Next, nothing gets attention

CHICAGO



like an international call.

And when you get attention, you get results...fast.

Calling adds a personal touch.

An informal conversation lets you exchange ideas, persuade, cajole, and convince.

Get a quick decision. Just the tone of a voice can set you on the right track. You can clear up possible misunderstandings.

And you can negotiate and close a profitable deal before you say goodbye.

AT&T international audio teleconferencing is cost-effective, too. Our operators

can put you in touch with as many as 60 locations at one time.

You'll be able to get every-

body together more frequently.

Only with the AT&T Network can you talk business all over the world. So call when you can.

It's productive, easy, economical, private. The fastest way.

It provides instant feedback.

PARIS



And improves your bottom line.

A network that takes you all over the world.

And operators to arrange

audio teleconferencing.

More cost-effective services for your business from the AT&T International Business Network.

Contact your Account Executive at AT&T Communications

or call toll free: **1 800 821-2121**

International service to and from continental U.S.



# R·E·V·I·E·W·E·R'S N·O·T·E·B·O·O·K

IT IS AMAZING how programmers seem to be squeezing more and more performance out of the 8088 microprocessor in the IBM Personal Computer (PC) and its compatibles. The first programs for the IBM PC were apparently converted from CP/M-80 programs and took little advantage of the 8088's increased address space and power. Now, three years after the IBM PC was first announced, not a month seems to go by when a new program does not appear that attempts to turn the PC from an expensive show horse into a thoroughbred.

One of the latest such programs is XyWrite from XyQuest, a small company in Bedford, Massachusetts, composed of some of the same people who developed the Atex editing/typesetting system. It seems that the XyQuest people have done an admirable job porting the editing part of the Atex system onto IBM PC-compatible systems. XyWrite II Plus, which sells for \$300, was written in assembly language and is extremely fast, powerful, compact, and flexible.

A few of the notable features include: fast scrolling; improved scrolling on the IBM color monitor (no flicker of "snow"); mail-merge capability; and the ability to do microjustification (i.e., expanding a printed line by adding small spaces between each character). More features will be listed in the upcoming review.

Of course, all is not perfect. XyWrite's documentation could benefit greatly from a complete rewrite. And the Help screens contain information that is organized in a somewhat less than intuitive manner. But if you don't like the Help screens, at least you have the option of writing your own.

The other way to get increased performance is to change the hardware. Two IBM compatibles recently arrived here sporting the 80186 micropro-

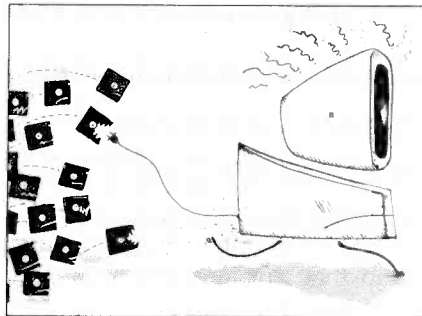

cessor, a fast chip that is compatible with the IBM PC's 8088 chip.

The first is MAD (Modular Advanced Design) from MAD Computer Inc. of Santa Clara, California. The MAD machine, which sells for \$3360 in the BYTE standard configuration (two floppy-disk drives, 256K bytes of RAM [random-access read/write memory], monochrome monitor, color capability, serial and parallel interfaces, and BASIC), looks like a European stereo set, but it can really perform. The MAD ran our spreadsheet-recalculation test in half the time of the IBM PC. Its innovative, compact design allows only one IBM-compatible expansion card, but most software is compatible. We haven't received MAD BASIC yet, and we are not sure about the service supplied by this small company, but so far it looks like an impressive machine.

Our second 80186 machine is the STM-PC Portable, from STM Electronics, a Canadian-based company that has previously brought us the Pied Piper, a transportable CP/M system. The new STM transportable features not only the 80186 and IBM compatibility, but also a 25-line LCD (liquid-crystal display), 256K bytes of memory, and a 1200-bps (bits per second) internal modem with a speaker phone—plus a 40-column thermal printer and dual 720K-byte floppy-disk drives, and the NewWord word-processor program. All this sells for \$3449.

Unfortunately, the machine we

received has ordinary 360K-byte floppy-disk drives that write data at a track density of 48 tracks per inch (tpi) instead of 96 tpi as in the 720K-byte drives.

This machine is a lot smaller than the usual sewing-machine-sized portables, but it is not really a portable, unless you are willing to carry around a 110-volt AC generator.

The 25-line LCD is from Epson (which suggests interesting possibilities) and is Flight Simulator compatible. The display is also backlit with an electroluminescent panel. But because the display has a rather flat aspect ratio, and because the contrast of the LCD is not very high, text characters can be hard to read. Also, in some software the cursor disappears.

In addition to the above supercharged systems, we have also received a few IBM compatibles with fairly standard 8088 chips. These include the Televideo Color PC and the ITT Xtra. The Televideo unfortunately features only one expansion slot, and it does not allow you to add an additional monitor or to adjust the brightness of the internal color RGB (red-green-blue) monitor. The ITT features an interesting communications program as part of its version of the MS-DOS operating system.

A month or two ago, I discussed our interest in getting a Zenith Z-150. We received the machine and it works well, but it did not come with any of the superior Zenith operating system software for which the Z-100 was acclaimed.

And one more note, while we are speaking of clones. We finally received the Columbia MPC VP portable. But again, no software was included. And the machine seems to blank itself out periodically. Oh well, you can't have everything.

—Rich Malloy, Product-Review Editor



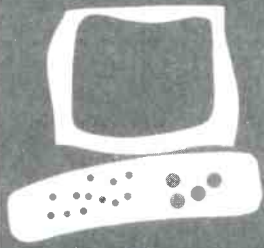

## The Fujitsu Micro 16s

### Adaptability is its greatest strength

BY ALEX POURNELLE

Japanese products have won a reputation for high reliability and quality. From cars to cameras to printers, their exports cannot be dismissed as "cheap." Fujitsu, Japan's largest computer company, is trying to extend that reputation with its Micro 16s microcomputer (see photo 1).

Designed by an American team in the Silicon Valley and built in Japan expressly for export to the United States, the Micro 16s has some truly distinguishing features. First and foremost is its obsolescence protection. Fujitsu will make plug-in cards with new processors as they become popular. These cards go in a Fujitsu-designed bus that is incompatible with any other bus. Second is the company's decision to supply CP/M-86 as the standard operating system, with MS-DOS as an option (opposite to IBM's strategy). Finally, the 16s *isn't* IBM hardware compatible—it is an honestly different machine.

Fujitsu has targeted the 16s as a business computer. Indeed, it is likely to do best there because of its speed and reliability. However, software developers might use it as a compiling engine: it's fast, expandable, and seems very reliable.

#### DESK SPACE

Most microcomputers are designed to sit on or near a desk. This has led to machines with very small footprints; that is, they take up little desk space or parts of them can sit on the floor. The 16s's footprint is about that of the IBM PC's and larger than an HP 150's or Tandy 2000's. Fujitsu did this with a reason in mind: the motherboard, expansion slots, and power supply are large to accommodate later additions. The 16s can be placed vertically on the floor and used with longer cables, but only with the right-hand side up—that's where the Reset button and power switch are.

#### HARDWARE

Physically, the system unit is a solid computer, weighing in at 33 pounds less disk

drives. Its fan runs extremely quietly. I had only a few complaints about engineering: the screws holding the internal drives and boards were difficult to reach; the keyboard plug is on the back; few chips have sockets. No chip sockets means fewer connection-related failures, but it also means dealers must keep a stock of complete main boards for even minor chip failures.

The 16s's keyboard is a little different from any other (see photo 2). The alphanumeric keys on the left are laid out exactly as if a Selectric II keyboard were transplanted to a computer. Its familiar layout, down to the large Return key, is a refreshing change from the IBM PC's and DEC Rainbow's rearrangements of the most popular keyboard for offices.

I think that the 16s's keyboard feels too plastic and thin, but everyone else I know who used it liked it. The keyboard does seem fast and responsive to the touch. It has a 16-character type-ahead buffer managed by the 68B09 housekeeper microprocessor on the motherboard. Hardware type-ahead, which lets you type characters during disk access, is addictive. You can enter several commands without waiting for the next prompt.

The KCLICK program turns an audible keyclick on and off. You can use it with an AUTOEXEC.SUB file that is executed on start-up. Similarly, the function keys can be defined at start-up. Under CP/M-86, their definitions appear on the twenty-fifth line of the display. The default definitions are sensible; for example, PF1 and PF2 run the SDIR superdirectory program for drives A and B.

Those editing keys between the alphanumeric keys and the numeric pad work within the operating system and in WordStar. The Delete key deletes one character to the left, for instance. The other keys produce similarly mnemonic results, although their actual control codes must be changed for different programs. This attention to detail is to be commended.

Alex Pournelle is chief programmer for Workman and Associates (112 Marion Ave., Pasadena, CA 91106), a software publisher. He also attends the University of California at San Diego and is collaborating on a textbook.

The unusual layout of the cursor-control keys was hard for me to get used to. I wish Fujitsu would exchange it for a more conventional layout. The Quote key (next to the right-hand Shift key) produces a normal double quote. The Break key handily produces a Control-C that can terminate some programs. Like the IBM PC, the 16s can be reset by simultaneously pressing the Control, Alt, and Delete keys. This won't work if the computer isn't looking at the keyboard. This is why the 16s has a Reset switch, which the IBM doesn't.

#### VIDEO DISPLAY

An RGB (red-green-blue) color monitor is optional with the 16s. Its display is extremely readable. Small holes in the rear of the monitor lead to adjustment controls, but I never needed them. The brightness control in front was enough. A minor flaw is that the RGB and light-pen sockets use identical DIN (Deutsche Industrie Norm) sockets.

I surmise from the hardware manual that any standard NTSC (National Television System Committee) monochrome monitor should plug into the "green CRT" socket with an adapter cable. I don't know if more than one monitor can be used at a time. The RGB monitor isn't hard on the eyes, but the option of color or monochrome is there. Both text and graphics displays are steady from screen warm-up through a 16-hour day. Graphics are displayed as 640 by 200 pixels (dots) with 8 colors. Monitors with variable intensity will show 16 colors. Simultaneous displays of text and graphics overlap rather than overwrite each other. Graphics and text have their own memory areas, according to the hardware manual. I don't know if application programs can access them directly.

Any character can be displayed in any one of the eight primary colors over any background color. This can be set with the supplied Screen program. The background can be set blinking—good mostly for attention-getting. Screen can also display a 24-hour

time clock in the upper right corner of the screen.

#### HARDWARE OBSERVATIONS

When you start up the 16s, it quickly checks what boards are installed and lists those it finds. It doesn't actually check each drive, so if you have an interface installed and no drives, it wouldn't know. If you then try to access those nonexistent drives, the system can lock up.

The built-in, four-channel A/D (analog-to-digital) converter is documented in the hardware manual, but that's about it. Fujitsu has made no plans to provide software support for this connector; for the moment, it's just there. Hobbyists could probably hook up a joystick or bit pad with no trouble at all, but they wouldn't get much help from Fujitsu.

One boon for hobbyists and experimenters is that Fujitsu will sell listings of its  
*(continued)*



Photo 1: The Fujitsu Micro 16s and an optional 13-megabyte 5¼-inch hard-disk drive.



CP/M-86, CCP/M-86, and MS-DOS BIOSes (basic input/output systems) for \$100 each. While this price is a little bit high, I applaud Fujitsu's decision to sell listings. Some of the best equipment around has been developed in homes on unremarkable micros. BIOS listings make this much easier.

**INTERNAL STRUCTURE**

Inside, the 16s looks much like any other computer, except for its expansion boards. The boards use a bus designed by Fujitsu specifically for the 16s. This bus has a data path 16 bits wide (twice the width of the IBM PC's, the same as the S-100/IEEE-696) and an address path 24 bits wide. In addition, provisions have been made for multiple processor boards.

Unlike the S-100/IEEE-696 bus, voltage regulation is handled in the power supply, leaving more room for functions on the expansion boards. Like the European/Motorola VME bus, the 16s's bus uses a socket on each board, mating with pins sticking up from the motherboard. This arrangement is supposed to be more reliable than the familiar card-edge and socket-on-motherboard arrangement of the IBM PC and S-100 buses.

The 16s has only six slots (plus one for the 5¼-inch disk-drive controller). But notice the functions already sup-

plied: an RS-232C port, a Centronics printer port, and the keyboard interface are all standard. The monochrome and color interfaces are also standard—and don't take up an expansion slot. So the "standard" 16s will have four empty slots. If you run out of room, you can remove the Z80A processor board and replace it with an 8-inch disk controller. Or you can replace the 8086-2 board with a more advanced processor, when available. All this can be done with full manufacturer support.

The novel bus arrangement has one side effect: it's difficult to insert or remove expansion boards. It's so hard, in fact, that I feared for the traces on the motherboard while reinserting the 8086-2 board (although the computer seemed none the worse for wear). The hardware manual described a pair of 9-inch-long L-shaped metal brackets for pulling boards. Dealers are supplied with these.

The 16s's unique bus provides food for thought: since only Fujitsu is likely to make boards for the 16s, you may not get the ones you need if the demand is light.

**PERFORMANCE**

The 16s is fast. It has an 8086-2 microprocessor (the 2 is for 8 MHz) for 16-bit (CP/M-86 and MS-DOS) programs and a Z80A for 8-bit (CP/M-80)

ones. The 8086 has 16-bit data paths. In the Fujitsu Micro 16s, the 8086 runs at about twice the speed of the IBM PC's 8088 microprocessor.

The correct processor is selected automatically for each application by Fujitsu's version of CP/M-86. The programs supplied with the computer worked just fine, except for Digital Research's DR Graph. WordStar, SuperCalc2, and the supplied utilities ran quickly and reliably. Even WordStar's tiresome overlay swapping ran fast, probably because of the 16-bit data paths on the Fujitsu's bus.

**MEMORY**

Fujitsu currently offers four different memory boards to supplement the standard 128K bytes on board, which I believe is far too little for a business machine. I received and installed the 256K-byte board, which ran fine. After setting switches on the 256K-byte board to address it above the internal 128K bytes, I put it in place and ran the supplied Health Check program. No switches are on the 16s itself to set for added memory. It automatically finds the amount of installed memory when started.

The 256K-byte board is well built, and its chips stay cool to the touch while running. It uses 64K-bit RAMs (random-access read/write memories), as does the 128K-byte memory board. The 1-megabyte board uses 256K-bit RAMs. Because these RAMs are new and scarce, this board is expensive. Currently, the maximum addressable RAM is 1 megabyte, which is a limitation of the 8086.

Whatever memory is installed can be partitioned between working RAM and a RAM disk (i.e., an area of memory that looks to the computer just like an extremely fast disk drive). The RAM disk makes compiling and file-sorting functions much faster.

Running the Health Check program uncovered the first of several software bugs: it won't run under CCP/M (Concurrent CP/M-86). Instead, it gave the message, "Illegal call of interrupt 1A," printed another A prompt, and then the 16s promptly died. It seems that

*(continued)*



Photo 2: The Fujitsu keyboard.

## AT A GLANCE

### Name

Fujitsu Micro 16s

### Manufacturer

Fujitsu Microelectronics  
3320 Scott Blvd.  
Santa Clara, CA 95051  
(408) 727-1700

### Components

Size: main system unit is 19¼ by 14½ by 5¾ inches

Weight: 33 pounds

Processors: 16-/16-bit 8-MHz 8086-2 and 8-/8-bit 4-MHz Z80A; an 8-/8-bit 2-MHz 68B09 controls housekeeping on the motherboard

Memory: 128K bytes

Display: 12-inch monochrome or RGB color monitor; 80 characters by 25 lines; 640 by 200 color graphics

I/O interfaces: one RS-232C serial port, one parallel printer port, a four-channel A/D converter, monochrome and RGB color-monitor interfaces

Mass storage: two 5¼-inch double-sided double-density floppy-disk drives, 320K bytes each

Expansion capability: seven expansion slots; standard system requires three slots

### Price

Standard system unit: \$2350

### Optional Hardware

SCSI/hard-disk controller card:	\$295
13-megabyte 5¼-inch hard-disk drive and controller:	\$1995
26-megabyte 5¼-inch hard-disk drive and controller:	\$2895
128K-byte memory board:	\$295
256K-byte memory board:	\$495
512K-byte memory board:	\$1195
1-megabyte memory board:	\$2095
Serial RS-232C interface (two ports):	\$395

### Documentation

*Operations Guide*, 62 pages, covers the basics of assembling and operating the computer; an optional hardware reference manual (\$75)



MEMORY SIZE (K BYTES)

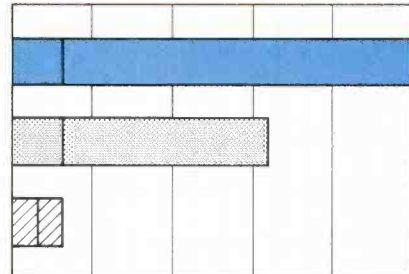

DISK STORAGE (K BYTES)

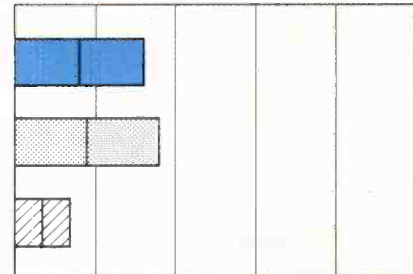

BUNDLED SOFTWARE PACKAGES

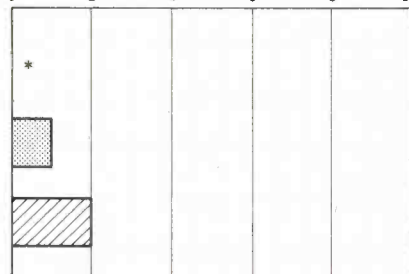

PRICE (\$ 1000)

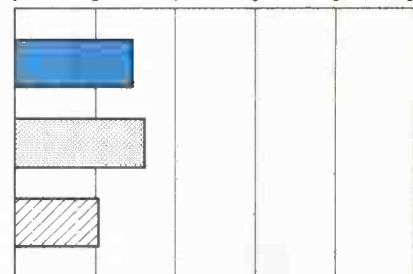

■ FUJITSU MICRO 16s    ■ IBM PC    ■ APPLE IIe

The Memory Size graph shows the standard and optional memory available for the computers under comparison. The graph of Disk Storage capacity shows the highest capacity of a single floppy-disk drive for each system. The Bundled Software Packages graph shows the number of software packages included with each standard system. The 16s is not normally sold with bundled software. The Price graph shows the Fujitsu Micro 16s list price (includ-

ing CP/M-86, monochrome monitor, and 256K bytes of RAM) compared to systems with two floppy-disk drives, a monochrome monitor, graphics and color-display capability, a printer port and a serial port, 256K bytes of memory (64K bytes for 8-bit systems), the standard operating systems, and a BASIC interpreter for each system. For details of the Fujitsu Micro 16s specifications, see the configuration details in the "At a Glance" listing.





A rear view of the Fujitsu Micro 16s.

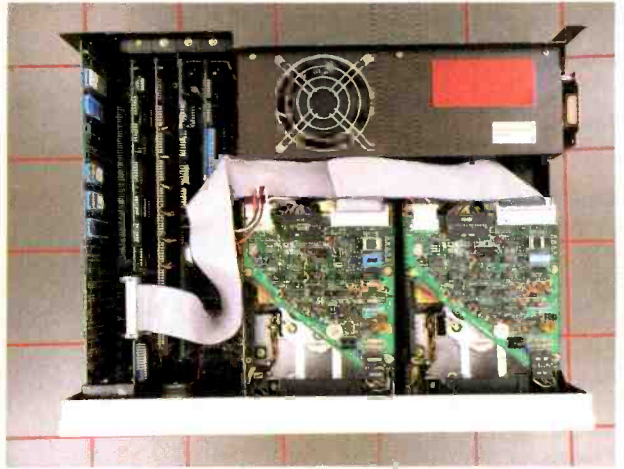

This interior view shows the unique Fujitsu motherboard with several cards installed.

DISK ACCESS IN BASIC (SEC)

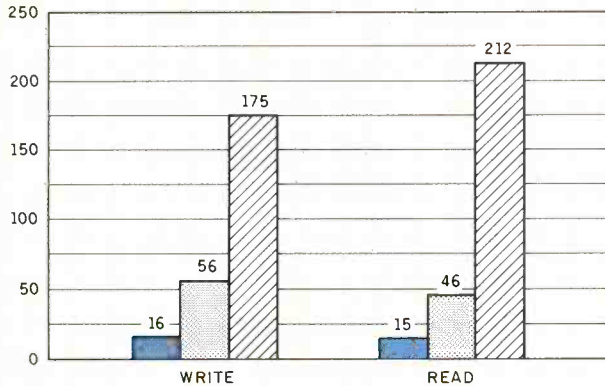

BASIC PERFORMANCE (SEC)

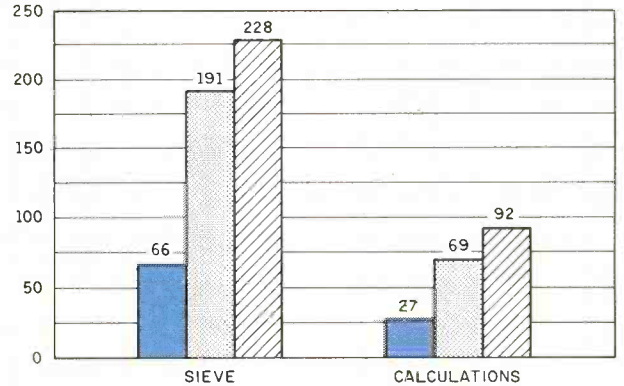

SYSTEM UTILITIES (SEC)

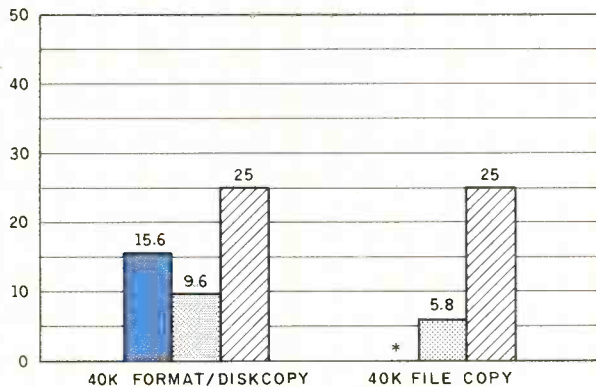

SPREADSHEET (SEC)

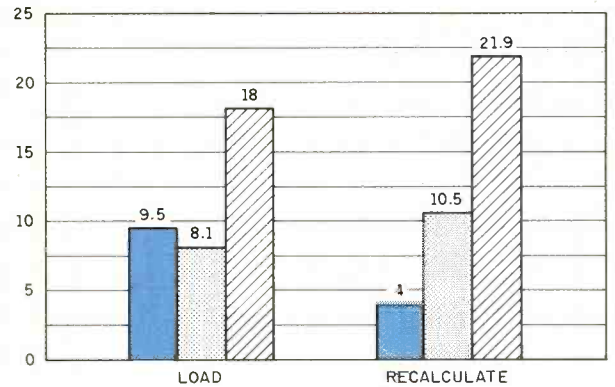

■ FUJITSU    ▨ IBM PC    ▩ APPLE IIe

The graphs for Disk Access in BASIC show how long it takes to write a 64K-byte sequential test file to a blank floppy disk and how long it takes to read this file. (For the program listings, see "The Chameleon Plus" by Rich Krajewski, June BYTE, page 327, and the revised listing in Fixes and Updates, page 33 of this issue.) The Sieve graph shows how long it takes to run one iteration of the Sieve of Eratosthenes prime-number benchmark. The Calculations graph shows how long it takes to do 10,000 multiplication and division operations using

single-precision numbers. The System Utilities graphs show how long it took to format and copy a disk (adjusted time for 40K bytes of disk data). (\*The 40K-byte file transfer was not performed.) The Spreadsheet graphs show how long the computers took to load and recalculate a 25- by 25-cell spreadsheet, where each cell equals 1,001 times the cell to its left. The Apple and IBM used Multiplan; the Fujitsu used SuperCalc2.

some serious software differences exist between CP/M-86 and CCP/M.

### DOCUMENTATION

The single manual that comes with the 16s isn't enough. It covers only portions of the included software. First-time computer users will find this manual woefully inadequate. I would be much happier if Fujitsu supplied a more detailed introduction to computers for novices covering such items as disk care and computer power requirements.

Most of the optional manuals are reprints: the CCP/M-86 manual is just a Digital Research manual with a 16-page insert about the 16s. The CP/M-86 manual's index doesn't list such important utilities as SDIR, Screen, and Setbaud. I found no mention of how to run CP/M-80 programs. BDOS (basic disk operating system) functions are referred to as DBOS functions throughout one section. However, Fujitsu has made serious improvements over the photocopied manuals I originally received. The 16s manuals are only slightly worse than, say, the IBM PC-DOS 1.1 manual.

The manuals for add-on hardware are much better than those for software. I am impressed by the manual for the hard-disk controller.

### CP/M-86

Almost everyone will run CP/M-86 on the 16s. It is a hybrid system, running both 16-bit programs (CP/M-86) and some 8-bit ones (CP/M-80). Several other computers, notably the DEC Rainbow, CompuPro 8/16, and Zenith Z-100, also switch automatically between their two processors, but I'm afraid they do a much better job. I couldn't find a single alternate 5¼-inch CP/M-80 floppy-disk format that the 16s could read properly except for CP/M-86 IBM PC format. This alone will make it hard to run 8-bit programs. In addition, several of the CP/M-80 applications I tried didn't run on the 16s, specifically, programs that did BIOS calls. Fujitsu's engineers promised that they would look into this.

Fujitsu has paid attention to detail.

The supplied utility programs will set the time, update it constantly on the screen, check the health of the 16s, and program the function keys. WordStar's Install program lets you change the colors in which text will be displayed. Fujitsu supplies an entire disk of on-line Help information, customized for the 16s, and blank disks to back up the supplied software.

Some gaps still are found, however. A backup program that will format, copy, and verify a disk with one command is needed. The entire computer locks up when you attempt to print to a nonexistent printer. CP/M-86 needs to support user numbers and disk-search lists more thoroughly. Also needed are programs to transfer data between CP/M and MS-DOS and a way to read different CP/M-80-format disks.

The 16s doesn't come with a BASIC. Claudia Natalia, the Fujitsu Micro 16s press-relations supervisor, says that the business marketplace doesn't need or want BASIC.

### CCP/M-86

Fujitsu's implementation of CCP/M-86 is well done. You can set up four different programs to run under CCP/M; for example, WordStar, SuperCalc2, a communications program, and a time manager. Each would wait for you to switch to its task, meaning you could have an entire set of your normal work programs set up for you. With the 16s's 8-MHz 8086, this would also run acceptably fast.

CCP/M works with most CP/M-86 programs and uses the same hard-disk partitions that CP/M-86 does, so you can switch freely between the two by just restarting the 16s. Unfortunately, it doesn't run 8-bit (CP/M-80) programs at all. A Fujitsu engineer told me that the Micro 16s would have to stop running 16-bit programs for the entire time that 8-bit ones were executing.

The CCP/M manual includes a large gap. The Fujitsu insert for the front of the CCP/M manual didn't mention how to switch tasks! An engineer filled me in: press the Graph key and the Numeric Pad key corresponding to

the task you wish, from zero through three.

### MS-DOS

I reviewed a preliminary copy of MS-DOS, so I can't comment on it as much as CP/M-86. The 16s uses the full MS-DOS version 2.0 in a double-sided nine-sector format. Disks made on the 16s read and write fine in the IBM PC. It will also make eight-sector disks, both single- and double-sided. Naturally, MS-DOS won't run many programs that are extremely IBM hardware dependent, but WordStar and SuperCalc2 (as supplied) work just fine.

A few highlights: MS-DOS also gets its time from the real-time clock on the hard-disk board, although you must press the Return key to confirm it. The Screen utility will set colors, clock placement, etc., just as under CP/M-86. Help under MS-DOS isn't as complete as under CP/M-86.

### GSX-86

GSX-86 is a Digital Research program supplied with the 16s that attempts to make graphics transportable. Data gathered on one computer should work on any other, both for display and output. Its companion product is DR Graph, which actually does the graphing.

DR Graph is rather slow, both to load and to display graphs, even with the high speed of the 16s. It's fragile, must be loaded after GSX-86, and used with the Run utility, or it will lock up the computer. It lacks many features, such as a way to display the directory from within DR Graph. It's not well tested; the message "press any key" actually means "press the Return key." It does make readable graphs.

### EXPANSION HARDWARE

I received two subsystems for review with the 16s: the dual 8-inch floppy-disk drives (no longer offered as an option) and the 13-megabyte hard-disk drive.

Many computers still use 8-inch drives, and the "IBM standard" 3740/1 single-sided single-density disks are

*(continued)*



**Applications Developers**

"C" INTO THE FUTURE

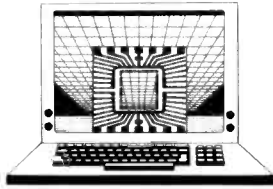

WITH  
**db\_VISTA**

The first DBMS  
designed exclusively  
for the C language.

C is the applications development language chosen by many of the largest and most successful microcomputer software houses. Now with **db\_VISTA**, C can be your development language choice, too.

**db\_VISTA** is the database management system that helps you easily define and manage databases — no matter how complex your information structuring requirements. Features include:

- \* Written in C, under Unix.
- \* Minimal data redundancy using the network database model.
- \* Virtual memory disk accessing.
- \* Fast B\*-tree indexing method for key files.
- \* Multiple key records--any or all data fields may be keys.
- \* Unlimited run-time distribution license available for \$795.
- \* Three month extended applications support included.
- \* PC-Write word processor/text editor included at no charge.

**AVAILABLE NOW**

For Lattice C, DeSmet C, or Computer Innovations' C86 under MS-DOS, with thirty day money-back guarantee. Available soon for Unix/Fortune 32.16, Xenix/Altos 586, and CTOS/Convergent Technologies systems.

**db\_VISTA versions:**

Lattice	\$495
DeSmet	495
Computer Innovations	495
db_VISTA Documentation	15

**Development Packages:**

Lattice C w/db_VISTA	\$795
Lattice C only	395
DeSmet C w/db_VISTA	595

**RAINIA**

CORPORATION

11717 Rainier Avenue South  
Seattle, WA 98178

206/772-1515

**REVIEW: FUJITSU**

*New processor cards  
will keep the 16s current  
for many years to come.*

still the only truly universal medium. True, IBM PC-DOS 5¼-inch disks are a close second, but most software-development companies still use 8-inch-drive machines. This is true at Chaos Manor, too.

The subsystem contains two half-height 8-inch drives that are double-sided. An interface card plugs into the 16s. Once installed (in about 15 minutes), I could use normal 8-inch CP/M-80 disks without difficulty. The drives became C and D, and programs, such as CRCK, that don't use BIOS calls work fine. They read, write, and format SSSD (single-sided single-density) disks using the Format program.

The 8-inch-drive interface seems to be standard except for the unique connector, which resembles a 50-pin Centronics connector. Fujitsu will sell just the drive-interface board, so you can hook up your own drives and save a lot of money. The hardware manual and Fujitsu confirm that it's a standard 8-inch interface. With the hardware manual, some connectors, wire, and a soldering iron, you can make an adapter cable for any 8-inch double-sided drive.

Software modifications *would* be required for using more than two 5¼- or 8-inch drives, even though there is an "out" connector on the 8-inch drives where you could hook up another pair.

I also tested the 13-megabyte hard-disk-drive subsystem. Again, this comes in two parts: an interface board that plugs into the computer and the hard-disk drive and another interface in a separate cabinet.

The interface is an SCSI (small computer standard interface) board. This is a standardized superset of the older SASI (Shugart Associates standard interface). The SCSI board plugs into the expansion bus and has another 50-pin connector on the rear of the

16s. The board I received was an early model with a number of jumper wires and resistors. Later ones are supposed to be free of these hand-wired modifications.

The SCSI board also contains a battery-backed-up real-time clock. Mine had a wire-wrap area, I guess for experimental interfaces. This area has been removed from current SCSI boards.

You can also choose to buy only the SCSI board and connect up to four of your own hard-disk drives. You'll also need an adapter to connect them to the SCSI/SASI board, plus a cable adapter for Fujitsu's unique connector. This do-it-yourself option is only for the patient and knowledgeable, but it could save a lot of money.

One bit of connector confusion: the cables for the 8-inch floppy-disk and hard-disk drives are identical 50-pin versions of Centronics connectors. Both the 8-inch and hard-disk-drive cables should be labeled.

**SUMMARY**

I like the Micro 16s's hardware. Everything is extremely well built. New processor cards will keep this machine current for many years to come. The large memory cards, high-bandwidth bus, and expansion boards should be the standard for other microcomputers.

The 16s will run some CP/M-80 programs and most CP/M-86 ones that don't rely on non-16s hardware. A wide range of software is available, especially in the IBM PC and CP/M-86 formats. MS-DOS for the 16s is well done, and my experimentation with CCP/M-86 impressed me. The staff at Fujitsu seems a bit disorganized but very knowledgeable. They are certainly attentive to customer needs.

The only real detraction to buying the 16s is compatibility. It isn't an IBM PC. Its unique bus means buying boards exclusively from Fujitsu. Much of the 16s's greatest potential awaits the introduction of more advanced processor boards, using microprocessors such as the 68000 or the 80286. Still, the Micro 16s is simply too good to be ignored. ■

# Introducing The First Directory Ever To Reach The Entire Membership Of The National Society Of Professional Engineers.

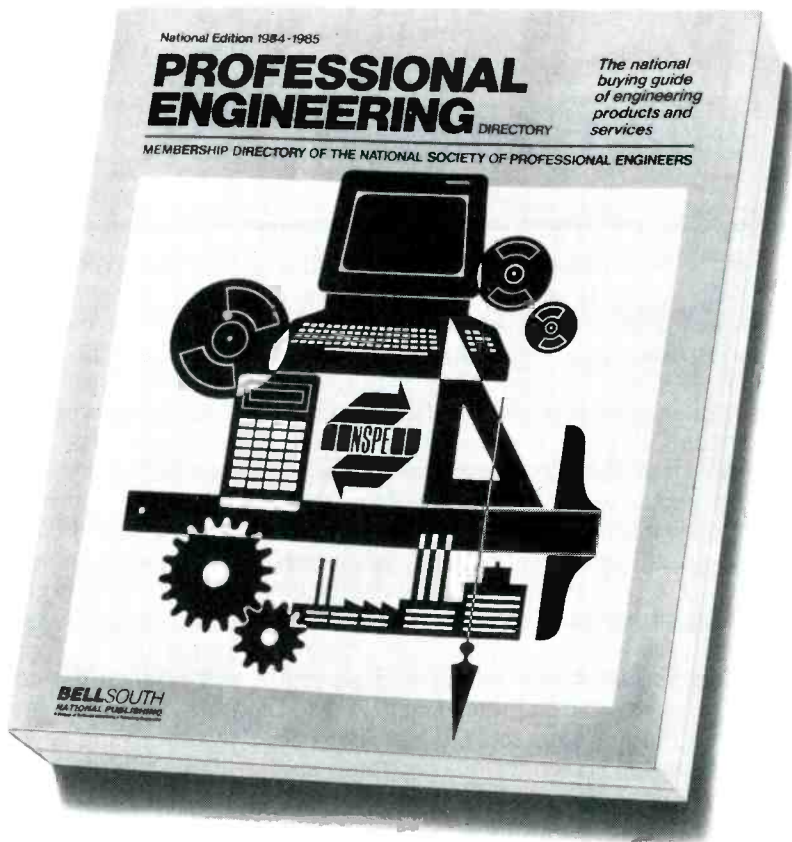

## You'll Want To Advertise In The Comprehensive Buyers' Guide Specified By Professional Engineers.

Now, for the first time, your advertising message can reach all 80,000 members of the NSPE in a single publication—the unique “Professional Engineering Directory.” Every member of NSPE—a group identified by a Gallup poll as a leading force in the profession—will be listed and have a copy for ready reference.

If you want to cover this elite market, it would be a mistake not to advertise your products or services in this most comprehensive and informative of all engineering directories.

### Professionally planned and designed.

To provide optimum convenience and usefulness to engineers, the “Professional Engineering Directory” has been planned and developed by a panel of NSPE engineers in cooperation with BellSouth National Publishing, one of the country's most experienced directory publishers with offices in Dallas, Chicago, Los Angeles, New York, Atlanta and Miami.

The directory has the official endorsement of the NSPE executive board.

### 120,000 total circulation.

Base circulation for the “Professional Engineering Directory” will be the 80,000 members of the NSPE in all five categories of practice: private, industry, government, construction, and education. Members will be listed individually and by firm.

In addition, copies will be sent to 40,000 specifiers of engineering products and services in such fields as architecture, construction, transportation, communications, government, and others. Altogether, circulation will total 120,000. And now you can reach all of these prospects in one single directory.

### 6,000 advertising headings.

Don't pass up this opportunity to sell to the cream of the engineering crop. Make sure your advertising program includes the “Professional Engineering Directory.”

If you sell more than one product or service, you'll want to consider ads under more than one category heading. The directory will offer up to 6,000 different headings.

So don't wait. Get all the facts now on this significant new advertising medium, and watch for other new directories from us. For complete details just write or call.

#### BELLSOUTH NATIONAL PUBLISHING

P.O. Box 19739, Atlanta, Georgia 30325

Please send me complete details on your new  
*Professional Engineering Directory.*

I am interested in advertising in it.  I would like to obtain a copy.

NAME _____	TITLE _____
FIRM _____	(PHONE) _____
PRODUCT OR SPECIALTY _____	
ADDRESS _____	
CITY _____	STATE _____ ZIP _____

**Toll free: 1-800-222-1207**  
(Inside Georgia 1-800-554-1169)

**BELLSOUTH**  
**NATIONAL PUBLISHING**  
A Division of BellSouth Advertising & Publishing Corporation



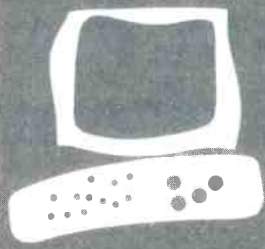

## The Panasonic Sr. Partner

The IBM PC-compatible portable that packs its own printer

BY RICH MALLOY

Several months ago we received a call from yet another new computer company. Panasonic, a branch of the Japanese giant, Matsushita (pronounced "mat-SUSH-ta") Electric Corporation, had set up a new division, the Panasonic Industrial Company, which would be offering a business computer on these shores.

According to the company spokesperson, this new machine would have some impressive specifications: IBM compatibility, portability, a built-in printer, and six software packages included in a reasonable base price (now \$2145 for a one-disk system).

The specifications sounded great, but specifications can be misleading. How good would the machine actually be? After all, Panasonic is known for quality stereo and television equipment, but we hadn't seen any computers from them, at least not in this country. And just *how* compatible would it be with the IBM Personal Computer?

### FIRST LOOK

Like the old Osborne I, the Compaq, and other transportable computers, the Panasonic Sr. Partner resembles a sewing machine when it is bundled up for travel. It is, however, a bit smaller than the Compaq (19 by 13 by 8½ inches versus the Compaq's 20 by 15¾ by 8 inches), and it has a nice padded handle on its left side. Like most transportables, the keyboard attaches to the front of the machine, protecting the display and the disk-drive openings. A removable panel on the back of the machine protects the power cord, the fan openings, and the interface connectors.

In the Sr. Partner's open, "ready to work" configuration, its keyboard is attached to the main system unit by a short coiled cable that plugs into the rear of the keyboard. This cable extends about 2½ feet and allows you to place the keyboard comfortably on your lap, although you won't be able to sit too far away from the computer.

The Sr. Partner's display measures 8½ inches diagonally and is of the green-

phosphor type. It is located on the left side of the unit's front panel, a fairly standard position for transportables.

On the right side of the front panel are one or two half-height 5¼-inch floppy-disk drives, depending on the configuration you choose. It has no space for floppy-disk storage.

On the bottom of the machine is a chrome-plated bar that flips down to raise the viewing angle. Most other transportables (with the notable exception of the IBM Portable PC) have short legs that can be folded out to accomplish this same purpose. When the computer is being transported, this bar seems to offer some protection to the keyboard.

The on/off switch for the Panasonic is in the somewhat traditional, if nonsensical, position on the back panel. Sharing this rather inaccessible location is the brightness control for the display. Thus, turning the machine on or off or adjusting the brightness of the screen involves a lot of fumbling with your fingers on the back panel.

Also on the back panel, and with more reason for being there, are the machine's serial connector (female, DB-25), a Centronics-type parallel printer port, and an RGB (red-green-blue) connector (9-pin, IBM PC style). A narrow metal plate on the left side of the back panel can be removed to provide access to expansion boards that have an external connector, such as a serial communications card.

On top of the machine is a small rectangular plastic panel, which, upon removal, reveals the most significant feature of the Panasonic Sr. Partner: its 80- or 132-column thermal printer. The printer is amazingly small, even though it includes space for a small roll of about 70 sheets of 8½-inch-wide thermal paper.

### THE DISPLAY

As mentioned above, the Sr. Partner has a 8½-inch, green-phosphor display (see photo

Rich Malloy is BYTE's product review editor. He can be contacted at POB 372, Hancock, NH 03449.

2). The characters on this display are similar to those on the Chameleon or on a non-IBM monochrome monitor connected to the IBM color/graphics adapter board in the IBM PC. In other words, they are not as sharp as those on the IBM monochrome monitor, or the Compaq or Corona PC for that matter. The reason is that the characters are composed on an 8- by 8-pixel matrix. When you take into account inter-character and interline spacing, the characters are made up of only 7 by 6 pixels, which is rather coarse, but this cell size is the most that the high-resolution screen of the IBM PC can accommodate (640 by 200 pixels).

While the Sr. Partner comes with a monochrome monitor, it will also support an external RGB color monitor. The graphics modes of the Panasonic are identical to those of the IBM PC, that is, 640 by 200 pixels with two colors or 320 by 200 with four colors.

Unlike the IBM color/graphics adapter board, the Panasonic circuitry can display colors as shades of gray. This feature is helpful, for example, with programs that display text against a colored background. On an IBM PC, the display looks great on a color monitor, but if you have a monochrome monitor connected to the color graphics adapter, the text may become impossible to read: the colored background is displayed as a hatched pattern that interferes with the patterns of the text characters. On the Sr. Partner, however, the colors are displayed as levels of gray, and as a result, the text is easy to read.

One other thing: the IBM monochrome monitor tends to flicker and look a bit "snowy" when you scroll text. The Panasonic has the flicker, but the snow is gone, which also makes the text clearer.

Overall, the Sr. Partner has a fairly good display. I found, however, that a few hours of reading text on the screen did bother my eyes a little. Panasonic could have improved its product if it had supplied an anti-glare

screen and a higher-resolution character generator, as did Compaq.

### KEYBOARD

Many of the IBM clones such as the Compaq and the Corona PC have the same exact keyboard, an IBM PC-like keyboard produced by Key Tronic of Spokane, Washington. The Sr. Partner, however, has a different keyboard (see photo 3). I don't have anything against the ubiquitous Key Tronic keyboards (although they do tend to feel a bit "mushy" sometimes), but it's nice to see something different.

The Panasonic keyboard has charcoal gray keys with, unfortunately, the same layout as the IBM PC's. The dreaded Backslash key strikes again. Why don't manufacturers follow the examples of Zenith and the TI Professional Computer? Another bad point

*(continued)*



Photo 1: The Panasonic Sr. Partner with optional second disk drive installed.



is a pair of rather flimsy plastic brackets that elevate the back of the keyboard. One improvement that Panasonic made on the standard design, however, is that certain keys (such as the Return and Shift keys) are larger and easier to find than on the IBM PC.

**UNDER THE COVER**

Under the off-white plastic casing of

the Sr. Partner is a rather standard 8088 microprocessor with a clock speed of 4.77 MHz—the same as that of the IBM PC. Supposedly, a socket exists for an optional 8087, but it's hard to find.

The standard unit now comes with 256K bytes of memory, and additional memory can be added by inserting chips on the memory card in one of the expansion slots (for more on this,

see "Expansion"). Up to 512K bytes can be present in the system.

**INTERFACES**

The Sr. Partner comes with a Centronics-type parallel printer port and an RS-232C serial port on the back panel. The integral thermal printer is set up as "Line Printer 1" (LPT1) and the external port is set up as LPT2. I had a little trouble getting my word processor of choice (PeachText) to print through LPT2, but it can be done; using most other word processors, it can be done fairly easily. Also, buried in the manual, Panasonic provides a key sequence to switch from the internal printer to the external. All you do is press the Alternate key and the Print Screen key. This sounds pretty logical when you think of it, but I didn't think of it.

As for the serial port, I connected the Sr. Partner to a modem, to a Hewlett-Packard HP-7475A plotter, and directly to other computers. I had no problems. Actually, serial communication is always a *bit* of a problem. But I had no more problems than I have had with other computers.

An RGB connector is also located on the back panel. I used it to connect to a Teknika MJ-22 RGB monitor using a standard IBM cable and the system worked quite well.

**THE PRINTER**

One of the high points of the Sr. Partner is its thermal printer. This 80/132-column printer is compatible with the control codes used by the Epson MX series printers. It is also compatible with the extended characters used by the IBM PC (see figure 1). We tested its graphics capability by setting up Lotus 1-2-3 for use with an Epson MX-80 printer. Panasonic's printer gave a better picture (figure 2) than many other printers that claim Epson compatibility.

This printer is so small and simple, you may start to wonder why other printers are so comparatively large. Since it is a thermal printer, it is very quiet. It uses shiny white rolled thermal paper, 8½ inches wide (sup-

*(continued)*



Photo 2: The display of the Panasonic Sr. Partner.



Photo 3: The keyboard of the Panasonic Sr. Partner. Note the oversize Return and Shift keys.

## AT A GLANCE

### Name

Panasonic Sr. Partner

### Manufacturer

Panasonic Industrial Company  
1 Panasonic Way  
Secaucus, NJ 07094  
(201) 392-4261

### Processor

16-/8-bit 8088, 4.77 MHz clock rate

### Memory

128K bytes on main board;  
up to 512K bytes with expansion board

### Display

8.5-inch, green phosphor, 80 characters by 25 lines, 640 by 200 pixels with two-color graphics, IBM PC-compatible

### Keyboard

Detachable, 83 keys, IBM PC layout

### Storage

One half-height, double-sided, 5¼-inch floppy drive (360K bytes); second drive optional

### Expansion

Two IBM-compatible expansion slots (one designed for memory)

### Special Feature

Integral thermal printer, uses 8½-inch-wide thermal paper rolls; text and graphics are Epson-compatible

### Bundled Software

MS-DOS (version 2.0),  
GW-BASIC, WordStar, VisiCalc,  
pfs:File, pfs:Report, pfs:Graph

### Price

With one floppy drive  
and 256K bytes of  
memory: \$2145

With two drives and  
256K bytes of memory: \$2595

### Options

Second disk drive: \$450



MEMORY SIZE (K BYTES)

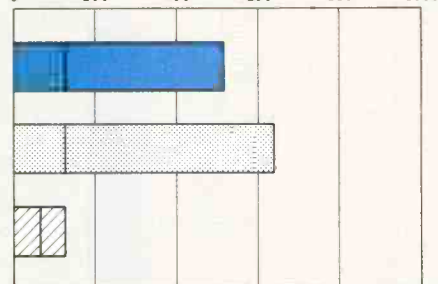

DISK STORAGE (K BYTES)

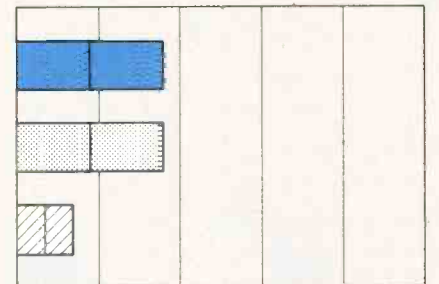

BUNDLED SOFTWARE PACKAGES

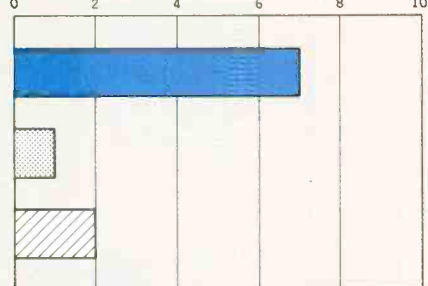

PRICE (\$ 1000)

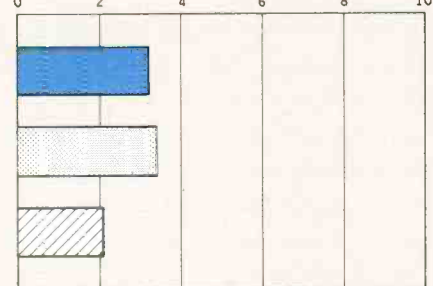

■ PANASONIC SR. PARTNER ■ IBM PC ■ APPLE II E

The Memory Size graph shows the standard and optional memory available for the computers under comparison. The Disk Storage graph shows the highest capacity of a single floppy-disk drive for each system. The Bundled Software Packages graph shows the number of software packages included with each system. The Price graph shows the list price of a system with two

high-capacity floppy-disk drives, a monochrome monitor, graphics and color-display capability, a printer port and a serial port, 256K bytes of memory (64K bytes for 8-bit systems), the standard operating system for each system, and the standard BASIC interpreter for each system. Note that the Panasonic Sr. Partner also includes a built-in thermal printer.





The rear panel of the Panasonic Sr. Partner. Along the bottom are a serial connector, a parallel printer connector, the brightness control for the display, and an RGB color monitor connector. The power switch is on the right. On the left is a removable plate hiding an expansion slot.

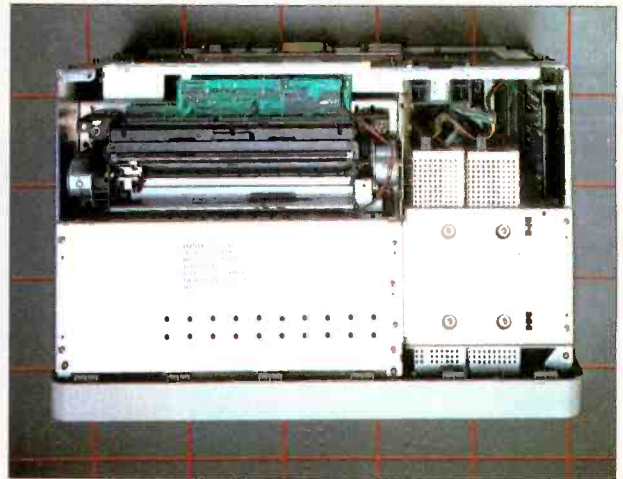

A top view of the Sr. Partner. The printer mechanism is in the left rear corner. The space for the expansion slots is on the extreme right.

DISK ACCESS IN BASIC (SEC)

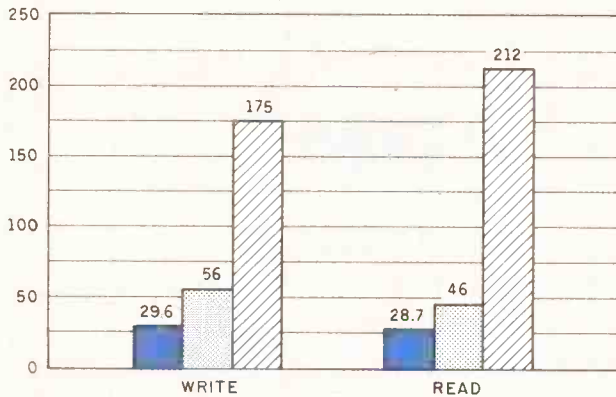

BASIC PERFORMANCE (SEC)

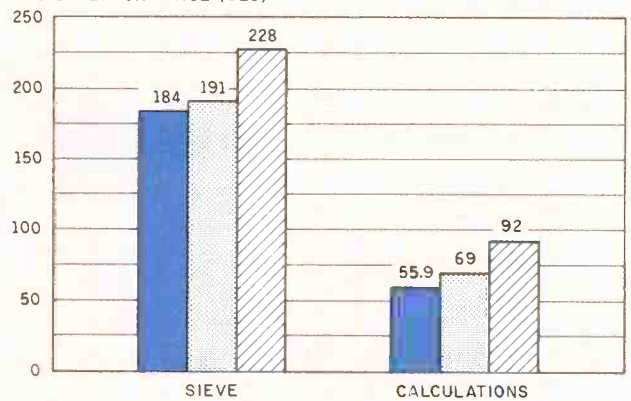

SYSTEM UTILITIES (SEC)

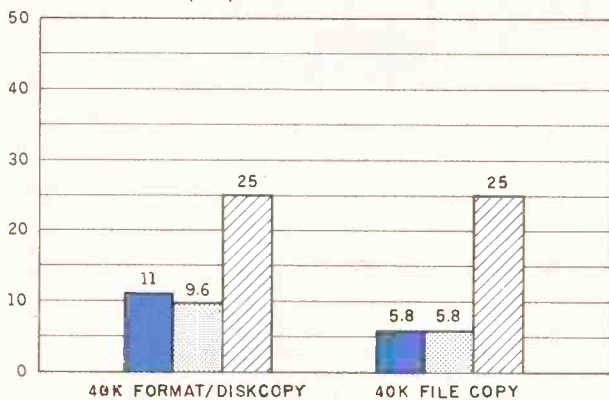

SPREADSHEET (SEC)

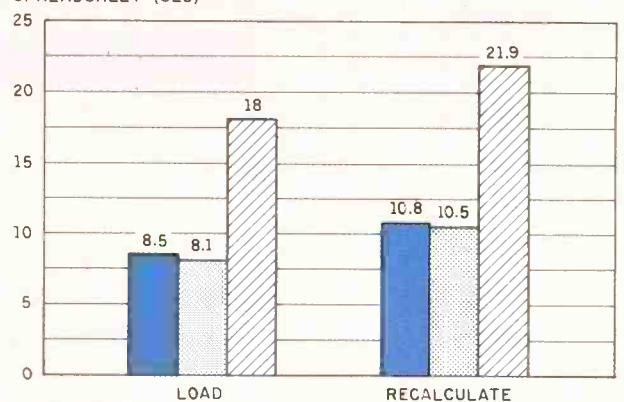

■ PANASONIC SR. PARTNER    ▨ IBM PC    ▩ APPLE II E

The graphs for Disk Access in BASIC show how long it takes to write a 64K-byte sequential text file to a blank floppy disk and how long it takes to read this file. (See the June BYTE, page 334, and the corrected listing in Fixes and Updates, page 33 of this issue.) The Sieve graph shows how long it takes to run one iteration of the Sieve of Eratosthenes prime-number benchmark. The Calculations graph shows how long it takes to do 10,000 multiplication and division opera-

tions using single-precision numbers. The System Utilities graphs show how long it took to format and copy a disk (adjusted time for 40K bytes of disk data) and to transfer a 40K-byte file using the system utilities. The Spreadsheet graph shows how long the computer took to load and recalculate a 25- by 25-cell spreadsheet where each cell equals 1.001 times the cell to its left. The spreadsheet program used was Microsoft Multiplan.

REVIEW: SR. PARTNER

posedly available only from Panasonic—\$4.95 for a 70-page roll). The vertical dimension of each page is up to you. You can tear off a page anywhere you want using a metal straight-edge. (Perforated rolls will also be available.) The printer has only one control—a linefeed button to advance the paper, and only one indicator light—to indicate when you are out of paper. A tiny unlabeled switch under the roll of paper turns on an auto-linefeed circuit for software that does not provide a linefeed with each carriage return. Though difficult to reach, this switch is more accessible than that of many other printers.

Of course, this printer is only meant as a draft printer. You're not going to want to print your resume on this. But when you want a quick printout of a memo or a graph, it should fit the bill.

EXPANSION

You give up two things when you go for transportability: display size and expansion capability. As for the latter, the Panasonic offers modest capability. The machine we received had two slots (see the photos on page 258), but one of them is occupied by a memory-expansion card. One of these slots will almost always be used for extra memory. Note that the space for these boards is relatively short—10 inches—compared to the 13-inch length required by most IBM PC boards. This length substantially limits the number of boards that will fit in

*Another notable feature is the large bundle of software that comes with the Sr. Partner.*

the unit. Fortunately, more and more companies are designing boards to fit in the short slot of the IBM PC XT, which is even shorter than that of the Sr. Partner.

DISK DRIVES

The standard Sr. Partner comes with only one half-height, 5¼-inch floppy-disk drive. The second disk drive is available for an extra \$450. Under MS-DOS 2.0, each drive can store 360K bytes of data. The drives are fairly quiet, though not as quiet as those on the Compaq.

SOFTWARE

The other really notable feature of the Sr. Partner is the large bundle of software that comes with it. This bundle includes MS-DOS (version 2.0), GW-BASIC, WordStar (version 3.3), Visi-Calc (the VisiCorp version), pfs:File, pfs:Report, and pfs:Graph.

The MS-DOS operating system is similar to IBM's PC-DOS. The BASIC interpreter, GW-BASIC, is very close to IBM's BASICA and is one of the few BASIC interpreters on the IBM PC clones that can run PC-Talk, a good.

(continued)

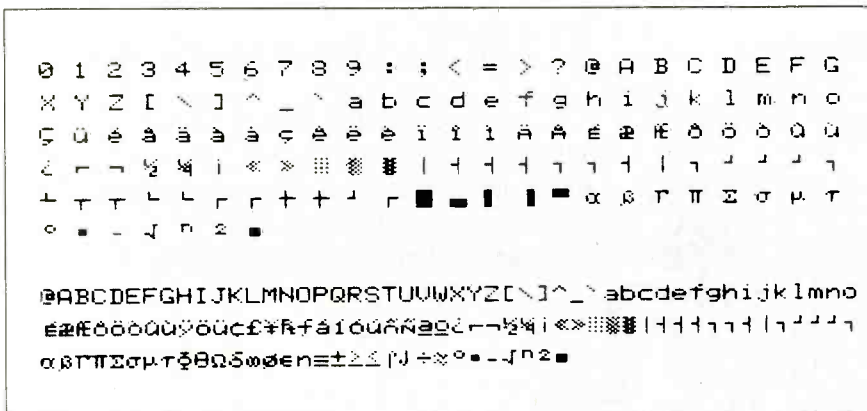
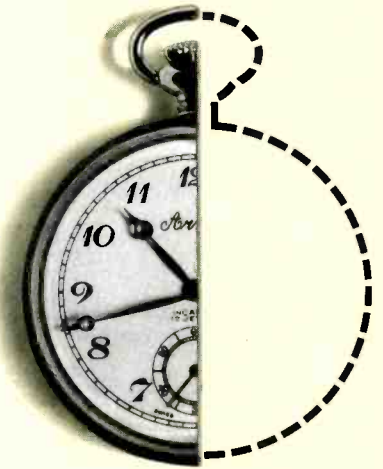

Figure 1: An example of text characters printed in 10 cpi (characters per inch) by Panasonic's internal thermal printer.

# Mylstar can cut your IBM-PC debugging time in half.



**Introducing MSD! Mylstar Symbolic Debugging Program for IBM Personal Computers, PC-DOS V 1.1, 2.0 and 2.1.**

MSD greatly enhances your IBM DEBUG Program. Using the same command structure as DEBUG, it lets you substitute symbol names and mathematical expressions for hex values. On-line help, multi-command macros and other time saving entries are also included. Even use symbols with assembly command.

**MSD adds on what IBM left out.**

Every symbol declared public in a source module becomes part of the symbol table. MSD contains commands for break points, repeat loops and input/output redirection. It lets you define macros which can be saved and used again. MSD also offers a Command to trace around calls, DOS interrupt calls, and repeat string instructions.

Call, write or check reader circle number for additional information. Only \$125. Phone orders accepted with Mastercard or Visa numbers.

**Dealer and Distributor  
Inquiries Invited.**

**MYLSTAR  
ELECTRONICS  
INC.**

165 West Lake Street  
Northlake, Illinois 60164  
Tel (312) 562-7400  
©1984 Mylstar  
All rights reserved

**A Unit of The Coca-Cola Company**



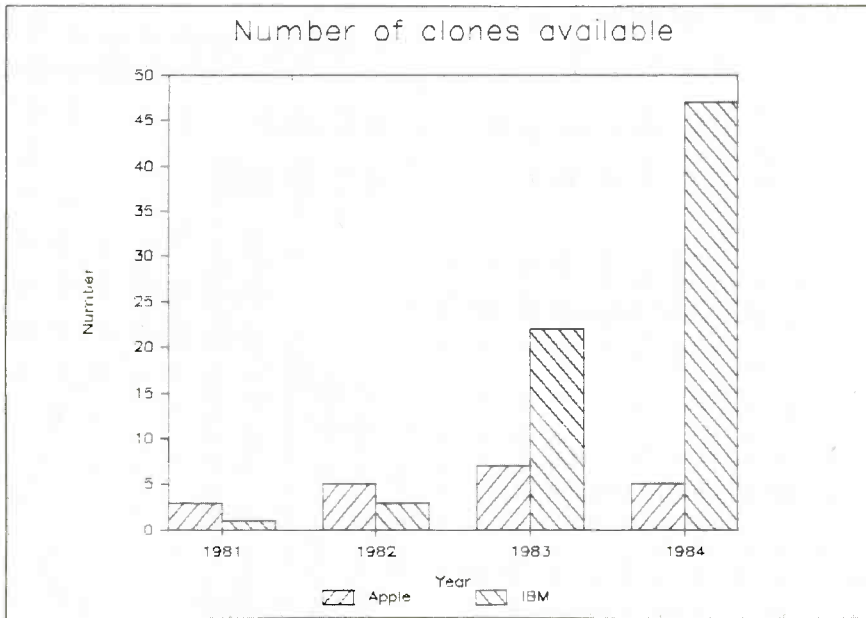

Figure 2: An example of a graph printed on Panasonic's printer. The graph was produced by Lotus 1-2-3 using a printer driver for the Epson MX-80 printer.

*The Sr. Partner's closest competitors have similar prices with various software and no thermal printer.*

inexpensive communications program written in BASIC (PC-Talk is available from Freeware, POB 862, Tiburon, CA 94920). Unlike the IBM and the Apple II, Panasonic's BASIC interpreter is entirely disk based rather than being resident on read-only memory (ROM) chips.

The other packages, WordStar, Visi-Calc, and the PFS series, are good serviceable products, even if they are not exactly on the leading edge of software technology. I have the impression that Panasonic signed the con-

# POWER-BASE™ PUTS YOU V

"Power-base™ is a menu-driven data management program with relational capabilities. It was the top-rated program overall, primarily because it was the easiest to learn and use, and rated highest in error handling." *The Ratings Book/Software Digest, March 1984*

"To track the Bank of New England's IRA sales for all 16 branches, I chose Power-base™ because it responds so well to change while protecting the integrity of my database." *Bruce Montgomery, Bank of New England*

"This program is impressive—it's easy to use, simple, logical, and powerful and comes with flawless written documentation." *Giovanni Perrone, InfoWorld, March 12, 1984*

"Because you don't have to wade through screens full of menus, the program is fast. Because your choices are always in front of you, the program is easy. Not much more you can ask for, is there?" *Bobbi Bullard, Computer Retailing, April 1984*

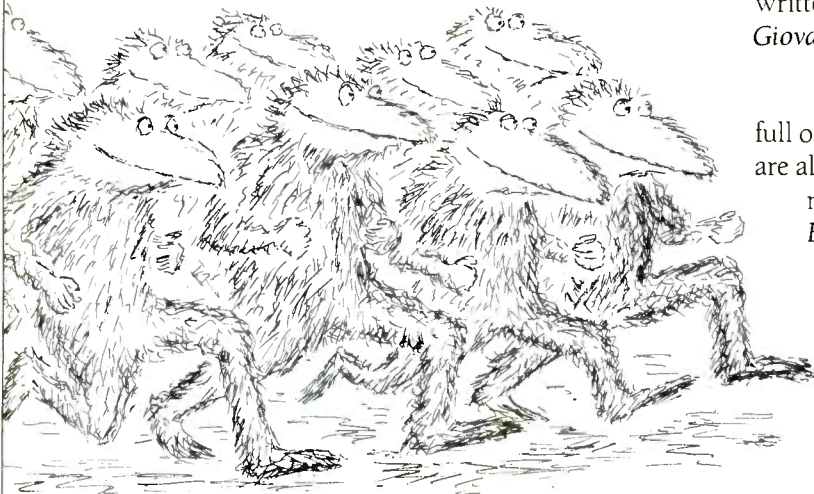

tracts for these packages a fairly long time ago.

**COMPATIBILITY**

No IBM PC clone is 100 percent IBM compatible. The question is, just how compatible is the Panasonic Sr. Partner?

We tried several of the major packages for the IBM PC, and with one exception, they all worked. This group included Multiplan, Lotus 1-2-3, PeachText 5000, Microsoft's Flight Simulator, and several others.

The one exception was part of a keyboard-enhancement package, ProKey. The Layout program in the package, which can be used to redesign the IBM's notorious keyboard layout, does not work. Note, though, that this particular program does not work on any other clone either and that the other programs in ProKey do work well on the Sr. Partner.

Of course, if you need a certain application program, you should first check it on the Sr. Partner to be sure it works. Overall, I must admit that I was impressed with the compatibility of this machine.

**FUTURE EXPANSION**

Panasonic has indicated that it will soon offer a number of expansion products. One of these is an expansion box that will have enough room for three standard 13-inch IBM PC expansion boards. This box will be connected to the Sr. Partner by a ribbon cable.

Panasonic is also working on a composite video adapter, a carrying case, and an integral 1200-bps (bits per second) modem.

**SUMMARY**

The Panasonic Sr. Partner is a good transportable IBM PC clone. At \$2595

for a two-drive system, including software and printer, its price is competitive with that of other clones, but keep in mind that you will probably want to buy a second printer for correspondence or heavy-duty printing. The Sr. Partner's closest competition—the Compaq, Corona PC, Chameleon, and the Columbia PCs—have similar prices with varying amounts of software and no thermal printer.

My one hesitation about the Sr. Partner is that Panasonic Industrial Company has no track record for computer servicing and repair. They have, however, set up a network of service centers and a hotline that will allow you to locate the nearest center.

The significant feature about the Panasonic Sr. Partner is its printer. If you need short, draft-quality printouts and graphs in remote locations, then the Sr. Partner may be a welcome addition to your staff. ■

# WAY AHEAD OF EVERYONE.

"Much to my surprise, my search for a data-base system took six months. But at last I've come up with a winner: Power-base™"

Paul Bonner, *Personal Computing*, February, 1984

SEND OR CALL TODAY FOR YOUR COMPLETE POWER-BASE™ DEMO

Experience Power-base™ yourself. Send \$10 with the completed coupon below for your Power-base demo.

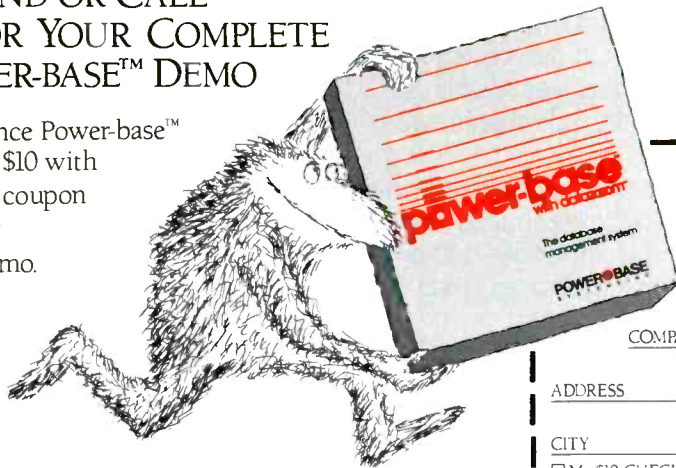

Or call 1-800-237-4778 (In NY, 212-947-3590). Use the demo to set up actual applications (restricted to 25 records) on your personal computer.\* See how simple it is to learn and use Power-base. We'll refund the \$10 when you purchase Power-base at any computer dealer.

WE MADE IT POWERFUL. BUT WE KEPT IT SIMPLE.

Send me my demo copy of Power-base.™

Mail to: PowerBase Systems, Inc. Dept. A-1  
12 West 37th Street, NY, NY 10018

NAME \_\_\_\_\_ TITLE \_\_\_\_\_

COMPANY NAME \_\_\_\_\_

ADDRESS \_\_\_\_\_

CITY \_\_\_\_\_ STATE \_\_\_\_\_ ZIP \_\_\_\_\_

My \$10 CHECK IS ENCLOSED  
 VISA  MASTERCARD # \_\_\_\_\_ EXP DATE \_\_\_\_\_

\*For use on the IBM PC and PC/XT or compatibles. Power-base and DataZOOM are trademarks of PowerBase Systems, Inc. IBM PC and IBM PC/XT are registered trademarks of the IBM Corporation.



# Now you don't have to sacrifice print quality for speed.

## The Canon® Impact Matrix Series Printers.

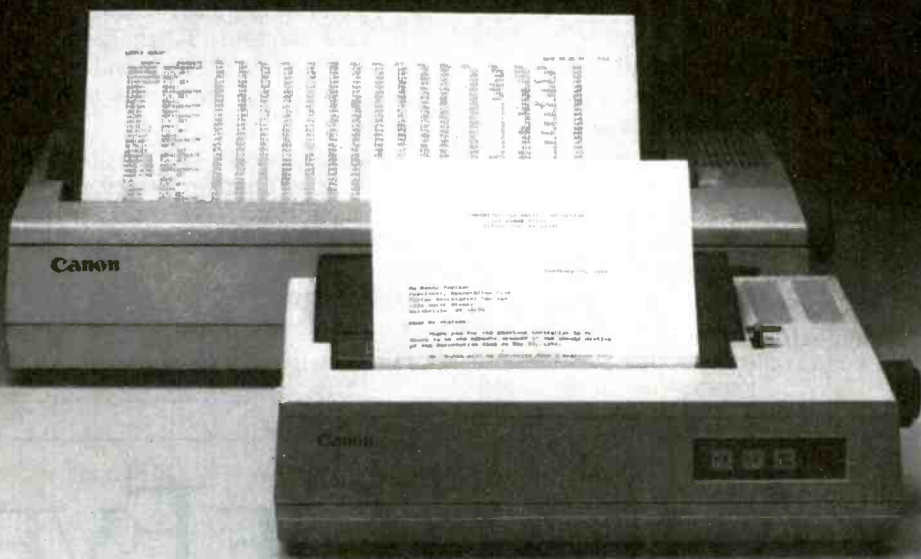

High speed and high quality in one functional, compact unit. That's what Canon's Impact Matrix Printers offer you.

They print hard copy at a rapid 160 characters per second. While in the double pass mode you get an impressive, high-density 23 X18 dot matrix that gives near letter quality printing suitable for word processing.

Canon's unique technology has also dramatically reduced bothersome clatter down to a muted noise level of less than 60dB.

Even at high speed.

And that, unlike many other impact matrix printers, makes them a pleasure to work with.

Plus there's limitless flexibility with the optional down-loading function that lets you print

whatever character fonts your host computer can create. As well as a choice of four different character styles (all printable on the same line) that you can enlarge or condense.

The Impact Matrix Series Printers give you a convenient choice of special paper widths—the PW-1080A for 80-character column printout and the PW-1156A for 156-character column.

Exceptional quality and high speed.

The Canon® Impact Matrix Series Printers give you the best of both worlds.

---

**For more information:**  
Call 1-800-323-1717, Ext. 300.  
(In Illinois call 1-800-942-8881, Ext. 300.)  
Or Write Canon U.S.A., Inc.,  
Printer Division, P.O. Box CN 11250,  
Trenton, N.J. 08638.

**Canon Printer Division**

Circle 386 on inquiry card.

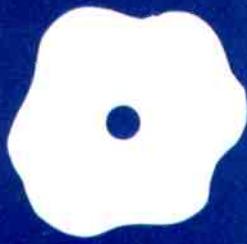

# Volkswriter Deluxe

A serious  
word  
processor  
that's easy  
to use

BY STEVANNE RUTH  
LEHRMAN

**I**n general, word-processing programs are either flexible or easy to use, but not both. Volkswriter Deluxe is a welcome exception to the norm. Lifetree Software, the publisher, obviously has a clear understanding of its customers' needs. Deluxe is easy to learn and use; anyone that has only an occasional need for word-processing capabilities will be able to get to work quickly. At the same time, the program offers all the formatting and text-manipulation options necessary for serious writing.

Deluxe is also multilingual. You can use it to write in Spanish, French, Italian, and German using the standard American IBM PC keyboard. (The European IBM PC keyboard, including the one sold in the U.K., is different.)

I used Deluxe with both PC-DOS 1.1 and 2.0. In most cases the program worked equally well. My comments in this review apply to both operating systems, but I'll point out any significant differences.

## PREPARING DELUXE

Preparing Deluxe for use is comparatively easy. The package provides an automatic set-up utility to transfer files from the original program disk to your working disk. This is a welcome change from the usual process in which you have to figure out which disk belongs in which drive and tell the computer which files to copy.

Configuring Deluxe for your computer is a bit more complex. The initial questions the program asks are simple and take only seconds to answer. (Many programs beep at you when they want your attention, but I find this extremely irritating. With Deluxe, you have your choice—at your command it will beep at you or be silent.)

Deluxe supports 18 different printers and also provides a "generic" printer category for all the varieties not listed. At initial configuration, printer selection is as simple as reading the choices and picking a number.

The final configuration question is the

killer; you are asked to define your work habits and preferences. Although you can easily correct your answer if you change your mind later on, Deluxe would be much more friendly, and a whole lot simpler, if the manual prepared you for the question. As it stands, before you know what's happening, you are in over your head.

It is also important that you be aware of Deluxe's "spill file" feature before you begin using the program.

## SPILL FILES

Not all word processors can handle long documents, which is a real nuisance for serious writers. And too many programs don't warn you that you have exceeded the document size limit—they just turn unresponsive or may even die when the memory requirements are overloaded. Given 256K bytes of memory, Deluxe can handle 40 pages of text. This is sufficient for an average long report. But Deluxe can also juggle longer files using what it calls a spill file. You may know this function as a "swap file."

Basically, a spill file is a temporary file. The program automatically writes text to it when the memory is full. As you page through a file, the program retrieves the relevant pieces of the document from the spill file. In effect, you use the disk to temporarily add extra memory to your system.

If you choose not to use a spill file, Deluxe will warn you when you are getting close to overload. Then you can divide the document into shorter files. If you expect to write long reports, you will need to establish a spill file. You can set the spill files on a hard disk, a third floppy-disk drive, or on the program disk itself. Do not put your spill files on your data disk. The disk with the spill files cannot be removed during a work session or you risk losing everything on the disk, not just the spill file. (This warning appears on the screen when you boot your program; however, I think Lifetree's warn-

(continued)

Stevanne Ruth Lehrman (15 Larkspur Rd., Newton, MA 02168) is the founder of Analytic Resources in Newton, Massachusetts. Her company specializes in competitive analysis of computer products, and informational design, writing, and editing of end-user documentation.



ing should be in boldface type in the manual and repeated several times.)

The documentation's explanation of what a spill file is and how it works is inadequate. Moreover, it gives no hint that you will have to deal with spill files at configuration before you get into the tutorial or the program. While it is easy to run configuration over again if you need to change your original answers, better documentation would eliminate this problem.

### CREATING AND EDITING

You begin serious work with Deluxe at the main menu. The choices are displayed at the top of the screen. Underneath, the prompt reads YOUR CHOICE. Typing a single letter initiates file retrieval, editing, printing, and other functions.

The bottom line of the screen is used as a status line. When you are working on a document, the filename is shown at the left. On the right, Deluxe lists line, column, and page numbers—you always know where you are in a document. Program information, editing, and error messages also appear on the status line.

Before you can edit an existing document you must retrieve it. If you type D and then specify a drive, your files will be displayed. If you are in PC-DOS 2.0, you can specify both drive and path; for example, C:\. Retrieval is accomplished by typing R at the prompt, and then your filename. You do not have to display files first.

I timed Deluxe's retrieval of a 4000-word document. It took 22 seconds to retrieve the document and its associated stored format and to bring up the editing screen. The original Volkswriter took only 15.1 seconds to retrieve the same file, but retrieving

and entering edit mode are separate operations. (See table 1 for a summary of this and all the other timed tests.)

Starting a new document is easy: type C to create a new file, then enter a filename. Enter E to edit the contents and get down to work. Use E to return to the document you have been working on after any action that brings you to the main menu. When you retrieve a file, Deluxe automatically moves into the edit mode.

You can insert additional material into the existing text by pressing the Ins key on the PC's keyboard. The cursor changes from a blinking line to a larger block, and old text is added. In the normal mode, new text is typed over the existing text, making correction of simple typos easy.

Deleting text is quick and logical. You can erase by letter, word, line, or block. If you delete text it is gone forever: there are no safety messages to prevent you from accidentally eliminating text you want. I prefer word processors that temporarily save deleted text or at least check with you before destroying it.

Moving around a document for editing is also quick and easy. Pressing the Home, End, Page Up, or Page Down keys by themselves or with the Control key moves the cursor by letter, word, or line. A Ctrl-F9 will move you to a specified page. Scrolling from top to bottom of my 4000-word file took 30.1 seconds. (Volkswriter took 44.9 seconds.) The ease and freedom of movement is delightful.

### SEARCH AND REPLACE

Deluxe's search and replace function can be global or selective. Once you have initiated a search, press F7 (Find

key) to continue the process. You do not have to reenter your word each time. When Deluxe reaches the end of the file, it automatically wraps around to the top and continues searching the whole document. In my timed test, searching for the last word took just 7 seconds.

As with most word processors, the search function is both case-sensitive and dumb. It can only recognize the exact pattern of letters in your query, even when they are in the middle of another word. You may have to search twice to find all occurrences, and some of those you find may not be correct. However, this is a minor annoyance.

### BLOCK MOVES

Identifying a block of text to move or copy involves marking the beginning and end of the block by using the F5 and F6 keys and moving the cursor to the spot where you want to insert the block. Press Alt-F5 to move the block, Alt-F6 to duplicate it, or Alt-F8 to delete it. Use F2 to store part of a document to a separate file. If you make a mistake and try to use too many block markers, Deluxe notifies you on the status line.

Column moves are identical, except you use Ctrl-F5 and Ctrl-F6 to mark the beginning and end, respectively, of the column.

One special block function—NotePad—bears notice. When you mark a block and then use Ctrl-F2, the text is appended to the end of the NotePad file. Text already in the file is preserved. The file can be retrieved, edited, and printed just like any other file. I've used it to store footnotes for a report and as a place to make notes about phone calls. I consider NotePad a strong plus.

Deluxe has a few problems with block and column functions. First, moves are slow. The longer your document, the slower the move, even if it is only two lines. Moving large blocks slows things down further. A 100-word block that took Volkswriter only 0.6 second to move required 4.7 seconds in Deluxe, approximately seven and a half times as long.

**Table 1:** The benchmark results for Volkswriter Deluxe compared to the original version of Volkswriter and WordStar version 3.3. All times are in seconds.

Function	Deluxe	Volkswriter	Wordstar 3.3
Load	22.0	15.1	9.9
Save	21.9	10.7	24.9
Scroll	30.1	44.9	41.2
Search	7.0	3.5	10.5

## AT A GLANCE

Second, when you move large blocks of text, unwanted text may be involved in the action. The program automatically reformats the text around the block. If a section does not end with a carriage return, the following paragraph will be included in the reformat, leaving you with a mess to untangle.

I found one interesting bug. I had retrieved a very short file (about 12 lines) from the disk. When I read it, I decided I didn't like what I had written and wanted to start over. Rather than returning to the main menu to create a new file, I attempted to use the block-delete ability to erase the whole file. It was a disaster. Instead of a gaining a blank screen, I was dumped back into DOS.

I've repeated this exercise with both PC DOS 1.1 and 2.0 with the same results. Although the problem does not affect deleting a block of text that is part of a longer file, the block-delete feature is one of the least satisfactory parts of the program.

### TEXTMERGE

TextMerge is one more feature that is right on target. I find it one of the easiest ways to do mass mailings and insert variable data into a standard text. It is considerably simpler to use than WordStar's MailMerge utility.

To use TextMerge you have to set up two files. The first is a standard text file containing your letter. The second contains the merge file of names and addresses. Many database-management programs, including dBASE II, will provide data in the format used by the merge file. At the beginning of the letter (called the base document in the users manual), you insert the embedded command `.FILE` to tell Deluxe which variable name in the text file corresponds with which variable in the merge file. In use, TextMerge automatically reformats paragraphs to maintain proper spacing and margins.

You can print all or part of the merge list. The output is printed simultaneously on your printer and monitor screen so you can see what

(continued)

#### Name

Volkswriter Deluxe, version 2.0

#### Manufacturer

Lifetree Software Inc.  
411 Pacific St., Suite 315  
Monterey, CA 93940  
(408) 373-4718

#### Format

5¼-inch floppy disk

#### Computer

IBM PC, IBM PC XT, and compatibles

#### System Requirements

PC-DOS 1.1, 2.0, or MS-DOS; 128K bytes of memory

#### Documentation

Three-ring binder, 150 pages, including on-line tutorial disk

#### Price

\$295

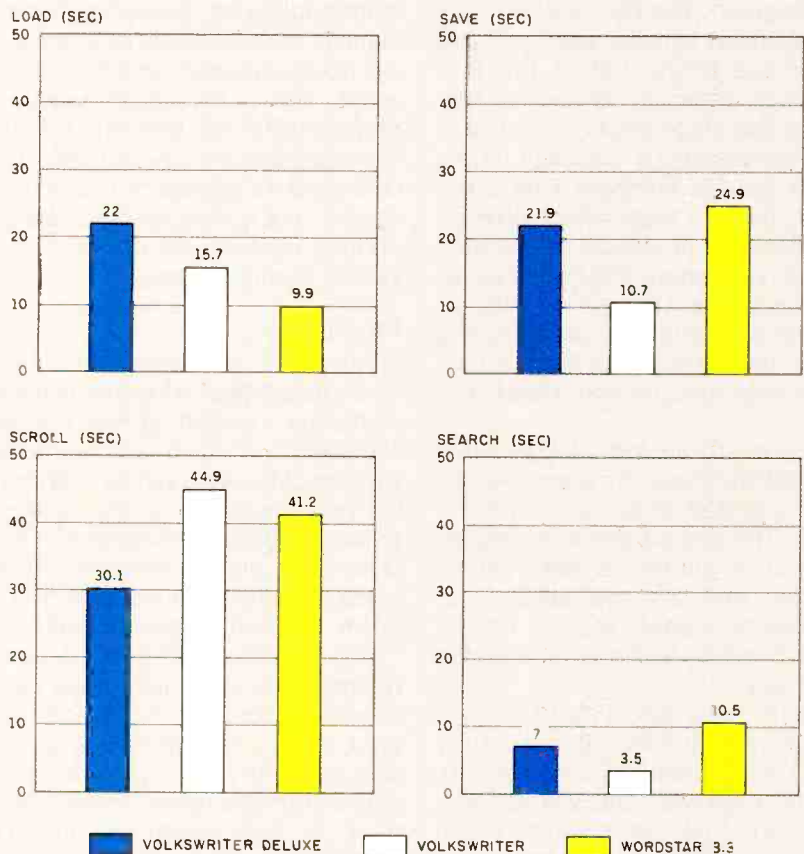

These graphs show the timing results of performing various standard word-processing functions using a 4000-word text file.

The times are for Volkswriter Deluxe, the original version of Volkswriter, and WordStar version 3.3.



is happening. One minor inconvenience with the TextMerge utility is that you cannot print just to the screen. You have to take the results on faith until you print out the finished letters.

The tutorial contains sample letter and merge files, as well as a file to create mailing labels. Load your printer with junk paper and play with the given files before trying to create your own.

### FORMAT AND PAGE LAYOUT

Deluxe belongs to the "what you see is what you get" family—you have to reformat each paragraph after editing. Reformatting requires moving to the start of a paragraph and pressing F8. You can reformat from the middle of a paragraph, but the function only works on text between the cursor and a carriage return. I think this is a nuisance, especially since other programs can automatically reformat.

A more serious problem arises when you are editing a long document that was originally created on another word processor, or one without carriage returns. I've had 19 neatly arranged pages dissolve into a hopeless solid mass of text. The only thing to do when something like this happens is to exit the editor and start over.

Page breaks are indicated by a thin line that shows exactly where the new page will start in the printed document. The line adjusts according to the values you set for page length, spacing, and first and last lines of printing on a page. You can force a page break by using an embedded command.

Deluxe has a logical method of setting margins and tabs: it uses a ruler line. The program can handle a 250-column page width and will automatically scroll past 80 columns if you select a wider page. Tabs are set by typing a plus sign along the ruler line. You clear tabs with the minus sign. To edit nontext documents, such as BASIC programs, you use an asterisk for the right margin. If you set multiple margins, Deluxe will recognize only the innermost pair.

You can create and save a format for a particular document or class of documents. Deluxe will automatically retrieve that format, rather than have you set the format each time. The format includes margins, tabs, printer type, page length, first and last lines of printing on a page, spacing, and right justification. The formatting options depend on which printer you selected during configuration.

Deluxe's short list of embedded commands covers the basics and then some. You can specify any number of headers and footers, as long as headers appear above the first line of printed text. Footers must be positioned below the last line of printed text. A `..COMMENT` command is used for nonprinting remarks. Information following the `verbatim` command is printed exactly as given and will not be mistaken for control characters. This is particularly useful in programming and scientific reports. Text immediately following the `PAUSE` command will appear on the monitor screen. I use it when I need to change printing elements or do something special during printing.

### PRINTING

Printing a file may seem confusing to a new user. (Again, the skimpy documentation is at fault.) In fact, printing with Deluxe is simple and functional because of the wide variety of printers the program supports. The "generic printer" setting is exceptional. I had Deluxe driving an electronic typewriter, a printing terminal, and my IDS Prism 132 with excellent results.

You can print from edit mode or by returning to the main menu and selecting P for print mode. From the print menu, you can check and/or alter your format. You can print all or part of the document. It only takes three or four keystrokes and the printer immediately starts pounding away, with no wait for the program to format the file. If you have a problem you can temporarily stop printing or quit.

If your printer is not amenable to printing a circumflex, grave accent, or umlaut, Chapter 7 in the users manual

will give you an overview of how to use Deluxe for multilingual and scientific applications. Appendix F shows how to make keyboard and printer translation tables. If you need these capabilities but are a novice, don't struggle to create the translation tables on your own. Get help from your dealer or a knowledgeable friend.

### SAVING DOCUMENTS

Saving a document couldn't be simpler. You have two choices. Return to the main menu and select S. Deluxe will respond by listing the original filename used to retrieve the document and will ask if you want to use the same name. If you say no, you can enter a new name for the file. Or, if you have set up the program to perform automatic backups, the original file will be renamed with the extension `.BAK` and your newly edited file will be saved under the filename. Saving is considerably faster than retrieving; Deluxe took 21.9 seconds to write to disk. Volkswriter again was faster at 10.7 seconds.

With some word processors, saving a file to a full disk can result in disaster—a total loss of data. This shouldn't happen with Deluxe. If the file you are trying to save will not fit on the disk, the program sends you a message to use another disk. You are safe as long as you have another formatted disk available.

### DOCUMENTATION

I have already made some negative comments about the documentation. Granted, the user's manual is adequate. However, although explanations are clear, they tend to be very brief. In some cases they are close to being cryptic, particularly the discussions of format selection and printer and keyboard customization. I would like to see more step-by-step explanations of the various functions. Examples, especially for using embedded commands, would also be welcome.

The on-line Help facility is also terse. Typing H at the main menu brings up a one-sentence explanation of the main menu options. In edit mode, you

can use F1 to toggle the function-key Help menu on and off as needed. Either Help screen can serve as a memory refresher, but neither is useful for rescuing you from a total panic situation. You will need to refer to the manual for fuller explanations.

The documentation does have a few saving graces. The user's manual index is good compared to most documentation. The table of contents is almost detailed enough to replace the index for many questions. And the troubleshooting appendix seems to answer many standard problems.

I suspect Lifetree Software is depending on the tutorial disk included in the package to replace the printed documentation. Good as the interactive tutorial is, it can't help you when you have questions while you're using Deluxe. I like the tone of the tutorial; it is friendly but not overly familiar or condescending. Computer novices will be able to understand the tutorial, but more experienced users will whiz through it.

Deluxe is polite about keeping you informed. First, the program gives you a long list of messages that appears on the status line as the program is carrying out some action. In addition to these working messages, Deluxe contains an error-trapping routine. Rather than having you rely on aggravating DOS (disk operating system) taunts when the program encounters a system error, Deluxe will suggest what needs to be corrected.

**PLUSES**

Deluxe has several outstanding features. I haven't found any full-function word processors that are easier to learn and/or use. The tutorial disk can be rated very good to excellent, depending on your prior knowledge of word processing and computers.

I award points for the on-line Help screens. Although Deluxe's Help screens are exceedingly brief, I prefer them to paging through multiple Help levels or doing without.

NotePad is an excellent concept, well carried out. I wish I had it on my database-management program.

I'd also rate TextMerge as very good

to excellent. This function makes Deluxe a reasonable choice for a business that requires many short standard letters.

**MINUSES**

Although my criticism of Deluxe's documentation and reformatting capabilities can be classified as personal prejudices, I do see a few flaws in the program.

The use of spill files adds to Deluxe's flexibility, but they are potentially dangerous. Remember that you risk losing everything if you remove the disk with the spill file during a work session. (Better documentation would minimize the problem.)

Deluxe's documentation is minimally adequate. I think Lifetree is doing its product a disservice. Good as Deluxe is, it would profit from upgraded documentation.

Block manipulation is poorly imple-

mented because it is so slow. However, marking the block to copy, move, or delete is easier than in some programs I have used. Paragraph reformatting is a minor nuisance.

**CONCLUSIONS**

On the whole, I'm impressed with Deluxe. I particularly like the logical use of function keys and the program's ease of use. I have seldom found a word-processing program that serves every need of a serious writer and is still easy to use. In the few weeks I've had the program in my office everyone there has shifted from their word-processing programs to Volkswriter Deluxe. I've even come to depend on it for my short letters and the many tables of figures I need for reports. Contrary to my own rule to never buy software I review, I am buying Volkswriter Deluxe. It stacks up as a definite winner. ■

**A Picture is worth a thousand words.**

**Paint your own with**

**Quick•Plan™**

The Executive Project Planning System

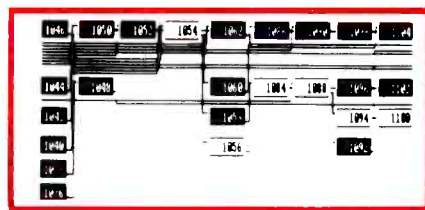

Quick•Plan runs on MS-DOS\* for:  
Data General DT\*, DEC RAJNBOW+\*, HP 150\*, IBM Compati-  
bles\*, WANG PC\*  
Requires: 384<sup>K</sup>, graphics option - 132 wide printer



For more information call or write:

**Mitchell Management Systems Inc.**

FORMERLY STRUCTURAL PROGRAMMING INC.  
Westborough Office Park 2000 West Park Drive, Westborough, Mass 01581 U.S.A.  
Telephone (617) 366-0800 TWX 710-347-1054

\*Registered trademarks for Data General, Digital Equipment Corp., Hewlett-Packard, International Business Machines, Micro-Soft, and Wang Laboratories.



**To communicate voice  
the ordinary modem**

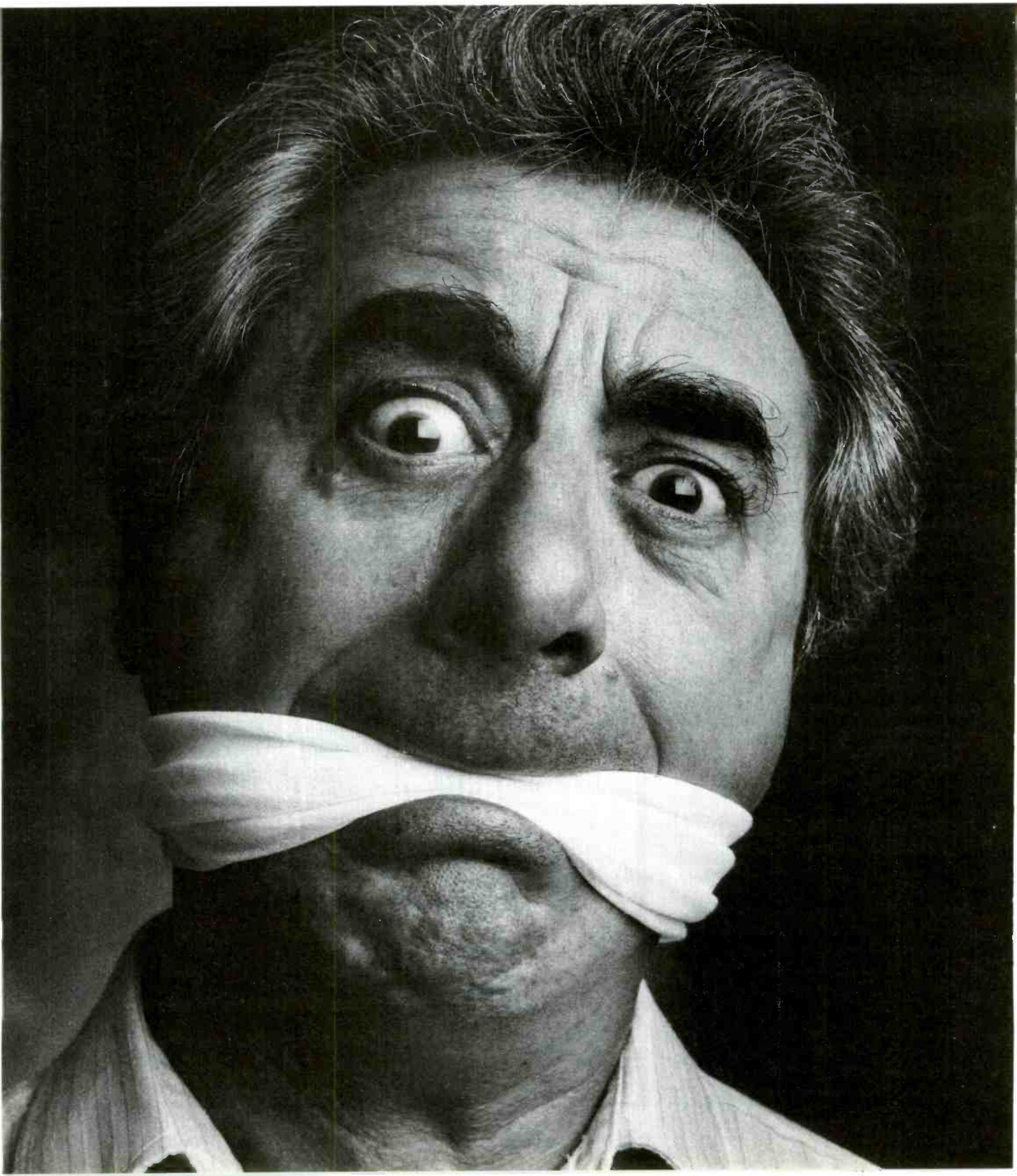

# and data simultaneously, leaves a lot to be desired.

## Introducing the Tel-A-Modem.

Now you and your personal computer can talk on the same phone at the same time.

Let's say, for example, certain data you were transmitting via your personal computer to a remote computer user needed some verbal explanation to go along with it. With the ordinary modem it couldn't be done. Not simultaneously.

You'd have to first call the user to inform them that data was coming. Hang up. Re-dial in order to connect modems. Transmit the data. Hang up. And then call back with your explanation. If you had additional input to transmit and discuss, you'd have to begin the whole process again. Talk about frustration.

Code-A-Phone's solution to this problem is the Tel-A-Modem. An innovative two-line desk telephone integrated with an intelligent modem capable of transmitting voice and data simultaneously.

Of course, the genius of Tel-A-Modem doesn't end with its unique communication capabilities and state-of-the-art convenience.

Specially designed for use with RS-232C compatible computers and terminals, it offers a full spectrum of both telephone and modem cost effective features, including: single button selector for voice or data on either line; full-duplex mode; automatic answer/origi-

nate modes; 300 and 1200 baud data transmission rates; automatic selection of baud rates; switch dialing for tone-dial or pulse-dial systems; memory autodial; and modem status LEDs.

So much for words.

For more information and the name of your nearest Tel-A-Modem dealer, call 1-800-547-4683. That is, just as soon as your computer gets off the phone.

*In Oregon, Alaska and Hawaii, call 1-503-655-8940.*

**Code-A-Phone®**  
A SUBSIDIARY OF CONRAC CORPORATION

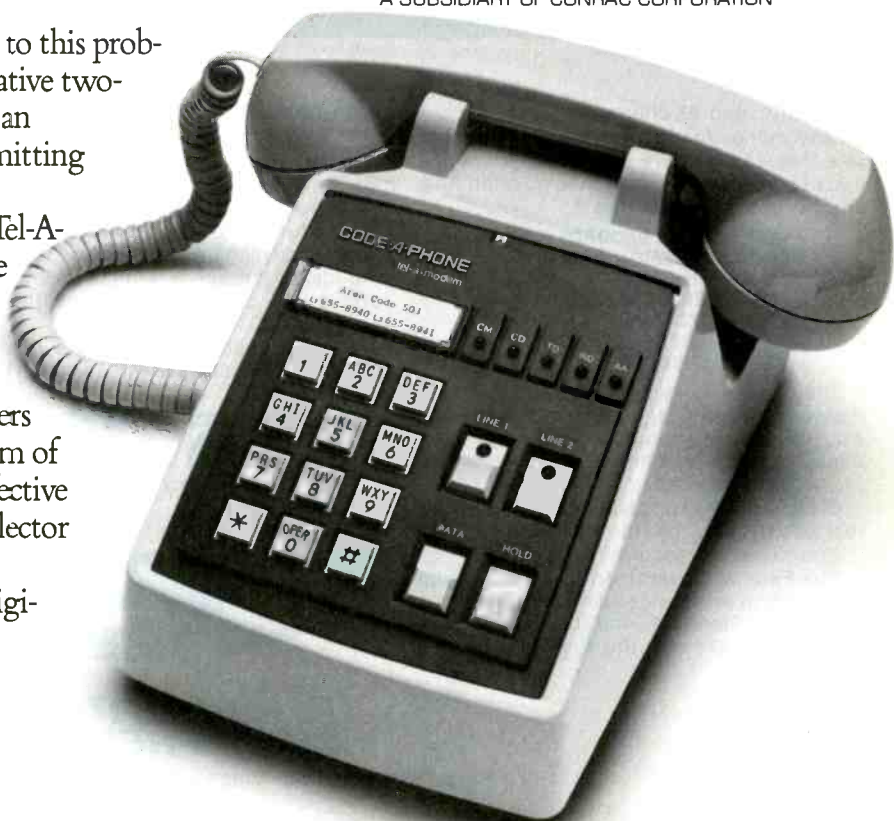

See us at

**COMDEX™ / Fall '84**

November 14-18, 1984

MGM GRAND HOTEL, Las Vegas, Nevada

Circle 51 on inquiry card.



# COMPUTER CRIME PAYS.

An estimated \$3-billion plus annually.

Easy money for the legions of computer data thieves out there who know just what kind of corporate information to go after. And what to do when they find it.

**ACCOUNTING RECORDS  
PRODUCT DESIGN DATA  
RESEARCH DATA  
CUSTOMER LISTS  
PRIVILEGED CLIENT DATA  
BANK FILES  
CREDIT RECORDS**

They'll steal. Copy it. Sell it to competitors. Ransom it. Even alter or destroy it. Ordinary, everyday information. The kind most companies assume no one's terribly interested in...until it's too late.

Stiffer laws may be on the way, but the only real way to deal with this pervasive problem is effective data security.

The Federal Government has spelled out the solution in no uncertain terms: the Data Encryption Standard. And it's the basis for the D E S 2000™ security system.

## MAXIMUM SECURITY WITH D E S 2000

The D E S 2000 protects your data files by encrypting transmitted and/or stored information—rendering it totally unintelligible to unauthorized individuals.

So whether there's an intrusion from the outside via modem or phone line tap...or from the inside through a terminal or by outright disk theft...confidential information *stays confidential.*

Easily installed within any Asynchronous RS-232-C compatible communication link, the

## **D E S 2000**™ DATA ENCRYPTION SYSTEM



from **PRACTICAL PERIPHERALS**™

31245 La Baya Drive, Westlake Village, CA 91362 • (818) 991-8200 • TWX 910-336-5431

D E S 2000 gives you a choice of four different security modes. Each one distinguished by its own particular utilization of 16-digit encryption/decryption keys.

And since each key is comprised of 56 bits of data, randomly arranged by the system itself...the number of possible combinations is staggering. More than *72-quadrillion.*

## THE MOST COST-EFFECTIVE SOLUTION

Priced under \$500, the D E S 2000 offers the same federally-approved protection methodology, the same reliability as custom encryption systems costing several times more. The kind of systems now used by many government agencies and banks.

In short, you can't buy better protection. At any price.

Think about it. But not too long. Because computer crime isn't going to go away. More likely, it's going to get worse.

So take a minute and call 1-800-641-0816 for more information on computer crime and the D E S 2000 Data Encryption System.

# HomeWord and Cut & Paste

Two  
easy-to-use  
word  
processors  
for the  
Apple II  
series

BY KEITH CARLSON

**W**ord processors designed for home use should be cheaper and simpler to use than those intended for the office. In the relatively simple, short writing jobs normally done at home (such as personal correspondence), home word processors should replace pens and typewriters. Two new word processors that meet these needs, Sierra On-Line's HomeWord and Electronic Arts' Cut & Paste, run on the Apple II series as well as other popular computers.

Most home users won't spend a long time learning to use a word processor. Both programs I reviewed eliminate the more esoteric features of a professional word processor, and both have carefully designed user interfaces that cut learning time to a minimum. Documentation for both programs is short and easy to read.

As a group, home users own and use a broad range of peripherals, less standardized than their office counterparts. A home word processor should be able to accommodate a wide variety of printers and interfaces without bothering the user with technical details of the actual interface. To accomplish this, the program must be sophisticated, but its complexity must be hidden from the user.

## HOMEWORD

HomeWord's user interface is primarily visual; the program uses icons in place of an on-screen menu and visual clues at the bottom of the screen to display free buffer memory and disk space. Instead of requiring an expensive 80-column card, HomeWord displays text in a 40-column format and provides a sketch or map at the bottom of the screen to represent the finished page (see photo 1). As you add text to the screen, it is represented on the sketch with its final format, including margins, line spacing, and cursor position.

HomeWord supports a full range of entry options: you can center, align (left, right, or both), indent, or tab text easily from the

icon menu. When you exhaust memory space (indicated by the scales at the bottom of the screen), you can only save and load files—you lose the other entry options. HomeWord controls cursor movement using either the arrow keys or control-key combinations. You have your choice of scrolling in either direction by increments of character, word, line, screen, or true formatted page.

When deleting, replacing, and moving text using the "edit" menu choice, you first tell the program where you want to start the change, then you mark or "paint" the area that will be affected. You can scroll either forward or backward from the anchor spot that you have marked, highlighting as you go, in a fashion similar to the dedicated word-processor feature. Any deleting errors can be quickly fixed if you have chosen the delete mode from the icon menu; a delete buffer holds the last deletion in case you need it back. Changes made with control keys are not stored in the delete buffer.

For the sake of simplicity, many high-powered functions are not included in HomeWord. These include features like reverse find or find and replace, multifile operations, columnar editing, and macros (single keystroke entries that can replace strings of frequently repeated commands). The average home user will probably not need these functions.

## COMMAND STRUCTURE

HomeWord's command structure, as represented by the icon menus, is simple and intelligible. The main menu can be reached at any time from the screen simply by pushing the Escape key. The icons are not mysterious symbols; each appears with its function listed beneath it, which helps eliminate confusion (see photo 2).

HomeWord's icons work because of the simplicity of the command structure and the small number of functions. Icon menus probably would not work with a complex

(continued)

Keith Carlson is an officer in the USAF stationed at Offutt AFB in Nebraska. He has a bachelor's degree from the University of Nebraska at Omaha in computer science. He has been a system administrator for several word-processing systems and is currently an instructor in programming languages and microcomputers at Headquarters, Strategic Air Command.



word processor like WordStar. The number of different icons needed to represent WordStar's dozens of functions certainly would be confusing, and duplicate icons undoubtedly would be needed. Most of HomeWord's icons are unique; that is, very

few symbols have one meaning in one submenu and another meaning somewhere else in the command structure. This minimizes mode-related errors.

Icons in the main menu call submenus made up of other icons. Some commands require that you make

your way through four levels of choices. Each menu level appears on the screen with a commonly used function highlighted as a default value. For example, the main menu appears with the "file" option highlighted. The "file" submenu offers "save document" as the default. This means that a Save operation requires very few keystrokes, encouraging frequent saving. Assuming that many people using HomeWord will be new computer users, unaccustomed to careful computing habits, this seems like a clever piece of design work.

Some operations, however, are cumbersome using the icon menus. For example, turning the underline function on and off using the icons requires 16 keystrokes. Sierra On-Line has provided keyboard alternatives, with a quick-reference card, for people who prefer not to use the icons.

**TEXT STORAGE**

HomeWord uses standard DOS (disk operating system) text files. When I dumped a file, I found that the text was in lowercase on the screen and displayed a variety of garbage. When I displayed the file with a program that translated everything to uppercase, I had better luck.

If you have at least 64K bytes of memory, you can configure your copy of HomeWord to work with two disk drives.

**BACKUP POLICY**

The HomeWord disk is copy-protected, but you can get a backup copy when you send in your product registration card along with \$10. I disagree with this policy—clever pirates will get copies anyway, while purchasers are forced to pay for the pirates' dishonesty. Perhaps Sierra On-Line should consider including an additional copy of the program with the purchase of HomeWord.

**PRINTING**

HomeWord works with a wide variety of printer interfaces. You can choose quickly and easily from among about a dozen drivers (short pieces of ma-

*(continued)*

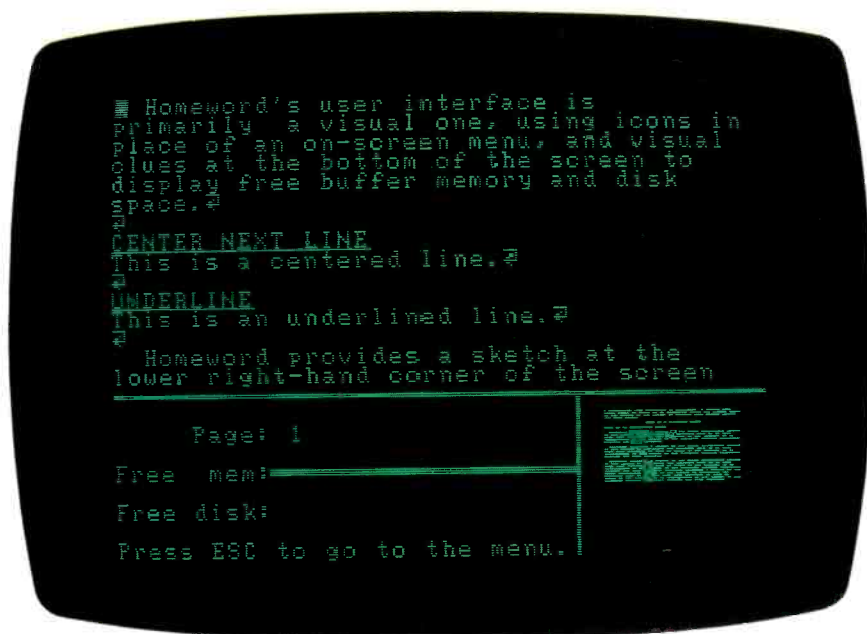

Photo 1: HomeWord's text mode. The scales at the bottom left-hand corner display memory and disk space. At the right is a sketch of the document.

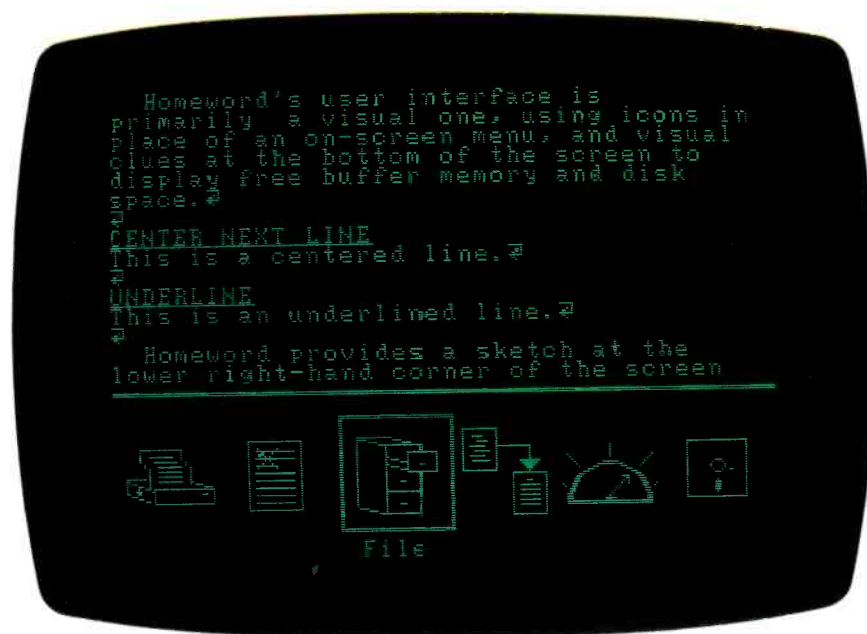

Photo 2: HomeWord's main icon menu.

# AT A GLANCE

**Name**

HomeWord

**Manufacturer**

Sierra On-Line  
POB 485  
Coarsegold, CA 93614  
(209) 683-6858

**Type**

Home word processor

**Format**

5¼-inch disk

**Requirements**

Apple II, II+, or IIe with at least 48K bytes of RAM and one disk drive; or Commodore 64 with one disk drive (soon to be available for Atari)

**Price**

\$69.95

**Documentation**

33-page manual, quick-reference card

**Name**

Cut & Paste

**Manufacturer**

Electronic Arts  
2755 Campus Dr.  
San Mateo, CA 94403  
(415) 571-7171

**Type**

Home word processor

**Format**

5¼-inch disk

**Requirements**

Apple IIe with 64K bytes of RAM and one disk drive; Apple IIc with 64K bytes and one disk drive; Commodore 64 with one disk drive (soon to be available for IBM PC and Atari)

**Price**

\$50

**Documentation**

14-page manual, quick-reference card

FIND (SEC)

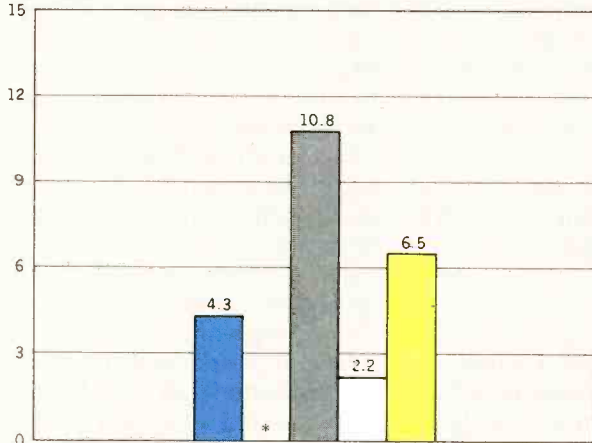

SCROLL (SEC)

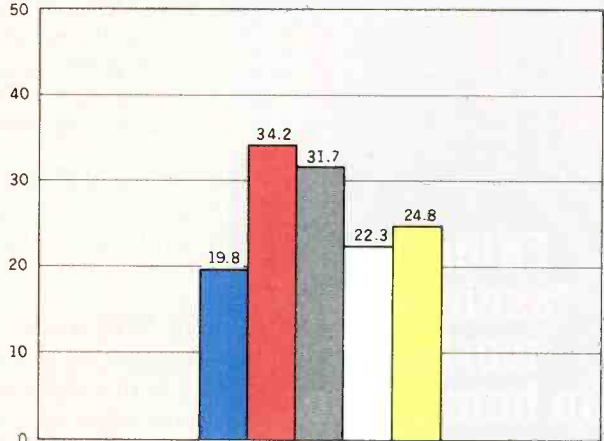

STORE TEXT FILE (SEC)

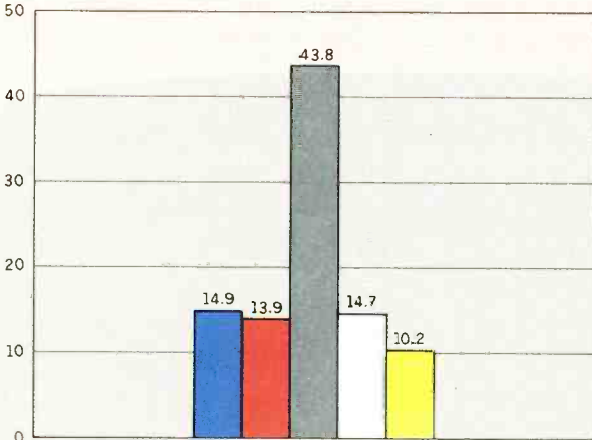

RETRIEVE TEXT FILE (SEC)

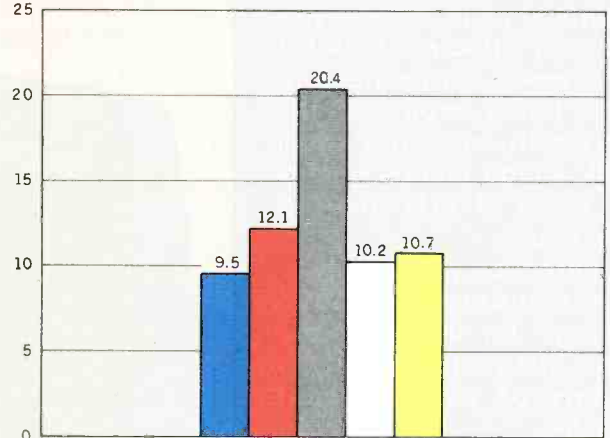

■ HOMEWORD   
 ■ CUT AND PASTE   
 ■ SCREENWRITER   
 ■ APPLEWRITER   
 ■ WORDSTAR

This is a comparison of HomeWord and Cut & Paste on the Apple IIe with ScreenWriter II, Apple Writer II, and WordStar (CP/M, using the Microsoft SoftCard). Because HomeWord could not accommodate large text files, a 95K-byte text file was used for testing rather than a 4000-word (or 24K-byte) text file, which is the usual standard. The Find (or Search) benchmark times how long it takes to find the

last word in the document, starting at the beginning. The Scroll benchmark times how long it takes to scroll through the document. The Store and Retrieve benchmarks time how long it takes to save and retrieve the document from the disk.

\*Cut & Paste does not have a Find function.



# Take your family beyond Computers.

## Enter the fascinating world of the home robot.

HERO JR. will wake you in the morning, guard your home at night, remind you of your appointments for the week, and entertain your family throughout the day with engaging small talk, songs, poems, games ... even strolls around the house.

Introduce your family to the wonders of robotic living...for less than the cost of a computer. For the name of your nearest dealer,

**"Call for HERO JR. at 1-800-253-0570"**

Ask for operator 7

(In Michigan, call 616-982-3454)

**Heath/Zenith**

## REVIEW: HOMEWORD

chine-language code that accommodate a particular printer). It is a joy to find a word-processing program that not only solves my Apple parallel-interface "high-bit blues," but also easily accommodates the excellent features of the Epson RX-80 printer.

Proportional spacing is accomplished with space insertion, and HomeWord's spacing looks about as good as space-insertion justification can. You can choose a wide variety of paper styles and widths from the icon menus, allowing almost any configuration. Using an Include function, you can print several files together, piecing together large documents from shorter files. This is an advantage because a HomeWord file is of limited size.

Using the preview mode from the print menu, you can watch your work scroll by on the screen in its final form.

### IN SUMMARY

HomeWord is truly "user friendly." It is both easy to learn (with the icons) and easy to use once you have learned it (with the key commands). HomeWord is a shining example of what a computer can do for people who want to work with their com-

puters without having to learn how their computers work.

### CUT & PASTE

There are a lot of similarities between HomeWord and Cut & Paste. They are both designed with the home user in mind. Cut & Paste doesn't use icons, but its menu choices, in English text, are just as easy to use.

You choose all commands (except cursor-control commands) from two menus—you can't get much simpler than that. There are no embedded control characters to remember, so you can use Cut & Paste shortly after you have it up and running. You select menu items by moving the cursor with the arrow keys until the proper selection is highlighted (see photo 3). The rest of the screen has a comfortable layout, with menu items along the bottom line and the amount of remaining memory noted in the upper right-hand corner.

Text entry with Cut & Paste is easy. In fact, as the documentation states, "getting started with Cut & Paste is like getting started with a new typewriter." Text wraps and reforms automatically, so you aren't distracted from the task of text entry.

Like HomeWord, Cut & Paste uses

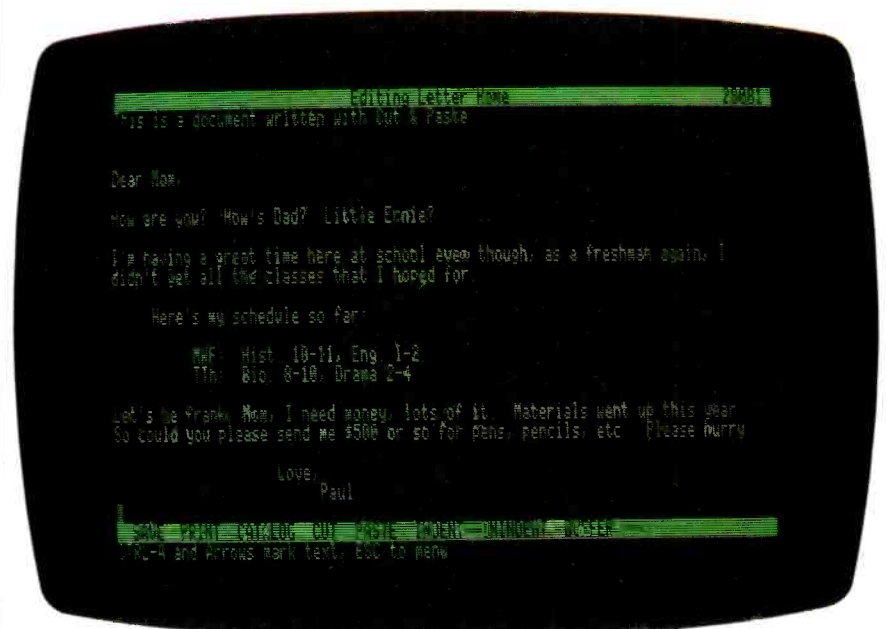

Photo 3: Cut & Paste's functions are listed at the bottom of the screen.

## REVIEW: HOMEWORD

the "painting" technique to highlight text for moving or deleting. The delete buffer appears to be a bit larger than HomeWord's, and you can view the buffer in case you forget what you put into it.

Many of the functions we have come to expect in a word processor, such as centering, columnar entry, search and replace, boldface printing, and underlining, are missing in Cut & Paste. There is no indication on the screen of the true formatted page, unless you are equipped with 80-column hardware. If you aren't, you're out of luck. For the most part, though, touch-typists can enter text easily and quickly, as long as they expect only the features that they are used to on the typewriter. As in HomeWord, a lot of the advanced features of a word processor simply are not there.

### DISK PROBLEMS

Cut & Paste seems to use its own disk-formatting scheme. This method makes normal Apple text files unusable in the Apple version of Cut & Paste. This is unfortunate if you have existing text files that you want to share with Cut & Paste. It also precludes passing files from other word processors.

If that isn't enough, the program disk is copy-locked. Although there is a 90-day warranty period within which a defective disk will be replaced free, Electronic Arts aggravated me by not even offering an inexpensive backup policy. If Electronic Arts would give two copies of the program or offer a low-cost backup policy it would be more in keeping with the company's emphatically stated "user-friendly" policy.

### PRINTING

Electronic Arts emphasizes the ease of using Cut & Paste with its "Five-Step Rhythm of Printing." I agree with the claim that it is easy to use. All of the printing functions are chosen with fill-in-the-blank menus. Although there are no fancy or complex functions available, the output looks clean and crisp.

(continued)

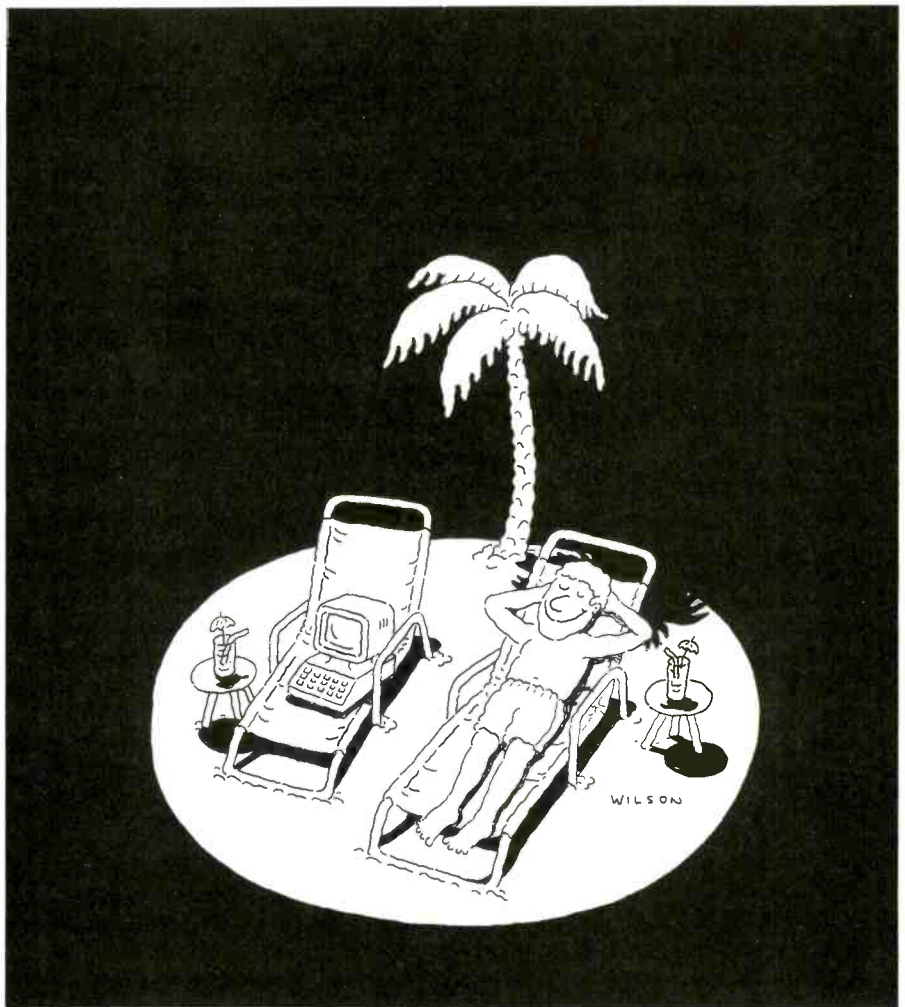

## Backyard or Boca?

Relaxing at a famous resort is just one of the many rewards of investment success. Improve your chances for that success with Dow Jones News/Retrieval®.

Even if you're just starting out in the market, Dow Jones News/Retrieval can help compress hours of research into instantaneous, well-organized, well-timed reports and analyses you can use to improve your chances for investment success.

Dow Jones News/Retrieval gives you more time to assess more of what you need to know: company and industry activity, economic and earnings forecasts, Securities and Exchange Commission reports, and Dow Jones Current and Historical Stock

Quotes that are continuously monitored for accuracy by our staff.

The wide variety of high-quality data bases accessible on most personal computers also includes exclusive access to *The Wall Street Journal*, *Barron's* and the Dow Jones News Service. And now, with Dow Jones Software™, you can organize the data from Dow Jones News/Retrieval to help you make more informed investment decisions. As smart investors everywhere have discovered, there's only *one* Dow Jones... and only *one* Dow Jones News/Retrieval. Invest a few moments right now and discover the difference it can make for you.

**DOW JONES**  
**NEWS/RETRIEVAL**®

Copyright © 1984 Dow Jones and Company, Inc. All Rights Reserved. Dow Jones News/Retrieval® is a registered trademark of Dow Jones and Company, Inc. Dow Jones Software™ is a trademark of Dow Jones and Company, Inc.

**FOR FULL DETAILS, CALL 800-345-8500, EXT. 144**

Alaska, Hawaii and foreign, call 1-215-789-7008, Ext. 144



# Multi-function RS-232 Transfer Switches

MFJ-1240  
**\$ 79 95**  
Choice of  
8 models



Multi-function RS-232 transfer switches let you switch your computer among printers, modems, terminals, any RS-232 peripherals; monitor data/line failure, protect data lines from surges, and use as null modem for less cost than a switch alone.

**Switches 10 lines** (2, 3, 4, 5, 6, 8, 11, 15, 17, 20). LED data/line indicators monitor lines 2, 3, 4, 5, 6, 8, 20. Metal oxide varistors protect data lines 2, 3 from voltage spikes and surges. Push button reverses transmit-receive lines (2,3). PC board eliminates wiring, crosstalk, line interference. Connects any one input to any one output.

Model	Price	In	Out	Model	Price	In	Out
MFJ-1240	\$79.95	1	2	MFJ-1244	\$139.95	3	3
MFJ-1241	\$99.95	2	2	MFJ-1245	\$169.95	3	5
MFJ-1242	\$119.95	2	3	MFJ-1246	\$199.95	5	5
MFJ-1243	\$119.95	1	4	MFJ-1247	\$99.95	1	2

switches 20 lines

## AC Power Centers

MFJ-1108  
**\$ 99 95**



MFJ-1108, \$99.95. Add convenience, prevent data loss, head bounce, equipment damage. **Relay** latches power off during power transients. **Multi-filters** isolate equipment, eliminate interaction, noise, hash. **MOVs** suppress spikes, surges. 3 isolated, switched socketpairs. One unswitched for clock, etc. Lighted power, reset switch. Pop-out fuse. 3 wire, 6 ft. cord. 15A, 125V, 1875 watts. Aluminum case. Black. 18x23/4x2 in. **MFJ-1107, \$79.95.** Like 1108 less relay. 8 sockets, 2 unswitched. **MFJ-1109, \$129.95.** Like 1107 but intelligent. Switch on device plugged into control socket and everything else turns on. Others available.

## Acoustic/Direct Coupled Modem



Use with any  
phone anywhere **\$ 129 95**

MFJ-1233 Acoustic/Direct Coupled 300 baud modem. Versatile. Use with virtually any phone, anywhere. Use battery or 110 VAC. **Direct connect mode:** Plug between handset and base. Use with single or multi-line phones. **Acoustic coupled mode:** Use with phones without modular plugs. Quality muffs give good acoustic coupling, isolates external noise for reliable data transfer. Originate/answer. Self test. Carrier detect, ON LEDs. RS-232, TTL compatible. Reliable single chip modem. Crystal controlled. Aluminum cabinet. 9x1 1/2x4 in. Other models available.

Order from MFJ and try it. If not delighted, return within 30 days for refund (less shipping). **One year unconditional guarantee.** Order yours today. Call toll free 800-647-1800. Charge VISA, MC. Or mail check, money order. Add \$4.00 each for shipping and handling.

**CALL TOLL FREE . . . 800-647-1800**  
Call 601-323-5869 in MS, outside continental USA.

**MFJ ENTERPRISES  
INCORPORATED**

921 Louisville Road, Starkville, MS 39759

## REVIEW: HOMEWORD

# BENCHMARKING HOMEWORD AND CUT & PASTE

**B**ecause the word-processing programs HomeWord and Cut & Paste are somewhat simpler than their more sophisticated cousins, I expected them to work faster than their counterparts. This was true with a few exceptions.

Each of the functions illustrated in the benchmark graphs on the "At a Glance" page was performed on the first part of the file used to prepare this review. It was approximately 9500 bytes long. I would have used a longer file, but HomeWord would not accommodate that. [Editors Note: The usual document used for BYTE standard word-processing tests is a 4000-word (or 20K-byte) text file.] The file was written with HomeWord and used as is with HomeWord and ScreenWriter II. Apple Writer II would not accommodate the formatting control characters used with HomeWord, so I edited out approximately 10 bytes for use with Apple Writer II.

WordStar is CP/M based, so I converted the normal Apple DOS (APDOS) text file created by HomeWord to CP/M format with the APDOS utility program supplied with the Microsoft CP/M

master disk. It was the same size because it was not necessary to remove the formatting control characters.

Cut & Paste uses its own unique format, so I had to retype the file into Cut & Paste. Because Cut & Paste does not have a Find function, there is no entry for that section of the table.

I used the standard BYTE word-processing benchmarks with a 9.5K-byte text file (instead of a 20K-byte text file). The Find benchmark consisted of finding the last word of the document starting at the beginning of the document. In the scroll benchmark, I started at the beginning of the file and used the SCROLL command to go to the end of the file, one line at a time, as fast as possible. I used the Repeat key on the Apple keyboard to accomplish this. For the Store and Retrieve benchmarks, I saved and retrieved the text file on an Apple floppy-disk drive. In all cases, I measured the time that elapsed beginning from the last keystroke required to initiate the action until the cursor reappeared and I regained control of the program.

As a matter of human engineering, the margins, headers, and footers are measured in inches, rather than in lines and columns. This is an excellent feature. It removes all of the calculating and figuring when you are trying to get certain margins.

The documentation states that Cut & Paste has been tested with a variety of interface cards. For the Apple version, these are Apple Parallel, Apple Super Serial, Epson, Microtek Apple Dumping, and Orange Micro Grappler/Grappler II+ to choose from. That covers a lot of the available popular interfaces. Cut & Paste has been tested for several printers: Apple Dot Matrix, C.1toh 8510, Epson FX-80/MX-80, Star Gemini 10X, and the Okidata 90 series. Notably missing from the list is the whole group

of daisy-wheel printers. Perhaps this is because they are in the minority for home use.

## CONCLUSIONS

Cut & Paste's manual is short and written in plain English. There is a quick-reference card but no on-line documentation. To be fair, on-line documentation really isn't necessary because menu selections are obvious. Support is good; and Electronic Arts has just installed a new hotline for user inquiries.

Despite some obvious limitations, Cut & Paste is a good word-processing program. It is easy to use and learn. In fact, it shouldn't take longer than half an hour for a new user to learn to work with the program. Add to that its \$50 price, and it's a good value. ■

# THE CARD: THE CLOUT:

TEAR HERE

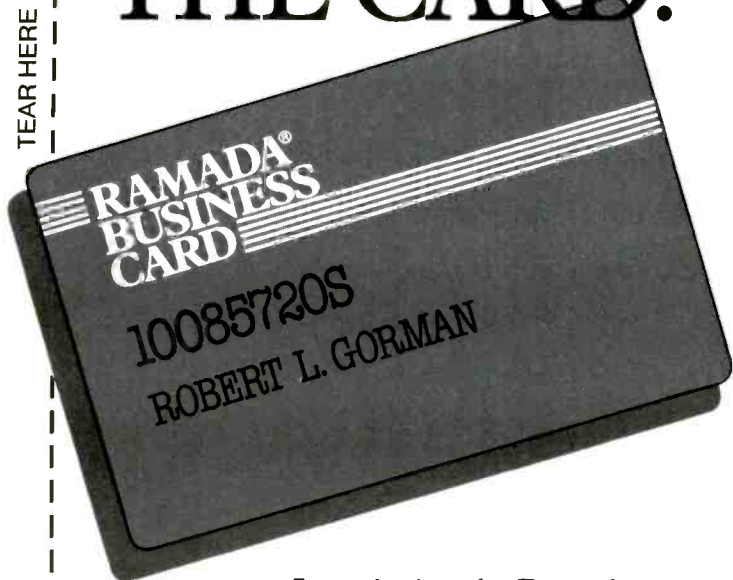

Introducing the Ramada Business Card. It can pay off faster than any other hotel preferred guest program while it makes every Ramada visit a better stay.

We decided not to be the hotel that offered the "first" hotel frequent traveler program. Instead we decided to offer the best. Carry the Ramada Business Card and you carry clout.

Clout that includes: preferred room rates, automatic room upgrade when available, extended check-out time when requested in advance, check cashing privileges up to \$100, Hertz rental car discounts, a free daily newspaper, and, at the discretion of your Ramada manager even more benefits like express check-in and check-out. Maybe even a free drink.

Clout that lets you earn Ramada Business Card Dividend Points good toward valuable travel awards and merchandise. Clout that can mean you build points faster than other programs because Dividends are awarded based on your total bill.

Don't spend another night without clout!

TEAR HERE

# I WANT IT ALL: THE CARD, THE CLOUT, AND I WANT IT NOW.

Tear out the ad and take it to any Ramada. *It's good for one extra bonus point* if you're a new applicant. Fill out the application at the front desk and you pick up another point. Spend the night and you're really moving up. Call 1-800-2-RAMADA for reservations. Or mail the ad to: Ramada Response Center, P.O. Box 4500, Woburn, MA 01888. We'll send you an application.

Circle 306 on inquiry card.

## NEXT TIME, RAMADA®

Desk Clerk: Please attach to application.

NAME

ADDRESS

CITY

STATE

ZIP

Membership # \_\_\_\_\_ (to be issued by desk clerk.)

TEAR HERE

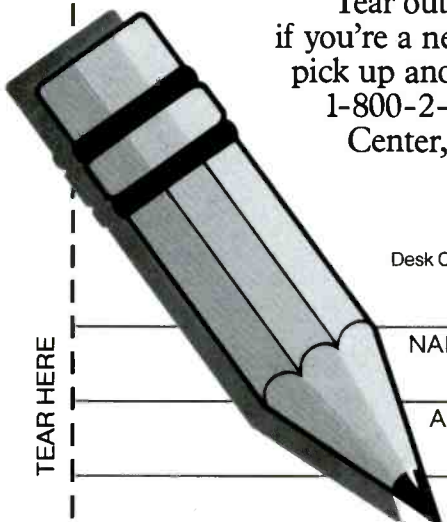



# The only Modula-2 native code compiler for 8086/8088-based machines and VAX<sup>®</sup> systems.

## All the strengths of Pascal, plus improvements in every respect.

Modula-2 is Niklaus Wirth's second generation programming solution. All the best features of his Pascal language plus major features for true modularity, support for multi-tasking, type checking between program modules, syntax improvements, and features for increased portability (to name just a few).

## A complete program development system.

LOGITECH MODULA-2 includes a complete implementation of Wirth's design, plus 8086 large model support and additional LOGITECH modules (including display handling and dynamic string handling).

A complement of powerful debugging tools—including compile-time error checks and symbolic debugging—is included.

## Professional support from the people who wrote LOGITECH MODULA-2.

LOGITECH's Modula-2 is a professional development tool, backed by the most professional support available for Modula users.

## LOGITECH's complete Modula family:

- MODULA-2/86™ native code 8086/8088 compiler
- MODULA-2/VMS™ VAX-resident compiler
- MODULA-2/VX86™ VAX to 8086/8088 cross compiler

## Don't start another project without considering LOGITECH MODULA-2.

Trademarks: MODULA-2/86, MODULA-2/VX86, MODULA-2/VMS—LOGITECH, Inc.  
Registered Trademarks: VAX—Digital Equipment Corporation

Circle 205 on inquiry card.

**LOGITECH MODULA-2**

**LOGITECH  
MODULA-2**

**To order, or for more information,  
call or write:**

**Chris Cale, 805 Veterans Blvd.  
Redwood City, CA 94063  
(415) 365-9852**

**In Europe contact: Willy Steiger,  
LOGITECH SA, Switzerland.  
(021) 77 45 45**



**LOGITECH**

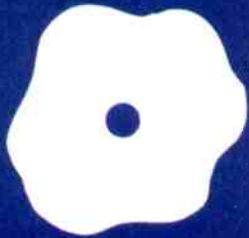

## CLOUT and SALVO

### A look at two natural- language query programs

BY GEORGE BOND

**E**ntering data has never been much of a problem, even in the days when we were giddy with excitement at the prospect of cramming 48K bytes of memory into our microcomputers. Screen-entry forms and sometimes field attributes were used to make entry easier.

Getting data out was another story. Query structures that looked like crosses between LISP notation and the scribbles of a Boolean logician gone mad, or that used an endless series of menus, did their very best to discourage us from using the data.

During the past year, however, programs claiming to use natural-language queries for data retrieval have begun appearing on microcomputer dealers' shelves. Natural-language query consists of questions asked in normal syntax using a normal vocabulary. The computer should understand and respond appropriately. I believe that this type of query structure first appeared on microcomputers in Versafile, a late 1970s program that ran on the TRS-80 Model I.

For example, if I type into my computer, "What's on Main Street?" and the computer responds, "The American Guernsey Cattle Club," that's natural-language querying.

One natural-language query program is CLOUT from MicroRIM Inc., which is an add-on program designed to manipulate databases created by MicroRIM's R:base. The name is a pseudo-acronym standing for conversational language option (the meaning of the "UT" remains a mystery). It lives up to its billing as a natural-language query system, but is not without shortcomings.

CLOUT comes on three disks, including two versions of "Disk I" and a "Disk II" that are packed in the back of the familiar IBM look-alike three-ring loose-leaf binder. The manual (it is much too clearly written to be called documentation) runs about 170 pages and is divided into four parts: introduction, reference, tutorial, and index. It is typeset and is nicely printed and illustrated. The index is useful—it lists things in ways that make sense (e.g., "who" fields are listed

under "Fields, Who"). There is also a four-page errata "Read Me" section that corrects some errors in the main manual.

#### THE BASIC REQUIREMENTS

An R:base data file is necessary to run CLOUT. CLOUT is not a database creator, only an interrogator, so it does not generate its own content files. CLOUT requires PC-DOS or MS-DOS version 1.1 or higher running on an IBM Personal Computer (PC) or compatible computer with a minimum of 256K bytes of RAM (random-access read/write memory). A second version of the program, included as standard, requires a minimum of 384K bytes of RAM. It also requires two double-density, double-sided floppy-disk drives or one double-density, double-sided floppy-disk drive and a hard-disk drive.

#### FIRST IMPRESSIONS

When I first began using CLOUT, I was struck by the slowness of response—why did it take so long for anything to happen?

Of course, it really was not taking a long time for anything to happen. Lots was happening. It just was taking a long time for the computer to get the answer I wanted. The computer had to do heavy thinking about what I had asked. It had to convert "Who earned a pot of money last year?" to something like "List employee where totsal gt \$100,000 and jobyr eq 1983." After doing the translation, the computer responded quickly. The snag is that most of us still think more quickly than a micro, at least in a situation like this. Maybe natural-language query isn't such a hot idea if you're in a rush.

My second feeling was a growing frustration with programs that insist on telling me that they don't understand what I want when they are supposed to talk my language. But, on reflection, this problem became clearer. Up here in the woods of New Hampshire, ask for a "milkshake" and

(continued)

George Bond is managing editor of User News for BYTE. He can be contacted at POB 372, Hancock, NH 03449.



## AT A GLANCE

**Name**

CLOUT

**Type**

Natural-language query system

**Manufacturer**

MicroRIM Inc.  
3380 146th Place SE  
Bellevue, WA 98007  
(206) 641-6619

**Price**

\$195

**Format**

Three 5¼-inch floppy disks  
(One "Disk I" requiring 256K bytes of RAM, one "Disk I" requiring 384K bytes of RAM, and one "Disk II." Both Disks I are copy-protected.)

**Computers**

IBM PC and compatibles

**Documentation**

IBM PC-style 170-page indexed manual

**Audience**

Anyone needing to make ad hoc inquiries of a database

**Name**

SALVO

**Type**

Application generator with  
natural-language query facility

**Manufacturer**

Software Automation, Inc.  
14333 Proton Road  
Dallas, TX 75234-9990  
(214) 392-2802

**Price**

\$495

**Format**

Two 5¼-inch floppy disks

**Computers**

IBM PC and compatibles

**Documentation**

IBM PC-style 256-page manual,  
not indexed

**Audience**

Anyone needing an application generator

likely as not what you get is milk and flavoring whipped up. If you want ice cream with it, you must request a "frappe" (and that's not even an English word). Why should my computer be any more accommodating? This realization, however, has not done much to reduce the frustration felt when told by a machine, "The following expression was encountered . . . (the expression I typed appears here). Quite frankly, CLOUT is confused. Could you please retype your request?" Or "CLOUT has become confused while trying to understand your question . . ." But it has made me aware that I must let the computer know that, to me at least, a "pot of money" means more than \$100,000.

In many ways, CLOUT's spelling checker more than compensates for the slowness and "I'm confused" responses. If you are only a moderately good typist or are plagued with a mushy keyboard, this little gem can speed up operations immensely. Type in "What companies are in Santa Clara?" and instead of getting an "I don't understand" or "There is no companies field" response, you get "By 'companies' did you mean 'companies'? (Y/N)". Until you have used a program with a good spelling checker in it, you simply cannot imagine what an asset you are missing.

Getting back to negatives, CLOUT cannot be fully hard-disk based: a copy-protected floppy must be in the system at boot time. This unnecessary busywork slows everything down—time is wasted swapping disks and load times are longer from a floppy than from a hard disk (it takes about 35 seconds for CLOUT to load when using a Columbia MPC 16-I with standard Tandon drives). An even more serious problem would arise if the copy-protected floppy disk were to become damaged. You could not use your database until it was replaced. I find it hard to imagine being comfortable with computerized business records that are critical to daily operations without true defense-in-depth against the ravages of Murphy's Law. One of the absolutely basic defenses-



Photo 1: The first thing to confront a user when booting CLOUT is the R:base logo and a request to enter a database name. Entering an escape cancels the program and returns to DOS.

in-depth is having the capability of making a new backup as soon as an existing backup gets put into regular service.

### USING YOUR CLOUT

CLOUT can be started in either of two ways. Disk II (which is copyable) can be put in drive A, Disk I in drive B, and the command B:CLOUT used to load the program. Or Disk I can go in drive A and be given the command CLOUT. It will load part of the program, then ask that Disk II be swapped into the drive to complete the loading. In either case, an R:base database goes into the B drive when you are ready to get down to business.

As CLOUT loads, it first displays the full-screen R:base logo and asks for the name of the database you want to use (see photo 1). When you enter this and the data is loaded, the main CLOUT menu (see photo 2) will be displayed. If you have already taught your database your special vocabulary, you can move right into asking it questions; otherwise, you must first do some educational work. In this way, CLOUT is like a not-very-smart dog—you have to train it before it can do much that is useful. This is not to say that CLOUT is totally ignorant when it comes out of the box. It isn't. It knows more than 240 words, phrases, and abbreviations—ranging from easy ones like "list" and "show" to whizzers like "standard deviation" and "approximately"—in addition to almost two dozen symbols (see table 1 for examples). But using these words is not too different from using any other query language, for instance SQL, INQUIRE, or, for that matter, dBASE II. The fun, and the power, of being able to ask a database of geopolitical information "Who are the freedom fighters?" and getting useful data in reply is what sets natural-language query apart. However, to have that fun you must do some work first because we don't all agree on terms and a program cannot be totally prewritten.

Setting up your own vocabulary using CLOUT is straightforward, if picky. Beginning at the main menu,

you select option 4, "Fine-tune the request process." This drops you into another menu (see photo 3), with two options of immediate interest when

training a new database—option 1, "Update a dictionary with database synonyms" and option 6, "Set fields

(continued)

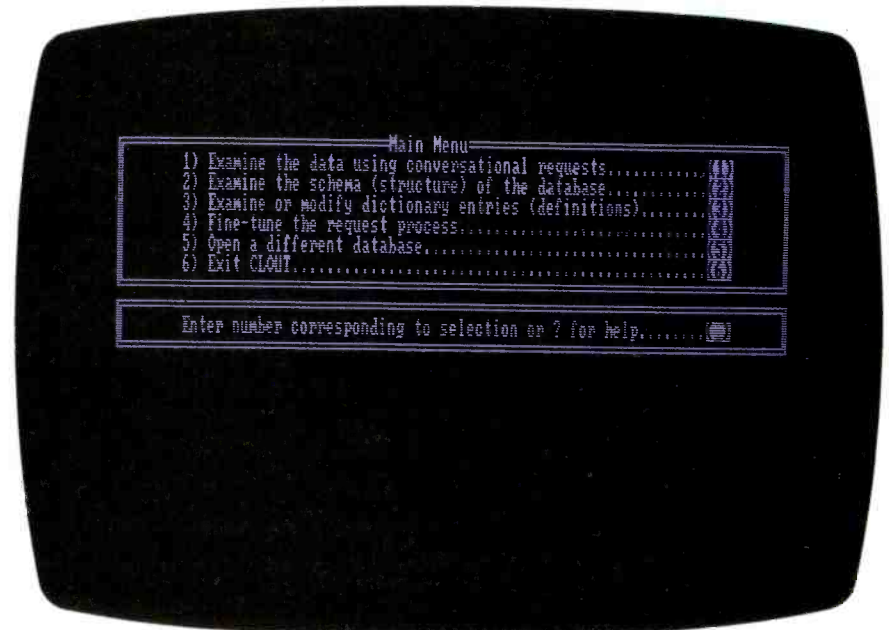

Photo 2: The main CLOUT menu offers six choices, including going back to DOS. Option 2, "Examine the schema..." is handy for checking database field names when creating new query definitions.



Photo 3: The "fine-tuning" menu gives access to modules that allow customization of CLOUT.





# LAST NIGHT WE EXCHANGED LETTERS WITH MOM, THEN HAD A PARTY FOR ELEVEN PEOPLE IN NINE DIFFERENT STATES AND ONLY HAD TO WASH ONE GLASS...

## **That's CompuServe, The Personal Communications Network For Every Computer Owner**

And it doesn't matter what kind of computer you own. You'll use CompuServe's Electronic Mail system (we call it Email™) to compose, edit and send letters to friends or business associates. The system delivers any number of messages to other users anywhere in North America.

CompuServe's multi-channel CB simulator brings distant friends together and gets new friendships started. You can even use a scrambler if you have a secret you don't want to share. Special interest groups meet regularly to trade information on hardware, software and hobbies from photography to cooking and you can sell, swap and post personal notices on the bulletin board.

There's all this and much more on the CompuServe Information Service. All you need is a computer, a modem,

and CompuServe. CompuServe connects with almost any type or brand of personal computer or terminal and many communicating word processors. To buy a Starter Kit, see your nearest computer dealer. To receive our informative brochure or to order direct, call or write:

## **CompuServe**

Consumer Information Service  
5000 Arlington Centre Blvd., Columbus, OH 43220  
**800-848-8199**  
In Ohio call 614-457-0802.

An H&R Block Company

**Table 1:** As delivered, CLOUT has a vocabulary of more than 250 words, phrases, arithmetical and comparison operators. Some examples of each are shown.

Vocabulary Word	CLOUT Definition	Arithmetic Operator	CLOUT Meaning	Comparison Operator	CLOUT Meaning
and	Use to select data. Signals continuation of the previous question if used as the first word. Also use to connect list items and conditions.	*	Multiplication.	<	Less than. Use to limit the data selected.
		x	multiplied by	less than or less than smaller than	
		+	plus	before	
		sum		below	
and or	Data will be selected if either or both of the conditions are satisfied.	sum	The sum of the computed value. CLOUT calculates the answer. Use in comparisons, as a sort field, or computations by group.	it	
		summation		under	
		total		< =	Less than or equal.
and/or	Signals continuation of the previous question if used as the first word.			= <	Use to limit the data selected.
				le	
any	Indicates a possible yes/no question. Will also select data.	-	Subtraction.	at most	
anybody		minus		or more	
anyone		/	Division.	< >	Not equal. Use to limit the data selected.
anything		divided by		> <	
	Did any salesman travel to Brussels	average	Use to compute an average.	different from	
approximately	Synonymous with about. Enhances the "fuzziness" of a number.	ave		different than	
	approximately 22,000 (finds numbers that would round to or truncate to 22,000 within the number of significant digits, i.e., 21,500 to 22,999)	avg		not equal	
		standard deviation	Use to compute the standard deviation.	ne	
		std		not same as	
		<	Exponentiation. Use to compute an exponential value.	=	Equal. Use to limit the data selected.
		raise to	What is the value of 2 < 5? (this would return 32)	during	
apr	April.			eq	
april				equal	
are	Indicates a possible yes/no question. May use as a verb.			equivalent	
				same as	
ascending	Qualifies the order in which sorts or group computations are performed.			>	Greater than comparison operator. Use to limit the data selected.
	show the cumsales in ascending order			bigger than	
				greater than	
				gt	
				more than	
				or more than	
				since	
				after	
				above	

to be labeled Who, Where, or When." Using the geopolitical example, if your database included fields named "organization" and "individual-member," you could use option 6 to tell CLOUT to print both when asked "Who." And with option 4, you would be able to define "group," "outfit," "company," "apparatus," "cell," and "wing" as

synonyms for "organization." While none of this training is especially difficult, it is time-consuming. Establishing a truly useful vocabulary means that you must know your data well and must do some careful thinking about how you will be referring to that data. And because CLOUT allows writing generalized macros ("concept

definitions" they are called), careful planning can save many lines of code.

**SALVO—INQUIRE MORE CAREFULLY**

Another program, SALVO (Software Automation Language Vocabulary) from Software Automation Inc., is

(continued)



# GREAT PRICES! GREAT SERVICE!

If you're looking for a great deal on business software, 800-Software is hard to beat. We became one of America's largest software marketers by offering great prices—and a lot more.

Here are some of the reasons to buy from 800-SOFTWARE:

■ **LOW DISCOUNT PRICES.** Generally 40-50% off suggested list price.

■ **FAST DELIVERY.** Our giant inventory makes this possible. (We can provide overnight delivery!)

■ **FREE TECHNICAL SUPPORT.**

Call our helpful and patient experts.

■ **RELIABILITY AND REPUTATION.**

Some of our best customers are America's biggest corporations, including IBM, Hewlett-Packard, G.E. and Honeywell. Also, we fully guarantee every product we sell against defects.

■ **EASY TERMS.** We accept purchase orders from qualified organizations.

## CHECK OUT THESE INCREDIBLE SOFTWARE PRICES:

AMDEK™ MONITORS	CALL	MICROSOFT® WORD	
AST 6-PACK PLUS™	CALL	W/MOUSE	\$359
CROSTALK™	\$105	MULTIMATE™	\$299
dBASE II/III™	CALL	MULTIPLAN™	\$149
EASYWRITER II		NORTON UTILITIES™	\$ 59
SYSTEM™	\$195	PFS: FILE/GRAPH/ WRITE/REPORT™	\$ 85
4-POINT GRAPHICS™	\$129	QUICKCODE™	CALL
FRAMEWORK™	CALL	RBASE 4000™	\$329
HAYES		SUPERCALC® 2	\$159
SMARTMODEMS™	CALL	SUPERCALC® 3	\$219
HERCULES GRAPHIC		WORDSTAR®	CALL
CARD™	CALL	WORDSTAR®	
INFOSTAR™	CALL	PRO. PAK	CALL
IUS ACCOUNTING		VOLKSWRITER	
MODULES™	\$299	DELUXE™	\$179
LOTUS 1-2-3/ SYMPHONY™	CALL	PLUS MUCH, MUCH MORE!	
MAXELL™ OR MEMOREX™			
DISKETTES	CALL		

### 800-SOFTWARE IS READY TO SERVE YOU.

TO ORDER CALL TOLL-FREE: 800-227-4587 OR 415-644-3611

- Dealer inquiries welcome.
- Quantity discounts available through our National Accounts Program.
- Purchase orders accepted. Please call in advance.
- Call for shipping charges. Overnight delivery available.
- We do not add surcharge for credit card purchases.
- Prices may change. Above prices are for IBM-PC and compatibles.
- International orders welcome: TELEX #751743 800-SOFTWARE UD
- CompuServe Key Word "GO-EH".

CA residents add sales tax.  
©Copyright 800-SOFTWARE 1984



# 800-SOFTWARE

940 Dwight Way, Berkeley, CA 94710

## REVIEW: CLOUT/SALVO

basically an application generator, but it uses a restricted natural-language query system.

SALVO is a very different sort of product from CLOUT. It is called "first and foremost an information manager" by its maker and is intended to help nonprogrammers write programs. It is described as being also an application generator and using a "new type of expert system" to help users. The expert system in SALVO allows natural-language queries.

The program runs under PC-DOS, MS-DOS, CP/M-80, or CP/M-86 and requires a minimum of 64K bytes of RAM and two double-sided, double-density floppy-disk drives or one floppy drive and one hard-disk drive. It is supplied on two floppy disks. The program disk is copy-protected and allows only two backups to be made. The second disk is a data disk, and it must be used—it contains seed programs required by SALVO. When you require a new data disk, you copy the old disk and erase redundant files to make room for new files. You may copy the data file to a hard disk, but you must have the program disk in drive A when you start SALVO or the program will not run.

The disks are packaged with the manual in a slightly slimmer version of the IBM PC documentation binder. The 256-page manual is well written, typeset, and nicely illustrated, but is hamstrung by the lack of an index. Although it is filled with excellent information, including some clear explanations of relational data structures, the information is difficult to get at without an index. The manual is divided into four sections—an introduction, a functional guide, a case study, and a language summary.

Nonprogrammers, even first-time computer users, can certainly use SALVO. In fact, it probably would have its greatest appeal to electronics neophytes. SALVO will guide you, step by step, through the process of creating a computer program that can do useful work. Your first program on SALVO could be quite complex, complete with related files calling each other

(continued)

LOMAS DATA PRODUCTS PRESENTS:

# THUNDER 186

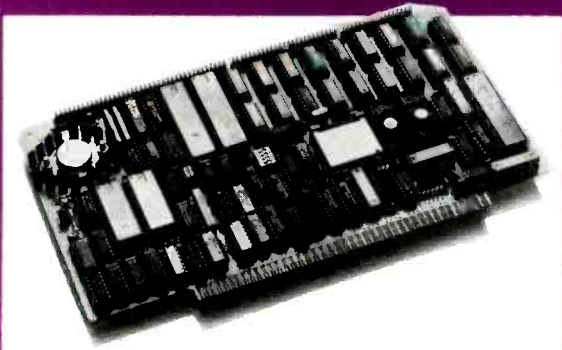

**THUNDER 186 offers the following standard features:**

- 8 Mhz 80186 processor
- Floppy disk controller (controls both 5 1/4" and 8" drives simultaneously)
- Two RS232 ports with hand shaking
- Centronics compatible parallel port
- 256K bytes of RAM
- Full IEEE-696 COMPLIANCE
- One year warranty

THUNDER 186 provides the earth shanking performance you have come to expect from LOMAS DATA PRODUCTS. THUNDER 186 is a complete SIXTEEN BIT SINGLE BOARD COMPUTER on a standard size S100 bus board. THUNDER's low price includes Concurrent CP/M-86\* version 3.1. This allows the user to run PC-DOS\*\*\*\* programs, as well as, CP/M-86\* programs on the same system. And, for those users that prefer, MS-DOS\*\*\* is also available.

## TEST: THUNDER 186 BENCHMARK.

In our April '84 advertisement, we compared the benchmarks of our other advanced CPU products, against the COMPUPRO CPU86/87 10 Mhz. The test consisted of assembling the example BIOS (BIOS.A86) distributed with standard CP/M-86. The operating system used was CP/M-86. Now, we put THUNDER 186 to the same test . . .

	LIGHTNING ONE* 10 MHZ	COMPUPRO CPU86/87 10 MHZ	LIGHTNING 286** 6 MHZ	THUNDER 186 8 MHZ
ASSEMBLY-TIME (SEC.)	47	55	41	48
RATIO TO 10 MHZ LIGHTNING ONE	1.00	1.17	.88	1.02
BOARD SET COST LIST PRICE AS TESTED	\$2545.00	\$3040.00	\$3290.00	\$1595.00
COST PERFORMANCE	\$2545.00	\$3556.80	\$2895.20	\$1629.00
RATIO	1.00	1.40	1.14	.64

## RESULT: THUNDER 186 THE LEADER.

The benchmark comparisons clearly make THUNDER 186 the leader in the 16 bit price/performance race. Other THUNDER 186 advantages are too numerous to mention here. CALL US, and we'll be glad to discuss the other advantages with you.

## S100 bus board products & support for the system integrator ...

### ■ LIGHTNING ONE \*\*\* 8086/8088 CPU

8086 or 8088, with 8087 and 8089 coprocessors. Up to 10 MHZ operation . . . . . **PRICES start at \$425.00**

### ■ HAZITALL SYSTEM SUPPORT BOARD

2 serial, 2 parallel ports, battery protected clock calendar, Hard disk controller host interface . . . . . **PRICE \$325.00**

### ■ LDP 128/256K DYNAMIC RAM

Advanced dynamic RAM with LSI controller for failsafe operation, parity . . . . . **PRICE 128K—\$495.00, 256K—\$795.00**

### ■ RAM67 HIGH PERFORMANCE STATIC RAM

High speed (100ns) low power CMOS static RAM. 128K bytes, extended addressing . . . . . **PRICE \$995.00**

### ■ LDP72 FLOPPY DISK CONTROLLER

Single/double density, single/double sided disks, both 8" and 5 1/4" inch drives simultaneously . . . . . **PRICE \$275.00**

### ■ LIGHTNING 286—80286 CPU BOARD

Offers 4 times the performance of a 5MHZ 8086 CPU while maintaining software compatibility. . . . . **PRICE \$1395.00**

### ■ OCTAPORT 8 PORT SERIAL BOARD

8 serial ports 0 to 19200 baud operation real time clock interrupt. Ideal for multi-user systems such as MP/M-86.\* . . . . **PRICE \$395.00**

All of LDP boards are fully tested to exacting standards and carry a one year warranty. We specialize in 16-bit products & support the four major operating systems for 16-bit processors: CP/M-86\*, MP/M-86, CONCURRENT CP/M-86\*, and MS-DOS (PC-DOS).

*Dealer inquiries invited.*



LOMAS DATA PRODUCTS, INC. □ 66 Hopkinton Road, Westboro, MA 01581 □ (617) 366-6434 □ Telex: 4996272

\*CP/M-86, MP/M-86 and CONCURRENT CP/M-86 are trademarks of Digital Research.  
\*\*MS-DOS is a trademark of Microsoft  
\*\*\*Lightning One is a trademark of Lomas Data Products, Inc.  
\*\*\*\*PC-DOS is a trademark of IBM



# Graduate school for professional software engineers is here.



## The Wang Institute of Graduate Studies

Name: \_\_\_\_\_

Business Address: \_\_\_\_\_  
\_\_\_\_\_  
\_\_\_\_\_

Telephone: Home \_\_\_\_\_ Business \_\_\_\_\_

Years of Software Development Experience: \_\_\_\_\_

I am currently a  software professional

10/84  student  other

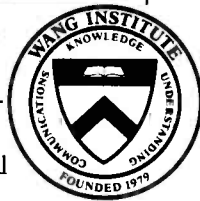

For tomorrow's leading software engineers, the Wang Institute offers an unprecedented educational opportunity.

Students enrolled in our Master of Software Engineering (M.S.E.) program prepare for positions of increasing challenge and responsibility, while studying the latest technical and managerial aspects of software development.

Working in teams with other professionals, M.S.E. students learn how to plan, organize and supervise real-world software projects. With access to a large and growing collection of software tools, our students develop a thorough understanding of the entire software life-cycle. At the same time, our low student/faculty ratio of seven to one allows them to work closely with teachers who have significant industrial and academic experience.

The Wang Institute's M.S.E. program is open to all qualified software professionals. Currently more than 20 companies have sponsored M.S.E. students, who may choose either part- or full-time schedules of study. Graduate assistantships for unsponsored, full-time students are also available.

If you're ready to become one of tomorrow's leading software engineers, the Wang Institute of Graduate Studies is the place to be.

For further information, write or call Janis Ackerman, Wang Institute of Graduate Studies, School of Information Technology, Tyng Road, Tyngsboro, MA 01879 (617) 649-9731.

The Wang Institute of Graduate Studies is an independent, non-profit educational institution founded in 1979.

## REVIEW: CLOUT/SALVO

for reports.

As noted, the application generator works and can generate sophisticated programs, which is an important quality.

### LANGUAGE BARRIERS

The "Expert Command Assistant," the module for natural-language query, leaves a great deal to be desired. Its glossary of recognized words cannot be expanded in the same way as CLOUT's, and it is discouragingly short:

List, print, get, display, show, add, alter, change, delete, enter, modify, remove, update, by, for, in, of, on, and, or.

Its list of forbidden words is discouragingly long:

Are, how, is, was, were, what, when, where, who, whose, why.

Given such a restricted vocabulary, it is difficult to ask for data from files in natural language. "List salesmen who earned more than \$5000," or "What salesman made more than \$5000?" draws a response of "Request too complex. Please re-enter your request" from SALVO. The "who" and "what" words apparently are the source of the complexity for SALVO, since they are on the forbidden list.

The vocabulary can be expanded, but only in specific programs. If a query is okay except for an unrecognized word, SALVO allows you to shift to a display of the underlying code (see photos 4 and 5). You can then write your new definition into this code and save it either as a temporary file or a new, named file. If you save it as a named file, it can be run later like any other program.

### CONCLUSION

There is an important point to keep in mind about any natural-language query system. It may be fun, it may be powerful, but because of the front-end time involved, it may not be the best tool to solve your problem. The time required to design and implement a proper vocabulary often can be justified only if the data is used



Photo 4: When SALVO finds a word it doesn't know in an otherwise acceptable query, it allows dropping into source code and entering the needed information.



Photo 5: The user then has the choice of making this change a one-time event or saving it as a new program.

regularly or if lots of people who know little about the structure of the database are going to be using it. Data that is needed only occasionally often can be better dealt with using other systems—a menu-driven query-

by-example program, for example. And if an expert user—a "power-user" in the current jargon—will be the sole inquisitor of a database, perhaps the raw programming language may be the fastest way to get answers. ■

# DeSmet C

8086/8088  
Development  
Package **\$109**

### FULL DEVELOPMENT PACKAGE

- Full K&R C Compiler
- Assembler, Linker & Librarian
- Full-Screen Editor
- Execution Profiler
- Complete STDIO Library (>120 Func)

### Automatic DOS 1.X/2.X SUPPORT

### BOTH 8087 AND SOFTWARE FLOATING POINT

### OUTSTANDING PERFORMANCE

- First and Second in AUG '83 BYTE benchmarks

**SYMBOLIC DEBUGGER \$50**

- Examine & change variables by name using C expressions
- Flip between debug and display screen
- Display C source during execution
- Set multiple breakpoints by function or line number

**DOS LINK SUPPORT \$35**

- Uses DOS .OBJ Format
- LINKs with DOS ASM
- Uses Lattice® naming conventions

Check:  Dev. Pkg (109)  
 Debugger (50)  
 DOS Link Supt. (35)

SHIP TO: \_\_\_\_\_

\_\_\_\_\_

\_\_\_\_\_ 71P \_\_\_\_\_

**CW A R E**  
CORPORATION

P.O. BOX C  
Sunnyvale, CA 94087  
(408) 720-9696

All orders shipped UPS surface on IBM format disks  
 Shipping included in price California residents add  
 sales tax Canada shipping add \$5, elsewhere add  
 \$15. Checks must be on US Bank and in US Dollars.  
 Call 9 a.m - 1 p.m to CHARGE by VISA/MC/AMEX



**SPECIAL OFFER!**



# TWO FREE

# StorageMaster™

**flexible diskettes  
with every box of ten.**

Buy the specially-marked boxes of Control Data's new StorageMaster brand 5¼-in. double sided, double density diskettes and get 2 extra floppies free during our special limited time offer. That's 12 disks—20% more—in every box, while supplies last.

So plan to stock-up now on StorageMaster brand diskettes. Ask for them at your local computer store or call your local authorized Control Data Business Products distributor.



**StorageMaster™  
Media**  
Premium Series  
5.25-inch Flexible Disks

100% Certified  
5-Year Warranty

Get 12  
Control Data  
Flexible Disks  
20% More In This Box.  
**2 FREE DISKS**

Give him a call...or call toll-free and we'll help you find the nearest source.  
1-800/328-6207 (In Minnesota call 1-612/835-8065).



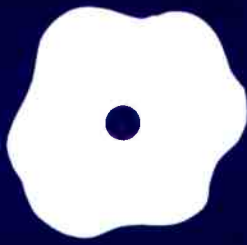

## DataEase vs. Condor and dBASE II

Comparison  
of a menu-  
driven  
program to  
two  
command-  
driven  
programs

BY BILL JACOBSON

**B**elittling the competition is a time-honored way of promoting computer programs. The popular dBASE II program from Ashton-Tate is the standard of excellence most often used to "prove" the alleged superiority of other software packages. For instance, a recent ad for DataEase, the subject of this review, boasts that it has "The power of dBASE without dBOTHER."

Some older programs still prosper, even though the competition from so-called state-of-the-art programs is intense. We shall examine how well DataEase, a relatively new program for the IBM PC, stacks up against two established database-management systems (DBMSs): Condor and dBASE II.

Test results are not conclusive. There are no winners or losers. These fine programs and others have their strengths and weaknesses. But the perfect DBMS program does not exist. Perhaps we must be content with database software that satisfies basic needs, yet has idiosyncrasies or deficiencies with which we can live.

### THE THEORY OF RELATIVITY

DataEase, Condor, and dBASE are *relational* DBMSs. Their capabilities exceed those of comparatively simple one-file data managers like pfs:File or UltraFile, and they provide the means to handle complex, multiple-file applications. Separate files may be set up for customers, vendors, inventory, accounts receivable, accounts payable, and any other activities of a typical business-control system, with information intermixed among them. For example, data from the customer (name, address, telephone number, etc.) and parts files can be used in the preparation of customer invoices.

A "relation" is used to bridge the gap between where information is stored and where it is needed. A common field is used as a unique identifier to provide the necessary bridge. For example, the customer-number field may be used as a bridge between a customer file and an order file. The

referencing file uses this identifier to match the appropriate record(s) in the referenced file.

Methods for handling data-file relationships vary among DBMSs. Condor relies exclusively on relational operators to accomplish this. One such operator is JOIN. The instruction JOIN CUSTOMERS ORDERS MATCHING CUSTNO will physically combine records in the Customers and Orders files, using customer number (CUSTNO) as a relational bridge. The resulting data file will contain all fields and information from both data sets and can be used to generate invoices, reports, and ad hoc inquiries that require data from both sources.

DataEase, dBASE, and some other DBMSs include other options as well. For example, information can be read interactively from a referenced data file, without having to combine two or more files physically. This Lookup function can be used to verify the accuracy of data keyed into a new record or to automatically obtain data from the referenced file (e.g., descriptive and price data from a parts file) after the appropriate part number is entered into an order form.

While a relational feature is essential for complex databases, it is only one of a variety of capabilities that a good DBMS should have. Others include processing speed, batch files to automatically process groups of commands, data quality assurance routines, data-entry standardization, etc.

Equipment used for this review includes an IBM Personal Computer (PC) with 512K bytes of RAM, two 360K-byte floppy-disk drives, a Davong 15-megabyte hard-disk drive, and monochrome and color monitors. PC-DOS 2.0 is the operating system of choice.

### HOW THEY WORK

Table 1 compares some key DataEase, Condor, and dBASE II features. The PC-DOS ver-

(continued)

Bill Jacobson (5063 Coleridge Dr., Fairfax, VA 22032) is the owner of Compu-HELP. He holds a master's degree in public administration. His hobbies include sports, reading, classical music, and playing the piano.



Table 1: A comparative overview of the features for the reviewed programs.

Notes: (1) Requires programming; (2) Very limited capabilities, requires programming; (3) Program files may be located on more than one disk.

Item	DataEase	Condor	dBASE II
Menu driven	Yes	No	No
Built-in programming language	No	No	Yes
Command/Batch file processing	Yes	Yes	Yes (1)
Custom screen generator	Yes	Yes	Yes
Password protection	Yes	No	No
Prevents duplicate entries	Yes	No	No
Data field masking	Yes	No	Yes (1)
Lookup file capabilities	Yes	No	Yes (1)
Maximum capacities			
Files open concurrently	No limit	1	2
Data-entry forms per file	No limit	1	1
Records per file	65,535	65,534	65,535
Fields per record	255	127	32
Characters per record	8000	1024	1000
Characters per field	255	127	254
Active index keys	255	1	7
Quick report generator	Yes	Yes	Yes
Complex report writer	Yes	Yes	No
Color capabilities	Yes	No	(2)
Uses IBM PC function keys	Yes	No	No
Program file disk space needed	590K (3)	270K	96K
Random-access memory required	192K	128K	128K
List price	\$595	\$650	\$495
Available formats	Most 16-bit	Most	Most
Format tested	PC-DOS	PC-DOS	PC-DOS
Version tested	2.10	2.11	2.40

sions of each program are pre-installed. You simply prepare working copies of master disks included in the package (they are not copy-protected) and boot the program. Some other hardware and software configurations may require preliminary installation.

The following paragraphs summarize methods used with each DBMS to set up a typical application. Keep in mind that Condor and dBASE are 8-bit CP/M operating-system designs adapted to 16-bit machines. On the other hand, DataEase is designed to take advantage of the 16-bit environment of the IBM PC and similar computers, including the extended memory, function keys, and other capabilities of those machines.

The new dBASE III program was not available at the time of this review. Unlike its predecessor, it is designed for 16-bit computers and promises vastly improved capabilities and

speed. dBASE III will initially be available only for the IBM PC.

### DATAEASE

This is one of the new breed of relational DBMSs that are fairly simple to set up and use and that offer many powerful features. DataEase is totally menu driven. That is, all activities are selected from a series of preformatted or custom menus and submenus. On-screen help is provided for many of DataEase's features, and current settings for function keys are shown at the bottom of the screen.

To initiate a database, enter a letter of the alphabet to identify it, your name, and a password. This sequence must be repeated each time you log on. Thus, up to 26 separate databases may be created, each of which may have an unlimited number of files—assuming you have an unlimited amount of disk space.

The DataEase password function provides three access levels: *high*, with no restrictions; *medium*, to view information, run reports, and enter or modify data; and *low*, to view information and run reports only. You may assign passwords to any number of people. DataEase does not provide foolproof protection for your information. All data is written to disk as ASCII (American Standard Code for Information Interchange) text files and can be read using the TYPE command of PC-DOS or transferred to a new file. Even so, this approach does regulate normal use of these files, and works very well.

After these preliminaries, the Main Menu appears (photo 1a). You may elect to customize the program to your liking and create data files, menus, and reports. The first stop is the System Administration menu, where you may "administer" password matters and three other options:

- Define Configuration: select the default disk drives, printer(s), and monitor type (color or monochrome); allocate system memory for sorting and other purposes
- Define Printers: modify existing printer drivers (15 are available) or create your own
- Define Screen Styles: modify color combinations, character blinking, and intensities

The next step is file creation. DataEase permits up to 255 fields per record and 255 characters per field. The combined length of all fields cannot exceed 8000 characters per record.

Data entry is accomplished with custom-designed forms (photo 2a), which are also used for record-by-record searches. Each form can contain one or more pages (there is no limit), with "page" defined as a computer screen of information. This is a useful feature if you want to decongest your screens by spreading fields over several pages. Once a form is named, a blank screen is displayed. To define the first and all subsequent fields, move the cursor to the desired spot on the screen and type in a field

description (e.g., First Name). This information may be located before, after, above, or below the data-entry area for the field.

Move the cursor to the spot where the data-entry area will begin and press the F10 function key on the IBM. You must then make a series of decisions about field characteristics, a wide variety of which are possible, including three that are required—name, field type, and length—and six that are optional—indexed, unique, prevent data entry, range check, derived, and protected (photo 3). A comprehensive set of characteristics, like those for DataEase, helps to ensure

the quality of data entered into your files. These field characteristics can help prevent errors by automatically entering the correct data, providing on-line verification of accuracy, or simplifying the keying of complex sets of data.

Field types can be text, numeric, numeric string, date, time, dollar, yes or no, and choice. Numeric strings are sets of numbers that have no mathematical significance (e.g., the sum of telephone numbers is meaningless) and may be divided by various types of separators. When data is keyed into a numeric-string field, any separators are automatically entered. This

speeds entry and reduces the incidence of errors. Typical numeric strings are Social Security and telephone numbers: "999-99-9999" and "(999) 999-9999;" respectively. If you are not satisfied with these preformatted options, custom data masks may be designed.

With the "choice" field type, as many as 99 optional entries of up to 60 characters each may be created. These options appear at the top of the screen during data entry or modification. Key in the number of your choice and it is automatically entered. For example, you might enter item 34

(continued)



Photo 1: (a) DataEase standard main menu.



(b) Initial Condor screen.

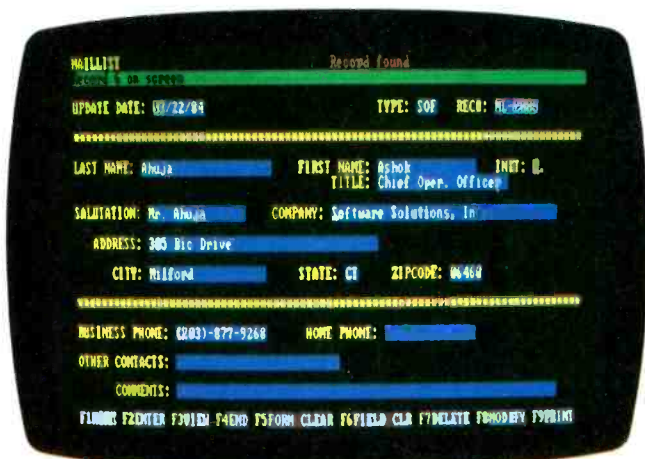

Photo 2: (a) DataEase data-entry screen example.



(b) Condor data-entry screen example.



of a field called Therapy Used to have the predefined message Dry Heat and Massage inserted. This technique not only speeds data entry, but also ensures that entries are of standard length and content.

When you want to create a derived field you have four options for the source of the field's information. They are: calculate (for calculated fields); lookup; sequence; and default. As indicated previously, the Lookup function may be used for the following purposes:

- entering information into a blank field on the form
- verifying the data in a form (that a part number keyed in manually actually exists)
- as a value in the calculation of a field

To implement the DataEase LOOKUP command, enter the name of the source file and field (e.g., LOOKUP Customer's Company). Then establish the correct relationship for this data, using item six on the Main Menu, "Menus and Relationships." You will receive an error message if the latter step is omitted.

The Sequence option permits sequential numbers to be entered automatically in a field. Check, invoice, customer, or other sequences of numbers are candidates for this feature. The next-higher number will always be entered.

An existing form may be modified at will. When the form to be modified appears on screen, make any corrections you want: delete fields, change their characteristics, add fields, etc. The revised version may be saved under another name or the original file overwritten. This function can be used to make duplicate copies of any form, with or without data.

The DataEase report feature is so powerful that you may initially be overwhelmed by it. Its features include:

- An optional data-entry form to provide user-supplied conditions—such as a range of ZIP codes—that specify what is to be printed in a report.
- Reports of any type. You may choose standard columnar or label-type formats or design your own report from scratch. Data also may be formatted as data-interchange format (DIF) or mail-merge files. Any standard

*DataEase's report feature is so powerful that you may initially be overwhelmed by it.*

format may be modified at will, using the report edit function. The edit screen does not scroll horizontally, making the design of reports wider than 80 columns rather cumbersome. A Report Print Style screen lets you customize other features for each report (photo 4).

- Ad hoc queries (e.g., a telephone operator retrieving the telephone number of a subscriber from his name and address) using the standard report-generation procedures—the so-called one-time-reports option on the "Reports and Questions" submenu. DataEase does not have the nonprocedural language capabilities of dBASE or Condor to obtain free-form responses and printed lists from your data files, without the bother of developing a report format. That type of feature is sorely missed and ought to be added to future releases.

Data from many files can be combined in a report, and the selection of fields and other display options may be totally manual, interactive, or some combination of both. The program diagnoses mistakes and whisks you to the location of an offending entry.

Custom menus and batch processing are accommodated through the "Menus and Relationships" option (photo 5). A menu screen may contain as many as nine instructions, and an unlimited number of menus and submenus may be created. Custom menus are then displayed each time DataEase is booted.

A variety of file commands may be batched (chained together) and executed automatically. These include predefined reports; various DataEase utilities, like file backup and restore; posting of updates to a master file; importing information from other

(continued)



Photo 3: DataEase file creation: selection of field definitions.

# HERE TODAY HERE TOMORROW

When buying a computer, you can't limit yourself to just satisfying today's needs. **The best value in a system comes from its productivity . . . both for today and tomorrow.** CompuPro's System 816™ computer has that value. With all the power and capacity to handle your needs now and down the road.

System 816's longevity stems from top quality components . . . high storage capacity . . . the flexibility to handle a large variety of applications . . . and the speed to get the job done fast. Upgrading is easy, and when it's time to expand from single to multi-user operation, it's as simple as plugging in boards and adding terminals. Your system grows as you grow.

CompuPro also provides a library of the most popular software programs with your system and because it's CP/M® based, you have more than 3,000 other programs to choose from.

Even our warranty is for today and tomorrow. It spans 365 days — and includes the additional security of Xerox Americare™ on-site service nationwide for designated systems.\*

What's more, CompuPro is one company you can count on to be around tomorrow. For more than ten years we've been setting industry standards, increasing productivity and solving problems.

For a free copy of our business computer buyer's primer, and the location of the Full Service CompuPro System Center nearest you, call (415) 786-0909 ext. 206.

CompuPro's System 816. The computer that's just as essential tomorrow as it is today.

## CompuPro®

A GODBOUT COMPANY

3506 Breakwater Court, Hayward, CA 94545

\* Available from Full Service CompuPro System Centers and participating retailers only.

System 816 and The Essential Computer are trademarks of CompuPro. CP/M is a registered trademark of Digital Research Inc. Americare is a trademark of Xerox Corporation.

System 816 front panel design shown is available from Full Service CompuPro System Centers only. © 1984 CompuPro

## The Essential Computer™





databases; and program calls. The batch file commands of DataEase are good but not as extensive as those for Condor or dBASE.

Virtually any program can be run

from within DataEase using the Program Call option. For instance, you may boot and use a word processor, another DBMS, or a graphics program and then return to the original Data-

Ease menu. Programs to be "called" may be specified in a menu or entered by the user.

**CONDOR**

In contrast to DataEase, application development with Condor is not menu driven and very little on-screen help is provided. After the program is booted, you are greeted with the system prompt "A>>" (photo 1b) if the default drive is A; then you must supply any subsequent instructions. On-line help is not available.

To create a file for your database, enter the command "DEFINE (filename)" and a blank data-entry screen will appear. This screen is used for all data-entry (photo 2b) and record-search activities. As with DataEase, data fields may be located anywhere on the screen. Position the cursor to the desired location, type and bracket the field name, and insert underscores—one for each character of the field—immediately after the field name. For example a 15-character field called "[FIRST NAME]" would require 15 underscores. Fields may be spread over two screens on 16-bit computers, and one screen on 8-bit models.

Each record in a file may contain up to 127 data-entry fields, the combined length of which cannot exceed 1024 characters. The maximum length of a field is 127 characters.

Once the field-creation process is complete, you must define the characteristics of each field on the data-entry screen. Options include alpha, alphanumeric, numeric, decimal, dollar, date, and required entry. Minimum, maximum, and default values may also be defined for a field. These choices are adequate for most purposes, but very limited when compared with DataEase. As explained previously, interactive use of information residing in other files is not possible, nor are numeric string masks like "(999) 999-9999."

Password protection is not available. A license number must be entered when the program is booted, but anyone who can boot the program

(continued)

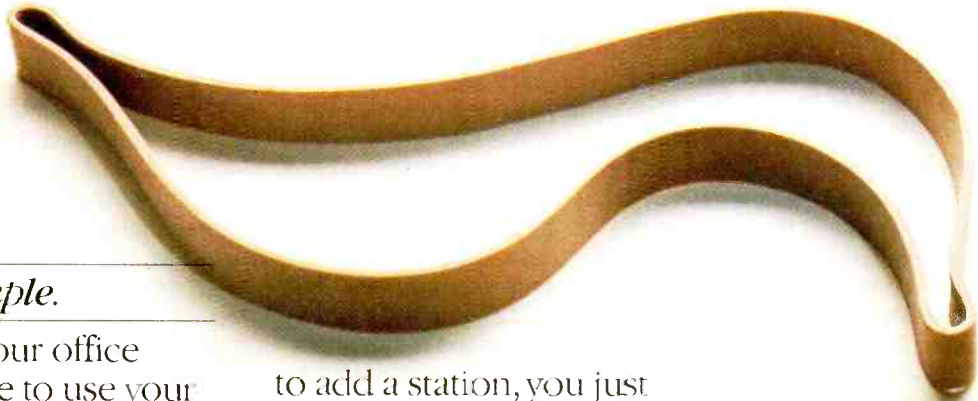

Photo 4: DataEase print-style-selection screen for entering custom printer, page, and other settings for a report. These may be modified prior to printing the report.



Photo 5: DataEase custom menu-creation screen. Any number of menus may be created.

# What every PC network should be.



---

## *Simple.*

Anybody in your office should be able to use your network. That's how we designed OmniShare.

OmniShare™ software lets any IBM XT or compatible share its disc space with other PC's or compatibles. All it takes is one transporter card per computer, plus the wire to connect them.

Then you just put in one floppy, answer one question and you've got a working network. It's that simple.

---

## *Expandable.*

A network should grow as easily as it starts.

Fair enough. With OmniShare whenever you want

to add a station, you just put a transporter card into your new computer and plug it into the network.

And if your storage or backup needs outgrow your XT's capacity? Corvus offers a complete range of network disc storage and backup.

---

## *Affordable.*

At under \$500 per connection, OmniShare makes OMNINET™ one of the most cost-effective networks you can install. Or expand.

Because when you need to add storage and backup, you'll find that Corvus has

some of the best values in the industry. Like a 200 MB random access backup at an amazing \$11 per megabyte.

---

## *Dependable.*

Of all the networks around, how many are really proven? We think the facts speak for themselves: Corvus networks now connect 3 out of every 5 locally-networked micros.\*

If you'd like to hear more, just call us at 800-4-CORVUS.

We really believe a PC network should be like a rubber band. Simple. Expandable. Affordable. Dependable.

And that's not stretching the point.

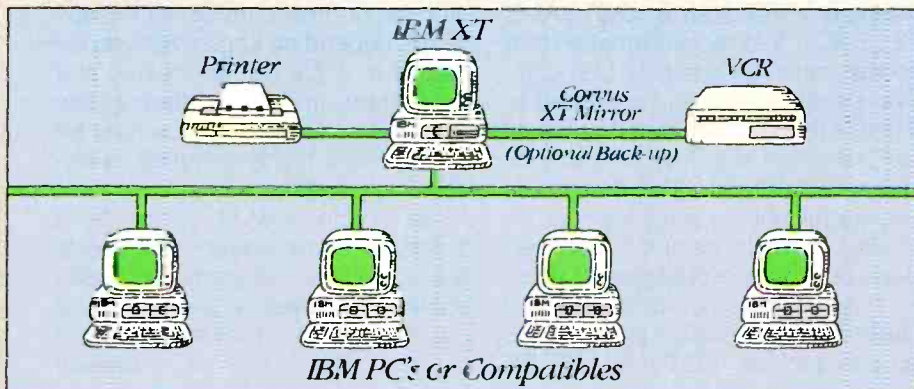

**CORVUS**  
The Networking Company.

\*59% of all locally-networked micros operate in a CORVUS network, according to InfoCorp. CORVUS, THE NETWORKING COMPANY, OMNINET, OMNISHARE and CORVUS XT MIRROR are trademarks of CORVUS SYSTEMS INC. IBM PC and PC XT are trademarks of International Business Machines.

Circle 84 on Inquiry card.



*dBASE II can be classified among the simplest or most complex of DBMSs to use, depending upon what you expect of it.*

has access to all of its functions.

The command options of Condor are much more extensive than those of DataEase, but less flexible than dBASE. Forty-four commands are available; some significant ones are listed and discussed below:

ENTER creates new records.

UPDATE modifies existing records.

COMBINE merges two files.

COMPARE compares the data in two files and copies records that do not meet the prescribed conditions into a "Result" database.

CHANGE makes global changes to a file, using prescribed values.

INDEX indexes a database, using up to eight key fields. Only one index file may exist, which is automatically updated when a record is created or modified. If a database is sorted, it must be reindexed.

JOIN merges the record of two files that match specified conditions.

POST updates information from one file with that from another (e.g., a master parts file using daily sales information).

PROJECT creates a new file from pre-selected fields of another file.

SELECT extracts records from an existing file that match specified conditions.

REORG adds, deletes, or rearranges fields on a data-entry screen.

Sets of these commands can be used to develop highly complex and versatile database systems. However, because information from two or more files must be combined physically for many reporting and updating activities, a great deal of disk space and time may be required to process large databases with many processing steps.

Custom menus and submenus may be created with the HELP command, using procedures similar to those for DEFINE. One menu item per line may be entered, with the command string to be executed appearing below or beside it—e.g., "2. Add Record to The File [ENTER Maillist]."

Menus may also reference an automated procedure file ("RUN (filename)") which, like the chain function of DataEase, may contain a series of commands to be batch processed. These files must be prepared with a word-processing program and can contain up to 127 separate procedures, including nested IF statements and some non-Condor command files. The latter capability is of little value, as the memory requirements of non-Condor files cannot exceed 28K. By contrast, I was able to boot such programs as WordStar, Condor, dBASE, and R:base 4000 using the DataEase program call function.

An automated procedure file capability is particularly important with Condor. For example, many separate procedures may be required to prepare information for a report or to update and verify the accuracy of new or modified records. All of this bother can be reduced to the flick of a key with a well-designed procedure file.

Reports may be generated using the LIST, PRINT TITLE, and REPORT functions. The List and Print functions are identical. Reports generated by the LIST function may be output to the screen or printer and generated from a command file or from the system prompt line. Any ASCII text file can be listed. Typical syntax is LIST (filename) {field names}; e.g., "LIST Maillist BY FIRST.NAME, LAST.NAME TELE.NO." To direct information to a printer, enter "[P]" after the LIST command string. Lists can be printed in data-file (by record number) or index-file order and may include statistics and subtotals/totals. This function is very useful, but the entire file must be printed. It would be nice if later versions of Condor would permit users to select subsets of data, using a variety of conditional WHERE clauses, such as "LIST MAILLIST BY

LAST.NAME CITY WHERE ZIPCODE GE (is greater than or equal to) 22000."

The Condor REPORT function is quite versatile. Unlike data-file-related commands, REPORT is menu driven and has on-line assistance. The headers, footers, and data fields for a report are "painted" on a blank screen, after which you must answer questions about the characteristics of each line of the report (how it will be printed, default values, statistics, etc.). You may opt for a "short method," where fewer questions are asked and reports may be generated or modified more quickly.

Multiple-file reports cannot be generated interactively. Instead, information must be physically combined from the necessary files into a new one, using some of the commands listed previously. In addition, the new file must be sorted in the order needed; otherwise, records are printed in data-file order (in the sequence they were originally entered). REPORT does not have a built-in sort function like DataEase, and it is not possible to print in index order, an option available only with the LIST and PRINT commands.

Condor has one of the best data import/export (read/write) functions available. It is uncomplicated to use and will handle most types of text files transferred between different types of word-processor, spreadsheet, and database programs.

## dBASE II

This program remains the standard that all newcomers are judged against. dBASE can be classified among the simplest or most complex of DBMSs to use, depending upon what you expect of it. A file can be created and data entry initiated within a few minutes, or several months may be devoted to a highly complex, many-tiered application.

Like Condor, dBASE is not menu driven. A blank prompt line greets you once the program has been booted. However, a useful feature with version 2.4 is the Help file. From

*(continued)*

## AT A GLANCE

<b>Name</b>	DataEase	Condor 3	dBASE II
<b>Type</b>	Relational database-management program	Relational database-management program	Relational database-management program
<b>Manufacturer</b>	Software Solutions Inc. 305 Bic Dr. Milford, CT 06460 (800) 243-5123	Condor Computer Corp. 2051 S. State St. Ann Arbor, MI 48104 (313) 769-3988	Ashton-Tate 10150 West Jefferson Blvd. Culver City, CA 90230 (213) 204-5570
<b>Format</b>	5¼-inch floppy disk	5¼-inch floppy disk	5¼-inch floppy disk
<b>Computer</b>	IBM, Victor, DEC, TI, and other MS-DOS and CP/M-86 compatible computers	Most 8- and 16-bit machines	Most 8- and 16-bit machines
<b>Documentation</b>	301 pages, 5.5 by 8.5 inches, in a 3-ring binder	736 pages, 5.5 by 8.5 inches, in two 3-ring binders	291 pages, 8.5 by 11 inches, in a 3-ring binder
<b>Price</b>	\$595	\$650	\$495

**SORTING (SEC)**

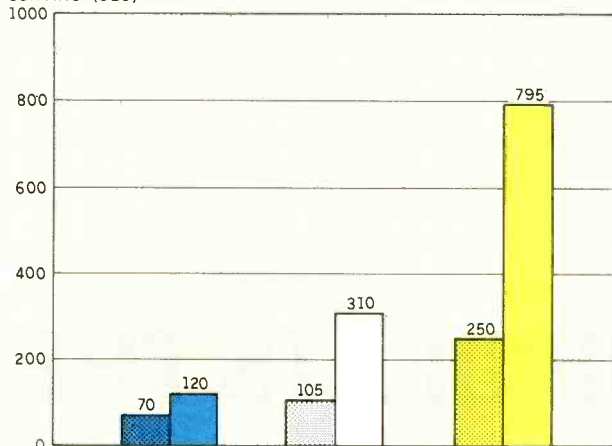

**RECORD SEARCH (NON-INDEXED FIELD) (SEC)**

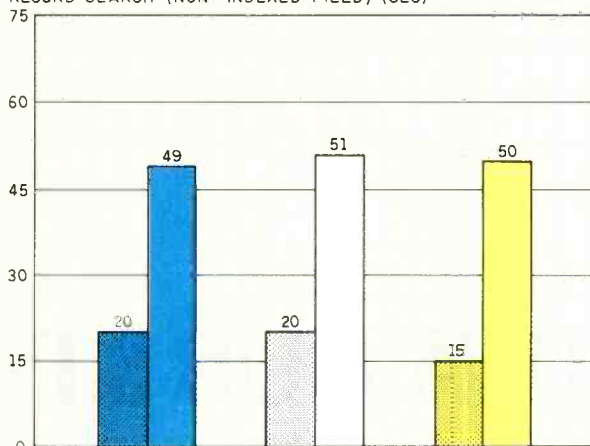

**INDEXING (SEC)**

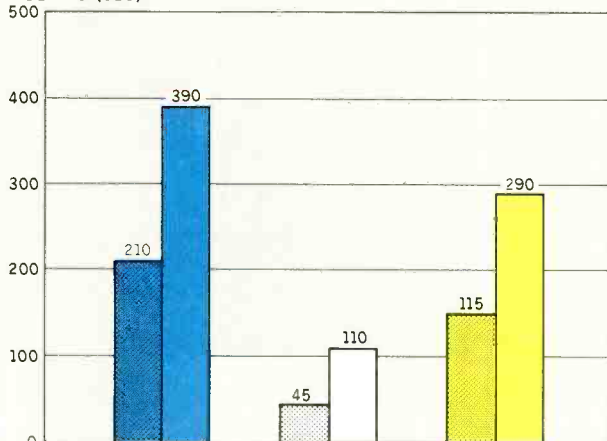

The database for these tests contains 1056 103-character records. Execution times are in seconds. The sort benchmark uses a 5-character key. DataEase sorts occur only when a report is run. The indexing benchmark uses a 4-character key. DataEase indexing occurs only if a new field is indexed or the file is reorganized. It automatically updates indexed fields at the time of record creation or modification. Indexed field record searches were essentially instantaneous for all the programs. However, Condor is limited to one active index key, and dBASE II supports seven active index keys, while DataEase may be indexed by all 255 fields.



*Hard-disk drives afford larger storage capacity and are faster than their floppy-disk relatives.*

the prompt line, enter "HELP (command name)". A brief description of the syntax needed to execute the command will then appear on the screen.

To start a new file, enter the command CREATE, the name of your new file, and the characteristics of each field in the file. Fields may be text strings, numeric, or logical (yes/no). Only 32 fields per record may be defined. Maximum record and field lengths are 1000 and 254 characters, respectively. After the last field is defined, you may immediately begin entering data. Password protection is

not available. Data-entry masks and similar features are possible, but they must be programmed by the user into a dBASE command file.

A utility for preparing custom data-entry screens is included with dBASE. This utility is neither as easy to use nor as powerful as the various DataEase or Condor screen-oriented utilities, but it does help simplify the cumbersome dBASE screen-layout process. Within such a utility, you must program each screen using a series of special commands. Like everything else in dBASE, the difficulty of doing this is totally dependent upon the complexity of your application.

There is an incredible array of dBASE special commands, operators, and functions; it is a database-application generator with packaged routines and a built-in programming language. This capability makes dBASE much more flexible than either Data-

Ease or Condor, which do not have programming-language interfaces. You may design just about any application you want using these features, but this effort may be very time-consuming and difficult. Some of the key dBASE commands are summarized below:

APPEND adds records to a file, from another dBASE application or an external ASCII text file.

BROWSE allows full screen viewing and editing of a file.

CHANGE allows global editing of selected records.

COPY copies file structure and/or records to another database or creates a mail-merge file.

FIND quickly locates records using the index key.

INDEX creates any number of index files. Only one index file may be active

# TWA. OUR 3 PAIR BEATS THEIR



at a time; indexes must be logged on to be used. Only the logged index is automatically updated when records are created or modified; other indexes may be updated using the REINDEX command.

LIST lists to screen or printer records of the file currently in use; unlike Condor, you may specify which records will be listed.

MODIFY COMMAND is a built-in command file text editor of limited capabilities. An external text editor or word processor may be substituted.

MODIFY STRUCTURE changes the structure of the database in use.

REPORT generates reports from the file in use. Report is easy to use but has limited capabilities. Existing reports cannot be modified. It is far less powerful than either the DataEase or Condor report generators. Complex dBASE reports must be written with the built-in programming language.

SELECT switches between the primary and secondary databases. Only two files can be open concurrently in dBASE, in contrast to the multifile capabilities of DataEase.

SORT creates a version of the data file in use that is sorted according to the specifications given in the command line.

STORE inserts data into as many as 64 memory variables. Sets of variables may be saved to disk and recalled as needed.

USE opens a database and closes the one in use. It also opens an index file if specified in the command line.

### EXECUTION SPEED

As might be expected, hard-disk drives not only afford larger storage capacity but are faster than their floppy-disk relatives. A hard disk may be important, if not essential, for applications that have large data files

and require a lot of disk-drive interaction (see graphs on the "At a Glance" page). Contemplate the difficulties of using and sorting a 10,000-record file that is divided into several floppy disks.

DataEase takes advantage of the 512K bytes of memory available in the IBM PC, which accounts in part for its superior sorting performance.

There are some "apples to oranges" comparisons in the benchmark graphs. DataEase does not have separate indexing and sorting operations. You may define as many as 255 index (key) fields in a DataEase file, all of which will be updated automatically each time a record is created or modified. In addition, it is necessary to sort reports only if nonindexed fields or two or more indexed fields are included in an "ORDER BY (sort)" specification.

(continued)

**ONLY TWA'S BUSINESS CLASS  
GUARANTEES 6 SEATS ACROSS TO BOTH  
EUROPE AND THE MIDDLE EAST.**



**MOST AIRLINES HAVE 8.**

For space and comfort across the Atlantic, the smart money's on TWA. Because TWA has 6-across seating on every nonstop from the U.S. to Europe and the Middle East. Most airlines have eight. And every seat is either an aisle seat or window seat, so you'll have more room to work, and more room to relax.

And now you get comfortable 6-across seating on every widebody TWA flies overseas—our L-1011's as well as our 747's. That's because we've folded down the two middle seats and added more legroom in our L-1011's. So now, they're more comfortable than ever.

TWA's Ambassador Class. Just six seats across on every flight to Europe and the Middle East—not eight like most airlines.

Who's your money on?

**You're going to like us**



**FULL HOUSE.**





As expected, the statistics for Condor are very impressive. A Condor application may require numerous sorting or indexing actions.

The poor performance of dBASE on indexing and sorting tests is an anomaly when you consider the overall power of this program. Sorting of large files will require enormous

amounts of time. Fortunately, utilities are available to overcome this and some other deficiencies of dBASE.

**RATINGS**

The comparative overall rating of the three programs is summarized in table 2.

*Ease of Use.* DataEase receives the

highest overall mark. Its menu-dependent design and on-screen help both make development of a fully configured database much less time-consuming. In addition, it is simple to make any kind of modification to your files, and data-entry and record-editing routines are among the best I have used.

Curiously, a simple but usable file may be developed fastest with dBASE. Adding features to your bare-bones database, however, can be quite difficult; these add-ons usually require a significant amount of programming with the dBASE built-in language.

Condor is somewhere between these ease-of-use extremes. Simple databases can be implemented fairly quickly, but procedural file generation can be highly complex.

*Error Detection and Correction.* A DBMS or any other program should be able to spot technical problems (printer off, inadequate disk space, etc.), and resolve them without danger to your data files or abrupt exiting of the program. Each program was able to handle errors without data loss or file damage. However, I was abruptly exited from each program on occasion for sometimes unexplained reasons. With DataEase, for example, I deliberately switched some report-formatting commands (a common error) and then ran the report. The system did not freeze, but I was quickly thrown out of the program with the curious diagnostic "No Core." Ideally, I should have been told of my "mistake" when I attempted to leave the report-formatting function. Barring that, a run-time message should have alerted me to the error and perhaps spirited me back to the report-format function or menu.

*Versatility.* All three programs are versatile and should be capable of handling most business and other database activities easily. The dBASE II built-in programming language clearly gives it the overall edge in versatility, but again, at a price.

*Documentation and Other Help.* The DataEase manual is packaged in a

(continued)

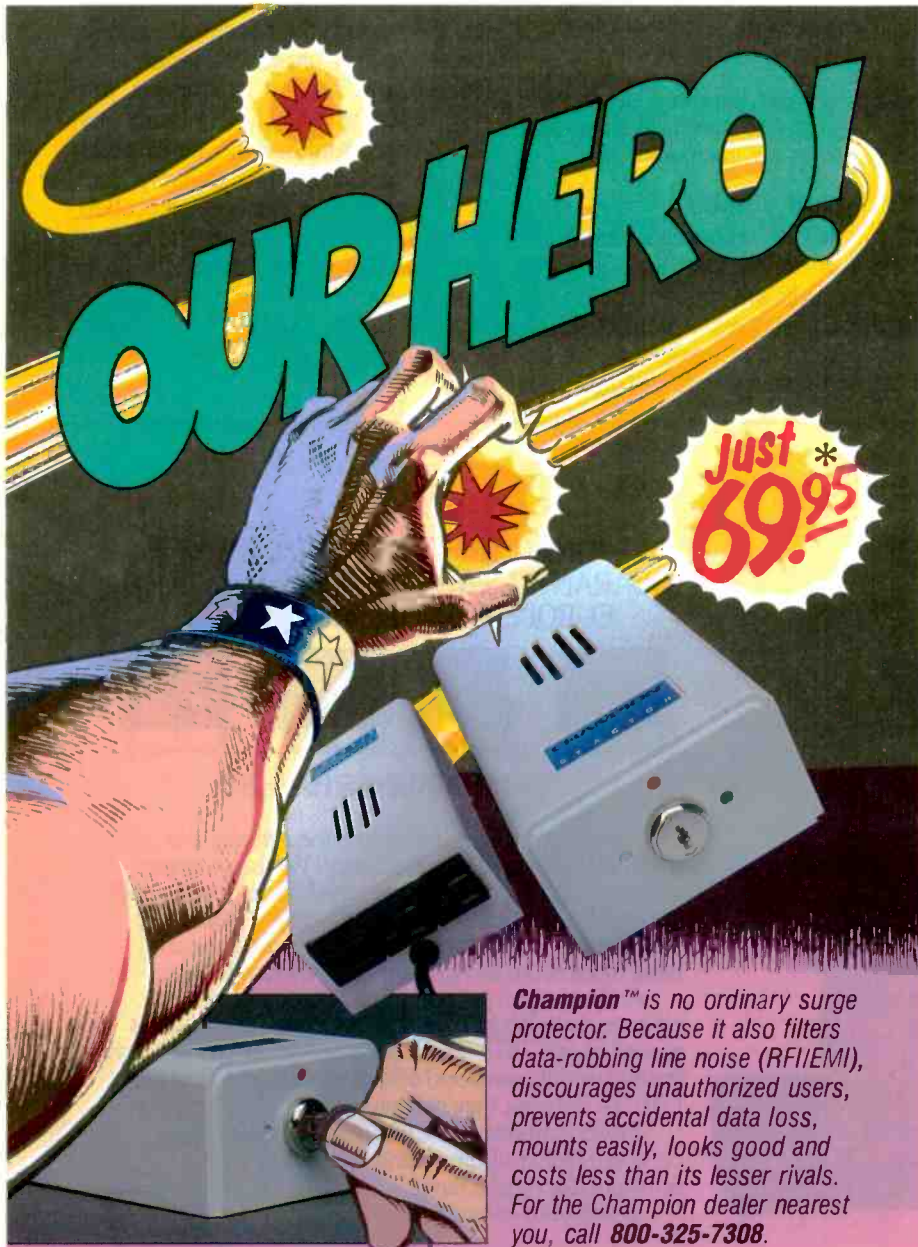

**Champion™** is no ordinary surge protector. Because it also filters data-robbing line noise (RFI/EMI), discourages unauthorized users, prevents accidental data loss, mounts easily, looks good and costs less than its lesser rivals. For the Champion dealer nearest you, call **800-325-7308**.

Key-lock switch activates computer, monitor and extra peripheral; key may be withdrawn in on or off position.

TM

Circle 7 on Inquiry card.

**CHAMPION SURGE PROTECTOR**

By Acton Corporation, 400 Laguna St., Santa Barbara, CA 93101. \*Suggested retail price. In California, call (805)963-3730. Telex 350665. Dealer inquiries welcome.



# Introducing the Most Powerful Business Software Ever!

TRS-80™ (Model I, II, III, or 16) • APPLE™ • IBM™ • OSBORNE™ • CP/M™ • XEROX™



## The VERSABUSINESS™ Series

Each VERSABUSINESS module can be purchased and used independently, or can be linked in any combination to form a complete, coordinated business system.

### VERSARECEIVABLES™ \$99.95

VERSARECEIVABLES™ is a complete menu-driven accounts receivable, invoicing, and monthly statement-generating system. It keeps track of all information related to who owes you or your company money, and can provide automatic billing for past due accounts. VERSARECEIVABLES™ prints all necessary statements, invoices, and summary reports and can be linked with VERSALEDGER II™ and VERSAINVENTORY™.

### VERSAPAYABLES™ \$99.95

VERSAPAYABLES™ is designed to keep track of current and aged payables, keeping you in touch with all information regarding how much money your company owes, and to whom. VERSAPAYABLES™ maintains a complete record on each vendor, prints checks, check registers, vouchers, transaction reports, aged payables reports, vendor reports, and more. With VERSAPAYABLES™, you can even let your computer automatically select which vouchers are to be paid.

### VERSAPAYROLL™ \$99.95

VERSAPAYROLL™ is a powerful and sophisticated, but easy to use payroll system that keeps track of all government-required payroll information. Complete employee records are maintained, and all necessary payroll calculations are performed automatically, with totals displayed on screen for operator approval. A payroll can be run totally, automatically, or the operator can intervene to prevent a check from being printed, or to alter information on it. If desired, totals may be posted to the VERSALEDGER II™ system.

### VERSAINVENTORY™ \$99.95

VERSAINVENTORY™ is a complete inventory control system that gives you instant access to data on any item. VERSAINVENTORY™ keeps track of all information related to what items are in stock, out of stock, on backorder, etc., stores sales and pricing data, alerts you when an item falls below a preset reorder point, and allows you to enter and print invoices directly or to link with the VERSARECEIVABLES™ system. VERSAINVENTORY™ prints all needed inventory listings, reports of items below reorder point, inventory value reports, period and year-to-date sales reports, price lists, inventory checklists, etc.

### VERSALEDGER II™ \$149.95

VERSALEDGER II™ is a complete accounting system that grows as your business grows. VERSALEDGER II™ can be used as a simple personal checkbook register, expanded to a small business bookkeeping system or developed into a large corporate general ledger system **without any additional software.**

- VERSALEDGER II™ gives you almost unlimited storage capacity (300 to 10,000 entries per month, depending on the system),
- stores all check and general ledger information forever,
- prints tractor-feed checks,
- handles multiple checkbooks and general ledgers,
- prints 17 customized accounting reports including check registers, balance sheets, income statements, transaction reports, account listings, etc.

VERSALEDGER II™ comes with a professionally-written 160 page manual designed for first-time users. The VERSALEDGER II™ manual will help you become quickly familiar with VERSALEDGER II™, using complete sample data files supplied on diskette and more than 50 pages of sample printouts.

### SATISFACTION GUARANTEED!

Every VERSABUSINESS™ module is guaranteed to outperform all other competitive systems, and at a fraction of their cost. If you are not satisfied with any VERSABUSINESS™ module, you may return it within 30 days for a refund. Manuals for any VERSABUSINESS™ module may be purchased for \$25 each, credited toward a later purchase of that module.

#### To Order:

**Write or call Toll-free (800) 431-2818**  
(N.Y.S. residents call 914-425-1535)

- \* add \$3 for shipping in UPS areas
- \* add \$4 for C.O.D. or non-UPS areas

- \* add \$5 to CANADA or MEXICO
- \* add proper postage elsewhere



DEALER INQUIRIES WELCOME

All prices and specifications subject to change / Delivery subject to availability.

# COMPUTRONICS

50 N. PASCACK ROAD, SPRING VALLEY, N.Y. 10977



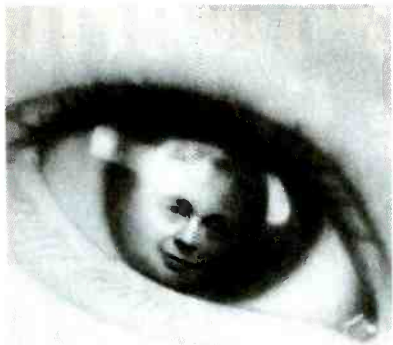

## Be Immortal.

If you could look into the eyes of generations yet to come, you would be there. You can make a difference.

By including the American Cancer Society in your will, you can have a powerful effect on those who come after you.

And leaving a legacy of life for others is a beautiful way of living forever yourself.

**AMERICAN CANCER SOCIETY**

For more information, call your local ACS unit or write to the American Cancer Society, 4 West 35th St., New York, NY 10001.

## REVIEW: DATAEASE

Table 2: Qualitative evaluation of the reviewed programs. See text for details.

Item	DataEase	Condor	dBASE II
Ease of use			
Simple database creation	Good	Good	V. Good
Complex database creation	V. Good	Fair	Poor
Data entry	Excellent	Good	Good
Simple report creation	Good	V. Good	V. Good
Complex report creation	Fair	Fair	Poor
Ad hoc queries	Fair	Good	Good
File layout modification	Excellent	Good	Poor to good
Error detection/correction	Good	Good	Good
Versatility	V. Good	V. Good	Excellent
Documentation	Good	Good	Good

tabbed and indexed loose-leaf binder. Detailed tables of contents appear at the beginnings of the manual and each chapter, and examples of actual screens are sprinkled liberally throughout. Page layouts are uncrowded and attractive. In short, Software Solutions uses the classic techniques of good manual design. For the most part, the DataEase manual achieves its goal of easing new users into a powerful computer program, but certain aspects of DataEase simply take time and experimentation to learn. A case in point is the excellent report-writer function, to which 114 carefully prepared pages are devoted. A fair amount of trial and error is required to become comfortable with it and even more to fully master it.

The Condor and dBASE programs are much more difficult to master, especially dBASE with its intricate programming language and command structure. The Condor and dBASE manuals are slick, professional, and beautifully packaged. Both have excellent quick-reference cards and lots of useful information packed into them. dBASE even offers a disk tutorial with version 2.4. I found that tutorial of marginal value, but a dBASE novice might react differently.

There are several by-products of dBASE's long-term popularity. User groups are available in some areas of the country, and several dBASE-related utility programs are marketed by several software companies. These utilities target some of the deficiencies of the parent program. For example, a sort utility called DBPlus

greatly improves the mediocre performance of the indigenous dBASE sort function: sorting the test file on hard disk took 40 seconds with DBPlus, rather than 250 seconds. Application generation packages are also available to simplify file and data-entry screen preparation. None of these application utilities totally eliminates the hard work of creating a complete dBASE design, but they can help.

### EPILOGUE

As indicated earlier, there are no winners or losers in this review of DataEase, Condor, and dBASE. Each program has its strengths and drawbacks. However, if you are looking for a DBMS program that has excellent interactive and data quality assurance capabilities and is relatively easy to master, DataEase should be considered. I was very impressed with its overall performance and features.

Condor and dBASE require considerably more time and dedication to learn and use. Condor does have good search, sort, index, and command file functions. It also offers a full range of relational features but does not permit interactive lookup or transfer of data among files.

For someone who wants the ultimate in DBMS flexibility, has or wishes to develop good programming skills, and is free to prepare complete applications in a step-by-step manner, dBASE may be a good choice. Database files can be set up quickly. And it is possible to add menus, special processing routines, and performance-enhancing utilities. ■

# A Picture's Worth:

U.S. SHIPMENTS (\$ BILLIONS)

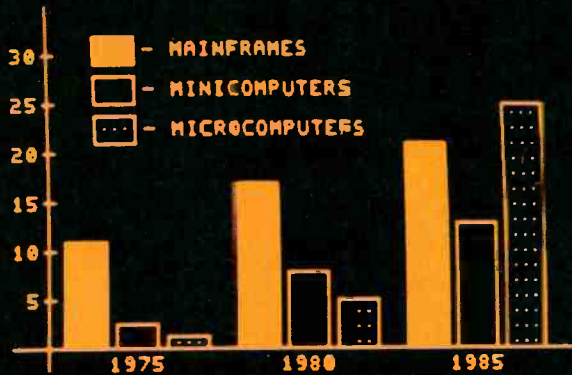

## \*\* GRAPHICS CAPABILITIES \*\*

- ◆ HIGH PERFORMANCE GRAPHICS
- ◆ TEKTRONIX 4010 COMPATIBILITY
- ◆ AUTOMATIC SCALING (1023x1023) WITH 250x512 RESOLUTION
- ◆ ALPHA MODE (35 LINES x 73 COLS)
- ◆ OPTIONAL JOYSTICK
- ◆ CONNECTION TO LOW COST PRINTER FOR GRAPHICS HARDCOPY
- ◆ ASCII AND APL CHARACTER SETS
- ◆ BLOCK FILL, DOTTED/DASHED LINES

## \*\* DISPLAY TERMINAL CAPABILITIES \*\*

- ◆ ANSI STANDARD CONFORMANCE
- ◆ DEC SOFTWARE COMPATIBILITY
- ◆ 80/132 COLUMNS, WINDOWING
- ◆ 4 PAGES OF MEMORY STANDARD (UP TO 8)
- ◆ 46 PROGRAMMABLE FUNCTIONS
- ◆ ASCII AND APL MODELS
- ◆ COMPACT ULTRA-THIN KEYBOARD
- ◆ HIGH RESOLUTION AMBER PHOSPHOR
- ◆ SETUP MODE



# \$1895\*

## CONCEPT GVT+™ Graphics Display Terminal

\*Quantity one, end user price; substantial discounts available.

human  
designed  
systems,  
inc.

Whether used in video display mode or in its high-performance graphics mode, Human Designed Systems' GVT+™ Graphics Display Terminal offers more user friendliness, more design features, and more advanced functionality to optimize productivity — and encourage creativity — for the terminal operator, interactive user, and applications developer than any other terminal available today.

Atlanta — (404) 391-9763; Boston — (617) 449-5446; Chicago — (312) 825-2960; Dallas — (214) 437-1888; Delaware — Infocon: (302) 239-2942; Denver — (303) 469-1953; Detroit — (313) 434-2729; Hawaii — Gray Associates: (808) 261-3751; Houston — (713) 952-1403; Los Angeles — (213) 410-9454; Northern New Jersey — Infocon: (201) 624-1372; New York City Area — Infocon: (212) 689-8833; New York State — Nanco Electronics: Rochester: (716) 223-4490; Syracuse: (315) 699-2651; San Francisco — (415) 692-4184; Washington, DC — International Systems Marketing: (301) 279-5775; Argentina — Itron SA: (01) 774-9369; Australia — Computer Clarity Pty. Ltd.: (02) 241 3385; Belgium — BELCOMP 091-31 52 22; Canada — CAIL Systems: Toronto: (416) 362-1063; Denmark — ADCOM Data Aps. 1-19 44 66; Finland — Valtamatic Oy: 0-742 011; France — Walton: (1) 226.06.90; Japan — Ampere: 03 (365) 0825; Portugal — Soc. Com. Crocker, Dellacerce Co. Ltd.: 1-6801 41; Singapore — ETS Singapore: 33-88-566; South Africa — Psittec (Pty.) Ltd.: (11) 836-9181; Switzerland — Mitek ag: 01/461 22 52; United Kingdom — Shandell Systems Ltd.: 2407-2027; Venezuela — H. Blohm SA: 2 541.21 22; West Germany — COMKO Computersystemges, mbH: 221-48 30 51. INTERNATIONAL DISTRIBUTORSHIP INQUIRIES INVITED.

Circle 163 on inquiry card.



# THE REAL TRICK IS GETTING OUT.



Expect the unexpected the first time you experience Infocom's interactive fiction. Because you won't be booting up a computer game. You'll be stepping into a story.

You'll find yourself at the center of an exciting world that continually challenges you with surprising twists, unique characters (many of whom possess extraordinarily developed personalities) and original, logical, often hilarious puzzles.



Communication is carried on just as it is in a book—in prose. And interaction is easy—you type in full English sentences.

But if you think getting inside a story is a pretty neat trick, just try getting out.

The most remarkable thing about Infocom's interactive fiction is that you become almost inextricably involved with it. That's not our opinion—it's the testimony of our customers. They tell us their pulse rates have skyrocketed and their palms have sweated as they've striven to solve the mysteries of our tales. And even when they've paused in the course of their adventures to attend to their everyday lives, their minds have continued to

churn away at what the next step should be, how to alter strategy, where the ultimate solution lies.

Obsessions? Yes, but magnificent ones. For the first time, you can be more than a passive reader—you can become the story's main character and driving force. You can shape its course of events by what you choose to do. And you enjoy enormous freedom in your choice of actions—you have



hundreds, even thousands of alternatives at every step. In fact, an Infocom interactive story is roughly the length of a short novel in content, but because you take an active role in the plot, your adventure can last for weeks and months. (Or longer. Frankly, some folks find being inside our stories so fascinating, they just don't seem to want to get out.)

As hard as getting out may be, though, we've made it easy for everyone to get into Infocom's interactive fiction.

We write everything from fantasy to mystery to science fiction to high adventure, for everyone from the first-time adventurer to the most experienced veteran of our interactive stories.

So find out what it's like to get inside a story. Get one from Infocom. Because with Infocom's interactive fiction, there's room for you on every disk.

**Ease into interactive fiction with our Can't-Lose Sampler Offer!** Watch for Infocom's new sampler disk at your favorite dealer—and get your first taste of interactive fiction for just \$7.95 (suggested retail price). You've got nothing to lose (in fact, you can make a shiny new nickel in the bargain) because your Infocom sampler disk even comes

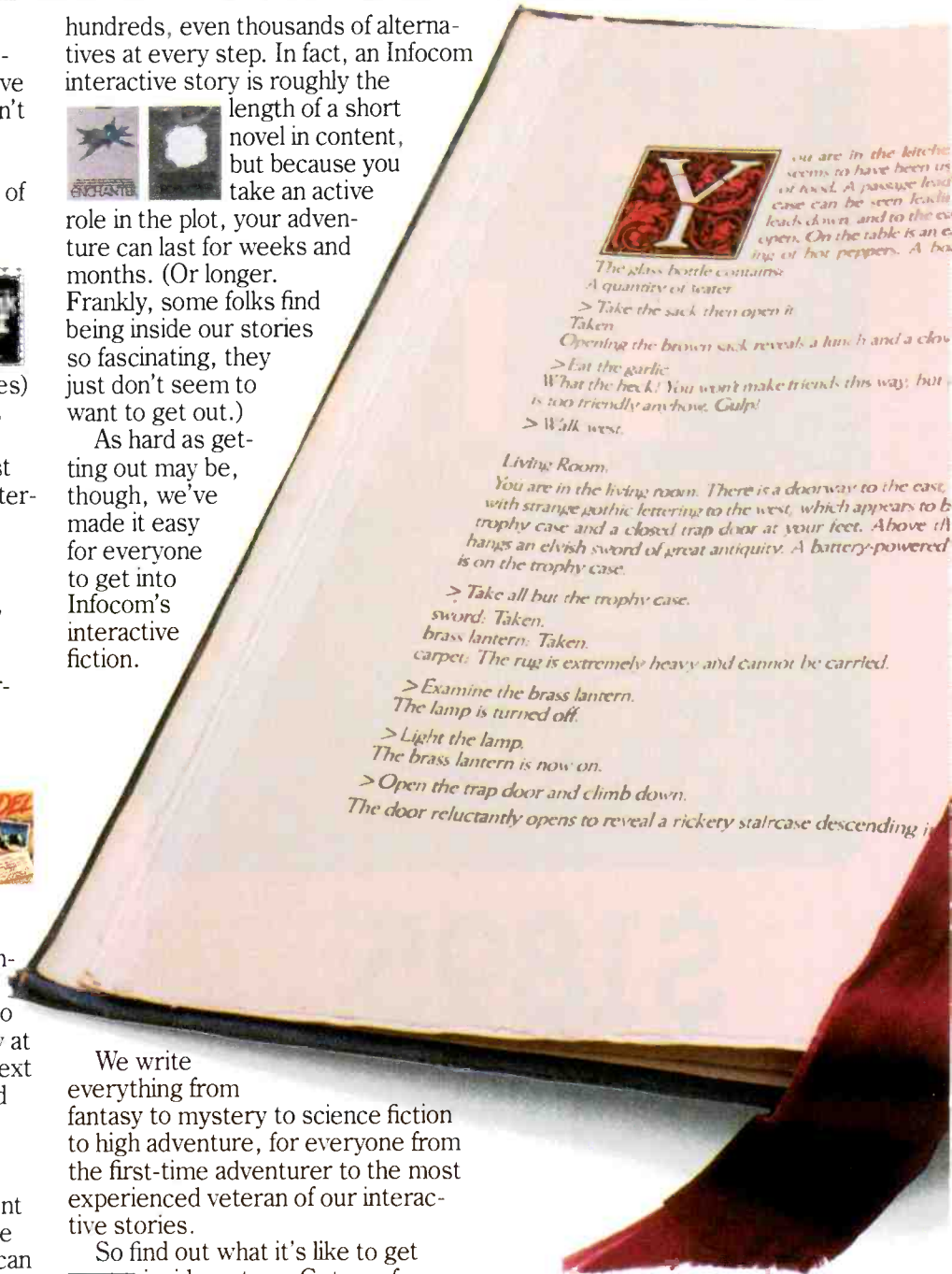

with a coupon entitling you to \$8 off the purchase of your first complete Infocom story, plus coupons for other exciting bonuses!

## INFOCOM™

55 Wheeler St., Cambridge, MA 02138  
For your: Apple II, Macintosh, Atari, Commodore 64, CP/M 8", DECmate, DEC Rainbow, DEC RT-11, HP 150 & 110, IBM PC\* & PCjr, KAYPRO II, MS-DOS 2.0\*, NEC APC, NEC PC-8000, Osborne, TRS-80 Color Computer, Tandy 2000, TI Professional, TI 99/4A, TRS-80 Models I & III.

\*Use the IBM PC version for your Compaq and the MS-DOS 2.0 version for your Wang, Mindset, Data General System 10, GRiD and many others.

the white house. A table  
only for the preparation  
of the west, and a dark stair-  
ward. A dark chimney  
small window which is  
of brown sack, smell-  
string on the table.

dic.

around here

den door  
d shut, a  
by case  
lantern





# R·E·V·I·E·W F·E·E·D·B·A·C·K

## LISP SLIPS

.....  
The LISP article (July, page 281) does not appear to have been reviewed before publication. These corrections cover only its first page.

MACSYMA's field is algebra, not calculus.

Eliza was not written in LISP. It was written in FORTRAN using the SLIP package of list-processing subroutines. The FORTRAN portions of Eliza and SLIP were later translated into MAD, and the MAD version was the one most widely demonstrated. There have been numerous reimplementations.

MYCIN is more therapist than diagnostician.

LISP was not developed from IPL. The IPL list-processing languages were developed at Carnegie Tech with minimal logical underpinning. They had the flavor of assembly languages for stack machines. LISP was developed around the same time, implementing theoretical ideas that McCarthy had developed at Massachusetts Institute of Technology.

The original LISP implementation was on the IBM 704, not the 7040. The 7040 designation was used for a solid-state version of the 704 that never caught on.

CDR stood for contents of decrement register, not data register.

ROBERT R. FENICHEL  
Phoenix, AZ

Your review of LISP for the IBM PC contains several misconceptions. Particularly aggravating is the sentence: "They [CAR and CDR] originally stood for Contents of Address Register and Contents of Data Register, respectively, on the IBM 7040." Sigh. On page 13 of *Anatomy of LISP* (published in 1978), I wrote: "These names [CAR and CDR] are hold-overs from the original implementation of LISP on the IBM 704. That machine had partial-word instructions to reference the address and decrement parts of a machine location. The "a" of CAR comes from "address," the "d" of CDR comes from "decrement." The "c" and "r" come from "contents of" and "register." Thus car could be read "contents of address part of register."

So the a and d do not refer to registers

and the d does not refer to data.

Furthermore, though I did implement LISP 1.5 on a 7040, that project occurred several years after LISP was installed on the 704, and that was over 20 years ago. But the LISP (both the language and the style) described in the review is also 20 years old. A modern LISP is also a general-purpose programming language (with first-class objects) and an object-oriented language (with classes or flavors). Its functional heritage has also re-emerged with more attention to functional objects. It really seems time to get the facts straight and get on with it.

JOHN R. ALLEN  
The LISP Company  
Los Gatos, CA

## TURBO PASCAL

.....  
I enjoyed Tom Wadlow's review of Turbo Pascal (July, page 267). I have been using the compiler for about two months and agree that it is an outstanding product at a reasonable price.

I want to point out two potentially misleading items in the review. Mr. Wadlow states that Turbo Pascal has "no built-in way of converting integers to reals." This is false. As in any Jensen and Wirth (J&W) Pascal implementation, if R is declared a real variable and E is an integer expression, the assignment statement R:=E is valid. Similarly, an integer expression can be used as the argument for a real parameter in a function or procedure (see page 21 of Jensen and Wirth's *User Manual and Report*).

The review also claims that, in J&W Pascal, the statement WRITELN(OUTPUT, FOO) is legal when FOO is a variable of an enumerated type. This might be allowed in some extensions of Pascal, but it is definitely illegal in J&W Pascal and the ISO Standard (see J&W, page 86, or Doug Cooper's *Standard Pascal User Reference Manual*, page 118).

MICHAEL MAIN  
Boulder, CO

A GOTO upon you for every potential or neophyte Pascal programmer you have discouraged by publishing Tom Wadlow's review of Turbo Pascal. Suggesting that

Turbo versus BASIC is the real comparison and Turbo is not really Pascal in the midst of benchmark programs at which Turbo excelled is folly.

The test program referenced to J&W generates a compile error in Turbo as it will in any other compiler that conforms to Jensen and Wirth or ISO standards. FLOAT is not a standard function or procedure, so it should not have been mentioned as missing in Turbo Pascal.

Having used Turbo Pascal exclusively for a course on data structures and algorithms, I feel that the dominance of Turbo as a structured programming learning tool on small systems makes it more deserving of a Robert Tinney cover than the patronizing review it received.

BOB JOHNSON  
Boulder, CO

The Turbo Pascal review was mostly factual, but I should point out one inaccuracy and one oversight.

First, contrary to your reviewer's statement, the short example program on page 269 is not acceptable in standard Jensen and Wirth Pascal; there is no provision in the language for input or output of user-enumerated data types from text files. See J&W, pages 84-86, where it is made clear that only data of types integer, real, and char can be read from a text file, and only data of types real, integer, char, or Boolean can be written. Almost all existing Pascal compilers will reject the test program.

Second, although it is true that Turbo has no method of building libraries of compiled procedures (page 272 of your review), it is quite easy to build your library routines in Pascal source text form, bringing these source files into an application program using the "include" compiler directive. This requires compiling the library files along with the program that uses them; because Turbo compiles so fast and links as it goes, this method gives you all the facility of a compiled library without a time-consuming link step.

RICHARD H. BALAY  
Denver, CO

I have a couple of notes on Tom Wadlow's  
(continued)



## COMPAQ PRESENTS

# How To Do More With Less

It used to be that when you wanted personal computers to do more, you added peripherals. A fixed disk for storage. A second monitor for graphics. A backup system for data protection. And slowly the octopus devoured your desk.

But now everything you wanted in a personal computer is *in* a computer. The new COMPAQ DESKPRO™ is here.

There's room *inside* for up to four storage devices. For instance, you could insert two diskette drives, a 10-megabyte fixed disk drive, even an exclusive tape backup system. The new COMPAQ DESKPRO can grow *inside* instead of *out*, saving your desktop.

Plus internal expansion slots will let you add even more functions like local area networking. A mouse. And more.

All that makes COMPAQ DESKPRO the most expandable PC you can buy. And thanks to some ingenious engineering, the COMPAQ DESKPRO displays high-resolution text *and* graphics on one monitor, not two.

It also runs thousands of business programs made for the IBM® PC and XT straight off the shelf—a full two to three times faster than older, slower computers.

So you can run the most complex software this side of mainframes quicker than you can say, “1-2-3.”

We designed the new COMPAQ DESKPRO around the same philosophy that made us the best-selling portable business computer in the world. We simply offer more in less space. For a free brochure or the location of your nearest Authorized COMPAQ Dealer, call toll-free 1-800-231-0900.



It simply works better

**COMPAQ**  
**DESKPRO™**



## REVIEW FEEDBACK

Turbo Pascal review. First, the ELSE clause in the CASE statement need not be preceded by a semicolon, and it can contain a BEGIN...END block. The example in the Turbo manual could just as well have read:

```
case Year of
  Min..1939: begin
    Time := PreWorldWar2;
    write('The world at peace');
  end;
  1946..max: begin
    Time := PostWorldWar2;
    write('Building new world');
  end
else begin
  Time := WorldWar2;
  writeln('We are at war');
end; {else}
end; {case}
```

The fault is not in the compiler (unless tolerance is a fault), but in the documentation, which fails to point out that the more Pascal-like syntax is available. Probably many users have noticed that when they are not looking at the manual they substitute the more sensible construction without much thought.

Also, Mr. Wadlow says that Turbo's typed constant produces a "read only" variable. If he means what I think he means, he is wrong. The manual calls it an "initialized variable"; you *can* assign values to it. You can use typed constants not only to save space but also to avoid the necessity of declaring variables in one spot and assigning initial values to them in another; then you can assign new values to them at run time.

**PETER S. BAKER**  
*Atlanta, GA*

We use Pascal for program development. We have found that we can move our applications to many different systems. News of new Pascal compilers is particularly important to us, so your review of Turbo Pascal was most welcome. Unfortunately, Mr. Wadlow missed using the most important tools for evaluating a Pascal implementation and thus presented an incomplete and inaccurate review.

The British Standards Institution (with the American National Standards Institute's support) has developed sophisticated, easy-to-use tools for testing Pascal systems. These include the Pascal Validation Suite (734 test programs) and the Standard Pascal Model implementation (a complete and valid compiler and interpreter). All serious developers of Pascal systems use these tools.

We would be glad to provide any reader with detailed information on BSI's Pascal compiler validation services. Send a stamped, self-addressed envelope to the address below.

**RICHARD J. CICHELLI**  
*Software Consulting Services*  
*Technology Center 125*  
*Lehigh University*  
*Bethlehem, PA 18015*

In his Turbo Pascal review, Tom Wadlow is right about the violation of Pascal grammar in the CASE statement default (ELSE without a BEGIN...END for multiple line block—the other clauses certainly require this).

On the other hand, he is wrong about typed constants. These are in-line static variables, similar to those in C (they can be used as local variables to carry values between subsequent calls of a procedure or function, and they have the advantage of maintaining locality of the variable). Assignments to these "constants" is possible, and the manual confirms this. Calling these variables constants is a far greater violation of the spirit of Pascal than the CASE...ELSE grammatical complaint; a constant should, after all, be constant. This style of variables is useful, but it should be provided as a class of variable.

The author contends that Turbo Pascal has no built-in FLOAT function. In fact, INT will accept an integer value and convert it to floating point (quite unlike BASIC where INT returns an integer value). The documentation on the INT function mentions that it accepts both integer and real values and returns a real value. I don't have a copy of Jensen and Wirth to check this against, so it might be quite proper although it feels incorrect.

The new version of Turbo Pascal (2.0) includes standard heap management (DISPOSE, NEW) and simple overlays. The author is not at fault here, but I feel this should be mentioned. A more serious omission occurs when the reviewer fails to emphasize the degree of upward compatibility between the 8- and 16-bit versions.

I have noticed one obscure problem in Turbo Pascal when I want to compile to disk and specify the starting address for the compiler code. The .COM file generated includes all the unused memory, so even a short program that starts in high memory can become huge. My only other complaint is that the Turbo menu does not provide any method for eliminating unwanted files.

As a final note of interest, Turbo Pascal

lets the programmer change the value of a loop index variable, but this does not affect the number of times that the loop executes (apparently Turbo uses an anonymous loop index to count repetitions and performs operations on the named index variable separately).

**ALLAN R. MCCOY**  
*Lafayette, IN*

Regarding your review of Turbo Pascal and your reviews of compilers generally, I would like to make a request. Please include in the review the precision of mathematical calculation that the compiler supports in its library functions and how extensive those library functions are for mathematical purposes. Also, it would be nice to see more in-depth review of the characteristics of the I/O library.

If you don't know how precise the mathematical capability is or the idiosyncrasies of the I/O, you might find that while adequate and inexpensive for general purposes, the compiler cannot satisfactorily perform specific applications—perhaps the reason you are buying the program.

**DONALD B. SLAUGHTER**  
*Seattle, WA*

### ELUSIVE 80187

.....  
You recently carried a product description of the Tandy Model 2000 MS-DOS micro-computer (March, page 306). In this article, Rich Malloy referred to a new product called the Intel "80187 floating-point numeric processor." We have received several inquiries about this chip.

In fact, our current production part, the 8087 Numeric Data Coprocessor, works with the entire 8086 family of microprocessors: the 8086, 8088, 80186, and 80188.

To use the 8087 coprocessor with an 80186 or 80188, the designer would use the 82188 Integrated Bus Controller (IBC). Literature on the IBC is available through Intel's Literature Department, 3065 Bowers Ave., Santa Clara, CA 95051, order #231051-001.

**LYNN MCLEOD**  
*Intel Corporation*  
*Santa Clara, CA*

### ATARI IN BUSINESS

.....  
We would like to provide an update on our review of the ATR8000 disk interface for the Atari 800 (December 1983, page 329).

In January of 1984 (well after we wrote the article), new regulations from the FCC

(continued)

# Now there's smart software™ for the Macintosh.

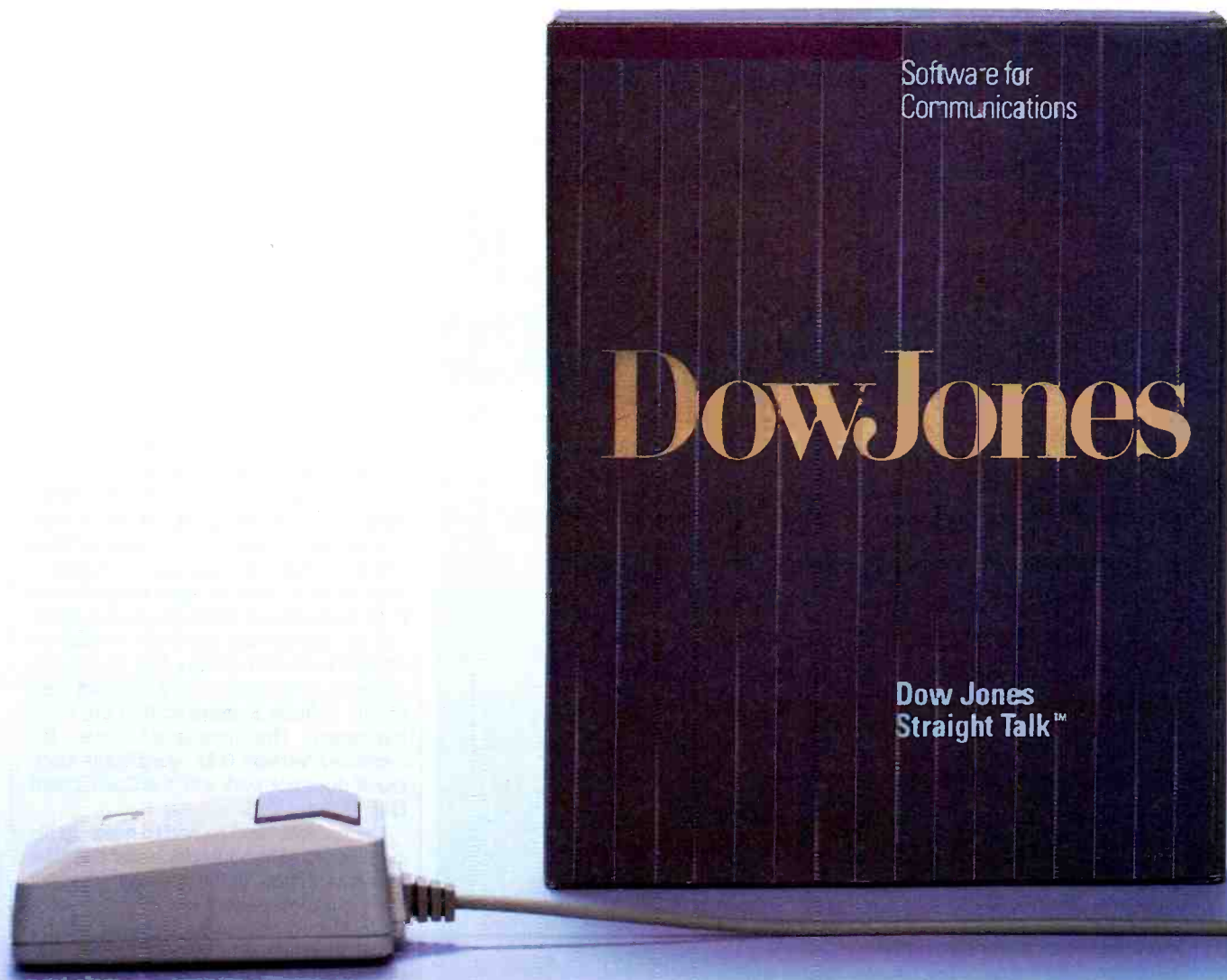

## Introducing Dow Jones Straight Talk™

Think of it. Now there's software as smart as the Apple® Macintosh™ computer itself. Dow Jones Straight Talk™ offers you all the facts in Dow Jones News/Retrieval® and the other

leading information services. With Straight Talk, you get the exact information you want, when you want it, to get the job done.



# Get an "A" on your Paper.

It's one o'clock in the morning. Your term paper on the American Revolution is due at 8 a.m. Where was the misnamed Battle of Bunker Hill really fought? It could be the difference between an "A" and a "B".

**Now there's smart software™ for the Macintosh™ computer.**

With Straight Talk, the smart software from Dow Jones, you can use an electronic encyclopedia to find the historical fact you need. Even if it's the fact that on June 17, 1776 the Battle of Bunker Hill was fought on Breed's Hill.

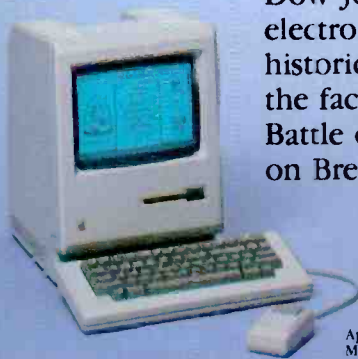

**Dow Jones  
Straight Talk™**

Apple is a registered trademark of Apple Computer, Inc. Macintosh is a trademark licensed to Apple Computer, Inc.

# Get that Big Promotion.

In half an hour, your boss is due to finalize a merger with a company you have doubts about. His career rides on this deal. How can you change his mind before it's too late?

**Now there's smart software™ for the Macintosh™ computer.**

With Straight Talk, the smart software from Dow Jones, you can get the lowdown on a company without ever leaving your office. You might even discover a revealing fact that saves your boss's job and earns you a new one.

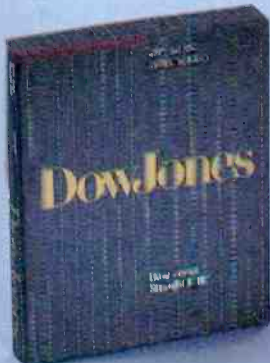

**Dow Jones  
Straight Talk™**

Apple is a registered trademark of Apple Computer, Inc. Macintosh is a trademark licensed to Apple Computer, Inc.

went into effect concerning RF (radio frequency) emissions from home computing equipment such as the ATR8000. Because of the many cables that act as transmitting antennas when hooked up to the ATR8000, it could not pass the requirements for a home computer but could pass the requirements for a business computer. Hence the ATR8000 is now being sold as a business computer with 64K bytes of memory, and the manufacturer is not allowed to manufacture and sell the home version that has only 16K bytes of memory. The manufacturer can, however, sell units already manufactured.

Many dealers still stock the 16K version, particularly mail-order houses.

DAVID AND SANDY SMALL  
Austin, TX

## MODULA-2

On behalf of Volition Systems, I'd like to thank BYTE for publishing the review of our Modula-2 (June, page 353). Eric Eldred deserves credit for his thoroughness in testing the software; however, many of the problems he encountered were due to his not reading the documentation.

The reviewer said that there is no overall summary of the manual. In the seven-page introduction is a section (on page 4) titled "How to Use This Manual." It explains what order to read the remaining sections in to avoid the problems he encountered.

If Mr. Eldred had read the installation notes, he would not have had to ruin the contents of his Corvus hard disk and then phone Volition Systems to find out what happened. The installation notes for Modula-2 version 0.3K specifically state that it does not work with the Corvus hard disk.

The reviewer said he had to make up his own list of intermodule dependencies. The implementation guide already contains such a list on page 23.

Mr. Eldred claims that Niklaus Wirth's book (*Programming in Modula-2*) states that the module LineDrawing should be included in every Modula-2 implementation. This is not true; Wirth makes it clear (on page 113) that this module is only a suggestion—not a standard.

Other than these problems, the reviewer was generally on the mark. The BYTE benchmark results were apparently switched; the execution time with range checking off is 322 seconds, not 375. Also, Volition Systems' Modula-2 programs are portable at the source level but not at the code level.

The long integer problem described in

## REVIEW FEEDBACK

the review is fixed on our current Modula-2 release (0.3n). Right now we are working on a new release that fixes the Corvus hard-disk problem and uses the full 128K bytes of memory available in Apple Pascal 1.2.

RICHARD GLEAVES  
Volition Systems  
Del Mar, CA

## WANG UPDATE

I read my letter (June, page 378) regarding the Wang Professional Computer with mixed feelings. I know it takes some time for a letter (or an article) to be published, but my letter was so dated that much of the information isn't correct.

But more important is an error I made. I referred to Wang's PC Database software rather negatively; at the time, Wang had not released the software for sale.

Recently support has improved in my area: I have located people who can provide pre-sales support and answer other questions. The people manning the PC Hotline are catching up. Although there is some delay in making contact with a representative (anywhere from three minutes to a day), once you make contact you will most likely get your answer during the same conversation.

In my letter I also complained that extras ordered with a computer had to be installed by the user. The company I work for has received two more machines since; the expansion cards and second drive were installed in both machines.

It has become much easier to use a non-Wang printer. The system software shipping with PCs now is version 1.22; among other nice features it includes a printer support menu. This menu has selections to let you fill in tables to create a printer driver. Tedious labor is involved and you need the printer's manual, but the ability to write a printer driver for most serial and parallel printers should be fully appreciated. This system software is also available as an upgrade for \$100 (part number UJ3199).

KANDACE L. MYERS  
Mechanicsburg, PA ■

REVIEW FEEDBACK is a new column of readers' letters. We welcome responses that support or challenge BYTE reviews. Send letters to Review Feedback, BYTE Publications, POB 372, Hancock, NH 03449. Name and address must be on all letters.

# Get a Summer House.

The stock market's about to close. That stock you bought has leveled off, and price patterns indicate that the bottom could drop out at any time. You should act before trading ends today.

## Now there's smart software™ for the Macintosh™ computer.

With Straight Talk, the smart software from Dow Jones, you can get current stock prices right on your desk. Maybe even a selling price that will allow you to buy the vacation property you've always wanted.



**Dow Jones  
Straight Talk™**

Apple is a registered trademark of Apple Computer, Inc. Macintosh is a trademark licensed to Apple Computer, Inc.

## Play it Smart.

Play the Information Game™  
and get \$60 off Dow Jones  
Straight Talk™ and Apple® Modem 1200.

Play the Information Game at your authorized Apple® dealer. Answer five questions on the Macintosh™ computer using Straight Talk. Show us how smart you are.

Play the Information Game and buy Straight Talk and we'll give you \$10 off Straight Talk and \$50 off Apple Modem 1200\*. It's a deal smart people can appreciate. One that will make you a winner — whatever your information game.



**Dow Jones  
Straight Talk™**

For a free brochure on Dow Jones Straight Talk, call: 1-800-345-8500 ext. 272 (Alaska, Hawaii and foreign, call 1-215-789-7008)

\*Rebated from Dow Jones and Apple with proof of purchase while supplies last.

Apple is a registered trademark of Apple Computer, Inc. Macintosh is a trademark licensed to Apple Computer, Inc.



*C Is The Language.  
Lifeboat Is The Source.*

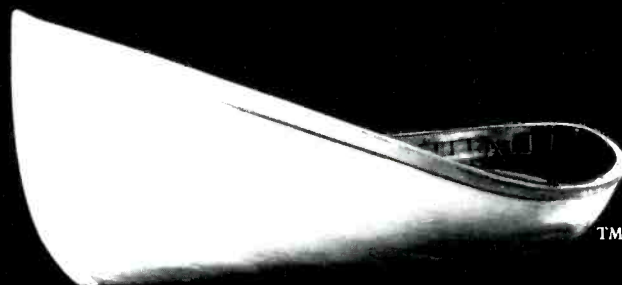

*Lifeboat.<sup>TM</sup>  
The Leading Source And Authority For Serious Software.  
1-800-847-7078.*

*In NY State: 212-860-0300*

# Serious Software For The C Programmer From Lifeboat.™

**Lattice® C Compiler:** *The serious software developer's first choice.*

Selected for use by IBM,® Texas Instruments, Wang,® MicroPro,® Ashton-Tate,™ IUS/Sorcim,® Microsoft® and Lotus™ to name a few of the many. Why?

Lattice C is clearly the finest 16 bit C compiler available today.

- Renowned for speed and code quality.
- Fully compatible with the C standards set forth by Kernighan and Ritchie.
- Four memory model options offer you unsurpassed control and versatility.
- Superior quality documentation.
- Now includes automatic sensing and use of the 8087 chip.
- Widest selection of supporting add-on packages.

**Halo™:** *A graphics development package rapidly emerging as the industry standard.*

- 140 graphics commands including plot, line, arc, box circle and ellipse primitives, bar and pie charts; pattern fill and dithering commands.
- New: multiple viewports and “stroke text” for angling, scaling and filling text.

**C Food Smorgasbord™:** *This beautifully written collection of C functions is a valuable time saver.*

- Library includes a binary coded decimal arithmetic package, level 0 I/O functions, a terminal independence package, IBM PC ROM BIOS access functions and much more.

**Pmate™:** *The premier editor for the programming professional.*

Pmate is a full screen editor with its own powerful macro command language:

- Perform on screen row and column arithmetic, alphabetize lists, translate code from one language to another, call up other macros.
- Customize Pmate almost any way you like.
- Contains 10 auxiliary buffers for storage of macros, text, subroutines.
- An “undo” feature allows the programmer to retrieve whole series of deleted items.

## Additional C Tools

Available From Lifeboat:

Panel™: Screen formatter and data entry aid.

Lattice Windows™: Windowing utility; create “Virtual Screens.”

Plink-86™: The popular linker; includes extensive overlay capabilities.

Pfix86™: Dynamic debugging utility.

Pfix86 Plus™: Symbolic debugger with capacity to debug overlays.

Btrieve™: Database record access/retrieval library.

Phact: Multikeyed ISAM C-Function library.

Fabs: Fast access B-tree database function library.

Autosort: Fast sort/merge utility.

ES/P: ‘C’ program entry with automatic syntax checking and formatting.

Greenleaf Functions™: Library of over 200 popular C functions.

And much more.

YES! Please rush me the latest FREE Lifeboat™ catalog of C products.

Company  
Name \_\_\_\_\_

Business  
Phone \_\_\_\_\_

Name \_\_\_\_\_

Title \_\_\_\_\_

Address \_\_\_\_\_

City \_\_\_\_\_

State \_\_\_\_\_

Zip \_\_\_\_\_

Please check the category where Lifeboat can best help you:

Software development

Corporate

Education

Dealer/distributor

Government

Other \_\_\_\_\_

Call Direct: 1-800-847-7078 (In NY State: 212-860-0300)

Return coupon to: Lifeboat Associates™  
1651 Third Avenue, New York, NY 10128.

Catalog 8 1984  
C Programming Tools

Lifeboat

™



# The best of both worlds

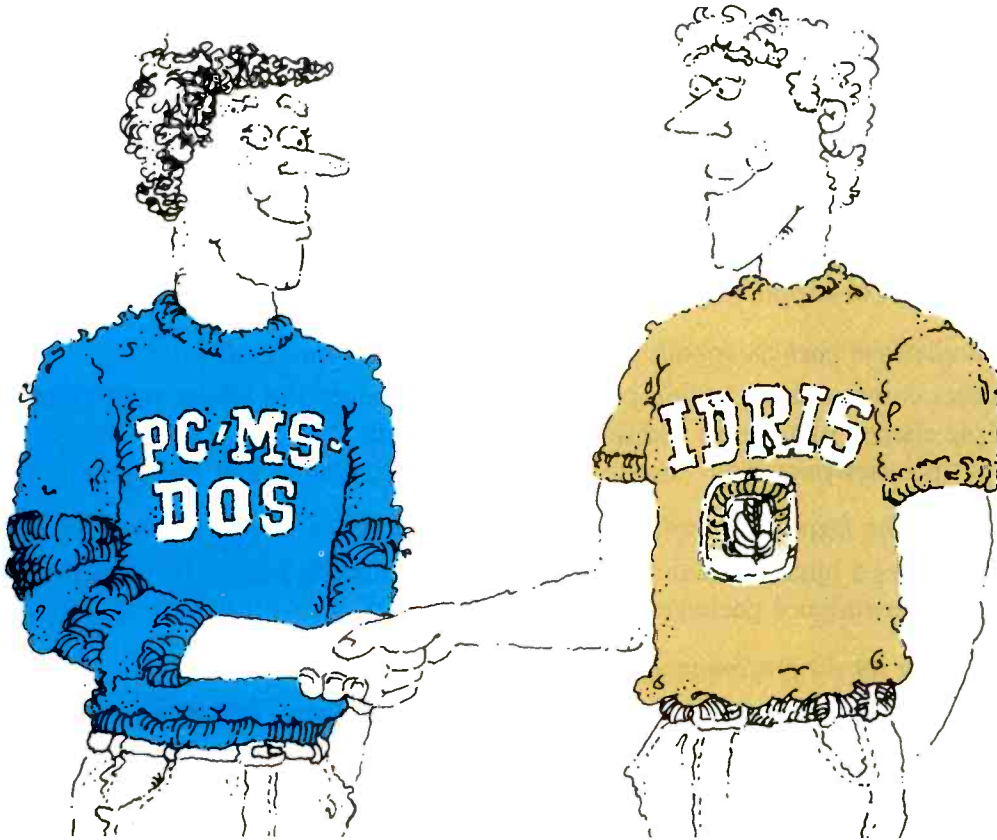

Now, software developers can expand their markets and increase their productivity with Co-Idris™, the newest UNIX-like operating system from Whitesmiths, Ltd.

Co-Idris is a professional, sophisticated tool enabling users to develop programs in a powerful and flexible UNIX-like environment, then easily port these applications to a wide range of PC/MS-DOS machines, including the IBM PC, DEC Rainbow, Wang PC, DG Desktop, and Olympia PC. With the Co-Idris package, you can construct C, Pascal, or assembler programs for operation under Co-Idris, DOS or CP/M-86.

Able to work in as little as 128 KB of total main memory, Co-Idris allows **concurrent** access to both Idris-based programs and PC- or MS-DOS based application programs. You get the multi-user, multi-tasking features of a UNIX environment as well as the rich selection of DOS applications. And there is no need to reboot DOS, ever.

Co-Idris works on most all PC/MS-DOS based configurations with hard disks, and it's **available now!**

Dealer inquiries invited.



## Whitesmiths, Ltd.

97 Lowell Road Concord, MA 01742 (617) 369-8499  
TLX 750246 SOFTWARE CNCM

See us at  
**COMDEX™ / Fall '84**  
Booth # H 8740

DISTRIBUTORS: Australia, Fawnray Pty. Ltd., Hurstville, (612) 570-6100; Japan, Advanced Data Controls Corp., Chiyoda-ku, Tokyo (03) 263-0383; United Kingdom, Real Time Systems, Douglas, Isle of Man 0624-26021; Sweden, Unisoft A. B., Goteborg, 31-125810. Rainbow is a trademark of Digital Equipment Corp. UNIX is a trademark of Bell Laboratories; MS-DOS is a trademark of Microsoft Corp. PC-DOS is a trademark of International Business Machines Corporation. Idris is a trademark of Whitesmiths, Ltd.

# Kernel

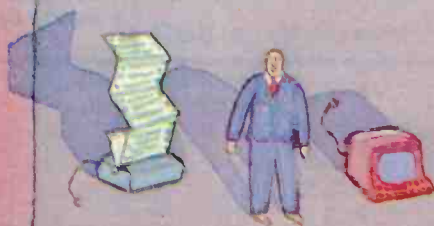

DESPITE STRUGGLING TO FINISH his new novel, Jerry Pournelle found time this month to report on a variety of new hardware and software, highlighted by the Macrotech MI-286 board, Borland's Sidekick, bubble memories, and some software from Bruce Tonkin.

BYTE West Coast gives more observations on Sidekick and looks at FidoNet, a do-it-yourself electronic-mail system. Our West Coast staff also tells about Get Organized!, a new integrated software package from Electronic Arts, and makes some optimistic observations about Apple.

In BYTE U.K., Dick Fountain describes POP and SNAP, a pair of languages for artificial intelligence that provide genuine alternatives to LISP and Prolog.

Bill Raikes news from the Japanese scene announces a new CMOS version of the 68000, relates experiences with the Brother EP-44 typewriter, and describes the Casio FP-5000.

<b>COMPUTING AT CHAOS MANOR: MIND PROBLEMS</b> <i>by Jerry Pournelle</i> .....	317
<b>CHAOS MANOR MAIL</b> <i>conducted by Jerry Pournelle</i> .....	346
<b>BYTE WEST COAST: FIDONET, SIDEKICK, APPLE, GET ORGANIZED!, AND HANDLE</b> <i>by John Markoff and Ezra Shapiro</i> .....	357
<b>BYTE JAPAN: BITS AND PIECES</b> <i>by William M. Raikes</i> .....	369
<b>BYTE U.K.: POP AND SNAP</b> <i>by Dick Fountain</i> .....	381





# PRIORITY ONE ELECTRONICS

## SANYO MS-DOS™ Color Computer \$749



**SYOMDC550-2 w/MS-DOS™ V2.11**  
**BJSY05502 w/One Double Sided Drive, 360K**  
 (Total Shipping Weight 32 lbs.) **\$749**

**SYOMDC555 w/MS-DOS™ V1.0**  
**BJSY0555 w/Two Single Sided Drives, 160K ea.**  
 and Starpak Software (Total Shipping Weight 35 lbs.) **\$995**

**SYOMDC555-2 w/MS-DOS™ V2.11**  
**BJSY05552 w/2 Double Sided Drives, 360K ea.**  
 and Starpak Software (Total Shipping Weight 35 lbs.) **\$1149**

### SYSTEM ENHANCEMENTS:

**BJPDBSY0128K 128K Memory Expansion** **\$108.00**  
**BJSYOMBC232 RS232 Serial I/O Port** **\$100.00**  
**BJSDCOPTLINK Modem Software** **\$99.00**

## Apple II+, IIe Compatible Disk Drives



**BJCRDC111**  
 List Price: \$279.00  
 (Sh. wt. 5 lbs.) **\$119**

**Includes One Year Warranty!**

**BJCRDC130 Controller (Sh. wt. 1 lb.) \$39**



## Surge Suppressor

# \$29.95

**BJWBDRG115S** List Price: \$49.95 (Sh. wt. 8 lbs.)

- 6 AC Outlets
- Noise Filter
- 6' Line Cord
- 15A Circuit Breaker
- Illuminated Power Switch
- 600V Spike Voltage Maximum



### COMPUTER SYSTEMS

#### MORROW DESIGNS

Description	Part no.	Price
Micro Decision w/5Mbyte hd disk&termi	BJPDBMDS105	\$1999.00
BasIO8, SuperCalc, Personal, Pearl and	BJSDMSD11SOFTS	350.00
Pilot software for MD5 above		

#### IBM PC™

w/ideal 1/2 height floppies & 256K RAM	BJBMCPO256TEA	\$1999.00
w/ideal IBM floppies & 256K RAM	BJBMS1502562	\$2150.00
w/ideal 1/2 height floppies, 256K RAM &	BJBPDBMTEA15	\$3250.00
15 Mbyte external hard disk		
w/ideal 1/2 height floppies, 256K RAM &	BJPDBMTEA10	\$3250.00
10 Mbyte internal hard disk		

#### SANYO

**MC8550-2 MS-DOS 1.0 w/5.25 disk drive** **BJPDBSY0999** **\$999.00**  
 term w/gm screen monitor & 80cps printer

### IBM PC™ COMPATIBLE ADD-ONS

15M byte External hard disk	BJTFCXD15	\$1295.00
& controller 18lbs		
RIXON 1200baud modem card for	BJPDBRIBIM	\$459.00
IBM with software 3lbs		
64K RAM expansion for IBM PC™	BJPDBMWMEM9	\$54.00
contains 9-4184's 1 lb		

### VIDEO CARDS

IBM color video card 2lbs	BJBIM1504910	\$250.00
IBM Monochrome Card 2lbs	BJBIM1504900	\$250.00

### MONITORS

IBM 12" green screen 18lbs	BJBMS151001	\$275.00
TAXAN 12" green screen for IBM 18lbs	BJTAX121	\$169.00
TAXAN 12" amber screen for IBM 18lbs	BJTAX122	\$179.00
IBM 13" color RGB 28lbs	BJBIM153001	\$680.00
TAXAN 12" color RGB w/cable 28lbs	BJTAXRG8420	\$495.00

### STD CARDS (2 lbs each)

Dual RS232, 1-cent parallel, clock cal.	BJTBSR10	\$319.00
game paddle port, and 256K RAM card		
(populated to 64K)		
1-cent, parallel and 1 RS232 port, clock cal.	BJTBS10	\$199.00
and game port card		
1-RS232, 1-cent par. Clock/cal, game port,	BJSTBR10PLS	\$289.00
and 384K card (populated to 64K)		
Graphics Plus II RGB, Monochrome par.	BJSTBGRPLS2	\$399.00

### QUADRAM CARDS (2 lbs each)

EXPANDED QUADBOARD	BJQDRDROXPDP	\$239.00
QUADBOARD II	BJQDRDROBDD10	\$229.00
QUADCOLOR I™	BJQDRDROCLRI	\$219.00
QUADCOLOR II™	BJQDRDROCLRII	\$449.00
QUAD 512 (64K installed)	BJQDRD051	\$259.00
QUADLINK	BJQDRDRODLINK	\$539.00
Serial int card 1-RS232	BJQDRRS232	\$89.00
Serial expansion for above	BJQDRRS232EXP	\$40.00
Parallel card	BJQDRRIPC	\$89.00

### APPLE II™ COMPATIBLE ADD-ONS

#### DISK DRIVES

INDUS GT for Apple II w/software	BJINDGTAPLE	\$269.00
CONCORDE Apple II disk drive add-on	BJCRCO111	\$179.00
CONCORDE Apple II 4 drive controller	BJCRCO130	\$75.00

#### CP/M™ CARDS

MICROSOFT Premium card IIe	BJMSF357750	\$299.00
w/CP/M™ and MBASIC™		
MICROPRO 280B 6MHz card, 64K RAM	BJMPRQWSTZR2A	\$299.00
CP/M™, and Wordstar 3.3™		
HAYES Microcom IIe	BJCH071400	\$249.00
DATASPEC 97 function key keyboard	BJDSCAPKB825	\$199.00

### PRACTICAL PERIPHERALS

Graphiccard	BJPPRPGPHCARD5	\$85.00
Printerface	BJPPRPRINTERFACE	\$59.00
Microbuffer II (serial)	BJPPRMB2PLUS16S	\$89.00
Microbuffer II (parallel)	BJPPRMB2PLUS16PS	\$89.00

### VIDEO MONITORS

SANYO 12MHz 12" Green 18 lbs	BJSYDM2112	\$89.00
SANYO 12MHz 12" Amber 18 lbs	BJSYDM2212	\$89.00
SANYO 18MHz 12" Green 24 lbs	BJSYDM8112CX	\$129.00
SANYO 18MHz 12" Amber 24 lbs	BJSYDM8212CX	\$129.00
TAXAN 18MHz 12" Green 18 lbs	BJTAX115	\$139.00
TAXAN 18MHz 12" Amber 18 lbs	BJTAX12	\$139.00
SANYO 13" RGB color 7MHz 30 lbs	BJSYDM7500	\$399.00
TAXAN 12" RGB color 6MHz 50 lbs	BJTAX210	\$329.00

### PRINTERS

#### STAR

Description	Part no.	Price
Gemini 10X 20 lbs.	BJSTRGEM10X	\$269.00
Gemini 10X for IBM PC 20 lbs.™	BJSTRGEM10XP	\$329.00
Gemini 15X 26 lbs.	BJSTRGEM15X	\$399.00
Gemini 15X for IBM PC™ 26 lbs.	BJSTRGEM15XP	\$449.00
Serial interface for GEMINI X series	BJSTRSERINTX	\$59.00
Serial interface with 4K buffer	BJSTRSERINTXAK	\$119.00
COEX 80PT - parallel 21 lbs	BJCDOX80PT	\$179.00

#### MANNESMANN TALLY

MT160L 80 col 20 lbs.	BJTALMT160L	\$75.00
MT180L 132 col 26 lbs.	BJTALMT180L	\$79.00

#### TOSHIBA

P1340 serial 30lbs	BJTSHHP1340S	\$799.00
P1340 parallel 30lbs	BJTSHHP1340P	\$799.00
P1351 parallel 35lbs	BJTSHHP1351P	\$1349.00
Bi-directional tractor for P1351 6lbs	BJTSHA0003	\$195.00
Single in out sheet feeder for P1351 15lbs	BJTSHA0002	\$95.00

### MODEMS

Description	Part No.	Price
PROMETHEUS ProModem 1200 4 lbs	BJPRMP1200	\$359.00
RIXON R212A 1200 baud 4 lbs	BJRIXR212A	\$399.00
RIXON R2C12A 1200baud IBM PC™	BJRXC12A	\$439.00
modem card w/software 3 lbs.		
HAYES 1200 Baud Smartmodem 4 lbs.	BJDCH0400P	\$519.00
HAYES 1200 Baud for IBM-PC™	BJDCH1200B	\$429.00
HAYES 300 Baud Smartmodem	BJDCH0200P	\$249.00
CH SYSTEMS SLEUTH dial back modem	BJCHS3LEUTH	\$429.00
security device 3 lbs		

### PRINTER DUFFERS

64K Microbuffer (serial) 2lbs	BJPPRMB1564	\$249.00
64K Microbuffer (parallel) 2lbs	BJPPRMB1564	\$249.00
Microbuffer II+ for Apple (serial) 2 lbs	BJPPRMB2PLUS16S	\$189.00
Microbuffer II+ for Apple (parallel) 2 lbs	BJPPRMB2PLUS16P	\$189.00

**5 1/4" Double Sided Double Density Diskettes**

**\$1.60 EACH In Packs of 25**  
 BJS025 (\$1.60 x 25 = \$40.00/pack)  
 (Sh. wt. 3 lbs. per pack)

**\$1.40 EACH In Boxes of 250**  
 BJS0250 (\$1.40 x 250 = \$350.00/box)  
 (Sh. wt. 30 lbs. per box)

**\$1.20 EACH In Cartons of 1000**  
 BJS01000 (\$1.20 x 1000 = \$1200.00/carton) (Shipped freight collect)

*These prices are so low, the manufacturer has requested to not be identified.*

### DISK DRIVES

#### 8" DRIVES

SIEMENS Single side 80density 18lbs	BJSIEF001008	\$110.00
WORLD DISK DRIVES OSVDD 18 lbs	BJWDD20020P	\$189.00
OLIVE TRAK 842 dual side, dbl dens 18lbs	BJOMETRAK842	\$459.00
MISUBI SHI 401 side, dbl dens 18 lbs	BJMITS0289463B	\$375.00
TANDON 1/2 height sgl side, dbl dens 9 lbs	BJTNDTMB481E	\$319.00
TANDON 1/2 height dbl side, dbl dens 9 lbs	BJTNDTMB482E	\$369.00

#### 5 1/4" DRIVES

PANASONIC 40trk 1/2 height, dbl side 3lbs	BJPANJA5512N	\$139.00
TEAC 36trk 1/2 height, dbl side 3 lbs	BJTEA55F	\$169.00
TANDON 100-2 40trk full height, dbl side 4 lbs	BJTNDTMB1002	\$189.00

#### 5 1/4" HARD DISK

QUANTUM 42Mbyte Hard disk 9lbs	BJQTM0540	\$1495.00
TANOCN 19 1/2 Mbyte Hard Disk	BJTND503	\$895.00

### DISKETTES and ACCESSORIES

8" 80density single sided 1lb	BJMFLD128H1200S	\$75.00
8" 80density double sided 1lb	BJMFLD220H1200S	\$49.95



## PRIORITY ONE ELECTRONICS

9161 Deering Ave., Chatsworth, CA 91311-5887

**ORDER TOLL FREE (800) 423-5922 - CA, AK, HI CALL (818) 709-5111**

MINIMUM PREPAID ORDER \$3.00 Terms U.S. VISA, MC, BAC, Check, Money Order, U.S. Funds ONLY CA residents add 6 1/2% Sales Tax. Include MINIMUM SHIPPING & HANDLING of \$15.00 for the first 3 lbs., plus 40¢ for each additional pound (20¢ if within California). Orders over 70 lbs. sent freight collect. Just in case, include your phone number. Prices subject to change without notice. We will do our best to maintain prices through October, 1994. Credit card orders will be charged appropriate freight. We are not responsible for typographical errors. Sale prices for prepaid orders only. Circle 287 on inquiry card.

### 5-100 CPU BOARDS

### S-100 RAM DISK BOARDS

### S-100 I/O BOARDS

### S-100 CONTROLLER BOARDS FOR FLOPPY DISKS

### FOR HARD DISK

### 5-100 HARD DISK SUBSYSTEMS

#### 8" ENCLOSURES

ParaDynamics dual desktop 35lbs	BJPDN2000D	\$479.00
ParaDynamics dual rack mount 35lbs	BJPDN2000R	\$499.00
JMR Dual desktop 30lbs	BJMRR2C8	\$229.00

#### 5 1/4" ENCLOSURES

JMR Single 5lbs	BJMRR1C5	\$59.00
JMR Dual full height 9lbs	BJMRR2C5	\$89.00
JMR Dual full height w/intermal data cable 9lbs	BJMRR2C5C	\$99.00
JMR Dual half height vert. mount 7lbs	BJMRR25V5	\$65.00
III Single hard disk enclosure 16lbs	BJIIIM0501	\$239.00
III Dual hard disk enclosure 20lbs	BJIIIM0502	\$299.00

#### S-100 ENCLOSURES

ParaDynamics 20 slot floor standing, with	BJPDNS8205	\$1195.00
provisions for 2 8" floppies and one 8" hard disk with power up sequence (shipped freight collect)		
SDS S0300 6 slot low profile desk 20lbs	BJSD051052	\$299.00

#### OCTAGON 19 1/2 Mbyte w/cabinet and data cables

BJOCTHDS0819 \$1699.00



**ORDER TOLL FREE (800) 423-5922 - CA, AK, HI CALL (818) 709-5111**

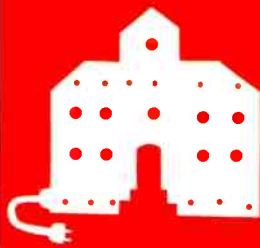

# C·O·M·P·U·T·I·N·G A·T· C·H·A·O·S· M·A·N·O·R

## Minor Problems

TMX BIOS

MI-286 Board

BASIC Rebounds

T.N.T. Software

Workman Software

Borland Sidekick

Copy Protection

Bubble Memory

Le Cafard

Inside IBM

Indexing Programs

BY JERRY POURNELLE

I've started this column in a blue funk. Fortunately, it won't last. My problems are strictly temporary. Still, they seem problem enough now.

First, Larry Niven and I didn't quite finish our novel *Footfall* last month. We worked daily, and we got a lot done, but there are three—maybe as many as five—chapters to go. True, we'll have them done in a week or so, but it's frustrating. I thought we'd be finished.

Second, the Golem, my big CompuPro System 8/16, is on the disabled list. I have no doubt that Tony Pietsch will have him up and going in a day or so. It's my own darned fault, anyway, for trusting double-sided tape. What happened was that two nights ago I was using the 8/16 to collect my mail on the net, and I noticed that his case was not just warm but nearly hot to the touch. I quickly looked at the fan filter, but I'd cleaned it a day or so before; that wasn't the problem. The machine was working fine, but it sure was hot, and finally I took the cover off to see why.

The telephone-connection box, which had been connected to a side wall with double-sided sticky tape, had fallen in such a way as to block most of the airflow from the fan. I fixed that and put the cover on, and I even used a small fan to blow air into the box while leaving it to cool off. The next day, though, when I turned him on, the Golem wouldn't boot. I've spares for nearly every board: processor, memory, Disk One controller for the 8-inch drives, System Support Board, so I swapped each one in turn; each time I got the same symptoms. I've written down everything I did, and I'm sure all will be well in a day or so—but the frustration is amazing.

It's only been a few hours, but I miss that hard disk. The Golem also drives my NEC Spinwriter printer. True, I have kludges to let Zeke II, the CompuPro Z80 I'm writing this on, drive printers, but it isn't the same. It's difficult to connect Zeke up to the Printer Optimizer print buffer; and worst of all, my

accounting system and the check-writing stuff all run off the Golem's hard disk, so I can't even pay my bills. Today is, of course, the Fourth of July, and I don't know where Tony is. Sigh.

Eleven a.m., 5 July: a five-minute telephone call took care of *that* problem: blown fuse. It took Tony about three minutes on the phone with me describing symptoms. For a second he was concerned that in my board swapping I'd set some switches wrong, but I assured him I had done no modifications to the original boards and they were all back in the machine. He thought for a second and told me which fuse it was; I needn't have tried the board substitutions at all. In my defense, the fuses in the CompuPro machines are not where you easily see them; they're on one wall of the box, next to those intimidatingly fat capacitors.

Anyway, all's well with my 8/16. I love that hard disk.

### MINOR MALAISE

My third gripe concerns a couple of readers. Once again I suppose it's my fault.

In the June issue I described some of the problems I'd had with the early test installation of the hard disk on my CompuPro 8/16 and how they were fixed. I thought I'd made it clear, in that issue and in many previous ones, that I'm a computer *user*. I do not really understand the hardware in the machine, nor do I want to. I can, if I have to, read instruction sheets and make minor adjustments, but I don't like it, and I don't claim fully to understand what I'm doing.

A few people read the June issue as an attempt on my part to make me look smarter than Tony Pietsch; and, of course, they had nothing better to do than look him up and tell him their theory. I suppose that if one or two could get the wrong idea from that column, others may have.

For the record: Tony Pietsch, unlike me, really knows what's happening inside these

*(continued)*

*Jerry Pournelle holds a doctorate in psychology and is a science-fiction writer who also earns a comfortable living writing about computers present and future.*



machines. He designs boards (such as the CompuPro S-100 IBM PC-compatible video board) and writes operating-system software, and if it weren't for him and my late mad friend Dan MacLean, I wouldn't have got started in this business. I'd apologize to Tony, except I don't need to. He's not that easy to upset.

## TMX BIOS

On that score, CompuPro is now supplying Tony's TMX BIOS (basic input/output system) for those running CP/M-8/16 on CompuPro "boat-anchor" systems. It's fully debugged; I've been running it for months now with no glitches. CompuPro's policy is to give a free update to those who bought their systems after May 1, 1984, and to sell updates at \$100 to those who got them earlier. The TMX BIOS works with or without the hard disk; knows about M-Drive/H memory drives; and can run with or without interrupts. When it's interrupt enabled you have full type-ahead, meaning that while your machine is doing one thing, you can type in the commands for what it's to do next. That's one of those features I never thought I'd want until I had it, and now I can't imagine how I ever got along without it.

CP/M-8/16 used with a Dual Processor CPU (central processing unit) uses the 16-bit chip to control disk operations and stores most of CP/M in high memory above the 64K-byte boundary. The result is a much larger temporary program area (TPA; it's the system's "workspace"), even for 8-bit programs. As an example, my favorite text editor WRITE has a 33K-byte workspace on Zeke II and 40K bytes on the Dual Processor using the TMX BIOS.

The TMX BIOS also uses full track buffering for disk operations, meaning that reading and writing to both hard and floppy disks are speeded up something wonderful. The TMX BIOS understands both 5¼- and 8-inch disk drives, and Tony has done a program that lets the CompuPro Disk 1-A controller board read, write, and format about 50 different 5¼-inch variations.

Finally, he's done something to the CP/M Command Processor. When you invoke a command file, the program first searches current user, currently logged disk; then current disk, user 0; then Drive A.; current user; and finally, system files under user 0, Drive A.. This means that often-used command files can be stored as system files on A0; and forgotten; when you need them, you'll have them like magic.

There are other goodies. You get source code and full instructions on how to configure your system and install it. Tony's code can be assembled with the Digital Research assembler that comes with CP/M-86; you don't need the dreaded Sorcim ACT assembler to get it working.

One caution: the instructions are complete, but they aren't entirely clear to naive users. If you don't know what you're doing, arrange to get help from someone who does or prepare to do some careful reading. As I write this there's no cookbook, although that could change. At all events, the resulting upgrade is more than worth the effort. Those using CP/M-8/16 with CompuPro equipment will not regret updating to Tony's TMX BIOS.

It also works with other systems . . .

## MACROTECH MOVES AHEAD

The other day Tom Harincar, president of Macrotech, and Frank Nichols, one of his hardware gurus, came over with a preproduction model of the Macrotech MI-286 processor board. This little wonder has an 8-MHz Z80h and a 6-MHz 80286 on a dual-processor board.

They wanted to test the system on my Golem with the TMX BIOS. We opened the box, removed my CompuPro Dual Processor 8085/8088 board—mine has Jim Hudson's 8-MHz 8087 math processor board attached—and dropped in their Z80h/80286 processor board.

It almost worked. My system has a lot of CompuPro RAM 21 boards; it turns out that three of my boards will work with the Macrotech board. The fourth had some timing problems with their processor although it always worked fine in my system.

Macrotech swapped me one of its RAM 21s for my "problem" board so that its people can restudy the situation; since CompuPro owns much of the S-100 market, Macrotech's people want to be sure their stuff is compatible with CompuPro's equipment.

After the one problem board was out, the system worked fine. The Macrotech crew then put in their 512-ST half-megabyte static-memory board, and we tested it with both the CompuPro Dual Processor and Macrotech's MI-286. Both worked splendidly, with no changes to the rest of my system.

The MI-286 is *fast*. That 8-MHz Z80h causes WRITE, and The Word Plus, and my accounting programs to just *fly*, and the 80286 makes the disks work like lightning. Typical time savings on big disk-directory sorts: jobs that took 11 seconds with the CompuPro Dual Processor took 7 seconds with the Macrotech MI-286. Large multiuser area-directory sorts are a good test because they combine both processor and disk operations.

On a processor-intensive operation like my matrix-multiplication program, the time savings are even more impressive over the Dual Processor alone. However, the time improvements aren't so dramatic over the combination of the CompuPro Dual Processor and Jim Hudson's 8087 board.

Alas, I can't give exact timing figures because the MI-286 had some overheat-generated difficulties. This is nothing to be alarmed about; it's July and *hot* in Southern California, that 80286 chip generates enough heat to fry eggs, the 8-MHz Z80h isn't a lot cooler, and this is a preproduction board.

I'm sure that before you read this Macrotech will have taken care of any problems, if need be by adding heat sinks or changing the board layout. When it's all stable, I'll convert Zeke II, the Z80 I'm writing this with, over to the MI-286; I crave that fast Z80h and the big workspace I get with a Dual Processor and Tony's TMX BIOS. Meanwhile, I've been running my

(continued)

## Every option you'll ever need.

You're looking at ULTRAFRAME™, a powerful 8/16 bit multiprocessor you can configure to handle any application.

It's the one system that can tackle your toughest jobs today with the capacity to grow up to 32 users or tasks — within the same chassis.

Get 5" & 8" Winchester drives from 10-120MB (formatted). Also, 14" models from 145MB to 1,160MB. And backup systems appropriate to any system you design.

## Now run both MS-DOS and CP/M software.

Our system lets you network IBM PC's, compatibles or other popular PC's into a serious multiuser business system. Tie PC's into the speed of an

S-100 buss with inexpensive boards and a coaxial cable.

Each PC can tap network resources including hard disks (10-300MB) and system printers with spooling.

The PC's gain the proven network

management capabilities of TurboDOS™. Run MS-DOS™ and CP/M 86 software plus true multiuser accounting and data base applications.

## The industry's longest warranty.

We've built the ULTRAFRAME to last — and backed it with a full three year warranty. Plus, we give a level of old-fashioned factory support you won't get from anyone else. And on-site maintenance is available nationwide through 45 service centers.

FRONT



BACK

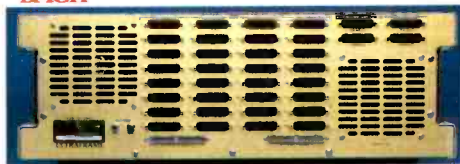

# ULTRAFRAME™



**INDEPENDENT BUSINESS SYSTEMS**

Call collect (415) 443-3131 TWX: 910-386-6003 IBSNET  
5915 Graham Court, Livermore, CA 94550

# The multiuser system that also networks IBM PC's.

See us at

COMDEX™/Fall '84

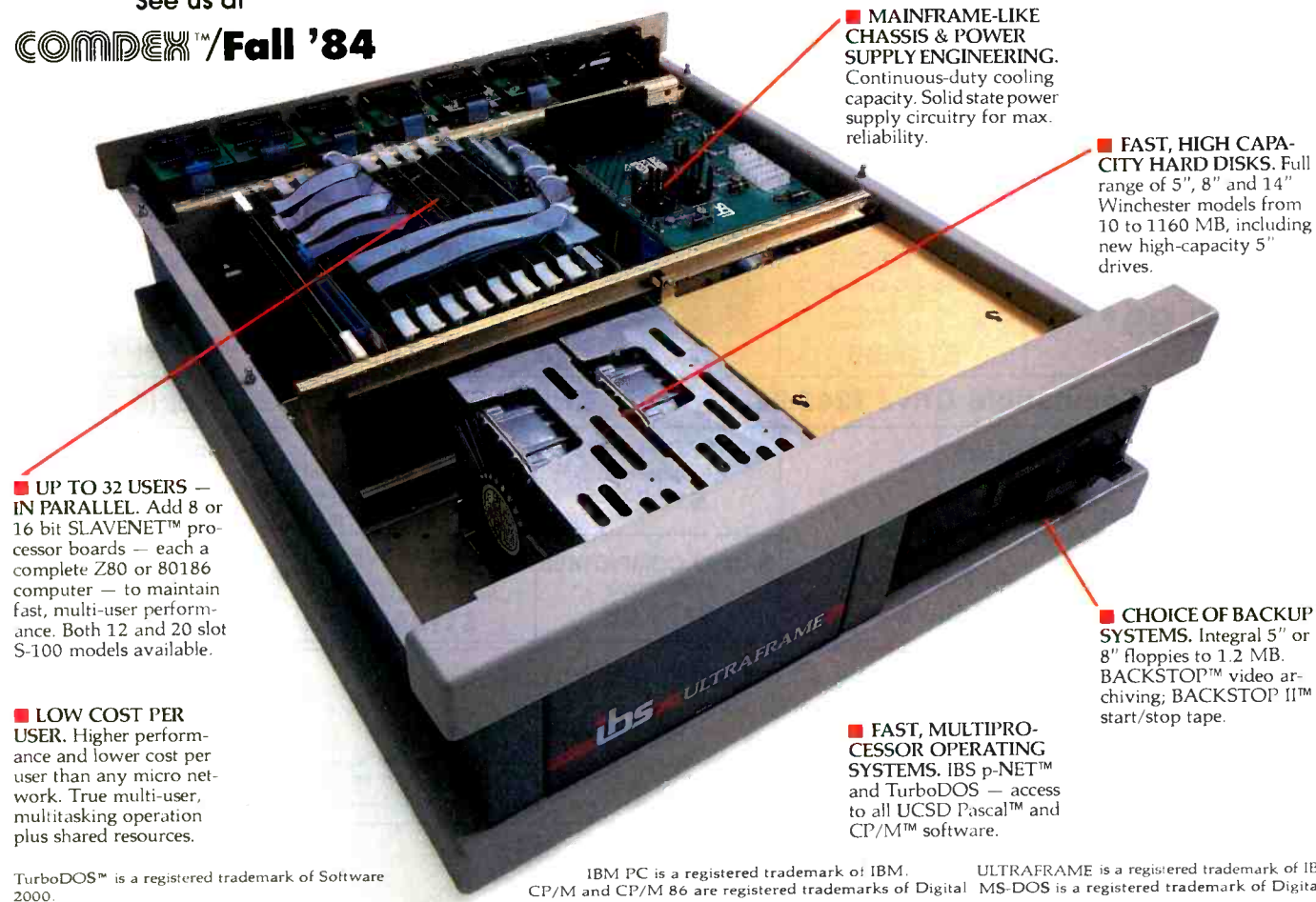

■ **MAINFRAME-LIKE CHASSIS & POWER SUPPLY ENGINEERING.** Continuous-duty cooling capacity. Solid state power supply circuitry for max. reliability.

■ **FAST, HIGH CAPACITY HARD DISKS.** Full range of 5", 8" and 14" Winchester models from 10 to 1160 MB, including new high-capacity 5" drives.

■ **UP TO 32 USERS — IN PARALLEL.** Add 8 or 16 bit SLAVENET™ processor boards — each a complete Z80 or 80186 computer — to maintain fast, multi-user performance. Both 12 and 20 slot S-100 models available.

■ **LOW COST PER USER.** Higher performance and lower cost per user than any micro network. True multi-user, multitasking operation plus shared resources.

■ **CHOICE OF BACKUP SYSTEMS.** Integral 5" or 8" floppies to 1.2 MB. BACKSTOP™ video archiving; BACKSTOP II™ start/stop tape.

■ **FAST, MULTIPROCESSOR OPERATING SYSTEMS.** IBS p-NET™ and TurboDOS — access to all UCSD Pascal™ and CP/M™ software.

TurboDOS™ is a registered trademark of Software 2000.

IBM PC is a registered trademark of IBM.  
CP/M and CP/M 86 are registered trademarks of Digital Research.

ULTRAFRAME is a registered trademark of IBS, Inc.  
MS-DOS is a registered trademark of Digital Research.



system with the Macrotech MI-286 half-megabyte memory board: that memory is as fast as anything on the S-100 market, and there's been nary a glitch.

Macrotech is known for its dynamic-memory boards. Tom says that when his people have the MI-286 completely stable, they'll get to work on producing dynamic memory for it. At the moment they haven't seen a dynamic-memory-board design that's fast enough to justify using an 80286 with it.

**DELAYED BASIC**

I'd intended the lead item this month to be a discussion of the future of BASIC. The language is experiencing a real comeback. There's Steve Ciarci's IBM PC Trump Card board that makes BASIC programs run from 10 to 100 times faster; and there's Morgan Computing Company's mar-

velous Professional BASIC, which is a BASIC programming environment that has features I haven't seen available for any other language.

Better than that, last year Microsoft quietly removed the licensing restrictions and royalty fees on distribution of programs compiled with the company's BASCOM BASIC compiler. BASCOM-compiled Microsoft BASIC programs run pretty fast. They're not as fast as C programs or those written in Turbo Pascal, but they're on a par with IBM Pascal and a lot faster than p-code.

Morgan Professional BASIC has a debugging system that should make writing BASIC programs a snap. I've seen it demonstrated, and I was really impressed. Alas, I've been too darned busy with *Footfall* to do justice to the program; and since my views on BASIC are in large part influenced by the existence of excellent debug-

ging tools like Professional BASIC, as well as structured preprocessors like Bruce Tonkin's P-BASIC, I want to give some illustrative examples when I write on BASIC's future.

However, I have seen Professional BASIC, and I can only wish I'd had a debugging environment like that when I was writing Microsoft BASIC programs. If you have an IBM PC and you intend to do much BASIC programming, you'll do well to look into Professional BASIC.

I have one complaint: Professional BASIC won't work with Magic Keyboard, and I find the IBM PC keyboard without Magic Keyboard something less than tolerable. I've spoken to Chris Morgan of Morgan Computing about this, and he says he'll look into ways they can modify Professional BASIC to let it work with reconfigured keyboards. They may

*(continued)*

# DANA'S COMPUTER DISCOUNT

**All Items In Stock ★ Highest Quality - Lowest Prices ★ No Waiting**

<p><b>EMPTY PC/XT CASES (New)</b></p> <p>The closest thing to an IBM we've seen—you're sure to be pleased</p> <p><b>**\$99.99**</b></p>	 <p><b>HALF HEIGHT</b> Apple II E &amp; C Compatible</p> <p>Slim line - 40 trac w/patch Single sided 163 K capacity</p> <p><b>\$149.95</b></p>	<p><b>FULL HEIGHT</b> Apple II C &amp; E Compatible</p> <p>35 Trac Single sided 143 K capacity</p> <p><b>\$149.95</b></p> 	 <p><b>TEAC FD55B</b> The Highest Quality!</p> <p>Slim line - 40 trac capability Double sided, double density Compatible</p> <p><b>\$149.95</b></p>	<p><b>HARD DRIVE</b> 10 MEG (internal) w/Controller CD complete</p> <p><b>PRE-CHRISTMAS SALE FOR IBM</b></p> <p><b>\$795.00</b></p> <p>"Better Hurry"</p>
---	---	---	---	---

**Commodore® Compatible Drive \$249.95**      **RAM CHIPS 64K 150 NS \$42.50/set (9 pc)**

<p><b>Dana's Discount Computer Buyers Club ★ ★ ★ ★</b></p> <ul style="list-style-type: none"> <li>•\$12.00 ANNUAL MEMBERSHIP</li> <li>•\$10.00 CREDIT TOWARD FIRST PURCHASE</li> <li>•SPECIAL MEMBERSHIP CARD</li> <li>•MONTHLY SPECIALS FOR MEMBERS ONLY (ID REQ)</li> </ul> <p><b>JOIN OUR CLUB AND SAVE</b></p>	<p><b>TEAC FD55F</b> Real Special <b>\$160.00</b></p>	<p><b>IBM</b> Color Grap. CD... 149<sup>95</sup> DISK Dr. CD... 139<sup>95</sup> LMS, Joy Stk. .... 19<sup>50</sup></p>	<p><b>Apple</b></p> <p>Z80 Card..... 4995 80 col CD..... 5995 16K Ram CD..... 3595 Disk Dr. Contr. CD..... 3995 Parallel Print. CD..... 2995 LMS Joystick..... 1795</p>
	<p><b>SANYO COMPATIBLE</b> FD55B/BIOS <b>\$179.95</b></p>	<p><b>HARD DRIVE</b> 10 MEG (External) with card &amp; software <b>\$1195.00</b></p>	<p><b>HARD DRIVE . \$1195</b> 10 MEG (EXTERNAL) complete/card/software</p>

ORDER DESK 8:00 A.M. TO 5:00 P.M.  
PST MON. THRU FRI.  
Orders normally shipped within 48 hours.

**Dana's Computer Discount**  
P.O. Box 15485, Santa Ana, CA 92705

Product shipped in factory cartons with manufacturer's warranty. Prices & availability subject to change without notice.

**ORDERS: 1-800-262-DANA**      In California: **(714) 953-9105**

International orders accepted with a \$5.00 surcharge for handling, plus shipping charges • We accept Visa, MasterCard, Money Orders, and Certified checks • California residents add 6% sales tax • All prices + Shipping • Satisfaction guaranteed or full refund.

Sanyo, IBM, Apple, Apple II E, and Commodore are all registered trademarks of Eagle, IBM, Apple and Commodore corporations.

QUARK ANNOUNCES  
a clever way to store more than sixty-five floppies.

# QC10™



## A 10MB hard disk for your Apple IIc, Apple IIe, Apple III or Macintosh.

Quark's new QC10 hard disk lets you store the contents of more than sixty-five floppies. Even if you're using an Apple IIc. Which means you can have the equivalent of nearly five thousand pages of information ready for instant retrieval.

You'll have room for dozens of programs. From complex accounting software to sales analysis tools. With space left over for your answer to "War and Peace."

And because there's a distinction between those who need to know and those who want to know, QC10 lets you create password-protected "volumes" of any size you choose. So you can segment your data to suit your particular needs, and protect sensitive information.

Plus, if you have an Apple IIc or Macintosh—or a 128K Apple IIe with Apple's Duodisk dual disk drive—QC10 *requires no accessories*.\* The drive simply plugs into the disk drive port. Two special switches let you set your QC10 for whatever computer you use.

And when you add Quark's Catalyst™ program selector, you can automatically load even copy-protected ProDOS

programs on QC10.\*\* And switch between applications with a simple keystroke sequence. So you won't have to change floppies when you need to change programs.

Best of all, QC10 has a suggested retail price of only \$1,995. So ask for a demonstration today. Just call toll-free, 1 (800) 543-7711, for the name of the Quark dealer nearest you.

**Quark**  
PERIPHERALS

A Subsidiary of  
Quark Incorporated

Quark, QC10 and Catalyst are trademarks of Quark Incorporated. Apple, ProDOS and Duodisk are registered trademarks of Apple Computer, Inc. Macintosh is a trademark licensed to Apple Computer by McIntosh Laboratories, Inc.

\*If you do not have a Duodisk, or use an Apple III, a special cable is available. See your dealer for details.

\*\*Catalyst works on the Apple IIc, IIe and Apple III. It is not compatible with Macintosh.

Photography by Barbara Kasten



have to build the keyboard configuration directly into Professional BASIC.

Prediction: the new BASCOM policy, Professional BASIC, and Tonkin's structured P-BASIC preprocessor have put BASIC back in the running as a major production language.

### T.N.T.

I have an 18-pound box from Bruce Tonkin's T.N.T. Software company. It includes an index program that he uses for all his documentation; a database; My Word, a text-editor program that's darned near as good as any I've ever seen, including some features like calculations and sorts that aren't in *any* major text editor, and it sells for a pittance; his structured P-BASIC; and a whole raft of other wonders. It all works, and at prices from \$25 to \$50!

Tonkin is amazing. We suggested a need for a terminal emulator for the IBM PC, and he had one done in two days, with further refinements like transferring files from the PC to a CP/M machine it's controlling and vice versa three days later. Working by himself, he produces more bug-free software faster than many program shops employing 20 people.

Like most programmers, Bruce Tonkin used to sell his own products; his wife and children and their friends helped out with duplicating disks and documents, packaging the stuff, shipping, and the rest of it—an onerous chore. There's also the problem of disk formats: there are about 50 nearly incompatible 5¼-inch systems, and stocking some of each is burdensome. Running a responsible mail-order business is a time-consuming process, one I'd have tired of long ago. So, I suspect, has the Tonkin family, but they're concerned: they don't want unhappy customers for Bruce's creations, and their prices are low enough that many software distributors simply aren't interested.

You can still buy any of his software direct from Bruce at T.N.T., but recently he made a deal with Barry Workman to handle most of the T.N.T. product line. A few special formats, like TRS-80 Model I, will stay exclusively with T.N.T., but most of the

CP/M, Macintosh, and IBM PC products will now go largely through Workman. That should free up enough time for Tonkin to produce even *more* software. He's certainly capable of it.

Bruce Tonkin is one of the last of the hobbyist programmers who made good without starting up an enormous high-hype company. His success story shows that you can do well by doing good.

### MORE UTILITIES

Barry Workman is another who's done well by doing good; Workman and Associates was one of the first mail-order software houses to offer unconditional money-back guarantees, and Barry really works at customer satisfaction.

Sarge Workman is an old friend, and my son Alex works over there as a programmer, so I'm not unbiased; but I'm willing to defend the proposition that the Workman Software Anthology Series is just about the best software bargain going for CP/M users. Workman now offers Disk Five in the Software Anthology Series of CP/M utilities. This one includes LSWEET, an updated version of SWEEP; if you use CP/M and don't use SWEEP, you're working far too hard.

It also has SUPERSUB, which is a jazzed-up version of SUBMIT that lets you put control characters in the SUBMIT files. You can also put in null lines and *nest* SUBMIT jobs.

For those who don't have them, either of those two programs is worth what Workman charges for the whole disk.

There's also XPIP, an improved PIP; ERAQ, an interactive erase utility; PATCH.ASM, which shows how to patch CP/M 2.2 to have the prompt display user number; another patch to let the CP/M command processor respond to both the backspace and the delete character without echoing; FFCOM, which will send a formfeed to the list device; UNLOAD.COM and UNLOAD.MAC, which take .COM files and turn them into Intel hex files; an older but very useful version of Tony Pietsch's XD.COM, one of the most

useful utilities I have; and NSWP206, a copyrighted disk-maintenance utility that's worth *more* than the price of Utility Disk Five. It includes the ability to compress files using the SQUEEZE and UNSQUEEZE utilities as well as doing everything SWEEP does.

As usual, Workman has taken utilities from a number of public-domain sources and combined them with copyrighted programs on which he pays royalties. The public-domain programs have been worked over, with documentation improved and bugs removed.

The Software Anthology Series is available in 8-inch IBM standard format and about 35 different 5¼-inch formats. I particularly recommend Disk Five of the series.

### BORLAND DOES IT AGAIN

Philippe Kahn's Borland International company shook up the micro world by selling the excellent Turbo Pascal for reasonable prices.

He now has a product that IBM PC users won't be able to do without. He ought to sell about a zillion copies of his new Sidekick program.

I do wonder where Kahn gets these goofy names. Turbo Pascal was bad enough; now I have to write about Sidekick. Alas.

The name's rotten, but the program is wonderful. Sidekick is a multiwindow utility program that resides in your IBM PC's memory. You can run other programs, but Sidekick is always there waiting. It contains a notebook (which has the Turbo Pascal text editor, similar to the UCSD Pascal editor but with more WordStar-like commands built in); a calendar; a *good* desk calculator with memory, unlike the crummy one that Apple put into Macintosh; and, wonder of wonders, an ASCII (American Standard Code for Information Interchange) table that shows IBM PC graphics characters. It also shows control characters and their standard ASCII mnemonics (NUL, SOH, ETX, etc.). Included are the decimal and hexadecimal values. Incidentally, the calculator will instant-

(continued)

# TeleVideo. The color PC with a black and white price.



Now, brilliant, high resolution color comes standard with the new TeleVideo® Color Personal Computer. At a price that's about the same as the IBM® monochrome system.

In fact, to match TeleVideo's color on an IBM PC, you'd have to add a color monitor, plus a color and graphics adaptor board. And unlike IBM, the TeleColor PC has memory that's dedicated to the color screen. So you get a faster, flickerless image that's easier on your eyes.

What's more, the TeleColor PC also comes with the popular PC™-DOS compatible operating system and three

essential business software programs—word processing, spread sheet and data base management.

It also has standard features that make it easier to use than an IBM PC. Like a tiltable monitor and a keyboard that's exceptionally comfortable to use.

And, of course, the TeleColor PC runs the same popular software as the IBM PC.

Contact the TeleVideo dealer nearest you for a demonstration of the color PC with a black and white price. Call 800-538-8725 (in California, 408-745-7760).

## Standard Features

- ▶ Word processing, spread sheet and data base software
- ▶ Color and graphics display
- ▶ 12 inch tilt color screen
- ▶ 256 Kbyte RAM
- ▶ Two 360 Kbyte slim-line floppy disk drives
- ▶ RS-232C serial port
- ▶ Parallel printer port
- ▶ Composite video port
- ▶ Internal expansion bus slot
- ▶ GW BASIC® programming language
- ▶ Self-running demonstration diskette
- ▶ PC-DOS compatible

The best hardware for the best software.



Personal Computers  
TeleVideo Systems, Inc.

Northwest (408) 745-7760 Southwest (714) 476-0244 Southcentral (214) 258-6776 Midwest (312) 397-5400  
Southeast (404) 447-1231 Mid-Atlantic (703) 556-7764 Northeast (617) 890-3282 East (516) 496-4777 Rocky Mountain (408) 745-7760  
IBM is a registered trademark of International Business Machines. GW BASIC is a registered trademark of MicroSoft Corporation. PC-DOS is a trademark of International Business Machines.



ly convert from decimal to hexadecimal to binary. No octal, but I don't use octal anyway.

There's a telephone dialer to use with your modem. It's also the Rolodex: you can make entries like

Fred (888) 623-1234 Computer Cleanout Inc.

and the dialer will pick out the number for you. The entries can be made by the Notepad or can be dragged in from your own database. Since the Notepad has a search function, finding phone numbers turns out to be fairly easy.

Philippe Kahn tells me he uses Sidekick with an IBM PC, then uses Crosstalk to fool the PC into thinking it is a TeleVideo 920 terminal; he then uses the PC to operate other computers but has Sidekick available all the time. That sounds great, and we just got Crosstalk with a view to mak-

ing our PC control the Golem and also (through a Tswitch) be one of the four terminals for Shirley (our CompuPro 10) as well as the terminal for the Sage IV. That will give me Sidekick available for notes, calendar, calculator, and telephone calls; Steve Ciarcia's Z8000 Trump Card for running quick-and-dirty BASIC programs; and all the capabilities of my other systems.

It's always seemed ridiculous that I've had to keep desk calculators next to a whole wall full of computers. Senseless it may have been, but the alternative was to save off whatever I was doing and load in BASIC or a calculator program; and that took too long. I suppose half the program-development workstations in the country have a TI Programmer hexadecimal calculator next to the computer keyboard. I certainly did until this week.

One of the things I liked about Ap-

ple's Macintosh was a calculator continuously available, but alas, like much of the Macintosh, the idea was good but the execution was execrable. The Macintosh calculator is Macuseless. Sidekick's is not.

Sidekick has a couple of problems, and I'd like to see a few new features. One thing I miss is the change-signs function on the calculator. No matter. I make no doubt that Borland will do updates; and right now the program is invaluable.

Sidekick does take up memory, about 56K bytes. There are ways to make it use less by giving up some of the Sidekick functions. Given the rapidly falling price of memory, it hardly seems worth it. I greatly prefer the convenience of Sidekick to the memory it costs.

If you use a PC, get Sidekick. You'll soon become dependent on it.

#### COPY PROTECTION YET AGAIN

I once swore I'd never recommend a copy-protected program. Sidekick is copy protected, and I sure recommend it. Now what?

First, Philippe Kahn's side of the story.

Borland doesn't copy-protect Turbo Pascal. The disk isn't a lot of use without the documents, and the thick book that comes with Turbo would be a lot of trouble to copy. In addition, except for schools, not many places would use a number of copies of Turbo, and of those, most would buy multiple copies.

Not so with Sidekick. Philippe tells me horror stories of big companies that routinely buy one copy of a program, then make 30 and more copies for internal distribution. Sidekick needs no documents. It comes with an attractive, indexed manual, but it has on-line Help files that are nearly good enough to teach the use of Sidekick without manuals—and are certainly good enough that you'll probably never use the manual after the first week. The manual itself is thin (73 pages, including the index) and easily copied.

If Borland didn't copy-protect

(continued)



If you liked our 1983 planbook, you'll love our new one. In fact, it's so new it's just now coming off the press.

With a bigger format that really captures the beauty and the practicality of a Lindal Cedar Home.

With a Lindal, you get the warmth, durability, and the beauty of Western Red Cedar. Post-and-beam construction gives you great flexibility in design. And you get superb energy efficiency—from thermal windows to R63 roofs.

We give you many outstanding house plans to choose from: 60 in all. Plus custom designs.

For the same \$5 price as our last brochure you can get started with our new 88 page planbook. Write Lindal Cedar Homes, P.O. Box 24426, Dept. V94, Seattle, WA 98124. Or call toll-free, 1-800-426-0536, and use MasterCard or VISA. In Washington call (206) 725-0900. In Canada write Box 2080, New Westminster, B.C. V3L5A3.

**LINDAL CEDAR HOMES**

# NOW YOU CAN HAVE COMPATIBILITY WITHOUT BUYING YOUR PERSONAL COMPUTER IN BITS AND PIECES.

## THAT'S THE WIZARDRY OF OLIVETTI.

If you've always wanted a personal computer that runs all the most popular business software, like Lotus 1-2-3<sup>®1</sup>, dBase II<sup>®2</sup>, WordStar<sup>®3</sup> and more, but want it in a single, easy-to-buy package, you need the wizardry of Olivetti.

You'll find it in the Olivetti Personal Computer. It's a complete system with some remarkable features.

Like a high resolution screen for clarity and superb graphics. Plus expandability to grow with your needs. It has optional storage capacity. You can choose either single or dual floppy disk drives. Even get a 10 megabyte disk drive for really large storage needs.

All with a choice of transportable or desktop models.

To please the hardcore computer buff, it has the flexibility to accept compatible expansion boards, plus the necessary printer and modem ports. And for computer beginners, you can get the PC Tutor program and a "Getting Started" booklet. So you don't have to be a wizard to use it.

In fact, the Olivetti Personal Computer is so complete, you can even get it bundled with five of the most popular business software programs.

And the Olivetti Personal Computer offers all this for a lower price than a comparable system from IBM<sup>®4</sup>.

How do we do it? Wizardry. Sheer electronic wizardry. See it all at the Olivetti dealer nearest you. He's a wizard.

# olivetti

Electronic wizardry  
at your fingertips.

Call 1-800-447-4700 for the dealer nearest you.  
In Alaska and Hawaii call 1-800-447-0890.

DOCUTEL  **olivetti**  
CORPORATION

Olivetti Typewriters and Personal Computers are marketed in the USA by Docutel/Olivetti Corporation, Dallas, Texas.

<sup>1</sup>Lotus Development <sup>2</sup>Ashton-Tate <sup>3</sup>MicroPro <sup>4</sup>IBM Corporation



Sidekick, a lot of places would buy one copy and use it in 10 and more installations.

Second, the copy-protection scheme isn't onerous. Once you load in Sidekick, you can remove the master disk and put it away. You don't need it again until you turn the machine off. It's not even very

sophisticated. Philippe reckons that any good hacker can defeat the copy protection in about an hour, and as far as he's concerned, they're welcome to do it; he's not trying to stop hobbyists and programmers from making backup copies but to stop wholesale rip-offs by big outfits.

Third, there's the price. Sidekick is

\$49.95, down there at the high end of the cost of a hardbound book. We don't expect publishers to give us free backup copies of reference works, nor do we routinely make copies ourselves; why should software be treated so much differently?

Those were Kahn's arguments.

I'm still thinking about the situation. I do not like copy protection; but I can see Kahn's point, particularly regarding companies that make a policy of illegally—and unethically—copying software for multiple simultaneous use.

I've always said that the ethical practice is not to restrict which machine a program runs on—it's silly to insist that a user repurchase all software when upgrading to a new machine—but rather to insist that only one copy of a program be in use at any one time. This is a close analogy to books: many people can read them, but it's unethical (and illegal) to make copies and either give or sell them to friends.

The kind of copy-protection scheme used by Kahn, and by Living Videotext on the excellent ThinkTank, accomplishes this. There's still the problem of disk destruction. I've got to think about this some more.

**BUBBLES . . .**

Several months ago I installed the Helix Bubble Memory board in Lucy Van Pelt, our fussy budget IBM PC. It works like a charm. The PC thinks it's a very fast hard disk.

Bubble boards have no moving parts, and once something is written to the board, it's permanent; not only is it immune to power failures but you could take the board out and mail it to a friend as an expensive way to transfer software.

The problem with bubble memory is that it's pretty costly for the amount of information stored. At \$1500 for half a megabyte the Helix board was rather overpriced, considering what you'd pay for a hard disk and controller.

Intel recently dropped the price of bubble-memory chips, meaning that Helix has been able to cut the price

*(continued)*

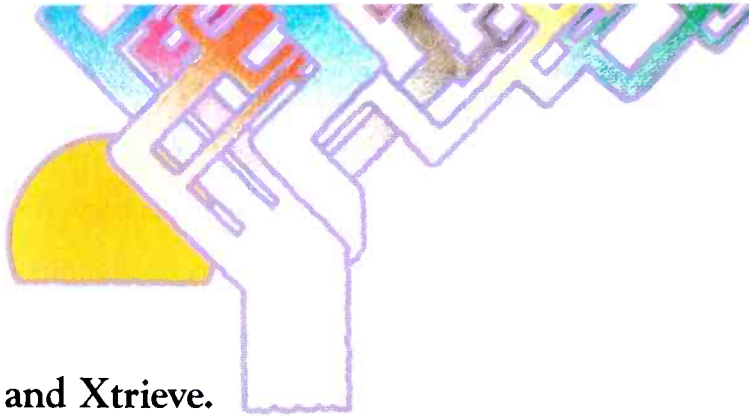

**Btrieve and Xtrieve.  
B-tree file access for all your programming languages. With the query tool your users demand.**

Introducing a powerful data base combination for PC application developers. Btrieve™, the most sophisticated file access method for your IBM™ PC. In single user and network versions. And Xtrieve™, a new menu-driven query tool that gives you—and your users—fast access to information.

**Btrieve: for professional programmers.** Btrieve provides fast, flexible file management for all your application development. All your programming languages—BASIC, Pascal, Cobol, C. With multikey access to records. Automatic file recovery. Unlimited records per file. Duplicate, modifiable, and segmented keys.

With Btrieve, you can develop *better* applications *faster*.

**Xtrieve: easy window interface.** The ideal complement to Btrieve,

Xtrieve is the non-programmer's interface. Xtrieve's full relational capabilities let users define a virtual table of data from multiple files. Then Xtrieve speeds them through query building with a series of easy-to-follow windows.

**No command language.** Xtrieve is completely menu-driven, so there's no need to memorize command language. Or special syntax. Everything you need is on the screen.

Xtrieve features a full range of restriction criteria. Online help messages. And interfaces to access information from Lotus 1-2-3™ and dBase II® files.

**Network capabilities.** Network versions of Btrieve and Xtrieve allow data sharing in PCnet™, NetWare™, EtherSeries™, MultiLink™, and OmniNet™ LANs.

For more information or to order, contact:



P. O. Box 9802 #590 Austin, Texas 78766 (512) 346-8380

**Suggested retail prices: Btrieve, \$245; Xtrieve, \$195. Btrieve/N (network), \$595; Xtrieve/N, \$395. Dealer inquiries welcome. Btrieve requires PC-DOS or MS™-DOS 1.X or 2.X; Xtrieve, PC-DOS or MS-DOS 2.X.**

Btrieve and Xtrieve, IBM, 1-2-3, dBase II, PCnet, NetWare, EtherSeries, MultiLink, OmniNet, and MS are trademarks of SoftCraft Inc., International Business Machines, Lotus Development Corp., Ashton-Tate, Orchid Technology, Novell Data Systems, 3Com Corp., Davong Systems Inc., Corvus Systems, and MicroSoft Inc.

**LURKING  
BEHIND EVERY  
COMPUTER  
IS THE POWER  
TO DESTROY  
ITSELF.**

That power cord may look innocent. But it could suddenly turn against your PC.

It could, for example, hurl a power spike from static or lightning into its delicate circuitry. Wiping out its memory. Or destroying a defenseless component.

Don't risk it. Get a 6-outlet Wire Tree Plus™ surge protector from NETWORX™. It guards against spikes. Filters out RF interference. And it's the only device with two phone jacks to protect modems against surges.

Other unique features include separate switches for the CPU and peripherals and a bracket that

mounts under the front of the workstation.

The illuminated switches are easy to reach, and yet recessed, so you can't accidentally shut down power and lose data.

If you don't need 6 outlets, pick up our 4-outlet Wire Tree™. Or our single-outlet Wire Cube™ that's ideal for portable computers.

That'll take care of power surges. But what if your foot gets tangled in a power cord? Prevent this potential disaster with the Wire Away™. It stores up to four 18-gauge wires and ends the hazardous mess of dangling cords.

All our products are backed by a 5-year warranty. So when you shop for a PC, ask for NETWORX computer station accessories. And don't go home without them.



**NETWORX™**

Computer Station Accessories

Networx, Brooklyn, NY 11237-1587 (718) 821-7555

Circle 250 on inquiry card.



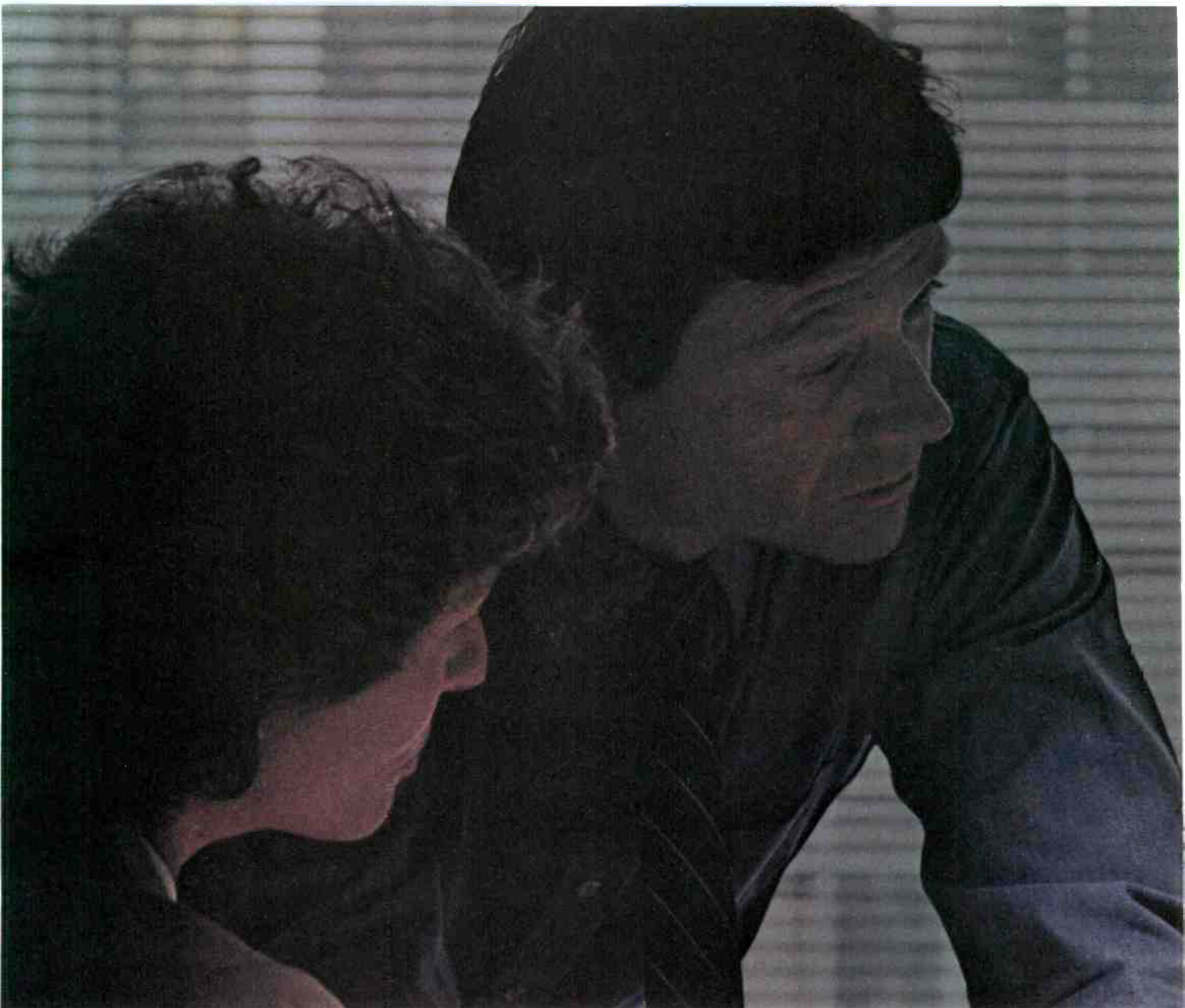

*Hayes. Leading the way with quality telecomputing systems for the personal computers that businesses use most.*

When it comes to communicating—computer to computer—Hayes says it best. All you need is a Hayes Smartmodem (it's like a telephone for your computer) and Smartcom II® software, to get you into all the right places.

In no time at all, and with no assistance at all, you can create, send and store files, and automatically log on to information services. The communication possibilities are endless!

---

*Introducing our new Smartcom II.  
More connection capabilities.  
More convenience.*

---

Now Hayes goes even further to streamline your communications and optimize your connections.

Smartcom II software is currently available for more than 16 personal computers (with even more to come). That means you can communicate,

Smartcom to Smartcom, with an IBM PC, DEC Rainbow 100, HP 150, TI Professional Computer\* and others.

And that's not all! Smartcom II also emulates the DEC VT100 and VT52 terminals, now in widespread use in many businesses. This feature lets your personal computer "pretend" it's a DEC terminal, opening the door to a vast installed base of DEC minicomputers!

---

*We stand on protocol.*

---

In addition to the popular Hayes Verification protocol, the new Smartcom II also includes the XMODEM protocol, ensuring accurate transmission to a wide range of personal computers and mainframes at information services. By matching the protocol (or "language") of a remote computer to yours, Smartcom II can transmit information error-free, regardless of interference on the phone lines.

*"When I got this computer I thought my problems were over. Then it dawned on me I needed to talk to the PC in sales and the TI in accounting. What I needed was the right modem and software, so I went with the leader!"*

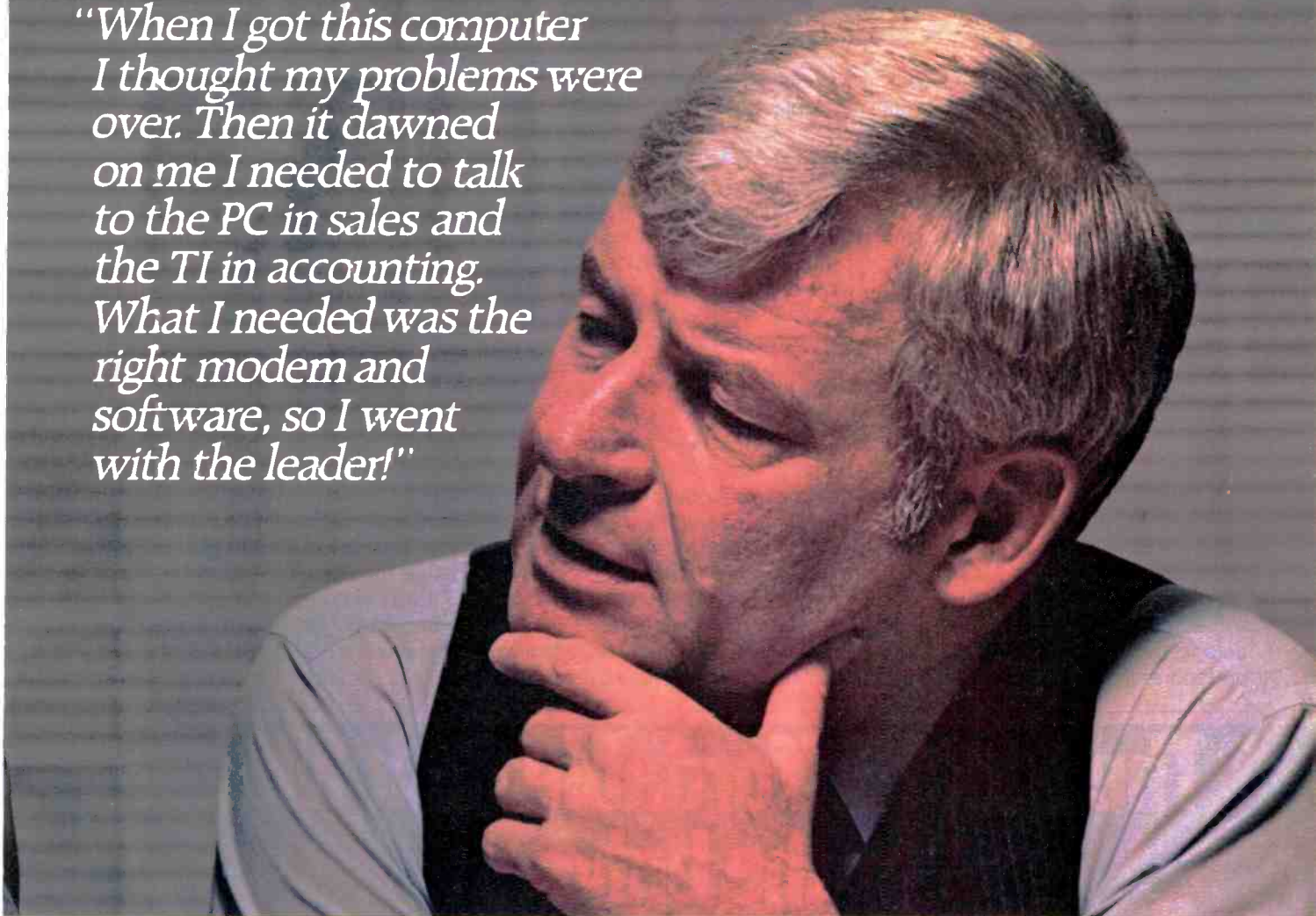

---

***Voice to data—in the same call!***

---

With Smartcom II, you can easily switch from voice to data transmission (and back again), all in the same phone call. This saves you time and money, since you don't have to hang up and dial again.

---

***Your Hayes telecomputing system works—totally unattended.***

---

Smartcom II makes telecomputing simple, even when you're not there. It allows your Smartmodem to receive a message for you when you're out, and leave it on your disk or printer. And you can tell Smartcom II to "save" the messages you've created during the day, and automatically send them at night, when phone rates are lowest.

---

***Get your hands on the leader.***

---

With an unsurpassed record of reliability, it's a small wonder Smartmodem

is such a smart buy! Smartmodem 300™ (the first of the Smartmodem series) dials, answers and disconnects calls automatically. Smartmodem 1200™ and Smartmodem 1200B™ (it plugs into an expansion slot inside an IBM PC or compatible), provide high-speed, high-performance communications for businesses of all sizes.

And when Smartmodem is purchased with Smartcom II, you have the most dependable telecomputing system available for your personal computer.

Everything we do at Hayes is designed to make communications easier for you. Feature-rich, direct-connect modems. Menu-driven software. Concise documentation. And a customer service organization, second to none!

See your dealer right now for a hands-on demonstration of Smartmodem and our latest version of Smartcom II. From the telecomputing leader, Hayes.

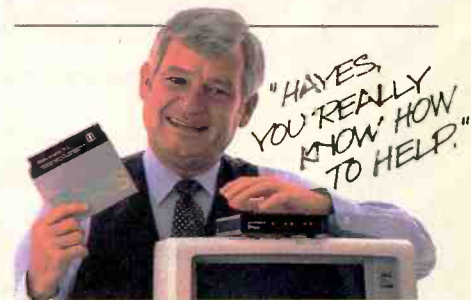

---

# Hayes

---

**Hayes Microcomputer Products, Inc.**  
5923 Peachtree Industrial Blvd.  
Norcross, Georgia 30092 404/441-1617.

Circle 151 on inquiry card.



of bubble memory. It's still not competitive on a megabytes-per-buck comparison, but it's no longer a frill either. Bubble memory is faster than a hard disk—and having no moving parts, it's safer. The Helix Bubble Memory board would be especially appropriate for a machine that had to operate in a harsh field environment or be carried about in a Jeep. I suppose that one day I'll replace it with a hard disk simply for the larger capacity, but I'm in no hurry. I like the speed and reliability I get with the Helix.

One day—probably well before the turn of the century—hard disks will be obsolete. Mass storage will not use moving parts. It may be bubble memory (greatly reduced in size over the present bubble chips) or something else, but you won't lose betting that systems requiring high-precision machined parts are on the

way out. Of course, it will take a while to replace them . . .

### LE CAFARD

Recently I've seen a great deal of speculation about the origin of the term "bug" to describe a computer problem. The most widely accepted story is that an actual moth was found blocking relay contacts in an early electromechanical computer.

That story may well be true, but it's unlikely to be the first use of the term "bug."

During the fifties and sixties, "I'm bugged" was considered an explanation of sorts for bizarre activities, such as a man leaving his wife so that he could hitchhike to Tijuana. Those hip to the jargon probably considered the term original with their generation.

It wasn't. As early as 1850 the primary malaise of *La Légion étrangère* was *le cafard*—which literally translates

as "the bug." *Le cafard* was, and probably still is, the generic excuse for Foreign Legionnaires to be irritable, stare at the wall, assault superiors, attempt to desert, be off their feed, etc. *Le cafard* was a small beetle that was imagined to have crawled in the ear and penetrated the brain, thereby causing madness. Legion officers swore that the only real cure for *le cafard* was a rifle and the opportunity to use it.

It would be interesting to trace the exact way that the Legion's *cafard* managed to creep into our computers.

### IBM CATCHES WISE

Rumor department: I have sources for this, but obviously I'm not going to name them.

It has been interesting to watch. Because of the IBM PC, for the past three years a larger and larger per-

(continued)

# The Most Affordable Disk Maker™ in the Universe

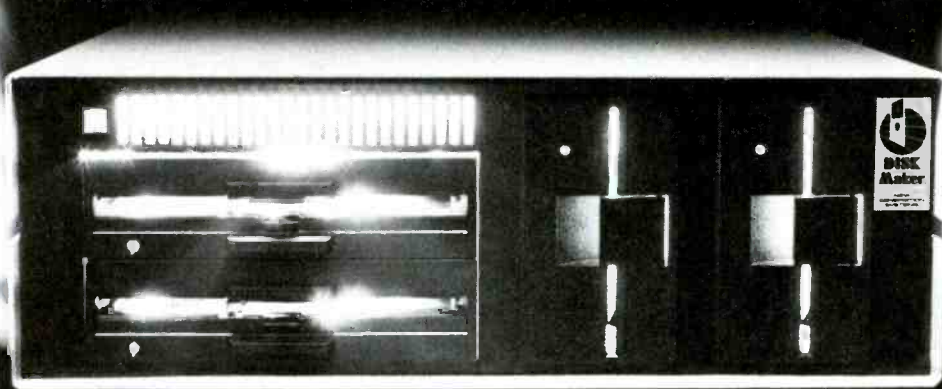

Disk Maker II shown with opt. drives

## Download fast, read over 100 formats easily, reformat rapidly

The more disk formats you work with, the more our Disk Maker™ system saves time and money by reading and/or writing disks in any of over 100 formats. No modems, no patches, no other special software necessary.

Disk Maker II is a complete, stand alone system with one 8" DSDD disk drive, one 48 tpi 5 1/4" DSDD disk drive, 6 MHZ Z80B, 64K CP/M system with Disk Maker™ software. (96 tpi and second 8" drive optional.) Just plug in your terminal and make disks! Bundled software includes MicroShell™/MCALL-II communications software.

Supported with comprehensive, easy-to-read manual, software updates (\$25.00, all formats in revision), and additional drives and hard disk options.

**Disk Maker™**  
prices from  
**\$1,495**

Disk Maker I runs as a peripheral with an S-100 system and comes with S-100 controller board, one 48 tpi DSDD 5 1/4" disk drive, dual drive cabinet and power supply, cables and Disk Maker software. 96 tpi and 8" drives are optional. Circle 251 on inquiry card.



1800 Michael Faraday Drive, Suite 206, Reston, VA 22090  
(703) 471-5598 Order Line: (800) 368-3359  
Dealer inquiries welcomed.



# ORCHID REWRITES AESOP'S FABLES

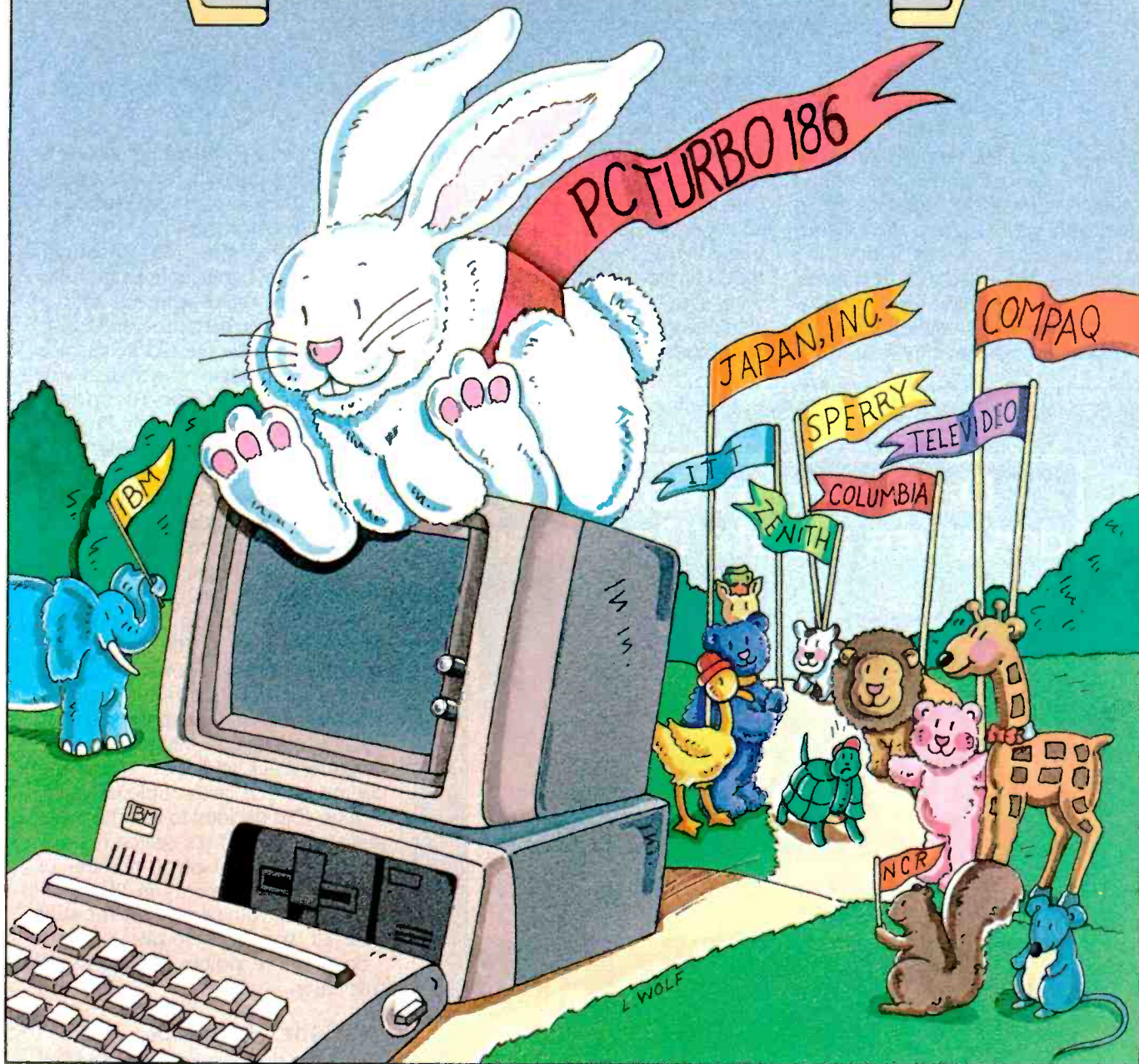

## PC TURBO 186...Speed Wins the Race.

In business, success comes to those who win the race against deadlines and competition. The IBM™ PC is a great tool, but valuable time can be wasted waiting for it to recalculate spreadsheets, retrieve data, or execute the newer and more complex software packages. PCTurbo™, new from Orchid, can help you win and enjoy the fruits of success.

PCTurbo is the ultimate IBM PC productivity enhancement. It boosts the execution speed of your PC so you can get more done in less time. And it's transparent to existing programs such as WordStar™, Lotus 1-2-3™, and dBase II™. So, with PCTurbo, your PC looks and acts the same as before; it just runs faster.

Who needs PCTurbo? Anyone who ever waits for their PC to finish executing so they can run something else. Programmers wait-

ing for compilers to finish before testing a new feature. Businessmen waiting for a data base to retrieve account information. Word processors waiting for the spelling checker to finish before printing.

PCTurbo does more than just speed up the PC. It extends the life of slower, older pro-

grams. It provides a base for new sophisticated software. And it protects your PC investment. You get your work done quicker and decisions made sooner. The very reasons you got a computer in the first place. Write or call for more information.



ORCHID TECHNOLOGY  
47790 Westinghouse Drive  
Fremont, CA 94539  
(415) 490-8586 Telex: 709289

### TECHNICAL DETAILS:

#### Hardware

- One slot plug-in board with high-speed processor (80186)
- Up to 640K on-board memory for a maximum of 1.28 Mbytes total PC memory.

#### Software

- Runs IBM PC-DOS.
- Provides disk caching, RAM disk using available PC memory up to 640 Kbytes.





centage of IBM employees have become IBM customers. They've had to learn the hard way what it's like to deal with Big Blue from the outside. A lot of them are not happy. The result has generated a quiet but real rebellion within IBM.

For example, IBM employees get big discounts when they buy an IBM PC.

However, for much of last year, the local ComputerLand stores simply couldn't get as many PCs as they could sell. Thus, if IBM employees tried to order through ComputerLand, they'd find themselves waiting a long time. The ComputerLand managers would naturally rather sell any PC they could come by at full price rather than

deliver one to an IBM employee at a profit-killing discount, so when a PC came in, it would often be diverted to a non-IBM employee.

Meanwhile, the IBM Product Centers were better able to get IBM PCs—but the word went out among IBM employees. Better to wait forever and get your discounted PC from a ComputerLand than have to deal with an IBM Product Center. The frustration level of dealing with Product Centers verged on intolerable.

As I said, this is all rumor from "Deep Blue," my source inside the company; I don't guarantee any of it. However, I do understand that IBM's management has got The Word, and the Product Centers are changing.

Another interesting development: until very recently, IBM did not use the inventory and bookkeeping software it sold for its own internal use. The company had computer systems, but it also relied on shipping mounds of paper back and forth across the country. In the last couple of years, though, IBM decided to bite the bullet and use the stuff it's selling.

The result has been a number of salutary improvements in IBM software. When you have to use the stuff yourself, you begin to *care*.

Score more points for the micro revolution.

#### THE INDEX DILEMMA

About the time you read this, the first book in the Pournelle Users Guide to Small Computers series should be available from Baen Books. The cover is by Robert Tinney, who does the BYTE covers. Jim Baen says that everyone who sees that cover just smiles and smiles . . .

The book is in large part a collection of my columns with update material, including a previously unpublished section written as a letter advising my colleague Robert Silverberg on how to buy a microcomputer. Since it has my name on it, it naturally had to have an index. I may be crazy, but I'm not stupid: I've been far too severe on books without indexes to leave one out of mine.

(continued)

## Data worth keeping deserves a Data Defender.

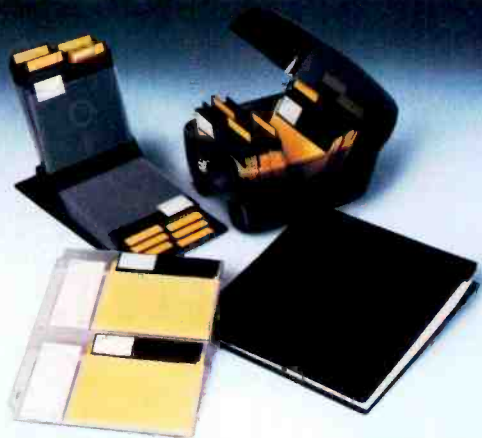

**Data Defenders by Ring King.** They're the finest quality protection you can buy for the information you have stored on 5¼" mini-diskettes and printout.

The Ring King 070 Tray holds 70 mini-diskettes in a tough copolymer shell with security lock. The Ring King Flip File II binder holds 20 mini-diskettes and converts to a desktop index. Ring King Looseleaf Files are punched to fit standard 3-

ring binders. Ring King Data Binders hold up to 8" of 9½" x 11" or 14⅞" x 11" unburst printout.

Ask for Ring King Data Defenders at your computer supply dealer. Or send for our free, full-color catalog of computer support products. Write Ring King Visibles, Inc., 2210 Second Avenue, P.O. Box 599, Muscatine, Iowa 52761. For customer service, phone (800) 553-9647, in Iowa (319) 263-8144.

# DATA DEFENDER™



*Only from Topaz...*

# Powermaker<sup>®</sup> Micro UPS

**Uninterruptible, computer-grade power  
— at half the cost**



It's in a class by itself.

For about half the cost of other Uninterruptible Power Systems, you can now get the same degree of protection with our Powermaker Micro UPS. This remarkable new system eliminates computer problems caused by blackouts, brownouts, voltage sags and power-line noise.

Providing up to 75 minutes of continuous computer-grade power, our Powermaker Micro UPS is compatible with microcomputers and PC's. It's fully automatic, maintenance-free, portable and compact. It fits neatly alongside or under your desk or workstation. And because you can't always tell when you've lost primary power, our little UPS even features an audible line-loss alarm.

But best of all is the price. The Powermaker Micro UPS is priced right and is ready for immediate shipment. Find out more about our Powermaker Micro UPS. Call us at (619) 279-0831, or contact your local Square D distributor.

**TOPAZ<sup>®</sup>**

*Excellence in Computer Power*

**SQUARE D COMPANY**



Indexing should be an ideal job for a computer. Since the job had to be done during a month when I wouldn't be here very much, I turned the task over to Peter Flynn, our long-suffering editorial assistant.

WRITE, the text editor I use, keeps what it's working on in memory: books are thus broken up into chapter-length files. I find that very convenient, but it does leave something to be desired for indexing. More: all our index programs want to work with WordStar (which is a good reason why one ought to have WordStar even if it isn't used for text creation).

Peter's game plan was to concatenate all the chapter files into one or two long WordStar files, print out the document, and make an index keyed to the printed manuscript. It would then be only about a day's work for one of the publisher's

copyreaders to take finished page proofs plus Peter's index and make an index keyed to the actual book pages.

He could have used Bruce Tonkin's index program. We also have an index program for the IBM PC that we got from Borland International. However, one of Peter's jobs is to test out software, and he had SuperDex from Spite Software (where *do* people get these company names?). We also have Oasis's wonderful The Word Plus, which includes a whole mess of word-handling utilities, including Wordfreq and Dictsort. Wordfreq will take any text and make a table of all the unique words sorted by their frequency of use. Dictsort will take a list of words and sort it alphabetically. The theory was to make a table of *all* the words, then eliminate the common ones and index the rest.

First, though, he had to concatenate the files. That's no great difficulty. The

WRITE text editor now comes with FILTER.COM, a utility that Tony Pietsch wrote that will convert WRITE files to WordStar, WordStar to standard ASCII, ASCII to WRITE, etc. Tony's program is so fast that for a long WordStar file it is quicker to:

1. Save the file within WordStar.
2. Exit WordStar to CP/M.
3. Use FILTER.COM to convert the file to WRITE format.
4. Use FILTER.COM to convert the file back to WordStar.
5. Enter WordStar and read the file.

than it is to use WordStar's global reformatting command!

FILTER.COM will concatenate files; it was designed to make one big WordStar file out of a lot of small WRITE files so that we can use Footnote and some of the other WordStar utilities. Thus, merging the separate

(continued)

ITEMS DISCUSSED

Helix PC Bubble Memory Board  
 128K bytes ..... \$750  
 256K bytes ..... \$995  
 500K bytes ..... \$1445  
 Helix Systems  
 11601 Wilshire Blvd., Suite 720  
 Los Angeles, CA 90025  
 (818) 710-0300

MI-286 Processor Board .... \$1395  
 Macrotech International Corporation  
 9551 Irondale Ave.  
 Chatsworth, CA 91311  
 (213) 700-1501

Professional BASIC ..... \$345  
 Morgan Computing  
 10400 North Central Expwy.,  
 Suite 210  
 Dallas, TX 75231  
 (214) 739-5895

Sidekick ..... \$49.95  
 Turbo Pascal ..... \$49.95  
 Borland International  
 4807 Scotts Valley Drive  
 Scotts Valley, CA 95066  
 (408) 438-8400

Star Fleet I (compiled) ..... \$49.95  
 postage and handling ..... \$2  
 Cygnus  
 POB 57825  
 Webster, TX 77598  
 (713) 486-4163

SuperDex Document-Indexing  
 Software ..... \$59.95  
 Spite Software  
 13531 SE Foster Place  
 Portland, OR 97236  
 (503) 224-0137

The Word Plus ..... \$150  
 Oasis Systems Inc.  
 7907 Ostrow St., Suite F  
 San Diego, CA 92111  
 (619) 279-5711

TMX BIOS for CP/M-8/16 ..... see  
 CompuPro text  
 3506 Breakwater Court  
 Hayward, CA 94545  
 (415) 786-0909

T.N.T. Software ... Contact for prices  
 Bruce Tonkin  
 34069 Hainesville Rd.  
 Round Lake, IL 60073  
 (312) 223-8595

T.N.T. Software ..... \$25-\$50  
 Software Anthology Series  
 (five disks) ..... \$32.50/disk  
 Workman and Associates  
 112 Marion Ave.  
 Pasadena, CA 91106  
 (818) 796-4401

Trump Card ..... \$995  
 Sweet Micro Systems  
 50 Freeway Dr.  
 Cranston, RI 02920  
 (401) 461-0530

8087 Support Board ..... \$495  
 Z Support Board  
 8087 no chips ..... \$595  
 256K bytes memory only ... \$595  
 8087 plus 256K bytes ..... \$995  
 James Hudson Associates  
 POB 2957  
 Santa Clara, CA 95055  
 (408) 554-1316

# Your schedule needn't be carved in stone.



When a decree comes down from above, your scheduling program better be flexible enough to adapt easily and efficiently. With any project, delays can occur, shipments can be late, specific elements of the job can take longer than expected, but with MicroTrak, changing one deadline won't smash your schedule. Other activities affected by the change will be adjusted accordingly. And you won't be left between a rock and a hard place.



## FEATURES

- Updates Quickly
- True Precedence Based Scheduling
- Menu Driven, Interactive
- Overlapping Relationships
- Clear, Useful Reports

MicroTrak available on PC-DOS, MS-DOS (\$595.00) and UNIX (\$895.00) operating systems.  
30-day trial with full refund if not satisfied.

# MICROTRAK™

APPLICATION SOFTWARE FOR PROJECT MANAGEMENT

SOFTRAK SYSTEMS P.O. Box 22156 AMF Salt Lake City, Utah 84122 (801)531-8550



What do you like  
better about the VISUAL 2000 ...  
its power or its versatility?

Personally,  
I like its price!



## Never has a UNIX-based multi-user system given so much to so many for so little.

### Introducing the VISUAL 2000

The VISUAL 2000 is the full-featured system with the power and flexibility to support multiple users in real business applications at a surprisingly low cost per station. It can be used with inexpensive video terminals. Or as a database manager or file server for a cluster of intelligent workstations or PCs, including both the IBM® PC and VISUAL's own lightweight, portable, totally IBM PC compatible COMMUTER. In all applications it offers greater performance, more flexibility, and lower cost than any other system in its class.

### Powerful Intel 286 processor

The Intel 286 is today's chip of choice for UNIX™-based systems. Only the Intel 286 has on-chip memory management, an instruction set optimized for multi-tasking, and the optional 287 numeric co-processor to speed up floating point by a factor of 10.

What do these features mean to the VISUAL 2000 end user? Faster response time, more users supported, and lower system cost!

### Cost-effective one-board design

A basic advantage of the VISUAL 2000 is its one-board base-level design. A single high-density board includes the 286 CPU, 512KB-2MB of RAM, controllers for Winchester, floppy, and streaming tape, an intelligent communications processor, six RS-232 ports, and a parallel printer port. Even a real-time clock with battery backup. One-board design means higher performance, lower cost, and greater reliability than comparable multi-board implementations.

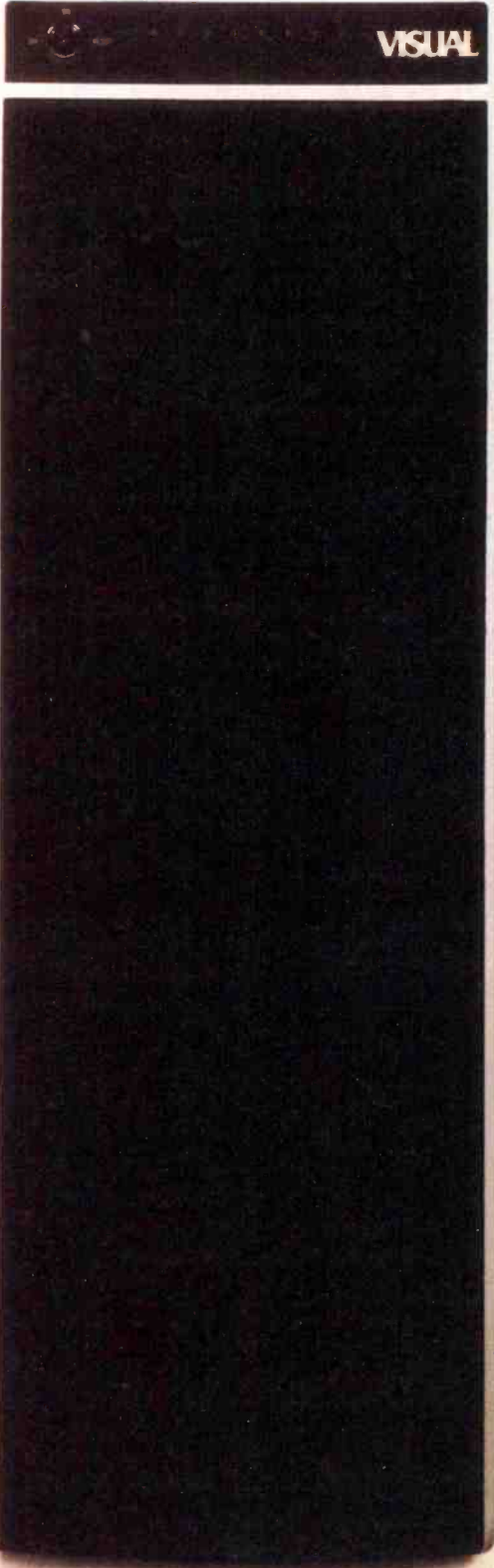

**VISUAL**



### **Configurability and Expandability: VISUAL gives you more**

The VISUAL 2000 spans a much wider range of configurability and expandability than other systems in its price class. Up to 16 independent users. 6 megabytes of RAM. 4 Winchester. Floppy. And streaming tape for simple, reliable disk backup. All in a small stand-up enclosure which looks right at home next to a desk.

And if a fully expanded VISUAL 2000 isn't enough, you can connect up to 254 VISUAL 2000s, PCs, and workstations in a local area network.

### **Extensive system software simplifies system integration**

The VISUAL 2000 runs XENIX, Microsoft's popular, enhanced version of UNIX, derived from UNIX under license from AT&T, and designed to be faster, more secure, and easier to use in business applications.

And VISUAL has worked hard to simplify the system integrator's job, by providing all the tools needed to deliver end-user applications with a minimum of effort.

Languages such as C, SMC BASIC, RM/COBOL, TOM BASIC, SOFTBOL, and MicroFocus Level II COBOL, to provide instant compatibility with hundreds of proven business application programs.

Other system-building tools, like the INFORMIX database management system and RealWorld modular accounting system.

And productivity software, such as the 20/20 integrated spreadsheet and XED office-grade word processor.

### **The Bottom Line**

High performance. Superior flexibility. Extensive software. And low cost... VISUAL 2000 systems start at under \$10,000, suggested list. No one gives you more in a UNIX-based multi-user system.

Whether you're an OEM, system house, distributor, or end-user, call today for further information on the VISUAL 2000 and see for yourself!

Circle 372 on inquiry card.



# **VISUAL** See for yourself®

Visual Technology Incorporated  
540 Main Street, Tewksbury, MA 01876  
Telephone (617) 851-5000. Telex 951-539

#### REGIONAL OFFICES:

Northwest: (415) 490-1482  
Southwest: (213) 534-0200  
North Central: (513) 435-7044  
South Central: (214) 255-8538  
Northeast: (201) 528-8633  
Southeast: (301) 924-5330



# 2,500 programmers depend on us...

... from giant corporations to small independents. There are many reasons why. First, THE PROGRAMMER'S SHOP provides the kind of personal service and support that is not available anywhere else: answers... technical literature... newsletters... evaluation... special disk formats... rush delivery... and more. But that's just the beginning. THE PROGRAMMER'S SHOP offers five times the product selection of any other supplier... at good prices. We are committed to helping you write better programs and get maximum productivity out of your software... while saving you time, trouble and money. Here are a few examples:

## Intriguing New Products

**The BRIEF™ Editor** for PCDOS is "Out of the way", fast, windows, undo, macros \$195

**LINT-like, SAFE-C** for C86 or Lattice/MS C also has runtime checks, more. "Pioneer". \$400  
**Profiler, source level in C** \$150

**"BASICA compiler"**, also access all RAM, modules, structured. Better BASIC, PCDOS \$195

## For CP/M-80

**ECOsoft C** is now complete, rich, fast, has library source, trig \$225  
Edit programs with **VEDIT** (\$119), **MINCE** (\$149) or "C" SE with source (\$75)

## Other Key Products

**C86** by CI (\$339), Lattice (\$359) from Lifeboat or Microsoft, and **Williams C** (\$475) are in a tight battle. Which is best for integration with Fortran? 8087? support libraries? speed? debugging?

**FORTRAN-86** from Microsoft (\$259) is improving with libraries for graphics (\$175), screen (\$265). Or consider the DR Fortran special.

**LISP** by Integral Quality (\$155) is well rounded while GC LISP (\$465) supports syntax closer to "Common LISP." Or Prolog-86 (\$125).

**Graphic "C" library** with source—for PC, Corona, printers, plotters, Hi-Res, 8087 option, with source \$195

**PLINK-86** is a program-independent overlay Linker to 32 levels for all MS Languages, C86 and Lattice. \$315

## FEATURED PRODUCT:

### Fast Incremental BASIC Compiler for IBM PC Programs and More: BetterBASIC™

Graphics, Screen and other extensions of BASICA are supported (with few exceptions) by this fast, pleasant, interactive, incremental compiler. PLUS it includes the extras you need.

- Built-in Full-screen Editing
- Speed: Sieve in 32 secs.
- Structured (Do... WHILE, etc.)
- 8087 Support Option, (\$99 extra)
- Recursion; shared variables
- Built-in WINDOWS support!
- Extensibility (make your own BASIC)
- Totally Interactive
- Assembler Interface
- Large Memory Use (to 640K)
- Procedures, functions, modules
- Local, Global, Shared Variables

**SUMMIT SOFTWARE** Wellesley, MA BetterBASIC is \$199  
BetterBASIC is for those who need BASIC without the frustrations.

For a catalog, comparisons, prices, or for an info packet on AI, or Editors, "C," BASIC, PASCAL, FORTRAN, or COBOL—or just for straight answers—

**CALL TOLL FREE 800-421-8006**

## THE PROGRAMMER'S SHOP™

The programmer's complete source for software, services and answers

128-B Rockland Street, Hanover, MA 02339 In Mass.: 800-442-8070 or 617-826-7531

## CHAOS MANOR

WRITE files into two large WordStar files with FILTER.COM was quick and easy; it took about 25 minutes on Zorro the Z-100.

Printing the resulting documents wasn't so easy. Although FILTER.COM changes WRITE formatting (dot) commands into their WordStar counterparts, the conversion isn't perfect because WRITE has some formatting commands that WordStar doesn't have. As an example, WRITE allows both right and left headers and footers; WordStar doesn't. If you have both sides of a header or footer in use, WordStar doesn't print it all—and worse, it eats the page numbers. Since the point of this exercise was to get a page-numbered manuscript, this was a futile exercise.

At this point Peter made a mistake: instead of going back to the original WRITE files and removing headers and footers (which would have taken less than an hour; WRITE is fast), he tried to work with the two enormous (about 300K bytes each) WordStar files, searching through them for dot commands. WordStar is slow at this kind of work. It took him several hours. There was also the problem of disk space: WordStar won't do elaborate searches without making backup files. Eventually he got that problem solved.

## FILE-SIZE BLUES

The next job was to get a list of unique words. Alas, Peter discovered that Wordfreq won't work with big files. It keeps its list in memory, and after reading through a document for many minutes, it can just give up and die with an "Out of Memory" error. Thus, it was back to FILTER.COM to chop up the WordStar files into manageable lengths. (FILTER.COM, with a whole bunch of other filter programs that convert files from one editor's format to another, is available on a disk of filters from Workman and Associates. I wrote some of the filters, and Tony wrote FILTER.COM at my request. I can't imagine living without these utilities.)

Eventually the job got done, and

(continued)





## IMAGINE IT. CREATE IT. EVEN PRINT IT. IT'S AMAZING WHAT YOU CAN DO WITH THE KOALAPAD.

You have the vision. Now you've got the touch. The KoalaPad™ touch tablet plugs right into your computer, and makes beautiful high-resolution graphics easy. For charts and graphs, for cartoons and electronic artwork, or just for doodling around. You don't need programming skills. You don't need to remember commands.

The KoalaPad comes complete with graphics software that displays a full array of colors, shapes, patterns and functions right on the screen. Just point to what you want, then draw right on your KoalaPad. Instantly, your visions turn into spectacular full-color images right on your screen.

You can save your designs to disk. And now, with our Graphics Exhibitor™ (for Apple®) or KoalaPrinter™ (for Commodore 64™) software, you can even print out your designs—for the best reproduction of on-screen graphics available. Your imagination knows no limits, with the KoalaPad and Koala software.

For the Apple, Atari®, Commodore 64, IBM® PC and PCjr. computers.



**Koala Technologies**  
800-KOA-BEAR

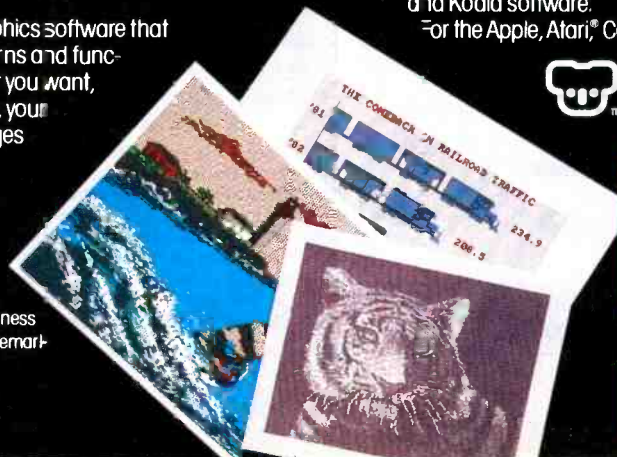

Apple, Atari, and IBM are registered trademarks of Apple Computer, Inc., Atari, Inc., and International Business Machines Corp., respectively. Commodore 64 is a trademark of Commodore Electronics, Ltd.

© Koala Technologies



*SuperDex scans the text and stops at any word or phrase you've told it to look for, then displays it and waits for a decision.*

Peter had a list of words, such as BASIC, FORTRAN, documentation, CP/M, and the like. There was only one problem: many of the words that ought to be indexed occurred hundreds of times in the book. No index needs *that* many entries.

The SuperDex indexing program scans through the text and stops at any word or phrase that you've told it to look for. Then it displays it in context and waits for a decision. You can then include that instance in the index, make a modified index entry, or forget it. With words like BASIC, though, where there are hundreds of occurrences, it would take forever to make an index. Peter tried a number of ways around the problem, such as finding words associated with the searched-for words. Eventually he had his index search list.

When he tried it, he found to his horror that SuperDex's document tells you, in the back of the book, that the program won't work with files larger than 64K bytes in size, but it can work with a document spread out over a number of files, provided that each ends with a forced .pa (end of page).

There was nothing for it but to go back to FILTER.COM; eventually he had 13 files of about 64K bytes each. Of course, using the forced end of page on each one changed the page numbering, so that the printed manuscript he'd started with was useless. The manuscript had to be printed all over again.

**THE LAST PROBLEM:  
SUDDEN DEATH**

Peter's report continues:

"With all this done I started SuperDex. Everything seemed fine. My only complaint was the time it took to go through a page. It seemed that there were two words per sentence that SuperDex would find that matched my list of words to watch out for. Clearly, there were too many words in the 'look for' list. Still, I was worried that if I removed too many I might miss an important reference.

"The worst part is that SuperDex stops and redraws the screen each time it finds a new match. This really slows things.

"Halfway through the first file the program stopped and said it was done. I didn't have time to find out why. Six pages had taken almost two hours, and the index was already late. I was just about to do the entire index by hand when I realized that SuperDex could still work if used in a different way.

"SuperDex works in two steps. First it creates a raw index file that lists

words and phrases along with their page locations in the document. It then prints a formal index based on the information from this file. It was the first half of the program that wasn't working properly. All I needed to do was read through the printed copy of the manuscript and jot down with a text editor any words or phrases that I wanted in the index along with their location, following the format of the SuperDex raw index.

"The resulting file looked like this:

```
Pcats
Ssmall gray ones
14
Pcats
S
47
Panimals
Scats
47
Pdogs
S
59
```

and so forth. Converted into a formal index, those (with other entries) came out

```
Animals
  cats, 47
  dogs, 59, 102
Cats, 47
  small gray ones, 14
```

"I found that to do a comprehensive index with plenty of cross-referencing and multiple listing it's still necessary to use the human brain to analyze in-

*(continued)*

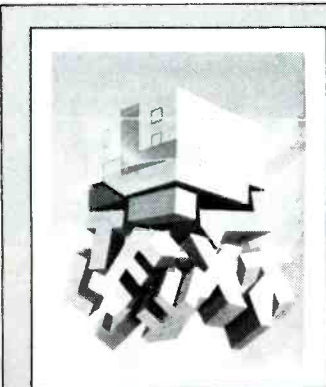

**Through the Trap Door**  
March 1979—\$35

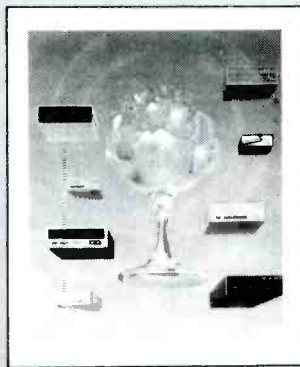

**Breaking the Sound Barrier**  
September 1977—\$35

**BYTE COVERS**

The prints shown at left are beautiful Collector Edition Byte Covers, strictly limited to 750 prints each, and signed and numbered by the artist, Robert Tinney. Each print is 18 in. x 22 in., and is accompanied by its own Certificate of Authenticity. To order, use the coupon below. Visa and MasterCard orders may call 1-504-272-7266.

Please send \_\_\_\_\_ **Through the**  Visa  MasterCard  
**Trap Door** prints (\$35), \_\_\_\_\_ Card No. \_\_\_\_\_  
**Breaking the Sound Barrier** Expires: \_\_\_\_\_  
 prints (\$35), or \_\_\_\_\_ sets of both prints Name: \_\_\_\_\_  
 (\$55). I have included \$3 per order shipping Address: \_\_\_\_\_  
 and handling (\$8 overseas). City: \_\_\_\_\_  
 I have enclosed check or money order. State: \_\_\_\_\_ Zip: \_\_\_\_\_  
 Please send me your color brochure.

**Robert Tinney Graphics** - 1864 N. Pamela Dr. - Baton Rouge, LA 70815

# \$2,490

## ***Great Lakes offers you add-on storage and tape back-up at an unforgettably attractive price***

So you're about to outgrow the storage capacity of your IBM PC™ or compatible computer? And now you're biting your nails over the cost of adding more bytes.

No need! Consider the eminently memorable combination price of the Great Lakes Superior 10™ hard disk subsystem and the Great Lakes Quartermaster 23™ tape back-up module.

### ***The Superior 10—\$1495***

Not only is our \$1495 price considerably lower than the nearest 10-megabyte competitor, but we offer the best dollar-per-megabyte ratio for the 23mb and 40mb subsystems as well. The ratios? 10mb at \$149 per mb; 23mb at \$98 per mb (retail \$2249); 40mb at \$70 per mb (retail \$2795).

### ***Quartermaster 23—\$995***

This optional 23mb tape back-up module is simple to use and efficient as well. Take, for example, our remarkable Selecta-File™ feature. This 1/4-inch tape drive module allows you to back up and restore data using selective file-by-file data transfer (or full streaming). And it masters all this for just \$43 per megabyte.

### ***Complete and ready-to-use***

When you buy a Superior hard disk subsystem, everything is there, ready to operate at high speed. This includes: high quality fixed hard disk, controller board, software that runs on DOS 1.1 and 2.0 (CP/M 86™ and other operating systems available), host adaptor board, integral power supply, cables, external custom chassis with additional space for our tape back-up, and documentation.

### ***Our line is expansive, not expensive***

Need even more storage for your IBM PC or compatible? We offer hard disk subsystems including 65, 110 and 140mb—all designed for superb quality at the very lowest possible prices. And we stand behind all our products with our 90-day warranty. That's because our quality lives up to our first name.

***Available at leading dealers everywhere***



**GREAT LAKES™**  
COMPUTER PERIPHERALS, INC.

***We live up to our first name***

2200 W. Higgins Road, Hoffman Estates, IL 60195  
1-800-323-6836/1-312-884-7272

IBM PC is a trademark of International Business Machines Corporation.  
Superior (10 through 140), Quartermaster 23, and Selecta-File are trademarks of Great Lakes Computer Peripherals, Inc.  
CP/M 86 is a trademark of Digital Research, Inc.

Circle 396 on inquiry card.



dividual words and their contexts. The best way is to read the manuscript yourself; having the computer seek out words and phrases actually slows you down if the index is of any significant size.

"An ideal program for me would not need to scan any documents but would keep track of all words you want to enter in the index, related page numbers, and cross-references or other duplicate entries you wanted. Once that's done it would print the index in proper form."

I think I recall seeing a program that works the way Peter describes: you go through a document and *mark* the words or phrases you want indexed, adding others (with special marks) as needed. The program then goes through and makes an index.

Alas, I seem to have mislaid that program.

We'll be producing many more

books that need indexes, so there'll be plenty of opportunity to test other programs.

### WRAPPING UP

I'm out of time and space (not unusual for a science-fiction writer). I'd hoped to have time to play with some more goodies. We have ThinkTank for the Macintosh; I just got it, and I must say I'm very fond of what I've seen.

There's Idea Ware's The Idea Processor, which is a sort of combined card file and text editor for the PC. It looks to be valuable, and I suspect I'm going to be using it a lot.

I'd hoped to do a detailed report on Savvy, which may be the most user friendly database program in existence. This is the one that recognizes misspelled comandz. We're still wringing it out, but I like everything about it so far.

Finally, we have Koala Technologies'

KoalaPad touchtablet for the IBM PC. I got to play with that at the Atlanta COMDEX, and I'm really looking forward to using it. The touchpad lets you add a whole bunch of new function keys to what you're doing or, alternatively, use it for finger painting. It'll be interesting to compare it to our Microsoft Mouse for the PC.

The game of the month for me has been Rogue; I've got to the twenty-first level with a saved game, and when I get back from NCC I'm going to see if I can't win. I also have a compiled version of Cygnus's Star Fleet I; compiling speeds it up wonderfully and removes many frustrations.

The clone of the month is still the Zenith Z-150, which does everything you'd want an IBM PC to do and does it just a bit more elegantly.

There are two recommended books this month. First, Richard Weiner and Richard Sincovec's excellent *Software Engineering with Modula-2 and Ada* (John Wiley and Sons, \$24.95) examines both those languages, compares them, and looks at what is meant by software engineering. It's not for the casual user, but anyone interested in software trends will want it.

The second book of the month is *Fire in the Valley: The Making of the Personal Computer* (Osborne/McGraw-Hill, \$9.95), a partial recount of what it was like in the early days of the computer revolution. Paul Freiberger and Michael Swaine have some details wrong, and they've left out some important players, but they've done a better job of capturing the flavor of Silicon Valley as it bloomed than any other book I've seen.

And, of course, there are boxes and boxes of stuff we'll get to Real Soon Now . . . ■

## Data Director Communications Switch. (DD-1)

**\$49<sup>00</sup>\***  
ea.

Special Factory-Direct Price

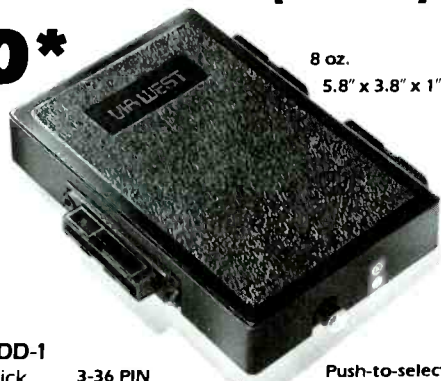

8 oz.  
5.8" x 3.8" x 1"

3-36 PIN  
Female Ports  
Mate to AMP 552144-1  
Connectors

Push-to-select  
switch

No power cables needed – just plug the DD-1 into your PC system and you can print quick rough drafts on a dot-matrix printer and then switch to a letter quality printer instantly with the push of a button. (Or you can specify Option A which allows two computers to share one printer.) DD-1 works with most popular PCs and printers using parallel data communications. This is a high quality industrial grade switch that is completely data transparent. To order DD-1 simply call [602] 623-5716 or write for shipment from stock. Ask about our special low prices on cable connectors.

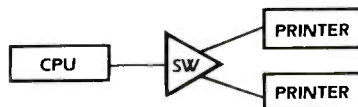

\*Single unit price – freight collect. For post-paid delivery send \$52 per switch. Checks, Visa, Master Charge and C.O.D. orders accepted. Quantity discounts available. AZ res. add 7%.

**VIA WEST, INC.**  
"The Interface Company"  
534 North Stone Ave., Tucson, Arizona 85705

Jerry Pournelle welcomes readers' comments and opinions. Send a self-addressed, stamped envelope to Jerry Pournelle, c/o BYTE Publications, POB 372, Hancock, NH 03449. Please put your address on the letter as well as on the envelope. Due to the high volume of letters, Jerry cannot guarantee a personal reply.



# LAST NIGHT, COMPU SERVE TURNED THIS COMPUTER INTO A TRAVEL AGENT FOR JENNIE, A STOCK ANALYST FOR RALPH, AND NOW, IT'S SENDING HERBIE TO ANOTHER GALAXY.

## No Matter Which Computer You Own, We'll Help You Get The Most Out Of It.

If you've got places to go, CompuServe can save you time and money getting there. Just access the Official Airline Guide Electronic Edition—for current flight schedules and fares. Make reservations through our on-line travel service. Even charter a yacht through "Worldwide Exchange."

If your money's in the market,

CompuServe offers a wealth of prestigious financial data bases. Access Value Line, or Standard and Poor's. Get the latest information on 50,000 stocks, bonds or commodities. All on line with CompuServe.

Or if, like Herbie, intergalactic gamesmanship is your thing, enjoy the best in fantasy, adventure, and space games. Like MegaWars, the ultimate computer conflict.

To get all this and more, you'll need a computer, a modem and

CompuServe. CompuServe connects with almost any personal computer, terminal, or communicating word processor. To buy a Starter Kit, see your nearest computer dealer. To receive our informative brochure or to order direct, call or write:

## CompuServe

Consumer Information Service  
5000 Arlington Centre Blvd., Columbus, OH 43220  
**800-848-8199**  
In Ohio call 614-457-0802.

An H&R Block Company



# Join the network

Develop a program for the new IBM  
PC Network.

Promote yourself into the top ranks of network programmers. Write new programs or modify existing ones to run on the local area network that's sure to be a best seller.

Capitalize on a chance to be in from the beginning with integrated business applications, productivity tools and office automation programs.

A high-level interface card makes programming for the IBM PC Network fast and easy. Full data sharing and byte locking capability, multiple servers, two megabits per second data transmission and a complete diagnostic package make the network equally as attractive to the end user.

For complete details about joining the network call 1-800-426-2700. Or write IBM Corporation, Editor, IBM Personal Computer Seminar Proceedings, 5Q9/4629, P.O. Box 1328 Boca Raton, FL 33432.

Circle 169 on inquiry card.

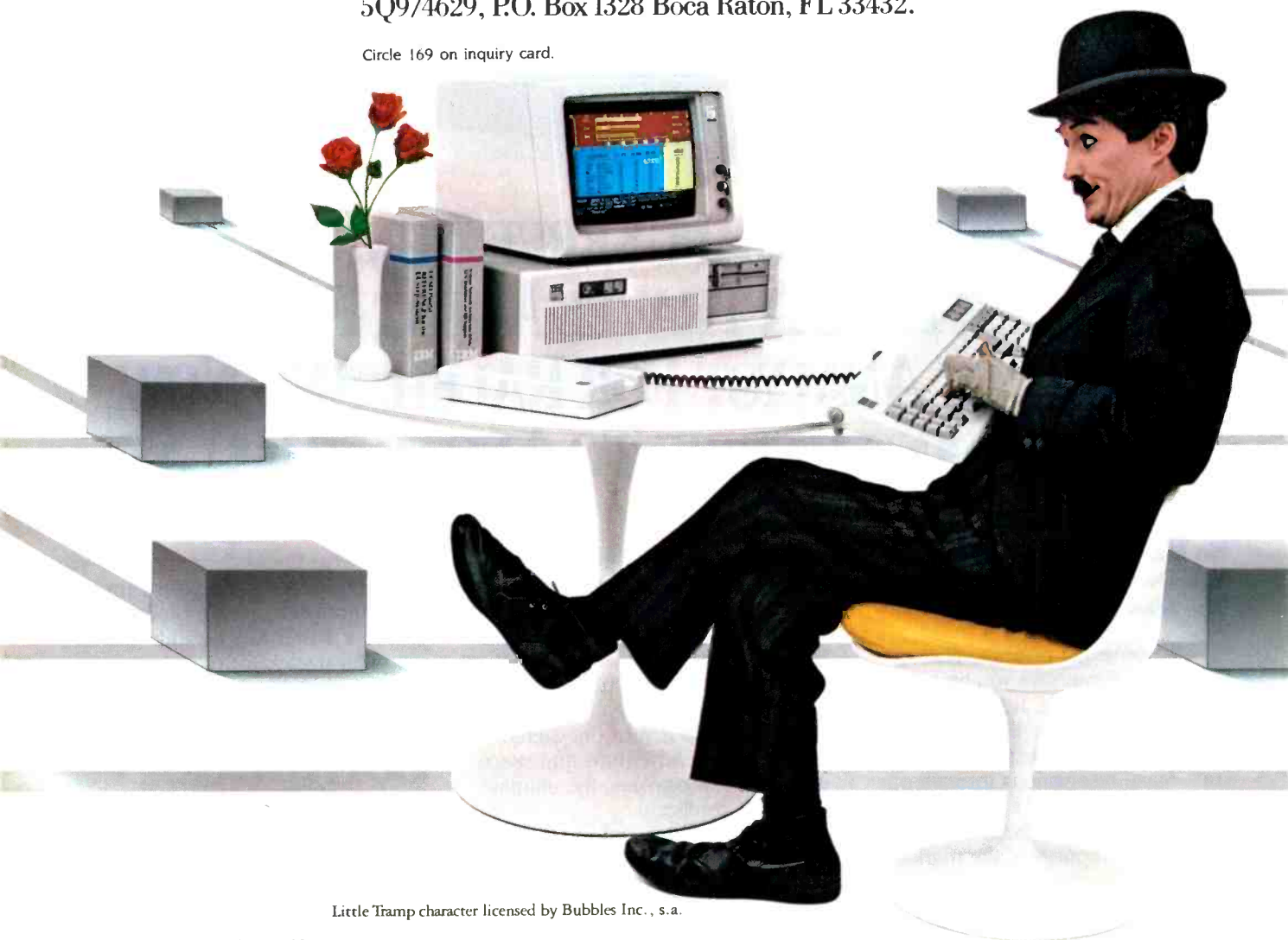

Little Tramp character licensed by Bubbles Inc., s.a.

# IBM PC Network Specifications

## IBM PC NETWORK ADAPTER

### HARDWARE HIGHLIGHTS

#### MICROPROCESSORS

- 6MHz 80188
- 6MHz 82586

#### MEMORY

- 32K PROTOCOL ROM
- 16K RAM
- 8K NET BIOS ROM

#### VIDEO COMPATIBLE RF MODEM

- TRANSMIT 50.75 MHz (CH T14)
- RECEIVE 219 MHz (CH J)
- SUPPORTS 1000 NODES
- MAXIMUM DISTANCE 5KM RADIUS FROM HEADEND
- MULTIPLE SERVICES POSSIBLE

#### DIAGNOSTICS

- POWER-ON SELF TEST
- ON-LINE MEDIA MONITORING

#### OTHER

- SUPPORTS DMA DATA TRANSFERS
- 2-MEGABIT/SECOND DATA RATE
- MID-SPLIT BROADBAND

### FIRMWARE HIGHLIGHTS

#### OPEN ARCHITECTURE

- PEER-TO-PEER NETWORK
- OPERATING SYSTEM INDEPENDENT
- LOCALNET/PC™, PUBLISHED LAYERED PROTOCOL

#### FUNCTIONS

- BASE FUNCTIONS PROCESSED ON THE ADAPTER, NOT THE PC
- DISTRIBUTED NAME SUPPORT
- REMOTE PROGRAM LOAD
- 32 CONCURRENT TWO-WAY SESSIONS
- HIGH THROUGHPUT RATE AT SESSION LAYER
- CHARACTER SET INDEPENDENT

## IBM PC NETWORK CABLING SYSTEM

### IBM PC NETWORK TRANSLATOR UNIT

#### HARDWARE HIGHLIGHTS

- SINGLE RF CHANNEL CONVERSION
- ATTACHMENT OF UP TO 72 PCs WITH IBM CABLING
- ATTACHMENT OF UP TO 256 PCs WITH CUSTOM CABLING
- DATA ONLY
- ALLOWS NODES WITHIN A 1000-FOOT RADIUS

#### CABLE

##### TYPE

- STANDARD CATV MEDIA (75 OHM COAX)
- TREE TOPOLOGY
- CATV STANDARD F-CONNECTORS
- PREBALANCED BROADBAND NETWORK

#### KITS

- BASE EXPANDER (ALLOWS EXPANSION FROM TRANSLATOR)
- SHORT-DISTANCE KIT (1 FOOT ADDITIONAL CABLE)
- MEDIUM-DISTANCE KIT (400 FEET ADDITIONAL CABLE REQUIRED)
- LONG-DISTANCE KIT (800 FEET ADDITIONAL CABLE REQUIRED)
- CABLE AVAILABLE IN 4 LENGTHS: 25 FT., 50 FT., 100 FT., AND 200 FT.

#### MAXIMUM PCs AND DISTANCES SUPPORT

	RADIUS FROM TRANSLATOR	PCS
• TRANSLATOR ONLY	200 FEET	8
• 8 SHORT-DISTANCE KITS	200 FEET	72
• 8 MEDIUM-DISTANCE KITS	600 FEET	72
• 8 LONG-DISTANCE KITS	1,000 FEET	72
• 8-KIT COMBINATION	200 to 1,000 FEET	72

## IBM PC NETWORK SOFTWARE

### DOS 3.1

#### EXPANDED SUPPORT FOR NETWORKING

- FILE SHARING
- RECORD LOCKING DOWN TO BYTE LOCKING

#### PROGRAM INTERFACE TO NETWORK SOFTWARE

- REDIRECTION CONTROL
- INSTALLATION CHECKING
- DIRECT EXECUTION OF NET BIOS FUNCTIONS
- MULTIPLE SERVERS

#### IBM PC NETWORK PROGRAM

#### FULL SCREEN INTERFACE AVAILABLE

##### REDIRECTOR

- ALLOWS USE OF SHARED PRINTERS
- ALLOWS USE OF SHARED DISKS AND DIRECTORIES
- PROVIDES CAPABILITY TO SEND MESSAGES

##### FILE SERVERS

- SHARED USE OF NAMED DISKS OR SUBDIRECTORIES
- PASSWORD PROTECTION AGAINST UNAUTHORIZED ACCESS
- VARIETY OF ACCESS MODES SUPPORTED (E.G. READ ONLY)
- RECORD LOCKING TO CONTROL MULTIPLE UPDATES

##### PRINT SERVER

- SHARED USE OF NAMED PRINTERS
- PASSWORD PROTECTION AGAINST UNAUTHORIZED ACCESS
- AUTOMATIC SPOOLING AND QUEUING OF OUTPUT
- QUEUE MANAGEMENT FACILITIES ON SERVER STATION

##### MESSAGE SERVER

- INTERACTIVE MESSAGE EDITING/TRANSMISSION/RECEPTION
- PRESERVES FOREGROUND APPLICATION CONTEXT
- AUTOMATIC NOTIFICATION OR LOGGING TO DISK/PRINTER

LOCALNET/PC IS A REGISTERED TRADEMARK OF SYTEK, INC.





## MISCELLANEA

Dear Jerry,

A few notes regarding your May column. Ahem, about your enthusiasm for the Sage, is it not a bit extreme to call it the best? Have you tried Charles River Data Systems' Universe, Microtechnology Unlimited's MTUI40, or even HP's 9826? Calling the Sage the best 68000 machine among those you've personally evaluated would perhaps be more fair. I own a Sage and certainly prefer it to any other micro or mainframe I've had to deal with.

I too would encourage you to venture into FORTH and would suggest David McClain's HyperFORTH+ as the vehicle of choice. David is an astrophysicist who worked on the control system written in FORTH for the multiple-mirror telescope; he has authored an impressive system. HyperFORTH+ runs (screams) on the Sage, and if you are familiar with the UCSD p-System, it should be easy to learn. The user interface is similar to the p-System, and the text files and screen editor are compatible. It is a multitasking FORTH with many extensions suitable for real-time control. The documentation is quite good, and there is an on-line Help utility. Source code can be in one contiguous text file, and you do not have to hassle with screens of code.

David McClain was at the Sage Faire, and I saw a demo of his new HyperFORTH II that left me speechless. It looks like the programming environment of the future. It has a flexible syntax, allowing you to use the syntax of other high-level languages; there is a Lisa-type windows feature, a code profiler/optimizer, and many other goodies that were over my head.

It seems of late that your column leans a little too much in the software review direction and not enough in the direction of software techniques. How about hiring some more staff and breaking your column into two parts: a software review part and a software techniques part. We need the equivalent of a Circuit Cellar for software.

Anyway, I much enjoy your column. Keep up the crusade against obfuscating obscurantists.

PETER NORTON

*You're right, of course: I should have qualified my statement. In my defense: I have several times spoken highly of the Charles River Data Systems machine; and the Charles River system costs quite a lot more than the Sage.*

*My son Alex is a Charles River Data Systems fan. I believe I've mentioned that.*

*For the past three weeks, Larry Niven and I have been grinding 8 hours a day on our novel Footfall; when that's done, I intend to enjoy my Sage IV a lot more. I've always wanted to learn FORTH just to see what all the enthusiasm is about. On the other hand—the Modula-2 operating system will be running on the Sage about the time this is in print, and I'm very much looking forward to that.*

*I used to do a lot more Software Circuit Cellar work, and once this novel is done I hope to get back to it. Thanks for the kind words. I like your stuff too.—Jerry*

## CP/M-86

Dear Jerry,

In the May User's Column, you discussed the CompuPro CP/M-8/16 system. I recently found that the Zenith implementation of CP/M-86 for the Z-100 computer also will automatically run 8-bit \*.COM programs as well as the 16-bit \*.CMD programs. This capability doesn't seem to be publicized, and I didn't even find it in the manual until after I accidentally discovered it. Naturally, there are a few restrictions, but they seem to be minor.

I haven't checked out this capability as thoroughly as you check your software, but everything that I have tried works fine. My requirements are considerably more modest than yours, but you might be interested in investigating this too.

LARRY HUDSON  
Ventura, CA

*Zorro, our Z-100, runs most CP/M 2.2 programs under CP/M-86 just fine; the Z-100 is indeed a good 8/16 machine. I think there are a couple of programs with fairly sophisticated BIOS calls that give it problems, but 95 percent of your 8-bit software will run under the 16-bit oper-*

*ating system. I believe I've mentioned this in previous columns.*

*I've no notion why Zenith doesn't advertise this 8/16 capability. The CP/M 2.2 programs that run under ZCP/M-86 run faster and better because they have a large TPA (temporary program area) for workspace.—Jerry*

## A SYSTEM THAT CAN TRAVEL

Dear Jerry,

I have a CompuPro 8088/8085 system with half a megabyte of RAM, a 20-megabyte hard disk, two 8-inch floppy-disk drives supporting four terminals, two printers, and a modem. It is running under MP/M-8/16. It works just fine looking after a small office environment. Although a bit slow when we are all on together, I know that I can upgrade it as new hardware and software become available. I like it. Not one hardware failure in 18 months!

I have a question that I am having difficulty finding an answer to. I believe that you have been there, and I am hoping that you will share your experiences with me.

I would like an additional system. I usually would reside at home but on occasions could travel with me on business. I would like it to be a portable system in the sense of the IBM or the Compaq. It would be a single-user system. As I am familiar with the MP/M-8/16 operating system, I would like to run the new system under CP/M-86 or CCP/M-86.

Such new systems use the IBM 5¼-inch disk format whereas the CompuPro I have uses the 8-inch IBM standard. I have not been able to find a suitable portable system that uses the 8-inch disk format.

I would like to be able to take 5¼-inch disks full of data files between the two. I am using WordStar, dBASE II, and SuperCalc, and I should like to be able to run these applications on both systems. I understand that I will require new versions of these programs, but I am hoping that there will be some way to interchange the data, other than using a modem.

Can I do it? Can I remove an 8-inch floppy-disk drive from the floppy-drive system and add an IBM-compatible

(continued)

# Silent/Scribe<sup>®</sup>

Go Quietly.



In these modern times, you have to go all out to stay ahead of the competition. And going with our up-to-date Silent/Scribe printers can help keep you there; because Silent/Scribe quietly goes about your business reports, letters, charts and graphs, while you quietly go about your business.

Unruffled. Undisturbed. And assured that the letter you signed on the first day of the month and the final monthly report will both have

the same crisp high-quality look.

All Silent/Scribe printers feature snap-in long life ribbon cartridges, easy-to-use controls, and Logic/Card<sup>®</sup> interfacing to fit virtually any computer.

And they come in a variety of models to fit your specific needs and budget.

Call us today and discover how going quietly can quickly get you ahead.

Outside California: (800) 4-ANADEx  
In California: (800) 792-9992

© Copyright 1984 Anadex, Inc.



**Anadex** ... When you know printers.

ANADEx, INC. • 1001 Flynn Road • Camarillo, CA 93010 • Tel: (805) 987-9660 • TWX: 910-494-2761



5¼-inch floppy instead, or even add a new 5¼-inch floppy-disk subsystem? Would the Disk I controller board in the CompuPro handle the different disk format? Would the BIOS in MP/M-8/16 "understand" it? Where can I start?

WILLIE FAHNESTOCK  
Toronto, Ontario, Canada

*I just got word that CompuPro's new Disk IA controller, which will run 5¼-inch drives as well as 8-inch ones, is available; Tony Pietsch's new BIOS was designed to work with it. I don't have my 5¼-inch drive installed yet, but I will very shortly—and with Tony's new Format program, I can read darned near any 5¼-inch disk format, including the Otrona, which I tend to take with me on trips.*

*The Otrona is very portable and an excellent Z80 machine. I'm not much impressed with the 8086 upgrade for it, but it does work. Eagle makes a fairly nice portable, but I don't really wish the documents on you.*

*I suspect it won't be long before darned near everything will run Concurrent CP/M and then you won't have a problem.—Jerry*

## LANGUAGE POPULARITY

Dear Jerry,

I respect your opinions regarding future developments, but I think you may be wrong concerning your C, Modula-2, and Ada prognosis. The micro business is so volatile that often the most accessible product becomes the standard, not the best. Of the three languages, I personally prefer Modula-2. It really is the best all-around language of the three for the micro world. Modula's problems, however, are numerous:

1. The best version requires the UCSD p-System and costs too much.
2. Licensing arrangements are prohibitive for the small entrepreneur.
3. Most versions are immature.
4. Even though the 8-bit world is waning in influence, there should be a CP/M version available.
5. It lacks a wide base of support.
6. It is not being promoted well.

Ada is too big and complicated to earn many fans in the microcomputer world. That leaves C, which is rapidly becoming the next new language. I think it may just become the most popular language for small systems. Just look at the ads. Many

versions are available, support tools abound, and its supporters are many. If the past can be used to predict the future, C will be the preeminent language.

It is unfortunate that the main producers of Modula-2 are in effect contributing to their own lack of rapid growth. They have the best product but are unnecessarily restricting their product to limited growth. They need to reduce the prices of their products, produce native-code MS-DOS and CP/M versions, actively promote their products, and support growth by tearing up the dumb licensing agreements.

Languages become popular in the micro world because the hackers use them. Most hackers can't afford to purchase a poorly supported language implemented on a nonstandard operating system for a computer they don't own. Modula-2 producers need to wake up before C relegates them to also-rans.

ROBERT A. WILLIS JR.  
Hampton, VA

*I completely agree: the Modula-2 implementations we can get just at the moment do not do the language justice, and your complaints are well founded.*

*However, things are changing. A new Modula-2 compiler, complete with native-code compiler and Modula-2 operating system, is due to come out of England just about the time this is in print. Volition Systems continues to swear blind that a 68000 stand-alone native-code Modula-2 compiler is "just about finished." Logitech continues to work on the 8086 stand-alone—and if the company doesn't get it done pretty soon, Philippe Kahn of Borland has promised me his own Turbo 8086 stand-alone complete with integrated editor and all the other features we get with Turbo Pascal.*

*If we don't get good implementations of Modula-2, C may just win by default; which, in my view, would be a pity, because I have trouble remembering just what lines of C do—even if I wrote the lines.*

*Hang in there . . .—Jerry*

## VALDOCS

Dear Jerry,

I've enjoyed your incisive discussion of the Epson QX-10 over the months, but I've always harbored the suspicion you aren't as familiar with Valdocs as you claim to be, certainly not as you are with WordStar and some of the others. Which makes sense: using WordStar or PeachText re-

quires some practice, while Valdocs does not.

But lo: In May's BYTE I find an actual, quantifiable "benchmark." In response to a letter praising Valdocs, you mutter, "it takes nearly a full minute simply to erase a single file under Valdocs . . ."

What?

Via Valdocs Index, I erased a 13-page, single-spaced document in 21 seconds. That's from writing screen back to writing screen. But then again, as a professional writer, I'm familiar with Valdocs.

So I pretended not to know Valdocs, and, wading through the menus, waiting for each to compose itself before selecting options, I erased copies of the same document in 31 seconds via Index and 34 seconds via Copydisk.

Anyone who requires "nearly a full minute" to erase a Valdocs file must spend half that time staring at the screen humming "dum dum dee dum dum" and wondering what's on tonight's Mr. Rogers.

How about some more QX-10 benchmarks from Pournelle?

PAUL BUNNING  
Spokane, WA

*With my Z80 CompuPro running WRITE under CP/M 2.2, I just saved a 23-page document in 7 seconds; erased all text in 2 seconds; and killed a file in 4 seconds. Killing additional files would take about 2 seconds each.*

*When I used Valdocs, I found my disk was full of back copies of the file because I save text often. Saving took forever; but killing those old dead files took time, too. If you say there's a way I could have erased the files in only 31 seconds I'll believe you—but that's quite a long time, you know.*

*With the version I had, it took a full minute, and I was actually watching The Pajama Game on the late show.*

*I'll do the new benchmarks on the QX-10 when Epson hands over the new and improved software it has sworn mighty oaths to provide.—Jerry*

## TOMCAT, ANYONE?

Dear Jerry,

I purchased a PCX-1800 personal computer from Tomcat International Inc., Intersystem Group, Tokyo. Before I received the systems software and documentation, Tomcat went bankrupt. Now all I have is unusable hardware.

Can you help me make contact with the  
*(continued)*

# Now, You Can Buy an IBM-PC™ and OPTOMUX from Opto 22.

(Industrial Control has never been Easier!)



**Opto 22, an IBM-PC Value Added Dealer,** combines OPTOMUX and the IBM-PC to provide a powerful general purpose industrial control or data acquisition system. Optically isolated analog and digital I/O modules plug into a variety of mounting racks which communicate to the IBM-PC over a simple pair of twisted wires.

Opto 22 provides the software to program the PC in a high level language, commanding OPTOMUX to perform:

- Process Control
- Energy Management
- Machine Control
- Data Acquisition or any combination of analog or digital control.

Our application engineers are ready to answer any questions you may have regarding the use of the IBM-PC and OPTOMUX. Call us at 1-800-854-8851.\*

**opto 22**

15461 Springdale Street ▪ Huntington Beach ▪ California ▪ (714) 891-5861

\*In California use our direct line.



representative of this firm in the U.S.? In case Tomcat is out of business for good, perhaps printing this letter would help me make contact with someone who purchased the same PC and has the software and documentation.

HUIBNER ALEKSANDAR  
Ljube Stojanovica 22  
11000 Beograd  
Yugoslavia

*Alas, I never heard of Tomcat International, and a quick check hasn't turned up anyone who has.*

*I'll ask them to include your address; perhaps someone with systems software and documents for your machine will make contact with you directly.*

*I don't go quite as far as my British columnist friend who advises his readers never to buy anything they haven't seen working in a store, but it certainly pays to be cautious, especially with international orders. Good luck.—Jerry*

NAVIGATION AIDS

Dear Jerry,

Being a merchant seaman, I have plenty of time at sea to work on my new hobby (computers) but few resources other than the written word from which to learn.

In the March User to User, I was interested in "A Mariner Queries" Mr. Williams asked about the suitability of his Z-100 for use as a navigation tool aboard a cruising sailboat, and I feel you gave him a good and honest answer. There are a couple of comments I'd like to make, however.

I've been playing around with programmable calculators and hand-held computers, trying to figure out how best to apply them to navigation and other ship-board applications. We have been promised Z-100s by our office, and to borrow your phrase, "they'll be here Real Soon Now." Anyway, my basic conclusion is that for navigation the best implementation is with programs in ROM or in a computer with nonvolatile memory, such as my Sharp PC-1500. My point is this: navigation does involve working with numbers, but it is not very difficult, nor especially tedious. For a computer to contribute to easing the work load, it must be both easier and faster (not to mention that it also *must* be at least as accurate and reliable) as doing the same operation by hand. If I had to spend a minute or two starting up a computer, loading a program, etc. before I could begin, I think I'd be better off with a scientific calculator and a

nautical almanac.

My conclusion, therefore, is that an ideal instrument for navigation would be a hand-held or lap-sized computer using CMOS technology and with the ability to maintain multiple programs in ROM or RAM. How much memory is required? I believe that 16K bytes of RAM is more than enough for even an elaborate navigation program. I have a fairly adequate program that does great circle and Mercator sailings, sight reductions, and azimuths and that is written in my own personal horrible BASIC code and fits in 1.8K bytes of standard PC-1500 RAM. With this type of implementation, it is a matter of picking up the computer, turning it on, and hitting one user-defined key to do what I need to do.

I've looked at the Radio Shack TRS-80 Model 100 and consider it to be suitable, but I think I'll be getting an HP 71B, mainly because it's smaller and can function as a calculator. A lot of navigation is improvisation and doesn't conform too well to the structure of a program! One last point: a printer is invaluable to peace of mind.

CHUCK BECKER  
Sparks, NV

*Captain, if you're an example of the Navy's computer neophytes, I don't think the nation has a lot to worry about. I've never done any blue-water navigation, but I have been led through the exercises; apparently there's a certain, uh, creative fudging done by the best.*

*On the other hand, sight reductions are a pain. I wonder why someone doesn't manufacture ROMs to turn one of the little CMOS machines into an instant navigation computer.*

*Of course, with a bit more work, all the almanac tables could be included on a disk or tape; but that would be a more complex machine. I always worry about moving parts in salt air—and everything in a small sailboat gets wet.—Jerry*

POTPOURRI

Dear Jerry,

After reading your column for the past three years or so, I feel like making a few comments.

I noticed your recommendations for a computer for someone that does a great deal of writing. I recommend the combination that I am currently using. The computer is a Sanyo MBC-1250 CP/M machine. It uses two 640K-byte drives, a green

screen that displays 80 columns by 34 lines, detached keyboard with 15 dedicated function keys, and the complete MicroPro software line. My printer is a Juki 6100 daisy-wheel printer that types at a reasonable speed of 18 cps. I purchased the entire system for \$1995 at a computer store in Colorado Springs. I feel that this system is excellent for writing and for people looking for a business computer. It certainly is a major improvement over my old Apple II+ that I tried to make a business computer out of. I agree that almost any non-toy/game computer is a definite improvement over a typewriter.

I would love to try WRITE, but I absolutely refuse to pay more than \$100 for a program! I feel that the price of excellent books should equal that of excellent software. This is one of the reasons I bought a computer that had a large amount of software included, plus runs CP/M-80. I've sent for Borland's Turbo Pascal on your recommendation and may one day try Modula-2. Obviously, Borland feels that you can earn a decent living selling software for less than \$100.

Congratulations on your victories in the software licensing contracts. I often wonder if lawyers ever took English I in college.

My main reason for writing is the S-100 bus. I have always wanted an S-100 system, but the high cost always seemed to be the negative deciding factor. Lately I have begun to feel that the S-100 is too costly for its own good. I felt rather justified when you acquired the Sage IV, and then I read the "Inside Track" column by John C. Dvorak, in the June 11, 1984 issue of *InfoWorld*. Mr. Dvorak pronounces, "The S-100 bus is dead." He gives these reasons for his decision: the magazine *S-100 Microsystems* changed its name to the *Journal for Advanced Microcomputing* and the high cost of the S-100 bus system. If it survives, "it will do so only as a ghost on the OEM level..." I don't know what background Mr. Dvorak has in the computer field, but some of the things he says ring the common-sense bell. Having the ability to change cards in the S-100 system really made sense when we saw the progress in microchip processors, memory boards, the advent of hard-disk systems with their special controllers, and I/O circuits, but I don't think that a home computer user really needs anything other than a Sage IV. As a matter of fact, a good Z80 machine might satisfy 90 percent of the home computer/small business users.

You have repeatedly mentioned that  
*(continued)*

**NEW INSIDER  
SUB SYSTEMS**

#18 SHOWN

**\$895.00**

- IS00**
- 10 Mega-Byte Winchester
  - Hard Disk Controller

**NOW WITH  
HARD DISK CACHE  
FOR INCREASED  
SPEED PERFORMANCE**

**UPGRADES FOR YOUR IBM PC /PC COMPATIBLES**

- |             |  |                  |
|-------------|--|------------------|
| <b>IS01</b> | • 10 Mega-byte Winchester<br>• Modular hard disk controller  | <b>\$1095.00</b> |
| <b>IS02</b> | • 10 Mega-byte Winchester<br>• Floppy/Hard disk controller   | <b>\$1295.00</b> |
| <b>IS16</b> | • Half-high tape drive<br>• XT-Power Supply  | <b>\$ 995.00</b> |
| <b>IS17</b> | • Half-high tape drive<br>• Half-high floppy drive<br>• XT-Power Supply                                      | <b>\$1265.00</b> |
| <b>IS18</b> | • Half-high tape drive<br>• Half-high 10 Mega-byte Winchester<br>• Hard disk controller<br>• XT-Power Supply | <b>\$2095.00</b> |
| <b>IS20</b> | • 20 Mega-byte Winchester<br>• Hard disk controller  | <b>\$1595.00</b> |
| <b>IS21</b> | • Half-high tape drive<br>• Half-high 20 Mega-byte Winchester<br>• Hard disk controller<br>• XT-Power Supply | <b>\$2495.00</b> |
| <b>IS40</b> | • 40 Mega-byte Winchester<br>• Hard disk controller<br>• XT-Power supply                                     | <b>\$2895.00</b> |

- |             |  |                  |
|-------------|--|------------------|
| <b>IS41</b> | • Half-high tape drive<br>• Half-high floppy drive<br>• 40 Mega-byte Winchester<br>• Hard disk controller<br>• XT-Power Supply | <b>\$3795.00</b> |
| <b>ISPS</b> | • XT-Power Supply  | <b>\$ 290.00</b> |

**TAPE FOR YOUR IBM XT**

- |             |  |                  |
|-------------|--|------------------|
| <b>XT01</b> | • Half-high tape drive<br>• Half-high floppy drive | <b>\$ 995.00</b> |
|-------------|--|------------------|

Micro Design International Inc. has been serving the computer industry for over 7 1/2 years, call us today for our complete catalog or to place your order.

**TO ORDER CALL COLLECT  
(305) 677-8333**

Master Card/Visa/Check/or Money Order

**MICRO DESIGN  
INTERNATIONAL INC.**

*"Your internal solution"*

6566 University Blvd.  
Winter Park, Florida 32792

\*IBM is a registered trademark of International Business Machines Corporation



S-100 systems require a good deal of knowledge to get going and that a lot of the CompuPro equipment you are using isn't bug free due to its new design. But it seems that every month you indicate that Tony Pietsch lives at your home! I find it very interesting reading to learn how you actually find the equipment problems with Tony, but I wouldn't want to pay for his visits.

In conclusion, think of the large amount of equipment that you own, especially the Sage IV, and do you still feel that the S-100 is the best system from a practical point of view?

Keep writing your excellent columns in BYTE and giving your honest opinion of computer hardware and software.

DONALD C. RUOKONEN  
Elbert, CO

*I wouldn't want to pay for Tony's visits either—but recall, Chaos Manor is a test site for new CompuPro systems and software. Sometimes I report the doings here; perhaps I shouldn't, if I'm giving the wrong impression. I have three Com-*

*puPro systems. One changes like dreams; we add to it, tear it apart, and generally reconfigure it.*

*Another, Zeke II, hasn't had the cover off in well over a year. The only maintenance I do is to clean the filter once in a while. He's so reliable that in two years I have had precisely one verify error in writing to a floppy disk—and that was probably a random piece of dirt. It happened while Larry Niven was here, and he smokes.*

*The third system is somewhere in between: it gets the latest stuff, but only after it has been checked out in other sites. I tend to work equipment pretty hard, so I'm an ideal one for finding potential bugs. That's what I usually report—but note that all these bugs are gone before you can buy a copy of the machine I have.*

*I give the S-100 bus another five years. Just last week Macrotech put in an 80286/Z80h microprocessor in my CompuPro system. Wow, is that fast! Try that with your other stuff.*

*As to CompuPro S-100 versus Sage IV:*

*so far there's more software for the 8088 and upward chips; but about the time this is in print there will be some wonderful Modula-2 developments for Sage.*

*I don't know which is "best." I'm glad I don't have to make such hard choices.—Jerry ■*

**Users Group Corner**

As a service, I'll try to include users group addresses in the future.

Larry Taylor  
Sanyo SIG  
POB 99367  
San Diego, CA 92109  
(619) 483-5393

National Epson QX-10 User Group  
POB 1076  
Lemont, PA 16851 (\$25/year dues)

First Attache Users Group  
1827 Haight, Room 16  
San Francisco, CA 94117-2791  
(\$35/year dues)

Engineers  
Mathematicians  
Research Scientists  
Academic Department Heads  
Product Development Managers  
Manuscript/Report/Proposal Writers  
Teachers  
Physicians

# TECHNICAL TYPING TOUGH?

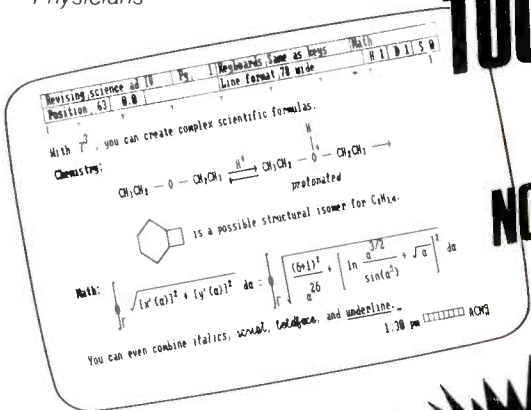

# NOT WITH

What you see is what you get.



**The Technical Word Processing System for the IBM PC**

- With T3, technical text is easy.
- With T3, use up to 25 levels of subscripting and superscripting.
- With T3, define and use up to 8 fonts (128 characters each) in a single document.
- With T3, use bold face, underline, and strike out with any characters.

All these features are properly displayed on the screen.

- With T3, save complex expressions by name, and you never have to type them again.
- With T3, footnotes and boiler plate are natural.

T3: It's easy to use. A revolutionary modeless user interface makes more use of the special capabilities of the IBM PC keyboard than any other word processor. To the novice user it is a simple menu driven interface. For the expert, it allows quick, easy operation by-passing the menus



by TRIAD COMPUTING, INC.  
Call us for more information:  
**1-800 TRIAD T3**  
IN NEW MEXICO (505) 522-4600  
1190-B FOSTER ROAD  
LAS CRUCES, NEW MEXICO 88001



See us at  
**COMDEX™/Fall '84**  
November 14-18, 1984  
Las Vegas Convention Center  
Las Vegas, Nevada

Engineering  
Excellence

CROSSTALK™  
XVI



THE STATE OF THE ART IN  
DATA COMMUNICATIONS  
SOFTWARE

DESIGNED BY

**MICROSTUF**®

CROSSTALK IS A TRADEMARK OF  
MICROSTUF, INC., ATLANTA, GEORGIA

CROSSTALK IS AVAILABLE FOR  
MOST SMALL BUSINESS  
COMPUTERS

DATE

2/16/84



# The one-stop, computer shopping center

## Heath/Zenith... Two great names in one all-service store.

A computer purchase is the beginning of a long-term partnership between you and the people you buy from. Your ongoing need for software, peripherals, accessories and add-on circuit boards requires a partner who will stand by you with a growing line of products to meet your needs. Heath/Zenith will be that strong partner for you. Look at what we have to offer.

## A fine selection of microcomputers.

The H/Z 100 series computers run 8- or 16-bit software. They have massive storage, flexible expansion capability and they include the MS-DOS operating system. Our desktop and portable 150 Series PC's are IBM compatible. They come with a standard 128 KB user memory and are loaded with enhanced features. All models are available in kit or fully factory assembled and tested.

## Your headquarters for add-on boards.

We have a full line of "Heath checked" boards for IBM and Heath/Zenith PC's. Decide what your computer should do; we've got boards like AST

SIX-PAK PLUS\* and Access 1-2-3 Modem to do it at the right price. Those "Best of Breed" boards come with complete instructions and our own 90 day money-back guarantee.

## A full range of printers, peripherals and furniture.

Trust us to match your computer to the compatible drive, printer or modem that works best. And to keep both operator and computer at maximum efficiency, we carry a full line of functional, comfortable computer furniture.

## The best software a store can stock.

The right software is as important as the computer itself. We offer the latest versions of best-selling management tools, word processing, accounting, data base management and home education software. And we make sure our software is up to date and competitively priced.

## We will teach you.

We have the education experience to help you understand your purchase before you buy. So, you can get more than a computer; you can get the knowledge to make it work at full potential.

## Or, you can teach yourself.

Gain true mastery over the computer. Master the software! Heathkit/Zenith Educational Systems self-paced, self-study courses can help you learn all about a programming language or operating system. Learn what you want, when you want. Another reason why Heath/Zenith is the Strong Partner you can depend on.

## Service and support.

Prompt, professional service and assistance is available nationally through Heathkit Electronic Centers, Zenith Data Systems for commercial users, or through Heath factory servicing and phone-in technical assistance.

Complete, integrated computer hardware and software, designed to serve and grow with you - that's what to look for in a strong partner. And with Heath/Zenith you get it all... in one stop.



\*MS is a registered trademark of Microsoft Corp.  
SIX-PAK PLUS is a registered trademark of AST Research, Inc.

# Heath ZENITH

your strong partner in  
microcomputers

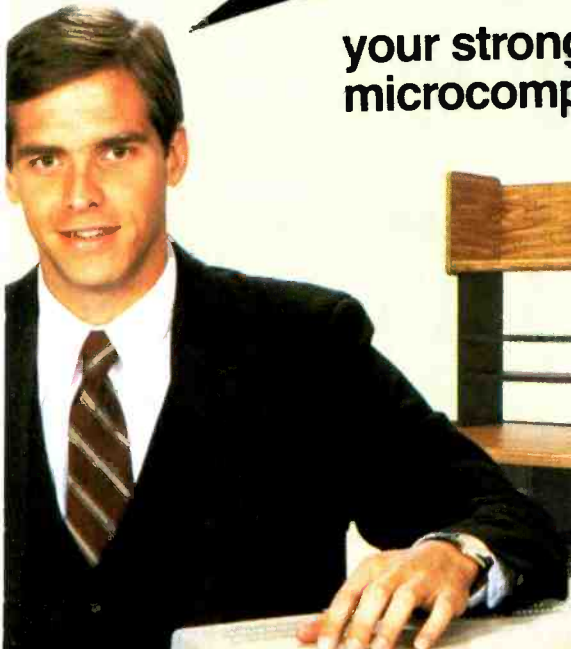

Make one stop at your Heathkit Electronic Center.  
64 stores throughout the U.S.

- PHOENIX, AZ  
2727 W. Indian School Rd.
- TUCSON, AZ  
7109 E. Broadway
- ANAHEIM, CA  
330 E. Ball Rd.
- CAMPBELL, CA  
2350 S. Bascom Ave.
- EL CERRITO, CA  
6000 Potrero Ave.
- LA MESA, CA  
8363 Center Dr.
- LOS ANGELES, CA  
2309 S. Flower St.
- POMONA, CA  
1555 N. Orange Grove Ave.
- REWOOD CITY, CA  
2001 Middlefield Rd.
- SACRAMENTO, CA  
1860 Fulton Ave.
- WOODLAND HILLS, CA  
22504 Ventura Blvd.
- DENVER, CO  
5940 W. 38th Ave.
- AVON, CT  
395 W. Main St., (Rt. 44)
- JACKSONVILLE, FL  
8262 Arlington Expressway
- MIAMI, FL  
4705 W. 16th Ave.,  
Hialeah
- FT. LAUDERDALE, FL  
7173 W. Broward Blvd  
Plantation
- TAMPA, FL  
4019 W. Hillsborough Ave.
- ATLANTA, GA  
5285 Roswell Rd.
- PEARL CITY, HI  
98-1254  
Kaahumanu St.
- CHICAGO, IL  
3466 W. Devon Ave.
- DOWNERS GROVE, IL  
224 Ogden Ave.
- INDIANAPOLIS, IN  
2112 E. 62nd St.
- KANSAS CITY, KS/MO  
5960 Lamar Ave.  
Mission, KS
- NEW ORLEANS, LA  
1900 Veterans  
Memorial Hwy.
- LOUISVILLE, KY  
12401 Shelbyville Rd.
- BALTIMORE, MD  
1713 E. Joppa Rd.
- ROCKVILLE, MD  
5542 Nicholson Lane
- PEABODY, MA  
242 Andover St. (Rt. 114)
- WELLESLEY, MA  
165 Worcester Ave. (Rt. 9)
- FARMINGTON  
HILLS, MI  
29433 Orchard Lake  
Rd. (At 13 Mile Rd.)
- EAST DETROIT, MI  
18149 E. Eight Mile Rd.
- ST. JOSEPH, MI  
Lakeshore Dr.
- MINNEAPOLIS, MN  
101 Shady Oak Rd.,  
Hopkins
- ST. PAUL, MN  
1645 White Bear Ave.
- ST. LOUIS, MO  
3794 McKelvey Rd.,  
Bridgeton
- GREENSBORO, NC  
4620C W. Market St.
- OMAHA, NE  
9207 Maple St.
- ASBURY PARK, NJ  
1013 State Hwy. 35, Ocean
- FAIR LAWN, NJ  
35-07 Broadway, (Rt. 4)
- BUFFALO, NY  
3476 Sheridan Rd.,  
Amherst
- JERICHO, LI, NY  
15 Jericho Turnpike
- ROCHESTER, NY  
937 Jefferson Rd.
- N. WHITE PLAINS, NY  
7 Reservoir Rd.
- CINCINNATI, OH  
10133 Springfield Pike  
Woodlawn
- CLEVELAND, OH  
28100 Chagrin Blvd
- COLUMBUS, OH  
2500 Morse Rd
- TOLEDO, OH  
48 S. Byrne Rd.
- OKLAHOMA CITY, OK  
2727 N.W. Expressway
- FRAZER, PA  
630 Lancaster Pike (Rt. 30)
- PHILADELPHIA, PA  
6318 Roosevelt Blvd.
- PITTSBURGH, PA  
3482 Wm. Penn Hwy.
- WARWICK, RI  
558 Greenwich Ave.
- DALLAS, TX  
2715 Ross Ave.
- FORT WORTH, TX  
6825-A Green  
Oaks Rd.
- NORTH HOUSTON, TX  
5050 FM 1960 W. (#126)
- HOUSTON, TX  
1704 W. Loop N
- SAN ANTONIO, TX  
7111 Blanco Rd.
- SALT LAKE CITY, UT  
58 East 7200 South,  
Midvale
- ALEXANDRIA, VA  
6201 Richmond Hwy.
- VIRGINIA BEACH, VA  
1055 Independence Blvd.
- SEATTLE, WA  
505 8th Ave. N
- TUKWILA, WA  
15439 53rd Ave. S
- VANCOUVER, WA  
516 SE Chaklov Dr. (# 1)
- MILWAUKEE, WI  
5215 W. Fond du Lac

For more  
information write:

**HEATH COMPANY**  
Benton Harbor,  
MI 49022

OR CIRCLE  
READER SERVICE  
NUMBER

**Heath®/Zenith®**  
Heath  
Company



# DID PICASSO DO IT?



## Create Print Masterpieces with Text and Graphics.

Upgrade the Apple II, II+, IIe or III computer and any parallel printer to a complete text and graphics output system with the newest and most versatile interface, PKASO/U. (Pronounced "Picasso," the "U" is for Universal). And make use of every capability available from the printer. And gain additional text and graphics features to turn every printout into a masterpiece.

## Get Greater Visual Range and Instant Screen Printouts.

Gain every state-of-the-art printing capability, including exclusive features not offered by any other interface:

- Magic Screen Dumps — instant, single-command snapshots of *any* image on the Apple screen, graphics or text. What you see is what you get!
- Print the graphics screen *any* size — from inches to feet — another PKASO/U exclusive.
- Instantaneous, single-command Lo Resolution Screen Snapshots, only from PKASO/U.
- Super Resolution — higher resolution graphics from your dot matrix printer than possible on the screen, only from PKASO/U.
- 4-way Rotation of image — 90°, 180°, 270°, 360° — positioned anywhere on the page.
- Direct or Reverse Printing — black on white or white on black.

- Full color for printers with color capability.
- 16-level gray scale for black and white photographic images, only from PKASO/U.
- Aspecting, with separate width and height adjustments for any size and aspect ratio.
- Windowing, the printout of any selected portion of a graphics image in any size — equal, enlarged or reduced, another PKASO/U exclusive.
- Low-cost clock/calendar option for time/date stamping, available soon.

## Get Universal Compatibility with Current/Future Technology.

Link the Apple computer with any and all major parallel printers of today or tomorrow. Unlike other printing interfaces which are limited by ROMs or DIP switches with pre-set configurations, PKASO/U is completely configurable for either present or yet-to-come Centronics parallel-interfaced printers. Another only-from-PKASO/U feature.

## Add ShuffleBuffer for a Complete Upgrade.

The new Buffer with a Brain, ShuffleBuffer, does the printer-feeding work of the Apple so the computer is free to perform other tasks. It's the only buffer that can rearrange stored data, mix and merge, repeat and reprint. Ask your dealer for a demonstration.

## Pays for Itself with Color Ribbon Savings.

Exclusive Mosaic Mode suspends color dot overprinting operation, uses color dots printed next to each other (not on top of each other) to achieve the desired shade. And since fewer dots are printed, less ink is used, ribbon life is doubled and the PKASO/U pays for itself in ribbons saved.

## Do it with PKASO/U.

A fully-documented Demonstration Diskette and detailed User Manual make it easy; just plug in the cables (included) and start producing masterpieces. Explore the amazing capabilities of PKASO/U by visiting a nearby computer peripherals dealer. Or call us directly at (215) 667-1713 and we'll send you the details. Unframed.

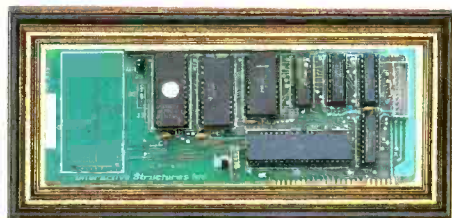

## PKASO/U DID IT.



Interactive Structures, Inc.  
146 Montgomery Avenue  
Bala Cynwyd, PA 19004  
(215) 667-1713

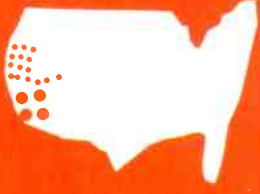

# FidoNet, Sidekick, Apple, Get Organized!, and Handle

Homebrew  
electronic  
mail, some  
integrated  
software, and  
other tidbits

BY JOHN MARKOFF  
AND EZRA SHAPIRO

**P**ersonal computer users have become accustomed to a wide variety of styles in electronic bulletin board systems (BBSs). Some are designed primarily for uploading and downloading software. Some are intended purely for conversations on topics of special interest. Almost all have been created and maintained—at no small cost in both time and money—by hobbyists intrigued with the potential of noncommercial computerized telecommunications.

As microcomputer software and hardware technology have evolved, BBSs have become both more widespread and more sophisticated. During recent years there even have been a number of experimental projects aimed at launching public-domain, multiuser, and networked BBSs. Though multiuser systems, by and large, have been successful (usually using spare processing time on larger computers), enthusiast networks and true electronic mail have not. They have remained the province of highly capitalized operations, including CompuServe, The Source, and MCI Mail. The cost of going on line with a nationwide mail system is prohibitive, at least if you start out with grandiose plans to maximize your coverage and your profit.

Today, the personal computer world's own Johnny Appleseed may be sowing communications networks instead of fruit trees. Tom Jennings, a system software designer for Phoenix Software, author of the public-domain Fido BBS software and system operator of the Fido electronic bulletin board in San Francisco, recently developed an additional program called FidoNet. (Jennings insists that Fido is not an acronym.) FidoNet is a utility that connects Fido BBSs for automatic message and file transfer; in other words, it's a low-cost public electronic mail service.

Jennings started the original Fido BBS in late 1983 as a hobby project. The idea was to make use of miscellaneous idle pieces of computer equipment. He never really ex-

pected that the software would spread or that he would become the founding father of a group of more than two dozen independent BBSs. But that's happened. Due to his own rethinking and constant queries from his family of operators, Jennings worked Fido through seven major revisions and countless minor overhauls and bug fixes.

Fido currently runs on several computers that support MS-DOS version 2.0 and higher, among them the IBM Personal Computer (PC), the Digital Equipment Corporation Rainbow, the Compaq, the Otrona Attache, and Jennings's own Multibus system. The program uses MS-DOS's capacity to segment groups of files into named directories. The segmenting trick has kept would-be hackers and system-crashers away from the guts of the program and gained Fido a reputation for being almost completely "bulletproof." Fido was written in Lattice (Microsoft) C. Jennings is the sole designer—he will not release the source code—and continues to modify the program based on input and support from users around the country.

"Fido wasn't designed," he notes, "it was just built."

After some weeks of bulletin-board discussion with other system operators, Jennings released FidoNet in June of 1984. As with Fido, the networking scheme has gone through constant improvement and fine-tuning.

Because FidoNet currently runs on single-task personal computers, it isn't yet a real-time network. FidoNet operates for only a short period each day; during the rest of the time, the regular Fido BBS software enables local and long-distance callers to upload and download files and receive and display messages. Then, for approximately one hour each day (late at night when the phone rates are low), FidoNet automatically activates itself, combines any messages marked as mail into packets, and transmits

(continued)

BYTE West Coast is prepared monthly by BYTE's editors and staff in San Francisco and Palo Alto. Correspondence should be addressed to BYTE West Coast, BYTE Magazine, 425 Battery St., San Francisco, CA 94111.



# SPECTACULAR

LOWEST PRICES



maxell DISKS

LIFETIME WARRANTY

**\$180** ea MD 1 5/4" (SS/DD) **\$240** ea MD 2 5/4" (DS/DD)

5/4" MD1-DDM SS/DD/96TPI .. \$2.65  
 5/4" MD2-DDM DS/DD/96TPI .. \$3.30  
 8" FD-1 SS/SD or DD .. \$2.85  
 8" FD-2 DS/DD .. \$3.30

1-800-328-3472

Dealer inquiries invited. COD's and charge cards accepted. All orders shipped from stock within 24 hrs.



**North Hills Corporation**  
 3564 Rolling View Dr.  
 White Bear Lake, MN 55110  
 MN Call Collect 1-612-770-0485

## CALCULATOR

4 FUNCTION W/MEMORY

**\$39** REGISTER TAPE **\$39**  
 PRINT FUNCTIONS

## INDEXER

PRINT FUNCTIONS **\$69** SORTS  
 NOTEBOOKS NAME  
 ROLODEX CARDS ADDRESS  
 MAILING LABELS CATEGORY

## CALENDAR

BY DAY **\$59** YOU'VE GOT TO SEE IT TO BELIEVE IT  
 BY WEEK  
 BY MONTH  
 EXPENSES AND NOTES

## IBM & COMPATIBLES

## MicroTime

SEE OUR AD ON PAGE 4

800-642-7684

ALL 3 FOR \$139

Circle 407 on Inquiry card.

## TDK



THE NO-RISK DISK ON SALE

LIFETIME WARRANTY

Box of ten 5/4" TDK diskettes, with labels, envelopes and reinforced hub-rings.

SS/DD **\$16.50** Soft or 16 Sector  
 DS/DD **\$21.50** Soft or 16 Sector

SS/DD **\$24.50** 96TPI  
 DS/DD **\$31.50** 96TPI

Head Cleaning Kit **\$11.00**

Ring King Diskette Filing Tray for 70 diskettes with Metal Lock **\$14.95**

Diskette Filing Tray for 70 mini diskettes **\$11.95**

Shipping & Handling \$3.00 for any order of diskettes, ribbons or cleaning kits. \$3.00 for each Diskette Filing Tray. We accept credit cards at NO extra charge. C.O.D. orders add \$1.65. Illinois residents please add 7% tax.

Call now TOLL FREE ANYWHERE in the US  
 Nationwide 1 800 336 6875  
 Illinois 1 800 942 1700  
 International 1 312 256 4456  
 9 a.m. - 6 p.m. (Central) Mon. through Fri.

**SMART DATA INC.**  
 P.O. Box 297  
 Wilmette, IL 60091

Circle 408 on inquiry card.

## BYTE WEST COAST

them to the other FidoNet members. Once the mail is received successfully, the Fido BBS returns.

The FidoNet transfer scheme is quite simple and ingenious, although probably not designed for many nodes. (Currently, FidoNet is functioning with approximately 35 systems.) At the start of the network hour, FidoNet creates its packets and places its calls. A simple collision-detection routine manages mail transfer. Each addressed node is called in turn until all packets are sent or until mail time is over. If an individual FidoNet fails to connect with another node, it continues to the next and repeats the failed attempt only after going through the rest of its list. In between each call, FidoNet waits for a random interval and checks for an incoming call. According to Jennings, this delay interval synchronizes the net after the first few minutes the process sorts itself out and almost no collisions occur.

If an incoming call is detected when the FidoNet station is in receive mode, the node attempts to connect. First, FidoNet determines the data-transmission rate and displays the message (to possible human callers looking for the BBS) that the system is taking calls only from other FidoNet nodes. Once a connection is established, packets are transferred to, and stored by, the receiving system for later distribution through the bulletin board.

After the specified network mail period, FidoNet erases all remaining outgoing packets (if there are any) and marks those that were sent successfully. Thus, the sender can tell if his message was transmitted.

One striking aspect of FidoNet is that Jennings has solved some of the communications-cost problems that previously confounded other system operators. The Fido BBS and FidoNet maintain cost records for each user as part of the regular BBS user log. If you want to use the system, you send cash, which the operator enters as a credit to your account. Every time you send a message, your account is debited by the appropriate amount.

The software will not send a message if you don't have a positive balance. Like the commercial MCI Mail service, sending messages costs, but receiving them is free. The price of short messages is very low, frequently in the neighborhood of five cents each, and Jennings plans to lower the cost of FidoNet even more by adding data-compression algorithms.

Each FidoNet operator may limit access to the mail area of his Fido BBS and can separate access to "free" systems from access to systems requiring a toll call. This reduces bookkeeping headaches, yet lets the system operators (and users with permission) send mail to remote network nodes. Another feature designed specifically for system operators is a BROADCAST-message type mailed automatically to all the nodes in the system. Jennings also uses this feature to transmit updated versions of the Fido software.

Jennings continues to evolve the FidoNet software, and he hopes to support non-Fido BBSs (both MS-DOS and CP/M) as part of the network in the future. "I'll rewrite my code just to be compatible with the other guys," he says. Additional planned enhancements include forwarding and holding of messages, file attachment, and routing control.

Although he recognizes transcontinental mail as the glamorous part of the FidoNet service, Jennings maintains that its real effectiveness will be for regional networks. In fact, such a group is already developing around St. Louis, where there are four Fido systems. "I use the cross-country stuff to communicate with the other system operators," he says, "but I don't know who else really needs it at this stage."

Whatever the future holds for an expanding FidoNet, this network is already a significant triumph for personal telecommunications.

## SOFTWARE SIDELIGHT

Borland International, the company that brought you Turbo Pascal (recently enhanced with automatic overlaying, windowing for the IBM PC, and

(continued)

# Our multi-mode printers accelerate from 100 cps to 480 cps and have an impressive finish everytime.

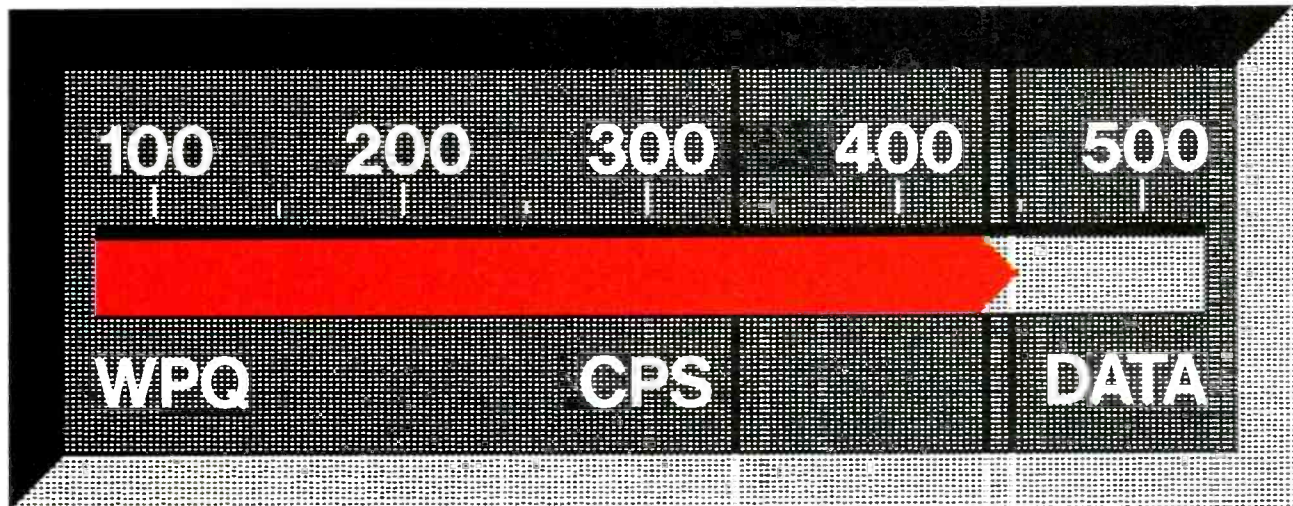

In the Grand Prix of office automation, HERMES multi-mode printers always come in first. Both 400/480 cps data and 100/120 cps single pass near letter quality are possible with the same print-head.

Speed and quality have never been as successfully combined. Professionals who want only the best will also appreciate:

**Their versatility.** Wide range of attractive characters sets in 16 national versions, as well as math symbols, bar codes and teletex. Dual ports, parallel (CENTRONICS™/EPSON™ compatible) and serial (RS-232C/RS-422) interfaces. DIABLO™ 630 emulation optional.

**Their resolution.** Finest print quality available on matrix printers. So good you can even print signatures. Bit mapping graphics in single and double density modes, 6 dots densities in each mode. A circle on the screen means a circle on the paper too!

**Their quality.** Swiss high quality construction. Quality that lasts - thanks to their exclusive «moving-ruby» head.

**Their multicolored printing.** Text and graphics printing in 8 colors on both models 615 and PC-Printer 2.

 **HERMES®**  
The impressive printers

Made by HERMES PRECISA INTERNATIONAL, CH-1401 Yverdon, Switzerland  
HERMES printers are distributed in Austria, Canada, Cyprus, Finland, France, Greece, Jordan, Kuwait, Lebanon, Saudi Arabia, South Africa, Spain, Sweden, Switzerland, United Kingdom, USA, West Germany.

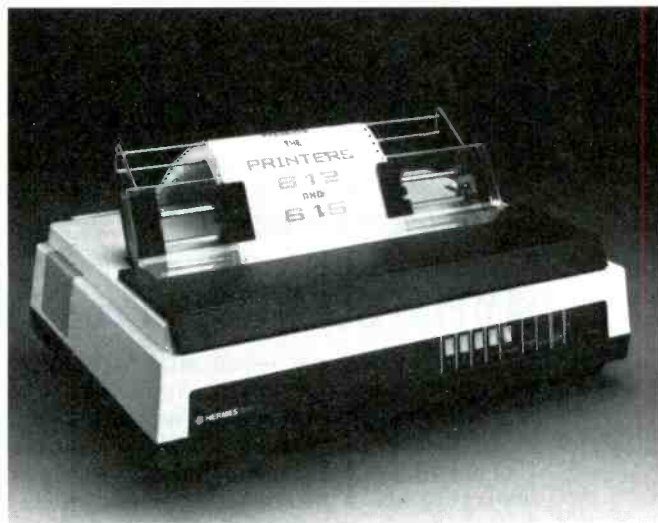

To receive a sample of the finest quality matrix print-out and additional information on the HERMES printers, please return the coupon below.

Please send me more documentation about your HERMES printers.

Name \_\_\_\_\_ Title \_\_\_\_\_  
Company \_\_\_\_\_  
Street \_\_\_\_\_ City \_\_\_\_\_  
State \_\_\_\_\_ Zip \_\_\_\_\_ Phone (\_\_\_\_) \_\_\_\_\_

Send to: HERMES PRODUCTS, Inc. - Printer Division  
1900 Lower Road, LINDEN, NJ 07036, (201) 574 0300



support for the Intel 8087 math coprocessor chip), has introduced its first consumer software product, Sidekick (\$49.95). It represents a novel approach to software integration for the IBM PC and compatibles.

In its full configuration, Sidekick includes a WordStar-like notepad text editor; a memory calculator that works in decimal, hexadecimal, or binary notation; a 200-year calendar and appointment book; a telephone dialer that sends phone numbers to any modem that accepts Hayes commands; and a table of the full 256 ASCII (American Standard Code for Information Interchange) characters used by the PC, which shows screen representation, decimal, hexadecimal, and control values. The distribution disk has four versions of the program with progressively fewer features. The smallest Sidekick contains only the calculator and the ASCII chart.

The trick to Sidekick is that you load it when you first turn on your computer and it remains resident in RAM (random-access read/write memory) until you reboot your machine. It chews up anywhere from around 22.5K bytes of memory (in the calculator/ASCII version) to a little more than 105K bytes in the full version when the notepad workspace is set up to handle a 50K-byte file. (The notepad can be set anywhere from 1K byte to 50K bytes.) Unless you're planning to use Sidekick for a major editing job—for which it is not designed—a reasonable workspace configuration should not cost you more than a single bank of RAM chips.

After you load Sidekick, you remain in DOS (disk operating system), and you can run any standard software. Pressing the Control and Alt keys simultaneously brings up Sidekick's main menu. A single-key mnemonic

then starts any of the individual Sidekick applications. Because Sidekick stays in memory, you do not have to close down the major software you've been running. Sidekick takes control only as long as you need it, then it returns you to whatever you were doing before you interrupted yourself.

The Sidekick applications appear in colorful windows that can be dragged around the screen to convenient positions. The notepad can be sized anywhere from three lines by 40 characters to the full dimensions of the screen. A single status line across the bottom of the screen shows function keys and their results. All of Sidekick's windows can be displayed at the same time, though only one can be active. You can move from one window to another by pressing the Alt key plus the appropriate mnemonic. To get back to your main program, you can successively shut down each window or you can press Control-Alt again to exit Sidekick. The next time you invoke the program, the windows will reappear as you left them.

Though the notepad is not intended for heavy use (it contains no real text-formatting commands), it is more than adequate for creating and saving brief text files. It does have full cursor movement, deletion, insert/overwrite, block move, and search-and-replace capabilities. Two new features that will be welcomed by people familiar with WordStar include an Undelete command that brings back text as long as you're still on the same line and a stamping system that inserts date and time taken from the DOS clock. You can also collect text from the screen display (Sidekick lifts the characters from the computer's video memory) and manipulate it with the editor. Moving text from the notepad to the screen is not quite so easy; notepad material can be transferred only into a word processor's file by saving the notepad to disk and then using the word processor's commands to read in the disk file. The notepad works in straight ASCII characters, so it is possible to use it with almost any other software.

(continued)

## TOUGH PRINTER NETWORK PROBLEM:

"How do I get my computers to share three different printers and a plotter... without getting all tangled up in cables, switches, protocols and programming?"

## SIMPLE SOLUTION: PrintDirector

PrintDirector — an automatic switch, buffer, and network controller product family — allows you to network your computers and printers... expandable from two to 35 of any mix of models and makes. Just plug it in. No worrying about protocols and baud rates. No cable changing or switch flipping. No modifications to your hardware or software. No problem. For information on the proven PrintDirector product family — and a configurator to tell you which particular PrintDirector can solve your tough printer network problem in a computer or PC center, or local work cluster — call or write:

## PrintDirector

Digital Products Inc. • The Simple Network Solution Company  
600 Pleasant Street, Watertown, MA 02172  
(617) 924-1680 • Outside Mass., call 1-800-243-2333.  
And check out our 30-day trial evaluation.

# Blazing BASIC.

Who said BASIC had to be slow?

Microsoft® BASIC Compiler lets you create MS™-DOS programs that are so fast users will never know they were written in BASIC.

The compiler produces fast, efficient native code. The result? Three to ten times faster operation than the same interpreted program. Even faster for programs that make maximum use of integers.

But it's not only fast in execution, it's fast for development. It's **MICROSOFT** the one BASIC compiler designed to work best with our BASIC interpreter — the de facto industry standard. Together, they let you develop and debug your programs interactively using the interpreter, then compile for speed.

And like all Microsoft languages, the standard linking

interface makes it easy to combine assembly language subroutines.

Microsoft BASIC Compiler is just one reason Microsoft is your best source for high performance languages for 8088/86 based micros.

**Call 800-426-9400 to order  
the blazing BASIC compiler.  
\$395\***

In Washington State, call 206-828-8088. Ask for operator A6, who will rush you your order, send you more information, or give you the name of your nearest dealer to see Microsoft BASIC in action.





The phone dialer uses as its directory an ASCII text file that you've prepared with any editor. Using the display-collection ability of the notepad, you can scroll through any database or text document, lift a number from the screen, save it as a phone directory, and dial it with the dialer. The dialer is not a telecommunications program, however; it merely dials through a modem.

Both the notepad and the appointment calendar can direct output to a printer, as well as save files on disk. Help for all applications exists as a 41K-byte file that must be on your default disk.

According to Philippe Kahn, president of Borland, Sidekick was not developed as a commercial product. It originally was created simply as an in-house convenience to help with the day-to-day activities of a small software vendor. Programmers and salespeople wouldn't have to drop what they were doing to take notes or make phone calls; important projects could remain on the screen. It was only after several months of use that Borland realized it had a marketable product, he says.

The fact that Sidekick can be sold, however, seems to point out a major drawback in quite a few integrated software packages. Why should owners of advanced, multifunction business programs that are supposedly easy to use and that claim to solve all problems be compelled to purchase a utility like Sidekick? It makes you wonder about all those advertising claims.

Borland had originally intended to distribute Sidekick only as a copy-protected product, but a storm of public protest on CompuServe convinced Kahn to change company policy. If you purchase Sidekick for the list price of \$49.95, you will receive the program on a copy-protected disk that must be used every time you load the program. However, if you sign a statement (included with the package) declaring your agreement not to distribute unauthorized copies of Sidekick and send that agreement (along with a check for

## Companies Mentioned

**Apple Computer Inc.**  
20525 Mariani Ave.  
Cupertino, CA 95014  
(800) 538-9696;  
in Canada, (800) 268-7796 or  
(800) 268-7637

**Borland International**  
4113 Scotts Valley Dr.  
Scotts Valley, CA 95066  
(800) 227-2400, ext. 953;  
in California, (800) 772-2666, ext.  
953

**Electronic Arts**  
2755 Campus Dr.  
San Mateo, CA 94403  
(415) 571-7171

**Fido BBS #1**  
2269 Market St., #118  
San Francisco, CA 94114  
(415) 864-1418 (by modem)

**Handle Corp.**  
POB 7018  
140 Mackinaw Rd.  
Tahoe City, CA 95730  
(916) 583-7283

**Taxan Corp.**  
18005 Cortney Court  
City of Industry, CA 91748  
(818) 810-1291

\$29.95) to Borland, you'll receive a second, unprotected disk that will enable you to make as many backup copies as you want. It's nice to know that there's still a software company that responds to its customers.

## APPLE WATCH

Lately one of the favorite sports here has been second-guessing Apple Computer. There is absolutely no end to the speculation about what Steve Jobs and Company are going to do to follow up on the successful Macintosh introduction. One thing is virtually certain, though: Apple has so much momentum it's not likely to rest on its laurels very long.

Beyond talk about the coming introduction of the 512K-byte "Fat Mac," the most frequently heard rumors mention a color-display Macintosh, a

redesigned digital board for the Mac, and an internal half-height Winchester drive. However, with Motorola recently introducing the 68020 microprocessor (a full 32-bit version of the 68000-class processor with a 16-MHz clock speed), the Macintosh's hardware evolution seems assured. More interesting projects may be going on in the software realm.

Significantly, Alan Kay and Dan Ingalls, two of the key computer scientists involved in the development of Smalltalk at the Xerox Palo Alto Research Center (PARC), have recently started working for Apple. Kay is widely known for his thinking on the potential of personal computers, and Ingalls did much of the work in actually implementing different versions of Smalltalk at Xerox. They will join a number of other PARC alumni at Apple, including Larry Tesler, who was responsible for the Lisa's user-interface design.

Steve Jobs has said frequently and publicly that he intends to have Apple build a Dynabook, an idea first introduced by Kay. The Dynabook, as Kay sketches it, will be a powerful, portable, personal computer no larger than a book and will serve as a general-purpose information tool.

One rumor that fits well with the Dynabook scenario says that Apple recently talked with a manufacturer of flat-panel electroluminescent displays. Allegedly, Apple wanted to know if the company could supply 50,000 per month.

## ENTERTAINING PRODUCTIVITY

To paraphrase one great thinker, "Here in Silicon Valley, everybody always talks about the coming shake-out, but nobody ever does anything about it." In fact, it hasn't been a particularly good quarter for many software and hardware companies. Major publishing houses as diverse as MicroPro, VisiCorp, and Sorcim all have had bad news to offer recently. And manufacturers like Eagle, Corvus, Kaypro, Qume, and Fortune Systems have announced either losses or layoffs.

(continued)

**You've got  
33 hours in that  
spread sheet.  
Now, it's time to hit  
"save."**

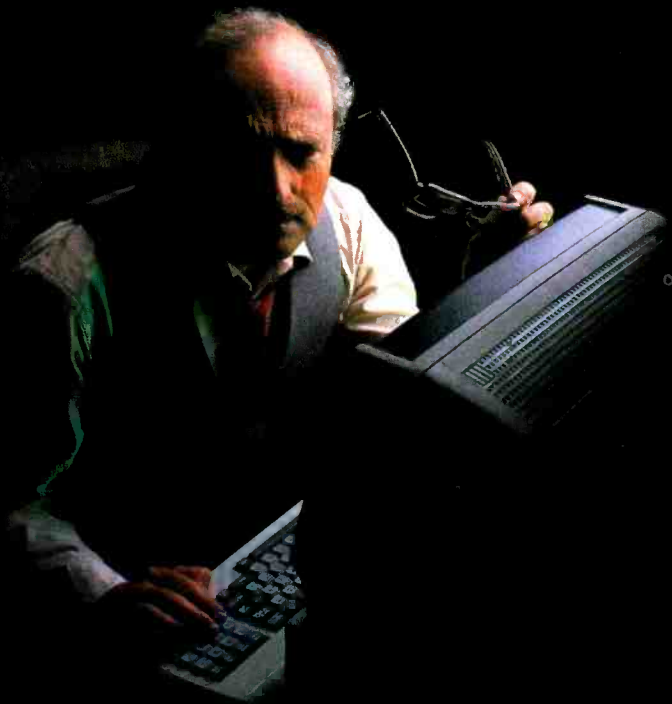

**The important work.** When you're doing important work, the most important thing in your computer is also the least expensive: the diskette that "saves" your work. That's why smart businesses rely on Janus.

**Better by design.** The most critical component of a diskette isn't the recording medium. It's the jacket. And once you've crimped or bent the jacket, you can say goodbye to the diskette inside — and all the important work you saved on it. It stands to reason... the stronger the jacket is, the safer your work is.

**Janus set the standard.** By simply increasing the thickness of the disk jacket by 25%, Janus increased the strength by almost 100%... setting a new standard. And, we set another standard with our absolute no-nonsense guarantee.

**Tested. 100%.** Janus 8" and 5 1/4" diskettes aren't simply batch tested. They're individually tested. 100%. Which means they work. And keep working.

**The guarantee.** If any Janus diskette ever fails to perform, for any reason, your Janus dealer will replace it. Free. No questions asked.

**Color coded.** Janus diskettes are color coded for your computer, which means you'll never forget which diskette fits what. If you're working in a double-sided, double-density format for instance, just ask for "Janus Blue." "Green" for single-sided, double-density... and so on.

**Time is money.** The most important thing you save on a diskette is your time. Your work. If that work is important, your diskette is important. Which is why you buy Janus. When you hit "save," it gets saved. That's our guarantee.

**JANUS™**

**For your important work.**

Janus Dync Company, 1860 Barber Lane,  
Milpitas, CA 95305 (800) 338-0100



Circle 186 on inquiry card.



Thus, it might seem like a strange time for a publisher known for entertainment software to jump into the personal computer "productivity" market. However, that's exactly what Electronic Arts, San Mateo, California, has done. Until now, Electronic Arts was known for innovative packaging of computer games and for marketing efforts that portray software artists in the same way the music industry boosts rock stars.

The decision to move into business software doesn't really establish a new pattern. In getting into the low end of the market for microcomputer business programs, Electronic Arts is following in the footsteps of other game manufacturers, like Sierra Online and Broderbund Software, that have introduced inexpensive word processors for home computers. Electronic Arts already had a word processor in its line of products, and the company recently added a personal financial-decision program.

But Electronic Arts is taking things a step further. It is offering Get Organized!, an integrated software package for the IBM PC. It's designed to compete with more expensive integrated programs like Visi On, DesQ,

Symphony, and Framework. One thing that sets Get Organized! apart from most of the crowd is that it is principally intended for those who work with words rather than those who work with numbers.

Get Organized! is priced at \$199 and features seven different functions: word processing, telecommunications, appointment scheduling, database management, notepad, address book, and calculator. None of the individual applications modules can be called "high-end" programs, as they're all simple in design. But unlike other budget packages (for example, Software Publishing's PFS series), the applications all function together. For example, the address book works with the word processor to let you create custom letters. Also, it's possible to pull out the notepad and jot down a few notes while you're in the middle of any other program.

It will be intriguing to find out what kind of marketplace reception awaits Get Organized! In spite of the package's pretentious name, Electronic Arts is one of the first software publishers to target the low end of the IBM PC market with an integrated product. Everyone else (Lotus Devel-

opment Corporation, Ashton-Tate, et al) seems to be going after what PR flacks call the "power user." Maybe Electronic Arts has a better idea in keeping it simple.

### UNIX IS COMING, UNIX IS COMING!

The Handle integrated software products, from the Handle Corporation, Tahoe City, California, are the first generally available microcomputer-like programs to run under AT&T's System 5 UNIX operating system. Initially, the software will run on the 3B2/300 and the 3B5, both rather expensive multiuser machines. Though nothing has been announced, if AT&T should start selling a UNIX subset for the 6300 personal computer or a similar machine, it seems a good bet that Handle will be there. In full configuration, Handle is a fully integrated seamless word-processing/spreadsheet/database/business-graphics conglomeration that uses a strip of blocks across the bottom of the screen to display current definitions of "soft" function keys. Rather than using a command entry area or control keys or full-screen menus, the user presses one function key, which produces a new display. This continues until you've done whatever you wanted. We haven't had actual hands-on time with the program, but it looks quite impressive on paper.

Handle indicated it has no plans to distribute the software itself. Ignoring traditional retail channels, the company intends to sell the program to OEMs (original equipment manufacturers) like AT&T; the OEMs will then decide how to sell the software.

### GOING THE OTHER WAY

Taxan Corporation has announced a new television tuner, Model 305 (see photo 1). It costs \$129.95 and lets you convert a composite video computer monitor into a television. Taxan claims that the higher quality of most monitor cathode-ray tubes will give you an amazingly sharp television picture. And all along we thought the idea of personal computers was to get us away from the vast wasteland. ■



Photo 1: Taxan's Model 305 tuner converts a color monitor into a television.

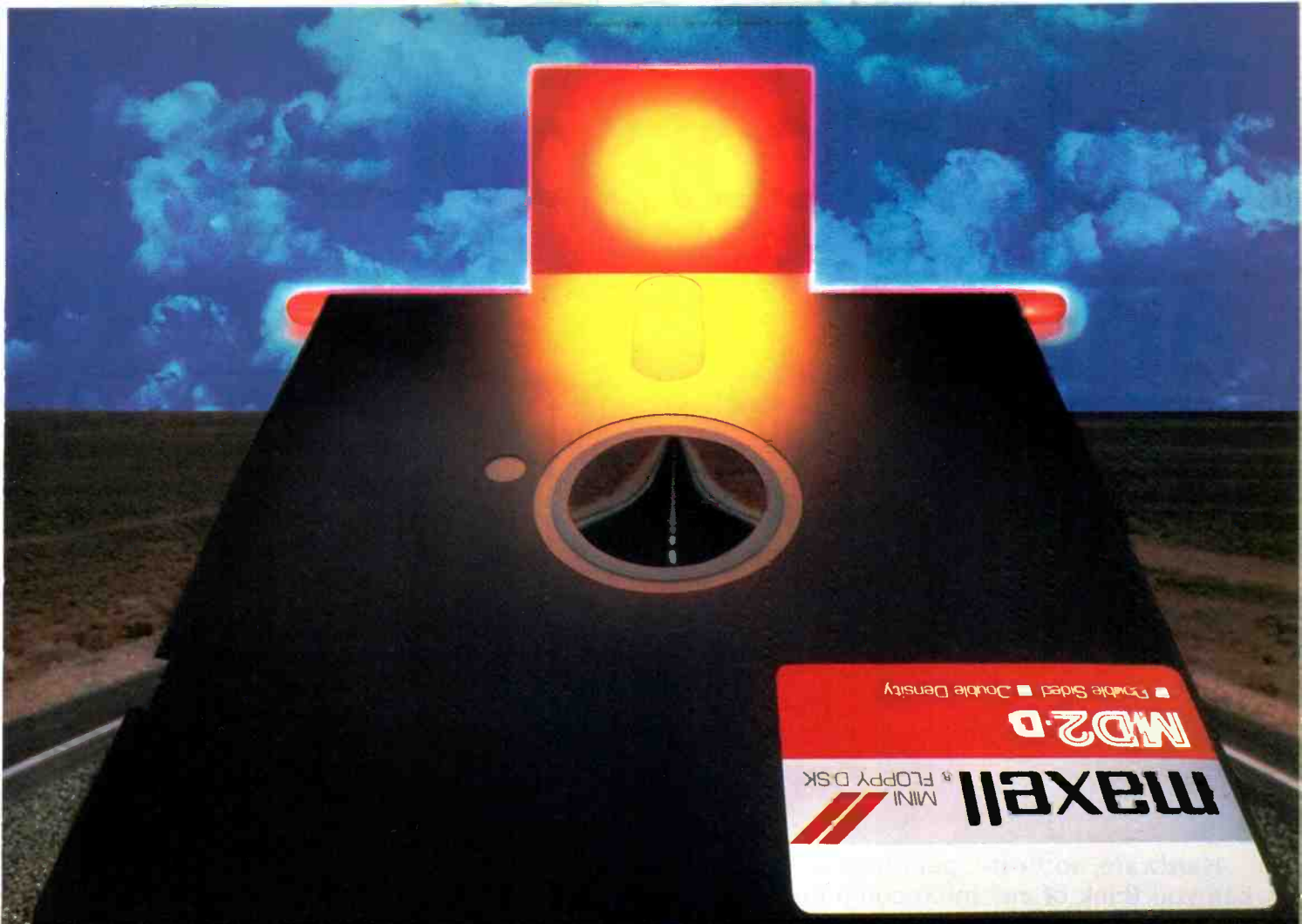

**You're traveling through 140° terrain  
at 300 rpm.**

**While some disks lose their way in the torrid zone of drive heat,  
Maxell guarantees safe passage.**

A lifetime warranty. And manufacturing standards that make it almost unnecessary.

Consider this: Every time you take your disk for a little spin, you expose it to drive heat that can sidetrack data. Worse, take it to the point of no return. Maxell's Gold Standard jacket construction defies heat of 140°F. And keeps your information on track.

And Maxell runs clean. A unique process impregnates lubricants throughout the oxide layer. Extending media and head life. How good is Gold?

Maxell's the disk that many drive manufacturers trust to put new equipment through its paces. It's that bug-free.

So you can drive a bargain. But in accelerated tests, Maxell was an industry leader in error-free performance and durability. Proving that if you can't stand the heat you don't stand a chance.

**maxell**®  
IT'S WORTH IT.





# Pick a computer... any computer

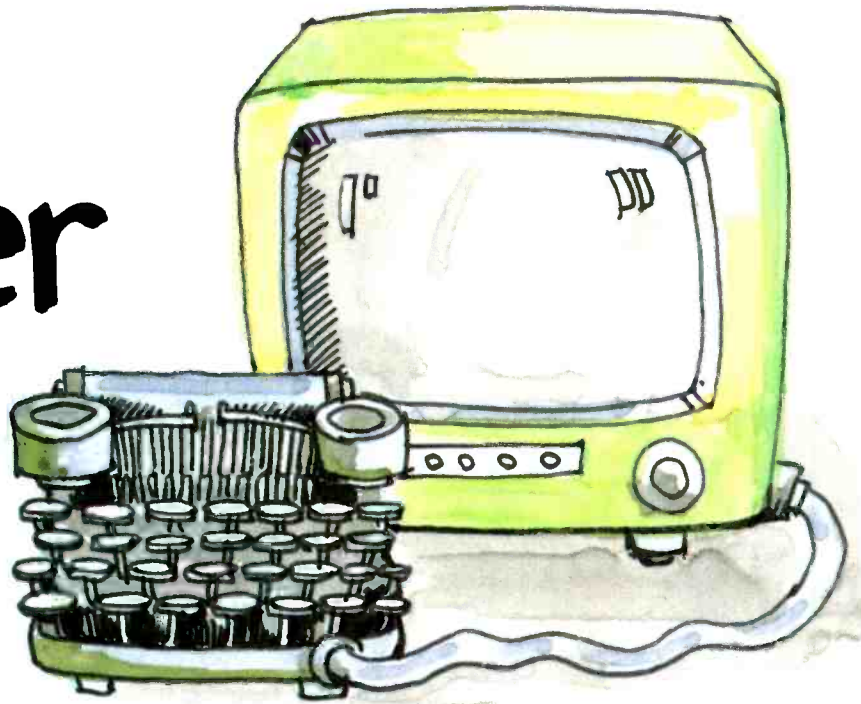

Hardware, software, peripherals... can you think of *any* microcomputer product that you haven't seen advertised in BYTE?

This is where success in the market begins. In BYTE. Where advertisers reach more than 430,000 paid readers... high-tech computer sophisticates who are the market's most active buyers.

And who are asked for tens of thousands of brand-name recommendations every month.

If you're an advertiser, either of an established small systems product, or of the next revolution in the market, talk to us—we're the people who wrote the book on microcomputer marketing. Just call Pete Huestis, Advertising Sales Manager, at 603/924-9281.

# They've all been advertised in BYTE.

## BYTE

THE INTERNATIONAL STANDARD

 BYTE is published monthly by McGraw-Hill, Inc., with offices at 70 Main St., Peterborough, N.H. 03458

# The PC Plotter: It will change the way business looks at graphics.

The lowest-priced professional plotter on the market today is Houston Instrument's new four-pen PC Plotter. It is designed to produce the crisp graphics you need to compete — and communicate — in business. Just what makes this plotter so competitive? Let's take a look:

**Price** — A multi-pen, compact, single-sheet plotter at \$595\* isn't just a low price — it's an unbelievably low price. What an affordable way to link the power of graphics communication to your personal computer.

**Performance — Yours and Ours** — Until the PC Plotter was born, it was too expensive to let the pictures do the talking. Now that's no longer true. So, the next time the boss walks into the office needing some "nice charts and graphs," you can quickly fill the request with clean, colorful, wonderful graphics. Who knows, you might even get a raise!

As to our performance, we're the only plotter manufacturer offering you hundreds of graphics software packages which are

compatible with the PC Plotter. That means you can produce any type of drawing you require.

**Flexibility** — Depending on your needs, you can select from two PC Plotter models. One (PC Plotter Model 595 for \$595.00\*) allows you to produce graphics or overhead transparencies on 8½" × 11" paper or film; the other (PC Plotter Model 695 for \$695.00\*) permits either 8½" × 11" or 11" × 17" graphics. And we didn't forget the OEM. Houston Instrument will work with you to configure a plotter that's perfect for your particular application.

For the name of your closest PC Plotter distributor or dealer, contact Houston Instrument, P.O. Box 15720, Austin, Texas, 78761 or call (512)835-0900. Outside Texas call 800-531-5205. In Europe, contact Houston Instrument, Belgium NV., Rochesterlaan 6, 8240 Gistel, Belgium. Tel. 059-27-74-45, Tlx. 846-81399.

Visit us at Comdex, Booth #W872.  
Circle 411 on inquiry card.



**houston  
instrument**





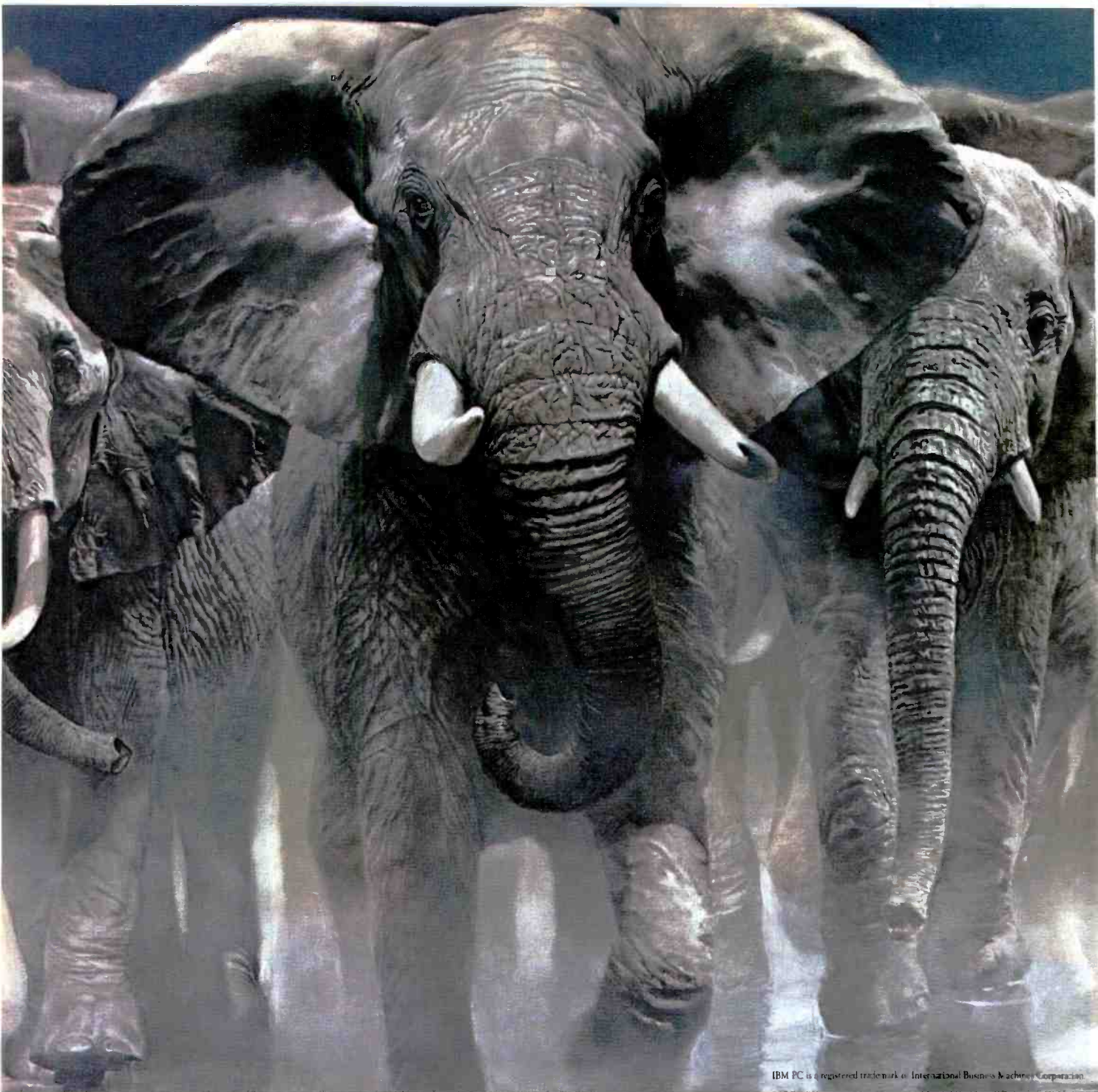

IBM PC is a registered trademark of International Business Machines Corporation.

# INTRODUCING A NEW BREED OF ELEPHANT™



The Elephant  
Memory System

Introducing Elephant Premium Floppy Disks. Specially designed for your most demanding business needs, they'll protect your data when other disks won't. In fact, they exceed industry certification standards by more than 50%. Which is why we say Elephant Never Forgets™.

Plus, Elephant Premium is the only floppy disk that features The Elephant Memory System™—a labeling and filing system that makes it easy to store, reference and protect your disks.

And since they're compatible with the IBM PC® and other popular business computers, our Elephants will be right at home in your office.

For the Elephant dealer nearest you, call 1-800-343-8413. In Massachusetts, call collect 617-769-8150.

## ELEPHANT NEVER FORGETS.

**Dennison**

Serving business for over 140 years.



# Bits and Pieces

---

 Hitachi CMOS 68000
 

---

 Brother EP-44
 

---

 Casio FP-6000
 

---

 C quicksort
 

---

BY WILLIAM M. RAIKE

**K**nowing that I would write parts of this column in Tokyo and the rest during a two-week period while traveling in the U.S., I was strongly tempted to either buy or borrow a portable computer before starting the trip. Instead, I decided to purchase the latest EP-44 "portable printer" (an electronic typewriter with an RS-232C interface) from Brother. I'll say more about the EP-44 here, along with other bits and pieces from the computer scene including an excerpt from a recent interview with Casio about its FP-6000 computer system.

## A CMOS 68000

The powerful 32-/16-bit MC68000 microprocessor from Motorola is soon to have a companion in the HD63000, a CMOS (complementary metal-oxide semiconductor) version that will be announced by Hitachi, probably later this year. Rumors have been circulating about a CMOS 68000 for some time; however, Hitachi would not confirm the HD63000 designation, saying only that the product was currently under development and that no details were available. But industry sources indicate that the new microprocessor, certain to have extremely low power consumption due to the CMOS technology employed, would be released in the same package size as the 68000, which comes in a 64-pin DIP (dual-inline package) configuration. The new chip is also expected to have a "flat-pack" version that will provide both cost and space advantages to designers who can incorporate it into compact, battery-powered equipment. The availability of an extremely low-power version of the 68000 is sure to boost interest in this microprocessor family, which, from at least some technical viewpoints, is superior to the more prevalent 8086/8088, particularly in the power and simplicity of its memory-addressing modes.

## MEET MY BROTHER

While lap-sized computers provide power-

ful word-processing features, being able to get an on-the-spot hard copy can be a real advantage. I wrote this column on my new Brother EP-44 electronic typewriter/serial printer, mostly in airline seats and at kitchen tables, and I like the machine more every day. (I printed the C program in listing 1 using the Brother as a serial printer connected to my computer and driven by WordStar.)

All of us who write (or type) for a living were impressed when the first Brother portable electronic typewriter appeared about a year and a half ago. But it produced 5 by 7 dot-matrix characters, and its convenience had to be weighed against the only marginally acceptable print quality.

The EP-44 is the latest in the EP series and has all of the word-processing capabilities necessary for on-the-go writing needs; its 3725 characters of RAM (random-access read/write memory) storage provide a reasonable ability to store short documents or boilerplate paragraphs, and the print quality is outstanding. Operating as a 24 by 18 dot-matrix thermal printer at 16 characters per second, it puts most letter-quality impact printers to shame. To top it all (and the feature that explains Brother's "personal printer" slogan), it has a built-in RS-232C interface. I paid the equivalent of about \$225 in one of the stalls near the Akihabara electronics bazaar in Tokyo. That makes it the least expensive letter-quality printer in town, besides being a useful full-duplex hard-copy terminal.

Using the EP-44 as a typewriter is simple and natural. The keyboard is full-sized, with Shift, Shift Lock, Backspace, Carriage Return, Tab, and Margin Release keys in their conventional positions. The keys are square, with a firm, single-stage action and good key feel. The F and J keys have little bumps on the keycaps to provide tactile confirmation that your fingers are in the home position. Almost no noise comes from the keyboard; in fact, one of the most

(continued)

*William M. Raiké, who holds a Ph.D. in applied mathematics from Northwestern University, has taught operations research and computer science in Austin, Texas, and Monterey, California. He holds a patent on a voice scrambler and was formerly an officer of Cryptext Corporation in the United States. In 1980, he went to Japan looking for 64K-bit RAMs. He has been there ever since as a technical translator and a software developer.*



noticeable features of the EP-44, commented on by nearly everyone, is its silent operation, a result of the thermal (rather than impact) printing method. A fringe benefit is that, if desired, you can type or print on thermal paper and eliminate the need for a ribbon cassette. With either the ribbon or thermal paper, the print is dense black, with 10-pitch characters that show clear serifs and no visible spacing between dots.

An alternate Shift key, located at the left of the keyboard together with the left and right Margin Setting keys and the Tab Set and Tab Clear keys, provides a third character associated with each key. The resulting character set includes various special symbols and letters from foreign alphabets, so that you can type in French, Spanish, German, or Swedish. The space bar, Backspace, and Carriage Return are auto-repeat keys, and a separate Repeat

key enables any key to be repeated automatically.

A blue "Code" key, analogous to a control key, located just to the left of the space bar gives you access to some of the electronic-typewriter functions of the EP-44, such as automatic centering, automatic underlining, flush-right margins (right justification), and automatic return and type-ahead at the end of a line. You can enter, insert, delete, and modify text within the character memory using Code key functions, and you can display the amount of memory remaining.

The 15-character LCD (liquid-crystal display) panel just above the keyboard enables you (when using the EP-44 in CP [correction print] mode) to correct, insert, and delete text in the 15 most recently typed characters. As new characters enter the display on the right, the display shifts left and

the leftmost characters are printed on the page. You can bypass this feature in the DP (direct print) mode, in which characters are printed as soon as they are typed. A no-print mode, in which characters can be entered into memory but not printed, is also available. You can insert text on either a character-by-character or line-by-line basis by positioning a cursor. The display also indicates the status of the various electronic-typewriter functions (flush-right margin, underlining, etc.) and the battery level.

Major text modifications are accompanied by yes/no prompts and queries on the display, preventing you from unintentionally destroying text or spoiling pages.

Another feature, both interesting and useful, is that the display is also used for the built-in calculator. After you complete a calculation, you can delete unwanted decimal places just by backspacing over them, which lets you select the number of significant digits to be printed on the page.

The EP-44 can become a full-duplex terminal or a remote serial printer when a cable is used to connect the RS-232C connector on the right side of the machine either to a modem or to a computer with an RS-232C interface. A Mode Selection key selects a transmission rate between 75 and 1200 bits per second (bps), any desired parity, and any of the three built-in character sets. Transmission and reception use an 8-bit format, plus one start and one stop bit, and the simple XON/XOFF protocol. I created a reinstalled version of WordStar on my computer to drive the EP-44 in less than 10 minutes.

Normally, the EP-44 runs on batteries (four D cells), but a receptacle on the back means you can use a 12-volt DC adapter if desired. Another feature is an on-board backup battery that gives you about one hour to change the batteries without losing any stored text. With batteries, the EP-44's total weight is only 5.5 pounds.

The ribbon cassettes cost a little over \$2 each and last for about

(continued)



# TALK TO YOUR COMPUTER

## It's as Simple as Saying "On" and "Off"

Plug in the new MICRO•EAR™ Voice Command System, and experience the incredible thrill of *talking with your personal computer*. Become virtually keyboard-independent, because your computer will now understand and obey your vocal commands.

## Just Think of the Applications

Speak a single word or phrase and you: invoke functions . . . load and run programs . . . enter data . . . perform practically *any* keyboard operation.

## You Select the Vocabulary — and Change It at Will

Input up to 256 words or short phrases you select, define, and train to your voice. MICRO•EAR achieves 95-98% recognition accuracy . . . and retains its training even when turned off!

## FREE Voice-Activated Software

You get demonstration software for the IBM PC™ and Apple II™ computers • voice-activated programs for a typewriter, a calculator, and voice-command video games • high quality microphone • plus communications software for the IBM PC and compatibles.

Software for the IBM PC includes EAR-DOS™, for concurrent voice/keyboard input capability while running applications software.

And because it plugs into a standard RS-232 interface port, you can use MICRO•EAR with just about *any* personal computer. Ideal for inventive application developers — MICRO•EAR Voice Command System awaits *your* voice to tell it what to do.

## Act Now —

Call or write today for more information.

**arctec|systems**

9104 Red Branch Rd. • Columbia, MD 21045 • (301) 730-1237

Micro•Ear and EAR-DOS are trademarks of Arctec Systems, Inc. Apple is the trademark of Apple Computers, Inc. IBM is the trademark of International Business Machines Corporation.

# Circuit-Board-Design Without the Tedium

smARTWORK™ lets the design engineer create and revise printed-circuit-board artwork on the IBM Personal Computer.

Forget tape. Forget ruling. Forget waiting for a technician, draftsman, or the CAD department to get to your project. smARTWORK™ software turns your IBM Personal Computer into a professional, high-quality drafting tool. It gives you complete control over your circuit-board artwork — from start to finish.



smARTWORK™ transforms your IBM PC into a CAD system for printed-circuit-board artwork. Display modes include both single-layer black and white and dual-layer color.

What makes smARTWORK™ so smart is that it understands electrical connections. Conductor spacing is always correct, lines don't become too narrow, and connecting lines do not intersect other conductors. smARTWORK™ can automatically find and draw the shortest route between two conductors. Or you can specify the route.

smARTWORK™ is the only low-cost printed-circuit-board artwork editor with all these important advantages:

- Complete interactive control over placement and routing
- Quick correction and revision
- Production-quality 2X artwork from pen-and-ink plotter
- Prototype-quality 2X artwork from dot-matrix printer
- Easy to learn and operate, yet capable of sophisticated layouts
- Single-sided and double-sided printed-circuit boards up to 10 x 16 inches
- Multicolor or black-and-white display
- 32 user selectable color combinations; coincident points can be displayed in contrasting colors.
- Can use optional Microsoft Mouse as pointing device

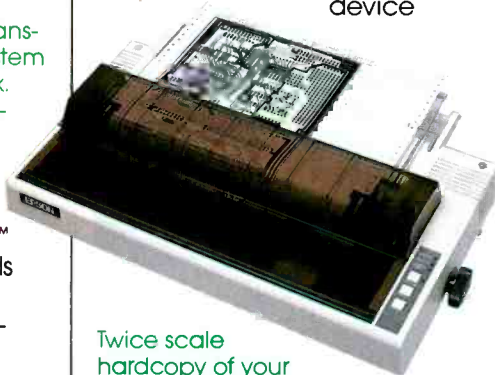

Twice scale hardcopy of your artwork is produced using the Epson dot-matrix printers or the Houston Instrument DMP-41 pen-and-ink plotter. Quick 1X check plot is also available from Epson printers.

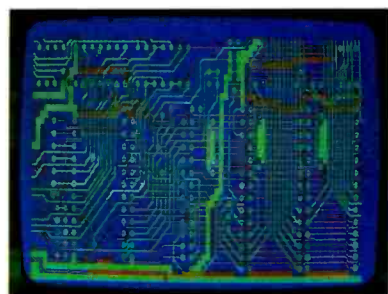

Dual-layer color display of a 2" by 4" section of a 10" by 16" circuit board

## The Smart Buy

At \$895, smARTWORK™ is an exceptional value, particularly when compared to conventional engineering workstation costs.

Call or write us for more information on smARTWORK™. We'll be glad to tell you how smARTWORK™ helps us design our own circuit boards and what it can do for your business.

Send a purchase order, or major credit card number, and smARTWORK™ can be working for you next week.

## System Requirements

- IBM PC or XT with 192K RAM, 2 disk drives and DOS Version 2.0
- IBM Color/Graphics Adapter with RGB color or b&w monitor
- Epson MX-80/MX-100 or FX-80/FX-100 dot-matrix printer
- Houston Instrument DMP-41 pen-and-ink plotter (optional)
- Microsoft Mouse (optional)



"smARTWORK" and "Wintek" are trademarks of Wintek Corporation.



40,000 characters, or 30 or more pages of double-spaced text.

### CASIO FP-6000

Casio perhaps is best known for pocket calculators and electronic watches, but its FP-1000/1100 family of 8-bit Z80-based personal computers, introduced last year, showed that Casio

was prepared for a serious entry into the personal computer field. When Casio announced the 16-bit FP-6000 computer system, I looked forward with considerable interest to seeing what this next step would be. The answer was that the FP-6000 is based on the 16-/16-bit 8086 microprocessor, running at 8 MHz and sup-

plied with 256K bytes of standard RAM, expandable to 768K bytes. Floppy-disk drives are only available in a separate unit; the same is true for RS-232C and 10-megabyte hard-disk interface boards.

The price for this rather ordinary system, including two 5¼-inch 320K-byte disk drives and a 12-inch display, is over \$2800, a good 50 percent above other 16-bit computers in its class, some offering substantially more features. Further, the system comes with MS-DOS and C<sub>86</sub>-BASIC as the only software, except for a floppy-disk format conversion utility; no applications software is included in the purchase price.

The following excerpt from a recent interview with Tadashi Senu, manager of the System Equipment Marketing Division of Casio, reflects some of the differences in marketing viewpoints in Japan and provides some perspective on the future of the personal computer industry.

BYTE: What are your plans for marketing the FP-6000 outside Japan?  
SENSU: We will market the FP-6000 in Europe, in over 15 countries, but not in the United States.

BYTE: What do you see as the chief marketing problems in the U.S.?

SENSU: In view of the limited production quantities possible for the FP-6000 and of the needs of U.S. users, we feel that the price and the limited software availability for the FP-6000 would result in a cost-performance ratio that would make it difficult for us to effectively market the FP-6000 in the U.S. Also, IBM has adopted an aggressive strategy; our technological capability is high, but legal factors make it virtually impossible to fight the IBM clones. To do that, it would be necessary to come in at a price 40 percent below IBM.  
BYTE: Why so little software?

SENSU: Actually, a great deal of MS-DOS software is available through cooperating vendors, but not through Casio directly. You must understand that while there are about 500 software firms in Japan, there are over

*(continued)*

**Winchester power  
for your PC**

The proven Winchester subsystem drives for your IBM or compatible PC. 10, 15, 25, or 33 megabytes of big system storage in a DiskSystem<sup>®</sup> you simply plug into your system and it's ready to use. At prices that make the speed and storage of a Winchester practical. Only \$1495 for a 10 megabyte DiskSystem, \$1795 for 15 megabytes, \$2245 for 25 megabytes, or \$2795 for 33 megabytes. DiskSystems can be bootable from the Winchester. See your dealer today for DiskSystem power for your PC.

**Interface Inc**  
21101 Osborne Street  
Canoga Park, CA 91304  
(818) 341-7914 • Telex: 662949

Dealer Inquiries Invited  
DiskSystems is a copyright of Interface Inc. IBM is a registered trademark of IBM Corporation. Prices are suggested retail and are subject to change without notice.



# THE PRINTER TO PICK WHEN THE PACE QUICKENS.

It's happening all over the PC and micro worlds.

You're getting hit with a ton of increased throughput requirements. Your applications are generating a deluge of paper. You need more printer speed. A lot more.

You're also looking for more professional-looking presentations so you need better print quality. A lot better.

Who's got the best of both worlds for you?

Okidata's Pacemark 2350 and 2410 dot matrix printers.

They'll not only help you *keep* pace with your world, they'll help you set new and exciting ones. In print speed. In print quality. And in vastly increased compatibility and capability.

Take throughput. The 2350 and 2410 can quickly get you out of the waiting game to where you're *really* cranking it out. And with flexibility, too: up to 5 pages per minute.

But wait. Cranking *what* out, you may ask? A single, restrictive printing mode? No way. The 2410 can give you DP, draft,

and a correspondence quality that truly rivals the daisywheel.

And the 2350 and 2410 can both print at up to 350 cps. While producing 120 to 420 lines a minute for you. With bidirectional printing and short line seeking logic. And both high speed horizontal and vertical slew.

---

## PC COMPATIBILITY. SOFTWARE COMPATIBILITY.

---

The 2350 and 2410 use industry standard interfaces making them hardware compatible with most mini and micro-systems on the market today. In addition, they are supported on the menus of most of the important software being offered to microsystem users like VisiCalc®, Lotus™ 1-2-3™, dBASE II®, Peachtree 500™ and General Ledger, Multimate™, WordStar®, etcetera, etcetera.

But wait, there's more. Like an outstanding all points addressable graphics capability with 144 x 144 dots per inch resolution.

Two color printing for highlighting. Down line loadable font sets for flexibility.

Subscripts and superscripts so your scientific and technical usage won't bog down. Six-part forms handling. The capability to print 132 columns on eight-inch paper using 17.1 characters per inch to save paper costs and make output easier to handle.

And—so that you can depend on getting all that good stuff, all the time—a mean time between failure of 2200 hours. A mean time to repair of only 30 minutes. An average printhead life of 200,000,000 characters.

No doubt about it, the quicker the pace at your place, the more you need Pacemark from our place. For more information, call toll free 1-800-OKIDATA. In New Jersey, 609-235-2600. Or write OKIDATA, Mt. Laurel, NJ 08054.

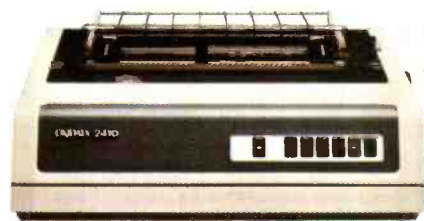

**OKIDATA**  
an OKI AMERICA company



- OUTSTANDING PRINT QUALITY
- OUTSTANDING VALUE



\$275.00

80 CHARACTER PER SECOND  
DOT MATRIX PRINTER

**EC** Everett/Charles®  
Marketing Services Inc.  
6101 Cherry Avenue  
Fontana, CA 92335  
800-443-1860  
(Calif. 800-821-1860)

Circle 132 on inquiry card.

## WORDPRINT for MICROSOFT WORD

The WORDPRINT printer driver toolkit enables you to configure Microsoft's WORD word processing program for use with various printers. Easy menu-driven installation allows multiple fonts, shadow/bold print, underlining, proportional spacing etc. if printer will support it. Translation tables for foreign/special characters. WORDPRINT generates a ready-to-use, WORD-compatible printer description (PRD) file and a matching PC-DOS device driver for your printer.

Program on IBM format diskette (180 Kb PC-DOS 2 only) with documentation . \$30.00 Dealer inquiries invited.



**Iceland  
Software Inc.**  
Skulatun 6,  
IS-105 Reykjavik  
ICELAND.

Please add \$5.00 p&p per order. Orders paid by certified or company check shipped immediately. Personal checks take 3-4 weeks to clear. Microsoft is a registered trademark of Microsoft, Inc. WORD is a trademark of Microsoft, Inc. Prices subject to change without notice.

Circle 170 on inquiry card.

## Fast ANALOG I/O BOARD

For Apple II, Commodore 64, TRS 80 Color, Timex, and others. Connects to CPU bus. 8 channels A/D & 8 channels D/A. 1.6 µS A/D convert time. 8 bit res. Easy to program. Box & cable available. \$220.

Software for Apple II & Commodore:

**SCOPE**  
Dual trace.  
256 samples taken at rates from 3 to 72000 Hz  
Trigger & cursor. Disk and printer utilities. Averaging. Usable subroutines.

**F.F.T.**  
128 spectrum lines.  
Displays 0 Hz to 1/2 sample freq. Mag & phase done in 1 sec!  
Needs CPM card.

Commodore Scope/FFT disk & manual . . . \$85.  
Apple II Scope/FFT disk & manual . . . \$100.  
Timex Scope/FFT Eprom Card . . . \$85.  
Please call or write for FREE CATALOG.

**Computer Continuum**

301 Sixteenth Avenue  
San Francisco, CA 94118 (415) 752-6294

## BYTE JAPAN

5000 in the U.S. Also, there are different buying habits in the U.S. and Japan. Americans choose the software they need, then buy a machine from the vendor, then purchase software. As a result, most software and hardware manufacturers develop their products separately in the U.S., while in Japan software is often developed together with the hardware manufacturer.

### NEVER OUT OF SORTS

Numerous versions of the quicksort algorithm exist; in fact, the quicksort seems to have become a de facto standard as one benchmark for comparing C compilers. The C language quicksort that appeared in two BYTE articles by Christopher Kern ("Five C

Compilers for CP/M-80," August 1983, page 110, and "Another Look at CP/M-80 C Compilers," June 1984, page 303) is compact and easy to understand and measures how well any given C compiler handles pointers. It doesn't provide a particularly efficient sorting algorithm, though, for sets of data that already are sorted (or nearly sorted) in either the correct or reverse order, which is often the case when you add new data to previously sorted records.

A couple of simple modifications, involving principles that are old hat to some but that are bound to be new to others, can dramatically improve the speed and efficiency of the quicksort (see listing 1).

(continued)

Listing 1: Modified quicksort algorithm in C uses center pivot to enhance speed in already sorted or nearly sorted data.

```

/* Quicksort */
quick(lo, hi, base) /* Sort strings pointed to by base[lo] . . . base[hi] */
int lo, hi; /* into increasing order */
char *base [ ];
{
    int i, j, piv;
    char *pivot;

    if (lo < hi) {
        piv = (lo + hi)/2; /* Select center pivot. */
        i = lo; j = hi; pivot = base[piv];
        while (i < j) {
            while (i < j && strcmp(base[i], pivot) <= 0)
                i++;
            while (j < i && strcmp(base[j], pivot) >= 0)
                j--;
            if (i < j) {
                swap(&base[i], &base[j]);
            }
        }
        if (piv < i && strcmp(base[i], pivot) > 0) i--;
        swap(&base[i], &base[piv]); /* Put pivot element in */
        /* correct "middle" position */

        if (i - lo <= hi - i) {
            quick(lo, i - 1, base);
            quick(i + 1, hi, base);
        } else {
            quick(i + 1, hi, base);
            quick(lo, i - 1, base);
        }
    }
}

swap(x,y) /* Swap a pair of pointers */
char *x[ ], *y[ ];
{
    char *temp; temp = *x; *x = *y; *y = temp;
}
#include stdlib.c

```

# A NOTED AUTHORITY SPEAKS OUT ON DATABASE MANAGEMENT.

"I've got 4 billion customers.

"The world's biggest database.

"So I need all the power I can get my hands on.

"That's why I use R:base.™

"With R:base, I can access billions of records. Open 40 files at the same time. Handle up to 400 fields. And sort it all out in a hurry. It's everything I need to keep my lists in order.

"And if your inventory is anything like mine, you'll appreciate the programming capability of R:base. It lets me do conditional processing. Post transactions. And update multiple files from one input form.

"But even with all that power, the real gift is that it's so easy to use.

"For starters, its on-screen tutorial makes R:base a snap to learn. And now, there's a new applications diskette with ready-to-use mailing list, inventory management, and forecasting applications.

"Not only that, R:base is designed to work with Clout.™ That's the program that lets me—and my elves—talk to our personal computers in plain English. Clout also remembers where my data is stored, and can search for it across

all files. So I don't have to!

"And here's the best package of all.

"For only \$14.95 (plus shipping), Microrim will send you a demo/tutorial packet of both R:base and Clout. Just call 1-800-547-4000, Dept. 897. In Oregon, call 1-503-684-3000. Or see your nearest software store now.

"Because if your workload starts to snowball, you could end up out in the cold!"



## R:BASE™ FROM MICRORIM®

Requires 256K of memory. Runs on MS-DOS and PC-DOS operating systems. CP/M-80 requires 64K.





## The critical feature is the way in which the pivot element is chosen.

The basic idea behind quicksort is to select one of the data elements as a "pivot" and then swap pairs of elements that "bracket" the pivot in order to end up with all elements that are less than the pivot to the left of the pivot and all elements greater than the pivot to the right. This sort divides the original data into two subsets; the same procedure is then applied (recursively) to each of the subsets until only one element remains in each subset. Of course, it is much faster to swap pointers than actual data elements.

The critical feature is the way in which the pivot element is chosen. In-

stead of selecting the "rightmost" element (the one with the highest subscript), the version in listing 1 selects the "middle" element. If you sort a few small examples using pencil and paper, you will see why this version works better on nearly sorted data or on data that starts out in reverse order.

There are lots of other, more complicated, possible pivot-selection rules, such as pivoting on the median value. The advantage of the "center-pivot" rule shown here is that it requires little additional computation to select the pivot.

Finally, the if...else statement at the end of the program allows the shorter of the two subsets to be handled first. Doing one before the other has essentially no effect on speed, but it limits the maximum length of the stack (the "depth" of the recursion) to  $\log_2 n$ , where  $n$  is the

number of items being sorted. Even for  $n = 32,768$  items, for example, the stack never gets deeper than 15 levels. Without limiting the stack length, the stack could reach a depth of  $n$ , potentially clobbering both program and data.

This routine was compiled using the Software Toolworks C/80 compiler; the #include STDLIB.C on the last line directs the compiler to include the file containing the standard library functions like strcmp(), which are provided with C/80.

### COMING UP

Next month, BYTE Japan will feature the NEC personal computers sold in Japan, plus a look at the Vectorio III, an Apple-compatible portable. You'll also find a C program that allows you to simulate "pipes," UNIX-style, and multiple-command lines under CP/M. ■

# THE PURCHASING AGENT

## COMPUTERS

Abacus AP3000	1,625
Alpha Micro 1000 WF	6,193
Altos 586 20 w/lo term.	5,525
586 40 w/lo term	7,063
586 40 w/lo term	8,403
Compupro Godbout	
Sys 816A RAM 17"	4,378
Sys 816A RAM 21"	4,489
Sys 816AH*	6,283
Sys 816C*	6,462
Sys 816CH*	8,324
Sys 816D*	9,402
Sys 816F (CPU 286)*	12,737
*Completely Assembled	
M-Drive-H	1,100
Pragmatic 20 meg, 8"	2,990
Pragmatic 40 meg, 8"	4,686
Columbia Sys-2-320K	2,244
Sys., portable	2,100
Molecular SM 8, 10 meg.	4,900
16K, 30 meg.	12,593
2,999	
NEC APC-H03	618
APC H12 Graphics	395
Special Softpacks	747
APC-H13	2,172
APC-H26, 10 meg.	2,172
8801A, System	CALL
Northstar Advantage	
w/Dual Floppies	1,978
w/15 meg.	3,986
w/30 meg.	4,864
Dimension, 15 meg.	5,691
Onyx 8001 MU 20, 256K	10,454
8002 MU 20, 512K	14,338
5001 MU 21 meg.	6,813
OSP	
Sanyo 555-2, w/2-320K	1,375
Tava Sys-2-360K	1,994
Televideo TS-1605 PC	1,877
Zenith ZF-110-22	2,685

## ACCOUNTING SOFTWARE

Cyma, each module	550
Micro. Consultants	CALL
Microtax	CALL
Open Systems, ea. mod	568

## HARD DISKS

lomega 10 meg.	2,091
20 meg.	2,866
Mountain Computer	
10 meg. internal	1,314
35 meg. external	3,484
Tailgrass 12 meg. w/tape	2,670
20 meg. w/tape	3,097
35 meg. w/tape	4,337

## IBM COMPATIBLES

Keytronics 5150 keyboard	189
5151 keyboard	239
Tava Sys-2-360K	1,984
Zenith ZF-151-22	2,565

## MODEMS

Hayes 1200	499
US Robotics Password	349

## MONITORS

Amdck Color IV T	767
NEC 1410 RGB	780
Princeton RGB w/cable	485

## PRINTERS

Anadex 9625B, parallel	1,190
Brother DX 15PS	379
HR-35PS	884
C. Itoh F10-55 cps	1,250
Dataproducs 8050	1,395
B300-4	5,921
Datasouth DS-220	1,568

## PRINTERS

Diablo 630 API	1,615
Fujitsu 830, 800 cps	CALL
IDS Prism 132 w/color	1,395
Juki 6100	487
NEC 2010	718
3550	1,584
7710	1,799

## OKidata

Printonix P300	5,900
Qantex 7065	1,575
Qume 11/40 w/interface	1,395
Tally 160L, w/tractor	569
180L, w/tractor	751
Texas Instr. TI810 Basic	1,323
TI855	842
Toshiba P-1340	773
P-1350	1,100
P-1351	1,365
Transtar 120 P/S	408

## PLOTTERS/DIGITIZERS

Hitachi HDG-2222 w/12	3,170
Houston Instr., DMP 29	1,778
DMP 40	771
DMP 41	2,321
DMP 42	2,321
DMP 52	3,484
Hi-Pad	763
461	

## STROBE M 100

DEC VT100	1,529
Freedom 200G	580
Hazeltine Esprit II	520
Qume QVT102A	542
QVT103A	861
Televideo 924	713
715	715
950	905
Wysa WY-50	539

## TERMINALS

DEC VT100	1,529
Freedom 200G	580
Hazeltine Esprit II	520
Qume QVT102A	542
QVT103A	861
Televideo 924	713
715	715
950	905
Wysa WY-50	539

CALL FOR YOUR PRICE ON ANY OF OUR 7,000 OTHER PRODUCTS.

Since 1980



## THE PURCHASING AGENT, INC.

2444 Old Middlefield Way, Suite J  
Mountain View, CA 94043

(415) 964-8222

B-8-10

## COMPETITIVE EDGE

P.O. Box 556, Plymouth, Mich. 48170

(313) 451-0065

### LOMAS DATA PRODUCTS, INC.

Thunder 186, 256K, 2 Serial, 1 Par, FDC, CCP/M 86 3.1	1,195
Thunder 186, 256K System, 2-5" Floppys 3 slot	1,895
Thunder 186, 256K System, Color Graphics, Keybrd & Mon	2,595
Lightning 286, LDP 72, 256K DRAM, CCP/M 3.1, 2-5" System	3,495
Lightning 286 System with Color Graphics, Keybrd & Monit	4,595
Lightning 286	\$1116
Lightning I 10MHZ 86	\$520
8MHZ 86	420
LDP 72	220
RAM 67 128K Static	725
Hazitall	275
Aurora Color Graphics Board Gives IBM PC Compatibility	396

### COMPUPRO®

#### ENTRY LEVEL SYSTEMS

85/88, RAM 17, Disk 1A, Interfacer 4, CP/M 2.2, 2-8" 10 SLT	2,995
85/88, RAM 21, Disk 1A, Interfacer 4, CP/M 86, 2-8" 10 SLT	3,395
CPU Z, RAM 17, Disk 1A, Interfacer 4, CP/M 2.2, 2-8" 10 SLT	2,895
8086, RAM 21, Disk 1A, Interfacer 4, CP/M 86, 2-8" 10 SLT	3,595
40 Megabyte Sub-System with Disk 3 for above	2,595
40 Megabyte Add-in less one Floppy for Systems above	1,995
MACROTECH 286/Z80H Add in less 85/88 for above	+ 769

MACROTECH 286/Z80H Replaces 85/88 1,109

Compupro A&T cash discount: 34% off list

on components — NO MINIMUMS

For Example: Disk 1A — \$459 RAM 22 256K — \$1155 Graphics — 327

### TELETEK ENTERPRISES, INC.

Systemmaster	\$557	6MHZ & 8MHZ Systemmaster II	CALL
SBC-1 6MHZ 128K	733	SBC-2 Dual Slave Board	837
SBC 86/87 Slave	CALL	CP/M 2.2	\$139
		CP/M 3.0	CALL
Turbodocs for SBC-1, SBC 86/87, SBC-2 W/PC Emulator			625
HD/CTC Hard Disk and Tape back up controller			499
System Systemmaster, 2-8" SSDD Drives 10 Slot Cab. & CPM			1,695
System Systemmaster, 2-8" DSDD Drives 10 Slot Cab. & CPM			2,295
System Systemmaster, 1-8" SSDD Dr 10 MB Hard Disk & CPM			2,795
System Systemmaster, 1-8" DSDD Dr 10 MB Hard Disk & CPM			3,195
Hard Disk Systems Available up to 280 Megabytes & 16 users			
System Systemmaster 4 User Slaves, 10 MB HD 1-8" SSDD			4,395
System Systemmaster 4 User 6MHZ 128K Slave, 10MB 1-8" DS			5,595
10MB Hard Disk Sub-System	\$1495	22MB	\$1895
		40MB	2,695

All prices subject to change and reflect cash discount. CP/M, CP/M-86, CCP/M-86 3.1 MP/M-86, are either trademarks or registered trademarks of digital research, CP/M 8-16, MP/M 8-16, Disk 1A, Interfacer 4, RAM 17, RAM 22, CPU Z are trademarks of Compupro, Compupro is a Godbout Company. Thunder 186, Lightning 286, Lightning 1, LDP 72, Hazitall, RAM 67 are trademarks of LDP, Inc. Systemmaster, Systemmaster II are registered trademarks of Teletek Enterprises, Inc. MSDOS is trademark of Microsoft. Turbodos is trademark of Software 2000, Inc. IBM and IBM PC is a trademark of International Business Machines.

**Thinking of  
buying a modem?  
You owe it  
to yourself to check out the Qubie' 212A modems.**

# Inside Outside

Just a few years ago, computers needed big air-conditioned rooms to operate in, balefuls of money to buy, and a team of wizards to keep them running. The constant march of technological progress has given more and more powerful machines which cost less and less. Desktop computers more powerful than the early mainframe computers are the result of the evolution. The Qubie' modems represent the latest extension of this progress. Because up until now, a 212A compatible modem cost at least \$500. Through the use of four low-cost, state of the art microprocessors, we can now offer two versions of our full featured 212A modem at prices the competition sells 300 baud modems for.

## In The Beginning

In September of 1983 we introduced the first 212A modem card for the IBM PC available for under \$300. The PC212A/1200 is a complete communications package including PC-TALK III software, modular phone cable, card edge guide, and instruction manual. The modem is an auto-dial, auto-answer type, which uses all the Hayes software commands so it can be used with any of the popular software packages including Crosstalk™, and Smartcom™. We picked the best software package we could find based on it's ease of use and features, PC-TALK III. Our modem includes features the old industry standard missed out on. Like being able to fit in one slot in a Portable PC or PC/XT.

Or an optional connector to use the modem's serial port when not using the modem. Of course the topper is the \$299 price, hundreds less than the competition.

## Now Available Outside

Our standalone modem, the 212E/1200 can be used with any computer or terminal with a RS-232C serial port. You can use any Hayes compatible communications software on anything from an Apple to a Zenith. Many owners of IBM PC's are using it because they lack available expansion slots, or have more than one computer they want to use their modem with.

It's attractive gold anodized case houses seven status lights (who says low prices means a shortage of features). It fits comfortably under a standard telephone. It is also a 212A compatible auto-dial, auto-answer modem which supports all Hayes software commands. Even the switch settings are the same, so any software giving recommended switch settings for a Hayes modem can be used, without knowing what the switches do. There is a volume control knob for easy adjustment of the speaker's output. Included in the package is modular phone cable, a cable to hook it to your computer or terminal, and instruction manual. Choose the communications package right for your needs, and you're ready to go!

## Four Hearts

The heart of the Qubie' modems are four digital signal microprocessors. Two handle sending, and two do the receiving. Rather than attempt to filter all but the relevant tones used for modem communications, the

microprocessors measure the tones digitally. This allows them to overcome line noise and static better than analog filter based modems

## Why Buy From Qubie'

Because you will get a product as good or better than any available, pay less for it, and get factory direct help if you need it. If at any time during the one year warranty period your modem should require service, we will fix it or replace it within 48 hours. Notice also there are no hidden charges in our prices. No extra for freight, insurance, credit cards, or COD fees. In a hurry? UPS 2nd day air service is just \$5 extra. If you are like many who say, "Nah, it's too good to be true," just apply the acid test and find out. Then you will be asking yourself, "Why should I pay what these modems used to cost?"

## The Acid Test

Qubie' gives you a 30 day satisfaction guarantee on your modem. If you are not completely satisfied we will refund the entire amount of your purchase including the postage to return it. If you can, get anyone selling another modem to give you the same guarantee. Buy both, and return the one you don't like. We know which one you will keep.

IBM is a trademark of International Business Machines Corporation  
Crosstalk is a registered trademark of Microstalk Inc.  
PC-Talk III is a registered trademark of The Headlands Press, Inc.



**PC212A/1200** Includes: Modem Card, PC-TALK III software, card edge guide, modular phone cable, quick reference card, and instruction manual. **\$299**  
Optional external serial port connector **\$20.**

**212E/1200** Includes: Standalone modem with cable (specify male or female), modular phone cable, and instruction manual. **\$329.**

## Order Today, Shipped Tomorrow!

All prices include UPS surface freight and insurance. Add \$5 for two day air service. For fastest delivery send certified check or credit card. Personal checks take 18 days to clear. Calif. residents add 6% sales tax. Corporations and Institutions call for purchase order details.

**(800) 821-4479**

Toll Free Outside California

**(805) 987-9741**

Inside California

**QUBIE'**

4809 Calle Alto  
Camarillo, Ca. 93010

Tempo House, 15 Falcon Road,  
London SW11 2PH, United Kingdom

Copyright Qubie' 1984

Circle 299 on Inquiry card.



# The best values always come from a name you can trust.

## APPLE SOFTWARE

**Advanced Analytics Technology**  
the "Banner" ..... \$ 22

**Ashton-Tate** ..... Call

**Beagle Bros.**  
DOS Boss ..... \$ 21  
Utility City ..... 25

**Broderbund**  
Bank Street Writer .... \$ 45

**Cdex**  
All Trng Prog's.....ea \$ 49

**Central Point**  
Copy II + ..... \$ 34

**Continental/Arrays, Inc.**  
Home Acct ..... \$ 59

**Digital Research** ..... Call

**Dow Jones**  
Market Analyzer ..... \$245  
Market Manager ..... 219  
Spreadsheet Link ..... 199

**Krell Logo** ..... \$ 75

**Living Videotext**  
Think Tank ..... \$ 99

**Micropro**  
Wordstar w/  
Star CP/M ..... \$295  
Infostar + w/ Strbrst .. 299

## MACINTOSH CORNER

**Continental/Arrays, Inc.**  
Home Acct ..... \$ 75

**Living Videotext**  
Think Tank ..... \$ 99

**Main St. Software**  
Main St. Filer ..... \$225

**Microsoft**  
Microsoft Basic ..... \$ 99  
Multiplan ..... 159

**Penguin** ..... Call

**Software Publishing**  
PFS: File/Rprt ..... ea \$ 95  
PFS: File/Rprt  
Combo ..... 149

**Davong**  
Disk Drives ..... Call

**Kensington Microware**  
Swivel ..... \$ 29  
Surge Suppressor... 45  
Modem ..... 399

**Maxell**  
3 1/2" diskettes ..... Call

**Memorex**  
Diskettes ..... \$ 49

**Teamar**  
Disk Drives ..... Call

**Microsoft**  
Cobol-80 ..... \$499  
Fortran-80 ..... 145  
Financial Statement... 79  
Budget ..... 119

**Peachtree** ..... Call

**Penguin Software** ... Call

**Software Publishing**  
PFS: File, Graph,  
Report ..... ea \$ 79

**Visicorp**  
Visicalc (II or IIE) ..... \$165  
VisiOn Series ..... Call

**Xerox Education**  
Sticky Bear ABC ..... \$ 35  
Sticky Bear Numbers . 35

## CP/M SOFTWARE

### Formats Available

All prices below are for 8" standard. Other formats are available. Some formats subject to "Download" fee and require minimum 2 weeks for dely. Please inquire.

**ATI**  
\*All Trng Prog's.....ea \$ 60

**Balcones**  
Boss Financial  
Acct'g System ..... \$999  
GL, AP, AR..... ea 399

**CompuView**  
\*V-Edit 8080 Z80,  
IBM/PC ..... \$130  
\*V-Edit CP/M 86 ..... 160  
Systran ..... 99

**Digital Research**  
\*Pascal MT+ w/ SPP ... \$389  
DR Assembler & Tools 149  
CP//M 2.2 ..... 125  
C Basic ..... 95  
PL/I-80 ..... 375  
Personal Basic ..... 120  
CP/M Gold Card ..... Call  
Access or  
Display Mgr ..... \$299  
C Lang/compiler ..... 260  
All 8" - 86 Version  
of Above ..... Call

**Infocorn**  
\*Deadline ..... \$ 49  
\*Starcross ..... 39  
\*Suspended ..... 39  
\*Zork, I, II, III ..... ea 39

**Mark of the Unicorn**  
\*Final Word ..... \$199

**Micro Pro**  
\*WordStar ..... \$250  
\*InfoStar + ..... 265  
\*Pro-Pak (WS,  
MM, SI, CS) ..... \$359  
All Others ..... Call



## PEACHTREE CORNER

Back to Basics  
Acct'g System ..... Call

Home Soft-  
ware Library ..... Call

PeachPak 4  
(GL, AP, AR) ..... \$249

Series 8 (GL, AP, AR,  
Sales Inv., Inv. Con-  
trol, Job Cost, Client  
Post. & Acct'g)  
Each Module ..... \$389

**Microsoft**  
Basic 80 ..... \$239  
Basic Compiler ..... 249  
Fortran 80 ..... 330  
Cobol 80 ..... 449  
Macro 80 ..... 130  
\*Multiplan ..... 149

**Microstuf**  
\*Crosstalk ..... \$109

**Northwest Analytical**  
\*Statpak ..... \$365

**Oasis**  
The Word Plus ..... \$120  
Punctuation & Style... 99

## dBASE II CORNER

**Anderson-Bell**  
Abstat ..... \$289

**Ashton-Tate**  
dBase II ..... Call  
dBase III ..... Call  
Framework ..... Call  
Friday ..... Call

**Better Business Solutions, Inc.**  
dBase II  
Writes Checks ..... \$ 75

**Data Based Solutions**  
dNAMES ..... \$ 95

**Fox & Geller**  
dGraph ..... \$199  
Quick Code ..... 175  
dUtil ..... 58

**Global Technologies**  
dbLINK ..... \$ 69

**Human Soft**  
DBPlus ..... \$ 90

**Sensible Designs**  
dProgrammer ..... \$199

**Software Banc**  
Advanced dBase II  
User's Guide ..... \$ 27  
Report Writing  
w/ purchase of  
dBase II ..... \$ 10

\*All above available  
on PC-DOS.

**Soraim**  
\*Supercalc II ..... \$189  
Superwriter  
(w/ Speller, Mailer)... \$189

**Supersoft**  
Disk Doctor ..... \$ 74  
Scratchpad Plus ..... 129  
T Maker III ..... \$195

## IBM/PC SOFTWARE

Please see CP/M listing. All products with an \* in front are also made for PC/DOS and are priced the same unless otherwise specified.

**Alpha Software**  
Alpha Base V ..... \$359  
ESP ..... 579  
Data Base Mgr II ..... 179  
Apple-IBM Conn ..... 169

**B&L Multi-Job** (runs 9  
programs at once)... \$145

**Central Point**  
Copy II PC ..... \$34

**Continental/Arrays, Inc.**  
Home Acct Enhncd ..... \$ 89

**Ctek** ..... Call

**Digital Research**  
Concurrent CP/M 86 .. \$225  
Pascal MT+ CP/M 86 .. 375  
Pascal MT+ DOS ..... 299  
DR Logo ..... 99

**Dow Jones**  
Market Analyzer ..... \$245  
Market Manager ..... 219  
Spreadsheet Link ..... 199

**Ecosoft, Inc.**  
Microstat ..... \$259

**Enertronics**  
Energraphics ..... \$265  
w/ Plotter Option ..... 299

**Fastware Thor** (the  
thought organizer)... \$245

**Financier, Inc.**  
Tax Series ..... \$105  
Financier II ..... 119

**Fox & Geller**  
Grafox ..... \$199  
OZ ..... Call  
RGraph (for  
R-base 4000) ..... \$215

**FYI**  
Superfile ..... \$149  
FYI 3000 ..... 287

**Graphic/Mosaic Software**  
Combo II & IV ..... \$350  
Integrated 6 ..... 359

**Hayes**  
Please ..... Call

**Lifetree**  
Volkswriter Deluxe ..... \$179

**Lighthouse Software**  
Key II (Data  
Mgmt for 1-2-3) ..... Call

**Living Videotext**  
Think Tank (256K) ..... \$139

**Micropro**  
Starburst ..... \$149

**Microrim**  
R-base 4000 ..... \$299  
R-base Clout ..... 169  
R-Writer ..... 119  
Prog Interface ..... 319

**Morgan Computing**  
Prof Basic ..... \$299  
Trace 86 ..... 99

**Peachtree**  
PeachText 5000 ..... \$249

**Satellite Software**  
Word Perfect w/ Sp... \$255

**Soraim**  
Supercalc III ..... \$249

**SPI Open Access** ..... \$399

**Star Software Systems**  
Property Mgmt ..... \$787  
Acct'g Partner ..... 269

**Supersoft**  
C Compiler - 8086 ..... \$350  
Basic Compiler ..... 225

**Visicorp** ..... Call

**Wang Software**  
Grammatik ..... \$ 59  
Proofreader ..... 42

**Warner Software**  
Desk Organizer  
(clears desk of 7  
business tasks) ..... \$249  
... and many more!

## DATABASE SYSTEMS

Three Top-Selling,  
Top-Rated Databases:

**Ashton-Tate**  
dBase II  
dBase III

**MicroRim**  
R:Base 4000

**PowerBase Systems**  
Power-Base  
w/ DataZOOM

Organize your data  
and have it readily  
available with a data-  
base. For information on  
the various databases,  
please call Tech Support  
at 1-715-848-1374.

## APPLE/ FRANKLIN BOARDS

### ALS

CP/M Card..... \$259  
Smarterm II..... 119  
Z-Card II..... 119

CCS 7710  
Asynch Serial..... \$109

East Side  
Wild Card II..... \$ 99

Microsoft  
16K Ramcard..... \$ 69  
Softcard..... 249  
Softcard +..... 449  
Prem Softcard (IIE)..... 335

Microtek  
Printer I/F..... \$ 75  
Dumpling-16K..... 169  
Dumpling-GX..... 89

Mountain  
A-D/D-A..... Call  
Music System..... \$349

Orange Micro  
Grappler + w/ buffer..... \$175

Prometheus  
Versacard..... \$159

Tymac  
Par I/F w/ cable..... \$ 79

Video-7, Inc.  
V-Color RGB cards.... Call

Videx  
Videoterm VT-600..... \$179  
Videoterm VT-602..... 249  
Ultraterm..... 249

### OCTOBER SPECIAL from Profit Systems, Inc.

**Tascmaster Software**  
(makes one PC worth  
nine, performs 9 tasks  
simultaneously)..... Call

Choose one of the  
following boards  
**FREE** w/ purchase  
of Tascmaster.

Adram Elite 64K  
(asynch [Ser. - RS232C]  
comm. adapter, clk,  
cal, par, printer,  
adapter, exp to 512K)

### OR

Adram Plus 64K (same  
above w/ 2 asynch  
[Ser. - RS232C]  
comm. adapter.)

## IBM/PC BOARDS

### DISPLAY CARDS

**Amdek**  
MAI Card..... \$420

**Fredericks/Plan-**  
**tronics** Colorplus... Call

**Hercules**  
Graphics Board..... \$349

**MA Systems**  
PC Peacock  
Color Board..... \$249

**Paradise/USI**  
Display Card  
(clr/monochrome)..... \$379

**Quadram**  
Quadcolor I..... \$199  
Quadcolor II..... 389  
Quadcolor I  
(upgrade)..... \$210

**Tecmar**  
Graphic Master..... \$479

**AST Research**  
Six Pak + 64K  
(exp 384K, S/P, Clk) .. \$269

MegaPlus 64K, (Cl/Cal,  
S Port, 512K cap  
w/ Megapak)..... \$269

Extra ports available  
for Megaplus and I/O  
Plus II (Game, P/S) .. \$ 40

5251 (PC to Syst/34,  
36, 38 connection) ... Call

Megapak 256K up-  
grade for Megaplus. Call

I/O Plus II Cl/Cal  
and S Port..... \$159

**Maynard Electronics**  
Floppy Drive Cntrlr... \$169

w/ Par Port..... 219  
w/ Ser Port..... 229

Sandstar..... Call

**Orange Micro**  
Mr. Chips..... Call

**Quadram**  
Quadboard 64K, (exp  
384K, Clk/Cal, S&P  
Ports, Software)..... \$269

Quadboard 384 (OK) .. 239

Microfazer Stack Printer  
-P/P 8K (exp 512K)..... \$139

-S/P 8K (exp 64K)..... 149

-S/S 8K (exp 64K)..... 149

Quadlink 64K Memory  
allows Apple SW to  
run on IBM/PC)..... \$469

Other Products..... Call

**Tecmar Products**..... Call

**Xedex/Microlog**  
Baby Blue..... \$325  
Baby Blue II..... 525

## MONITORS

**Amdek**  
300A Amber..... \$149  
Color II +..... 429

**NEC**  
JB1201-12" Green..... \$169  
JB1260-12" Green..... 119  
JC1216 RGB..... 429

**Panasonic**  
CT160 10" comp..... Call

**PGS**  
HX12 RGB Color..... \$489  
MAX 12..... 189

SR12 (690x480 Res) ... 639  
Doubler Card..... 175

**Quadram**  
Quadchrome..... \$495

**Sanyo**  
8112 12" HR Green.... \$195

**Taxan**  
KG12N-UY  
12" HR Am..... \$129

KG12N 12" HR Gr..... 132  
RGB Vision-1 12" Clr.. 319

RGB Vision-3 12" Clr.. 459

**USI 1200A**  
12" HR Am..... \$139

### SONY

#### Component TV System I

**Profeel 19" Trinitron  
Color Monitor.** (Analog  
digital RGB inputs for  
graphics and Teletext/  
Videotext applications.  
Built-in stereo amp w/  
5 watt per channel  
output)..... Call

**VTX-100R - Profeel  
Access Tuner.** (Cable  
ready express tuning,  
pay-TV ready, stereo  
ready, 10-key express  
cmdr, multiple video  
& stereo I/Os)..... Call

**SS-X2A Speakers..** Call

## MODEMS

**Hayes**  
Smartmodem 300..... Call  
Smartmodem 1200..... Call  
Smartmodem 1200B... \$449

**Novation**  
Apple-Cat II..... \$259

**Orchid Technology**  
the "Orchid Blossom"  
(To 384K, Clk w/ alarm,  
S&P ports, ram disk,

**Orchid Tech. (cont'd)**  
disk caching, upgrade-  
able to PCNet)..... Call

**Prometheus**  
Promodem..... \$399

**US Robotics**  
Auto-Dial 300/1200 ... \$459  
S-100 Modem..... 349

**Zoom Telephonics**  
Networker w/ SW..... \$109

## DISK DRIVES

**CDC 1800**..... \$219

**Corona**  
5 MB Hd w/ cntrlr... \$1495  
10 MB Hd w/ cntrlr... 1895

**Corvus Hd**..... Call

**Datamac**  
Trustor 10H (for  
MacIntosh, Ile, PC) ... Call

**Davong Hd**..... Call

**I-Omega**  
Bernoulli Box  
(Single 5" for Mac,  
8" for PC)..... Call

**Santa Clara Hd**..... Call

**Tandon TM-100-2**..... \$199

**Vista**  
Dynaframe Systems  
w/ 5-40 MB Pri DD .. Call

**HALF HIGHS**  
**Matsushita Electric**  
(w/ brackets)..... \$179

**Shugart**..... 225

**Super 5** (Apple)..... Call

**Teac w/ brackets**..... \$179

## PRINTERS

**Dana/Abati**  
LQ-20P..... \$429

**Diablo**  
630 ECS..... Call

**Juki Industries**  
6100..... \$449

**Mannesman Tally**  
MT180L..... \$799  
MT160L..... 569

Spirit..... 299

**NEC 3550**..... \$1625

**Okidata 82-93**..... Call

**Printek, Inc.**  
920 S/P..... \$2099

**Star Micronics**..... Call

**Teletex T1014**..... \$499

**Transtar**  
T-130 P&S..... \$659  
T-315 P - Dot Matrix... 489  
T-120 P&S..... 475  
... and much more.

## DISKETTES

**3M 5" DS, DD Box** ... \$ 40

**CDC**..... \$ 28

**Maxell 5" DS,  
DD MD2 Box**..... \$ 40

**Verbatim**  
5" DS, DD, Box..... \$ 35

**Ultra Magnetics 5"**  
DS, DD, (box/10)..... \$ 35  
(3 Boxes Diskettes Min.)

## PLOTTERS

**Enter**  
P100 Sweet P..... \$545  
Sweet P Six Shooter... Call

**Houston Instruments** Call

**Panasonic**  
VP6801P Plotter..... \$1375

## MISC.

**Alpha-Delta "MACC"**  
Surge Protector..... \$ 69

**Computer Accessories**  
Power Director..... Call

**Hauppauge**  
87 Chip..... \$159  
Other Products..... Call

**Keytronic**  
Keyboard 5150..... Call  
WP KB5151..... Call  
WP KB5151 Dvorak ... Call

**PC Innovations, Inc.**  
PC Reset (pushbutton  
oper. direct system  
reset for PC & XT).... Call

**SGL Homalite**  
Optech CRT filters.... Call

**Street Electronics**..... Call

**TG**..... Call

**Versa Computing**  
VersaWriter..... \$239

A variety of complete  
PC compatible systems  
are available at Oryx.  
For assistance in  
determining your needs,  
use our technical line.  
We will be happy to  
provide full support.

## POLICY:

- ▶ Wisconsin residents add 5% for sales tax.
- ▶ Minimum \$4.00 for shipping, handling and insurance for orders to \$200.
- ▶ For orders over \$200, add 2½% for shipping, handling and insurance.
- ▶ For cash prepayment of orders \$200 or more, add ONLY 2% for shipping, handling and insurance.
- ▶ Foreign — either add 15% handling & shipping (Int'l money order) or inquire.
- ▶ Prices are subject to change without notice.
- ▶ All items subject to availability.

## WE WELCOME:

- ▶ Visa, MasterCharge and American Express. (No charge for credit cards.)
- ▶ Corporate, government or educational volume purchases, please ask for special accounts desk for additional discount. (1-715-848-1374)
- ▶ COD (Add \$2.00 per box/parcel. Cash or certified check required.)
- ▶ Checks. (Allow 1-2 weeks for clearing.)

## WORKING HOURS:

Monday-Friday 8:30-6:00 • Saturday 10:00-2:00 • Central Time

Circle 263 for Hardware inquiries. Circle 264 for Software inquiries. Circle 265 for October Specials.

**ORYX SYSTEMS, INC.**  
CRAFTSMEN OF THE NEW TECHNOLOGY

**1 800 826-1589**

WITHIN WISCONSIN **1 800 472-3535**

425 First Street • P.O. Box 1961  
Wausau, Wisconsin 54401

\*For tech. support & order status: 715-848-1374





FOR THE IBM® PC, IBM® XT, COMPAQ™  
CORONA™, CORONA™ PORTABLE, LEADING EDGE®, EAGLE PC®, TAVA™



# 10, 20, 33 Mbyte Hard Disk Systems from \$895

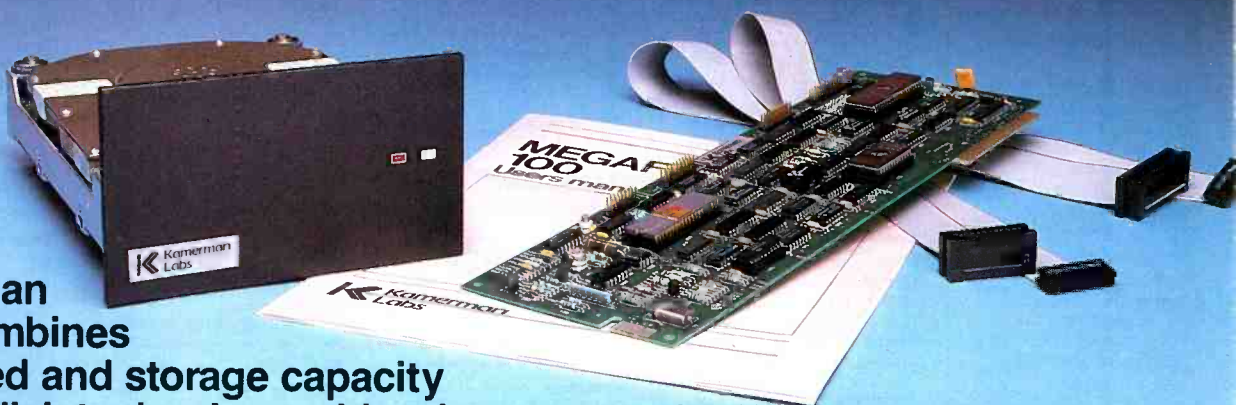

**Kamermerman Labs combines the speed and storage capacity of hard disk technology with prices you can't afford to pass up.**

**A dramatic leap in performance for your personal computer.**

Even the smallest Kamermerman Labs hard disk unit gives you 30 times the storage capacity of a typical floppy disk. Sophisticated business and professional data storage requirements can now be handled with ease.

Better yet, you can access data up to 10 times faster than with floppies. Spend more time working and less time waiting.

And it's easy to use. Kamermerman Labs lets you boot directly off the hard disk, just like the IBM XT.

**A complete backup solution.**

Backup of hard disk data is a critical requirement in many microcomputer applications, so Kamermerman Labs offers several reliable and cost-effective backup devices that are fully compatible with our hard disk units.

**Lower prices than ever.**

Because you deal directly with Kamermerman Labs, we offer you remarkably low prices. Finally, you can realize the full benefits of hard disk technology without the excessive costs.

**Tested and formatted.**

All Kamermerman Labs systems have been thoroughly tested and formatted before delivery.

**Full warranty and technical support.**

Kamermerman Labs backs all its products with a full one-year warranty on both parts and labor. Plus you get prompt technical support through a toll-free hotline number.

**To order, call toll-free 800-522-2237.**

In Oregon, Hawaii and Alaska call 503-626-6877.

IBM is a registered trademark of International Business Machines Corp.  
Compaq is a trademark of Compaq Computer Corp.  
Corona is a trademark of Corona Data Systems.

Leading Edge is a registered trademark of Leading Edge Products, Inc.  
Eagle is a registered trademark of Eagle Computers.  
TAVA is a trademark of TAVA Corporation.

All Kamermerman Labs Units come in either Internal or external configurations.

Circle 191 on inquiry card.

 **Kamermerman  
Labs**

8054 S.W. Nimbus, Bldg. 6, Beaverton, Or 97005  
Phone 503-626-6877

# POP *and* SNAP

## Another AI language family

BY DICK POUNTAIN

If it's true that the world is an electronic global village, I find it rather strange that national and regional differences still persist within the computing community, the supposed vanguard of the revolution. Nowhere are these differences more pronounced than in artificial intelligence (AI) research, which surely is the vanguard of the vanguard.

The best-known example of such a difference is the LISP/Prolog divide. By and large, American AI researchers are committed to LISP, whereas Europeans favor Prolog. Because LISP was invented in America at the Massachusetts Institute of Technology, while Prolog was developed in France, Hungary, and the U.K., the academic debates often contain a nationalist undercurrent that is less than useful. The recent adoption of Prolog by the Japanese Fifth-Generation workers only adds to the emotional charge.

However, reality is rather more complicated than rumor. While Prolog is certainly popular on European campuses, it is not the only tool used by AI researchers in the U.K. A variety of experimental languages are in use at different centers (especially functional languages), but one particular language family has been established long enough to qualify as a third option.

### POP

POP-2 was developed at Edinburgh University (by Burstall, Collins, and Popplestone) in the late 1960s as an alternative to LISP. While POP does all the same things LISP does—it's a list-processing language in which all data objects are in the end represented as lists—it's far easier for nonspecialists to learn because it uses a more conventional, procedural syntax. POP programs look rather like Pascal and are much more readable than their LISP equivalents. Before I start to receive letterbombs by transatlantic mail, I should add that this is not meant to disparage the economy and elegance of LISP syntax, nor to devalue its

historical influence—without LISP there could have been no POP or Prolog.

POP was taken a step further at Sussex University (by Clowes, Sloman, Hardy, and others), where it became a powerful integrated programming environment called POP-11. POP-11 includes a full-screen, syntax-checking editor and a variety of debugging tools that are probably unrivaled anywhere outside of Smalltalk. Also, the emphasis has subtly shifted. Though POP-11 is an excellent tool for AI research, the Sussex workers decided that it also would be fine for teaching novices to program, and this has been tested in a few selected English schools.

The argument runs that novices need powerful rather than puny systems on which to learn. The best analogy is not the automobile (where you wouldn't dream of turning a learner loose in an AC Cobra), but music; you'll find it much easier to learn on a fine instrument than a creaky old wreck.

Dr. Aaron Sloman, one of the developers of POP-11 (in a research paper, *Why Beginners Need Powerful Systems*, 1982—see "For More Information" on page 388) lists 25 features he considers essential in a good teaching language. I don't have space to catalog them here, but I'll mention a few.

First, the environment is as important as the language. BASIC still is the most popular language despite its shortcomings because the integrated editor environment it provides is so much friendlier than a compiler/editor/linker/loader setup. All operating-system functions and debugging and tracing aids should be available without leaving the system.

This leads naturally to an interpreter or incremental compiler (as in FORTH) as the preferred choice. General-purpose data structures are necessary, but strong typing is not. You need lists as well as variables and arrays, and they should all be able to hold data of any type as in LISP, Logo, and Prolog.

(continued)

Dick Pountain is a technical author and software consultant living in London, England. He can be contacted c/o BYTE, POB 372, Hancock, NH 03449.



Procedures should be objects that can be stored in variables, passed as parameters, and generated by other procedures.

Memory allocation should be handled automatically and be transparent to the user. Because we're using lists, this means efficient automatic garbage collection.

Users must be able to interrupt and suspend program execution and do anything that the language allows, including defining new procedures and editing existing ones, during the break.

Error trapping should be user-definable and dynamically alterable, so that different levels of error reporting can be provided for different levels of student skill.

Finally, graphics are essential, preferably in an easy-to-program form as in Logo.

None of this comes cheaply—POP-11 at the moment runs only on the Digital Equipment Corporation (DEC) VAX and some other large UNIX systems. In fact, the latest development is an even larger system called POPLOG, which brings together POP-11, Prolog, and LISP in a common, incrementally compiled environment; programs compiled from Pascal, FORTRAN, or C can be linked in as well, which covers just about all the bases.

## SNAP

The story does not end here for personal computer users. A group from the Social Psychology department at Sheffield University is in the process of implementing a language called SNAP, based on POP, for MS-DOS systems (including the IBM Personal Computer) running in 128K bytes of memory. SNAP is not a full implementation of POP-11, but it includes many of its important features and even improves on it in some areas. SNAP already is running on the department's Onyx (UNIX) system, and this is the version that I've tried out—the conversion to MS-DOS is on target for a preliminary version to come out in October of this year.

The reason that psychologists be-

came involved in writing a programming language is simple; they need to use computers in their experimental work and have become dissatisfied with the available languages. They find themselves continually facing the "4:30 Friday" problem—how to get medium-sized but complex programs up and running in a short time. The programs tend to be cognitive psychology experiments that require symbol processing and sophisticated screen handling.

In a typical experiment, random English sentences might be generated and displayed fleetingly, one word at a time, with an adjustable real-time delay. Microcomputer LISPS don't have the screen-handling capability, while Pascal and C are hampered by the slow edit/compile/link/load cycle. BASIC just isn't powerful enough. SNAP fills the vacancy and has the added benefit of being easy for non-computer specialists to learn and use. The intention is that SNAP should be sufficiently general purpose to handle all a lab's programming chores, from experiments and simulations through data capture and statistical analysis to instrument control and graphical output.

In case you run away with the idea that anyone can implement POP, note that two of the team (T. Green and A. Arblaster) are specialists in the psychology of computer use, one (A. Cornah) is a computer scientist, and another (T. McClusky) is a professional programmer.

Using SNAP feels much like using BASIC, LISP, or FORTH. You type in commands and they are executed immediately, or you can type in definitions to add new commands—they are compiled on the spot into a dictionary, more like FORTH than BASIC.

SNAP doesn't at present have a built-in editor. The development is being done under UNIX, which lets you call an external editor (Mark of the Unicorn's Mince) from inside the system. Since MS-DOS lacks this multitasking ability, a Tiny Editor is being developed to reside in the system.

The syntax of SNAP resembles a less-fussy Pascal with overtures to C

(it's written in C). Like most non-computer scientists, the authors hate typing, so keywords tend to be terse.

The overall structure of programs is similar to that of LISP. Function definitions cannot be nested and they stand alone, without any need for a program body or main function as in Pascal and C. There is no necessary order to function definitions, and one function definition can include a call to another that is not yet defined, as long as it gets defined before run time. You can run any function merely by typing its name. As an example, the factorial function could be defined as shown in listing 1.

The `edef` and `eif` mark the end of each control structure, formed by adding `e` (for end) to its name.

## SNAP FUNCTIONS

Functions return their values on a stack, so to use the function you type `print(factorial(5))`, or `factorial(5) = >`, both of which print the stack top value 120. The optional giving 1 specifies that exactly one value will be returned. If used, it causes a compile-time check that the definition actually does return the right number of results and thus alleviates the explosive effects of stack errors with which FORTH programmers are familiar.

Functions can return as many (or no) results as desired. Real as well as integer arithmetic is provided, and the system is equally happy with infix, prefix, or reverse Polish notation.

An alternative nonrecursive factorial function that includes some more features is shown in listing 2.

`Locals` declares the two variables to be local to the definition; if declared outside the definition by `vars`, they would become global. The scope of variables is lexical (i.e., fixed by the program text at compile time) as in Pascal. The assignment operator `->` is immensely flexible because you can assign any kind of object (number, string, array, list, or function) to any name.

You also can alter the system by assigning a new function to one of the system functions. In this case, the

*(continued)*

# Two more great reasons to buy the Canon<sup>®</sup> AS-100 Microcomputer.

1. Incredibly low price.
2. Free software.



Now there's even more incentive to buy Canon's AS-100 Microcomputer.

Because not only will you get one of the most advanced, small business microcomputers you can buy, but with a price that's now dramatically reduced, you'll also get value that's just as far ahead of its time. Plus free business management programs.

That's an unprecedented saving on this elegantly compact, yet powerful microcomputer.

It has a high-speed, 16-bit microprocessor with standard 128K-bytes RAM expandable to 512K bytes.

A high-resolution, color display system for easy-to-read figures, charts and graphs (monochrome green display if you prefer).

The convenience and versatility of a lightweight keyboard that's adjustable for maximum comfort. Plus external storage capacity that includes 5¼-inch mini or 8-inch floppy disks, with hard disk drive

also available.

And if all this isn't reason enough, the AS-100 now comes fully equipped with a choice of popular business software packages. Software such as WordStar\* for word processing, CalcStar\* and SuperCalc 2\*\*\* for spreadsheet analysis and dBase II\*\*, InfoStar\* and Friday!\*\*\* for data base management. There's also a choice of Canon's exclusive software—Canowriter† and Canobrain II†.

Terrific savings and a choice of software packages.

Two more great reasons to buy the only microcomputer that comes with the assurance, reliability and technological quality of Canon.

The Canon AS-100.

**For more information:**  
Call 1-800-323-1717, Ext. 302.  
(In Illinois call 1-800-942-8881, Ext. 302.)  
Or Write Canon U.S.A., Inc.,  
Systems Division, P.O. Box CN 11250  
Trenton, N.J. 08638.

\*InfoStar, CalcStar and WordStar are trademarks of MicroPro. \*\*Friday! is a trademark and dBase II is a registered trademark of Ashton-Tate. \*\*\*SuperCalc 2 is a trademark of Sorcim. †Canowriter and Canobrain II are trademarks of Canon, Inc.

Available through Canon authorized dealers.  
Offer good through October 31, 1984.

© 1984 Canon U.S.A., Inc.

**Canon Systems Division**

Circle 387 on inquiry card





235  
48  
6  
289

3.00

(Formerly Warehouse Software) Call for programs not listed  
**Technical & Other Information (602) 246-2222**  
**TOLL-FREE ORDER LINE 1-(800) 421-3135**

BYTE U.K.

**FREE SOFTWARE! FREE SOFTWARE! FREE SOFTWARE!**

Purchase an Okidata, Epson, or Gemini printer and receive at no charge a program to set print characteristics and to make your computer function as a correcting typewriter. Retail value \$50. Available for most disk formats.

**DATA BASE MANAGEMENT SYSTEMS**

Fox and Geller Quickcode .....	\$159
Knowledgeman .....	\$275
Condor III .....	\$320
NWA Statpak Special .....	\$285
Tim IV .....	\$249
Infostar .....	\$249
FRIDAY .....	\$165
Personal Pearl .....	\$215
Fast Facts for IBM PC .....	\$135
RBase 4000 .....	\$269
CLOUT .....	\$119

**WORD PROCESSING**

Wordstar, Mail Merge, Correct Star, Star Index .....	Call
Wordstar .....	Call
Leading Edge Word Processor with Mail Merge .....	\$95
Mail Merge or Correct Star .....	\$130
Microsoft Word With Mouse .....	\$284
Word Perfect .....	\$248
Volkswriter for the IBM PC .....	\$110
Volkswriter DeLuxe .....	\$155
Wang Spellchecker .....	\$36
Metasoft Benchmark .....	\$265
Multimate .....	\$249
Peachtext 5000 .....	\$185

**SPREADSHEETS**

Calcstar .....	\$89
Supercalc II .....	\$145
Supercalc III .....	\$195
Microsoft Multiplan .....	\$119
!TK Solver .....	\$259

**ACCOUNTING**

**TCS, equivalent of Peachtree - Specially augmented by Warehouse Software Customized for your IBM PC Terminal and Printer - GL, AR, PA, AP, CP/M-80 CP/M-86 for PC XT, DOS 1.1, 2.0. Each Module ... \$75 For All Four \$275**

CYMA .....	Call
Dollars & Sence .....	\$115
MBSI Real World, GL, PA, AP, AR Each Module .....	\$350

**TRANSFER PROGRAMS**

Hayes Smartcom .....	\$88
Move-it .....	\$78
Microstuff Crosstalk .....	\$95

**BEST PRICE IN U.S. FOR IBM PC OR CLONES Multifunction Board - Includes Async Adapter, Parallel Adapter, Clock with battery back-up and Software, 64K memory expandable to 512K, 1 year warranty. \$249**

**LANGUAGES**

Lifeboat Lattice C Compiler .....	\$295
Microsoft C Compiler .....	\$315
Microsoft Pascal Compiler .....	\$215
Microsoft Basic Compiler .....	\$245
Microsoft Basic Language .....	\$235
CBASIC 86 for IBM PC .....	\$135
<b>FOR PC DOS</b>	
Norton Utilities .....	\$48
Copy II PC .....	\$34
Prokey V3.0 .....	\$79
Harvard Project Manager .....	\$225
Microsoft Flight Simulator .....	\$32

**HARDWARE**

Hayes 1200 Modem .....	\$485
Hayes 1200b Modem for IBM PC .....	\$415
Internal Modem for IBM PC .....	\$285
Anchor Signalman 1200 baud Modem .....	\$265
CDC 360K Disk Drives .....	\$199
1/2 Height Panasonic Drives D/S D/D .....	\$185
10 MB Sigma hard drive for the PC .....	\$895
10 MB Datamac external hard drive for IBM PC .....	\$1095
Princeton RGB monitor .....	\$469
Taxan RGB Vision 420 .....	449

**COMPUTERS**

Corona Computer .....	Call
All new Televideo Portable — 99.9% IBM Compatible with Software .....	\$1795

**BOARDS FOR THE IBM PC**

**OR LOOKALIKES**

Quadram Color I .....	\$199
Quadram Color II .....	\$225
Plantronics Color Plus Board .....	\$365
256K Sigma Ram Board .....	\$299
Maynard Sandstar Controller .....	\$195
STB Graphics II Board .....	\$340
Tecmar Graphics Card .....	\$495
New Quadram Multifunction Board .....	Call

**PRINTERS**

Gemini 10X .....	\$265
Gemini 15X .....	\$365
Okidata 82A .....	Call
Okidata 83A .....	Call
Okidata 84P .....	\$895
Okidata 92P .....	Call
Okidata 93P .....	Call
Juki 6100 .....	\$409
<b>Call on all Epson Models</b>	
Daisywriter 2000 .....	\$975
Silver-Reed .....	Call
Diablo 620 .....	Call
Diablo 630 .....	Call
NEC 3550 .....	Call

TERMS: Prices include 3% cash discount. Add 3% for charge orders. Shipping on most items \$3.00. AZ orders +6% Sales Tax. Prices subject to change.

**TOLL-FREE ORDER LINE 1-(800)-421-3135**

**WAREHOUSE DATA PRODUCTS**

2701 West Glendale Ave., Suite 6  
 Phoenix, AZ 85021



operator nonop is required. Nonop stops a function being evaluated and returns it as an object (also required for arrays but not for variables or lists); e.g., nonop newprompt -> nonop prompt.

Such latitude offers the powerful possibility of storing functions in an array (maybe dynamically during a program run), where they can be executed by obey as in obey (funarray(23)).

This flexibility is typical of SNAP. Take another example. The ASCII (American Standard Code for Information Interchange) characters are divided up into classes (letters, numbers, symbols, control characters, separators, white space, quotation marks) and the class of any character can be found by the function charclass. If in a particular application it's convenient to change the class of a character, say, to allow \ to be used in identifiers, all you do is assign the class of any letter (for example, a to \). SNAP uses this class system when lexically analyzing input text; for input purposes, a word ends whenever the class of the characters changes, so A+B without any spaces will be read in as three separate words. In a similar way, all infix operators have a precedence property that can be assigned to set the precedence of user-defined operators.

(continued)

**Listing 1: A sample factorial function.**

```
def factorial (number); giving 1
  if number = 1 then 1
  else number * factorial (number-1) eif
edef
```

**Listing 2: A nonrecursive factorial function.**

```
def factorial (num); giving 1
locals j p
  1 -> p
  for 2 to num -> j do
    p * j -> p
  edo
  p
edef
```

# Hard Disk, Soft Shell

## The Complete Hard Disk Solutions

For Desktop & Portable PC's 10 Megabytes \$888, Or 20 Meg \$1288.

We have the whole package you need to add a hard disk to your IBM PC or compatible. Our half-height 10 and 20 megabyte drives have the lowest current draw in the industry. Unlike most aftermarket hard disks ours can "boot" direct from the hard disk. No software patches, or drivers to install just a copy of IBM PC DOS 2.0 or 2.1.

**Idirfully Easy** with the popular Idir menu driven "visual shell" software. It replaces complicated DOS commands with menus that allow you to just point at what you want to do. Help files explain DOS commands and give you on-line advice when you need it. Idir takes the wonder out of the tree structured subdirectories so useful in organizing a hard disk.

**Hard Problems** like excessive current draw and heat have until now been unsolved problems with aftermarket hard disks. Most drives draw lots of power. If your PC has many expansion boards in it, power to run a hard disk is probably not available. Hard disks have also been easily damaged by vibration and movement. And of course the problem any non-IBM product must face, compatibility with the IBM PC. We have tackled all these problems and come up with the best solutions available at any price.

**Cool & In Control** with half-height drives so efficient they draw the same amount of power as a floppy disk drive. This means a minimum of heat inside your PC with more power available for expansion boards. The controller uses LSI technology to provide fewer components, drawing less power, and giving significantly improved performance over the IBM XT.

**The Portable Plus** is 10 or 20 megabytes to go. In fact, the drives we use have been selected by several computer makers for use in their portable computers. Their plated recording media helps withstand vibration, and allows the drive to be used at any angle.

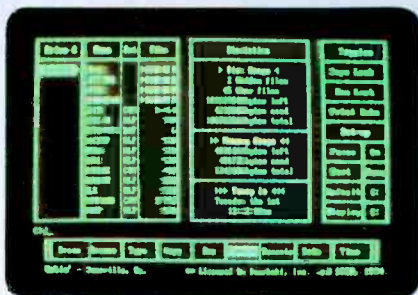

**Total Compatibility** is a necessity. Our hard disks have the ability to boot directly from the hard disk. Check around, very few aftermarket systems can. In fact, all you need is a copy of DOS 2.0 or 2.1 and you are ready to go, no software drivers to install, or DEBUG patches to apply.

**Why Buy From Us?** It's simple really. Better value, and no hassles. You see, the price advertised is the whole price. No extra for freight, credit cards, COD fees, or insurance. Perhaps the best part is if you have a question you deal direct with Qubie'. We have the knowledge and ability to

help you quickly. And, if you do have a hardware problem during the warranty period it is fixed or replaced within 48 hours!

**No Risk.** Don't be afraid to save. Our manual is written so even the novice can successfully install his own system. And remember, if for any reason you are not happy within 30 days of purchase you may return it for a full refund, and we'll pay the freight back! Get our competition to make the same offer, and find out which system is best. We know which one you will choose.

**System Requirements:** Any IBM PC with 64k RAM and PC DOS 2.0 or later. Compatible owners call for application information.

**PC10:** Includes 10 Megabyte drive, controller, cables, installation instructions, Idir software, and 1 year warranty. **\$888**

**PC20:** Same as above with 20 Megabyte drive. **\$1288.**

**Options:** Auxiliary power supply, for those with computers already full of power hungry expansion boards. #PCPWR \$88.

Half-height bezel (specify computer), #HHBZL \$15.

**DEALER AND QUANTITY PURCHASE INQUIRIES INVITED**

### Order Today, Shipped Tomorrow!

Price includes UPS surface freight and insurance. Add \$12 for two day air service. For fastest delivery send certified check or credit card. Personal checks take 18 days to clear. Calif. residents add 6% sales tax. Corporations and Institutions call for purchase order details.

**(800) 821-4479**

Toll Free Outside California

**(805) 987-9741**

Inside California

**QUBIE'**

4809 Calle Alto  
Camarillo, CA 93010

Tempo House, 15 Falcon Road,  
London SW11, United Kingdom

9/62 Blackshaw, Mortdale  
2223 N.S.W., Australia



**Idir Directory System Included**

Circle 402 on inquiry card.



# There's a better way to pack more muscle in your micro.

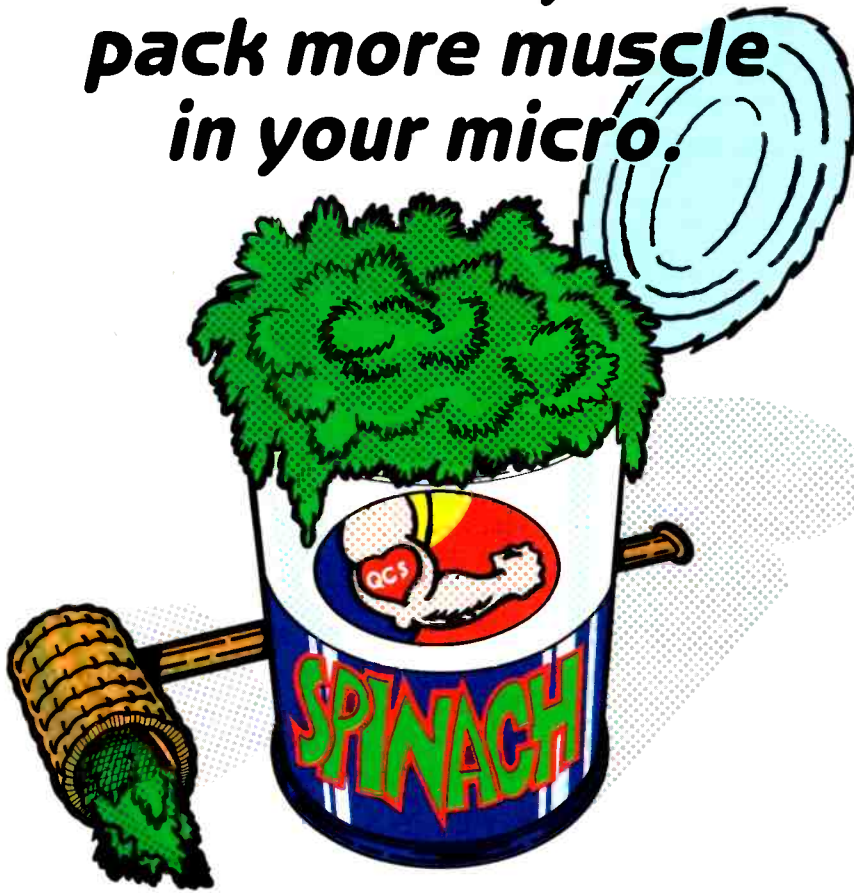

## The HarDrive™ by QuCeS. More bytes for your buck. In a flash.

If you're looking for a way to get more performance out of your microcomputer, look no further than QuCeS.

With a QuCeS HarDrive subsystem, you can make your micro behave almost like a mainframe. 10 to 114 megabytes of mass storage lets you handle data bases that would make the normal micro blow a fuse. And you can access, update and process data so incredibly fast, you won't believe your eyes. A QuCeS HarDrive with an optional 5 megabyte backup cartridge, also means you won't have to rely on a very unreliable storage medium for your crucial data—namely floppy disks—ever again.

Another QuCeS plus is compatibility. It interfaces with most popular microcomputers like IBM, Radio Shack, Apple, DEC, Epson—you name it. Installation couldn't be easier, our software is easy to use, and each HarDrive is backed by a 1-year warranty.

The QuCeS HarDrive. It will make your micro mightier and faster than ever before.



For complete details, contact

**Quality Computer Services**



3 Quces Drive, Metuchen, N.J. 08840 (201) 548-2135  
TELEX 299410 QCS

File I/O (input/output) is performed by redirecting the print and read functions to a named device or file. It's also easy to redirect I/O to data objects inside the system by assigning them to the system variables sink and source.

SNAP accommodates arrays of up to five dimensions, and you must set both the upper and lower bounds when they are declared (an inheritance from Algol). For example:

```
array([1,10,1,20]) -> x
```

makes x a 10 by 20, two-dimensional array with lower bounds of 1. You can use variables or expressions in the declaration to give dynamically variable size and dimensionality. And the functions ndims, ubo, and lbo (upper bound and lower bound) enable a receiving function to find out what sort of array it has been passed. Arrays can hold any mixture of any sort of object, so it's possible to use them like Pascal records or to do things like pass a variably sized array of mixed functions and data as a parameter.

SNAP has a full set of string functions cribbed directly from BASIC (a nice recognition that BASIC has some good elements): len, mid, left, right, and instr work just like their S counterparts.

Lists are handled as in LISP but are contained in square rather than round brackets—e.g., ["A" x [1 2 3]]. One level of evaluation takes place unless quotation marks are placed, as around A, and a whole list can be quoted by using curly brackets, as in {a b c 1 2 3}.

The functions to manipulate lists are hd (head), tl (tail), and cons (construct), supplemented by first, second, third, fourth, nth, and last to return the specified elements in a single step. The head, tail, and construct functions are equivalent to the CAR, CDR, and CONS functions in LISP. CAR returns the first element in a list, CDR eliminates the first element, and CONS builds a new list structure.

Among the many built-in predicates (or tests) is llist to test for listhood; llist is unLISPlike in that it returns

(continued)

# THE PANASONIC SR. PARTNER™ NO PERIPHERALS NEEDED

Because they're already built-in. The 80/132-column printer. The 9-inch, high-resolution display. There's even a built-in 360K disk drive. Which all make the Sr. Partner a complete computer as is.

The Sr. Partner is IBM hardware and software compatible so you can run popular business programs immediately. The software bundle currently offered with the Sr. Partner is WordStar, VisiCalc, pfs:Graph, File, Report, MS-DOS 2.11 and GW BASIC.\*

And with its 256K internal memory expandable to 512K, the Sr. Partner can run the new integrated software.

Built-ins also include expansion slots and parallel and serial I/O ports. There's even a built-in RGB monitor port so you can take advantage of the Sr. Partner's color and graphics capability.

If you want 10 megabytes of storage, choose the new hard disk Sr. Partner.

Both the Sr. Partner and the hard disk Sr. Partner come with an exceptional Panasonic warranty.\*\*

For the dealers nearest you, call: 201-392-4261. The Panasonic Sr. Partner. No peripherals needed. It makes the competition look like Jr. Executives.

## Panasonic Industrial Company

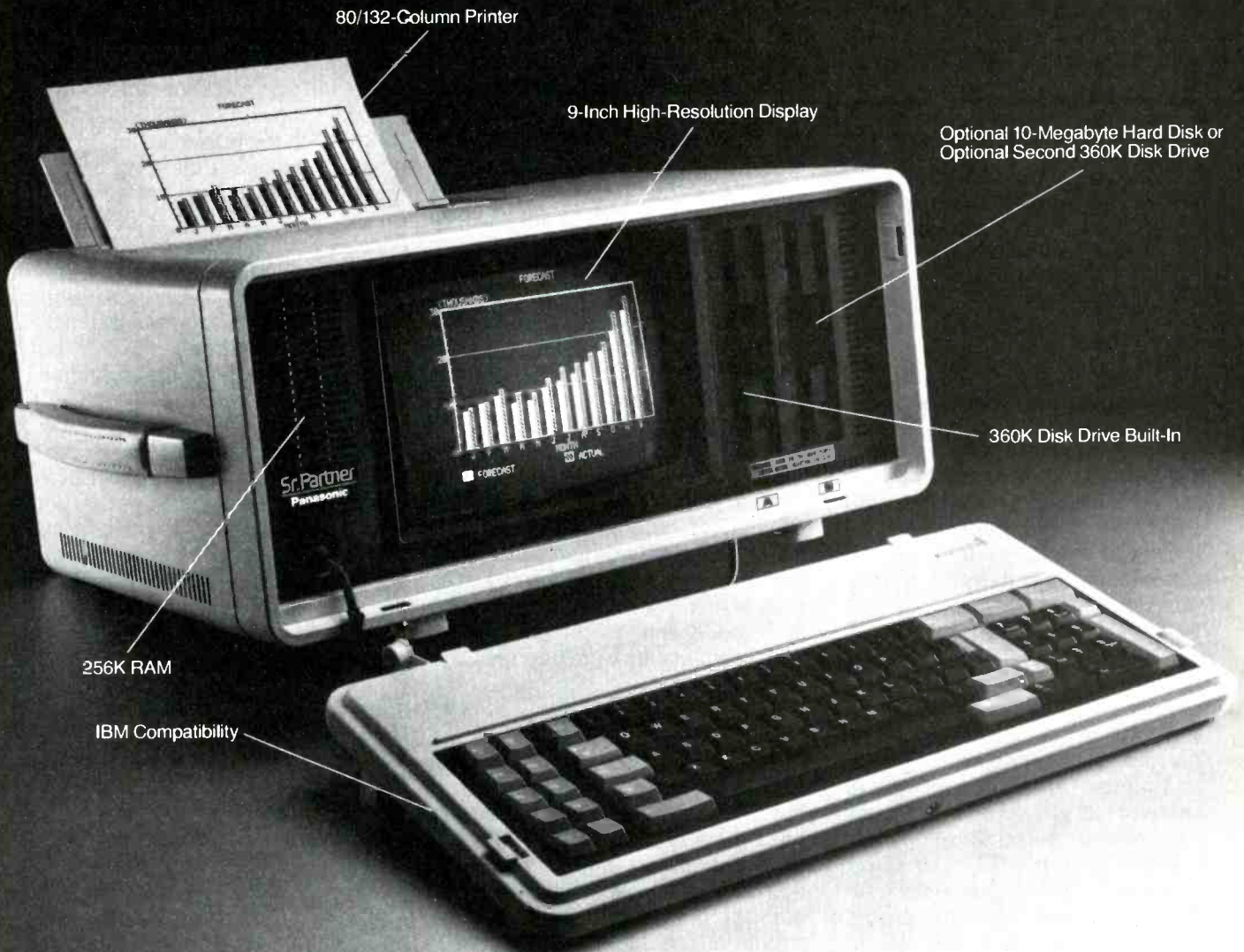

\*Software bundle offer subject to change or withdrawal at any time without notice. \*\*One-year limited warranty 6 months on thermal-printer head. Carry-in or mail-in service. Sr. Partner is a trademark of Matsushita Electric Industrial Company Ltd; WordStar is the trademark of MicroPro International Corporation; VisiCalc is the registered trademark of VisiCorp (Software Arts, Inc.); pfs:Graph, File, Report are the registered trademarks of Software Publishing Corporation; GW BASIC, MS-DOS are the trademarks of Microsoft Corporation.



To summarize,  
SNAP combines  
the best of  
BASIC, LISP,  
and FORTH with  
the readability  
of Pascal.

FALSE when a list becomes empty, which is more convenient for controlling iterative loops. As a sample of how list processing is done, listing 3 shows the definition of a function that applies any function to each element of a list (like MAPCAR in LISP) and returns a single list of its results.

Listing 3: A sample apply-to-all definition.

```
def apply-to-all (function list); giving 1
  [
    while islist(list) do
      function(hd(list))
      tl(list) -> list
    ewhile
  ]
edef
```

Perhaps the most powerful built-in feature of POP-11 is its pattern matcher. SNAP has such a matcher, but it comes as a library function and it is somewhat less powerful. The POP pattern matcher can assign values to variables:

```
[Fred Brown lives in Liverpool]
-> [??x lives in ?y]
```

leaves x having the value Fred Brown and y having the value Liverpool. The ? means take any one item, ?? means any number of items, and the -> operator will give an error if a match is not found. An alternative operator, matches, returns TRUE or FALSE depending on whether the match succeeds. You can make this process even more powerful by placing functions after the match variables to

restrict choice. Suppose you have a function called is-a-town that checks a list of town names and returns a truth value. Then:

```
[Fred Brown lives in sin] matches
[ ??x lives in ?y:is-a-town]
```

will fail. With tools like this it becomes almost trivial to write natural-language parsing systems.

The SNAP matcher merely compares a list to a pattern template and returns TRUE or FALSE. Variable assignment is not possible because SNAP employs static scoping whereas POP is dynamically scoped like LISP. A number of restriction functions (e.g., *allof*, *noneof*, *oneof*) are supplied so that, for example, `[1 2 [oneof [3 4]] 5]` will match `[1 2 3 5]` but not `[1 2 5 5]`. The syntax of the SNAP pattern matcher is slightly different from that of the language itself and is far less elegant than that of POP. An additional tool is a list matcher that matches list structures regardless of their contents, so that it can, for instance, check whether two trees are isomorphic.

One feature in SNAP that POP lacks is a mechanism to let you create modules. Such modules are called lids (as in putting on the lid) and you declare them by surrounding a group of definitions with `lid...elid`. The first line of a lid contains a list of its functions and variables that are to be visible outside it, and all others are hidden.

Other advanced features include lazy list evaluation, right-hand functions, coroutines, updaters, and macros (definitions that are executed at compile time to provide conditional compilation or to alter the language's syntax).

**USEFUL TOOLS**

Given SNAP's intended role in the laboratory, it's not surprising that it has interfaces to machine-code routines, I/O ports, PEEK and POKE, and bit-level operators, which in combination make it capable of driving peripherals such as graphics tablets and instruments. Graphics primitives based on the new Graphics Kernel System

(GKS) will be included in the SNAP system.

The library will contain a number of development tools such as a beautifier to print nicely formatted listings, a spelling corrector with knowledge of the syntax, a straightforward trace and pause package, and a calls and called-by cross-referencer. Some of these are already written in SNAP, and an inspection of the source code reveals how easy and compact they can be when list and string processing are available. Application-oriented tools include a menu handler that constructs menu-driven user interfaces from lists of prompt strings, a forms handler, and *treedraw*, which draws trees from list structures. *Tree-draw* is used by the menu handler to print a route map of the menus if the user hits ? for help.

I'll sum up by saying that SNAP combines the best of BASIC, LISP, and FORTH with the readability of Pascal. I have to confess a bias: I'm one of those zealots (crazed by years of BASIC, FORTH, and LISP) who believes that personal computer programming should be interactive. Try-it-and-see hacking really is a faster way to program if you have the right tools. If I could afford a VAX I'd be running POP-11, but in the meantime SNAP might just do.

One thought that strikes me is how much Lisa and Macintosh need a programming system of this sophistication; a glaring contradiction exists between their superb graphics user interface and the impoverished semantics of BASIC and Pascal (even with all the extensions under the sun). ■

**FOR MORE INFORMATION**

SNAP:  
Dr. T. R. G. Green  
MRC Applied Psychology Unit  
15 Chaucer Rd.  
Cambridge, England

POP-11/POPLOG:  
Dr. Aaron Sloman  
Cognitive Studies Programme  
Arts Building E  
University of Sussex  
Brighton, England

# You don't need a computer to talk to another computer.

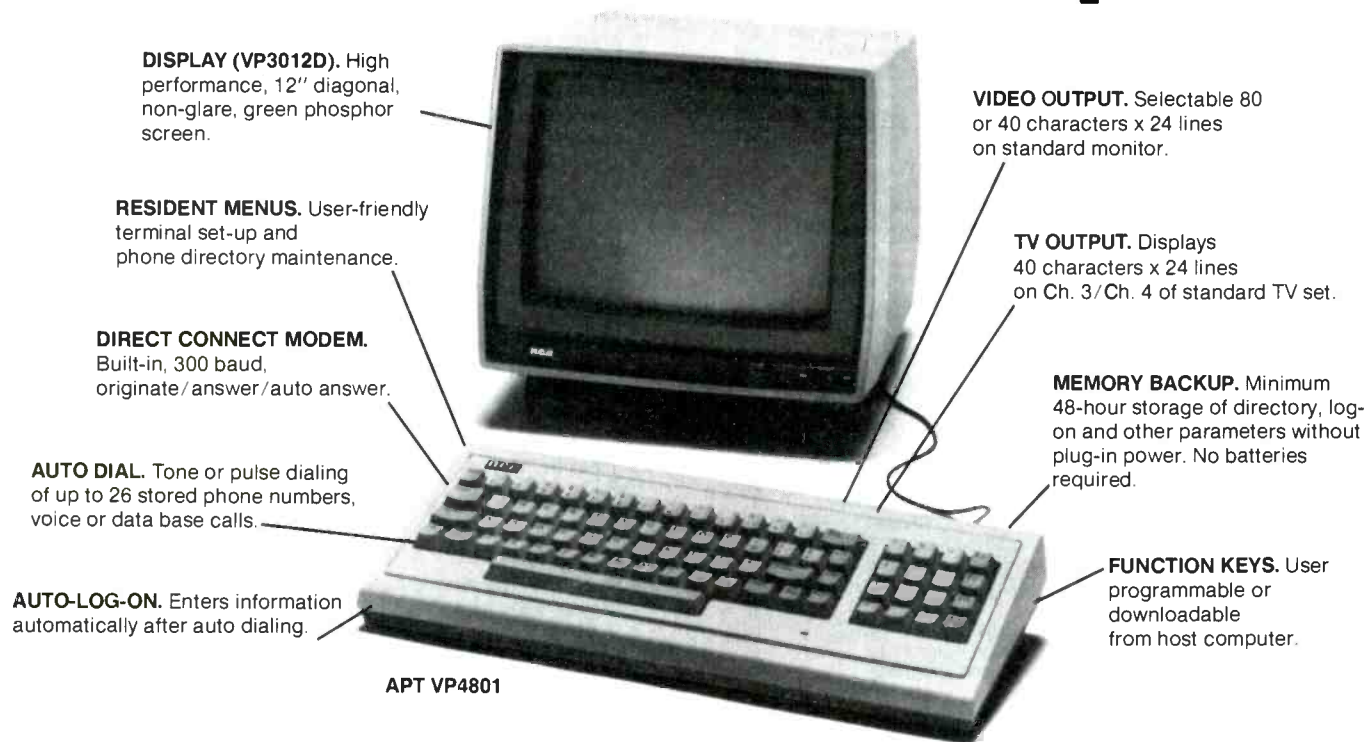

**DISPLAY (VP3012D).** High performance, 12" diagonal, non-glare, green phosphor screen.

**RESIDENT MENUS.** User-friendly terminal set-up and phone directory maintenance.

**DIRECT CONNECT MODEM.** Built-in, 300 baud, originate/answer/auto answer.

**AUTO DIAL.** Tone or pulse dialing of up to 26 stored phone numbers, voice or data base calls.

**AUTO-LOG-ON.** Enters information automatically after auto dialing.

**VIDEO OUTPUT.** Selectable 80 or 40 characters x 24 lines on standard monitor.

**TV OUTPUT.** Displays 40 characters x 24 lines on Ch. 3/Ch. 4 of standard TV set.

**MEMORY BACKUP.** Minimum 48-hour storage of directory, log-on and other parameters without plug-in power. No batteries required.

**FUNCTION KEYS.** User programmable or downloadable from host computer.

APT VP4801

## The new RCA APT (All Purpose Terminal) expands your data communications capabilities for a lot less money.

For business, professional and personal data communications, you'll find more user-friendly features and greater communications capabilities in the RCA APT than in other terminals selling for up to three times the price.

The new APT terminals are ideally suited to multi-data base time sharing and dedicated, direct computer-connected applications. They feature menu-controlled operation and a programmable "personality" to match specific communications requirements for your data bases.

A single keypress can dial a stored number, send the log-on sequence on the host computer, and return terminal control to the user. Password protection prevents unauthorized access to designated numbers. APT can also be used as an auto-dialer for voice communications.

### OTHER FEATURES

RS232C port for direct computer connections at data rates to 9600 baud, or for connecting high speed modems and other accessories. Parallel printer port for hard copy. Numeric keypad, can dial phone numbers not in terminal directory. Built-in speaker with adjustable volume control for audio monitoring of phone line. Smooth scroll display. Automatic screen blanking to reduce possibility of burn. Briefcase size: 17" x 7" x 2". Weight: under 4 lbs.

Quite simply, matching features with price, there is no other professional quality terminal available today that can do as much at such low cost.

APT terminals list for \$498, in your choice of full stroke or membrane keyboard versions. Either style is also available with a display monitor for \$697 list. The data display monitor alone, VP3012D, \$199 list.

For more information—or to order—call 800-722-0094. In Penna., call 717-295-6922. Or write for fully descriptive brochure to RCA Data Communications Products, New Holland Avenue, Lancaster, PA 17604. OEM and dealer pricing available. The new RCA APT. Expansive. Not expensive.

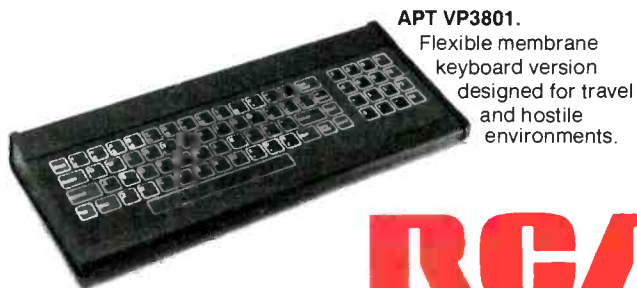

**APT VP3801.** Flexible membrane keyboard version designed for travel and hostile environments.

# RCA



# THE FORTH SOURCE™

## MVP-FORTH

Stable - Transportable - Public Domain - Tools  
 You need two primary features in a software development package - a stable operating system and the ability to move programs easily and quickly to a variety of computers. MVP-FORTH gives you both these features and many extras. This public domain product includes an editor, FORTH assembler, tools, utilities and the vocabulary for the best selling book "Starting FORTH". The Programmer's Kit provides a complete FORTH for a number of computers. Other MVP-FORTH products will simplify the development of your applications.

### MVP Books - A Series

- Volume 1**, *All about FORTH* by Haydon MVP-FORTH glossary with cross references to fig-FORTH, *Starting FORTH* and FORTH-79 Standard. 2<sup>nd</sup> Ed. \$25
- Volume 2**, *MVP-FORTH Assembly Source Code*. Includes CP/M®, IBM-PC®, and APPLE® listing for kernel \$20
- Volume 3**, *Floating Point Glossary* by Springer \$10
- Volume 4**, *Expert System* with source code by Park \$25
- Volume 5**, *File Management System* with interrupt security by Moreton \$25

### MVP-FORTH Software - A Transportable FORTH

- MVP-FORTH Programmer's Kit** including disk, documentation, Volumes 1 & 2 of MVP-FORTH Series (*All About FORTH*, 2<sup>nd</sup> Ed. & *Assembly Source Code*), and *Starting FORTH*. Specify  CP/M,  CP/M 86,  CP/M+,  APPLE,  IBM PC,  MS-DOS,  Osborne,  Kaypro,  H89/Z89,  Z100,  TI-PC,  MicroDecisions,  Northstar,  Compupro,  Cromenco,  DEC Rainbow,  NEC 8201,  TRS-80/100 \$150

- MVP-FORTH Enhancement Package** for IBM-PC/XT Programmer's Kit. Includes full screen editor, MS-DOS file interface, disk, display and assembler operators. \$110

- MVP-FORTH Cross Compiler** for CP/M Programmer's Kit. Generates headerless code for ROM or target CPU \$300

- MVP-FORTH Meta Compiler** for CP/M Programmer's Kit. Use for applications on CP/M based computer. Includes public domain source \$150

- MVP-FORTH Fast Floating Point** Includes 9511 math chip on board with disks, documentation and enhanced virtual MVP-FORTH for Apple II, II+, and IIE. \$450

- MVP-FORTH Programming Aids** for CP/M, IBM or APPLE Programmer's Kit. Extremely useful tool for decompiling, callfinding, and translating. \$200

- MVP-FORTH PADS (Professional Application Development System)** for IBM PC, XT or PCjr or Apple II, II+ or IIE. An integrated system for customizing your FORTH programs and applications. The editor includes a bi-directional string search and is a word processor specially designed for fast development. PADS has almost triple the compile speed of most FORTH's and provides fast debugging techniques. Minimum size target systems are easy with or without heads. Virtual overlays can be compiled in object code. PADS is a true professional development system. Specify Computer. \$500

- MVP-FORTH Floating Point & Matrix Math** for IBM with 8087 or Apple with Applesoft on Programmer's Kit or PADS \$85

- MVP-FORTH Graphics Extension** for IBM or Apple on Programmer's Kit or PADS. \$65

- MVP-FORTH MS-DOS file interface** for IBM PC PADS \$80

- MVP-FORTH Expert System** for development of knowledge-based programs for Apple, IBM, or CP/M. \$100

**FORTH CROSS COMPILERS** Allow extending, modifying and compiling for speed and memory savings, can also produce ROMable code. Specify CP/M, 8086, 68000, IBM, Z80, or Apple II, II+ \$300

**Ordering Information:** Check, Money Order (payable to MOUNTAIN VIEW PRESS, INC.), VISA, MasterCard, American Express. COD's \$5 extra. Minimum order \$15. No billing or unpaid PO's. California residents add sales tax. Shipping costs in US included in price. Foreign orders, pay in US funds on US bank, include for handling and shipping by Air. \$5 for each item under \$25, \$10 for each item between \$25 and \$99 and \$20 for each item over \$100. All prices and products subject to change or withdrawal without notice. Single system and/or single user license agreement required on some products.

## FORTH DISKS

FORTH with editor, assembler, and manual.

- APPLE** by MM, 83 \$100
- ATARI®** valFORTH \$60
- CP/M®** by MM, 83 \$100
- HP-85** by Lange \$90
- HP-75** by Cassidy \$150
- IBM-PC®** by LM, 83 \$100
- NOVA** by CCI 8" DS/DDS \$175
- Z80** by LM, 83 \$100
- 8086/88** by LM, 83 \$100
- 68000** by LM, 83 \$250
- VIC FORTH** by HES, VIC20 cartridge \$50
- C64** by HES Commodore 64 cartridge \$40
- Timex** by HW \$25

**Enhanced FORTH** with: F-Floating Point, G-Graphics, T-Tutorial, S-Stand Alone, M-Math Chip Support, MT-Multi-Tasking, X-Other Extras, 79-FORTH-79, 83-FORTH-83.

- APPLE** by MM, F, G, & 83 \$180
- ATARI** by PNS, F, G, & X. \$90
- CP/M** by MM, F & 83 \$140
- Multi-Tasking FORTH** by SL, CP/M, X & 79 \$395
- TRS-80/II or III** by MMS F, X, & 79 \$130
- Timex** by FD, tape G, X, & 79 \$45
- C64** by ParSec. MVP, F, 79, G & X \$96
- Victor 9000** by DE, G, X \$150
- FDOS** for Atari FORTH's \$40
- Extensions** for LM Specify IBM, Z80, or 8086
  - Software Floating Point \$100
  - 8087 Support (IBM-PC or 8086) \$100
  - 9511 Support (Z80 or 8086) \$100
  - Color Graphics (IBM-PC) \$100
  - Data Base Management \$200

- fig-FORTH Programming Aids** for decompiling, callfinding, debugging and translating. CP/M, IBM-PC, Z80 or Apple. \$200

## FORTH MANUALS, GUIDES & DOCUMENTS

- ALL ABOUT FORTH** by Haydon. See above \$25
- FORTH Encyclopedia** by Derick & Baker \$25
- The Complete FORTH** by Winfield \$16
- Understanding FORTH** by Reymann \$3
- FORTH Fundamentals, Vol. I** by McCabe \$16
- FORTH Fundamentals, Vol. II** by McCabe \$13
- FORTH Tools, Vol. 1** by Anderson & Tracy \$20
- Beginning FORTH** by Chirlan \$17
- FORTH Encyclopedia Pocket Guide** \$7
- And So FORTH** by Huang. A college level text. \$25
- FORTH Programming** by Scanlon \$17
- FORTH on the ATARI** by E. Floegel \$8
- Starting FORTH** by Brodie. Best instructional manual available. (soft cover) \$18
- Starting FORTH** (hard cover) \$23
- 68000 fig-Forth** with assembler \$25
- Jupiter ACE Manual** by Vickers \$15
- Installation Manual for fig-FORTH**, \$15
- Source Listings of fig-FORTH**, for specific CPU's and computers. The Installation Manual is required for implementation. Each \$15
  - 1802  6502  6800  AlphaMicro  IBM
  - 8080  8086/88  9900  APPLE II
  - PACE  6809  NOVA  PDP-11/LSI-11
  - 68000  Eclipse  VAX  Z80
- 1980 FORML Proc.** \$25
- 1981 FORML Proc 2 Vol** \$40
- 1982 FORML Proc.** \$25
- 1981 Rochester FORTH Proc.** \$25
- 1982 Rochester FORTH Proc.** \$25
- 1983 Rochester FORTH Proc.** \$25
- A Bibliography of FORTH References, 1st Ed.** \$15
- The Journal of FORTH Application & Research**
  - Vol. 1, No. 1 \$15
  - Vol. 1, No. 2 \$15
- META FORTH** by Cassidy \$30
- Threaded Interpretive Languages** \$23
- Systems Guide to fig-FORTH** \$25
- Invitation to FORTH** \$20
- PDP-11 User Man.** \$20
- FORTH-83 Standard** \$15
- FORTH-79 Standard** \$15
- FORTH-79 Standard Conversion** \$10
- Tiny Pascal fig-FORTH** \$10
- NOVA fig-FORTH** by CCI Source Listing \$25
- NOVA** by CCI User's Manual \$25

# MOUNTAIN VIEW PRESS, INC.

PO BOX 4656

MOUNTAIN VIEW, CA 94040

(415) 961-4103

(continued from page 125)

issues INT 20, control returns to MOUS123 immediately after the call to function 4Bh. All segment registers except CS have been destroyed, but since they all point to the same place, they can be reloaded. Just before it returns control to DOS, MOUS123 prints a message that tells whether the operation was successful or not.

### THE INTERRUPT HANDLER

In the description of mouse function 12 in the Microsoft mouse documentation, an interrupt routine is defined. A bit mask, one of the parameters for interrupt initialization, identifies which of the following conditions will invoke the interrupt handler. The supplied mask calls for a button press or mouse movement, but not for a button release. (The coordination of button presses and releases lets you "drag" the mouse to indicate an entire area rather than a single cursor position.)

At entry time, the register AX contains flags describing the reason for the call, BX gives the button status, and CX and DX contain the coordinates of the mouse. BX is only used to help identify the "both buttons" condition. (At first I found it difficult to press both buttons at the same time, and the program treated them as sequential button presses.) The interrupt handler calls the subroutines required to take care of all the flags set in AX by the mouse driver.

These subroutines receive a pointer to a "state" variable in register BX—one state is for the spreadsheet area and the other is for the menu area. This variable records the last known position of the cursor in that state, its sensitivity to mouse movement, and what characters are to be passed back to the handler for mouse movement or button presses. Pressing both buttons switches between states. From the display area you can switch to the menu area using a slash (/), but to switch from the menu to the display area you must type the escape character (Esc). A customized front-end for another program might have more or fewer states, each with its own

movement ratios and button meanings.

Each keystroke is represented by a two-character word. The first byte is the ASCII (American Standard Code for Information Interchange) character representation of the keystroke or its "meaning." The second byte is the "key number" or scan code, a number used only within the IBM PC to map keystrokes into characters. It is irrelevant for our purposes unless the character value is zero. Then you are dealing with an extended ASCII code (like a function key or a keypad key) and the key number tells you which special code you have. The scan codes are given in Appendix K of the DOS 2.0 update to the BASIC manual and in the part of the technical refer-

ence manual covering the keyboard. The 2-byte extended ASCII codes are discussed in Appendix G of the BASIC manual and under Keyboard Encoding in the technical reference manual.

In the spreadsheet state, MOUS123 sends the slash character when you push both mouse buttons. In listing 2, "both\_ch" represents both a scan code of 53 (decimal) and a character value of 47, the / character. The state structure stores the keystroke representations in the same format used in the keyboard buffer.

### PRESSING A BUTTON

The simplest subroutines handle button presses. Listing 3 shows the code

(continued)

Listing 1: A segment of MOUS123 showing stack-pointer and segment-boundary manipulations and the passing of parameters.

```

mov sp,offset pgmend + 256 ; set up new stack ptr
mov bx,sp ; find end of this pgm
add bx,15 ; round to paragraph: stack end
shr bx,1
shr bx,1 ; /16 to get paragraphs
shr bx,1
shr bx,1 ; ES -> seg, BX = new size
mov ah,4ah ; setblock: change segment size
int 21h ; change the size
jc errstblk ; handle SETBLOCK error
; Set up parm list for ATTACH
mov ax,ds:[2ch] ; -> environment from my prefix
mov envptr,ax ; -> environment for new seg
mov cmd_s,cs ; seg for text
mov fcb1_s,cs
mov fcb2_s,cs
mov bx,offset parm4b ; -> parm list
mov dx,offset pgm ; -> pgm name (driv.name.ext)
mov ax,4b00h ; (f'n), ai=0 (load & execute)
int 21h ; ret code in ax
mov dx,offset msg03 ; done msg
mov bx,cs ; f'n 4b destroys the seg regs
mov ss,bx
mov ds,bx
jnc init800 ; OK, write msg & quit
...
cmd__lin dw 0 ; parameters to be passed (null)
pgm db 'lotus.com',0 ; Name of pgm to execute (w/ path)
parm4b: ; parm list used by f'n 4B
envptr dw 0 ; -> environment string for new seg
cmd__o dw cmd__lin ; offset for cmd line
cmd_s dw 0 ; segment for cmd line
fcb1__o dw 5Ch ; offset & seg for FCB1 @ 5C
fcb1_s dw 0
fcb2__o dw 6Ch ; offset & seg for FCB2 @ 6C
fcb2_s dw 0
pgmend dw 10 dup (0) ; low end of stack
    
```



used when the left button is pressed. The program saves AX since it is used in the routine and it uses the pointer in BX to select the left-button-press character from the current state structure. It also disables interrupts while it uses the ISET routine to insert the chosen character into the keyboard buffer. Then the routine restores AX and exits.

### TRACKING THE CURSOR

The mouse-tracking routine, CURS, is the most complex. It's also the only routine that may put more than one character into the keyboard buffer. It's really a double routine since it treats horizontal and vertical movement separately.

The Microsoft mouse tracks its position on a virtual screen 640 pixels (picture elements) wide and 200 pixels high. Position (0,0) is the upper left-hand corner of the screen and (639,199) is the lower right-hand

corner. The mouse cursor can move pixel by pixel on a screen driven by the color/graphics board. For text displays like the Lotus 1-2-3 spreadsheet, where the cursor moves character by character, only pixel addresses in multiples of eight are valid. For each coordinate, the interrupt handler determines whether the mouse moved and, if it did, calculates how far by adding the pixels left over from the last calculation and subtracting the previous location value (see listing 4). If the difference is positive, the mouse moves down or to the right. If it is negative, it moves up or to the left.

While the width of each spreadsheet column is variable, MOUS123 can't tell which column is which or where the cursor is located. Therefore, it uses a fixed ratio of distance to the number of cursor-movement key presses. The ratio, "horz\_\_ratio," of five horizontal characters (40 pixels) to one arrow key seems com-

fortable and allows you to position the mouse at the desired cell without overshooting or undershooting. Since cells are always one character high, the natural vertical ratio is one character (8 pixels) to one arrow key as specified in "vert\_\_ratio." The distance moved (in pixels) is divided by the ratio to get the number of arrow keys to insert. The new current position and remainders are saved. If MOUS123 didn't save the remainders, you would never see any horizontal cursor movement because one interrupt wouldn't report enough pixels to move the cursor and partial characters couldn't be accumulated across interrupts.

Just before CURS exits, it checks the current position of the mouse. If it is near the screen edge, CURS repositions it to the center by changing the values of "cursh" and "cursv" as required. This ensures that the mouse can continue to move the cursor to the limits of the spreadsheet. Most mouse-based applications deal with one screen at a time and handle scrolling in another way. MOUS123 can't do that because it doesn't control the screen directly.

### THE KEYBOARD BUFFER

Information is passed to Lotus 1-2-3 by converting it to characters and inserting them into the system's keyboard buffer. Each keystroke takes 2 bytes in the buffer—the key position number or scan code takes one and the character value the other. A capital "A", for example, has a key position number of 30 (decimal) and a character value of 65 (also decimal) while a small "a" has the same key position number of 30 but a character value of 97. By the time a character appears in this buffer, all shifting has been taken into account. The process is described in the BIOS (basic input/output system) listing in the technical reference manual following the "Keyboard Interrupt Routine."

Function keys and arrow keys all have the character value zero and are identified by their position numbers.

(continued)

Listing 2: The routine from MOUS123 that defines the fields used to track the cursor.

```
state      struc
cursv     dw    200/2      ; last vertical pixel loc
cursh     dw    640/2      ; last horizontal pixel loc
remv      dw    4         ; uncounted vert pixels (rem'der)
remh      dw    0         ; uncounted horiz pixels (rem'der)
vert__ratio dw    8         ; sensitivity, mickeys/byte vert.
horiz__ratio dw    40      ; cursor sensitivity horizontally
lbut__ch  dw    28*256 + 13 ; ah = scan code, al = char value <CR>
rbut__ch  dw    59*256      ; F1 key (char value = 0): HELP
both__ch  dw    53*256 + 47 ; change state: ' ' or Esc
up__ch    dw    72*256      ; cursor up
down__ch  dw    80*256      ; cursor down
left__ch  dw    75*256      ; cursor left
right__ch dw    77*256      ; cursor right
state     ends
```

Listing 3: The MOUS123 code that is in control when the left mouse button is pressed.

```
lbut      proc    near
push     ax
mov      ax,[bx].lbut__ch ; al = ASCII, ah = key #
cli      ; hold all interrupts
call    iset           ; stuff the buffer
sti      ; interrupts back on
pop     ax
ret
lbut     endp
```

**TRADE IN Your Unused  
IBM\* PC Or XT\* Keyboard**  
See Your Participating Dealer For Details

# The Key Tronic KB 5151: A Superior Keyboard For The IBM\* PC or XT.\*

Improve your IBM\* PC or XT\* with a plug-compatible KB 5151 keyboard from Key Tronic. This professional series keyboard is designed for word processing, spread sheets, as well as other applications. Advantages over the regular IBM keyboard are:

- Separate numeric pad.
- Separate cursor keys.
- Function keys on top row for easier and more accurate operation.
- SHIFT & RETURN keys in familiar typewriter locations.
- Easy-to-read key legends instead of symbols.
- LED indicators on all LOCK keys.
- Convenient ENTER key.
- Solid-state capacitive switches.
- Positive tactile feedback.

Designed for reliability, each key switch is rated at 100 million cycles, which translates into eight hours of daily use for 12.8 years at 80 words per minute.

The KB 5151 — from Key Tronic, the world's largest independent manufacturer of computer keyboards.

Ask your local dealer about the IBM\* compatible KB 5151 today, or call us toll-free for more information . . . 1-800-262-6006 (7 am to 3 pm Pacific Time) — Washington State (509) 928-8000.

\*IBM and XT are registered trademarks of IBM Corporation.



\*This layout is also available for the PCjr.

**key tronic**  
*The Responsive Input Company*

P.O. Box 14687 • Spokane, WA 99214 (U.S.A.)  
(509) 928-8000

Circle 193 on inquiry card.



602-820-8819

MEMORY PLUS DISTRIBUTORS



2632 W. Baseline  
Mesa, Arizona 85202

Other Products Available Call or Write  
DEALERS AND CLUBS INVITED!

All Orders Add \$3.00 Shipping  
Visa/MC  
OK

36.95  
ONLY



DEALERS  
TURN YOUR PROFITS.

Circle 219 on inquiry card.

### TURBO™ PASCAL TOOLS for PROGRAMMERS

Works under DOS 2.0, Turbo 2.0. Consists of: (1) A **Graphics** package. (2) A **Text Window** package with overlapping windows, instant text recall, window swapping and a window compiler allowing all text to be in a separate file. (3) **Formula** evaluator, evaluates any formula string. (4) **System** check: access all system parameters from your program. Offered for a limited time at \$29.95.

#### Paragon Courseware

4954 Sun Valley Rd., Del Mar  
CA 92014 Tel: (619) 481-1477

*Turbo Pascal is a trademark  
of Borland International.*

Circle 271 on inquiry card.

### PRINTERS

Banana GX-100, 50 CPS ..... \$159.00  
Gemini 10X, 120 CPS ..... \$269.00  
Okidata ML 93P, 160 CPS ..... \$649.00  
Brother HR-15 ..... \$449.00

### COMPUTERS

Sanyo  
MBC 550 w/software ..... \$759.00  
MBC 555 w/software ..... \$1,089.00

### DISKETTE 5 1/4" Soft Sector

Verbatim SSSD ..... \$16.95  
BASF SSDD ..... \$18.95  
Memorex DSDD ..... \$22.95  
Verbatim Head Cleaning Kit ..... \$6.95  
Flip-N-File 15 ..... \$6.95  
6 Outlet Spike Protector ..... \$12.95  
4 Outlet Spike Strip  
w/switch & 6' cord ..... \$24.95

### ATLANTIC • ENTERPRISES

VISA P.O. Box 21268  
Chattanooga, TN 37421  
MasterCard  
Orders Only Call: 1-800-221-2501  
Tenn. Residents Call: (615) 899-9556

Circle 31 on inquiry card.

## MOUSE AND 1-2-3

### Listing 4: The MOUS123 routine for handling cursor movement.

```

; cx = horizontal cursor position (pixels)
; dx = vertical cursor position (pixels)
; Suppress interrupts to ensure serialization

curs proc near
    cli ; suppress interrupts
    push ax
    push cx ; save horizontal pos'n
    push dx ; save vert pos'n
    sub dx,[bx],cursv ; get change in vert pos'n
    jz curs50 ; no change
; how many positions up or down?
    mov ax,dx ; set for division
    add ax,[bx].remv ; leftover pixels from last time
    cwd ; propagate sign of ax to dx
    idiv [bx].vert_ratio ; get # of chars vertical (+ or -)
    mov [bx].remv,dx ; save leftover pixel count
    push cx ; save cx during repeat
    mov cx,ax ; quotient, # of chr moved
    mov ax,[bx].down_ch ; prime reg: positive = > down
    cmp cx,0 ; any chrs?
    je curs48 ; no chrs, skip
    jg curs30 ; positive: go use right arrow
    neg cx ; abs(cx), make positive
    mov ax,[bx].up_ch ; up arrow char
curs30: call iset ; put char into keyboard buffer
        loopnz curs30
curs48: pop cx ; restore value from repeating
curs50: pop dx
        mov [bx].cursv,dx ; save vert position for next time

```

All the codes that MOUS123 uses are stored in the state structures.

### TALKING TO LOTUS 1-2-3

The ISET routine actually passes mouse information to Lotus 1-2-3. The routines that handle motion and key presses call ISET for each character they want to pass, first putting the 2-byte code in register AX. ISET moves the pointers to the beginning and the end of the keyboard buffer located at 40:1E (the segment register contains 40h, the displacement 1Eh), at label KB\_BUFFER in the BIOS listing. ISET's calling routines disable the interrupts before it is called to ensure that no other routine (like the keyboard-interrupt handler) can manipulate the pointers or the buffer until it is finished. CURS disables the interrupts during its entire execution because it may call ISET several times and needs to ensure that the mouse interrupts are handled in the order they occur and do not become intermixed.

### BEYOND LOTUS 1-2-3

With minor changes to the state values for sensitivity and the character codes for button presses, you could use MOUS123 with many screen-oriented programs. WordStar addicts could easily modify the state definition to use Ctrl-E instead of the up arrow, Ctrl-D instead of the right arrow, etc. Key redefinition using the ANSYS device driver in DOS 2.0 could further expand the possibilities.

MOUS123 works with the Lotus 1-2-3 version 1 and 1A, DOS 2.0, and both IBM color and monochrome monitors. It would be nice to say it works with other mice, but there is no standard mouse interface.

Nevertheless, a mouse performs a useful function for all users by using natural, comfortable hand and arm movements on a desktop to point at items on the screen. MOUS123 and similar programs can extend the usefulness of a mouse to many screen-oriented programs that don't normally support one. ■

(continued from page 127)

$10^{250}$ , now meets all of our requirements, and it is inconceivable at this time that such an  $N$  could be factored.

The CHOOSEP algorithm does the above but does not check that "neither  $p+1$  nor  $q+1$  consists entirely of rather small prime factors." Nor does it use the numbers of digits shown unless called with those numbers. Knuth does not specify how small are "rather small prime factors" and determination of the method is left to his reader.

By the way, the Smith article states the condition that " $p-1$  and  $q-1$

should both contain at least one large prime factor"; note the minus, rather than plus. Smith's mention that "the ratio  $p/q$  should not approximate a simple fraction" is covered by  $p$  and  $q$  differing in magnitude by several powers of 10 in Knuth's algorithm.

The CHOOSEP function first assigns 0 to  $C$  and 1 to  $A$ ; in a loop  $C$  counts to the  $N$  passed to the function, while  $A$  is multiplied by 10 each time, so that  $A$  comes out as the  $N$  power of 10. The next loop asks for a random number between zero and that value of  $A$ ,  $10^N$ . When the length is the full length desired,  $N$ , the loop is exited. The random number is in  $P1$ , and the reference to function

NXPRIME gets the next prime equal to or larger than  $P1$ , and this is assigned into  $P1$ .

The next few lines, including a couple of loops, similarly find another large random number, this time of length  $N2$ , which is put into  $P2$ . Initially,  $K$  is then set to  $P2 + \text{MOD}(P1 - P2, 3)$ . This makes  $K$  congruent to  $(\equiv) P1 \pmod{3}$ , as Knuth's algorithm demands. Because  $K$  also must be even, the loop adds 3 if  $k$  is odd, making it even while preserving its congruence mod 3. The loop, rather than a simple IF...THEN, is a result of muSimp's requirement that all actions dependent on an IF (actually WHEN

(continued)

**Listing 1:** *The highest-level module in the key-selection system, with a sample run, producing 101-digit keys. The key N is public, used in encoding and decoding, while D is kept secret, used only in decoding.*

```
? DISPLAY(SETUP);
@:

FUNCTION SETUP (),
  RANDOMIZE (),
  P: CHOOSEP (33, 8),
  Q: CHOOSEP (45, 16),
  N: P * Q,
  D: QUOTIENT (2*(P - 1)*(Q - 1) + 1, 3),
ENDFUN

? P;Q;N;D;
@:
5669682733234183949743401862732403737825
1

? @:
1112245192858508592950635202981592638763
495067113359264305331

? @:
6306077365072611053931059220460476141900
0135895287313649294616210624533300703021
096023498624002756081

? @:
4204051576715074035954039480306984094599
9349100062970093801072585729479577483173
444625171960467381667

? SYSTEM();
@:

1)PR# 0
```

**Listing 2:** *The function CHOOSEP that chooses primes in the appropriate range.*

```
? DISPLAY(CHOOSEP);
@:

FUNCTION CHOOSEP (N, N2, P1, P2, K, C, A, P),
  C: 0,
  A: 1,
  LOOP
    C: C + 1,
    WHEN C > N EXIT,
    A: A * 10,
  ENDLLOOP,
  LOOP
    P1: LRAND (A),
    WHEN LENGTH (P1) = N EXIT,
  ENDLLOOP,
  C: 0,
  A: 1,
  LOOP
    C: C + 1,
    WHEN C > N2 EXIT,
    A: A * 10,
  ENDLLOOP,
  LOOP
    P2: LRAND (A),
    WHEN LENGTH (P2) = N2 EXIT,
  ENDLLOOP,
  K: P2 + MOD (P1 - P2, 3),
  LOOP
    WHEN MOD (K, 2) = 0 EXIT,
    K: K + 3,
  ENDLLOOP,
  LOOP
    P: K*P1 + 1,
    WHEN PRIME (P) EXIT,
    K: K + 6,
  ENDLLOOP,
  P,
ENDFUN
```



# 100% FLAWLESS COPIES . . . . . . FAST!

No need to tie up your valuable computer to duplicate disks . . . when VICTORY can provide you with a duplicator that will do the job flawlessly, and *much* faster.

Duplicate up to 3 disks at a time from an original diskette, or up to 4 disks at a time from a high capacity winchester. With a Winchester, you can choose from up to 8 master routines, duplicating any one, or all of them simultaneously.

VICTORY can supply you with literally dozens of standardized formats to match the protocol of virtually any current computer. In addition, built-in utilities enable you to read or devise any format you may require. If that's not enough, VICTORY can help you with unusual or unique formatting, serializing or copy-protecting problems.

VICTORY Duplicators are fast, attractively priced and reliable. VICTORY Duplicators use industry-proven drives combined with 100% digital technology . . . there are no analog circuits to slowly drift out of tolerance.

Let us help free you from your disk-duplicating bottleneck. Write or call: VICTORY ENTERPRISES TECHNOLOGY, Inc., 8910 Research Blvd., Suite B2, Austin, Texas 78758—(512) 450-0801.

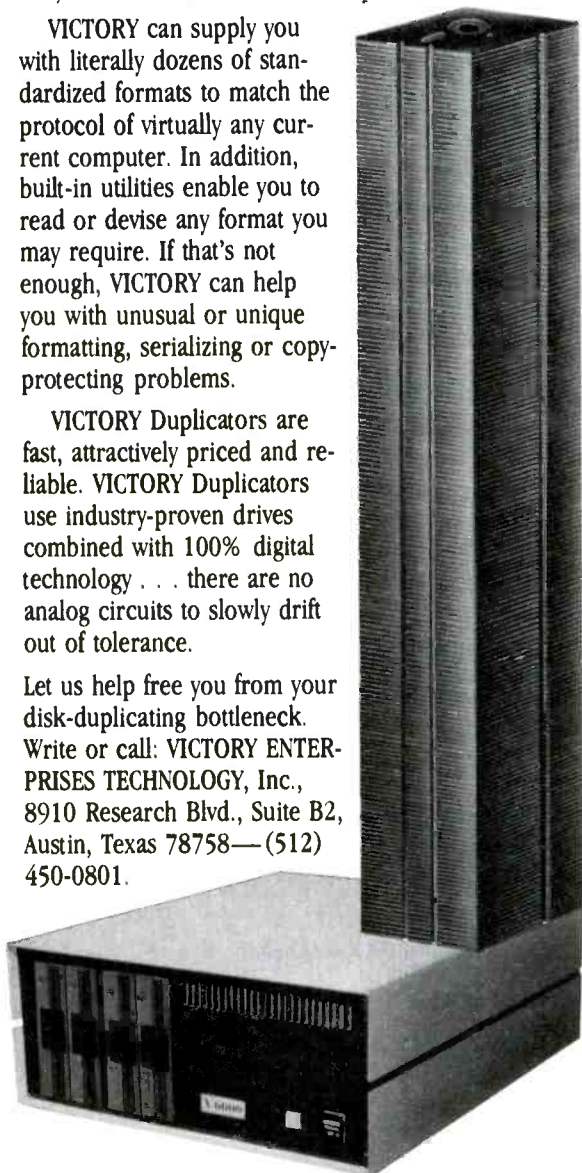

## Victory Enterprises Technology, Inc.

## CRYPTOGRAPHIC KEYS

Listing 3: *The functions for producing pseudorandom numbers for the RSA system.*

```
? DISPLAY(LRAND);
@:

FUNCTION LRAND (N),
  RAND#: RND (),
  LOOP
    WHEN RAND# > N EXIT,
    RAND#: RAND# * 67099547 + RND(),
  ENDLLOOP,
  RAND#: MOD (RAND#, N),
ENDFUN

? DISPLAY(RND);
@:

FUNCTION RND (),
  RND#: MOD (RND# * 8192, 67099547),
ENDFUN

? DISPLAY(RANDOMIZE);
@:

FUNCTION RANDOMIZE (),
  PRINT ('ENTERSEED),
  SCAN (),
  RND#: SCAN,
  RND (),
ENDFUN
```

Listing 4: *The functions for finding the next prime number equal to or larger than the one given, and for testing if a given number is prime, according to a probabilistic primality test, repeated 50 times for almost certain assurance of primality.*

```
? DISPLAY(NXPRIME);
@:

FUNCTION NXPRIME (X),
  LOOP
    WHEN MOD (X, 2) = 1 EXIT,
    X: X + 1,
  ENDLLOOP,
  LOOP
    WHEN PRIME (X),
    X EXIT,
    X: X + 2,
  ENDLLOOP,
ENDFUN

? DISPLAY(PRIME);
@:

FUNCTION PRIME (N, I, X, J, Y, Q, K, T),
  WHEN MOD (N, 2) = 0,
  FALSE EXIT,
  Q: FIRST (ODDFACT (N - 1));
  K: REST (ODDFACT (N - 1)),
  I: 0,
  LOOP
```

(continued)

# GenTech



## COMPUTERS

<b>COLUMBIA</b>	
MPC 4210 (128K, 2 Drives)	\$Call
MPC 4810 (10 MB Hard Disk)	\$Call
VP 2110 (Portable)	\$Call
MPC 4220 (256K, 2 Drives)	\$Call
MPC 4820 (256K, 10 MB Hard Disk)	\$Call
VP 2220 (Portable w/256K)	\$2195



<b>COMPUPRO All Models</b>		\$Call
<b>CORONA</b>		
PC-22 (256K, 2 Drives)		\$Call
Portable PC-22 (256K, MS-DDS 2.0)		\$Call
Portable PC-XT (256K, 10 MB Disk)		\$Call
<b>FUJITSU MICRD 16s (8088/280A)</b>		\$Call
<b>MORROW DESIGNS All Models</b>		\$Call
<b>NEC</b>		
PC-8201A (w/ 16K RAM)		\$479
PC-8801A (280A, 84K, 2 Drives, 12" Monitor, WordStar, MailMerge, Multiplan, NBASIC)		\$1199
PC-8801A W/8088, DOS		\$1499
APC-H02 (8088, 128K, 2 8" Drives)		\$2849

<b>SANYO</b>		
MBC 550-2 (8088, 128K, 1 DSDD Drive (320K), WordStar, CalcStar, EasyWriter)		\$Call
MBC 555-2 (550-2 Plus 1 Add. Drive, Mailmerge, Spellstar & Infostar)		\$Call
<b>SEQUA Chameleon/Plus (8088, 280A)</b>		\$Call
<b>SWP Micro Computer Products</b>		
Co-Power-88 Board (8088 w/ 256K, 1 MB) For KAYPRO 2, 4 & 10		\$Call
** Lotus Patch Now Available **		
<b>TAVA IBM Look-Alike (128K, 2 Drives)</b>		\$Call
<b>TELEVIDEO</b>		
1605 (8088, 128K, 2 Drives, DDS 2.0)		\$Call
TPC-II (Portable Version of Above)		\$Call
<b>FRANKLIN All Models</b>		\$Call

## FOR IBM-PC & COMPAQ

<b>AST RESEARCH INC.</b>		
MEGA PLUS II (84K, Ser & Ck)		\$285
SIX PACK PLUS (84K, Ser/Par, Ck)		\$285
COMBO PLUS (84K, Ser/Par, Ck)		\$285
I/O PLUS II (Serial Port, Clock/Cal)		\$129
** OPTIONS **		
84K Installed		\$60
Serial/Parallel/Game Port		\$45
MDND GRAPH PLUS Card		\$Call

<b>QUADRAM</b>		
EXPANDED QUADBOARD (S, P, Clock, Game)		
84K	\$279	\$384K
QUAD 512+ (Serial Port, Maximum 512K)		\$389
84K	\$239	\$256K
QUADCOLDR I (Video Board)		\$199
QUADLINK (8502 w/ 84K)		\$479
AMOEK MAI Board (128K, 840 x 400)		\$389
CCS SuperVision (132 Column)		\$489
HERCULES Graphics Board (720 x 384)		\$339
Color Card (RGB, Composite, Parallel)		\$Call
INTEL 8087 Math Co-Processor		\$249
KEYTRONIC Deluxe IBM Keyboard (515)		\$209

<b>MA SYSTEMS PC Peacock (RGB &amp; Composite, Parallel Port)</b>		\$259
<b>MICROLOG Baby Blue II (280B, 84K, Parallel &amp; Serial Ports, Clock/Calendar)</b>		\$539
<b>ORCHIO PC Turbo</b>		\$Call
<b>PANASONIC JA 551-2 (DSDD Thinline Drive)</b>		\$159
<b>PARADISE SYSTEMS Multi-Display Card</b>		\$409
Modular Graphics Card		\$Call
<b>PLANTRONICS ColorPlus</b>		\$419
<b>STB SYSTEMS Graphix plus</b>		\$269
<b>TANDON TM 100-2 (DSDD Disk Drive)</b>		\$185
<b>TEAC FD-55B (DSDD Thinline Drive)</b>		\$169

<b>TECMAR Graphics Master (640 x 400 RGB)</b>	\$519
The Captain (w/ DK)	\$259
1st Mate (w/ DK)	\$229

## HARD DISK

<b>CORVUS</b>		
Dmndrive (11 MB)		\$2079
Transporter	\$399	Printer Server \$809
Network Mirror	\$809	The Bank \$1779



<b>DAVONG</b>		
Universal External: 10/21 MB		\$1925/\$2845
Internal for IBM: 10/21 MB		\$1895/\$2495
<b>IOMEGA Bernoulli Box</b>		
Dual 10 MB Remov. Cartridge Drives		\$Call
<b>PEGASUS-GREAT LAKES</b>		
10 MB Internal For IBM		\$1079
23 MB External (w/ Controller)		\$1789
<b>MICRO SCI 10 MB Half Height</b>		\$879
<b>QCS</b>		
10/20 MB (w/ 5 MB Back-Up)		\$2995/\$3495
<b>SYSGEN</b>		\$Call
<b>TALBRASS</b>		
12 MB External w/ Tape Back-Up		\$2799
20 MB External w/ Tape Back-Up		\$3179
<b>TANDON TM 5112 (10 MB External)</b>		\$1095
<b>TECMAR</b>		
Remov. Cartridge Winchester in PC (5 MB)		\$1589
10 MB w/ 5 MB Cartridge in Chassis		\$3149
<b>THOUGHT WORKS for SANYO: 10 MB</b>		\$1875
<b>XCOMP 18 MB External (For IBM, Apple, Kaypro &amp; Morrow Designs)</b>		\$1749

## DOT MATRIX PRINTERS

<b>BROTHER/DYNAX DM-40</b>	\$Call
<b>C-ITON Prowriter I 8510 AP</b>	\$349
<b>DATASOUTH DS-180</b>	\$1149

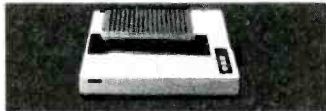

<b>EPSON JX-80: Color Printer</b>	\$Call
LQ-1600	\$1149
RX-100	\$509
RX-80	\$279
RX-80 F/T	\$329
FX-80	\$459
FX-100	\$889
** NLQ Option Board for FX/JX Available **	

<b>FLORIDA DATA (800 CPS, 4 Fonts)</b>	\$3095
<b>MANNESMANN TALLY</b>	
MT 180L	\$599
MT 180L	\$789
Spirit-80	\$289
MT 1802	\$Call

<b>NEC</b>		
P2 Pinwriter (180 CPS, 10" Carriage)		\$649
P3 Pinwriter (180 CPS, 15" Carriage)		\$869

<b>OKIDATA</b>		
ML 82	\$Call	ML 93 \$Call
ML 84(P)	\$Call	Pacemark \$Call

<b>PANASONIC KX-P1090/1091</b>	\$279/\$329
<b>SMITH CORONA D-200</b>	
(120 CPS, NLQ 17 x 18)	\$489

<b>STAR MICRONICS</b>		
Gemini 10X	\$285	Gemini 15X \$389
Delta 10	\$409	Deltas 18 \$549
Radix 10	\$589	Radix 15 \$889
<b>TEXAS INSTRUMENTS</b>		
850 RD	\$489	855 RD \$759

<b>TOSHIBA</b>	
P1340	\$789
P1350/1351	\$Call
<b>TRANSTAR T315 Color Printer</b>	\$449

## LETTER QUALITY PRINTERS

<b>ABATI LQ-20 (18 CPS, 15" Carriage)</b>	\$385
<b>BROTHER/DYNAX</b>	
HR-15 (13 CPS, Diablo Compat.)	\$389
HR-25/HR-35	\$649/\$889
<b>DIABLO</b>	
820 API	\$809
630 ECS/IBM	\$2049
<b>JUKI 6100 (17 CPS, Diablo Compat.)</b>	\$439
<b>NEC</b>	
2030	\$685
2050	\$815
3530	\$1275
7710	\$1725
** CALL FOR 8800 SERIES PRICING **	
<b>OLYMPIA Compact RD/2</b>	\$459/\$429
ESW 3000 (50 CPS, 15" Carriage)	\$1399

<b>QUADRAM Quadjet (Ink Jet Printer)</b>	\$759
<b>QUME Sprint 1140/1155</b>	\$1299/\$1479
<b>SILVER-REED</b>	
EXP 500/550 Parallel	\$409/\$519
EXP 770 (35 CPS, 15" Carriage)	\$889
<b>STAR MICRONICS Power Type (18 CPS)</b>	\$339
<b>TRANSTAR T120/T130</b>	\$409/\$569

## PLOTTERS

<b>AMOEK DXY-100/Amplot II</b>	\$809/\$879
<b>ENTER COMPUTERS</b>	
Sweet-P	\$Call
Six Shooter	\$889
<b>HOUSTON INSTRUMENTS</b>	
DMP-40-2	\$779
DMP-29	\$1849
DMP-41/42	\$2399
DMP-51/52	\$3895
DT-114 Digitizer (1-Button Cursor)	\$719
DT-114 Digitizer (4-Button Cursor)	\$779
<b>PANASONIC VP-8801A</b>	\$1449
<b>ROLAND DXY-101/DXY-800</b>	\$539/\$709
<b>STROBE Model 200/Model 280</b>	\$519/\$729

## MONITORS

<b>AMOEK</b>		
Video 300/300A/310A		\$135/\$145/\$159
Color I+	\$289	Color II+ \$419
Color III+	\$379	Color IV \$859
<b>DYNAX Fortis FC10 (840 x 200)</b>		\$Call
<b>MONITECH 12" Green</b>		\$89
<b>PRINCETON GRAPHICS HX-12</b>		\$479
SR-12 (890 x 480)		\$819
Max-12 (12" Amber, TTL)		\$185
<b>QUADRAM Quedscreen (17" 988 x 512)</b>		\$1499
<b>ROLAND</b>		
MB-121G	\$135	MB-121A \$145
MB-122G	\$155	MB-122A \$185
CB-141	\$279	CC-141 \$559
<b>SAKATA</b>		
SB-1000	\$109	SC-100 \$269
SA-1000	\$119	SC-300 \$699



<b>TAXAN</b>		
KG-12N	\$109	KG-12N/U.Y. \$119
Z10 (380 x 282)	\$259	420 (840 x 282) \$439
<b>ZENITH</b>		
ZYM-123A	\$99	ZYM-122A \$105
ZYM-135 (13", RGB/Composite, 840 x 240)		\$459

## TERMINALS

<b>ESPRIT</b>		
Esprit I	\$Call	Esprit II \$499
Esprit III	\$Call	ESP-8310 \$589
<b>QUME 102/102A</b>		\$535/\$549
103/108 (Green)		\$849/\$549
<b>TELEVIDEO 914/924</b>		\$519/\$675
950/970		\$Call
Personal Terminal		\$419
w/ 300 Baud Modem		\$528



<b>VISUAL 50/55</b>	\$559/\$889
102/300	\$839/\$769
<b>WYSE</b>	
WY-50	\$519
WY-75	\$619
WY-100	\$859
WY-300	\$819
<b>ZENITH</b>	
Z-29	\$649
Z-49	\$Call
ZTX-10	\$329
ZTX-11	\$389

## COMMUNICATIONS FOR IBM

<b>ANCHOR</b>		
Mark VI	\$179	Mark XII \$259
<b>OCA Irma/Irmaline</b>		\$Call
Smartmodem 300/1200		\$219/\$509
Smartmodem 1200B (IBM)		\$439
<b>NOVATION</b>		
Smart Cat Plus 300/1200 w/ Mite		\$Call
<b>RACAL-VADIC Maxwell Modem</b>		\$Call

<b>QUADRAM Quadmodem</b>	\$Call
<b>TRANSENO</b>	
PC Modem Card 1200	\$419
VEN-TEL 1200 Plus	\$Call

## SOFTWARE

<b>ASHTON-TATE dBase III/Framework</b>	\$Call
<b>LOTUS 1-2-3/Symphony</b>	\$329/\$Call
<b>MBSI, STAR Accounting Software</b>	\$Call
<b>MDBS Knowledge Manager</b>	\$349
<b>MICROPRO WordStar Pro Pack (IBM)</b>	\$Call
<b>MICROIM R:Base 4000</b>	\$309
<b>MICROSOFT Multiplan</b>	\$129
<b>SAMNA Word III</b>	\$Call
<b>SATELLITE SOFTWARE WordPerfect</b>	\$259
<b>SOFTWARE PUBLISHING PFS:Write</b>	\$105
<b>SOFTWARE SYSTEMS Multimate</b>	\$319
<b>SORCIM SuperCalc 3</b>	\$289

## FOR APPLE II/IIe

<b>ALS CP/M Card</b>	\$279
Smarterm II (80 Column Card)	\$129
<b>DIGITAL RESEARCH CP/M Gold Card w/ 84K</b>	\$349
<b>FOURTH DIMENSION 16K RAM Card</b>	\$55
80 Column Card w/ 84K (IIe Only)	\$129
<b>HAYES</b>	
Micromodem IIe w/ SmartCom II	\$245
Smartmodem 300/1200	\$219/\$509
<b>INTERACT. STRU. PKASD Universal</b>	\$125
<b>MA SYSTEMS Omnigraph</b>	\$79
<b>MICROSOFT Premium Softcard (IIe)</b>	\$279
Softcard (Apple/Franklin)	\$229
<b>MICROTEK Duplicing-GX</b>	\$75
<b>NOVATION</b>	
J-Cat (Auto Drip/Answer, 300 Baud)	\$105
Apple Cat II (300 Baud)	\$225
212 Apple Cat II (1200 Baud)	\$409
103/212 Smart Cat (1200 Baud)	\$399
<b>ORANGE MICRO Grappler+</b>	\$109
Buffered Grappler+ (18K)	\$189
<b>PCPI Applicard 6 MHz</b>	\$249
<b>RANA Elite II/III</b>	\$349/\$429
<b>TRANSENO ASID</b>	\$125
Modemcard w/ Source	\$239

## MISCELLANEOUS

<b>SINGLE-SIDED DISKETTES</b>		
3M	\$23	Dysan \$24
Maxell	\$23	Verbatim \$23
<b>DOUBLE-SIDED DISKETTES</b>		
3M	\$30	Dysan \$32
Maxell	\$32	Verbatim \$31

<b>PRINT BUFFERS</b>		
<b>Quadram Microfazer</b>		
Parallel/Parallel		
16K	\$139	84K \$185
128K	\$239	
Serial/Serial, Serial/Parl, Parl/Serial		
8K	\$145	16K \$155
84K	\$209	
<b>INTERACTIVE STRUCT. ShuffleBuffer 32K</b>		\$219

<b>SURGE PROTECTORS</b>		
<b>NETWORX Wire Tree</b>		\$59
<b>ULTIMA SF-800</b>		\$39

<b>EMERGENCY POWER SYSTEMS</b>		
<b>TrippLite 200 Watt w/ battery</b>		\$275
<b>Power General 200 Watt</b>		\$329

<b>FOR COMMODORE-64</b>		
<b>CARD CD Card+ G</b>		\$59
<b>DRANGE MICRO Grappler CD</b>		\$102

## CUSTOMER SERVICE

# 401-781-0020

## ORDERS ONLY

# 800-843-4302

150 Broadway, Suite 2212, N.Y., NY 10038

Money Order, Cashier's Ck., Personal Ck (2 Weeks To Clear)  
 All Prices Reflect 3% Cash Discount, 2% COD Charge.  
 APO Orders Add 8%. Add 3% For Net Terms.  
 All Returned Non-Defective Merchandise Are Subject To  
 20% Restocking Charge.  
 GenTech Reserves the Right to Change Advertised Prices.



## 64K S100 STATIC RAM

**\$199<sup>00</sup>**  
KIT

**NEW!**

LOW POWER!

RAM OR EPROM!

BLANK PC BOARD  
WITH DOCUMENTATION  
\$55

SUPPORT ICs + CAPS  
\$17.50

FULL SOCKET SET  
\$14.50

FULLY SUPPORTS THE  
NEW IEEE 696 S100  
STANDARD  
(AS PROPOSED)  
FOR 56K KIT \$185

ASSEMBLED AND  
TESTED ADD \$50



### FEATURES:

- Uses new 2K x 8 (TMM 2016 or HM 6116) RAMs.
- Fully supports IEEE 696 24 BIT Extended Addressing.
- 64K draws only approximately 500 MA.
- 200 NS RAMs are standard. (TOSHIBA makes TMM 2016s as fast as 100 NS. FOR YOUR HIGH SPEED APPLICATIONS.)
- SUPPORTS PHANTOM (BOTH LOWER 32K AND ENTIRE BOARD).
- 2716 EPROMs may be installed in any of top 48K.
- Any of the top 8K (E000 H AND ABOVE) may be disabled to provide windows to eliminate any possible conflicts with your system monitor, disk controller, etc.
- Perfect for small systems since BOTH RAM and EPROM may co-exist on the same board.
- BOARD may be partially populated as 56K.

## 256K S-100 SOLID STATE DISK SIMULATOR!

WE CALL THIS BOARD THE "LIGHT-SPEED-100" BECAUSE IT OFFERS AN ASTOUNDING INCREASE IN YOUR COMPUTER'S PERFORMANCE WHEN COMPARED TO A MECHANICAL FLOPPY DISK DRIVE.

### FEATURES:

- 256K on board, using + 5V 64K DRAMS.
- Uses new Intel 8203-1 LSI Memory Controller.
- Requires only 4 Dip Switch Selectable I/O Ports.
- Runs on 8080 or Z80 S100 machines.
- Up to 8 LS-100 boards can be run together for 2 Meg. of On Line Solid State Disk Storage.
- Provisions for Battery back-up.
- Software to mate the LS-100 to your CP/M\* 2.2 DOS is supplied.
- The LS-100 provides an increase in speed of up to 7 to 10 times on Disk Intersive Software.
- Compare our price! You could pay up to 3 times as much for similar boards.

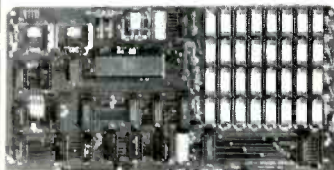

BLANK PCB  
(WITH CP/M\* 2.2  
PATCHES AND INSTALL  
PROGRAM ON DISKETTE)

**\$69<sup>95</sup>**

**\$319<sup>00</sup>**

#LS-100 (FULL 256K KIT)

## THE NEW ZRT-80 CRT TERMINAL BOARD!

A LOW COST Z-80 BASED SINGLE BOARD THAT ONLY NEEDS AN ASCII KEYBOARD, POWER SUPPLY, AND VIDEO MONITOR TO MAKE A COMPLETE CRT TERMINAL. USE AS A COMPUTER CONSOLE, OR WITH A MODEM FOR USE WITH ANY OF THE PHONE-LINE COMPUTER SERVICES.

### FEATURES:

- Uses a Z80A and 6845 CRT Controller for powerful video capabilities.
- RS232 at 16 BAUD Rates from 75 to 19,200.
- 24 x 80 standard format (60 Hz).
- Optional formats from 24 x 80 (50 Hz) to 64 lines x 96 characters (60 Hz).
- Higher density formats require up to 3 additional 2K x 8 6116 RAMS.
- Uses N.S. INS 8250 BAUD Rate Gen. and USART combo IC.
- 3 Terminal Emulation Modes which are Dip Switch selectable. These include the LSI-ADM3A, the Heath H-19, and the Beehive.
- Composite or Split Video.
- Any polarity of video or sync.
- Inverse Video Capability.
- Small Size: 6.5 x 9 Inches.
- Upper & lower case with descenders.
- 7 x 9 Character Matrix.
- Requires Par. ASCII keyboard.

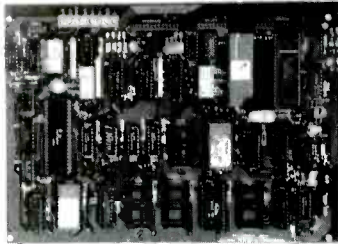

BLANK PCB WITH 2716  
CHAR. ROM, 2732 MON. ROM

**\$59<sup>95</sup>**

SOURCE DISKETTE - ADD \$10  
SET OF 2 CRYSTALS - ADD \$7.50

WITH 8 IN.  
SOURCE DISK!  
(CP/M COMPATIBLE)

**\$129<sup>95</sup>**

(COMPLETE KIT,  
# ZRT-80 2K VIDEO RAM)

## Digital Research Computers

P.O. BOX 461565 • GARLAND, TEXAS 75046 • (214) 225-2309

**TERMS:** Add \$3.00 postage. We pay balance. Orders under \$15 add 75¢ handling. No C.O.D. We accept Visa and MasterCard. Texas Res. add 5% Tax. Foreign orders (except Canada) add 20% P & H. Orders over \$50 add 85¢ for insurance.

## CRYPTOGRAPHIC KEYS

```

LOOP
  X: LRAND (N);
  WHEN X > 1 EXIT,
ENDLOOP,
J: 0,
Y: POWERMOD (X, Q, N),
LOOP
  WHEN J = 0 and Y = 1 OR Y = N - 1,
  T: TRUE EXIT,
  WHEN J > 0 and Y = 1,
  T: FALSE EXIT,
  J: J + 1,
  WHEN J = K,
  T: FALSE EXIT,
  Y: MOD (Y * Y, N),
ENDLOOP,
WHEN NOT T,
  FALSE EXIT,
I: I + 1,
WHEN I > 50,
  TRUE EXIT,
ENDLOOP,
ENDFUN
    
```

? DISPLAY(ODDFACT);

@:

FUNCTION ODDFACT (N, K),

K: 0,

LOOP

WHEN MOD (N, 2) = 1,

ADJOIN (N, K) EXIT,

N: QUOTIENT (N, 2),

K: K + 1,

ENDLOOP,

ENDFUN

Listing 5: A recursively defined function for raising a large number to a large power mod a third number. This is not incorporated into the system, as it runs out of memory rapidly through its use of a stack.

? DISPLAY(POWERMOD);

@:

FUNCTION POWERMOD (X, Y, N),

WHEN Y = 0,

1 EXIT,

WHEN MOD (Y, 2) = 1,

MOD (X \* POWERMOD (X, Y - 1, N), N)

EXIT,

POWERMOD (MOD (X \* X, N), QUOTIENT (Y, 2), N),

ENDFUN

? SYSTEM ();

@:

2)PR# 0

# Introducing the software that makes communications a piece of cake.

EasyLink™ Instant Mail™ Manager software is probably the only communications package you'll ever need. Designed to blend in perfectly with Western Union's EasyLink service, it makes the total communication process easy, instant, and automatic too.

## **All the right ingredients.**

EasyLink Instant Mail Manager works with EasyLink service to provide automatic access and transmission of almost any type or length correspondence over the EasyLink network. So sending mail instantly to virtually any other phone-equipped PC or word processor is a snap.

You can even reach people without equipment. Thanks to EasyLink's instant access to Western Union's Worldwide communications services.

EasyLink Instant Mail Manager also lets you access your company's computer or connect instantly to other business and information services.

## **The frosting on the cake.**

EasyLink Instant Mail Manager is more than simple "send and receive" software. With it, you also have complete word processing capabilities. So you can easily create, edit and change the format of

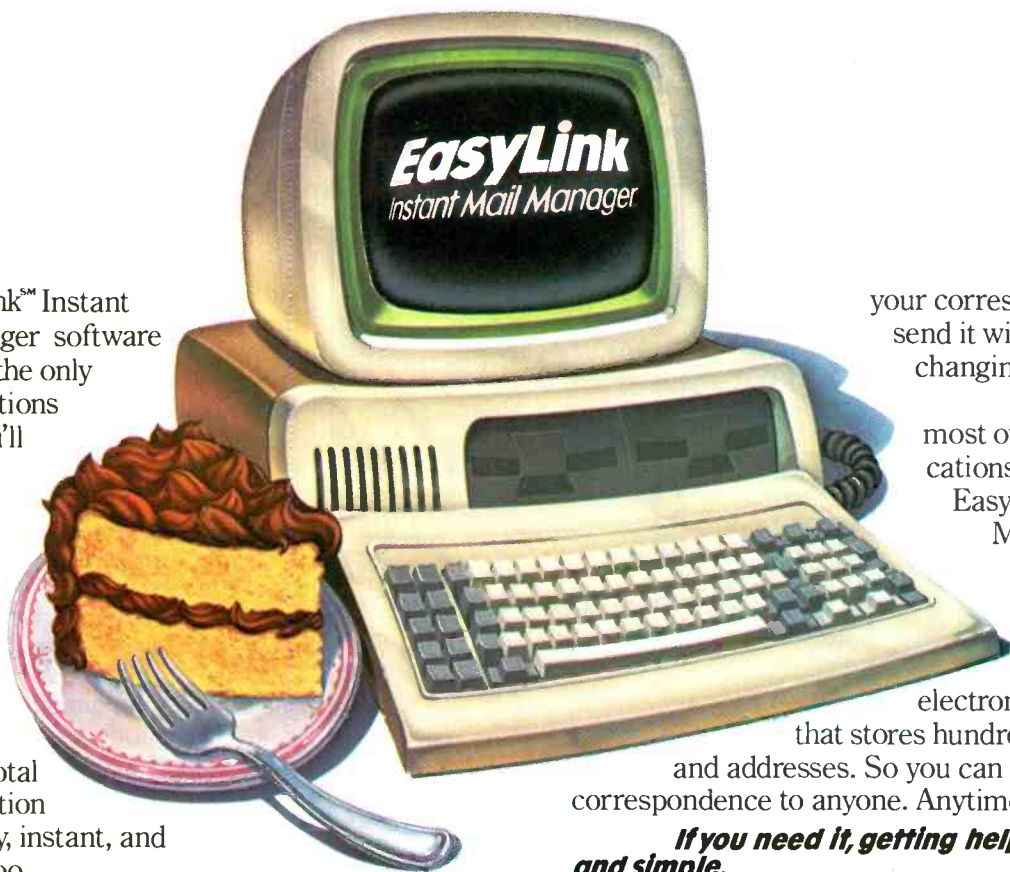

your correspondence, then send it without ever changing software.

And, unlike most other communications software, EasyLink Instant Mail Manager allows you to create and manage a permanent electronic address file that stores hundreds of names and addresses. So you can instantly speed correspondence to anyone. Anytime.

## **If you need it, getting help is sweet and simple.**

EasyLink Instant Mail Manager is set up to guide you step by step. From how to format messages to how you go about sending them.

EasyLink Instant Mail Manager software and EasyLink service. The perfect mix.

Available now at your computer software dealer or call 1-800-336-3797 ext. 908 for more information.

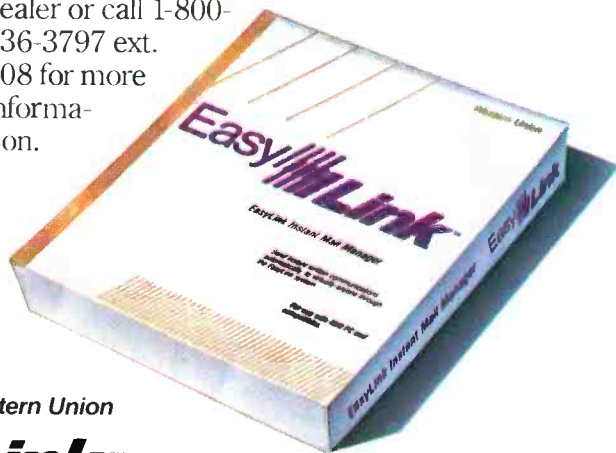

Western Union  
**EasyLink**™



# Softline

FOR YOUR  
BOTTOM LINE.

<b>Lotus 1-2-3 \$309</b>	<b>dBase III \$CALL</b>	<b>WordStar Professional \$359</b>	<b>MultiMate \$269</b>
----------------------------------	-----------------------------	--	----------------------------

WORD PROCESSING/ EDITORS	LANGUAGES/UTILITIES	DATABASE SYSTEMS
Easywriter II System (3 pak) \$219	Concurrent w/Windows Digital Research \$219	Alpha Data Base Manager II \$179
Fancy Font \$159	C Compiler \$219	Condor III \$329
Final Word \$189	Lattice C \$309	dBase II \$289
Microsoft Word \$239	Microsoft C Compiler \$329	DBplus \$ 89
Microsoft Word/Mouse \$299	MS Basic Compiler \$249	Friday \$179
Multimate \$269	MS Fortran \$239	InfoStar \$269
PeachText 5000 \$219	Norton Utilities \$ 59	Knowledgeman \$299
PFS: Write \$ 95	<b>COMMUNICATIONS/ PRODUCTIVITY TOOLS</b>	PFS: File/PFS: Report \$169
Volkswriter Deluxe \$169	Crosstalk \$119	Powerbase \$269
The Word Plus (Oasis) \$109	Memory Shift \$ 79	QuickCode \$169
Word Perfect (SSI) \$Call	Move II \$109	R-base 4000 \$279
WordPlus-PC with The Boss \$319	Prokey 3.0 \$ 95	TIM IV \$269
WordStar \$239	Relay \$ 99	Versaform \$249
WordStar Professional (MS/MM/SS/SI) \$359	Smartcom II \$109	<b>PROFESSIONAL DEVELOPMENT</b>
WordStar Options Pak (MM/SS/SI) \$189	<b>GRAPHICS/STATISTICS</b>	Management Edge \$169
XYWrite II+ \$229	Abstat \$279	Think Tank \$129
<b>SPREADSHEETS/ INTEGRATED PACKAGES</b>	BPS Business Graphics \$229	<b>HOME/PERSONAL FINANCE</b>
Electric Desk \$Call	Chartman Combo (II&IV) \$349	Dollars and Sense \$119
Framework \$Call	Chartmaster \$259	Financier II \$119
InteCalc \$189	dGraph \$189	Home Accountant Plus \$ 99
Jack 2 \$329	DR Draw \$199	Sundex-CPA \$109
Lotus 1-2-3 \$309	Energraphics w/Plotter \$319	Tax Preparer 84 \$189
Multiplan \$135	Execucision \$279	<b>HARDWARE PERIPHERALS*</b>
Open Access \$379	Fast Graphs \$219	AST Six Pack Plus (64k) \$269
Ovation \$Call	Graphwriter Combo \$399	Quadboard (0k) \$Call
Smart System \$579	PC Draw \$279	Hayes 1200B with Smartcom \$399
SuperCalc 3 \$239	PFS: Graph \$ 95	Hayes Smartmodem 1200 \$499
Symphony \$Call	Statpac-NWA \$329	Keytronic 5151 DLX \$209
TKI Solver \$269	Statpac-Waltonick \$299	IRMA \$995
VisiCalc IV \$159	<b>ACCOUNTING MODULES</b>	Hercules Graphics Board \$349
<b>PROJECT MANAGEMENT</b>	Ask Micro Accounting \$299	Epson FX-100 Printer \$Call
Harvard Project Manager \$239	BPI Accounting \$369	Comrex II Printer \$Call
IntePert/Plan \$239	IUS EasyBusiness System \$319	C Itoh Prowriter \$Call
Scitor Project Scheduler \$229	MBA Accounting \$369	C Itoh Starwriter \$1199
VisiSchedule \$199	Open Systems Accounting \$459	Okidata 93A \$749
	Peachpak 4 (GL/AP/AR) \$239	64K Memory \$ 55
	Peachtree Accounting \$399	
	Real World Accounting \$469	
	Star Accounting Partner (GL/AP/AR/PAY) \$269	

<b>R: base 4000 \$279</b>	<b>Volkswriter DLX \$169</b>	<b>AST 6 Pak Plus \$269</b>	<b>Smartmodem 1200B \$399</b>
-----------------------------------	--------------------------------------	-------------------------------------	---------------------------------------

**free!**

Diskette Library Case with your order



**DISCOUNT COUPONS**

With each order, we offer discount coupons worth up to \$10 on your next order.

**1-800-221-1260**  
In New York State call (212) 438-6057

TERMS:  
Checks—allow 14 days to clear. Credit processing—add 3% COD orders—cash, M.O. or certified check—add \$3.00. Shipping and handling UPS surface—add \$3.00 per item. UPS Blue \$6.00 per item. NY State Residents—add applicable sales tax. All prices subject to change.



**Softline**

Softline Corporation  
P.O. Box 729, Brooklyn, N.Y. 11230  
TELEX: 421047 ATLN UI

## CRYPTOGRAPHIC KEYS

in the muSimp language) terminate in an EXIT.

The final value for  $k$  is then found by continually adding 6 until  $kp_i + 1$  is prime. Adding 6 preserves  $k$ 's being even and its congruence to  $p_i \pmod 3$ . This  $kp_i + 1$  is then assigned to  $p$ , which is then returned as the value chosen. Remember that  $P$  within the CHOOSEP function is a local variable, and that the result of one call to CHOOSEP goes into the global variable  $P$  and the other goes into global variable  $Q$  from the second call in SETUP (listing 1).

Going down one level now, listing 3 shows the functions defined for random numbers. When I needed one, I called LRAND with an argument equal to the upper limit of the random number to be chosen, the lower limit being 0.

Let me first describe the function one level lower. RND uses a linear congruence one in fact proposed by Hare, Russ, and Faulkner in a Call—A.P.P.L.E. article to replace the random-number generator in AppleSoft. RND produces a number between 0 and 67099547. As LRAND seeks to find a random number that could conceivably be very much larger, it treats each number chosen by RND as a digit in a base-67099547 number. It follows the base-conversion procedure of multiplying each partial sum by the base and adding the next "digit." This is done until a large enough number is built; then it is brought down to size by taking its value mod the parameter passed to LRAND.

The RANDOMIZE function in the same listing prints a prompt to enter a seed. The reference to the SCAN function then causes a wait for user input terminated by a carriage return. What the user typed is put into a variable called SCAN, which RANDOMIZE then assigns into RND#, the global variable that is used by RND as its seed and new random value. RND is then called once to warm up the generator.

You should probably prepare your own secret linear congruence

(continued)

# Command

# Assist™

**YOUR  
DOS MANUAL  
ON  
DISK  
THERE  
WHEN YOU  
NEED IT!**

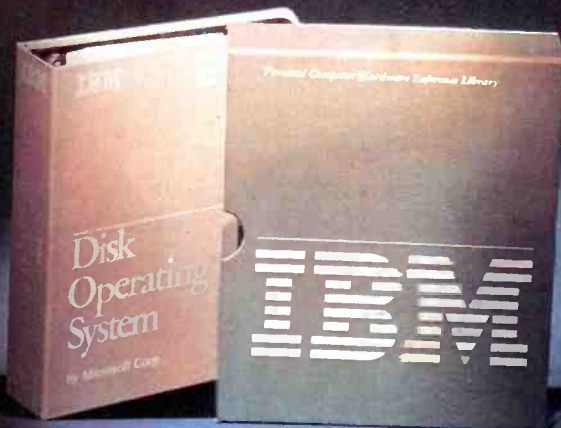

## \$49.95

AVAILABLE ONLY FOR  
IBM PC, XT AND  
COMPATIBLES  
USING PC/MS DOS  
2.0 or GREATER

## NOW TAKE COMMAND OF YOUR DOS

Now your DOS manual is available on disk! Think of it, no more searching or fumbling through hundreds of pages to find the command you need. Suppose you want to know how to use a DOS command, just type HELP and the command name. In the blink of an eye the information is on your screen, full instructions on how to properly use the command, complete with examples. Suppose you can't remember the command you want, just type HELP and all the commands are displayed on the screen in alphabetic order. Command/Assist gives you the ability to create custom help displays.

**NOW YOU CAN TAKE COMMAND.**

Micro Design International Inc.  
6566 University Blvd., Winter Park, FL 32792 • (305) 657-6604

Outside U.S. add \$15.00 (Payment must be a bank draft payable in U.S. dollars.)

IBM, IBM PC, XT, and PC-DOS are registered trade marks of INTERNATIONAL BUSINESS MACHINE CORP.  
MS-DOS, a registered trade mark of MICROSOFT CORP.

**ORDER YOUR COPY OF Command/Assist TODAY!**

For Visa and MasterCard orders call:

**TOLL FREE 800-221-6444 Ext. 800**

(OUR LINES ARE OPEN ANY TIME DAY OR NIGHT)

Dealer and Distributor inquiries welcome, Call: **TOLL FREE 800-327-1056 Ext. 5118/IN FLORIDA 800-432-8515 Ext. 5118**

Another quality product from MICRO DESIGN INTERNATIONAL your internal Hard Disk solution.

Command/Assist \$49.95 Plus \$5.00 shipping and handling.

COD orders add an additional \$2.50.

Certific Check  M/C

MC/ VISA/ # \_\_\_\_\_

Expires \_\_\_\_\_ / \_\_\_\_\_ / \_\_\_\_\_

Name \_\_\_\_\_

Address \_\_\_\_\_

City \_\_\_\_\_

State/Zip \_\_\_\_\_



MAKE THE CONNECTION...IN THE SLOT

Now you can plug the ease of use and leadership features of a POPCOM™ personal communications modem directly into one of the expansion slots of your IBM PC, XT, Portable, or IBM slot compatible computer.

With the new POPCOM modem from Prentice Corporation...

- Your personal computer becomes essentially a voice and data workstation, and the need for costly extra telephone lines is eliminated.
- Activity on the phone line is detected (most modems don't do this) and the costly extra load placed on your company's internal phone system is reduced.
- You communicate at the fast, economical 1200 bps rate as well as the standard 300 bps rate.
- Telephone numbers you have selected are automatically dialed and redialed if busy, and incoming calls are automatically answered.
- You have compatibility with the popular communications software packages of today, and advanced features that will let you take advantage of the next generation of communications software as well.
- Only one slot in your PC, XT, or Portable is required.

With a suggested retail price of \$415, the C100 means real price-performance. All of these leadership performance features are also available in the external POPCOM X100 modem, so now you have a choice...inside or outside.

See your local dealer for more information, or contact:  
PRENTICE Corporation  
266 Caspian Drive  
P.O. Box 3544  
Sunnyvale, CA 94088-3544  
(408) 734-9855



**PRENTICE**  
Corporation

**POPCOM**<sup>TM</sup>  
C100  
MODEMS

POPCOM™ is a trademark of PRENTICE Corporation  
IBM® is a registered trademark of International Business Machines Corporation  
© 1984 Prentice Corporation



## CRYPTOGRAPHIC KEYS

random-number generator and install it in the place of this RND to prohibit someone's determining your public or private key,  $n$  or  $d$ .

Listing 4 shows the functions for finding the next prime equal to or greater than a given number and for testing a number for its being prime. The former, NXPRIME, first loops until the internal variable corresponding to the passed parameter is odd. (Obviously it needs to be done just once, but the loop structure is necessary to satisfy WHEN's requirement to EXIT.) The second loop then continues to add 2, testing all successive odd numbers until a prime is found, at which time PRIME returns a value of TRUE.

That function, PRIME, is listed next in listing 4. It follows Knuth's Algorithm  $P$  for a probabilistic prime-number test. All the variables but  $N$  in the parameter list merely set up local variables, as they are not passed as arguments in the calls (references) to PRIME.

First, PRIME checks if  $N$  is even; if so, FALSE is returned as the value of the function. A few extra checks here for multiples of 3, 5, and 7 to avoid more complicated checks might speed up the processing of most non-primes, but the function does work as shown.

Knuth's algorithm starts from a point where  $k$  and  $q$  are chosen such that  $n = 1 + 2^k q$  where  $q$  is odd. The PRIME function determines these by calling ODDFACT with  $n - 1$ , to be expressed as  $2^k q$ . (Named such because  $q$  is the largest odd factor of the argument passed.) ODDFACT produces a tree structure with only two branches attached to its single node. The first is the value appropriate for  $q$ , the other for  $k$ .

FIRST and REST are built into the muSimp language and are much more mnemonic than the equivalent LISP car and cdr. With only two branches, here each gives one of the branches.

With  $k$  and  $q$  chosen, the probabilistic algorithm is performed 50 times, as recommended by Knuth (page 388), by setting  $l$  to 0 and in-

(continued)

← Circle 278 on inquiry card.

### 15-BIT A/D CONVERTER FOR IBM® PC

- 7.48 VOLT INPUT RANGE  
4 DIFFERENTIAL CHANNELS  
6 SAMPLES/SECOND **\$265**

**THERMOCOUPLE THERMOMETERS**  
2 or 6 CHANNELS ..... \$135 or \$155

\*\*\*\*\*

### FOR APPLE II®

**TIMER/CLOCK WITH CALENDAR**  
1 MILLISECOND RESOLUTION ..... \$175

**DATA LOGGING SOFTWARE**  
128 CHANNEL PACKAGE ..... \$100

**12-BIT A/D** 40,000 SAM/SEC ..... \$325

**8-BIT A/D** 111,000 SAM/SEC ..... \$165

**12-BIT A/D** 12 SAM/SEC ..... \$175

MULTIPLEXERS, OUTPUT CONTROLLERS  
AND CUSTOM SYSTEMS AVAILABLE

### LAWSON LABS, INC.

5700 RAIBE ROAD  
COLUMBIA FALLS, MT 59912  
406-387-5355

Circle 196 on Inquiry card.

## FREE PC BOOK

\*\* GET ONE BOOK FREE FROM THIS AD WITH EVERY \$20.00 PURCHASE \*\*

**Small Business Programs for the IBM PC**  
Easy ready to run programs for your PC: mailing list, cost proposal, mortgage, invoicing and a very powerful BUSIPACK containing invoice writing, mailing list and inventory control. Inventory file is automatically updated by the invoice writing part. All this plus twelve more programs to increase productivity on your PC.

**Book and disk package**  
Want to save 8 hours? Go ahead and get the combination package "PC-COMBO".  
Order No. 821 (Book+disk) **\$39.00**  
Order No. 82 (Book only) **\$12.95**  
Order No. 820 (Disk only) **\$26.05**

**MB-COBOL Introduction and Applications**  
How to get the most out of your IBM PC or Compatible. Use this book and keep it right beside your computer. It contains numerous "how-to-do" information, application programs, how to add your own commands, and how to use the assembler.  
Order No. 88 (Book only) **\$8.95**

**Book and disk package containing all the programs from book No. 88 on disk**  
Order No. 881 (book+disk) **\$39.00**

**Dealer and Distributor inquiries are invited.**  
ELCOMP PUBLISHING, INC.  
2134 W. Foothill Blvd., Unit B  
Upland, CA 91786  
Phone: (714) 623-8314, Telex: 26 81 81

**Statistics on the IBM PC**  
Fundamentals of data in bar graphs and pie-charts, probability, Markov Analysis, discrete distribution, normal distribution, Gauss Distribution, statistical test (chi square), t-distribution, non-parametric test, variance, linear regression, auto correlation, forecasting and trend, matrix and gambling.

**Each subject contains an introduction, a program in BASIC, and a practical application.**  
Order No. 47 (Book only) **\$12.95**  
Order No. 470 (Disk only) **\$26.95**  
Order No. 471 (Book+disk) **\$39.00**

**BASIC in 80 Minutes**  
An easy way to learn BASIC on the APPLE IIc, IBM PC + Compatibles, Commodore and ATARI. Each command with a practical sample and cross reference. 130 pages.  
Order No. 36 (book) **\$7.95**

**Small Business Programs for the Commodore-64**  
Ready to use and easy to run programs including: bar-graph, invoice writing, mortgage, economic order quantity and break-even analysis. Plus 8 other powerful programs.  
Order No. 188 (Book) **\$12.95**  
Order No. 1880 (Disk only) **\$26.95**  
Order No. 187 (Book+disk) **\$39.00**

**PAYMENT:** Check, VISA, MC  
CA residents add 8% sales tax.  
Add \$ 2.00 for shipping.  
Outside USA, add 15% for shipping.  
In Singapore contact: telex 22 456  
In Germany contact: telex 52 88 72

Circle 126 on Inquiry card.



### EDGE-PC: An Affordable IBM PC-Compatible System for \$1361

- PC-88 CPU card **\$349**
- Color/Graphic card **\$189**
- Click adapter with cable **\$120**
- Monochrome card **\$189**
- Keyboard **\$149**
- System Enclosure **\$119**
- 120W Power Supply & fan **\$139**

**EDGE MICRO SYSTEMS, INC.**  
2350 WALSH AVE., SANTA CLARA, CA 95051  
(408) 980-9866 TLX 3719075 EDGE UB

Circle 124 on Inquiry card.



## flexible disks

Call Free **(800)235-4137**  
for prices and information.  
Dealer inquiries invited.  
C.O.D. and charge cards  
accepted.

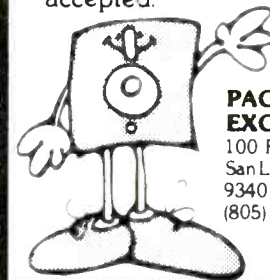

VISA

**PACIFIC EXCHANGES**  
100 Foothill Blvd.  
San Luis Obispo, CA  
93401 (In Cal. call  
(805) 543-1037)

Circle 268 on Inquiry card.

**Logo is the  
simplest  
programming  
language  
you can use.**  
**Terrapin™ is the  
simplest Logo  
to use.**

**Terrapin™**  
The Original Logo People  
(617) 492-8816

Circle 355 on Inquiry card.

## \$91.00 Single Board Computer

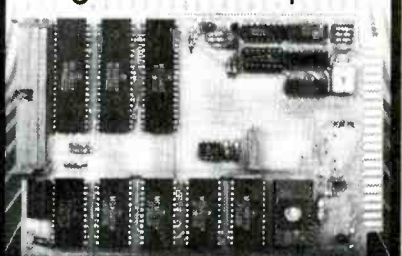

\*900 pinless price, master 16245 (shown)

6800 MPU, serial I/O, parallel I/O, RAM,  
EPROM, 44-pin 4.5" x 6.5" PCB  
**EXPANSION MODULES:** RAM, EPROM, CMOS  
RAM/battery, analog I/O, serial I/O,  
parallel I/O, counter/timer, IEEE-488,  
EPROM programmer, floppy disks,  
cassette, breadboard, keyboard/display.

**WINTEK**  
Wintek Corp.  
1801 South Street  
Lafayette, IN 47904  
317-742-8428

Circle 380 on Inquiry card.



# MICROPROCESSOR COMPONENTS

**7400** \*Number of Pins of each I.C. for part stock purchase

Part No.	**Pins	Price	Part No.	**Pins	Price	Part No.	**Pins	Price
SN7400N	14	25	SN7472N	14	29	SN74155N	16	59
SN7401N	14	25	SN7473N	14	35	SN74157N	16	59
SN7402N	14	25	SN7474N	14	35	SN74160N	16	59
SN7403N	14	25	SN7475N	14	35	SN74162N	16	59
SN7404N	14	25	SN7476N	16	35	SN74163N	16	59
SN7405N	14	25	SN7477N	14	35	SN74164N	16	59
SN7406N	14	25	SN7478N	14	35	SN74165N	16	59
SN7407N	14	25	SN7479N	14	35	SN74167N	16	59
SN7408N	14	25	SN7480N	14	35	SN74168N	16	59
SN7409N	14	25	SN7481N	14	35	SN74169N	16	59
SN7410N	14	25	SN7482N	14	35	SN74170N	14	29
SN7411N	14	25	SN7483N	14	35	SN74171N	14	29
SN7412N	14	25	SN7484N	14	35	SN74172N	14	29
SN7413N	14	25	SN7485N	14	35	SN74173N	14	29
SN7414N	14	25	SN7486N	14	35	SN74174N	14	29
SN7415N	14	25	SN7487N	14	35	SN74175N	14	29
SN7416N	14	25	SN7488N	14	35	SN74176N	14	29
SN7417N	14	25	SN7489N	14	35	SN74177N	14	29
SN7418N	14	25	SN7490N	14	35	SN74178N	14	29
SN7419N	14	25	SN7491N	14	35	SN74179N	14	29
SN7420N	14	25	SN7492N	14	35	SN74180N	14	29
SN7421N	14	25	SN7493N	14	35	SN74181N	24	95
SN7422N	14	25	SN7494N	14	35	SN74182N	16	59
SN7423N	14	25	SN7495N	14	35	SN74183N	16	59
SN7424N	14	25	SN7496N	14	35	SN74184N	16	59
SN7425N	14	25	SN7497N	14	35	SN74185N	16	59
SN7426N	14	25	SN7498N	14	35	SN74186N	16	59
SN7427N	14	25	SN7499N	14	35	SN74187N	16	59
SN7428N	14	25	SN7500N	14	35	SN74188N	16	59
SN7429N	14	25	SN7501N	14	35	SN74189N	16	59
SN7430N	14	25	SN7502N	14	35	SN74190N	16	59
SN7431N	14	25	SN7503N	14	35	SN74191N	16	59
SN7432N	14	25	SN7504N	14	35	SN74192N	16	59
SN7433N	14	25	SN7505N	14	35	SN74193N	16	59
SN7434N	14	25	SN7506N	14	35	SN74194N	16	59
SN7435N	14	25	SN7507N	14	35	SN74195N	16	59
SN7436N	14	25	SN7508N	14	35	SN74196N	16	59
SN7437N	14	25	SN7509N	14	35	SN74197N	14	29
SN7438N	14	25	SN7510N	14	35	SN74198N	14	29
SN7439N	14	25	SN7511N	14	35	SN74199N	14	29
SN7440N	14	25	SN7512N	14	35	SN74200N	14	29
SN7441N	14	25	SN7513N	14	35	SN74201N	14	29
SN7442N	14	25	SN7514N	14	35	SN74202N	14	29
SN7443N	14	25	SN7515N	14	35	SN74203N	14	29
SN7444N	14	25	SN7516N	14	35	SN74204N	14	29
SN7445N	14	25	SN7517N	14	35	SN74205N	14	29
SN7446N	14	25	SN7518N	14	35	SN74206N	14	29
SN7447N	14	25	SN7519N	14	35	SN74207N	14	29
SN7448N	14	25	SN7520N	14	35	SN74208N	14	29
SN7449N	14	25	SN7521N	14	35	SN74209N	14	29
SN7450N	14	25	SN7522N	14	35	SN74210N	14	29
SN7451N	14	25	SN7523N	14	35	SN74211N	14	29
SN7452N	14	25	SN7524N	14	35	SN74212N	14	29
SN7453N	14	25	SN7525N	14	35	SN74213N	14	29
SN7454N	14	25	SN7526N	14	35	SN74214N	14	29
SN7455N	14	25	SN7527N	14	35	SN74215N	14	29
SN7456N	14	25	SN7528N	14	35	SN74216N	14	29
SN7457N	14	25	SN7529N	14	35	SN74217N	14	29
SN7458N	14	25	SN7530N	14	35	SN74218N	14	29
SN7459N	14	25	SN7531N	14	35	SN74219N	14	29
SN7460N	14	25	SN7532N	14	35	SN74220N	14	29
SN7470N	14	29	SN7533N	14	35	SN74221N	14	29

**74LS**

Part No.	**Pins	Price	Part No.	**Pins	Price
74LS01	14	25	74LS192	16	79
74LS02	14	25	74LS193	16	79
74LS03	14	25	74LS194	16	79
74LS04	14	25	74LS195	16	79
74LS05	14	25	74LS196	16	79
74LS06	14	25	74LS197	14	29
74LS07	14	25	74LS198	14	29
74LS08	14	25	74LS199	14	29
74LS09	14	25	74LS200	14	29
74LS10	14	25	74LS201	14	29
74LS11	14	25	74LS202	14	29
74LS12	14	25	74LS203	14	29
74LS13	14	25	74LS204	14	29
74LS14	14	25	74LS205	14	29
74LS15	14	25	74LS206	14	29
74LS16	14	25	74LS207	14	29
74LS17	14	25	74LS208	14	29
74LS18	14	25	74LS209	14	29
74LS19	14	25	74LS210	14	29
74LS20	14	25	74LS211	14	29
74LS21	14	25	74LS212	14	29
74LS22	14	25	74LS213	14	29
74LS23	14	25	74LS214	14	29
74LS24	14	25	74LS215	14	29
74LS25	14	25	74LS216	14	29
74LS26	14	25	74LS217	14	29
74LS27	14	25	74LS218	14	29
74LS28	14	25	74LS219	14	29
74LS29	14	25	74LS220	14	29
74LS30	14	25	74LS221	14	29
74LS31	14	25	74LS222	14	29
74LS32	14	25	74LS223	14	29
74LS33	14	25	74LS224	14	29
74LS34	14	25	74LS225	14	29
74LS35	14	25	74LS226	14	29
74LS36	14	25	74LS227	14	29
74LS37	14	25	74LS228	14	29
74LS38	14	25	74LS229	14	29
74LS39	14	25	74LS230	14	29
74LS40	14	25	74LS231	14	29
74LS41	14	25	74LS232	14	29
74LS42	14	25	74LS233	14	29
74LS43	14	25	74LS234	14	29
74LS44	14	25	74LS235	14	29
74LS45	14	25	74LS236	14	29
74LS46	14	25	74LS237	14	29
74LS47	14	25	74LS238	14	29
74LS48	14	25	74LS239	14	29
74LS49	14	25	74LS240	14	29
74LS50	14	25	74LS241	14	29
74LS51	14	25	74LS242	14	29
74LS52	14	25	74LS243	14	29
74LS53	14	25	74LS244	14	29
74LS54	14	25	74LS245	14	29
74LS55	14	25	74LS246	14	29
74LS56	14	25	74LS247	14	29
74LS57	14	25	74LS248	14	29
74LS58	14	25	74LS249	14	29
74LS59	14	25	74LS250	14	29
74LS60	14	25	74LS251	14	29
74LS61	14	25	74LS252	14	29
74LS62	14	25	74LS253	14	29
74LS63	14	25	74LS254	14	29
74LS64	14	25	74LS255	14	29
74LS65	14	25	74LS256	14	29
74LS66	14	25	74LS257	14	29
74LS67	14	25	74LS258	14	29
74LS68	14	25	74LS259	14	29
74LS69	14	25	74LS260	14	29
74LS70	14	25	74LS261	14	29
74LS71	14	25	74LS262	14	29
74LS72	14	25	74LS263	14	29
74LS73	14	25	74LS264	14	29
74LS74	14	25	74LS265	14	29
74LS75	14	25	74LS266	14	29
74LS76	14	25	74LS267	14	29
74LS77	14	25	74LS268	14	29
74LS78	14	25	74LS269	14	29
74LS79	14	25	74LS270	14	29
74LS80	14	25	74LS271	14	29
74LS81	14	25	74LS272	14	29
74LS82	14	25	74LS273	14	29
74LS83	14	25	74LS274	14	29
74LS84	14	25	74LS275	14	29
74LS85	14	25	74LS276	14	29
74LS86	14	25	74LS277	14	29
74LS87	14	25	74LS278	14	29
74LS88	14	25	74LS279	14	29
74LS89	14	25	74LS280	14	29
74LS90	14	25	74LS281	14	29

**74S/PROMS\***

Part No.	**Pins	Price	Part No.	**Pins	Price
74S01	14	35	74S24	14	29
74S02	14	35	74S25	14	29
74S03	14	35	74S26	14	29
74S04	14	35	74S27	14	29
74S05	14	35	74S28	14	29
74S06	14	35	74S29	14	29
74S07	14	35	74S30	14	29
74S08	14	35	74S31	14	29
74S09	14	35	74S32	14	29
74S10	14	35	74S33	14	29
74S11	14	35	74S34	14	29
74S12	14	35	74S35	14	29
74S13	14	35	74S36	14	29
74S14	14	35	74S37	14	29
74S15	14	35	74S38	14	29
74S16	14	35	74S39	14	29
74S17	14	35	74S40	14	29
74S18	14	35	74S41	14	29
74S19	14	35	74S42	14	29
74S20	14	35	74S43	14	29
74S21	14	35	74S44	14	29
74S22	14	35	74S45	14	29
74S23	14	35	74S46	14	29
74S24	14	35	74S47	14	29
74S25	14	35	74S48	14	29
74S26	14	35	74S49	14	29
74S27	14	35	74S50	14	29
74S28	14	35	74S51	14	29
74S29	14	35	74S52	14	29
74S30	14	35	74S53	14	29
74S31	14	35	74S54	14	29
74S32	14	35	74S55	14	29
74S33	14	35	74S56	14	29
74S34	14	35	74S57	14	29
74S35	14	35	74S58	14	29
74S36	14	35	74S59	14	29
74S37	14	35	74S60	14	29
74S38	14	35	74S61	14	29
74S39	14</				



# Commodore

## RS232 ADAPTER FOR VIC-20 AND COMMODORE 64

New!



New!

The JE232CM allows connection of standard serial RS232 printers, modems, etc. to your VIC-20 and C-64. A 4-pole switch allows the inversion of the 4 control lines. Complete installation and operation instructions included.

- Plugs into User Port
- Provides Standard RS232 signal levels
- Uses 6 signals (Transmit, Receive, Clear to Send, Request to Send, Data Terminal Ready, Data Set Ready).

**JE232CM . . . . . \$39.95**

## VOICE SYNTHESIZER FOR APPLE AND COMMODORE

Great Educating Tool!



JE520AP

JE520CM

Over 250 word vocabulary affixes allow the formation of more than 800 words. Built-in amplifier, speaker, volume control, and audio jack. Recreates a clear, natural male voice. Plug-in user ready with documentation and sample software. Case size: 7 1/4" L x 3 1/4" W x 1-3/8" H

**APPLICATIONS:**

- Security Warning
- Teaching
- Instrumentation
- Telecommunication
- Handicap Aid
- Games

The JE520 VOICE SYNTHESIZER will plug right into your computer and allow you to enhance almost any application. Utilizing National Semiconductor's DIGITALKER™ Speech Processor IC (with four custom memory chips), the JE520 compresses natural speech into digital memory. Including the original inflections and emphases. The result is an extremely clear, natural vocalization.

Part No.	Description	Price
JE520CM	For Commodore 64 & VIC-20	\$114.95
JE520AP	For Apple II, II+, and IIe	\$149.95



New! Documentation for CPM Computers

## JE664 EPROM PROGRAMMER 8K to 64K EPROMS — 24 & 28 Pin Packages

Completely Self-Contained — Requires No Additional Systems for Operation

- Programs and validates EPROMs
- Checks for properly erased EPROMs
- Emulates PROMs or EPROMs
- RS232C Computer Interface for loading and program loading
- Loads data into RAM by keyboard
- Changes data in RAM by keyboard
- Loads RAM from an EPROM
- Compares EPROMs for content differences
- Copies EPROMs
- Power Input: 115VAC, 60Hz, less than 10W power consumption
- Enclosure: Color-coordinated, light tan panels with milled end pieces in mocha brown
- Size: 18 1/4" L x 8 1/4" D x 3 1/4" H
- Weight: 5 1/2 lbs

The JE664 EPROM Programmer erases and programs various 8-Bit Word EPROMs from 8K to 64K-Bit memory capacity. Data can be entered into the JE664's internal 8K x 8-Bit RAM in three ways: (1) from a ROM or EPROM, (2) from an external computer via the optional JE565 RS232C BUS, (3) from its panel keyboard. The JE664's RAMs may be accessed for emulation purposes from the panel's test socket to an external microprocessor. In programming and emulation, the JE664 allows for examination, change and validation of program content. The JE664's RAMs can be programmed quickly to all "1"s (or any value), allowing unused addresses in the EPROM to be programmed later without necessity of "UV" erasing. The JE664 displays DATA and ADDRESS in convenient hexadecimal (alphanumeric) format. A "DISPLAY EPROM DATA" button changes the DATA readout from RAM word to EPROM word and is also used in both hexadecimal and binary code. The front panel features a convenient operating guide. The JE664 Programmer includes one JM16A Jumper Module (as listed below).

**JE664-A EPROM Programmer . . . . . \$995.00**  
Assembled & Tested (Includes JM16A Module)

**JE665 — RS232C INTERFACE OPTION** — The RS232C Interface Option implements computer access to the JE664's RAM. This allows the computer to manipulate, store and transfer EPROM data to and from the JE664. A sample program listing is supplied in M6801C for CPM computers. Documentation is provided to adapt the software to other computers with an RS232C port: 8080 Basic, 8-bit word, odd parity and 2 stop bits.

FOR A LIMITED TIME A SAMPLE OF SOFTWARE WRITTEN IN BASIC FOR THE TRS-80 MODEL II LEVEL II COMPUTER WILL ALSO BE PROVIDED.

**JE664-ARS EPROM Prog. w/ JE665 Option . . . . . \$1195.00**

**EPROM JUMPER MODULES** — The JE664's JUMPER MODULE (Personality Module) is a plug-in Module that pre-sets the JE664 for the proper programming pulses to the EPROM and configures the EPROM socket connectors for that particular EPROM.

JE664 EPROM Jumper Mod. No.	EPROM	Programming Voltage	EPROM MANUFACTURER	PRICE
JM16A	2708	25V	AMC, Motorola, NEC, Perkin TI	\$14.95
JM16A	2716/2732 (M17)	25V	Intel, Motorola, NEC, TI, AMC, Philips, Mosaic	\$14.95
JM16B	2862/2716 (3-VOL)	5V - 5V + 12V	Motorola, TI	\$14.95
JM32A	2862/2716	25V	Motorola, TI, Hitachi, DGC	\$14.95
JM32B	2732	25V	AMC, Fujitsu, NEC, Hitachi, Intel, Matsushita, National	\$14.95
JM32C	2732A	25V	Fujitsu, Intel	\$14.95
JM44A	MC16475A, MC16481A	21V	Motorola	\$14.95
JM44B	2764	21V	Intel, Fairchild, ONI	\$14.95
JM44C	2862/2764	25V	TI	\$14.95

# ProModem 1200

## PROMETHEUS



## Intelligent 300/1200 Baud Telephone Modem with Real Time Clock/Calendar

The ProModem™ is a Bell 212A (300/1200 baud) Intelligent Stand-alone modem. Full featured expandable modem. Stand-alone features include Auto Answer and Auto Dial, Help Commands, Programmable Intelligent Dialing, Touch Tone™ and Pulse Dialing & More. Hayes command set compatible plus an additional extended command set. Shown w/ alphanumeric display option.

**PM1200 . . . . . \$375.00**

## KEYBOARDS



13 1/4" L x 4 1/4" W x 3/4" H

## Mitsumi 54-Key Unencoded All-Purpose Keyboard

- SPST keyswitches
- 20 pin ribbon cable connection
- Low profile keys
- Features cursor controls, control, caps (lock), function, enter and shift keys
- Color (keycaps): grey
- Wt.: 1 lb.
- Pinout Included

**KB54 . . . . . \$14.95**



New!

16-9/16" L x 6 1/4" W x 1 1/4" H

## 76-Key Serial ASCII Keyboard

- Simple serial interface
- SPST mechanical switching
- Operates in upper and lower case
- Five user function keys: F1-F5
- Six finger edge card connection
- Color (keycaps): tan
- Weight: 2 lbs.
- Data Incl

**KB76 . . . . . \$29.95**



## Nationally Known Manufacturer!

21 1/4" L x 9 1/8" W x 3 1/4" H

## 106-Key Serial ASCII Keyboard

- 8-bit serial ASCII (12-bit data structure — requires 3 instruction bits and 1 sync bit)
- The terminals were designed to be daisy chained around a central host computer and used as individual work stations
- Hall effect switching
- Numeric and cursor keypad
- 10 user definable keys
- 50' Interface cable with 9-pin sub-miniature connector
- 7 LED function displays
- Security lock
- N-key rollover
- Automatic key repeat function
- Color (case): white with black panel
- Key (caps): grey and blue
- Weight: 6 1/2 lbs.
- Data included

**KB139 . . . . . \$49.95**



New!

14 1/4" L x 5 1/4" W x 1 1/4" H

## 68-Key Keyboard with Numeric Keypad for Apple II and II+

- Plugs directly into Apple II or II+ motherboard with 16-pin ribbon cable connector
- 26 spec. func.
- Color (keys): white/grey
- Wt. 2 lbs.
- Enclosures available

**KB-A68 . . . . . \$89.95**

## POWER SUPPLIES



## TRANSAC TECHNOLOGY, INC. 5VDC @ 1 AMP Regulated Power Supply

- Output: +5VDC @ 1.0 amp (also +30VDC regulated)
- Input: 115VAC, 60 Hz
- Two-tone (black/beige) self-enclosed case
- 8 foot, 3-conductor black power cord
- Size: 6 1/4" L x 7" W x 2 1/4" H
- Weight: 3 lbs.

**PS51194 . . . . . \$14.95**



## PowerMate Corp. REGULATED POWER SUPPLY

- Input: 105-126/210-250 VAC at 47-63 Hz
- Line regulation: ±0.05%
- Three mounting surfaces
- Overvoltage protection
- UL recognized
- CSA certified

**Part No. Output Size Weight Price**

**EMAS/6B 5V @ 3A/6V @ 2.5A 4 1/4" L x 4" W x 2 1/4" H 2 lbs \$29.95**

**EMAS/6C 5V @ 6A/6V @ 5A 5 1/4" L x 4 1/4" W x 2 1/4" H 4 lbs \$39.95**



## POWER SUPPLY +5VDC @ 7.6 AMP, 12VDC @ 1.5 AMP SWITCHING

- Input: 115VAC, 50-60Hz @ 3 amp/230VAC, 60Hz @ 1.8 amp
- Fan volt./power supply select switches (115/230VAC)
- Output: 5VDC @ 7.6 amp, 12VDC @ 1.5 amp
- 8 foot black power cord
- Size: 1 1/4" L x 13 1/4" W x 3 1/4" H
- Weight: 8 lbs.

**PS94VOS . . . . . \$34.95 or 2 for \$59.95**



## KEPCO/DTK 4-OUTPUT SWITCHING POWER SUPPLY

Ideal for disk drive needs of CRT terminals, microcomputers and video games

- Input: 115/230VAC 50/60Hz
- Output: -5V @ 5 amp, +12V @ 1.8 amp, +12V @ 2 amp, -12V @ 0.5 amp
- UL recognized
- CSA certified
- Size: 7 1/4" L x 6-3/16" W x 1 1/4" H
- Weight: 2 lbs.

**MRM 174KF . . . . . \$59.95**



## POWER PAC INC. REGULATED POWER SUPPLY

- Perfect for computer systems
- Output: +5VDC @ 11 Amps, -5VDC @ 3 Amps, +12VDC @ 2 Amps, -12VDC @ 0.5 Amp and +24VDC @ 1 Amp
- Over-voltage protection
- Size: 12 1/4" L x 6 1/4" W x 4 1/4" H
- Weight: 17 lbs.
- Spec incl.

**PS2922 . . . . . \$69.95**



## 4-CHANNEL SWITCHING POWER SUPPLY

- Microprocessor, mini-computer, terminal, medical equipment and process control applications
- Input: 90-130VAC, 47-440Hz
- Output: +5VDC @ 5A, -5VDC @ 1A, +12VDC @ 1A, -12VDC @ 1A
- Line regulations: ±0.2%
- Ripple: 30mV p-p
- Load regulation: ±1%
- Overcurrent protection
- Adj. 5V main output ±10%
- Size: 8 1/4" L x 1 1/4" W x 4-1/16" H
- Weight: 1 1/2 lbs.

**FCS-604A . . . . . \$69.95 each**



## Switching Power Supply for APPLE II, II+ & IIe™

- Can drive four floppy disk drives and up to eight expansion cards
- Short circuit and overload protection
- Fits inside Apple computer
- Fully regulated +5V @ 5A, +12V @ 1.5A, -5V @ 5A, -12V @ 5A
- Direct plug-in power cord included
- Size: 9 1/4" L x 3 1/4" W x 2 1/4" H
- Weight: 2 lbs.

**KHP4007 . . . . . \$79.95**

\$10.00 Minimum Order — U.S. Funds Only  
California Residents Add 6 1/2% Sales Tax  
Shipping — Add 5% plus \$1.50 Insurance  
Send S.A.S.E. for Monthly Sales Flyer!

Spec Sheets — 30¢ each  
Send \$1.00 Postage for your  
FREE 1984 JAMECO CATALOG  
Prices Subject to Change



1355 SHOREWAY ROAD, BELMONT, CA 94002

10/84 PHONE ORDERS WELCOME — (415) 592-8097 Telex: 176043

# Fiberoptics

## NEW! The EDU-LINK Learning Kit



The EDU-LINK fiber optic system is a low-cost, TTL compatible data transmission system designed specifically as an educational tool for students and engineers working in many different industries. Includes: transmitter PCB, a receiver PCB, one meter of plastic optic fiber, and all the necessary electrical hardware. Complete step-by-step instructions, theory of operation, and tutorial information are included.

## ELK-1 . . . . . ONLY \$19.95

## APPLE ACCESSORIES



## 5 1/4" APPLE™ Direct Plug-In Compatible Disk Drive and Controller Card

The ADD-514 Disk Drive uses Shugart SA390 mechanics—143K formatted storage • 35 tracks • Compatible with Apple Controller & ACC-1 Controller. The drive comes complete with connector and cable — just plug into your disk controller card. Size: 6" L x 3 1/4" W x 8-9/16" D. Weight: 4 1/2 lbs.

**ADD-514 (Disk Drive) . . . . . \$179.95**

**ACC-1 (Controller Card) . . . . . \$ 59.95**

Also Available...

**JE864 (80 Col. — 64K RAM for IIe) . . . . . \$124.95**

**JE614 (Numeric/Aux. Keypad for IIe) . . . . . \$89.95**

**F051APC (Apple Compat. 1/2-Ht. Drive) . . . . . \$189.95**



## Model 100 . . . . . \$69.95

## Protect Yourself... DATASHIELD Back-Up Power Source

Eliminates voltage spikes and LMI-HI noise before it can damage your equipment or cause data loss • 6 month warranty • Power Disruption (100 microsecond), 1,000,000 watts • 6 sockets • 6 foot power cord • Normal line voltage indicator light • Brown out/black out reset switch • Weight: 2 lbs.

**Model 200 (PC200) . . . . . \$349.95**

For more demanding systems (e.g. with hard disks)

• Output rating: 300 watts

**XT300 . . . . . \$489.95**

## IBM MEMORY EXPANSION KIT COMPAQ COMPATIBILITY

## SAVE HUNDREDS OF \$\$\$ BY UPGRADING MEMORY BOARDS YOURSELF!

Most of the popular memory boards allow you to add an additional 64K, 128K, 192K, or 256K. The IBM64K kit will populate these boards in 64K byte increments. The kit is simple to install — just insert the nine 64K RAM chips in the provided sockets and set the two groups of switches. Directions are included.

**IBM64K (Nine 200ns 64K RAMs) . . . . . \$49.95**

## TRS-80 MEMORY EXPANSION KIT

## TRS-80 to 16K, 32K, or 48K

\*\*Model 1 = From 4K to 16K Requires (1) One Kit  
Model 3 = From 4K to 48K Requires (3) Three Kits  
Color = From 4K to 16K Requires (1) One Kit

\*\*Model 1 equipped with Expansion Board up to 48K Two Kits Required — One Kit Required for each 16K of Expansion —

**TRS-16K3 \*200ns for Color & Model III . . . . . \$12.95**

**TRS-16K4 \*250ns for Model I . . . . . \$10.95**

## TRS-80 Color 32K or 64K Conversion Kit

Easy to install kits come complete with 8 ea. 4164-2 (200ns) 64K dynamic RAMs and conversion documentation. Converts TRS-80 color computers with D, E, ET, F and NC circuit boards to 32K. Also converts TRS-80 color computer II to 64K. Flex DOS or OS-9 required to utilize full 64K RAM on all computers.

**TRS-84K2 . . . . . \$44.95**

## UV-EPROM Eraser



8 Chips — 51 Minutes

1 Chip — 37 Minutes

Erase 2708, 2716, 2732, 2754, 2816, 2832, 2854. Erase up to 8 chips within 51 minutes (1 chip in 37 minutes). Maintains constant exposure distance of one inch. Special conductive foam liner eliminates static build-up. Built-in safety lock to prevent UV exposure. Compact — only 9.00" x 3.70" x 2.60". Complete with holding tray for 8 chips.

**DE-4 UV-EPROM Eraser . . . \$79.95**

**UVS-11EL Replacement Bulb . . \$16.95**



# Powerful CP/M® Software.

For Apple, Osborne, Kaypro, Rainbow, NEC, Epson, Heath, Xerox and others.

Now only **\$39<sup>95</sup>** each!

## NEVADA COBOL™

- When we introduced Nevada COBOL in 1979, it was loaded with innovations. Today's, Edition 2.1 is even better!
- Extremely Compact. You can compile and execute up to 2500 statements in 32K RAM, 4000 statements in 48K, etc.
  - It's based upon the ANSI-74 standards with level 2 features such as compound conditionals and full CALL CANCEL.
  - You get a diskette, 165-page manual with lots of examples and 16 complete COBOL source code programs.

Also available: COBOL Application Packages, Book 1 \$9.95

## NEVADA PASCAL™

- This newest addition to the 8-bit Nevada product line has many advanced features:
- 14-digit precision, BCD Math, no round-off errors with decimal arithmetic for business and floating point +63 -64 for scientific.
  - A very nice TRACE style debugging.
  - Arrays up to 8 dimensions and 64K strings.
  - External procedures and functions with dynamic auto-loading.
  - One-step compile, no assembly or link required.
  - No limits on size of procedure, nesting levels, recursion.
  - Requires 60K RAM and one disk drive with at least 90K storage.
  - You get a 184-page manual and diskette rev. 4.1.

## NEVADA FORTRAN™

- FORTRAN IV based upon ANSI-66 standards with some 1977 level features.
- IF . . THEN . . ELSE constructs.
- A very nice TRACE style debugging.
- 150 English language error messages.
- You get a diskette, including an 8080 assembler and Nevada FORTRAN rev 3.2, 214-page manual and five sample programs. Requires 48K RAM.

## NEVADA BASIC™

- This interpreter has a built-in full-screen editor.
- Single- and Multi-line functions.
- BCD Math—no round-off errors.
- Full Matrix operations.
- Requires 48K RAM.
- You get 220-page manual and diskette rev. 2.5.

## NEVADA EDIT™

- A full-screen video display text editor rev. 3.1 designed specifically to create COBOL, PASCAL and FORTRAN programs.
- See the review in May 1983 Microcomputing.

## NEVADA PILOT™

- See review in January 1983 MICROCOMPUTING.
- You get a diskette rev. 6.1, 131-page manual and ten useful sample programs.



This is a limited time offer, so order yours today!

### ELLIS COMPUTING, INC.

3917 Noriega Street  
San Francisco, CA 94122 Phone (415) 753-0186

The CP/M Operating System, an 8080, 8085 or Z-80 microprocessor, and 32K RAM are required, unless stated otherwise above.

#### Diskette format:

8" SSSD (Standard CP/M IBM 3740)

5 1/4" Diskette for:

- Apple CP/M
- DEC VT 180
- DEC Rainbow
- Epson QX-10
- Heath Hard Sector (Z-89)
- Heath Soft Sector (Z-90, Z-100)
- IBM-PC (Requires Z-80, CP/M-80 card)
- Kaypro Double Density (NCR)
- Micropolis Mod II
- NEC PC 8001

- North Star Double Density
- North Star Single Density
- Osborne Single Density
- Sanyo 1000, 1050
- Superbrain DD DOS 3.X (512 byte sec)
- Televideo
- TRS-80 Model I Base 0 mapper
- Xerox 820 Single Density

Satisfaction is guaranteed—or your money back. If for any reason you're not completely satisfied, just return the package—in good condition with the sealed diskette unopened—within 30 days and we'll refund your money.

Please send me: Software Packages

COBOL  FORTRAN  EDIT  PASCAL  BASIC  PILOT

Send my order for \_\_\_\_\_ packages @ \$39.95 each Total \_\_\_\_\_

COBOL Applications Package @ \$9.95 each Total \_\_\_\_\_

California deliveries add 6% or 6.5% sales tax \_\_\_\_\_

Outside North America, add \$6.00 per package for \_\_\_\_\_

shipping. (Postage paid within North America.)

Checks must be in U.S. Dollars and drawn on a U.S. Bank.

Check enclosed  COD if COD add \$4.00

MasterCard

VISA

**TOTAL** \_\_\_\_\_

Card # \_\_\_\_\_ Exp. \_\_\_\_\_

Signature \_\_\_\_\_

Ship to: Name \_\_\_\_\_

Street \_\_\_\_\_

City/St/Zip \_\_\_\_\_

CP/M is a registered trademark of Digital Research, Inc. Microsoft is a registered trademark of Microsoft Corp. TRS-80 is a registered trademark of Tandy Corp. Apple II is a trademark of Apple Computer, Inc. Osborne is a registered trademark of Osborne Computer Corp. Xerox 820 is a trademark of Xerox Corp. Kaypro is a trademark of Non-linear Sys. Heath/Zenith is a trademark of Heath Corp. IBM is a registered trademark of International Business Machines Corp. Nevada BASIC, Nevada COBOL, Nevada FORTRAN, Nevada PILOT, Nevada EDIT, Nevada PASCAL, and Ellis Computing are trademarks of Ellis Computing, Inc. © 1984 Ellis Computing, Inc.

crementing it by 1 each time until  $l$  is greater than 50.

The first step of the repeated algorithm is to choose a random number larger than 1 and less than  $n$ . That is done in the loop calling LRAND. Then, following Knuth's algorithm,  $j$  is set to 0 and  $y$  to  $x^q \text{ mod } n$ . This is done by a call to POWERMOD, which raises the first parameter to the second parameter power mod the third parameter. That is, if your parameters are  $A$ ,  $B$ , and  $C$ , POWERMOD raises  $A^B$  and the result is then mod  $C$ , or  $A^B \text{ mod } C$ .

This is the third step:

If  $j = 0$  and  $y = 1$ , or if  $y = n - 1$ , terminate [this iteration of the 50 iterations of] the algorithm and say " $n$  is probably prime." If  $j > 0$  and  $y = 1$  [terminate the algorithm and say that " $n$  is definitely not prime"].

This is incorporated into a PRIME inner loop by assigning TRUE or FALSE to local variable  $T$  and exiting that loop. Knuth's next step is to add 1 to  $j$ , and if  $j < k$ , then set  $y$  to  $y^2 \text{ mod } n$  and repeat from step 3 above. Otherwise declare " $n$  is definitely not prime." The assignment  $J:J+1$  is made and if  $J = K$ ,  $T$  is given the value FALSE and the loop is exited; if  $K$  is not yet reached,  $Y$  is re-evaluated at  $Y * Y \text{ mod } N$ , and the loop restarted.

When the loop is eventually exited, if  $T$  is FALSE, the number is declared nonprime by exiting the outer loop with a value of FALSE. This is still the last evaluation before exit and is thus the value returned by the function. If, however, the number has been declared "probably prime," the loop counter  $l$  is incremented by 1. Then if  $l$  is still 50 or less, the algorithm starts another iteration with another random assignment of  $x$ . If, however,  $l$  exceeds 50, the loop is exited with a TRUE value, which, again, is passed as the value of the function. The odds are astronomically great that  $n$  is prime.

As mentioned above, PRIME uses ODDFACT to determine the largest odd factor of  $n$ ,  $q$ , and the power of

(continued)

# To master the computer, master the software

Challenge your ability. Take charge of your computer. Take pride in the results.

You've invested in the computer. Now invest in yourself. Writing your own software lets you define your own boundaries, broaden your problem-solving resources and puts you in complete command at the keyboard. It's challenging. It's exciting. And now it's easier than ever before with Self-Study Computer Courses from Heathkit/Zenith.

Master today's most powerful contemporary languages including Microsoft BASIC, PASCAL and FORTRAN. And learn the popular CP/M and MS-DOS operating systems, too. When you need to learn, take us as far as you want to go.

For more information, send for our FREE colorful catalog below or circle the reader service number.



Our colorful catalog is FREE! If coupon is missing write: Heath Company, Dept. 334-222, Benton Harbor, MI 49022.



Send for yours today!  
**FREE CATALOG**

Mail to: Heath Company  
Dept. 334-222  
Benton Harbor, MI 49022

Name \_\_\_\_\_

Address \_\_\_\_\_

City \_\_\_\_\_

State \_\_\_\_\_ Zip \_\_\_\_\_

CF-225

**Heathkit**  
Heathkit/Zenith



*With POWERMOD you can avoid any more than twice as many digits in intermediate results as in the base and power.*

2 that it is multiplied by,  $k$ , to make  $n$ . That is,  $n = 1 + 2^k q$  where  $q$  is odd. ODDFACT successively divides  $n$  and its quotients by 2 until the quotient is odd.  $K$  counts the number of divisions, and  $q$  is the final quotient. The built-in function ADJOIN creates the two-branch binary tree that is returned as the value of ODDFACT.

Finally, we get to POWERMOD, the function that allows the whole structure to work without overflowing the

611-digit capacity of muMath/muSimp. If you had to raise a 100-digit number to a 100-digit power, the result would be a 10,000-digit number. This intermediate result before doing a mod  $n$  would cause our algorithm to fail. Smith got around this problem by using a "Russian Peasant" method that uses 7-digit bases and powers without exceeding a 14-digit result in any intermediate step. Likewise, with POWERMOD you can avoid any more than twice as many digits in intermediate results as in the base and the power, assuming the power and the base have the same number of digits.

Listing 5 shows my first attempt at POWERMOD. I later abandoned it. Remember, the idea is to get the first parameter raised to the second parameter power mod the third parameter. This function definition has the elegance that LISP programmers like,

using the recursive ability of muSimp (or its model, LISP). If the power  $y$  is 0, the result is 1. Otherwise, if the power is odd,  $x^y \bmod n = x(x^{y-1} \bmod n) \bmod n$ , using a recursive call to POWERMOD. Even values of  $y$  allow a greater reduction:  $x^y \bmod n = (x * x \bmod n)^{y/2} \bmod n$ , again done recursively, with POWERMOD calling itself. If  $l$  is the length of  $y$  in decimal notation, POWERMOD would nest about  $5l$  levels deep, or 500 levels for a 100-digit power. No intermediate result would be longer than twice the length of  $x$  or  $n$ . (The  $5l$  accounts for a binary representation 3.3 times as long as the decimal, and half the bits being 1-bits, those corresponding to odd quotients, requiring an extra level for reduction to an even value. Each division by 2 corresponds to the removal of 1 from the length of the binary representation.)

Unfortunately, it seems even a nesting level of 50 or so is too much for muSimp, even with 11K bytes of free space left, so I had to go to a second version (see listing 6), using Smith's "Russian Peasant" algorithm translated into muSimp.

In the working nonrecursive version of POWERMOD, local variable  $M$  starts out set to 1. In a loop,  $Y$ , the power, is continually divided by 2, while  $X$ , the base, is squared, until a quotient  $y$  is odd. Then the loop is exited. At that time,  $M$  is multiplied by the current value of  $x$ , then mod  $n$ , and again  $x$  is squared and  $y$  is divided by 2, both mod  $n$ , just as in the even case. This whole thing continues until  $y$  is eventually 0. Note that the use of an inner loop with a repetition of some of its contents outside that loop is again the result of all WHEN statements in muSimp having to EXIT a loop or function. For that reason we could not have made the multiplication of  $M$  by  $X$  contingent upon an odd quotient. The final line before the ENDFUN returns  $M$  as the power mod  $n$ .

Listing 7 shows a small-scale version. I defined SETUP to provide keys to about 19 digits (3+5+5+6), and the keys produced,  $n = 442440459100390237$  and  $d = 294960281403280211$

Listing 6: The nonrecursive function for raising to a power mod  $n$ , used in the RSA system.

```
? DISPLAY(POWERMOD);
@:

FUNCTION POWERMOD (X, Y, N, M),
M: 1
LOOP
  WHEN Y = 0 EXIT,
  LOOP
    WHEN MOD (Y, 2) = 1 EXIT,
    X: MOD (X * X, N),
    Y: QUOTIENT (Y, 2),
  ENDOLOOP,
  M: MOD (M * X, N),
  X: MOD (X * X, N),
  Y: QUOTIENT (Y, 2),
  ENDOLOOP,
M,
ENDFUN
```

Listing 7: A testing of the muSimp RSA system using short keys (18 digits). This part sets up the keys.

```
2)RUN

? DISPLAY(SETUP);
@:

FUNCTION SETUP (),
RANDOMIZE (),
P: CHOOSEP (3, 5),
Q: CHOOSEP (5, 6),
N: P * Q,
D: QUOTIENT (2*(P-1)*(Q-1) + 1, 3),
ENDFUN

? SETUP ();
@:ENTERSEED835141012
294960281403280211

? P;Q;N;D;
@: 11963183

? @: 36983506739

? @: 442440459100390237

? @: 294960281403280211

? SAVE(ENV1,2);
@: TRUE
```

280211, have 18 digits each. The prompt ENTERSEED has been answered in this instance with 835141012 to provide a seed for the random-number generator. (Remember, I recommend putting another random-number generator into place (LRAND and RND) and changing the constants of the linear congruence to protect your code further.)

You can store this whole environment on disk, including the values of the variables  $P$ ,  $Q$ ,  $N$ ,  $D$ , and all the defined functions, by using muSimp's SAVE command. You can restore this environment (called ENV1) using the LOAD command (see listing 8). Then, an encryption and a decryption are performed. The number to be encrypted, 704177610121492, is raised to the third power mod  $N$ , using POWERMOD.

Remember, the question marks (?) that appear are the prompts, similar to a READY or Apple's (). The items appearing after them are immediate-mode commands. Usually they are function references, but mention of a variable name terminated with a semi-colon and return lists its value. You can make assignments in immediate mode as well. In the example X:@, the "at" sign has a special meaning; it is the last evaluation returned. So here you are assigning the encoded value to X. Then, to decode, we raise X to the  $D$  mod  $N$ , again using POWERMOD, and the original value is returned.

This simple example takes about 15 minutes to find  $p$ ,  $q$ ,  $n$ , and  $d$ . Encoding takes only a couple of seconds and decoding 15 seconds. Using 37-digit keys requires 45 minutes to produce a set of  $p$ ,  $q$ ,  $n$ , and  $d$ , but only a couple of seconds to encode (cube) and about one minute to decode (find the cube root) a message.

Listing 9 shows that SETUP from listing 1 produces 101-digit keys. The keys themselves take about eight hours to produce. Encoding takes under 30 seconds, and decoding about 15 minutes. Note that you have to set up your key only once, so eight hours is not too long to wait.

(continued)

Listing 8: *The keys of Listing 7 reloaded into the system and used in coding and decoding a number, the former by cubing mod N, the latter by taking the cube root through the use of raising to the D power, as D was chosen so as to have this effect in the modular arithmetic used.*

```
? LOAD(ENV1,2);
@:

? N;
@: 442440459100390237

? D;
@: 294960281403280211

? POWERMOD(704177610121492,3,N);
@: 371529140824544191

? X:@
@: 371529140824544191

? POWERMOD(X,D,N);
@: 704177610121492

? SYSTEM();
@:

2)PR# 0
```

Listing 9: *The full 101-digit keys used for actually encoding and decoding a number, representing a message.*

```
? LOAD(ENV3);
@:

? P;Q;N;D;
@:
5669682733234183949743401862732403737825
1

? @:
1112245192858508592950635202981592638763
495067113359264305331

? @:
6306077365072611053931059220460476141900
0135895287313649294616210624533300703021
096023498624002756081

? @:
4204051576715074035954039480306984094599
9349100062970093801072585729479577483173
444625171960467381667

? MS:3141592654271828182180123456789987654321017761492106615821983181258
599988877
7666555;
@:
31415926542718281821801234567899876543210
1776149210661582198318125859998887776665
55
```

(continued)



? POWERMOD(MS,3,N);  
 @:  
 2391917580137497327887542324950723701987  
 5242707876113408781547556820671025272647  
 494310831318125653516

? CD:@;  
 @:  
 2391917580137497327887542324950723701987  
 5242707876113408781547556820671025272647  
 494310831318125653516

? POWERMOD(CD,D,N);  
 @:  
 3141592654271828182801234567899876543210  
 177614921066158219831812585999888776665  
 55

? SYSTEM();  
 @:  
 2)PR# 0

As Smith has mentioned, you can create an electronic "signature" by decoding something first, using your private key,  $d$ , in POWERMOD (message,  $D,N$ ). The recipient, by converting it (cubing) to the original message via POWERMOD (code,  $3,N$ ), using the known public key, can tell the message must have come from only one person, the one possessing the unknown  $d$ . ■

REFERENCES

Block, David. "The Trapdoor Algorithm", *Creative Computing*, May 1983, page 189.  
 Hare, Tom, John Russ, and Gary Faulkner. "A New Pseudo-Random Number Generator", *Call-A.P.P.L.E.*, January 1983, page 33.  
 Knuth, Donald. *The Art of Computer Programming: Semi-Numerical Algorithms*, Volume 2, 2nd ed. Reading, MA: Addison-Wesley, 1981.  
 Smith, John. "Public Key Cryptography", *BYTE*, January 1983, page 198.

# BYTE Back issues for sale

	1976	1977	1978	1979	1980	1981	1982	1983	1984
Jan.				\$2.75	\$3.25	\$3.25		\$3.70	\$4.25
Feb.			\$2.75	\$2.75	\$3.25	\$3.25		\$3.70	\$4.25
March			\$2.75		\$3.25		\$3.70	\$3.70	\$4.25
April			\$2.75	\$2.75	\$3.25	\$3.25	\$3.70	\$3.70	\$4.25
May		\$2.00	\$2.75	\$2.75	\$3.25		\$3.70	\$3.70	\$4.25
June		\$2.00	\$2.75	\$2.75	\$3.25		\$3.70	\$3.70	\$4.25
July	\$2.00	\$2.00	\$2.75	\$2.75	\$3.25		\$3.70	\$4.25	\$4.25
Aug.		\$2.00	\$2.75	\$2.75		\$3.25	\$3.70	\$4.25	\$4.25
Sept.		\$2.75	\$2.75	\$2.75	\$3.25		\$3.70	\$4.25	\$4.25
Oct.			\$2.75	\$2.75	\$3.25	\$3.25	\$3.70	\$4.25	
Nov.				\$3.25		\$3.25	\$3.70	\$4.25	
Dec.		\$2.75	\$2.75	\$3.25	\$3.25	\$3.25	\$3.70	\$4.25	

Special BYTE Guide to IBM PC's — \$4.75

Circle and send requests with payments to:  
**BYTE Back Issues**  
**P.O. Box 328**  
**Hancock, NH 03449**

Prices include postage in the US. Please add \$ .50 per copy for Canada and Mexico; and \$2.00 per copy to foreign countries (surface delivery).

Check enclosed

Payments from foreign countries must be made in US funds payable at a US bank

VISA

Master Card

Card # \_\_\_\_\_

Exp. \_\_\_\_\_

Signature \_\_\_\_\_

Please allow 4 weeks for domestic delivery and 12 weeks for foreign delivery.

**NAME** \_\_\_\_\_

**ADDRESS** \_\_\_\_\_

**CITY** \_\_\_\_\_

**STATE** \_\_\_\_\_ **ZIP** \_\_\_\_\_

Specializing in  
Corporate Accounts

MC-P

APPLICATIONS, INC.  
The Best Computer Solution

The Best Prices - Best Service - Best Technical Support

ORDER DESK ONLY—  
**(800) 292-3360**  
TOLL FREE IN CALIFORNIA

ORDER DESK ONLY—  
**(800) 292-3360**  
TOLL FREE OUTSIDE CALIF.

**SOFTWARE**

**SPREAD SHEETS**

Lotus 1-2-3 .....	\$299
Symphony .....	425
Framework .....	372
Multiplan .....	135
Open Access .....	369
TK Solver .....	265
Supercalc III .....	195
Visicalc IV .....	157
Design Manager .....	475

**DATA BASE**

dBase II .....	279
dBase III .....	372
R:Base 4000 .....	289
Knowledgeman w/K pen & K graph .....	295
Powerbase .....	275
Friday .....	195
DB Plus .....	95
Quick Code & DUtil Pak .....	185

**UTILITY**

Peter Norton Utility .....	55
Prokey .....	87
Sideways .....	45

**COMMUNICATION**

Microstuf Crosstalk .....	115
Smartcom II .....	109
Transporter .....	205

**PROFESSIONAL**

Desk Organizer .....	195
Harvard Project Manager .....	275
Composoft Legal/Software— Call for info.	
Real Estate Analyser II .....	175
Visi Schedule .....	125

**COMPILERS**

Cobol Compiler .....	485
Fortran Compiler .....	245
Lattice 'C' Compiler .....	325
Microsoft 'C' Compiler .....	325
Microsoft Pascal Compiler .....	215
Macro Assembler .....	65
Digital C Basic Compiler .....	375
Pascal MT and CPM186 .....	255

**FINANCIAL**

Home Accountant-Apple .....	49
Personal Investor .....	135
Accounting Plus GL, AP, AR, PR, INV Each .....	399
State of the Art GL, AP, AR, PR, INV Each .....	485
Peachtree GL, AR, AP Each .....	475
Think Tank .....	125
Data Cell II (Tax Preparer) ..	1125

**WORD PROCESSING**

Bank Street Writer IBM .....	55
Edix/Wordix Each .....	129
Peach Text 5000 .....	245
Pfs: File .....	84
Pfs: Report .....	79
Multimate .....	275
Volkswriter Deluxe .....	162
Word Perfect .....	275
Wordstar Pro w/Correctstar .....	299

**NATIONAL SALES**

MC-P

APPLICATIONS INC.

1630 Oakland Road,  
Suite A114  
San Jose, CA 95131  
U.S.A.

Telephone: (408) 293-3360  
Telex: 821 396.MCPA UD

**RETAIL OUTLETS**

**Pick 'N Pay Software**  
San Jose, CA  
Telephone (408) 293-3360

**Pick 'N Pay Software**  
Phoenix, AZ  
Telephone (602) 285-1700

**MC-P International Sales Offices**

AUSTRALIA .....	02-929-8468
NEW ZEALAND .....	09-34545
ENGLAND .....	02357-2189
HOLLAND .....	020-268829

**ORDER STATUS AND  
TECH. SUPPORT — CALL  
(408) 293-3360**

**PLEASE CALL FOR  
HARDWARE & SOFTWARE  
NOT LISTED THIS AD**

**INTERNATIONAL DEALER  
INQUIRIES WELCOMED**

**TERMS:** All prices subject to change without notice. Payment by cashier's check/MO/bank transfer. Please allow approximately one week shipping delay for clearance of personal or company checks. California residents add sales tax. For non cash sales please add 3% handling charge.

**SHIPPING:** Add \$4 per item for UPS Surface, \$8 for UPS Blue Label. For Monitors add \$20 and Printers \$25 for shipment within continental U.S.A.

**HARDWARE**

**COMPUTERS**

IBM PC 64K/1DD/Ctrl Cd .....	\$1545
IBM PC/XT 128K .....	3495
IBM Portable .....	2195
Apple IIc .....	1145
Apple IIe 80 col & Mon. ....	1295
Macintosh w/Imagewriter Printer ....	2595

**DISK DRIVES**

Teac Half Height .....	165
Tandon 100-2 .....	195

**HARD DISKS**

Tall Grass 12 Mgb .....	2245
Pegasus 10 Mgb (Internal) .....	1195
Iomega 10 Mgb .....	call

**PRINTERS**

Epson FX100 .....	695
IBM Parellel Printer Cable .....	29
LQ 1500 .....	1145
NEC 3550 .....	1675
Okidata 92P .....	409
Qume 1140 plus .....	1435

**MONITORS**

Amdek 12" 310A .....	169
Amdek Color II RGB Hi-Res .....	399
Princeton RGB Hi-Res .....	485
IBM Monochrome .....	235
IBM color .....	565

**MODEMS**

Smart Mod. 300 w/Smartcom .....	199
Smart Mod. 1200 .....	495
Smart Mod. 1200B .....	429
J-Cat .....	99
Smart Cat 103 .....	169
Smart Cat 103/212 .....	425

**HARDWARE & PERIPHERALS**

Megaplus 64K .....	265
Six Pac Plus 64K .....	265
Quadboard II .....	285
Orchid Blossom .....	255
64K Ram Chips .....	45
Techmar Graphics .....	525
Hercules Graphics .....	335
Plantronics .....	395
STB .....	335
Everix .....	call
Intel 80/87 Chip .....	175
Orange .....	94
Peach .....	64
Irma Board .....	895
Compuguard .....	call
Kraft Joysticks .....	35
TG Joysticks .....	35
Hayes Mach III Joysticks ....	39
PC Mouse w/Software .....	165

**NETWORK**

Orchid PC Net .....	345
PC Net w/Blossom .....	525

**COMMUNICATIONS**

AST 3780 .....	635
AST 5251 .....	545

Circle 218 on Inquiry card.



**FOR 15 YEARS,  
WE'VE BEEN  
MAKING  
THE WORLD'S  
MOST POPULAR  
MODEMS.**

**NOW YOU CAN  
BUY ONE.**

Introducing the Maxwell Modem™ from Racal-Vadic.

It's not your fault you didn't buy one sooner. You couldn't. Unless you happened to be a major corporation. They're the ones who buy the most modems. And the modems they buy most are ours.

Now we've taken everything we know about modems and made one you can buy.

The Maxwell Modem.

It's designed expressly for personal computers. And the people who use them. It's rugged. Reliable. And it even operates over low-quality phone lines that other modems can't handle.

But best of all, it's uncomplicated. So you don't have to know how one works to work one. There's no control panel to control. No switches to switch.

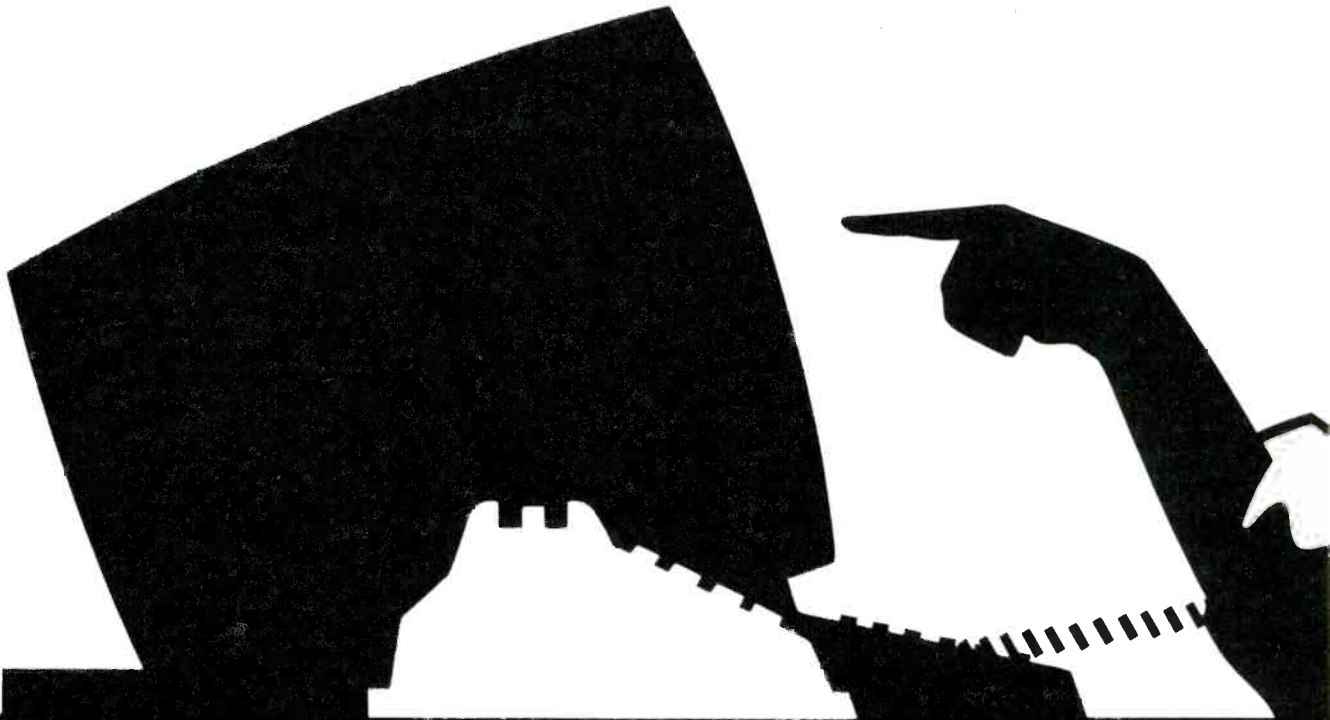

The Maxwell Modem and George are trademarks of Racal-Vadic. IBM is a registered trademark of International Business Machines Corp. ©1984, Racal-Vadic.

Instead, every feature makes sense. Auto-dialing. Auto-answer. And complete unattended operation.

Our communications software is just as accommodating. It's called George.™ And we've made George so simple to use you may never have to open your manual.

The Maxwell Modem comes in two different versions and two different speeds: Internal modems for the IBM PC and compatibles, and desktop models for virtually every personal computer. Both are available with speeds of 300- or 1200-bps.

And every Maxwell Modem has diagnostic features built in. So we can test your modem right over the phone from our Remote Diagnostic Center. We'll even pay for the call.

So where can you get your hands on a Maxwell Modem? To find our dealer nearest you, just do what modems do.

Call 800-4-VADICS.

Racal-Vadic, 1525 McCarthy Blvd., Milpitas, CA 95035.

# THE MAXWELL MODEM.

From Racal-Vadic.

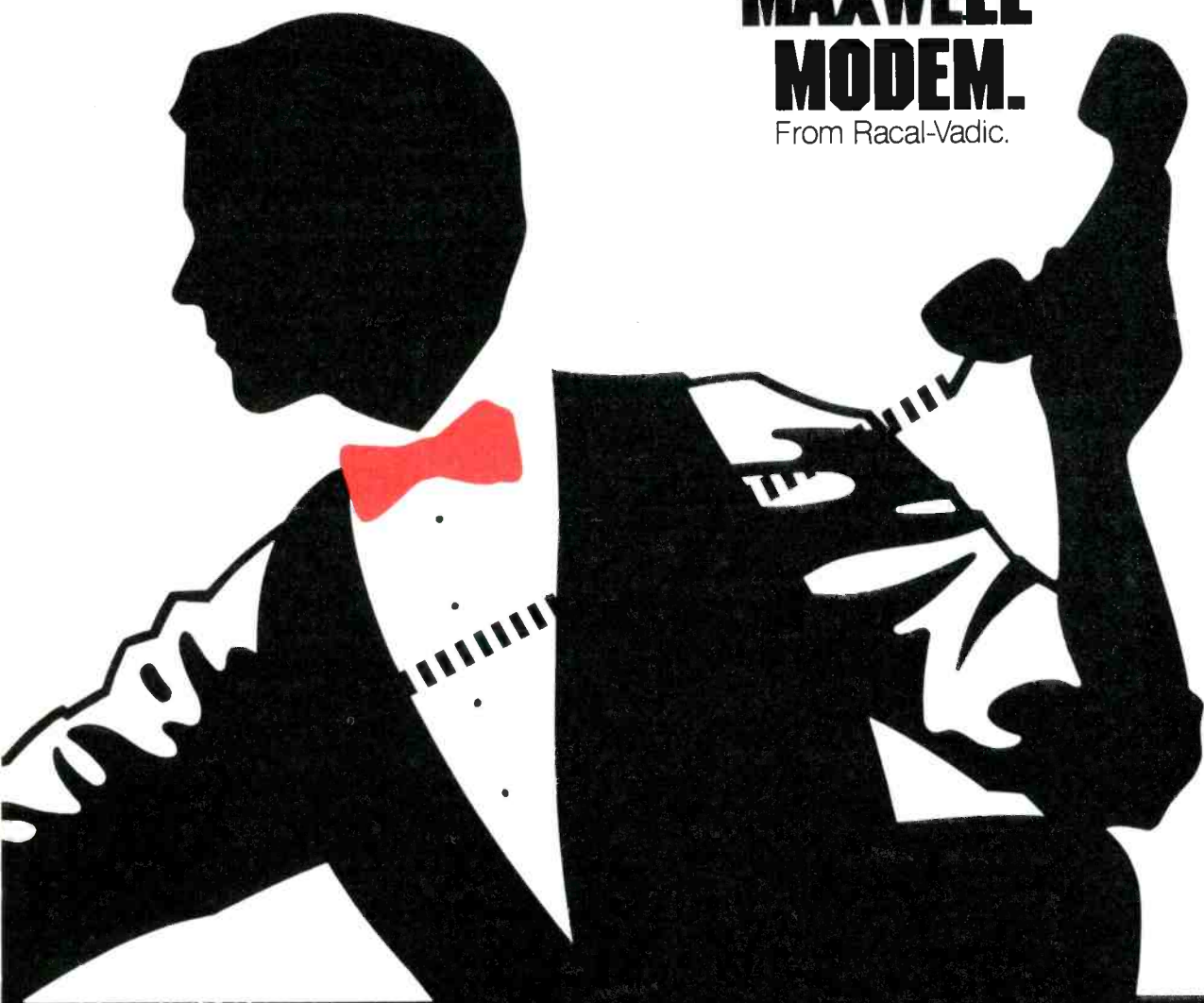



(continued from page 131)

type in terms of an algebra. In the general theory of algebras, an algebra is a pair  $\langle A;F \rangle$ , where  $A$  is a non-empty set and  $F$  is a family of operations on  $A$ . For instance, the familiar algebra of grade school mathematics is defined by the set of real numbers and the operations of addition, subtraction, and so on. Since an abstract data type consists of a set of objects that carry the type and the operations on those objects, it is easy to see how abstract data types lend themselves to definition in terms of an algebra.

The meaning (or the effect) of the operations is defined as a set of formal axioms that state the relationships among the operations. The reduction of the operations' meanings to a set of axioms makes it possible

to reason formally about the correctness of a design before it is implemented. This is one of the productive ways of using this approach in program design.

The algebraic approach to specifying abstract data types is rigorously defined by John Guttag and J. J. Horning (see reference 1) and consists of two parts: a syntactic specification and a semantic specification. The syntactic specification defines how the type interfaces with the outside world: it defines the name of the type, the names of all its operations, and the types of the domains (inputs) and ranges (outputs) of the operations. Figure 3 illustrates the syntactic specification for the abstract type *intset*.

The operations on any data type fall into two classes: generator operations

and inquiry operations. The generators are those operations that produce an object of the type of interest (for example, *intset*). The inquiry operations focus on objects of interest but produce a result that is of a different type (for example, Boolean). The blank line in the example of figure 3 separates the two classes of operators. Within the set of generators there is a subset called basic generators that are sufficient to generate any object of the type of interest. The basic generators, *create* and *insert*, are marked in figure 3 with a preceding asterisk.

The semantic specification of the operations consists of a set of axioms that define the meaning of the operations by stating their relationships to one another. The axioms are presented as equations in which the left-hand side specifies an expression to be defined and the right-hand side gives its meaning. For the basic generators, no definitions are written; they are assumed as given. Thus we first write axioms that define the meaning of the nonbasic generators (for example, *remove*); the right-hand sides of these equations must eventually be reduced to expressions involving only basic generators. Then

(continued)

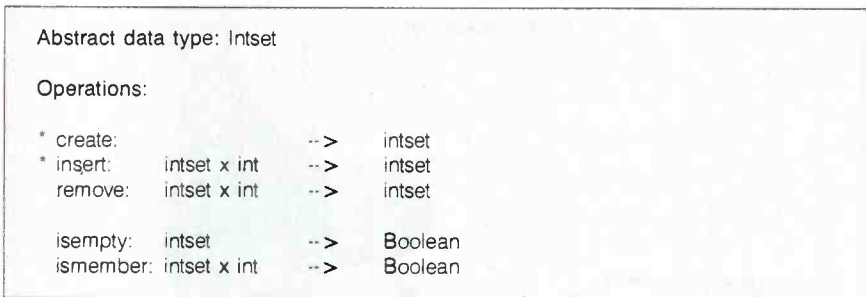
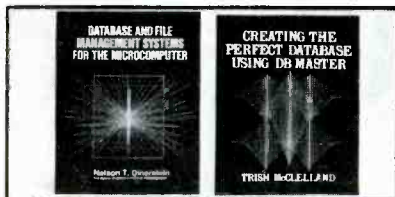

Figure 3: Syntactic specification for abstract type *intset*.

## Get Productive!

### With these new how-to-do-it books



#### Apple to IBM PC Conversion Guide

by Richard Steck. The first book to show Apple users how to convert Apple programs and peripherals to IBM PC use. 18047, \$11.95

#### Database and File Management Systems for the Microcomputer

by Nelson T. Dinerstein. A timely, clear introduction to database management from the best-selling author of *dBASE II for the Programmer*. 18088, \$15.95

#### Creating the Perfect Database Using DB MASTER

by Trish McClelland. Outlines a tested process you can use to create a database using DB MASTER on your Apple or IBM PC. 18039, \$17.95

#### The ABCs of Lotus 1-2-3

by Bill Kling. This step-by-step tutorial for beginners helps you put 1-2-3 to work immediately in your business. 15996, \$18.95

To order, contact your local bookstore or computer store, or contact

**Scott, Foresman and Company**  
**Professional Publishing Group,**  
**Dept. BY-2**  
**1900 East Lake Avenue**  
**Glenview, IL 60025**  
 312/729-3000, x2208

**For Canadian orders,**  
**please contact**  
 Gage Publishing Company  
 164 Commander Blvd.  
 Agincourt, Ontario M1S 3C7

# Make Stat Magic

## Statistics, reports and plots happen magically with SPSS/PC™—the Statistical Package for IBM PC/XTs.\*

SPSS/PC is the most comprehensive statistical package for performing simple or complex tasks, regardless of data size. It maintains feature and language compatibility with mainframe SPSS, while optimizing for the PC environment.

Statistics range from simple descriptive to complex multivariate, including Multiple Regression, ANOVA, Factor and Cluster analysis. Loglinear and nonparametric procedures are also included.

Simple facilities allow transfer of files between

SPSS/PC and programs like Lotus 1-2-3, dBase II and SAS. A complete Report Writer, Plotting facilities and a Communications program for mainframes round out a fully integrated product.

For more information, contact our Marketing Department without further ado. And see what a little stat magic can do for you.

SPSS Inc., 444 N. Michigan Avenue, Chicago, IL 60611, 312/329-2400.

In Europe: SPSS Benelux B.V., P.O. Box 115, 4200 AC Gorinchem, The Netherlands, Phone: +31183036711 TWX: 21019.



**SPSS inc. PRODUCTIVITY RAISED TO THE HIGHEST POWER™**

\*SPSS/PC runs on the IBM PC/XT with 320K memory and a hard disk. An 8087 co-processor is recommended. Contact SPSS Inc. for other compatible computers.

IBM PC/XT is a trademark of International Business Machines Corporation. dBase II is a trademark of Ashton-Tate. 1-2-3 is a trademark of Lotus Development Corporation. SAS is a trademark of SAS Institute, Inc. SPSS and SPSS/PC are trademarks of SPSS Inc. for its proprietary computer software.

© Copyright 1984, SPSS Inc.

Circle 338 on inquiry card.





# PREVENT THE DISASTER OF HEAD CRASH AND DROPOUT.

The war against dust and dirt never ends. So before you boot-up your equipment, and everytime you replace a cassette, disk or drive filter, be sure to use Dust-Off® II; it counteracts dust, grit and lint. Otherwise you're flirting with costly dropouts, head crashes and downtime.

Dust-Off II is most effective when used with Stat-Off II. Stat-Off II neutralizes dust-holding static electricity while Dust-Off II blasts loose dust away. There's also the Dual Extender and Mini-Vac for vacuuming dust out of hard-to-reach places.

Photographic professionals have used Dust-Off brand products consistently on their delicate lenses and expensive cameras for over ten years. They know it's the safe, dry, efficient way to contaminant-free cleaning.



Cleaning not provided by liquid cleaners.

Dust-Off II's remarkable pinpoint accuracy zeros in on the precise area being dusted. And you have total control—everything from a gentle breeze for



**Stat-Off II neutralizes dust-holding static electricity from media and machines.**

delicate computer mechanisms to a heavy blast for grimy dirt.

Don't let contamination disrupt your computer operation.

Stock up on Dust-Off II—the advanced dry cleaning system, at your local computer or office supply dealer.

Or send \$1.00 (for postage and handling) for a 3 oz. trial size and literature today.



## Dust-Off II

The safe dry cleaning system

Falcon Safety Products, Inc., 1065 Bristol Road, Mountainside, NJ 07092

we provide axioms that define the meaning of applying each inquiry operation to each of the basic generators. Note that since the meaning of any nonbasic generator can be expressed in terms of basic generators alone, there is no need to write axioms defining the application of inquiry operations to nonbasic generators. Figure 4 gives a sample semantic specification for the type intset. The equal sign used in the axioms is to be read as "means the same thing as."

Note that there are three sets of axioms, one for each nonbasic generator and inquiry operation that must be defined. Each is defined in terms of two axioms, one for each of the two basic generators of the type of interest.

The definition of isempty is easy to understand. If an intset, *s*, were generated by create, then the set has no members yet, and the expression empty(*s*) means the same thing as T, or true. If the intset was generated by insert, then the set must have members, and empty means the same thing as F, or false.

Remove and ismember use a basic generator of type Boolean named equal. It tests two integers for equality. In conjunction with this Boolean generator, they use the if-then-else operation that is defined by the following two axioms:

if T then  $a$  else  $b = a$   
if F then  $a$  else  $b = b$

That is, "if T then  $a$  else  $b$ " means the same thing as (or, can be reduced to)  $a$ , and "if F then  $a$  else  $b$ " means simply  $b$ . In other words, if the Boolean condition reduces to true then the whole expression reduces to the *then* clause, otherwise to the *else* clause.

Both remove and ismember are defined recursively, that is, in terms of themselves. For instance, the second axiom for ismember says that if the integer *i* is not equal to the first item in the intset generated by "insert (*i*,*s*)", then the expression "ismember(*i*, insert(*i*,*s*))" means the same thing as "ismember(*i*,*s*)". We then apply the

(continued)

# Learn robotics and industrial control as you build this robot

New NRI home training prepares you for a rewarding career in America's newest high-technology field.

The wave of the future is here. Already, advanced robotic systems are producing everything from precision electronic circuits to automobiles and giant locomotives. By 1990, over 100,000 "smart" robots will be in use.

## Over 25,000 New Jobs

Keeping this robot army running calls for well-trained technicians . . . people who understand advanced systems and controls. By the end of the decade, conservative estimates call for more than 25,000 new technical jobs. These are the kind of careers that pay \$25,000 to \$35,000 a year right now. And as demand continues to grow, salaries have no place to go but up!

## Build Your Own Robot As You Train at Home

Now, you can train for an exciting, rewarding career in robotics and industrial control right at home in your spare time. NRI, with 70 years of experience in technology training, offers a new world of opportunity in one of the most fascinating growth fields since the computer.

You need no experience, no special education. NRI starts you at the beginning, takes you in easy-to-follow, bite-size lessons from basic electronics right on through key subjects like instrumentation, digital and computer controls, servomotors and feedback systems, fluidics, lasers, and optoelectronics. And it's all reinforced with practical, hands-on experience to give you a priceless confidence as you build a programmable, mobile robot.

## Program Arm and Body Movement, Even Speech

Designed especially for training, your robot duplicates all the key elements of industrial robotics. You learn to operate, program, service, and troubleshoot using the same techniques you'll use in the field. It's on-the-job training at home!

Building this exciting robot will take you beyond the state of the art into the next generation of industrial robotics.

You'll learn how your completely self-powered robot interacts



You get and keep Hero 1 robot with gripper arm and speech synthesizer, NRI Discovery Lab for electronic experimentation, professional multimeter with 3½-digit LCD readout, 51 fast-track training lessons.

with its environment to sense light, sound, and motion.

You program it to travel over a set course, avoid obstacles using its sonar ranging capability. Program in complex arm and body movements using its special teaching pendant. Build a wireless remote control device demonstrating independent robot control in hazardous environments. You'll even learn to synthesize speech using the top-mounted hexadecimal keyboard.

## Training to Build a Career On

NRI training uniquely incorporates hands-on building experience to reinforce your learning on a real-world basis. You get professional instruments, including a digital multimeter you'll use in experiments and demonstrations, use later in your work. And you get the exclusive NRI Discovery Lab®, where you examine and prove out theory from basic electrical concepts to the most advanced solid-state digital electronics and microprocessor technology. Devised by an experienced team of engineers and educators, your experiments, demonstrations, and equipment are carefully integrated with 51 clear and concise lessons to give you complete confidence as you progress. Step-by-step, NRI takes you from the beginning, through today, and into an amazing tomorrow.

## Send for Free Catalog Now

Send for NRI's big free catalog describing Robotics and Industrial Control plus over a dozen other high-technology courses. You'll see all the equipment you get in detail, get complete descriptions of every lesson, find out more about career opportunities for trained technicians. There's no cost or obligation, so send today. Your action today could mean your future tomorrow.



## NRI SCHOOLS

McGraw-Hill Continuing  
Education Center  
3939 Wisconsin Ave.  
Washington, DC 20016

**WE'LL GIVE YOU TOMORROW.**



**APPLEWARE, INC.**  
The Apple Users Group  
Software Library

For the first time enjoy your Apple to its fullest capacity with specially packed disks with over 100 outstanding programs each (not available from any other source)

Each packed disk contains a full range of interesting, useful and entertaining programs individually tailored to different users:

**BUSINESS** • EDUCATION • OFFICE USE • GAMES • UTILITIES • SCIENCE • MUSIC • GRAPHICS • FINANCE

Library Disks I, II and III are mixed categories. Single category disks are: GAMES • UTILITIES • GRAPHICS • INTEGER • SCIENCE • TECH • MUSIC & AUDIO

Individual disks available at \$59.95 each



Order disks from this ad and receive two additional disks free. I, II and III and get a special bonus disk FREE. Over 260 programs for \$179.95 + \$4 shipping. BUT for a Best Value, receive only 9 disks featuring over 600 different programs for only \$55 each for a package price of \$399. Certified Postage, plus handling paid!

\*Send one-time membership fee of \$15. (no fee charged to institutions) for 1000 program catalog and gain access to a library of over 10,000 programs at a special 15% discount (Foreign memberships \$28. U.S.)

For orders only call now  
TOLL FREE: 1-800-327-8665  
Florida: 1-305-987-8665

or write:  
Appleware, Inc.  
640C Hayes St. SW  
Hollywood, Fla. 33024

Program disks compatible with Apple II, II+, IIe, III Emul., Franklin Ace and IBM Quad

Circle 23 on inquiry card.

**C SOFTWARE DEVELOPMENT PC DOS/MSDOS**

- FULL C COMPILER PER K&R
  - inline 8087 C Assembler
  - Floating Point
  - Full 1MB Addressing for Code & Data
  - Transcendental Functions
- MSDOS 1.1/2.0 LIBRARY SUPPORT
  - Program Chaining using Exec
  - Environment Available to Main
- C-WINDOW C SOURCE CODE DEBUGGER
  - Variable Display & Alteration
  - Using C Expression
- FAST 8088/8086 ASSEMBLER

**Combined Package \$199**

Call or write:  
c-systems Fullerton, CA 92634  
P.O. Box 3203 714-637-5362  
Tivoli-systems

**BASF** 

**FlexyDisks®**

5 1/4"

Specify soft, 10 or 16 sector

	Price 10-90	Price 100
Single side double density	1.60 ea.	1.45 ea.
Double side double density	1.85 ea.	1.70 ea.

Hard sectors in library box only add .15.  
Certified Check - money Order - Personal Check. Allow up to 2 weeks for personal checks to clear. Add \$3.00 per 100 or part to each order for U.P.S. shipping charges.  
No Residents add 6% sales tax.

**DATA EXCHANGE, INC.**

178 Route 206 South P.O. Box 993  
Somerville, N.J. 08876 • (201) 874-5050

Circle 92 on inquiry card.

## DATA ABSTRACTION

same axioms to this simplified expression to reduce it ultimately to T or F. The recursive application of the axioms is easily illustrated. For instance, imagine an intset of three members: {1,2,3}. In the language of our axioms, this set would be represented by the expression:

```
insert(1,insert(2,insert(3,create)))
```

We now want to test if 4 is a member of the set. This test is equivalent to the expression:

```
ismember(4,insert(1,insert(2,insert(3,create))))
```

To discover what this expression means, we simplify it by applying the

axioms repeatedly until it can be reduced no further. Figure 5a illustrates this process; we see that the expression ultimately reduces to F, or false. Similarly, we can test if 2 is a member of the set. This is done in figure 5b where we see that the result is T, or true.

These illustrations demonstrate the potential of the method for giving us a rigorous way to reason about the meaning and ultimately the correctness of program designs. The sequences of derivations in figure 5 are actually proofs that "ismember(4, {1,2,3})" means false and that "ismember(2, {1,2,3})" means true. In

(continued)

**Axioms:**  
For all i, i' of type Int, and all s of type Intset:

```
remove(i,create) = create
remove(i,insert(i',s)) = if equal(i,i') then s else insert(i',remove(i,s))

isempty(create) = T
isempty(insert(i,s)) = F

ismember(i,create) = F
ismember(i,insert(i',s)) = if equal(i,i') then T else ismember(i,s)
```

Figure 4: Semantic specification for abstract type intset.

(a) Is 4 a member of the set {1,2,3}?

```
ismember(4,insert(1,insert(2,insert(3,create)))) =
if equal(4,1) then T else ismember(4,insert(2,insert(3,create))) =
if F then T else ismember(4,insert(2,insert(3,create))) =
ismember(4,insert(2,insert(3,create))) =
if equal(4,2) then T else ismember(4,insert(3,create)) =
if F then T else ismember(4,insert(3,create)) =
ismember(4,insert(3,create)) =
if equal(4,3) then T else ismember(4,create) =
if F then T else ismember(4,create) =
ismember(4,create) =
F
```

(b) Is 2 a member of the set {1,2,3}?

```
ismember(2,insert(1,insert(2,insert(3,create)))) =
if equal(2,1) then T else ismember(2,insert(2,insert(3,create))) =
if F then T else ismember(2,insert(2,insert(3,create))) =
ismember(2,insert(2,insert(3,create))) =
if equal(2,2) then T else ismember(2,insert(3,create)) =
if T then T else ismember(2,insert(3,create)) =
T
```

Figure 5: Reducing expressions by axiomatic substitution.

# Gifford's Multiuser Concurrent DOS.<sup>TM</sup> The net that works!

Gifford has the network solution. It's simple, fast, secure, complete, and it works. Multiuser Concurrent DOS is based on Digital Research's Concurrent DOS, the only major microcomputer operating system specifically designed for networking.

Users can share disks and printers transparently, and can also take advantage of true multiuser features like file and record lockout. And Gifford has added a bundle of features that makes Multiuser Concurrent DOS easy to install and use. It lets you get right to work.

## Our net is ARCNET.<sup>TM</sup>

Multiuser Concurrent DOS utilizes Datapoint's ARCNET, the most popular network hardware in the industry. It's reliable, economical, and fast — so you can add users without overloading the network.

You can network up to 255 single and multiuser systems. You can connect single or multiuser Gifford or CompuPro<sup>®</sup> systems as well as IBM PC-XTs<sup>®</sup>. Dual processor Gifford and CompuPro systems can run thousands of 8 or 16 bit CP/M or MP/M applications. PC-XTs can run 16 bit CP/M and MP/M programs as well as most popular MS-DOS applications, such as Lotus 1-2-3.<sup>™</sup>

## Gifford adds to your net worth.

Our enhancements of Concurrent DOS make it possible to get more and better work done in less time. Network-wide features include electronic mail, event calendar, inter-terminal communication, user time accounting and usage report generation, telecommunications, user expandable HELP facility,

reminder messages, message of the day, automatic startup and shut-down procedures, and easily prepared files for initializing terminals, printers, and network nodes.

Gifford's Virtual Terminals<sup>™</sup> increase productivity

by offering full-screen concurrency; you can run up to four programs simultaneously from one physical terminal.

## The safety net.

Multiple users can mean multiple security problems. Gifford's security enhancements include

login account names and encrypted passwords to control

access to the system. Users can be further restricted to specified

terminals, user areas, programs, or nodes on the network. You're also safe from

excessive down time, since the modular network architecture gives you immunity from single point failure.



## Gifford nets a big one: Simplicity.

If you've gone through the ordeal of typing as many as seven commands just to get on and off a network, Gifford has your number.



A single, menu-driven network command handles all your network options. Everything you

need is right in front of you. The net effect is simplicity — and sanity.

If you'd like to see how Gifford's Multiuser Concurrent DOS can solve your networking problems, or if you'd like to know about Gifford's selection of multiuser systems and software options, call (415) 895-0798.

Or write us at the address below.

We'll send you a free networking brochure and give you the name of the nearest dealer.



Multiuser Concurrent DOS is a trademark of Gifford Computer Systems. Concurrent DOS is a trademark of Digital Research, Inc. ARCNET is a trademark of Datapoint Corporation. IBM PC-XT is a registered trademark of IBM Corporation. CompuPro is a registered trademark of CompuPro Corporation. Lotus 1-2-3 is a trademark of Lotus Development Corp. Virtual Terminals is a trademark of Gifford Computer Systems.

**GIFFORD**  
COMPUTER SYSTEMS

2446 Verna Court  
San Leandro, CA 94577  
(415) 895-0798 TELEX: 704521

Houston, TX (713) 680-1944  
 Los Angeles, CA (213) 477-3921  
 Amherst, NY (716) 833-4758

**THE MULTIUSER COMPANY<sup>™</sup>**

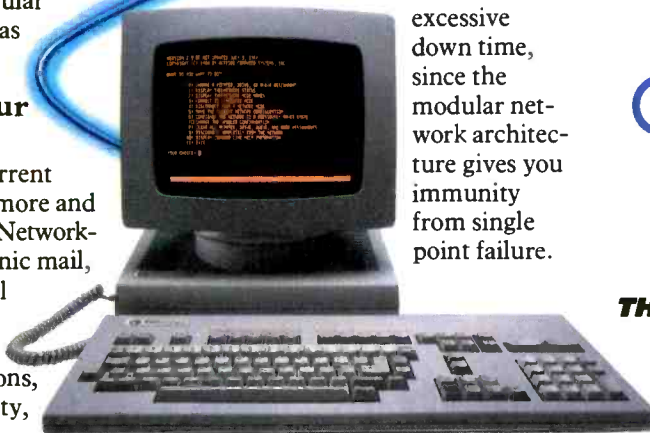



a formal proof, we would also need to list with each reduction a reference to the axiom used.

These examples should make it clear that the axioms are expressed rigorously enough that a computer could help us in the tedious work of reducing expressions as we reason and test our designs. In fact, the ax-

ioms could be implemented directly on a substitution (or reduction) machine as a way of testing the design. Cristoph Hoffman and Michael O'Donnell describe just such a system in their article, "Programming with Equations" (see reference 2). Certainly the specification of data abstractions, whether by formal or informal means,

is a powerful new tool for software designers.

### IMPLEMENTING ABSTRACT DATA TYPES IN BASIC

We now turn our attention to the practical application of data abstraction by implementing two versions of the intset abstraction in BASIC. BASIC is by no means an ideal language for implementing data abstractions. However, in as much as it is the lingua franca of personal computing, there is perhaps no better way of demonstrating the principles of data abstraction to a general audience. Not only should this exercise illustrate the benefits of the data-abstraction technique, it should also demonstrate that with discipline, a programmer can produce good code in BASIC that is maintainable and portable.

BASIC lacks two things that data abstraction needs: parameterized procedure calls (for invoking the operations) and limited scoping of variables (to support information hiding). Neither shortcoming is insurmountable; both are solved by requiring a more careful use of variables. Unfortunately, this puts a greater responsibility on the programmer than would be required by more modern languages and consequently increases the opportunity for programming errors.

The variables used in a BASIC implementation of an abstract data type fall into three categories: variables used to pass parameters to, and return values from, the operations; variables used in the concrete representation of the abstract type; and variables used locally in the implementation of the operations. Unfortunately, all variables in BASIC have a global scope and so nothing can be used without reference to how it is used elsewhere in the program. The first category of variables defines the user's interface with the operations of the data type. These must be known and understood in order to use the data type. The second and third categories need not be understood by the user, but their names must be known.

(continued)

## What do you get when you cross 1200 baud, free on-line time, and extra features at a price Hayes can't match?

### Data Rate?

The MultiModem gives you a choice—either 1200 or 300 bits per second. So you can go on-line with the information utilities. Check out bulletin boards. Dial into corporate mainframes. Swap files with friends.

### On-Line Time?

With the MultiModem you get CompuServe's DemoPak, a free two-hour demonstration of their service, and up to seven more free hours if you subscribe. You also get a \$50 credit towards NewsNet's business newsletter service.

### Features & Price?

Of course, the MultiModem gives you automatic dial, answer, and disconnect. Gives you the Hayes-compatibility you need to support popular communications software programs like Crosstalk, Data Capture, our own MultiCom PC, and dozens of others. Gives you a two-year warranty, tops in the industry.

### But Better?

Yes. The MultiModem gives you features the Hayes Smartmodem 1200™ can't match. Features like dial-tone and busy-signal detection for more accurate dialing and redialing. Like a battery-backed memory for six phone numbers. All at a retail price of just \$549—compared to \$699 for the Smartmodem.

What do you get? The new MultiModem, from Multi-Tech Systems. Isn't this the answer you've been looking for?

For the name of your local distributor, write **Multi-Tech Systems, Inc.**, 82 Second Avenue S.E., New Brighton, MN 55112. Or call us at (612) 631-3550.

# MultiModem.



**MultiTech** Systems

The right answer every time.

Trademarks—MultiModem, MultiCom PC, Multi-Tech Systems, Inc.—CompuServe, CompuServe Information Services, an H & R Block company—NewsNet, NewsNet, Inc.—Crosstalk, Microstar, Inc.—Data Capture, Southeastern Software—Smartmodem, Hayes Microcomputer Products, Inc.

Circle 245 on inquiry card.

Circle 292 on inquiry card. →

# Best Connection

## ProModem™ 1200A Apple Card Pack



It's the best 300/1200 baud 212A telephone modem for your Apple® II, II+, and IIe. "Best" because it's the easiest to install and use, provides more useful modem features for your money, and lets you add software capabilities as your needs grow.

We really do mean easy. Just plug the ProModem Card Pack into any expansion slot and connect the telephone cord. On-board intelligent software in ROM includes a simple but powerful terminal program. With a few keystrokes, you'll be "on line" and communicating.

ProModem 1200A offers you the best price-to-performance modem available with Auto-Answer and Auto-Dial, Programmable Intelligent Dialing, Built-in Speaker with Volume Control, Help Commands, Extensive Diagnostics, and more.

And when you need more sophisticated capabilities like Terminal Emulation, you're all set.

The 1200A is fully Hayes compatible. You'll be able to use most of the Apple II communications programs available.

### PRICE COMPARISON

#### PROMETHEUS

- (1) ProModem 1200A Apple Card Pack, complete with on-board software and all necessary hardware  
List Price: \$449

#### HAYES

- (1) Smartmodem 1200 "standalone modem"
- (2) Serial Card
- (3) RS-232C Cable
- (4) Communications Software  
Total List Price: \$957

The "Help" Screen and "Auto redial if busy" functions make the 1200A convenient to use. The second phone jack for the telephone handset allows switching from voice to data. You get all of this, ready to use, complete with easy to understand documentation, and a telephone cord for only \$449.

See your local dealer for a demonstration. He'll show why ProModem 1200A is your best connection.

Prometheus Products, Inc.  
45277 Fremont Blvd.  
Fremont, CA 94538  
(415) 490-2370

Apple is a registered trademark of Apple Computer, Inc.

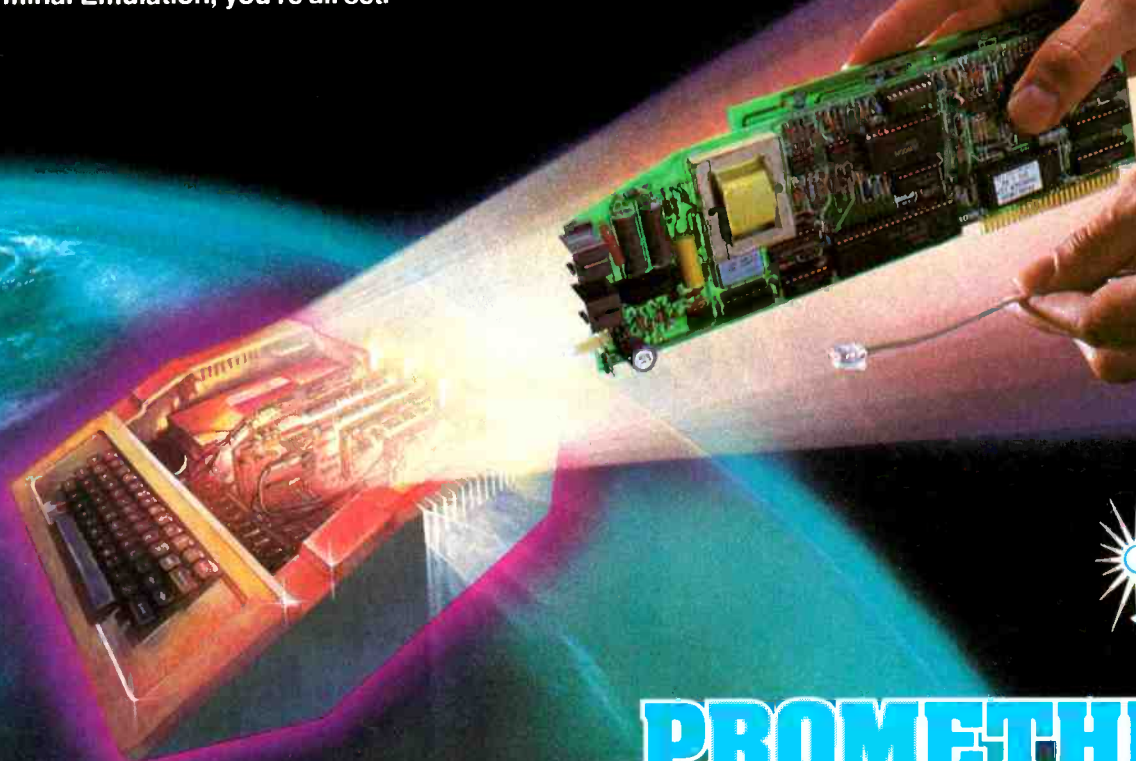

# PROMETHEUS®



# The room with a better view.



At over 300 Holiday Inn® hotels, hit movies are beamed right to your room at no extra charge by our privately-owned satellite earth station network. For hotel reservations just call 800-HOLIDAY.

*A better  
place to be<sup>SM</sup>*



The programmer must know what variables are used in the implementation of the data type, in order to avoid abusing the type by inadvertently using one of these variables for a different purpose elsewhere.

In a pure information-hiding environment this would not be the case. When a data abstraction truly hides the concrete representation of a type, then the way one type is represented cannot interfere with how another is. But in BASIC this does not come automatically since all variables have a global scope and the representation of one type can therefore interfere with another if the variables are not unique. The BASIC programmer must therefore be content with a weaker form of data abstraction that hides the meaning and use of the data structures that implement an abstract type but cannot hide their names.

After an abstract data type has been

specified, as discussed in the preceding sections, there are three steps in its implementation: (1) define the user interface, (2) define the concrete representation, and (3) implement the operations. Each of these steps will be considered in turn.

**DEFINING THE USER INTERFACE**

The user interface refers to what a person must know in order to invoke the operations of the data type. For each operation, the following items must be defined: the line number where the subroutine begins, the variables in which input parameters are passed to the operation, the variables in which values are returned, and the variables in which exception codes are signaled. All of this information can be conveyed in a one-line REM (remark) statement that serves as a header for the subroutine. (The

version of BASIC used in the listing below allows ' as shorthand for REM.)

Figure 6 illustrates a possible definition of the user interface for the abstract type intset. Note, for instance, the header for the operation "insert." The address of the subroutine is identified as line 1200. The input parameters (a set identifier and an integer to insert into the set) are passed in the variables S and X respectively. The operation returns s as the set identifier of the resulting set. The operation may signal one of three exception codes; this is done with three variables that return a Boolean value. If one of these variables has a value of true when the subroutine returns, then that condition has occurred. Thus the insert operation may signal "not a valid set" in NS, "not a valid integer" in NI, or "no more room" in NR.

(continued)

# Meet The Controllers.



*Control Power, Peripherals, Spikes, and Glitches.*

Power Control™ protects computer circuitry and data stored in memory against the damage voltage spikes can cause.

Puts on/off control of your computer, terminal, printer, and more at your fingertips in a slim panel unit sized to fit underneath your computer terminal.

Contains a master switch (to turn your computer, terminal, printer, a modem or a lamp on or off at the same time) and three additional switches to turn peripherals on or off in any order.

*Eliminates reaching over, behind and around devices to turn them on or off.*

*Puts control of computer at your fingertips.*

*16" width, 10" depth allows placement under terminal for fingertip control.*

*Master switch turns computer and all peripherals on or off at same time.*

*Additional switches give individual control over peripherals.*

*Less than 2" high.*

*Organizes power wires. 4 cords in- 1 cord out.*

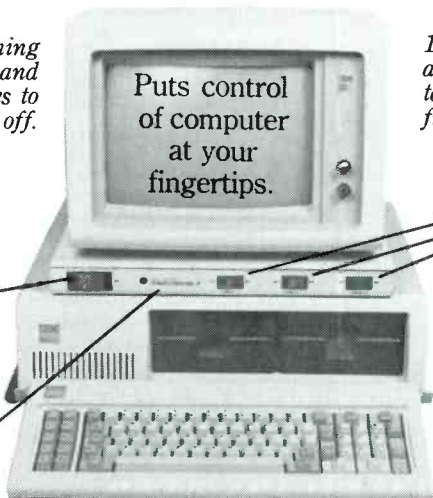

**Relax Technology.**

To order, phone: 415/471-6112 or mail to: 3101 Whipple Rd., #25, Union City, CA 94587  
\*Calif. Residents add applicable sales tax.  
Prices include shipping.

- Power Control 1: \$69.95\*
- Power Control 2: \$89.95\*  
*10 amp circuit breaker. RFI noise filtering. IEC power connector.*
- Power Control 3: \$129.95\*  
*Cross suppression between all 4 outlets. Illuminated switches. 3-stage RFI filter.*

Check for \$\_\_\_\_\_ enclosed.

VISA  MasterCard

Card # \_\_\_\_\_

Exp. Date \_\_\_\_\_

Bank # \_\_\_\_\_

Name \_\_\_\_\_

Address \_\_\_\_\_

City \_\_\_\_\_

St. \_\_\_\_\_

Zip \_\_\_\_\_

Signature \_\_\_\_\_

©Relax Technology. *The company that works so you can relax and get down to business.*



Note also that figure 6 defines four new operations on type intset: display, kill, intersect, and union. Display prints the contents of a set on the screen. Kill deletes an existing set.

Intersect produces a new set that is the intersection of two existing sets. Union produces a new set that is the combination of two existing sets. These operations provide a fuller en-

vironment for testing our implementations of the intset abstraction.

**USING THE ABSTRACT DATA TYPE**

With the design of the user interface in hand, we know enough to write a program that uses the type. Figure 7 gives the overall design for a program to test an implementation of intset. (It overlooks the details of what to do when an exception is signaled.) The test program repeatedly takes a one-letter command and two numerical arguments, executes the named operation, and displays the resulting set.

See listing 1 for the test program. As an example of how to use an operation, consider the use of insert in lines 410 and 420. The operation is invoked by GOSUB 1200, but before calling the subroutine we must pass the parameters. The interface requires

*(continued)*

```

1000 'abstract data type: INTSET
1100 'create( ) returns(s) signals(os)
1200 'insert(s,x) returns(s) signals(ns,ni,nr)
1300 'remove(s,x) returns(s) signals(ns,ni)
1400 'isempty(s) returns(b) signals( ns)
1500 'ismember(s,x) returns(b) signals(ns,ni)
1500 'display(s) signals(ns)
1700 'kill(s) signals(ns)
1300 'intersect(s1,s2) returns(s) signals(ns,os)
1300 'union(s1,s2) returns(s) signals( ns,os,nr)

Key to exception codes:

n = not a valid integer
nr = no more room
ns = not a valid set
os = out of sets
    
```

Figure 6: User interface for abstract data type intset.

# BYTE CONNECTION INC.

presents **MONTHLY PRICE BUSTERS!!!**

**CALL (714) 778-6496**

**FALL SPECIALS AT AFFORDABLE PRICES**

**PERSONAL COMPUTERS:**

- IBM PC 256k, 2 drives 360k each, color card, monitor, Dos 2.1 Silver-Reed Printer & Cable ..... **\$2499.00**
- IBM PC 256k, 2 drives 360k each, 10mb Winchester, color card, monitor, Dos 2.1 ..... **\$2999.00**
- IBM XT 256k, IBM Mono card, IBM Mono Display..... **\$4195.00**
- ALTOS 856 Configured for 6 users unix based system with 5 12k, 20mb Winchester, 1mb Floppy, ALTO-II Terminal.... **\$7595.00**
- ALTOS 586 All the above with 40mb Winchester ..... **\$9595.00**
- COMPAQ PC256k, 2 drives, Smartmodem 1200 ..... **\$2895.00**
- EPSON QX-10 256k, complete with Valdoc O.S..... **\$1995.00**
- CORONA 128k, graphics card, monitor & software ..... **\$1895.00**
- MEMOTECH 64k, Parallel/Game Port ..... **\$495.00**

**PRINTERS:**

- EPSON RX 80FT ..... **\$325.00**
- EPSON RX 80 ..... **\$259.00**
- EPSON FX 80 ..... **\$449.00**
- EPSON FX 100 ..... **\$659.00**
- JUKI 6100 L.Q. .... **\$489.00**
- TOSHIBA 1351 ..... **CALL**
- OKIDATA 82A ..... **\$299.00**
- OKIDATA 92P ..... **\$399.00**
- OKIDATA 84P ..... **\$775.00**
- OKIDATA 93P ..... **\$629.00**
- NEC 2050 ..... **\$815.00**
- NEC 3550 ..... **\$1559.00**
- NEC 8850 ..... **\$1995.00**
- NEC 7710/15 ..... **\$1695.00**
- NEC 7730 ..... **\$1695.00**

Call for printer prices not listed above

**MODEMS:**

- U.S. ROBOTICS 300 ..... **\$169.00**
- U.S. ROBOTICS 1200..... **\$369.00**
- U.S. ROBOTICS PASSWORD 1200 ..... **\$369.00**
- HAYES SMARTMODEM 300/1200..... **CALL**

**MONITORS:**

- AMDEK 300 Green ..... **\$135.00**
- AMDEK 300 Amber..... **\$135.00**
- TEXAN Amber ..... **\$139.00**
- TEXAN RGB III..... **479.00**

**DISK DRIVES & SUCH:**

- TANDON TM 100-2 ..... **\$179.00**
- TEAC 55-B ..... **\$139.00**
- 10mb Winchester complete Subsystem ..... **\$895.00**
- 64k Memory Chip Bank ..... **\$49.00**
- 6PACK 6-function to 384k..... **\$269.00**
- COLOR CARD ..... **\$199.00**

Prices & availability subject to change without notice.

**BUSINESS HOURS: MONDAY-FRIDAY 8:00 AM - 5:00 PM**  
**163 WEST CERRITOS AVENUE, BUILDING 2, ANAHEIM, CALIFORNIA 92805**

# 100 MHz scope, counter, timer, multimeter: All one integrated system.

**100 MHz dual time base scope.** 3.5 ns risetime; sweeps from 0.5 s to 5 ns/div; alternate sweep;  $\pm 2\%$  vertical/horizontal accuracy; vertical sensitivity to 2 mV/div @ 90 MHz.

**9-digit fluorescent display.** Digitally accurate readouts accompany the CRT waveform. Error messages and prompts also appear on the display.

**Dc volts and ac coupled true RMS volts.** Measured through the Ch 1 scope input.

**Gated measurements.** Use the scope's intensified marker to measure frequency, period, width and to count events within specified portions of the signal.

**Auto-ranged, auto-averaged counter/timer.** Frequency, period, width, delay time,  $\Delta$ -time, plus totalize to more than 8 million events — with 7 digits plus exponent displayed.

**Auto-ranged DMM.** Use floating DMM side inputs with up to 5000-count resolution. Get precise readouts of average dc and true RMS voltage. Measure resistance from milliohms to gigohms.

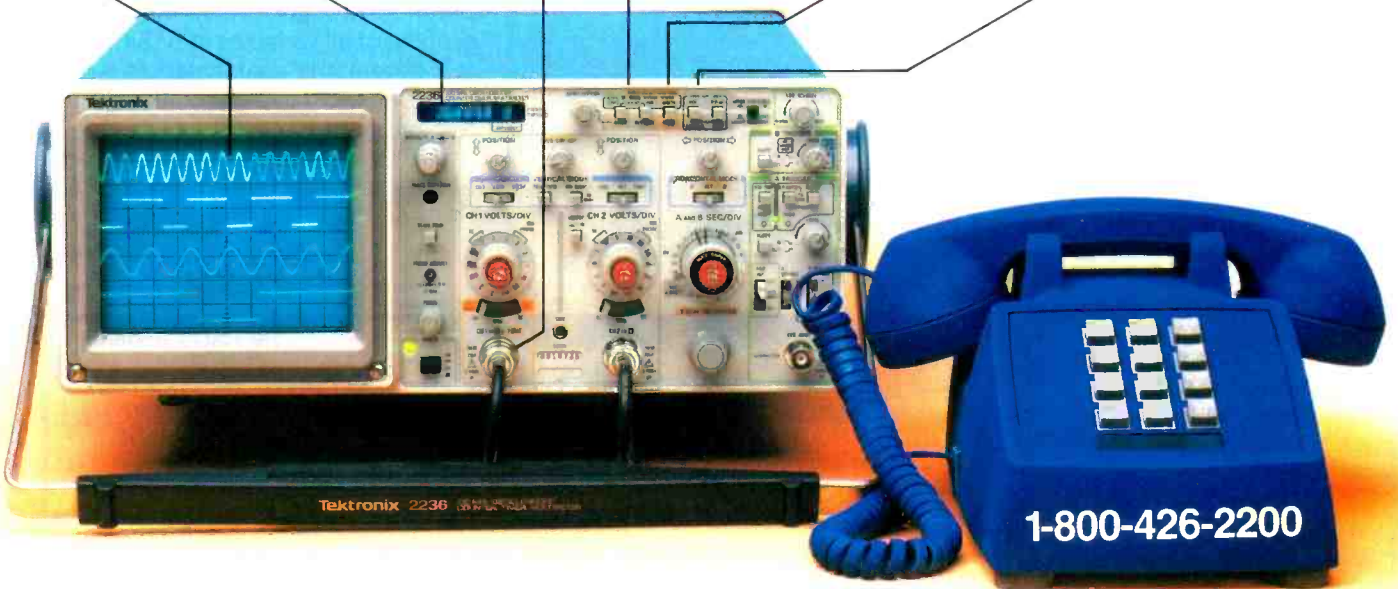

**Now make measurements faster, easier, with greater accuracy and user confidence.** The Tek 2236 makes gated counter measurements, temperature, time, frequency, resistance and voltage measurements push-button easy. You see results concurrently on the 9-digit numeric readout and CRT display.

Its complete trigger system includes pushbutton trigger view, plus peak-to-peak auto, TV line, TV field, single sweep and normal modes.

At just \$2650\*, the 2236 includes the industry's first 3-year warranty on all parts and labor, including the CRT.

**Integrated measurement system. 3-year warranty. 15-day return policy. And expert advice. One free call gets it all!** You can order, or obtain literature, through the Tek National Marketing Center. Technical personnel, expert in scope applications, can answer your questions and expedite delivery. Direct orders include operating and

service manuals and worldwide service back-up.

**Call toll-free:  
1-800-426-2200,  
Extension 145.**

In Oregon, call collect:  
(503) 627-9000, Ext. 145.  
Or write Tektronix, Inc.  
P.O. Box 1700  
Beaverton, OR 97075

**Tektronix**  
COMMITTED TO EXCELLENCE



that the set identifier be passed in S and the integer to insert in X, thus the code: "S=P1: X=P2". In line 420, the statement GOSUB 1600 calls display. This too requires a set identifier in S but since insert returns with the current set in S, there is no need for an

assignment statement to pass the parameter. As long as S was not an invalid set identifier, that is, as long as NS=False, we display the resulting contents of set S. It is assumed that all exception conditions will generate an error message when they are dis-

covered by intset. If NI or NR occurs, a message will be given, but we still want to display the current status of S. The use of the other operations follows the same principles.

It is important to note that we were able to write a program using intset before we decided how the type is to be represented or implemented. This is the power of information hiding and data abstraction at work. As long as we stick to the interface definition in figure 6 when we implement the data type, the test program will work.

There is, however, one slight complication brought on by the global scoping of all variables in BASIC. Our test program is guaranteed to work only if we avoid variable conflicts. The test program happens to use three variables of its own that are not part of the intset interface. These are C\$, P1, and P2. The test program is

(continued)

```

PROCEDURE test intset abstraction:
  Initialize abstract data type Intset
  REPEAT until commanded to quit,
    Get a command and two parameters (p1 and p2)
  CASE of command,
    c: display(create( ))
    d: display(p1)
    e: isempty(p1)
    i: display(insert(p1,p2))
    k: kill(p1)
    m: ismember(p1,p2)
    q: quit program
    r: display(remove(p1,p2))
    u: display(union(p1,p2))
    x: display(intersect(p1,p2))
    
```

Figure 7: Design for program to test an implementation of intset.

Come visit us in our  
New York City Showroom  
226 Sherwood Ave.  
Farmingdale, NY 11735

# Computer Channel

Se Habla Español  
Cable: COMSYSTEC NEW YORK  
Telex: CSTNY 429418

---

**OUR SPECIALTY: IBM COMPATIBLE PRODUCTS, GRAPHICS, DATABASE, 68000 UNIX, EXPORT**

<p style="text-align: center;"><b>IBM PC &amp; COMPATIBLES</b></p> <p style="text-align: center;">Columbia, Corona, Zenith, Leading Edge, Televideo, Sanyo, Tava, &amp; IBM PC</p> <p style="text-align: center;"><b>OTHER POPULAR COMPUTERS</b></p> <p style="text-align: center;">Epson, Cromemco, NEC PC, Altos, North Star, Dual 68000, DEC Rainbow, OSM</p>	<p style="text-align: center;"><b>AN AFFORDABLE CAD SYSTEM FOR ENGINEERS &amp; DESIGNERS</b></p> <div style="text-align: center;"> </div> <p style="font-size: small;">AutoCAD™ is a two-dimensional computer-aided drafting and design system suitable for many applications including drawings for architectural, mechanical, electrical, PCB layout, chemical, structural, and civil engineering.</p> <p style="font-size: small;">For the configuration as shown in the above flowchart,</p>	<p style="text-align: center;"><b>PRINTERS</b></p> <p><b>EPSON, OKIDATA</b> full line <span style="float: right;"><b>Call</b></span></p> <table style="width: 100%; font-size: x-small;"> <tr><td>Prism 132</td><td>200 cps, 132 col.</td><td>1,100</td></tr> <tr><td>Toshiba P1340</td><td>80 col., 160 cps</td><td>799</td></tr> <tr><td>Microprism</td><td>110 cps, 80 col. graphic</td><td>379</td></tr> <tr><td>Dataprodukt</td><td>8000 series</td><td>CALL</td></tr> <tr><td></td><td>8010 180 cps, graphic</td><td>545</td></tr> </table> <p style="text-align: center; font-size: x-small;">***Letter Quality***</p> <table style="width: 100%; font-size: x-small;"> <tr><td>NEC 2050</td><td>20 cps for IBM PC</td><td>840</td></tr> <tr><td>3550</td><td>35 cps for IBM PC</td><td>1,610</td></tr> <tr><td>C.Itoh F-10</td><td>40 cps</td><td>999</td></tr> <tr><td>Juki 6100</td><td>18 cps</td><td>459</td></tr> <tr><td>Qume 11/40</td><td>w/IBM interface</td><td>1,420</td></tr> <tr><td>Star Power Type</td><td>18 cps</td><td>399</td></tr> <tr><td>Diablo 630</td><td>ECS/IBM ext. char. set</td><td>2,100</td></tr> <tr><td>Dynax HR35</td><td>33 cps</td><td>910</td></tr> <tr><td>Comrex Comwriter III</td><td></td><td>740</td></tr> <tr><td>Transtar 315</td><td>graphic, color</td><td>479</td></tr> </table>	Prism 132	200 cps, 132 col.	1,100	Toshiba P1340	80 col., 160 cps	799	Microprism	110 cps, 80 col. graphic	379	Dataprodukt	8000 series	CALL		8010 180 cps, graphic	545	NEC 2050	20 cps for IBM PC	840	3550	35 cps for IBM PC	1,610	C.Itoh F-10	40 cps	999	Juki 6100	18 cps	459	Qume 11/40	w/IBM interface	1,420	Star Power Type	18 cps	399	Diablo 630	ECS/IBM ext. char. set	2,100	Dynax HR35	33 cps	910	Comrex Comwriter III		740	Transtar 315	graphic, color	479							
Prism 132	200 cps, 132 col.	1,100																																																				
Toshiba P1340	80 col., 160 cps	799																																																				
Microprism	110 cps, 80 col. graphic	379																																																				
Dataprodukt	8000 series	CALL																																																				
	8010 180 cps, graphic	545																																																				
NEC 2050	20 cps for IBM PC	840																																																				
3550	35 cps for IBM PC	1,610																																																				
C.Itoh F-10	40 cps	999																																																				
Juki 6100	18 cps	459																																																				
Qume 11/40	w/IBM interface	1,420																																																				
Star Power Type	18 cps	399																																																				
Diablo 630	ECS/IBM ext. char. set	2,100																																																				
Dynax HR35	33 cps	910																																																				
Comrex Comwriter III		740																																																				
Transtar 315	graphic, color	479																																																				
<p style="text-align: center;"><b>PLOTTERS/DIGITIZERS</b></p> <table style="width: 100%; font-size: x-small;"> <tr><td>Amdek</td><td>6-pen X-Y Plotter</td><td>895</td></tr> <tr><td>Houston Instrument</td><td>DMP-29 8-pen X-Y Plotter</td><td>1,795</td></tr> <tr><td></td><td>DMP-40 1 pen plotter</td><td>795</td></tr> <tr><td></td><td>DMP41, DMP42 22x34", 24x36" plotter</td><td>CALL</td></tr> <tr><td></td><td>DMP-51, DMP-52 22x34", 24x36" plotter</td><td>CALL</td></tr> <tr><td></td><td>HIPAD DT-11AA Digitizer</td><td>725</td></tr> <tr><td></td><td>HIPAD DT-114 4-button digitizer</td><td>CALL</td></tr> <tr><td>Hewlett Packard</td><td>7470A 2-pen plotter</td><td>940</td></tr> <tr><td></td><td>7475A 6-pen plotter</td><td>1,640</td></tr> <tr><td>Calcomp M84</td><td>8-pen plotter</td><td>1,650</td></tr> </table>	Amdek	6-pen X-Y Plotter	895	Houston Instrument	DMP-29 8-pen X-Y Plotter	1,795		DMP-40 1 pen plotter	795		DMP41, DMP42 22x34", 24x36" plotter	CALL		DMP-51, DMP-52 22x34", 24x36" plotter	CALL		HIPAD DT-11AA Digitizer	725		HIPAD DT-114 4-button digitizer	CALL	Hewlett Packard	7470A 2-pen plotter	940		7475A 6-pen plotter	1,640	Calcomp M84	8-pen plotter	1,650	<p style="text-align: center;"><b>SPECIAL CALL FOR \$5,800.00</b> (cables included)</p> <p style="font-size: x-small;">Package with 10 MB hard disk also available</p> <p style="text-align: center;">***** CALL FOR DETAILS *****</p>	<p style="text-align: center;"><b>MONITORS</b></p> <p style="font-size: x-small;">(TERMINALS: HAZELTINE, ZENITH, WYSE, VISUAL...CALL)</p> <table style="width: 100%; font-size: x-small;"> <tr><td>Panasonic amber super</td><td>199</td></tr> <tr><td>Comrex CR6800 14"RGB</td><td>489</td></tr> <tr><td>NEC JC1216 RGB monitor, 640x300 resolution</td><td>435</td></tr> <tr><td>JB1201 20 Mhz green monitor</td><td>185</td></tr> <tr><td>Princeton Graphic HX12 RGB monitor</td><td>490</td></tr> <tr><td>SR12 RGB</td><td>630</td></tr> <tr><td>Amdek 300 12" green monitor</td><td>155</td></tr> <tr><td>Color IV Xtra</td><td>710</td></tr> <tr><td>Zenith ZVM 123 Green Monitor</td><td>87</td></tr> <tr><td>ZVM 122 Amber monitor</td><td>135</td></tr> <tr><td>ZVM 135 RGB monitor for IBM PC</td><td>475</td></tr> </table> <p style="font-size: x-small;">Prices subject to change. American Express, Visa/Mastercard add 3%. F.O.B. point of shipment. 20% restocking fee for returned merchandise. Personal checks take 3 weeks to clear. COD on certified check only. N.Y. residents add sales tax. Manufacturers' warranty only. International customers, please confirm price before order. Accept P.O. from Fortune 500, schools and gov't.</p>	Panasonic amber super	199	Comrex CR6800 14"RGB	489	NEC JC1216 RGB monitor, 640x300 resolution	435	JB1201 20 Mhz green monitor	185	Princeton Graphic HX12 RGB monitor	490	SR12 RGB	630	Amdek 300 12" green monitor	155	Color IV Xtra	710	Zenith ZVM 123 Green Monitor	87	ZVM 122 Amber monitor	135	ZVM 135 RGB monitor for IBM PC	475
Amdek	6-pen X-Y Plotter	895																																																				
Houston Instrument	DMP-29 8-pen X-Y Plotter	1,795																																																				
	DMP-40 1 pen plotter	795																																																				
	DMP41, DMP42 22x34", 24x36" plotter	CALL																																																				
	DMP-51, DMP-52 22x34", 24x36" plotter	CALL																																																				
	HIPAD DT-11AA Digitizer	725																																																				
	HIPAD DT-114 4-button digitizer	CALL																																																				
Hewlett Packard	7470A 2-pen plotter	940																																																				
	7475A 6-pen plotter	1,640																																																				
Calcomp M84	8-pen plotter	1,650																																																				
Panasonic amber super	199																																																					
Comrex CR6800 14"RGB	489																																																					
NEC JC1216 RGB monitor, 640x300 resolution	435																																																					
JB1201 20 Mhz green monitor	185																																																					
Princeton Graphic HX12 RGB monitor	490																																																					
SR12 RGB	630																																																					
Amdek 300 12" green monitor	155																																																					
Color IV Xtra	710																																																					
Zenith ZVM 123 Green Monitor	87																																																					
ZVM 122 Amber monitor	135																																																					
ZVM 135 RGB monitor for IBM PC	475																																																					
<p style="text-align: center;"><b>POWERFUL ADD-ON BOARDS</b></p> <p style="font-size: x-small;">from AST, PERSYST, PLANTRONIC, TECMAR, QUADRAM, HERCULES, TITAN</p> <p style="text-align: center;"><b>MORE FOR YOUR IBM PC</b></p>	<p style="text-align: center;"><b>MODEMS</b></p> <table style="width: 100%; font-size: x-small;"> <tr><td>HAYES</td><td>Smartmodem 300/1200 bps</td><td>499</td></tr> <tr><td></td><td>1200B modem for IBM PC</td><td>CALL</td></tr> <tr><td>USR</td><td>300/1200 bps w/64K, parallel port</td><td>550</td></tr> <tr><td></td><td>Password 300/1200 bps modem</td><td>339</td></tr> <tr><td>NOVATION</td><td>Smartmodem 300/1200 bps modem</td><td>415</td></tr> <tr><td></td><td>PC Cat 300/1200 bps modem</td><td>450</td></tr> </table>	HAYES	Smartmodem 300/1200 bps	499		1200B modem for IBM PC	CALL	USR	300/1200 bps w/64K, parallel port	550		Password 300/1200 bps modem	339	NOVATION	Smartmodem 300/1200 bps modem	415		PC Cat 300/1200 bps modem	450	<p style="text-align: right;"><b>TELEX:</b> 429418 <b>CSTNY</b></p> <p style="text-align: center;"><b>Computer Channel</b> 226 Sherwood Ave. Farmingdale, NY 11735</p> <p style="text-align: center;"><b>For information CALL (516) 420-0142</b> <b>To order CALL 1-800-331-3343</b></p>																																		
HAYES	Smartmodem 300/1200 bps	499																																																				
	1200B modem for IBM PC	CALL																																																				
USR	300/1200 bps w/64K, parallel port	550																																																				
	Password 300/1200 bps modem	339																																																				
NOVATION	Smartmodem 300/1200 bps modem	415																																																				
	PC Cat 300/1200 bps modem	450																																																				

# WHAT TO WEAR WHILE BALANCING THE BOOKS.

Go ahead. Slip into something comfortable. Wear the most comfortable, most sophisticated microcomputer accounting software in the world. Open Systems. Accounting software so rich in features, it can handle the complex problems of today's small business with unprecedented ease. Software so flexible, it runs on all popular microcomputers. And can grow right along with your business needs.

No other accounting software line is so complete. With a choice of General Ledger, Accounts Receivable, Accounts Payable, Inventory, Payroll, Job Cost, Sales Order, Purchase Order and Fixed Assets as well as a

Report Writer that links your accounting data to popular spreadsheets, word processors and graphics software. Assuring you the luxury of a perfect software fit.

The fact is, Open Systems meets the needs of today's small business so completely, it's become one of the best selling lines of accounting software on the market. More than 300,000 accounting products are providing comprehensive accounting solutions for businesses throughout the world. Now that's comforting. Call Open Systems right now. And get your mind off the books.

For the dealer nearest you call 1-800-328-2276

Circle 259 on inquiry card.

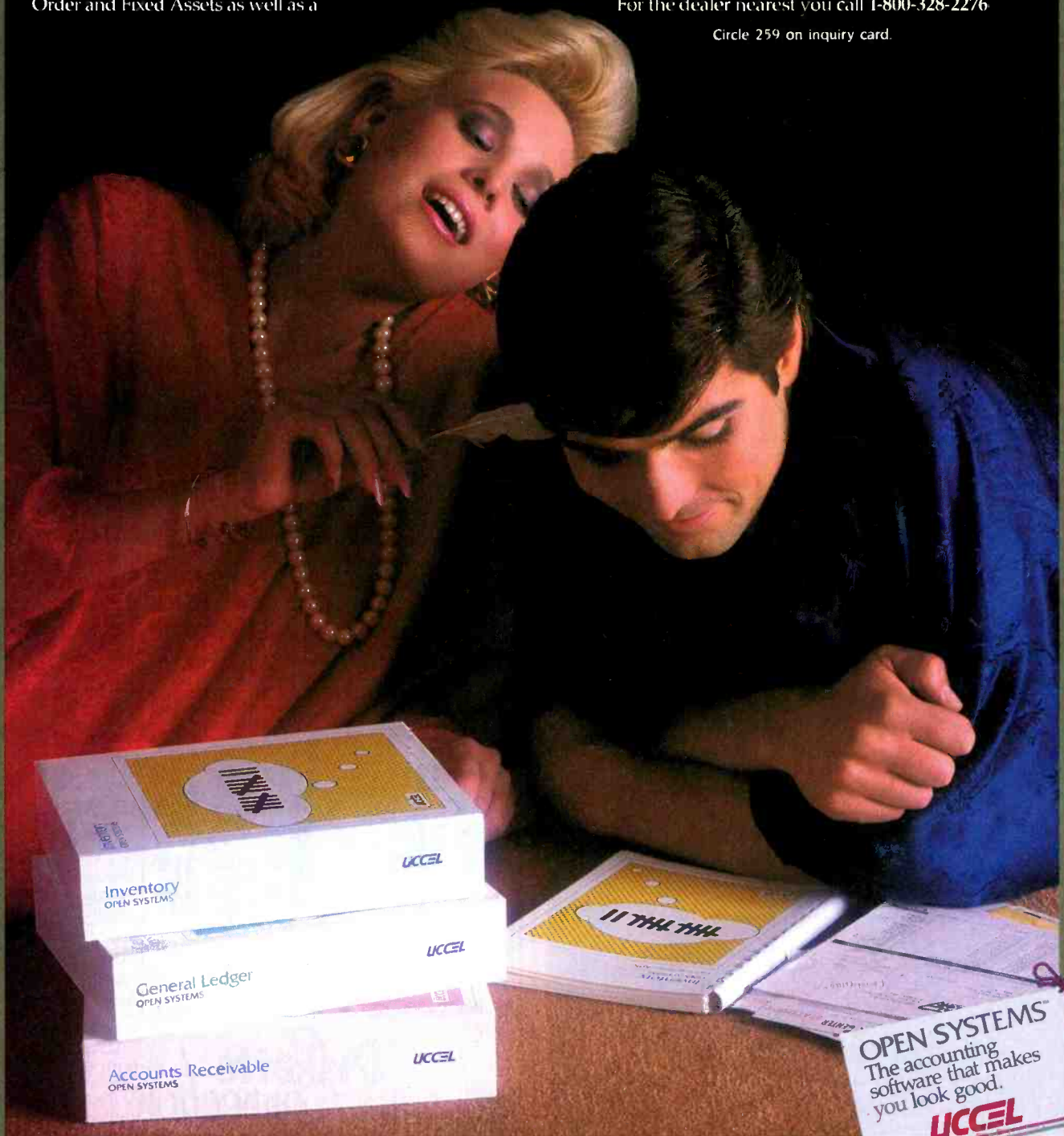



guaranteed, therefore, only if the implementation of intset stays away from these three variable names. Conversely, if we begin with an already implemented data type and want to write a program that uses it, that program may not use any variable as a free variable that is used in the implementation of the data type.

**DEFINING THE CONCRETE REPRESENTATION**

The second step in implementing an abstract data type is to define the concrete representation. A straightforward representation for integer sets is to store them in a matrix where each row represents a set and the columns hold individual set elements. A value of -1 means that the matrix cell is empty; a positive integer is a set element. A value of -1 in column 0 means that the whole row is unused. Note that in figure 6, the first oper-

ation is not coded until line 1100. The lines between 1000 and 1100 are reserved for comments that describe the concrete representation, followed by an initialization subroutine that sets up the storage space for the data type as required by the method of representation. This subroutine is the first thing called by the test program of listing 1.

Listing 2 gives a full implementation of intset with an underlying matrix representation of 11 sets (in rows 0 to 10) with 10 elements each (in columns 1 to 10). Note lines 1000 to 1040, which are comments describing the method of representation, and lines 1050 to 1080, which define an initialization routine that sets up the storage space for intsets.

**IMPLEMENTING THE OPERATIONS**  
Now we are ready for the third step, implementing the operations. The

headers defined for the user interface (see figure 6) serve as the first lines for the subroutines that implement each of the operations. Given the representation of the data type and the variables specified in the header for parameter, result, and exception code passing, the implementation of the operations falls into place. See listing 2 for the complete implementation of the operations. Note that the implementation makes use of two private subroutines (at lines 2000 and 2100) for checking the validity of parameters s and x. These do not appear in the list of operations of the data type (figure 6) because they are meant to be used only from within the module, not by outside users.

A new complication presents itself when implementing the operations. That is the problem of local variables. One must ensure that the extra vari-

(continued)

IBS

**MAXIMUM IBM PC/XT COMPATIBILITY**  
MADE IN USA

**\$595**  
OEM BASIC SYSTEM

**\*OEM Basic System** \$595 (Minimum Order 10 Units)

**\*2-Drive PC-2000 System** \$1395 (Special\*\*), \$1595 (List)  
\$1150 (Dealer at Quantity 2 Price)

**\*10 Mega Byte XT-2000 System** \$2195 (Special\*\*), \$2495 (List)  
\$1785 (Dealer at Quantity 2 Price)

IBS PC/XT-2000 System Includes:  
•Mother Board with 2 Serial & 1 Parallel Ports •128K Expandable to 640K •Keyboard •TEAC Drive(s) with controller •Color Graphics Card •(XT with Hard Disk and controller)

Basic System Ideal for  
**IBM PC NETWORK**

\*\*Special Prices at Participating Dealerships

\*10 Mega Byte HARD DISK and controller (Low Quantities) **\$695**

IBS CORPORATION

2732 E. MIRALOMA AVE.  
ANAHEIM, CA 92806  
(714) 630-6361, 630-6362  
TELEX 753197

FREE SHIPPING  
DISKETTES

West Coast "Call"  
**1(800) 621-6221**

Central & East "Call"  
**1(800) 654-4058**

Discounts Starting at 3 Box Quantities

3M	Dysan	maxell	Verbatim
•5 1/4"•	•5 1/4"•	3 1/2" CALL	•5 1/4" Datalife
s-side 17 <sup>95</sup>	s-side 22 <sup>95</sup>	•5 1/4"•	s-side 18 <sup>95</sup>
d-den. 23 <sup>95</sup>	d-den. 30 <sup>50</sup>	s-side 19 <sup>95</sup>	d-den. 24 <sup>95</sup>
d-side 27 <sup>50</sup>	d-side 34 <sup>50</sup>	d-den. 25 <sup>95</sup>	d-side 30 <sup>95</sup>
s-side quad 33 <sup>95</sup>	s-side quad 45 <sup>50</sup>	d-side 28 <sup>95</sup>	s-side quad 39 <sup>95</sup>
d-side quad 21 <sup>50</sup>	d-side quad 28 <sup>50</sup>	quad 36 <sup>95</sup>	d-side quad 24 <sup>75</sup>
•8"•	•8"•	•8"•	•8" Datalife
s-side 26 <sup>00</sup>	s-side 30 <sup>95</sup>	s-side 31 <sup>95</sup>	s-side 26 <sup>95</sup>
d-den. 31 <sup>50</sup>	d-den. 34 <sup>95</sup>	d-den. 34 <sup>95</sup>	d-side 31 <sup>95</sup>
d-side d-den.	d-side d-den.	d-side d-den.	d-side d-den.

**3M**

DC100A...13<sup>95</sup>

DC300A...18<sup>40</sup>

DC300XL 20<sup>25</sup>

DC600A...24<sup>45</sup>

**AMARAY MEDIA MATE**

(3 1/2"...11<sup>95</sup>)

**DISK MINDERS**

(5 1/4"...16<sup>75</sup>) (8"...21<sup>50</sup>)

**BULK PACKED DISKS "CALL"**

**Head Cleaners**

Kits...520

Refills...955

**Analyzers 25<sup>00</sup>**

Diskettes 10/Box

the Diskette Connection™

OKLAHOMA & NEVADA

MasterCard VISA

Circle 172 for Dealer inquiries

Circle 173 for End-User inquiries.

Dealer Inquiries Welcomed

1(800) 654-4058

Circle 106 on inquiry card.

# THE MI-286 DUAL CPU BOARD IS AT LEAST TWICE AS FAST AS COMPUPRO'S 8085/88... AND IT'S A DIRECT REPLACEMENT!

**The 20-second revolution.** It only takes about 20 seconds to bring your S-100 system up to its ultimate speed/power potential. Just pull out the old fashioned 8085 '88 board and plug the MI-286 in its place. That's all there is to it. You're off and running with more power than ever before.

**The 80286 and Z-80H.** The MI-286 is the first dual-CPU board using the new, high speed Intel 80286 coupled with a Z-80H. It is designed for use with a variety of operating systems, including MP/M 8-16. It will support all your current 8086/88 and Z-80/8085 software. It can accommodate an optional 80287 math co-processor. In short, it gives you the best of both worlds.

**Add more users.** The MI-286. It improves throughput so dramatically you can add those extra users you've always wanted. It carries S-100 technology to its logical limit. And it only costs \$1395!\*

**Upgrade your S-100.** The MI-286 is only one of Macrotech's products designed to maximize the performance of your S-100 system. The MAX Dynamic Memory gives you up to 1 Mbyte of memory for your system memory and virtual disk applications. ADIT lets you control up to 16 different terminals, modems or printers from a single slot in your S-100 bus. And our static board is the S-100 world's first 1/2 Mbyte static memory. Call or write us today, and find out how easy it is to upgrade your S-100 system.



**Macrotech International Corp.**  
9551 Irondale Avenue  
Chatsworth, CA 91311  
Phone: (818) 700-1501

Circle 210 on inquiry card.

Dealer/Distributors: Priority One Electronics, (800) 423-5922, (213) 709-5111 / John D. Owens Assoc., (212) 448-6298  
In England: Fulcrum (Europe) (0621) 828-763 / MP/M is a registered trademark of Digital Research \*Math co-processor extra

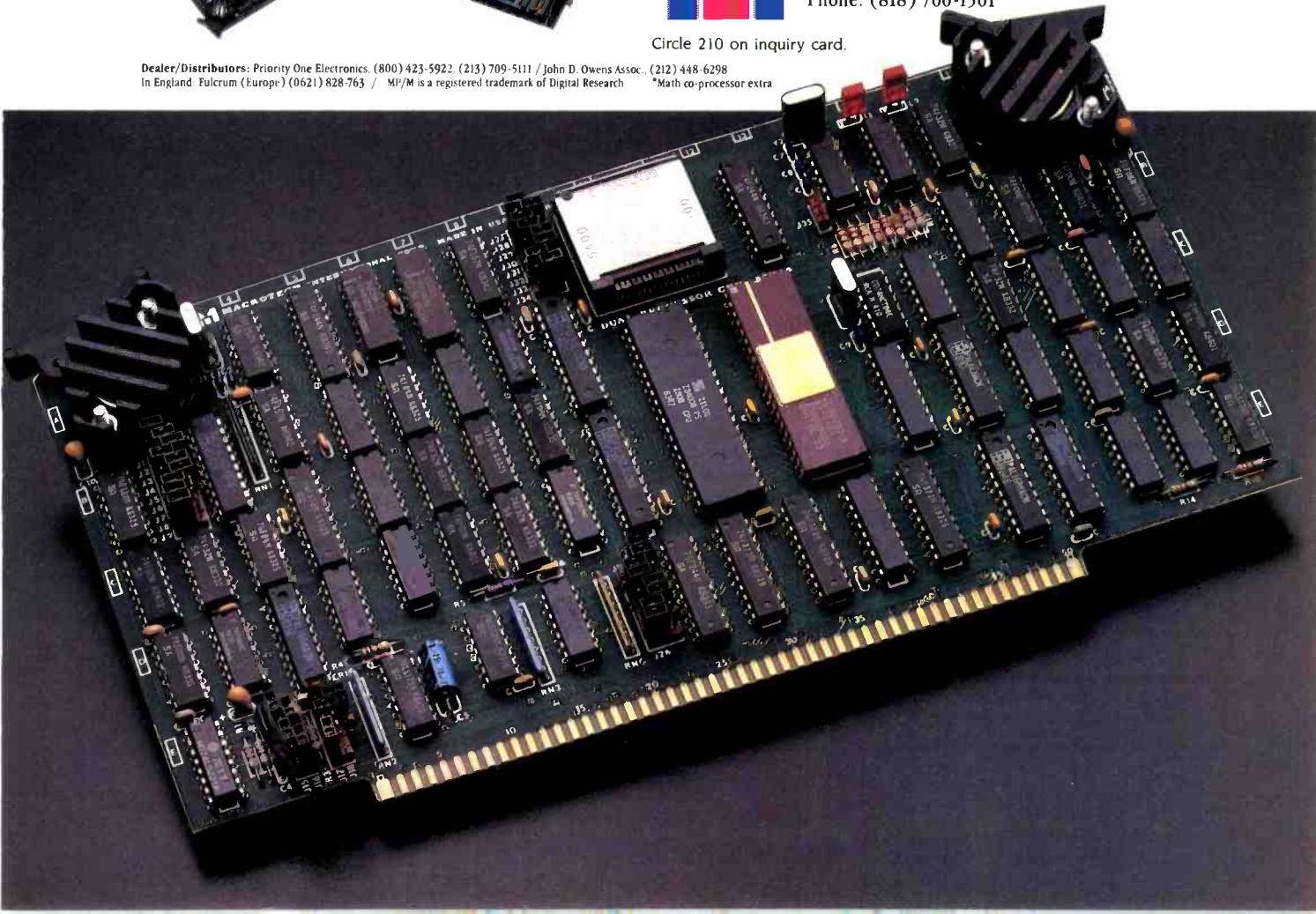



\*IBM® PC Compatible



E-PROMS — Call! Lowest Prices Anywhere

\*4164-150/200 ..... 4<sup>80</sup>  
 2764-250 ..... 6<sup>75</sup>  
 6116-LP3 ..... 4<sup>99</sup>  
 HMM 256K. .... Call for quote  
 TTL Parts — now avail ..... Call

**Disk Drives:** (F.O.B. Tampa)

\*TM-100-2 or Half-Heights. . . . 169<sup>95</sup>  
 \*1 pr. Teac Drives. . . . . 299<sup>99</sup>  
 \*10 mb Microscience  
 w/cable & controller . . . . . 959<sup>99</sup>

Add \$3.95 shipping to all orders • Prices subject to change • P.O.'s on approval • C.O.D. OK • All new, no surplus, no seconds, QUANTITY DISCOUNTS.  
 4920 Cypress St., Ste. 100, Tampa, FL 33607  
 In FL and for info, call 813-875-0299

**FOR ORDERS ONLY, 800-237-8910**



8 AM-7 PM EDT

Circle 272 on Inquiry card.



**Sure  
it's insured?**

SAFEWARE Insurance provides full replacement of hardware, media and purchased software. As little as \$35/yr covers:

- Fire • Theft • Power Surges
- Earthquake • Water Damage • Auto Accident

For information or immediate coverage call:

**1-800-848-3469**

In Ohio call (614) 262-0559



SAFEWARE, THE INSURANCE AGENCY INC.

Circle 397 on inquiry card.



		100 Qty	20 Qty
5 1/4	SS DD 104/1D	1.97	2.10
	DS DD 104/2D	2.66	2.82
8	SS SD 3740/1	2.50	2.65
	DS DD 3740/2D	3.18	3.36



		1.74	1.86
5 1/4	SS DD MD1	1.74	1.86
	DS DD MD2	2.29	2.44
8	SS DD FD1	2.79	2.95
	DS DD FD2	3.07	3.24



		1.40	1.52
5 1/4	SS SD M11A	1.40	1.52
	DS DD M14A	2.12	2.26
8	SS SD F11A	1.67	1.80
	SS DD F13A	2.36	2.51

**CALL 818-706-8602**

★ Credit For USA Direct Dial Call With Any Disk Order. ★



5505 Softwind Way  
 Agoura Hills, CA 91301  
 Free Price List Available



Circle 107 on inquiry card.

DATA ABSTRACTION

Listing 1: Program for testing the intset abstraction.

```

100 GOSUB 1000 'initialize INTSET storage
110 T=-1: F=0 'initialize TRUE and FALSE
200 INPUT C$,P1,P2: IF C$ < "a" THEN C$ = CHR$(ASC(C$) + 32)
250 IF C$ = "c" THEN 260 ELSE 300
260 GOSUB 1100 'create()
270 IF NOT OS THEN GOSUB 1600 'display(s)
280 GOTO 200
300 IF C$ = "d" THEN 310 ELSE 350
310 S=P1: GOSUB 1600 'display(p1)
320 GOTO 200
350 IF C$ = "e" THEN 360 ELSE 400
360 S=P1: GOSUB 1400 'is-empty(p1)
370 IF NOT NS THEN IF B THEN PRINT "True" ELSE PRINT "False"
380 GOTO 200
400 IF C$ = "i" THEN 410 ELSE 450
410 S=P1: X=P2: GOSUB 1200 'insert(p1,p2)
420 IF NOT NS THEN GOSUB 1600 'display(s)
430 GOTO 200
450 IF C$ = "k" THEN 460 ELSE 500
460 S=P1: GOSUB 1700 'kill(p1)
470 IF NOT NS THEN PRINT "Set";S;"deleted"
480 GOTO 200
500 IF C$ = "m" THEN 510 ELSE 550
510 S=P1: X=P2: GOSUB 1500 'is-member(p1,p2)
520 IF NOT NS AND NOT NI THEN IF B THEN PRINT "True" ELSE PRINT "False"
530 GOTO 200
550 IF C$ = "q" THEN 560 ELSE 600
560 STOP 'quit program
600 IF C$ = "r" THEN 610 ELSE 650
610 S=P1: X=P2: GOSUB 1300 'remove(p1,p2)
620 IF NOT NS THEN GOSUB 1600 'display(s)
630 GOTO 200
650 IF C$ = "u" THEN 660 ELSE 700
660 S1=P1: S2=P2: GOSUB 1900 'union(p1,p2)
670 IF NOT NS AND NOT OS THEN GOSUB 1600 'display(s)
680 GOTO 200
700 IF C$ = "x" THEN 710 ELSE 750
710 S1=P1: S2=P2: GOSUB 1800 'intersect(p1,p2)
720 IF NOT NS AND NOT OS THEN GOSUB 1600 'display(s)
730 GOTO 200
750 PRINT "Unrecognized command": GOTO 200
    
```

Listing 2: Matrix implementation of intset abstraction.

```

1000 'Abstract data type: INTSET
1005 '
1010 'Representation:
1015 'Each row of matrix S(10,10) stores a set. There is thus
1020 'a maximum of 11 sets (numbered 0 to 10). If the 0 element
1025 'of a row is -1, then that set has not been created.
1030 'That leaves columns 1 to 10 for set elements. A cell with
1035 'value -1 is empty; otherwise the cell contains an element
1040 'of the set
1050 'Initialize the INTSET storage:
1060 DIM S(10,10)
1070 FOR I=0 TO 10: FOR J=0 TO 10: S(I,J)=-1: NEXT J,I
1080 RETURN
1095 '
1100 'create() returns(s) signals(os) local(i)
1110 'OS=F
    
```

(continued)

Circle 255 on inquiry card. →

# New Calais from Oldsmobile.

## Building a car of this quality meant revolutionizing the way cars are built.



Of all the things that changed when the 1985 front-wheel-drive Calais was created, what changed most was the thinking behind it. It was clear, the only way to build a car to these exacting standards was to build it a whole new way.

It starts with computer design to engineer in quality from the word go.

On the assembly line, work teams take over. Every member receives 40 to 100 hours of specialized training before a single bolt is tightened. Over 200 robots

ensure that welds are computer precise. And the critical parts of the body are electro-chemically coated to fight rust.

Another innovation: a computer-built, full-size model of the new Calais to help assure precise fit. Like a giant jigsaw puzzle, it makes sure parts fit the way they're supposed to. If the size of a fender is even 1/1000th of an inch off, electronic sensors will catch it.

One thing, though, hasn't changed where the new Olds Calais is concerned. It's that special Oldsmobile feeling of pride you enjoy every time you take a ride.

The new Olds Calais. Test drive one. You'll agree everything about it is, well, downright revolutionary.



*Calais*



There is a special feel  
in an

*Oldsmobile*





## SINGLE BOARD COMPUTER

### ZINGER ONE

INS 8073 CPU WITH TINY BASIC INCL.  
2K RAM EXPANDABLE TO 12K ON BOARD  
RAM/ROM INTERCHANGEABLE  
EXPANDABLE TO 56K RAM/ROM OFF BOARD  
EEPROM PROGRAMMER ON BOARD  
24 LINE 3 PORT PARALLEL I/O (8255)  
REQUIRES +5V @ 300 MA ONLY  
ON BOARD SWITCHING POWER SUPPLY  
EIA - RS 232 I/O PORT  
IDEAL FOR CONTROL OR ROBOTICS  
\*\*\*\* \$119.95 ASMBLD & TESTED \*\*\*\*

### ZINGER INTERFACE BOARD

MAY BE PURCHASED WITH ANY OR ALL COMB.  
276 WORD SPEECH SYNTHESIZER  
8 CHANNEL A/D CONVERTER  
REAL TIME CLOCK WITH BATT. BACKUP  
24 LINE 3 PORT PARALLEL I/O (8255)  
64 KEY KEYBOARD INTERFACE  
8 CHAR ALPHA/NUMERIC DISPLAY  
INTERRUPT REGISTER ON ALL DEVICES  
COMMODORE VIC 20  
ADAPTER AVAILABLE

### SCHULZ ENTERPRISES INC.

1285 LAS TUNAS DR.  
SAN GABRIEL, CA 91776  
(818) 287-5067

Circle 322 on inquiry card.

## SPEED UP YOUR dBASE PROGRAMS

with dB/RA, dBRX,  
dBRx/87,  
dHELPER & RA+

Add arrays, math functions,  
8087 support, syntax  
checking, animation &  
windowing.

Call or write for details!



**GRYPHON**  
microproducts

P.O. BOX 6543 SILVER SPRING, MD. 20906  
(301) 946-2585

See us at COMDEX in Las Vegas

## DATA ABSTRACTION

```

1120 FOR I=0 TO 10 'find first unused set
1130 IF S(I,0)=-1 THEN S(I,0)=0: S=I: GOTO 1150
1140 NEXT I: OS=T: PRINT "Out of sets"
1150 RETURN 1195 '
1195 '
1200 'insert(s,x) returns(s) signals(ns,ni,nr) local(i,j)
1210 GOSUB 2000: IF NS THEN RETURN
1220 GOSUB 2100: IF NI THEN RETURN
1230 NR=F: J=0 'J holds first available cell
1240 FOR I=10 TO 1 STEP -1
1250 IF S(S,I)=X THEN RETURN 'no duplicates in a set
1260 IF S(S,I)=-1 THEN J=I
1270 NEXT I
1280 IF J=0 THEN NR=T: PRINT "No more room in set":S: ELSE S(S,J)=X
1290 RETURN
1295 '
1300 'remove(s,x) returns(s) signals(ns) local(i)
1310 GOSUB 2000: IF NS THEN RETURN
1320 GOSUB 2100: IF NI THEN RETURN
1330 FOR I=1 TO 10
1340 IF S(S,I)=X THEN S(S,I)=-1
1350 NEXT I
1360 RETURN
1395 '
1400 'is-empty(s) returns(b) signals(ns) local(i)
1410 GOSUB 2000: IF NS THEN RETURN
1420 B=T
1430 FOR I=1 TO 10
1440 IF S(S,I)>-1 THEN B=F 'test for a used cell
1450 NEXT I
1460 RETURN
1495 '
1500 'is-member(s,x) returns(b) signals(ns) local(i)
1510 GOSUB 2000: IF NS THEN RETURN
1520 GOSUB 2100: IF NI THEN RETURN
1530 B=F
1540 FOR I=1 TO 10
1550 IF S(S,I)=X THEN B=T
1560 NEXT I
1570 RETURN
1595 '
1600 'display(s) signals(ns) local(i)
1610 GOSUB 2000: IF NS THEN RETURN
1620 PRINT "Set";S;"; ";
1630 FOR I=1 TO 10: IF S(S,I)<>-1 THEN PRINT S(S,I);
1640 NEXT I: PRINT "}"
1650 RETURN
1695 '
1700 'kill(s) signals(ns) local(i)
1710 GOSUB 2000: IF NS THEN RETURN
1720 FOR I=0 TO 10
1730 S(S,I)=-1 'every cell becomes unused
1740 NEXT I
1750 RETURN
1795 '
1800 'intersect(s1,s2) returns(s) signals(ns,os) local(i,j,k)
1810 S=S1: GOSUB 2000: IF NS THEN RETURN
1815 S=S2: GOSUB 2000: IF NS THEN RETURN
1820 GOSUB 1100: S3=S: IF OS THEN RETURN 'create new set for result
1830 FOR K=1 TO 10
1840 IF S(S1,K)=-1 THEN 1860 'for each member of first set,
1850 X=S(S1,K): S=S2: GOSUB 1500 'if it is a member of second set,
1855 IF B THEN S=S3: GOSUB 1200 'then insert into result
1860 NEXT K

```

(continued)

**3M** THE RELIABLE  
**3M** ONE  
**3M** DAY AFTER DAY  
**3M** 5 1/4 Diskettes  
**3M** Hard or Soft Sector with  
Reinforced Hub (RH)  
UNLIMITED WARRANTY.  
Sold in Boxes of 10.

Single Sided, Double Density ..... \$1.62  
Double Sided, Double Density ..... \$2.19  
SS-DD-96TPI-RH ..... \$2.45  
DS-DD-96TPI-RH ..... \$3.05  
10% Surcharge for quantities less than 50 diskettes

### Attention

\* Software Duplicators \* Bulk - No logo  
Call for Special Pricing on orders of 50 or more only.



**Precision Data Products**  
P.O. Box 8367, Grand Rapids, MI 49508  
(616) 452-3457 • Michigan 1-800-632-2468  
Outside Michigan 1-800-258-0028

MI Residents, Add 4%  
Sales Tax.  
Shipping & Handling,  
Add \$3.00/100  
C.O.D. Add \$2.00

ORDER  
TOLL-FREE



C.O.D.

Circle 281 on inquiry card.

# What's the best recommendation you can make when you're asked about business graphics?



## The Business Professional Plotter from Hewlett-Packard — The 6-Pen HP 7475A

Today, business professionals are more aware of the vital importance of business graphics to their success. Tomorrow, they may ask for your recommendation. Here's some important information that will help. Tell them...

### Make a first impression that lasts

Truly impressive graphic presentations can create a first impression of quality and professionalism that lasts and lasts. The way you present your information can be equally as important as the information you're presenting. And that's where the HP 7475A Business Professional Plotter lets your professionalism shine through.

### Standards unsurpassed in the plotter business

The technical standards of the HP 7475A have no equal for producing quality graphics. With a resolution of one-thousandth-of-an-inch, curved lines are smooth, not jagged, and straight lines are consistently straight. Its exceptional repeatability (the ability of a pen to return *precisely* to a given point) assures that intersecting lines and circular shapes will meet *exactly*.

### Compatible with almost any personal computer in your office and supported on today's most popular graphics software packages

The HP 7475A quickly "makes friends" with most of the personal computers you may already have in your office, including IBM®, Apple™, and Compaq™—as well as a host of HP computers. You even have a choice of many off-the-shelf software packages, such as Lotus 1-2-3™ and Symphony™, that give you "first-day" productivity with the HP 7475A.

### Your Choice: 2 media sizes

While most professional business applications will be satisfied with standard 8½ x 11" paper or transparencies, the HP 7475A adds the capability of plotting on larger 11 x 17" media, too.

### The cost? Surprisingly affordable

The HP 7475A Business Professional Plotter is an amazingly affordable \$1895. When you consider the high cost of having your graphics prepared by an outside service, you'll find the return on your investment is almost immediate.

## Another choice: HP's low-cost, high performance Personal Computer Plotter

For the "business on a budget," you may also want a look at our 2-pen Personal Computer Plotter, the HP 7470A. Its low-cost (only \$1095) is as remarkable as the quality of its plots. With many of the same features as the HP 7475A, the HP 7470A plots on media up to 8½ x 11." It stores and caps two-pens, and you can easily change the pens for multi-color plotting.

### Send for your FREE "Better Presentations Package" today!

For a FREE sample plot, overhead transparency, and more details, mail the coupon below. We'll also enclose a list of graphics software packages you can use right "off-the-shelf."

For the name of your nearest Hewlett-Packard dealer, call toll-free 800-547-3400.



1101404

**YES!** I want to make the most informed business graphics recommendation I can. Please send me your FREE "Better Presentation Package," so I can learn more about the HP 7475A Business Professional Plotter and the HP 7470A Personal Computer Plotter. I understand I will receive this valuable package without cost or obligation.

Name \_\_\_\_\_ Title \_\_\_\_\_

Company \_\_\_\_\_

Address \_\_\_\_\_

City, State & Zip \_\_\_\_\_

Phone Number (     ) \_\_\_\_\_

My computer is \_\_\_\_\_

Send to: Hewlett-Packard, 16399 W. Bernardo Drive,  
San Diego, CA 92127-1899  
Attn: Marketing Communications

11404 BTO

1-2-3 and Symphony are trademarks of Lotus Development Corporation

Circle 385 on inquiry card.



```

1870 S=S3: RETURN
1895 '
1900 'union(s1,s2) returns(s) signals(ns,os,nr) local (i,j,k)
1910 S=S1: GOSUB 2000: IF NS THEN RETURN
1915 S=S2: GOSUB 2000: IF NS THEN RETURN
1920 GOSUB 1100: S3=S: IF OS THEN RETURN 'create new set for result
1930 FOR I=1 TO 10
1935 S(S3,I)=S(S1,I) 'copy first set into result
1940 NEXT I
1950 FOR K=1 TO 10
1960 IF S(S2,K)=-1 THEN 1980 'for each member of second set,
1970 S=S3: X=S(S2,K): GOSUB 1200 'insert it into result
1975 IF NR THEN 1990
1980 NEXT K
1990 RETURN
1995 '
2000 'is-valid-set(s) return(ns)
2010 IF S<0 OR S>10 THEN NS=T: PRINT S;"not a valid set number": RETURN
2020 IF S(S,0)=-1 THEN NS=T: PRINT "Set";S;"not created yet": RETURN
2030 NS=F: RETURN
2095 '
2100 'is-not-integer(x) returns(ni)
2110 IF X<0 OR X<>INT(X) THEN NI=T:PRINT X;"not a valid integer";RETURN
2120 NI=F:RETURN
    
```

ables used (that is, those not part of the concrete representation or the user interface) do not conflict with those used elsewhere, whether in another abstraction, the calling procedure, or in other operations of the same data type. For this reason it is advisable to add one more item of information to the header for each operation, namely, a list of the additional local variables that it uses. Note that this is done in listing 2.

The local variables are ones that the operations use temporarily. Whatever value they may have had previously is destroyed. When a subroutine returns, their value is undefined and they are free to be used again. Keeping track of local variables becomes tricky (and imperative) when one operation calls another. The implementation of intersect (line 1800 and following) is a case in point. One

(continued)

**Technologically Superior**

**Syntech Data Systems (SD)**  
**S-100 Boards at a Discount**

including...but not limited to...

- CPU 8/16 - dual processor-Z80 & 8088... \$785.00  
Plus many other features
- Dynamic Ram - 256k up to 2 MB... Starting at... \$750.00
- SBC 300 - single board computer-master or slave... \$615.00
- Versafloppy II - controls up to 4 floppy drives... \$330.00
- I/08-I/04 - 4 or 8 serial channels...starting at... \$575.00
- Hard Disk Controller - up to 4 winchester drives... \$525.00
- Z80 Starter Kit - Kit form or A&T...starting at... \$469.00

Many More Boards & Systems Available...  
 Call for details...

**PLUS**  
 Concurrent CP/M only \$125.00\*  
 \* With any CPU 8/16 purchase

For more information call: 301-942-5442

**MCC** MICRO COMPUTER COMPANY INC  
 101 Wheaton Pike North Wheaton, Maryland 20802  
 SALES \* SERVICE \* SUPPORT

Mention this ad for FREE FREIGHT

**MEGA-BYTES FOR MICRO-BUDGETS**  
 expand your system...shrink your cost.

Why pay more for top quality products when our prices are consistently among the lowest anywhere?  
 We invite you to compare prices, then call us.

**MISC. PERIPHERALS**

HAYES SMARTMODEM 1200B (IBM-PC).....	\$399.50
HAYES SMARTMODEM 1200 (RS-232).....	489.50
HAYES CHRONOGRAPH.....	189.50
ROLAND DG XY800 6 PEN PLOTTER.....	799.50
BAUSCH&LOMB DMP-29 PLOTTER.....	1885.00
PENCEPT PENPAD 320.....	900.00
PRINCETON GRAPHICS SYSTEMS HX-12.....	Call

**EPSON PRINTERS**

MX-100.....	\$475.00	RX-80.....	\$309.00
FX-80.....	489.00	RX-80 F/T.....	375.00
FX-100.....	689.00	LQ-1500.....	1135.00
<b>DYSAN DISKETTES (Box of 10)</b>		<b>3740/1 8" SSSD.....</b>	<b>\$32.39</b>
104/1 5 1/4" SSSD.....	\$31.20	<b>3740/1D 8" SSDD.....</b>	<b>40.19</b>
104/1D 5 1/4" SSDD.....	32.98	<b>3740/2 8" DSDD.....</b>	<b>40.19</b>
104/2D 5 1/4" DSDD.....	38.99	<b>3740/2D 8" DSDD.....</b>	<b>46.89</b>

**GREAT LAKES (PEGASUS) HARD DISK SYSTEMS**

10 MEGABYTE INTERNAL.....	\$1149.00
10 MEGABYTE EXTERNAL.....	1295.00
23 MEGABYTE EXTERNAL.....	1895.00
40 MEGABYTE EXTERNAL.....	2449.00
65 MEGABYTE EXTERNAL.....	3249.00
140 MEGABYTE EXTERNAL.....	4995.00
TAPE DRIVE 23 MEGABYTE INTERNAL.....	950.00
TAPE DRIVE 23 MEGABYTE STAND ALONE.....	1249.00

**COMMERCIAL BUSINESS SYSTEMS**

2858 S. ROBERTSON BLVD., LOS ANGELES, CA 90034

ORDERS ONLY 800-858-4810  
 IN CALIF. 800-821-6662



INFORMATION  
 (213) 559-0596

Phone orders accepted on Visa and MC only. CA residents add 6 1/2% sales tax. No COD. Actual shipping and handling charge added to all orders. Prepaid orders as follows: M.O. or cashier's check—merchandise shipped upon receipt. Personal checks must clear before shipping. 20% restocking fee. Prices and availability subject to change. \$100 min. order.



ENGINEERS

# A Telecommunications Engineering Revolution in Progress

The time is now and the company is Hayes Microcomputer Products, Inc. in Atlanta. . . America's emerging super high technology arena.

Here at Hayes we've designed and supported an engineering environment free of constraints. We've promoted an atmosphere that encourages each individual's unique ability to make a contribution — to see a project through from concept to completion.

For those among you who look to achieve, perhaps it's time to take a good hard look at Hayes. There's a future in it.

HARDWARE/MICROPROCESSOR  
DESIGN ENGINEERS

SOFTWARE DEVELOPMENT  
PROGRAMMERS/ANALYSTS

VLSI/DSP DEVELOPMENT ENGINEERS  
PRODUCT ENGINEERS

Interested, qualified candidates should forward a confidential resume to:  
**Hayes Microcomputer Products, Inc.,**  
Dept. TJC-84, 5923 Peachtree Industrial  
Blvd., Norcross, GA 30092. An Equal  
Opportunity Employer M/F.

Opportunity for  
the here and now.

 **Hayes**<sup>®</sup>

Hayes Microcomputer Products Inc.





*Data abstraction allows you to modify a program simply by changing a module's implementation.*

would be tempted to use I as the local indexing variable as is done in all other operations. However, intersect calls insert (line 1200 and following), which already uses I and J as local variables; we see this by looking at the local statement in the header of insert. This alerts us to the fact that if we use I in intersect we are in for trouble; every call to insert would destroy its value. Thus, we use a new variable, K. Note also that the local variables for intersect are given as I, J, and K, even though I and J do not appear in the code for the intersect operation. This is because a pro-

cedure always inherits the local variables of any procedure it calls.

**MAINTENANCE AND PORTABILITY**

From the perspective of the program code that is outside an abstract data type, we have already seen that an advantage of programming with data abstractions is that you can write programs that use them without knowing how they are implemented on the inside. Now we take the perspective of the program code inside the abstract data type and see that an advantage of programming with data abstractions is that you can modify the implementation without affecting the outside programs that use it. This is a boon for maintaining a program and porting it to other systems.

For instance, suppose we decided that limiting our sets to a maximum of 10 elements (as does the implementation of listing 2) is too restrict-

ing. We decide we want to modify our program to allow for sets of up to 20 elements. Because the information about how the intset abstraction is represented is hidden inside the intset module, any programs that use the abstraction (in this case the test program of listing 1) are not affected. The only changes to make include redefining the matrix dimensions in the initialization procedure (lines 1050-1080) and changing the upper bound of the FOR statements in all the subroutines for the operations. We soon discover that this latter change gets rather tedious and that we would have been better off in the first place to make the maximum size of a set a variable in the concrete representation of intset, and then to use that variable in the FOR loops for all the subroutines. Then changing the maximum size of sets would mean chang-

*(continued)*

# WOW!



**IBM PC**  
**\$1399.95**

**OKIDATA 92**  
**\$369.95**

**PRINTERS**

Okidata 92	369	Gemini 10X	234	Juki 6100	359
Okidata 93	569	Gemini 15X	349	Tractor	114
Okidata 82	309	Radix 15	554	Panasonic KXP 1091	269
Okidata 83	524	Radix 10	519	Panasonic KXP 1090	199
Epson RX80 FX	290	Brother HR15	344	Silver Reed EXP 550	369
Epson RX80	239	Brother HR25	569	Silver Reed EXP 500	319
Epson RX100	479	Brother HR35	759	Silver Reed EXP 770	809
Epson FX80	414	Keyboard	129	Itoh Pwriter 8510	959
Delta 10	339	Tractor	79	Stirwriter F10	1389
Delta 15	489	Cut Feed	169	Nec 3550	1389

800-441-1144

**IBM**

PC 64K	1399
PC XT	3299
Printer Card	89
Tandon Drive	169
Monitor Card	139
Color Card	169
IBM Monitor (GRN)	244
Hercules Graphic Master	309
Koala Pad	74
Tecmar Caplan 64K	269
AST Six Pack	239
Tailgrass 20 Meg	2895



**APPLE**

2E w/Disk Drive	799
Macintosh	1749
Apple 2C	939
Imagewriter	499
Printer Card	79
CPM 2.2 Card	109
RGB Card	124
Att. Drives From \$99 & Up	69
System Saver Fan	74
Koala Pad	74

**MONITORS**

Amdek 300 Green	114	<b>COMMODORE</b>	184
Amdek 300 Amber	124	Commodore 64	154
Color 1	234	Disk Drive	214
Color 2	349	1702 Monitor	214
Color 3	549	MPS801 Printer	179
310 Amber	134	1526 Printer	224
BMC Green	89	1650 Modem	89
Banana Green	74	<b>FRANKLIN</b>	
Taxan 210	209	Micromodem 2E	209
		1000 Pro	679
		1200 OMS	1059

**MODEMS**

Hayes 1200	424
Hayes 1200B	364
Hayes 300	189
Access 123	339
Novation Scat	88

**ATARI**

800 XL	169
1027 Printer	169
1050 Drive	169

**HARMONY VIDEO & COMPUTERS**  
2357 CONEY ISLAND AVE., BROOKLYN, NY 11223  
TO ORDER CALL TOLL FREE  
800-VIDE084 OR 212-627-1000 OR 800-441-1144

## MICRO CONTROLLED DIGITAL DATA RECORDER

**FEATURES:**

- Microprocessor controlled data buffering
- Buffers data in RAM
- Data comes in at any standard baud rate, plays back at any baud rate (switchable)
- Tape runs only during block record/playback
- RS232 input/output 110/220 v ac or 12 v dc • 1.2 MB per tape side
- Uses chrome oxide audio cassettes
- Has hold-off during playback via CTS line
- No data hold-off during record.



**APPLICATIONS:**

PROCESS CONTROL • POINT OF SALE • TELEPHONE SWITCH LOGGING (SMDR) • INSTRUMENTATION • DIAGNOSTIC SUPPORT • PROGRAM LOADING • DATA LOGGING.

**BUFFERED VERSION MODEL PD1-BF . . . . . \$595.00**  
**NON BUFFERED VERSION - MODEL PD-1 . . . . . \$335.00**



**TO ORDER, DIAL:**  
**(201) 356-9200**

236 Lackland Drive  
Middlesex, N.J. 08846

# Rio Plus II™ For The IBM PC Or XT. The "One Slot" Winner.



## All The Power & Performance *You Can Handle* In One Exceptional Multi-Function Board.

When it comes to getting more usable features, greater performance, and better benefits into—and out of—your IBM Personal Computer... Rio Plus II is the *very best* multi-function board you can buy. Why? Because the Rio Plus II includes the very best features of *two* power-packed multi-function boards (the Rio Plus, and Super Rio)—conveniently built into *one*. Without a bet, the Rio Plus II offers the *most complete* one slot answer to your need for greater memory and additional ports.

### "Pack" The Odds In Your Favor

Now, you can have almost everything you want or need. All in one slot. Rio Plus II gives you: One or two serial ports; a parallel port; an IBM compatible game port; the 'PC Accelerator' software (offering emulation of *two* RAM disks and a parallel print buffer); a battery operated clock calendar (remembers date/time even with PC turned off); and *additional memory* of up to 384K.

Using the RS-232C serial ports, you can easily connect

mice, modems, plotters, (serial) printers, or other necessary peripherals. With the parallel port, you'll be able to operate any IBM compatible (parallel) printer, or SASI (Shugart Associates Standard Interface) hard disk controller. And courtesy of the PC Accelerator™, you get printer buffering and RAM disks which can even survive a warm boot. (For example, do an ordinary reset, and all the data entered on both RAM disks will *still* be there. *Everytime.*)

### The Winning Combination

Rio Plus II is totally software compatible with IBM's hardware adapter boards. And, the Rio Plus II saves you time, money, slots...*and* hassle. You'll have additional memory and functions available—*exactly* when you need them. At a

price that's *very* competitive. And just think what you can do with all the *other* slots.

Rio Plus II. The only (card) game in town that *consistently* lets you win big. See your local dealer for the inside story. Or call or write STB Systems, Inc., 601 North Glenville, Richardson, Texas 75081 (214) 234-8750.



**STB**™  
STB Systems, Inc.

Circle 342 on inquiry card.

IBM PC, XT are registered trademarks of International Business Machines Corporation.

**Expanding Microcomputing**

PC Accelerator is a registered trademark of ResiCorp.



# MEMOREX

## SAVE 50% ON DATA RELIABLE DISCS

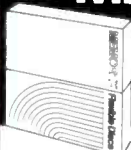

Dealer Inquiries Invited

**5 1/4"** Specify Soft  
10 or 16 Sector Box/10  
3481 1 side/dbl dens.....**\$22.30**  
3491 2 sides/dbl dens.....**\$30.70**  
3504 1 side/quad 96 tpi.....**\$30.00**  
3501 2 sides/quad 96 tpi.....**\$39.30**

**8"** Specify Soft or 32 Sector  
3062 1 side/sgl dens.....**\$22.10**  
3090 1 side/dbl dens.....**\$28.90**  
3102 2 sides/dbl dens.....**\$33.80**

Checks-VISA-MC-C.O.D./Add \$2 Shipping  
Call or write for our discount catalog.

**LYBEN COMPUTER SYSTEMS**

1250 Rankin, Bldg. E, Troy, MI 48084  
Phone: (313) 777-7780

**CERTIFIED 100% ERROR-FREE**

Circle 207 on inquiry card.

## MEMORY MODULES

8Kx8  
CMOS  
RAM

**Radio Shack Model 100  
NEC PC-8201A  
Olivetti M10**

✓ Suggested List \$120.00.  
Purpl Price **\$59.95**

- ✓ Low power CMOS design.
- ✓ Simple installation.
- ✓ 30 day satisfaction guarantee or your money back.
- ✓ 1 Year warranty.
- ✓ Next day shipment via UPS included in price.
- ✓ Optional Memory Test program \$15. (Cassette)
- ✓ No frills direct connect Modem Cable - \$9.95

Shipping: From stock. Free UPS surface Cont. USA —  
Add \$4.00 for UPS 2 day Air — Add \$7.00 for Canada  
— Payment: VISA, Master Card, or American Express.  
Checks held 14 days — Tax: 6% (Calif only).

**CALL NOW**

PURPLE COMPUTING  
2068 Ventura Blvd. Camarillo, CA 93010  
1 - (800) 732-5012  
Calif (805) 987-4788

VISA  
Master Card  
American Express

Circle 296 on inquiry card.

## STAND-BY POWER SUPPLY



- 200 WATTS
- 10 MINUTE  
BACKUP TIME
- BATTERY  
INCLUDED

Fits most desktop and portable computers.  
Complete, just plug it in. 4-(3 prong) outlets  
on back protected by line filters. Neat, clean  
appearance on desk. Don't risk damage or  
data loss with POWER FAILURES.

MODEL BC200-10



**\$299\***



Units available to 1000 Watts

**312-490-9239**  
**SHEPHERD MARKETING**  
P.O. BOX 941339  
SCHAUMBURG, IL 60194

\*Add \$7 each shipping & handling

Circle 328 on Inquiry card.

## DATA ABSTRACTION

ing only one assignment statement in the concrete representation of the data type. In any case, all program modifications are confined to the intset module.

Unfilled sets waste space, and increasing the size of the matrix to accommodate potentially larger sets has the disadvantage of wasting even more space. One solution is to represent an intset as a linked list of elements so that the set never uses more memory than it needs. With such a scheme, the maximum length

of a set depends on the total length of all other sets, rather than a fixed limit for each set.

Normally such a change would require a complete rewrite. When data abstraction is used, it means replacing only the implementation of the intset module; the programs that use intset change in no way. As an example, listing 3 gives a completely new implementation of the intset abstraction using a linked-list representation. This implementation adheres

(continued)

Listing 3: *Linked list implementation of intset abstraction.*

```

1000 'Abstract data type: INTSET
1005 '
1010 'Representation:
1015 ' ST(10) is the "Set Table"
1020 ' ST(I) specifies the address in S of the first element of set I
1025 ' ST(I) = -1 means set I not yet created
1030 ' S(100,1) stores the set elements
1035 ' Column 0 stores a set element
1040 ' Column 1 is link which specifies address in S of next element
1045 ' Column 0 value of -1 marks end of list (and of set)
1050 ' A points to next available cell of S
1055 ' Initially all cells of S are linked together on available list
1060 ' Initialize the INTSET storage:
1065 DIM ST(10): FOR I = 0 TO 10: ST(I) = -1: NEXT I
1070 DIM S(100,1): FOR I = 0 TO 99: S(I,1) = I + 1: NEXT I 'link all cells
1075 S(100,0) = -1: A = 0 'put entire list of cells on available list
1080 RETURN
1095 '
1100 'create() returns(s) signals (os) local(i,n)
1110 OS = F
1120 FOR I = 0 TO 10
1130 IF ST(I) = -1 THEN 1150 'find first unused set
1140 NEXT I: OS = T: PRINT "Out of sets": RETURN 'fail with OS if none
1150 GOSUB 2200: IF NR THEN OS = T: RETURN 'or if no more room
1160 ST(I) = N: S(N,0) = -1: S = I: RETURN 'initialize set
1195 '
1200 'insert(s,x) returns(s) signals(ns,ni,nr) local(i,n)
1210 GOSUB 2000: IF NS THEN RETURN
1220 GOSUB 2100: IF NI THEN RETURN
1230 GOSUB 1500: IF B THEN RETURN 'no duplicates
1240 GOSUB 2200: IF NR THEN RETURN
1250 S(N,1) = ST(S): ST(S) = N S(N,0) = X 'insert the element
1260 RETURN
1295 '
1300 'remove(s,x) returns(s) signals(ns,ni) local(i,j)
1310 GOSUB 2000: IF NS THEN RETURN
1320 GOSUB 2100: IF NI THEN RETURN
1330 I = ST(S): J = 0 'J will point to cell preceding one to remove
1340 IF S(I,0) = -1 THEN RETURN
1350 IF S(I,0) >> X THEN J = I: I = S(I,1): GOTO 1340 'find element to remove
1360 IF J = 0 THEN ST(S) = S(I,1) ELSE S(J,1) = S(I,1) 'remove it
1370 S(I,1) = A: A = I 'return removed cell to available list
1380 RETURN
1395 '
1400 'is-empty(s) returns(b) signals(ns)

```

(continued)



# Submarine Engineering. Tomorrow is today at NUSC

The Naval Underwater Systems Center is the Navy's principal research, development, test and evaluation center for submarine warfare and submarine weapon systems. We provide high technology vital to the Navy's tactical and strategic edge in combat systems (sonar, combat control, electromagnetics, underwater weapons and targets, weapon launch and handling), surface ship sonar and undersea ranges.

Engineers and scientists who join the Center's laboratories at Newport, Rhode Island and New Lon-



don, Connecticut, are encouraged to take responsibility almost immediately. They design, develop and test prototypes of these systems

and work with private industry on production of the final product.

"I got responsibility right away," says Ronald Jackson, an electronic engineer. "As I showed ability, my responsibility grew. Today, I'm a project engineer."

Through NUSC's liberal education policy, Ron has earned a master's since he joined Newport and is working toward a Ph.D.

Because the Center helps its scientists become expert in other fields, electronic engineer Donna Doane is concentrating on computer software. "I'm doing things people never have done before," Donna says. "I design the project, and I see it to the end—to the final product." Monica Sachs is learning something new each day. "I'm working on weapons systems engineering, a broad subject that allows you to get into several different kinds of engineering. I use my electronic engineering background to understand the other disciplines." And Peter Santiago applies his com-

puter background to quality assurance. "I look for self-gratification in the job, and I get that at NUSC."

We seek graduating and experienced electronic and computer engineers with degrees from accredited colleges and universities. We also need computer scientists with degrees from colleges and universities affiliated with a school of engineering and specializing in scientific and technical applications.

We offer you challenge, freedom to be innovative and creative, and the opportunity to contribute your skills to our national defense.

And the living is good, too! Newport and New London areas are popular for their excellent beaches, fishing and sailing.

We believe we have both the challenge and the opportunity for you. For further information, contact Naval Underwater Systems Center, Personnel Staffing Division, B Newport, Rhode Island 02841 or call (401) 841-3585.



**An Equal Opportunity Employer  
U.S. Citizenship Required**



```

1410 GOSUB 2000: IF NS THEN RETURN
1420 IF S(ST(S),0)=-1 THEN B=T ELSE B=F
1430 RETURN
1495 '
1500 'is-member(s,x) returns(b) signals(ns,ni) local(i)
1510 GOSUB 2000: IF NS THEN RETURN
1520 GOSUB 2100: IF NI THEN RETURN
1530 I=ST(S)
1540 IF S(I,0)=-1 THEN B=F: RETURN 'end of set, not found
1550 IF S(I,0)<>X THEN I=S(I,1): GOTO 1540 'not yet, keep looking
1560 B=T: RETURN 'it is found
1595 '
1600 'display(s) signals(ns) local(i)
1610 GOSUB 2000: IF NS THEN RETURN
1620 PRINT "Set";S;" = {";
1630 I=ST(S)
1640 IF S(I,0)=-1 THEN 1660
1650 PRINT S(I,0);: I=S(I,1): GOTO 1640
1660 PRINT " }": RETURN
1695 '
1700 'kill(s) signals(ns) local(i)
1710 GOSUB 2000: IF NS THEN RETURN
1720 I=ST(S)
1730 IF S(I,0)<>-1 THEN I=S(I,1): GOTO 1730 'find end of set
1740 S(I,0)=0: S(I,1)=A: A=ST(S) 'return cells to available list
1750 ST(S)=-1: RETURN 'mark ST entry unused
1795 '
1800 'intersect(s1,s2) returns(s) signals(ns,os) local(i,j,n)
1810 S=S1: GOSUB 2000: IF NS THEN RETURN
1815 S=S2: GOSUB 2000: IF NS THEN RETURN
1820 GOSUB 1100: S3=S: IF OS THEN RETURN 'create a new set for result
1830 J=ST(S1)
1840 IF S(J,0)=-1 THEN 1870
1850 X=S(J,0): S=S2: GOSUB 1500 'if a member of S1 is in S2,
1855 IF B THEN S=S3: GOSUB 1200:IF NR THEN 1870 'then insert in result
1860 J=S(J,1): GOTO 1840
1870 S=S3: RETURN
1895 '
1900 'union(s1,s2) returns(s) signals(ns,os,nr) local(i,j,n)
1910 S=S1: GOSUB 2000: IF NS THEN RETURN
1915 S=S2: GOSUB 2000: IF NS THEN RETURN
1920 GOSUB 1100: S3=S: IF OS THEN RETURN 'create a new set for result
1930 J=ST(S1) 'insert every element of S1 into result
1940 IF S(J,0)=-1 THEN 1960
1945 X=S(J,0): S=S3: GOSUB 1200: IF NR THEN 1990
1950 J=S(J,1): GOTO 1940
1960 J=ST(S2) 'insert every element of S2 into result
1970 IF S(J,0)=-1 THEN 1990
1975 X=S(J,0): S=S3: GOSUB 1200: IF NR THEN 1990
1980 J=S(J,1): GOTO 1970
1990 S=S3: RETURN
1995 '
2000 'is-not-set(s) returns(ns)
2010 IF S<0 OR S>10 THEN NS=T: PRINT S;"not a valid set number": RETURN
2020 IF ST(S)=-1 THEN NS=T: PRINT "Set";S;"not created yet": RETURN
2030 NS=F: RETURN
2095 '
2100 'is-not-integer(x) returns(ni)
2110 IF X<0 OR X<>INT(X) THEN NI=T:PRINT X;"not a valid integer":RETURN
2120 NI=F: RETURN
2195 '
2200 'get-next-cell() returns(n) signals(nr)
2210 IF S(A,0)=-1 THEN PRINT "No more room": NR=T: RETURN
2220 N=A: A=S(A,1): NR=F: RETURN

```

to the interface of figure 6 and therefore is equivalent to the matrix implementation in its external effects. The test program works equally well, whether one combines it with the intset module of listing 2 or the module of listing 3.

Since nearly any two implementations of BASIC differ in some details, BASIC programs turn out to be of limited portability in actual practice. Writing software in terms of data abstractions is an excellent way to enhance a program's ultimate portability. Information hiding localizes the details of implementation that are likely to be changed, such as variable names, matrix dimensions, and input/output protocols.

Passing parameters with assignment statements and calling GOSUB in most lines of a program can get tedious. It may often seem justifiable on the grounds of efficiency to access a data structure directly without going through the operations. You should avoid such temptations at all costs: you'll pay the price when it comes time to debug, enhance, or port the program. ■

#### REFERENCES

1. Guttag, J., and J. J. Horning. "The Algebraic Specification of Abstract Data Types." *Acta Informatica*, volume 10, 1978, pages 27-52.
2. Hoffman, C. M., and M. J. O'Donnell. "Programming with Equations." *ACM Transactions on Programming Languages and Systems*, volume 4, 1982, pages 83-112.
3. Liskov, B. "Modular Program Construction Using Abstraction." *Abstract Software Specifications*, D. Björner, ed. *Lecture Notes in Computer Science*, number 86. Berlin: Springer-Verlag, 1980, pages 354-389.
4. Parnas, D. L. "A Technique for Software Module Specification with Examples." *Communications of the ACM*, volume 15, 1972, pages 330-336. Reprinted in *Communications of the ACM*, volume 26, number 1, 1983.

#### ACKNOWLEDGMENTS

The author is indebted to two of his colleagues of the Summer Institute of Linguistics: to Graeme Costin for many helpful comments on an earlier draft of the article, and to Dr. Joseph E. Grimes (also of Cornell University) for some insights on programming with data abstractions in BASIC.

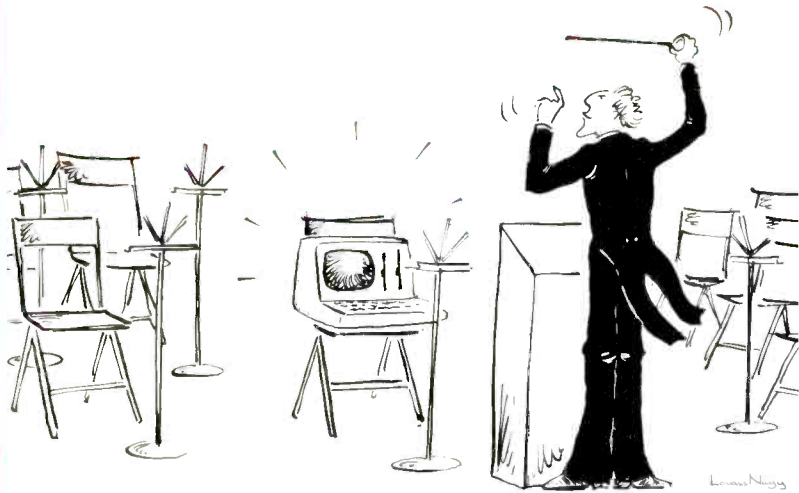

Would you hire an entire band when all you need is one instrument? Of course not.

So why use a whole orchestra of computers when all you need is one to develop software for virtually any type of micro-processor?

The secret? Avocet's family of cross-assemblers. With Avocet cross-assemblers you can develop software for practically every kind of processor — *without having to switch to another development system along the way!*

## Cross-Assemblers to Beat the Band!

### Development Tools That Work

Avocet cross-assemblers are fast, reliable and user-proven in over 4 years of actual use. Ask NASA, IBM, Xerox or the hundreds of other organizations that use them. Every time you see a new micro-processor-based product, there's a good chance it was developed with Avocet cross-assemblers.

Avocet cross-assemblers are easy to use. They run on almost any personal computer and process assembly language for the most popular microprocessor families.

### Your Computer Can Be A Complete Development System

Avocet has the tools you need to enter and assemble your soft-ware and finally cast it in EPROM:

**VEDIT Text Editor** makes source code entry a snap. Full-screen editing plus a TECO-like command mode for advanced tasks. Easy installation. INSTALL program supports over 40 terminals and personal computers. Customizable keyboard layout. CP/M-80, CP/M-86, MSDOS, PC DOS . . . . . \$150

**EPROM Programm**ers let you program, verify, compare, read, display EPROMS but cost less because they communicate through your personal computer or terminal. No personality modules! On-board intelligence provides menu-based setup for 34 different EPROMS, EEPROMS and MPUs (40-pin devices require socket adaptors). Self-contained unit with internal power supply, RS-232 interface, Textool ZIF socket. Driver software (sold separately) gives you access to all programmer features through your computer, lets you download cross-assembler output files, copy EPROM to disk.

**Model 7228 Advanced Programmer** — Supports all PROM types listed. Superfast "adaptive" programming algorithm programs 2764 in 1.1 minutes.

**Model 7128 Standard Programmer** — Lower-cost version of 7228. Supports all PROM types except "A" versions of 2764 and 27128. Standard programming algorithm programs 2764 in 6.8 minutes.

Avocet Cross-assembler	Target Microprocessor	CP/M-80	CP/M-86 IBM PC, MSDOS**
XASM04 <i>NEW</i>	6804	\$ 250.00	\$ 250.00
XASM05	6805	200.00	250.00
XASM09	6809	200.00	250.00
XASM18	1802/1805	200.00	250.00
XASM48	8048/8041	200.00	250.00
XASM51	8051	200.00	250.00
XASM65	6502/65C02	200.00	250.00
XASM68	6800/01, 6301	200.00	250.00
XASM75	NEC 7500	500.00	500.00
XASM85	8085	250.00	250.00
XASM400	COP400	300.00	300.00
XASMF8	F8/3870	300.00	300.00
XASMZ8	Z8	200.00	250.00
XASMZ80	Z80	250.00	250.00
XMAC682 <i>NEW</i>	68200	595.00	595.00
XMAC68K <i>NEW</i>	68000/68010	595.00	595.00

**Model 7956 and 7956-SA Gang Programmers** — Similar features to 7228, but program as many as 8 EPROMS at once. 7956-SA stand-alone version copies from a master EPROM. 7956 lab version has all features of stand-alone plus RS-232 interface.

**EPROM:** 2758, 2716, 2732, 2732A, 2764, 2764A, 27128, 27128A, 27256, 2508, 2516, 2532, 2564, 68764, 68766, 5133, 5143. **CMOS:** 27C16, 27C32, 27C64, MC6716. **EEPROM:** 5213, X2816A, 48016, I2816A, 5213H. **MPU (w/adaptor):** 8748, 8748H, 8749, 8749H, 8741, 8742, 8751, 8755.

7228	Advanced Programmer	\$ 549
7128	Standard Programmer	429
7956	Laboratory Gang Programmer	1099
7956-SA	Stand-Alone Gang Programmer	879
PDV	Driver Software	95
481	8748 Family Socket Adaptor	98
511	8751 Socket Adaptor	174
755	8755 Socket Adaptor	135
CABLE	RS-232 Cable (specify gender)	30

**HEXTRAN Universal HEX File Converter** — Convert assembler output to other formats for downloading to development systems and target boards. Also useful for examining object file, changing load addresses, extracting parts of files. Converts to and from Intel, Motorola, MOS, RCA, Fairchild, Tektronix, TI, Binary and HEX/ASCII Dump formats. For CP/M, CP/M-86, MSDOS, PC DOS . . . . . \$250

Ask about UNIX.

**AVOCET'S SUPERB 68000 CROSS-ASSEMBLER** — With exhaustive field testing completed, our 68000 assembler is available for immediate shipment. XMAC68K supports Motorola standard assembly language for the 68000 and 68010. Macros, cross-reference, structured assembly statements, instruction optimization and more. Linker and librarian included. Comprehensive, well-written manual. XMAC682 for MK68200 has similar features.

Call us toll-free for some straight talk about development systems.

**1-800-448-8500**

(in the U.S. Except Alaska and Hawaii)

VISA and Mastercard accepted. All popular disc formats now available. \*Please specify. Prices do not include shipping and handling - call for exact quotes. OEM INQUIRIES INVITED.

\*Trademark of Digital Research \*\*Trademark of Microsoft



**AVOCET SYSTEMS INC.™**

DEPT. 1084-B  
**804 SOUTH STATE STREET**  
**DOVER, DELAWARE 19901**  
**302-734-0151 TELEX 467210**



(continued from page 129)  
 sufficiently large (compared with the segment length,  $m$ ), the mapping will take the point out of the current segment at each jump. The successive positions of the point within each segment will then be an erratic function. You can consider these successive positions pseudorandom numbers if

you suppose each segment is renumbered from 0 to  $m-1$ , as in figure 2. You can accomplish such a subdivision of the  $I$ -space by introducing the modulus function

$$\text{mod}(I,m) = I - \lfloor I/m \rfloor m$$

where  $\lfloor I/m \rfloor$  is the integer part of the quotient, derived by truncation.

When, for example,  $\text{mod}(11,3) = 2$ , the result always lies between 0 and  $m-1$ . In some forms of BASIC, this is written  $11 \text{ MOD } 3$ .

Now rewrite the mapping as

$$I_{i+1} = \text{mod}(aI_i + c, m)$$

This equation is a general form for the LCG, and it produces a series of integers in the range  $0 < I_i < m-1$ . Three parameters describe this mapping: the multiplier ( $a$ ), the difference ( $c$ ), and the modulus ( $m$ ).

Often it is convenient to "normalize" the values, dividing each by the modulus. The result is a series in the range  $0$  to  $(m-1)/m < 1$ , which can be written as

$$x_{i+1} = \text{FLOAT}(I_{i+1}) / \text{FLOAT}(m)$$

Note that the smallest nonzero difference between terms is  $1/m$ , which means the numbers the LCG produces comprise a set of  $m$  equally spaced rational fractions in the range  $0 \leq x \leq (m-1)/m$ .

To see some of the properties of series that are generated this way, look at the following series:

$$I_{i+1} = \text{mod}(5I_i + 3, 8)$$

By starting with an arbitrary value, the "seed," and taking  $I_1 = 1$ , you find 1, 0, 3, 2, 5, 4, 7, 6, 1, 0, 3, 2, 5, . . . .

This series starts off with a haphazard appearance, but since it repeats itself every 8 terms, it is said to have a "period" of 8. It is not hard to see why this is the period. First, the modulus of the series is 8, so the series cannot have more than 8 integers. (You remove larger integers by subtracting the modulus.) Second, the series is deterministic. Each appearance of a particular integer must be followed by a uniquely determined integer. That is, each appearance of "2" must be followed by "5." As a result, the series must repeat itself with a period no longer than its modulus.

This reasoning suggests adopting a large modulus if you want a long period. But it isn't the only possibility. Some generators will skip many of the possible numbers and give an in-

(continued)

# Microshop

COMPUTER PRODUCTS

---

## MONITORS

Amdek 300	\$139.00
Amdek 300A	\$159.00
Amdek 310A	\$179.00
Amdek Color I	Best Price
Amdek Color II	Best Price
PGS-HX-12	\$480.00
PGS-MAX-12	\$195.00
PGS-SR-12	Best Price
IBM Monochrome Display	\$265.00
IBM Color Display	\$590.00

---

## PRINTERS

Epson FX 80	\$499.00
Epson FX 100	\$699.00
Okidata 92 A	\$465.00
Okidata 93 A	\$699.00
Okidata ML 84	\$899.00
Okidata 2410	\$2085.00
Okidata 2350	\$1925.00
Toshiba P1351 & 1340	Best Price
NEC Spinwriters 3550	\$1699.00
NEC Spinwriters 7730	\$1799.00
C-Ittoh Starwriter 40CPS	Best Price
C-Ittoh Printmaster 55CPS	Best Price
Gemini 10X	\$290.00
Gemini 15X	\$399.00

Also available DX-15, HR-25, HR-35, & Silver-Reed.

---

## DRIVES

Tandon TM 100-2	\$205.00
Slimline Drives - Your Choice - Toshiba, Hitachi, Panasonic	\$175.00

---

**IBM Personal Computer**

256KB Memory, DS/DD Drive, FDC, Color Card, Amdek 300 Monitor with 10MB Hard Disk Sub System.

\$2899.

(We configure and test the system for you at no extra cost)

---

## MULTIFUNCTION BOARDS

AST I/O + Ser & Par	\$179.00
AST Six Pack 64K	\$269.00
AST Mega Plus 64K	\$269.00
AST Combo 64K	\$269.00
Quadboard 64K	\$269.00
IBM Color Graphic Adapter	\$225.00
IBM Mono/Printer Adapter	\$240.00
Hercules Graphic	\$359.00
Plantronics	Best Price
Paradise Multifunction Card	Best Price
Orchid - Blossom	Best Price
64K Ram Upgrade Kit	\$50.00

---

## MODEMS

Hayes Smart Modem 1200	\$489.00
Hayes Smart Modem 300	\$209.00
Hayes 1200B Plug in Modem Card	\$429.00

---

## HARD DISK FOR IBM PC

10MB Hard Disk Sub System includes: Software, Controller Cables, Etc.

Internal	\$875.00
External	\$1025.00

---

Many other products available, Please call for low - low Prices!

Microshop

2640 Walnut Ave., Unit K, Tustin, CA 92680  
**(714) 838-7530**

Prices & availability subject to change without notice - IBM is a registered trademark of IBM Corp.

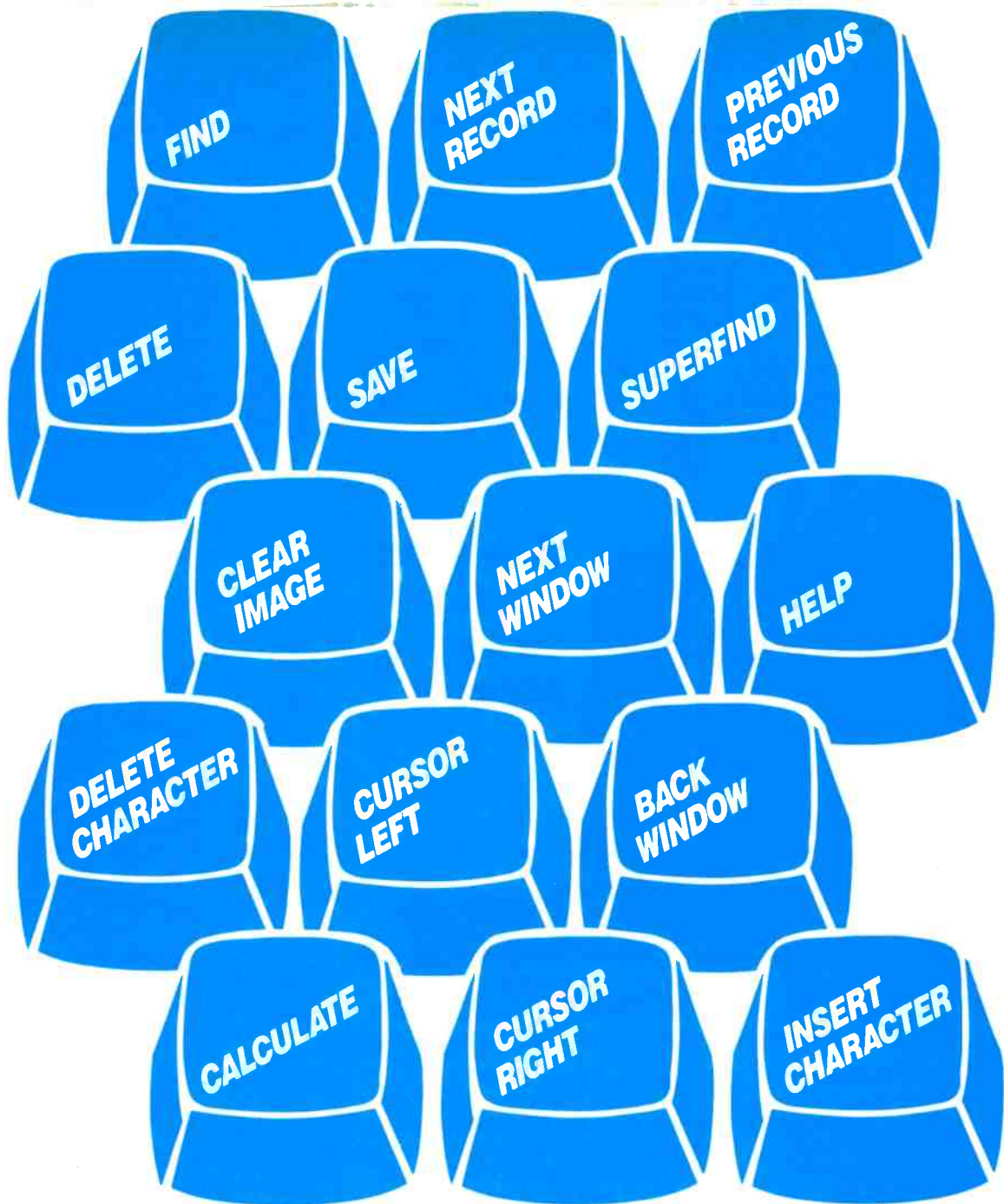

Fifteen user defined Flex-Keys provide single keystroke data entry and database commands, making DataFlex one of the most user-friendly database systems available. DataFlex's powerful program generator processes easy to create screen "images" to quickly define applications and produce ready to run, menu-driven software that's perfectly tailored to your needs. From simple

single file applications to complex multi-file/multi-key/multi-indexed systems, nothing does it faster, better or easier than DataFlex. Even multiple page HELP screens are produced with a one word command and called automatically at literally, the touch of a button. Call or write today for our latest literature and a list of existing DataFlex applications.

# DATA FLEX™

DATA ACCESS CORPORATION.

8525 SW 129 Terrace, Miami, FL 33156 (305) 238-0012

Telex 469021 DATA ACCESS CI

See us at  
**COMDEX™/Fall '84**  
 November 14-18, 1984  
 Las Vegas Convention Center  
 Las Vegas, Nevada

Circle 90 on inquiry card.

compatible with MSDOS, PC-DOS, CP/M, CP/M-86, MP/M-86, TurboDOS, Novell Sharenet, PC-Net, Molecular N-Star, Televideo MmmOST, Action DPC/OS, Onminet, IBM PC w/Corvus and OS/2 Muse.

MSDOS is a trademark of Microsoft. CP/M and MP/M are trademarks of Digital Research. DataFlex and FlexKeys are trademarks of Data Access Corp.



complete set of "random" numbers. A series that generates all of the  $m$  distinct integers ( $0 < n < m-1$ ) during each period is called a "full period." Whether a series will have a full period or not depends in large measure on the values you choose for the parameters ( $a, c, m$ ). Table 1 illustrates some of the series with  $a =$

5 and  $m = 8$  for various values of the additive constant,  $c$ . Take the first series as an example. If you use a seed, 6, you obtain the pseudorandom series 6, 7, 4, 5, 2, . . . . If you use the seed 5, you get 5, 2, 3, 0, 1, 6, . . . .

Because several of the series in table 1 do not have a full period, they

generate subsets of integers with many useful properties. In the first place, the sum of the periods of the subsets equals the modulus of the series. This property helps you decide whether you have found all the subsets. Second, if the series does not have a full period, different seeds start each subset. For example, the series with  $c = 4$  has six subseries of periods 1 or 2, and the seed you use will determine which subseries you generate.

When you set up a random-number generator, look for a long and full period because it will produce the richest set of numbers. Several established rules for selecting the parameters will achieve a full period. These rules are discussed in Donald Knuth's *The Art of Computer Programming*, referenced at the end of this article. One rule is that the modulus,  $m$ , and the constant,  $c$ , must have no factors in common. Another rule is that  $a$  must be greater than the square root of  $m$  ( $a > \sqrt{m}$ ) to avoid the serial correlation that upward runs produce. (This rule ensures that the mapping quickly takes the number out of the current segment, the same condition mentioned earlier.) Finally, you will get the longest possible periods if the modulus is a prime number equal to or less than the largest integer your computer can handle. (For a 16-bit processor, this condition implies that  $m \leq 32,768$ .)

Two additional examples of LCGs with short, full periods follow:

$$I_{i+1} = \text{mod}(7I_i + 5, 9)$$

$$I_{i+1} = \text{mod}(7I_i + 7, 9)$$

In practice, you develop a pseudorandom-number generator in a cut-and-try process, testing and modifying various possibilities.

In describing the LCG, I assumed that the coefficients were all integers. You can increase the series' apparent period by taking real (decimal) values. For example, if you substitute 5.1 and 3.111 for the coefficients in the series above, the terms won't repeat precisely after a period of eight terms. But the terms in successive cycles will

(continued)

## Graphics with Gray Matter.

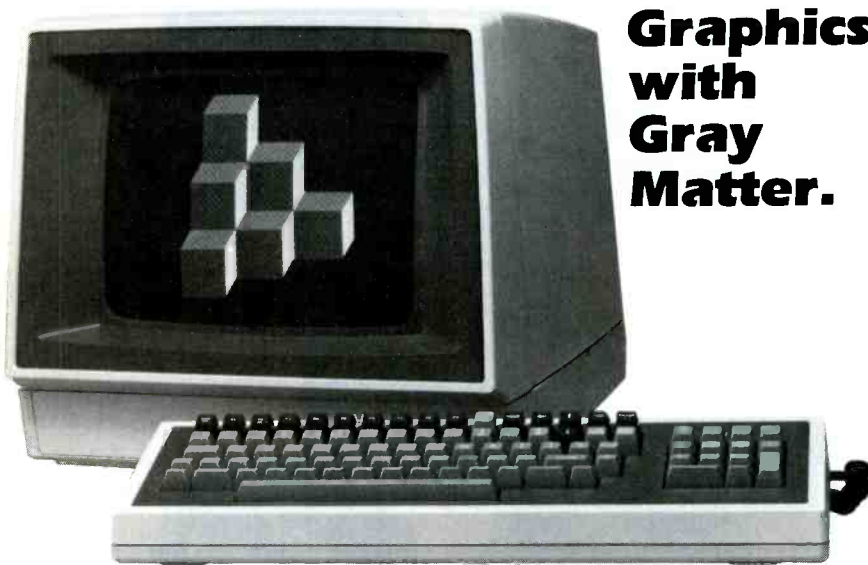

### New GRAPHICS-PLUS GP-29. Big Features. Little Cost.

The GP-29 delivers the graphics and text versatility of powerful, expensive terminals at significant cost savings. And you can buy the GP-29 as a ready to use terminal or as a retrofit board for the Zenith Z29.

Expand your applications with dual plane graphics. Create images with "shades of gray." Overlay two separate images. Animate the images. Store multiple images in local memory.

The GP-29 gives you low cost graphics you never imagined possible. 1024 x 500 hi-res and 512 x 250 lo-res selectable resolution. 128k of display memory. And our dedicated graphics processor provides selective vector erase, area erase, area fill, area move, arc drawing, pan and zoom.

You also get Tektronix 4014 compatibility as well as DEC VT100 and VT220 compatibility.

#### Enhanced Text Too!

The GP-29 offers four selectable display formats: 80 and 132 columns with 24 or 49 lines. Off-screen scrolling memory. Storage for pages and pages of text. Off-line editing capability. Double high and double wide characters and much, much more.

Plus, you get operator convenience features like "plain English" set-up menu, easy to use programmable keys, local function keys, transparent mode and non-volatile memory. And a serial printer port is standard. Call or write today to place your order.

GP-29 retrofit for Zenith Z29 . . . . \$ 995.  
GP-29 complete terminal . . . . . 1695.  
Optional long-persistence CRT . . . . . 95.

## Northwest Digital Systems

P.O. Box 15288, Seattle, WA 98115  
(206) 524-0014

GP-19 board for the Zenith Z19 terminal is also available for \$695.

**FINALLY! MAIL ORDER SERVICE YOU CAN DEPEND ON!**



**BUSINESS SOFTWARE**

Now **you** can take advantage of the same personalized service enjoyed by America's largest corporations . . . at the same low prices!

**PROKEY 3.0  
92**

**WORDSTAR  
PROPAK  
317**

**SYMPHONY  
449**

**OPEN  
ACCESS  
349**

**WORD  
PERFECT  
265**

**SUPER  
CALC 3  
199**

**HARVARD  
PROJECT  
MGR. 299**

**MULTIMATE  
259**

**CROSS  
TALK  
98**

**LOTUS 1-2-3  
299**

<b>Advanced Data Institute</b> Aladin 595 399	<b>Digital Marketing</b> Writers Pak 295 199 Footnote 99 84 Datebook II 295 179 Notebook 150 98	<b>Lexisoft</b> Spellbinder 495 239	<b>Microsoft</b> Multiplan 250 139 Basic Interpreter 350 249 Word/Mouse 475 319 Chart (Mac) 125 99 Cash Plan (IBM) 150 99	<b>Perfect Software</b> Perfect Writer 349 218 Perfect Writer/ Speller 399 298
<b>Alpha Software</b> Data Base Manager II 295 179	<b>Fox &amp; Geller</b> dGraph or Quickcode 295 164 dUtil 99 58	<b>Lifefree</b> Volkswriter Deluxe 295 169	<b>Monogram</b> Dollars and Sense (IBM) 179 149 Dollars and Sense (Mac) 149 119	<b>Peter Norton</b> Norton Utilities 80 52
<b>Ashton-Tate</b> dBase II 495 CALL dBase III 695 CALL Framework 695 CALL	<b>Fox Research</b> 10 Base 495 399 10 Net 695 499	<b>Living Video Text Inc</b> Think Tank (IBM) 195 149 Think Tank (Apple) 150 109	<b>Oasis</b> Word Plus 150 105 Punctuation and Style 150 95	<b>Prentice-Hall</b> Execuvision 395 299
<b>ATI</b> Training WordStar 75 45 Training dBase II 75 45	<b>Funk</b> Sideways 60 45	<b>MDBS</b> Knowledgeman 500 299	<b>Pacific Data Systems</b> Money Track 295 219	<b>Select Information Systems</b> Select Word Processor 295 199
<b>Axel Johnson</b> AutoCode 195 139	<b>Heritage</b> Smart Key II 90 79	<b>Micropro</b> WordStar 495 225 SpellStar 150 99 CorrectStar 250 175 MailMerge 250 125 InfoStar 495 248	<b>Peachtree</b> Peachtext 5000 425 185 Calendar Mgmt 195 165 Decision Manager 625 495 Business Graphics System 295 219 Peachpak 4 395 238	<b>Sorcim</b> SuperCalc 2 295 154
<b>CDEX</b> Advanced Lotus 1-2-3 70 45	<b>Humansoft</b> DBPlus 125 84	<b>Microrim</b> R Base 4000 495 310 Extended Report Writer 150 119 Clout 195 159	<b>Tylog</b> dBase Window 249 155	<b>Visicorp</b> ViciCalc IV 250 159
<b>Chang Labs</b> Rags to Riches Ledger 99 79	<b>IUS</b> Easy System II 395 184 General Ledger 595 319 Accounts Payable 595 319		<b>Warner Software Inc.</b> The Desk Organizer 295 239	<b>Woolf Systems</b> Move It 150 85
<b>Condor</b> Condor 3 650 259				

We can't fit all of our huge inventory in this ad, so please call for products you don't see here.

**CALL FOR OUR FREE CATALOG**

**TO ORDER CALL TOLL-FREE:**

**(800) 235-3020 (USA)**

**(800) 235-3021 (CA)**

**(415) 382-9085**



94 Galli Drive, Suite E, Novato, CA 94947

**TERMS:**

- Call for shipping charges and support policies.
- Full guarantee against manufacturers defects
- Allow 3 weeks for checks to clear
- Prices may change
- Call for availability
- **NO CASH REFUNDS!** Due to our low prices, **ALL SALES FINAL.**

- SAME DAY SHIPMENT ON MOST ORDERS
- Prompt UPS service
- Authorized Purchase orders accepted
- Dealer, institutional and quantity discounts available
- No surcharge for credit card purchases
- VISA & Mastercard accepted
- COD



show only a slight shift, and the overall pattern of the cycle will be the same—except for occasional jumps when the fractional parts accumulate sufficiently. Thus, the increase of period is only illusory, and, since I don't want to fool you with this illusion, I will restrict myself to integer coefficients.

**STATISTICAL TESTS FOR RANDOMNESS**

Often, you can look at a series and see that it was probably not generated by a random process. For example, who would claim that a real coin would lead to a series of heads (H) and tails (T) such as HTHHTTHHHTT-THHHHTTTTHHHHTTTT? It could happen (with a probability of about  $(1/2)^{29} = 0.000000001$ ), but you wouldn't expect it in your lifetime.

But some series are not so obvious, and you need a more reliable test than the eyeball and a hunch. For this, you must compare some statistical properties of the series with some theoretical predictions you make after assuming that the series was generated by a truly random process. When I refer to a statistical property, I'm talking about one that is independent of the seed you used to start the series, including those tests that are obliv-

**THE CHI-SQUARE TEST**

This test is commonly used for agreement between a series of observed values,  $O_i$ , and expected values,  $E_i$ . In this case, the "observations" are the actual bin populations listed in table 2, and the expected value is the average  $1000/100 = 10$ . There are  $n = 100$  observations, and because  $n \gg 1$ , the test can be expressed in a simplified form, as follows. For each bin compute the difference,  $O_i - E_i$ ; square these values, divide by the corresponding value of  $E_i$ , and sum the quotients over all the observations. Divide the result by the number of observations, obtaining

$$X^2 = (1/n) \sum (O_i - E_i)^2 / E_i$$

If this quantity lies between 0.5 and 2.0, the scatter of the observations is consistent with random numbers. If  $X^2 < 0.5$ , the observations are suspiciously close to average values; if  $X^2 > 2.0$ , they are too far from the average. This test is applicable only to quantities that are expected to obey the classic law of errors—and this is often a debatable point. For the numbers in table 2,  $X^2 = 0.79$ ; therefore, the populations have the properties of random numbers.

ious to the order of terms in the series. (The mean value is one such property.) These statistical tests reveal how likely it is that a random process generated a certain series.

No statistical test is a sure bet, and few tests are reliable in themselves. Some pseudorandom series will pass one test with flying colors, only to fail miserably in another. Therefore, you have to apply several different tests. I will apply some tests to the LCG and the generator that the IBM PC's Advanced BASIC supplies. Then I'll discuss how to develop a more powerful random-number generator that anyone can use.

Let's start with the simplest test: determining the period of the series.

**PERIOD**

You can determine a period by noting a series' first number and then stepping through it while computing one number after another until the first number recurs, that is, until  $x_n = x_1$ . Then  $n-1$  is the period of the series. (In order to ensure that  $x_n$  is, indeed, the start of a repeat cycle, the first few values,  $x_1 - x_{1+i}$ , can be saved for comparison with  $x_n - x_{n+i}$ .)

Figure 3 shows the unfortunate effect of a short period on the random

(continued)



**HIGH PERFORMANCE LEADER**  
**EPROM PROGRAMMERS & UV ERASERS**

**GANG MULTIPROGRAMMER™**

- Programs over 400 devices
- Detachable keyboard (opt.)
- Stand Alone - RS232
- Bipolar • Microchips (opt.)
- 3 Voltage EPROMS (opt.)

**\$15-G \$995**

**other systems under \$600**

**ORDER NOW Toll Free 1-800-53-BYTEK**

BYTEK® Computer Systems Corp.  
4089 S Rogers Circle  
Boca Raton FL 33431



**UV MULTIERASER™**

- Built-in safety switch
- Removable anti-static UNITRAY™ (opt.)
- 1 Hour Timer (opt.)

**\$67**  
**BUV-3C**

**(305) 994-3520**  
Telex: 5109527637

Distributor Inquiries Welcome



## WHOLESALE + 8% PRICING

### OUR 400 PAGE CATALOG OF 20,000 COMPUTER PRODUCTS

### 12 TO 21 DAY SOFTWARE RENTALS†

### FOR NETWORK MEMBERS ONLY!

Listed below are just a few of the over 20,000 products available at our EVERYDAY LOW PRICES! All software below is priced in IBM-PC format. The NETWORK carries software for IBM, Apple, CP/M, Kaypro and over 50 other popular systems.

For as little as \$8 per year you can join the thousands of value wise buyers who have saved more than \$12,000,000 on 30,000 and received these 15 unique benefits:

- Wholesale + 8% Pricing
- Our 400 Page Catalog—Over 20000 Products
- In-stock Delivery On Popular Products
- Experienced Sales Consultants
- Add-on Quantity Discounts
- Free Technical Support
- 12-21 Day Business Software Rentals (optional)
- 12-21 Day Game Software Rentals (optional)
- Special Savings Newsletters "The Printout"
- Discount Book Library—Over 1000 Titles
- Membership Referral Bonus
- Corporate Accounts
- Price Reduction Protection
- Membership Refund Guarantee
- 10 Day Hardware Return Policy

#### GAMES & EDUCATIONAL SOFTWARE

(Please add \$1 shipping and handling for each title ordered from below.)

Wholesale	Wholesale
Avant-Garde Air Traffic Controller	21.00*
Bluebush Chess (Your Toughest Opponent)	18.00*
Broderbund Lode Runner	24.00*
CBS Goran-Bridge Made Easy	17.00*
CBS Mastering the SAT	29.00*
Epyx Temple of Apshai	20.00*
Infocom Zork I, II, or III	17.00*
Infocom Quadtime: Witness or Suspended	27.00*
Microsoft Flight Simulator	17.00*
Orion J/BD (QBart Look Alike)	20.00*
Scarborough Masterytype	23.00*
Scriptyfy Asylum (works with mono card I/O)	21.00*

#### BUSINESS SOFTWARE

(Please add \$2.50 shipping and handling for each title ordered from below.)

ATI How to use MultiMate	\$42.00*	Microsoft Word with Mouse—Latest Version	255.00*
ATI How to use Microsoft Word	42.00*	Microsoft Multiplan	105.00*
ATI How to use Lotus 1-2-3	42.00*	Monogram Dollars & Sense	89.90*
Ashton-Tate DBASE II	CALL	Multimate Multimate (Latest Version)	240.00*
Ashton-Tate Framework	CALL	Oasis The Word Plus	90.00*
Ashton-Tate Friday	158.00*	Open Systems P/O Sales: A/R/INV/G/L/A/P	370.00**ea
Central Point Copy II PC	23.00*	Team Mgr	
Conceptual Instruments Desk Organizer	177.00*	RDS Interiors	705.00*
Cosmos Revelation (Requires 8087)	575.00*	Real World G/L/A/P/A/R/P/R/OE/INV	387.50**ea
Digital Research CP/M-86	33.00*	Rossoft Prokey Version 3	74.00*
Digital Research DR Logo	99.00*	Ryan McFarland RM CDBOL (Development System)	570.00*
Digital Research PL/1 Compiler	399.00*	Sanna Sanna III World Processor	325.00*
Digital Research Concurrent CP/M w/Windows	90.00*	Satellite Software WordPerfect	210.00*
Funk Software Sideways	35.00*	SoftCall Fancy Fonts	125.00*
Harvard Harvard Project Manager	215.00*	Softstyle SET-FX	35.00*
Hayes SmartRoom II	86.00*	Software Publishing PFS: File	74.00*
Human Edge The Management Edge	145.00*	Software Publishing PFS: Report	65.00*
Human Edge The Sales Edge	145.00*	Software Publishing PFS: Write	74.00*
Lotus Development Lotus 1-2-3	CALL	Software Publishing PFS: Graph	74.00*
Lotus Development Symphony	CALL	TCS Client Ledger	750.00*
MicroRim RBase 4000	230.00*	Verbatim Disk Drive Analyzer	25.00*
Microsoft C Compiler	275.00*		

#### HARDWARE

(Please add shipping and handling charges found in italics next to price.)

#### COMPLETE SYSTEMS

Apple Macintosh Base System	1,200.00* (38.89)
Apple Apple //c	940.00* (20.30)
Apple Apple //e	CALL
Columbia Desktop & Portable Systems	CALL
Compaq All Models	CALL
Eagle Desktop PC and Spirit Portables	1,713.00*
IBM PC Starter System 1 DSDD/1 CDC/Color/Dr/Port/Monitor/54K	1,715.50* (37.07)
IBM PC Base System	1,715.50* (37.07)
IBM PC Professional Hard Disk (XT) 1 DSDD/FDC/10 MB Hard Disk/256K	2361.50* (51.00)
NEC Notebook New Price	420.00* (10.00)
Sanyo MBC-550 (Lowest Cost Compatible)	640.00* (13.82)
Tava PC Complete IBM Compatible (64K/Color or Mono Card/2 drives)	1,450.00* (31.32)
Texas Instruments Precision	CALL

#### DISK DRIVES & CONTROLLERS

Everex 1 1/2 Hi Low Power 10MB Winchester W/IBM Controller	760.00* (16.42)
IBM Floppy Disk Controller	100.00* (2.50)
Maynard WS-1 10MB Internal Hard Disk with Sandstar Multi-Function Card	770.00* (18.15)
Maynard WS-2 same as WS-1 but with Sandstar Floppy Controller (uses 1 slot)	930.00* (20.30)
Maynard Floppy Controller/Serial Port	145.00* (2.50)
Panasonic Half Height DSDD Drive Pair	250.00* (5.40)
Quime Half Height DSDD Drive Pair (Same as used on IBM Portables)	350.00* (7.00)
Tandon TM100-2 Full Height DSDD Drive	158.00* (3.16)
Taligrass 20MB External Hard Disk with Tape Backup	2,800.00* (46.20)
Teac FDS-5 Half Height DSDD Drive Pair	265.00* (5.72)

#### MEMORY CHIPS

64K Memory Upgrade Kits (9 Chips)	40.50* (1.00)
64K Dynamic Ram Chips (Each)	4.50* (1.00)
256K Dynamic Ram Chips	33.00* (1.00)

#### MODEMS

Anehor Mark XII LOWEST PRICE 1200BPS Hayes COMPATIBLE EXTERNAL MODEM	230.00* (5.00)
Hayes Smartmodem 300	180.00* (3.60)
Hayes Smartmodem 1200B External	366.90* (2.50)
Smartcom II	CALL
Rixon RT12A Stand Alone 1200BPS U.S. Robotics Password (Compact 1200BPS External)	335.00* (8.50)
	290.00* (6.50)

#### MONITORS

Amdek Video 3000 Composite Green	110.00* (3.00)
Amdek Video 300A Composite Amber	120.00* (3.00)
Amdek Video 310A IBM Type Amber	130.00* (3.00)
Amdek Color 300 (NEW) Composite	215.00* (4.54)
Amdek Color 500 (NEW) Composite/RGB/VCR	320.00* (6.91)
Amdek Color 600 (NEW) High Res RGB	395.00* (8.53)
Amdek Color 700 (NEW) Ultra High Res	455.00* (9.83)
Amdek Color 710 (NEW) 700 w/Non-Glare/Long Phosphor	485.00* (10.48)
Princeton HX-12 RGB Monitor	CALL
Princeton MA-12 IBM Mono	CALL
Princeton SR-12 Ultra High Res RGB	CALL
Quadram Quadchrome II NEW 640x200 RGB w/1.4" Screen/Black Phosphor Mask/IBM Case	370.00* (8.21)
Taxan 420 Super High Res RGB Monitor	380.00* (8.21)
Taxan 440 Highest Res RGB (20x400) Currently Available Works With Persys Bob Card	525.00* (11.34)
Zenith ZVM-123 Green High Res (Consumer Reports Rated Best Buy!)	76.00* (2.50)

#### MULTIFUNCTION CARDS

Apparat 256K Memory Board with OK	90.00* (2.50)
Apparat Combo II w/Ser/Par/game/clock/fax	123.00* (2.50)
AST Six-Pack Plus with OK	205.00* (2.50)
AST MegaPlus II with OK	205.00* (2.50)
AST I/O Plus II	105.00* (2.50)
ORCHID BLOSSOM w/4K	205.00* (2.50)
Teclar Captain Multifunction Card w/OK	200.00* (2.50)

#### PRINTERS

Abati 18CPS Letter Quality	340.00* (8.00)
Amdex 6025 (NEW) 25CPS LQ w/2K Buffer	485.00* (10.48)
C. Itoh F10/40 Starwriter 40 CPS LQ	875.00* (18.90)
Comrex Brother CR-11 24CPS LQ Printer	325.00* (6.33)
Comrex/Brother Typewriter Keyboard for CR-11	180.00* (3.99)
Comrex/Brother CR-11 Cut Sheet Feeder	180.00* (3.99)
Epson RX-80	267.00* (6.00)
Epson FX-80	415.00* (9.25)
Epson FX-100	600.00* (14.58)
Epson LQ1500	CALL
Epson IBM-to-EPSON Parallel Cable	21.00* (1.00)
NEC 2050 20CPS LQ Fax/letter	825.00* (16.33)
NEC 2050 20CPS Letter Quality Printer	755.00* (16.53)
NEC 3530 33CPS LQ Parallel	1,185.00* (31.54)
NEC 3530 33CPS Letter Quality Printer	1,460.00* (31.54)
Okidata ML84P 20CPS 132 Col	720.00* (16.00)
Okidata ML92P 160CPS 80 Col Printer	395.00* (8.55)
Okidata ML93P 160CPS Wide Platen	590.00* (15.00)
Okidata 24 Pin Parallel 350CPS 132 Col	1,850.00* (60.00)
Okidata IBM-to-Okidata Parallel Cable	20.75* (1.00)
Quime Sprint 1145 45CPS Letter Quality	1,155.00* (24.00)
Quime IBM Cable and Interface (required)	72.00* (1.00)
Star Micronics Gemini 10X	246.00* (6.00)
Texas Instruments 855 D/PL/O w/Tractor	716.00* (15.50)
Toshiba P-1351 160/100CPS Draft/LQ Printer	1,200.00* (25.92)

#### VIDEO CARDS

Amdex MAI Card	310.00* (2.50)
Eagle Monochrome Display Card	160.00* (2.90)
Hercules Monochrome Graphics Card	298.00* (2.50)
Hercules Color Card with Parallel Port	CALL
Paradise New MultiDisplay Card	CALL
Persys Bob Card Ultra High Res Color Card with Mono Quality Text in Color	365.00* (2.50)
Quadram Quadcolor I Color Card	170.00* (2.50)
Quadram Quadrome Mono Card w/Ser/Par/Clock	210.00* (2.50)
STB Graphics Plus II (NEW) (Simultaneous Mono Graphics & Color)	240.00* (2.50)
STB Graphics Plus II (NEW)	285.00* (2.50)

#### ACCESSORIES AND SUPPLIES

Brand Name DSDD Diskettes	18.00* (1.00)
Guaranteed for Life!	
Keytronic KB515 Deluxe IBM Keyboard	170.00* (4.00)
Source-Tek Replacement 100W IBM-PC Power Supply lets old PC's Drive Internal Hard Disk & More	215.00* (4.64)
WP Printer Paper 2600 Sheets Microfilm Perfs (invisible when torn)	17.00* (10.00)

IL Residents Add Sales Tax

## CALL TOLL FREE 1-800-621-S-A-V-E

In Illinois call (312) 280-0002

Your Membership Validation Number: B3B1

You can validate your membership number and, if you wish, place your first money-saving order over the phone by using your VISA, MASTERCARD or AMERICAN EXPRESS. Our knowledgeable service consultants are on duty Mon-Fri 8 AM to 7 PM, SAT 9 AM to 5 PM CST.

**PERSONAL COMPUTER NETWORK**  
320 West Ohio  
Chicago, Illinois 60610

Call now...Join the PC NETWORK and start saving today!



#### PC NETWORK • MEMBERSHIP APPLICATION

YES! Please enroll me as a member in the PC NETWORK™ and rush my catalog featuring thousands of computer products, all at just 8% above DEALER WHOLESALE PRICES. I will also periodically receive "THE PRINTOUT", a special up-date on merchandise at prices BELOW even those in my wholesale catalog, and all the other exclusive, money-saving services available to Members.

I am under no obligation to buy anything. My complete satisfaction is guaranteed. Please check (✓) all boxes that apply:

- |   |  |
|---|--|
| <input type="checkbox"/> Basic Membership   | <input type="checkbox"/> Special V.I.P. Membership*  |
| <input type="checkbox"/> One-year membership for \$8  | <input type="checkbox"/> One-year membership for \$15  |
| <input type="checkbox"/> Two-year membership for \$15   | <input type="checkbox"/> Two-year membership for \$25  |
| <input type="checkbox"/> \$15 (SAVE \$1)  | <input type="checkbox"/> (SAVE \$5)  |
| <input type="checkbox"/> Business Software Rental Library for \$25 add'l per year—with 12 day rentals   | <input type="checkbox"/> BOTH Business and Game Software Rental Libraries for \$30 add'l. per year—with 21 day rentals |
| <input type="checkbox"/> Games Software Rental Library for \$10 add'l per year  | <input type="checkbox"/> *VIP members receive advance notice on limited quantity merchandise specials                  |
| <input type="checkbox"/> Bill my credit card: <input type="checkbox"/> VISA <input type="checkbox"/> MasterCard <input type="checkbox"/> American Express |  |

Account Number:

Exp. Date:  mo.  year

Check or money order enclosed for \$

Name:

Address:  Apt. No.

City:  State:  Zip:

Telephone (  )

My computer(s) is:  IBM PC  Apple II  TRS-80  Kaypro  Other

Signature:

(Signature required to validate membership)

Copyright © 1984, PC NETWORK INC.

†RENT BEFORE YOU BUY—Members are eligible to join THE NETWORK's Business and Game Software Rental Libraries and evaluate products for a full 12 (Regular) or 21 (VIP) days to see if it meets your needs. AND THE NETWORK's rental charges are far less than other software rental services—JUST 20% OF THE MEMBER WHOLESALE PRICE.

Hardware prices highlighted by ► reflect recent major price reductions



# COMPUTER HUT™

COMPARE  
OUR  
SERVICE & PRICE!

## SPECIAL OF THE MONTH

IBM-PC & XT  
& PORTABLE  
CALL FOR  
PRICE

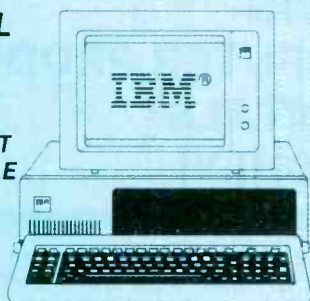

### DISK DRIVES

<b>Tandon</b> TM100-2 DS/DD	\$185
<b>MATSUSHITA</b> JA 551	159
<b>TEAC</b> FD-55B Slimline	179
<b>SHUGART</b> SA-455 half-high	CALL
<b>MAYNARD</b> WS1/WS2/WS3	CALL
<b>SYSGEN</b> — Hard disk & Tape	CALL

### ME MAYNARD ELECTRONICS

Floppy Disk Controller	\$129
FDC w/Par. Port or Ser Port	CALL
SANDSTAR SERIES	CALL

### QUADRAM

Quadboard expand to 384K	CALL
Quadcolor	CALL

### AST RESEARCH

MegaPlus II 4-Funct 64K + s/w	\$279
6-Pack 5-Funct 64K + s/w	\$279
I/O Plus	\$129
MonoGraphPlus	CALL

### STB

<b>MICROLOG</b>	
Baby Blue	\$359
Baby Blue II 64K	\$499

### GRAPHICS BOARDS

#### TECMAR

Graphics 720 x 400 16 colors	\$499
------------------------------	-------

#### HERCULES

Hi Res Mono Graphics 720 x 348	\$335
Color Graphics w/Par Port	CALL

#### PGI PRODUCTS

COLORPLUS 640 x 200, 16-Color w/Par Port + s/w	\$389
---	-------

#### PARADISE

Multi-display	\$349
---------------	-------

<b>EVEREX</b> Graphics Edge	CALL
-----------------------------	------

### MODEMS



Smartmodem 1200	\$489
Smartmodem 1200B	\$419
<b>NOVATION, ANCHOR</b>	CALL

### PRINTERS

<b>EPSON</b>	
FX80	CALL
FX100	CALL

#### brother

HR-15 Par	\$399	Ser	\$399
HR-25	\$649	HR-35	CALL

#### DYNAX

DX-15 Par	\$399	Ser	\$399
-----------	-------	-----	-------

#### C-ITOH

STARWRITER A-10	CALL
STARWRITER F-10 P	\$1095

#### star MICRONICS

Gemini 10X	\$289	15X	\$399
Radix	CALL		

#### OKIDATA

84P	CALL	84S	CALL
92P	BEST	92S	BEST
93P	PRICES	93S	PRICES

#### NEC

3510	\$1375	7730	\$1895
3530	\$1375	2030	\$749
3550	\$1675	2050	\$895

#### TOSHIBA

P1351	\$1499
P1340	\$839

#### DAISYWRITER

2000 w/48K Buffer	\$995
-------------------	-------

ICS Prism	CALL
-----------	------

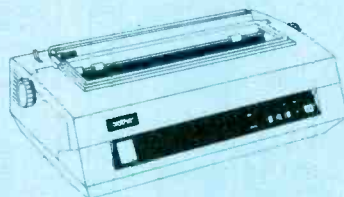

ANY PRODUCT NOT  
LISTED? CALL

### COMPUTERS



CALL



TAVA PC

CALL



CALL

### MONITORS

#### AMDEK

Video 300G	\$145	300A	\$155
Video 310A			\$179

#### PGS

HX12 Hi Res RGB monitor	BEST
MAX-12 Hi Res Mono	PRICES
SR-12 Super Hi Res RGB	



### SOFTWARE FOR IBM-PC

Volkswriter	\$135	VW delux	\$199
R:base 4000			\$319
Harvard Proj. Mgr.			\$279
Crosstalk			\$129
PFS: File			\$119
PFS: Graph			\$109
PFS: Report			\$109
PFS: Proof			\$89
FLASH COM			CALL
LOTUS			CALL
Word Perfect	\$279	WordStar	CALL
dBase III	\$499		
Multiplan	\$135	Multimate	\$299
Microsoft Word			\$269
Framework			CALL

AND LOTS MORE

## CANADIAN COMPUTER HUT

AUTHORIZED DEALER

MICROCONTEXT INC.

5253 Ave Du Parc  
Montreal Que H2V4P2.

(514) 279-5114

Published Prices are for U.S.A. Only  
Please call for Canadian Prices

### EAST COAST

## COMPUTER HUT

OF NEW ENGLAND INC.

101 Elm St. Nashua, NH 03060

(603) 889-0666

For Orders Only — (800) 525 5012



### MID-WEST

## COMPUTER HUT INC.

524 S. Hunter  
Wichita, Kansas 67207

(316) 681-2111

For Orders Only — (800) 572 3333

All products usually in stock for immediate shipment and carry full manufacturers' warranty. Price subject to change — this ad prepared two months in advance. You get the lowest price. We honor personal checks — allow 10 days to clear COD up to \$300 add 2%. Visa, MasterCard add 2%. For shipping & insurance add 2% or \$5.00 min. for small items and \$10 min for monitors, printers, etc. We accept company checks and P.O.'s from Fortune 1000 Companies.

IBM is a trademark of IBM Corp.

Return authorization and order status call information line

Circle 68 on inquiry card.

104

## RANDOM NUMBERS

walk generated by one of the LCGs in table 1. You can easily spot the periodicity, and you wouldn't want it as the imitation of a very long random walk. (This walk was generated from a normalized LCG by stepping upward if  $x > 0.5$  and downward if  $x < 0.5$ .)

When I applied this test to the pseudorandom-number generator supplied with the Advanced BASIC Interpreter of the IBM Personal Computer (PC), it showed a period of 65,535. This result was as good as I

could have hoped, but a detailed plot of a walk shows that it also has a much shorter wave-like cycle superposed. Figure 4 shows such a plot and reveals a subcycle that is about 18,000 steps long.

### DISTRIBUTION

A random sequence ought to contain representative numbers from all parts of the permitted range. Some programs generate numbers that follow

*(continued)*

Table 1: Because several of these series do not have a full period, they generate subsets of integers with several useful properties, for example, the sum of the periods of the subsets equals the modulus of the series.

Linear Congruential Generators,  $I_{i+1} = \text{mod}(5I_i + c, 8)$

Expression	$I_i$	Period
5I + 1	1, 6, 7, 4, 5, 2, 3, 0	8
	1, 7, 5, 3, 1, 7, 5, 3	4
	4, 6, 0, 2, 4, 6, 0, 2	4
	1, 0, 3, 2, 5, 4, 7, 6	8
5I + 2	1, 1, 1, 1, 1, 1, 1, 1	1
	2, 6, 2, 6, 2, 6, 2, 6	2
	3, 3, 3, 3, 3, 3, 3, 3	1
	4, 0, 4, 0, 4, 0, 4, 0	2
5I + 3	5, 5, 5, 5, 5, 5, 5, 5	1
	7, 7, 7, 7, 7, 7, 7, 7	1
	1, 2, 7, 0, 5, 6, 3, 4	8
	1, 3, 5, 7, 1, 3, 5, 7	4
5I + 4	2, 0, 6, 4, 2, 0, 6, 4	4
	1, 4, 3, 6, 5, 0, 7, 2	8



Figure 1: Schematic diagram of mapping in a linear congruential generator (LCG). Each successive term in the series is larger than the preceding. This series does not imitate a random series, but it is the first step in that direction. See figure 2.

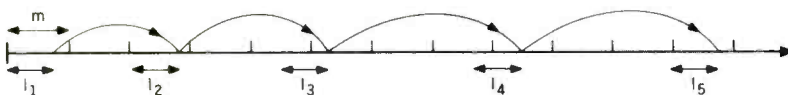
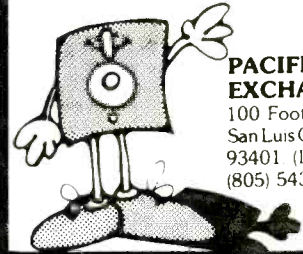

Figure 2: Schematic of an LCG, showing how the division of the number line into equal intervals,  $m$ , can produce pseudorandom numbers. The location of each number inside the corresponding interval is haphazard. It results from using the modulus function and leads to a pseudorandom series.



Solve your disc problems, buy 100% surface tested Dysan diskettes. All orders shipped from stock, within 24 hours. Call toll FREE (800) 235-4137 for prices and information. Visa and Master Card accepted.



**PACIFIC EXCHANGES**  
100 Foothill Blvd  
San Luis Obispo, CA  
93401 (In Cal call  
(805) 543-1037)

Circle 268 on inquiry card.

## ICs PROMPT DELIVERY!!!

SAME DAY SHIPPING (USUALLY)

### DYNAMIC RAM

256K	150 ns	\$35.77
64K	200 ns	4.62
64K	150 ns	4.87
64K	120 ns	5.59
16K	200 ns	1.21

### EPROM

27256	32Kx8	300 ns	\$49.97
27128	16Kx8	300 ns	23.99
27C64	8Kx8	200 ns	22.50
2764	8Kx8	250 ns	7.97
2732	4Kx8	450 ns	5.40
2716	2Kx8	450 ns	3.60

### STATIC RAM

6264LP-15	150 ns	\$35.97
6116P-3	150 ns	6.36

Open 6 1/2 days; we can Ship via Fed-Ex on Sat.

MasterCard VISA or UPS CASH COD

**Factory New, Prime Parts**  
MICROPROCESSORS UNLIMITED  
24,000 South Peoria Ave  
BEGGS, OK 74421 (918) 267-4961

Prices shown above are for August 14, 1984.

Please call for new discount & current prices. Prices subject to change. Please expect higher prices on some parts due to world wide shortages. Shipping and insurance extra. Cash discount prices shown. Small orders received by 6 PM CST can usually be delivered to you by the next morning, via Federal Express Standard Air - \$5.95!

QUANTITY ONE PRICES SHOWN

Circle 231 on inquiry card.

## LOWEST PRICES "GUARANTEED"

FIND A LOWER ADVERTISED PRICE IN THIS MONTHS BYTE AND WE WILL BEAT IT BY 5%.

☆☆ PC EXPANSIONS ☆☆☆  
BABY BLUE II (256K) BACKGROUND PROCESSING, CP/M-80 EMULATOR SMART TERMINAL EMULATOR PACKAGE \$649  
AST SIXPACK PLUS (64K) 256  
AST SIXPACK PLUS (384K) 531  
EVEREX 10MB HD 1/2 HEIGHT (INT) 749  
SYSGEN 10MB HD WITH 10 MB STREAMING TAPE BACKUP 2199

☆☆ APPLE EXPANSIONS ☆☆☆  
ULTRATERM 40 TO 160 COLUMNS 229

☆☆ PRINTERS ☆☆☆  
BROTHER HR25 23 CPS (DAISY) 669  
OKIDATA 92 160 CPS (DOT) 419  
OKIDATA 93 160 CPS (DOT) 685  
SILVER REED 550 19 CPS (DAISY) 399  
ComRiter CR-II 160 CPS (DOT) 439

**TETON DIGITAL GROUP**  
BOX 20320 JACKSON, WY 83001  
(307) 733-9315

Circle 356 on inquiry card.



# 3M

diskettes

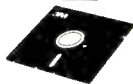

## 5 1/4"

Specify soft,  
10 or 16 sector

Price 10-90    Price 100 +

Single sided double density    **1.90** ea    **1.75** ea

Double sided double density    **2.45** ea    **2.30** ea

Certified Check - Money Order - Personal Check. Allow up to 2 weeks for personal checks to clear. Add \$3.00 per 100 or part to each order for U.P.S. shipping charges. NJ Residents add 6% sales tax.

### DATA EXCHANGE, INC.

178 Route 206 South, P.O. Box 993  
Somerville, N.J. 08876 • (201) 874-5050

Circle 93 on inquiry card.

## WHOLESALE PRICES

### PLUS 6%

Hardware, Software, Supplies, Accessories

## SOFTWARE RENTAL

RENT: LOTUS 1-2-3    \$99.00  
OR  
dBase III    \$99.00

Annual Membership    \$ 8.00  
Software Rental Library    \$25.00

## COMPUMART

16 Shipmaster, Clover, SC 29710

CALL 1-800-334-3818 In SC 831-8502

8:30-5:00 ET  
Monday-Friday



Circle 60 on inquiry card.

## Now... You Can Monitor 7 Most Important RS-232 Lines

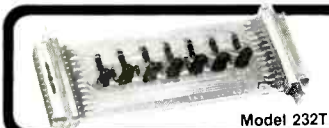

Model 232T

RS-232 INTERFACE TESTER connects in series with any RS-232 interface. LED's clearly display status of 7 functions: TD, RD, RTS, CTS, DSR, CD, DTR. Requires no power; may be left in permanently. Satisfaction guaranteed. **Order Direct! Only \$39.95.** All cash orders postpaid (IL res add 6% sales tax); we accept MC, Visa. **Free:** new illustrated catalog of RS-232 interface and testing equipment. Phone: 815-434-0846. Make checks payable to:

**B & B electronics**  
MANUFACTURING COMPANY  
P.O. Box 1008B, OTTAWA, IL 61350

Circle 33 on inquiry card.

## RANDOM NUMBERS

special distribution laws (the normal distribution, for example), but I will consider only the ones that are intended to produce uniformly distributed numbers. If I normalize an LCG, my program should produce numbers in the range 0 to 1.0 with equal prob-

ability. However, the numbers won't arrive in a perfectly uniform way. They will exhibit a tendency to clump, just as the flips of a real coin will show runs of more than one head or tail instead of HTHTHT.

(continued)

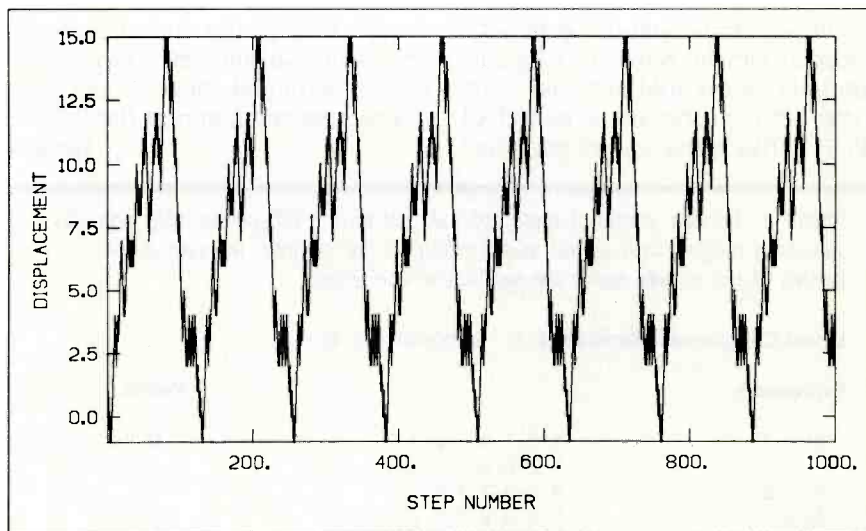

Figure 3: A random walk generated with a pseudorandom-number generator of the type in table 1, with a period of 127. Each step upward or downward was determined by simulated flip of a coin. This diagram illustrates the repetitive pattern of some random-number generators.

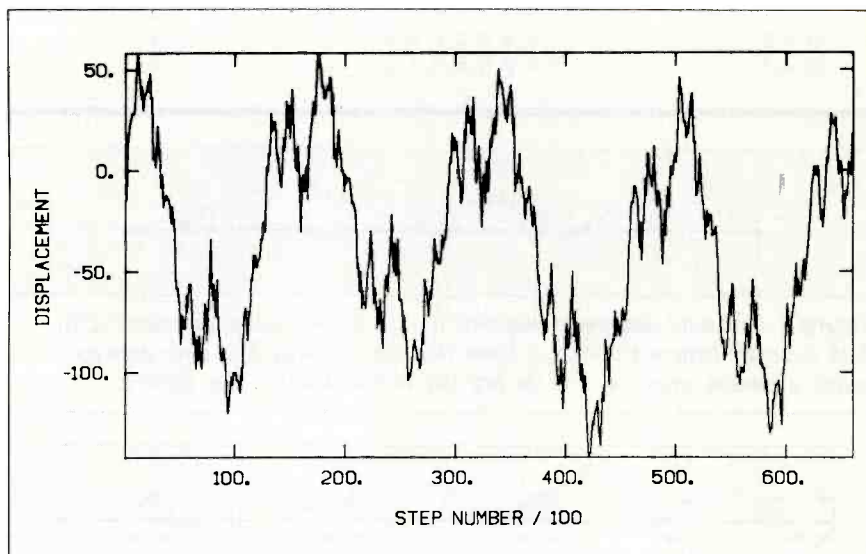

Figure 4: Similar to figures 1 and 2, this walk was generated with the RND function of the Microsoft Advanced BASIC supplied with the IBM PC operating under MS-DOS 2.0. It shows an approximate periodicity of about 18,000 steps, although the rigorous period is about 64,000. Using such a function for Monte Carlo simulations requiring more than 8000 steps could produce misleading results.

# SAVE OVER \$1500 ON YOUR NEXT IBM PC.

## AND YOUR NEXT. AND YOUR NEXT. AND YOUR NEXT.



Until now, adding extra users to your office system has presented some real problems. Additional PCs are costly. And the problems get tougher when you need shared data access and communication between PCs. Alloy's revolutionary PC-PLUS solves these problems. For \$1195 for each user processor and the addition of a dumb terminal, PC-PLUS transforms your IBM PC into a powerful multi-user, multi-processor system.

In any system requiring more than one PC, PC-PLUS provides a more powerful and less expensive alternative. PC-PLUS is almost twice as fast as an IBM PC. And PC-PLUS is ten times faster than LANs (Local Area Networks) at

half the cost. It also eliminates the cost of LAN controllers, taps, and expensive cabling.

So whether you're adding your secretary or 15 colleagues, Alloy's PC-PLUS can do it at a much lower cost and with higher performance. Best of all, it's available right now. See PC-PLUS in action at Computerland®, Businessland, and at your local dealer. Or call Alloy today at (617) 875-6100.



**ALLOY**  
Computer Products, Inc.

**COMDEX™/Fall '84**  
November 14-18, 1984  
Las Vegas Convention Center

Alloy Computer Products, Inc., 100 Pennsylvania Ave., Framingham, Massachusetts 01701. (617) 875-6100, TWX: 710-346-0394  
In Europe: Alloy Computer Products (Europe) Ltd., Cirencester, Gloucestershire, England. Tel: 0285-68709, Tlx: 43340



Table 2: Sample bin populations; the results for  $N = 1000$  numbers in 100 bins computed with the BASICA RND. The observed values cluster about the expected mean,  $\langle NB \rangle = N/Q = 10$ .

Sample Bin Populations with BASICA RND

7	12	17	9	10	12	7	10	11	12
8	13	9	12	12	9	9	11	11	15
9	10	9	11	10	8	9	10	9	8
11	8	13	8	10	11	11	10	17	11
6	9	12	9	8	14	9	10	13	17
9	5	18	10	9	12	9	9	13	10
12	9	6	7	8	5	6	12	6	11
6	7	9	11	9	7	13	7	9	11
9	6	7	5	15	6	12	8	12	19
12	11	12	8	10	8	9	10	12	8

You can test the distribution of numbers by setting up  $Q$  bins and putting each member of the series into one of the bins. For example, if the numbers are restricted to the interval  $0 < x_i < 1$ , each can be put

into bin  $J$ , where  $J$  is computed from

$$J = \text{int}(Q \times x_i), 0 < J < Q - 1$$

On each occurrence of  $J$ , the bin count,  $NB(J)$ , is incremented, so that  $NB(J) = NB(J) + 1$ .

Table 2 shows the result for  $N = 1000$  numbers in 100 bins computed with the BASICA RND. The observed values cluster about the expected mean,  $\langle NB \rangle = N/Q = 10$ . When you run the test several times, the excesses and deficiencies appear in different bins. As a result, no evidence appears that any particular bins consistently receive more than  $1/Q$  of the counts.

A quantitative measure of performance is the conventional chi-square test, which evaluates a measure of the spread (see "The Chi-Square Test" on page 446). This test estimates how likely it is that the actual value will be different from the expected value in a randomly generated series. If you look at table 2, you find no bins with less than 5, two bins with  $NB = 5$ , seven with  $NB = 6$ , and so on. The chi-square test examines all the bin populations and tells how often you can expect this particular distribution of populations from a randomly generated series, where you expect  $NB = 10$  on the average.

Applying the chi-square test to the bin populations of table 2 and then for much longer runs using the BASICA generator, you will find that if the random-number generator is pushed to 30,000 terms, it still performs well. The story changes as soon as you get close to the full period of about 65,000 terms. There, all bins are more or less equally filled and the histogram of bin populations,  $NB(J)$ , becomes tightly peaked about the mean value,  $\langle NB \rangle$ , because all possible values have been achieved. The generator has displayed its entire full period. Near this extreme limit, the generator fails the chi-square test because the chances are small that actual values will be any different from the expected value.

What happens when a random-number generator comes to the end of its period is similar to what happens in a game of blackjack when the cards are not collected into the deck after each hand. When 51 cards have been laid out, there is no doubt what the next card will be. You pro-

(continued)



# SEEKER!

**Multifunction Products for the TI Professional Computers**

<p><b>SEEKER S1 BOARD</b></p> <ul style="list-style-type: none"> <li>- Expandable memory from 0 to 512K bytes, fully socketed</li> <li>- SCSI/SASI interface</li> <li>- RS-232 Sync/Async port</li> <li>- Optional clock</li> <li>- Completely TI PC hardware and software compatible</li> <li>- Plugs into any open TI PC expansion slot</li> </ul>	<p><b>INTERNAL WINCHESTER</b></p> <p>Resides inside the Texas Instruments PC, interfaced to the SEEKER S1 board.</p> <ul style="list-style-type: none"> <li>- 10 &amp; 20 Megabyte</li> <li>- TI software compatible</li> <li>- Includes bootstrap EPROM</li> <li>- Format and test routines included</li> </ul>	<p><b>EXPANDABILITY</b></p> <p>Western Automation SEEKER products allow TI Professional Computers to expand to their full 768K memory. The SEEKER S1 board will control eight SCSI/SASI Winchester disks and streaming tape drives, like the SEEKER 60MB streaming tape system.</p>
<p><b>SEEKER S2 BOARD</b></p> <ul style="list-style-type: none"> <li>- RAM from 0K to 192K</li> <li>- Fully TI compatible</li> <li>- Will attach to SEEKER S1</li> </ul>	<p><b>EXTERNAL WINCHESTERS</b></p> <p>Cables to SEEKER S1</p> <ul style="list-style-type: none"> <li>- 10 &amp; 20 Megabyte</li> <li>- Cabinet matches TI PC</li> <li>- 110/220 VAC operation</li> </ul>	<p>SEEKER S1 board list \$425 SEEKER S1 and 10 MB internal drive list \$1895</p>

Ninety day warranty on all products. Available through Dealers and OEMs.

SEE US AT **COMDEX** / Fall '84

**WESTERN AUTOMATION LABORATORIES, INC.**  
5595 Arapahoe Road, Boulder, CO 80303

For Information write or call (303) 449-6400 or Toll Free (800) 227-4637

# CompuPro...

for Performance, Quality and Reliability

Anyone can sell you a box full of hardware. But is it too much computer? Too little? Will it run the appropriate software? What about service? If you need the right answers both before and after the sale, call your nearest **Full Service CompuPro System Center**. For product information, see pgs. 199 & 293.

## ALABAMA

**Birmingham**  
CPC Computers  
(205) 879-5976

## ARIZONA

**Scottsdale**  
S-100  
(602) 991-7870

## CALIFORNIA

**Bakersfield**  
Creative Computing  
(805) 835-1118

**Berkeley**  
American Computers  
& Engineers  
(415) 849-0177

**Track Computer Center**  
(415) 845-6366

**Burlingame**  
Mentzer Computer  
Systems  
(415) 340-9363

**Canyon Country**  
Creative Computing  
(805) 251-9877

**Chatsworth**  
Priority One Electronics  
(818) 709-6789

**Hayward**  
Best Computers  
(415) 886-4732

**Irvine**  
Priority One Electronics  
(714) 660-1411

**Los Angeles**  
American Computers  
& Engineers  
(213) 477-6751

**Gifford Computer  
Systems**  
(213) 477-3921

**Milpitas**  
Pragmatic Test  
Systems, Inc.  
(408) 943-3200

**Mountain View**  
ACC  
(415) 969-4969

**Oakland**  
Track Computer Center  
(415) 444-8725

**Pasadena**  
Omni Unlimited  
(818) 795-6664

**Petaluma**  
Advanced Information  
Management  
(707) 763-7283

**Pleasanton**  
Best Computers  
(415) 463-2233

**Sacramento**  
Logic Systems  
(916) 922-3377

**San Leandro**  
Gifford Computer  
Systems  
(415) 895-0798

**San Rafael**  
Computer House  
(415) 453-0865  
**Santa Barbara**  
Data Bank  
(805) 962-8489

**Santa Cruz**  
Cochlin Computer  
Systems  
(408) 429-6728

**Santa Maria**  
Data Bank  
(805) 922-1333

**Santa Rosa**  
Matrix Computers  
(707) 542-0571

**Simi Valley**  
Micro Power Unlimited  
(805) 584-6789

## COLORADO

**Lakewood**  
Rocky Mountain  
Microsystems  
(303) 232-4545

## CONNECTICUT

**Orange**  
Affordable Business  
Computers  
(203) 795-6046

## FLORIDA

**Gainesville**  
Online Computing  
(904) 372-1712

**Orlando**  
Data/Office  
(305) 629-6776

**Satellite Beach**  
Binary Magic, Inc.  
(305) 777-7080

**Tampa**  
Micro-Computer  
Technology  
(813) 985-0919

**West Palm Beach**  
Steve's Computer  
Works, Inc.  
(305) 683-5900

## HAWAII

**Kahului Maui**  
Capacity Plus  
Computers  
(808) 871-7984

## ILLINOIS

**Athens**  
Computers Plus  
(217) 636-8491

**La Grange Park**  
Small Business  
Systems, Inc.  
(312) 579-3311

**Mundelein**  
Computers 'n Stuff  
(312) 949-8585

**Skokie**  
Lillipute Computer  
Mart, Inc.  
(312) 674-1383

## KANSAS

**Ellinwood**  
Genesis Systems, Inc.  
(316) 564-3636

## MARYLAND

**Bethesda**  
JR Systems  
(301) 657-3598

## MASSACHUSETTS

**Boston**  
New England  
Electronic Exch.  
(617) 491-3000

**Chestnut Hill**  
Key Micro Systems  
(617) 738-7306

## MICHIGAN

**Ann Arbor**  
Waldorf Associates, LTD  
(313) 996-0646

## MISSISSIPPI

**Jackson**  
Professional Systems  
(601) 362-6673

**Pascagoula**  
Automated Accountants  
(601) 769-2937

## MISSOURI

**Kansas City**  
BBRL  
(816) 753-5900

**MONTANA**  
Missoula  
Harris-Larsen &  
Associates  
(406) 542-0146

## NEW YORK

**Amherst**  
Gifford Computer  
Systems  
(716) 833-4758

**Deer Park**  
Datapro Systems, Inc.  
(516) 595-1311

**New York**  
Park Plaza Computer  
Center, Inc.  
(212) 759-5820

**Staten Island**  
John D. Owens Assoc.  
(212) 448-6283

## NORTH CAROLINA

**Greensboro**  
General Semantics  
Computers  
(919) 378-1500

## OREGON

**Eugene**  
Midland-Cascade  
(503) 344-2111

**Portland**  
Microwest Computer  
Products  
(503) 238-6274

## PENNSYLVANIA

**Philadelphia**  
Forefront Technology  
(215) 386-1500

**Reading**  
Fraser Business  
Equipment  
(215) 378-0101

## RHODE ISLAND

**Coventry**  
Key Micro Systems  
(401) 828-7270

**Warwick**  
Systems &  
Solutions, Inc.  
(401) 732-2913

## TEXAS

**Austin**  
CPA Systems, Inc.  
(512) 458-9281

**Informa, Inc.**  
(512) 474-4449

**Omegax Systems**  
(512) 476-6069

## FL. Worth

**Dataworth Computer  
Systems**  
(817) 877-4041

**Houston**  
Gifford Computer  
Systems  
(713) 680-1944

**Informa, Inc.**  
(713) 861-7612

**Irving**  
Dator Systems  
(214) 986-0422

**San Antonio**  
RFCanon, Inc.  
(512) 379-0444

**Seguin**  
CPA Systems, Inc.  
(512) 379-0661

## VIRGINIA

**Woodbridge**  
Office Networks Corp.  
(703) 690-3312

## WASHINGTON

**Bellevue**  
North Ridge Computer  
Systems  
(206) 453-0596

**Seattle**  
American Computers  
& Engineers  
(206) 583-0130

## WISCONSIN

**Madison**  
Beam International  
(608) 233-1945

**Milwaukee**  
Byte Shop of Milwaukee  
(414) 281-7004

## AUSTRALIA

**Bankstown**  
Automation Statham  
Pty., Ltd.  
(02) 709-4144

## CANADA

**Coquitlam, B.C.**  
CSC System Center, Ltd.  
(604) 941-0622

**Vancouver, B.C.**  
Dynacomp Business  
Computers, Ltd.  
(604) 872-7737

## THE PHILIPPINES

**Quezon City**  
Corona International, Inc.  
78-34-71

## UNITED KINGDOM

**Swansea**  
Comcen Technology, Ltd.  
(0792) 796000

# CompuPro®

3506 Breakwater Court, Hayward, CA 94545



# Traditionally, databases have been left-brained.

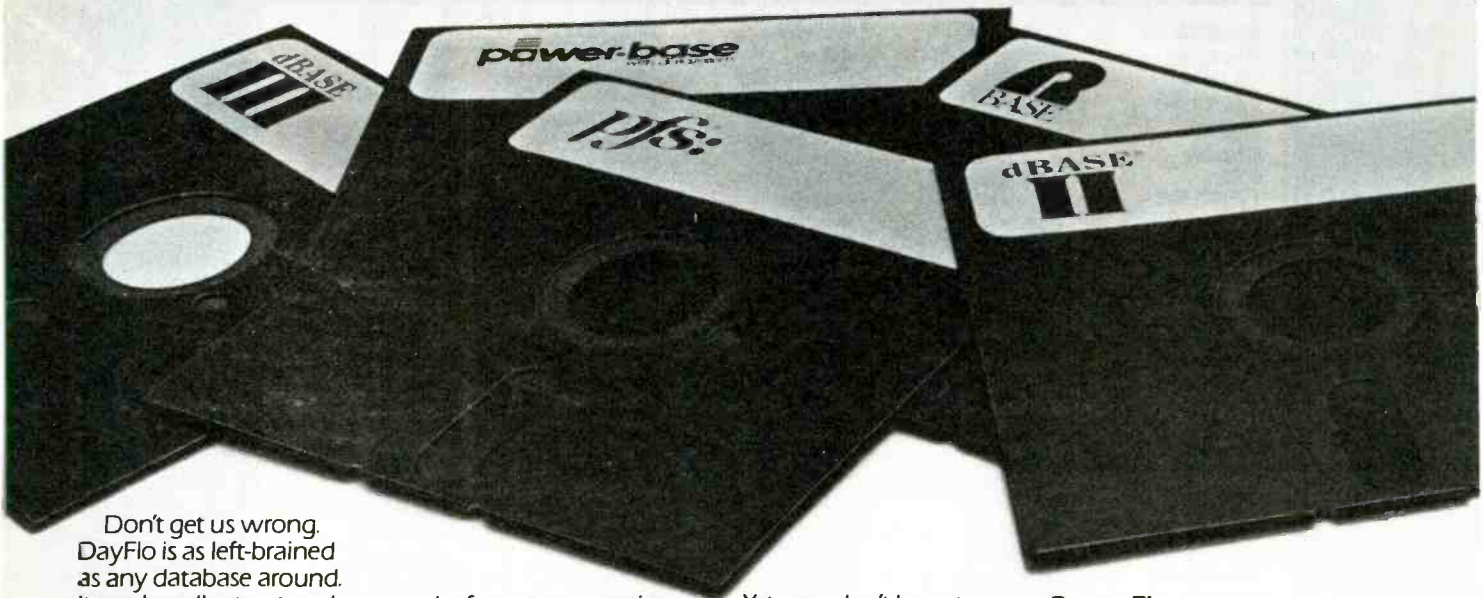

Don't get us wrong. DayFlo is as left-brained as any database around. It can handle structured information such as customer lists and personnel records. Keywords and field names are used to gain access to records.

Just like traditional databases. However, solving traditional problems in traditional ways is just one side of DayFlo. It's also flexible enough to handle today's new challenges in exciting new ways.

And that's where strictly left-brained databases get left behind. **The First Free-Form Database.**

In the real world, there's always an exception to the rule.

Which wreaks havoc on traditional databases. For example, because of fixed formats, entering a new field such as a Telex number into a single customer record is next to impossible. Unless you're prepared to reprogram

and reformat your entire database.

DayFlo, on the other hand, eliminates these tedious operations.

### **Word-Oriented Database.**

Unlike traditional databases, DayFlo has integral word processing. For instance, you can store letters and memos along with customer lists in the same database.

Now you're free to manipulate data at will. Free to enter, retrieve, edit and shuffle information whenever and wherever you please.

Every fact you need, from key client lists to spontaneously entered notes and ideas, is just a few keystrokes away. **Power, Yes.**

### **Programming, No.**

DayFlo is a powerful package that runs on an IBM PC with hard disk, Compaq Plus, or compatibles.

Yet, you don't have to be a programmer to use it.

So you see, DayFlo is a much greater information management tool than any traditional database. Much more flexibility and power than pfs. Much easier to use than dBASE II.

### **ReportFlo.**

With our ReportFlo package, you can produce presentation-quality documents, reports, letters, memos and so forth from the data stored in DayFlo. This potent report writer also performs calculations.

#### COMPARING DAYFLO TO TRADITIONAL DATABASES

TRADITIONAL DBMS	THE BENEFITS OF DAYFLO
<ul style="list-style-type: none"> <li>• Fixed record format. All records must look alike.</li> <li>• No word processing capabilities.</li> <li>• Fixed field length.</li> <li>• Adding new fields requires remapping or reformatting of database.</li> <li>• One value per field.</li> <li>• Retrieves data based on pre-planned criteria only.</li> </ul>	<ul style="list-style-type: none"> <li>• Free-Form record format. No two records need look alike. All record formats are stored in same database.</li> <li>• Integral word processing. Create and store letters, memos, notes, ideas, etc.</li> <li>• Variable field length. No counting character spaces.</li> <li>• Instantly add new fields to existing records without reformatting the entire database.</li> <li>• Multiple values per field. Information where you want it.</li> <li>• Retrieves information based on content or key words.</li> </ul>

#### WHAT YOU CAN DO WITH DAYFLO

<ul style="list-style-type: none"> <li>• Client Record Tracking</li> <li>• Sales Lead Tracking</li> <li>• Personnel Records</li> </ul>	<ul style="list-style-type: none"> <li>• Letters, Memos, Reports</li> <li>• Form Letters</li> <li>• Note Taking</li> <li>• Purchase Order Tracking</li> </ul>	<ul style="list-style-type: none"> <li>• Project Management</li> <li>• Field Service Tracking</li> <li>• And much more</li> </ul>
--	---	---



# Until now.

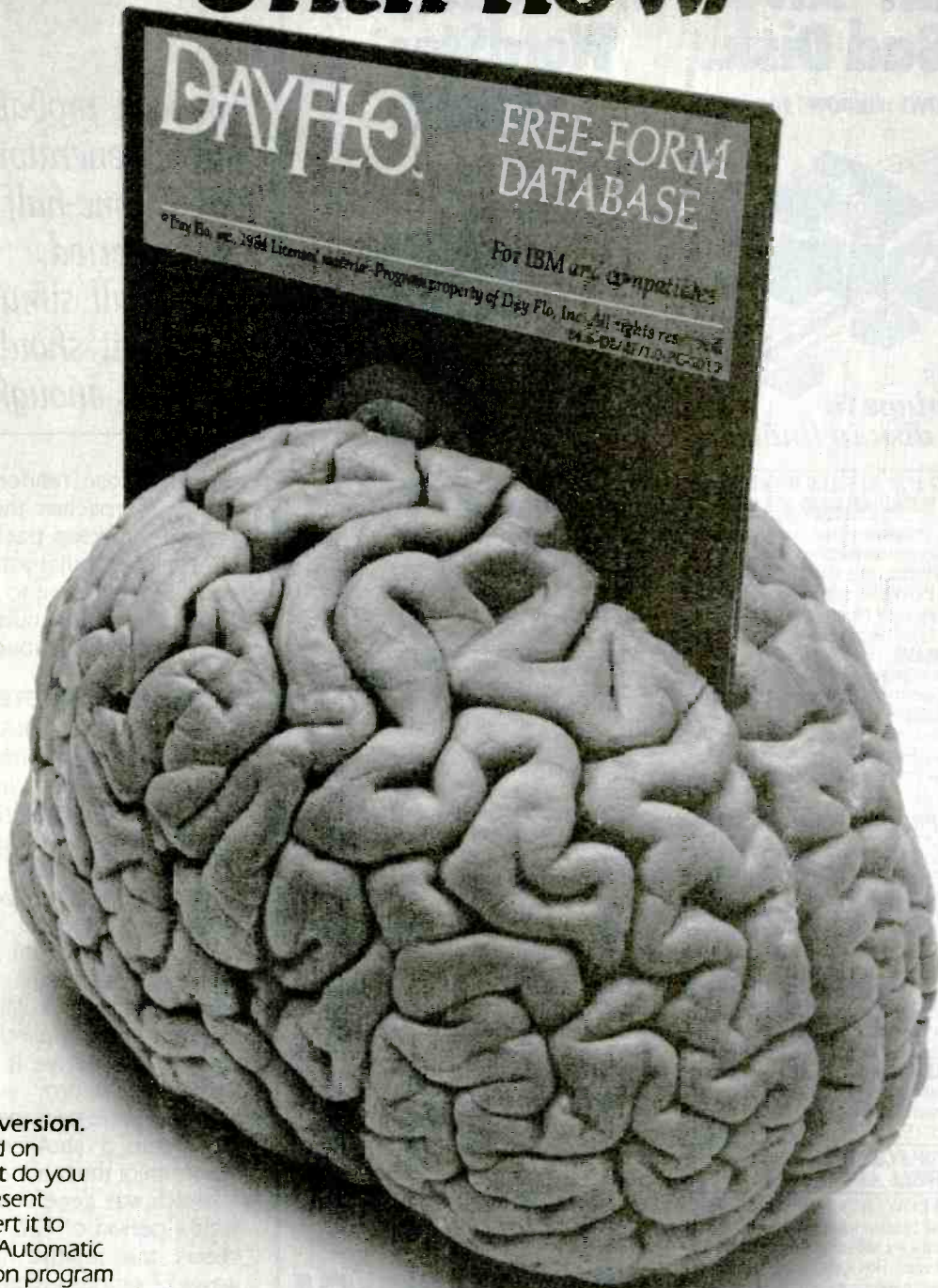

#### **Automatic Conversion.**

OK, you're sold on DayFlo. But what do you do with your present database? Convert it to DayFlo. Use our Automatic Record Conversion program for your pfs or dBASE II data.

#### **Seeing Is Believing.**

Visit your nearest DayFlo Dealer and see DayFlo in action for yourself. Or, if you prefer, we'll send you a Demo Disk for \$10. For details, call 1-800-7DAYFLO. In California, call 1-800-CDAYFLO.

And please ask questions. Anything your brain, either side, can conjure up.

## DAYFLO™

# The right brain will love it.

DayFlo, Inc., 2500 Michelson Drive, Building 400, Irvine, CA 92715



# Of course, POWER!™ saves your Bad Disk.

NOW! WINDOWS FOR IBM!

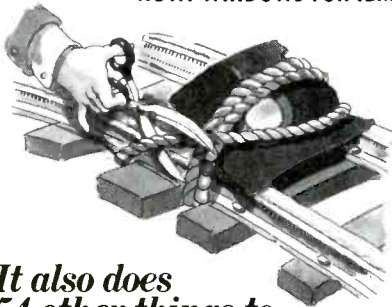

*It also does  
54 other things to  
keep your disk in line.*

### **EVERYTHING YOU ALWAYS WANTED TO DO, BUT WERE AFRAID TO TRY**

Unlike some utility programs that are a headache to use, POWER! is engineered to spoil you with 55 features, simple and uniform commands, and utter simplicity of use. POWER! automatically alphabetizes and numbers your files. You select by the number and never type file names again. Need to [COPY], [RENAME], [ERASE], or [RUN] programs? Just type in their menu number! POWER! also locks out your disk's bad sectors [TEST] without destroying files—a critical difference from other utilities that search and destroy, without informing you what they've done, leaving you to wonder why your programs won't run. (And POWER! still has 50 commands to go!)

### **POWER! ONE PROGRAM DOES IT ALL!**

You may own a few utility programs for your computer housekeeping, each with its own commands to memorize. POWER! has all the programs rolled into one 16K integrated package, so you do things you've never tried before—every day. Save sensitive data from prying eyes with [PASS] word protect, move a block of memory [MOVE], look for data [SEARCH] or compare files [CHECK]. POWER! also makes easy work of patching, [DISPLAY/SUBSTITUTE], customizing software [LOAD/SAVE]. Among the other commands are [SIZE], [STAT] [LOG], [DUMP], [TYPE], [JUMP], [FILL], [SET], and the CP/M version lets you restore erased files—even when you don't remember the filename—at a flick of the POWER! [RECLAIM] command. (Still 31 commands to go!)

### **POWER! NOW FOR IBM'S PC-DOS AS WELL AS CP/M**

We first developed POWER! for CP/M two years ago, and a stack of testimonials from FORD to XEROX testify to its excellence. For IBM-PC™ users, special features like managing sub-directories, [CHANGE], and a separate creation of up to 8 simultaneous, on-screen [WINDOWS] have been added.

### **MONEY-BACK GUARANTEE AND A 10 DAY TRIAL**

POWER! has the Seal of Approval from the Professional Software Programmers Association, and you, too, must be happy with POWER!—or your money back! For only \$169 you can now really be in control of your computer. Call Computing! at (415) 567-1634, or your local dealer. For IBM-PC or any CP/M machine. Please specify disk format.

**TO ORDER CALL 800 TOLLFREE**

IBM and IBM-PC are registered trademarks of International Business Machines Corporation.

# DOCU-POWER!™ will make your WordStar™ SHINE!



### **CREATE NEW TEXT WITHOUT RETYPING.**

DOCU-POWER! turns your existing text files into a database. Now you can create new documents from parts of old files by simply picking sections from the DOCU-POWER! master index. You never have to retype the same words again.

### **DOCU-POWER! WORKS WITH ANY WORD PROCESSOR.**

At your leisure, you set up your library files, and then give a DOCU-POWER! mark to any section, paragraph, or even groups of pages you think you may want to use again. DOCU-POWER! automatically indexes them for you, and, at the same time, extracts a comment description from your text—up to 40 characters long.

### **NOW YOU CAN WRITE BY NUMBER.**

To create your new text, simply scroll through your DOCU-POWER! index—you have instant window preview into any text—and pick the appropriate numbers. Now you can walk away, free to work on something else. DOCU-POWER! pulls together all the pieces of text, and gets it ready for printing or further editing with your own word processor.

### **MONEY-BACK GUARANTEE AND A 10 DAY TRIAL**

DOCU-POWER! is available by mail or through your software dealer—for only \$149. To order, call our 800 Toll Free number. For more information, call Computing! at 415-567-1634. For IBM-PC or any CP/M machine. Please specify disk format.

# COMPUTING!

*The company that earns  
its exclamation point.*

2519F Greenwich,  
San Francisco, CA 94123

# TOLL FREE

**800-428-7825 Ext. 96F**

**In CA: 800-428-7824 Ext. 96F**

WordStar is a trademark of MicroPro.

## RANDOM NUMBERS

*You can probably  
use a generator  
out to one-half  
of its period.  
For small simulations  
this limit should  
be good enough.*

gressively lose randomness as the dealer approaches the end of the deck—if you keep track.

The upshot is that you can probably use a generator out to one-half of its period. For small simulations this limit should be good enough.

### **AMPLITUDE SPECTRUM FROM FOURIER TRANSFORM**

I've already remarked that the random-walk pattern in figure 4, generated from BASICA RND, shows clear signs of waves. The Fourier amplitude spectrum lets you quantitatively measure the waves' size (see "Fourier Spectrum" on page 464). You can derive this spectrum from the fundamental definition of the Fourier coefficients that you'll find in introductory books on applied mathematics. Or you can derive it from the fast Fourier transform subroutines in some software packages. As an example, figure 5 shows the frequency spectrum of the random walk in figure 3, which was generated with an LCG with a period of 127. This spectrum shows the relative amplitudes of waves of various frequencies. You plot the frequencies in terms of the walk's full length, namely 1000 steps, so that the primary period of 127 shows as a peak in the spectrum at about 8 cycles (1000/127) on this spectrum. Because it quickly becomes repetitious, you can't use such an LCG for simulations involving more than a few dozen steps, and the Fourier spectrum puts you on your guard. Figure 6 shows the amplitude spectrum for the BASICA RND pseudorandom-number generator that comes with

## RANDOM NUMBERS

the IBM PC's MS-DOS 2.0 operating system. In this diagram, the frequency is the number of peaks in every 64,000-step run. For example, significant waves show 4, 12, 21, 28, and 37 peaks per 64,000 steps. The most prominent is the wave with frequency 4, which accounts for the main random-walk plot pattern. The fact that you can divide two of the higher frequencies, 12 and 28, by 4 accounts for the repeated pattern of details on the waves. This test is a clear call for caution in using BASICA RND, and it implies that you need an improved generator.

### SHUFFLING A GENERATOR

How can you extend the period? As mentioned earlier, an LCG's period has two limitations: only integers less than the modulus,  $m$ , are generated; and the series is deterministic, meaning a particular number always has a

particular sequel. For a computer capable of handling integers smaller than a fixed limit,  $I_{max}$ , you can do nothing about the first restriction. You can, however, alleviate the second restriction and alter the simple determinism of the series using a technique called "shuffling."

Consider an LCG with a period of 8. Each member of the series is an integer from 0 to 7, and if the selection is purely sequential, the period inevitably will be 8. But suppose you set up a secondary list of five numbers and use a second LCG to select the next member of the series from one of them. Then, after each five selections, you replace the five numbers in the secondary list with a randomly selected set. By using two LCGs, you can shuffle the series and extend the effective period. You do not increase the possible integers but prevent an

(continued)

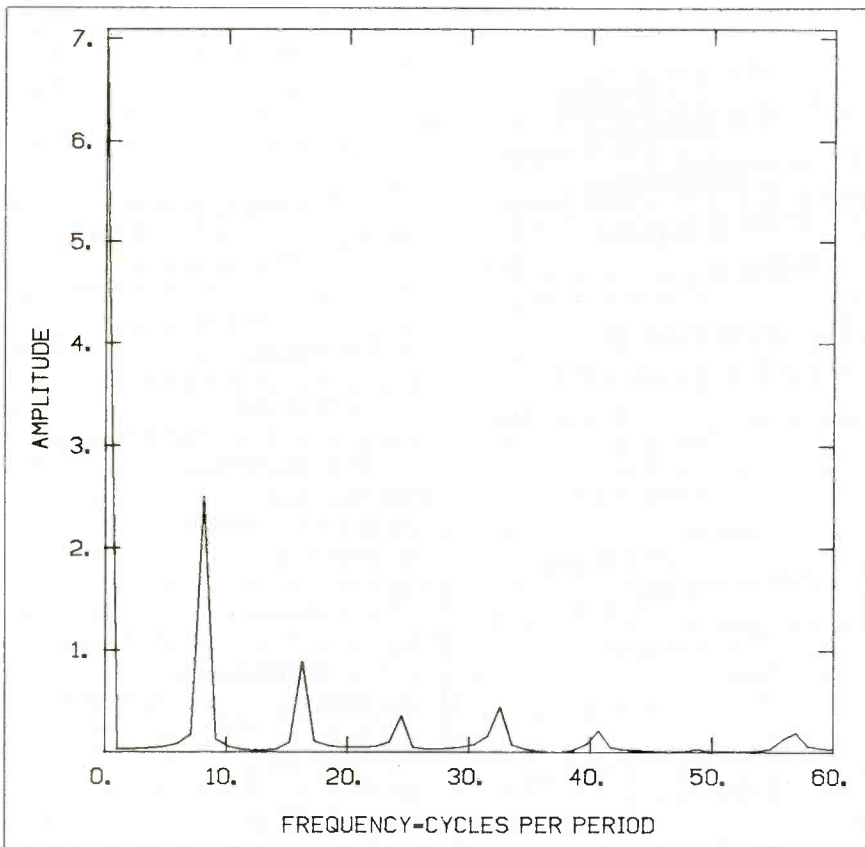

Figure 5: Amplitude spectrum for the random walk generated by the simple LCG in figure 3. The sharply peaked pattern indicates a highly repetitive pattern.

## DISK DRIVES

Qume 142A	\$199
Teac FD55B	\$169
Tandon TM100 2	\$199
Tandon TM100 4	\$295
CDC 9409	\$219
Case and PS	\$ 45

## PC EXPANSIONS

Maynard Disk Controller	\$ 114
Sandstar Series	call
Internal 10MB systems, WS1	\$899
WS2	\$1079
Quadboard (64K)	\$269
Quadboard (348K)	\$514
Quadcolor I	\$199
AST SixPakPlus (64K)	\$269
SixPakPlus (384K)	\$514
MegaPlus (64K)	\$269
I/O Plus	\$129
AST-3780	\$659
PCnet starter kit	\$809
MonoGraphPlus	\$389
HERCULES graphics board	\$349
HAYES Modems 300	\$209
Smartmodem 1200	\$489
Smartmodem 1200B	\$ 45
Set of 9 chips (64K)	\$ 45

## VLM Computer Electronics

10 Park Place • Morristown, NJ 07960  
(201) 267-3268 Visa, MC, Check or COD

Circle 373 on inquiry card.

## INTRODUCING THE CYPHER™

A COMPLETE 68000 & Z 80 SINGLE BOARD COMPUTER SYSTEM WITH ULTRA-HIGH-RES GRAPHICS!!

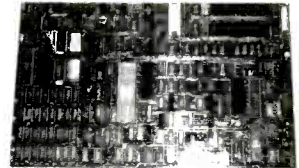

- 68000 & Z80 DUAL PROCESSORS (BEST OF BOTH WORLDS)
- 256K TO 1 MEGABYTE MEMORY
- DOUBLE DENSITY FLOPPY DISK CONTROLLER IN ONE SLOT
- DMA CONTROLLER FOR FAST IMAGE TRANSFER TO/FROM VIDEO MEMORY (H/RT)
- 2 SERIAL PORTS (EIO)
- 24 BIT ADDRESS MANAGEMENT FOR Z80
- 4 LAYER PCB (8% + 4%)
- ULTRA HIGH RESOLUTION GRAPHICS (256K PROGRAMMABLE UP TO 1024x1024 RESOLUTION GREAT FOR CAD SYSTEMS)
- REAL TIME CLOCK MULTITASKING CAPABILITY
- TWO CHANNELS OF DIGITAL AUDIO (8 BIT RESOLUTION MUSIC PROTOTYPES)
- 16K IN 64K BOOT PROM
- 64K TO 54K STATIC RAM
- PROGRAMMABLE AUDIO RATE GENERATOR
- PARALLEL ASCII KEYBOARD INPUT
- FULL EXPANSION 16 BIT EXPANSION BUS

(HARD DISK INTERFACE PLUG-IN CARD COMING SOON)

- |   |        |  |        |
|---|--------|--|--------|
| COMPLETE MANUAL   | \$200  | COMPLETE KEY ASSEMBLY SYSTEM INCLUDES BASIC MEMBERSHIP FOR ONE YEAR (96 VIDEO) | \$1495 |
| BASIC BOARD (CPU & BUS) WITH 64K RAM  | \$499  | REAL TIME CLOCK AD & DA  | \$149  |
| MONITOR, 484 MONITOR AND UTILITIES  | \$449  | KEYBOARD   | \$59   |
| BASIC ASSEMBLY SYSTEM INCLUDES 117 TESTED WITH MANUFACTURED SERIAL I/O, 128K DRAM, 4x 5.25 INCH AND DISK CONTROLLER | \$1495 | BUFFERING POWER SUPPLY   | \$54   |
|   |        | CASE   | \$49   |

ALL PRICES IN U.S. DOLLARS. SHIPPING AND HANDLING CHARGES APPLY. LOCAL DELIVERY AND WE WILL APPROXIMATELY 2 TO 4 WEEKS FROM THE TIME YOUR ORDER IS RECEIVED. PRICES SUBJECT TO CHANGE WITHOUT NOTICE.

Circle 401 on inquiry card.

## MEMOREX FLEXIBLE DISCS

WE WILL NOT BE UNDER-SOLD!! Call Free (800)235-4137 for prices and information. Dealer inquiries invited and C.O.D.'s accepted.

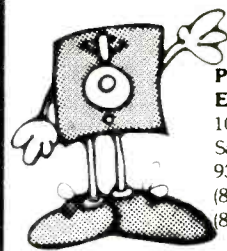

PACIFIC EXCHANGES  
100 Foothill Blvd.  
San Luis Obispo, CA  
93401 In Cal call  
(800)592-5935 or  
(805)543-1037

Circle 268 on inquiry card.



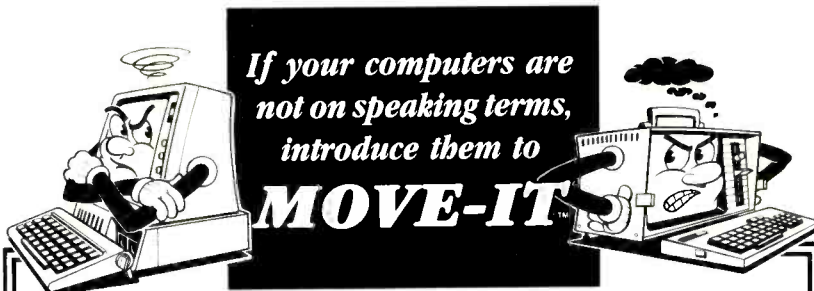

*If your computers are not on speaking terms, introduce them to*  
**MOVE-IT**

Now you can move files, programs and data between incompatible computers. When adding a new computer, data and programs from one system can be transferred to another with MOVE-IT, even if the two have different disk formats and use different operating systems.

A mini-network can be set up by equipping each computer with MOVE-IT, increasing utilization by sharing information freely between machines.

**Error Free.** A 16 bit error checking technique assures accurate and error-free data transmission even at high speeds and over "dirty" telephone lines or long cable runs. MOVE-IT is the ideal program for telephone line use with modems as well as direct wire applications.

If you have ever faced the problem of intercomputer communication, MOVE-IT is what you need.

**The simplest dependable solution,** the lowest in cost. No expensive circuit boards to install. Easiest to set up. No programming knowledge necessary. Over 17,000 programs sold and operating.

**Also MOVE-IT puts you in touch with information networks** such as "The Source," "CompuServe," "Dow Jones" and "News Net."

**With MOVE-IT you can communicate with over 120 different makes of computers using PC DOS, CPM/86 and CP/M systems.** Retail price is \$125 for all CP/M systems and \$150 for all CPM/86 and MS-DOS systems including the IBM PC. Available from your local dealer or from:

**WOOLF SOFTWARE SYSTEMS, INC.**  
 6754 ETON AVE., CANOGA PARK, CA 91303 • (818) 703-8112  
 Dealer inquiries invited.

© COPYRIGHT 1984 WOOLF SOFTWARE SYSTEMS, INC.

**SEE US AT COMDEX**

**RANDOM NUMBERS**

*An LCG's period has two limitations: only integers less than the modulus are generated; and the series is deterministic.*

early repetition of the pattern.

Another way to think of this manipulation is in terms of a fictitious game of solitaire. Suppose I have two decks of cards. One of them has been shuffled, but I am asked to produce the longest possible nonrepeating series by laying down the cards from the unshuffled deck. I must follow some well-defined rule of my own choosing, and when I have gone through the deck I can start again. Before continuing, however, I must put the cards back into their original order. Since I cannot shuffle the deck in the usual way, if I merely start over, I will have come to the end of the deck and the series will repeat. What can I do with the other deck?

Here is one procedure, and you can invent others that will work just as well or better. They are analogs for shuffling in the LCG. (The two decks correspond to the two LCGs.) Lay the cards in the unshuffled deck into five piles. Then remove a few cards from the shuffled deck so that it will not have the same number as the unshuffled deck. Then draw a card from the shuffled deck and take its value modulo 5 to compute a number designating one of the five piles. Select the first card from that pile and put it into a discard pile. Continue drawing cards from the shuffled deck, computing the number of their piles and selecting a card from that pile until you exhaust the shuffled deck. Then, start again with the cards in the same order. When the five piles from the unshuffled deck are exhausted, pick up the discard pile, put the cards back into their original order, and lay out five piles again. Continue as before. You will probably find that the

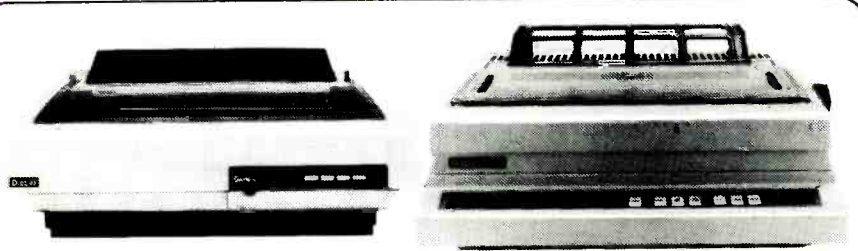

Series 36: 35 cps - all-purpose interface      630 API: 40 cps - all-purpose interface

**Treat your personal computer to famous Diablo letter-quality printing.**

Don't settle for less: your choice of hundreds of printwheel styles, fully-formed characters, interfaces with IBM, Apple, Radio Shack, Commodore IEEE 488, Centronics "Parallel" and RS232C "Serial". In MTI's opinion, the best letter-quality printers on the market.

Whether you lease or buy, you'll find MTI is the one source for all the computer and data communications equipment, applications expertise and service you'll ever need. At hard-to-beat prices. Call us.

New York: 516/621-6200, 212/767-0677, 518/449-5959  
 New Jersey: 201/227-5552    Pennsylvania: 412/931-9351  
 Ohio: 216/464-6688, 513/891-7050  
 Outside N.Y.S.: 800/645-6530

"QED" Discounts  
 VISA & MasterCard



Diablo Authorized Distributor

Computer & Data Communications Equipment  
 Distribution/Systems Integration/Maintenance  
 DEC, Intel, Texas Instruments, Hewlett-Packard, Dataproducts, Diablo, Lear Siegler, Esprit, C. Itoh, Racal-Vadic, MICOM, Ven-Tel, Develcon, PCI, U.S. Design, Digital Eng., Cipher, MicroPro, Microsoft, Polygon & Select.

## RANDOM NUMBERS

order is quite different the second time and in succeeding sequences. The success of this method depends on having an appropriate number of piles and taking an appropriate number of cards out of the shuffled deck before starting. In a similar way, the success of the shuffled LCG depends on the two series having appropriate relationships between them.

The efficiency of the shuffling technique is quite spectacular. For instance, from a pair of LCGs with periods of only 8 and 9, you can generate a pseudorandom series with a period greater than 200. By tailoring the pair of LCGs to the word length of the computer, you can create shuffled LCGs with much longer periods.

Listing 1 is a BASIC shuffling pro-

gram that generates a random walk consisting of  $NG$  groups of  $NS$  steps and prints the displacement after each group. By analyzing this listing, you can develop a random-number subroutine suitable for virtually any computer. Notice that subroutine 1010 initializes the program by filling the "piles" with numbers, as in laying out the five piles of cards described above. The program uses two distinct LCGs, and their parameters are listed in statement 32. Before demonstrating the power of this program, I will describe how I selected these parameters.

### TAILORING A SHUFFLED LCG

I looked for the largest modulus and the largest multiplier consistent with

(continued)

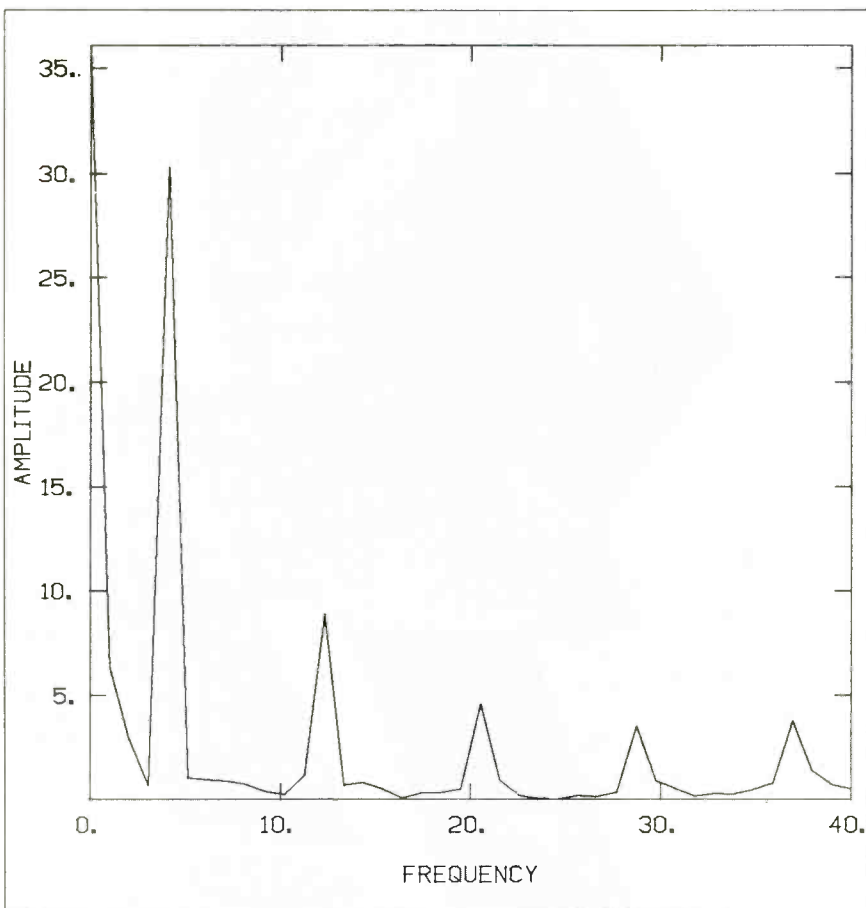
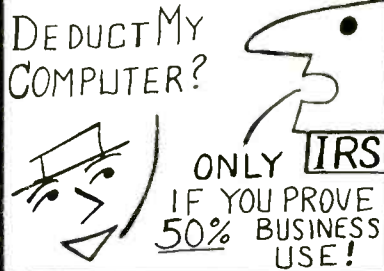

Figure 6: Amplitude spectrum for the Advanced BASIC random-number generator, showing the prevalence of certain cycles. "Frequency" is the number of cycles in 64,000 steps. The peak at about 4 corresponds to the wavy pattern evident in figure 4.

**DEDUCT MY COMPUTER?**



ONLY IRS  
IF YOU PROVE  
50% BUSINESS  
USE!

PROTECT YOUR DEDUCTION

DEDUCT YOUR COMPUTER?

New tax laws require proof of 50% business use. The PYD (Prove Your Deduction) program records and reports use on most CP/M and MS-DOS computers.

Only \$24.95

Call BCD-COMPUTERS  
(800) 223-5369 EXT 242

Circle 41 on inquiry card.

WHY PAY MORE?  
ORDER DIRECT AND SAVE \$\$\$  
1 YEAR WARRANTY ON ALL ITEMS

IBM		Our Price	List
KYB-1 83 Key Keyboard for PC		\$99	\$149
PX-IV .31mm Pitch RGB 13" Monitor w/Green Text & Tilt Swivel		\$469	\$699
CGA Color Graphics Adaptor Bd		\$160	\$244
ComboPX-IV/CGA		\$599	\$943
PCB-201 Light Pen		\$64	\$99

APPLE

MAK-1 90 Key Detach Kbd. w/ user defined Keys for II/II+, Franklin	\$99	\$149
SMC-II Light Pen w/software for II/II+/Ile	\$149	\$179

COD, VISA/MC ACCEPTED

SYSTEMS

INCORPORATED

27 Station Square, Bergenfield, N.J. 07621  
201-387-1109

Circle 209 on inquiry card.

OK-WRITER™.M.



LETTER QUALITY

Enhancement for Dot Matrix Printers

- Easy to install
- Plug-in module
- Okidata printers
- Letter Quality 30 cps
- Draft Quality 120 cps
- 10, 12, 17 cpi

- Full dot addressable graphics
- Front panel access to all features
- Proportional spacing, bold, double width, underlining, self-test, etc.
- Serial and parallel interfaces retained
- HELP mode; Diagnostic HEX dump
- And many other features

Designed for upgrading your current or new ML82A/83A printer.

RAINBOW

TECHNOLOGIES INC

P.O. Box 7200, Costa Mesa, CA 92628  
(714) 241-0565 Telex 386078

Circle 305 on inquiry card.



TOGETHER,  
STOPPING  
YOU.



# THERE'S NO

## **KnowledgeMan™ and You. The possibilities are endless.**

To succeed in business, you need a partner that's fast, flexible, intelligent and easy to work with. A partner that can help turn your big ideas into well-conceived reality. One that gives you the support you need to make critical decisions confidently.

No partner can give you more of what you need than KnowledgeMan, the knowledge management software from MDBS.

## **A powerful partner.**

KnowledgeMan helps you manage more knowledge, in more ways, than ordinary software. It can help you make better decisions on just about everything from production scheduling to financial planning to market

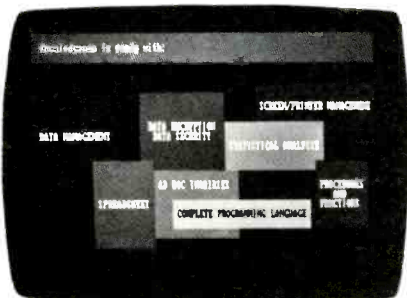

forecasting. KnowledgeMan and its optional components offer data management, spreadsheet analysis, statistical analysis, text processing, forms management, business graphics, programming and more.

The key to KnowledgeMan's versatility is its exclusive synergistic integration, allowing you to accomplish your computing needs within one program. Unlike other software, there's no need to exit one function before entering another. The result: different kinds of processing can be intermingled. Quickly and easily.

## **A partner that speaks your language.**

For all of its power and sophistication, KnowledgeMan is remarkably simple to understand. Even a beginner can start putting KnowledgeMan to work in minutes. With a single query, you can obtain related data from unlimited multiple tables. You can even teach KnowledgeMan to understand your own jargon.

## **A partner that helps you along.**

The on-line HELP facility allows you to draw on 6800 lines of helpful information organized into 380 screens. If you have a problem or question, KnowledgeMan allows you to access the pertinent HELP screen immediately. Each screen is carefully designed to provide a quick reference guide to KnowledgeMan commands.

## **A partner that gives you room to grow.**

Ordinary software packages can be frustratingly easy to outgrow. Not KnowledgeMan. Each KnowledgeMan component has more power than you'll probably ever need—far more than conventional integrated programs. With KnowledgeMan, you don't sacrifice capability, capacity or convenience. So with KnowledgeMan, you spend your time solving problems—not trying to overcome software limitations.

## **A partner that protects your interests.**

KnowledgeMan offers sophisticated security features. Unauthorized access to data is next to impossible, thanks to password checking, thousands of access code combinations and data encryption.

So your secrets are safe with KnowledgeMan.

## **A partner you can build on.**

To add yet another dimension to KnowledgeMan's capabilities, you can get fully-integrated options like K-Graph, an extensive business graphics facility that



lets you plot information in a variety of colorful graphs, charts and diagrams. For text processing, the K-Text option lets you incorporate data into written documents quickly and easily. Or, create highly-polished, full-color customized forms with K-Paint, our forms painting option. To short-cut the keyboard, put the K-Mouse option to work.

## **A partner you should get to know better.**

To see KnowledgeMan in action, visit your dealer. Or contact Micro Data Base Systems, Inc., P.O. Box 248, Lafayette, IN 47902, (317) 463-2581, Telex: 209147 ISE UR.

It may be the beginning of a long, successful partnership.

Current version is 1.07 as of 9/10/84. KnowledgeMan, K-Graph, K-Paint, K-Text, and K-Mouse are trademarks of Micro Data Base Systems, Inc. MDBS is a registered trademark of Micro Data Base Systems, Inc.

# KNOWLEDGE man™

The Knowledge Management Software  
from MDBS

Circle 224 on inquiry card.





# wabash

Flexible Diskettes

6 Year Warranty - 100% Certified

**\*FREE DELIVERY**

<b>5 1/4" \$135</b> SINGLE SIDE SINGLE DENSITY 48 TR/W/HUB RING each QTY-20 Packed 10 per Soft Pack	<b>BULK SSSD \$119</b> 100/CASE White Envelope W/HUB RING each
<b>5 1/4" \$155</b> SINGLE SIDE DOUBLE DENSITY 48 TR/W/HUB RING each QTY-20 Packed 10 per Soft Pack	<b>BULK SSDD \$138</b> 100/CASE White Envelope W/HUB RING each
<b>5 1/4" \$189</b> DOUBLE SIDE DOUBLE DENSITY 48 TR/W/HUB RING each QTY-20 Packed 10 per Soft Pack	<b>BULK DSDD \$169</b> 100/CASE White Envelope W/HUB RING each

24 Hour Order Desk



TOLL FREE NAT'L. **1-800-634-2248**

Visa, MasterCard, Cert. chk., M/O, C.O.D. cash.  
Get immediate shipment. Schools & govt. on P.O. #.  
Personal or company checks held 14 days.  
APO, FPO, Can. and other non-UPS delivered, add \$5.  
\*Free delivery on minimum orders of \$50 or more. Others add \$2 for S & H.

**Software Services**

1326 25th St. S., Suite H, Fargo, ND 58103 1-701-280-0121

Circle 334 on inquiry card.

## Buy/Sell Used Hardware Without Risk!!!

In addition to receiving a monthly newsletter containing latest computer information and sales, membership allows you 1 free ad plus additional ads at reduced prices. Buyer selects ad, sends purchase price to Computer Swap Shop who holds same in escrow and notifies seller who ships to buyer. Buyer has 7 days to examine the equipment and if satisfied, seller receives sales price less small commission; otherwise, money is refunded. You must be a member to buy or sell with Computer Swap Shop Inc.

**NO RISK! BONDED.**

Send \$20 subscription fee to:

**Computer Swap Shop, Inc.**  
Box 2988  
Delray Beach, FL 33444

Circle 73 on inquiry card.

**ALSO RS232C**



**Dot Matrix Printer Interfaces with Apple II**  
Featuring an Apple II-compatible parallel interface, Addmaster Corporation has produced a new dot matrix printer, Model 170. The interface includes a Centronics-type handshake and DB-25 interface connector, Baudot, and day and time clock. The Model 170 provides 18 or 21 characters per line, 6 lines per inch print density, on standard 2 1/2" adding machine tape. Designed to use with personal computers, Model 170 will produce hard and carbonless copies of programs, data or results. Write Addmaster Corporation, 416 Junipero Serra Dr., San Gabriel, CA 91776 or call 213/285-1121.

Circle 8 on inquiry card.

## RANDOM NUMBERS

$I_{max} = 32,768$ , the largest integer my computer can handle.

I first needed an expression for the largest integer that will be computed by a particular LCG. It is approximately  $a \times m + c$  before it is reduced modulo,  $m$ . This integer must satisfy  $a \times m + c < I_{max}$ .

The condition  $a > \sqrt{m}$  also constrains the multiplier to avoid serial correlations. These two constraints suggest taking a small value for the additive constant,  $c$ , and setting  $a = m$ , which leads to the approximate relationship  $a = m = \sqrt{I_{max}}$ . For a 16-bit computer,  $I_{max} = 32,768$ , which

implies  $a = m < 181$ . Thus, you can construct a shuffled LCG from a pair of LCGs with periods less than 181. I then wrote a program to run through the output of an LCG and test for full period. After some experimenting, I found that the following pair of LCGs have full periods:  $I_{i+1} = \text{mod}(111I_i + 11, 151)$ ; and  $I_{i+1} = \text{mod}(113I_i + 13, 137)$ . Finally, the choice of the number of piles did not seem to me to be critical, and I settled on NPILES = 121.

Figure 7 shows a 50,000-step random walk generated on an IBM PC by  
*(continued)*

Listing 1: A program in BASIC for generating pseudorandom sequence from two LCGs with shuffling.

```

10 ' PROGRAM RANWALK5 with shuffling; MS-BASICA
15 OPEN "RANWALK5.OUT" FOR OUTPUT AS #2
16 DIM IXS(200)
18 INPUT "NPILES";NPILES ' *** Use NPILES = 121 for secondary list
30 INPUT "SEED";IS
32 IM2 = 137:IA2 = 113:IC2 = 13:IM1 = 151:IA1 = 111:IC1 = 11 ' *** LCGs
34 GOSUB 1010 ' TO INITIALIZE RAND
40 INPUT "STEPS PER GROUP";NS
50 INPUT "NUMBER OF GROUPS"; NG
60 PRINT -2, "RANWALK5,
   LCG#(111,11,151),LCGC(113,13,137):";NS;NG;NPILES
68 ICOUNT = 0
70 FOR I = 1 TO NG
90 FOR J = 1 TO NS
92 GOSUB 2010 ' TO COMPUTE RAND
93 ICOUNT = ICOUNT + 1
94 IF ICOUNT = NPILES + 1 THEN GOSUB 1010:ICOUNT = 0 ' reset piles
100 IF RAND > .50 THEN MD = 1 ELSE MD = - 1
110 M = M + MD
111 NEXT J
114 PRINT #2,I," ",M," " ' *** output of random displacement
128 NEXT I
130 GOTO 5000
140 ' *** end of main program
1000 ' *** Initialize piles of secondary list for shuffling
1010 FOR IK = 1 TO NPILES
1020 IX1 = IX1*IA1 + IC1
1022 JJ = INT(IX1/IM1):IX1 = IX1 - IM1*JJ
1029 IXS(IK) = IX1
1030 NEXT IK
1040 RETURN
2000 ' *** RAND drawing from piles without replacement
2010 IX2 = IX2*IA2 + IC2
2011 JJ = INT(IX2/IM2):IX2 = IX2 - IM2*JJ
2012 ICELL = INT(NPILES*IX2/IM2) + 1
2020 RAND = IXS(CELL)/IM1
2040 RETURN
5000 END

```

## RANDOM NUMBERS

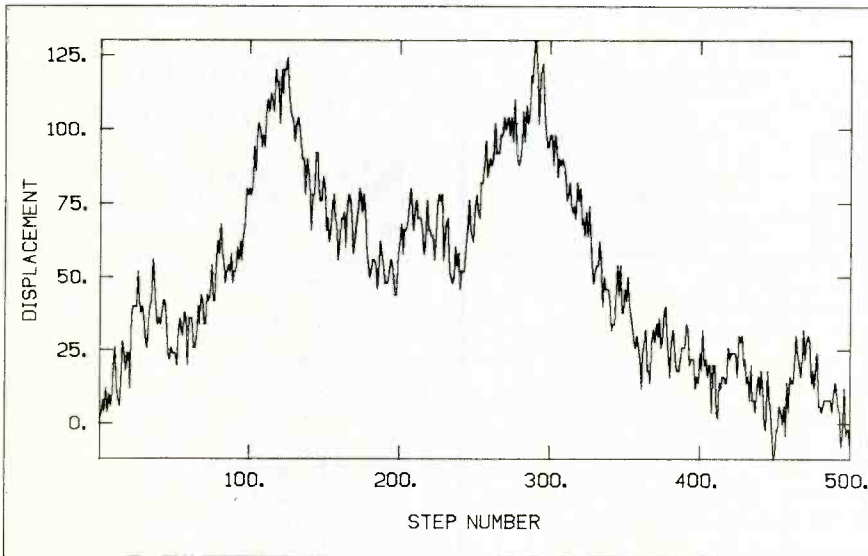

Figure 7: A random walk with shuffling, tailored to a 16-bit computer. In the absence of shuffling, this generator would be limited to a period of several hundred. With shuffling, the period is longer than 50,000. This walk was generated with an IBM PC.

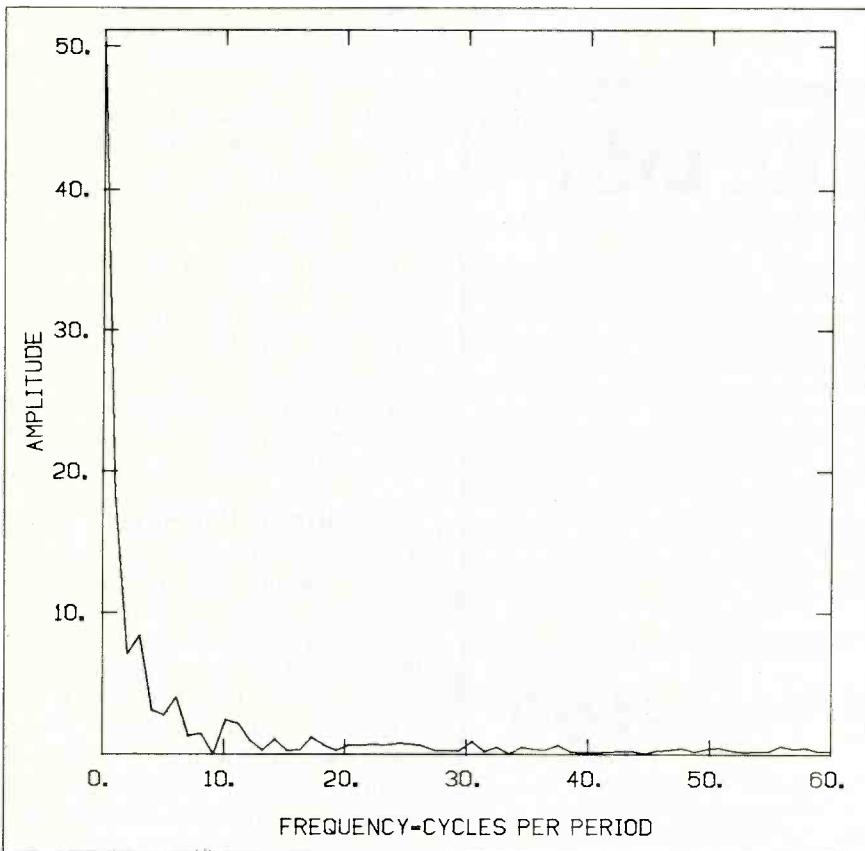

Figure 8: Amplitude spectrum of the random walk in figure 7, showing absence of significant periodicities and indicating that the shuffled pair of LCGs passes this test successfully.

The best, best value, best reliability,  
or best feature on sale. OFFERING

### THE BEST FOR LESS \$

IBM PC	Call
BEST graphic card	\$349
BEST VALUE word processing	128
BEST VALUE spreadsheet	139
BEST VALUE diskettes DS/DD 5 $\frac{1}{4}$ " 10	35
STB Super Rio 64 K	315
Quadram Expanded Quadboard	Call
Hayes Smartmodem 1200B	419
PRINTERS Ok! 92 par	425
Brothers HR-25	695
Epson	Call
Diablo	Call
Ricoh	Call

**BEST PC Compatible Package:** including  
a BEST VALUE computer system and  
a BEST VALUE word processing \$2189

COMPUTER SALES Co  
(619) 576-9185

Mon.-Fri. 9 a.m.-5 p.m. Pacific Time.

8199 Claremont Mesa Blvd. #A-1 Visa, MasterCard  
P.O. Box 112425 Prices reflect cash discount  
San Diego, CA 92111 No returns on software

Circle 72 on inquiry card.

**1  
800  
292-1492**

**Lifetime  
Guarantee!!**

**DISKS**

Fuji - Memorex and Others...

**Order 2 Boxes and SAVE!**

**Call Disk Works for our latest  
prices on Memorex, Fuji and  
3M diskettes.**

**1-800-292-1492 Nationwide or  
(312) 368-0359 in Illinois**

**5 1/4 SSDD \$1.79 each**

**5 1/4 DSDD \$2.29 each**

**3 1/5 DSDD \$3.80 each**

Prices are per disk in quantity 2 boxes of  
10. Add \$2.50 shipping and handling. Call  
for quantity pricing and shipping. All  
orders shipped same day via UPS ground.

**DISK WORKS**

11 S. LaSalle St., Suite 2601  
Chicago, IL 60603

Circle 105 on inquiry card.

**NEW!**

**SafeSkin**  
KEYBOARD PROTECTOR

Remains in place during keyboard use.  
Prevents damage from liquid spills, dust,  
ashes, etc. Fits like a second skin, excellent  
feel. Homerow and numeric locators.  
Available for: IBM-PC, Apple IIe, Radio  
Shack Model 100, Commodore 64.  
Send \$29.95, check or M.O., Visa & MC  
include exp. date. Specify computer type.  
Dealer inquires invited. Free brochure  
available.

MERRITT Computer Products, Inc.  
2925 LBJ, #180 / Dallas, Texas 75234  
(214) 942-1142

Circle 220 on inquiry card.



# Eco-C Compiler

## Release 3.0

We think Rel. 3.0 of the Eco-C Compiler is the fastest full C available for the Z80 environment. Consider the evidence:

### Benchmarks\* (Seconds)

Benchmark	Eco-C	Aztec	Q/C
Seive	29	33	40
Fib	75	125	99
Deref	19	CNC	31
Matmult	42	115	N/A

\*Times courtesy of Dr. David Clark  
CNC - Could Not Compile  
N/A - Does not support floating point

We've also expanded the library (120 functions), the user's manual and compile-time switches (including multiple non-fatal error messages). The price is still \$250.00 and includes Microsoft's MACRO 80. As an option, we will supply Eco-C with the SLR Systems assembler - linker - librarian for \$295.00 (up to six times faster than MACRO 80).

For additional information, call or write:



(317) 255-6476

6413 N. College Ave. • Indianapolis, Indiana 46220



NEW RELEASE

## RANDOM NUMBERS

# FOURIER SPECTRUM

Named for the French mathematician J. B. J. Fourier (1768-1830), the Fourier series is a representation of a series of data points,  $F(t)$ , as a sum of harmonic terms in the form

$$F(t) = \sum [a_n \sin(nwt) + b_n \cos(nwt)]$$

When  $F(t)$  is specified at a discrete set of points—such as the displacements in a random walk at uniformly spaced times—the coefficients,  $a_n$  and  $b_n$ , can be found by summing products of the data and the trigonometric functions. These coefficients comprise the amplitude spectrum, and the quantity  $\sqrt{a_n^2 + b_n^2}$  is a measure of the importance of harmonic frequency  $nw$  in the data. Large values of  $a_n$  or  $b_n$  indicate that the data has a significant component of variation with a period  $2\pi/(nw)$ .

using listing 1, and figure 8 shows the corresponding amplitude spectrum. The spectrum shows a wide and fairly smooth distribution of frequencies, and the period of this shuffled LCG is evidently very long. A walk of this length represents a satisfactory type of pseudorandom-number generator for use with 16-bit computers. When 32-bit machines come along, changing the parameters to take advantage of the greater range of integers will be fairly straightforward.

### CONCLUDING REMARKS

If you want to pursue the art of making new generators, I recommend Donald E. Knuth's three-volume classic, *The Art of Computer Programming* (Reading, MA: Addison-Wesley Publishing Co., Vol. 1 [2nd ed.], 1974; Vol. 2 [2nd ed.], 1981; Vol. 3, 1973).

I've tried to show that the testing of random-number generators is important but not difficult. In fact, developing your own tests is an interesting game. There is no single right way, but the listing for the program provided here works quite well on my 16-bit machine. ■

# WALTZ LISP (TM)

The one and only **adult** Lisp system for CP/M users.

Waltz Lisp is a very powerful and complete implementation of the Lisp programming language. It includes features previously available only in large Lisp systems. In fact, Waltz is substantially compatible with Franz (the Lisp running under Unix), and is similar to MacLisp. Waltz is perfect for Artificial Intelligence programming. It is also most suitable for general applications.

**Much** faster than other microcomputer Lisps. • Long integers (up to 611 digits). Selectable radix • True dynamic character strings. Full string operations including fast matching/extraction. • Flexibly implemented random file access. • Binary files. • Standard CP/M devices. • Access to disk directories. • Functions of type lambda (expr), nlambda (fexpr), lexpr, macro. • Splicing and non-splicing character macros. • User control over all aspects of the interpreter. • Built-in prettyprinting and formatting facilities. • Complete set of error handling and debugging functions including user programmable processing of undefined function references. • Virtual function definitions. • Optional automatic loading of initialization file. • Powerful CP/M command line parsing. • Fast sorting/merging using user defined comparison predicates. • Full suite of mapping functions, iterators, etc. • Assembly language interface. • Over 250 functions in total. • The best documentation ever produced for a micro Lisp (300+ full size pages, hundreds of illustrative examples).

Waltz Lisp requires CP/M 2.2, Z80 and 48K RAM (more recommended). All common 5" and 8" disk formats available.

**PC** (TM)  
**RO** **CODE**  
INTERNATIONAL

15930 SW Colony Pl.  
Portland, OR 97224

Unix: Bell Laboratories.  
CP/M: Digital Research Corp.

**Version 4.4**

(Now includes Tiny Prolog written in Waltz Lisp.)

**\$169\***

\*Manual only: \$30 (refundable with order). All foreign orders: add \$5 for surface mail, \$20 for airmail. COD add \$3. Apple CP/M and hard sector formats add \$15.

Call free **1-800-LIP-4000** Dept. #12  
In Oregon and outside USA call 1-503-684-3000

# EXPOTEK

**ORDER LINE**                      **CUSTOMER SERVICE**  
**800-528-8960**                      **602-482-0400**

- SANYO COMPATIBLE RS232 PORT**  
 Directly Interchangeable With Sanyo. Can be Programmed for Bi-Sync Operation ..... \$79
- RS232 PORT W/CABLE**  
 As Above With Modem Cable ..... 99  
 Modem Cable Only ..... 29
- SHEET FEEDERS**  
 High quality mechanical single bin feeders for Diablo, Qume, NEC, C.Itoh, Ricoh, Daisy, Daisywriter, Juki, Dataproducts and Others (specify type) ..... \$495  
 Electronic Dual Bin sheet feeders for most printers ..... Call
- TRACTOR FEEDERS**  
 High Swiss quality bi-directional tractors for Diablo, Qume, NEC, C.Itoh, Ricoh, Radio Shack and others, (specify type) ..... 199  
 Silver Reed ..... 125
- PRINT WHEELS & RIBBONS** ..... Call Save \$

**DEALER INQUIRIES INVITED**

2017 EAST CACTUS • PHOENIX, AZ 85022

All prices are for cash, cashiers check or money order. Allow 4 weeks bank clearance for personal checks. C.O.D.'s, Visa/MC, and P.C.'s accepted at additional charge. Prices subject to change. Returns must have authorization number and are subject to a restocking charge.

**“There’s no magic to using your personal computer for data acquisition.”** Fred Molinari, President

There’s no trick to it. Just take your choice of our new single board plug-ins and bring complete analog and digital I/O capabilities to your personal computer.

Whether you’re working in laboratory research or industrial process control, our single boards can give you measurement and control capabilities without having to spend big bucks.

And who knows that better than the leading supplier of low cost data acquisition boards, systems, and software?

Our boards include A/D with programmable gain, D/A, digital I/O, clock and direct memory access capabilities. With power and performance to match your PC, our analog interfaces provide 12 or 16-bit A/D resolution and direct connection for high or low level signal inputs.

And these boards just plug into the PC’s backplane. No messy external boxes or cables. User input connections are simple with our compatible line of screw terminal panels.

DATA ACQUISITION FOR PC'S					
	12-BIT A/D	12-BIT D/A	DIGITAL I/O	PROG CLOCK	SOFTWARE LIBRARY
IBM PC™	X	X	X	X	X
APPLE II™	X			X	
TI PROFESSIONAL™	X	X	X	X	X
DEC RAINBOW™	X	X	X	X	X
COMPAQ™ Portable	X	X	X	X	X

Comprehensive user manuals with many programming examples get you up and running fast.

So why look any further? No other analog I/O systems can offer PC users such quality, power and performance for

such a reasonable price.

After all, making data acquisition easy is what we’re all about.

And that’s no illusion.

Call (617) 481-3700, Ext. PC

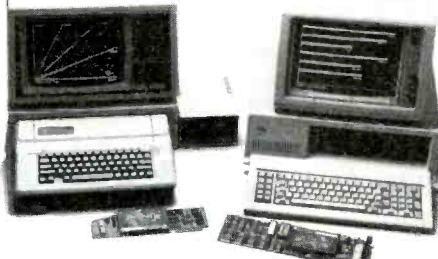

Data Translation is the leading supplier of personal computer hardware and software for data acquisition and control.

## DATA TRANSLATION

World Headquarters: Data Translation Inc., 100 Locke Dr., Marlboro, MA 01752 (617) 481-3700 T1x 951-646. European Headquarters: Data Translation, Ltd., 430 Bath Rd., Slough, Berkshire SL1 6BB England (06286) 3412 T1x 849-862.  
 In Canada: (416) 625-1907.  
 IBM PC is a registered trademark of IBM. Apple II is a registered trademark of Apple Computer Corp. TI Professional is a registered trademark of Texas Instruments, Inc. DEC Rainbow is a registered trademark of Digital Equipment Corp. COMPAQ is a registered trademark of COMPAQ Computer Corp.

# The Random House College Dictionary

•The most complete, authoritative, up-to-date desk dictionary available

•More than 170,000 entries -many more than any comparable dictionary

•More than 1500 illustrations

•Prepared and verified by more than 400 experts

**REVISED EDITION**

**MORE OF WHAT YOU NEED MOST**

- ABSCAM • ABU DHABI • AGENT ORANGE
- AWACS • B-1 • BAG LADY • BENCH PRESS
- BLOCK GRANT • DISINFORMATION
- DISK PACK • ECOCIDE • FACTOID
- FARSI • FAST TRACK
- GRIDLOCK

Now at your bookstore





# What type of printer should you buy?

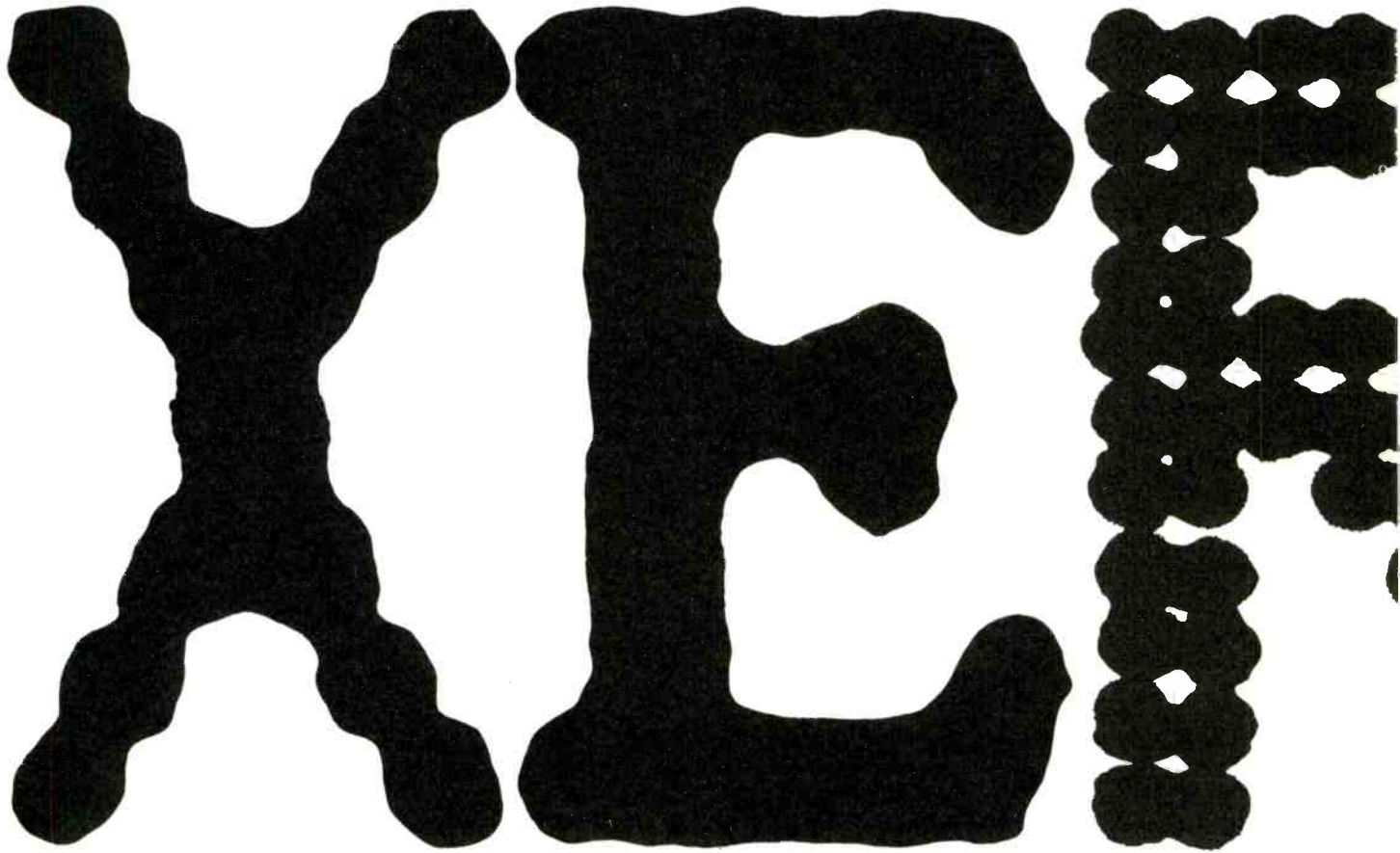

## Dot Matrix Printers.

At draft speed, characters come out crisp and clear, at up to 400 cps.

## Dot Matrix Printers.

At correspondence quality speed, characters are so readable they make the term "computer printout" almost obsolete.

## Ink Jet Printers.

Full color graphics and text capabilities make these some of the most versatile printers in the world.

It's a simple fact: Xerox has the widest range of printers in the world.

From dot matrix printers that can churn out 400 characters per second, to laser printers that run up to a miraculous 120 pages a minute.

Included in the Xerox family of printers is our Diablo® line, which many people consider to be one of the best in the world.

In fact, Diablo® daisywheel printers have



been voted number one when it

comes to brand preference,\* but that should come as no surprise since we had a head start on the rest of the industry, inventing the daisywheel back in 1972.

Then, when you add our high quality, color



Printer typography enlarged 40x.

**Daisywheel Printers.**

We invented the category, and now it's the accepted standard among letter-quality printers.

**Laser Printers.**

The state of the art in high volume, whisper quiet high resolution electronic printing.

graphic ink jet printers to the list, and consider how most Xerox printers are IBM compatible, unusually quiet and reliable, it starts becoming obvious why Xerox is the type of printer you should buy.

So if you're in the market for a printer, call 1-800-833-2323, ext. 800, or your local Xerox office, or mail in this coupon. Once you do, you'll discover printers that are anything but typical.

For more information, call 800-833-2323, ext. 800, or your local Xerox office, or mail in this coupon: Xerox Corp., Box 24, Rochester, New York 14692.

- Please have a sales representative contact me.
- Please send me more information.

NAME _____		TITLE _____	
COMPANY _____			
ADDRESS _____		CITY _____	
STATE _____	ZIP _____	PHONE _____	192 10/84

XEROX and DIABLO are registered trademarks of XEROX CORPORATION.

\*Source: Datamation Magazine 1983 Brand Preference Study of printer preference by end users and OEMs.



## Peripheral Networking Now



### Buy ASCI Intelligent Port Expanders

- Eliminate Manual Switching by Remote Control
- Improve Productivity and Reliability
- Share Printers, Modems or Plotters
- Expand Computers or Terminals
- Use Matrix Switching for Multiple Transmission or Security
- Supports Polling and Queuing

INSTANT COMPATIBILITY with new computer devices and MAJOR OEM PRODUCTS:

Altos — Burroughs — Data General — DEC  
H.P. — IBM — NCR — Northstar — Victor  
and other key manufacturers.

Call 213-793-8979 to EXPAND YOUR SYSTEMS TODAY.



**Advanced Systems Concepts Inc.**  
435 N. Lake Ave., Dept. B10  
Pasadena, CA 91101  
**800-824-7080 Telex: 701 215**

## Quelo™ 68000 Assembler

New 5.0 Release First Commercial Release  
January, 1983

The Quelo™ portable 68000 assembler conforms to the Motorola resident assembler, publication M68KMASM[D4].

### Quelo™ 68000 Assembler Package Features:

Input file concatenation, include function, macros, global parameter substitution from command line, listing date-time stamp, up to 31 character symbols, conditional assembly, structured programming directives, instruction optimization, 68010 instructions, relocation and linking, complex expression linking (all operators), DB-DW-DL directives for Z80 byte order data generation, object library utility, software configuration tracking, conditional linking, options for assembler and linker to write complete symbol table to a file, detailed symbol table listings, assembler symbol cross-reference, linker global symbol cross-reference, object library symbol cross-reference, superb linker load map, various HEX load formats produced by linker, error messages in English, extensive typeset manual with index, readily transported to any system with a C compiler and "UNIX like" system interface.

Ready to run in various disk formats for CP/M-80, -86, -68K, MS-DOS and PC-DOS	\$595
Portable source version with detailed installation and testing instructions.	\$750 and license agreement.

For more information or to order write or call Patrick Adams **Quelo™**  
2464 33rd Ave. W., Suite #173  
Seattle, WA 98199  
(206) 285-2528

COD, Visa, MasterCard.

CP/M-80, CP/M-86, CP/M-68K TM DRI. UNIX TM Bell Labs. MS-DOS TM Microsoft. PC-DOS TM IBM.

## B.O.O.K.S R.E.C.E.I.V.E.D

THE ACORN BBC MICRO. Mike James. Englewood Cliffs, NJ: Prentice-Hall, 1984; 174 pages, 15 by 22.8 cm, softcover, ISBN 0-13-003161-5. \$14.95.

ADAPTIVE FILTERING PREDICTION AND CONTROL. Graham C. Goodwin and Kwai Sang Sin. Englewood Cliffs, NJ: Prentice-Hall, 1984; 560 pages, 18.5 by 24 cm, hardcover, ISBN 0-13-004069-X. \$41.95.

THE ADDISON-WESLEY BOOK OF ATARI SOFTWARE 1984. Jeffrey Stanton, Robert P. Wells, Sandra Rochowansky, and Michael Mellin. Reading, MA: Addison-Wesley, 1984; 432 pages, 21.3 by 27.8, softcover, ISBN 0-201-16465-X. \$19.95.

ADVANCED MECHANISM DESIGN: ANALYSIS AND SYNTHESIS. Vol. 2. George N. Sandor and Arthur G. Erdman. Englewood Cliffs, NJ: Prentice-Hall, 1984; 704 pages, 16.3 by 24.3 cm, hardcover, ISBN 0-13-011437-5. \$45.95.

THE ANATOMY OF THE COM-MODORE. Michael Angerhausen, Achim Becker, Lothar Englisch, and Klaus Gerits. Grand Rapids, MI: Abacus Software, 1984; 298 pages, 13.8 by 20.8 cm, softcover, ISBN 0-916439-00-3. \$19.95.

THE ANATOMY OF THE 1541. Lothar Englisch and Norbert Szczepanowski. Grand Rapids, MI: Abacus Software, 1984; 328 pages, 13.8 by 20.8 cm, softcover, ISBN 0-916439-01-1. \$19.95.

APPLE II APPLICATIONS. Marvin L. De Jong. Indianapolis, IN: Howard W. Sams & Co., 1983; 240 pages, 13.5 by 21.3 cm, softcover, ISBN 0-672-22035-0. \$13.95.

THE ART OF COMPUTER MANAGEMENT. Jim McNitt. New York:

Simon & Schuster, 1984; 272 pages, 14.5 by 22 cm, hardcover, ISBN 0-671-46471-X. \$15.95.

ARTIFICIAL INTELLIGENCE. Tim O'Shea and Marc Eisenstadt, eds. New York: Harper & Row, 1984; 500 pages, 18.5 by 23.5 cm, softcover, ISBN 0-06-041894-X. \$25.50.

BASIC TRICKS FOR THE IBM. Allen Wyatt. Indianapolis, IN: Howard W. Sams & Co., 1984; 136 pages, 20 by 23.5 cm, softcover, ISBN 0-672-22250-7. \$7.95.

BEYOND PROBLEM SOLVING AND COMPREHENSION. Arthur Whimbey and Jack Lochhead. Philadelphia, PA: The Franklin Institute Press, 1984; 400 pages, 15.3 by 22.8 cm, softcover, ISBN 0-89168-051-9. \$14.95.

A BIT OF LOGO MAGIC. Donna Bearden. Reston, VA: Reston Publishing, 1984; 110 pages, 21.3 by 28 cm, softcover, ISBN 0-8359-0495-4. \$10.95.

BUSINESS BASIC. 2nd ed., Robert J. Bent and George C. Sethares. Monterey, CA: Brooks/Cole Publishing, 1984; 304 pages, 21.8 by 27.8 cm, softcover, ISBN 0-534-03179-X. \$20.95.

COMMODORE MAGIC. Michael Callery. New York: E. P. Dutton, 1984; 240 pages, 17.8 by 22.8 cm, softcover, ISBN 0-525-48120-6. \$12.95.

COMPUTER BOOKS AND SERIALS IN PRINT 1984. R.R. Bowker Company's Department of Bibliography and Serials Bibliography Department with the Publication Systems Department. New York: R. R. Bowker, 1984; 580 pages, 22 by 28.5 cm, ISBN 0-8352-1814-7. \$49.50.

COMPUTER CAREERS: WHERE THE JOBS ARE & HOW TO GET THEM.

.....  
THIS IS A LIST of books recently received at BYTE Publications. The list is not meant to be exhaustive, its purpose is to acquaint BYTE readers with recently published titles in computer science and related fields. We regret that we cannot review or comment on all the books we receive; instead, this list is meant to be a monthly acknowledgment of these books and the publishers who sent them.

## A SMART TERMINAL

in a small (and inexpensive) package

The TERM-MITE ST

price: \$214\*

size: 4½" x 6½"

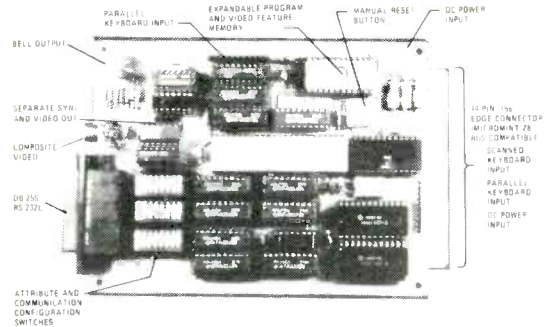

Why pay \$1000 or more for a comparable smart terminal? The TERM-MITE ST featuring the new NS405 terminal management processor offers you all of the following on a single 4½" x 6½" board:

- 128 displayable characters
- 11 graphics characters
- 24 lines by 80 characters
- 25th line reverse video status display
- 21 escape functions
- 14 control functions
- CRT refresh at 50 or 60 Hz
- Separate transmit & receiver baud rates (110 - 19,200 bps)
- Supports scanned or encoded keyboards
- Directly drives composite video or separated sync monitors

- Video attributes - reverse video
- half intensity
- double height
- double width
- underlined
- blinking and blank characters

\* in 100 quantity.

Single quantity price \$284.

— TO ORDER —

The TERM-MITE ST video display terminal board item #BCC22 . . . \$284.00 postpaid

Orderline 1-800-645-3479

Information: 1-516-374-6793



THE MICROMINT, INC.  
561 Willow Avenue, Cedarhurst, NY 11516

the editors of *Consumer Guide*. New York: Ballantine Books, 1984; 256 pages. 15.3 by 22.5 cm, softcover, ISBN 0-449-90127-0, \$6.95.

COMPUTER COMPANION FOR THE APPLE II/APPLE IIe, Robert P. Haviland. Blue Ridge Summit, PA: Tab Books, 1983; 128 pages. 13 by 21 cm, spiral-bound, ISBN 0-8306-1603-9, \$10.25.

COMPUTER COMPANION FOR THE SINCLAIR/TIMEX COMPUTERS, Robert P. Haviland. Blue Ridge Summit, PA: Tab Books, 1983; 128 pages. 13 by 21 cm, spiral-bound, ISBN 0-8306-1623-3, \$10.25.

COMPUTER COMPANION FOR THE VIC-20, Robert P. Haviland. Blue Ridge Summit, PA: Tab Books, 1983; 128 pages. 13 by 21 cm, spiral-bound, ISBN 0-8306-0613-0, \$10.25.

COMPUTER LITERACY SURVIVAL KIT, Arthur Luehrmann and Herbert Peckham. New York: McGraw-Hill, 1984; 430 pages. 18.5 by 23.3 cm, softcover, ISBN 0-07-049206-9, \$29.95. Includes floppy disk.

THE COMPUTER PROGRAMMER, Mike James. Englewood Cliffs, NJ: Prentice-Hall, 1984; 158 pages. 15.3 by 22.8 cm, softcover, ISBN 0-13-162272-2, \$14.95.

COMPUTERS MADE RIDICULOUSLY EASY, Sully Blotnick. New York: McGraw-Hill, 1984; 206 pages. 15 by 22.8 cm, softcover, ISBN 0-07-006123-8, \$12.95.

THE COMPUTHINK GUIDE TO: SPREADSHEET SOFTWARE, Jesse Berst. Indianapolis, IN: Howard W. Sams & Co., 1983; 168 pages. 20 by 23.5 cm, softcover, ISBN 0-672-22164-0, \$11.95.

DIRECTORY OF PUBLIC DOMAIN AND USER-SUPPORTED SOFTWARE FOR THE IBM PERSONAL COMPUTER, Santa Clara, CA: PC Software Interest Group (PC-SIG), 1984; 116 pages. 15.3 by 22.8 cm, softcover, ISBN 0-915835-01-0, \$4.95.

ELECTRONIC ILLUSIONS, Ian Reinecke. New York: Penguin Books, 1984; 256 pages. 12.8 by 19.8 cm, softcover, ISBN 0-14-00-7103-2, \$7.95.

FREE SOFTWARE FOR THE IBM PC, Bertram Gader and Manuel V. Nodar. New York: Warner Books, 1984; 480 pages. 13.3 by 20 cm, softcover, ISBN 0-446-38143-8, \$39.95.

GRAPHICS GUIDE TO THE COM-MODORE 64, Charles Platt. Berkeley, CA: Sybex, 1984; 288 pages. 17.8 by 22.8 cm, softcover, ISBN 0-89588-138-1, \$15.95.

HOW TO PROGRAM YOUR APPLE IIe, Tim Hartnell. New York: Ballantine Books, 1984; 112 pages. 15.3 by 22.8 cm, softcover, ISBN 0-345-31662-2, \$6.95.

HOW TO PROGRAM YOUR COM-MODORE 64, Tim Hartnell. New York: Ballantine Books, 1983; 128 pages. 15.3 by 22.8 cm, softcover, ISBN 0-345-31663-0, \$6.95.

HOW TO PROGRAM YOUR IBM PC, Tim Hartnell. New York: Ballantine Books, 1983; 112 pages. 15.3 by 22.8 cm, softcover, ISBN 0-345-31661-4, \$6.95.

THE IBM PC CONNECTION, James W. Coffron. Berkeley, CA: Sybex, 1984; 288 pages. 47.8 by 22.8 cm, softcover, ISBN 0-89588-127-6, \$16.95.

IMPROVING INSTRUCTION WITH MICROCOMPUTERS, John H. Tashner. Phoenix, AZ: The Oryz Press, 1984; 272 pages. 21.5 by 28 cm, softcover, ISBN 0-89774-095-5, \$24.50.

INFORMATION TECHNOLOGY AND THE COMPUTER NETWORK, K. G. Beauchamp, ed. New York: Springer-Verlag, 1984; 288 pages. 16.8 by 24.8 cm, hardcover, ISBN 0-387-12883-2, \$34.50.

INTRODUCTION TO COMPUTER SCIENCE USING THE TURING PROGRAMMING LANGUAGE, R. C. Holt

(continued)

## a message to our subscribers

From time to time we make the BYTE subscriber list available to other companies who wish to send our subscribers material about their products. We take great care to screen these companies, choosing only those who are reputable, and whose products, services, or information we feel would be of interest to you. Direct mail is an efficient medium for presenting the latest personal computer goods and services to our subscribers.







Many BYTE subscribers appreciate this controlled use of our mailing list, and look forward to finding information of interest to them in the mail. Used are our subscribers' names and addresses only (no other information we may have is ever given).

While we believe the distribution of this information is of benefit to our subscribers, we firmly respect the wishes of any subscriber who does not want to receive such promotional literature. Should you wish to restrict the use of your name, simply send your request to the following address.





BYTE Publications Inc.  
Attn: Circulation Department,  
70 Main St., Peterborough, NH 03458



**QUALITY PARTS AT DISCOUNT PRICES!**

<p><b>SUB-MINIATURE D TYPE CONNECTOR</b></p>  <p>SOLDER TYPE SUB-MINIATURE CONNECTORS USED FOR COMPUTER HOOK UPS</p> <p>DB-15 PLUG \$2.75 DB-15 SOCKET \$4.00 DB-15 HOOD \$1.50 DB-25 PLUG \$2.75 DB-25 SOCKET \$3.50 DB-25 HOOD \$1.25</p>	<p><b>KEY ASSEMBLY</b></p>  <p>5 KEY \$1.00 EACH CONTAINS 5 SINGLE POLE NORMALLY OPEN SWITCHES MEASURES 3 3/4" LONG</p> <p>6 KEY \$1.25 EACH CONTAINS 6 SINGLE POLE NORMALLY OPEN SWITCHES MEASURES 4 1/4" LONG</p>	<p><b>7 CONDUCTOR RIBBON CABLE</b></p>  <p>SPECTRA-STRIP RED MARKER STRIP 28 GA STRANDED WIRE \$5.00 PER ROLL (100 FT.)</p>
<p><b>"PARALLEL" PRINTER CONNECTOR</b></p>  <p>SOLDER STYLE 36 PIN MALE USED ON "PARALLEL" DATA CABLES \$5.50 EACH</p>	<p><b>CRYSTAL</b></p>  <p>CASE STYLE HC33/U 2 MHZ \$3.50 EA COLORBURST 3579.545 KC \$1.00 EACH</p>	<p><b>13 VDC RELAY</b></p>  <p>CONTACT S.P.N.C. 10 AMP @ 120 VAC ENERGIZE COIL TO OPEN CONTACT COIL 13 VDC 650 OHMS SPECIAL \$1.00 EACH</p>

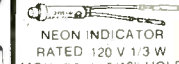
**FREE! FREE! FREE! SEND FOR FALL '84 48 PAGE CATALOG**

<p><b>MINIATURE TOGGLE SWITCHES</b></p> <p>ALL ARE RATED 5 AMPS @ 125 VAC</p> <p>S.P.D.T. (on-on) \$1.00 EACH P.C. STYLE NON-THREADED BUSHING 75¢ EACH 10 FOR \$7.00</p>	<p><b>SOLID STATE BUZZER</b></p>  <p>STAR #SMB-06L 6VDC TTL COMPATIBLE \$1.00 EACH 10 FOR \$9.00</p>	<p><b>EDGE CONNECTORS</b></p>  <p>22/44 22/44 GOLD PLATED CONTACTS 156 CONTACT SPACING \$2.00 EACH 10 FOR \$18.00</p>
<p>S.P.D.T. (on-off-on) \$1.00 EACH P.C. STYLE NON-THREADED BUSHING 75¢ EACH 10 FOR \$7.00</p>	<p><b>120V INDICATOR</b></p>  <p>NEON INDICATOR RATED 120 V 1/3 W MOUNTS IN 5/16" HOLE 75¢ EACH RED LENS 10 FOR \$7.00 100 FOR \$65.00</p>	<p><b>5 STATION INTERLOCKING</b></p>  <p>MADE BY ALPS 3-2PDT AND 2-6PDT SWITCHES ON FULLY INTERLOCKING ASSEMBLY 3" BETWEEN MOUNTING CENTERS \$2.50 EACH</p>

**ALL ELECTRONICS CORP.**  
905 S. VERMONT • P.O. BOX 20406 • LOS ANGELES, CA 90006

**TOLL FREE ORDERS • 1-800-826-5432**  
(IN CALIFORNIA: 1-800-258-6666)

AK, HI, OR INFORMATION • (213) 380-8000

QUANTITIES LIMITED • FOREIGN ORDERS INCLUDE SUFFICIENT SHIPPING  
MINIMUM ORDER \$10.00 • CALIF. RES. ADD 6 1/2%  
USA. \$2.50 SHIPPING • NO C.O.D.

**BOOKS RECEIVED**

and J. N. P. Hume. Reston, VA: Reston Publishing, 1984; 416 pages, 18 by 24 cm, hardcover, ISBN 0-8359-3168-4, \$24.95.

AN INTRODUCTION TO PROGRAMMING THE ACORN ELECTRON. R. A. and J. W. Penfold. London, England: Bernard Babani Ltd., 1984; 144 pages, 11 by 17.8 cm, softcover, ISBN 0-85934-117-8, £1.95.

AN INTRODUCTION TO PROGRAMMING THE BBC MODEL B MICRO. R. A. and J. W. Penfold. London, England: Bernard Babani Ltd., 1984; 144 pages, 11 by 17.8 cm, softcover, ISBN 0-85934-114-3, £1.95.

INVITATION TO ADA, condensed version, Harry Katzman Jr. Princeton, NJ: Petrocelli Books, 1984; 184 pages, 17.8 by 25.5 cm, softcover, ISBN 0-89433-239-2, \$14.95.

LEARNING TI 99/4A, ira McComic. Englewood Cliffs, NJ: Prentice-Hall, 1984; 344 pages, 19 by 23.5 cm, softcover, ISBN 0-13-527862-7, \$16.95.

LEARNING TRS-80 MODEL 4/4P BASIC, David A. Lien. San Diego, CA: Compusoft Publishing, 1984; 500 pages, 17.5 by 22.8 cm, softcover, ISBN 0-932760-19-8, \$19.95.

LEVEL II ROMs, Mark D. Goodwin. Blue Ridge Summit, PA: Tab Books, 1983; 546 pages, 13 by 24 cm, softcover, ISBN 0-8306-0175-9, \$17.50.

LOGICS OF PROGRAMS, Edmund Clarke and Dexter Kozen, eds. Lecture Notes in Computer Science #164, New York: Springer-Verlag, 1984; 536 pages, 16.8 by 24.3 cm, softcover, ISBN 0-387-12896-4, \$22.50.

THE MACMILLAN COMPLETE COMPUTER BUYER'S CHECKLIST, Howard Hillman. New York: Macmillan Publishing, 1984; 128 pages, 19 by 11.3 cm, softcover, ISBN 0-02-008260-6, \$7.95.

MASTERING THE COMMODORE 64, A. J. Jones and G. J. Carpenter. Sussex, England: John Wiley & Sons Ltd., 1984; 384 pages, 17 by 25 cm, softcover, ISBN 0-471-80755-9, £14.95. Floppy disk.

MASTERING THE VIC-20, John Herriott. Blue Ridge Summit, PA: Tab Books, 1983; 224 pages, 13 by 21 cm, softcover, ISBN 0-8306-1612-8, \$10.25.

A MULTIPROCESSOR OPERATING SYSTEM, Mathai Joseph, V. R. Prasad and N. Natarajan. Englewood Cliffs, NJ: Prentice-Hall, 1984; 496 pages, 15.8 by 23.5 cm, hardcover, ISBN 0-13-605170-7, \$28.95.

THE 99000 MICROPROCESSOR, Avtar Singh and Walter A. Triebel. Englewood Cliffs, NJ: Prentice-Hall, 1984; 208 pages, 18.3 by 24.3 cm, hardcover, ISBN 0-13-622853-4, \$23.95.

1-2-3 Go! Julie E. Bingham. Reading, MA: Addison-Wesley, 1984; 288 pages, 18.8 by 23.5 cm, ISBN 0-201-13047-5, \$14.95.

PARALLEL PROGRAMMING IN ANSI STANDARD, ADA, George W. Cherry. Reston, VA: Reston Publishing, 1984; 224 pages, 18 by 24.3 cm, hardcover, ISBN 0-8359-5434-X, \$21.95.

PERSONAL COMPUTERS HANDBOOK, 2nd ed., Walter H. Buchsbaum. Indianapolis, IN: Howard W. Sams & Co., 1984; 320 pages, 13.5 by 21.3 cm, softcover, ISBN 0-672-22094-6, \$14.95.

THE PLAIN ENGLISH REPAIR AND MAINTENANCE GUIDE FOR HOME COMPUTERS, Henry F. Beechhold. New York: Simon & Schuster, 1984; 288 pages, 15.5 by 23.5 cm, softcover, ISBN 0-671-49293-4, \$14.95.

POLYMORPHIC PROGRAMMING LANGUAGES, David M. Harland. New York: John Wiley & Sons, 1984; 154 pages, 17 by 24.5 cm, hardcover, ISBN 0-470-20029-4, \$49.95.

THE POWER OF: FINANCIAL CALCULATIONS FOR LOTUS 1-2-3, Robert E. Williams. Englewood Cliffs, NJ: Prentice-Hall, 1984; 180 pages, 21.3 by 27.5 cm, softcover, ISBN 0-13-687690-0, \$28.95.

PREVIEW BOOK FOR THE WILEY DATA PROCESSING TRAINING SERIES, Ruth Ashley and Judi N. Fernandez, eds. New York: John Wiley & Sons, 1984; 108 pages, 21.3 by 27.3 cm, softcover, ISBN 0-471-80743-5, \$1.

PROBLEM SOLVING USING UCSD PASCAL, 2nd ed., Kenneth L. Bowles, Stephen D. Franklin, and Dennis J. Volper. New York: Springer-Verlag, 1984; 352 pages, 15.5 by 23.3 cm, softcover, ISBN 0-387-90822-6, \$17.95.

(continued)

	LIST PRICE	*EVALUATION UNIT
<b>BASIC SYSTEM</b>		
MODEL USC-100**	\$ 895.00	\$ 795.00
(see note below)		
<b>COMPLETE SYSTEM (128K)</b>		
MODEL USC-100***	\$1995.00	\$1650.00
(see note below)		

**EVERYTHING FOR PC AND COMPATIBLES**



Computer Case with Power Supply & Fan... (65 Watt)..... \$179.00

Computer Case with Power Supply & Fan... (130 Watt)..... \$259.00

Computer Case w/o Power Supply & Fan..... \$ 95.00

Keyboard..... \$139.00

Half Height DSDD Disk drive..... (360K)..... \$149.00

Disk Controller..... \$ 99.00

Monochrome Display Board..... \$129.00

Color Graphics Board..... \$149.00

NOTE: \*Special Introductory Offer expires December 31, 1984.  
\*\*Basic System USC-100 includes Mother Board with 64K expandable to 256K, Power Supply with Cooling Fan, Low Profile 83-Key IBM Compatible Detached Keyboard, 2 Serial Ports, 1 Parallel Port, and Metal Case with Hardwares.  
\*\*\*Complete System USC-100 includes Basic System USC-100 upgraded to 128K, 2 OS/00 Slim Drives, Disk Controller Card, Color Video Card, and High Resolution Monitor.

**U.S. COMPONENT CORP.**

1055 Sunnyvale-Saratoga Road, Suite #6  
Sunnyvale, California 94087  
(408) 730-1399 (408) 730-8833

TERMS: Prepaid check or money order. VISA or Mastercharge.  
PRICES SUBJECT TO CHANGE WITHOUT NOTICE

# The Little Board™ ...\$349\*

The world's simplest and least expensive CP/M computer

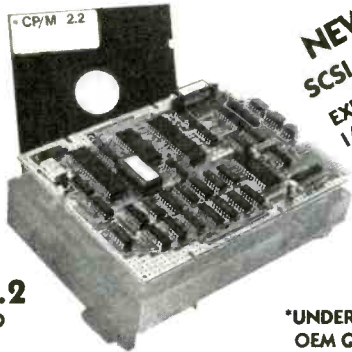

**NEW**  
SCSI/PLUS™  
EXPANSION  
I/O OPTION

**CP/M 2.2  
INCLUDED**

**\*UNDER \$200 IN  
OEM QUANTITIES**

- 4 MHz Z80A CPU, 64K RAM, Z80A CTC, 2732 Boot ROM
- Mini/Micro Floppy controller (1-4 Drives, Single/Double Density, 1-2 sided, 40/80 track)
- Only 5.75 x 7.75 inches, mounts directly to a 5 1/4" floppy drive
- 2 RS232C Serial Ports (75-9600 baud & 75-38,400 baud), 1 Centronics Printer Port
- Power Requirement: +5VDC at .75A; +12VDC at .05A/On-board -12V converter
- CP/M 2.2 BDOS • ZCPR3 CCP • Enhanced AMPRO BIOS
- AMPRO Utilities Included:
  - read/write to more than 2 dozen other formats (Kaypro, Televideo, IBM CP/MB6....)
  - format disks for more than a dozen other computers
  - menu-based system customization
- BIOS and Utilities Source Code Available
- SCSI/PLUS Adapter:
  - Mounts directly to Little Board
  - Slave I/O board control
  - Full ANSC X3T9.2
  - 16 bidirectional I/O lines
  - \$99/Quantity 1

**AMPRO**  
COMPUTERS, INCORPORATED

Distributor/Dealer/Reps  
Inquiries Invited

Z80A is a registered trademark of Zilog, Inc.  
CP/M is a registered trademark of Digital Research.

67 East Evelyn Ave. • Mountain View, CA 94041 • (415) 962-0230 • TELEX 4940302

## BEFORE YOU BUY CABLE ASSEMBLIES,

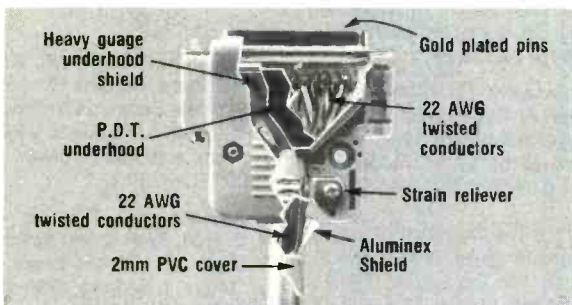

## CHECK UNDER THE HOOD!

DATA SPEC™ cable assemblies are the very best. Each cable is fully shielded to exceed FCC EMI/RFI emission requirements. Furthermore, the unique P.D.T. technique is employed beneath the hood shield for maximum integrity under the most adverse conditions. DATA SPEC™ was the first to use the P.D.T. process, and cable assemblies constructed with P.D.T. carry a lifetime warranty. DATA SPEC™ has interface cables for all your requirements: Modems, Monitors, Disk Drives, and much more. Insist on DATA SPEC™ cables in the bright orange package. Available at better computer dealers everywhere. For more information, call or write:

**DATA SPEC™**

A Division of Alliance Research Corporation

20120 Plummer Street • Chatsworth, CA 91311 • (818) 993-1202

# Main/Frames

from  
**\$175**

Wow!  
70 Models!

- 70 Models of Enclosures
- Assembled and tested
- Quasi-Coax Motherboards
- Power Supply
- Card cage and guides
- Fan, line, cord, fuse, power & reset switches

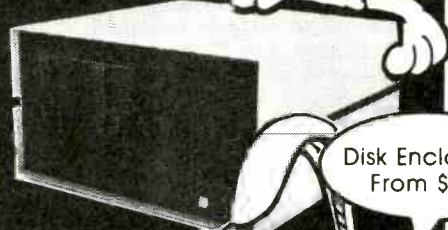

Disk Enclosures  
From \$100

\$499

8" Floppy Main/Frame

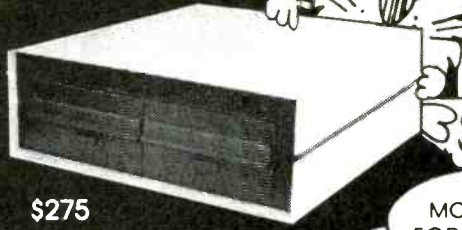

MORE BANG  
FOR THE BUCK

\$275

8" Disc Enclosure

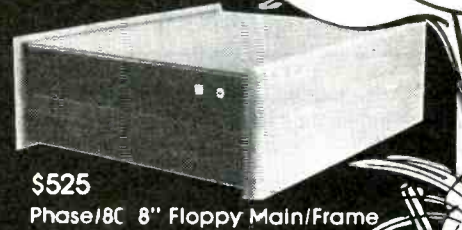

\$525

Phase 18C 8" Floppy Main/Frame

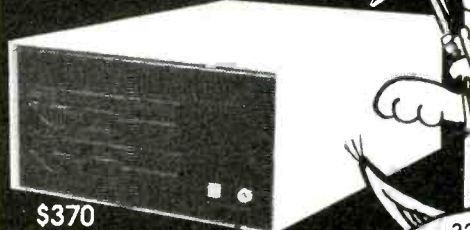

\$370

Slim Line 8" Floppy Main/Frame

32 Page  
Free Fakt  
Pakt Catalog

Write or call for our  
brochure which includes our  
application note:

"Making micros better than  
any ol' box computer"

**INTEGRAND**

8620 Roosevelt Ave. • Salina, CA 93291  
209/651-203

We accept BankAmericard/Visa  
and MasterCard



## DUMP/RESTORE-XT Directory Management at Your Fingertips

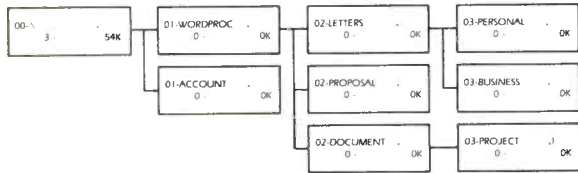

COGITATE's **DUMP/RESTORE-XT** is a package of utilities specifically designed to handle directory manipulation and file backups under MS-DOS.

▄ **COGTREE**-A graphic tree display. Hardcopies are available as well as file and directory dumps.

▄ **COGDIR**-A multiple wildcard directory utility; i.e.:

C>COGDIR\ACCOUNT\\*.DAT, \*.IDX, \*.BAK

The \*.BAK excludes all .BAK files.

▄ **COGBKUP**-Reads lists created by COGDIR and compresses the files to the floppy diskette. Diskettes can be spanned and are serialized.

▄ **COGRSTR**-Reads diskettes created by COGBKUP and restores to hard disk based upon multiple wildcards.

The package includes other utilities to assist in file and directory manipulations. COGITATE's **DUMP/RESTORE-XT** is priced at \$90. Dealer inquiries welcome. MasterCard and Visa accepted.



# COGITATE

24000 Telegraph Road  
Southfield, Michigan 48034 USA  
(313) 352-2345

## BOOKS RECEIVED

**PROGRAMMING ASSEMBLER LANGUAGE**, 2nd ed., Peter Abel. Reston, VA: Reston Publishing, 1984; 592 pages, 18 by 24.5 cm, hardcover, ISBN 0-8359-5661-X, \$26.95.

**THE PROGRAMMING GUIDE TO THE Z80 CHIP**, Phillip R. Robinson. Blue Ridge Summit, PA: Tab Books, 1984; 360 pages, 13 by 21 cm, softcover, ISBN 0-8306-1656-X, \$13.50.

**PROGRAMMING THE IBM PERSONAL COMPUTER: BUSINESS BASIC**, Wilson T. Price. New York: Holt, Rinehart and Winston, 1984; 234 pages, 17.5 by 23.5 cm, softcover, ISBN 0-03-063746-5, \$17.95.

**PROGRAMMING THE IBM PERSONAL COMPUTER: FUNDAMENTALS OF BASIC**, Neill Graham. New York: Holt, Rinehart and Winston, 1984; 304 pages, 17.8 by 23.3 cm, softcover, ISBN 0-03-059561-4, \$17.95.

**PROGRAMMING WITH STRUCTURED FLOWCHARTS**, Krishna K. Agarwal. Princeton, NJ: Petrocelli Books, 1984; 184 pages, 13.8 by 20.8 cm, softcover, ISBN 0-89433-226-0, \$12.

**ROBOTS & ROBOTOLGY**, R. H. Warring. Blue Ridge Summit, PA: Tab Books, 1983; 128 pages, 13 by 21 cm, softcover, ISBN 0-8306-1673-X, \$8.25.

**THE SALARIED PROFESSIONAL**, Joseph A. Raelin. New York: Praeger Publishers, 1984; 304 pages, 16 by 24 cm, hardcover, ISBN 0-03-068918-X, \$35.95.

**SCUTTLE THE COMPUTER PIRATES**, Richard H. Baker. Blue Ridge Summit, PA: Tab Books, 1984; 208 pages, 18.8 by 23.5 cm, softcover, ISBN 0-8306-0718-8, \$15.50.

**THE SECRET GUIDE TO COMPUTERS**, Vol. 1, 11th ed., Russ Walter. Boston, MA: Russ Walter, 1984; 352 pages, 24.5 by 27.8 cm, softcover, ISBN-none, \$14.

**THE SECRET GUIDE TO COMPUTERS**, Vol. 2, 11th ed., Russ Walter. Boston, MA: Russ Walter, 1984; 400 pages, 21.8 by 27.8 cm, softcover, ISBN-none, \$14.

**SECRETS OF THE COMMODORE 64**, P. Cornes and A. Cross. London, England: Bernard Babani Ltd., 1984; 128 pages, 11 by 17.8 cm, softcover, ISBN 0-85934-110-0, £1.95.

**STRATEGY OF COMPUTER SELECTION: A STEP-BY-STEP APPROACH**, Fred Kelly and Peter Poggi. Reston, VA: Reston Publishing, 1984; 348 pages, 21.3 by 28 cm, softcover, ISBN 0-8359-7067-1, \$19.95.

**SWIFT'S DIRECTORY OF EDUCATIONAL SOFTWARE FOR THE IBM PC**, 1983-84 edition. Austin, TX: Sterling Swift Publishing Co., 1984; 234 pages, 14 by 21.5 cm, three-hole punched, ISBN 0-88408-274-1, \$18.95.

**TEACHING COMPUTERS TO TEACH**, Esther R. Steinberg. Hillsdale, NJ: Lawrence Erlbaum Associates, 1984; 200 pages, 15.8 by 23.5 cm, hardcover, ISBN 0-89859-368-9, \$24.95.

**TERMINALS & PRINTERS BUYER'S GUIDE**, Tony Webster. New York: McGraw-Hill, 1984; 358 pages, 20.8 by 27.8 cm, softcover, ISBN 0-07-068968-7, \$19.95.

**25 GAMES FOR YOUR TRS-80 MODEL 100**, David D. Busch. Blue Ridge Summit, PA: Tab Books, 1983; 160 pages, 19.5 by 23.3 cm, softcover, ISBN 0-8306-1698-5, \$10.25.

**UP AND RUNNING**, H. Dines Hansen. New York: Yourdon Press, 1984; 152 pages, 17.8 by 25.3 cm, softcover, ISBN 0-917072-41-3, \$25.

**USING AND PROGRAMMING THE COMMODORE 64**, John Herriott. Blue Ridge Summit, PA: Tab Books, 1984; 158 pages, 19.8 by 23.5 cm, softcover, ISBN 0-8306-1712-4, \$9.25.

**VAX PASCAL**, J. N. P. Hume and R. C. Holt. Reston, VA: Reston Publishing, 1984; 416 pages, 18 by 24 cm, hardcover, ISBN 0-8359-8247-5, \$23.95.

**VISICALC EXTENSIONS FOR THE APPLE II AND APPLE IIe**, Jack Grushcow. Reston, VA: Reston Publishing, 1984; 208 pages, 17.3 by 23.3 cm, softcover, ISBN 0-8359-8403-6, \$16.95.

**VLSI ENGINEERING**, Tosiyasu L. Kunii, ed. Lecture Notes in Computer Science #163. New York: Springer-Verlag, 1984; 320 pages, 16.5 by 24.3 cm, softcover, ISBN 0-387-70002-1, \$14.

**YOUR APPLE II NEEDS YOU**, Frank Wattenberg. Englewood Cliffs, NJ: Prentice-Hall, 1984; 350 pages, 17.3 by 23.5 cm, softcover, ISBN 0-13-977975-2, \$16.95. ■

## Preserve Your Copies of BYTE

**NOW AVAILABLE:** Custom-designed library files or binders in elegant blue simulated leather stamped in gold leaf.

**Binders—Holds 4 issues, opens flat for easy reading, \$8.50 each, three for \$24.75, six for \$48.00 postpaid. (Add \$2.50 each for shipping outside U.S.A.)**



**Files—Holds 6 issues, \$6.95 each, three for \$20.00, six for \$36.00 postpaid. (Add \$2.50 each for shipping outside U.S.A.)**



**Order Now!**

Mail to: Jessie Jones Industries (Since 1843), Name \_\_\_\_\_  
P.O. Box 5120, Dept. BYTE,  
Philadelphia, PA 19141

Address \_\_\_\_\_

Enclosed is my check or money order for \$ \_\_\_\_\_ City \_\_\_\_\_

State \_\_\_\_\_ Zip \_\_\_\_\_

Please send me: \_\_\_\_\_ binders  
\_\_\_\_\_ files.

Note: Satisfaction guaranteed or money refunded.  
Allow five to six weeks for delivery in the U.S.

**BYTE**

## NEW SYSTEMS

## PC-Compatible ES.3 Comes with Telephone



The ES.3 professional workstation from Zaisan combines compatibility with the IBM Personal Computer and a built-in telephone for concurrent voice/data communications. Simultaneous voice and data communications can be achieved using two telephone lines. The use

of the telephone or any productivity software does not suspend an operational program.

The telephone control console has a Touch-Tone keyboard, 13 programmable telephone function keys, and 8 dynamic soft keys for menu selection. A telephone

directory with single-key-stroke dialing and automatic redialing of the last 15 numbers called are provided. A calendar-management function helps you keep track of appointments and jot down notes. Additional features include a handset, a speakerphone, and a pair of modular (RJ-11) phone jacks.

The ES.3's computer hardware is made up of a 9-inch high-resolution nonglare screen, an internal full-duplex 300-bps modem, a detached keyboard with 10 function keys, a 360K-byte floppy-disk drive, and an integrated package of software. Three processors, the Z80, a CMOS 6805, and an 8088, control operations and are backed by 128K bytes of RAM. A real-time clock and a parallel printer port are also supplied.

The monitor has a 25-

row by 80-character format and produces 7- by 9-dot green characters on a black background. A PC color card-compatible graphics display with eight monochrome shades is standard.

The ES.3 runs under MS-DOS. System software comprises a telephone directory, calendar reminder, phone log, scratch-pad storage, and electronic message/text editor.

Up to 640K bytes of RAM are optional. Some of the other options are an RS-232C serial and cassette interface, a second communications channel, a disk drive, and battery-backed RAM and ROM cartridges. The ES.3's suggested retail price is \$2595. For further details, contact Zaisan Inc., 14511 Falling Creek, Houston, TX 77014, (713) 580-6191.

Circle 609 on inquiry card.

## UNIX Environment for Multiusers Has Low Per-User Cost

Morrow's Tricep, a 16-/32-bit microcomputer, supports four to eight users under UNIX System V. Retail pricing begins at less than \$9000, and the manufacturer claims that a UNIX environment can be operated with a per-user cost of under \$2500.

The 10-MHz MC68000 serves as the Tricep's central processing unit. Optional 80188 slave boards running MS-DOS are used to free the central processor of applications overhead and to create a local operating arena with a dedicated processor and 128K bytes of dual-ported RAM, expandable to 512K bytes. The 68000 loads tasks into the slave's memory for execution.

Tricep comes with an on-

board MC68451 memory-management unit, 512K bytes of RAM, an I/O controller with four RS-232C serial ports, a Centronics-type parallel printer port, and DMA controllers for both floppy- and hard-disk drives. System boards plug into the Tricep's 14-slot S-100 backplane.

Mass storage is provided by one to four 16- or 32-megabyte 5¼-inch Winchester hard-disk drives. The maximum hard-disk storage capacity is 128 megabytes. Optional storage schemes can be ordered.

The serial I/O controller communicates with terminals and printers at rates as high as 19,200 bps. The hard-disk controller averages 85 milliseconds per seek with the 16-megabyte Winchester and



35 milliseconds with the larger unit. The data-transfer rates are up to 625K bytes per second.

Tricep runs a version of Unisoft Systems' UNIX that is fully compatible with the AT&T Bell Laboratories standard and has been enhanced with record-locking and floating-point capabilities. An optimizing C language compiler is supplied.

Available languages are Ada, BASIC, COBOL, FORTRAN-77, and Pascal.

Ethernet local-area network support and graphics will be available. The slave boards cost less than \$700. For more information, contact Morrow Inc., 600 McCormick St., San Leandro, CA 94577, (415) 430-1970. Circle 610 on inquiry card.

(continued)



## NEW SYSTEMS

**Vantage Point Manages Energy, Runs CP/M At Same Time**

The Vantage Point Computer is a multiprocessor computer that can simultaneously perform energy-management and security functions and run standard CP/M applications software.

The primary unit contains multiple Z80As, a pair of 1-megabyte (unformatted) floppy-disk drives, 128K bytes of RAM, 16-channel A/D and 16-channel D/A converters, a real-time clock, three RS-232C serial inter-

faces, a Centronics port, and a 12-slot motherboard. A built-in scientific calculation function lets you tabulate figures and insert them into a program on screen.

The detachable keyboard has 93 keys, including 20 function keys. All control, monitoring, and applications programming are handled through the Vantage Point's keyboard. The green-screen monitor has an 80-column by 24-line format and a status line.

A plug-in firmware card gives the Vantage Point the ability to perform real-time office security and energy management and has been nicknamed ROSE. The ROSE card allows standard CP/M applications to run on screen, while the system monitors the office and manages energy usage in the background. The status line displays the time, date, day of week, and zone security and energy conditions. A multitasking tech-

nique lets ROSE handle more than 100 interface points in real time.

More than 15 functions cards are available for customization. RAM can be extended to 1 megabyte. The basic Vantage Point Computer costs \$6500 with ROSE. For more information, contact Industrial Computer Designs Inc., 31121 Via Colinas #1005, Westlake Village, CA 91362, (818) 889-3179.

Circle 611 on inquiry card.

## MASS STORAGE

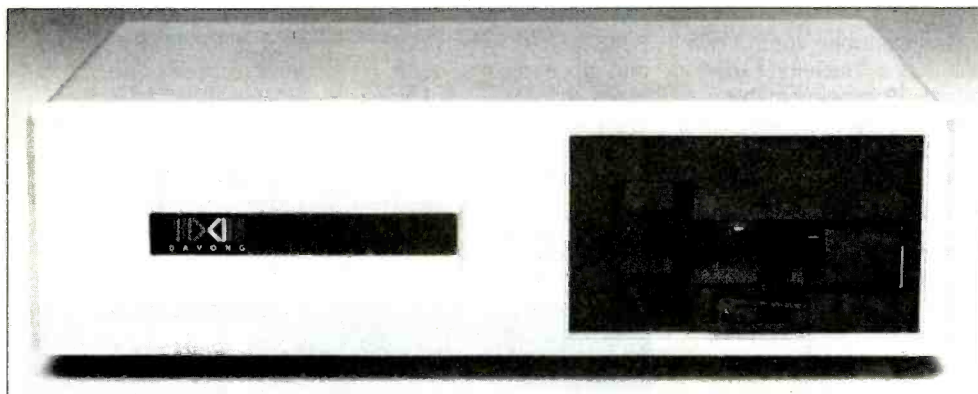
**Hard Disk with Tape Backup Designed for PC**

DataSystem from Davong is a hard-disk and tape backup combination for the IBM PC and PC XT. It is offered with 10-, 21-, 32-, or 40-megabyte

capacities, each with a built-in 24-megabyte tape backup system with an on-line performance option.

DataSystem features compressed or full-volume

backup, file-by-file or full-volume restore, and automatic flaw mapping for complete media interchangeability. Password protection is available with the use of

Davong's Multi-OS software.

The hard disk uses two to eight heads and a corresponding number of cylinders, depending on capacities. The average access times are 40 to 100 milliseconds, and the disk-transfer rate is 62.5K bytes per second. The interface to the IBM requires one short slot. User-selectable features include two interrupts, a pair of DMA channels, and 16 bytes of I/O memory.

Prices range from \$3295 to \$4995. For further details, contact Davong Systems Inc., 217 Humboldt Court, Sunnyvale, CA 94089, (408) 734-4900.

Circle 612 on inquiry card.

**Streaming Tapes for Winchester Boost IBM's Storage**

Dragon Industries recently introduced 45- and 60-megabyte streaming-tape backup system options for its IBM-compatible SP-65 and SP-140 hard-disk drives. The streaming tapes have a single-track serpentine and nine recording tracks for data transfer and read-after-write recording mode.

The read/write transfer rate of the streamer tape averages 86.7K bytes per second (200K bytes per second maximum). Both the read/write speed and the rewind rate are 90 ips.

The SP-65 and the SP-140 are 5¼-inch Winchester hard-disk drives offering formatted storage capacities of

57 and 121 megabytes, respectively. Both are supplied with controller, host adapter, power supply, cables, and PC/MS-DOS compatibility. The SP-65 is \$4995, and the SP-140 sells for \$6995.

The streaming tapes are offered in a dual box with the Winchester and as up-

grades. The SP-65 with its streaming-tape backup is \$6995, while the SP-140 with its backup is \$2000 more. The upgrades are \$2195. Contact Dragon Industries, 35 Main St., Hopkinton, MA 01748, (800) 824-8006; in Massachusetts, (617) 435-4183.

Circle 613 on inquiry card.

## ADD-INS

**Color Graphics Board for S-100**

**I**lluminated Technologies GB3MP is a single-board S-100 color graphics controller with 348K bytes of RAM under the direction of the 16-bit NEC 7220 graphics processor. This board can produce an eight-color display of 1024 by 1024 pixels. Pixel rates of up to 44 MHz are supported. Connections to a host are through a block of four S-100 I/O ports.

Supplied utilities program the GB3MP for use with any RGB or monochrome monitor. Monitors can be configured for 640- by 480-pixel resolution. High-performance monitors can display a raster of 1200 by 872 pixels.

The NEC 7220 chip carries out arc and vector drawing in microcode to provide a drawing speed of 1.65 million pixels per second.

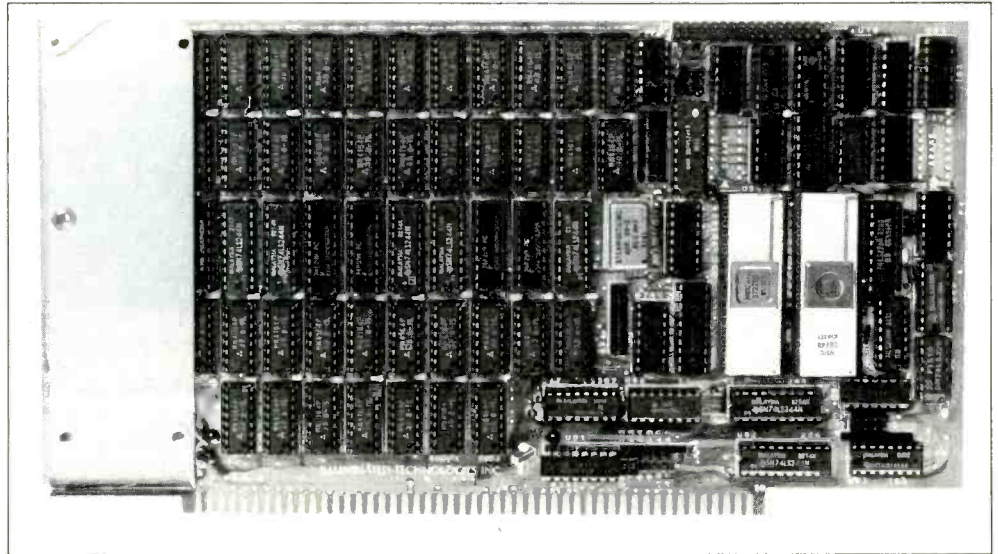

Complete driver software and interactive drawing utilities are supplied in C and as executable programs.

An 8748 processor for

character-display functions is optional. The GB3MP is \$1195 for eight colors or \$895 for the upgradable monochrome version. Con-

tact Illuminated Technologies Inc., POB 83348, Oklahoma City, OK 73148. (405) 943-8086.

Circle 614 on inquiry card.

**Multibus Computer Built Around 16032**

**T**he ZP1632 is a single-board Multibus computer based on the 32-bit 16032 microprocessor from National Semiconductor, which has full internal 32-bit data paths and a 16-bit external architecture.

The board includes a 16082 memory-management unit, which implements a demand-paged virtual memory-management architecture that is similar to the VAX-11's. The MMU automatically detects page faults and protection violations and invokes the abort and retry features of the 16032. The ZP1632 also is equipped with a 16081 floating-point unit, providing it with 32- and 64-bit IEEE-compatible floating-point instructions.

The ZP1632 features 16 prioritized vector interrupts, 16-megabyte (24-bit) direct

addressing, 256K bytes of on-board parity-checked dynamic RAM, 16K bytes of on-board ROM, two asynchronous ports, and one parallel I/O port. RAM is expandable to 1 megabyte, and ROM can be expanded to 128K bytes. The serial and parallel I/O is provided

through a Signetics SCN 2681 dual UART and an Intel P8255A parallel interface. An iLBX memory port provides a direct-access memory bus for high-speed data transfers.

An optional monitor program that's compatible with National Semiconductor's

NSX16 cross-development software is available. The ZP1632 costs \$2350, when fully configured. In Canada, the price is \$2995. Contact TIL Systems Ltd., Suite 1100, 60 Yonge St., Toronto, Ontario M5E 1H5, Canada. (416) 869-1157.

Circle 615 on inquiry card.

**Overlay Computer Graphics with Video**

**T**he PC-MicroKey System from Video Associates Labs lets you overlay computer-generated text and graphics on any incoming video source. This plug-in board, which is available in different packages, works with any IBM PC software.

The PC-MicroKey System Level I is an RGB-only system that works with videodisc players equipped with external sync. It's suitable

for interactive training stations and point-of-sale displays. A Sony KX series monitor or its equivalent is required.

The second package, Level II, adds broadcast-quality NTSC composite-video output to the RGB capability of the Level I system. Level II can overlay graphics with the output of any videodisc player, videotape player, still-frame video-

tape, or camera.

Both boards operate in conjunction with the IBM, Plantronics, or Tecmar graphics cards. Level I costs \$900, and Level II is priced at \$1805. For more information, contact Video Associates Labs Inc., Suite B-106, 3933 Steck Ave., Austin, TX 78759, (512) 346-5781.

Circle 616 on inquiry card.

(continued)



## PERIPHERALS

**Dial-back Authenticator Guards Data**

**S**leuth, a dial-back access authenticator, connects your modem and the Hayes Smartmodem and prevents unauthorized use of data ports.

Sleuth requires all would-be users to enter a password and to identify themselves. After receiving the password and identification, it disconnects the dialer and proceeds to verify the caller's authenticity. If the information matches its memory, Sleuth dials back the caller through the Smartmodem, which



then establishes normal connections.

Sleuth is menu-driven and can only be programmed at

the host computer site. Its EAROM can hold up to 74 names, passwords, and telephone numbers. It sup-

ports such long-distance networks as MCI and Sprint, and its operation is totally transparent to normal outgoing calls.

Compatible with computers using standard RS-232C interfaces, Sleuth does not require external software. The suggested retail price is \$465, which includes power supply, manual, and an RS-232C cable. Contact C. H. Systems Inc., Suite 106, 8533 West Sunset Blvd., Los Angeles, CA 90069, (213) 854-3536. Circle 617 on inquiry card.

**Integrated Systems Automate Data Acquisition and Control**

**C**yborg Corporation's ISAAC 41-I and ISAAC 91-I are integrated systems for automated data acquisition and control. They work with the IBM Personal Computer and are designed to automate analytical instruments and industrial pro-

cesses. These units are suitable for temperature monitoring, measuring vibrations, and observing physiological testing.

ISAAC 91-I is a general-purpose system designed for workstation applications. Its hardware includes an IBM

interface, 16 channels of 12-bit A/D converters, 4 channels of D/A converters, 16 binary inputs and outputs, 4 programmable Schmitt triggers, a 16-bit timer, and 8 slots for the Cyborg I series expansion boards.

Cyborg's ISAAC 41-I is a modular system for applications that do not require the capabilities of the ISAAC 91-I. This device is made up of the interface, a system unit, and four expansion slots for D/A, A/D, and other functions. It's capable of handling up to 256 low-level inputs.

Both units have LabSoft software, which provides such programming tools as real-time signal acquisition routines, graphics utilities, and diagnostics. Its data-acquisition features can be combined with the analysis abilities of such programs as Lotus 1-2-3. In addition, both units can be programmed in interpreted or compiled BASIC, FORTRAN, or C.

A library of application notes and a variety of binary, signal-conditioning, remote, and multiplexing boards are optional. An extensive tutorial accompanies each unit. The ISAAC 41-I is \$1900, and the ISAAC 91-I is priced at \$4400. Contact Cyborg Corp., 55 Chapel St., Newton, MA 02158, (617) 964-9020.

Circle 618 on inquiry card.

**EZ Adaptors Eliminate RS-232 Cable Mismatch**

**T**he EZ-232 Adaptor from Micro-Module Systems is a cabling system for interconnecting computers, peripherals, printers, terminals, modems, and any other serial equipment regardless of the type of connector used. A partial list of manufacturers whose connectors are supported by EZ-232 includes Alpha Micro, Apple, Anderson-Jacobson, Centronics, Columbia, Epson, Hewlett-Packard, IBM, Okidata, Quadram, Radio Shack, Tektronix, US Robotics, and Zenith.

The EZ-232 Adaptors terminate in standard six-wire, RJ-12 jacks and are attached to the computer's serial port and to the pe-



ripheral device's port. Telephone cabling is then plugged into each Adaptor, completing the interface.

The EZ-232 Adaptors cost \$12.95 each. The cabling

costs between \$8 and \$10, depending on length. Contact Micro-Module Systems Inc., POB 2198, La Jolla, CA 92038, (619) 268-8028.

Circle 619 on inquiry card.

## SOFTWARE • APPLE

**Communications Channels Between IBM and Mac Established**

**P**C to Mac and Back bridges the communications gap between the IBM PC and the Apple Macintosh. This program will transfer files between an IBM PC and a Mac, two Macintoshes, two IBM PCs, or between the Mac or IBM to any other computer with an RS-232C serial port and communications software. In addition, a Mac or PC equipped with this program

can serve as a terminal to an information service, bulletin board, or a mainframe computer.

PC to Mac and Back has four modes of operation: text with handshake, PC to Mac and Back, X-Modem, and ASCII. The first mode provides error detection and ensures that transmitted files are saved by transferring data at appropriate intervals. The second mode provides

error detection and automatic saving of transferred files and uses the capabilities of DOS 2.0, including the option of sending files with the filename and wildcard files. X-Modem provides error detection, and ASCII is a simple text mode without error detection.

This program makes use of pull-down menus on both the Mac and the IBM. It's compatible with the Micro-

soft mouse for the IBM; however, if you do not have a mouse, menu selection is done with cursor control with prompt lines.

The retail price for PC to Mac and Back has been set at less than \$100. Contact dilithium Press Ltd., Suite 151 Southwest Nimbus, Beaverton, OR 97005, (800) 547-1842; in Oregon, (503) 646-2713. Circle 620 on inquiry card.

**Fast Graphics on Apple**

**C**harts Unlimited combines machine-language speed and a 16-screen drawing area to give you fast graphics. It can create almost any type of chart including flowcharts, organizational charts, floor plans, Gantt charts, and block, wire, and circuit diagrams. It produces a worksheet grid of 124 columns by 90 rows for an effective work area of 868 by 630 pixels.

Charts Unlimited comes with 36 predefined shapes, such as triangles and brackets. You can modify the shapes and create and store alternative shapes. A 36-member set of symbols and the ability to draw solid or dashed lines in eight directions are standard.

Text can be intermingled with graphics anywhere on the worksheet. Hard-copy printouts measuring 8½ by 11 inches or 11 by 14 inches can be obtained from more than 25 different printers.

Charts Unlimited requires an Apple II with 64K bytes of memory. It costs \$195. Contact Graphware Inc., 5084 Mosiman Rd., Middletown, OH 45042, (513) 424-6733. Circle 621 on inquiry card.

**Develop Mac Applications in FORTRAN or Pascal**

**D**evelopment software packages for the Macintosh are available from Softech Microsystems. The packages are compiled FORTRAN-77 and Pascal languages and a development toolkit with a 68000 assembler.

The UCSD Pascal development system allows access to the Mac's mouse, graphics, and text fonts, which are provided by the Mac's ROM. This arrangement lets you create applications that take full advantage of the Mac's

user interfaces. In addition, UCSD Pascal and Apple Pascal are said to be compatible enough to permit porting of Apple II and III programs to the Mac. The suggested retail price is \$195.

The FORTRAN-77 development system gives you an ANSI-77 subset of FORTRAN, complete with support for structured programming and improved character types. It lists for \$295.

Softech's Advanced Development Toolkit bolsters the

environment provided by the Pascal and FORTRAN-77 systems. It includes source code for a graphics/mouse interface, a symbolic debugger, a 68000 assembler, and a linker. With the Toolkit, you can analyze and optimize programs during development. It can be purchased for \$150.

For further information, contact Softech Microsystems Inc., 16885 West Bernardo Dr., San Diego, CA 92127, (619) 451-1230. Circle 622 on inquiry card.

**Tutorial Programming Language**

**S**pellcaster from Shenandoah Software is a computer language designed primarily to teach computer programming. It's made up of 32 primitive operations, most of which are graphic rather than numeric operations. A majority of the operations are entered through single keystrokes. Command response is instantaneous so that novice programmers can see the effect of each operation on their programs immediately.

Spellcaster uses such control structures as iteration,

loop exits, IF . . . THEN . . . ELSE, subroutines, and recursion; it has no GOTOs. It also provides simple support for multiprocessing.

It shows beginners how to program art graphics and video games. The games, used as example programs, are featured because they have many requirements in common with modern DOSes, such as real-time control of multiple processes. More than 80 pages of on-screen tutorial are built into this program.

Spellcaster comes with a

language interpreter, tutorial on disk, a manual, and a magazine called *The Spell-swapper*, which is accompanied by a disk of Spellcaster programs and an extended tutorial. The suggested list price is \$39.95. Versions are available for the Apple II series and the Commodore 64. It will be available for the IBM PCjr shortly. Contact Shenandoah Software, 1111 Mount Clinton Rd., Harrisonburg, VA 22801, (703) 433-8788. Circle 623 on inquiry card.

(continued)



## C Compiler and Statement Counter

**C**atalytix Corporation's Safe C Compiler provides extensive run-time checking of C-language programs and produces a dynamic trace of function calls with their arguments and returned values. It does not impose any restrictions on the use of C, and it accepts the same code as an ordinary C compiler. It checks for stray pointers and array indexes out of bounds

and verifies that the types and number of arguments used agree between the function call and the function definition. Safe C Compiler flags arithmetic overflow, division by zero, and overflow in the standard routines for manipulating strings. It can be linked with object modules generated by other compilers.

Also from Catalytix is the Safe C Profiler, which pro-

vides statement-level statistics. It counts the number of times each function in a program is called and reports on the execution count for each statement during a run. It can indicate the number of times a particular loop is executed or how many times each branch of a conditional is taken. You can apply Profiler selectively to individual modules or particular func-

tions. An auxiliary command displays the function profile as a table with a histogram or the statement profile alongside the original code. It's invoked as an option to the Safe C Compiler.

The Safe C Compiler for MS-DOS systems is \$400. Profiler is \$200. Contact Catalytix Corp., 55 Wheeler St., Cambridge, MA 02138, (617) 497-2160. Circle **624** on inquiry card.

## Program Creates Surveys

**A** survey-processing program, Synthesis comes with step-by-step instructions that show you how to build questionnaires, compile and analyze responses, and generate custom reports.

It can devise up to 120 questions per questionnaire, categorize up to 2500 respondents, check the correlation between questions, report the total number of responses for each question, and calculate up to 20 indexes as either averages or sums. It can select from three answer types and create seven response headings for each question. Questionnaires can have 24 group titles or footnotes. Synthesis tabulates the response distribution in absolute terms and percentages and computes the mean score for each question.

Synthesis runs on any MS-DOS-based computer with 128K bytes of RAM and two disk drives. It costs \$595. A version that runs under AppleDOS 3.3 is available. Contact Bauer & Associates Inc., 210 East Huron St., Ann Arbor, MI 48104, (313) 668-1303. Circle **625** on inquiry card.

## Straight-through Printing Capability

**T**ypewriter, a CP/M-80 program, lets you enter text directly from a keyboard to a printer. It gives you control over the print head's left, right, up, and down movements and four modes of operation: default, graphics, typewriter, and one-line word processing.

Spacing, direction, and

font control is provided by the default mode. Its graphics mode lets you move and print out dots in any fashion, effectively converting a printer into a manual plotter. The typewriter mode is the straight-through typing ability. The last mode lets you enter, edit, and output a single line. Boldface and

underlining are supported, but disk saves and multiline editing are not.

Versions of Typewriter are available for dot-matrix and daisy-wheel printers for \$25. A combined package is \$40. Contact MicroCost Software, 19705 1st Ave. S, Seattle, WA 98148.

Circle **626** on inquiry card.

## Shared File Access Under dBASE

**C**ommunications Professionals' dLOCK permits multiuser, shared file access under dBASE II. It coordinates access to data files by making standard BDOS calls to the operating system to attempt to secure or lock a file for a user prior to allowing access. It returns to the dBASE command file with a

return code that indicates success or failure of the lock attempt. dLOCK also provides a method of polling your keyboard to test for the presence or absence of a keystroke.

A hexadecimal file that loads into the free memory outside of dBASE, dLOCK is accessed through a standard

CALL command. It works with most CP/M-80 compatible operating systems. It's \$150 per user license. The manual alone is \$15. For more information, contact Communications Professionals, Suite 1-238, 701 East Bay St., Charleston, SC 29403, (803) 722-7572. Circle **627** on inquiry card.

## Program Analyzes DC Networks

**D**CNAP is a general-purpose DC network analysis program from BV Engineering. This program can analyze circuits consisting of resistors, voltage sources, independent current sources, and dependent current sources. A circuit can contain as many as 200 components and 30 nodes.

DCNAP automatically computes worst-case node voltages, component sensitivities, branch currents, and component power dissipation.

A built-in editor will add, delete, and change components and nodes. DCNAP accepts free-format input and has error-trapping capa-

bilities. Its menu-driven input makes it easy to learn.

Versions of DCNAP are available for systems running under MS-DOS, CP/M, and PC-DOS. The list price is \$62.95. Contact BV Engineering, Suite 207, 2200 Business Way, Riverside, CA 92501, (714) 781-0252. Circle **628** on inquiry card.

SOFTWARE • IBM PC

**Multidimensional Tables Manager Aids Decisions**

**T**ables Manager/1, or TM/1, is a decision-management tool that gives managers a panoramic overview of the operating and financial picture of an organization. It helps analyze and control complex operating and financial statistics through its ability to create a tabular database that represents the many facets of an organization, such as payroll and research.

The database serves as the common denominator between dimensions; data

is centralized rather than moved among tools. This approach minimizes input errors, simplifies cell dependencies, and eliminates spreadsheet maintenance. The TM/1 database can handle 9999 elements per dimension with up to eight dimensions per table. Twenty tables can be accessed simultaneously. The maximum file size is 8 megabytes.

The spreadsheet portion of TM/1 gives you 9999 lines and 9999 columns as well as a full set of editing

commands. Other features include keyboard macros, integrated graphics, natural-order calculations, logical operators, data sorting on up to four fields, and string, math, financial, and time functions.

An IBM PC or Compaq with 192K bytes of RAM, MS-DOS 2.0, and a floppy- or hard-disk drive are required. The suggested price is \$795. Contact Sinper Corp., 120 Northeast 9th St., Miami, FL 33132, (305) 371-8000.

Circle 629 on inquiry card.

**Word Processor Aids Motor Disabled**

**H**-Key is a word processor for individuals with severe motor disability. It's operated using a single switch, generally the space bar, and a keyboard displayed on screen. H-Key features word-wrap, full cursor control, insert, automatic underline, character and block delete, block move and copy, and page-breaking and get-page functions. It costs \$25. Contact W. S. A., 40 89th St. #3C, Brooklyn, NY 11209.

Circle 630 on inquiry card.

**Monitor Your Diet and Exercise**

**M**aster Control: A Diet and Exercise Program that runs on 128K-byte IBM computers strives to provide a comprehensive approach to weight management. It comes with *The Master Control Diet Guidebook*, which offers instructions on how to design a practical and effective diet and exercise program. The program calculates a diet using your information, monitors your progress, and provides graphic reports. Its database contains information on the caloric expenditure of more than 100 exercises and caloric count on more than 3000 foods. A quiz tests your understanding of information presented.

Two disk drives and a monochrome display or an 80-column color monitor are required. The price is \$69.95, plus \$3 shipping. A demonstration program costs \$6 (credited toward purchase). Contact HealthWare, Suite 209, Physicians Plaza, 2300 Round Rock Ave., Round Rock, TX 78664, (512) 863-6910. Circle 631 on inquiry card.

**Wire-Wrapping Editor**

**W**hen used in conjunction with an editor such as WordStar, Wirelist lets you manage all aspects of the wire-wrapping process. The editor handles the information needed to site components on a printed-circuit board, the types of component, and the logical connections between components. With this information, Wirelist produces a graphics display of each wire, which can then be connected, added, deleted, or rerouted. Wirelist can create forms and reports including

wiring lists, debugging aids, and diagnostic reports. A board update facility generates a report outlining wires to be added or removed.

Wirelist can handle 512 components, 127 pins per component, and boards as large as 25 by 25 inches; there is no limit on the amount of pins per wire string. Other features are user-defined macros, named and unnamed strings, the ability to define arbitrary pinouts for components, adjustable scale factor, and batch or interactive mode

operation. Requirements include PC-DOS 2.01, 128K bytes of RAM, IBM color monitor adapter, a floppy-disk drive, and a printer. It costs \$149. Contact Starbow Software, 10403 Caminito Banyon, San Diego, CA 92131, (619) 578-4893. Circle 632 on inquiry card.

**Color Painting with Junior**

**I**BM's PCjr ColorPaint is a graphic-design cartridge that lets you devise freestyle artwork in full color. It allows you to use your mouse to draw pictures and paint in a variety of brush styles and patterns, with 16-color palettes. You can copy and move any component in your drawings, and completed works can be printed. ColorPaint requires a 128K-byte PCjr, DOS 2.1, and the PCjr-compatible serial interface mouse. The price is \$99. Contact IBM Corp., Entry Systems Division, POB 1328, Boca Raton, FL 33432. Circle 633 on inquiry card.

.....  
 : WHERE DO NEW PRODUCT ITEMS COME FROM?  
 : The new products listed in this section of BYTE are culled  
 : from the thousands of press releases, letters, and telephone  
 : calls we receive each month from manufacturers, distributors,  
 : designers, and readers. The basic criteria for selection for  
 : publication are (a) does a product match our readers' inter-  
 : ests, and (b) is it new or is it simply a reintroduction of  
 : an old item. Because of the volume of submissions we must  
 : sort through every month, the items we publish are based  
 : on vendors' statements and are not individually verified. If  
 : you want your product to be considered for publication (at  
 : no charge), send full information about it, including the price  
 : and an address and telephone number where a reader can  
 : get further information, to New Products Editor, BYTE, POB  
 : 372, Hancock, NH 03449.  
 : .....



# HOBBYIST SPECIAL

## IBM PC COMPATIBLE KIT AVAILABLE.

Complete CPU Board with 64KB Memory, Serial Port, Parallel Port.  
Runs DOS, CPM/86 and more. . . . . **\$399**

Assembled complete: Chassis with Cover, Fan, Power Supply, Filter,  
AC Outlet, Power Cord, Speaker. . . . . **\$399**

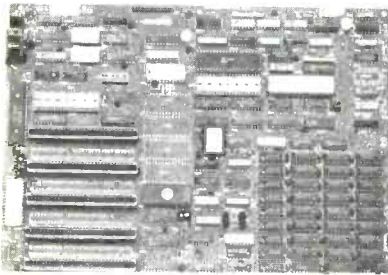

- Power Supply 100 Watts . . . . . **\$ 99**
- Floppy Drive Controller . . . . . **\$ 99**
- Monochrome Card . . . . . **\$ 99**
- Color Graphics Card. . . . . **\$129**
- ½ Height DSDD Floppy 320 KB Disk Drive by TEAC. . . . . **\$149**
- RAM Chips kit 64K . . . . . **\$ 39**
- Nice Soft Touch IBM Compatible Keyboard . . . . . **\$ 99**
- MS DOS 2.1 . . . . . **\$ 60**
- ABM Multifunction Board . . . . . **Call**
- Taxan Monochrome Monitor (Green or Amber) . . . . . **\$135**

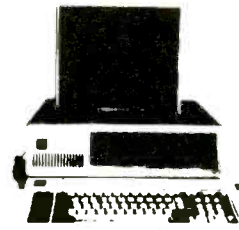

**IBM**  
PERSONAL  
COMPUTER

**Special  
of the  
Month!**

### IBM PC<sup>®</sup> COMPLETE LINE

256K RAM, 360KB Disk Drive, FDC, Video Monitor & Adaptor 10MB Hard Disk Sub-System . . . . . **\$2795**

Hard Disk for IBM PC Complete Sub-System Internal 10MB H, Winchester Drive . . . . . **\$775**

IBM PC 256K, Floppy Controller, 2 Disk Drives 320 KB Each, Monochrome Card Monochrome Monitor . . . . . **\$1895**

# Scientific Research Corp.

17895 Skypark Circle / Suite E • Irvine, CA 92714

**714/261-9137**

IBM PC is a registered trademark of IBM Corp.  
CPM/86 is a registered trademark of Digital Research, Inc.  
MS DOS is a registered trademark of Microsoft Corp.  
TEAC is a registered trademark of TEAC Corp.  
Taxan is a trademark of Taxan Corp.

All transactions subject to COD, Cashier Check or Prepaid  
Prices and Availability subject to change without notice.



**SUNTRONICS CO., INC.**

12621 Crenshaw Blvd., Hawthorne, CA 90250

1-800-421-5775 (ORDERS ONLY) (213) 644-1140 (CA. Order & INF.)

STORE HOURS : 9:00 a.m. to 6:00 p.m. (Mon.-Fri.) 10:00 a.m.-5:00 p.m. (Sat.)

### IBM XT Compatible

**System I :** 2 Slimline DSDD, 128K RAM,  
1 Parallel Printer Port & Serial Port,  
Color Graphics Card, Monitor (Amber  
or Green) . . . . . **\$1,699.00**

**FREE!** Software (Personal Pearl : Data Base  
Management System)

**System II :** System I Plus 10MB Hard  
Disk Drive System . . . . . **\$2,599.00**

**Features:**

- ✓ Intel 8088 CPU
- ✓ Intel 8087 Math Co-Processor (Option)
- ✓ Expandable on-board to 256K
- ✓ 128K RAM w/Parity
- ✓ 8 IBM Compatible Expansion Slots
- ✓ 4 Channel DMA 8237
- ✓ 8 Channel Interrupt 8259
- ✓ Mother Board dimension same as IBM PC
- Mother Board w/128K RAM . . . . . **\$475.00**
- Computer Cabinet . . . . . **\$99.00**
- 83 Key full-funtion Keyboard . . . . . **\$120.00**
- 100 WATT Power Supply . . . . . **\$130.00**
- Monochrome Graphic Card w/Printer Port . . . . . **\$289.00**
- FDD Controller Card . . . . . **\$149.00**
- Parallel Printer Card . . . . . **\$75.00**
- Dual ASYNC & RS232 Port . . . . . **\$99.00**
- 320KB DS/DD Slimline Disk Drive . . . . . **\$149.00**
- IBM Parallel Cable 10' . . . . . **\$29.95**
- IBM Prototype Board (SUN-208) . . . . . **\$9.50**
- MICROLOG Z-80B Co-Processor, Multi-funtion (Run CP/M80 Software) . . . . . **\$499.00**
- Apparat EPROM Blaster . . . . . **\$129.00**
- IBM Up-Grade Kit (4164) . . . . . **\$44.00/per kit**

### Apple Compatible Products

- SUN Z80 Card (w/o Software) . . . . . **\$55.00**
- SUN 80 Column Card (w/Soft switch) . . . . . **\$97.00**
- Power Supply (5 Amp) . . . . . **\$59.95**
- Cooling Fan . . . . . **\$42.00**
- Parallel Printer Card . . . . . **\$39.00**
- Floppy Disk Controller . . . . . **\$47.00**
- EPROM Programmer (2716, 2732, 2764) . . . . . **\$75.00**
- APPARAT PROM Blaster . . . . . **\$119.00**
- ALS Z-Card (Z80 CPU) . . . . . **\$149.00**
- ALS 80 Column Card . . . . . **\$159.00**
- AFDC-1 Floppy Disk drive Controller . . . . . **\$55.95**  
Run DOS 3.3 with any standard Shugart compatible 5¼ Disk drive (2 drives per card, Does not read ½ track, Apple II & Apple II Plus)
- Apple Prototype Board (SUN-722) . . . . . **\$5.95**

### S-100 Products

- 64K Static Memory Board (6116) w/o RAM A & T . . . . . **\$155.00**
- 64K Static Memory Board (6116) w/RAM A & T . . . . . **\$339.00**  
Uses 6116 CMOS RAMS, ½ Amp Max, w/64K @6MHz Extended Addressing, Bank Select 4-16K Blocks, 2716 EPROM can replace any 6116RAM, 8 Bit IEEE 696
- UFDC-1 5¼ and 8 Floppy Disk Controller (BIOS available) A & T . . . . . **\$245.00**
- Clock/Calendar A & T . . . . . **\$115.00**
- Prototype Board (SUN-721) . . . . . **\$9.95**
- Mother Boards/Card Cages (6, 8 & 12 Slots) are available . . . . . **Call**

### General Products

#### SAM WOO HIGH RESOLUTION DISPLAY

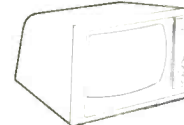

- ✓ 22 MHz Bandwidth
- ✓ Composite Video
- ✓ Anti-glare Screen
- ✓ Passes FCC & UL Approved
- ✓ 1000 Lines or 132 Characters Across
- AMBER or GREEN, 12" . . . . . \$99.00**

★ ★ ★ SPECIAL ★ ★ ★

- ★ 10MB Hard Disk Drive (Internal) w/Controller for IBM PC . . . . . **\$790.00**
- ★ Personal Pearl (Data Base Management System) IBM Format . . . . . **\$99.00**
- ★ S-100 12 Slot Motherboard A & T . . . . . **\$55.00**
- Bare Board . . . . . **\$23.00**
- ★ IBM Prototype Board (SUN-208) . . . . . **\$9.50**

**TTL IC, ROM, RAM & CPU CHIPS, CONNECTORS & IC SOCKETS ARE AVAILABLE, PLEASE CALL !!**

**TERMS :** VISA, MASTER Card, C.O.D (Cash or Certified Check Required), Check (Allow 2-3 WKS for Clearing) Shipping & H/C \$3.00 for 3 Lbs plus \$0.50 for each add Lb. Calif. residents add Calif. Sales Tax.

IBM & Apple are registered trade marks of IBM & Apple



# CALL 1-800-222-2602

## MONITORS

AMDEK COLOR I PLUS	309.95
AMDEK COLOR II PLUS	454.95
AMDEK COLOR IV	694.95
AMDEK VIDEO 300 (GREEN)	139.95
AMDEK VIDEO 300 (AMBER)	154.95
AMDEK VIDEO 310 (AMBER)	169.95
BMC 12" GREEN	89.95
BMC 13" COLOR	239.95
BMC 13" RGB	259.95
COMREX 13" COLOR W/SOUND	294.95
COMREX 12" HI-RES AMBER	119.95
COMREX 12" HI-RES GREEN	114.95
COMREX 13" RGB CR-6600	274.95
COMREX 13" RGB CR-6800	489.95
GORILLA 12" AMBER	84.95
GORILLA 12" GREEN	79.95
NEC 12" HI-RES GREEN	154.95
NEC 12" ECONO GREEN	109.95
NEC 12" LO-RES COLOR	294.95
NEC 12" AMBER SCREEN	159.95
NEC 12" COLOR - IBM	434.95
PRINCETON GRAPHICS HX-12	509.95
PRINCETON GR. 12" AMBER	189.95
SAKATA 13" COLOR	294.95
SAKATA 13" RGB COLOR	549.95
SAKATA SUPER RGB	749.95
SAKATA 12" GREEN	119.95
SANYO CTR-36 GREEN	169.95
TAXAN 12" GREEN	124.95
TAXAN 12" AMBER	134.95
TAXAN RGB 210 MED RES	309.95
TAXAN RGB 415 HI RES	439.95
TAXAN RGB 420 IBM	519.95
ZENITH 12" AMBER	109.95
ZENITH 12" GREEN	99.95
ZENITH RGB ZVM-135 COLOR	524.95
USI 9" AMBER PI-4	129.95
USI 9" GREEN PI-1	119.95
USI 12" AMBER PI-3	149.95
USI 12" GREEN PI-2	124.95
USI 13" LO-RES COLOR	309.95

## MODEMS

ANCHOR MARK VII (RS-232)	119.95
ANCHOR MARK X (RS-232)	124.95
ANCHOR MARK XII (RS-232)	289.95
APPLE-CAT II MODEM	244.95
KENSINGTON MODEM 1200	429.95
NOVATION J-CAT	119.95
RIXON R212A 1200 BAUD	409.95
SMARTCAT 103/212	429.95
SMARTCAT 103	199.95
HAYES MICROMODEM Ite	234.95
SMARTMODEM 300 BAUD	219.95
SMARTMODEM 300 for //c	274.95
SMARTMODEM 1200 BAUD	484.95
SMARTMODEM 1200B - IBM	419.95
US ROBOTICS PASSWORD	379.95

## DISKETTES

SS/SD ELEPHANT #1	16.95
SS/SD ELEPHANT #2	16.95
DS/DD ELEPHANT #5	25.95

## PRINTERS

AMDEK 5040 40CPS DAISY	1439.95
ANADEX DP-9501B	1099.95
ANADEX DP-9625B	1299.95
ANADEX DP-9620B	1179.95
ANADEX WF-6000	229.95
ANADEX DP-6500TR 500CPS	5229.95
ANADEX 9725B COLOR	1394.95
C-ITOH A10 DAISY WHEEL	509.95
C-ITOH 8510SP	489.95
C-ITOH 8600BP	7279.95
C-ITOH 8510 SCP COLOR	569.95
COMREX CR-II DAISY WHEEL	499.95
COMREX CR-III DAISY	819.95
DAISYWRITER 2000 48K	1129.95
DELTA-10	424.95
DELTA-15	624.95
EPSON FX-80 W/TRACTOR	519.95
EPSON FX-100 F/T	719.95
EPSON MX-100 F/T	449.95
EPSON RX-80	289.95
EPSON RX-80 F/T	339.95
EPSON RX-100	579.95
EPSON LQ-1500P COMPLETE	1189.95
GEMINI 10X	284.95
GEMINI 15X	409.95
GORILLA BANANNA	129.95
IDS PRISM 132	1659.95
JUKI 6100 PRINTER (P)	449.95
LEGEND 800 80CPS	279.95
MANNESMANN TALLY MT160L	319.95
MANNESMANN TALLY MT180L	879.95
MANNESMANN TALLY SPIRIT	319.95
NEC 3550 SPINWRITER-IBM	1769.95
OKIDATA PACEMARK 2350P	2279.95
OKIDATA PACEMARK 2410P	2569.95
OKIDATA PACEMARK 2410S	2639.95
OKIDATA 82A	334.95
OKIDATA 83A	629.95
OKIDATA 84P	874.95
OKIDATA 84S	994.95
OKIDATA 92P	474.95
OKIDATA 93P	709.95
OKIDATA 93S	819.95
PANASONIC P1090	219.95
PANASONIC P1091	329.95
PRINTMASTER (DAISY)	1319.95
PROWRITER I (8510P)	344.95
PROWRITER II (1550P)	564.95
QUME SPRINT 11/40+	1439.95
SANYO PR5000 DAISY WHEEL	499.95
STAR POWER-TYPE DAISY	409.95
STARWRITER DAISY WHEEL	1039.95
TOSHIBA P-135 1P	1479.95
TRANSTAR 315 COLOR	499.95
MICROBUFFER (EPSON RS232)	124.95
GRAFITTI CARD (APPLE)	89.95
GRAPPLER + (APPLE)	114.95
BUFFERED GRAPPLER (AP)	169.95
MICROBUFFER II+ 16K (AP)	199.95
PRINTFACE CARD (APPLE)	59.95
PKASO PRINTER I/P (APPLE)	139.95
WIZARD BPO 16K (APPLE)	139.95
WIZARD SPO 16K (APPLE)	199.95

OTHER PRINTERS AVAILABLE

## APPLE

4TH DIMENSION DRIVE-ONLY	199.95
4TH DIMENSION DRIVE+CTRL	299.95
ALS CP/M CARD	299.95
d-BASE II (REQ Z-80)	356.95
DOLLARS & SENSE (MAC)	109.95
GIBSON LIGHT PEN	179.95
GRAPHICS MAGICIAN (MAC)	39.95
HOME ACCOUNTANT (MAC)	74.95
MACH II JOYSTICK Ite	34.95
MACH III JOYSTICK Ite	41.95
MANAGEMENT EDGE (MAC)	179.95
MICRO-SCI A2 DRIVE-ONLY	194.95
MICROSOFT BASIC (MAC)	119.95
MICROSOFT CHART (MAC)	99.95
MICROSOFT WORD (MAC)	149.95
MILLIONAIRE (MAC)	49.95
MOUNTAIN MUSIC SYSTEM	299.95
MULTIPLAN (MAC)	144.95
PFS:FILE	89.95
PFS:FILE & REPORT (MAC)	149.95
PREMIUM SOFTCARD Ite	299.95
QUADRAM 64K80COL CRD Ite	124.95
RANA ELITE I	274.95
SOFTCARD II	354.95
SOUNDCHASER MUSIC KEYBRD	634.95
TAXAN 410-64 80 COL.II	249.95
VIDEX VIDEOTERM W/SPT	239.95
VIDEX ULTRATERM	294.95
WILDCARD I	129.95
WS/MW/SS/SI w/STARCARD	459.95
ZORK I (MAC)	29.95

## IBM

IBM PC 256k 2-DS/DD	2149.95
dBASE III	499.95
ACCESS 1,2,3	469.95
DR DRAW PC DOS	199.95
DOW JONES MARKET ANALYZE	149.95
HERCULES GRAPHICS CARD	389.95
KOALA PAD TOUCH TABLET	119.95
KRAFT JOYSTICK	39.95
KGRAPH	164.95
KPIANT	124.95
MEGA PAK 256k	399.95
MICROPRO PRO PAK	419.95
MICROSOFT SYSTEMCARD 256K	479.95
MICROSOFT MOUSE	139.95
MOUSE SYSTEMS PC MOUSE	219.95
MULTIPLAN	139.95
PFS:WRITE	99.95
PLANTRONICS COLORPLUS	439.95
QUADCHROME MONITOR	589.95
QUADLINK APPLE EMULATOR	59.95
QUADRAM QUADBOARD I 64K	299.95
QUADRAM QUADCOLOR I	229.95
R:BASE 4000	359.95
RANA DS/DD DISK DRIVE	274.95
SIX PAK PLUS I 64k	309.95
STB SUPER I/O MULTIFUNCT	184.95
TG JOYSTICK W/TOGGLE	44.95
TRANSEND P.C. MODEM 1200	439.95
VERSAWRITER GRAPH TABLET	249.95
VISION MONITOR	199.95
WIZARD SPOOLER P/S 16K	249.95

## COMPUTERS

ALTO 586-40 16-BIT	8229.95
ALTO 986-40 16-BIT	9899.95
APPLE Iic	LOW!!
APPLE IIc	LOW!!
ATARI 800XL COMPUTER	309.95
ATARI 850 INTERFACE	199.95
BMC 800-GREEN COMPUTER	1424.95
280A, 64K, PRINTER, MONITOR,	
RS-232, WORDSTAR, CALCSTAR,	
CPM2.25, MAILMERGE, SPELLSTAR	
COMMODORE 64 COMPUTER	LOW!!
COMMODORE 1541 DISK DRIVE	LOW!!
EAGLE PC PLUS-2 SYSTEM	3399.95
128K, 2-DS/DD DRIVES,	
MONITOR, EAGLEWRITER, MS-DOS,	
EAGLECALC, & CP/M-86	
EAGLE SPIRIT-II	2264.95
EAGLE SPIRIT-XL	3354.95
PORTABLE 128K EXPANDABLE TO	
640K ON BOARD, 1 320K FLOPPY,	
10 MEGABYTE HARD DISK IBM	
COMPATABLE KEYBOARD, 2 SERIAL	
1 PARALLEL PORT, ME-DOS 2.0,	
MONOCHROME MONITOR, CP/M 86	
NEC APC-H01	2239.95
NEC APC-H02	2799.95
NEC APC-H03	3524.95
NEC APC-H04	2939.95
NEC 8201 COMPUTER	449.95
SANYO 550-1 1SS/DD DRIVE	769.95
SANYO 555-1 2SS/DD DRIVE	1079.95
SANYO 550-2 1DS/DD DRIVE	829.95
SANYO 555-2 2DS/DD DRIVE	1249.95
ZENITH IBM COMPATABLE	2649.95
ZENITH W/10 MEG DSK	3999.95
TAVA PC - IBM COMPATIBLE	1999.95
128K-RAM, 2 SERIAL PORTS,	
PARALLEL PORT, 2 DS/DD DRIVES,	
COLOR GRAPHICS CARD, & MORE.	
WALNUT PC - IBM PC COMPATIBLE	
SPECIAL \$1799.95	
128K RAM, 2 DS/DD DRIVES, SERIAL,	
PARALLEL, COLOR CARD & SOFTWARE.	

## IQ TECHNOLOGIES, INC.

### SMART CABLES

INSTANT RS-232 CONNECTIONS

#817 (WORKHORSE) 79.95  
#821 DIAGNOSTIC FEATURES 164.95

\* ONE CABLE FITS ALL \*



# YOU CAN BANK ON IT!

## Our Rock Bottom prices will make a believer out of you!

### CHECK US OUT!

Apple Country Ltd is the leader in Rock Bottom computer prices.

We intend to keep it that way!

We will try to meet or beat any advertised price!

## CALL TODAY...

## WE CAN HELP!



### CREDIT CARD ORDERS 1-800-222-2602

For order status, technical assistance and California calls (619) 765 0239 Apple Country, Ltd., P.O. Box 1099, 2602 Washington St., Julian, Calif. 92036

We accept AmEx. Prices reflect 2% discount for VISA/MC cash & check (2 weeks to clear). S&H in continental US 5% (\$5 min) Monitors \$10 min. APO/FPO & others cal. Calif add 6% tax. P.O. must include check. No COE. All orders prepaid. All items are new with Mfg'r's warranty. Prices, products & terms subject to change without notice. All sales final. Returns require FMA#. No returns on software. Volume discounts available.

Apple Country, Ltd. is a DISCOUNT MAIL ORDER HOUSE for the micro computer industry and is a California corporation not affiliated with Apple Computer Inc. Apple is a trademark of Apple Computer Inc.



**IBM PC 128K**  
**(1) 360k DSDD Drive**  
**Diskette Adaptor Card**  
**Color Graphic Card**  
**10 Mb Hard Disk System**  
**\$2995.00**

**IBM PC 128K**  
**(1) 360k DSDD Drive**  
**Diskette Adaptor Card**  
**IBM Monochrome Card**  
**IBM Monochrome Monitor**  
**\$2195.00**

**IBM PC Portable**  
**(1) 360k DSDD Drive**  
**Diskette Adaptor Card**  
**Amber Display**  
**256K Ram**  
**\$2450.00**

**DISPLAY BOARDS**

LazerColor	\$199
Hercules Card	349
QuadColor I	239
PC Peacock	295

**EXPANSION BOARDS**

AST 6-pac 64K	225
Quadram EXII 64K	245
10Mb Hard Disk	899
Baby Blue II	599

**MONITORS**

Roland DG121 (comp)	\$129
Roland DG122 (mono)	149
PGS HX12 RGB	495
Max 12 Amber (mono)	195
Sakata 12" green	129
Sakata Color (comp)	295
Sakata Color (RGB)	495

**EXPANSION ACCESSORIES**

64K Upgrade (9/IC's)	50
----------------------	----

**MODEMS**

Hayes 1200 Int	\$429
Hayes 1200 Ext	489
Qubie Int	289
Anchor 1200	289

**PRINTERS**

Epson FX80	475
Epson Fx100	725
Brother HR-15	575
Brother HR-25	750

**IBM XT 128K**

**\$3895.00**

**TAVA SYSTEM ONE**  
 (2) 360K DSDD Disk Drives  
 Keyboard  
 (2) RS-232 Serial Ports  
 (1) Parallel Printer Port  
 Color Graphic Board  
 Roland DG121s Monitor

\$1895.00

**TAVA SYSTEM TWO**  
 (2) 360K DSDD Disk Drives  
 Keyboard  
 (2) RS-232 Serial Ports  
 (1) Parallel Printer Port  
 Color Graphic Board  
 Roland DG121G Monitor  
 10 MEGABYTE HARD DISK

\$2795.00

DEALER AND  
 CORPORATE  
 VOLUME PRICING

501 W. Glenoaks Boulevard  
 Glendale, CA 91202  
 (818) 240-0997

**compumax**



**SUNNY LOW LOW COST**  
**POWER SUPPLIES**  
 (LINEAR & SWITCHING)  
 FOR S-100, DISK DRIVES

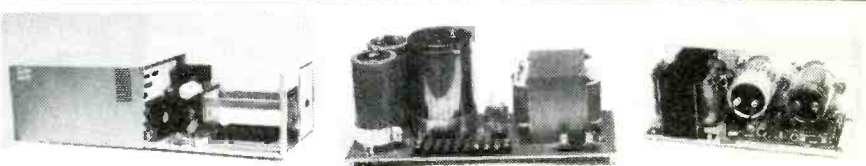

**S-100 & DISK POWER SUPPLIES:**

No. 806 & No. 516 Mainframes									
Kit 1, 2 & 3 for S-100									
R <sub>2</sub> , R <sub>3</sub> for 2 Drives (Floppy & Hard)									
OPEN FRAME, ASSY. & TESTED, 6 OUTPUTS, ADJU. & FUSES PROTECT.									
ITEM		+5V OVP	* -5 or -12V	* +24 or +12V	+8V	±16V	SIZE W x D x H	PRICE	
S <sub>3</sub>	12 SLOT & 2 FLOPPY (1 Floppy & 1 Hard Disk)	5A	1A	4-5A PEAK	13A	3A	10" x 6" x 5"	105.95	
S <sub>4</sub>	6 SLOT & 2 FLOPPY	4A	1A	4-5A PEAK	8A	3A	8 3/8" x 5" x 4 3/4"	95.95	

**DISK POWER SUPPLIES:** OPEN FRAME, ASSY. & TESTED, REGULATED, ADJUSTABLE & FUSES PROTECT.

ITEM	IDEAL FOR	+5V OVP	* -5 or -12V	* +24 or +12V	+8V Unreg.	±12V	SIZE W x D x H	PRICE	
R <sub>0</sub>	2 x 8" SLIMLINE	2.5A		2.5A - 5A Peak			5" x 4" x 4"	51.95	
R <sub>1</sub>	2 x 8" or 2 x 5 1/4" DISK	4A	1A	3A - 5A Peak	2A		8" x 4" x 3 3/4"	56.95	
R <sub>2</sub>	3 x 8" (or 5 1/4") FLOPPY	6A	1A	6A - 8A Peak			10" x 4 7/8" x 3 3/4"	71.95	
R <sub>3</sub>	or 1x Floppy & 1x Hard	6A	1A	6A - 8A Peak		1A	9" x 6 1/4" x 4 3/8"	98.95	S <sub>3</sub> , S <sub>4</sub> for S-100 & 2 Drives

AC & DC POWER CABLES WITH CONNECTOR FOR 2 DRIVES 8.00

**S-100 POWER SUPPLY KITS** (OPEN FRAME WITH BASE PLATE, 3 HRS. ASSY. TIME)

ITEM	(IDEAL FOR)	+8V	-8V	+16V	-16V	+28V	SIZE: WxDxH	PRICE
KIT 1	15 CARDS	15A	---	2.5A	2.5A	---	12" x 5" x 4 7/8"	54.95
KIT 2	20 CARDS	25A	---	3A	3A	---	12" x 5" x 4 7/8"	61.95
KIT 3	DISK SYSTEM	15A	1A	3A	3A	5A	13 1/2" x 5" x 4 7/8"	69.95

**POWER TRANSFORMERS** (WITH MOUNTING BRACKETS)

ITEM	PRIMARY	SECONDARY #1	SECONDARY #2	SECONDARY #3	SIZE W x D x H	PRICE
T <sub>1</sub>	110/120	2 x 8 Vac, 15A	28 Vac, CT, 2.5A		3 3/4" x 3 3/8" x 3 1/8"	22.95
T <sub>2</sub>	110/120	2 x 8 Vac, 25A	28 Vac, CT, 3.5A		3 3/4" x 4 3/8" x 3 1/8"	28.95
T <sub>3</sub>	110/120	2 x 8 Vac, 15A	28 Vac, CT, 2.5A	48 Vac, CT, 2A	3 3/4" x 4 3/8" x 3 1/8"	30.95
T <sub>4</sub>	110/120	2 x 8 Vac, 6A	28 Vac, CT, 1.5A	48 Vac, CT, 3A	3 3/4" x 3 3/8" x 3 1/8"	23.95
T <sub>5</sub>	110/120	2 x 8 Vac, 6A	28 Vac, CT, 2A		3" x 3" x 2 1/2"	15.95

SHIPPING FOR EA. PWR SUPPLY: \$5.50 IN CALIF.;  
 \$8.00 IN OTHER STATES; \$18.00 IN CANADA.  
 FOR EA. TRANSFORMER: \$5.00 IN ALL STATES;  
 \$12.00 IN CANADA. CALIF. RESIDENTS ADD  
 6.5% SALES TAX.

\* R<sub>1</sub> COULD BE FACTORY  
 MODIFIED TO +5V 3A, +12V  
 2.5A and -12V 1A. PLEASE  
 SPECIFY WHEN ORDERING.

MAILING ADDRESS:  
 P.O. BOX 4296  
 TORRANCE, CA 90510  
 TELEX: 182558

**SUNNY INTERNATIONAL**  
 (TRANSFORMERS MANUFACTURER)  
 (213) 328-2425 MON-SAT 9-6

SHIPPING ADDRESS:  
 22129 1/2 S. VERMONT AVE  
 TORRANCE, CA 90502







# COMPUTER DISCOUNT PRODUCTS

Stocking **HUGE** Inventories of APPLE & IBM Products SINCE 1977

★ GUARANTEED Fair Pricing Is Our Policy ★



**KOALA**  
For Ite/c & PCjr

**Muppet Learning Keys**  
Ite/c 59.99  
**Koala Touch Pad**  
Ite/c & PCjr 95.99

## DISKETTES

	10	100
CY54N 5" SS/DD	31.99	299.99
CY54N 5" DS/DD	38.99	369.99
NAZELL 5" SS/DD	27.99	259.99
NAZELL 5" DS/DD	37.99	359.99
VEFBATIM 5" SS/DD	21.99	205.99
VEFBATIM 5" DS/DD	28.99	269.99

MEMOREX 3 1/2" (MAC) 41.99

## DISKBANK



HOLDS 50

5 1/4"  
\$12.99

## RECENT RELEASES!

Call For More Information

**ORANGE MICRO** For Your IBV PC

Mr. Chips - 4 Function Board • Chipmunk - 9 Function Board

**TRILLIUM** Adventure Games For Apple

Fahrenheit 451 • Rendezvous with Fama • Shadowkeep

**WINDHAM CLASSICS** Adventure Games For Apple & IBM

Wizard of Oz • Gulliver's Travels • Swiss Family Robinson

## SPINNAKER

FOR APPLE & IBM

ALPHABET ZOO HEY DIDDLE	ea21.99
DELTA DRAWING	32.99
FACE MAKER	23.99
FRACTION FEVER	24.99
KINDERCOMP	21.99
MOST AMAZING THING	26.99
RHYME & RIDDLE	19.99
SNOOPER TROOPS I & II	29.99
STORY MACHINE	23.99

## APPLE SOFTWARE

BPI (GL AR AP PAY INV)	ea275.99
BRODERBUND Arcade Machine	39.99
Bank Street Writer	44.99
Drol: Loderunner	ea24.99
DLM Alien Addition: Alligator Mix	ea22.99
Demolition Division	22.99
Dragon Mix	22.99
Meteler Multiplication	22.99
Minus Mission	22.99
Verb Viper/Word Invasion	ea31.99
Word Radar Spelling Wiz	ea31.99
EDUWARE (Now Peachtree)	
Algebra I-III	ea31.99
Counting Bee	23.99
Decimals / Fractions 3.0	ea33.99
PSAT Word Attack	33.99
SAT Word Attack	33.99
JACK REPORT	74.99
KENSINGTON Format II	109.99
LEARNING CO Bumble Games	26.99
Bumble Plot/Magic Spell	ea26.99
Gertrudes Puzzle/Secret	ea29.99
Mootown Parade/Hotel	ea26.99
Rocky's Boots	34.99
MASTERTYPE	31.99
MICROLAB Miner 20-49er	27.99
MICROSOFT Multiplan	165.99
DOLLARS & SENSE (Ite/c)	79.99
ODESTA Chess	45.99
PFS Report	79.99
File	69.99
Graph	69.99
Write	69.99
SENSIBLE SPELLER	79.99
SUBLOGIC Night Mission Pinball	32.99
Flight Simulator II	37.99
ULTIMA II	39.99

## ACCESSORIES

FINGERPRINT (Epson Enhancement)	44.99
FLIP'N FILE (original)	14.99
FLIP'N FILE w/Locktray (25)	17.99
FLIP'N FILE w/Locktray (50)	27.99
HAYES 300 Baud Smartmodem	219.99
1200 Baud Smartmodem	495.99
LIBRARY CASE	1.99
KENSINGTON PC Saver	29.99
PRINTERS C-ITOH	379.99
Epson FX80	499.99
Epson RX80	329.99
OKidata 82-93	SCALL
PRINTER STAND Sm (plxgls)	24.99
PRINTER STAND Lg (plxgls)	23.99
RIBBONS-Brother	SCALL
MX & FX 80	4.99
MX & FX 100	7.99
OKI 82, 83, 92, 93 & Gemini	2.99

OKIDATA 92P For IBM Only  
Includes Plug 'n Play 459.99

## APPLE HARDWARE

1/2 HEIGHT DRIVE	219.99
AUTD REPEAT KEY	19.99
DAN PAYMAR Lower Case 1 (rev 1-6)	25.99
Lower Case 2 (rev 7)	19.99
EASTSIDE Wildcard II	111.99
HAYES Micromodem Ite	219.99
KOALA PAD	SCALL
KRAFT Joystick	44.99
MICRO SCI A-2 Drive	219.99
MICROSOFT Softcard	229.99
MOUNTAIN Rampus + 32K	159.99
MOCKINGBOARD	109.99
ORANGE MICRO Grappier + Bufferboard	1'4.99
Buffered Grappier + PADOLE ADAPPLE	179.99
TITAN TECH 128K Ram	84.99
Salurn 64K	379.99
Salurn 64K	279.99
Accelerator II	449.99
Neptune 64K	199.99
TG Joystick	39.99
Paddles	29.99
THUNDERLOCK	99.99
MOCKINGBOARD (Ite/c)	99.99



ALPHA Typefaces	79.99
ASHTON TATE dBase II	399.99
Friday	184.99
Encyclopedia	59.99
AST I/O Plus	SCALL
Mega Plus	289.99
Six Pack Plus	279.99
BRODERBUND Serpentine	26.99
Lode Runner	24.99
CAI Masters	ea31.99
Subjects	ea16.99
CROSS TALK	139.99
EDUWARE (Now Peachtree) Algebra I	34.99
HAYES 1200B Modem	439.99
JOYSTICK Kraft or TG	44.99
LIFETREE Volksmodem	119.99
LOTUS 1-2-3	SCALL
MASTERTYPE	34.99
MICROLAB Miner 20-49er	27.99
MICROSOFT Flight Simulator II	35.99
Mouse	129.99
Multipian	165.99
MONOGRAM Dollars & Sense	119.99
NORTON Utilities	55.99
PC GRAYON	49.99
Tutor	47.99
PFS Write	99.99
File	99.99
Report	89.99
Graph	99.99
SIERRA ON-LINE Frogger	26.99
SIR-TECH Wizardry	44.99
SUBLOGIC Night Mission Pinball	32.99
TEAC 1/2 Height DS/DD Drive	239.99
TITAN 64K BOARD	499.99
VISICORP Visicalc	164.99
Schedule	ea199.99

PLANTRONICS ColorPlus 375.99



ALP-4A PLOT	25.99
APP E-WECH FLEX TEXT	ea19.99
EEASLE BASIC DOUBLE TAKE	ea23.99
DOS BOSS	17.99
FRAME UP	19.99
GPLE	32.99
FRONTO DOS	15.99
TIP DISK #1	15.99
TYPFACES	15.99
UTILITY CITY	18.99

## QUADRAM

APIZ (APPLE III PARALLEL)	129.99
eRAM 80 column 64K IIE	129.99
MICROFAZER (All Configurations)	149.99
QUAD 512+(64K)	229.99
QUADBOARD I or II (Ite/c)	219.99
QUADBOARD I or II (64K)	269.99
QUADCOLOR I	209.99
QUADCOLOR I UPGRADE	209.99
QUADLINK	479.99

## QUADCHROME

Hi-Res Color Monitor \$529.99



10C Smart Cat	169.99
10C/212 Auto Cat	399.99
J Cat	109.99
Access 123 (IBM)	435.99
Applecat Upgrade 1200 Baud	309.00
Ca Modem	135.99
Expansion Module	29.99

## APPLECAT II

1200 Baud Modem 259.99

## INFOCOM

FOR APPLE & IBM  
For CP/M Versions - SCALL

DEADLINE	32.99
ENCHANTER	32.99
PLANETFALL	32.99
SORCERER	37.99
STARCROSS	24.99
SUSPENDED	32.99
WITNESS	32.99
ZORK	24.99
SEASTALKER	31.99

## KENSINGTON

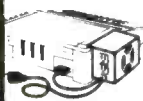

SYSTEM SAVER  
\$65

## QUALITY MONITORS

AMDEK 300A Apple	159.99	TAXAN 12" Amber IBM	169.99
AMDEK 310A IBM	179.99	TAXAN 12" Green 20MHZ	129.99
PRINCETON RGB HX-12	475.99	USI P1 19" Green 20 mh	99.99
TAXAN 420 RGB	489.99	USI P1 4.9" Amber 20 mh	109.99
TAXAN 12" Green IBM	159.99	USI 1400C Color Composite	279.99

TAXAN 12" Amber For Apple 20MHZ 139.99

## MicroPro

INFOSTAR	259.99
MAILMERGE	159.99
SPELLSTAR	159.99
WORDSTAR	259.99
WORDSTAR PRO	369.99
PRO OPTIONS PACK	182.99

## Videx

ENHANCER II	109.99	PRE-BOOTS Apple Writer	14.99
FUNCTION STRIP	31.99	Apple Writer for Ultraterm	25.99
HARD SWITCH	15.99	Visicalc	36.99
MICROMODEM CHIP	24.99	Visicalc/Memory Expansion	71.99
PSIO	169.99	Visicalc for Ultraterm	54.99
SOFTSWITCH	25.99	ULTRATERM	259.99
ULTRAPLAN	129.99	VID-OTERM w/SS + INV	219.99

## MAIL AND PHONE ORDERS

Inquiries Welcome!

(408) 985-0400

MAIL PHONE, WILL-CALL  
SERVICE FROM 6 AM (PST)

## COMPUTER DISCOUNT PRODUCTS

860 So. Winchester Bl., San Jose, CA 95128

— CALL (408) 985-0400 —

Retail Showrooms In California

San Jose • San Mateo • San Francisco

- No Charge For Credit Cards
- Prices Subject To Change
- Software Sales Are Final
- International Orders Welcome
- Min. UPS Chg. \$4 + Ins.
- Min. US Postal Chg. \$10
- P.O.'s Welcome - SCALL





# MEGA-BOARD™

*new!*

**Ideal for**

- **COMPUTERISTS**
- **OEM MANUFACTURERS**
- **DEVELOPMENT LABS**
- **UNIVERSITIES**
- **INDUSTRIAL APPLICATIONS**

**THE ULTIMATE OEM/PC  
COMPATIBLE SINGLE  
BOARD COMPUTER**

**FULL IBM - PC\*  
COMPATIBILITY!**

**DEALERS AND OEM MANUFACTURERS  
QUANTITY DISCOUNTS AVAILABLE**

**Standard Key-  
board Interface**  
(Full PC compatible)

**Hardware Reset**  
(Overcomes reset flaw  
in PC)

**Eight Compatible  
I/O Interface  
Connectors**

(Full PC compatible)  
(compatible with all  
IBM-PC\* plug-in cards)

**Power Connector**  
(Full IBM\* pinout  
compatible)

**Special J1  
Interface**

(Allows horizontal mount-  
ing of compatible expansion  
cards for easy bus  
expansion and custom  
configuring) (Board has  
62 pin gold plated compat-  
ible connector)

**8088 Processor**  
(Same as PC)

**8087 Numeric  
Processor**  
(Same as PC)

**Peripheral  
Support Circuits**  
(Same as PC)

**Extended ROM  
Capability**

(Runs all compatible PC  
ROMs) (Jumper program-  
mable to accommodate all  
popular 8K, 16K, 32K and  
64K ROM chips and NEW  
EE ROMs! VPP power pin  
available for EP ROM  
burning!) (External  
VPP voltage required)

**Configuration  
Switches**  
(Same as PC)

**Speaker/Audio  
Port**  
(Same as PC)

**Board Size**

10.5 inch X 13.5 inch

**Wire Wrap Area**  
To facilitate special custom  
applications!

**ORDER NOW!!!**

**Full Mega-Byte Ram Capacity!  
On board!**

(With parity)

- 256K Bytes using 64K chips
- 1 Mega Bytes using 256K chips

**ONLY!**  
**\$9995**  
**Evaluation  
Board Kit**

**MEGA-BOARD™ Evaluation Board Kit!**

(Blank board with full assembly  
instructions and parts list.)

Includes highest quality PC board  
with gold plating, silk screen,  
solder mask

- MEGA-BOARD™** with full assembly instructions . . . . \$99.95
- USERS MANUAL** with theory of operation,  
schematics, block diagram, application notes . . . . \$19.95
- MEGA-BIOS™** fully compatible MS-DOS/PC-DOS BIOS \$29.95

**ORDER NOW!!!**

**SATISFACTION GUARANTEED!**

10-day money back guarantee if not completely satisfied.

**DTC™** DISPLAY  
TELECOMMUNICATIONS  
CORPORATION

4100 SPRING VALLEY ROAD  
SUITE 400  
DALLAS, TX 75234  
(214) 991-1644

**TERMS:** Shipment made 2 to 5 weeks from  
receipt of order. VISA, MC, money order,  
Company check accepted. COD'S require  
\$25 deposit. Balance UPS COD. Please  
add \$2.00 shipping and handling per order.

# Announcing 4 New Collector Edition

# BYTE COVERS

The 4 Byte covers shown below are the newest additions to the Collector Edition Byte Cover series. Each full color print is 11" x 14", including a 1 1/2" border, and is part of an edition strictly limited to 500 prints. Each print is a faithful reproduction of the original Byte painting, printed on museum quality acid free paper, and is personally inspected, signed and numbered by the artist, Robert Tinney. A Certificate of Authenticity accompanies each print.

Collector Edition Prints are carefully packaged flat to avoid bending, and are shipped first class within one week of receipt of order. The price of each print is \$25. All 4 prints are available as a set (Set 21-24) for only \$80.

Other Collector Edition Byte Covers are also available from Robert Tinney Graphics. For a color brochure, or to order one or more of the prints shown, please check the appropriate box in the coupon below.



#21 The Wall Street Terminal \$25

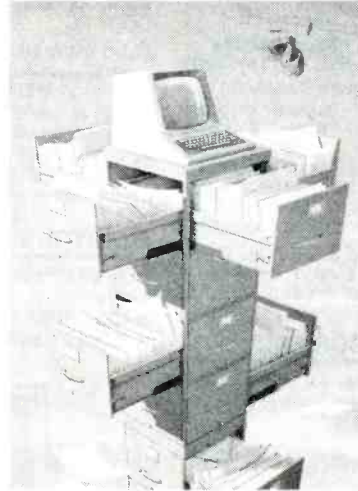

#22 "Opening Files ..." \$25

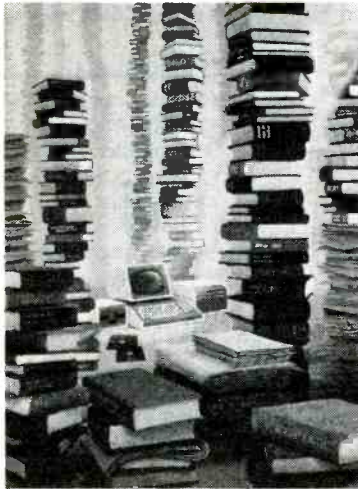

#23 The Stacks \$25

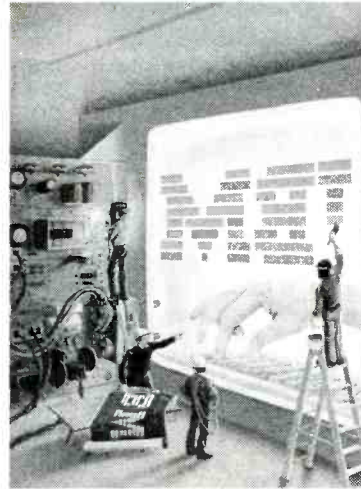

#24 Inside IBM \$25

Please send me the following Prints (\$25), or Sets (\$80).

QTY.	TITLE & PRINT NO.	AMOUNT
_____	_____	\$ _____
_____	_____	\$ _____
_____	_____	\$ _____
postage & handling \$3.00 (Overseas \$8.00)		\$ _____
<b>TOTAL \$</b>		_____

Please send me your color brochure.

I have enclosed check or money order.

Visa  MasterCard

Card No. \_\_\_\_\_

Exp. Date: \_\_\_\_\_

SHIP MY PRINTS (OR BROCHURE) TO:

Name: \_\_\_\_\_

Address: \_\_\_\_\_

City: \_\_\_\_\_

State: \_\_\_\_\_ Zip: \_\_\_\_\_

Mail this coupon to:

**robert tinney graphics**  
1864 N. Pamela Drive  
Baton Rouge, LA  
70815

**FOR VISA OR MASTERCARD ORDERS**  
or for more information  
**CALL 1-504-272-7266**  
Daytime or Evenings



# AB Computers

THE VALUE LEADER SINCE 1976

## COMPUTERS

IBM PC and PC XT in stock available at special prices. **CALL**

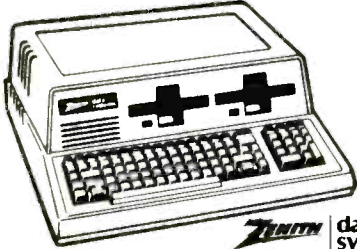

**Zenith** data systems

Zenith—All Zeniths fully software & hardware compatible with the PC and XT... superior keyboard:

Computer	Ram	Drive	Ports	Price
ZF-151-21	128K	360	1PL/2 SER.	CALL
ZF-151-52	320K	720 (2 drives)	1PL/2 SER.	CALL
ZW-151-52	320K	10.6 MB + 360	1PL/2 SER.	CALL
ZF-161-21	128K	360	1PL/2 SER.	CALL
ZF-161-52	320K	720 (2 drives)	1PL/2 SER.	CALL

Sanyo—We have Sanyo 550 & 555 PC's. Built-in software includes MDOS Version II, Wordstar, CalcStar, Basic, more. Great Prices. **CALL**  
Portable

## DISKS AND ACCESSORIES

VERBATIM—Verbatim DATALIFE™ Minidisks are super quality, super durable. Price per 5 1/4" minidisk (sold in boxes of 10)

	Qty. 10	Qty. 50	Qty. 100
SS/DD	1.95	1.90	1.85
DS/DD	2.60	2.55	2.50

★ **AB's OWN DISKETTES**—Top disk quality at a low, low price. buy 100 (DS/DD) and pay only **\$1.60** per disk.

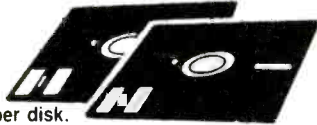

Plus, before November 30, get a free Amaray Mediamate 5 disk file in the bargain!

AB carries all major brands... 3M, Verbatim, Maxell, Wabash, BASF, Sentinel, Dysan... in all popular sizes and configurations. **CALL** for super prices.

### DISK STORAGE

Mini Flip 'N File (50 5" disks)	\$17.45
Rolltop 100 (100 disks, 10 dividers)	28.99
Mini Kas-ette/10 (for 5" disks) 1/2.25 10/2.05 ea	

★ **Amaray Mediamate 5** 'til Nov. 30, only **11.99**

**PLUS**—“HEAD” disk cleaning kit (w/2 disks) 11.99  
 IBM drive analyzer (Verbatim) 22.50

## COMMUNICATIONS

Mark X Auto Dial/Auto Answer	\$129.
Anchor Mark XII Smart modem	265.
Hayes Smartmodem 1200B (includes Smartcom II software)	409.
Hayes SmartModem 1200/300	489.
“Crosstalk” software	135.
AB communication software (works with Anchor, Hayes, others)	29.

## SOFTWARE

Lotus 1-2-3	\$345.
Lotus Symphony	479.
Multi-Mate	325.
Multiplan (Microsoft)	129.
Wordstar	335.
dBASE II (Ashton-Tate)	CALL
dBASE III (Ashton-Tate)	CALL
Microsoft “WORD” (with MOUSE)	325.
Peachtree Peachtext 5000	189.
Spinnaker Software—full line	CALL
UNIX Operating System for PC	CALL
COPY PC	29.
PLUS many other software specials	CALL

### FREE CATALOG!

This ad space can accommodate only a few of the exceptional values available from AB. Our latest catalog is packed with fantastic buys, top brands, thousands of items. For a free copy call or write.

## MONITORS

USI—20 MHz band width, 1000 lines resolution. Easily capable of 80 character display.  
 ★ 1200G (Pi-2)—12" green phosphor SPECIAL \$85.  
 ★ 1200A (Pi-3)—12" amber phosphor SPECIAL 89.

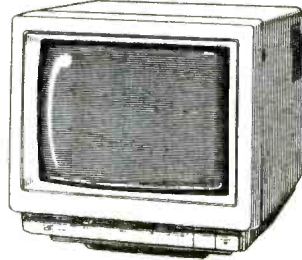

### AMDEK

Video 310A—12" amber, 18 meg. TTL-IBM. \$155.  
 Color II + -13" RGB TTL input 435.

### ZENITH

ZVM-124—12" amber...22 MHz, TTL for IBM \$150.  
 ZVM-135—High res. RGB + composite monitor 470.  
 ZVM-135-1—Cable for RGB monitor 23.

### COMMODORE SPECIALS

WC 6420 Auto Modem (also available for Atari & Apple at slightly higher price)	\$ 65.
Tech Sketch Light Pen & Micro Illustrator	44.
<b>MSD Dual Superdrive for C64 &amp; IEEE</b>	<b>570.</b>
CBC 4/12 Analog to Digital 4 Chan/12 Bit	179.
Typing Tutor III with Letter Invaders (Also for Apple & IBM)	35.
Paper Clip Word Processor CBM/C64	60.
Oracle (Consultant) Data Base (BY batteries included)	89.
All other “batteries included” items in stock	CALL
<b>FORTH for PET/C 64</b> (Full Fig. Model) by Cargile/Riley	50.
Ditto Disk 64 (copy discs even if original is copy protected)	36.
STAT for PET/CBM/C64 & Apple comprehensive Statistical Analysis Routines	95.

## OUTPUT DEVICES

Printers by Star, Epson, Okidata, Brother:

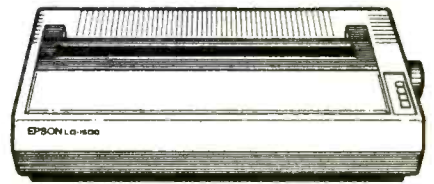

Star Micronics Gemini 10X -10" carriage. FIT 120 CPS	\$295
Epson LQ-1500—NEW 24-pin. letter qual. dot matrix	CALL
Epson RX-80—Tractor feed. Galrtrax +	289.
Okidata 92	CALL
Brother HR-35 Daisywheel 25 CPS Bi-Directional	915
Brother HR-25 Daisywheel—23 CPS Bi-Directional	675.
Brother HR-15 Daisywheel—13 CPS Bi-Directional	399.
Panasonic 1090 Printer with Correspondence Mode	249

## PLOTTERS BY AMDEK, SWEET-P:

Amdek Amplot II—Six Pen	890.
★ <b>SWEET-P 100</b> —Single Pen (with 4 color pens)	CALL
★ <b>SWEET-P 600</b> —Six Pen	<b>SPECIAL 939.</b>
Microfazer Printer Buffers (Quadram):	
MP Parallel 8K-\$145, 16K-\$155, 32K-\$175, 64K-\$205	
IBM Parallel Printer Cable	19.

## INPUT DEVICES

★ **OBERON Optical Scanning Wand**—Now, scan typed lines for fastest input. Handles 10 pitch characters, most common fonts. Great for mail list updates, much more. RS-232 \$395.  
 Zenith keyboard 229  
 Keytronics 5150 keyboard 179.

## /ETC.

Panasonic, Amdek, Hitachi & Other—1/2 height, double side drives...from \$149.  
 ★ **Winchester Drives (10 MB)** 895.  
 Quadram Quadboard—Parallel port, serial port, clock/calendar.  
 No RAM-\$229, w/64K-\$279, w/384K-\$499  
 Hercules graphics board 359.  
 Votrax speech synthesizers—  
 Personal Speech System 249.  
 AST—full line of IBM cards & boards...CALL

## POWER DEVICES

Datashield back-up power source  
 200 PC-200 watt 265.  
 300 XT-300 watt 390.  
 “BITS” Power back-up—250W, True uninterruptible 695.  
 Brooks 6 Outlet—  
 Surge Suppressor/Noise Filter 54.

### AB SATISFACTION GUARANTEE

Every product sold by AB Computers is factory packed and comes with the manufacturers warrantee. However, if an item is defective when received, you may return it to us within 15 days for repair, adjustment or replacement at our option. Returns must be accompanied with copy of your invoice, letter detailing defect, blank warrantee card and all original factory packing. To expedite handling, please call for return authorization number. (Sorry, no returns on computer software, once opened)

**Ordering Information:** Prices shown include cash discount. Add 3% for credit card purchases (Mastercard or VISA). Personal checks take 15 days to clear, no waiting on certified checks or money orders. Add \$1.50 shipping and handling on all orders. Mail, APO/FPO. Air may require additional charges. PA residents add 6% sales tax. All items subject to availability. Prices subject to change. Additional discounts available to qualified educational institutions.

# AB Computers

THE VALUE LEADER SINCE 1976

252 BETHLEHEM PIKE

COLMAR, PA 18915

OR USE OUR ORDER LINE, MONDAY-SATURDAY

9 A.M. — 6 P.M. EST

# 800-822-1211

(IN PA, 215-822-7727)





**74LS00**

74LS00	22	74LS166	1.50
74LS01	24	74LS168	1.35
74LS02	25	74LS169	1.35
74LS03	25	74LS170	1.35
74LS04	30	74LS173	1.35
74LS05	25	74LS174	85
74LS08	30	74LS175	90
74LS09	30	74LS181	2.50
74LS10	25	74LS190	1.45
74LS11	30	74LS191	1.45
74LS12	30	74LS192	1.45
74LS13	75	74LS193	1.45
74LS14	75	74LS194	1.45
74LS15	35	74LS195	1.45
74LS20	25	74LS196	1.35
74LS21	30	74LS197	1.35
74LS22	30	74LS221	1.35
74LS26	30	74LS240	1.85
74LS27	30	74LS242	1.85
74LS28	30	74LS243	1.85
74LS40	30	74LS244	2.25
74LS42	35	74LS245	3.95
74LS48	35	74LS247	1.65
74LS51	35	74LS248	1.65
74LS54	35	74LS249	1.65
74LS55	35	74LS251	1.75
74LS73	35	74LS253	1.75
74LS74	45	74LS258	1.50
74LS75	45	74LS259	2.95
74LS76	45	74LS260	1.15
74LS78	75	74LS261	3.75
74LS83A	75	74LS266	1.35
74LS85	75	74LS273	1.75
74LS86	35	74LS275	1.95
74LS90	75	74LS279	75
74LS92	75	74LS283	75
74LS93	75	74LS290	75
74LS95	75	74LS293	1.25
74LS96	75	74LS295	1.65
74LS107	35	74LS298	1.65
74LS109	45	74LS323	2.95
74LS113	75	74LS324	1.15
74LS114	75	74LS347	1.55
74LS122	95	74LS348	1.45
74LS123	95	74LS352	1.65
74LS124	95	74LS353	1.95
74LS125	75	74LS363	1.95
74LS126	75	74LS365	1.25
74LS132	95	74LS366	1.25
74LS133	75	74LS367	95
74LS136	75	74LS368	95
74LS138	95	74LS373	1.95
74LS139	95	74LS374	1.95
74LS145	95	74LS375	95
74LS148	95	74LS377	95
74LS151	75	74LS378	1.55
74LS153	75	74LS379	1.55
74LS154	95	74LS381	1.95
74LS155	75	74LS385	1.95
74LS156	75	74LS386	1.25
74LS157	75	74LS390	2.55
74LS158	75	74LS393	1.55
74LS160	75	74LS395	1.55
74LS161	75	74LS424	1.95
74LS162	75	74LS640	1.95
74LS163	75	74LS668	2.75
74LS164	95	74LS645	1.95
74LS165	95	74LS670	1.50
		74LS690	1.50

**74S00**

74S00	30
74S02	30
74S03	30
74S04	35
74S05	35
74S08	65
74S09	65
74S10	95
74S11	95
74S15	95
74S20	95
74S22	95
74S30	95
74S32	95
74S38	95
74S40	95
74S51	95
74S64	95
74S65	95
74S74	95
74S86	95
74S112	95
74S113	95
74S114	1.25
74S124	3.65
74S133	95
74S134	1.25
74S135	1.65
74S136	2.25
74S138	1.25
74S139	1.25
74S140	1.25
74S151	1.25
74S153	1.95
74S157	1.95
74S158	1.95
74S160	1.95
74S161	1.95
74S163	2.95
74S174	2.25
74S175	2.25
74S188	3.55
74S194	2.55
74S195	2.55
74S196	2.55
74S225	7.75
74S240	2.95
74S241	2.95
74S242	2.95
74S243	2.95
74S251	2.25
74S253	2.25
74S257	1.95
74S258	1.95
74S260	1.25
74S280	2.95
74S283	3.95
74S287	3.95
74S288	3.95
74S289	4.95
74S373	3.95
74S374	3.95
74S387	3.95
74S471	4.95
74S472	7.95
74S473	7.95
74S474	9.95
74S475	9.95

**GENERAL PURPOSE BOARDS**  
**BLANK BOARD — HOLES ON 100" GRID, No ETCHED CIRCUIT**  
**EXCEPT CONTACT FINGER**

No. Contacts	Size	Contact Centers	Price	
P 441-1	22/44	4.5" x 6"	156"	9.95
P 442-1	22/44	4.5" x 9"	156"	10.95
P 721-1	36/72	4.5" x 6"	100"	9.95
P 722-1	36/72	4.5" x 9"	100"	10.95

**D— SUBMINIATURE CONNECTORS**

Description	Solder Cup		Right Angle PC Mounting		Hood	
	Pin	Socket	Pin	Socket	Grey	Black
Part No.	DXXP	DXXS	RDXXP	RDXXS	DXXCGY	DXXC
Contacts	9	2.05	2.65	3.90	3.20	1.55
	15	2.05	3.60	3.70	5.40	1.55
	25	2.50	3.25	4.50	4.80	1.55
	37	4.75	7.10	9.40	10.95	2.95
	50	6.00	9.25	---	---	3.50

**MODEMS**

HAYES	IBM PC SMARTMODEM 1200B, Plug-in	449.00
	SMARTCOM II COMMUNICATIONS SOFTWARE	99.00
	SMARTMODEM 300, AUTO ANS/DIAL, 300 BAUD, RS232	199.00
	SMARTMODEM 1200, AUTO ANS/DIAL, 1200 BAUD, RS232	475.00
	SMARTMODEM IIe, 300 BAUD, AUTO ANS/DIAL, Plug-in	249.00
	SMARTCOM I COMMUNICATIONS SOFTWARE	79.00

**RESISTORS**

WATT	5%	CARBON FILM	FROM 1 OHM TO 10M OHM
50 pcs			.99
100 pcs			1.89
1000 pcs			9.50
5000 pcs			42.50
1/2 WATT	5%	CARBON FILM	
50 pcs			1.25
100 pcs			2.35
1000 pcs			11.50
5000 pcs			52.50

**JOYSTICK FOR APPLE II \$19.95**

**Joy Stick for IBM P/C \$22.95**  
**8087 MATHEMATICS CO-PROCESSOR \$189.00**

**Apple II/Ile Compatible Disk Drive \$139.00**  
**CONTROLLER CARD \$44.95**

**FOR APPLE II & Ile 16K RAM CARD \$39.95**  
Compatible with:  
DOS 3.3 CP/M  
Visicalc, PASCAL  
1 YR. WARRANTY



**Speedy EPROM Programmer for Apple II \$149.00**

Programming 2716, 2732, 2732A, 2764, 27128, 2516, 2532, 2564 in 30 seconds, software control programming, no additional hardware required.

**New Multichannel Hobby Microwave Antenna System**  
**Freq. Range: 2.1 - 2.7 GHz**

- Includes:
1. Wide Band Probe With Down Converter
  2. 20" White Painted Dish
  3. 60' and 3' Coax Cable Set
  4. Steel Case 5 - 20 DCV Tuneable Power Supply
  5. Mounting Accessories and Instructions
- ALL FOR \$97.95**

**IC SOCKETS**

WW = WIRE WRAP	1 - 99	100
8 PIN WW	55	45
14 PIN WW	65	55
16 PIN WW	65	55
18 PIN WW	89	79
20 PIN WW	1.00	90
22 PIN WW	1.15	1.05
24 PIN WW	1.19	1.09
28 PIN WW	1.45	1.35
40 PIN WW	1.89	1.69
LP = LOW PROFILE		
6 PIN LP	.10	.09
8 PIN LP	.12	.10
14 PIN LP	1.4	1.2
16 PIN LP	1.6	1.4
18 PIN LP	1.8	1.6
20 PIN LP	2.8	2.6
22 PIN LP	2.8	2.4
24 PIN LP	3.0	2.6
28 PIN LP	4.0	3.2
40 PIN LP	4.8	3.8
64 PIN LP	4.10	

**U/V EPROM ERASER General Industries \$37.50**

**SUPER COOLING FANS For APPLE WITH SURG \$37.50**

**MOSS EPROM**

2708	5.95
2716-450	3.95
2732-450	5.95
2732-250	6.95
2764-450	7.95
2764-250	9.95
2764-300	9.95
27128-250	25.95
TMS2516	4.95
TMS2716	7.95
TMS2532	5.95

**STATIC RAM**

2101	2.95
5101	4.95
2114-450	1.95
2114-200	2.15
2147	4.95
6116-4	5.75
6116-3	6.75
6116-2	7.95
6116LP-4	6.75
6116LP-3	6.95
6116LP-2	8.95

**SOUND CHIPS**

76477	2.95
76489	8.95
AY3-8910	9.95
AY3-8912	12.95



**CRYSTALS**

32.758khz	1.75
1.0mhz	3.95
1.8432	3.95
2.0	2.95
2.097152	2.95
2.4576	2.95
3.579535	2.95
4.0	2.95
5.0	2.95
5.0688	2.95
5.185	2.95
5.7143	2.95
6.0	2.95
6.144	2.95
6.5536	2.95
8.0	2.95
10.0	2.95
10.738635	2.95
12.00	2.95
14.31818	2.95
15.0	2.95
16.0	2.95
17.430	2.95
18.0	2.95
18.432	2.95
20.0	2.95
22.1184	2.95
32.0	2.95

**1984 IC Master Manual \$79.95 plus \$5.00 shipping**

**DYN. RAM**

4116-200	1.95
4116-150	2.25
4116-120	2.95
4164-200	6.75
4164-150	6.95

**MISC**

8031	24.95
8035	5.95
8039	12.50
8085	14.95
8086	24.95
8087	189.00
8088	24.95
8155	12.95
8212	3.25
8237A	22.95
8250	14.95
8251	9.95
8253	9.95
8255	9.95
8257	5.95
8259	5.95
8279	9.95
8284	9.95
8286	24.95
8288	21.95
8748	55.00
6502	4.95
68000	39.95
Z80ACPU	3.95

**Build Your IBM™ PC/XT Compatible at Competitive Prices \$1,687**

- DEALER AND OEM ARE INVITED
- Completed Unassembled System Hardware Only
- MULTIFUNCTION BOARD**
- 2 serial ports, 1 parallel port real time clock, 64K RAM up to 256K RAM ..... 249.00
  - Floppy disk drive controller board ..... 169.00
  - Hard disk controller board/DTC 5150BX ..... 299.00
  - Color graphic board ..... 219.00
  - Monochrome + color + graphic board ..... 299.00
  - Panasonics disk drive, 320k, half height ..... 159.00
  - Hard disk drive 10 MB/Shugart SA712 ..... 699.00
  - 100W power supply with fan ..... 169.00
  - Case ..... 119.00
  - Manual ..... 25.00
  - Keyboard ..... 149.00
  - High resolution color RGB monitor/Taxan ..... 449.00
  - High resolution green monitor/Taxan ..... 129.00
  - Monitor stand ..... 19.95
  - Hayes 1200B modem ..... 449.00
  - Hayes 1200 modem ..... 475.00
  - Tandon TM100-2A ..... 199.00
  - 64K Memory Expansion Kit ..... 44.95
  - 50 5 1/4 Diskette Store ..... 19.95



- MOTHER BOARD:**
- 8088 CPU with socket for co-processor 8087
  - 8088 is supported by 8259A interrupt controller and 8237 DMA controller
  - 2 (two) 28 pin sockets for ROM
  - 8 (eight) expansion slots
  - No RAM on board (RAM is on multifunction board)
- Bare Board ..... 69.00  
Ready Board ..... 199.00  
(With IC sockets, resistors, capacitors, connectors, crystals, transistors soldered)  
Tested Board (w/o ROM) ..... 399.00  
IC kit ..... 199.00
- IBM is the trademark of International Business Machines.  
Prices subject to change without notice.

**7400 SERIES CALL FOR PRICE**

- CAPACITORS**
- \* Ceramic Disc
  - \* Electrolytic
  - \* Tantalum
  - \* Mylar
  - \* Monolithic

TERMS: For shipping include \$2.50 for UPS Ground or \$3.50 for UPS Blue Label Air. Items over 2 lbs. require additional shipping charges **\$10.00 minimum order.** COD Additional \$2.00 Fee.

IBM is a trademark of International Business Machines Corporation. Apple is a trademark of Apple Computer.

Price is subject to change without notice.

**Handwellcorp**

4962 EL CAMINO REAL • LOS ALTOS, CA 94022 • (415) 962-9265  
TELEFAX (415) 962-8249 TXL 171947 HANDWELL LTOS

# HOW TO MAKE A GREAT FINANCIAL STATEMENT

We realize buying a computer is feasible only if it pays for itself. The best way to cost-justify a computer is to have less cost to justify. Our business is supplying your business with the best computing products and services available. Why continue paying more and getting less? If you're not buying from us, you're not taking advantage of the lowest prices, the best technical support and one of the largest inventories anywhere in the nation. The bottom line is: We'll help make your bottom line look even better. **CALL US NOW AT 1-800-446-7995** and we'll show you why we're called **PROGRESSIVE**.

 **PRICE**     **STOCK**     **SERVICE**     **SUPPORT**

**Disk Drives For Less:**  
**TANDON TM 100-2 ... \$199**  
**HEY XT OWNERS!!!** Add a B drive with our **HALF HEIGHT SPECIAL!!!** Two half height drives, cable, brackets, 1 year warranty all for just... **\$329**  
 Individual **HALF HEIGHTS** each **\$169**  
**PEACHTREE PERIPHERALS P-10** \$1049  
 This is the best quality 10MB half height in the market! Specially designed for the PC's power supply. Comes with auto boot ROM, 2 year warranty.

## Printers:

EPSON FX-80 (160cps, 10")	\$499
EPSON FX-100 (160cps, 15")	\$699
EPSON RX-80T (100cps, 10")	\$279
EPSON RX-100 (100cps, 15")	\$499
OKIDATA ML92 (160cps, 10")	\$449
OKIDATA ML93 (160cps, 15")	\$695
OKIDATA ML84 (200cps, 15")	\$875
OKIDATA PACEMARK 2410 (350cps, 15")	\$2195
DIABLO P38 (400cps, 15")	\$1699
GEMINI 10X (120cps, 10")	\$279
GEMINI 15X (120cps, 15")	\$429
DATA PRODUCTS 8000 SERIES (dot matrix, LQ)	CALL
TOSHIBA P1340 (LQ dot matrix, 10")	\$799
TOSHIBA P1351 (LQ dot matrix, 15")	\$1399
TI-855 (LQ dot matrix w/font cart)	\$799
EPSON LQ-1500 (LQ dot matrix) complete	\$1299
DIABLO 630API (40cps LQ)	\$1699
DIABLO 630ECS (192 chars on wheel)	\$1999
NEC 2050 (Durable, low cost LQ)	\$865
NEC 3550 (33cps LQ)	\$1595
NEC 7730 (55cps LQ)	\$1999
C.I.TOH STARWRITER (40cps LQ)	\$1025
C.I.TOH PRINTMASTER (55cps LQ)	\$1425
QUIME SPRINT 1140 (40cps LQ)	\$1395
QUIME SPRINT 1155 (55cps LQ)	\$1595
BROTHER HR-25 (20cps LQ, 15")	\$699
DYNAX DX-15 (17cps, LQ, 10")	\$449

## Hard Disk Drives:

SYSGEN 10MB HARD DISK (w/streamer)	\$2399
SYSGEN 20MB HARD DISK (w/streamer)	\$2899
SYSGEN IMAGE (Back-up for XT)	\$849
TECMAR 10 + 5.15 + 5.33 + 5MB exp chassis)	from \$2699
PEACHTREE PERIPHERALS 10MB internal hard disk	\$1099
DAVONG 10, 20, 30, 40MB	from \$1599
INFAX removable 10 & 20 MB flexible media drives	CALL

## Multifunction Boards:

ORCHID BLOSSOM (64-384K S.P.C.C, opt PC Net)	from \$269
AST 6-PAK (64-384K S.P.C.C, opt G)	\$279/524
AST MEGA+ (64-512K*, S.C.C, opt S.P.G)	from \$269
AST I/O PLUS (S.C.C, opt S.P.G)	from \$139
EXPANDED QUADBOARD (64K-384K S.P.G.C.C)	\$279/524
TECMAR CAPTAIN (64-384K S.P.C.C)	from \$269
BABY BLUE II (64-256K, Z80B, 2S, P.C.C)	from \$499
PERSYST Time Spectrum (64-384K S.P.C.C, 2 yr. wrty)	\$269

## Modems:

HAYES 300 baud external	\$209
HAYES 1200 (300 or 1200 baud ext)	\$489
HAYES 1200B (300 or 1200 baud int w/soft)	\$419
HAYES Compatibles	CALL

## Display Cards:

EVEREX GRAPHIC EDGE (132 Mono, color, ports & more)	\$399
TSENG UltraFAK (132 mono, S. P. C.C, opt RAM, FDC, color)	\$419
NEW PARADISE CARD (mono, color, more!)	CALL
PERSYST BoB (finally clear text on a color monitor)	CALL
STB GRAPHIC PLUS II (Mono, color, par)	\$389
PROFIT MULTIGRAPH (Mono, color, opt par)	\$379
TECMAR GRAPHICS MASTER (640x400 + mono)	\$485
QUAD COLOF I and II (Color, hires opt)ea	\$219
PARADISE (Ivono, color, par)	\$399
HERCULES COLOR CARD (New from old faithful)	CALL
AST MonoGraphPlus (New from AST)	\$399
PLANTRONICS Colorplus (Hires w/color magic)	\$379

## Monitors:

AMDEK'S NEW SERIES 500,600,700 (New case, better res)	CALL
AMDEK 300 A and G (Amber or Green)	\$149/\$139
AMDEK 310A (Amber, dark non-glare tube)	\$179
PGS SR-12 (€90x480 non-interlaced)	\$599
PGS HX-12 (€90x480 interlaced)	\$479
PGS MAX-12 (720x350 mono)	\$189
TAXAN RGBv sion (Hi/res color monitors)	BEST PRICE

## Chips (Always in stock):

64K RAM CHIP MEMORY UPGRADE (set of 9) **\$49**  
 full 90 day warranty  
**WE ARE CHIP BROKERS, ASK FOR QUANTITY PRICES**

## Networks:

ORCHID PC NET PLUS NODE CARDS	BEST PRICES-CALL
OTHER BRAND NAMES AVAILABLE	BEST PRICES-CALL

## Miscellaneous:

INTEL 8087 COPROCESSOR (High speed math)	\$179
ISOBAR SURGE PROTECTORS (4 & 8 plug)	\$59/\$79
KEYTRONIC 5151 KEYBOARD (Sep. cursor keys)	\$199
IRMA by DCA (3278 Terminal Emulation)	\$949
IRMLINE (Remote Emulation)	CALL
MOUSE SYSTEMS (Optical mouse, runs LOTUS)	\$159
POWER BACK-UP (200 & 425 watts)	\$269/\$499
ORCHID PC TURBO (80186 coprocessor-runs at 8MHz)	CALL
MICROFAZER (8-128K print buffer)	from \$139
BRET SALTER'S new debug board w/software	CALL

## Software:

SYMPHONY (New from LOTUS)	BEST PRICE
FRAMEWORK (New from ASHTON-TATE)	CALL
MULTIMATE (Emulates WANG dedicated WP)	\$289
SAMNA ("Ult-a-WANG")	BEST PRICE
WORDSTAR PRO-PAK (New version)	\$289
PFS Write, Report, File and Graph	each \$99
OPEN ACCESS (Proven Integrated Package)	CALL
dBASE II & III (From Ashton-Tate)	\$299
KNOWLEDGEMAN (Version 1.06)	\$299*
RBASE 4000 & 6000 (Enhance them w/CLOUD)	from \$329*
POWER BASE (Relational, hierarchical)	\$379*
CIP (New anc fantastic!)	CALL*
DAYFLOW (New type of database)	CALL*
LATTICE C COMPILER (Version 2.1)	\$289

DIGITAL RESEARCH (All products)	CALL
MICROSOFT (All products)	CALL
DOW JONES (All products)	CALL
IUS A.R. A.P.G.L.	\$299
FINANCIER II	\$119
DECISION RESOURCES CHART MASTER	\$259
BPS BUSINESS GRAPHICS	\$259
Z-SOFT PC PAINTBRUSH w/FRIEZE GRAPHICS	\$99
PROKEY VERSION 3.0	\$95
SET-FX for your EPSON	\$45
NORTON UTILITIES	\$59
COPY II PC by CENTRAL POINT	\$35
COPYWRITE (Copies all IBM software)	\$45

COMPUERVE STARTER KIT	\$35
SIDEWAYS by FUNK SOFTWARE	\$49
HAYES SMART COM II	\$89
CROSSTALK XVI by MICROSTUF	\$109
NEW MACINTOSH PRODUCTS	CALL

## NEW IBM PRICES!!

IBM PC w/64K, 1 360K drive, controller	\$1650
IBM PC w/256K, 2 360K drives, controller	\$1995
IBM PC w/256K, 2 360K drives, controller, Monochrome/Printer adapter, Amdek 310A	\$2395
IBM PC w/256K, 2 360K drives, controller, Color/Graphics adapter, PGS HX-12	\$2695
IBM PC w/256K, 2 1/2 ht. 360K drives, controller, Peachtree Peripherals 10MB hard disk	\$2995

(These systems are brand new, fully tested and burned in, fully warranted for 90 days AND ARE ALWAYS IN STOCK!)

# PROGRESSIVE MICRO DISTRIBUTORS

"IBM PC System Enhancement Is Our Business ... Personal Service Is Our Commitment."

## FOR ORDERS ONLY

**1-800-446-7995**

for further information and technical support

**1-404-446-7995**

HOURS: 9AM to 9PM EST

(Sat/Sun-10AM to 4PM EST)

7000 Peachtree Industrial Blvd.

Norcross, Georgia 30071

All prices are subject to change

IBM is a registered trademark of International Business Machines.

\*New dBASE alternatives



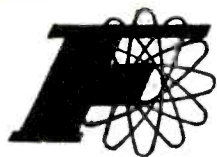

# FORTRON CORPORATION

## Quality at Low Cost

Designed for

**UPGRADE IBM®  
PC to PCXT**

### 140 Watts Switching Power Supply

Model: FC 135-40



#### Full Replacement

Same Dimension, same power connector, same pin out to regular pc power supply.

#### 4 Disk Drives Connectors

Capable of handling 4 Drives.  
Hard or Floppy.

#### Built-In "ROTRON" Cooling Fan

High CFM, Low Noise, Reliable.

Ideal for

- Development Labs
- Industrial Application
- OEM Manufacturers

**Worldwide  
Representatives  
Wanted!**

\*Do not be fooled by identical outlooking, there is a BIG difference inside, between FC135-40 and other imported brands on the market surface:

Features:	FC 135-40	Imported Product on Market
•POWER	140 WATTS	130 WATTS
•EFFICIENCY	70-75%	60-65%
•COOLING FAN	Built in "Rotron" Fan, High CFM, Low noise, Reliable	Use FAR EAST made Fan. Low CFM, High noise
•WARRANTY	One Year	None-90 days
—	Assembled Tested in USA	Made in FAR EAST

ONLY  
**\$189.00**

[Quantity discount available]

—ORDER TOLL FREE—

**(800) 821-9771**

[Outside Calif.]

Tel. [415] 490-8171

TLX=559291 Fortron UD

**3797 YALE WAY  
FREMONT, CA 94538**







-  File #E82453
- European Safety Design
- 115 V/230 VAC Input Dual Selectable
- Assembled, Fully Tested in USA
- One year Warranty

Terms:

Shipping immediately from stock usually. Minimum \$5.00 shipping & handling. Personal check ship two weeks later. 6.5% sales tax for CA residents.

\*Also carry: Hundreds of standard models power switches from 30 watts to 300 watts, single output-multiple outputs.

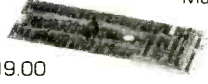
### Dealer & OEM Manufacturers Quantity Discounts Available

<p>FC-427  <b>KEYBOARD</b> \$129.00</p> <ul style="list-style-type: none"> <li>• 100% IBM® PC Plug-in Compatible</li> <li>• Use High Quality TS-M0001 Switch, Life Time 20 Million Cycles</li> <li>• High performance, High reliability</li> </ul>	<b>I.C.</b>																																																																																																																															
<p>HSC130-40  130 W. Switching Power Supply \$179.00</p> <ul style="list-style-type: none"> <li>• To Build an IBM PCXT Compatible</li> <li>• Power Switch on Back Side Position</li> <li>• Fit Cabinet FC-630</li> </ul>	<p>FC-330  Hard Disk Card \$299.00</p> <p>IBM PCXT Compatible</p>	<table border="1"> <tr><td>MC1488</td><td>0.29</td><td>7406</td><td>0.49</td><td>74LS155</td><td>0.95</td></tr> <tr><td></td><td></td><td>7407</td><td>0.49</td><td>74LS161</td><td>0.49</td></tr> <tr><td></td><td></td><td>74LS00</td><td>0.39</td><td>74LS165</td><td>0.95</td></tr> <tr><td></td><td></td><td>74LS02</td><td>0.39</td><td>74LS175</td><td>1.20</td></tr> <tr><td></td><td></td><td>74LS04</td><td>0.49</td><td>74LS191</td><td>0.95</td></tr> <tr><td></td><td></td><td>74LS05</td><td>0.39</td><td>74LS244</td><td>1.20</td></tr> <tr><td></td><td></td><td>74LS08</td><td>0.49</td><td>74LS245</td><td>1.20</td></tr> <tr><td></td><td></td><td>74LS09</td><td>0.39</td><td>74LS251</td><td>1.50</td></tr> <tr><td></td><td></td><td>74LS10</td><td>0.39</td><td>74LS257</td><td>0.50</td></tr> <tr><td></td><td></td><td>74LS12</td><td>0.39</td><td>74LS283</td><td>0.50</td></tr> <tr><td></td><td></td><td>74LS20</td><td>0.39</td><td>74LS375</td><td>1.20</td></tr> <tr><td></td><td></td><td>74LS51</td><td>0.49</td><td>74LS670</td><td>1.50</td></tr> <tr><td></td><td></td><td>74LS74</td><td>0.70</td><td>74S74</td><td>1.20</td></tr> <tr><td></td><td></td><td>74LS86</td><td>0.49</td><td>74S280</td><td>4.00</td></tr> <tr><td></td><td></td><td>74LS90</td><td>0.39</td><td></td><td></td></tr> <tr><td></td><td></td><td>74LS107</td><td>0.39</td><td></td><td></td></tr> <tr><td></td><td></td><td>74LS123</td><td>0.49</td><td></td><td></td></tr> <tr><td></td><td></td><td>74LS125</td><td>0.79</td><td></td><td></td></tr> <tr><td></td><td></td><td>74LS132</td><td>0.89</td><td></td><td></td></tr> <tr><td></td><td></td><td>74LS138</td><td>0.69</td><td></td><td></td></tr> <tr><td></td><td></td><td>74LS139</td><td>0.69</td><td></td><td></td></tr> </table>	MC1488	0.29	7406	0.49	74LS155	0.95			7407	0.49	74LS161	0.49			74LS00	0.39	74LS165	0.95			74LS02	0.39	74LS175	1.20			74LS04	0.49	74LS191	0.95			74LS05	0.39	74LS244	1.20			74LS08	0.49	74LS245	1.20			74LS09	0.39	74LS251	1.50			74LS10	0.39	74LS257	0.50			74LS12	0.39	74LS283	0.50			74LS20	0.39	74LS375	1.20			74LS51	0.49	74LS670	1.50			74LS74	0.70	74S74	1.20			74LS86	0.49	74S280	4.00			74LS90	0.39					74LS107	0.39					74LS123	0.49					74LS125	0.79					74LS132	0.89					74LS138	0.69					74LS139	0.69		
MC1488	0.29	7406	0.49	74LS155	0.95																																																																																																																											
		7407	0.49	74LS161	0.49																																																																																																																											
		74LS00	0.39	74LS165	0.95																																																																																																																											
		74LS02	0.39	74LS175	1.20																																																																																																																											
		74LS04	0.49	74LS191	0.95																																																																																																																											
		74LS05	0.39	74LS244	1.20																																																																																																																											
		74LS08	0.49	74LS245	1.20																																																																																																																											
		74LS09	0.39	74LS251	1.50																																																																																																																											
		74LS10	0.39	74LS257	0.50																																																																																																																											
		74LS12	0.39	74LS283	0.50																																																																																																																											
		74LS20	0.39	74LS375	1.20																																																																																																																											
		74LS51	0.49	74LS670	1.50																																																																																																																											
		74LS74	0.70	74S74	1.20																																																																																																																											
		74LS86	0.49	74S280	4.00																																																																																																																											
		74LS90	0.39																																																																																																																													
		74LS107	0.39																																																																																																																													
		74LS123	0.49																																																																																																																													
		74LS125	0.79																																																																																																																													
		74LS132	0.89																																																																																																																													
		74LS138	0.69																																																																																																																													
		74LS139	0.69																																																																																																																													
<p>FC-630  <b>CABINET</b> \$99.00</p> <ul style="list-style-type: none"> <li>• Comes with two different slots, panels, accepts CPU BOARDS with 0.75" or 1" apart slot connectors.</li> <li>• Use Power Supply HSC130-40.</li> <li>• Back Side Power Switch Position</li> </ul>	<p>FC-530  Monochrome Card \$219.00</p> <p>IBM PCXT Compatible</p>	<p>MC1489 0.29</p> <p>8086 9.00</p> <p>8284A 4.50</p> <p>8237A-5 7.50</p> <p>8284C 1.50</p> <p>8275 15.00</p> <p>↑ Prices for Min. Order 100 pcs</p> <p>Single Unit Prices →</p>																																																																																																																														
<p>FC-630 A-2  <b>CABINET</b> \$99.00</p> <ul style="list-style-type: none"> <li>• IBM Type Right Side Power Switch Position</li> <li>• Comes with different slot panel, accepts CPU Board with 0.75" or 1" apart slot connectors</li> <li>• Use Power Supply FC135-40</li> </ul>	<p>FC-230  Floppy Drive Control Card \$139.00</p> <p>IBM PC Compatible</p>	<p>64K DRAM 41.00/9 pcs</p> <p>2764 250 ns 5.25/pcs</p>																																																																																																																														

IBM® PC, PCXT are trademarks of IBM Corp.

# Lycy Computer Marketing & Consultants

TO ORDER  
CALL US

TOLL FREE 800-233-8760  
In PA 1 717-327-1824

## MANNESMANN TALLY

SPIRIT 80	\$299.00
MTL-160L	\$559.00
MTL-180L	\$775.00

## NEC

NEC8023	\$369.00
NEC8025	\$699.00

## PRINTER INTERFACING

AVAILABLE FOR COMMODORE  
VIC. APPLE. ATARI. IBM-PC.  
TRS 80, TI, AND OTHERS

## BLUE CHIP

M12010	\$279.00
M12010 C-64	\$279.00
D4015	\$1399.00

## CARDCO

LQ1	\$449.00
LQ2	\$279.00
LQ3	\$339.00
PRINTER INTERFACE	\$39.75
PRINTER INTERFACE WITH FULL GRAPHICS	\$65.75
LIGHT PEN	\$29.75
5 Slot Expansion 64	\$54.00
64 Write NOW	\$39.00
64 Mail NOW	\$29.00
2J Write NOW	\$29.00
64 Keypad	\$29.00
Universal Cass. Int.	\$29.75
Printer Utility	\$19.75
6 Slot Expansion	\$79.95
3 Slot Expansion	\$24.95

## PRINTING PAPER

3000 SHEETS FANFOLD	\$42.75
1000 SHEETS FANFOLD	\$19.75
1000 SHEETS LETTER	\$21.95
200 SHEETS LETTER	\$8.99
150 RAG STATIONERY	\$10.99
MAILING LABELS (1 in)	\$9.75
14x11 1000 FANFOLD	\$24.75

## MODEMS

ANCHOR MARK I	\$45.75
ANCHOR MARK II	\$45.95
HAYES SMART	\$239.00
HAYES MICRO II	\$309.00
MICROBIT 1000C	\$129.00
CAT	\$144.00
D-CAT	\$155.00
J-CAT	\$115.00
APPLE CAT II	\$279.00
212 APPLE CAT	\$589.00

## Mitey Mo's

MITEY MO	\$79.95
----------	---------

## STAR MICRONICS

GEMINI 15X	\$379.00
DELTA 10	\$449.00
DELTA 15	\$525.00
RADIX 10	\$575.00
RADIX 15	\$675.00
POWERTYPE	SCALL
SWEETP (Model 100)	\$549.00
STX80	\$149.00

**GEMINI 10X \$259.00**



# SAVE ON THESE IN-STOCK PRINTERS

## CITOH

GORILLA GX-100	\$169.00
GORILLA SERIAL	\$199.00
PROWRITER 8510	\$335.00
PROWRITER II	\$575.00
8600	\$899.00
STARWRITER	\$929.00
PRINTMASTER	\$1199.00
SHEET FEEDER	\$425.00
620	\$929.00
630	\$1699.00
8510 SP	\$499.00
#510 SCP	\$559.00
A10 LETTER QUAL	\$499.00

## EPSON

RX-80	\$269.00
RX-80FT	\$299.00
FX-80	\$439.00
FX-100	\$639.00

## OKIDATA

80	\$199.00
82A	\$299.00
83A	\$569.00
84	\$959.00
92	\$409.00

## LEGEND

880	\$259.00
1000	\$279.00
1200	CALL
1500	CALL
1018	CALL

## PANASONIC

1090	\$279.00
1091	\$309.00
1092	\$459.00

## OVER 2000 SOFTWARE TITLES IN STOCK

CATALOG AVAILABLE

## HARD DISK DRIVES

-FOR-

### IBM, APPLE, TRS80

10 MEG	\$975.00
20 MEG	\$1399.00
30 MEG	CALL

\* D.O.S. EXTRA



## DISKETTES

### ELEPHANT

5 1/4" SSSD	\$16.75
5 1/4" SSDD	\$19.95
5 1/4" DSDD	\$25.95

### MAXELL

5 1/4" MD-1	\$24.75
5 1/4" MD-2	\$34.75

### CERTRON CASSETTES

CC-10 (12)	\$15.99
CC-20 (12)	\$17.99

## AMDEK

VIDEO 300	\$139.00
VIDEO 300A	\$149.00
COLOR 1+	\$269.00
COLOR 11+	\$399.00

## GORILLA

12" GREEN	\$82.00
12" AMBER	\$89.00

## NEC

JB1260 GREEN	\$99.00
JB1201 GREEN	\$145.00
JB1205 AMBER	\$145.00
JC1215 COLOR	\$269.00
JC1216	\$399.00

## SAKATA

SC100 COLOR	\$229.00
SG1000 GREEN	\$99.00
SA AMBER	\$109.00

## MONITORS

### TAXAN

100 GREEN	\$115.00
105 AMBER	\$125.00
210 RGB COMPOSITE	\$269.00
400 RGB MEDRES	\$295.00
410 RGB HI RES	\$349.00
420 RGB HI RES (IBM)	\$475.00
121 GREEN	\$145.00
122 AMBER	\$149.00

### ZENITH

ZVM 122A AMBER	\$95.00
ZVM 123G GREEN	\$85.00
ZUM 124IBM-PC	\$129.00
ZUM COLOR	\$275.00
ZUM 133 RGB	\$389.00
ZUM 135 RGB	\$449.00
ZUM 136	\$589.00

## PERCOM

AT88S1	\$249.00
AT88S1 PD	\$299.00

ADD-ON DRIVES ..... CALL  
AT 88 DOUBLER ..... \$119.00

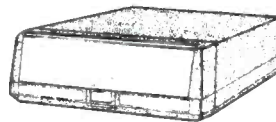

## INNOVATIVE CONCEPTS

FLIP-N-FILE 10	\$3.75
FLIP-N-FILE 15	\$8.95
FLIP-N-FILE 25	\$18.95
FLIP-N-FILE 50	\$17.75
FLIP-N-FILE (Rom Holder)	\$17.75

## DISK DRIVES

RANA 1000 .... \$299  
INDUS GT. .... \$325

## CONCORD

ATARI 176K MASTER	\$289.00
ATARI 348K MASTER	\$369.00
ATARI ADD-ON DRIVES	SCALL

## TRACK DRIVES

AT-D2	\$329.00
AT-D2 TURBO PAK	\$22.95
AT-DH	CALL
PRINTER CABLE	\$22.95



TO ORDER



Circle 208 on inquiry card.

POLICY

CALL TOLL FREE

**800-233-8760**

or send order to  
Lycy Computer  
P.O. Box 5088

Risk Free - No deposit on C.O.D. orders. Free shipping on prepaid cash orders within the continental U.S. APO and FPO, order add \$5.00 plus 3% for priority mail service. PA residents add sales tax. Advertized prices show 4% discount offered for cash. Add 4% for Master Card or Visa.

Customer Service 1-717-327-1825 Jersey Shore PA 17740



## ZENTH/Heath Users

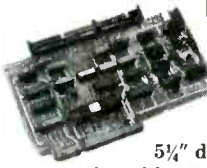

**Double Your  
5 1/4" disk storage  
capacity without adding a drive.**

Get twice as much from your H88 or H89 microcomputer. Our FDC-880H floppy disk controller, in conjunction with your 5 1/4" drives, for example, expands memory capacity from 256 bytes to 512 bytes per sector.

And it handles single and double-sided, single and double-density, 8" and 5 1/4" drives — simultaneously.



**C.D.R. Systems Inc.**  
Controlled Data Recording Systems Inc.  
7210 Clairmont Mesa Blvd., San Diego, CA 92111  
(619) 560-1272

Circle 46 on inquiry card.

## HOFACKER

Books • Software • Hardware Add Ons • for your ATARI 600XL/800 XL, Commodore 64, VIC-20, Sinclair, Timex, Apple II, Osborne-O2!

**BOOKS for ATARI 400/600XL/800XL 1200XL**  
ATARI BASIC — Learning by Using  
An excellent book for the beginner. Many short programs and learning exercises. All important features of the ATARI computers are described (screen drawings, special sounds, keys, paddles, joysticks, specialized screen routines, graphics, sound applications, perks, jokes and special stuff!)  
Order No. 154 \$7.95  
Small Business Software for all ATARI computers  
SUPERMALL (500 addresses on 1 disk) Completely written in FORTH. Comes on auto-load disk. No cartridge, no DOS, no FORTH language required!  
Order No. 7312 \$49.00  
SUPERINVENTORY (1000 items & disks) Completely written in FORTH. Same as above (Disk only)  
Order No. 7320 \$49.00  
BUSIPACK 1 (written in FORTH). Complete order entry, inventory, mailing and shipping (Disk only)  
Order No. 7313 \$98.00  
ATCASH  
Convert your ATARI 800 into a powerful cash register. (Disk only)  
Order No. 7303 \$49.95  
Inventory program in BASIC  
Order No. 7201 (IC) \$29.95  
Order No. 7200 (DI) \$39.95  
Mailing List in BASIC  
Order No. 7212 (IC) \$19.95  
Order No. 7213 (DI) \$24.95  
Inventory control in BASIC  
Order No. 7214 (IC) \$19.95  
Order No. 7215 (DI) \$24.95  
Dealer and Distributor inquiries are invited.  
ELCOMP PUBLISHING, INC.  
53 Rowack Lane  
Farmingdale, CA 91768  
Phone: (714) 623-8314, Tlx. 29 81 91

**SOFTWARE IN MACHINE LANGUAGE (FOR ATARI)**  
ATMONA 1  
Machine language monitor. A MUST for those who want to get into 6502 machine language.  
Order No. 7022 ICI \$19.95  
ATMONA 2  
This is a tracer (debugger) that lets you explore the ATARI RAM/RDM area and source code.  
You can stop at previously mislabeled address, observe, or operate. Also very valuable in understanding the microprocessor. At each stop, all registers of the CPU may be changed, includes Altmon 1!  
Order No. 7049 cassette \$49.95  
Order No. 7050 disk \$54.00  
ATMAS  
Macro-Assembler for ATARI 800/48K. One of the most powerful editor/assemblers on the market. Versatile editor with scrolling. Up to 17% of source code. Very fast. Translates 8k source code in about 5 seconds. Source code can be saved on disk or cassette (line Altmon 1).  
Order No. 1099 disk \$89.00  
Order No. 7999 cartridge \$129.00  
ATMS APPLICATION DISK  
All programs and machine language sub-routines from books no. 159 on disk.  
Order No. 7311 \$20.00  
ATAS  
Same as ATMAS but without macro capability (32K and 48K RAM)  
Order No. 7098 \$49.95  
PRINTER INTERFACES  
Construction articles and software. No 320 needed!  
For EPSON printers  
Order No. 7211 \$19.94  
RS232, 300 Baud, 5V  
Order No. 7291 \$19.95  
ATARI is a registered trademark of ATARI INC.  
PAYMENT: Check, VISA, MC, CA Residents add 8.5% sales tax. Outside the US add 16% for shipping.  
In Germany contact: LISA, RS 224M  
In Germany contact: LISA, RS 224M  
In Germany contact: LISA, RS 224M

Circle 127 on inquiry card.

## RS-232 PINS Reversed?



**Model 232D23R**

The RS-232 PIN 2/3 REVERSE allows you to make a quick test to verify this very common problem. Pins 2 and 3 are crossed with all others straight through. One male and one female connector. Order Direct! Only \$24.95. All cash orders postpaid (IL res. add 6% sales tax); we accept MC, Visa. Free: New illustrated catalog of RS-232 interface and testing equipment. Phone: 815-434-0846. Make checks payable to:

**B & B electronics**  
MANUFACTURING COMPANY  
P.O. Box 1008B, OTTAWA, IL 61350

Circle 34 on Inquiry card.

## DISK DRIVES and PERIPHERALS for IBM PC

Teac 55-B	\$125
Tandon T-M 100-2	\$158
Shugart SA455	\$135
Monochrome Board	\$129
Colorgraphic Board	\$139
Verbatim DS DD Diskettes (qty 100 boxes)	\$23.49

THE ABOVE DEALER PRICES ARE QTY 25+  
HARD DISK DRIVES ALSO AVAILABLE  
PLEASE CALL FOR COMPLETE PRICE LIST.  
END USER INQUIRIES ALSO WELCOME.

**PACE SYSTEMS, INC.**  
24 W 500 MAPLE AVE., NAPERVILLE, IL 60540  
(312) 355-9722

Circle 267 on Inquiry card.

## Serial ↔ Parallel

**NEW!**



**Convert What You Have  
To What You Want!**

- RS232 Serial
- 8 Baud Rates
- Latched Outputs
- Centronics Parallel
- Handshake Signals
- Compact 3 1/2" x 4 1/2" x 1 1/2"

No longer will your peripheral choices be limited by the type of port you have available! Our new High Performance 700 Series Converters provide the missing link. Based on the latest in CMOS technology, these units feature full baud rate selection to 19.2K, with handshake signals to maximize transfer efficiency. Detailed documentation allows simplified installation. Order the Model 770 (Ser/Par) or Model 775 (Par/Ser) Today!

Buffer Products  
Coming Soon!

**ligertronics**  
1501-B Pine Street  
Post Office Box 2233  
Oxnard, California 93028

only \$89.95  
Connector Option \$10.00  
CA Residents 5% tax  
UPS Shipping \$3.00

CALL (805) 487-1665 or 487-1666  
For FAST Delivery

Circle 131 on inquiry card.

## ELIMINATE CABLE SWAPPING

at a price NO ONE can beat!



PI-01S Two way	\$ 59.95
PI-03S Three way	\$ 89.95
PI-05S Five way	\$109.95
PI-08S Eight way	\$149.95
PARALLEL TWO WAY	\$ 94.95
Serial CABLE 5ft.	\$ 15.00
Serial CABLE 10ft.	\$ 17.50
Parallel CABLE 5ft.	\$ 27.00

**TRANSFER SWITCH FEATURES**

- PI-SWITCH lets you SAFELY SHARE multiple SERIAL (RS-232) devices.
- Great for printers, modems, etc.
- Handsome black and beige case female DBC-25 connectors
- Switches pins 1-7 & 20 or set any way you need before shipping
- Male connectors available.

**ONE (1) YEAR WARRANTY**

TERMS: M.O., Check, MasterCard, Visa, COD.  
UPS ground \$2/each 2nd air \$4/each COD add \$2 per order.  
Please call for your CUSTOMER switch needs.

**SAB-LINK, Inc.**  
7301 N.W. 41 Street, Miami, FL 33166  
(305) 592-6092  
Dealer inquiries welcome!

Circle 319 on inquiry card.

## The Statistician

CPM IBM-PC  
TRS-DOS XENIX

- Multiple Regression
- Stepwise Ridge
- All Subsets
- Backward Elimination
- Time Series Analysis
- Descriptive Statistics
- Transformations
- Survey Research
- Nonparametrics
- XY Plots
- ANOVA
- Random Samples
- Data Base
- Search & sort
- Hypothesis tests

Please call **TOLL FREE**  
**1-800-334-0854 (Ext. 814)**

**Q** for more information or write:  
Quant Systems  
Box 628  
Charleston, SC 29402  
VISA/MC Accepted

Circle 297 on inquiry card.

## LIONHEART

Get ahead of the competition! You don't need to be a pro to use these professional level book/software packs. Explanatory books, compiled software.

- Experimental Statistics ..... \$100
- Business Statistics ..... \$120
- Linear & Non-linear Programming ..... \$ 75
- Forecasting and Time-Series ..... \$100
- Business and Economic Forecasting ..... \$120
- Optimization ..... \$ 75
- Pert & Critical Path Techniques ..... \$ 75
- Decision Analysis Techniques ..... \$ 75
- Business and Finance Math ..... \$ 50

PC/MS-DOS, CPM, Apple Dos 3.3

VISA, MasterCard, Check

**LIONHEART, PO Box 379,  
Alburl, VT, 05440  
(514) 933-4918**

Circle 201 on inquiry card.

## Scotch® Diskettes

Rely on Scotch® diskettes to keep your valuable data safe. Dependable Scotch diskettes are tested and guaranteed error-free. The low abrasivity saves your read/write heads. They're compatible with most diskette drives.



**(800)235-4137**

**PACIFIC EXCHANGES**  
181 Franklin Blvd.  
San Luis Obispo, CA  
94901 In Cal call  
(805) 522-5455  
(805) 541-1117

Dealer Inquiries Invited

Circle 268 on inquiry card.



# Micro Products

We accept  
Visa, M/C,  
or Pre-pay by Check  
or Money Order. COD's  
are accepted by Telephone  
& Mail. COD Terms are: Cashier's  
Check for first time orders over \$1000.  
**714/898-0840**

## Hot Summer Movers!

**We Cater to IBM™ Users!**  
★ Hardware ★ Software  
★ Training Tapes  
Call for our Catalog now!

### COLOR RGB

Three models of Color to choose from, each with higher and higher resolution.



MON-1600-00 \$345.00

### MONOCHROME

Monochrome Monitor is outstandingly clear and easy on the eyes. Available in Green or Amber. Green Screen MON-1000-00 \$125.00  
Amber Screen MON-1010-00 \$135.00



### XPC-XT / IBM-PC KEYBOARDS

Keyboards with the Touch you have been searching for! (Even nicer than IBM!) L.E.D. indicator for CAPS and NUM Lock. Choose IBM type or Selectric Keyboard layout.  
FREE Extender Cable with each Order.



KEY-1000-00 IBM \$139.00  
KEY-1024-00 Selectric \$195.00

### ADD-ON POWER SUPPLY

Power Supply with Fan and Power Filter. Uses 140 watts, runs Hard Disk & Tape Back-Up.  
IBM Replacement type for Hard Disk.



POW-1040-00 \$175.00

### IBM STYLE MOTHERBOARDS

Two IBM-style Motherboards to choose from, 5-slot and 8-slot. Both expandable to 256K. 5-slot has two serial slots and one parallel.



BOA-6000-00 5-Slot \$395.00

BOA-6050-00 8-Slot \$395.00

### POWER BACK-UP

Protect your Data with Datasheed® in case of a Power failure. Datasheed® is a battery operated, self-contained Power Generator which instantly supplies even uninterrupted AC Power to a Microprocessor in the event of a Power Drop or Outage. In addition provides Surge Protection, which filters and eliminates voltage spikes (surges) above 140 VAC.



PC-200 200 watts POW-2000-00 \$329.00  
PC-300 300 watts POW-2050-00 \$495.00

## Do it Yourself!

Think of this System as a "Do it Yourself" System. Start by choosing or 8 Slots. Some of the standard Features: • 64K RAM expandable to 256K • 4 DMA Channels • Runs MS-DOS™ and CP/M-86™ software (not included) • Multi-function Keyboard & Cable • Hard Disk Ready Power Supply • Serial Ports • Parallel Ports And MORE! SYS-8000-00 Only \$895.00



3M type Case only  
1 Slot CAB-3050-00 \$110.00  
2 Slot CAB-3060-00 \$110.00

### This is our junior!

Use this "Driveless" workstation for low-cost networking. Features: • 4-slot IBM™ compatible Motherboard • 128K Standard Memory • 8088, 8087 Math Coprocessor • Optional Floppy Drive with Controllers. SYS-8100-00 \$475.00  
Full System w/Keyboard, Mono Monitor, Video Display Card, 128K RAM SYS-8725-00 \$895.00

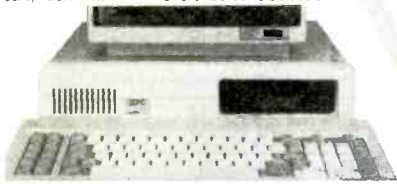

## SAVE \$700.00 XPC-XT by XOR



\$1745.00  
Beat this price!

### Standard Features:

- Operating System Software Rebate Check
- 256K of parity checked RAM on the Motherboard
- 8088 16-bit CPU
- 5 IBM™ compatible expansion Slots
- 4 DMA and 3 Timer channels
- Up to 32K of EPROM (supplied with full 8K)
- DOS BIOS on EPROM
- Power Supply is Hard-Disk-Ready, no need to add-on additional power
- High resolution 12" Monitor with Green Screen and 18MHz bandwidth
- Two Slimline 5 1/4" DS/DD 48 TPI Floppy Drives @ 360K Storage each
- Floppy Disk Controller expansion Card, runs up to four SS or DS Floppies
- Supports PC-DOS™, MS-DOS™, CP/M-86™ Operating Systems
- Full-size Keyboard with 10 Function keys and Calculator-type Numeric Keypad

Complete Serial & Parallel Ports

## Add-On H.D. & Tape



Back-up with this Tape Drive by Irwin is a joy. It will back-up a 10 Meg in as little as 8 minutes and it only needs 14 watts of power. A nice addition to your XT for only \$495.00, and only \$395.00 if you buy a Hard Disk Add-on from us. If you have an IBM PC you'll have to get an Add-On Power Supply to run a Hard Disk. DRI-8100-00 \$495.00  
Tape Cart. CRT-1000-00-2800 \$ 95.00

### Hard Disk Add-On Complete Packages

Adding a Hard Disk to complete your system is a "must." These Packages include: • BIOS Software • 5 1/4" Winchester Hard Disk Mounting Hardware • Interface PCB for Expansion Slot • • • and all the necessary power and data Cables (the Power Supply in the XPC-XT, of course, is Hard Disk Ready).

<b>10 Megabyte</b> \$795 int / \$995 ext	<b>65 Megabyte</b> \$2495
<b>20 Megabyte</b> \$1095 int / \$1295 ext	<b>105 Megabyte</b> \$3295
<b>40 Megabyte</b> \$1595 int / \$1795 ext	<b>140 Megabyte</b> \$4195

## Not enough room here - Call for Catalog

### MITS MultiMedia Interactive Training Systems

### INTERACTIVE Video or Audio Tape Training! That's Right!

Learn at home - at your own pace -

Lotus 1-2-3™ Framework™ WordStar™  
IBM-PC DOS™ dBase II™ Symphony™  
SuperCalc™ BusinessMaster™

At last! An inexpensive, convenient means of learning how to use a Computer and Software. With this System you sit comfortably in front of your Computer, watch a demonstration, and then, the Tape system (Audio or Video) actually INTERACTS with you! Telling you what keys to strike, waiting for you to do the exercises at your own rate. As much practice time as You want. A pace that you set. Some classes 10 hours in length! Fantastic detail and tips! Call us for more information and practical demonstrations. Nothing like it anywhere else!

The following are registered Trademarks and their Companies: 1-2-3, Symphony - Lotus Development Company, MS-DOS, PC-DOS, Flight Simulator - MicroSoft, dBase II - Ashton-Tate, WordStar - MicroPro International Corp., SuperCalc - Sorcim, Inc., VisiCalc - VisiCorp, Inc., CP/M-86 - Digital Research Inc., IBM, IBM-PC, IBM-PC XT - International Business Machines.

### PROM LASER

This is the One! Our PROM Burner allows reading, storing-to-disk, recalling, and burning. Hi-speed algorithms burns 2764 in 45 seconds! Also handles 2716, 2732, 27128, 27256. Features: Zero insertion force sockets; On-board Voltage Generator; No interference with normal computer operations. BOA-8640-00 \$249.00

### 300 / 1200 BAUD MODEM

Does your computer communicate? If not, get one of ours - it's by *Quibie*! This little jewel mounts in the Short-Slot in your PC. Includes: Phone jack cables, PC Talk III Software, One Year parts and labor warranty, and a manual. BOA-8725-00 \$310.00

Optional Async Com Port circuitry and connector BOA-8726-00 \$ 20.00

### ADD-ON MEMORY

This single Card will enable you to expand the smallest 64K PC to its full \* 640K limits in increments of 64K. Includes RAM Disk and PrintSpool software and runs DOS 1.1 and 2.0 with no wait states. BOA-8650-00 \$265.00



\* Additional \* 64K Memory Chips  
ICC-7801-00 \$ 75.00

### SUPER 12 PAK MULTI-FUNCTION

This one is loaded! Two (2) IBM™ compatible Joystick Ports, Real-Time Chronograph / Calendar with Battery Back-up, Parallel Port, RS232-C Serial Port, \* 64K to 384K of Parity-checked Memory, PrintSpool and RAM Disk Software. Supplied with OK of Memory. BOA-8680-00 \$225.00

\* Additional 64K Memory Chips  
ICC-7801-00 \$ 75.00

### COLOR / MONOCHROME GRAPHICS

A Color Graphics Card with smooth scrolling display - No Flicker! Includes Light Pen Interface, PrintSpooler, and RAM Disk Emulator. BOA-8400-00 \$289.00  
This Monochrome Graphics Card is 100% compatible with Lotus 1-2-3. Features bit-mapped graphics with a resolution of 720H x 348V and Simultaneous display of Text AND Graphics. BOA-8500-00 \$245.00

### SERIAL SWITCHER I/O BOX

Expand your System with this low-cost A-B Serial Switcher Box. It allows you to connect Two Printers to One Port or Two Computers to One Printer. Switch from Dot Matrix to Daisy Wheel with the push of a button.



ACC-2000-00 \$79.95



## IBM PC/XT COMPATIBLE

Prices for dealers in quantities of 10 or more.  
End users inquiries are also welcomed.

PC/XT Bare Board (8 slot/ 8 ROM design).....	\$ 55.00
128K Assembled and Tested CPU Board.....	\$375.00
4-Floppy Disk Controller w/Serial. Parallel Game Ports, & Cables.....	\$195.00
Shugart SA455 360KB Floppy Disk.....	\$110.00
Teac FD-55B 360KB Floppy Disk.....	\$115.00
Tandon TM100-2 360KB Floppy Disk.....	\$140.00
DTC Hard Disk Controller 5150BX w/Cables.....	\$240.00
Shugart SA712 10MB Hard Disk.....	\$450.00
MiniScribe 2012 10MB Hard Disk.....	\$470.00
MicroScience HH-612 10MB Hard Disk.....	\$450.00
AST 6-PAK Compatible Board.....	\$160.00
Hercules Compatible Graphic Board.....	\$175.00
Color Graphic Board.....	\$150.00
2-Floppy Disk Controller w/Cable.....	\$ 95.00
Computer Case (5 or 8 slots).....	\$ 90.00
Key Tronic Keyboard 5150.....	\$105.00
Key Tronic Keyboard 5151.....	\$180.00
XT 100W Power Supply w/Fan.....	\$110.00
XT 130W Power Supply w/Fan.....	\$130.00
Monochrome Monitor.....	\$115.00

**ELECTRADE CO.**  
780 Trimble Rd., Suite 605  
San Jose, CA 95131  
(408) 946-2541

Circle 128 on inquiry card.

## Maxell Floppy Disks

The Mini-Disks  
with maximum quality.



Dealer inquiries  
invited. C.O.D.'s  
accepted. Call  
FREE (800) 235-4137.

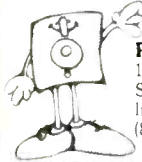

**PACIFIC EXCHANGES**  
100 Foothill Blvd., San Luis  
San Luis Obispo, CA 93401  
In Cal. call (800) 592-5935 or  
(805) 543-1037

Circle 268 on inquiry card.

## SUPER FAST!

### Z80 DISASSEMBLER

- Two pass operation - generates labels at referenced locations.
- Generates Zilog mnemonics.
- Allows user defined labels.
- Allows define byte, define word and define space directives.
- COMPLETE cross-reference
- Output to console, list or disk device(s) in any combination.
- Generates mnemonics for CP/M system calls.
- Start and stop at any location in file.
- Source or complete listing type output.

Most formats available  
for Z80 CP/M, CDOS,  
and TURBODOS.

**\$6995**

**S L R Systems**

For more information or to order call.  
**1-800-833-3061**  
In PA. (412) 282-0864  
1622 North Main Street, Butler, PA 16001

Circle 329 on inquiry card.

**Marymac**  
INDUSTRIES

**mi MARYMAC**  
INDUSTRIES INC.

800-231-3680

800-231-3680

### Radio Shack TRS-80's Epson Printers

People you Trust to give you the very best!



- Lowest Price
- Reliable Service
- Quality Products

22511 Katy Fwy., Katy (Houston) Texas 77450  
(713) 392-0747 Telex 774132

Circle 214 on inquiry card.

### APPLE Compatible Disk Drives

DISK DRIVES WEST of California has purchased a large quantity of 100 % Apple compatible half height floppy disk drives and is offering them to the public at UNBELIEVABLY LOW PRICES!

- High quality 100% Apple compatible
- 100 % tested before shipment
- Includes cable and enclosure
- Ready to plug in and use
- 30 day return or replacement policy

**\$119.00**

**- BRAND NEW - NO SECONDS -  
NAME BRAND MANUFACTURER**

DISK DRIVES WEST  
14252 Culver Drive, Suite A  
Irvine, CA 92714 (714) 660-7030

TERMS: MC, VISA, Prepaid (no personal checks) or C.O.D.  
certified check. Add \$3.50 for postage and handling.  
California residents add sales tax.

IBM 1/2 High Compatibles -- DSD -- also  
available -- \$ 149.00 + P&H

Circle 228 on inquiry card.

### DATA ACQUISITION and control for ANY computer

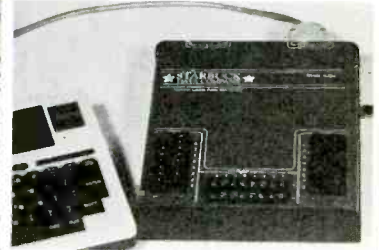

The Model 8232 communicates via RS-232, and has 8 analog inputs (0-5 VDC; 8 bits), 8 digital inputs and outputs, and a 2000 point buffer. Suitable for field data logging or lab use, the 8232 costs only \$540. Direct bus-connect unit for TRS-80/III & 4 is \$295. Detailed manual, \$6. Phone our applications engineer or write:

★★ **STARBUCK** ★★  
DATA COMPANY

225 Crescent St., Waltham, MA 02154 • (617) 899-8629

Circle 341 on inquiry card.

## PROGRAMMABLE COMMUNICATIONS TRANSLATOR

THE PCT-100 IS A CONFIGURABLE IN-LINE RS-232 PROTOCOL AND DATA TRANSLATOR. THE PCT-100 CAN PROVIDE:

- \* TERMINAL OR PRINTER EMULATION
- \* DEC OR IBM SYSTEM COMPATIBILITY
- \* MACRO-FUNCTION KEYS
- \* "TYPE-AHEAD" AND DATA BUFFERING
- \* BAUD RATE CONVERSION
- \* HANDSHAKE PROTOCOL TRANSLATION (E.G. CTS/RTS, XON/XOFF)

THE PCT-100 IS CONFIGURED USING A BUILT-IN COMMUNICATIONS TRANSLATION LANGUAGE. PROGRAMS CAN BE EASILY ENTERED & EDITED FROM ANY ASCII DEVICE.

PCT-100-PCB (PCB ONLY).....\$ 359  
PCT-100-ASM (PCB w/ CASE)....\$ 433  
PCT-512-MOD (POWER SUPPLY)....\$ 62

*MSI*

METHOD SYSTEMS INCORPORATED  
3511 LOST NATION RD. STE 202  
WILLOUGHBY, OHIO 44094  
(216) 942-2100

Circle 221 on inquiry card.

## Logic Simulation System

Type: 4 state unit delay  
(1,0,unknown,hi-z)

Input: ASCII files or keyboard entry  
User defined macros  
Circuit description  
Named nodes  
Signal sources, patterns  
Full editing

Output: Timing diagram (screen/printer)  
Loading report (fanout)  
Circuit listings

For MS-DOS, CP/M  
Price \$175

**Tatum Labs**  
P.O. Box 698  
Sandy Hook, CT 06482  
(203) 426-2184

Circle 352 on inquiry card.

## NEW Monitor Mover Gives Back the Desk



**\$149.95**

- Models to fit most CRT's
- Rotates 360° on base
- Adjustable height
- Support tray swivels and tilts
- Holds up to 50 lbs
- Clamp, screw and wall mountings

**Lintek**

P.O. Box 8056  
Grand Rapids, MI 49508  
(616) 241-4040

Circle 200 on inquiry card.

# OKTOBERFEST SALE LOWEST PRICES IN BYTE

**COMPUTER CONNECTION**  
**TOLL FREE ORDER LINE**

## PRINTERS

<b>OKIDATA</b>	
ML82A, 10" Para. & Ser.	\$ 289
ML83A, 15" Para. & Ser.	545
ML92P, 160 cps	419
ML92 IBM Graphics Comp.	439
ML92S, 160 cps	499
ML92 Apple Mac. 2K Graphics	Call
ML93P, 160 cps	629
ML93 IBM Graphics Comp.	649
ML93S, 160 cps	769
ML84P, 200 cps	799
ML84S, 200 cps	899

<b>RITEMAN</b>	
Riteman Plus 120 cps w/Tractor	\$ 257
Riteman Blue Plus 140 cps IBM	342
Riteman II 160 cps, 8K mem. w/Trac.	369
Riteman 15, 160 cps, 15" carr.	549

<b>QUME</b>	
Letterpro 20P Prop. Spc. Enh Print	\$ 567
Sprint 1140+, 2K, 40 cps, 132 col. width	1299

<b>STAR MICRONICS</b>	
Gemini 10X, 10", 120 cps	\$ 265
Gemini 15X, 15", 120 cps	367
Delta 10, 10", 160 cps	399

<b>EPSON</b>	
RX80, 120 cps	\$ 289
RX80FT, Friction & Tractor	319
FX80, 10" 160 cps	447
MX100, 15" Carriage	469
FX100, 160 cps	667
LQ 1500	Call

<b>C. ITOH</b>	
Prowriter 8510 AP, 120 cps	\$ 318
Prowriter 8510 BC2, 120 cps	429
Prowriter 8510 SP, 180 cps	455
Prowriter II 1550 P, 15" 120 cps	527
Prowriter II 1550BCD, 15" 120 cps	557
Starwriter F10-40PU, 40 cps	949
Starwriter A10, 18 cps	479
Printmaster F10-55PU, 55 cps	1199

<b>BROTHER</b>	
HR15	\$ 459
HR25	769

<b>DYNAX</b>	
DX15 By Brother, Same as HR15	\$ 379

<b>JUKI</b>	
6100, L.Q. 18 cps w/proportional spc.	\$ 439

<b>TOSHIBA</b>	
P1351 Dot Matrix, 192 cps, letter quality 100 cps, does graphics. 3 in 1 printer	\$1345
P1340 same as above but 10" carr.	757

<b>MANNESMANN-TALLY</b>	
160L, 160 cps	\$ 559
180L, 180 cps	777

<b>PANASONIC</b>	
1091 w/Tractor, 120 cps, 1 yr. war.	\$ 339

## SOFTWARE

<b>LOTUS DEVELOPMENT CORP.</b>	
Lotus 1-23	\$ 295
Symphony	437

<b>ASHTON TATE</b>	
D Base II	\$ 329
D Base III	419

<b>MICROPRO INTERNATIONAL</b>	
ProPak (WS/MM/SS/Star Index)	\$ 399
Option Pak (M/M, C/S, S/I)	199

<b>MICROIM</b>	
R.Base Series 4000	\$ 289

<b>MICROSOFT</b>	
Softcard (CP/M)	\$ 239
Microsoft Word	315

## PRINTER ACCESSORIES

<b>ORANGE MICRO</b>	
Grappler +	\$ 115
Buffered Grappler +, 16K exp. 64K	175
Mr. Chips for PC & XT, Par. Ser. Clock & Cal., 64K	389

<b>TOSHIBA</b>	
Bi-Directional Tractor	\$ 159
Font Disk for Downleading P1351	48

<b>WIZARD</b>	
Par. Card & Cable for Apple	\$ 89

<b>MICROTEK</b>	
Dumpling GX (same as Grappler +)	\$ 68
Dumpling GX w/16K buffer	149
Dumpling GX w/32K buffer	165
Additional Buffering 16K	16

<b>FOURTH DIMENSION</b>	
Par. Card & Cable for Apple	\$ 49

<b>OKIDATA</b>	
Plug and Play for IBM	\$ 35
Okigraph I for 82A	43
Okigraph I for 83A	43
Tractor for 82A & 92	49

<b>CABLES</b>	
IBM PC to Parallel Printer	\$ 16
Serial Cable	18

## DISPLAY MONITORS

<b>NEC</b>	
JB 1260, 12" Green	\$ 109
JB 1201, 80 col., 20MHz	146
JB 1205(A) 12" Amber, 20MHz	149
JC 1215 Color Composit w/audio	256
JC 1216 RGB, Hi-Res. 13" IBM 640 x 300	379

<b>AMDEK</b>	
V300	\$ 126
V300A	133
V310A for IBM PC	162
Color I +, Composite 13"	279
Color II +, Hi-Res. 13" IBM	419

<b>TAXAN</b>	
IBM Green Monochrome #121	\$ 139
IBM Amber Monochrome #122	145
RGB IBM w/Cable #420	439
RGB Super Hi-Res. #415	393
RGB/Comp. Med. Res. #210	259

<b>PRINCETON GRAPHICS</b>	
HX-12 for use with IBM PC	\$ 469
Max 12 Amber for IBM	189

<b>JAGUAR</b>	
12" Green, Hi-Res Non-Glare	\$ 99
12" Amber, Hi-Res Non-Glare	99

## OKTOBERFEST SPECIALS!

**IBM PC  
2 DRIVES 256K  
\$1721**

**TAXAN 12" GREEN  
FOR IBM  
\$139**

**64K MEM. UPGRADE  
\$39**

**DYNAX DX15  
\$379**

**MICROSCI A2  
100% Apple Compat.  
\$179**

**OKIDATA ML92P  
For IBM  
\$439**

**KAMERMAN  
10 MEG. H.D.  
W/Cont. & Software  
1 yr. warranty  
48 hr. replacement  
\$895**

**VUTEK  
Multifunction Card  
For IBM  
\$249**

## IBM PC ACCESSORIES

<b>PARADISE</b>	
Multi-function Card	\$ 273

<b>PC PEACOCK</b>	
Color Graphics Card w/Par. Printer Port, Compat. w/All IBM Software, 2 yr. war.	\$ 234

<b>64K MEMORY UPGRADE</b>	
64K (9 chips)	\$ 39

<b>AST RESEARCH</b>	
Six Pak +	\$ 263
Mega Plus II	265
Combo Plus	269
I/O Plus II	129

<b>QUADRAM</b>	
Color Graphics Card	\$ 215

<b>VUTEK</b>	
Vutek - CPS, Fully IBM PC Software & Hardware Compatible. RGB & Composite Outputs. Parallel Printer Port. Serial Port 50-9600 Baud. Two Year Warranty	\$ 249

## APPLE & FRANKLIN ACCESSORIES

<b>ACCESSORIES</b>	
System Saver	\$ 69
Fan for Apple II & IIe w/surge	37

<b>APPLE</b>	
Super Serial Card	\$ 139

<b>MICROMAX</b>	
Viewmax 128K extended 80 col. card for Apple IIe	\$ 129
80 col. card for Apple II & II+	139

## MODEMS

<b>ANCHOR</b>	
Mark XII	\$ 229

<b>U.S. ROBOTICS</b>	
Password 300/1200	\$ 335
Auto Dial 212A	439

<b>HAYES MICRO</b>	
300 Baud Smart Modem	\$ 205
1200 Baud Smart Modem	467
1200 B for IBM PC	399
Micro Modem IIe w/Term. pkg.	259
Chronograph	189

## PERSONAL SYSTEMS

<b>APPLE</b>	
Apple IIe Starter System incl: Apple IIe, Tilt Monitor, 1 Drive w/controller, 80 col. card.	\$1189
Apple IIc Lightweight Portable	999
Macintosh w/Image Writer	2500

<b>IBM</b>	
IBM PC 64K, 1 Drive	\$1445
IBM PC 64K, 2 Drives	1615
IBM PC, 2 Drives w/256K Alt II IBM	1721
IBM XT, 128K, 10 Meg, 320K Dr.	2995

<b>KAYPRO</b>	
Kaypro II	\$1179
Kaypro 4	1695
Kaypro 10	2295

<b>SANYO</b>	
MBC 555-2 w/1320K Drive & sftwr.	\$ 895
MBC 555-2 w/2 320K Drives & more software	1095
Serial Port for Sanyo	69

<b>TAVA</b>	
1 Par. & 2 Ser. Ports, 128K, 2-320K Drives, Color Card & Monitor	\$1699

<b>NEC</b>	
PC8800, 2-320K Drives, TB1205 Amber Monitor, FREE Software, Wordstar, Mailmerge, Multiplan	\$1145

<b>COMPAQ</b>	
256K, w/2-320K Drives	\$1995

## DISK DRIVES

<b>SIEMENS</b>	
FD 100-8	\$ 145

<b>TANDON</b>	
TM100-2 for IBM PC	\$ 159
TM65-2, 1/2 Height, 320K	189

<b>KAMERMAN</b>	
10 Meg. Internal Low Power w/Controller Card & Software, 1 Year Warranty, 48 Hour Replacement Guarantee	\$ 895

<b>CDC</b>	
9409, 320K, IBM PC	\$ 229
Controller add	Call

<b>TEAC</b>	
55B Double Sided 360K	\$ 139
Quad Density	189

<b>PANASONIC</b>	
1/2 Height, 360K	\$ 139

<b>Drives For Apple &amp; Franklin</b>	
<b>RANA SYSTEMS</b>	
Elite I	\$ 213
Elite II	339
Elite III	399
Controller add	75

<b>SUPER 5</b>	
Sup-5 (1/2 Height)	\$ 199
Controller Add	65

<b>MICRO-SCI</b>	
A-2	\$ 179
Controller Add	70

<b>JMR</b>	
JMR 100% Apple Comp. Drive	\$ 165

**GIVE US A CHANCE TO BEAT THE COMPETITION'S ADVERTISED PRICE. IF YOU SEE IT ADVERTISED FOR LESS, CALL COMPUTER CONNECTION FIRST FOR LOWEST QUOTE!**

### MAIL ORDER:

12841 S. Hawthorne Blvd., No. 585  
Hawthorne, California 90250



NO SURCHARGE FOR CREDIT CARDS

We accept VISA, MasterCard, CDD (w/deposit), Certified Checks or Wire Transfers. Minimum Shipping Charge \$4.00. Some items subject to back order. California Res. add 6 1/2% Sales Tax. Prices subject to change without notice.

**TOLL FREE ORDER LINE  
(800) 732-0304**

(Outside California)

[213] 514-9019

(Inside California)

**TECH. SALES & INFO. :**  
[213] 514-9019

Mon.-Fri. 8 a.m. to 6 p.m.  
Saturday 11 a.m. to 3 p.m.

**COMPUTER CONNECTION**





# EPROM PROGRAMMER



APPROTEK 1000  
ONLY  
**\$249.95**  
COMPLETE WITH  
PERSONALITY  
MODULE

117 AC POWER-RS232  
-6 BAUD RATES - HANDSHAKE TO HOST  
**ALLOWS READ, WRITE, VERIFY & COPY**  
Comes complete with CPM & BASIC Driver  
Program Listings for most desired micros

## Full 1 Year Warranty

Programs the following: 5 Volt 24 or 28 pin  
devices, 27xx series through 27256,  
25xx series, 68766 plus others  
Specify Personality Module desired with order  
Additional Personality Modules only \$15.00 ea.

TO ORDER: CALL OR WRITE

## APROPOS TECHNOLOGY

1071-A AVENIDA ACASO Add  
CAMARILLO, CA 93010 \$4.00 Shipping-USA  
(805) 482-3604 VISA or MC Add 3%

## ANALOG I/O CAPABILITY FOR HP 150

- 16 CHANNEL A/D SINGLE ENDED
- 8 CHANNEL A/D DIFFERENTIAL
- 2 CHANNEL D/A
- 12 BIT RESOLUTION

- DISPLAY 1 TO 4 CHANNELS OF DATA  
ON SCREEN IN REAL TIME.

- BOARD MOUNT'S IN ACC. SLOT OF HP  
150

- COMPLETE LOW COST SOFTWARE  
HANDLER AND EXAMPLE PROGRAMS  
AVAILABLE.

**\$995 QTY 1-5**

CLINICAL MICROSYSTEMS, INC.

Box 1055

Melbourne, Florida 32936

(305) 723-5475

## IBM® XT COMPATIBLE OEM COMPONENT SALE

Computer Case .....	\$150.00
Key Board-KT5150 .....	\$199.00
Power Supply .....	\$225.00
Mother Board-Bare .....	\$ 95.00
Mother Board without ICs .....	\$225.00
Mother Board with ICs .....	\$525.00

Dealers/OEM Buyers  
Quantity Discounts Available.

All items are 100% XT compatible as  
replacement kits. Boards with ICs are  
tested and burn-in. Evaluation units are  
available at \$3,500 with 128K RAM, 10M  
Hard Disk, Floppy Drive, RGB Card, RS232  
Serial, Parallel and Game Ports.

Subject to stock on hand

Price change without notice

IBM is a trademark of  
International Business Machine



**HiTech International, Inc.**  
1180 Mirakoma Way, Suite M  
Sunnyvale, CA 94086  
(408) 730-0601 TLX 171854 IBC

Circle 27 on inquiry card.

Circle 50 on inquiry card.

Circle 159 on inquiry card.

## TeleVideo USERS RETAIL

- Fast Dump/Restore CPM, TurboDOS  
over 600k per disk ..... \$90.00
- Basic/Z with Graph/Z ..... \$345.00
- TurboDOS for TeleVideo ..... from \$300.00
- LINC Communications Package ..... \$195.00
- 8" Disk Drive for 802 and 800A  
Drive, board and software ..... \$1200.00
- RM/COBOL Systems ..... from \$250.00
- DataFlex 2.0 ..... from \$750.00
- 803, 803H, TPC-1 and GRAPHIC programs:  
Draw! ..... \$90.00
- Games Pak I ..... \$34.95
- 816 and 806C Tape Backup ..... from \$175.00
- Soft Standby Power Systems:  
200VA/400VA ..... from \$575.00
- Anti-Static Products ..... from \$39.95

### PC & COMPATIBLE USERS!

Run your PC as a slave to your 8-Bit  
TurboDOS System! Also see our ad on Page 459.  
Available soon: Backup for TELEVIDEO PM & 1608.  
PLUS OTHER GOOD TELEVIDEO & PC STUFF!

## COGITATE, INCORPORATED

SPECIALISTS IN UNIQUE SOFTWARE  
24000 Telegraph Road, Southfield, MI 48034  
(313) 352-2345 Telex 386581  
VISA/MASTERCARD Accepted

## SWEETALKER II™ welcomes you to the 3rd generation in speech synthesis.



as featured in *Circuit Cellar*, #375  
*Magazine*, March 1984

- SSI 263 based Apple II com-  
patible speech synthesis board
- 256 phoneme equivalents
- 4096 pitch variations
- 5 8 bit internal registers
- 4 handshaking modes
- 16 speed settings
- 255 settings of vocal-tract  
frequency response
- Measures 3" x 3 1/4"
- Operates on +5 and +12v

TO ORDER:

### SWEET TALKER II™

Apple II compatible speech synthesizer  
with text-to-speech algorithm on disk

catalogue no. ST22 ..... \$104.00 postpaid

Call 1-800-645-3479, in N.Y. 1-516-374-6793

THE MICROMINT, INC.  
561 Willow Avenue  
Cedarhurst, N.Y. 11516



Circle 53 on inquiry card.

Circle 160 on inquiry card.

## SL-MICRO

STATISTICAL LANGUAGE  
for MICROCOMPUTERS

### features

- |              |                 |
|--------------|-----------------|
| FREQUENCIES  | FULL LABELING   |
| CROSSTABS    | TRANSFORMATIONS |
| PEARSON CORR | * DATA EDITOR   |
| REGRESSION   | CONDESCRIPTIVE  |
| * ANOVA      | * BREAKDOWN     |
- \* = new

Only \$250. Manual \$15  
Available for IBM PC, CP/M,  
MS-DOS or CP/M-86.

**QSC BOX 23056**  
**LANSING, MI 48909**  
**PHONE (517) 641-4428**

## wabash®

When it comes to  
Flexible Disks, nobody  
does it better than  
Wabash.

MasterCard, Visa Accepted.  
Call Free: (800) 235-4137

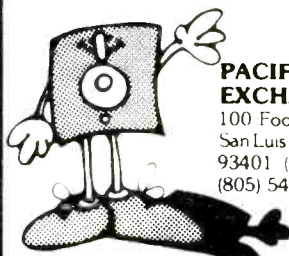

### PACIFIC EXCHANGES

100 Foothill Blvd  
San Luis Obispo, CA  
93401 (In Cal call  
(805) 543-1037)

Circle 302 on inquiry card.

Circle 268 on inquiry card.

Circle 120 on inquiry card.

## PRINTER RIBBONS

	PRICE	PER RIBBON	PER DOZEN
ANADEX 9500 .....	10.50		109.80
APPLE DMP .....	5.25		52.20
C. ITOH PROWRITER .....	5.25		52.20
EPSON MX-FX 70/80 .....	5.00		48.00
EPSON MX-FX 100 .....	6.75		69.00
GEMINI 10-10X-15-15X .....	2.50		23.40
IBM HARMONICA 1/2" .....	6.75		78.00
IBM HARMONICA 3/4" .....	7.95		92.40
IBM 4-COLOR .....	15.75		180.00
IDS MICROPRISM-480 .....	5.75		58.80
IDS PAPER TIGER 460/560 .....	6.75		78.00
IDS PRISM .....	7.95		92.40
IDS 4-COLOR .....	15.75		180.00
NEC - 3500 M/S Non Flip .....	6.25		69.00
NEC - 3500 NYLON .....	9.00		96.00
NEC PC-8023A .....	5.25		52.20
OKIDATA 80/82/83/92 .....	2.50		23.40
OKIDATA - 84 .....	5.00		57.00
RADIO SHACK DMP-2100 .....	7.50		87.00
RADIO SHACK LP VI & VIII .....	5.75		58.80
SILVER REED EX 550 S/S .....	5.00		57.00
SILVER REED EX 550 NYLON .....	9.00		105.00
TOSHIBA - 1350 .....	7.50		87.00
XEROX 610/620 M/S .....	5.95		66.00

Add \$3.00 Ship. & Hand. — To Order Call  
Toll Free 1-800-742-1122  
In MI (313) 569-3218 or Write for our Catalog  
**DWIGHT COMPANY, INC.**  
15565 Northland Drive - West Tower  
Southfield, Michigan 48075-6496

**TOLL-FREE  
ORDERING:  
800-222-8686**

# CCT<sup>®</sup> CUSTOM COMPUTER TECHNOLOGY

**FOR TECHNICAL SUPPORT/  
SERVICE / IN ARIZONA:  
602-282-6299**

**1 CRAFTSMAN COURT — BOX 4160 — SEDONA, ARIZONA 86340**

Purchase your Hardware and Software directly from an OEM / Systems Integrator. Take advantage of our buying power! We stock a full line of Board Level Components, Software and Peripherals. Call for your needs. We'll give you the Lowest Prices, and the Technical Support and Know-How we are quickly becoming well-known for. Satisfied Customers Nationwide. The Nation's Custom Systems House for Business, Education and Science. Call for a system quote. CCT implements tomorrow's technology today!

**• FOREMOST QUALITY • ADVANCED SUPPORT • REASONABLE COST •**

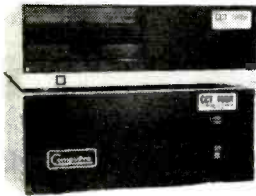

### 80286 NOW!

- CCT-286Z is our modified version of the MI-286 dual processor board from Macrotech. It features a Z-80H and the Intel 80286, with socket for the 80287. Directly replaces 8085/88 under MP/M 8-16, at throughput increases of 3 to 5!
- Introductory price - \$1099.
- Call about the new **CCT-4** machine using this board.

## INDUSTRIAL GRADE SUPERIOR QUALITY CCT DISK DRIVE SYSTEMS ROLLS ROYCES OF THE INDUSTRY

### S-100 HARD DISK SUBSYSTEMS

Professionally engineered ST-506 type systems for the business market S-100 Computer user. Includes industry top quality drives, CompuPro Disk 3 DMA controller, all cabling, A&T, formatted, burned-in. Provisions for up to two hard disks in each system. We include operating system update. CP/M 80, CP/M 86, CP/M 8-16, MP/M 8-16, CP/M 68K. (/1 Systems are CCT innovated hard/floppy combinations, with Mitsubishi DSDD 8" drive.) 12 month warranty.

CCT-10 (11 + MEG) .....	\$1799	CCT-10/1 .....	\$2349
CCT-20 (22 + MEG) .....	\$2319	CCT-20/1 .....	\$2869
CCT-40 (36 + MEG) .....	\$2799	CCT-40/1 .....	\$3349
CCT-60 (58 + MEG) (New) .....	\$3999	CCT-60/1 .....	\$4549
CCT-90 (87 + MEG) (New) .....	\$5209	CCT-90/1 .....	\$5759
CCT-125 (123 + MEG) (New) .....	\$6399	CCT-125/1 .....	\$6949

Drive capacities shown are **after** formatting! We are working on tape cartridge back-up units.

### • 8" CP/M SOFTWARE SPECIALS •

- dBASE II - Latest Version 2.4 ..... \$349
- Supercalc 86 - for CP/M 86 & MP/M ..... \$ 99
- Wordstar ..... \$299 Pro-Pak ..... \$429
- Microsoft BASIC ..... \$299 Compiler ..... \$339
- Supersoft FORTRAN IV ..... \$339 C Comp ..... \$399
- Peachtree Series 8 Modules ..... each \$599

### • TOP SELLING PERIPHERALS •

- CCT-90K Parallel S-100 Terminal  
Amber Screen - 90K Baud ..... \$749
- Wyse 100-14" Green ..... \$699  
Wordstar Prom Option ..... \$ 75
- Wyse 50 ..... \$529 75 ..... \$609  
200/300 ..... \$1069
- Visual 50 ..... \$599 Televideo 925 ..... \$749  
950 ..... \$950 970 ..... \$1099
- Liberty Freedom 100 — \$479 200 — \$679
- Okidata 82 — \$329 83 — \$619 84 — \$899  
92 ..... \$459 93 ..... \$719
- NEC 7710 ..... \$2150 7730 ..... \$2150
- Diablo 620 ..... \$969 630 ..... \$1899

### CCT-2.4 • Dual 8" DSDD

Mitsubishi 2.4 Megabyte in Extra Heavy horizontal enclosure, removeable filter air system, all cabling, A&T, Burned in. The fastest system available: ..... \$1229

### FLOPPY SYSTEMS

### CCT-5 • 5 1/4" DSDD

IBM Compatible Tandon 320K. Extra Heavy Cabinet accommodates two drives, hard or floppy. All cabling, A&T, Burned-in. Perfect for our MS-DOS Package ..... \$399

## ★ SUPER PRICES ★ COMPUPRO COMPONENTS ★ IN STOCK ★

- CCT-2 - \$6799 • CCT-3 - \$6699 • Disk 1A w/CP/M - \$619 • CPU 8086/87 - \$819 • M-Drive/H - \$1099
- CPU 8085/88 - \$349 • CPU 8086 - \$559/10Mhz - \$599 • CPU 68K - \$519/10Mhz - \$639
- CPU-Z - \$249 • Disk 1A - \$519 • Disk 3 - \$499 • RAM 16 (12Mhz) - \$389 • RAM 21 (128K) - \$749
- RAM 22 (256K) - \$1319 • Interfacer 3 - \$459 • Interfacer 4 - \$349 • System Support 1 - \$329
- Enclosure 2 Desk - \$649/Rack - \$699 • CP/M 80 (CCTHMX) - \$125 • CP/M 86 (CCTTMX) - \$175
- CP/M 8-16 (CCTTMX) - \$199 • MP/M 8-16 (CCTSX) - \$499 • CP/M 68K (CCTCX) - \$279

CP/M 86 Upgrade Kit: CP/M 86, RAM 16, Sys. Supt. 1, Cable - \$849

Call for CSC Boards — New Releases — CCT Mods Updates - \$30/O.S.

### CCT-1 — ENTRY LEVEL S-100 BUSINESS SYSTEM

- Enclosure 2-Desk-20 Slot Mainframe • • CCT-2.4-Dual 8" Mitsubishi
- CPU 8085/88 - 6Mhz 8085/8Mhz 8088 • DSDD Drive System - 2.4 Megabytes •
- Disk 1A - DMA Floppy Disk Controller • • CP/M 80 - 2.2 HMX - CCT Modified •
- RAM 16 - 64K Static RAM - 12Mhz • • All Cabling, Complete CCT Assembly, Testing, and Minimum 20 Hour Burn-in •
- Interfacer 4 - 3 Serial/2 Parallel I/O •

**SPECIAL PRICE  
\$3,699**

**RUNS ALL STANDARD 8" CP/M SOFTWARE - INCLUDES OUR EXCLUSIVE 12 MONTH DIRECT WARRANTY**

**OPERATING SYSTEM NOTE:** Latest CP/M, CP/M86, MP/M8-16, CP/M68K, have each been restructured and optimized by CCT, for utmost flexibility, power and speed. All CCT products are supported.

### MS-DOS FOR COMPUPRO - IBM COMPATIBLE CCT MODIFIED SYSTEM

For any CP/M 86 CompuPro System — Includes MS-DOS Version 2.0 and 5 1/4" DMA Disk Controller, All Manuals - \$699

Prices & availability subject to change. All products new, and carry full manufacturer's warranties. Call for catalog. Free technical help to anyone. All products we sell are CCT individually tested and set up for your system - Plug-In & Go! Arizona residents add sales tax CCT © Trademark — Custom Computer Technology; MS-DOS © Trademark — Microsoft; IBM © Trademark — International Business Machines; CompuPro © Trademark — W.J. Godbout; CP/M © MP/M © Trademarks — Digital Research



# Verbatim flexible disks

Call Free (800) 235-4137 for prices and information, Dealer inquiries invited. C.Q.D. and charge cards accepted.



**PACIFIC EXCHANGES**  
100 Foothill Blvd.  
San Luis Obispo, CA  
93401. In Cal. call  
(800) 592-5935 or  
(805) 543-1037.

Circle 268 on inquiry card.

## Powerful Single Board Computer Includes CP/M Plus (3.0 banked)



# \$599

Assembled, Tested  
Includes CP/M 3.0 on disk  
with all manuals

Model MSC-ICO

All Features Fully Supported By CP/M Plus

- 280A, 4 MHz, No wait states
- 128Kb Banked RAM, 60Kb TPA
- 80 x 24 line high speed video
- Disk Controller (up to 4 drives)
- 8" 55/50, DS/DD (1.2 Mb)
- 5" 55/DD, DS/DD, QHD (1.2Mb)
- Use 5" and 8" simultaneously
- Both 5" and 8" connectors built-in
- Two programmable RS232C ports
- Centronics printer port
- 16 bit TTL I/O port
- Parallel keyboard input port
- Clock/calendar with battery backup
- Expansion bus for enhancements
- Requires only +5V 1.2A, +12V 0.1A

MSC-ICO +5" QHD (1.2 Mb) drive \$975

Manufactured by:

**Southern Pacific Limited**, 1-3-18 Santornii Bldg.  
Tsurumichuo, Tsurumi, Yokohama, JAPAN 230  
TEL: 045-501-8842 TLX: 3822320 SPACIF J

USA Distributor:

**ARTISOFT, Inc.**, 2450 East Speedway, Suite 4  
Tucson, Arizona 85719. TEL: (602) 327-4305

Circle 30 on inquiry card.

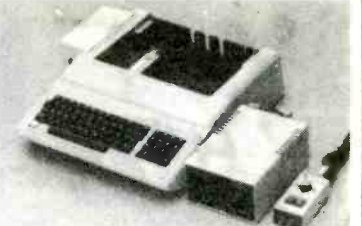

## APPLE COMPATIBLE

Prices for dealers in quantities of 10 or more.  
End Users Inquiries welcomed.

IIc Slim Drive ..... \$170.00 ea.  
II + , IIe Slim Drive ..... \$140.00 ea.  
II + , IIe Shugart Drive ..... \$130.00 ea.  
Controller Card ..... \$35.00 ea.  
Computer Case ..... \$55.00 ea.  
Keyboard ..... \$70.00 ea.  
(Numeric and Function Keys)  
Switching Power Supply .. \$45.00 ea.

**ELECTRADE CO.** (408) 946-2541  
780 Trimble Rd. Suite 605  
San Jose, CA. 95131

Circle 129 on inquiry card.

## PSYCHE™

### THE COMPUTER COUNSELOR

**ARTIFICIAL INTELLIGENCE.** PSYCHE is a modern software simulation of a Rogerian counselor who will hold a delightfully real keyboard conversation with you on over 50 subjects including marriage, sex and work. You may type anything you wish. PSYCHE analyzes your remarks and creates responses that are reflective, nondirective and nonjudgmental.

**REALISTIC.** Thanks to 1984 techniques, responses are grammatical, lively and on the subject. You soon catch yourself thinking of PSYCHE as a real person.

**NOT A GAME.** A state-of-the-art fullscale simulation with over 156K program and files. PSYCHE knows over 1,500 key words and responses.

**TEACH PSYCHE MORE.** Comprehensive menus let you easily improve both vocabulary and responses, or add whole new subjects, without programming. PSYCHE even lists unrecognized words so you can add them. Conversations can be saved and printed. Includes 12 page manual.

FOR ALL IBM PC COMPATIBLES WITH 96K

**ONLY \$49.50**

CALL NOW AND WE'LL SEND IT 1ST CLASS TODAY

Shipping \$2.50. Florida Res. add 5% Tax

PHONE OR MAIL. VISA, MCARD OR CHECK

••• 305 - 391-4610 ••• 305 - 395-6552 •••

**BALIS COMPUTING, INC.**

PO Box 273261, Boca Raton, FL 33427

Circle 35 on inquiry card.

IN STOCK      MODEMS      UPS 2 DAY

★ Hayes Compatible ★

★ Free Communications Software ★

HAYES 1200 ..... \*\$449  
SIGNALMAN ..... ANCHOR AUTOMATION  
300 BAUD ..... \$ 69  
300 BAUD AUTO DIAL/ANS ..... \*\$119  
1200/300 AUTO DIAL/ANS ..... \*\$249  
US ROBOTICS ..... 300/1200 AUTO  
PASSWORD w/cables, spkr ..... \*\$314

### CARDS

HERCULES Mono Graphics ..... \$335  
STB Super Rio+64k(256k)  
Ram Dsk, PrtBuf ..... \$309  
AST Six Pack Plus ..... \$259  
ORANGE MICRO Mr. Chips 64k(256k)  
Ram Dsk, PrtBuf, Game Prts, CLK/cal ..... \$319

### HARD DISKS

#### GREAT LAKES

10MB INTERNAL W/SOFTWARE ..... \$1195  
23MB EXTERNAL W/SOFTWARE ..... \$1895

### DIRECT CONNECT DEVICES

P.O. Box 13256, San Luis Obispo, CA 93406  
CALL TO ORDER ..... Call For:  
(805) 543-6308 ..... FREE  
7 dys/24 hr.      CATALOG

Circle 104 on inquiry card.

## SAGE IV OWNERS

**5 MB EXPANDED WINCH.  
BACKUPS AVAILABLE  
ON REMOVABLE  
CARTRIDGE DISK.**

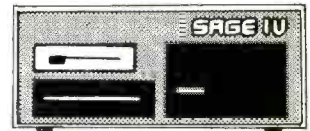

**NOW AVAILABLE:**

• FLEXWARE™ Financial Software Sys.

• Our ULTRA-STREAM™ Graphics

Contact: **MASTERBYTE  
COMPUTERS OF N.Y.**

Suite 815, 19 W. 34 St. N.Y., N.Y. 10001  
(212) 760-0340

Authorized SAGE Distributor

Circle 215 on inquiry card.

## DUST COVERS

For Personal Computers and Small Business Systems, Peripherals, Game Units - Protective, Long-Lasting Vinyl Resists Both Dust and Liquids.

- CHOICE OF COLORS -

Amdek	Franklin Ace
Apple	IBM
Atari	Kaypro
BMC	Okidata
Columbia	Rana Systems
Commodore	Star Micronics
Corona	Televideo
Eagle	Texas Instruments
Epson	PLUS OTHERS

GROUP/VOLUME DISCOUNTS AVAILABLE

FOR FREE BROCHURE WRITE:

ENCHANTED FOREST  
P.O. Box 5261, Newport Beach, CA 92662  
(118 Qnyx)

Dealer Inquiries Invited

Circle 35 on inquiry card.

## BUY UNITED STATES SAVINGS BONDS

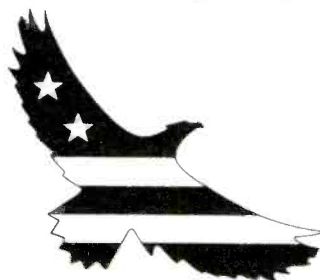

## E-Z TOUCH FULL CONTACT

### NEW! TOUCHDOWN™ KEY OVERLAY KITS

Re-assign commands on your PC key tops for Dvorak, Wordstar, DisplayWrite 2 and other software. Also for 5250/5251 or 5250 emulation. Overlays are transparent: original commands show through. Rigid, non-glare overlays look and feel like original keytops. Do-it-yourself and blank overlay kits are also available.

**TOUCHDOWN CUSTOM KEY OVERLAYS**  
Re-word key tops to match your software package. Choose your colors! Call or write for info.

ASK FOR TOUCHDOWN KEYTOPS OR TOUCHDOWN OVERLAY KITS AT YOUR NEAREST COMPUTER DEALER OR ORDER DIRECT

Kits range from \$6.95 to \$29.95. Price includes postage. Int'l add \$3.50. AZ residents add 5% sales tax.

**VISA/MC CALL (802) 634-4507  
or 634-4503**

Dealer and Custom Order Hotline: 634-7517  
**MOOLEON COMPANY**  
Dept. 8  
PO Box 201  
Cornville, AZ 86325

Circle 162 on inquiry card.



# California Digital

17700 Figueroa Street • Carson, California 90248



## EAGLE \$895

The Eagle IIE/2 Computer features a 12" non-glare green phosphor CRT, typewriter style keyboard with separate numeric cluster. This unit provides two 5 1/4" drives for a combined storage capacity of 780 K/Byte. The computer contains a 4Mhz Z-80A, DMA disk interface, two RS-232C serial ports, Centronics printer interface, along with an auxiliary parallel port. Software included consists of ULTRACALC electronic spread sheet, SPELL-BINDER word processor, CBASIC2, CP/M 2.2, and an exclusive Eagle menu driven utility package. These units are all "factory new" and are being offered far below their suggested price of \$2495. This is your opportunity to purchase a complete CP/M system for only \$895. EAG-2E2

### Compupro \$629 RAM 21

**16 BIT MICROPROCESSORS**  
 Octagon dual CPU 8088/280, 5 controller. OCT-88280 795.00  
 Compupro 8086/8087 microcomp. 16 bit. GBT-8687 495.00  
 Compupro dual processor 8086/8088, 8/16. GBT-8652 359.00

**SINGLE BOARD COMPUTERS**  
 Advanced Digital, Floppy & 64K. AMD-280 750.00  
 Teletek System master, 765 floppy, 64K. TEL-SM1 895.00

**8 BIT MICROPROCESSORS**  
 Compupro 280, 24 bit extended add. GBT-280 250.00  
 Compupro 280 microprocessor. CCS-2810 275.00  
 Tarbell 280 with two RS232 ports. TAR-280 339.00

**MEMORY BOARDS**  
 Calif. Digital 256K dynamic expand to 1 Meg. CAL-D256 495.00  
 Compupro Ram 16, 64K 16 bit data transfer. GBT-R16 429.00  
 Compupro Ram 17, 64K 8 bit 24 bit address. GBT-R17 429.00  
 Compupro Ram 21, 128K byte 8/16 transfer. GBT-R21 629.00  
 Compupro Ram 22, 256K static 16 bit transfer. GBT-R22 1179.00  
 Compupro Ram 23, information pending. GBT-R23 call

**FLOPPY DISK CONTROLLERS**  
 Compupro Disk 1A, double density. GBT-DSK1A 495.00  
 California Computer 2422A with CPM. CCS-2422 339.00  
 Tarbell Electronics double density. TAR-DDC 419.00  
 Tarbell Electronics single density. TAR-SDC 279.00

**CPM OPERATING SYSTEM**  
 Digital Research CPM 3.0, 8" sig. den. DRC-CPM30 249.00  
 Compupro CPM 2.2 for Disk 1. GBT-CPM22 159.00  
 Compupro CPM86 for 8088 and 8086. GBT-CPM86 265.00  
 Tarbell Electronics CPM 2.2. TAR-CPM22 159.00

**HARD DISK CONTROLLERS**  
 Octagon hard disk controller with E/C. OCT-HD1 475.00  
 Godbout Disk 2, 8" & 14" hard disk. GBT-DSK2 569.00  
 Godbout Disk 3, for 5 1/4" Winchester. GBT-DSK3 629.00  
 Western Digital new WD-1001 (not S-100). WDI-1001 319.00

**EPROM BOARDS**  
 Inner Access EPROM Bd. programs 27128. IAC-P100 465.00  
 Digital Research PROM board, 32K. DGR-P32 119.00

**INTERFACE BOARDS**  
 Compupro Interfacar II, with 5 serial ports. GBT-135A 495.00  
 Compupro Interfacar III, with 8 serial ports. GBT-138A 585.00  
 Compupro Interfacar IV, 3 serial, 2 parallel. GBT-187A 329.00  
 California Computer 2710, 4 serial ports. CCS-2710 279.00  
 California Computer 2719, 2 serial, 2 par 1. CCS-2719 295.00  
 California Computer 2720, 4 port par 1. CCS-2720 219.00

**SPECIAL FUNCTION BOARDS**  
 QT Computer clock calendar, battery. QTC-CC100 139.00  
 Compupro System support board, 4K EPROM. GBT-SYS1 350.00  
 Dual Systems, 2 channel 12 bit D/A conv. DSC-AOM12 619.00  
 Dual System 12 bit resolution, 32 ch. A/D. DSC-AIM12 629.00  
 Mullins Opto-isolator, controls 8 ch. MUL-HCB10 179.00  
 Mullins extender board with logic & probe. MUL-T84 79.00  
 I/O Technology wire wrap prototype. IOT-W100 49.00  
 Artec Electronics wire wrap prototype. ART-WW100 25.00

**MAINFRAMES & MOTHER BOARDS**  
 Eclipse Data, stainless, 22 slot torid supply. EDP-100 495.00  
 Compupro Enclosure 2, 20 slots. GBT-MP20 675.00  
 California Digital 16 slot mother board. CAL-MB14 35.00

### ENCLOSURES

California Digital manufactures an assortment of stock and custom disk drive enclosures. If the volume is justified we will custom design an enclosure for your application. The following disk drive enclosures are available from stock. All include power supplies the 8" enclosures are supplied with exhaust fans.

- Horizontal mount dual 8" full height drives \$279.00
- Vertical mount dual full height 8" drives 299.00
- Horizontal mount one full height or two half height 8" 239.00
- Horizontal one full height or two half height 5 1/4" 89.00

### IBM PC \$1495

### XT \$3650

PC system includes 64K byte of memory one 320K byte double sided disk drive, and keyboard. Monitor and video board available. Please contact our sales office for other configurations.



### DEC Q-BUSS \$49

This is the same backplane used with Digital Equipment PDP-11/23 computer. Four slot dual height suitable for use on all kinds of Q-buss systems DEC-H9281



### Commodore HesModem \$39

The HesModem 1 is designed to be used with the VIC-20 or the Commodore 64 microcomputers. The Hes Modem 1 comes complete with terminal communication software. Plugs directly into the communications port of your Commodore Computer. HES-M1

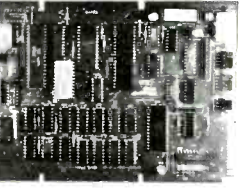

### Ampro Little Board \$339

The Ampro Little Board is a single board Z-80A microcomputer with on board 5 1/4" disk controller, 54K/bytes of memory two serial ports along with a Centronics parallel printer port. This computer is supplied with enhanced CP/M 2.2 with well documented user manual. APD-LB1A



### CONRAC 9" MONITOR \$59

A crisp display is assured with the conrac 9" monitor. This unit features 12 volt only operation, open frame construction, separate high resolution video and most of all incomparable contrast quality. Documentation includes schematic and theory of operation. CON-96W

### AST \$219 SIX PAK PLUS



**MULTIFUNCTION CARDS**  
 AST SixPakPlus zero memory \$219.00  
 AST SixPakPlus 64K with software 265.00  
 AST SixPakPlus 384K fully populated board 499.00  
 AST MegaPlus II 64K to 512K with MegaPak 269.00  
 AST MegaPak 256K piggyback / MegaPlus 279.00  
 Persyst Board 64K with software 319.00  
 Quadboard 64K with six functions 249.00  
 STB RIO Plus 64K with PC accelerator 279.00  
 STB Super I/O serial/par/l game port 184.99

**VIDEO DISPLAY CARDS**  
 AST Monograph Plus monochrome/graphic 449.79  
 Hercules Graphic two year warranty 339.89  
 PC Peacock Color mono. RGB, graphics 229.00  
 Plantronics ColorPlus printer port / software 379.98  
 Quad Color I expandable, high res. 209.75  
 STB Graphics Plus with software 379.67

**HARD DISK DRIVES**  
 Franklin 10MB ext. controller, power 1195.45  
 Franklin 10MB int. 3X speed of XT 995.95  
 Maynard 10MB int. full XT emulation 998.97

**INTEGRATED CIRCUITS**  
 4164 Memory Chips 150 or 200 ns 5.95  
 64K Set (9 chips) with instructions 48.95  
 8087 CoProcessor arithmetic chip 199.54

### CONNECTORS



### S-100 Gold

GOLD S-100 EDGE CARD CONNECTORS	catalog	each 10-99 100+
msai s/i 250	CNE-IMS	2.95 2.50 2.19
Sulins Hi-Rel	CNE-H100	4.19 3.85 3.47
2-100 Wire W.	CNE-W10	3.95 3.50 3.19
Alair 110	CNE-100A	4.95 4.50 4.19
<b>156 CENTER EDGE CARD CONNECTORS</b>		
32-44 Eyelet	CNE-44E	5.20 2.15 1.95
43-72 Mfg. S/I	CNE-72S	6.50 6.15 5.75
36-72 D/G S/I	CNE-72S	8.95 8.50 8.19
*Other connectors available upon request		
<b>RIBBON CONNECTORS</b>		
DB25P male	CND-25P	5.65 5.25 4.15
25 pin socket	CNI-D25P	3.50 2.50 2.15
37-30360P male	CNC-36S	5.95 5.59 4.50
37-30360P female	CNC-36F	7.95 6.75 5.90
20 pin edge	CNI-DE0	4.35 3.30 2.50
20 pin socket	CNI-DS20	2.75 1.85 1.60
26 pin edge	CNI-DE26	4.95 3.50 2.70
26 pin socket	CNI-DS26	3.50 2.50 2.15
34 pin edge	CNI-DE34	4.95 4.30 3.50
34 pin socket	CNI-DS34	4.50 3.95 3.15
30 pin edge	CNI-DE30	5.95 5.60 4.90
50 pin socket	CNI-DS50	4.95 4.60 3.80
<b>AMPHENOL CENTRONICS TYPE</b>		
57-30360 36 P	CNC-36P	7.95 6.35 3.97
IEEE488 C dor	CND-24P	7.95 6.35 3.55
<b>DISK DRIVE POWER CONNECTORS</b>		
8 pin D C	CNP-8DC	1.95 2.29 89
8 3AC Sp/I	CNP-3IS	1.69 1.09 69
8 3AC Dbl S	CNP-3DS	1.69 1.09 69
5 1/4 pin D C	CNP-4DC	1.79 1.19 89
5 pin D recept	CNP-3DS	2.59 1.95 1.59

**TOLL FREE ORDER LINE**  
**(800) 421-5041**  
**TECHNICAL & CALIFORNIA**  
**(213) 217-0500**



Shipping: First five pounds \$3.00, each additional pound \$ .50.  
 Foreign orders: 10% shipping, excess will be refunded.  
 California residents add 6 1/2% sales tax. • COD's discouraged.  
 Open accounts extended to state supported educational institutions and companies with a strong "Dun & Bradstreet" rating.



# California Digital

17700 Figueroa Street • Carson, California 90248

## LETTER QUALITY JUKI® 6100

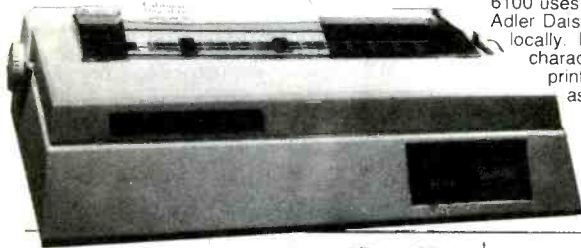

# \$319

The JUKI 6100 is the ideal low cost daisywheel printer. This economical printer features a standard Centronics interface, 18 characters per second, bi-directional printing and a print buffer expandable to 8 K/bytes. The JUKI 6100 uses IBM Selectric II ribbons and Royal Triumph Adler Daisy wheels allowing the purchase of supplies locally. Printing enhancements include 10, 12, 15 characters per inch, with proportional spacing, bold print, super script, subscript, under lining, as well as line spacing in 1/48 inch increments.

Because of a computer manufacturers over purchase we are able to sell these printers for only \$319. The 6100 typically retails for \$599. The printer was private labeled by Juki for this major computer manufacturer.

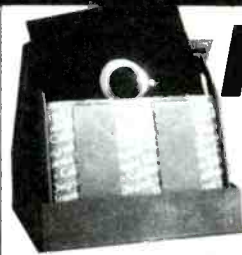

# FREE

Plastic library case supplied with all diskettes purchased from California Digital.

## DISKETTES AS LOW AS \$16.50

FIVE INCH SINGLE SIDED DOUBLE DENSITY

	5 1/4" Single Sided	10 Boxes	100 Boxes
<b>CAL DIGITAL</b>	CAL-501 CAL-510 CAL-516	18.95	17.50 16.50
<b>SCOTCH</b>	MMM-744/0 MMM-744/10 MMM-745/16	24.95	22.75 21.75
<b>VERBATIM</b>	VRB-525/01 VRB-525/10 VRB-525/16	24.95	22.75 21.75
<b>MEMOREX</b>	MRX-3481 MRX-3483 MRX-3485	24.95	21.75 17.75
<b>MAXELL</b>	MXL-MD1 MXL-MH1/10 MXL-MH1/16	24.95	22.75 21.25
<b>DYSAN</b>	DYS-104/1D DYS-107/1D DYS-105/1D	35.00	33.00 30.50

FIVE INCH DOUBLE SIDED DOUBLE DENSITY

	5 1/4" Double Sided	10 Boxes	100 Boxes
<b>CAL DIGITAL</b>	CAL-551 CAL-561	24.95	22.75 20.50
<b>SCOTCH</b>	MMM-745/0 MMM-745/10 MMM-745/16	37.95	35.95 31.25
<b>VERBATIM</b>	VRB-550/01 VRB-550/10 VRB-550/16	37.95	35.95 32.75
<b>MEMOREX</b>	MRX-3491 MRX-3493 MRX-3495	32.95	31.25 26.25
<b>MAXELL</b>	MXL-MD2 MXL-MD2/10 MXL-MD2/16	37.95	35.95 33.75
<b>MAXELL / 96</b>	N/A	45.00	43.00 41.25
<b>DYSAN</b>	DYS-104/2D DYS-107/2D DYS-105/2D	42.50	40.50 35.50
<b>DYSAN / 96</b>	DYS-204/2D N/A	49.95	47.95 45.75

EIGHT INCH SINGLE SIDED SINGLE DENSITY

	8" Single Sided	10 Boxes	100 Boxes
<b>SCOTCH</b>	MMM-740/0	28.50	27.50 23.80
<b>MEMOREX</b>	MRX-3062	27.75	26.60 22.25
<b>VERBATIM</b>	VRB-34/9000	31.50	29.50 25.60
<b>DYSAN</b>	DYS-3740/1	35.75	32.75 29.75

EIGHT INCH SINGLE SIDED DOUBLE DENSITY

	8" Single Sided	10 Boxes	100 Boxes
<b>SCOTCH</b>	MMM-741/0	33.95	31.75 29.15
<b>MEMOREX</b>	MRX-3090	31.95	27.75 26.15
<b>VERBATIM</b>	VRB-34/8000	35.25	33.25 28.75
<b>DYSAN</b>	DYS-3740/1D	40.75	38.75 32.25
<b>MAXELL</b>	MXL-FD1	45.50	39.75 35.15

EIGHT INCH DOUBLE SIDED DOUBLE DENSITY

	8" Double Sided	10 Boxes	100 Boxes
<b>SCOTCH</b>	MMM-743/0	45.95	43.25 37.50
<b>MEMOREX</b>	MRX-3102	37.95	36.75 31.50
<b>VERBATIM</b>	VRB-34/4001	41.75	37.50 32.25
<b>DYSAN</b>	DYS-3740/2D	54.65	49.75 40.50
<b>MAXELL</b>	MXL-FD2	52.50	48.75 40.45

## \$49 Apple Macintosh Diskettes



# \$139

Your Choice  
**TEAC 55B 55F**  
48TPI-96TPI

Five Inch Single Sided Drives

	One	Two	Ten
<b>TEAC FD-54A</b> half height	99	95	89
<b>SHUGART SA400L</b> full height	189	179	175
<b>TANDON TM100-1</b> full height	169	165	179

Five Inch Double Sided Drives

	One	Two	Ten
<b>TEAC FD55B</b> half height	139	135	129
<b>TEAC FD55F 96 TPI</b> , half ht.	139	135	129
<b>CONTROL DATA 9409 PC</b>	219	199	195
<b>CONTROL DATA 9428 1/2 ht.</b>	219	199	195
<b>SHUGART SA455 Half Height</b>	189	179	175
<b>PANASONIC JA551/2N (455)</b>	139	135	129
<b>SHUGART SA465 1/2 Ht. 96TPI</b>	269	259	249
<b>TANDON 100-2 full height</b>	179	175	169
<b>TANDON 101-4 96TPI full ht.</b>	329	319	305
<b>MITSUBISHI 4851 half height</b>	169	159	155
<b>MITSUBISHI 4853 96/TPI 1/2 ht.</b>	179	169	165
<b>MITSUBISHI 4854 8" elec.</b>	395	385	375
<b>QUME 142 half height</b>	219	205	199

# REMAX

## DOUBLE SIDED \$219

Eight Inch Single Sided Drives

	One	Two	Ten
<b>SHUGART 801R</b>	385	375	365
<b>SIEMENS FDD 100-8</b>	129	125	119
<b>TANDON 848E-1 Half Height</b>	369	359	349

Eight Inch Double Sided Drives

	One	Two	Ten
<b>SHUGART SA851R</b>	495	485	475
<b>QUME 842 "QUME TRACK 8"</b>	459	459	449
<b>TANDON 848E-2 Half Height</b>	459	447	435
<b>REMAX RFD-4000</b>	219	219	209
<b>MITSUBISHI M2894-63</b>	447	439	433
<b>MITSUBISHI M2896-63 1/2 Ht.</b>	459	449	409

# \$389

## TANDON 603SE

These Tandon 14.2 Megabyte hard disk drives are the excess inventory of a major computer company. Each unit has passed 24 hours of incoming burn-in.

Five Inch Winchester Hard Disk Drives

	One	Two
<b>FUJITSU M2235AS</b> 27 Meg.	999	959
<b>RODINE R0-208</b> 53 Meg.	1589	1493
<b>MAXTOR XT1065</b> 65 Meg.	1995	1965
<b>SHUGART 712 13 Meg. 1/2 Ht</b>	795	765
<b>TANDON 503</b> 19 Meg.	795	775
<b>TANDON 603</b> 14.2 Meg.	389	379

Three Inch Disk Drives

<b>SHUGART SA300</b>	229	219
----------------------	-----	-----

Upon request, all drives are supplied with power connectors and manual

## MEMORY

# 4164 DYNAMIC MEMORY 150ns

## \$5.95

DYNAMIC MEMORY

	1-31	32+	100+
4116 150ns. 16K	1.75	1.65	1.45
4116 200ns. 16K	1.75	1.65	1.45
4154 150ns. 54K 128 refresh	5.95	5.25	4.95
41256 150ns. 256K	39.95	34.85	27.70
DP8409 dynamic controller	39.00	35.00	29.00
<b>STATIC MEMORY</b>			
21L02 200ns. 1K static	1.49	1.29	1.15
11L02 450ns. 1K static	1.29	1.15	.99
2112 450ns. 2K static	2.99	2.80	2.75
2114 300ns. 1K x 4	1.95	1.85	1.75
4044TMS 450ns. 4K x 1	3.49	3.25	2.99
5257 300ns. 4K x 1	2.50	2.25	1.99
6116 P4 200ns. 2K x 8	4.85	4.65	4.50
6116 P3 150ns. 2K x 8	5.25	4.05	4.85
<b>EPROMS</b>			
2708 450ns. 1K x 8	4.95	4.75	4.55
2716 450ns. 2K x 8	4.50	4.25	3.97
2716TMS 450ns. Tri-voltage	7.95	7.65	7.25
2732 450ns. 4K x 8	4.50	3.75	3.55
2764 350ns. 8K x 8	6.95	6.95	6.95
27128 350ns. 16K x 8	24.95	23.75	22.50

Shipping: First five pounds \$3.00, each additional pound \$.50. Foreign orders: 10% shipping, excess will be refunded. California residents add 6 1/2% sales tax. • COD's discouraged. Open accounts extended to state supported educational institutions and companies with a strong "Dun & Bradstreet" rating.





# California Digital

17700 Figueroa Street • Carson, California 90248

## NEC RGB COLOR MONITOR \$259



The NEC JC-1401D is a 13" medium/high resolution RGB monitor suitable for use with the Sanyo MBC-550/555 or the IBM/PC. The monitor features a resolution of 400 dots by 240 lines. Colors available are Red, Green, Blue, Yellow, Cyan, Magenta, Black and White. These monitors are currently being used in applications far more critical than microcomputers. The NEC monitor carries the Litton-Monroe label and was originally scheduled for use in their Office of the Future equipment. A change in Monroe's marketing strategy has made these units excess inventory which we are selling to California Digital. We are offering these prime new RGB monitors at a fraction of their original cost. Sanyo compatible NEC-1401/S, IBM/PC Computer compatible NEC-1401/PC

## MONITORS

BMC 12A green phosphor 15 MHz composite video	BMC 12A	78.95
BMC 12 high resolution 20MHz	BMC 12EN	119.00
Amdex 300G 12" green phosphor	AMK 300G	128.95
Amdex 300A 12" amber phosphor high resolution	AMK 300A	138.95
Amdex 310A designed for IBM PC amber	AMK 310A	158.95
Zenith ZVM122 Amber Phosphor 12" 40-80 column switch	ZTH 122	94.95
Zenith ZVM123 green phosphor 12" 40-80 column switch	ZTH 123	94.95
NEC JB1201 green phosphor 18 MHz composite video	NEC JB1201	159.00
NEC JB1260 commercial grade composite video	NEC JB1260	119.00
Monitors 23" open frame s/wk white composite video	MCT-BW23	159.00
Contra 33" open frame requires horiz sync & 12v supply	CON-33	59.00

NEC JC1401D Medium High 13" RGB	NEC 1401-X	259.00
BMC AU9191U Color composite video with sound	BMC 9191	238.95
BMC 9191M RGB designed for use with the IBM computer	BMC 9191M	379.00
NEC JC1203DM RGB color monitor	NEC 1203	699.00
NEC JC1201 color composite	NEC JC1201	339.00
Zenith ZVM135 RGB & composite suitable for IBM PC	ZTH 135	375.00
Amdex Color II 13" composite video	AMK 100	299.00
Amdex Color II 13" RGB hi resolution	AMK 200	419.95
Amdex Color III 13" RGB medium resolution	AMK 300	359.95
Princeton HX 12" RGB IBM/PC compatible	PRN-HX12	476.95

## Return of a Smash Hit Sellout DRAGON \$139



Compatible with the Radio Shack Color Computer. The world famous Dragon computer is now available in the United States. Manufactured by the Tano Corp. under license of the British Broadcasting Company. The Dragon comes complete with 64K Byte of memory, serial modem port along with a Centronics printer interface. This unique microcomputer features Motorola's advanced 6809E microprocessor and comes standard with Microsoft Color Basic, data base manager, and a complete word processing package. The computer outputs color composite video along with R.F. video that allows the unit to be used in conjunction with any color television. This is the ideal low cost computer to be used with any dial up information system such as the Source, Western Union's EasyLink or any other time share service.

California Digital has agreed to act as exclusive agent for North America in an effort to assist The Tano Corporation in reducing their overstock. For a limited time California Digital can offer the Dragon computer for only \$139.

## PRINTERS

**MATRIX PRINTERS**

Star Gemini-10X 120 char/sec	STR-G10X	279.00
Star Gemini-15X 100 char/sec 15 paper	STR-G15X	389.00
Star Gemini Delta 10 160 Char/sec	STR D10	399.00
Star Cuser 50PT tractor tractor	VST-C50FT	195.00
Toshiba P1351 192 char/sec letter quality	TOS 1351	1199.00
Okidata 82A serial & parallel 9" paper	OKI 82A	347.00
Okidata 92A parallel interface 160 char/sec	OKI 92A	427.00
Okidata 93A & parallel 15 paper	OKI 93A	567.00
Okidata 84A & parallel 15 paper	OKI 84A	997.00
Okidata 2350 (new) 350 char/sec	OKI 2350	1995.00
Epson FX 8010 120 Char/sec	EPS-FX80	317.00
Epson FX 80 10 160 char/sec with graphitax	EPS-FX80	529.00
Anadex 9601B high speed with graphics	ADX-9601B	1029.00
Anadex 9620B 200 char/sec par & serial	ADX-9620B	1129.00
Prowriter 8510 parallel 9" paper	PRO-8510P	359.00
Prowriter II parallel 15 paper graphics	PRO 2P	689.00
Dataproducts B-600-3 band printer 600 LPM	DPS-B600	6995.00
Pintertronix P300 high speed printer 300 lines per minute	PTX P300	3995.00
Pintertronix P600 ultra high speed 600 lines per minute	PTX P600	5795.00

**WORD PROCESSING PRINTERS**

NEC 7710 55 char/sec serial interface	NEC 7710	1795.00
NEC 7720 55 char/sec par interface	NEC 7720	1795.00
NEC 3550 popular printer designed for the IBM PC	NEC 3550	1599.00
NEC 2050 designed for IBM PC 20 char/sec par I	NEC 2050	995.00
Silver Reed EXP500 14 char/sec par I interface	SRL EXP500	659.00
Silver Reed EXP550 17 char/sec par I interface	SRL EXP550	699.00
Dalco 630 40 char/sec serial	DEL 630	1785.00
Okibo 620 proportional spacing horz & vert tab 20 cps	DEL 620	879.00
Juki 6100 18 char/sec 5PCS/AL	JUK 56100	319.00
StarWriter F10 serial 40 char/sec	BTH-HR15	695.00
StarWriter F10 parallel 40 char/sec	PRO-F10S	1125.00
Comtex CR2 36 pin/line proportional spacing par I	PRO-F10P	1125.00
	CRX-CR2P	483.00

## SANYO IBM Compatible \$759

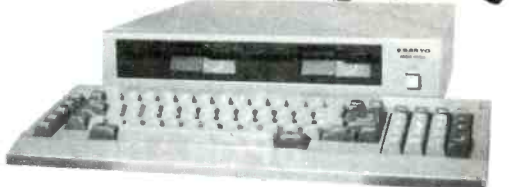

The Sanyo MBC-550 Microcomputer includes 128K byte of memory, a 5 1/4" disk drive along with a parallel printer port. The computer outputs both RGB color and monochrome composite video. Extensive software such as Sanyo Basic, Wordstar, Calcstar and Easy Writer I is included with the MBC-550.

Sanyo 550	reduced SALE price	759.00
Sanyo 550 Plus	two single sided drives	829.00
Sanyo 550-2	one double sided drive	949.00
Sanyo 550-2 Plus	two double sided drives	1095.00
Sanyo 555	two sgl. drives, bonus soft.	1095.00
Sanyo 555-2	two dbl. drives, bonus soft.	1249.00
Memory Upgrade	256K total memory	99.00
Serial Card	modem interface	85.00

## MODEMS

**MODEMS**

**\$319**

The CTS212AH Modem is 300 1200 Auto Answer Auto Dial Hayes Compatible Mycroft Labs Companion communications software \$35.00 additional

CTS 212AH 1200 baud auto dial	CTS 212AH	319.00
Signalman Mark 12 1200 baud Hayes compatible	SGI MK12	259.00
Signalman Mark 1 direct connect with terminal cable	SGI MK1	175.00
Hayes Smart Modem 1200 baud auto answer auto dial	HYS 212AD	479.00
Hayes 1200B for use with the IBM PC 1200 baud	HYS 1200B	429.00
Hayes Smartmodem 300 baud only auto answer auto dial	HYS 103AD	229.00
Hayes Micromodem II 103 Apple direct connect	HYS-MM2	279.00
Hayes Chronograph time & date	HYS-CHR222	189.00
U.S. Robotics 212A 300/1200 baud auto dial answer	USR 212A	439.00
U.S. Robotics Password 300/1200 baud	USR-PW120	369.00
Fennel 300 1200 industrial quality	FEN-12AD	595.00
Universal Data 103FL line power answer & originate	UDS-103FL	169.00
Universal Data 212L 1200 baud duplex line power	UDS 212L	219.00
Universal Data 212P 1200 baud duplex line power	UDS 212P	359.00
Novation V-Cat direct connect auto answer	NOV-SCAT	115.00
Novation SmartCat 103/212 1200 baud auto dial	NOV-SC212	529.00

## ASCII KEYBOARD \$49



California Digital has purchased over 3000 of these Microswitch keyboards from the General Dynamics Corporation. 93 ASCII equivalent full effect switches includes 6 function keys and 14 key numeric cluster make this keyboard an excellent value at only \$49. MIC 93200 5 lbs. We also have available a matching General Dynamics steel trim panel \$10.

Non-enclosed Hytek 85 key metal contact keyboard. HIK-58 \$24.95. Matching 15 key numeric cluster \$9.95. HIK-15. Both for only \$29.95. HIK-5815.

## TERMINALS

**TERMINALS**

Freedom 100 split screen, detachable keyboard	L/B-F100	495.00
Come 102 green phosphor terminal	COM-102	539.00
Amdex Dialogue 128 green screen	AMP-D125G	675.00
Amdex Dialogue 175 amber screen two page func. keys	AMP-D175A	719.00
Wyse 50 14" green phosphor	WYS 50	595.00
Wyse 300 8" green color display split screen	WYS 300	1159.00
Zenith 29 terminal VT52 compatible detachable keyboard	ZTH-Z29	785.00
Televideo 910 Plus black mode	TVI-910P	575.00
Televideo 925 detachable keyboard 22 function keys	TVI-925	755.00
Televideo 950 graphic char. split screen 22 func.	TVI-950	950.00
Televideo 970 14" green 132 column European	TVI-970	1095.00

## Switching Supply \$49

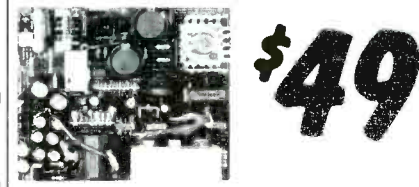

Power your single board system with one supply! This Kepro switcher power supply outputs +5 volts at 5 amps, -12 volts at 1.8 amps, 2.8 amps surge, -12 volts at 0.5 amps, and a second -12 volts at 2.0 amp output. It is jumper selectable for both 120 volt and 220 volt operation. Units measures approximately 6" by 6". This board is capable of supplying power for two 5 1/4" Winchester, a single board computer along with a hard disk controller. Also suitable for use with all IBM look-a-like. Priced at only \$49.95 this power supply offers excellent value along with high reliability. KPT-512

## Advanced Logic Systems CP/M 3.0 CARD \$179



We have just purchased from Digital Research over eight hundred of the Advanced Logic Systems CP/M 3.0 cards. This unique product offers performance up to 300% faster than existing Apple CP/M cards. Featuring a 6 MHz Z80B micro-processor, 64K/Byte of on board memory, with CP/M 3.0 along with GSX 80 graphics and CBasic. The ALS card supports larger programs with enhanced CP/M editing features. Manufacturers suggested price on the CP/M board is \$399, while supplies last California Digital is offering this card at only \$179. ALS-Z80

TOLL FREE ORDER LINE (800) 421-5041 TECHNICAL & CALIFORNIA (213) 217-0500



## The Source For All IBM Compatible Products

**300 BAUD  
PC MODEM  
ONLY \$59**

- ★ 300 Baud - Mark VI
- ★ Anchor Automation
- ★ Internal (No Ports Needed)
- ★ New - 90 Day Warranty

**5 1/4" DRIVE  
FOR PC  
ONLY \$109**

- ★ MPI B-52
- ★ 320K Dbl/DbI
- ★ Overstocked Special!!

**64K  
UPGRADE  
ONLY \$39 set**

- ★ Prime 64K Chips
- ★ 9 to a Set

**5 1/4" DISKETTES  
ONLY \$18  
100 for \$160**

- ★ 1 Year Warranty
- ★ Reinforced Hub

**SAM WOO  
MONITOR**

- ★ Monochrome
- ★ 310A Compatible
- ★ Hi-Res. Amber

**\$99**

**IBM PC**

- ★ 1 - 320K Drive
- ★ Controller
- ★ 64K, Keyboard
- ★ 90 Day Warr. w/Pipeline

**\$1399**

**IBM SYSTEM**

- ★ 256K, 2-Drives
- ★ Amber Monochrome Monitor
- ★ Monochrome Adaptor
- ★ 90 Day Warr. w/Pipeline

**\$1949**

**NEC 3550**

- ★ 35 cps Letter Quality
- ★ PC Plug Compatible

**\$1650**

Tractor **\$199**

**The Source!**



- We Accept MC, Visa, Wire Transfers, Certified Checks
- COD's Available
- No Surcharge for Credit Cards

- Shipping Minimum \$5.00
- Purchase Orders Accepted
- This Ad Supersedes all Others

Prices Subject to Change

**The Source!**



Circle 275 on inquiry card.



# CALL TOLL-FREE (800) 841-0905 For Lowest Prices & Fast Delivery

## IBM & COMPATIBLE COMPUTERS

### IBM

PC w/64K, 1 Drive	\$1399
PC w/256K, 2 Drives	1743
PC XT, 256K 10 Meg Disk	3695

### COMPAQ

Compaq, 256K, 2 Drive	\$2250
-----------------------	--------

### COLUMBIA

1600-1, 2-Drives (360K)	\$2295
1600-4, 12MB Hard Disk	3795
MPC-XP Portable	2095

### SANYO

MBC 550, 1-Drive, software	\$ 699
MBC 555, 2-Drives, 160K ea.	999
MBC 550-1, 1-Drive, 320K	799
MBC 555-2, 2-Drives, 320K ea.	1099
Optional Serial Port	79
Optional Drive w/Software	189

### TAVA

2-Drives, 128K, 2 Ser. 1 Par. Port, Color Graphics Card & Hi-Res. Green Monitor	\$1789
---	--------

## MODEMS

### HAYES MICRO INC.

Smart Modem 300	\$ 205
Smart Modem 1200	489
1200B for PC	399

### ANCHOR

Mark VI 300 Baud, Internal	\$ 59
Mark XII 1200 Baud	239

### PROMETHEUS

ProCom 1200	\$ 339
-------------	--------

### RIXON

PC212A, 1200 Baud Stand Alone	\$ 399
-------------------------------	--------

### U.S. ROBTICS

Password, 1200 Baud	\$ 319
---------------------	--------

## DISKETTES

### PIPELINE

Dbl./Dbl. Reinforced Hub 1 year warranty	\$ 18
Flip File Holds 70 (smk. plexiglass)	16

## PRINTERS

### OKIDATA

ML 92A (160 cps)	\$ 399
ML 93A (160 cps)	637
92 & 93 Plug & Play	49

### STAR MICRONICS

Gemini 10X, 120 cps	\$ 249
Gemini 15X, 120 cps, 15" car.	389

### JUKI

6100, 18 cps ltr. qual.	\$ 439
Tractor Feed	129

### EPSON

RX80	\$ 269
RX80FT	309
FX80	439
FX100	659

## MONITORS

### AMDEK

300G, 12" Green	\$ 129
300A, 12" Amber	139
310A, 12" Amber Monochrome	165
Color I + Color Composite	299
Color II + RGB w/Cable	409

### PRINCETON GRAPHICS

PGS HX12	\$ 469
PGS MAX12	189
PGS SR12	640

### TAXAN

420 (PGS Compatible)	\$ 399
----------------------	--------

## IBM COMPATIBLE DISK DRIVES

### TANDON

TM-65-2, 1/2 Height (360K)	\$ 179
TM-100-2 (360K)	\$ 159

### TEAC

FD55B, 1/2 Height (360K)	\$ 134
--------------------------	--------

### MATSUSHITA

Same as Panasonic, 1/2 Ht. 360K	\$ 129
---------------------------------	--------

### CDC

9409, (360K)	\$ 198
--------------	--------

## INTERFACE CARDS FOR IBM AND COMPATIBLES

### AST RESEARCH

SixPac + 64K Par. & Ser. Software	\$ 259
Mega + 64K exp. to 512K Ser. Port	259
MegaPack 256K option for Mega	269
I/O + Ser. & Optional Par Game	149
Additional Ports	49

### QUADRAM

Color I	\$ 209
Color II	229
Quadlink	449
Quad Board 64K w/Game Port	279
Quad Board II	269

### HERCULES

Color Graphics Card	\$ 329
---------------------	--------

### PLANTRONICS

Color +	\$ 379
---------	--------

### IBM

Dos 2.1	\$ 49
Monochrome Monitor or Adaptor	229

### FLOPPY DISK CONTROLLERS

Maynard	\$ 169
Maynard w/Ser. Port	229
Maynard w/Par. Port	229
Sigma Controller	159
Pipeline Controller	129

### DUST COVER

Covers Monitor, Mainframe & Keyboard	\$ 19
--------------------------------------	-------

### MORE ACCESSORIES

Koala Graphics Tablet	\$ 85
8087 Co-Processor	149
Kraft Joystick	39
Par. Printer Cable	24

### USI

Paradise	\$ 299
----------	--------

### PIPELINE

Color Card	\$ 189
------------	--------

### VUTEK

Color Card w/Par. & Ser. Ports	\$ 249
--------------------------------	--------

### PC PEACOCK

Color board w/Par.	\$ 219
--------------------	--------

# The Source!



ORDER DESK:  
(213) 320-6822  
(800) 841-0905  
(OUTSIDE CALIFORNIA)

MAIL ORDER & WAREHOUSE:  
20317 Western Avenue  
Torrance, CA 90501



# DoKay

COMPUTER  
PRODUCTS,  
Inc.

ORDER TOLL FREE

(800)  
538-8800

(CALIFORNIA RESIDENTS)

(800)  
848-8008



## STATIC RAMS

2101	256 x 4 (450ns)	1.90
5101	256 x 4 (450ns) (cmos)	3.80
2102-1	1024 x 1 (450ns)	.88
2102L-4	1024 x 1 (450ns) (LP)	.98
2102L-2	1024 x 1 (250ns) (LP)	1.45
2111	256 x 4 (450ns)	2.45
2112	256 x 4 (450ns)	2.95
2114	1024 x 4 (450ns)	.99
2114-25	1024 x 4 (250ns)	1.10
2114L-4	1024 x 4 (450ns) (LP)	1.20
2114L-3	1024 x 4 (300ns) (LP)	1.30
2114L-2	1024 x 4 (200ns) (LP)	1.40
2125	1024 x 1	2.48
2147	4096 x 1 (55ns)	4.90
TMS4044-4	4096 x 1 (450ns)	3.45
TMS4044-3	4096 x 1 (300ns)	3.95
TMS4044-2	4096 x 1 (200ns)	4.45
MK4118	1024 x 8 (250ns)	9.90
TMM2016-200	2048 x 8 (200ns)	4.10
TMM2016-150	2048 x 8 (150ns)	4.90
TMM2016-100	2048 x 8 (100ns)	6.10
HM6116-4	2048 x 8 (200ns) (cmos)	4.70
HM6118-3	2048 x 8 (150ns) (cmos)	4.90
HM6116-2	2048 x 8 (120ns) (cmos)	8.90
HM6116LP-4	2048 x 8 (200ns) (cmos) (LP)	5.90
HM6116LP-3	2048 x 8 (150ns) (cmos) (LP)	6.90
HM6116LP-2	2048 x 8 (120ns) (cmos) (LP)	9.95
Z-6132	4096 x 8 (300ns) (Qstat)	33.95
HM6264P-15	8192 x 8 (150ns) (cmos)	38.95
HM6264LP-15	8192 x 8 (150ns) (cmos)	48.95

LP = Low Power Qstat = Quasi-Static

## DYNAMIC RAMS

TM84027	4096 x 1 (250ns)	1.95
UPD411	4096 x 1 (300ns)	2.95
MM5280	4096 x 1 (300ns)	2.95
MK4108	8192 x 1 (200ns)	1.90
MM5298	8192 x 1 (250ns)	1.80
4116-200	16384 x 1 (200ns)	.79
4116-150	16384 x 1 (150ns)	1.20
2118	16384 x 1 (150ns) (5v)	4.90
4164-250	65536 x 1 (250ns)	4.45
4164-200	65536 x 1 (200ns) (5v)	5.45
4164-150	65536 x 1 (150ns) (5v)	6.45

5V = Single 5 Volt Supply

## EPROMS

1702	256 x 8 (1µs)	4.45
2708	1024 x 8 (450ns)	2.49
2758	1024 x 8 (450ns)	2.49
2758	1024 x 8 (450ns) (5v)	5.90
2716	2048 x 8 (450ns) (5v)	2.95
2716-1	2048 x 8 (360ns) (5v)	5.90
TMS2516	2048 x 8 (450ns) (5v)	5.45
TMS2716	2048 x 8 (450ns) (5v)	7.90
TMS2532	4096 x 8 (450ns) (5v)	5.90
2732	4096 x 8 (450ns) (5v)	4.45
2732-250	4096 x 8 (250ns) (5v)	8.45
2732-200	4096 x 8 (200ns) (5v)	11.45
2764	8192 x 8 (450ns) (5v)	8.45
2764-250	8192 x 8 (250ns) (5v)	7.45
2764-200	8192 x 1 (200ns) (5v)	16.45
TMS2564	8192 x 8 (450ns) (5v)	14.45
MC68764	8192 x 8 (450ns) (5v) [24 pin]	38.95
27128	16384 x 8 Call	24.46

5v = Single 5 Volt Supply

## 74LS00

74LS00	.23	74LS173	.68
74LS01	.24	74LS174	.54
74LS02	.24	74LS175	.54
74LS03	.24	74LS181	2.10
74LS04	.23	74LS189	8.90
74LS05	.24	74LS190	.88
74LS08	.27	74LS191	.88
74LS09	.28	74LS192	.78
74LS10	.24	74LS193	.78
74LS11	.34	74LS194	.68
74LS12	.34	74LS195	.68
74LS13	.44	74LS196	.78
74LS14	.58	74LS197	.78
74LS15	.34	74LS221	.88
74LS20	.24	74LS240	.94
74LS21	.28	74LS241	.98
74LS22	.24	74LS242	.98
74LS26	.28	74LS243	.98
74LS27	.28	74LS244	1.25
74LS28	.34	74LS245	1.45
74LS30	.24	74LS247	.74
74LS32	.28	74LS248	.98
74LS33	.54	74LS249	.98
74LS37	.34	74LS251	.58
74LS38	.34	74LS253	.58
74LS40	.24	74LS257	.58
74LS42	.48	74LS258	.58
74LS47	.74	74LS259	2.70
74LS48	.74	74LS260	.58
74LS49	.74	74LS266	.54
74LS51	.24	74LS273	1.45
74LS54	.28	74LS275	3.30
74LS55	.28	74LS279	.48
74LS63	1.20	74LS280	1.95
74LS73	.38	74LS283	.68
74LS74	.34	74LS290	.88
74LS75	.38	74LS293	.88
74LS76	.38	74LS295	.98
74LS78	.48	74LS298	.88
74LS83	.59	74LS299	1.70
74LS85	.68	74LS323	3.45
74LS86	.38	74LS324	1.70
74LS90	.54	74LS352	1.25
74LS91	.88	74LS353	1.25
74LS92	.54	74LS363	1.30
74LS93	.54	74LS364	1.90
74LS95	.74	74LS365	.48
74LS96	.88	74LS366	.48
74LS107	.38	74LS367	.44
74LS109	.38	74LS368	.44
74LS112	.38	74LS373	1.35
74LS113	.38	74LS374	1.35
74LS114	.38	74LS377	1.35
74LS122	.44	74LS378	1.13
74LS123	.78	74LS379	1.30
74LS124	2.85	74LS385	1.85
74LS125	.48	74LS386	.44
74LS126	.48	74LS390	1.15
74LS132	.58	74LS393	1.15
74LS133	.58	74LS395	1.15
74LS136	.38	74LS399	1.45
74LS137	.98	74LS424	2.90
74LS138	.54	74LS447	.36
74LS139	.54	74LS490	1.90
74LS145	1.15	74LS624	3.95
74LS147	2.45	74LS640	2.15
74LS148	1.30	74LS645	2.15
74LS151	.54	74LS668	1.65
74LS153	.54	74LS669	1.85
74LS154	1.85	74LS670	1.45
74LS155	.68	74LS674	9.60
74LS156	.68	74LS682	3.15
74LS157	.64	74LS683	3.15
74LS158	.58	74LS684	3.15
74LS160	.68	74LS685	3.15
74LS161	.64	74LS688	2.35
74LS162	.68	74LS689	3.15
74LS163	.64	74LS783	23.95
74LS164	.68	81LS95	1.45
74LS165	.94	81LS96	1.45
74LS166	1.90	81LS97	1.45
74LS168	1.70	81LS98	1.45
74LS169	1.70	25LS2521	2.75
74LS170	1.45	25LS2569	4.20

## 7400

7400	.18	7482	.94	74172	5.90
7401	.18	7483	.49	74173	.74
7402	.18	7485	.58	74174	.88
7403	.18	7486	.34	74175	1.75
7404	.18	7489	2.10	74176	.88
7405	.24	7490	.34	74177	.74
7406	.28	7491	.39	74178	1.10
7407	.28	7492	.49	74179	1.70
7408	.23	7493	.34	74180	.74
7409	.18	7494	.64	74181	2.20
7410	.18	7495	.54	74182	.74
7411	.24	7496	.69	74184	1.95
7412	.29	7497	2.70	74185	1.95
7413	.34	74100	1.70	74190	1.10
7414	.48	74107	.29	74191	1.10
7416	.24	74109	.44	74192	.78
7417	.24	74110	.44	74193	.78
7420	.18	74111	.54	74194	.84
7421	.34	74116	1.50	74195	.84
7422	.34	74120	1.15	74196	.78
7423	.28	74121	.28	74197	.74
7425	.28	74122	.44	74198	1.34
7426	.28	74123	.48	74199	1.34
7427	.28	74125	.44	74221	1.34
7428	.44	74126	1.44	74246	1.34
7430	.18	74128	.54	74247	1.24
7432	.28	74132	.44	74248	1.80
7433	.44	74136	.49	74249	1.90
7437	.28	74141	.64	74251	.74
7438	.28	74142	2.90	74259	2.20
7440	.18	74143	2.90	74265	1.30
7442	.48	74145	.59	74273	1.90
7443	.64	74147	1.75	74276	1.20
7444	.68	74148	1.75	74279	.74
7445	.68	74150	1.30	74283	1.95
7446	.68	74151	.54	74284	3.70
7447	.68	74152	.64	74285	3.70
7448	.68	74153	.54	74290	.94
7450	.18	74154	1.20	74293	.74
7451	.22	74155	.74	74298	.84
7453	.22	74156	.64	74351	2.20
7454	.22	74157	.54	74365	.64
7460	.22	74159	1.60	74366	.64
7470	.34	74160	.88	74367	.64
7472	.28	74161	.68	74368	.64
7473	.33	74162	.84	74376	2.15
7474	.32	74163	.68	74390	1.70
7475	.44	74164	.84	74393	1.30
7476	.34	74165	.84	74425	3.10
7480	.58	74166	.95	74426	.84
7481	1.05	74167	2.90	74490	2.50
		74170	1.60		

## 6500

1 Mhz	
6502	4.90
6504	6.90
6505	8.90
6507	9.90
6520	4.30
6522	6.90
6532	9.90
6545	21.50
6551	10.85

## 6800

68000	58.95
6800	3.90
6802	7.90
6808	12.90
6809E	18.95
6809	10.95
6810	2.90
6821	3.20
6828	13.95
6840	11.95
6843	33.95
6844	24.95
6845	13.95
6847	10.95
6850	3.20
6852	15.70
6860	9.90
6862	10.95
6875	6.90
6880	2.20
6883	21.95
68047	23.95
68488	18.95

## 2 Mhz

6502A	6.90
6522A	9.90
6532A	10.95
6545A	26.95
6551A	10.95

## 3 Mhz

6502B	9.90
-------	------

## 1 Mhz

68800	9.95
68802	21.25
68809E	28.95
68809	28.95
68810	6.90
68821	6.90
68845	18.95
68850	5.90

## 74S00

74S00	.31	74S163	1.90
74S02	.34	74S168	3.90
74S03	.34	74S169	3.90
74S04	.34	74S174	.94
74S05	.34	74S175	.94
74S08	.34	74S181	3.90
74S09	.39	74S182	2.90
74S10	.34	74S188	1.90
74S11	.34	74S189	6.90
74S15	.34	74S194	1.44
74S20	.34	74S195	1.44
74S22	.34	74S196	1.44
74S30	.34	74S197	1.44
74S32	.39	74S201	6.90
74S37	.87	74S225	7.90
74S38	.84	74S240	2.15
74S40	.34	74S241	2.15
74S51	.34	74S244	2.15
74S64	.39	74S251	.94
74S65	.39	74S253	.94
74S74	.49	7	



### DISC CONTROLLERS

1771	14.95	2797	84.95
1791	23.95	6843	33.95
1793	25.95	8272	38.95
1795	48.95	UPD765	38.95
1797	48.95	M88876	28.95
2791	79.95	M88877	33.95
2793	79.95	1691	16.95
2795	84.95	2143	17.95

### CRYSTALS

1.0000 MHz	3.99	8.0000 MHz	2.69
1.8432 MHz	3.99	10.0000 MHz	2.69
2.0000 MHz	2.99	10.7386 MHz	2.69
2.0972 MHz	2.69	12.0000 MHz	2.69
2.4576 MHz	2.69	14.3182 MHz	2.69
3.2768 MHz	2.69	15.0000 MHz	2.69
3.5795 MHz	2.69	16.0000 MHz	2.69
4.0000 MHz	2.69	17.4300 MHz	2.69
4.1943 MHz	2.69	18.0000 MHz	2.69
4.9160 MHz	2.69	18.4320 MHz	2.69
5.0000 MHz	2.69	19.8608 MHz	2.69
5.0688 MHz	2.69	20.0000 MHz	2.69
5.1850 MHz	2.69	22.1184 MHz	2.69
5.2429 MHz	2.69	32.0000 MHz	2.69
5.7143 MHz	2.69	36.0000 MHz	2.69
6.0000 MHz	2.69	48.0000 MHz	2.69
6.1440 MHz	2.69	49.4350 MHz	2.69
6.4000 MHz	2.69	49.8900 MHz	2.69
6.5536 MHz	2.69		

32.768 KHz. .... 1.69

### CRYSTAL CLOCK OSCILLATORS

PART NO.	FREQUENCY	PRICE
1.000	1.0000 MHz	9.95
1.843	1.8432 MHz	9.95
2.000	2.0000 MHz	9.95
4.000	4.0000 MHz	9.95
8.000	8.0000 MHz	9.95
10.000	10.0000 MHz	9.95
16.000	16.0000 MHz	9.95
18.432	18.4320 MHz	9.95
19.860	19.8608 MHz	9.95
20.000	20.0000 MHz	9.95
32.000	32.0000 MHz	9.95

### VOLTAGE REGULATORS

7805T	.74	7905T	.84
78M05C	.34	7908T	.84
7808T	.74	7912T	.84
7812T	.74	7915T	.84
7815T	.74	7924T	.84
7824T	.74	7905K	1.44
7805K	1.34	7912K	1.44
7812K	1.34	7915K	1.44
7815K	1.34	7924K	1.44
7824K	1.34	79L05	.78
78L05	.68	79L12	.78
78L12	.68	79L15	.78
78L15	.68	LM323K	4.90
78H05K	9.90	UA7884D	1.90
78H12K	9.90		

C,T = TO-220 K = TO-3  
L = TO-92

### DIP SWITCHES

4 POSITION	.84
5 POSITION	.89
6 POSITION	.89
7 POSITION	.94
8 POSITION	.94

### IC SOCKETS

(1 to 99)

8 pin ST	.12	8 pin WW	.58
14 pin ST	.14	14 pin WW	.58
16 pin ST	.16	16 pin WW	.58
18 pin ST	.19	18 pin WW	.98
20 pin ST	.28	20 pin WW	1.04
22 pin ST	.29	22 pin WW	1.34
24 pin ST	.29	24 pin WW	1.44
28 pin ST	.39	28 pin WW	1.64
40 pin ST	.48	40 pin WW	1.94

ST = Solderetail WW = Wirewrap

### ZIF SOCKETS

16 pin ZIF	5.90
24 pin ZIF	7.90
28 pin ZIF	8.90

ZIF = TEXTTOOL (Zero Insertion Force)

1984

**- THE IC MASTER -**  
Your ticket to fast and  
easy IC selections  
**\$ 89.95**

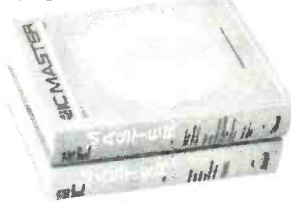

**IBM Expansion KIT**  
Upgrade Chips

4164 200ns 9 @ 5.45 ea.

micromax

**VIEWMAX-80 149.95**

- 80 Column card for Apple II+
- Video Soft Switch
- Inverse Video
- 2 Year Warranty



**VIEWMAX-80e 129.95**

- 80 Column card for Apple IIE
- 64K RAM expandable to 128K

**64K RAM Upgrade 43.60**



**QUV-T8/1**  
**EPROM Eraser**

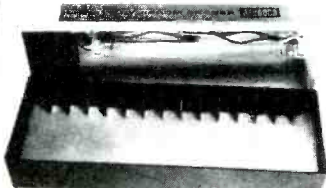

**QUV-T8/1 Economy Model:**

Low cost EPROM eraser in plastic enclosure. The UV element is in the lid and you place the EPROMS in the bottom half. No timer or switch option.

- Erases up to 8 EPROMS in 15 - 20 minutes.
- 12,000 uWatts at 1" distance.
- 90-Day Warranty **49.95**

**The FLIP SORT™**

The new Flip Sort™ has all the fine qualities of the original with some added benefits: a new design and 50% greater capacity. Holds 75 diskettes and the price is now lower than ever— **\$16.95**



**ATHANA BULK 5 1/4" DISKETTES (NO LABEL)**

SS/SD ... 15.90  
SS/DD ... 16.90  
DS/DD ... 22.90  
100 up — CALL

### APPLE ACCESSORIES

80 Column Apple II+ ... 149.95  
80 Column Apple IIE ... 129.95  
Z80 Apple II+ ... 89.00  
Z80 Apple IIE ... 89.00  
16K Card ... 39.95  
Cooling Fan ... 38.95  
Power Supply ... 74.95  
Joystick ... 29.95  
RF Modulator ... 13.95  
Disk Drive ... 199.00  
Controller Card ... 59.95

### APPLE COMPATIBLE DISK DRIVE

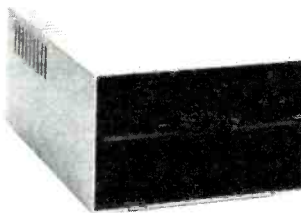

**199.00**

- Shugart mechanism, made in U.S.A.
- Directly replaces Apple Disk II
- Fully compatible with Apple Controller or other Apple compatible controllers.
- One Year Warranty

**CONTROLLER CARD... 59.95**

### COOLING FAN

**38.95**



### APPLE COMPATIBLE POWER SUPPLY

**74.95**



- Powers Apple type systems
- +5V @ .5A +12V @ .3A  
-5V @ .5A -12V @ .5A
- includes instructions

**The Flip Sort PLUS™**

The new Flip Sort PLUS™ adds new dimensions to storage. Its smoked acrylic elegance holds over 100 diskettes with all the features you expect from the Flip Sort Family— **\$24.95**



### APPLE COMPATIBLE JOYSTICK

**29.95**



**16K RAM Card - Apple II+**  
• 2-Year Warranty



Assembled & Tested ... **39.95**  
For the **APPLE HOBBIEIST**  
**DoKay KITS:**

16K RAM card ... 24.95  
80 Column Card II+ ... 89.95  
Z80 Card ... 69.95  
Printer Card ... 24.95  
80 Column Card IIE ... 89.95

### KEYBOARD (99/4)

**48 keys 4" x 10" 6.95**



### Reg. Power Supply Model 4A/PS (99/4)

**3 DC Outputs:**

12V @ .4A, +5V @ 1.1A  
-5V @ .2A Highly Filtered

**6.95**



**TERMS:** Minimum order \$10.00.

For shipping and handling, include \$2.50 for UPS ground or \$3.50 for UPS Blue (air). For each additional air pound, add \$1 for UPS Blue shipping and handling. California residents must include 6% sales tax. Bay area and LA residents include 6 1/2% sales tax. Prices are subject to change without notice. We are not responsible for typographical errors. We reserve the right to limit quantities and to substitute manufacturers. All merchandise subject to prior sale.

### CALL FOR VOLUME Quotes

**HOURS:** Mon - Fri 7:30 to 5:00  
Saturdays 10:00 to 3:00

VISIT OUR RETAIL STORE

2100 De La Cruz Blvd  
Santa Clara, CA 95050  
(408) 988-0697

**ALL MERCHANDISE IS 100% GUARANTEED**

**Telex: 756440**

**DoKay**



## PERIPHERAL SWITCH

### AUTOMATIC SWITCHES FOR IBM PC

Fast, easy, automatic way to share a printer or modem among many computers. **No software required.** RS232 or centronics. It scans for peripheral request, connects to the peripheral, handles all hardware handshaking, and releases the port. LEDs display channel selected and busy status. Attractive aluminum box. # channels-price:

2-\$200 4-\$250 6-\$300 8-\$350

### MANUAL SWITCHES FOR IBM PC

Uses PC board and aluminum box. # lines switched RS232-10 Cent-20

RS232 1:2 \$59(wow) 1:4 \$89  
Centronics 1:2 \$99 1:4 \$179

Free book with each order entitled *Serial and Parallel Explained*

**ROSE ELECTRONICS** MC AND VISA  
P.O. Box 742571 Houston, Tx 77274 (713)240-ROSE

Circle 316 on inquiry card.

## PAL, EPROM PROGRAMMERS & UV ERASERS FROM \$49.95

### LOGICAL DEVICES INC.

*Where Reliability and Customer Support is of utmost Importance*

SEE OUR AD ON PAGE 32

# LOGICAL

ORDER TOLL FREE  
**1-800-EEI-PROM**  
(1-800-331-7766)

Circle 203 on inquiry card.



## SAVE MORE THAN EVER ON 3M Scotch® DISKETTES

**\$163** ea 5 1/4" SSDD **\$217** ea 5 1/4" DSDD  
Qty. 20 Qty. 20

LIFETIME WARRANTY!

5 1/4" SSDD-96TPI \$2.42 ea 5 1/4" DSDD-96TPI \$3.05 ea  
8" SSDD \$2.05 ea 8" SSDD \$2.50 ea  
8" DSDD \$3.10 ea

All diskettes are boxed in 10's with Tyvek sleeves, reinforced hubs on 5 1/4" user identification labels and write-protect tabs  
Shipping: 5 1/4" DISKETTES—Add \$3.00 per 100 or fewer diskettes  
8" DISKETTES—Add \$4.00 per 100 or fewer diskettes Payment: VISA and MASTERCARD accepted. COD orders only, add \$3.00 handling charge Taxes: Illinois residents only, add 8% sales tax.

WE WILL BEAT ANY NATIONALLY ADVERTISED PRICE ON THE SAME PRODUCT AND QUANTITIES!

For orders only: **1-800-621-6827**  
(In Illinois: **1-312-944-2788**)  
(All other calls: **1-312-944-2788**)  
Hours: 9AM-5PM Central, Mon.-Fri.

**DISK WORLD!, Inc.**

Suite 4806 • 30 East Huron Street • Chicago, Illinois 60611

DISK WORLD!

Authorized Distributor  
Information Processing  
Products



Circle 111 on inquiry card.

NOW INCLUDES TINY BASIC FORTH AVAILABLE

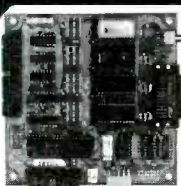

## SIBEC 51 8051/52 DEVELOPMENT BOARD

8051-Based Single-Board Computer with Monitor/Debugger

■ 4 28-pin byte-wide sockets; monitor will program EEPROMS.  
■ Perfect for System Development and Educational Applications

**\$335**

Binary Technology

P.O. BOX A-59 • HANOVER, NH 03755 • 603/643-2881

Circle 38 on inquiry card.

## GILTRONIX SWITCHES ARE THE BEST CHOICE.

... and here are 10 good reasons why:

### IBM PC



1. Serial (RS232) or Parallel (Centronics)
2. Prompt Deliveries
3. Nationally Advertised Products
4. Broad Product Line
5. Over 30,000 Units Sold to Date
6. Sales and Technical Support

### APPLE



7. FCC Approved Units
8. Manual and Automatic Units
9. Highest Quality PC Board Switch Technology
10. Buy Direct From Giltronix, or From Any Authorized Distributor

Manual Units—2 to 6 Ports  
Automatic Units—3 to 15 Ports

Apple is a registered trademark of Apple Computer, Inc.  
IBM is a registered trademark of International Business Machines Corporation.



3780 Fabian Way  
Palo Alto, CA 94303  
(415) 493-1300

ORDER HOT-LINE: 1-800-531-1300 (Outside of California)

Circle 143 on inquiry card.

## IBM PC & COMPATIBLES COMPAQ & COMPATIBLES INTERNAL 10MB HARD DISK

W/ WESTERN DIGITAL Controller  
No change in BIOS, Boot from hard disk, Simple to install like a floppy, DOS 2.0. 1 Year factory warranty, tested & formatted, several installed. Complete kit \$895

Additional 10 MB hard disk \$600;  
Fixed + Removable HD (10MB) -\$CALL  
Hard disk + Tape backup -\$CALL

MOTOROLA 64K .. \$49.00  
JUKI Printer . . . . . \$CALL

### SRI DATA SYSTEMS

10 S. Route 17, Paramus, NJ 07652  
(201) 684-4518 Visa, MC, Check, COD

Circle 339 on inquiry card.

## AFFORDABLE M-68000 COMPUTER SYSTEM



**M68KCPU** 6-10 MHz CPU, 20K static RAM, 16K EPROM, on board monitor, two RS-232 Serial ports, 16-bit parallel port, 5 timer/counters expansion bus.

Bare board..... \$ 99.95  
Complete Kit..... \$595.00

**MDS12K** 128-512K static RAM, floppy disk controller & hard disk interface Bare board..... \$ 99.95  
Complete Kit (128K)..... \$725.00

**M68KE** Enclosure with power supply, fan, filter, 4 slot card cage..... \$249.00

**M68KASM** M68000 Macro Cross Assembler for CP/M80, IBM PC, TRS-80 and Apple II computers..... \$199.00

UPS shipping & handling \$ 4.00

COD orders add \$ 3.00

Foreign orders add \$20.00

California residents add 6.5% tax

**EMS** Educational Microcomputer Systems (714) 553-0133  
P.O. Box 16115 • Irvine, CA 92713

Circle 125 on inquiry card.

## SPECTACULAR LOWEST PRICES 3M DISKETTES LIFETIME WARRANTY

**\$168** ea 5 1/4" SS/DD \$219 ea 5 1/4" DS/DD  
Qty 20 (744) Qty 20 (745)

5 1/4" SS/QD/96TPI... \$2.55  
5 1/4" DS/QD/96TPI... \$3.20  
8" SS/SD \$2.00  
8" SS/DD \$2.45  
8" DS/DD \$2.95

1-800-328-3472

Dealer inquiries invited. COD's and charge cards accepted. All orders shipped from stock within 24 hrs.



**North Hills Corporation**  
3564 Rolling View Dr.  
White Bear Lake, MN 55110  
MN Call Collect 1-612-770-0485

DIGITAL RESEARCH • SORCIM •  
ASHTON-TATE • MICROSOFT • MICROPRO

*Selection*

*Service*

*Savings*

*Simply The Best!*

**Crystal Software**

P.O. Box 4135 W.N.Y. N.J. 07093  
1-800-932-0627  
*New Jersey*  
1-800-624-0799

Circle 48 on Inquiry card.

# IBM PRICES SLASHED!

• HARD DISKS • DISK DRIVES • RAM KITS • NETWORKS

## NEW! FROM JADE IBM Multifunction Card

Up to 384K, parallel printer port, RS-232 serial port. FREE serial cable, clock/calendar, RAM Disk/spooler and diagnostic software package

	LIST	JADE SALE
0K	349	198.95
64K	449	243.90
256K	549	372.90
384K	649	458.90

## AST For IBM PC

	LIST	JADE
SIX PAK PLUS 64K	395	269.95
SIX PAK PLUS 256K	695	489.95
SIX PAK PLUS 384K	945	589.95

MEGA PLUS 64K	395	269.95
MEGA PLUS 256K	665	429.95
MEGA PLUS 512K	1095	799.95

I/O PLUS	165	119.95
----------	-----	--------

MP PLUS 64K	295	199.95
MP PLUS 128K	395	249.95
MP PLUS 192K	495	299.95
MP PLUS 256K	595	349.95

MP II 64K	345	249.95
MP II 128K	445	299.95
MP II 192K	545	349.95
MP II 256K	645	399.95
MP II 384K	845	499.95

## 10 MEGABYTE HARD DISK For IBM PC

Plug-n-Run, ready to go, complete with controller card, data cable, and mounting hardware, totally PC/XT compatible, faster than XT, handles 4 different operating systems, streamer tape back-up available. External model includes cabinet & power supply

	LIST	JADE
10 mbyte internal	1795	899.95
10 mbyte external	2095	999.95
15 mbyte internal	1995	1299.95
15 mbyte external	2295	1399.95
22 mbyte internal	2495	1699.95
22 mbyte external	2795	1799.95

## HI-RES MONITORS

	LIST	JADE
AMDEK 300G	179	139.95
AMDEK 310A	230	179.95
AMDEK 300A	199	149.95
AMDEK COLOR I	379	249.95
AMDEK COLOR II	559	419.95
AMDEK COLOR IV	995	499.95
PGS MAX-12	269	199.95
PGS HX-12	699	469.95
PGS SR-12	799	649.95
QUADCHROME	795	499.95
COMREX CR6800	649	499.95

## KEYTRONICS KEYBOARDS

	LIST	JADE
KEYTRONICS KEYBOARD	209	159.95

## HIGH SPEED 8087 APU

List Price 293 SALE PRICE 199.95

## COLOR PLUS—Vutek

Multifunction display adapter, fully hardware and software compatible with IBM PC. Provides color graphics, parallel printer port and async. serial port. The 640 x 200 resolution graphics operates in both RGB color or composite video modes. Backed by two year warranty.

	LIST	JADE
COLOR PLUS	449	395.00

## 320K DISK DRIVES For IBM PC

Double-sided, double-density

TANDON 100-2	169.00 each
TEAC 55B	\$149.00 each

## SOFTWARE For IBM PC

	LIST	JADE
MICROSOFT WORD	395	249.95
R-BASE 4000	495	319.95
SMART KEY	89	69.95
MOVE-IT	125	89.95
MULTIPLAN	250	169.95
ACCOUNTING PARTNER	395	249.95
CROSSTALK	195	129.95
PROKEY	129	99.95
MULTIMATE	495	299.95
SUPERCALC III	395	249.95
TRANSEND PC	189	139.95

## MICROSOFT For IBM PC

	LIST	JADE
MOUSE w/WORD	495	339.95
MOUSE	199	129.95
SYSTEM CARD 64K	395	279.95
SYSTEM CARD 256K	625	429.95

## LOCAL AREA NETWORKS For IBM PC

	LIST	JADE
QUADNET II	995	879.95
QUADNET VI	1995	1659.95
QUADNET IV	2295	1989.95
AST-PC net II	495	399.95
ORCHID TECHNOLOGY	595	499.95

## DISKETTES For IBM PC

High quality double-sided, double-density diskettes, certified to be absolutely error free. Box of 10, warranted for one year

	LIST	JADE
Box of 10 w/FREE plastic case	39	19.95

## IBM VIDEO BOARDS

	LIST	JADE
HERCULES COLOR	245	189.95
HERCULES GRAPHIC	499	339.95
PLANTRONICS COLOR PLUS	549	379.95
QUADCOLOR I	295	209.95
QUADCOLOR II	275	209.95
AMDEK MAI	649	449.95
AST MONOGRAPH PLUS	595	449.95

## 64K RAM UPGRADE For IBM PC

High speed RAM upgrade kit with FREE! parity (error detection) and one year warranty

	LIST	JADE
64K KIT For IBM PC	90	44.95
128K KIT For IBM PC	180	88.95
192 KIT For IBM PC	270	131.95
256K KIT For IBM PC	360	173.95
384K KIT For IBM PC	540	259.95

## QUADRAM For IBM PC

	LIST	JADE
QUADBOARD No RAM	269	234.95
QUADBOARD 64K	395	275.95
QUADBOARD 128K	495	339.95
QUADBOARD 256K	595	399.95
QUADBOARD 384K	795	595.95
QUADLINK	680	449.95
QUAD 512 PLUS 64K	325	239.95
QUAD 512 PLUS 256K	550	389.95
QUAD 512 PLUS 512K	895	549.95
QUADCOLOR I	295	209.95
QUADCOLOR II	275	199.95

We accept cash, checks, credit cards, or purchase orders from qualified firms and institutions. Minimum prepaid order \$15.00 California residents and 6½% tax. Export customers outside the U.S. or Canada please add 10% to all prices. Prices and availability subject to change without notice. Shipping and handling charges via UPS Ground 50c/lb. UPS Air \$1.00/lb. minimum charge \$3.00 Prices quoted are for pre-paid orders only.

4901 West Rosecrans Ave, Hawthorne, California 90250

Circle 183 on inquiry card

Continental U.S.  
800/421-5500

Inside California  
800/262-1710



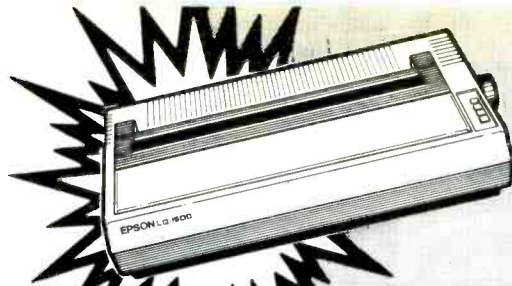

**NEW! EPSON  
LQ-1500  
200 CPS &  
letter quality!**

24 pin head, 200 CPS draft mode, 67 CPS letter quality mode

LQ-1500	_____	SAVE 200.00
	LIST	JADE
TRACTOR	_____	89 54.95
SHEET FEEDER	_____	499 439.95

**EPSON  
Call us for our best price!**

EPSON RX-80 100 CPS w/tractor, graphics  
CALL FOR BEST PRICE

EPSON RX-80FT 100 CPS w/FREE graphics Friction & tractor feed	_____	SAVE 150.00
EPSON MX-80FT 80 CPS w/FREE graphics Friction & tractor feed	_____	SAVE 150.00
EPSON FX-80 160 CPS w/FREE graphics Friction & tractor feed	_____	SAVE 150.00
EPSON FX-100 160 CPS 15 inch platten Friction & tractor feed	_____	SAVE 150.00

Apple IIc or Macintosh Universal serial interface  
4K buffer, x-on, x-off \_\_\_\_\_ 119.95

**OKIDATA  
Prices slashed!**

**FREE\*  
IBM  
ROMS**

<b>160 CPS, Correspondence Quality</b>	LIST	JADE
OKI 92 parallel	599	409.95*
OKI 93 parallel FREE tractor	995	649.95*
2K serial board	120	99.95
IBM PC ROMS for 92	59	49.95
IBM PC ROMS for 93	69	59.95
Extra 82/93 Ribbons (2)	19	9.95
82/92 tractor	89	54.95

**120 CPS & 200 CPS OKIDATAS**

OKI 82 120 CPS	499	299.95
OKI 83 120 CPS	775	569.95
OKI 84 parallel 200 CPS	1395	849.95*
OKI 84 serial 200 CPS	1495	999.95
2K serial board	150	119.95
IBM PC ROMS for 82/83	49	39.95
IBM PC ROMS for 84	99	89.95

**350 CPS, Near Letter Quality,  
High-Resolution Graphics**

OKI 2350 parallel	2695	1899.95
OKI 2350 serial	2775	1999.95

\* FREE Plug-n-Play option with purchase of 92, 93, or 84

**A-B PRINTER SWITCH**

Allows your computer to run either of two printers. Standard parallel switch box

	LIST	JADE
Printer Switch	149	89.95
Extra Cable	40	29.95

*Super  
Prices  
on  
Printers*

**LETTER QUALITY  
PRINTERS ON SALE!**

	LIST	JADE
Diablo 630 40 CPS	2340	1699.95
Tractor for 630	250	219.95
Starwriter F-10 40 CPS	1895	999.95
Starwriter F-10 55 CPS	1995	1299.95
Tractor for F-10	250	219.95
Comrex CR-II 5K parallel	599	489.95
Comrex CR-II 5K serial	644	589.95
Tractor for CR-II	120	99.95
Keyboard for CR-II	199	179.95
Sheet feeder for CR-II	259	199.95
Silver Reed 500 14 CPS	599	499.95
Tractor for 500	149	124.95
Silver Reed 550 18 CPS	699	599.95
Tractor for 500	159	129.95
Silver Reed 770	1295	999.95
Tractor for 770	159	139.95
Juki 6100 18 CPS	599	449.95
Tractor for 6100	149	124.95
NEC 3550 33 CPS	2250	1699.95
Tractor for 3550	265	229.95

**TOSHIBA P1351  
High speed & letter quality!**

High quality 24 pin head, 192 CPS draft mode,  
96 CPS letter quality

	LIST	JADE
P1351	1895	1299.95
TRACTOR	195	174.95
SHEET FEEDER	1095	899.95

**PRINTER ACCESSORIES**

	LIST	JADE
IBM PC style cable	54	28.95
STANDARD parallel cable	40	28.95
APPLE Card & Cable	109	49.95
TRS-80 MDL-3 cable	109	49.95
COLUMBIA MPC cable	50	39.95
RS-232 serial cable	30	24.95
PRINTER stands	AS LOW AS	19.95
RIBBONS	AS LOW AS	4.99

**NEW! 80 CPS DIABLO  
daisywheel printer**

80 CPS, serial and parallel interfaces,  
extended character set, fully IBM  
compatible, built-in buffer, computerized  
front panel

**FREE AUTOMATIC  
DUAL BIN SHEET FEEDER!**

	LIST	JADE
DIABLO 80 CPS	3495	2995.00
CABLE Specify	70	59.95

**MICROFAZER BUFFERS  
Quadram**

Expandable to 64K (parallel model expands to  
512K)

<b>Parallel in/Parallel out</b>	LIST	JADE
8K	169	139.95
32K	225	164.95
128K	445	269.95

<b>Serial in/Parallel out</b>	LIST	JADE
8K	199	169.95
32K	260	199.95

<b>Parallel in/Serial out</b>	LIST	JADE
8K	199	169.95
32K	260	199.95

<b>Serial in/Serial out</b>	LIST	JADE
8K	199	169.95
32K	260	199.95

**MICROBUFFER  
Practical Peripherals**

<b>Stand alone Microbuffers</b>	LIST	JADE
Parallel, 32K	299	229.95
Parallel, 64K	349	269.95
Serial, 32K	299	229.95
Serial, 64K	349	269.95
64K add-on board	179	149.00

**Microbuffers for Apple II**

Parallel, 16K	259	189.95
Parallel, 32K	299	229.95
Serial, 16K	259	189.95
Serial, 32K	299	229.95

**Microbuffers for Epson Printers**

Parallel, 16K	159	129.95
Serial, 8K	159	129.95

**STAR MICRONICS  
Lowest prices!**

GEMINI 10X \_\_\_\_\_ 269.95

Call for prices on Gemini 15X, Delta 10 & 15,  
Radix 10 & 15, Power Type LQ

**Continental USA  
800/421-5500**

**Los Angeles  
213/973-7707**

**Inside California  
800/262-1710**

Circle 184 on inquiry card.

**JADE  
Computer Products**

# WWW SUPER DISKETTE SPECIAL

Ultra-high quality diskettes from a premium U.S. manufacturer, certified to be error free for one year!  
Box of 10 w/FREE! case

JADE 16.95

# Fanon BW-12

## COMPLETE COMPUTER \$1095.

with FREE! SOFTWARE

4MHz Z-80A, 64K RAM, 9-inch hi-res non-glare amber monitor, composite video output, two 180K disk drives, full size 63 key keyboard with separate numeric keypad and 16 programmable function keys, speech synthesizer, two serial ports, centronics parallel printer port, bit mapped graphics, sculpted high-impact plastic case, only 26 lbs. (sale subject to FCC approval)

FANON BW-14 with twice the storage 1395.00



- ◀Wordstar
- ◀Mailmerge
- ◀Calcstar
- ◀Datastar
- ◀Reportstar
- ◀CP/M & BASIC
- ◀KAYPRO compatible
- ◀Speech Synthesizer

90 day warranty  
30 day exchange  
Local service through nationwide field service team.

### HAYES Smartmodem

Sophisticated direct-connect auto-answer/auto dial modem, touch tone or pulse dialing RS232C interface programmable

	LIST	JADE
Smartmodem 1200	699	475.00
1200B for IBM PC	599	399.95
Smartmodem 300	289	199.00
Hayes Cronograph	249	199.95
Micromodem 100	399	299.95
Micromodem IIe	299	239.95
PLEASE Software	395	299.95
Smartcom II	149	99.95

### AMDEK MONITORS

COLOR 4	499.95
COLOR I plus COMPOSITE VIDEO	249.95
COLOR II plus RGB VIDEO	419.95
300G, 12 inch GREEN	139.95
300A, 12 inch AMBER	149.95
310A, MONOCHROME AMBER	179.95

### PRINCETON GRAPHICS

PGS HX12, IBM copy	469.95
PGS SR-12, Hi-res COLOR	649.95
PGS MAX-12, 12 inch MONOCHROME	199.95
PGS DOUBLER BOARD	229.95

### ISOBAR

The ISOBAR looks like a standard multioutlet power strip but contains surge suppression circuitry and built-in noise filters, plus 15 amp circuit breaker

	LIST	JADE
4 receptacle	89	59.95
8 receptacle	99	69.95

Complete Computer under 400.00

### THE LITTLE BOARD with FREE! CP/M 2.2

Miniature single board CP/M computer designed to mount directly on top of a 5 1/4" floppy disk drive (7.75" x 5.75"). Contains Z 80A, CPU, 64K RAM, Boot Eprom, terminal port, modem port, parallel printer port, floppy disk controller, and CP/M 2.2 included FREE!

	LIST	JADE
Little Board with CP/M	400	348.95
Support package	50	48.95
Serial Cable	13	11.95
Diskless Monitor Eprom	30	24.95
190K Disk Drive	249	99.95
350K Disk Drive	399	149.95

### ULTRA-VIOLET EPROM ERASERS

Inexpensive erasers for industry or home

	LIST	JADE
Spectronics w/o timer	99	69.95
Spectronics with timer	139	94.95
Logical Devices	89	49.95

### DISK DRIVES

SIEMENS FDD 100-8 SS/DD	
List 399	149.00 ea 2 for 139.00 ea
SHUGART SA 801R SS/DD	
List 502	355.00 ea 2 for 349.00 ea
SHUGART SA-851R DS/DD	
List 605	459.00 ea 2 for 455.00 ea
TANDON TM 848-2 DS/DD thin-line	
List 599	439.00 ea 2 for 435.00 ea
NEC FD1165 DS/DD thin-line	
List 599	450.00 ea 2 for 440.00 ea

Handsome metal cabinet with proportionally balanced air flow system, rugged dual drive power supply, cable kit, power switch, line cord, fuse holder, cooling fan, neovermar rubber feet. All necessary hardware to mount two 8 inch disk drives, power supply, and fan. Does not include signal cable

Dual 8" Sub-Assembly Cabinet	LIST	JADE
Bare cabinet	75	49.95
Cabinet Kit	299	199.95
A & T	349	249.95

8" Sub-System—Single sided, double density		
Kit w/2 Siemens FD100-8Ds	950	479.00
A & T w/2 Siemens FD100-8Ds	995	529.00
Kit w/2 Shugart SA-801Rs	1195	939.00
A & T w/2 Shugart SA-801Rs	1295	969.00

8" Sub-Systems—Double sided, double density		
Kit w/2 Shugart SA-851Rs	1495	1199.00
A & T w/2 Shugart SA-851Rs	1595	1219.00

Dual 8" Slimline Cabinet	LIST	JADE
Bare Cabinet	75	59.95
A & T w/o drives	249	164.95
A & T w/2 DS/DD drives	1495	1099.00



### APPLE ACCESSORIES ON SALE!

	LIST	JADE
Full Height Disk Drive	299	179.95
Half Height Disk Drive	249	169.95
Controller	100	79.95
8 inch 2 Mbyte system	2495	1395.00
CP/M 3.0 Card	399	199.95
Z-Card with CP/M	169	119.95
16K RAM Card	99	39.95
Best 80 Column Card	219	139.95
Printer card & Cable	109	49.95
Fan w/surge protect	99	59.95
Koala Pad	125	89.95
Grappler Plus	175	119.95
Buffered Grappler/16K	245	175.95
Buffered Grappler/64K	345	239.95

### S-100 MAINFRAME

2 8 inch cut-outs	
6 SLOT	439.95
12 SLOT	499.95

### MEMORY BANK BARE BOARD

25.00 each 4 for 49.00

We have showrooms in—  
Los Angeles, Woodland Hills,  
Santa Ana, San Diego,  
Sunnyvale, and Dallas

(Prices will be slightly higher in our retail stores—  
But we're still the best deal in town!)

Serving Your Computer Needs Since 1975

# JADE

Computer Products

Circle 184 on inquiry card.



ORDER  
TOLL FREE

**800-345-7100**

[TOLL FREE NUMBER NOW IN SERVICE]

ORDERS INSIDE CALIF.  
& CUSTOMER SERVICE

**213-675-2115**

**Sav-On**

**Computers, Inc.**

WITH OUR FIRST CLASS SERVICE MATCHING OUR LOW PRICES, WE CAN'T BE BEAT

**COMPUTERS**

**SANYO**

MBC550	\$699
MBC550-2	1035
MBC555	Call
MBC555-2	1275

**COMPAQ**

PORTABLE [2 Dr. & 256K]	\$2385
COMPAQ +	2499
DESK TOP	Call

**IBM**

IBM 64K w/1 Drive	\$1525
IBM 256K w/2 Drives	1899
IBM PCXT	3795

**KAYPRO**

KAYPRO II	Call
KAYPRO II+	Call
KAYPRO 4+	1795
KAYPRO 10	2494

**DISK DRIVES**

**TANDON**

100-2	\$189
101-4	Call
55-2	195

**SHUGART**

SA455	\$219
SA456	229

**TEAC**

55B	\$149
55A	160
55F	199

**CDC**

9403	\$199
9403T	299

**DISK DRIVES**

**MATSUSHITA**

SLIMLINE	\$145
----------	-------

**MPI**

B52	\$189
-----	-------

**MICRO SCI**

A-2	\$199
-----	-------

**RANA SYSTEMS**

ELITE I	\$240
ELITE II	335
ELITE III	455

**DRIVE CONTROLLERS**

RANA [Controls 4]	\$89
MAYNARD	160
MAYNARD [w/Parallel Port]	210
MAYNARD [w/Serial Port]	230

**MONITORS**

**PRINCETON GRAPHICS**

HX12	\$469
SR12	649
MAX12	209

**IBM**

COLOR	Call
MONOCHROME	Call

**AMDEK**

300G	\$139
300A	159
310 [Monochrome]	179
COLOR IT [Composite Video]	279
COLOR II+ [RGB Video]	419

**ZENITH**

ZVM122	\$109
ZVM123	109

**BMC**

12AUW	Call
12EUN	Call
9191 [Color]	239

OTHER MONITORS AVAILABLE Call

**SPECIALS  
THIS MONTH ONLY**

**IBM PC**

(64K ONE DRIVE)

(always in stock) List \$1995

**Only \$1450**

**TEAK 55B ..... \$143.00**

(Call, we'll beat any advertised price)

**MEMORY UPGRADE**

"64K" ..... \$44.00

**HAYES 1200B**

**MODEM**

**Now Only \$389.00**

**SANYO 555-2 .. \$1260.00**

(with all software)

**TANDON 100-2**

**Now Only \$189.00**

**APPLE DISK DRIVE**

Fourth Dimension Super Drive II

40 Track Slimline ..... \$199.00

**MATH COPROCESSOR**

8087

**\$159.00**

**MODEMS**

**HAYES**

300	\$205
1200	488
1200B	399
MICROMODEM IIe	238

**NOVATION**

ACCESS 123	\$448
J-CAT	129

**RIXON**

PC212A	\$408
P212	408

**ANCHOR**

MARK VII 300	\$94
MARK XII 1200	268



## SOFTWARE BARGINS

### KAYPRO SOFTWARE

BPI SYS Accts Payable	\$457
BPI SYS Accts. Receivable	457
BPI SYS General Acct.	457

### IBM SOFTWARE

List 695 **YOUR CHOICE \$499 ea.**

- Open Systems • Job Cost • Payroll
- AP • AR • GL • Inventory
- Purchase Order Processing

### PEACH TREE

Accts Payable	\$599
Accts Receivable	599
General Ledger	599

## The Sav-On System

### IBM PC

- 2 Drives
- 256K
- Hayes 1200B Modem
- Hercules Mono Card
- Amdek 310A Monitor

System List \$3399

**Only \$2795** while they last

### NEW IBM AT BASE MODEL

- 256K • (1) 1.2M 5¼ Floppy
- Parallel & Serial Port

**\$3795.00**

### ENHANCED MODEL

- 512K • 20M Hard Disk
- (1) 1.2M 5¼ Floppy
  - Parallel & Serial Port
  - Seven Expansion Slots

**\$5595.00**

### APPLE CPU's

Prices too Low to Advertise  
Call, will beat any advertised price

(Example; Iic  
\$1165.00)

## APPLE PRODUCTS

### TG

JOY STICK	\$39
SELECT PORT	39
PADDLES	39

### KENSINGTON

SYSTEM SAVER	\$69
--------------	------

### MICRO TEK

BAM 16	\$58
SERIAL INTERFACE	89

### MICRO SOFT

16K CARD	\$67
SOFT CARD	239

### MICROMAX

VIEWMAX 80	\$138
VIEWMAX 80E	228

## IBM PRODUCTS

### AST

6 PAC PLUS [64K]	Call
I/O PLUS [serial & clock]	\$139
I/O PLUS [ser, par. & clock]	145
MEGA PLUS	Call
MEGA PAC	Call

### IBM

MONO CARD	Call
COLOR CARD	Call

### HERCULES

GRAPHICS CARD	\$340
---------------	-------

### LOTUS

1, 2, 3	\$309
SYPHONY	529

### QUADRAM

QUAD COLOR 1	\$218
QUAD COLOR 2	228
QUAD BOARD 1	238
QUAD BOARD 2	268

### MEMORY

64K	\$45
128K	88

### MATH COPROCESSOR

INTEL 8087	\$175
------------	-------

### KEYTRONICS

5150	Call
5151	Call

## PRINTERS

### DYNAX

DX15	\$409	DX25	\$729
------	-------	------	-------

### STAR MICRONICS

GEMINI 10X	\$259
GEMINI 15X	399
POWER TYPE	399

### OKIDATA

82A [par. & ser. interface]	\$300
83A [15" carriage]	569
84P [200cps, frict & tractor]	319
92P [160cps]	410
93P [160cps, 15" carriage]	669

### EPSON

RX80 [120cps]	\$299
RX80FT [120cps, frict/tract]	319
FXX [160cps]	459
FX100 [160cps, 15" car.]	699

### NFC

8023A-C [120cps]	Call
8025 [15" carriage]	Call

### JUKY

6100 [18cps & let. quality]	\$469
-----------------------------	-------

## PRINTER INTERFACE and PERIPHERALS

### CABLES

IBM to Printer	\$20
RS232	20
Centronics to Centronics	20

### FOURTH DEMINION

CARD to CABLE	\$48
---------------	------

### MICRO TEK

DUMPLING GX	\$88
DUMPLING GX [Exp to 64k]	148
16K UPGRADE	14

### OKIDATA

TRACTOR for 82 & 92	\$59
SERIAL INTERFACE	98

### ORANGE MICRO

GRAPPLER +	\$113
GRAPPLER + w/16K	178

**WE'VE DECIDED TO JOIN THE PRICE WAR • CHECK OUT OUR LOW PRICES TODAY**

# Sav-On Computers, Inc.

12595 Crenshaw Blvd., Hawthorne, CA 90250

OPEN: 7:30am till 6:00pm Mon.-Fri.  
9:00am till 2:00pm Sat.

TERMS: We accept Visa, MasterCard, CDD's, and Wire Transfers.  
No surcharge for Credit Cards. UPS, Federal Express and  
Emergency shipping available. Calif. residents please add  
6½% sales tax to order. Prices subject to  
change without notice. Not responsible  
for typographical errors.

Circle 321 on inquiry card.



**FLUKE** FLUKE 77  
DVO METER \$119  
0.3% DC ACCURACY

**Votrax** PERSONAL SPEECH  
SYSTEM \$285

**ProModem 1200 from...  
PROMETHEUS**

HAYES COMMAND COMPATIBLE  
W/HELP MENU \$329

**U.S. ROBOTICS**  
FREE Telpac INCLD.

PASSWORD 1200 AUTO ANS/DIAL \$359  
AUTO DIAL 212A (HAYES COMPAT.) \$459  
IBM PERSONAL MODEM W/ SOFTWARE \$297  
IBM PERSONAL MODEM W/ 64K.  
PRT PORT, CLOCK, S.W. \$469  
IBM PERSONAL MODEM W/ 256K, ETC. \$759  
Telpac MSDOS/ CP M 80 \$79

HAYES 1200 MODEM \$489

## SOFTWARE

SOFTWARE IS NOT RETURNABLE

BDS "C" COMPILER \$95  
C86 C COMPILER \$299  
COMPUVIEW TRANSYS MS-DOS  
CP/M86 FILE TRANSFER \$159  
COMPUVIEW VEDIT 86 \$156 MS-DOS \$120  
KNOWLEDGEMAN 86 8" DBMS \$345  
K-PAINT \$75  
SORCIM SUPER CALC 3 IBM-PC \$245  
PERSONAL PEARL DBMS (PC) \$215  
ACCOUNTING PEARL (PC) \$635

DATAFlex MULTI-USER  
FILE & RECORD LOCKING DBMS  
AVAIL. FOR MOST O/S FORMATS CALL

NEW WORD WORD PROCESSOR IS  
WORD STAR COMPATIBLE & HAS  
MERGE PRINT SINGLE/MULTI-USER  
CP/M 80 OR 86 & PC-DOS \$169

## DIGITAL RESEARCH

"C" LANGUAGE COMPILER-86 \$229  
CP/M PLUS (3.0) \$245  
ACCESS MNGR 80 \$195 86 \$260  
DISPLAY MNGR. 80 \$260 86 \$325  
SPEED PROG PKG. 80 \$130 86 \$163  
GSX 80 \$55 86 \$65  
C BASIC COMPILER 80 \$325 86 \$390  
PASCAL MT+ 80 \$225 86 \$390  
PL 1 W/ UTILITIES 80 \$359 86 \$488  
ASMBLR + TOOLS 80 \$130 86 \$130

## TERMINALS & MONITORS

QUME QVT 102G \$489  
FREEDOM 200 TERMINAL - AMBER  
(EMUL TELEVIDEO 950 & ADM 31) CALL  
LIBERTY FREEDOM 220G  
DEC VT220 EMUL W FULL  
SUPERSET OF VT100 CALL  
PRINCETON GRAPHICS HX12 HI-RES RGB \$495  
TAXAN RGB 420 (IBM LOOK-ALIKE) \$489  
USI AMBER 12" HI-RES MON. (20MHz) \$99  
WYSE 50 14" 132 COL. EMUL TVI 910.  
920, 925, ADDS VP & HAZELTINE 1500 \$519  
ZENITH ZVM122A GRN. NON GLARE \$85  
ZM123A AMB. NON GLARE \$85

## PRINTERS

BROTHER HR-15 \$425  
BROTHER HR-25 \$695  
BROTHER HR-35 \$975  
BROTHER M-2024 MATRIX L.Q. \$1,099  
DAISYWRITER 2000 W/48K \$975  
EPSON RX80FT CALL  
EPSON FX80FT FOR  
EPSON FX100 LOW  
EPSON LQ1500 W/ CENTRONICS I/F PRICE  
OKIDATA 92P \$419  
OKIDATA 92S \$489  
OKIDATA 93P \$650  
OKIDATA 93S \$749  
TALLY SPIRIT - 80 PARALLEL \$289  
TALLY SPIRIT - 80 2K SERIAL I/F \$85  
TALLY MT-160L P&S W/ TRACTOR \$595  
TALLY MT-180L P&S W/ TRACTOR \$795  
TALLY MT-1805 SERIAL "DEMO SALE" \$995  
TALLY PIXY-3P PLOTTER \$489  
TEXAS INST. TIB55 W/ TRACT \$798  
NEC 2010-1 20 CPS SERIAL/FRICTION \$707  
NEC 3510-1 35 CPS SERIAL/FRICTION \$1,339  
NEC 7710-1 55 CPS SERIAL/FRICTION \$1,819

## PRACTICAL PERIPHERALS

MICROBUFFER EPSON "CARDS"  
MBP-16K PARALLEL \$65  
MBS 32K SERIAL \$153  
MBS 64K PARALLEL \$195  
MEM 32K EXPANSION MODULE \$58  
MICROBUFFER IN-LINE "STAND ALONES"  
MBIS SERIAL 64K \$244  
MBIP PARALLEL 64K \$244  
MEM-64 EXPANSION MODULE \$118

APPLE II, II+, IIE MICROBUFFER II+ 16K \$181  
PROCLOCK/ APPLE II, II+, IIE \$108  
SERIAL/ APPLE II, II+, IIE W/ RS232  
COMMUNICATIONS & GRAPHICS \$119  
GRAPHICARD W/ ON-BD S.W. FOR 35 PRT \$65  
TTX UNIVERSAL 64K BUFFER  
"IN" S OR P \$209  
"OUT" S OR P

## INDUSTRIAL QUALITY CABINETS

DUAL 1/2 HI HORIZ. 5 1/4" FLPY. \$75  
SINGLE STD HI HORIZ. 5 1/4" FLPY \$59  
5 1/4" H.D. CABINET, P.S. & FAN \$225

## INTEGRAND

800 B2BF W/ NECESSARY OPTIONS \$495  
800 DW SAME AS ABOVE  
W/ PROVISION FOR 8" H.D. \$575  
1100D W/ OAK SIDE PANELS \$445  
2906 DUAL 5 1/4" W/ 1 SLOT \$159

## PARA DYNAMICS

2818 PRONTO 18 SLOT. 2X8" FLPY BAYS \$695  
3820S PRONTO W/ SEQUENCER \$1,159  
2810 MINI-PRONTO 10 SLOT  
2X8" BAYS \$749  
3510D 10 SLOT W/ 2X5 1/4" FLPY BAYS \$669  
2200D DUAL STD. 8" DRV. CAB. \$295

## POWER SOLUTIONS

Litton JEFFERSON  
ELECTRIC

TRUE SINE WAVE, 100% BATTERY OPER. W. NO  
SWITCH-OVER, BYPASS STATIC SWITCH  
750 WATTS @ 15 MIN #370-811-100 \$1,575  
1 HR. W/ AUXILIARY BATTERY \$149

## TRIPP-LITE

STAND-BY POWER  
W/ YUASA BATTERY  
EXCELLENT FOR  
SWITCHING P/S PC'S

SB-400-LVC 1HR+ @ 400 WATTS \$395  
SB-1000 1/2HR+ @ 1000 WATTS \$695

ISOBAR LINE FILTERS:  
IBAR 2-6 2 OUTLETS & 6 FT. CORD \$40  
IBAR 4-6 4 OUTLETS & 6 FT. CORD \$55  
IBAR 8-15 8 OUTLETS & 15 FT. CORD \$65

## DISK DRIVES

CALL FOR LOW, LOW  
PRICES ON SUBSYSTEMS

Tandon 100-2 5 1/4" DSDD \$175

Qume 6 MONTH WARRANTY

142 DSDD 5 1/4" 1/2 HI \$159  
242 DSDD 8 1/4" HI \$389  
842 DSDD 8" STD HI \$449

## MITSUBISHI

M2894 STD 8" DSDD \$445  
M2896 1/2 HI 8" DSDD \$445

NATIONAL/PANASONIC  
5 1/4" 1/2 HI FLPY. DIRECT DRV. 1 YR. WARR. \$129

## SANYO

5 1/4" 1/2 HI FLPY. DIRECT DRV. 1 YR. WARR. \$115

## TOSHIBA

FOR IBM-PC & PORTABLE  
RATED HIGHEST ENGINEERING  
QUALITY

5 1/4" 1/2 HI FLPY. DIRECT DRV. 1 YR. WARR. \$155  
ST506 5 1/4" INCH BARE HARD DRIVES:

## Seagate

ST212 12.76Mb HALF-HIGH \$595  
ST419 19.14Mb STD. HT. \$995

## QUANTUM

Q540 42.66Mb 45m SEC ACCESS \$1,395

## Maxtor

XT-1065 66.99Mb 30m SEC ACCESS \$1,995  
XT-1105 105.27Mb 30m SEC ACCESS \$2,995  
XT-1140 143.55Mb 30m SEC ACCESS \$3,749

## DISKETTES

DATAMAG "DYSAN QUALITY"  
ECONOMIC PRICE

5 1/4" SSDD SOFT BOX/10 \$15.95  
5 1/4" DSDD SOFT BOX/10 \$21.95

## Dyan

104/ 2D 5 1/4" DSDD \$30 \$27  
101/ 2D 8" DSDD \$36 \$33  
707906 5 1/4" 5Mb CART. \$99 \$85  
703529 8" 25Mb \$140 \$120

## Fuji

MD1D 5 1/4" SSDD BOX/10 \$19.95  
MD2D 5 1/4" DSDD BOX/10 \$26  
MD2D 96TPI 5 1/4" DSDD  
80 TRACKS BOX/10 \$35.95  
FD2D 1024N 8" DSDD BOX/10 \$33.95

## Datacom Northwest, Inc.

SOLUTION FOR SERIAL I/F PROBLEMS  
TRI-STATE RS232 V.24 BREAKOUT  
& ACTIVITY TESTER W/9V BATT. \$165



# WORLD'S LARGEST SELECTION OF S-100 PRODUCTS

# S-100™

## CompuPro®

SYSTEM 816/A SINGLE-USER	\$4,199
SYSTEM 816/B TWO-USER	\$4,899
SYSTEM 816/C MULTI-USER	\$6,299
SYSTEM 816/D 8086 10MHz	\$9,299
SYSTEM 816/Dd W/O M-DRIVE/H	\$5,699
SYSTEM 816/E 68000-10MHz	\$7,099
SYSTEM 816/Ee W/O M-DRIVE/H	\$5,099
TO ADD 40Mb H.D. TO ABOVE ADD.	\$1,900
TO HAVE 2ND 8" FLYP W/ H.D.	\$500
SYSTEM 816/10 4-USERS	\$4,095
SYSTEM 816/10-H20 20Mb H.D.	\$6,399
SYSTEM 816/10-H40 40Mb H.D.	\$6,895

QUANTUM 40Mb W/ CABINET, CABLES,  
AND DISK 3 FOR ALL ABOVE SYSTEMS \$2,200

CPU 286 A&T W/ 287 MATH CHIP	\$1,313
CPU 286 6MHz CSC W/ 287 MATH CHIP	\$1,449
CPU Z 6MHz A&T	\$229
CPU 8085/88 A&T	\$349
CPU 8086 10MHz A&T	\$569
CPU 86/87 5MHz A&T	\$739
CPU 68K W/MMU OPTION CSC	\$795
CPU 68K 10MHz CSC	\$600

RAM 16 64K STATIC 8&16 A&T	\$309
RAM 17 64K STATIC A&T	\$295
RAM 21 128K STATIC 8&16 A&T	\$595
RAM 22 256K STATIC 8&16 A&T	\$1,075
M-DRIVE/H 512K RAM-DISK	\$895
INTERFACER 3-8 SERIAL A&T	\$489
INTERFACER 4-3 SERIAL/2 PARALLEL	\$319
SYSTEM SUPPORT 1 A&T	\$319
DISK 1A 5 1/4" & 8" FLYP CTRL	\$489
DISK 2 A&T 8" H.D. CNTRL SET	\$559
DISK 3 A&T 5 1/4" H.D. CNTRL W/ CP/M 80&86	\$559

## MORROW

MD2 SYSTEM W/ TERMINAL & EPSON RX80FT PRT.	\$1,599
MD3 AS ABOVE W/ PEARL DBMS	\$1,999
MD-3E AS EQUIP ABOVE WITH ONLY CPM 2.2 NEW WORD CO-PILOT	\$1,499
MD3-MDCP88-256 AS ABOVE W/ 8088 CO-PROC & 256K RAM UPRD	\$2,498
MDP-3 PORT. SAME AS MD3 EXCEPT WITH 5X7" SCREEN & EPSON RX80FT PRT.	\$1,799

### SUPER WORD PROCESSOR SALE

MD3-E PLUS W/ 2 DSDD DRVS., TERMINAL, NEW WORD CO-PILOT MENU SYSTEM, SPELLING CHECKER, PLUS BROTHER HR-15 PRT.	\$1,499
MD5-E W/ 1 FLYP & 5Mb H.D.	\$1,825
MD5-E W/ 2 FLYP & 5Mb H.D.	\$1,895

MD11 SYSTEM W/ 11Mb H.D., 128K, 1DSDD DRV., TERMINAL, CP/M 3.0, ALL MD3 SOFTWARE EPSON FX80 160 CPS DOT MATRIX OR BROTHER HR-15 13 CPS DAISY PRINTER	\$2,995
--	---------

MD-16 SAME AS MD11 W/ 16 44Mb	\$3,495
MD-34 SAME AS MD11 W/ 34Mb	\$4,995

## MAYDAY!™ \$149

The Software Support Service

120 MINUTES OF SOFTWARE SUPPORT ON FREE PHONE CALL—IF THEY CAN'T ANSWER YOUR QUESTION IN 2 MIN. OR LESS THEY'LL CALL BACK FULL SUPPORT FOR OVER 350 SW PROGRAMS, LANGUAGES AND OPERATING SYSTEMS

## COLUMBIA

160C-1 W/ KEYTRONICS 5150 K B U S I. 12" AMBER MONITOR	\$2,195
1600 4 ABOVE W/ 12Mb H.D.	\$3,695
1600-VP PORTABLE	\$1,949
PRINCETON GRAPHICS HX-12 HI-RES RGB MONITOR	\$495

## ZENITH data systems

ZF-121-22 SYS W/ 2 DRVS. COLOR, MSDOS 2.0, LOTUS 1-2-3, ZVM135 HI-RES RGB 13" MONITOR	\$3,395
CV-1952 19" HI-RES RGB MON.	\$395



SUPER SIX 128-6MHz	\$595
SUPER SLAVE 128-6MHz	\$570
SUPER 186/256-SLAVE-4 USERS CP/M 3.0	\$1,439
TURBODOS MULTI-USER	\$650
HDC *001-5 5 1/4" H.D. CONTROLLER W/ S/W DRIVERS	\$450
SUPER STAR SYSTEM SUPER SIX 128K, 5Mb FIXED, 5Mb REMOV. CART., DSDD FLYP, 2 SUPER SLV-128-6, TURBODOS 1.3 MULTI-USER	\$4,949



CPZ 48006 6MHz MASTER	\$739
256KMB MEMORY BOARD	\$709
CPS-MX 64K RAM SLAVE 4MHz	\$339
CPS-MX 64K RAM SLAVE 6MHz	\$389
CPS-BMX 128K RAM SLAVE 4MHz	\$495
CPS-BMX 128K RAM SLAVE 6MHz	\$529

## Electralogics

QUASI DISK 512K RAM-DISK W/ ON-BD DRV. STATUS LED'S WRITE PROTECT, DMA E Z INSTALL W/ SAMPLE CP/M BIOS	\$895
512K FIDGY BACK EXPANSION	\$695
BATTERY RECHARGE-UP W/ PWR SUPPLY	\$169

MF10 ALL-IN-ONE I/O BD. IEEE S-100/696 B ASYNCH. SERIAL, 2 PARA., BAUD RATE GEN., CLOCK-CAL, BATT., PROG PRIORITY INTERRUPT W/ B LEVEL CTRL PERSONALITY BDS & CBLs OPTIONAL	\$469
---	-------

SERIAL OPTION BD. FOR MF10	\$25
CENTRONICS PARA OPTION FOR MF10	\$39
STD PARALLEL OPTION BD. FOR MF10	\$25

## SYNTECH DATA SYSTEMS

SBC 3C0 MASTER OR SLV 6MHz, 64K, 1S, 1P, SASI PORT	\$595
EXPANDORAM IV 256 W/ PARITY	\$825
I/O 8 W/B ASYNCHRONOUS RS232	\$435
SBC8/16 DUAL CPU EXECUTES Z80 & 8088 CODE, 5 1/4" & 8" FLYP CTRL, 2S, 8 VECTORED & REAL TIME INTERRUPTS	\$689
EXPANDORAM V 256K	\$652

## Cromemco

ZPU Z-80 CPU	\$299
SMDI SMD HARD DISK I/O	\$675
DPU 68000 & Z80A	\$669
FFP FAST FLOATING POINT	\$2,369
MCU MEMORY CONTROL/FOR 512MSU	\$419
512MSUJ ERROR CORRECTING MEMORY	\$2,119

## IBM

### BUILD YOUR OWN P.C.

IBM PC W/ 64K RAM, PC DOS 2.1	
1 DSDD DRV & CONTROLLER W/ K.B	\$1,825
1 TANDON TM 100-2 (SEE DISK DRVS.)	\$175
STB GRAPHICS PLUS II MONO & COLOR GRAPHICS W/ CLOCK PRT PORT	\$325
64K RAM 4164-150 NS 9 CHIPS/SET	\$41.95
U.S. I 20MHz 12" AMBER MONITOR	\$109
PGS HX12 HI-RES RGB MONITOR	\$495
INTEGRATION BURN-IN & TEST	\$95
5Mb REMOV. CARTRIDGE H.D. IN P.C. (WILL BOOT FROM THE HARD DISK)	\$1,395
10Mb "PC-INSIDER" H.D. SUBSYS	\$888
16Mb "PC-OUTSIDER" H.D. SUBSYS	\$1,495
10Mb+10Mb "PC-OUTSIDER" H.D. SUBSYS	\$1,649
26Mb "PC-OUTSIDER" H.D. SUBSYS	\$1,849
H.D. CTRL ST506 I F	\$295

## TEGMAR FOR IBM-PC

CAPTAIN 64K, IS, IP, CLK/CAL	\$269
CAPTAIN ABOVE W/ 384K	\$549
1st MATE 64K, IS, IP, CLK/CAL	\$269
1st MATE ABOVE W/ 265K	\$405
WAVE XT MEMORY BD 64K	\$210
DYNAMIC MEMORY W/ 256K	\$335
INTERNAL REMOV. H.D. IN PC INSTALLS DIRECTLY INTO PC. STORES 30X MORE THAN FLYPS & IS 9X FASTER	\$1,455
10Mb H.D. IN MINI-CAB. HIGH DENSITY PRIMARY STORAGE, 4 CONFIG POSS., STORES 30X MORE THAN FLYPS	\$1,595
5Mb REMOV. H.D. & 33Mb IN EXPAN. CHASSIS - HIGH DENSITY PRIMARY STORAGE, MANY CONFIG POSS., STORES 100X MORE THAN FLYPS, 5 ADDITIONAL SLOTS FOR OPTS	\$4,009
EXPANSION CHASSIS W/ 8 SLOTS GRAPHICS MASTER - HIGH RES. COL. (640X400), MONO (720X700), RGB, NTSC COMPOSITE & IBM MONO MON., 128K, LT. PEN INTERFACE	\$495
SCRIBE TENDER IP & IS CABLE, IP & 2S PORTS, MULT. I/O CAPABILITIES	\$169
TIME MASTER - SETS TIME/DATE AUTO., 5 YR BATT., ALARMS AVAIL	\$99
jrCAPTAIN 64K P.C. 1 YR BATT LIFE	\$255
jrWAVE 64K	\$239
jrCADET 64K ADD ON PIGGYBACK BD FOR jrCAPTAIN/WAVE	\$159
jr 2ND MATE 64K, P.C. 1YR BATT LIFE	\$119

## Mac Drive

73200 - 10Mb FIXED H.D.	\$1,496
73020 - ABOVE W/ 5Mb REMOV. H.D.	\$2,468
73010 - 5Mb REMOV. H.D.	\$1,496
73210 - 2.5Mb REMOV. H.D.'s	\$2,468

## STB

RIO PLUS RS232 S, P I/O, G, CLK/ CAL. 64K & PC ACCEL. STB-RIO-64	\$257
GRAPHIX PLUS. RGB & MONO., P, LT PEN INTER., CLK OPT. STB CLR	\$239
GRAPHIX PLUS II. RGB & MONOCHROME PRINTER & LT. PEN PORTS	\$325
SUPER RIO. RAM I/O MULTI-FUNC. W/ 64K (UPGRD TO 768K), 2S, 1P (IBM COMPAT.) I.G. CLK/CAL.	
STB-SRIO 64	\$273
STB-PB-64 PIGGYBK (EXPAND TO 512K)	\$162
MEMORY EXPAN. BD 64K (EXPAND TO 384K) STB-1-64	\$192

Circle 317 for Dealer inquiries.  
Circle 318 for End-User inquiries.

PRICES INCLUDE CASH DISCOUNTS &  
MAY CHANGE WITHOUT NOTICE.  
SHIPPING & INSURANCE EXTRA

SUBJECT TO AVAILABLE QUANTITIES  
HRS: 8:30AM - 5:00PM M-F





# ADVANCED COMPUTER PRODUCTS

SEND \$2.00 for 1984 CATALOG

## IBM PC MULTICARD II™

"MULTICARD II" multifunction card for the IBM PC & XT expandable to 384K. Thousands of this popular card have already been shipped by ACP.

- 64-384K
  - Parallel Port
  - Serial/Game Port
  - 1 Year Warranty
  - Disk Emulator Software
  - Printer Spooler Software
  - Clock/Calendar
  - Clock Software
- \$229.00 w/OK \$229.00**

## S-100 64K "CMOS" RAMCARD

Unbelievable Price!

**\$249.00**

Assembled and Tested

- ACP has sold over 1000 of these IEEE compatible, low-priced, high-reliability 64K Static RAM Cards.
- Single 5-Volt operation.

## SIEMEN'S SALE

You can now purchase Shugart compatible 8" Disk Drives below your existing factory direct pricing!

These Prices are the lowest ever published!

\*Siemens's DSD2 FDD200-8... **\$199.00**

Also, with purchase of Disk Drives you can buy the Vista V-1000 Dual Case with Power Supply and Cable for only **\$375.00** Regular Price \$495.00

Offer Limited! Factory Warranty 90 Days! Shipped Immediately from Stock! OEM Quantities

**8 Disk Drives \$139.00**

## DOT MATRIX PRINTER COEX 80-FT

- ✓ 9x7 Dot Matrix 80 CPS Bi-Directional Printing
- ✓ 2K Buffered Memory
- ✓ 80, 96, 132 Columns, Graphics and Block Printing
- ✓ Selectable Char Pitch, Line Spacing and Feed

COEX Interface Card to Apple **\$49.95**

**\$169.00**

## ACP HAS DISK DRIVES

### APPLE II™ COMPATIBLE

Thin Line Drive

**\$179.00**

Compatible Disk Controller 49.95

APPLE COMPATIBLE DISK DRIVES STANDARD HEIGHTS

VISTA Solo 5 1/4" Std. **\$199.00**

FOURTH DIMENSION **199.00**

QUENTIN **209.00**

### TANDON 100-2

PC Compatible • Double Sided

**\$199.00**

TM100-1... **\$169.00**

Mounting Kit for IBM PC **\$4.95**

### TOSHIBA Half-High

PC Compatible • Double Sided

**\$169.00**

OTHER DRIVES WE STOCK

TANDON 848-2 Thinline	\$479.00	SHUGART 801R	\$299.00
TEAC F058B	179.00	QUIME Datarack 8	449.00
SEAGATE 10Mb Hard Disk	499.00	CDC 1800 DS (320K)	224.00
MPI 852	239.00	SEAGATE ST506 (6MB Win.)	349.00

## Apple Compatible Software BUSINESS

APPLIED SOFTWARE	Versalorm	ACP PRICE
Versalorm Hard Disk		\$299.00
ARTSOI Magic Window II		95.00
Magic Combo		169.00
ASHTON-TATE dBASE II (CPM)		385.00
Friday (CP/M)		198.00
BPI (GL, AR, AP, Pay, Inv)	ea.	299.00
BRODERBUND Bank Street Writer		49.00
BUSINESS SOLUTIONS The Incred Jack		149.00
CONTINENTAL (GL, AR, AP, Pay)	ea.	189.00
Home Accountant		49.00
DATAMOST Real Estate Inv.		99.00
223.00		49.00
MARKET ANALYZER		269.00
Market Microscope		499.00
EAGLE Money Decisions Vol. I		149.00
199.00		69.00
FOX & GELLER Quickcode		199.00
d Utility		99.00
d Graph		99.00
HAYDEN Pie Writer		79.00
Compiler Plus		45.95
BASIC COMPILER Tax Preparer		199.00
Real Estate Analyzer		139.00
KENNINGTON Formal II		99.00
LIGHTNING MasterType		35.00
LIVING VIDEOTEXT Think Tank(III,III)		119.00
149.00		139.00
Maimering or Spellstar		449.00
Wordstar Prof. 4 Pak		Call
Impo Pak or InfoStar		179.00
MICROSOFT Multiplan		79.00
MultiTool Financial		119.00
MultiTool Budget		69.00
MEGAHAUS Megawriter		379.00
PEACHTREE Series 40 (GL, AR, AP)		239.00
PERFECT SOFTWARE		Call
QUARK Word Juggler (Ile)		199.00
Lexcheck (Ile)		99.00
Call for Apple III		
SIERRA ON-LINE		99.00
Screenwriter II		149.00
Screenwriter Professional		169.00
General Manager II		79.00
Dictionary		89.00
SOFTWARE PUBLISHING PFS:File		89.00
PFS:Graph or PFS:Report		89.00
Call		249.00
STONEWARE DB Master 4.0		89.00
DBB Utility 1 or 2		599.00
SYSTEMS PLUS Acct Plus (GL, AR, AP)	Set	179.00
VISICORP Visicalc 3.3		179.00
Visicalc Enhanced		179.00
Visible or Visible+		
HOME & EDUCATION		228.00
BRODERBUND Choplifter		28.00
Drol or Loderunner		44.00
Arcade Machine		24.00
Apple Fanc		24.00
BUDGEO Raster Blaster		29.00
Pinball Construction Set		26.00
COUNTERPOINT SOFTWARE		29.00
Early Games for Young Children		23.00
DATAMOST Aztec		23.00
Fig Pen or Shark Attack		31.00
DATASOFT Zaxxon (I, II, e, c)		37.00
EDU-WARE Compumath		30.00
Algebra I, II or III		23.00
Compuaid or Compuspell		73.00
EINSTEIN Memory Trainer		24.00
ELECT. ARTS Music Construction		Call
HARCOURT Computer SAT		Call
HAYDEN Sargon II		29.00
INFOCOM Zork I, II or III		36.00
Deadline		Call
KOALA Modules (B available)		30.00
LEARNING COMPANY		40.00
Juggles Rainbow		45.00
Bumble Games		40.00
Gettrude's Secrets		41.00
L & S Crossword Magic		Call
MICROFIN Minter 2049r		25.00
MICROLAB		25.00
MICROSOFT Deactivation		19.00
Typing Tutor II		74.95
MONOGRAM Dollars & Sense		41.95
ORIGIN Exodus Ultima III		16.00
PENQUIN The Quest		99.00
SENSIBLE Sensible Speller		28.00
SIERRA ON-LINE Frogger		29.00
SIRTECH Legacy of Lyligama		29.00
Knight of Diamonds		54.95
SOUTHEASTERN Data Capture 4.0		20.00
Delta Drawing		35.00
Fracton Fever		23.00
Kindercomp		28.00
Facamaker		40.00
SUBLOGIC Flight Simulator or Pinball		75.00
SUNDEX No. 1 Related Home Finance		74.95
CPA Personal Accountant		74.95
CPA Personal Investor		42.95
Personal Payables		\$119.00
TERRAPIN Logo		75.00
TRANSEND Transend I		29.00
VIRTUAL Micro Cookbook (I, II, e, c)		
UTILITIES SYSTEM		\$30.00
BEAGLE Apple Mechanic		30.00
Apple Plot or Pronto DOS		20.00
Beagle Basic		30.00
DOS Boss		30.00
Double Take or Utility City		16.00
CENTRAL POINT Fier		31.00
Copy II Plus		79.00
LOCKSMITH		95.00
MICROSOFT A L D S (Req. Softcard)		\$75.00
Fonta 80 (Req. Softcard)		155.00
Fonta 80		65.00
PENQUIN CGS System		31.95
PHOENIX Zoom Graphix		49.00
SOUTHWEST Merlin		

Send for Complete Catalog of Software

## APPLE™ COMPATIBLE DISK CONTROLLER

Only **\$49.95**

## Apple Compatible Printer Interface

w/Apple to Epson Cable **\$49.95**

## Apple IIe Compatible 80 Column Card w/64K

**\$99.95**

## APPLE COOLING FAN

with Surge Suppression **\$49.95**

## QUENTIN/FORTH DIMENSION

Apple II/Ile Compatible Disk Drive

Totally compatible to Apple Drives.

Only **\$199.95**

Controller **\$49.95**

Just plug in and run.

## Apple II 16K RAM CARD

Compatible with Z80 Softcard™, PASCAL CP/M™

Full 1 year Warranty, Top Quality by COEX

NEW LOW ACP PRICE **\$49.95**

Also from COEX, NEW EPSON Parallel Interface for Apple **\$49.95**

With cable **\$49.95**

## RAINBOW 100A MODEL CLEARANCE

RAINBOW 100A w/64K of Main Memory, 800Kb/Disk Floppy Disk Drive, Keyboard plus User Kit, Serial Printer Port and Modem Port built-in.

Retail \$2995 **ACP \$1995**

## VR201 MONOCHROME MONITOR

Retail \$325 **ACP \$259**

CPM/86/80 and MS-DOS Retail \$250 **ACP \$195**

## 5Mb WINCHESTER HARD DISK w/CONTROLLER

(While Supplies Last) (128Kb Min. Memory Req.) **ACP \$780**

192Kb Memory Retail \$650 **ACP \$521**

Call for Special Rainbow 100 • Pricing!

## Apple computer Authorized Dealer

Complete Apple Support Facility  
Complete Apple Service Center  
We service most Floppy Disk Drives

Apple IIe w/64K Apple IIe Business System **\$995.00**

Includes: Apple IIe w/128K, Dual Disk, 80 Column Card, Monitor II, Profile Extension Option

Apple IIe Entry System **995.00**

Includes: Apple IIe w/64K, Disk II w/Controller, Apple IIe Professional System

Apple III Plus 256K System **2995.00**

Apple III Plus Business System **4495.00**

Lisa 2 **3495.00**

Macintosh System **2495.00**

Apple IIc System **1295.00**

Apple Products Available In-store Only

## Apple Compatible Hardware

ALS CPM 3.0 Plus Card	LIST	ACP
Power Control Center P12	\$399.00	\$299.00
COMPUTER ACCESSORIES		149.00
COEX 16K Ram Card	99.00	49.95
Apple II Printer Card	29.00	20.00
Apple II Extender Card	29.00	20.00
64K Extended 80 Column	199.00	99.95
CORVUS Hard Disk Omninet		Call
EASTSIDE Wildcard (11" w/64)		89.00
Wildcard 2 (Ile)		119.00
Wildcard Plus (64K in 10 sec)		149.00
FINGERPRINT Epson Enhancer		59.00
GIBSON Light Pen (new improved)		Call
IS PKASO Interface (I/IIe)	199.00	139.00
PKASO Interface (III)	199.00	159.00
KENNINGTON System Saver	89.95	69.95
PC Saver	49.95	39.95
KEYTRONICS KB200 II + Keyboard	299.00	225.00
KOALA Graphics Pad	49.00	36.00
KRAFF Joystick	49.00	36.00
MCT Speed Demon	295.00	249.00
MPC 128K Bubble Memory	875.00	699.00
M&R Sup / Mod II RF Modulator	69.00	49.00
MICROPRINT Epson Enhancer		38.00
MICROPRO 6MHz Applicard + Word		Call
MICROSOFT Z-80 Softcard	395.00	249.00
Z-80 Softcard Plus	645.00	479.00
Softcard Premium Pak (II+)	695.00	499.00
Softcard Premium Pak (Ile)	495.00	395.00
MOUNTAIN COMPUTER		
Music System	395.00	335.00
A/D Plus D A	350.00	299.00
MICROTEK Dumping Buf w/64K	349.00	265.00
ORANGE MICRO		
Grappier Plus	175.00	129.00
16K Buffercard	175.00	129.00
Grappier Buffered w/16K	245.00	199.00
PCPI Applicard w/128K, 6MHz	595.00	499.00
8088 Coprocessor	595.00	499.00
Applicard w/128K, 4MHz	495.00	429.00
PERISOFT (All w/1 Year Warranty)		
Printerlink Intell. Printer I/O	99.00	79.00
Messenger Unit, Serial I/O	135.00	109.00
Timelink Realtime Clock	110.00	89.00
Graphlink Graphics I/o	175.00	139.00
Bufferlink w/16K Buffer	189.00	159.00
PRACTICAL PERIPHERALS		
Microbuffer 16K (Epson Parallel)	159.00	149.00
Microbuffer 32K (Epson Parallel)	199.00	179.00
Microbuffer 16K (Epson Serial)	179.00	159.00
Microbuffer 32K (Epson Serial)	219.00	199.00
Microbuffer In-line 64K (Parallel)	349.00	279.00
Microbuffer In-line 64K (Serial)	349.00	279.00
PROMETHEUS Versacard 4 in 1	199.00	165.00
QUADRAM		
Quadlink (IBM to Apple)	680.00	499.00
Microfazer 16K (Parallel)	189.00	169.00
Microfazer 16K (Serial)	220.00	195.00
Microfazer 32K (Parallel)	225.00	199.00
SATURN TITAN		
32K Ramcard	219.00	189.00
64K Ramcard	349.00	289.00
128K Ramcard	499.00	399.00
Accelerator II Card (2.2e, 2+)	599.00	449.00
Neptune 64K - 80		199.00
Neptune 128K - 80		299.00
Neptune 192K - 80		389.00
STREET Echo II (Apple)	149.00	99.00
Echo II Serial (In-line)	249.00	199.00
SYNETIX Sprite I	149.00	129.00
Sprite II	249.00	224.00
Supersprite	395.00	259.00
Flashcard 143K	449.00	389.00
Flashcard 288K	629.00	549.00
TG PRODUCTS		
Joystick	59.95	48.95
Select-a-port	59.95	49.95
Trackball	64.95	54.95
Joystick w/Toggle Ite	64.95	54.95
VIDEX Videoterm (80)	345.00	229.00
UltraTerm (132)	379.00	279.00
149.00		129.00
VISTA COMPUTER		
Enhancer II	149.00	129.00
A800 B Disk Controller	379.00	299.00
A500 S + Disk Controller	399.00	49.95
VOTRAX Type N Talk	259.00	199.00
Personal System	399.00	329.00

## RAM 64K RAMS

Set of 9 Pcs **\$50.00**

Apple™ Apple Trademark of Apple Computer  
IBM™ IBM Trademark of International Business Machines

TERMS: We accept VISA, MC, MCO. Cashiers and Personal checks. Separate and Company P.O.'s. We do not charge your card until we ship. Personal checks require drivers license and credit card. No Surcharge Added on VISA or MC. COD's over \$500 require 20% deposit with order. Add 3% shipping and handling fee. We offer same-day shipment. Prices subject to change without notice. We reserve the right to substitute manufacturers. We are not responsible for typographical errors. Retail Sale Prices May Vary



# ADVANCED COMPUTER PRODUCTS

Serving Computer Professionals Since 1976

TOLL FREE 800-854-8230

# IBM PC



★ COLOR SPECIAL ★  
THE COLOR GRAPHICS CARD  
(same designer as ColorPlus Card)  
PRICE \$269.00  
BREAKTHRU! 1 year Warranty \$269.00

## MULTI CARD II™ (exp. ) \$229.00 (INTRODUCTORY OFFER)

Advanced Computer Product's best selling multifunction card for the IBM PC & XT (plus compatibles) now has been improved with expansion capability to a full 384K and at no charge an additional game port. You also get Print Spooler and Disk Emulation Software plus a full year SWAP-OUT Warranty at no extra charge. Why pay more when you can get the same function and performance as Quadboard II™ and AST Sixpak Plus™ for substantially less money. You compare! Try it at no obligation. 10 day no questions asked return privilege.

FUNCTION	Multicard II	Quadboard II	Sixpak Plus
Memory	0 to 384K	0 to 384K	0 to 384K
Parallel/Serial	Yes	Yes	Yes
Clock/Calendar	Yes	Yes	Yes
Game Port	Yes	Yes	No (\$50 list Opt.)
Software	Yes	Yes	Yes
Warranty	1 Year	1 Year	1 Year
ACP Price with 0K	229.00	259.00	259.00

## EXPANSION MEMORY

- 64K Upgrade (Set of 9 64K RAMS) . . . \$50.00
- 256K RAM's (256K x 1) . . . \$29.95 ea
- 16K RAM's (16K x 1) . . . 10/\$9.99
- 8087 CPU (Arithmetic Processor) . . . \$199.00

## 10/XT (Serial, Parallel, Clock/Calendar) . . . \$129.00

The most popular expansion card for the short slot of your IBM XT. All these functions on one card optimized to fit in one slot. 1 year warranty.

### COLOR/GRAPHICS/COLOR/GRAPHICS

- Plantronics COLORPLUS™ . . . \$399.00
- Hercules GRAPHICS CARD . . . \$369.00
- Graphics X Software . . . \$42.00
- Quadram QUADCOLOR I&II . . . \$199.00/call
- Scanoptik COLORGRAPHICS . . . \$269.00
- Amdek MAI . . . \$399.00
- Hercules COLOR CARD w/Par. port . . . \$229.00
- Paradise MULTIDISPLAY . . . \$378.00
- CONOGRAPHIC CARD . . . \$895.00
- MA Sys PEACOCK . . . \$299.00

### IBM PC COMPATIBLE DISK DRIVES

Tandon TM-100-1 Single Sided (160K) \$169.00

Tandon TM-100-2 Double Sided (320K) 199.00

Control Data 9409 Double Sided (320K) 224.00

TEAC 55B 1/2 high Double Sided (320K) 189.00

Toshiba 1/2 high Double Sided (320K) 169.00

IBM PC Mounting Hardware for 1/2 highs 4.95

Vista "Diskmaster" 5 1/4" & 8" Diskcontroller 149.00

ACP has on hand several hundred demo 5 1/4" and 8" disk drives from virtually all manufacturers. Most are priced at \$99.00 ea. Call for current availability.

### HARDWARE

AST Sixpakplus w/0K(SPC)	\$259.00
Megaplus II w/0K(SC)	269.00
I/O Plus II (CS)	139.00
Game Serial/Parallel Options	45.00
Monographics Graphics Card	445.00
CHALKBOARD	99.00
COEX IBM PC Extender Card	29.00
IBM PC Prototype Card	36.00
DAVONG Hard Disk Drives	Call
KENNINGTON PC Saver	39.00
KEYBOARD IBM PC Compatible	149.00
KEYTRONICS 5150/5151 (PC&XT)	199/239
KOALA	89.00
KRAFT or TG	Call
IBM PC Joystick	59.00
Game Paddies	29.00
MICROSOFT Mouse	169.00
M&R PC/XT Exp Chassis (6 slots)	439.00
MOUSE SYS Mouse for PC	169.00
PERSYST Time Spectrum w/64K	289.00
PTI Back-up Power 200 400W	328.00
QUADRAM Quadboard II w/0K	259.00
Quadtrak (Apple Prox)	479.00
Quaddisk (up to 72Mb)	Call
Microfazer MP64 w/64K	179.00
VISTA Multicard Plus 0K	229
Maxicard w/64K (up to 576K)	269.00
PC Master (10 I/O)	329.00
Diskmaster (Floppy Cont.)	149.00
Dynafamer Hard Disk	Call
PC Clock I/O	129.00

### 15 Mb on IBM PC and Compatibles



Complete subsystem to add Hard Drive with Controller to your PC. External or Internal. Some internal applications will require additional power supply. Order our Power Pack, listed below, which adds 30 Watts to your PC.

10Mb Internal HDPC-10 . . . \$885.00  
15Mb Internal HDPC-15 . . . \$1049.00  
22Mb Internal HDPC-22 . . . \$1449.00  
33Mb Internal HDPC-33 . . . \$1849.00  
80 Watt Power Pack. . . Only \$149.00

For External Case and Power Supply for above . . . Add \$169.00  
For External Dual Case and Power Supply for above. . . Add \$299.00

### TAPE STREAMER

Uses 3M Cartridge to back up your Hard Disk. 10 Mb capacity transfers files in 8 minutes. Half-High configuration.

10Mb Streamer Internal HDST-10 . . . \$699.00  
10Mb Streamer with Dual Enclosure for Hard Disk HDST-C10 . . . \$1299.00  
10Mb Streamer with External Thin-line Case & Power Supply HDST-X . . . \$1099.00

### IBM PC POWER SUPPLY

Add a new Power Supply to your IBM PC. Great for upgrading PC to XT.

MPS-26 130 Watts \$179.00  
MPS-27 100 Watts 149.00

### AST COMBO PLUS INVENTORY SALE

While supply lasts. AST's popular COMBO PLUS expansion board or IBM PC.

ACP Price Only . . . \$199.00 w/0K

### \$199.00 5Mb \$199.00 SUPER CLOSE-OUT

All Sales Final - While Supply Lasts  
Great for IBM PC upgrade or just adding to any enclosure using standard 5Mb housing. Internal upgrade may require Power Pack 80 Watt upgrade supply listed above. For external Case & Power Supply add \$169. Factory Warranty.

Order ACP-5Mb SA604 Hard Disk . . . Only \$199.00

### MODEMS

BIZCOMP Model 2120 (Internal)	449.00
HAYES Smartmodem 1200	\$525.00
Smartmodem 1200B (w/Smartcom II)	445.00
Smartmodem 300	229.00
Smartmodem II	109.00
Smartmodem/IBM Cable	25.00
NOVATION Access 1-2-3	38.00

TERMS: We accept VISA, MC, MD, Cashiers and Personal checks. School and Company P.O.s. We do not charge your card until we ship. Personal checks require drivers license and credit card. No Surcharge Added on VISA or MC. CDO's over \$500 require 30% deposit with order. Add 3% shipping and handling for UPS. We offer same-day shipment. Prices subject to change without notice. We reserve the right to substitute manufacturer. We are not responsible for typographical errors. Retail Sale Prices May Vary. IBM™ trademark of International Business Machines. Quadboard II™ trademark of Quadram Corp. Sixpak Plus™ trademark of AST Research Inc.

### PRINTERS/MONITORS

BROTHER HR-25P/25S	\$699.00
HR-15P/15S	449.00
HR-35P or 35S	805.00
COEX 80/FT (80cps)	Sale \$169.00
DAISYWRITER 2000 (40cps)	1199.00
DTC Dasyprinter 380Z	1059.00
DYNAX DX-15P/15S	449
DIABLO 630AP/KSR	1890 2650
630 IBM/620 Ser	2299/995
EPSON FX-80/100	449/649
RX-80/80FT	299/399
LQP-1500	1249.00
NEC Spinwriter 3550	1885.00
OKIDATA Model 82AP/83AP	339/629
Model 84P/84S	995/1049
Model 92P/92S	526/575
Model 93P/93S	769/869
Model 84 IBM	1039.00
Model 92/93 IBM	549/839
SILVER REED EXP500P	490.00
EXP500P	630.00
EXP770P	1049.00
TRANSTAR 315 (4 Color)	499.00
STAR Gemini 10X/15X	299/429
Delta 10/15 (160cps)	529/679
Radix 10/15	720/850
Powertype LQP	409.00
Call for New Star PC Compatible Family	Call
TOSHIBA	Call
SANYO PP5000LQ	399.00
AMDEK Video 300G/A	145.00/155.00
Video 310A amber (IBM)	159.00
Color I (composite)	299.00
Color I Plus (earp/nonglare)	329.00
Color II RGB (IBM) analog	449.00
Color II Plus	479.00
Color III RGB (IBM)	399.00
Color IV RGB (IBM) analog	779.00
BMC or ELKA 12 Green	699.00
PGS HX-12 RGB (690x240)	499.00
SR-12 RGB (690x480)	699.00
MAX-12 Amber	Call
SANYO 6500 Med-Res	269.00
7500 Hi-Res	389.00
TAXAN 400 RGB Med-Res	329.00
420 Hi-Res IBM	559.00
121 TTL Green/Amber	179/189
ZENITH ZVM-122 Amb/123 Grn	109/105
ZVM-131 13" Color	379.00
ZVM-135 Color Hi-Res	499.00

### DISKETTES

DYSAN 5 1/4" SS DD	10 \$55	\$28
DYSAN 5 1/4" DS DD	10 65	36
IBM 5 1/4" SS DD	10 60	43
IBM 5 1/4" DS DD	10 65	47
VERBATIM 525-01 SS DD	10 55	20
VERBATIM 550-01 DS DD	10 55	20
MAXELL MD1 SS DD	10 50	22
MAXELL MD2 DS DD	10 60	32
Flip Storage Box 5 1/4" (80 disks)		18
BULK SPECIAL SS	10/25	16
With Sleeve and Box	100/195	149

### IBM ACCESSORIES

COMPUABLE Keyboard/drive dust covers (set)	\$16.00
CURTIS Titlusewei Monitor ped.	43.00
PC Pedestal (IBM Mono)	58.00
PGS Quachrome disp Adapter	9.00
Vertical PC Stand	20.00
Mono Extension Cable	43.00
Keyboard Ext Cable	35.00
AC Plug Adpt (any mon to PC)	8.00
EDP PROTECTION DEVICES The Lemon Patch	39.00/63.00
The Orange Line	94.00/58.00
GILTRONIX SWITCH BOXES 2 Way 8 Lines	90.00
4 Way 8 Lines	179.00
2 Way Centronics	3.95
RIBBONS Each Dozen	
Epson MX-80	5.75
Epson MX-100	10.95
Star Gemini 10/15	2.50
Okidata 80/82/83	3.95
Okidata 84/92/93	4.95
NEC 3550	11.95

## WE STOCK CABLES • RIBBONS • DISKETTES • SPARE PARTS

Circle 9 on inquiry card.

MAIL ORDER: P.O. Box 17329 Irvine, CA 92713  
Retail: 1310 E. Edinger, Santa Ana, CA 92705 (714) 558-8813  
542 W. Trimble, San Jose, CA 95131 (408) 946-7010

TOLL FREE 800-854-8230  
TWX 910-595-1565

1984 CATALOG AVAILABLE SOON • 64K UPGRADE KITS - ONLY \$50.00

64K UPGRADE - ONLY \$50.00 • CUSTOM CABLES AVAILABLE



# Computer Components Unlimited PERIPHERAL "CHALLENGE"

We Guarantee the Lowest Prices on All Peripherals

## THIS MONTH ONLY PERIPHERAL DISCOUNTS

<p><b>Siemens Disk Drive</b> ★ FDD100-8 ★ 8" Sgl/Dbl <b>\$119</b> 2 For <b>\$115 ea.</b> <b>Brother HR15</b> ★ 12 cps ★ Letter Quality ★ 2K Buffer <b>\$379</b></p>	<p><b>Monitor Stand</b> ★ Tilt &amp; Turn ★ Fits all 12" Monitors <b>\$19</b> <b>Teac or Mitsubishi</b> ★ Models 55F or 4853 ★ Quad Density <b>\$169</b> 2 For <b>\$159 ea.</b></p>	<p><b>64K UPGRADE</b> ★ 9 - 4164 ★ 90 Day Warranty <b>\$39 set</b> <b>Gorilla Monitor</b> ★ Hi-Res Green ★ Composite <b>\$79</b></p>
---	---	--

**CCU YOUR LARGEST DISK DRIVE SUPPLIER**  
We Also Have Used Drives Available Call

**Apple Compatible Drives**

	QUANTITY		
	1	2	10
<b>Micro Sci</b>			
A-2, 35 Track Controller	\$199 70	\$189 60	\$179 50
<b>Rana Systems</b>			
Elite I	\$235	\$230	\$225
Elite II, Dbl. Head	355	345	335
Elite III, Quad Density	455	445	435
Controller Controls 4 Drives	90	80	75
<b>Half Height</b>			
FD525A Fully Apple com.	\$140	\$130	\$120
<b>Sigma Technology</b>			
Full HT Apple	\$170	\$160	\$150

**5 1/4" Disk Drives**

	QUANTITY		
	1	2	10
<b>Teac</b>			
FD55A, 160K	\$160	\$150	\$140
FD55B, 360K	139	129	119
FD55F, Quad Density	180	170	160
All Teac's are Half Heights			
<b>Tandon</b>			
TM100-1, 160K	\$200	\$190	\$180
TM100-2, 360K	159	155	150
TM101-4, Quad Density	280	270	260
TM55-2, 360K 1/2 Height	220	210	200
<b>MPI</b>			
B-52, 360K PC Compatible	\$150	\$130	\$110
<b>Shugart</b>			
SA400, 160K	\$190	\$180	\$170
SA455, 360K 1/2 Height	200	190	180
SA465, Quad Den. 1/2 Height	230	220	210
<b>Mitsubishi</b>			
4851, 1/2 Height	\$200	\$190	\$180
4853, Quad Den. 1/2 Height	169	149	139
<b>Control Data Corp.</b>			
CDC 9409, 360K	\$200	\$190	\$180
CDC 9409T, Quad Density	300	250	200
<b>Matsushita</b>			
JA-155	\$140	\$130	\$120

**8" Disk Drives**

	QUANTITY		
	1	2	10
<b>Siemens</b>			
FDD-100-8	\$119	\$115	\$110
FDD-200-8	180	170	160
<b>Shugart</b>			
801R, Sgl./Dbl.	\$340	\$330	\$220
851R, Dbl./Dbl.	430	420	410
<b>Tandon</b>			
TM848-1E, Sgl./Dbl. 1/2 Ht.	\$240	\$230	\$220
TM848-2E, Dbl./Dbl. 1/2 Ht.	370	360	350
<b>Mitsubishi</b>			
M2894-63, Dbl./Dbl.	\$400	\$390	\$380
M2896-63, Dbl./Dbl. 1/2 Ht.	400	390	380
<b>Qume</b>			
DT8, Datatrak 8	\$450	\$440	\$430

**5 1/4" & 8" Power Supply & Cabinets**

	QUANTITY		
	1	2	10
<b>PC Products 5 1/4"</b>			
Single Cabinet w/ pwr	\$ 70	\$ 60	\$ 50
Dual Thinline Cab w/ pwr	80	70	60
Dual Cabinet & Power	80	70	60
All have 6 month Warranty			
<b>PC Products 8"</b>			
Sgl. Cabinet w/ pwr & fan	\$220	\$210	\$200
Dual w/ pwr for 2 thinlines	230	220	210
Dual w/ pwr & fan	270	260	250

## INTEGRATED CIRCUIT SPECIALS

Eproms		Static Rams		Dynamic Rams	
1702	\$4.30	2101 (450ns)	\$1.90	4116-2	\$1.50
2708	3.80	2114 L-2	1.75	4164-250	4.25
2716	3.80	TMS 4044-2	4.20	4164-200	4.75
TMS 2716	7.80	6116-4	4.70	4164-150	4.95
TMS 2532	5.80			<b>Co-Processor</b>	
2732	4.80			8087 Intel	\$ 159
2764	6.80				

**WE ACCEPT ANY UNIVERSITY OR QUALIFIED FIRM'S PURCHASE ORDER — CALL TOLL FREE FOR CORPORATE ACCOUNTS (800) 847-1718**



# (800) 847-1718

## Your Largest Computer Dealer

### COMPUTER SYSTEMS

<b>Apple</b>	
IIE cpu	\$ 690
Macintosh	Call
IIC Portable	999
<b>Compaq</b>	
Portable (PC Compatible) 2, 360K Drives	
256K of Memory	\$2195
Call for all new Compaq's	
<b>Columbia</b>	
Columbia VP	\$1995
Columbia MPC	2495
Columbia MPC w/ Hard Disk	3795
<b>Franklin</b>	
Ace 1000	\$ 675
Ace 1200 OMS	1395
<b>Kaypro</b>	
Kaypro II	\$1119
Kaypro 4	1695
Kaypro 4 + 88	1995
Kaypro 10	2350
Kaypro IIX	1399
<b>IBM</b>	
PC 64K, No Drives	\$1250
PC 64K, 1 Drive	1399
PC 64K, 2 Drives	1650
XT w/ 10 Meg, 256K	3695
Additional Memory 64K	39
<b>Sanyo</b>	
MBC 550-2	\$ 799
MBC 555-2	1099
Optional Serial Port	79
Optional 360K Drive	159
<b>Tava</b>	
PC Compatible w/ Monitor	\$1779

### APPLE ADD ON'S

<b>ALS</b>	
Z Card	\$ 119
CPM 3.0 Card	Call
<b>Astar</b>	
RF Modulator	\$ 15
Fan w/ Surge	29
<b>Kensington</b>	
System Saver	\$ 69
<b>Koala</b>	
Graphics Tablet	\$ 89
<b>Kraft</b>	
Joystick	\$ 44
<b>Micro Max</b>	
Viewmax 80, 80 col. card	\$ 139
Viewmax 80E (F for IIE) 64K	129
<b>Micro Soft</b>	
16K Card	\$ 69
Premium Soft Card IIE	369
Multiplan	189
Soft Card (Z80)	239
<b>Micro Tek</b>	
Serial Interface	\$ 89
<b>TG</b>	
Joystick	\$ 39
Select-A-Port	31
Paddles	34

### IBM ADD ON'S

<b>Ast Research</b>	
Six Pac < +	\$ 265
Mega +	265
<b>IBM</b>	
Monochrome Adapter	\$ 229
Color Card	239
<b>Plantronics</b>	
PC + w/ Software	\$ 389
<b>Quadram</b>	
Quad Color Card	\$ 219
<b>64K Upgrade</b>	
64K of Memory	\$ 39
<b>USI Research</b>	
Paradise Systems multi-display card	\$ 329
<b>PC Products</b>	
PC Peacock	\$ 219

### PRINTERS

<b>Brother</b>	
HR15, Letter Quality	\$ 379
HR25	719
<b>Epson</b>	
RX-80 (120 cps)	\$ 299
RX-80FT (120 cps) Friction & Tractor	319
FX-80 (* 60 cps)	459
FX-100 (160 cps) 15" Carriage	699
<b>Okidata</b>	
82A (120 cps) Par & Ser Inter.	\$ 299
83A (15" Carriage)	569
84P (200 cps) Friction & Tractor	849
<b>Okidata 90 Series</b>	
92P (160 cps)	\$ 409
93P (15" Carriage)	669
<b>Star Micronics</b>	
Gemin 10X (120 cps)	\$ 269
Gemin 15X (120 cps) 15" Carriage	399
Power type (18 cps) Ltr. qual.	399

### PRINTER INTERFACES

<b>Cables</b>	
IBM to Printer	\$ 29
Kaypro to Printer	29
RS232 Cables	29
<b>Fourth Dimension</b>	
Card & Cable	\$ 49
<b>Microtek</b>	
Dumping GX (Grappler Compatible)	\$ 89
Dumping GX exp to 64K	149
Dumping GX 16K w/ 16K exp to 64K	169
for each additional 16K	15
<b>Okidata Options</b>	
Tractor for 82 & 92	\$ 59
Serial Interface	99
<b>Orange Micro</b>	
Grappler +	\$ 113
Grappler + w/ 16K	179
<b>Star or Epson</b>	
Epson Serial Interface	\$ 119
Star Serial Interface	59

### MONITORS

<b>Amdek</b>	
Color I + Composite Video	\$ 249
Color II + RGB Video	419
300G, 12" Green	139
300A, 12" Amber	149
310A, Monochrome Amber	179
<b>BMC</b>	
9191 Color New Version	\$ 239
<b>IBM</b>	
Monochrome Hi-Res Green	\$ 239
<b>Princeton Graphics</b>	
PGS HX-12, IBM Copy	\$ 469
PGS SR-12, Hi-Res Color	649
PGS MAX-12, 12" Monochrome	199
<b>Zenith</b>	
ZVM122, Hi-Res Green	\$ 99
ZVM123, Hi-Res Amber	99

### 5 1/4" DISKETTES

<b>CCU</b>	
Sgl/ Dbl reinforced hub	\$16 100 for 140
Dbl/ Dbl reinforced hub	19 100 for 170
Not Bulk Packed	
<b>Dysan</b>	
Sgl/ Dbl	\$33 100 for 300
Dbl/ Dbl	39 100 for 370
<b>Fuji</b>	
Sgl/ Dbl	\$19 100 for 180
Dbl/ Dbl	25 100 for 230
<b>Maxell</b>	
MD1 Sgl/ Dbl	\$25 100 for 235
MD2 Dbl/ Dbl	38 100 for 360
<b>Verbatim</b>	
Sgl/ Dbl	\$26 100 for 240
Dbl/ Dbl	36 100 for 340

### 8" DISKETTES

<b>Dysan</b>	
Sgl/ Sgl	\$34 100 for 320
Dbl/ Dbl	53 100 for 480
<b>Maxell</b>	
Sgl/ Dbl	\$44 100 for 380
Dbl/ Dbl	50 100 for 469
<b>Verbatim</b>	
Sgl/ Sgl	\$30 100 for 280
Dbl/ Dbl	40 100 for 360

### DISK ACCESSORIES

<b>Verbatim</b>	
8" or 5 1/4" Head Cleaning Kit	\$ 9
<b>Flip Tub</b>	
5 1/4" Holds 50 disks, plexiglass	17
5 1/4" Holds 70 disks, plexiglass	21

### MODEMS

<b>Hayes Micro Computer</b>	
Smart Modem 300 Baud	\$ 205
Smart Modem 1200 Baud	489
Smart Modem 1200B for PC	399
Micro Modem IIE	239

# Computer Components Unlimited

A California Corporation

**RETAIL STORE:**  
11976 Aviation Blvd.  
Inglewood, CA 90304

**MAIL ORDER:**  
P.O. Box 1936  
Hawthorne, CA 90250

No Surcharge for  
Credit Cards  
This Ad Supersedes  
All Others

**Sales Desk**  
**(800) 847-1718 (213) 643-5188**  
Outside California Inside California

**Customer Service & Technical**  
**(213) 643-5191**

All merchandise new. We accept MC, Visa, Wire Transfer, COD Call, Certified Check, P.O.'s from qualified firms. APO accepted. Shipping: Min mum \$4.50 first 5 pounds. Tax: California Res. Only add 6 1/2% sales tax. All returns subject to 15% restocking charge. Prices Subject to Change.



AMERICA'S NO. 1  
**IBM Systems Specialists**

WE CUSTOMIZE IBM PC SYSTEMS

**IBM PC \$1899**

256K, two disk drives 360K each,  
Drive Controller and Keyboard

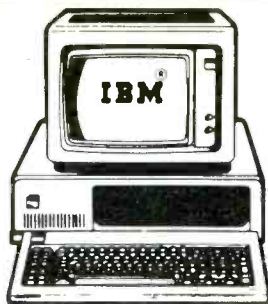

**IBMPC w/10MB**

256K, one floppy Drive, Keyboard  
10 MB Hard Disk with Controller  
**\$2599**  
BOOTS FROM HARD DISK Backup also available

ALL SYSTEMS ARE CONFIGURED  
AND TESTED AT NO EXTRA CHARGE

**IBMPCw/30MB**

256K, one floppy Drive, Keyboard  
30 MB Hard Disk with Controller  
and Booster Power Supply  
**\$3699**  
BOOTS FROM HARD DISK

★ **PRICE WAR** ★ CALL US **LAST** WITH YOUR BEST QUOTES ★

**PRINTERS**

<b>EPSON</b> RX-80	\$259	FX-80	\$429
RX-80FT	\$299	FX-100	\$629
LQ-1500 Parallel	\$1,149	Serial	\$1199
LQ-1500 Tractor	\$50	Cutsheet feeder	\$399

<b>OKIDATA</b> 92P	\$399
93P	\$619
INCLUDES PLUG & PLAY 84P	\$749

<b>JUKI 6100</b> Ltr Quality, 18 CPS, 13" wide	\$399
Tractor	\$129

2050	\$799
3550	\$1,499
<b>NEC</b> PINWRITER P2 and P3	CALL

<b>DYNAX DX-15</b>	\$399
Keyboard	\$149
Tractor	\$99
Sheet Feeder	\$199

<b>BROTHER</b> HR-25	\$619	HR-35	\$899
Tractor	\$119	Cut Sheet Feeder	\$199

<b>DATA PRODUCTS IDS PRISM COLOR PRINTER</b>	
80	\$999
132	\$1199
OPTIONS	CALL

**ANADEX • DIABLO**  
**QUME • TOSHIBA** CALL

**MONITORS**

<b>PGS</b> MAX-12 Amber—Monochrome	\$179
HX-12—Hi-Res Color	\$449
SR-12—Super Hi-Res Color	\$599

<b>TAXAN</b> COLOR & MONOCHROME	CALL
---------------------------------	------

310A	\$169	300A	\$149	300G	\$119
------	-------	------	-------	------	-------

**AMDEK COLOR MONITORS** .. CALL

**MODEMS**

<b>MICROCOM ERA 2</b>	
PC Internal 1200 Baud w/software, 4 Yr. Warranty	\$359

<b>HAYES SMARTMODEM</b> 1200 Standalone	\$469
1200B w/software	\$389

<b>QUBIE</b> Standalone	\$329	Internal	\$299
-------------------------	-------	----------	-------

<b>POPCOM</b> Internal or Standalone	CALL
--------------------------------------	------

**NOVATION • ANCHOR**  
**PROMETHEUS • RIXON**  
**U.S. ROBOTICS** CALL

P.O. & FOREIGN ORDERS  
Call, write or telex for details

**HARD DRIVES**

<b>TALL GRASS TECHNOLOGY</b>	
20 MB w/20 MB Backup	\$3,099
35 MB w/45 MB Backup	\$4,299
70 MB w/60 MB Backup	\$5,999

<b>QUBIE 10MB</b>	\$888
-------------------	-------

<b>EVEREX 10MB</b>	... \$888
--------------------	-----------

<b>MAYNARD 10MB/30MB</b>	
10MB/WS-1	\$888
10MB/WS-2	\$1,029
30MB/WS1A	\$1999
30MB/WS-2A	\$2,099
WS-1 Gemini	\$1049
WS-2 Gemini	\$1149
"The Gemini" includes 10MB Hard Disk & Half Ht. Floppy	

**FLOPPY DRIVES**

<b>TEAC</b> HALF 55B-DSDD	\$149
HEIGHT 55F-QUAD	\$199

Full Ht. - DSDD	\$199
Half Ht. - DSDD	\$179

<b>TANDON 100-2</b>	\$179
Full Ht. DSDD	

★ **SUPER SPECIALS** ★

<b>64K RAM</b> Set of 9 chips	\$45
-------------------------------	------

<b>HAYES SMARTMODEM</b> 1200 Standalone	\$469
1200B w/Software	\$389

<b>8087 CHIP</b>	\$159
------------------	-------

<b>JUKI 6100</b>	\$399
------------------	-------

<b>MAYNARD 10MB/WS-2</b>	\$1,029
--------------------------	---------

<b>IBM PC Keyboard (original)</b>	\$129
-----------------------------------	-------

<b>OKIDATA</b> 92P	\$399
93P	\$619
INCLUDES PLUG & PLAY 84P	\$749

<b>BROTHER</b> HR-25 (23CPS)	\$619
HR-35 (36CPS)	\$899

<b>KEYTRONIC</b> Deluxe Keyboard KB5151	\$179
---	-------

**LOTUS 1-2-3/SYMPHONY**  
Will Call Only

MasterCard VISA AMERICAN EXPRESS  
NO SURCHARGE ON COD, VISA or MC AMEX 5%

**NETWORKING**

<b>ORCHID TECHNOLOGY</b>	
PC Net PLUS Starter Kit	\$899
PC netBlossom, PC turbo, PC netPlusRam	CALL

**CORVUS OMNINET**  
CALL FOR YOUR CONFIGURATION AND PRICES

**MULTI-DISPLAY CARDS**

<b>PERSYST</b> Mono OR Color	\$199
BOB Mono and Color	CALL

Profit Systems **MULTIGRAPH** CALL

<b>EVEREX</b> Graphics Edge	\$399
-----------------------------	-------

<b>TECMAR</b> Graphics Master	CALL
-------------------------------	------

<b>HERCULES</b> Mono Graphics	\$329
Color Graphics	\$199

<b>NEW STB</b> Graphix Plus II	\$349
--------------------------------	-------

<b>PLANTRONIC</b> Color Plus	\$366
------------------------------	-------

<b>PARADISE</b> Multi-display Card	\$299
NEW Multidisplay Card	CALL

**MULTI-FUNCTION CARDS**

<b>ORCHID TECHNOLOGY</b>	
Blossom - OK (to 384K)	Best Price
PC net/upgrades	CALL

<b>NEW QUADBOARD</b> 0-K (to 384K)	\$219
------------------------------------	-------

<b>AST SIX PAK</b> with 64K (to 384K)	\$249
---------------------------------------	-------

<b>EVEREX</b> Magic Card w/software 0-K (to 384K)	\$199
---	-------

**MISC. ADD ONS**

<b>8087 CHIP</b>	\$159
Math Software	\$130
Both	\$269

<b>CABLE</b> Parallel	\$20	Serial	\$25
Keyboard Extension, 6 ft.			\$10

**BOOSTER POWER SUPPLY**  
ADDS POWER TO PC CALL

<b>VERBATIM</b> Datalife DSSD	
Box of 10	\$29

<b>COMPUTER ACCESSORIES</b> POWER DIRECTOR	P2 \$109
	P12 \$149

<b>STANDBY POWER SUPPLY</b> 200 WATTS	\$279
300 WATTS	\$379
Surge Protection, up to 30 minutes Standby Power	

**WILL CALL:** Please call first for workorder number.

**COMPUTER** **805-498-6635**

3541 OLD CONEJO ROAD, SUITE 102, THOUSAND OAKS, CA 91320 **TELEX 888522** Ad #191

**WOW!**

**IBM-PC DISK DRIVE \$1399.<sup>95</sup>**  
**APPLE 2e DRIVE \$799.<sup>95</sup>**  
**SANYO 555 DSDD \$969.<sup>95</sup>**  
**COMMODORE 64 \$179.<sup>95</sup>**

**JUKI 6100 \$359.<sup>95</sup>**  
**OKIDATA 92 \$369.<sup>95</sup>**  
**EPSON RX80 Ft \$289.<sup>95</sup>**  
**BROTHER 15 \$339.<sup>95</sup>**  
**GEMINI 10X \$244.<sup>95</sup>**

**HARMONY VIDEO & COMPUTERS**  
 2357 Coney Island Ave., Bklyn., NY 11223  
 Call Toll Free  
 800-VIDEO84 or 800-441-1144  
 or 212-627-1000

Circle 405 on inquiry card.

**Apple II/IIe®**  
**Robotic Development Package**

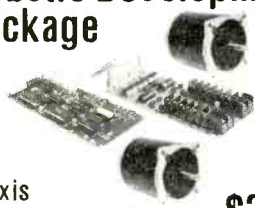

**2 Axis Stepper Motor System \$365**

- A6 T/D Plug-in Interface (PMS 23)
- R2 D23 Driver with (2) Size 23 Motors (35 oz. in.)
- Positioning Command with Ramping from Applesoft® BASIC

Also Available with:

- (2) Size 34 Motors (220 oz. in.) & R2 D34 Dual Axis Driver (PMS 34) **\$595**
- Power Supply for PMS 23 System, 12/24V-2A/5V-1A Reg **\$145**

**ROGERS LABS (714) 751-0442**  
 2710 S. Croddy Way, Santa Ana, CA 92704

Circle 312 on inquiry card.

**Apple II/IIe®**  
**Industrial Control Plug-In Boards**  
 (SOFTWARE INCLUDED)



**Opto-Isolated A32 I/O Board**

- Individually Configurable
- Compatible with SSR Modules
- Opto-Isolated Interrupt Inputs

**\$375**

**2 Axis Stepper Motor Interface**

- Positioning Control
- Pulse Counting/Timing
- Frequency Measurements

**\$250**

**ROGERS LABS (714) 751-0442**  
 2710 S. Croddy Way, Santa Ana, CA 92704

Circle 313 on inquiry card.

**FREE SOFTWARE**  
**RENT THE PUBLIC DOMAIN!**

User Group Software isn't copyrighted, so no fees to pay! 1000's of CP/M and IBM software programs in .COM and source code to copy yourself! Games, business, utilities! All FREE!

**CP/M USERS GROUP LIBRARY**  
 Volumes 1-92, 46 disks rental—\$45

**SIG/M USERS GROUP LIBRARY**  
 Volumes 1-90, 46 disks rental—\$45  
 Volumes 91-172, 40 disks rental—\$45  
**SPECIAL! Rent all SIG/M volumes for \$85**  
**MOST FORMATS AVAILABLE! SPECIFY.**

**IBM PC-SIG (PC-DOS) LIBRARY**  
 Volumes 1-135, 5 1/4" disks \$135

Public Domain User Group Catalog Disk \$5 pp. (CP/M only) (payment in advance, please)  
 Rental is for 7 days after receipt, 3 days grace to return. Use credit card, no disk deposit.

Shipping, handling & insurance—\$7.50 per library.  
**(619) 941-0925 information.**  
**(619) 727-1015 anytime order machine**  
 Have your credit card ready!

**Public Domain Software Center**  
 1533 Avohill Dr. Vista, CA 92083

Master Charge, VISA, Discover, AM EX

Circle 294 on inquiry card.

**FOR YOUR APPLE II, IIe, IIc, IIx, IIc+, IIc+, IIc+, IIc+**

**THE DOCTOR IS IN!**



Meet ELIZA, the computer psychotherapist.

Created at MIT in 1966 to run on a large mainframe, ELIZA has become the world's most celebrated artificial intelligence program. ELIZA will analyze any statement you enter and respond in true Rogerian fashion—and her remarks are often amazingly appropriate!

Unlike the stripped down versions you may have seen, our ELIZA has retained the full power and range of expression of the original mainframe program.

Best of all, ELIZA comes with the complete Source Program (written in BASIC) anyone, even a beginner, can easily customize ELIZA's responses.

So next time people ask you what your computer can do, bring out ELIZA and show them!

ELIZA is only \$45 and available in the following formats:

- Apple II, II plus, IIe, IIc, IIx
- IBM PC and all compatibles
- Commodore 64 (disk or cats)
- 8" CP/M disk
- 5 1/4" CP/M disk
- Specify make and model!

Add \$3.00 shipping & handling (Calif. res. add 6 1/2% sales tax)

Checks, MasterCard, and VISA accepted

**Artificial Intelligence RESEARCH GROUP**  
 921 N. La Jolla Ave., Dept. B  
 Los Angeles, CA 90046 **(213) 656-7368 or 654-2214**

Circle 29 on inquiry card.

**Apple Macintosh**  
**IBM, XT, Hard disks**  
**Eagle, Compaq, Columbia**  
**NCR, Olivetti, Leading Edge**

**Multiusers**  
 up to 16/TermSyst.  
**Printers/Plotters**  
**Monitors, Disk Drives**  
**Modems, Diskettes**  
**Software**  
 for PC & Multiusers  
**Printers: Epson, Okidata**  
**Gemini, Radix, NEC, HP**

**COMPUTER EXPO INC.**  
**SOURCE COMPUTERS**

**(213) 208-0352 208-0259**  
**(213) 906-1984 906-1634**

Circle 67 on inquiry card.

→ All **LOMAS DATA PRODUCTS\*** ←

16-Bit, S-100 Bus: Systems & Boards

\*\*\* **FIREBALL DISCOUNTS** \*\*\*

25% off List Price (UPS extra) for Cashier's Check or Money Order

You save **MONEY** = We save **TIME**

See → **LOMAS** ← ad in **BYTE** or request complete specifications

**LIGHTNING SPEED /**

80286-CPU & 80287-NDP: \$1468.75

!! **THUNDERING PERFORMANCE!!**

80186 & I/O & 256K-DRAM & 5.25"/8" disk controller & CCP/M-86: \$1196.25

Configured for **SanTec-S700 printer:**  
**TeleVideo-GA970C VDT: \$1121.75**  
**Spellbinder-6.30 W/P: \$371.25**

**HERIATIC COMPUTER SYSTEMS**  
 BOX 133; MEDFORD, MA 02155  
 (617) 683-6540

Circle 158 on inquiry card.

**IBM®**

**FLEXIBLE DISCS**

**WE WILL NOT BE UNDER-SOLD!! Call Free (800)235-4137** for prices and information. Dealer inquiries invited and C.O.D.'s accepted.



**VISA**

**PACIFIC EXCHANGES**  
 100 Foothill Blvd.  
 San Luis Obispo, CA 93401. In Cal. call (800)592-5935 or (805)543-1037

Circle 268 on inquiry card.

**NEW!**  
**NOTHING LIKE IT!**  
**THE PRINTER STAND™**

Only! **\$44.95**  
 Plus \$2 Postage



- Elevates & Tilts 80 Column Printer 45° Angle for easy readability • Saves space!
- Paper feeds from underneath
- Solid Hardwoods

**ORDER NOW**

SEND CHECK, MONEY ORDER OR CHARGE IT: VISA • MASTERCARD • AM. EX SPECIFY FINISH: LT. OR DARK POPLAR OR WALNUT UNCONDITIONALLY GUARANTEED 2 TO 4 WEEK DELIVERY

**(812) 897-5351**

**SYNERGY PRODUCTS**  
 BOX 485, BOONVILLE, IN 47601

Circle 404 on inquiry card.



# 4164 64K DYNAMIC 200ns 9/44.95 SSI 263 SPEECH SYNTHESIZER 39.95

## STATIC RAMS

2101	256 x 4	(450ns)	1.95
5101	256 x 4	(450ns) (cmos)	3.95
2102-1	1024 x 4	(450ns)	.89
2102L-4	1024 x 4	(450ns) (LP)	.99
2102L-2	1024 x 1	(250ns) (LP)	1.45
2125	1024 x 1	(45ns)	2.95
2111	256 x 4	(450ns)	2.49
2111L	256 x 4	(250ns) (LP)	2.95
2112	256 x 4	(450ns)	2.99
2114	1024 x 4	(450ns)	8/9.95
2114-25	1024 x 4	(250ns)	8/10.95
2114L-4	1024 x 4	(450ns) (LP)	8/12.95
2114L-3	1024 x 4	(300ns) (LP)	8/13.45
2114L-2	1024 x 4	(200ns) (LP)	8/13.95
TC5514	1024 x 4	(850ns) (cmos)	4.95
2147	4096 x 1	(35ns)	4.95
TMS4044-4	4096 x 1	(450ns)	3.49
TMS4044-3	4096 x 1	(300ns)	3.99
TMS4044-2	4096 x 1	(200ns)	4.49
UPD410	4096 x 1	(100ns)	3.95
MK4118	1024 x 8	(100ns)	9.95
TMM2016-200	2048 x 8	(200ns)	4.15
TMM2016-150	2048 x 8	(150ns)	4.95
TMM2016-100	2048 x 8	(100ns)	6.15
HM6116-4	2048 x 8	(200ns) (cmos)	4.75
HM6116-3	2048 x 8	(150ns) (cmos)	4.95
HM6116-2	2048 x 8	(120ns) (cmos)	8.95
HM6116L-P-4	2048 x 8	(200ns) (cmos) (LP)	5.95
HM6116L-P-3	2048 x 8	(150ns) (cmos) (LP)	6.95
HM6116L-P-2	2048 x 8	(120ns) (cmos) (LP)	10.95
TC5516	2048 x 8	(250ns) (cmos)	9.95
TMS4016	2048 x 8	(200ns)	6.95
Z-8132	4096 x 8	(300ns) (Qatalt)	34.95
HM6284P-15	8192 x 8	(150ns) (cmos) (LP)	37.95
HM6284LP-15	8192 x 8	(150ns) (cmos) (LP)	49.95

LP = Lower Power Qatalt = Quasi-Static

## DYNAMIC RAMS

TMS4027	4096 x 1	(250ns)	1.99
2107	4096 x 1	(200ns)	1.95
MMS280	4096 x 1	(300ns)	1.95
TMS4060	4096 x 1	(300ns)	1.95
UPD411	4096 x 1	(300ns)	1.95
TMS4050	4096 x 1	(300ns)	1.95
MK4108	8192 x 1	(200ns)	1.95
MMS298	8192 x 1	(250ns)	1.85
4116-300	18384 x 1	(300ns)	8/11.75
4116-250	18384 x 1	(250ns)	8/7.95
4116-200	18384 x 1	(200ns)	8/12.95
4116-150	18384 x 1	(150ns)	8/14.95
4116-120	18384 x 1	(120ns)	8/28.95
2118	18384 x 1	(150ns) (5v)	4.95
MK4332	32768 x 1	(200ns)	9.95
4164-200	85536 x 1	(200ns) (5v)	9/44.95
4164-150	85536 x 1	(150ns) (5v)	9/48.00
4164-120	85536 x 1	(120ns) (5v)	8.95
MCM6665	85536 x 1	(200ns) (5v)	8.95
TMS4164	85536 x 1	(150ns) (5v)	8.95
TMS4416	16384 x 4	(150ns) (5v)	9.95
41258-150	262144 x 1	(150ns) (5v)	44.95
41258-200	262144 x 1	(200ns) (5v)	39.95

5v = Single 5 volt supply

## EPROMS

1702	256 x 8	(1us)	4.50
2708	1024 x 8	(450ns)	3.95
2758	1024 x 8	(450ns) (5v)	5.95
2716-6	2048 x 8	(650ns)	2.95
2716	2048 x 8	(450ns) (5v)	3.95
2716-1	2048 x 8	(350ns) (5v)	5.95
TMS2516	2048 x 8	(450ns) (5v)	5.50
TMS2716	2048 x 8	(450ns)	7.95
TMS2532	4096 x 8	(450ns) (5v)	5.95
2732	4096 x 8	(450ns) (5v)	4.95
2732-250	4096 x 8	(250ns) (5v)	11.95
2732A-4	4096 x 8	(450ns) (5v) (21vPGM)	6.95
2732A-2	4096 x 8	(250ns) (5v) (21vPGM)	9.95
2732A-2	4096 x 8	(200ns) (5v) (21vPGM)	13.95
2764	8192 x 8	(450ns) (5v)	6.95
2764-250	8192 x 8	(250ns) (5v)	7.95
2764-200	8192 x 8	(200ns) (5v)	19.95
TMS2564	8192 x 8	(450ns) (5v)	14.95
MCM68764	8192 x 8	(450ns) (5v) (24pin)	39.95
MCM68766	8192 x 8	(350ns) (5v) (24pin)	42.95
27128-30	16384 x 8	(300ns) (5v)	22.95
27128	16384 x 8	(250ns) (5v)	24.95

5v Single 5 Volt Supply 21vPGM Program at 21 Volts

## CRYSTALS

32.768 khz	1.95
1.0 mhz	3.95
1.8432	3.95
2.0	2.95
2.097152	2.95
2.4576	2.95
3.2768	2.95
3.579545	2.95
4.0	2.95
5.0	2.95
5.0688	2.95
5.185	2.95
5.7143	2.95
6.0	2.95
6.144	2.95
6.5536	2.95
8.0	2.95
10.0	2.95
10.738635	2.95
14.31818	2.95
15.0	2.95
16.0	2.95
17.430	2.95
18.0	2.95
18.432	2.95
20.0	2.95
22.1184	2.95
32.0	2.95

## CMOS

4000	.29	4528	1.19
4001	.25	4531	.95
4002	.25	4532	1.95
4006	.89	4538	1.95
4007	.29	4539	1.95
4008	.95	4541	2.64
4009	.39	4543	1.19
4010	.45	4553	5.79
4011	.25	4555	.95
4012	.25	4556	.95
4013	.38	4581	1.95
4014	.79	4582	1.95
4015	.39	4584	.75
4016	.39	4585	.75
4017	.69	4702	12.95
4018	.79	74C00	.35
4019	.39	74C02	.35
4020	.75	74C04	.35
4021	.79	74C08	.35
4022	.79	74C10	.35
4023	.29	74C14	.59
4024	.65	74C20	.35
4025	.29	74C30	.35
4026	1.65	74C32	.39
4027	.45	74C42	1.29
4028	.69	74C48	1.99
4029	.79	74C73	.65
4030	.39	74C74	.65
4034	1.95	74C76	.80
4035	.85	74C83	1.95
4040	.75	74C85	1.95
4041	.75	74C86	.39
4042	.69	74C89	4.50
4043	.85	74C90	1.19
4044	.79	74C93	1.75
4046	.85	74C95	.99
4047	.95	74C107	.89
4049	.35	74C150	5.75
4050	.35	74C151	2.25
4051	.79	74C154	3.25
4053	.79	74C157	1.75
4060	.89	74C160	1.19
4066	.39	74C161	1.19
4068	.39	74C162	1.19
4069	.29	74C163	1.19
4070	.35	74C164	1.39
4071	.29	74C165	2.00
4072	.29	74C173	.79
4073	.29	74C174	1.19
4075	.29	74C175	1.19
4076	.79	74C192	1.49
4078	.29	74C193	1.49
4081	.29	74C195	1.39
4082	.29	74C200	5.75
4085	.95	74C221	1.75
4086	.95	74C244	2.25
4093	.49	74C373	2.25
4098	2.49	74C374	2.45
4099	1.95	74C901	.39
14409	12.95	74C902	.85
14410	12.95	74C903	.85
14411	11.95	74C905	10.95
14412	12.95	74C906	.95
14419	7.95	74C907	1.00
14433	14.95	74C908	2.00
4502	.95	74C909	2.75
4503	.65	74C910	9.95
4508	1.95	74C911	8.95
4510	.85	74C912	8.95
4511	.85	74C914	1.95
4512	.85	74C915	1.19
4514	1.25	74C918	2.75
4515	1.79	74C920	17.95
4516	1.55	74C921	15.95
4518	.89	74C922	4.49
4519	.39	74C923	4.95
4520	.79	74C925	5.95
4522	1.25	74C926	7.95
4526	1.25	74C928	7.95
4527	1.95	74C929	19.95

## ★★★★★ HIGH TECH ★★★★★

**41256** 262144x1 DYNAMIC RAM  
 \*PIN COMPATIBLE WITH 4164  
 \*LOW POWER CONSUMPTION:  
 350mW ACTIVE  
 23mW STANDBY  
 \*FAST! 150-200ns VERSIONS AVAILABLE  
 150ns 200ns  
**\$44.95 \$39.95**

## ★★★★★ SPOTLIGHT ★★★★★

- ★ Computer managed inventory - virtually no back orders!
- ★ Very competitive prices!
- ★ Friendly staff!
- ★ Fast service - most orders processed within 24 hours!

## UARTS

AY5-1013	3.95
AY3-1015	6.95
PT1472	9.95
TR1602	3.95
2350	9.95
2651	8.95
IM6402	7.95
IM6403	8.95
INS8250	10.95

## GENERATORS BIT-RATE

MC14411	11.95
BR1941	11.95
4702	12.95
COM5016	16.95
COM8116	10.95
MMS307	10.95

## FUNCTION

MC4024	3.95
LM566	1.49
XR2206	3.75
8038	3.95

## MISC.

UPD7201	29.95
TMS99532	29.95
ULN2003	4.29
3242	7.95
3341	4.95
MC3470	4.95
MC3480	9.00
11C90	13.95
95H90	7.95
2513-001 UP	9.95
2513-002 LDW	9.95

## CLOCK CIRCUITS

MM5314	4.95
MM5369	3.95
MM5369-EST	4.25
MM5375	4.95
MM58167	12.95
MM58174	11.95
MSM5832	3.95

## KEYBOARD CHIPS

AYS-2376	11.95
AYS-3600	11.95
AYS-3600 PRO	11.95

## 6800 6500 8000 8200 Z-80

68000	49.95	6502	1 MHz	4.95
6800	2.95	6504		4.95
6802	7.95	6504		6.95
6803	19.95	6505		8.95
6808	13.90	6507		8.95
6809E	14.95	6520		4.35
6809	11.95	6522		6.95
6810	2.95	6532		9.95
6820	4.35	6545		22.50
6821	2.95	6551		11.85
6828	14.95	6502A	2 MHz	6.95
6840	12.95	6522A		9.95
6843	34.95	6532A		11.95
6844	25.95	6545A		27.95
6845	14.95	6551A		11.95
6847	11.95	6502B	3 MHz	9.95
6850	3.25			
6852	5.75			
6860	7.95			
6875	6.95			
6880	2.25			
6883	22.95			
68047	24.95			
68488	19.95			
6800	1 MHz			
68800	10.95			
68802	22.25			
68809E	29.95			
68809	29.95			
68B10	6.95			
68B21	6.95			
68B40	19.95			
68B45	19.95			
68B50	5.95			
68B00	2 MHz			

## DISC CONTROLLERS

1771	16.95
1791	24.95
1793	26.95
1795	29.95
1797	49.95
2791	54.95
2793	54.95
2795	59.95
2797	59.95
6843	34.95
8272	39.95
UPD765	39.95
MBR876	29.95
MBR877	34.95
1691	17.95
2143	18.95



# 41256 256K DYNAMIC 200ns 39.95 HM6264-15 8Kx8 STATIC 150ns 37.95

### 74LS00

74LS00	24	74LS173	69
74LS01	25	74LS174	55
74LS02	25	74LS175	55
74LS03	25	74LS181	2.15
74LS04	24	74LS189	8.95
74LS05	25	74LS190	89
74LS08	28	74LS191	89
74LS09	29	74LS192	79
74LS10	29	74LS193	79
74LS11	35	74LS194	69
74LS12	35	74LS195	69
74LS13	45	74LS196	79
74LS14	59	74LS197	79
74LS15	35	74LS221	89
74LS20	25	74LS240	95
74LS21	29	74LS241	99
74LS22	25	74LS242	99
74LS26	29	74LS243	99
74LS27	29	74LS244	1.29
74LS28	35	74LS245	1.49
74LS30	25	74LS247	75
74LS32	29	74LS248	99
74LS33	55	74LS249	99
74LS37	35	74LS251	59
74LS38	35	74LS253	59
74LS40	25	74LS257	59
74LS42	49	74LS258	59
74LS47	75	74LS259	2.75
74LS48	75	74LS260	59
74LS49	75	74LS266	55
74LS51	25	74LS273	1.49
74LS54	29	74LS275	3.35
74LS55	29	74LS279	49
74LS63	1.25	74LS280	1.98
74LS73	39	74LS283	69
74LS74	35	74LS290	89
74LS75	39	74LS293	89
74LS76	39	74LS295	99
74LS78	49	74LS298	89
74LS83	60	74LS299	1.75
74LS85	69	74LS323	3.50
74LS86	39	74LS324	1.75
74LS90	55	74LS352	1.29
74LS91	89	74LS353	1.29
74LS92	55	74LS363	1.35
74LS93	55	74LS364	1.95
74LS95	75	74LS365	49
74LS96	89	74LS366	49
74LS107	39	74LS367	45
74LS109	39	74LS368	45
74LS112	39	74LS373	1.39
74LS113	39	74LS374	1.39
74LS114	39	74LS375	95
74LS122	45	74LS377	1.39
74LS123	79	74LS378	1.18
74LS124	2.90	74LS379	1.35
74LS125	49	74LS385	3.90
74LS126	49	74LS386	45
74LS132	59	74LS390	1.19
74LS133	59	74LS393	1.19
74LS136	39	74LS395	1.19
74LS137	99	74LS399	1.49
74LS138	55	74LS424	2.95
74LS139	55	74LS447	95
74LS145	1.20	74LS490	1.95
74LS147	2.49	74LS624	3.99
74LS148	1.35	74LS640	2.20
74LS151	55	74LS645	2.20
74LS153	55	74LS668	1.69
74LS154	1.90	74LS669	1.89
74LS155	69	74LS670	1.49
74LS156	69	74LS674	14.95
74LS157	65	74LS682	3.20
74LS158	59	74LS683	3.20
74LS160	69	74LS684	3.20
74LS161	65	74LS685	3.20
74LS162	69	74LS688	2.40
74LS163	65	74LS689	3.20
74LS164	69	81LS595	1.49
74LS165	95	81LS596	1.49
74LS166	1.95	81LS597	1.49
74LS168	1.75	81LS598	1.49
74LS169	1.75	25LS2521	2.80
74LS170	1.49	25LS2569	4.25

### 74S00

74S00	32	74S124	2.75	74S197	1.49
74S02	35	74S132	1.24	74S201	6.95
74S03	35	74S133	45	74S225	7.95
74S04	35	74S134	50	74S240	2.20
74S05	35	74S135	39	74S241	2.20
74S08	35	74S138	35	74S244	2.20
74S09	40	74S139	35	74S251	.95
74S10	35	74S140	55	74S253	.95
74S11	35	74S151	.95	74S257	.95
74S15	35	74S153	.95	74S258	.95
74S20	35	74S157	.95	74S260	.79
74S22	35	74S158	.95	74S273	2.45
74S30	35	74S161	1.35	74S280	1.95
74S32	40	74S162	1.35	74S287	1.90
74S37	88	74S163	1.35	74S288	1.90
74S38	85	74S168	3.35	74S289	6.89
74S40	35	74S169	3.35	74S301	6.95
74S51	35	74S174	.95	74S373	2.45
74S54	40	74S175	.95	74S374	2.45
74S55	40	74S181	3.35	74S387	1.95
74S56	40	74S182	2.35	74S412	2.98
74S57	50	74S188	1.35	74S471	4.95
74S58	1.99	74S189	6.35	74S472	4.95
74S59	50	74S194	1.49	74S474	4.95
74S60	50	74S195	1.49	74S570	2.95
74S61	50	74S196	1.49	74S571	2.95

### VOLTAGE REGULATORS

7805T	75	7905T	85
7805C	35	7908T	85
7808T	75	7912T	85
7812T	75	7915T	85
7815T	75	7924T	85
7824T	75	7905K	1.49
7805K	1.39	7912K	1.49
7812K	1.39	7915K	1.49
7815K	1.39	7924K	1.49
7824K	1.39	79L05	.79
78L05	69	79L12	.79
78L12	69	79L15	.79
78L15	69	LM323K	4.95
78H05K	9.95	UA78540	1.95
78H12K	9.95		

C, T TO-220 K TO-3  
L TO-92

### 7400

7400	.19	74123	.49
7401	.19	74125	.45
7402	.19	74126	.45
7403	.19	74132	.45
7404	.19	74136	.50
7405	.25	74143	4.95
7406	.29	74145	6.00
7407	.29	74147	1.75
7408	.24	74148	1.20
7409	.19	74150	1.35
7410	.19	74151	.55
7411	.25	74153	.55
7413	.35	74154	1.25
7414	.49	74155	.75
7416	.25	74157	.55
7417	.25	74159	1.65
7420	.19	74160	.85
7421	.35	74161	.69
7425	.29	74163	.69
7427	.29	74164	.85
7430	.19	74165	.85
7432	.29	74166	1.00
7437	.19	74167	2.95
7438	.29	74170	1.65
7442	.49	74173	.75
7445	.69	74174	.89
7446	.69	74175	.89
7447	.69	74177	.75
7448	.69	74181	2.25
7451	.23	74184	2.00
7473	.34	74185	2.00
7474	.33	74191	1.15
7475	.45	74192	.79
7476	.35	74193	.79
7482	.95	74194	.85
7483	.50	74195	.85
7485	.59	74197	.75
7486	.35	74198	1.35
7489	2.15	74221	1.35
7490	.35	74246	1.35
7492	.50	74247	1.25
7493	.35	74259	2.25
7495	.55	74273	1.95
7497	2.75	74276	1.25
74100	1.75	74279	.75
74107	.30	74366	.65
74109	.45	74367	.65
74116	1.55	74368	.65
74121	.29	74393	1.35
74122	.45		

### BYPASS CAPS

.01 UF DISC	100/6.00
.01 UF MONOLITHIC	100/12.00
1 UF DISC	100/8.00
1 UF MONOLITHIC	100/15.00



### EPROM ERASERS

## SPECTRONICS CORPORATION

	Capacity	Intensity	
	Timer	Chip	(uW/Cm <sup>2</sup> )
PE-14		9	8,000
PE-14T	X	9	8,000
PE-24T	X	12	9,600
PL-265T	X	30	9,600
PR-125T	X	25	17,000
PR-320T	X	42	17,000

### INTERFACE

8T26	1.59
8T28	1.89
8T95	8.99
8T96	8.99
8T97	8.99
8T98	8.99
DM8131	2.95
DP8304	2.29
DS8833	2.25
DS8835	1.99
DS8836	.99
DS8837	1.65
DS8838	1.30

### DATA ACQUISITION

ADC0800	15.55	DAC0800	4.95
ADC0804	3.49	DAC0808	2.95
DAC0806	1.95	DAC1020	8.25
ADC0809	4.49	DAC1022	5.95
ADC0816	14.95	MC1408L6	1.95
ADC0817	9.95	MC1408L8	2.95

### CONNECTORS

RS232 Male	2.50
RS232 Female	3.25
RS232 Hood	1.25
S-100 ST	3.95

### EXAR

XR 2206	3.75
XR 2207	3.75
XR 2208	3.75
XR 2211	5.25
XR 2240	3.25

### LINEAR

LM301	34	LM348	99	LM567	89	LM1812	8.25
LM301H	79	LM350K	4.95	NE570	3.95	LM1830	3.50
LM307	45	LM350T	4.60	NE571	2.95	LM1871	5.49
LM308	69	LM358	69	NE590	2.50	LM1872	5.49
LM308H	1.15	LM359	1.79	NE592	2.75	LM1877	3.25
LM309H	1.95	LM376	3.75	LM709	59	LM1889	1.95
LM309K	1.25	LM377	1.95	LM710	75	LM1896	1.75
LM310	1.75	LM378	2.50	LM711	79	ULN2003	2.49
LM311	64	LM379	4.50	LM723	49	LM2877	2.05
LM311H	89	LM380	89	LM723H	55	LM2878	2.05
LM312H	1.75	LM380N-B	1.10	LM733	98	LM2900	85
LM317K	3.95	LM381	1.60	LM741	35	LM2901	1.00
LM317T	1.19	LM382	1.60	LM741N-14	35	LM2917	2.95
LM318	1.49	LM383	1.95	LM741H	40	LM3900	59
LM318H	1.59	LM384	1.95	LM747	69	LM3905	1.25
LM319H	1.90	LM386	89	LM748	59	LM3909	98
LM319	1.25	LM387	1.40	LM1014	1.19	LM3911	2.25
LM320 (see 7900)	LM389	1.35	LM1303	1.95	LM3914	3.95	
LM322	1.65	LM390	1.95	LM1310	1.49	LM3915	3.95
LM323K	4.95	LM392	69	MC1330	1.69	LM3916	3.95
LM324	59	LM393	1.29	MC1349	1.89	MC4024	3.95
LM329	85	LM394H	4.60	MC1350	1.89	MC4044	4.50
LM331	3.95	LM399H	5.00	MC1358	1.69	RC4136	4.25
LM334	1.19	NE531	2.95	MC1372	6.95	RC4151	3.95
LM335	1.40	NE555	34	LM1414	1.59	LM4250	1.75
LM336	1.75	NE556	65	LM1458	59	LM4500	3.25
LM337K	3.95	NE558	1.50	LM1488	69	RC4558	69
LM337T	1.95	NE561	24.95	LM1489	69	LM13080	1.29
LM338K	6.95	NE564	2.95	LM1496	85	LM13600	1.49
LM339	99	LM565	99	LM1558H	3.10	LM13700	1.49
LM340 (see 7800)	LM566	1.49	LM1800	2.37	MPQ2907	1.95	

F TO-5 CAN T TO-180 K TO-3

### RCA

CA 3023	2.75	CA 3082	1.65
CA 3039	1.29	CA 3083	1.55
CA 3046	1.25	CA 3086	8.00
CA 3059	2.90	CA 3089	2.99
CA 3060	2.90	CA 3096	3.49
CA 3065	1.75	CA 3130	1.30
CA 3080	1.10	CA 3140	1.15
CA 3081	1.65	CA 3146	1.85



**27128** 16Kx8 EPROM  
250ns

**4116** 16K DYNAMIC  
250ns **8/7.95**

**BARGAIN HUNTERS CORNER**

**FLOPPY SALE**

**FD200-8** For 8-100 **\$195.00**

- \* Manufactured by Siemens w/ 90 day warranty
- \* 8" Double sided, double density
- \* Manual included
- \* NEW (not surplus as sold by others)

**MPI-852** FOR IBM PC **\$139.95**

- \* Manufactured by MPI w/ 90 day warranty
- \* 5 1/4" DS/DD, better than Tandon
- \* NEW (not surplus as sold by others)

**BAL-525** FOR APPLE USERS **\$139.95**

- \* 1/2 Height — ALPS mechanism
- \* 100% Apple compatible
- \* Full 1 YEAR WARRANTY

**DISKETTES**

NASHUA 5 1/4" DS/DD WITH HUB RING **\$15.95**  
 VERBATIM DATALIFE 5 1/4" DS/DD **\$29.95**

**SPECIALS END 11/30/84**

**ZIF SOCKETS**

ZIF =  
Zero  
Insertion  
Force

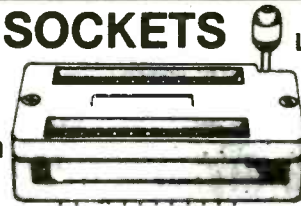

LEADS	UNIT PRICE
14	5.95
16	5.95
24	7.95
28	8.95
40	10.95

**OPTO-ISOLATORS**

4N26	1.00	MCA-7	4.25
4N27	1.10	MCA-255	1.75
4N28	.69	IL-1	1.25
4N33	1.75	ILA-30	1.25
4N35	1.25	ILQ-74	2.75
4N37	1.25	H11C5	1.25
MCT-2	1.00	TIL-111	1.00
MCT-6	1.50	TIL-113	1.75

**CAPACITORS  
TANTALUM**

	8V	10V	15V	20V	25V	35V
.22uf						.40
.27						.40
.33						.40
.47			.35			.50
.68						.45
1.0		.40	.40	.45	.45	
1.5			.45			.50
1.8						.75
2.2		.35	.40	.45		.65
2.7		.40	.45			.90
3.3		.45	.50	.55	.60	.65
3.9			.45			
4.7	.45	.55		.80	.85	.85
6.8			.70			.75
10	.55	.85	.80	.85	.90	1.00
12	.85		.85	.90		
15	.75	.85	.90			
18				1.25		
22		1.00	1.35			
27				2.25		
39		1.50				
47	1.35					
56	1.75					
100		3.25				
270	3.75					

**RESISTORS**

1/4 WATT 5% CARBON FILM  
ALL STANDARD VALUES  
FROM 1 OHM TO 10 MEG OHM  
50 PCS. SAME VALUE .025  
100 PCS. SAME VALUE .02  
1000 PCS. SAME VALUE .015

**BYPASS CAPS**

.01 UF DISC	100/8.00
.01 UF MONOLITHIC	100/12.00
.1 UF DISC	100/8.00
.1 UF MONOLITHIC	100/15.00

**DIODES**

1N751	5.1 volt zener	.25
1N759	12.0 volt zener	.25
1N4148	(1N914) switching	25/1.00
1N4004	400PIV rectifier	10/1.00
KBP02	200PIV 1.5amp bridge	.45
KBP04	400PIV 1.5amp bridge	.55
VM48	Dip-Bridge	.35

**MUFFIN FANS**

4.88" Square	14.95
3.125" Square	14.95

**HEAT SINKS**

TO-3 style	.95
TO-220 style	.35

**SWITCHES**

SPDT mini-toggle	1.25
DPDT mini-toggle	1.50
SPST mini-pushbutton	.39

**TRANSISTORS**

2N918	.50	MPS3706	.15
MPS918	.25	2N3772	1.65
2N2102	.75	2N3903	.25
2N2218	.50	2N3904	.10
2N2218A	.50	2N3906	.10
2N2219	.50	2N4122	.25
2N2219A	.50	2N4123	.25
2N2222	.25	2N4249	.25
PN2222	.10	2N4304	.75
MPS2369	.25	2N4401	.25
2N2484	.25	2N4402	.25
2N2905	.50	2N4403	.25
2N2907	.25	2N4857	1.00
PN2907	.125	PN4918	.25
2N3055	.79	2N5086	.25
3055T	.69	PN5129	.25
2N3393	.30	PN5139	.25
2N3414	.25	2N5209	.25
2N3563	.40	2N6028	.35
2N3565	.40	2N6043	1.75
PN3565	.25	2N6045	1.75
MPS3638	.25	MPS-A05	.25
MPS3640	.25	MPS-A06	.25
PN3643	.25	MPS-A55	.25
PN3644	.25	TIP29	.65
MPS3704	.15	TIP31	.75
		TIP32	.79

**IC SOCKETS**

1-99 100	
8 pin ST	.13 .11
14 pin ST	.15 .12
16 pin ST	.17 .13
18 pin ST	.20 .18
20 pin ST	.29 .27
22 pin ST	.30 .27
24 pin ST	.30 .27
28 pin ST	.40 .32
40 pin ST	.49 .39
64 pin ST	4.25 call

ST = SOLDERTAIL

8 pin WW	.59 .49
14 pin WW	.69 .52
16 pin WW	.69 .58
18 pin WW	.99 .90
20 pin WW	1.09 .98
22 pin WW	1.39 1.28
24 pin WW	1.49 1.35
28 pin WW	1.69 1.49
40 pin WW	1.99 1.80

WW = WIREWRAP

**RF MODULATOR**

(ASTECCUM1082) QUANTITIES LIMITED

- \* PRESET TO CHANNEL 3
- \* USE TO BUILD TV-COMPUTER INTERFACE
- \* +5 VOLT OPERATION

**NOW ONLY \$6.95**

**LED LAMPS**

	1-99	100-up
JUMBO RED	.10	.09
JUMBO GREEN	.18	.15
JUMBO YELLOW	.18	.15
LED MOUNTING HARDWARE	.10	.09

**LED DISPLAYS**

HP 5082-7760	.43"	CC	1.29
MAN 72	.3"	CA	.99
MAN 74	.3"	CC	.99
FND-357 (359)	.375"	CC	1.25
FND-500 (503)	.5"	CC	1.49
FND-507 (510)	.5"	CA	1.49
TIL-311 4x7	.270"	HEX W/LOGIC	9.95

**DIP SWITCHES**

4 POSITION	.65
5 POSITION	.90
6 POSITION	.90
7 POSITION	.95
8 POSITION	.95

**COMPUTER GRADE**

500	16V .42
1000	16V .60
1500	16V .70
6000	16V .85

**VISIT OUR NEW, EXPANDED RETAIL STORE AT 1256 SOUTH BASCOM IN SAN JOSE**

HOURS: M-W-F, 9-5 T-TH.. 9-9 SAT.. 10-3



1224 S. Bascom Avenue, San Jose, CA 95128

800-538-5000 • 800-662-6279 (CA)

(408) 995-5430 • Telex 171-110

FAX (408) 275-8415

PLEASE USE YOUR CUSTOMER NUMBER WHEN ORDERING

TERMS: Minimum order \$10. For shipping and handling include \$2.50 for UPS Ground and \$3.50 for UPS Air. Orders over 1 lb. and foreign orders may require additional shipping charges — please contact our sales department for the amount. CA residents must include 6% sales tax. Bay Area and LA residents include 6 1/2%. Prices subject to change without notice. We are not responsible for typographical errors. We reserve the right to limit quantities and to substitute manufacturer. All merchandise subject to prior sale.



**HM6116-4** 2Kx8 STATIC CMOS 200ns

**2732** 4Kx8 EPROM 450ns **4.95**

**CABINETS FOR 5 1/4" DISK DRIVES**

**CABINET #1 \$29.95**

- ★ Dimensions 8 1/2 x 5 1/8 x 3 1/8"
- ★ Color matches Apple
- ★ Fits standard 5 1/4" drives, inc. Shugart
- ★ Includes mounting hardware and feet

**CABINET #2 \$79.00**

- ★ Complete with power supply, switch, line cord, fuse & standard power connector
- ★ Dimensions: 11 1/2 x 5 1/8 x 3 1/8"
- ★ +5V @ 1 AMP, +12V @ 1.5 AMP
- ★ Please specify gray or tan

NOTE: Please include sufficient amount for shipping on above items.

**TRANSFORMERS FRAME STYLE**

12.6VAC	2amp	4.95
12.6VAC CT	2amp	5.95
12.6VAC CT	4amp	7.95
12.6VAC CT	8amp	10.95
25.2VAC CT	2amp	7.95

**PLUG CASE STYLE**

12VAC	250ma	3.95
12VAC	500ma	4.95
12VAC	1amp	5.95
12VAC	2amp	6.95

**DC ADAPTER**

6, 9, 12 VDC selectable with univolar adapter 8.95  
Please include sufficent amount for shipping on above items.

**DISK DRIVES**

TM 100-1 5 1/4" (FOR IBM) SS/DD	\$199.00
TM 100-2 5 1/4" (FOR IBM) DS/DD	\$199.00

**MPI**

MP-52 5 1/4" (FOR IBM) DS/DD	\$249.00
------------------------------	----------

**TEAC**

FD-55B 1/2 HEIGHT DS/DD	\$159.00
FD-55F 1/2 HEIGHT DS/QUAD	\$200.00

**SHUGART**

SA 400L 5 1/4" (40 TRACK) SS/DD	\$199.95
---------------------------------	----------

**8" DISK DRIVES**

FD100-8 BY SIEMENS, SHUGART 801 EQUIV. SS/DD 10/\$129.95 ea.	\$149.95
FD200-8 BY SIEMENS, SHUGART 805 EQUIV. DS/DD	\$195.00

JFORMAT-2 \$59.95

SUPPORT FOR QUAD DENSITY DRIVES FROM TALL TREE SYSTEMS

PLEASE INCLUDE SUFFICIENT AMOUNT FOR SHIPPING ON ABOVE ITEMS

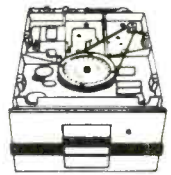

TANDON 5 1/4"

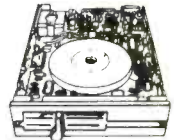

TEAC HALF HEIGHT

**MICROCOMPUTER HARDWARE HANDBOOK FROM ELCOMP — \$14.95**

Over 800 pages of manufacturers data sheets on most commonly used IC's.

Includes:

- ★ TTL — 74/74LS and 74F
- ★ CMOS
- ★ Voltage Regulators
- ★ Memory — RAM, ROM, EPROM
- ★ CPU's — 6800, 6500, Z80, 8080, 8085, 8086/8
- ★ MPU support & interface — 6800, 6500, Z80, 8200, etc.

**ORDER TOLL FREE**

**800-538-5000**

**800-662-6279**

(CALIFORNIA RESIDENTS)



**CENTRONICS**

IDCEN36	Ribton Cable	36 Pin Male	8.95
IDCEN36/F	Ribton Cable	36 Pin Female	8.95
CEN36	Solcer Cup	36 Pin Male	7.95

**RIBBON CABLE**

CONTACTS	SINGLE COLOR		COLOR CODED	
	1'	10'	1'	10'
10	.50	4.40	.83	7.30
16	.55	4.80	1.00	8.80
20	.65	5.70	1.25	11.00
25	.75	6.60	1.32	11.60
26	.75	6.60	1.32	11.60
34	.98	8.60	1.65	14.50
40	1.32	11.60	1.92	16.80
50	1.38	12.10	2.50	22.00

**BEST SELLING BOOKS OSBORNE/MC GRAW-HILL**

Apple II User's Guide	18.95
CRT Controller's Handbook	9.95
68000 Assembly Language Programming	18.99
CBASIC User Guide	15.00

**SYBEX**

Z-80 Applications	15.95
IBM PC DOS Handbook	16.95
Programming the 8086/8088	15.95
The Best of IBM PC Software	16.95
Microprocessor Interfacing Techniques	17.95

**EDGE CARD CONNECTORS**

S-100 ST	3.95
S-100 WW	4.95
72 pin ST	6.95
72 pin WW	7.95
50 pin ST	4.95
44 pin ST	2.95
44 pin WW	4.95

**DIP CONNECTORS**

DESCRIPTION	ORDER BY	CONTACTS								
		8	14	16	18	20	22	24	28	40
HIGH RELIABILITY TOOLED ST IC SOCKETS	AUGATxx-ST	.99	.99	.99	1.69	1.89	1.89	1.99	2.49	2.99
COMPONENT CARRIERS (DIP HEADERS)	ICCxx	.65	.75	.85	1.00	1.25	1.25	1.35	1.50	2.10
RIBBON CABLE DIP PLUGS (IDC)	IDPxx	---	1.45	1.65	---	---	---	2.50	---	4.15

For order instructions see "IDC Connectors" below.

**D-SUBMINIATURE**

DESCRIPTION	ORDER BY	CONTACTS				
		9	15	25	37	50
SOLDER CUP	MALE DPxxP	2.08	2.69	2.50	4.80	6.06
	FEMALE DBxxS	2.66	3.63	3.25	7.11	9.24
RT. ANGLE	MALE DBxxPR	1.65	2.20	3.00	4.83	---
PC SOLDER	FEMALE DBxxSR	2.18	3.03	4.42	6.19	---
IDC RIBBON CABLE	MALE IDBxxP	3.37	4.70	6.23	9.22	---
	FEMALE IDBxxS	3.69	5.13	6.84	10.08	---
HOODS	BLACK HOOD-B	---	---	1.25	---	---
	GREY HOOD	1.60	1.60	1.25	2.95	3.50

MOUNTING HARDWARE - \$1.00

For order instructions see "IDC Connectors" below.

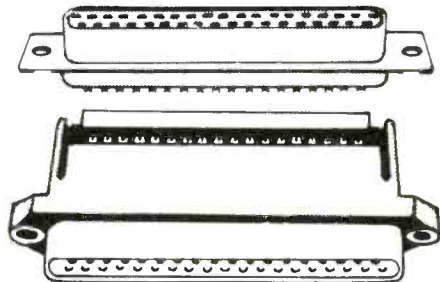

**IDC CONNECTORS**

DESCRIPTION	ORDER BY	CONTACTS					
		10	20	26	34	40	50
SOLDER HEADER	IDHxxS	.82	1.29	1.68	2.20	2.58	3.24
RT. ANGLE SOLDER HEADER	IDHxxSR	.85	1.35	1.76	2.31	2.72	3.39
WW HEADER	IDHxxW	1.86	2.98	3.84	4.50	5.28	6.63
RT. ANGLE WW HEADER	IDHxxWR	2.05	3.28	4.22	4.45	4.80	7.30
RIBBON HEADER SOCKET	IDSxx	1.15	1.86	2.43	3.15	3.73	4.65
RIBBON HEADER	IDMxx	---	5.50	6.25	7.00	7.50	8.50
RIBBON EDGE CARD	IDExx	2.25	2.36	2.65	3.25	3.80	4.74

ORDERING INSTRUCTIONS: Insert the number of contacts in the position marked "xx" of the "order by" part number listed. EXAMPLE: A 10 pin right angle solder style header would be IDH 10 SR.

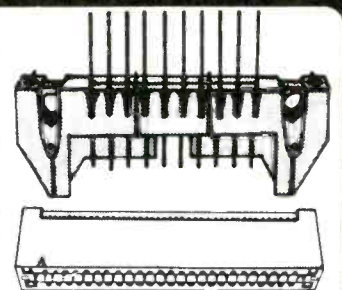



# MPI B52 DS/DD FULL HEIGHT FDD FOR IBM \$139.95

## 130W POWER SUPPLY



XT COMPATIBLE  
+5V @ 15A  
+12V @ 4.2A  
-5V @ .5A  
-12V @ .5A  
**\$175.00**  
1 YEAR WARRANTY

## PROTOTYPE BOARDS

BOTH CARDS FEATURE GLASS EPOXY WITH PLATED-THROUGH HOLES, SOLDER MASK, SILK-SCREENED, GOLD CARD-EDGE, MOUNTING BRACKETS AND INSTRUCTIONS INCLUDED.

**IBM-PR1 \$27.95**  
GENERAL PURPOSE DEVELOPMENT BOARD WITH CONVENIENT LINES FOR POWER AND GROUND. HOLES ON .1" CENTERS.

**IBM-PR2 \$29.95**  
AS ABOVE, WITH MODULAR SIGNAL DECODING AREA PROVIDING BUSS BUFFERING, BLOCK DECODING, AND ADDITIONAL DECODING.

## TANDON TM 100-2

\* SAME DRIVE AS SUPPLIED BY IBM  
\* DS/DD - 320K  
**\$199.00**

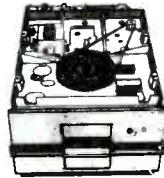

## TEAC FD 55-B 1/2 HEIGHT

\* 6ms STEP RATE  
\* DS/DD  
\* INCLUDES INSTRUCTIONS  
**\$159.00**

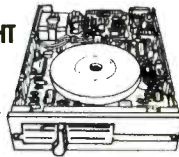

BUY 2/\$299.00, AND GET FREE MOUNTING BRACKETS!

## MAXIMIZER by SIGMA DESIGNS, INC.



## MAXIMIZE YOUR IBM OR XT

	MAXIMIZER	AST 6-PACK+
Maximum Memory	384K/512K <sup>1</sup>	384K
RS-232 Serial	2 <sup>2</sup>	1
Parallel Port	1	1
Clock Calendar	YES	YES
Game Adaptor	OPTIONAL	OPTIONAL

<sup>1</sup> With Optional 128K MAXISTACK  
<sup>2</sup> Second Serial Port Optional

**OPTIONS:**  
\* 2nd Serial Port \$49.95  
\* Game Adaptor \$29.95  
**\$259.95 (64K)** \* 128K MAXISTACK \$159.95  
\* Additional 64K Ram \$49.00  
**ONE YEAR WARRANTY**

# FOR APPLE COMPUTER USERS

## JDR 16K RAM CARD

- \* 2 YEAR WARRANTY
- \* EXPAND YOUR 48K APPLE TO 64K
- \* USE IN PLACE OF APPLE LANGUAGE CARD

**\$39.95**

BASE PC CARD \$9.95



## JDR HALF HEIGHT DISK DRIVE

- \* TEAC MECHANISM-DIRECT DRIVE
- \* 100% APPLE COMPATIBLE-35 TRACK
- \* 40 TRACK WHEN USED WITH OPTIONAL CONTROLLER

**\$169.95**

## MITAC AD-1 \$179.95

- \* FULL HEIGHT SHUGART MECHANISM
- \* DIRECT REPLACEMENT FOR APPLE DISK II CONTROLLER CARD \$49.95

## OMNIGRAPH

BY MA SYSTEMS  
PARALLEL GRAPHICS INTERFACE FOR APPLE II AND APPLE IIe

- \* HIGH RESOLUTION MULTICOLOR GRAPHICS
- \* CENTRONICS STANDARD FOR EPSON, OKIDATA...
- \* SCREEN DUMP, ROTATION, INVERSION, ZOOM, AND MORE!
- \* 1 YEAR WARRANTY

**\$79.95**

## MICROMAX

ALL WITH A 2 YEAR WARRANTY

**VIEWMAX-80 \$159.95**

\* 80 COLUMN CARD FOR APPLE IIe

**VIEWMAX 80-8 \$129.95**

\* 80 COLUMN CARD FOR APPLE IIe

\* 64K RAM EXPANDABLE TO 128K

**GRAPHMAX \$129.95**

- \* HIGH RESOLUTION GRAPHICS
- \* PRINTER CARD

## OTHER ACCESSORIES FOR APPLE II

### THUNDERCLOCK \$129.95

- \* OFFICIAL PRODOS CLOCK CALENDAR
- \* 100% MOUNTAIN SOFTWARE COMPATIBLE
- \* BSR CONTROL OPTIONS AVAILABLE

### KRAFT JOYSTICK

- \* SELF CENTERING
- \* AXIS ISOLATION

**\$39.95**

### APPLE COMPATIBLE POWER SUPPLY

- \* USE TO POWER APPLE TYPE SYSTEMS
- \* +5V @ 4A +12V @ 2.5A
- \* -5V @ 5A -12V @ 5A
- \* APPLE POWER CONNECTOR
- \* INSTRUCTIONS INCLUDED

**\$49.95**

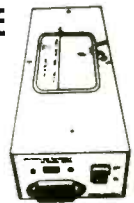

# PERIPHERALS AND ACCESSORIES



## MONITORS

**BMC MONITOR STAND MODEL PA-900**

Your Display will Tilt & Swivel **\$29.95**

## MONOCHROME

BMC BM JJ1201G GREEN 12" 89.98

BMC BM 12EUV 18MHz AMBER 139.95

BMC BM 12EUN 18MHz HIGH RES GREEN 115.00

NEC JB 1201M 20MHz GREEN 169.00

ZENITH ZVM-123 15MHz GREEN 105.00

## COLOR

BMC BM AU9191U COMPOSITE 13" 279.00  
NO C.O.D. ORDERS PLEASE

## BMC BX-80 PRINTER

- \* 80 CPS DOT MATRIX PRINTER
- \* PRINTS BI-DIRECTIONAL IN 40, 80, 71 OR 142 COLUMNS IN NORMAL, DOUBLE WIDTH OR COMPRESSED TEXT.
- \* PRINT SUPERSCRIP AS WELL AS SUPERB GRAPHICS IN CHARACTER OR BIT IMAGE.

**\$249**



## 5 1/4" DISKFILE

- \* ATTRACTIVE, FUNCTIONAL DISK STORAGE SYSTEM
- \* 75 DISK STORAGE CAPACITY

**\$16<sup>99</sup>**



## NASHUA DISKETTES

5 1/4" WITH HUB RING

MD1 SOFT, SS/SD 19.95

MD1D SOFT, SS/DD 26.25

MD2D SOFT, DS/DD 30.75

MD2F SOFT, DS/4D 45.00

MD110 10 SECTOR, SS/SD 19.95

MD210D 10 SECTOR, DS/DD 30.75

## 8 INCH

FD1 SOFT, SS/DD 24.75

FD1D SOFT, SS/DD 30.00

FD2D SOFT, DS/DD 36.75

## VERBATIM

DATALIFE DISKETTES

SS/DD SOFT SECTOR 29.95

SS/DD 10 SECTOR HARD 29.95

DD/DD SOFT SECTOR 34.95

VISIT OUR NEW, EXPANDED RETAIL STORE AT 1256 SOUTH BASCOM IN SAN JOSE

HOURS: M-W-F, 9-5

T-TH., 9-9

SAT., 10-3



**JDR Microdevices**

1224 S. Bascom Avenue, San Jose, CA 95128

800-538-5000 • 800-662-6279 (CA)

(408) 995-5430 • Telex 171-110

FAX (408) 275-8415

PLEASE USE YOUR CUSTOMER NUMBER WHEN ORDERING

TERMS: Minimum order \$10. For shipping and handling include \$2.50 for UPS Ground and \$3.50 for UPS Air. Orders over 1 lb. and foreign orders may require additional shipping charges - please contact our sales department for the amount. CA residents must include 6% sales tax. Bay Area and LA residents include 6.75%. Prices subject to change without notice. We are not responsible for typographical errors. We reserve the right to limit quantities and to substitute manufacturer. All merchandise subject to prior sale.

APPLE IS A TRADEMARK OF APPLE COMPUTER CO.

# U·N·C·L·A·S·S·I·F·I·E·D A·D·S

*BYTE is concerned about software piracy. Unclassified ads proposing exchanges of software must specify that the software was written by the individual or is in the public domain. BYTE reserves the right to reject any unclassified ad that does not meet this criterion.*

**WANTED:** Urgent need for IBM PC hard disk, expansion cards, LQ printer for handicapped project. Contributions to nonprofit organization are tax deductible (IRS 503c) Handicapped & Retarded Assoc. Inc., POB 2904, Texas City, TX 77592. (713) 337-5074.

**WANTED:** Donations of Kaypro, Osborne, Commodore 64-compatible peripherals and software for overseas missionaries and Christian school. Tax-deductible receipts upon request. Will pay shipping. Reverend Ken Marks, 61476 Blakley Rd., Bend, OR 97702. (503) 389-0084.

**FOR SALE:** Heathkit H-10 paper-tape reader and punch with four rolls of unused tape and manuals, excellent condition, practically unused. Philip Nunn, 201 Netherfield, Comstock Park, MI 49321. (616) 784-5237.

**FOR SALE:** TRS-80 computer, 48K, two 40K DD disk drives, aerocomp doubler, LSIS amber nonglare screen, upper- and lowercase, RS-232C, MDX expansion interface, stringy floppy drive, CTR-80 cassette and data-dubber, everything works, in good condition. \$1200 or best offer. Tom Niderost, POB 6, Talmage, CA 95481. (707) 462-8139 between 9 a.m. and 9 p.m. PT.

**WANTED:** Information and computer science major in need of computer and hardware donations for school and personal use. Could pay shipping. Amy L. Justus, Route 2, Clarkesville, GA 30523.

**FOR SALE:** Integral Data Systems 460C, heavy-duty NLO dot-matrix printer with serial and parallel interfaces plus graphics. 150 cps (draft), 75 cps (correspondence). Excellent condition: \$500. Walter Sikonowicz, 2 Petre Dr., Auburn, NY 13021. (315) 252-3960 after 4:30 p.m. and weekends.

**FOR SALE:** Cromemco Z-2D. Three 16K memory boards and Tu-Art card with two serial and two parallel communication ports—RS-232C. Two Wangco 5 1/4-inch disk drives. 21-slot motherboard. Teletype Model 43 printing terminal. Microterm Act IV CRT terminal. Originally cost \$6100, will sell for \$3000. Curtis Turner, 5128 Newburg Rd., Rockford, IL 61108. (815) 397-6679 evenings.

**FOR SALE:** CompuPro 384K CPU with dual floppy and 23-megabyte hard disk includes spare disk drive. \$7500. Bob Weber, 23850 Commerce Park Dr., Beachwood, OH 44122. (216) 831-0480.

**WANTED:** Student will appreciate any used or broken computer hardware. I will be responsible for all postage costs. Johnathan Jones, 1426 St. Mark's Ave., Brooklyn, NY 11233. (212) 773-5983.

**FOR SALE:** Advanced Digital Super-Quad SBC with one parallel and two serial adapters. \$600. Two NEC FD1165 DS/DD 8-inch drives \$375 each. Sierra Data Mainframe S-100-SL/2, 7-slot. \$575. H-29 terminal. \$525. Will sell complete system for \$2200. Mike Schwartz, RD 7232, Reading, PA 19606. (215) 779-4105.

**WANTED:** IBM PC XT with at least one disk drive or compatible. Also, Apple II, II+, or IIe with at least one drive. Monitors, printers, modems, and card also. Darwin D. Airola III, 1740 Lombard Ave., Apt. #1, Oshkosh, WI 54901. (414) 426-5672.

**NEEDED:** If you know of any horror stories that have happened to you or your computer friends in world of personal computers, let me know. I am assembling a comprehensive collection of them, including hardware, software, environmental, and operator error. Howard Hillman, 220 East 63rd St., New York, NY 10021.

**FOR SALE:** First year of BYTE. Best offer. Prefer local buyer. Bob Fenichel, 2200 Columbia Pike #1112, Arlington, VA 22204.

**FOR SALE:** Morrow Designs Micro Decision WD2 (two drives, SS/DD). Also, AMPEX DI175 (amber display) with a Selectric-style keyboard and numeric and editing keypads. \$549. John Birk, 458 East 600 N., Orem, UT 84057. (801) 224-4809.

**FOR SALE:** Two brand new Lambda LGS-5-5-OV-R high-efficiency switching power supplies with 5 volts/45 amps and overvoltage protection and remote sensing. Bought for over \$325 each, but will sell for \$200 each or \$375 for both. Tareq Hoque, 159 North Oller Ave., Waynesboro, PA 17268. (717) 762-8406.

**WANTED:** If you have a modem and would like your number in a pamphlet, send your name, your modem telephone number, type of computer and a description of what you use your modem for. Richard Grossman, 1106 Swissvale Place, Richmond, VA 23229.

**FOR EXCHANGE:** dBASE II end user seeks to trade tips, command files, application ideas, techniques, and more for home and business use. Trade printouts only, you must be a registered dBASE owner. SASE for details. Robert Greenwald, POB 401, Wheatley Heights, NY 11798.

**WANTED:** Any or all issues of Robert Wainwright's *Lifeline* newsletter about Conway's "Game of Life." Let me know what you have and what you want for them. Brad Whitlock, 6905 Holly Dr., Raleigh, NC 27609. (919) 847-6851.

**WANTED:** Laser Disk Sears Catalog. POB 330, Valley Mills, TX 76689.

**FOR SALE:** TRS-80 Model III with 48K RAM, two Tandon disk drives, Micro Mainframe FDC-3C disk controller, Alpha Products joystick, DOSPLUS 3.5 operating system, and all manuals and cables. In perfect working condition. \$1200. Mark Schwabacher, 14 East 90th St., New York, NY 10128. (212) 831-1226.

**FOR SALE:** Terak 8510/a graphics computer, LSI-11, 64K. Two SS/DD 8-inch drives. Run only on Sundays with p-System by a Pascal fanatic. Realistic offers entertained. Mark Erenburg, POB 2102, Springfield, IL 62705. (217) 787-6036.

**FOR SALE:** Three HRAM64. \$350 each. HRAM: S225. 4-port I/O. S275. Z-80PB. S250. ST506 and controller. S1250. MD5 controller. S200. Shugart 800/2. S200. Used less than six months. Manuals available. Multiuser. TSS/C HDOOS. J. M. DeFigh, 26 Brownville Ave., Ipswich, MA 01938. (617) 356-4394.

**FREE:** Several hundred DEC flip-chip modules, mostly from PDP-11 peripherals. If you seek spares, send wants or SASE for list. Gene Clough, Physics Dept., Bates College, Lewiston, ME 04240.

**WANTED:** Copy of *Beneath Apple DOS* and Apple's *DOS Toolkit* manual. Will pay generously for books and shipping. Scott Barnes, Star Route, Parkesburg, PA 19365. (215) 593-6454.

**FOR SALE:** OSI C8P-DF whole or part, three 16K 520 boards, a 540 color board, a 505 CPU, a 495 proto board with two AY3-8910 music generators, OSI books, two joysticks, and a Bigboard ASCII keyboard. Any offer considered. Tom Kisko, Rt. 1, Box 787, Micanopy, FL 32667. (904) 466-3038.

**FOR SALE:** Hewlett-Packard 85A with built-in printer, high-performance tape drive, and monitor. 16K RAM module (32K total). HP-IB (IEEE-488) interface. ROMs advanced programming, I/O, mass storage, plotter/printer; all manuals. Retail value \$3500, asking \$2200. Ron Riedel, 1031 Redwood Dr., Loveland, CO 80537. (303) 667-7886.

**FOR SALE:** BYTE 1977, April, June–September, November, December, 1978: January–July, October–December, 1979: January–May, July–November. \$75 for all 27 copies. George Colman, (617) 879-4031 evenings and weekends.

**WANTED:** Apple system or parts (disk drives, monitors, etc.) to further my programming skills. Anything accepted. Will pay postage. Jeff Klammer, 3714 Prairie Rd., White Bear Lake, MN 55110.

**FOR SALE:** Apple Disk II with 3.3 DOS. \$275. 80-column text card for the IIe. \$45. Shipping prepaid. George W. Ziegler Jr., 16 South Bayard Lane, Mahwah, NJ 07430. (201) 934-0121.

**WANTED:** Used Winchester disk for Victor 9000 Gold. 11514 Burdine, Houston, TX 77035.

**WANTED:** Method for plotter/dot-matrix printer to create symbols in various languages (e.g., Hebrew) for plotting texts. Avraham Gutbir, 374 Merton St., Toronto, Ontario M4S 1B3, Canada. (416) 482-2244.

**FOR SALE:** SwTPC 69/A, 6809, 28K RAM, serial, parallel, DS/DD disk controller, and more. \$600. Epson MX-80 with Grafrax. \$350. Robert Alexander, 1630 Worcester Rd., Apt. 222C, Framingham, MA 01701. (617) 872-6739 evenings.

**WANTED:** BYTE issues 1–4, 12, and 13. Also *Creative Computing* (any volume 1 or 2), *Personal Computing* (any volume 1 or 2), *Interface Age*, *Softline*. Thomas Kariya, POB 157, Brookeville, MD 20833.

**FOR SALE:** Teletype Model 33 KSR printer. Asking \$150, will accept best offer. John Butera, 729 Indiana Ave., Trenton, NJ 08638. (609) 989-0946.

**WANTED:** Computer club seeks used computers or accessories. Will pay postage. Jim Fuller III, 6329 Cricket Lane, Columbus, GA 31909. (404) 563-8596.

**WANTED:** High school senior interested in computer science seeks donation or purchase of a used Apple computer and disk drive or a TRS-80 Model III with one or two disk drives. Brian Neidig, Rt. 2, Box 157cc, Taylor, TX 76774.

**FOR SALE:** MFE 8-inch floppy disk Model 571 and Priam 70-megabyte drive Model 5070, both never used. Also Data General Nova and Eclipse boards, both used. Send for list. Todd Allen, 328 Richard Rd., Naperville, IL 60540.

**FOR SALE:** IBM 8087-3 (Intel) coprocessor chip, with IBM documentation. orig. \$260 asking \$160 firm. Would like to correspond with other IBM PC users in medicine. Philip Chao, 105-17 63 Rd., Forest Hills, NY 11375.

**FOR SALE:** 200+ 4116 dynamic RAMs, SSM SBI music board, Tarbell cassette interface, five each 8KB static RAM boards, Jade Z80 CPU board with serial I/O, two each 19-inch rack-mount paper-tape readers, L. C. Snyder, S78W17675 Canfield Dr., Muskego, WI 53150. (414) 679-9706.

**WANTED:** Used QDP-100 computer. S. Ball, 289 Olmstead St., #2, Vanier, Ontario K1L 7J9, Canada.

**WANTED:** Information, manuals, documentation, or literature on a Datamedia 1520. Willing to buy, rent, or copy any material available. C. I. Black, 3651 Red Lion Rd., E-I, Philadelphia, PA 19114.

**WILL DONATE:** TRS-80 Model I 48K with expansion interface, monitor, lowercase, double-density board, "floppy-disk drive," RS-232C joystick, gold plugs, and more. Also will sell new 64K memory extension option for DEC Rainbow 100, never used. Sells for \$400 asking \$200. Rick LaFlamme, 50 Blood St., Pepperell, MA 01463. (617) 433-9094.

**WANTED:** Sierra Data Sciences SBC-100M. State price and condition. Russ Michaelson, 1727 East 3015 South, Salt Lake City, UT 84106. (801) 467-6785.

**WANTED:** Information on how to create errors 20–24, 27, and 73 on Commodore 1541 disks for purpose of copy-protecting programs. David Alexander, 1667 Midland Dr., East Meadow, NY 11554.

**FOR SALE:** Victor 9000 with 256K bytes RAM and 2.4 megabytes of floppy-disk storage on two drives. Includes Mannesmann Tally MT-160L dot-matrix printer. Complete system with documentation. \$5000. William Heubbaum, 4021 Country Club Blvd., Sioux City, IA 51104. (712) 252-0711.

UNCLASSIFIED POLICY: Readers who have computer equipment to buy, sell, or trade or who are requesting or giving advice may send a notice to BYTE for inclusion in the Unclassified Ads section. To be considered for publication, an advertisement must be noncommercial and nonprofit (individuals or bona fide computer clubs), typed, double-spaced, contain 60 words or less, and include name and address. This is a free service; notices are printed as space permits. Your confirmation of placement is appearance in an issue of BYTE as we engage in no correspondence. Please allow at least four months for your ad to appear. Send your notices to BYTE, Unclassified Ads, POB 372, Hancock, NH 03449.



# B·O·M·B

## BYTE'S ONGOING MONITOR BOX

ARTICLE#	PAGE	ARTICLE	AUTHOR(S)
1	108	The IBM PC AT	BYTE staff
2	112	Ciarcia's Circuit Cellar: An Ultrasonic Ranging System	Ciarcia
3	124	Using a Mouse with Lotus 1-2-3	Doolittle
4	126	Implementing Cryptographic Algorithms on Microcomputers	Cluepfel
5	128	Generating and Testing Pseudorandom Numbers	Whitney
6	130	Data Abstraction	Simons
7	137	Database Types	Krajewski
8	147	Text Databases	Shapiro
9	155	The DayFlo Architecture	Atkins, Mazur
10	167	Low-Cost On-Line Databases	Lesko
11	177	The Pick Operating System, Part I: Information Management	Cook, Brandon
12	203	Adding a Hard Disk	Matney
13	215	Optical Memory: Data Storage by Laser	Rothchild
14	227	A Database Catalog	Bond
15	246	The Fujitsu Micro 16s	Pournelle, A.
16	254	The Panasonic Sr. Partner	Malloy
17	263	Volkswriter Deluxe	Lehrman
18	271	HomeWord and Cut & Paste	Carlson
19	279	CLOUT and SALVO	Bond
20	289	DataEase vs. Condor and dBASE II	Jacobson
21	317	Computing at Chaos Manor: Minor Problems	Pournelle, J.
22	357	BYTE West Coast: FidoNet, Sidekick, Apple, Get Organized!, and Handle	Markoff, Shapiro
23	369	BYTE Japan: Bits and Pieces	Raike
24	381	BYTE U.K.: POP and SNAP	Pountain

### JULY'S RESULTS ARE RINGING

Steve Ciarcia's Circuit Cellar project, "A Musical Telephone Bell," proved to be the most popular feature in the July issue. Next on the poll appears Jerry Pournelle's Computing at Chaos Manor column, "The AT&T Computers" in third place is the review of Borland International's Pascal compiler, netting Tom Wadlow \$100 for "Turbo Pascal." Jerry Pournelle gains another mention for "The West Coast Faire" that placed fourth in the lineup this month. In fifth place, and bringing its author the \$50 bonus, is Rik Jadrnicek's "Symphony: A Full-Orchestra Version of Lotus 1-2-3." (Rik is eligible for this bonus because his article was submitted prior to his appointment as a BYTE Contributing Editor.) Congratulations, authors

### BYTE ADVERTISING SALES STAFF:

**J. Peter Huestis, Advertising Sales Manager, 70 Main Street, Peterborough, NH 03458, tel. (603) 924-9281**

#### NEW ENGLAND

ME, NH, VT, MA, RI  
Paul McPherson Jr. (617) 262-1160  
McGraw-Hill Publications  
575 Boylston Street  
Boston, MA 02116

#### ATLANTIC

NY, NJ, CT  
Dick McGurk (212) 512-3588  
Leah Goldman (212) 512-2096  
McGraw-Hill Publications  
1221 Avenue of the Americas—39th Floor  
New York, NY 10020

#### EAST

PA (EAST), NJ (SOUTH),  
MD, VA, W.VA, DE, D.C.  
Daniel Ferro (215) 496-3833  
McGraw-Hill Publications  
Three Parkway  
Philadelphia, PA 19102

#### SOUTHEAST

NC, SC, GA, FL, AL, TN  
Maggie M. Dorvee (404) 252-0626  
McGraw-Hill Publications  
4170 Ashford-Dunwoody Road—Suite 420  
Atlanta, GA 30319

#### MIDWEST

IL, MO, KS, IA, ND, SD, MN, WI, NB  
Bob Denmead (312) 751-3740  
McGraw-Hill Publications  
Blair Building  
645 North Michigan Ave.  
Chicago, IL 60611

#### GREAT LAKES, OHIO REGION

MI, OH, PA (ALLEGHENY), KY, IN,  
EASTERN CANADA  
Mike Kisseberth (313) 352-9760  
McGraw-Hill Publications  
4000 Town Center—Suite 770  
Southfield, MI 48075

#### SOUTHWEST, ROCKY MOUNTAIN

UT, CO, WY, OK, TX, AR, MS, LA  
Dennis Riley (214) 458-2400  
McGraw-Hill Publications  
Prestonwood Tower—Suite 907  
5151 Beltline  
Dallas, TX 75240

#### SOUTH PACIFIC

SOUTHERN CA, AZ, NM, LAS VEGAS  
Jack Anderson (714) 557-6292  
McGraw-Hill Publications  
3301 Red Hill Ave.  
Building #1—Suite 222  
Costa Mesa, CA 92626

Karen Niles (213) 480-5213, 487-1160  
McGraw-Hill Publications  
3333 Wilshire Boulevard #407  
Los Angeles, CA 90010

#### NORTH PACIFIC

HI, WA, OR, ID, MT, NORTHERN CA,  
NV (except LAS VEGAS), W. CANADA  
David Iern (415) 362-4600  
McGraw-Hill Publications  
425 Battery Street  
San Francisco, CA 94111

#### Bill McAfee (415) 964-0624

McGraw-Hill Publications  
1000 Elwell Court—Suite 225  
Palo Alto, CA 94303

#### WEST COAST SURPLUS

AND RETAIL ACCOUNTS  
Tom Harvey (805) 964-8577  
3463 State Street—Suite 256  
Santa Barbara, CA 93105

#### Post Card Mailings

**National**  
Bradley Browne (603) 924-6166  
BYTE Publications  
70 Main Street  
Peterborough, NH 03458

### International Advertising Sales Representatives:

Mr. Hans Csokor  
Publimedia  
Reisnerstrasse 61  
A-1037 Vienna, Austria

Mrs. Gurit Gepner  
McGraw-Hill Publishing Co.  
PO Box 2156  
Bat Yam, 59121 Israel  
866 561 321 39

Mr. Fritz Krusebecker  
McGraw-Hill Publishing Co.  
Liebigstrasse 19  
D-6000 Frankfurt/Main 1  
West Germany  
72 01 81

Mrs. Maria Sarmiento  
Pedro Teixeira 8, Off. 320  
Iberia Mart 1  
Madrid 4, Spain  
45 52 891

Mr. Andrew Karnig  
Andrew Karnig & Associates  
Finnbodavagen  
S-131 31 Nacka, Sweden  
46-8-44 0005

Mr. Jean Christian Acis  
McGraw-Hill Publishing Co.  
17 rue Georges Bizet  
F 75116 Paris  
France  
720 33 42

Mr. Arthur Scheffer  
McGraw-Hill Publishing Co.  
34 Dover St.  
London W1X 3RA  
England 01 493 1451

Mr. Savio Pesavento  
McGraw-Hill Publishing Co.  
Via Flavio Baracchini 1  
20123 Milan, Italy  
86 90 656

Seavex Ltd.  
05-19/50 Tanglin Shopping Center  
19 Tanglin Rd.  
Singapore 1024  
Republic of Singapore

Seavex Ltd.  
503 Wilson House  
19-27 Wyndham St.  
Central, Hong Kong  
Tel: 5-260149  
Telex: 60904 SEVEX HK

Hiro Morita  
McGraw-Hill Publishing Co.  
Overseas Corp.  
Room 1528  
Kasumigaseki Bldg.  
3-2-5 Kasumigaseki,  
Chiyoda-Ku  
Tokyo 100, Japan  
581 9811

# R·E·A·D·E·R S·E·R·V·I·C·E

Inquiry No.	Page No.	Inquiry No.	Page No.	Inquiry No.	Page No.	Inquiry No.	Page No.	
1	1st PLACE SYSTEMS	78	68	COMPUTER HUT OF N.E.	448	132	EVERETT CHARLES MKTGSER	374
2	800 SOFTWARE	284	69	COMPUTER INNOVATIONS	174	134	EXPOTEK	465
3	A.S.T. RESEARCH	19	70	COMPUTER MAIL ORDER	164, 165	135	EXPOTEK	487
4	A.S.T. RESEARCH	19	72	COMPUTER SALES	463	136	EXPRESS BUSINESS SOFTWARE	445
5	AB COMPUTERS	486	73	COMPUTER SWAP SHOP	462	137	FALCON SAFETY PROD.	416
6	ACL INC	222	71	COMPUTER WAREHOUSE	226	138	FLOPPY DISK SERV. INC.	30
7	ACTON CORP	300	70	COMPUTERBANK	96	139	FORTRON. INC	490
8	ADDMASTER CORP	462	74	COMPUTERS AND MORE	67	140	FORTRON. INC	490
9	ADV. COMP. PROD.	514, 515	76	COMPUTERS WHOLESALE	173	141	GENERAL TECHNOLOGY	397
10	ADV. SYS. CONCEPTS	468	77	COMPUTING!	456	142	GIFFORD COMP. SYS.	419
*	ALF PRODUCTS INC.	178	79	COMPUVIEW PROD. INC.	72, 73	143	GILTRONIX INC.	506
12	ALL ELECTRONICS CORP.	470	80	CONDOR COMP. CORP.	239	144	GOLD HILL COMPUTERS	207
13	ALLOY COMPUTER PRODUCTS	451	81	CONROY-LAPOINTE	86, 87	396	GREAT LAKES COMP.	341
14	ALPHA OMEGA COMPUTER	90	82	CONROY-LAPOINTE	86, 87	*	GRYPHON MICRO PROD.	432
15	ALPHA OMEGA COMPUTER	26	83	CONROY-LAPOINTE	86, 87	146	GTEK INC.	91
16	AMDEK CORP.	144, 145	*	CONTROL DATA	288	*	H&E COMPUTRONICS	301
18	AMPEX CORP.	194, 195	84	CORVUS SYS INC.	295	147	HANDWELL CORP.	488
*	AMPRO COMPUTERS INC.	471	85	COSMOS	136	148	HARMONY VIDEO	436
19	ANADEX	347	86	CROMEMCO	5	405	HARMONY VIDEO	519
20	ANTEX DATA SYS.	83	87	CUESTA SYSTEMS	70	150	HAYES MICROCOMP PROD.	56, 57
*	APPLE COMPUTER INC.	CII, 1	88	CUSTOM COMP. TECH.	497	151	HAYES MICROCOMP PROD.	328, 329
22	APPLE COUNTRY LTD.	481	89	DANA COMP. DISCOUNT	320	*	HAYES MICROCOMP PROD.	435
23	APPLEWARE, INC.	418	90	DATA ACCESS CORP.	443	152	HEATH COMPANY	274
24	APPLIED COMPUTER PROD.	50	92	DATA EXCHANGE	418	395	HEATH COMPANY	354, 355
25	APPLIED COMPUTER PROD.	51	93	DATA EXCHANGE	450	153	HEATH COMPANY	407
26	APPLIED SOFTWARE TECH.	85	94	DATA SPEC	471	154	HELIX SYS. & DEVL. CORP.	25
27	APROPOS TECHNOLOGY	496	95	DATA SPEC	471	155	HELIX SYS. & DEVL. CORP.	25
28	ARCTEC SYSTEMS	370	96	DATA TRANSLATION	465	156	HERCULES COMPUTER TECH.	71
29	ARTIFICIAL INT'L. RESEARCH	519	97	DATASOUTH COMP. CORP.	58	157	HERMES PRECISA INT'L.	359
30	ARTISOFT	498	399	DATQAQ INSTRUMENTS INC.	102	*	HEWLETT-PACKARD	202
*	AT&T INT'L.	244	98	DAYFLO SOFTWARE	454, 455	*	HEWLETT-PACKARD	223
*	AT&T TECHNOLOGY	183, 184, 185	99	DECISION RESOURCES	209	385	HEWLETT-PACKARD	433
31	ATLANTIC ENTERPRISES	394	391	DENNISON COMP. SUPPLIES	368	158	HERIATIC COMPSYS.	519
32	AVOCET	441	101	DIGI DATA CORP.	217	159	HITECH INT'L. INC.	496
33	B&B ELECTRONICS	450	102	DIGITAL PRODUCTS INC.	360	161	HOLIDAY INNS, INC.	422
34	B&B ELECTRONICS	492	*	DIGITAL RESEARCH COMP.	398	162	HOOLEON COMPANY	498
35	BALIS COMPUTING	498	104	DIRECT-CONNECT DEVICES	498	411	HOUSTON INSTRUMENTS	367
36	BAY TECHNICAL ASSOC.	22	*	DISCOUNT COMPUTER CENTERS	218	163	HUMAN DESIGNED SYSTEMS	303
37	BAY TECHNICAL ASSOC.	23	228	DISK DRIVES WEST	494	164	HUMAN EDGE SOFTWARE	170
*	BELLSOUTH ADV&PUBL.	253	105	DISK WORKS	463	165	I.B.C.	17
38	BINARY TECHNOLOGY	506	106	DISKETTE CONNECTION	428	166	I.B.C.	17
39	BORLAND INT'L.	28, 29	107	DISKS 'N THINGS	430	172	I.B.S. CORP.	428
*	BORLAND INT'L.	41	108	DISKWORLD INC.	210	173	I.B.S. CORP.	428
40	BOTTOM LINE, THE	189	109	DISKWORLD INC.	180	168	IBM CORP.	46, 47
41	BUSINESS COMPUTER DIV. INC.	459	110	DISKWORLD INC.	68	169	IBM CORP.	344, 345
42	BYTE CONNECTION, THE	424	111	DISKWORLD INC.	506	170	ICELAND SOFTWARE INC.	374
*	BYTE ADVERTISING MESSAGE	366	112	DISPLAY TELECOMMUNIC. INC.	484	*	INDEPENDENT BUSN. SYS. INC.	319
*	BYTE BACK ISSUES	410	113	DOCUTEL OLIVETTI	325	171	INFOCOM	304, 305
*	BYTE BINDERS & FILES	472	114	DOKAY COMP. PROD. INC.	504, 505	174	INPUT/OUTPUT TECHNOLOGY	55
*	BYTE SUBSCRIBER NOTICE	469	115	DOW JONES	275	175	INTEGRAND	471
43	BYTEK COMP. SYS. CORP.	446	116	DOW JONES SOFTWARE	18	176	INTELLIGENT DATA SYS.	186
*	"C" WARE/DeSMET	287	*	DOW JONES SOFTWARE	309	177	INTERACTIVE STRUCT.	356
*	C-SYSTEMS	418	*	DOW JONES SOFTWARE	310	178	INTERFACE INC.	372
*	CALIF. DIGITAL	499, 500, 501	119	DOW JONES SOFTWARE	311	179	INTERFACE INC.	372
386	CANON	262	120	DWIGHT CO. INC.	496	182	INTERTEC DATA SYS.	15
387	CANON	383	121	DYNAX INC.	191	183	I.A.D.E. COMP. PROD.	507
44	CAPITAL EQUIPMENT CORP.	187	122	DYSAN CORP.	64	184	I.A.D.E. COMP. PROD.	508, 509
46	CDR SYSTEMS	492	*	ECONOMY SOFTWARE	142	185	JAMECO ELECTR.	404, 405
47	CHORUS DATA SYSTEMS	154	123	ECOSOFT	464	186	JANUS DYSC CO.	363
48	CHRYSAL SOFTWARE	506	124	EDGE MICROSYSTEMS INC.	403	187	IC SYSTEMS	79
49	CITIZEN AMERICA	152, 153	125	EDUCATIONAL MICROCOMP.	506	188	IDR MICRODEVICES INC.	520, 521
50	CLINICAL MICROSYSTEMS INC.	496	126	ELCOMP	403	189	IDR MICRODEVICES INC.	522, 523
51	CODE-A-PHONE CORP.	268, 269	127	ELCOMP	492	190	IDR MICRODEVICES INC.	524
52	COGITATE	472	128	ELECTRADE CO.	494	191	KAMERMAN LABS	380
53	COGITATE	496	129	ELECTRADE CO.	498	192	KENSINGTON MICROWARE	97
54	COMMERCIAL BUSINESS SYS.	434	*	ELLIS COMPUTING INC.	406	193	KEY TRONIC CORP.	393
55	COMP. COMPNTS. UNLTD.	516, 517	*	EMPIRICAL RESEARCH GROUP	149	194	KOALA TECHNOLOGIES CORP.	339
*	COMPAQ COMPUTER CORP.	307	*	ENCHANTED FOREST	498	195	LABORATORY MICROSYS.	66
56	COMPETITIVE EDGE	376	*	EPSON AMERICA	61, 62, 63	196	LAWSON LABS	403
59	COMPUMAIL	518	311	EPSON AMERICA	132, 133	197	LIFEBOAT ASSOC.	312, 313
60	COMPUMART	450						
*	COMPUMAX	482						
61	COMPUPRO	199						
409	COMPUPRO	213						
62	COMPUPRO	293						
*	COMPUPRO	453						
63	COMPUSERVE	343						
403	COMPUSERVE	282						
64	COMPUTER CHANNEL	426						
65	COMPUTER CONNECTION INC.	495						
*	COMPUTER CONTINUUM	374						
66	COMPUTER DISCOUNT PROD.	483						
67	COMPUTER EXPO	519						
198	LINDAL CEDAR HOMES	324						
199	LINDE TECHNOLOGY INC.	159						
200	LINTEK INC.	494						
201	LIONHEART PRESS	492						
202	LOGICAL DEVICES	32						
203	LOGICAL DEVICES	506						
204	LOGICAL MICROCOMPUTER	60						
205	LOGITECH INC.	278						
206	LOMAS DATA PRODUCTS	285						
207	LYBEN COMP. SYS.	438						
208	LYCO COMPUTER	491						
209	M-SYSTEMS	459						
210	MACROTECH INT'L.	429						
211	MAGNUM PC	206						
212	MANX SOFTWARE SYS.	16						
213	MANX SOFTWARE SYS.	139						
214	MARYMAC INDUSTRIES	494						
215	MASTERBYTE COMP. OF N.Y.	498						
216	MAXELL DATA PRODUCTS	365						
217	MAYNARD ELECTRONICS	38						
218	MC-P APPLICATIONS	411						
219	MEMORY PLUS DISTRIB.	394						
220	MERRITT COMP. PRODUCTS	463						
221	METHOD SYS. INC.	494						
222	MFI ENTERPRISES INC.	276						
223	MICRO AGE COMP. STORES INC.	69						
224	MICRO DATA BASE SYS.	460, 461						
225	MICRO DESIGN INT'L.	351						
226	MICRO DESIGN INT'L.	401						
227	MICRO MART, INC.	232, 233						
383	MICRO PRODUCTS	493						
*	MICRO RIM	375						
238	MICRO WAY	205						
229	MICROCOMPUTER CO. THE	434						
230	MICROMINT INC.	214						
406	MICROMINT INC.	469						
*	MICROMINT INC.	496						
231	MICROPROCESSORS UNLTD.	449						
232	MICROSHOP	442						
*	MICROSOFT CORP.	169						
*	MICROSOFT CORP.	200, 201						
*	MICROSOFT CORP.	361						
233	MICROSTUF INC.	353						
234	MICROTECH EXPORTS	76						
236	MICROTIME	4						
407	MICROTIME	358						
237	MICROVOICE CORP.	161						
239	MIDWEST MICRO-PERIPHERALS	140						
343	MITCHELL MANAGEMENT SYS.	267						
240	MODULA SYS. CORP.	82						
242	MORROW	166						
401	MOTEL COMPUTIMITED	457						
243	MOUNTAIN VIEW PRESS	390						
244	MTI SYSTEMS CORP.	458						
245	MULTI-TECH SYSTEMS	420						
246	MYLSTAR ELECTRONICS	259						
247	NATIONAL INSTRUMENTS	34						
*	NAVAL UNDERWATER SYS. CTR.	439						
248	NCR	20, 21						
249	NEC HOME ELECTR. USA	CIII						
250	NETWORX INC.	327						
251	NEW GENERATION SYS.	330						
*	NORTH HILLS CORP.	358						
*	NORTH HILLS CORP.	506						
252	NORTHWEST DIGITAL SYS.	444						
*	NRI SCHOOLS ELECTR. DIV.	417						
253	OKIDATA	99						
254	OKIDATA	373						
255	OLDSMOBILE DIVISION	431						
259	OPEN SYSTEMS INC./UCCEL	427						
260	OPTO-22	349						
261	OPTO-22	349						
262	ORCHID TECHNOLOGY	331						
263	ORYX SYSTEMS	378, 379						
264	ORYX SYSTEMS	378, 379						
265	ORYX SYSTEMS	378, 379						





# NO OTHER LETTER-QUALITY PRINTER CAN TOUCH OUR NEW SPINWRITER FOR SPEED AND EASE- OF-USE.

## Introducing the Spinwriter 8850.

Our newest, and fastest, Spinwriter® printer operates at over 550 words-per-minute. And is extraordinarily easy to operate.

For one thing the Spinwriter 8850 takes care of basic settings such as pitch and forms length automatically. Of course you can also change either



printer available for the IBM® PC. It's still one of the few that works with all IBM PC software, as well as all other popular packages. You'll notice even its looks are compatible.

CHANGE FORMS LENGTH AT THE PRESS OF A BUTTON

years without a failure is not unusual. No wonder there are more Spinwriter printers hooked up to IBM PC's than any other letter-quality printer.

### How to get up to speed.

For more information on the Spinwriter 8850 or our two companion



THE 8850 PLUGS RIGHT INTO THE IBM PC

models, just call NEC Information Systems at: 1-800-343-4419; in Massachusetts call (617)264-8635.

Also available at:

Entre, 1-800-HI  
ENTRE: Sears Business System Centers, 1-800-228-2200; and Comput-erland stores, (In California) 1-800-321-1101; (Outside California) 1-800-423-3008.

Find out why more and more IBM PC users are saying, "NEC and me."

## NEC AND ME

NEC Information Systems, Inc.  
1414 Mass. Ave.  
Dept. 1610  
Boxborough, MA 01719



THE 8850 JOINS THE HIGHLY-RELIABLE SPINWRITER LINE

one at the touch of a button. It also has a unique control panel.

With large, legible alphanumeric LED's to indicate the specific operating status.



UNIQUE LED DISPLAY TELLS USER EVERYTHING FROM THE FACT THAT PAPER IS OUT



TO THE FACT THE COVER IS OPEN

And make it simple for even an unfamiliar operator to use.

And, of course, the 8850 has all the features, quality and reliability that

make a Spinwriter a Spinwriter.

### The first choice of IBM PC users.

The Spinwriter printer was the first totally plug compatible letter-quality

Spinwriter printers also give you capabilities you won't find on other printers. Like a selection of 80 different print styles.

And, nine easily installed forms handling options that can accelerate your printed output even more. Spinwriter printers also have an enviable record for reliability. In fact, several

Spinwriter is a registered trademark of NEC Corp. IBM is a registered trademark of International Business Machines Corp.



# New Low Price!

## 2-Disk TRS-80® Model 4

### Now Cut \$700



- The Ideal Desktop Computer for Word Processing, Data Base Management, Spreadsheet Analysis, Accounting and Other Tasks
- Ready to Go to Work With Software Available "Off the Shelf" at Radio Shack
- Optional CP/M Plus Operating System Lets You Choose From Thousands of Programs

**A Smart Investment!** Now you can save time, effort—and money—with your own TRS-80 Model 4. It's the personal desktop computer designed to meet the needs of every professional.

**Improve Your Productivity.** With ready-to-run software, you can prepare sales forecasts, compose correction-free letters and reports, store and retrieve information, streamline your bookkeeping, send electronic mail, and more—all with astounding ease and accuracy.

**Features That You Demand.** You get a 64K memory (expandable to 128K), two disk drives, an 80 x 24

display, a printer port and an RS-232C interface.

**Easy to Expand.** Store up to 20 million characters of data with hard disk drives. Turn complicated columns of numbers into easy-to-understand charts by using our high-resolution graphics option. Add a printer or plotter or even a modem for telephone communications.

**Available Nationwide.** You can get the Model 4 at any Radio Shack Computer Center, participating store or dealer. We've also reduced the price on our other Model 4 computers. The cassette-ready 16K Model 4 (26-1067) has been cut

\$200 to \$799. The 1-Disk Model 4 (26-1068) has been cut \$600 to \$1099. The Model 4P has been cut \$500 to \$1299.

TRS-80 Model 4 Desktop Computer

**129900**

26-1069

Was \$1999 in Cat. RSC-11

As Low As  
\$73 Per Month  
on Citicard Credit

**Radio Shack®**  
**The Technology Store**

A DIVISION OF TANDY CORPORATION

Prices apply at participating Radio Shack stores and dealers. CP/M Plus is a trademark of Digital Research.

Circle 304 on inquiry card